

Friction and wear of sand-contaminated lubricated sliding

Mohamed Ahmed RAMADAN

Faculty of Engineering at Helwan, Helwan University, Helwan 11795, Egypt

Received: 24 December 2016 / Revised: 19 May 2017 / Accepted: 24 September 2017

© The author(s) 2017. This article is published with open access at Springerlink.com

Abstract: This paper reports a test investigation of friction and wear responses from sand contaminated lubricated sliding. The influence of sand contaminants on wear and friction is characterized. Analyses are completed utilizing segments of piston ring sliding against the cylinder liner. Paraffin oil, with and without sand contaminants, is utilized. The effects of the concentration and particle size of sand are examined.

Based on the observations in the present work, we found that friction and wear increase with sand concentration in the lube. Solid proposals ought to be considered, in order to enlighten the general population on the importance of changing a car engine's oil filter regularly.

Keywords: sand contamination; lubrication oil; abrasive wear; lubricated sliding

1 Introduction

Motors in the Middle East experience serious wear as a result of the dusty atmosphere. The dust particles, sourced from outside contaminants such as sand, grits, chips, and abrasive materials, penetrate the lube. These contaminants transmit through the lube and deposit on the insides of the motor parts. The friction from such contaminants damages the moving contact surfaces, creating escalated wear with respect to the motor parts [1–3]. The concentration and particle size of these contaminants essentially impact the episode wear.

A few examiners had investigated the effectiveness of the contaminants and lubricant additives on friction and wear, utilizing reciprocating and rotating movement under high loading [4, 5]. Some have proposed the assessment of harsher wear by the “morphology” of the worn surfaces. The results showed how lubricant defiling causes critical wear toward the mating surfaces, thus causing component breakdown [6, 7].

Different studies have reported the results of abrasives defiled to lubricant versus friction and

wear [8–10]. The results showed that the concentration of contaminants plays a pivotal role in controlling wear and friction along at the contact surfaces. In addition, images from a scanning electron microscope (SEM) showed abrasive wear as the predominant wear. This wear is a result of the hard surfaces of the contaminants sliding over one more of the mating surfaces [11–14]. The characterization of the wear elements and the “soot” that tainted the lube has been performed by different examiners [15, 16].

With an end goal to eliminate the breakdown of motor components, the present work explores the concentration and the particle size of sand defiling oil, utilizing segments of the piston ring sliding against the cylinder liner.

2 Experimental

The test rig consists of an electric motor which provides reciprocating motion for a segment of the cylinder line (300–3,100 strokes/min.). The electric motor was connected to an electric speed regulator to obtain the required test speed. The piston ring specimen was held in place in the groove of a piston segment clamped

* Corresponding author: Mohamed Ahmed RAMADAN, E-mail: eng_mohamedramadan@yahoo.com

by a chuck. The details of the test rig are illustrated in (Figs. 1 and 2). The piston ring specimen slides against the inner surface of the cylinder liner segment when paraffin oil, a lubricant, is used. The test ring specimens were prepared by cutting commercial piston rings into small segments. The piston rings were made of silicon cast iron whereas the cylinder liner was made of alloy cast iron. The friction force was measured using a load cell connected to a digital screen to detect the friction force, as shown in Fig. 2.

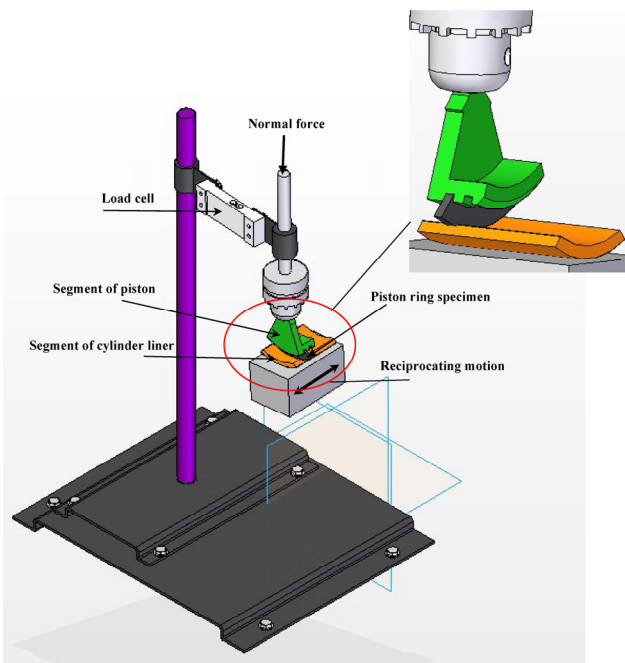

Fig. 1 Schematic illustration of the test rig.

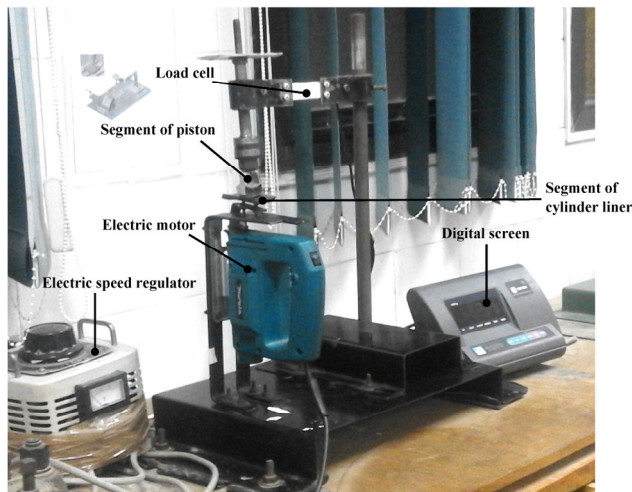

Fig. 2 Configuration of test rig.

The test approach in this work was partitioned into two sections: The test specimens of the primary bit, which was subjected to fresh oil, was considered as a reference, while the specimens of the second partition were subjected to sand-contaminated oil. The sand was provided to the inner surface of the cylinder liner segment. The test process was carried out by dispensing the lubricant onto the sliding surfaces that contained sand. The effect of different concentrations of sand particles (2 g/L, 4 g/L, 6 g/L, 8 g/L, and 10 g/L) has been studied. These concentrations were chosen according to the high levels of dust in the Middle East. The sand particle sizes used were (0–80 μm), (80–200 μm), and (200–500 μm). All experiments were performed at room temperature (27 °C) and carried out at constant normal load (6 N), which applies the same side pressure on the cylinder wall. Further, all experiments were carried out at a constant speed (150 strokes/min), a constant running time (600 s), and a constant stroke (20 mm). The velocity of the piston segment is chosen to resemble the worst friction and wear conditions, at which the mixed lubrication regime prevails. The worst friction and wear conditions were found near the top and the bottom of the cylinder wall of the internal combustion engine where the velocity is small.

3 Results and discussion

Every experiment has been undertaken three times and the mean values were plotted. The effect of sand contamination in lubricant on friction was studied for different sand particle sizes. Figure 3 shows the effect of sand contamination in lubricant on friction for sand particles of size 0–80 μm . It is clearly shown that the friction coefficient increases with sand concentration in the lubricant. This can be attributed to the additional particles that came into contact thus increasing friction. Further, the high friction coefficient could be a result of possible partially metal/metal contact, as illustrated in Fig. 4. At the beginning of the trend where the lubrication oil is free of abrasives, the friction coefficient value was small (0.1). This can be attributed to the oil film that completely separates the surfaces, as illustrated in Fig. 5. At the end of the trend, the friction coefficient decreases slightly, which may be

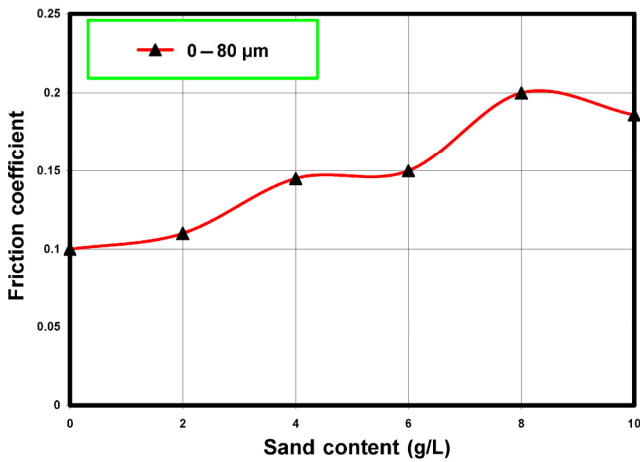

Fig. 3 Effect of sand contamination in lubricant on friction for sand particles of size 0–80 μm.

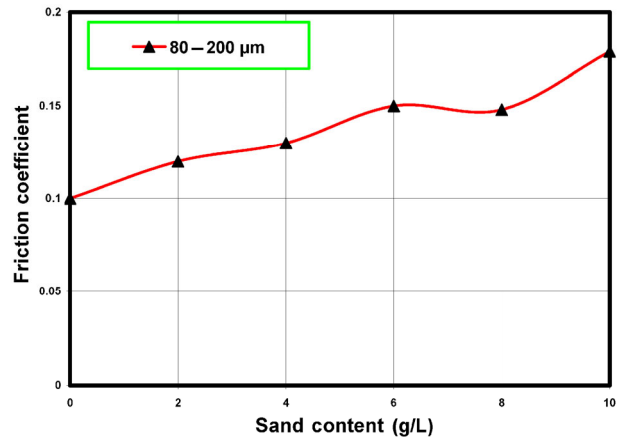

Fig. 6 Effect of sand contamination in lubricant on friction for sand particles of size 80–200 μm.

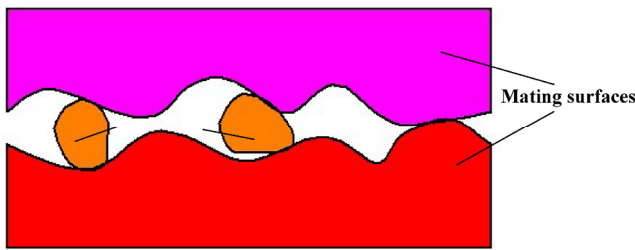

Fig. 4 Illustration of wear mechanism.

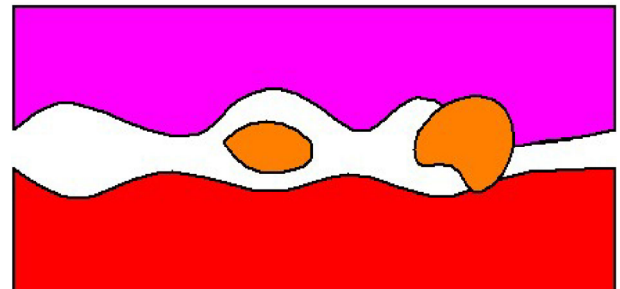

Fig. 7 Illustration of wear mechanism.

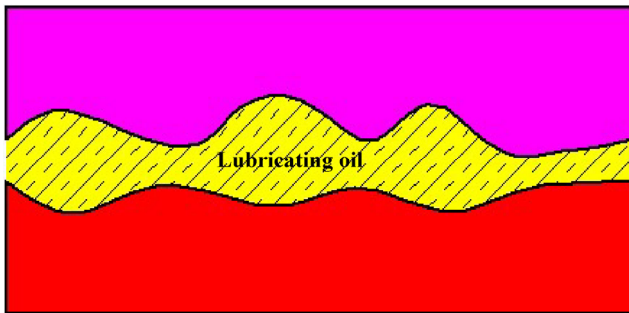

Fig. 5 Illustration of wear mechanism.

due to the rolling action of the sand particles.

The friction coefficient for sand particles of size 80–200 μm in Fig. 6 showed slight increase with increasing sand concentration in the lubricant. This may be due to the increasing number of sand particles that contacted the walls, thus accelerating friction. The friction coefficient values were lower than that observed for sand particles of size 0–80 μm, due to the relatively big particles, which completely separate the surfaces and decrease the metal/metal contact, as illustrated in Fig. 7.

With even bigger sand particle sizes, i.e., 200–500 μm, the friction coefficient fluctuates, but less so with increasing sand content (see Fig. 8). This can be attributed to the irregular distribution of the oil layer due to particles passing through the contact. These variations increase with the increasing particle size of contaminants. Duplicate tests, which were run to establish reproducibility, showed that the trends were valid.

Using a sand concentration of 2 g/L, the effect of particle size on friction coefficient was studied. With the increase of sand particle size from (0–80 μm) to (200–500 μm), the values of friction fluctuations increase, as shown in Fig. 9. This may be due to higher embeddability of particles in one of the rubbing surfaces, and additionally the separation and elimination of worn surfaces. We noticed that the average value of friction coefficient increases with increasing sand particle size.

The contamination of lubricant due to sand particles is inevitable in the Middle East. These particles cause abrasive wear on the sliding surfaces. With regard to

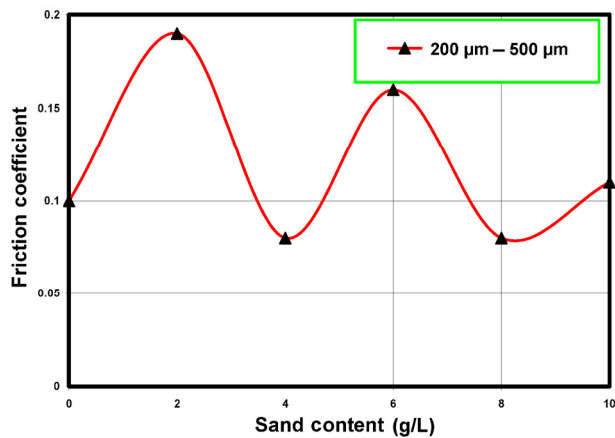

Fig. 8 Effect of sand contamination in lubricant on friction for sand particles of size 200–500 μm .

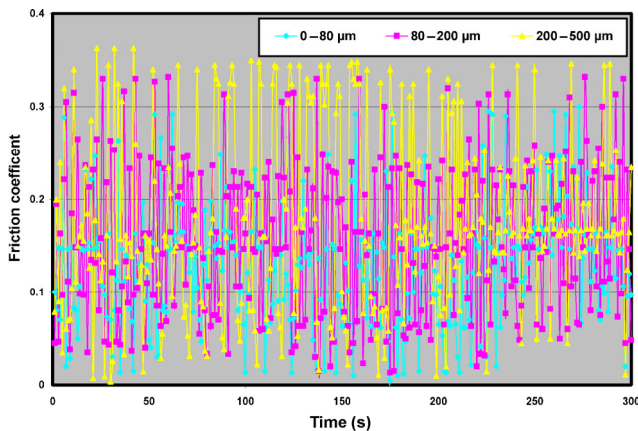

Fig. 9 Effect of sand particle size on friction for a sand concentration of 2 g/L.

the effect of sand concentration in lubrication oil on the wear rate of piston ring specimen, we found that the wear rate of the piston ring specimen increased with increasing sand concentration in lubricant, as shown in Fig. 10. In this case, increasing the sand concentration will cause an increase of material removal from the piston ring specimen due to the embedded abrasive particles, as well as the abrasive action. The embeddability of the rubbing surfaces is the most important factor in controlling abrasive wear. This is clearly observed by photomicrographs of the surface of the piston ring specimen, as shown in Fig. 11, where the damages caused by the sliding surfaces take place in the deep surface grooving due to the penetration of sand particles. Furthermore, it is clearly shown that the deep surface grooving increases with increasing sand concentration.

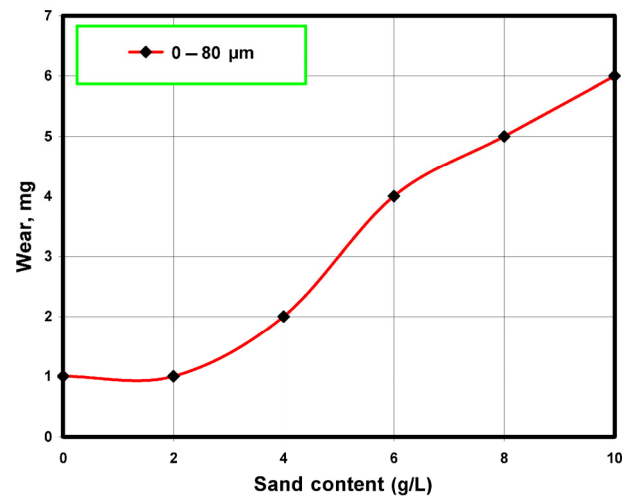

Fig. 10 Effect of sand contamination in lubricant on wear for sand particles of size 0–80 μm .

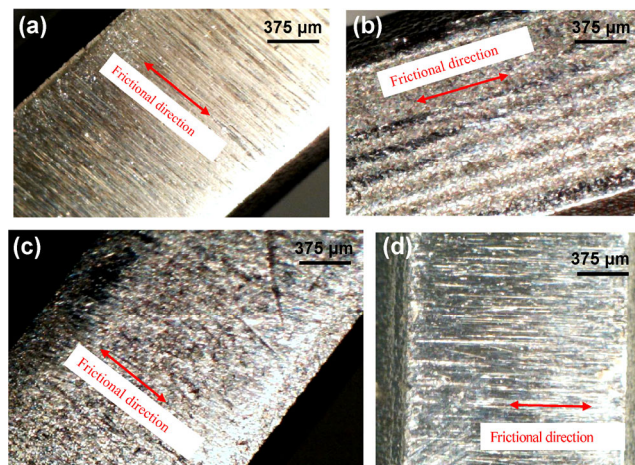

Fig. 11 Photomicrographs of the surface of the piston ring specimen tested using (a) lubrication without abrasives, (b) lubrication with sand particles of size 0–80 μm and a concentration of 10 g/L, (c) lubrication with sand particles of size 0–80 μm and a concentration of 4 g/L, and (d) lubrication with sand particles of size 0–80 μm and a concentration of 8 g/L.

Figure 12 shows the effect of sand concentration in lubrication oil on the wear rate of the piston ring specimen, using sand particles of size 80–200 μm . The trend is the same as that shown in Fig. 10, in which the wear rate of the piston ring specimen increases with increasing sand concentration in lubrication oil. The presence of contaminants in the lubricant forms a monolayer of abrasive particles, which enter between the mating surfaces and cause wear when some of the particles are embedded in one of the rubbing surfaces, which then abrades the other surface.

Moreover, Fig. 13 shows an increase in the wear rate of the piston ring specimen with increasing sand concentration in lubrication oil. Table 1 shows a comparison of wear values of the piston ring specimen at different sand particle sizes and sand concentrations. It shows that wear values increases slightly with increasing abrasive particle size. This behavior might be attributed to the fact that as particle size increases, the depth of penetration of the particles into the sliding surfaces increases and consequently causes an increase in the volume of material removed. Further, it is clearly observed that the wear values increase significantly with increasing sand concentration in lubrication oil. The sand concentration in lubrication oil has a larger effect on wear than the particle size of sand, as shown in Table 1. Photomicrographs of sand

show a relatively sharp shape for the different sizes of sand particles, as shown in Fig. 14.

For better clarity on wear, photomicrographs of the surface of the piston ring specimens were taken. Figure 11(a) characterizes the surface of the piston ring specimen tested using lubrication oil that is free of abrasives. Figure 11(b) shows the worn surface of the piston ring specimen caused by abrasive wear using lubrication oil with sand particles of size 0–80 μm and a concentration of 10 g/L. The worn surface of the piston ring specimen tested using lubrication oil with sand particles of size 0–80 μm and a concentration of 4 g/L is shown in Fig. 11(c). Figure 11(d) shows the worn surface of the piston ring specimen tested using lubrication oil with sand particles of size 0–80 μm and a concentration of 8 g/L. We noticed that the surface wear of the piston ring is accelerated by increasing the sand concentration in lubrication oil. The inner surface of the cylinder liner was also exposed to wear as a result of the abrasive action of the sand. The photomicrograph of the worn surface of the cylinder liner is shown in Fig. 15. The latter illustrates a wear mode in which the breakdown of the boundary lubricant film occurred due to the instability of the

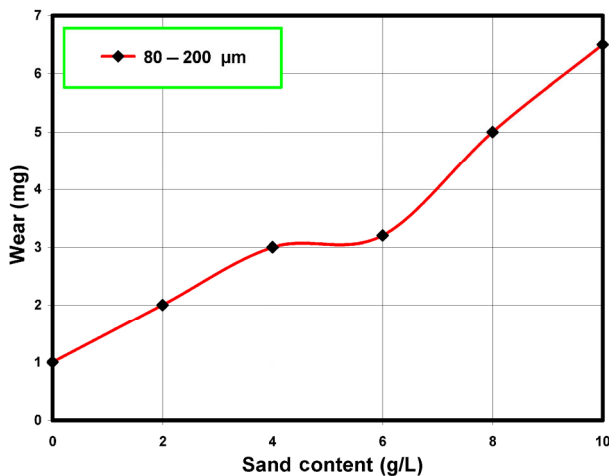

Fig. 12 Effect of sand contamination in lubricant on wear for sand particles of size 80–200 μm .

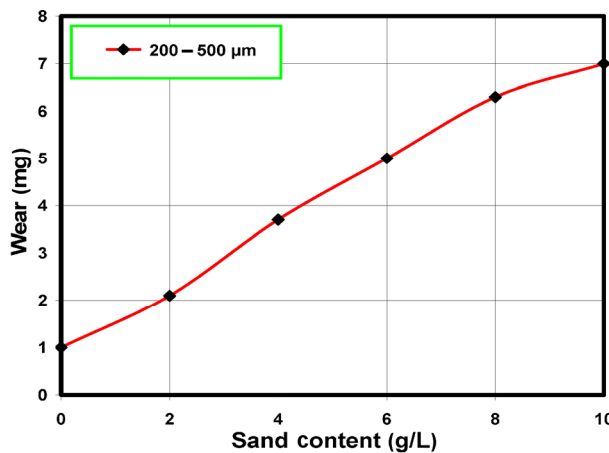

Fig. 13 Effect of sand contamination in lubricant on wear for sand particles of size 200–500 μm .

Table 1 Wear values of the piston ring specimen for different sand particle sizes and sand concentrations.

Sand particle size	Wear values of piston ring specimen (mg)					
	Sand concentration in lubrication oil (g/L)					
	0	2	4	6	8	10
0–80 μm	1	1	2	4	5	6
80–200 μm	1	2	3	3.2	5	6.5
200–500 μm	1	2.1	3.7	5	6.3	7

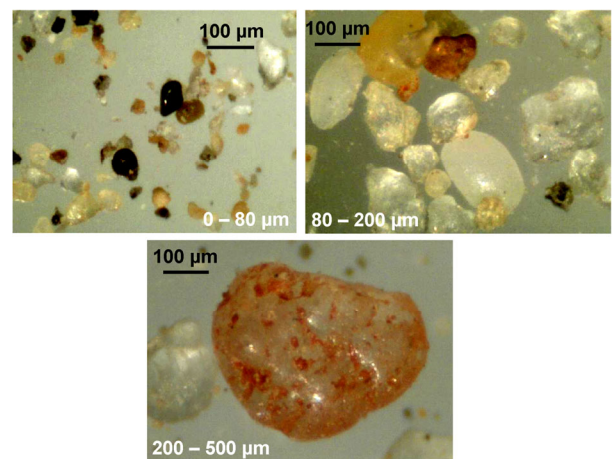

Fig. 14 Photomicrographs of sand dispersed in lubrication oil.

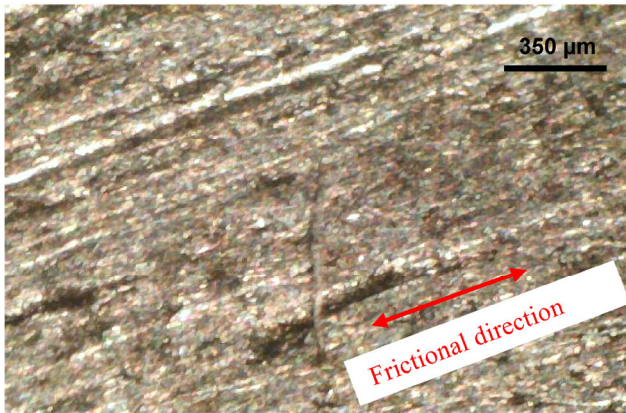

Fig. 15 Photomicrographs of the inner surface of the cylinder liner.

shear mixed layer, which then results in the severe plastic flow on the surface.

4 Conclusions

This paper presents the results of friction and wear from sand-contaminated lubricated sliding. The study of sand-contaminated engine lubricant is important in understanding machine and engine failures caused by severe wear and high friction rates, and is especially critical in the Middle East where issues caused by dust are prevalent.

Our results show that friction and wear increase with increasing sand particles concentration in lubricated sliding contact. This may be due to the increasing number of particles that come into contact with the surface, which then accelerates the friction. In addition, increasing the sand concentration will cause an increase in the material removal, or wear, of the piston ring specimen due to the embedded abrasive particles. The embeddability of the rubbing surfaces is the most important factor in controlling abrasive wear. Further, friction and wear rate increase with the increasing size of sand particles in the lubricated sliding contact.

This study affirms the effect of sand contaminated lubricant on friction and wear. The sand particles increase the friction between the sliding mating surfaces, which lead to “severe” wear, and subsequently machine element failure.

Open Access: The articles published in this journal are distributed under the terms of the Creative Commons Attribution 4.0 International License ([http://](http://creativecommons.org/licenses/by/4.0/)

creativecommons.org/licenses/by/4.0/), which permits unrestricted use, distribution, and reproduction in any medium, provided you give appropriate credit to the original author(s) and the source, provide a link to the Creative Commons license, and indicate if changes were made.

References

- [1] Sari M R, Ville F, Haiahem A, Flamand L. Effect of lubricant contamination on friction and wear in An EHL sliding contact. *Mechanika* **2**(82): 43–49 (2010)
- [2] Aldi N, Morini M, Pinelli M, Spina P R, Suman A. An interdisciplinary approach to study the fouling phenomenon. *Energy Procedia* **82**: 280–285 (2015)
- [3] Ebert F J. Fundamentals of design and technology of rolling element bearings. *Chin J Aeronaut* **23**(1): 123–136 (2010)
- [4] Maru M M, Tanaka D K. Influence of loading, contamination and additive on the wear of a metallic pair under rotating and reciprocating lubricated sliding. *J Braz Soc Mech Sci Eng* **28**(3): 278–285 (2006)
- [5] Maru M M, Tanaka D K. Oil contamination and additive effects on the wear and friction of metallic specimens in reciprocating lubricated sliding tests. In *Proceedings of the 17th International Congress of Mechanical Engineering, São Paulo, Brazil, 2013*.
- [6] Sheikh A M, Khashaba M I, Ali W Y. Reducing the mechanical wear in a dusty environment (Cement Factory). *Int J Eng Technol IJET-IJENS* **11**(6): 138–144 (2011)
- [7] Mousa M O, Ali W Y. Particle size effect on friction and wear caused by abrasive contaminants in lubricating oil. In *Proceedings of the 3rd Int Ain-Shams Univ Conf on Prod Eng & Des for Development, 1990: 27–29*.
- [8] Ali W Y, Mousa M O. Wear and friction of cylindrical contacts by lubricant abrasive contaminants. In *The EGTRIB First Tribology Conference, Cairo, Egypt, 1989: 20–21*.
- [9] Ali W Y, Fodor J, Westcott V C. The effect of abrasive contamination on journal bearing performance. In *The ASME/ASLE Tribology Conference, Westtin William Penn, Pittsburg, 1986: 20–22*.
- [10] Alrawadeh M, Aldajah S. Tribological characterization of the sand particles concentration on sliding lubricated contact. *Int J Adv Technol Eng Sci* **3**(5): 2348–7550 (2015)
- [11] Rabinowicz E. *Friction and Wear of Materials*. New York, NY (USA): Wiley, 1965.
- [12] Bhushan B. *Introduction to Tribology*. New York, NY (USA): Wiley, 2002.
- [13] Rabinowicz E. *Friction and Wear of Materials*. 2nd ed.

New York, NY (USA): Wiley, 1995.

- [14] Khrushchov M M. Principles of abrasive wear. *Wear* **28**(1): 69–88 (1974)
- [15] Yunus S, Rashid A A, Latip S A, Abdullah N R, Ahmad M A, Abdullah A H. Comparative study of used and unused engine oil (Perodua Genuine and Castrol Magnatec Oil) based on property analysis basis. *Procedia Eng* **68**: 326–330 (2013)
- [16] La Rocca A, Bonatesta F, Fay M W, Campanella F. Characterisation of soot in oil from a gasoline direct injection engine using transmission electron microscopy. *Tribol Int* **86**: 77–84 (2015)



Mohamed Ahmed RAMADAN. He received his PhD degree in mechanical engineering from El-Minia University, Egypt, in 2010. His current position is an assistant

professor at Faculty of Engineering at Helwan, Helwan University, Egypt. His research areas cover the tribology and mechanical design, material science, and tribology of biomaterials.