

Efficiency of CO₂ Dissociation in a Radio-Frequency Discharge

Laura F. Spencer · Alec D. Gallimore

Received: 15 June 2010 / Accepted: 29 October 2010 / Published online: 12 November 2010
© Springer Science+Business Media, LLC 2010

Abstract One possible solution to mitigating the effects of high atmospheric concentrations of carbon dioxide (CO₂) is the use of a plasma source to break apart the molecule into carbon monoxide (CO) and oxygen. This work experimentally investigates the efficiency of dissociation of CO₂ in a 1-kW radio-frequency (rf) plasma source operating at 13.56-MHz in a low-pressure discharge. Mass spectrometry diagnostics are used to determine the species present in the discharge, and these measurements are used to calculate the energy efficiency and conversion efficiency of CO₂ dissociation in the rf plasma source. Experimental results have found that the conversion efficiency of CO₂ to CO can reach values near 90%, however energy efficiency reaches a maximum of 3%. A theoretical energy cost analysis is also given as a method to evaluate the effectiveness of any plasma system designed for CO₂ emissions reduction.

Keywords Carbon dioxide · Efficiency · rf plasma

Introduction

Current dependence on fossil fuels to satisfy increasing energy needs has had a nontrivial effect on the overall carbon dioxide (CO₂) content in the atmosphere. Similar to other greenhouse gases, CO₂ molecules absorb infrared radiation emitted from the Earth's surface in asymmetric vibrationally excited modes, inhibiting radiation from leaving the atmosphere. These molecules release the radiation in all directions when they de-excite, thus heating the planet by re-directing outward bound radiation back to the Earth's surface. The 2009 U.S. Greenhouse Gas Inventory Report has stated that CO₂ emissions account for 85% of all greenhouse gas emissions with the majority of these emissions created as the result of fossil fuel combustion [1]. Given that the atmospheric concentrations of CO₂ have risen about 36% since the industrial revolution, the earth's carbon cycle has become unbalanced and unable to compensate for the extra anthropogenic CO₂ emissions, resulting

L. F. Spencer (✉) · A. D. Gallimore
University of Michigan, Ann Arbor, MI, USA
e-mail: laspen@umich.edu

in climate change [1]. Several solutions have been proposed to mitigate the environmental effects of rising CO₂ emissions through both government policy and scientific innovation [2–5]. In particular, plasma-assisted CO₂ dissociation is receiving attention for its ability to use electron impact collisions as an unconventional catalyst for the reduction of CO₂. Reports have shown the successful dissociation of CO₂ to carbon monoxide (CO) and oxygen in various plasma systems such as dielectric barrier discharges [6], microwave discharges [7, 8], and glow discharges [9, 10].

The work presented here discusses the experimental investigation of CO₂ dissociation in a radio frequency (rf) plasma source operating at low pressure with and without the influence of an external magnetic field. The objective of the study is to determine the maximum efficiency of CO₂ dissociation in the described system and to evaluate the use of this technology for emissions reduction. This low-temperature plasma system was chosen because of the capability of obtaining high electron densities to increase electron collisions stimulating dissociation, and because the low gas temperature of the discharge protects CO and oxygen from reverse reactions by lowering the reaction rates, which otherwise would hinder the efficiency of the entire process. The total enthalpy of CO₂ decomposition can be represented by

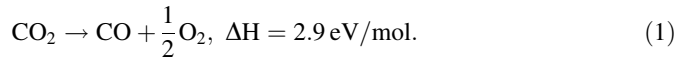

The above reaction is actually a two-step process that begins with breaking down carbon dioxide to carbon monoxide and atomic oxygen, and is completed when atomic oxygen forms molecular oxygen, O₂, through reaction with another neutral CO₂ molecule to form a second CO molecule. From (1) we expect to find CO and O₂ as the main products of dissociation in the rf plasma system.

Experimental Setup

Experiments were performed in the Cathode Test Facility (CTF) at the Plasmadynamics and Electric Propulsion Laboratory (PEPL) located at the University of Michigan. CTF consists of a cylindrical vacuum chamber measuring 0.61 m in diameter and 2.44 m in length used in conjunction with an Edwards XDS 35i dry pump for chamber evacuation reaching a base pressure of less than 3 mtorr. The rf plasma source is mounted on the side of the chamber on a port measuring 15 cm in diameter. Gas is injected into the chamber via a 15-cm-diameter by 50-cm-long quartz tube vacuum sealed to the side of the chamber by a rubber O-ring.

Plasma Source

The plasma source consists of a 13.56-MHz, 1-kW rf power supply connected to a double helix antenna via a pi-style matching network. The matching network reduces the reflected power to about 1% or less during operation. The antenna is wrapped around the quartz gas injection tube and is surrounded by three electromagnetic coils that provide an external peak magnetic field of 415 G along the centerline. The electromagnetic coils are powered by a Lambda DC power supply capable of outputting a maximum current of 60 A. While electron density and electron temperature measurements were not taken during these tests, previous experiments performed in CTF under similar operating conditions have found that

the electron density is about 10^{15} – 10^{17} m⁻³ and electron temperature is typically in the range of 2–4 eV [13].

Residual Gas Analyzer

A Stanford Research Systems RGA100 residual gas analyzer is used in all experiments to identify the species present in the system. The maximum allowable operating pressure of the RGA is 10^{-4} torr, which is much lower than the plasma discharge operating regime of 50–300 mtorr. To accommodate the pressure requirements of the RGA, a differentially pumped subchamber was attached to the top of CTF in which the RGA was housed, reaching a base pressure of 10^{-9} torr. A variable leak valve is used to isolate the subchamber from the main plasma facility, while the subchamber is evacuated by a Varian V70LP turbomolecular pump. Figure 1 shows a diagram of the plasma source and the separate RGA chamber.

In order to extract quantitative information from RGA spectra, a calibration must be performed for each gas species to be identified in the plasma. The RGA was calibrated using the method described by Nguyen [11] in which a known fixed amount of argon flows

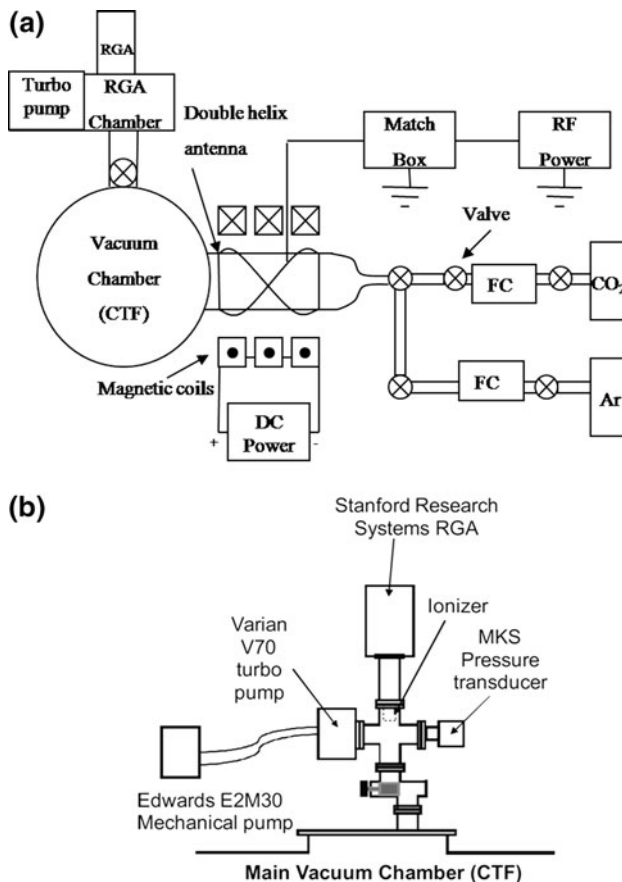

Fig. 1 a Diagram of plasma source, b diagram of differentially pumped RGA chamber

into the plasma chamber with a varying amount of the target gas species (e.g. CO) to be identified. A calibration factor can be determined from the ratios of the partial pressure of Ar and the target gas and from the known flow rates of each gas. Once the calibration factor is found, a flow rate of the species created in the plasma discharge can be calculated from Eq. 2.

$$\dot{m}_i = \frac{\dot{m}_{\text{Ar}}}{\text{CF}} \frac{P_i}{P_{\text{Ar}}} \quad (2)$$

In Eq. 2, \dot{m}_i is the plasma produced flow rate of the species in question, \dot{m}_{Ar} is the constant flow rate of Ar, CF is the calibration factor, P_i is the partial pressure of the target species in question, while P_{Ar} is the partial pressure of Ar. The ratio of partial pressures can be plotted versus the ratio of flow rates for CO₂, CO, and O₂ and a linear relationship should be found. The slope of the line represents CF.

Error Analysis

For all RGA data presented here, results shown are the mean values of a sample of measurements. Error bars represent one standard deviation among the spread in the measurement sample. The sample size for the calibration data is three sets with three spectra for each data point. The sample size for the CO₂ plasma species measurements is two sets of data with three spectra for each data point.

Results and Discussion

To determine the optimal operating conditions for CO₂ dissociation in the rf discharge, three parameters were varied: flow rate of CO₂, rf power, and magnetic field strength. All results are presented for the combined CO₂/Ar plasma in which the flow rate of Ar remained constant at 10 sccm while the flow rate of CO₂ varied from 15 sccm up to 100 sccm. The flow rate of Ar was limited by the flow controller, which reached a maximum of 10 sccm. The flow rate of CO₂ was confined to 100 sccm to maintain a stable discharge. As the total flow rate increased, the pressure also increased inside the chamber and the discharge became harder to sustain at powers under 700 W. The total flow rate range corresponds to an operating pressure range of 80–280 mtorr in CTF. For this set of experiments we were concerned with characterizing the efficiency of CO₂ dissociation with CO₂ as the majority gas in the system. The addition of Ar was solely used as a calibration gas and thus the flow rate of Ar remained constant throughout all tests. By increasing the ratio of Ar/CO₂, it is possible that more rf power would go into ionizing Ar, which is undesirable since we prefer all power to go into CO₂ dissociation to achieve high energy efficiency. RF power was manually set to 0, 250, 500, 750, and 1,000 W in random order, and the applied dc current for the magnetic coils was set to 0, 30, and 60 A for each flow rate.

The RGA identifies gas species present in the plasma by ionizing gas molecules inside the RGA head and separating the species according to the mass/charge ratio. Given that the atomic masses of CO and N₂ are 28.0101 and 28.0134, respectively, the RGA is not capable of distinguishing between singly-ionized CO and singly-ionized N₂. To eliminate this ambiguity, a preliminary background scan was taken before any CO₂ flowed into the chamber. Assuming that there are no significant leaks in the vacuum system (a good

assumption given the low base pressure), the partial pressure of N_2 should not increase with the introduction of CO_2 . By subtracting the background scan from all subsequent scans, any resulting partial pressure measurements at the mass/charge ratio of 28 can be taken to correspond to singly-ionized CO.

Figure 2 displays the results of the flow rate of species created in the plasma as a function of power with no external magnetic field applied. The input flow rates are shown for 15 sccm and 100 sccm of CO_2 with 10 sccm of Ar. The decline of the CO_2 flow rate is evident in all cases as well as the rise in CO and O_2 flow rates, indicating dissociation has occurred. From (1) we expect the flow rate of CO to be twice the amount of the flow rate of O_2 , however at many of the data points the flow rate of CO is closer to three times that of O_2 . This imbalance can be explained by looking at the reaction kinetics of the system. The main reactions for the creation of oxygen start with $CO_2 + M \rightarrow CO + O + M$, which has a reaction rate on the order of $10^{-7} \text{ cm}^3/\text{s}$, and ends with $CO_2 + O \rightarrow CO + O_2$ with a reaction rate of $10^{-12} \text{ cm}^3/\text{s}$. The second reaction is much slower than the first, leaving atomic oxygen to participate in the reverse reaction of $O + CO \rightarrow CO_2$ before it can create O_2 . The process of O_2 dissociation, $O_2 + M \rightarrow O + O + M$, also has a high reaction rate on the order of $10^{-8} \text{ cm}^3/\text{s}$. Therefore, it is more probable that the recombination of atomic oxygen or the dissociation of molecular oxygen occurs before it reaches the RGA head for measurement. It is unlikely that CO further decomposed to carbon and oxygen because we would expect to see a decrease in the flow rate of CO if this were true. There is no decrease present in the cases shown here. Any amount of carbon that is made would presumably recombine with oxygen to form CO_2 or it would stick to the walls of the chamber.

Applied Magnetic Field Effects

Previous studies of this rf plasma source have shown that the application of an axial magnetic field can produce two competing processes that will affect molecular dissociation. First, the magnetic field lines will confine electrons to the annular volume of the quartz tube closest to the antenna preventing electrons from diffusing to the core of the discharge. This can hinder electron impact reactions from taking place with CO_2 molecules. However, increasing electron confinement also increases the probability of electron collisions in the confined area that can lead to more electron attachment and dissociative attachment processes resulting in dissociation [13]. In Fig. 3, the effects of the applied magnetic field on the production of CO from CO_2 are shown for (a) 0 A of current and (b) 60 A of current. There is almost no difference between the two cases, indicating that the applied magnetic field has little effect on CO_2 dissociation. The only noticeable difference occurs at the highest flow rate of 100-sccm- CO_2 at 1,000 W of input rf power in which case the production of CO increases from around 65 sccm for 0 A of current to about 78 sccm for 60 A of current. This may indicate that the plasma changes from a capacitive to inductive mode at higher flow rates when the magnetic field is applied. However, due to the ambiguous nature of the results, the effects of the applied magnetic field cannot be confirmed in this study.

Energy and Conversion Efficiency

In order to determine the effectiveness of this rf discharge for CO_2 dissociation, the energy efficiency and conversion efficiency must be calculated. Energy efficiency, η , is defined in (3) where ΔH is the dissociation enthalpy given as 2.9 eV/mol for CO_2 from (1) and E_{CO} is

Fig. 2 Flow of species created in the plasma with no external applied magnetic field for
a 15 sccm of CO_2 and
b 100 sccm of CO_2

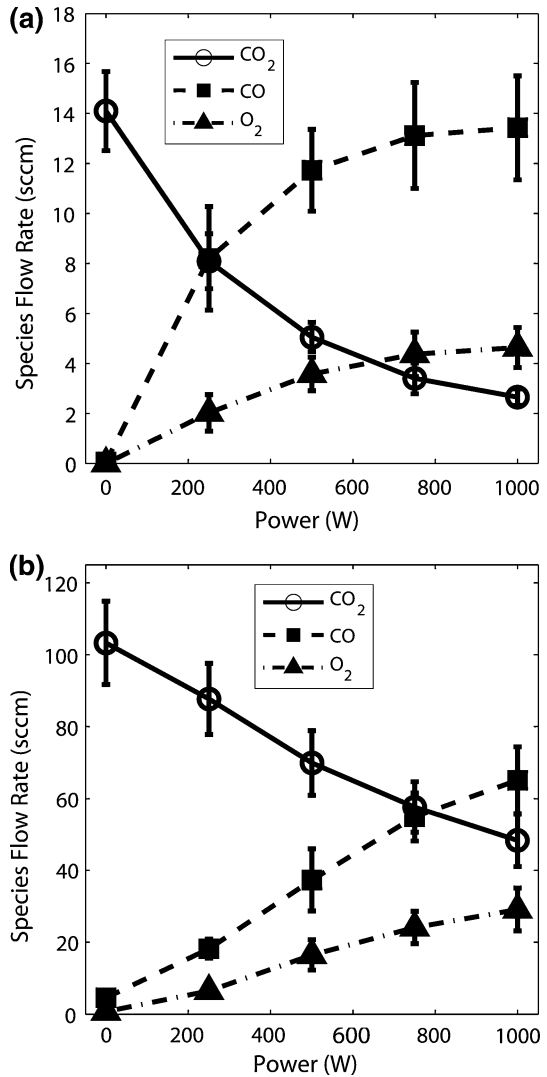

the actual energy cost of one CO molecule in the system. The actual energy cost can be calculated by taking $E_{\text{CO}} = E_v/\alpha$, where E_v is the specific energy input in units of eV/mol and α is the conversion efficiency in units of percentage.

$$\eta = \frac{\Delta H}{E_{\text{CO}}} \quad (3)$$

$$E_v = \frac{\text{power}}{\dot{m}_{\text{CO}_2\text{in}}} \text{ (eV/mol)} \quad (4)$$

$$\alpha = \frac{\dot{m}_{\text{COout}}}{\dot{m}_{\text{CO}_2\text{in}}} \quad (5)$$

Fig. 3 The effect of the applied magnetic field on the production of CO is shown as a function of power for all flow rates ranging from 15-sccm-CO₂ to 100-sccm-CO₂ for **a** 0 A of current and **b** 60 A of current

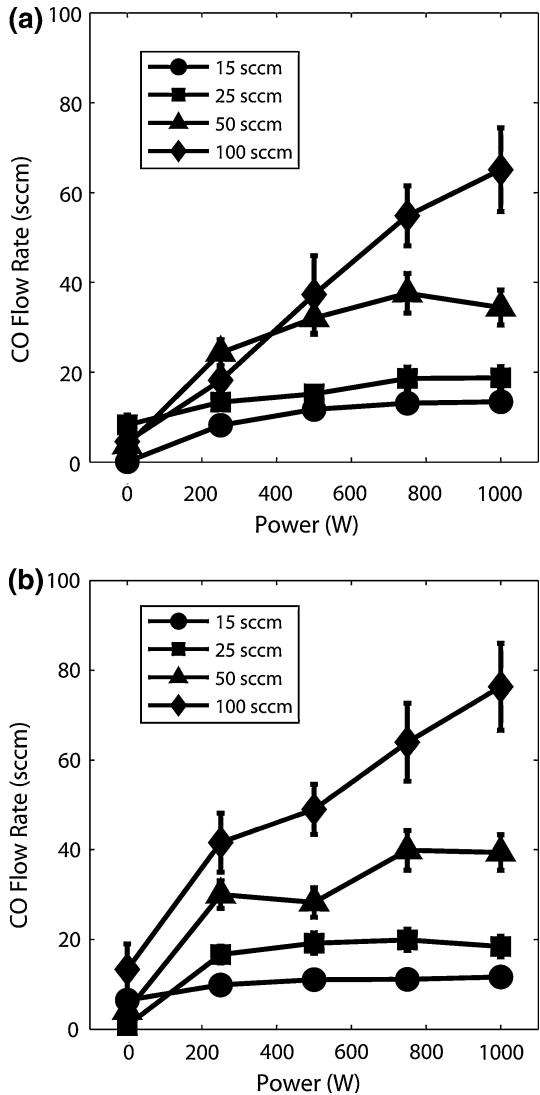

Therefore the energy efficiency can be written as

$$\eta = \alpha \cdot \frac{\Delta H}{E_v} = \dot{m}_{CO_{out}} \cdot \frac{2.9}{power} \tag{6}$$

The results for the calculated efficiencies are shown in Figure 4 plotted as a function of specific energy input. The highest energy efficiency achieved is only 3% for a flow rate of 100 sccm at 250 W of power corresponding to the lowest specific energy of 39 eV/mol. However, this operating condition also achieved one of the lowest conversion efficiencies of only 20%. As flow rates decrease, the energy efficiency also decreases while the conversion efficiency increases with respect to specific energy. The conversion efficiency reaches a maximum of about 90% for 15 sccm at 1,000 W corresponding to a high specific

energy greater than 1,000 eV/mol. Given such a high specific energy, it is no surprise that the energy efficiency is very low, only about 0.2%. The inverse relationship between η and specific energy is evident in Fig. 4a as result of (6) where $\eta \sim 1/E_v$. In order to increase η the specific energy must decrease or the conversion efficiency must increase. However α is not independent of E_v ; Figure 4b shows that α increases as specific energy increases. Therefore if we try to increase η by decreasing E_v , α will consequently decrease as well, negating any effects the decrease in E_v may have on η . To successfully increase η , the plasma system must be able to increase the conversion degree without increasing the specific energy input, which essentially requires using techniques other than increasing the input power to increase α . Until this can be accomplished, any plasma system built for CO₂

Fig. 4 Plots of **a** calculated energy efficiency and **b** calculated conversion efficiency versus specific energy input

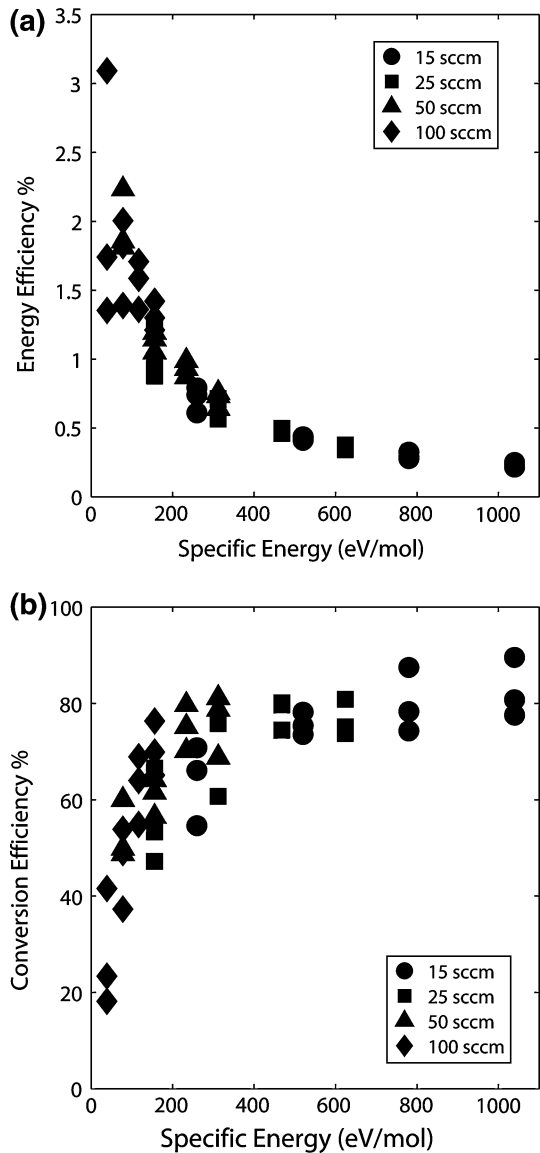

dissociation will always encounter a trade-off between energy efficiency and conversion efficiency.

The low energy efficiency indicates that electronic excitation must be the dominant mechanism of dissociation in this system. Plasma assisted dissociation of molecules occurs through electron impact by vibrational and electronic excitation. Vibrational excitation is the most effective means for CO₂ dissociation because the process requires the least amount of energy. Plasma electrons excite low vibrational levels of the ground electronic state CO₂ (¹Σ⁺), and these low-energy excited species participate in vibrational-vibrational (VV) energy exchange to create highly excited species with enough energy for dissociation to occur. The non-adiabatic dissociation of vibrationally excited CO₂ resulting from the transition ¹Σ⁺ → ³B₂ shown in (7) requires only 5.5 eV/mol, which is the exact energy of the OC = O bond [12]. This is a non-direct multi-step process that takes place through VV quantum exchange.

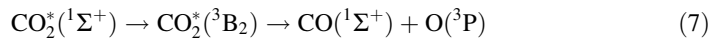

From here, the electronically ground state oxygen atom that is created can participate in a secondary reaction with another vibrationally excited CO₂ molecule to create another CO molecule.

In contrast, dissociation by electronic excitation is a one-step process that results from just one collision shown in (8).

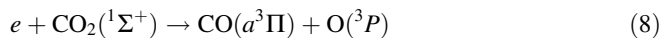

This dissociation mechanism is typically dominant in low-pressure discharges with high values of reduced electric field, which describes the operating conditions used in this experiment. Energy efficiency is limited in plasmas with dissociation via electronic excitation because the electron energy must exceed 8 eV for dissociation to occur via reaction (8), which is significantly higher than the OC = O bond energy [12]. Also, the high electron energies required give rise to the excitation of various other states that do not contribute to dissociation, resulting in low energy efficiency.

Energy Efficiency Requirements

To determine if CO₂ reduction in a low-pressure rf plasma discharge is valid for large-scale applications aimed at reducing atmospheric CO₂ emissions, it is necessary to understand the energy efficiency requirements for such a system to be profitable from an energy standpoint. Therefore energy required to dissociate CO₂ will be compared with how much energy is released from burning natural gas and coal, and we will discuss how much CO₂ is emitted from burning these fossil fuels. Normally all of the energy released during the combustion of coal and methane would be used to power a specific process. Here we will propose using a portion of that released energy to dissociate the molecules of CO₂ produced during the process, creating a system in which fossil fuels can still be used to produce energy while simultaneously dissociating the CO₂ molecules that are a result of producing this energy.

From (1) we know that a plasma system used for CO₂ dissociation will require a cost of at least 2.9 eV for every CO₂ reduced to CO. Equation 9 describes the combustion of methane (CH₄), which releases 891 kJ/mol of energy, equivalent to 9.25 eV/mol, and creates one molecule of CO₂ for every molecule of CH₄ burned. However, we must

consider the conversion efficiency of the natural gas power plant, which can reach as high as 60%, leaving us with only 5.55 eV/mol of energy to be consumed.

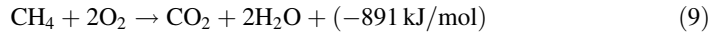

If the plasma system is 100% energy efficient, only 2.9 eV is required to dissociate the one molecule of CO_2 created by the combustion of one methane molecule. We propose that the remaining 5.55 eV released from methane combustion will be used to ‘pay’ for the dissociation of CO_2 . By subtracting the 2.9 eV needed to reduce CO_2 to CO from the total energy output of methane combustion, the resulting net energy gain is 2.65 eV. This 2.65 eV of energy can be considered ‘clean’ energy and free of any carbon footprint because the CO_2 molecule that is normally emitted into the atmosphere has been dissociated with the energy from combustion. However, realistically the system will not be 100% efficient. With this information, a minimum level of energy efficiency can be defined such that the system will “break even” (i.e. 5.55 eV is released from combustion and 5.55 eV is used to produce one molecule of CO from CO_2). Using (3) as the definition of energy efficiency with $E_{\text{CO}} = 5.55 \text{ eV/mol}$ (recall that E_{CO} is the actual energy cost of one CO molecule in the system), we find that $\eta_{\text{min}} = 52\%$. If we can lower the energy cost of producing one CO molecule, thereby increasing the energy efficiency greater than η_{min} , this will result in an overall net energy gain for the system. For example in the work presented by Rusanov et al. [14], a 2.4 GHz microwave plasma system operating at moderate pressure of 50–200 torr with up to 1.7 kW of microwave power was able to achieve an energy efficiency of 80%. This will result in a net energy gain of 1.9 eV.

A similar analysis can be performed for the combustion of charcoal. Equation 10 describes charcoal combustion, which releases 393 kJ/mol of energy, equivalent to 4 eV/mol, and creates one molecule of CO_2 for each molecule of carbon burned. However, the conversion efficiency of coal power plants is only around 35%, leaving just 1.4 eV/mol.

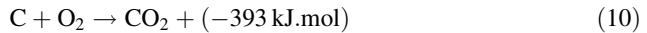

If the plasma system is 100% energy efficient, then 2.9 eV/mol is needed to dissociate CO_2 , which is already more than the remaining energy gained from coal combustion. Therefore, there will be a net energy loss if this method is applied for reducing emissions from coal combustion.

This analysis has not included the energy conversion efficiency of the chosen plasma system, which could introduce an additional 50% loss into the calculations, making this technology undesirable for the reduction of CO_2 emissions from any fossil fuel source. A better option may be to use renewable energy sources such as wind or solar power, which do not release any carbon into the atmosphere.

Conclusion

A low-pressure rf plasma source has experimentally shown the capability of dissociating CO_2 to CO and O_2 . While the discharge can generate high conversion efficiencies near 90%, the energy efficiency is less than 3% for almost all operating conditions. Therefore this plasma system is not a good candidate for CO_2 emission reductions for either coal or natural gas combustion processes. However, a plasma system that is capable of achieving $\eta > 52\%$ (e.g., microwave discharge) has the possibility to be apply this technology to natural gas combustion while still achieving a net energy output. Experimental results have

shown that microwave discharges can achieve energy efficiency as high as 90% under certain operating conditions [12]. This high performance stems from the unique ability of microwave discharges to excite the vibrational modes of the CO₂ molecule, which is the most effective path to dissociation. The optimum operating conditions to excite vibrational modes of CO₂ include having a specific energy input of ~ 1 eV/molecule, an electron temperature of ~ 1 eV, and an ionization degree (n_e/n_o) $\geq 10^{-6}$ [14]. The rf plasma source studied in this work did not meet this criteria, which explains the low energy efficiency. However microwave sources operating at moderate pressures have shown that they can meet these conditions and thus may be a good candidate for CO₂ dissociation.

References

1. Inventory of U.S. Greenhouse Gas Emissions and Sinks: 1990–2007, U.S. EPA, April 2009
2. Dinan T (2007) Trade-offs in allocating allowances for CO₂ emissions. Economic and Budget Issue Brief, Congressional Budget Office, April 27
3. Rubin ES, Rao AB (2002) A technical, economic and environmental assessment of amine-based CO₂ capture technology for power plant greenhouse gas control. U.S. Department of Energy, DOE/DE-FC26-00NT40935
4. Herzog H, Golomb D (2004) Carbon capture and storage from fossil fuel use. *Encycl Energy* 1–6: 277–287
5. Varghese OK, Paulose M, LaTempa TJ, Grime CA (2009) High-rate solar photocatalytic conversion of CO₂ and water vapor to hydrocarbon fuels. *Nano Lett* 9(2):731–737
6. Zheng G, Jiang J, Wu Y, Zhang R, Hou H (2003) The mutual conversion of CO₂ and CO in dielectric barrier discharge (DBD). *Plasma Chem Plasma Process* 23(1):59–68
7. Oberreuther T, Wolff C, Behr A (2003) Volumetric plasma chemistry with carbon dioxide in an atmospheric pressure plasma using a technical scale reactor. *IEEE Trans Plasma Sci* 31(1):74–78
8. Tsuji M, Tanoue T, Nakano K, Nishimura Y (2001) Decomposition of CO₂ into CO and O in a microwave-excited discharge flow of CO₂/He or CO₂/Ar mixtures. *Chem Lett* 1:22–23
9. Wu D, Outlaw RA, Ash RL (1996) Extraction of oxygen from CO₂ using glow-discharge and permeation techniques. *J Vac Sci Technol A* 14(2):408–414
10. Wang J-Y, Xia G-G, Huang A, Suib SL, Hayashi Y, Matsumoto H (1999) CO₂ decomposition using glow discharge plasmas. *J Catal* 185:152–159
11. Nguyen SVT, Foster JE, Gallimore AD (2009) Operating a radio-frequency plasma source on water vapor. *Rev Sci Instrum* 80
12. Fridman A (2008) *Plasma chemistry*. Cambridge University Press, New York ch. 5
13. Nguyen SVT (2009) Hydrogen production in a radio-frequency plasma source operating on water vapor. Ph.D. thesis, University of Michigan
14. Rusanov VD, Fridman AA, Sholin GV (1981) The physics of a chemically active plasma with non-equilibrium vibrational excitation of molecules. *Sov Phys Usp* 24:447–474