



A Novel CNN-TLSTM Approach for Dengue Disease Identification and Prevention using IoT-Fog Cloud Architecture

S. N. Manoharan¹ · K. M. V. Madan Kumar² · N. Vadivelan²

Accepted: 8 July 2022 / Published online: 25 August 2022

© The Author(s), under exclusive licence to Springer Science+Business Media, LLC, part of Springer Nature 2022

Abstract

One of the mosquito-borne pandemic viral infections is Dengue which is mostly transmitted to humans by the *Aedes aegypti* or female *Aedes albopictis* mosquitoes. The dengue disease expansion is mainly due to the different factors such as climate change, socioeconomic factors, viral evolution, globalization, etc. The unavailability of certain antiviral therapy and specific vaccine increases the risk of the dengue disease spreading even further. This arises the need for a novel technique that overcomes the complexities associated with dengue disease prediction such as low reporting level, misclassification, and incompatible disease monitoring framework. This paper mainly overcomes the above-mentioned problems by integrating the Internet of Things (IoT), fog-cloud, and deep learning techniques for efficient dengue monitoring. A compatible disease monitoring framework is formed via the IoT devices and the reports are effectively created and transferred to the healthcare facilities via the fog-cloud model. The misdiagnosis error is overcome in this paper using the novel Hybrid Convolutional Neural Network (CNN) with *Tanh* Long and Short Term Memory (TLSTM) based Adaptive Teaching Learning Based Optimization (ATLBO) algorithm. The ATLBO optimized CNN-TLSTM architecture mainly analyzes the dengue-related parameters such as Soft Bleeding, Muscle Pain, Joint Pain, Skin rash, Fever, Water Site, Carbon Dioxide, Water Site Humidity, Water Site Temperature, etc. for an efficient clinical decision making and timely disease diagnosis. The experimental results are conducted using a real-time dataset and its performance is validated using various performance metrics. When compared in terms of different statistical parameters such as accuracy, f-measure, mean square error, and reliability, the proposed method offers superior results in the case of dengue disease detection than other existing methods. The ATLBO optimized hybrid CNN-TLSTM shows an accuracy of 96.9%, a precision of 95.7%, recall of 96.8%, and F-measure of 96.2% which is relatively high when compared to the existing techniques. The proposed model is capable of identifying the patients in a certain geographical region and preventing the disease emergency

✉ S. N. Manoharan
kritimanoharan@gmail.com

¹ Department of Computer Science & Engineering, Vel Tech Rangarajan Dr. Sagunthala R&D Institute of Science and Technology, Chennai, Tamil Nadu, India

² Computer Science and Engineering, Teegala Krishna Reddy Engineering College, Hyderabad, India

via immediate disease diagnosis and alerting the healthcare officials to offer the stipulated services.

Keywords Healthcare monitoring · Internet of things · Dengue disease prediction · Deep learning · And adaptive teaching learning optimization algorithm

1 Introduction

Nowadays, there is a progressive growth in healthcare applications based on the Internet of Medical Things (IoMT) and several IoT healthcare sensors are integrated to support various healthcare applications [1]. The future reachability and connectivity enhance the IoT thereby generating massive data. The large volumes of data streams during processing are emitted by billions of interconnected IoT devices [2]. The processing services and on-demand scalable storage are offered with cloud computing [3–5]. In the healthcare industry, accurate data collection is one of the multiple problems which prevent healthcare providers from offering healthcare services in a real-time context [6].

Recently, the major public health concern is dengue because of its severity in which it harms the central nervous system and the spinal cord. Superior health monitoring systems [2] are critical for the population, regardless of geographic location. Dengue is a viral disease spread by the mosquitos which are infected by the dengue virus and the mosquitos mainly emerge in the tropical and sub-tropical climates worldwide [7]. The disease can attack a man a total of four times based on the four dengue virus serotypes. In most, Asian and Latin American countries, the people affected by dengue severely are prone to death. These people need to be monitored by medical professionals continuously since there exists no specific treatment for dengue. If the dengue-affected people are identified in the early stage, then they can be provided with proper medical access and the fatality rate will be decreased by 1% [8]. A total of 100–400 million dengue infections are identified each year and the disease can be controlled only when there are appropriate precaution measures in place.

Compared to the previous healthcare systems, the major threat and challenging task are to identify the dengue-affected areas and this can be done by deploying the smart sensors developed with the advancements of IoT technology. In real-time applications, the powerful health monitoring system is made with the growth of technology and the advent of pervasive computing. Dengue disease transmission is more prevalent in recent times as per the World Health Organization (WHO) [44]. The main drawbacks associated with dengue disease prediction are the low level of reporting, the complexity associated with disease monitoring, and misclassification errors. The patient health status can be determined via regular monitoring which can be easily achieved via hybridizing different architectures such as IoT, cloud-fog computing, etc. The integrated architectures also offer reliable reporting regarding the patient status and the artificial intelligence technique can be incorporated to yield effective disease diagnosis.

The scarcity of the reverse transcription-polymerase chain reaction (RT-PCR) kits also raises the need for an efficient clinical dengue disease diagnosis procedure. The emergence of different machine learning and deep learning techniques in dengue prediction has helped physicians make quick and meaningful decisions. The different neural network architectures such as handcrafted feature-based neural networks, a cascaded ensemble of Convolutional Neural networks (CNN) [36], Support Vector Machine (SVM) [37], and pre-trained CNN architectures have been used for developing a medical decision support system. These models

are capable of predicting different diseases in various organs. These models offer rapid and accurate decisions and can also be applied to other disease predictions.

Because of accurate data analysis, perception of efficiency, large storage capacity, and extreme processing power, the Ternary IoT-Fog-Cloud (TIFC) model gained wide acceptance. The healthcare application is implemented in the TIFC model to monitor the remote site, and improve life quality and emergency decision-making [9, 10]. Several healthcare agencies adopt the TIFC technology to accomplish the targets like minimal delay, output delivery, and smart healthcare monitoring. The current TIFC framework is presented by monitoring new developments in fog-cloud knowledge. In the early stages, the smartphone creates the alert message to the end-user and our proposed TIFC detects the diseases at the initial stage. The major contributions of this study are described as follows:

- The fog-based model is designed to offer a remote diagnosis of dengue fever concerning the ambient environmental conditions and patient health symptoms.
- A hybrid CNN-TLSTM with ATLBO algorithm is developed for dengue fever detection and classification which analyzes the disease based on the features extracted from the IoMT sensors. The main aim of this technique is to simplify the dengue disease diagnosis process.
- The proposed model also aims to monitor the symptoms of dengue-affected patients in remote regions and prevent the disease outbreak by alerting the nearby healthcare centers and people in the locality.
- The IoMT sensors are initially placed in the regions of infected individuals which offer real-time healthcare provisioning and immediately diagnoses and generate the alert message to the patients.
- The performance of this model is evaluated in a real-time dataset using different performance metrics such as training time, absolute error, mean absolute percentage error, etc.

The rest of the article is arranged as: Sect. 2 presents the related works concerning the particular domain. The hybrid Convolutional Neural Network-based Tanh Long Short Term Memory (CNN-TLSTM) with Adaptive Teaching Learning Based Optimization (ATLBO) algorithm is formulated in Sect. 3 followed by the proposed work in Sect. 4. The experimental results are discussed in Sect. 5 and the article is concluded in Sect. 6.

2 Related Works

Verma et al. [11] proposed an IoT-aware student-centric stress monitoring (I-SCSM) model to predict the student stress index. At the fog layer, the physiological readings collected from medical sensors with the stress event are classified as normal or abnormal through Bayesian Belief Network (BBN). Based on different stress-oriented parameters at the cloud layer, the time-enriched dataset sequence analyzes abnormal temporal structural data. Further, they formed a multi-level Temporal Dynamic Bayesian Network to calculate the stress index of students. The accuracy and utility of BBN are superior to conducting investigations on both cloud and fog layers. But, it takes larger storage space and unsecured communication.

For a large-scale IoT-based healthcare application, He et al. [12] offered proactive personalized services via fog-cloud computing. In data stream processing, an advantage of complex event processing (CEP) was leveraged. For personalized service to reduce resource waste and accelerate response time, they proposed a hierarchical fog-cloud computing CEP structure. Depending upon this structure, the prototype system called FogCepCare was implemented

and it demonstrated higher performance results than other conventional techniques. This model is a large-scale- IoT-based healthcare application with a complex structure.

For healthcare, Gupta et al. [13] suggested the energy-efficient fog-cloud-based structure (EEFCS). Usually, the energy consumption increased because of the huge workload on cloud data centers. This architecture does not include any security protocols due to reduce the system complexity. For hospitals and medical enterprises, the partitioning and scheduling of deep neural network (DNN) based applications via IoT-assisted mobile fog cloud were suggested by Lakhan et al. [14]. This design has better energy consumption and accuracy results. Nevertheless, they only considered the complex mobility features with a dynamic environment and there was a higher delay as well as service cost.

IoT-fog-based cloud architecture for smart systems was introduced by Kallel et al. [15] for COVID-19 monitoring. The IoT-aware business process modeling was enabled via the extension of the business process model and notation (BPMN). Further, the experimental analysis showed the enhanced performances in case of entire system reliability, computational time, and guaranteed data integrity. But, the overall performance is degraded due to the system production time improvements, reliability, and security. Based on Fog-cloud environments, a one-Dimensional CNN (1D-CNN) approach was established by Cheikhrouhou et al. [16] for ECG arrhythmia analysis. Over the Fog infrastructure, deploy the inference module of the 1D-CNN. While applying the Grid Search algorithm, the MIT-BIH Arrhythmia database with the proposed model demonstrated better performances of F1-measure and accurate results with minimum response time but it met a few limitations such as no latency-sensitive health application, additional delay, and no security model.

Lakhan et al. [38] presented a Deep Neural Networks Energy Cost-Efficient Partitioning and Task Scheduling (DNNECTS) algorithm for cloud-based healthcare partitioning applications. They are mainly focusing on the overhead associated with heavyweight profiling and offloading. The expensive healthcare services are other issues mainly faced by hospitals, and to overcome this issue, different authors used blockchain-based techniques [39, 42], fog networks [40], bio-inspired robotics [43], etc. A critical healthcare management module [41] was developed by integrating different models such as fog and edge computing to improve the healthcare application performance. The ECG signal monitoring, blood pressure control, and heartbeat of the patients in remote locations are analyzed by cloud computing. The edge to the cloud is completely monitored here using the multi-agent system. The main advantage offered by this module is the network usage minimization of 79% and network delay minimization of 65%.

Even though there is different research conducted for dengue disease prediction, the accuracy rate still needs to be enhanced creating room for improvement. This is mainly because when dengue is not predicted in time, it may impact the bone marrow which is the main platelet producing center of the body. Hence this paper presents a novel dengue prediction model to offer real-time disease prediction services to the patients in the remote areas.

3 Formulation of Hybrid CNN-TLSTM with ATLBO Algorithm

In this section, we formulate the Hybrid Convolutional Neural Network-based Tanh/Long Short Term Memory (CNN-TLSTM) with Adaptive Teaching Learning Optimization (ATLBO) algorithm, which is explained as follows:

3.1 CNN-TLSTM Model

This section constructs the Convolutional Neural Network-based Tanh Long Short Term Memory (CNN-TLSTM) model. Figure 1 describes the CNN-TLSTM architecture. The input and output layers with TLSTM layer and CNN layers are present in this model [17]. The relevant data input for classification is the features from the convolution layer which is reduced by the pooling layer. Next to feature extraction, a time series prediction on the input data is performed by the TLSTM layer thereby computing the final output at the output layer.

3.1.1 Convolutional Neural Network (CNN)

The classification and prediction tasks are accurately performed using the CNN model. Further, CNN tackles the issues in feature extraction based on artificial neural networks. The predicted value accuracy is affected based on the feature extracted by the CNN and the core of CNN is the convolutional layer [18]. After the convolutional layer, perform the convolution via the pooling layer. The overfitting, as well as network parameters, are reduced. In the overall CNN, the fully connected layer is considered as the classifier.

3.1.2 Tanh Long Short Term Memory (TLSTM)

The LSTM model structure is improved using the new model called Tanh Long Short Term Memory (TLSTM). From overfitting, the input gate in the LSTM output value is prevented by designing TLSTM. Next to the LSTM input gate, the $1-tanh$ function is introduced and it retains the significant features of the input data. The sigmoid function activates the LSTM input gate and discards the output values close to zero. The output value close to one is transferred and preserved. The correlation among the time series data is captured by transforming data into several distinct intervals. Figure 2 delineates the architecture of TLSTM.

The following equation explains the formulas of TLSTM.

$$I_t = \sigma(w_i \cdot [H_{t-1}, y_t] + a_i) \tag{1}$$

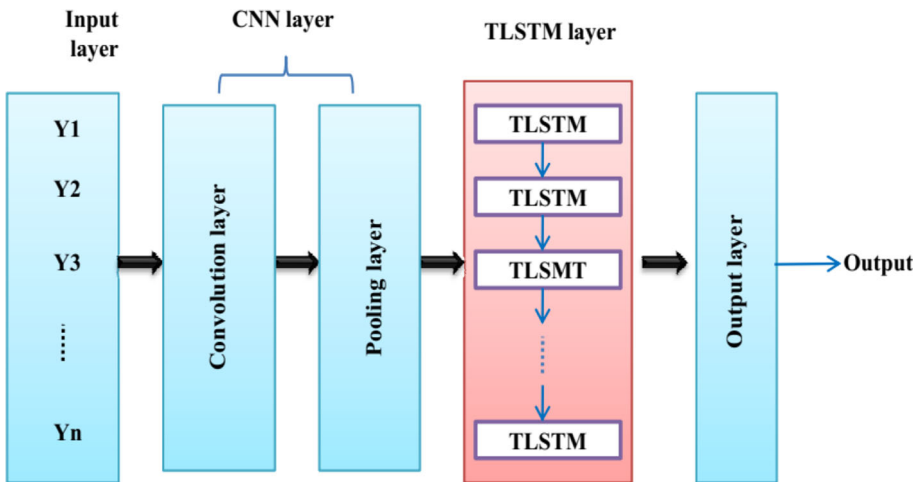

Fig. 1 General architecture of CNN-LSTM

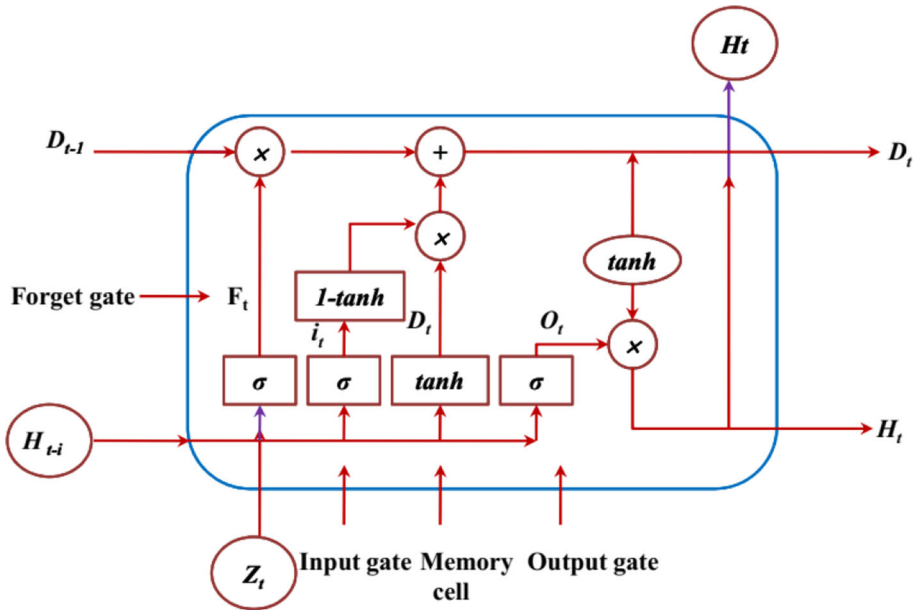

Fig. 2 Architecture of TLSTM

$$O_t = \sigma(w_O \cdot [H_{t-1}, y_t] + a_O) \tag{2}$$

$$F_t = \sigma(w_F [H_{t-1}, y_t] + a_F) \tag{3}$$

$$t_t = 1 - \tanh(I_t) \tag{4}$$

$$\tilde{D}_t = \tanh(w_d \cdot [H_{t-1}, y_t] + a_d) \tag{5}$$

$$D_t = F_t * D_{t-1} + t_t * \tilde{D}_t \tag{6}$$

$$H_t = O_t * \tanh(D_t) \tag{7}$$

From the above equations, the input gate weights, forget gate bias, and forget gate weights are w_i , a_F and w_F . The bias output gate, output gate weights, and candidate memory cell bias are a_O , w_O and a_d . Where, w_d and a_I are the candidate cell weight and the input gate bias. Obtain the relevant values based on the previous TLSTM unit in which the candidate memory cell, forget gate, input, and output gate are entered via the input data of the current moment. After that, the output value of the input gate is transformed via the $1-\tanh$ function. Finally, calculate the present memory cell state, previous TLSTM memory cell state, candidate memory cell state, transformed output value of the input gate, and candidate memory cell state. According to the output gate value and the current memory cell state, calculate the output value of TLSTM.

3.2 Adaptive Teaching–Learning-Based Optimization (ATLBO) Algorithm

The superior student considers one student in a realistic class. The student has an active learning ability and good self-learning capacity. Here, we discussed the adaptive teaching–learning-based optimization (ATLBO) algorithm regarding the actual ‘teaching–learning’ situation that reveals the higher convergence speed and better solution quality when compared to the TLBO algorithm. The teaching and learning phases are two major stages of the ATLBO algorithm [19]. The following section explains the ATLBO algorithm.

3.2.1 Teaching Stage

The influence effects of the teacher on learners inspire the conventional TLBO algorithm. In different classes, consider two teachers teaching subjects. Teacher T1 demonstrates optimal results while teacher T1 performs better than teacher T2. In the instructor phase of the TLBO [20], the mark is extremely important for enhancing individual marks. When the fitness value of j^{th} students falls below the mean mark for the minimal optimization issue, consider them superior. Equation (8) updates the obtained knowledge from self-study and best individuals.

$$Y_{new,j} = (Y_{old,j} + (random - 0.5) \times 2 \times (Y_{mean} - Y_{old,j})) \times \lambda_1 + D \times \lambda_2, \tag{8}$$

$$, \quad \text{if } F(Y_{old,j}) > F(Y_{mean})$$

$$Y_{new,j} = Y_{old,j} \times M + (Y_{best} - Y_{old,j}) \times random, \quad \text{if } F(Y_{old,j}) < F(Y_{mean}) \tag{9}$$

From this, the mean fitness value $F(Y_{mean})$ is less than the old fitness value $F(Y_{old})$. At the starting stage, the student receives knowledge from his teacher. The mean mark and the inertia weights are Y_{mean} and M . In the initial steps, the student’s knowledge is improved via teachers. Equation (10) shows the updating mechanism.

$$M = \lambda_{start} - (\lambda_{start} - \lambda_{end}) \times \frac{iteration}{iteration_{max}} \tag{10}$$

$$\lambda_1 = \sin\left(\frac{\pi}{2} \times \frac{iteration}{iteration_{max}}\right) \tag{11}$$

$$\lambda_2 = \cos\left(\frac{\pi}{2} \times \frac{iteration}{iteration_{max}}\right) \tag{12}$$

The maximum number of iteration is $iteration_{max}$ with the current iteration ($iteration$). Linearly descend the inertia weight from λ_{start} to λ_{end} . At the initial steps, the search spaces are explored by allowing the ATLBO algorithm to adjust the inertia weight process. The convergence speed is accelerated by introducing λ_1 and λ_2 . At the latter steps, the population diversity is increased to avoid trapping into the local optimum. The student’s knowledge is improved with the important role. The convergence speed and the solution qualities are enhanced via two inertia weights regarding the analysis.

3.2.2 Learning Stage

Store all learners’ fitness values in ascending order next to the teaching phase. Consider the top half of the students in the first class and the rest of the students in the second class. The superior students regard the first group members. Based on Eqs. (13) and (14), updates the

initial class and second class results.

$$\begin{aligned}
 & \text{If} \quad F(Y_{old,j}) > F(Y_{neighbour}) \\
 & \quad Y_{new,j} = Y_{old,j} + (Y_{neighbour} - Y_{old,j}) \times \cos\left(\frac{\pi}{2} \times \frac{iteration}{iteration_{max}}\right) \\
 & \text{Else}
 \end{aligned} \tag{13}$$

$$\begin{aligned}
 & \quad Y_{new,j} = Y_{old,j} + (random - 0.5) \times 2 \times (Y_{ul} - Y_{ll}) \\
 & \text{End} \\
 & \quad Y_{new,j} = Y_{old,j} + (Y_{best} - Y_{old,j}) \times \cos\left(\frac{\pi}{2} \times \frac{iteration}{iteration_{max}}\right)
 \end{aligned} \tag{14}$$

The ATLBO algorithm pseudocode clearly explains the implementation procedures as discussed in Algorithm 1.

Algorithm 1: Pseudocode of ATLBO algorithm

Initialize the ATLBO parameters with the maximum number of iteration
 Create the individual starting population
 Compute the population's fitness
While the stopping criterion is met or not **do**
Update teaching stage
 Based on the current population, the best individual Y_{best} is selected
 Mean value Y_{mean} calculation and separate the students into two classes
For every student in the population **do**
If
 Equation (8) creates the new solution $Y_{new,j}$
Else
 Equation (9) creates the new solution $Y_{new,j}$
End If
 Compute the new solutions and update the optimal solutions
End For
Update learning stage
 The fitness values of learners are separated into two classes
If
 Equation (13) generates the new solution $Y_{new,j}$
Else
 Equation (14) generates the new solution $Y_{new,j}$
End If
 Compute the new solution and update the optimal solutions
 $Iteration = Iteration + 1$
End While
 Obtain the optimal best solution

3.3 Hybrid CNN-TLSTM with ATLBO Algorithm

The structure of hybrid CNN-TLSTM with the ATLBO algorithm is delineated in Fig. 3. A set of m layers is the convolutional layer. The feature extraction on various time periods is performed by the convolution kernel size. Set $n \times n$ convolution kernel size to maximize the previous data. Before the pooling layer, batch normalization is added to enhance the efficiency of training. The global feature extraction is performed by compressing data [21]. The prediction ability is improved by increasing the number of CNN-TLSTM networks. The ATLBO algorithm prevents overfitting in the dropout layer and the number of neurons in each layer of the CNN-TLSTM model is minimized.

The below equation expresses the individual fitness function.

$$Fitness = \frac{1}{Error} \left(1 + \beta \left(1 - \frac{m_{Con}}{m_{All}} \right) + \gamma \left(1 - \frac{m_{LSTM}}{m_{All}} \right) \right) \tag{15}$$

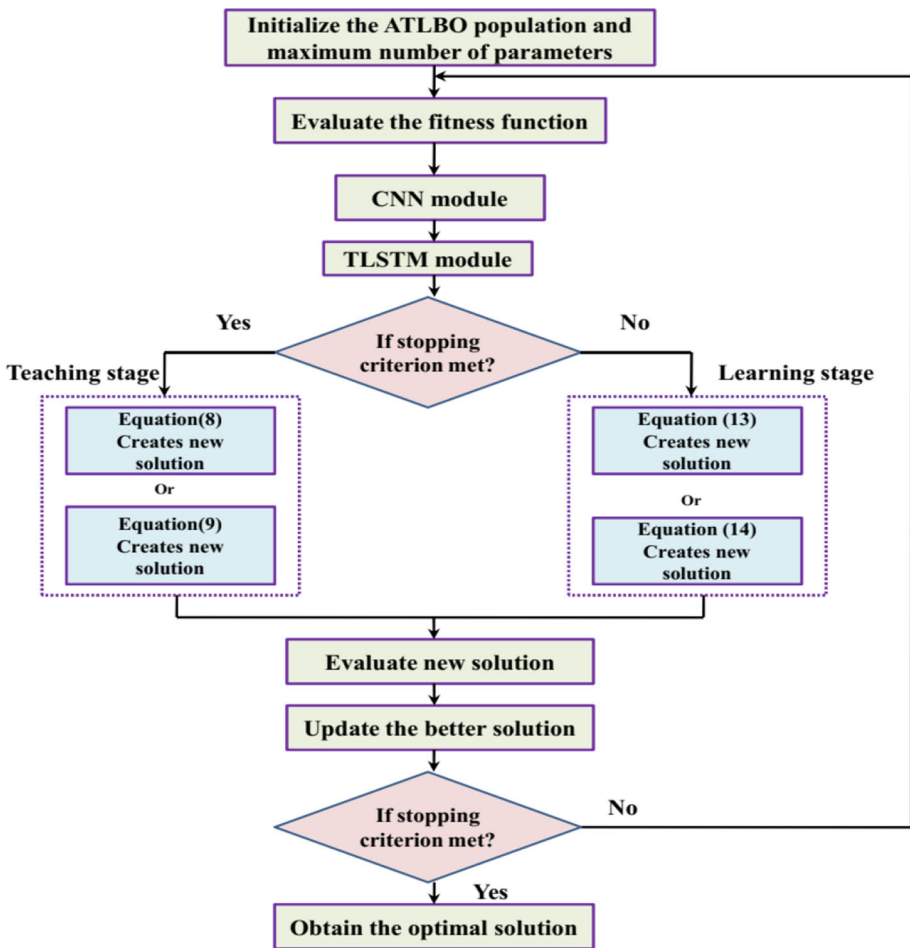

Fig. 3 Structure of hybrid CNN-TLSTM with ATLBO algorithm

Based on Eq. (15), the MAPE error and the fitness function are *Error* and *Fitness* computed. The influences of LSTM and convolution layer on network performance are γ and β . The total number of convolutional kernels in CNN and the number of neurons in the LSTM is m_{Con} and m_{LSTM} . The major advantage of CNN-TLSTM is to predict the time series data and thereby avoiding the gradient disappearance problem. But it consumes more time and is complete to select the most relevant parameters. The enhancement of the CNN-TLSTM model is performed using the ATLBO algorithm [22]. The ATLBO algorithm optimizes the CNN and TLSTM modules. Obtain the best individual and updater the better one.

4 Proposed Framework

The vital acquisition element of IoT technology is integrated using several real-time applications. The massive data extraction, health-related data management, processing, and data storage are performed using IoT. The cost-effectiveness, storage capacity, accessibility, and scalability are provided via cloud computing. The remote patient health monitoring system is realized based on the healthcare agencies. The overall block diagram of the proposed method is illustrated in Fig. 4. Several numbers of medical sensors and IoT sensor-based devices provide the data for data acquisition. The infected patients are identified and also the details are forwarded to the fog layer. After that, the data classification is performed using a hybrid CNN-TLSTM with ATLBO algorithm and it generates an alert message. The detailed process of the proposed work is discussed as follows:

The hybrid CNN-TLSTM with the ATLBO algorithm is the one that is accommodated for dengue disease prediction. Based on the patient’s historical data stored in the cloud, the proposed model identifies the health state of a person. The results are mainly based on the different disease and environmental parameters such as Soft Bleeding, Muscle Pain, Joint

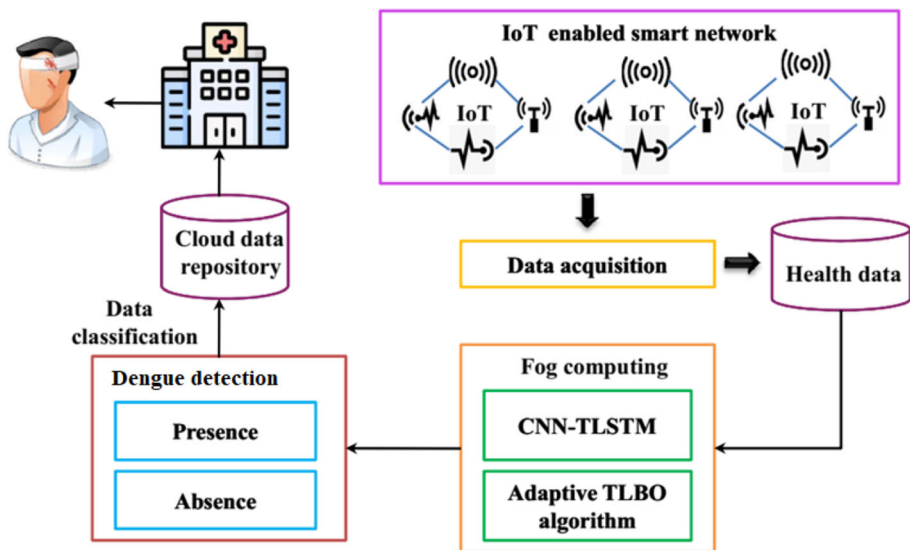

Fig. 4 Block diagram of the proposed model

Pain, Skin rash, Fever, Water Site, Carbon Dioxide, Water Site Humidity, and Water Site Temperature. The hybrid CNN-TLSTM architecture mainly depends on three stages: disease monitoring, training, and prediction. The hybrid CNN-TLSTM architecture assigns unique values for each parameter based on their importance. The probabilistic values are mainly determined by the domain experts. The monitoring process mainly happens based on the computational capability of the fog layer and it stores the parameters based on the temporal data.

4.1 Data Acquisition

In real-time from the different sensors, the health-related data is collected using the data acquisition layer [23]. The remote devices transit the acquired information that is responsible for data analysis and it acts as the fog node. Over the wireless network, transmit the data for in-depth analysis and detailed processing. Address the security and privacy concerns of IoT networks in addition to data accumulation. Effective data security is provided with several protocols. All data to and from IoT devices must be encrypted using stronger data security methods such as the Elliptic Curve Cryptography (ECC) algorithm and the Secure Socket Layer (SSL) protocol. Over the Message Query Telemetry Protocol (MQTP) and Hypertext Transfer Protocol (HTTP), these protocols guarantee secure communication [24]. The IoT devices are implemented in a software-level platform with an easy-to-use Application Programming Interface (API). The Amazon Web Services (AWS) architecture allows for increased efficacy and accuracy in data storage. Every data value is subjected to real-time processing at the fog layer. If an intrusion is discovered, the system processes all data values in real-time.

4.2 Hybrid CNN-TLSTM with ATLBO Algorithm for Data Classification and Visualization

It is important to formulate the data into multiple groups after the heterogeneous data is accumulated from various sensor devices. For better classifications, apply the extraction techniques because of data heterogeneity. Disorientation, Coma, Joint pain, Paralysis, Nausea, Vomiting, and High fever are the vital symptoms present in the health data. These kinds of data are collected by using different health-related medical sensors. The data analysis is required to detect health-related vulnerability. The fog layer detects patients using the health state categorization components. The real-time analysis of heterogeneous data is carried out at multiple time slots (Δt) to use fog computing nodes [25]. The fog layer detects the patients by using the health state categorization components.

In this study, we used hybrid CNN-TLSTM with the ATLBO algorithm (as discussed in Sect. 3) for dengue disease data prediction and classification. The major task is Spatio-temporal detection in the fog layer. An event in time data value is stored on a primary basis. The event manifestation is assigned to the Spatio-Temporal Granulation [26]. The proposed hybrid CNN-TLSTM with the ATLBO model classifies the identical data instances into two classes which denotes the presence or absence of dengue illness based on the dengue accumulated features. While taking the dataset partition, the cost function of hybrid CNN-TLSTM with ATLBO reduces the error [27]. Based on the classification results, 0 means the absence of dengue, and 1 is for the presence of dengue. Finally, the patient's result is sent to their mobile devices as an alert message.

5 Experimental Results and Discussion

This section evaluates the performance of the proposed model using state-of-art comparisons with different evaluation criteria for its performance. Table 1 explains the hardware and software used for implementation.

The optimal parameter setting with its ranges of hybrid CNN-LSTM with ATLBO algorithm is tabulated in Table 2.

5.1 Dataset Explanation

The health attributes based on dengue fever are explained in Table 3. The environmental attributes like temperature, carbon dioxide, humidity, and mosquito-dense sites are captured

Table 1 Hardware and software used for implementation

Experimental platform	Environmental constraints
Software environments	TensorFlow: 1.14.0 Keras: 2.1.0 Python: 3.7.6
Hardware environments	Operating system: Window 10.0 bit Graphics card: NVIDIA MAX 450 Hard Disk Capacity: 512 G Memory: 16 GB Processor: 8 compute cores 4.2 GHz, i5-1135G7 Rade on R4

Table 2 Optimal parameter settings

Methods	Parameters	Ranges
CNN-TLSTM	Activation function of convolutional layer	Sigmoid
	Kernel size	2
	Filters in the convolutional layers	60
	Number of hidden units in the TLSTM layer	60
	Number of nodes in input and output layer	16 and 2
	Activation function of TLSTM layers	Tan <i>h</i>
	Loss function	MAE
	Batch size	60
ATLBO algorithm	Number of epochs	50
	Number of learners	10
	Number of duplicate elimination	10
	Random interval	[0, 1]
	Number of iterations	Maximum
	Variation of inertia weight	0.85–0.95
	Convergence ratio	95%

Table 3 Health attributes description

Criterion	Attributes	Explanation
Health	Soft bleeding (MB)	Is the registered individual feel soft bleeding in the gums, nose, or easy bruising? (Y/N)
	Muscle pain (MP)	Does the registered individual suffer from muscle pain? (Y/N)
	Joint pain (JP)	Does the registered individual suffer from joint pain? (Y/N)
	Skin rash (SR)	Does the registered individual have rashes on the body after the fever? (Y/N)
	Severe abdominal pain (AP)	Is the registered individual suffering from severe abdominal pain? (Y/N)
	Vomiting (V)	Does the registered individual feel like vomiting? (Y/N)
	Nausea (NA)	Does the registered individual feel restlessness or discomfort? (Y/N)
	Pain behind eyes (PE)	Is the registered individual suffering from pain behind the eyes? (Y/N)
	Severe headache (SH)	Is the registered individual suffering from severe headaches? (Y/N)
	Fever (F)	Is the registered individual suffering from fever? (Y/N)
Environmental	Water site carbon Dioxide	Value of carbon dioxide around a standing water site
	Water site humidity	Humidity around a standing water site
	Water site Temperature	Temperature around standing water site
	Breeding sites count	Total number of breeding sites in a particular area
	Mosquito breeding Site	The geographical location of the mosquito breeding site
	Mosquito dense site	The geographical location of mosquito dense site
	Mosquito density	The density of mosquitoes in a location
Personal	relatives	Name and contact number of Registered individual's relatives
	Mobile number	Registered individual's mobile number
	Residential's address and location	Registered individual's residential address and geographical location
	Workplace's address and location	Registered individual's workplace address and geographical location

Table 3 (continued)

Criterion	Attributes	Explanation
	Sex	Registered individual's gender
	Age	Registered individual's age (in years)
	Name	Registered individual's name
	uid	Registered individual's unique identification number

and deployed in a total of 1240 sensors in different locations [28]. To generate environmental attributes random values, the send script program these sensors [29]. The attribute value, Sensor ID, and sensor location are present in the environmental dataset. From this, the symptoms of Yes are referred to as Y and No are denoted as N .

During simulation, different parameters were altered for tuning. The health-related parameters of the patients are collected via the IoT devices which are interconnected with different devices for healthcare data transmission. The application also provides a form for the patients to enter if they feel any abnormalities such as soft bleeding, muscle pain, joint pain, skin rash, severe abdominal pain, vomiting, pain behind the eyes, severe headache, etc. With these details, the patient's health conditions are sent to edge computing for processing. The physical movements of the patients are also analyzed by their wearable devices. These data gathered are then preprocessed by the Hybrid model.

The missing values are rectified via the imputation and the TLSTM technique. The noise is minimized to improve the detection accuracy and the data is mainly analyzed in terms of rows and columns. To minimize the complexity associated with the diagnosis process, the normalization takes place in the 0 to 1 range for multiple data distribution. The data is obtained from a total of 1500 patients in the rural areas via different sensing gadgets such as smartwatches, mobile phones, etc. Here 70% of data is taken for training and the remaining 30% is taken for testing. For each parameter, their associated threshold value is computed based on their symptoms. There are a total of 6 environmental-related symptoms and 10 health-related symptoms with a label yes or no. We generate the synthetic dataset by allocating the probability value to the health and environmental-related attributes. The probabilities generated for the different dengue symptoms are presented in Table 4.

5.2 Performance Metrics

The performance measures like accuracy, precision, recall, and F-score values are delineated in the following equations [30], which are essential to evaluate the performance of the proposed model.

$$Accuracy = \frac{Tn + Tp}{Tn + Tp + Fn + Fp} \quad (16)$$

$$Recall = \frac{Tp}{Tp + Fn} \quad (17)$$

$$Precision = \frac{Tp}{Tp + Fp} \quad (18)$$

$$F - measure = \frac{2Tp}{2 \times (Fp + Fn + Tp)} \quad (19)$$

Table 4 Probabilities generated for different dataset symptoms

Symptoms	Probability value	Symptoms	Probability value
Soft bleeding (MB)	0.7	Pain behind eyes (PE)	0.5
Fever (F)	0.8	Water site carbon dioxide	0.6
Nausea (NA)	0.5	Vomiting (V)	0.5
Muscle pain (MP)	0.7	Water site humidity	0.59
Joint pain (JP)	0.69	Water site temperature	0.36
Skin rash (SR)	0.5	Breeding sites count	0.25
Severe abdominal pain (AP)	0.5	mosquito breeding site	0.56
Vomiting (V)	0.6	Mosquito dense site	0.12
Severe headache (SH)	0.7	Mosquito density	0.60

where the true positive and true negative classes are represented as Tp and Fn with the false positive and false negative classes are represented as Fp and Fn .

Equation (20) delineates the mean square error values.

$$MSE = \frac{1}{m} \sum_{j=1}^m (x_j - \hat{x}_j) \tag{20}$$

The true and predicted values are x_j and \hat{x}_j . If the prediction capability of the model is high means the MSE is closer to zero. Equation (21) explains the mean absolute percentage error (MAPE),

$$MAPE = \frac{100\%}{m} \sum_{j=1}^m \left| \frac{\hat{x}_j - x_j}{x_j} \right| \tag{21}$$

The true and predicted values are x_j and \hat{x}_j . The limit $[0, \infty]$ is the range of MAPE. The better classification accuracy is attained with the smaller value of MAPE.

5.3 Performance Analysis

The performance of accuracy based on the number of epochs is shown in Fig. 5. Figure 6 describes the performance of loss based on the number of epochs [31, 32]. These graphs showed the effectiveness of the proposed method. During dengue fever prediction, the proposed hybrid CNN-TLSTM with the ATLBO model reveals higher training and testing accuracies with lower training and testing loss values. Hence, the hybrid CNN-TLSTM with the ATLBO method is well suitable for dengue fever prediction.

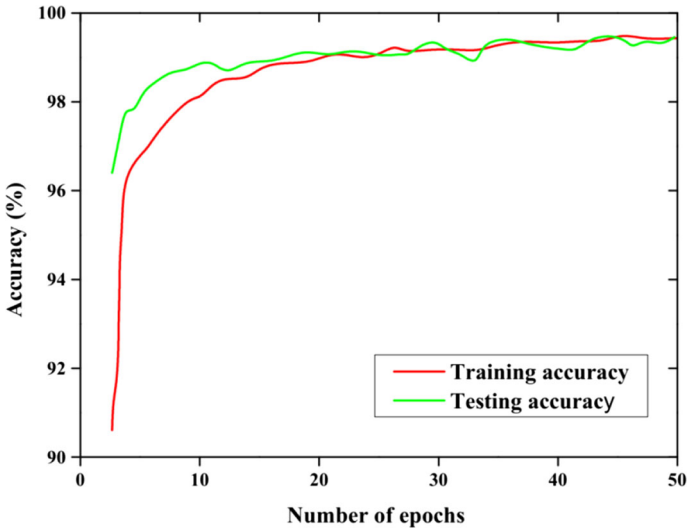

Fig. 5 Performance of accuracy based on the number of epochs

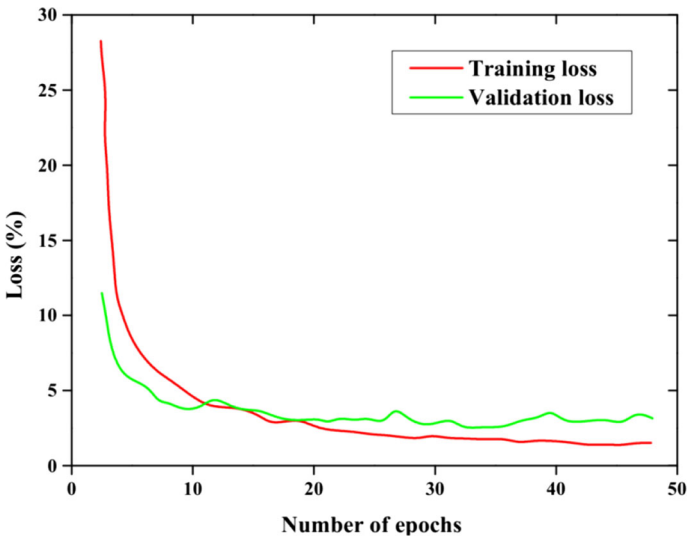

Fig. 6 Performance of loss based on the number of epochs

Table 5 evaluates the training and testing time based on different health records. The training and testing time varies based on a varying number of health records from 200 to 1000 [33–35]. Based on 1000 health records, we have obtained 0.034 s of training time and 0.024 s of testing time respectively. The state-of-art results based on the health records are plotted in Fig. 7 in which both training and testing times are plotted in Fig. 7a and b. The methods like I-SCSM, EEFCS, DNN, and proposed hybrid CNN-TLSTM with ATLBO

Table 5 Evaluation of training and testing time

Number of health records	Training time (s)	Testing time (s)
200	1.23	0.003
400	1.02	0.05
600	0.09	0.12
800	0.05	0.04
1000	0.034	0.024

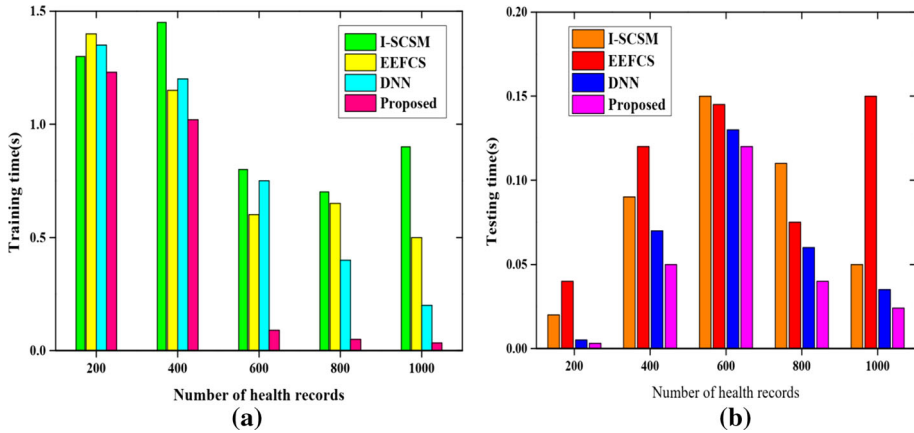

Fig. 7 State-of-art results based on the health records, **a** Training time, and **b** Testing time

models with varying times are taken. The proposed method takes lower training and testing time than other existing methods like I-SCSM, EEFCs, and DNN respectively.

The comparative analysis of accuracy with respect to a varying number of health records is plotted in Fig. 8. For this experiment, the number of health records varied from 200 to 1000 with respect to state-of-art techniques like I-SCSM, EEFCs, DNN, and the proposed model. From this investigation, the overall accuracy based on dengue fever records with the proposed hybrid CNN-TLSTM with ATLBO method offers superior accuracies when compared to the existing studies like I-SCSM, EEFCs, and DNN.

The state-of-art comparison of mean absolute percentage error is shown in Fig. 9. This investigation is performed using state-of-art techniques like multilayer perceptron layer (MLP), Recurrent Neural Network (RNN), LSTM, CNN, CNN-TLTM, and the proposed method. From this investigation, the MAPE value of MLP is 0.0412, RNN is 0.2892, CNN is 0.3092, LSTM is 0.243, CNN-TLSTM is 0.2012 and the proposed method is 0.1856. From this investigation, the proposed technique has fewer MAPE values than all other methods such as MLP, CNN, LSTM, RNN, CNN, and CNN-LSTM.

The state-of-art comparison of mean square error is plotted in Fig. 10. The state-of-art techniques like CNN, LSTM, RNN, MLP, CNN-TLTM, and proposed hybrid CNN-TLSTM with ATLBO method. The methods like LSTM, RNN, CNN, MLP, CNN-LSTM, and proposed methods demonstrated the mean square error values of 0.00047, 0.00084, 0.00090, 0.00125, 0.00042, and 0.00036 respectively. However, the proposed method demonstrated lower mean square error values than the other previous methods.

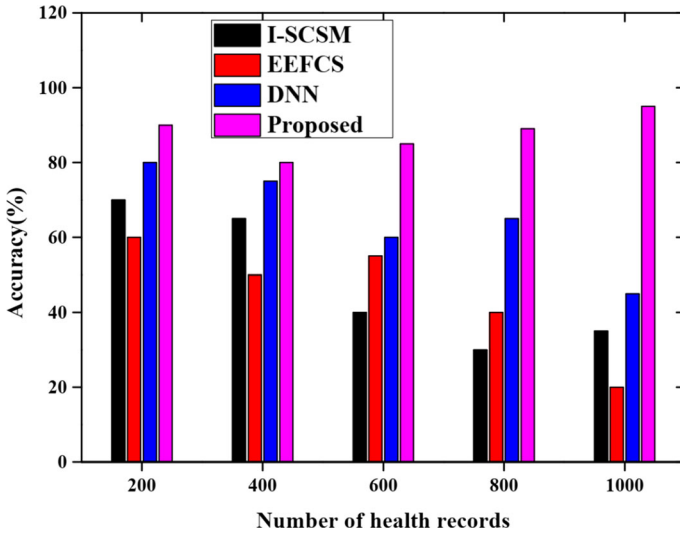

Fig. 8 State-of-art accuracy based on varying number of health records

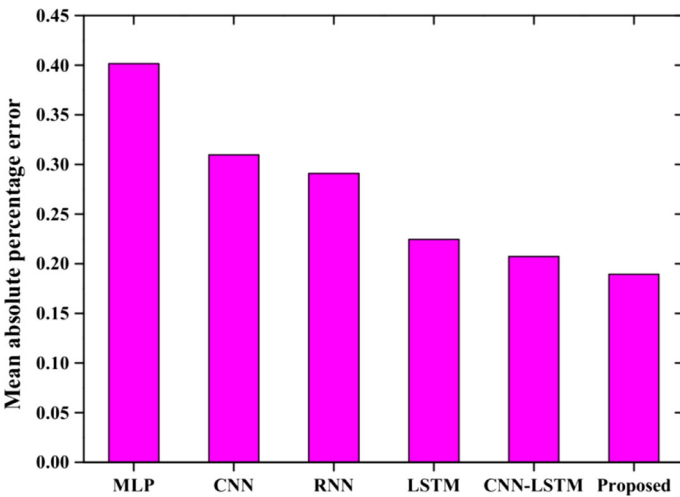

Fig. 9 State-of-art comparison of mean absolute percentage error

The state-of-art result of classification performance is plotted in Fig. 11. This graph plots the accuracy, precision, recall, and F-score values of the proposed method. During dengue fever classification, the overall classification performance is analyzed using various state-of-art techniques such as I-SCSM [11], EEFCs [13], DNN [14], and 1D-CNN [16], the proposed hybrid CNN-TLSTM with ATLBO method. From this examination, we have attained 96.9% accuracy, 95.7% precision, 96.8% recall, and 96.2% F-measure values. Among all the existing techniques, the proposed hybrid CNN-TLSTM with the ATLBO method provided higher classification results.

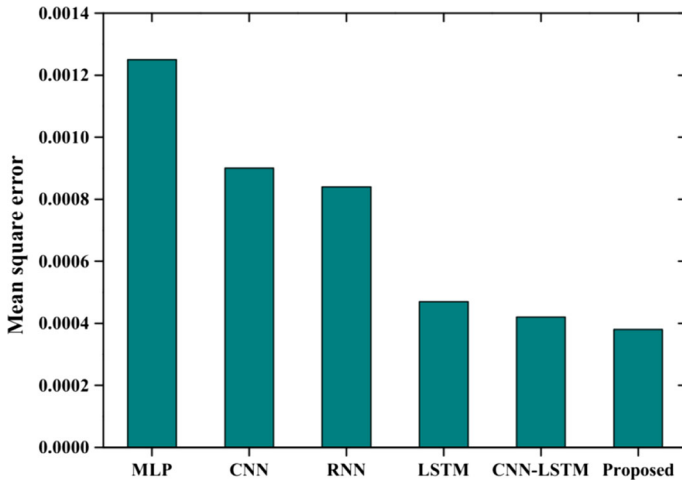

Fig. 10 State-of-art comparison of mean square error

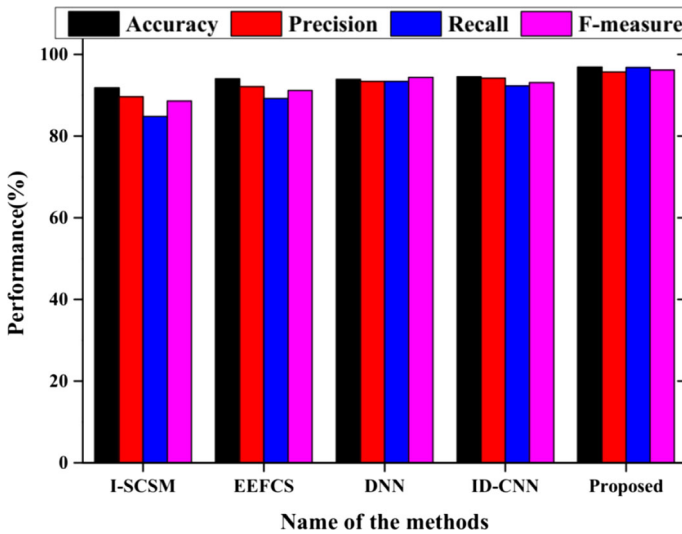

Fig. 11 State-of-art result of classification performance

The performance analysis of reliability is plotted in Fig. 12. Additionally, the proposed method is tested for reliability in order to quantify the general outcomes obtained. The classification model is tested and changed for confirmation. When compared to other models, the introduced model achieved superior performances, according to the implementation findings. In comparison to the other techniques of I-SCSM [11], EEFCs [13], DNN [14], and 1D-CNN [16], the proposed model is believed to have superior reliability based on the final result. In comparison to previous state-of-the-art edge techniques, execution prediction analysis shows that the suggested model is extremely reliable.

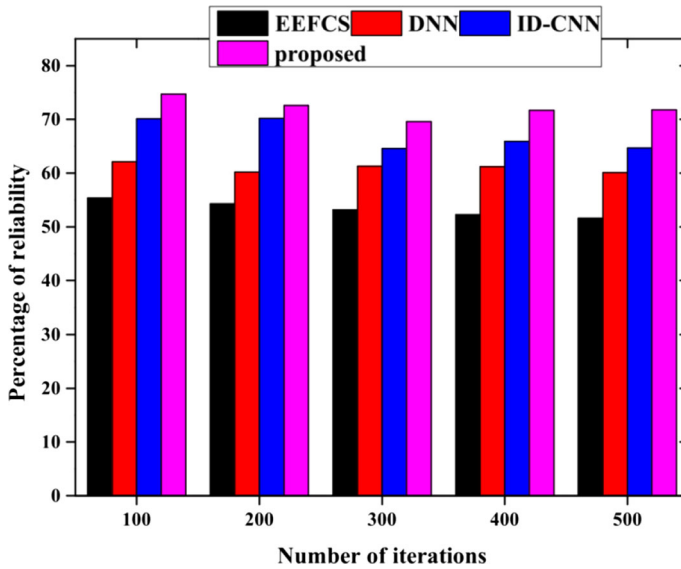

Fig. 12 Performance analysis of reliability

To evaluate the performance of the results one step further, the proposed methodology is compared with different techniques such as Cascading ensemble of CNN [36]. Multimodel classification [37], Deep Reinforcement Learning (DRL) [42] in terms of accuracy, latency, and time complexity. The results obtained are shown in Table 6 for a total of 500 patient records. The table is self-explanatory. The use of fog computing minimizes the latency of this approach and the ATLBO optimized hybrid CNN-TLSTM model selects the accurate parameters (geographical and disease) for disease diagnosis. The results show that the proposed model offers improved accuracy, low latency, and minimal time complexity.

The ATLBO which tunes the hybrid CNN-TLSTM architecture minimizes the training and testing time and also shows improvements in terms of different parameters. The incorporation of the ATLBO algorithm minimizes the local optima problem and helps to discover efficient solutions. In this way, the hybrid CNN-TLSTM architecture assigns appropriate disease labels for effective decision-making. After the report is obtained from the hybrid CNN-LSTM

Table 6 Performance analysis

Techniques	Latency (seconds)	Time complexity (seconds)	Accuracy (%)
Cascading enssemble of CNN [36]	0.071	24	93
Multimodel classification [37]	0.054	22	91
DRL [42]	0.079	25	92
1DCNN [16]	0.086	16	94
DNN [14]	0.093	28	93
Proposed ATLBO optimized hybrid CNN-TLSTM	0.075	10	96.9

technique it is transmitted to the fog-cloud server. The fog-cloud server sends the results to the healthcare organizations which takes effective decisions based on the report. The main limitation of this technique is the absence of the information regarding the Complete blood count which helps to identify the severe blood loss associated with dengue.

6 Conclusion

This article presented Hybrid CNN-TLSTM with ATLBO algorithm for Dengue disease identification and prevention. While compared to the LSTM, RNN, CNN, MLP, and CNN-LSTM methods, the proposed model outperforms lower error values in terms of both MSE and MAPE but the overall accuracy is higher. The training and testing time of 0.034 and 0.024 s are obtained based on the varying number of health records. Several simulations are carried out for validation in which the experimental outputs are contrasted to state-of-art techniques like I-SCSM, EEFCs, DNN, and 1D-CNN. While comparing several statistical parameters, the simulation results concluded that the proposed method is more effective and better. The performance is evaluated in terms of different metrics such as accuracy, recall, precision, and F-score. The proposed ATLBO optimized hybrid CNN-TLSTM offers accuracy, precision, recall, and F-measure values of 96.9%, 95.7%, 96.8%, and 96.2% respectively. Due to the usage of the fog based computing strategy, the proposed model offers a lower latency of 0.075 which is relatively lower than the Cascading ensemble of CNN (0.071), Multimodel classification (0.054), DRL (0.079), 1DCNN (0.086), and DNN (0.093). The proposed model's efficiency is observed by the results obtained for different statistical parameters. In this work, we have created a healthcare model to meet the needs of dengue disease diagnosis irrespective of gender, age, or race. In the future, we plan to incorporate more disease-related parameters and also improve the security of the patient's credentials stored.

Acknowledgements The authors are grateful to all respondents who participated in this study and to the data collectors for their contribution.

Author Contributions All authors who participated in data analysis, drafting or revising the manuscript gave approval of the final version to be published.

Funding This study has received no external funding.

Declarations

Conflicts of interest The authors declare that they have no conflicts of interest.

Informed Consent Consent was secured from all of the respondents who participated in the study.

References

1. Andrade E, Nogueira B, de Farias Junior I, Araújo D (2021) Performance and availability trade-offs in Fog-Cloud IoT environments. *J Netw Syst Manage* 29(1):1–27
2. Alli AA, Alam MM (2020) The fog cloud of things: a survey on concepts, architecture, standards, tools, and applications. *Internet of Things* 9:100177
3. Sundararaj V (2019) Optimal task assignment in mobile cloud computing by queue based ant-bee algorithm. *Wire Personal Commun* 104(1):173–197

4. Malarvizhi N, Aswini J, Sasikala S, Chakravarthy MH, Neeba EA (2021) Multi-parameter optimization for load balancing with effective task scheduling and resource sharing. *J Amb Int Human Comput*: 1–9
5. Sundararaj V, Selvi M (2021) Opposition grasshopper optimizer based multimedia data distribution using user evaluation strategy. *Multi Tools Appl* 80(19):29875–29891
6. Chegini H, Naha RK, Mahanti A, Thulasiraman P (2021) Process automation in an IoT–Fog–cloud ecosystem: a survey and taxonomy. *IoT* 2(1):92–118
7. Sood Sk (2020) Fog-Cloud centric IoT-based cyber physical framework for panic oriented disaster evacuation in smart cities. *Earth Science Informatics*, pp1–22.
8. Abbasi M, Mohammadi-Pasand E, Khosravi MR (2021) Intelligent workload allocation in IoT–Fog–cloud architecture towards mobile edge computing. *Comput Commun* 169:71–80
9. Selvaraj S, Sundaravaradhan S (2020) Challenges and opportunities in IoT healthcare systems: a systematic review. *SN Applied Sciences* 2(1):1–8
10. Abdali-Mohammadi F, Meqdad MN, Kadry S (2020) Development of an IoT-based and cloud-based disease prediction and diagnosis system for healthcare using machine learning algorithms. *IAES Int J Artificial Intell* 9(4):766
11. Verma P, Sood SK (2019) A comprehensive framework for student stress monitoring in fog-cloud IoT environment: m-health perspective. *Med Biol Eng Compu* 57(1):231–244
12. He S, Cheng B, Wang H, Huang Y, Chen J (2017) Proactive personalized services through fog-cloud computing in large-scale IoT-based healthcare application. *China Communications* 14(11):1–16
13. Gupta V, Singh Gill H, Singh P, Kaur R (2018) An energy efficient fog-cloud based architecture for healthcare. *J Stat Manag Syst* 21(4):529–537
14. Lakhani A, Mastoi QUA, Elhoseny M, Memon MS, Mohammed MA (2021) Deep neural network-based application partitioning and scheduling for hospitals and medical enterprises using IoT assisted mobile fog cloud. *Enterprise Infor Syst*. <https://doi.org/10.1080/17517575.2021.1883122>
15. Kallel Ameni, Rekik Molka, Khemakhem Mahdi (2021) IoT-fog-cloud based architecture for smart systems: Prototypes of autism and COVID-19 monitoring systems. *Softw: Practice Exp* 51(1):91–116. <https://doi.org/10.1002/spe.2924>
16. Cheikhrouhou O, Mahmud R, Zouari R, Ibrahim M, Zaguia A, Gia TN (2021) One-dimensional CNN approach for ECG arrhythmia analysis in fog-cloud environments. *IEEE Access* 9:103513–103523
17. Wang J, Wang X, Li J, Wang H (2021) A prediction model of CNN-TLSTM for USD/CNY exchange rate prediction. *IEEE Access* 9:73346–73354
18. Chen Q, Zhang W, Lou Y (2020) Forecasting stock prices using a hybrid deep learning model integrating attention mechanism, multi-layer perceptron, and bidirectional long-short term memory neural network. *IEEE Access* 8:117365–117376
19. Rao RV, Patel V (2013) An improved teaching-learning-based optimization algorithm for solving unconstrained optimization problems. *Scientia Iranica* 20(3):710–720
20. Singh M, Panigrahi BK, Abhyankar AR (2013) Optimal coordination of directional over-current relays using Teaching Learning-Based Optimization (TLBO) algorithm. *Int J Electr Power Energy Syst* 50:33–41
21. Krishna PR, Sao S (2016) An improved TLBO algorithm to solve profit based unit commitment problem under deregulated environment. *Procedia Technol* 25:652–659
22. Lu W, Rui H, Liang C, Jiang L, Zhao S, Li K (2020) A method based on GA-CNN-LSTM for daily tourist flow prediction at scenic spots. *Entropy* 22(3):261
23. Durga S, Nag R and Daniel E (2019) March. Survey on machine learning and deep learning algorithms used in internet of things (IoT) healthcare. In: 2019 3rd International Conference on Computing Methodologies and Communication (ICCMC) (pp. 1018–1022). IEEE.
24. Khaled AE, Helal S (2019) Interoperable communication framework for bridging RESTful and topic-based communication in IoT. *Futur Gener Comput Syst* 92:628–643
25. Ashmore P, Lindahl JF, Colón-González FJ, Sinh Nam V, Quang Tan D, Medley GF (2020) Spatiotemporal and socioeconomic risk factors for dengue at the province level in Vietnam, 2013–2015: clustering analysis and regression model. *Tropical Medicine and Infectious Disease* 5(2):81
26. Bhatia M, Kumari S (2021) A Novel IoT-Fog-cloud-based healthcare system for monitoring and preventing encephalitis. *Cognitive Comput*. <https://doi.org/10.1007/s12559-021-09856-3>
27. Edussuriya C, Deegalla S, Gawarammana I (2021) An accurate mathematical model predicting number of dengue cases in tropics. *PLoS Negl Trop Dis* 15(11):e0009756
28. Sood SK, Sood V, Mahajan I, Sahil. (2021) An intelligent healthcare system for predicting and preventing dengue virus infection. *Computing*. <https://doi.org/10.1007/s00607-020-00877-8>
29. Phakhounthong K, Chaovalit P, Jittamala P, Blacksell SD, Carter MJ, Turner P, Chheng K, Sona S, Kumar V, Day NP, White LJ (2018) Predicting the severity of dengue fever in children on admission based on clinical features and laboratory indicators: application of classification tree analysis. *BMC Pediatr* 18(1):1–9

30. Singh S, Bansal A, Sandhu R, Sidhu J (2018) Fog computing and IoT based healthcare support service for dengue fever. *Int J Pervasive Comput Commun* 14(2):197–207. <https://doi.org/10.1108/IJPC-C-D-18-00012>
31. Sood SK, Kaur S, Chahal KK (2020) An intelligent framework for monitoring dengue fever risk using LDA-ANFIS. *J Ambient Int Smart Environ* 12(1):5–20
32. Tanner L, Schreiber M, Low JG, Ong A, Tolfvenstam T, Lai YL, Ng LC, Leo YS, Thi Puong L, Vasudevan SG, Simmons CP (2008) Decision tree algorithms predict the diagnosis and outcome of dengue fever in the early phase of illness. *PLoS Negl Trop Dis* 2(3):e196
33. Barniol J, Gaczkowski R, Barbato EV, da Cunha RV, Salgado D, Martínez E, Segarra CS, Sandoval EBP, Mishra A, Laksono IS, Lum LC (2011) Usefulness and applicability of the revised dengue case classification by disease: multi-centre study in 18 countries. *BMC Infect Dis* 11(1):1–12
34. Im J, Balasubramanian R, Ouedraogo M, Nana LRW, Mogeni OD, Jeon HJ, van Pomeran T, Haselbeck A, Lim JK, Prifti K, Baker S (2020) The epidemiology of dengue outbreaks in 2016 and 2017 in Ouagadougou. *Burkina Faso Heliyon* 6(7):e04389
35. Pravin A, Jacob TP, Nagarajan G (2020) An intelligent and secure healthcare framework for the prediction and prevention of Dengue virus outbreak using fog computing. *Heal Technol* 10(1):303–311
36. Sharma AK, Tiwari S, Aggarwal G, Goenka N, Kumar A, Chakrabarti P, Chakrabarti T, Gono R, Leonowicz Z, Jasiński M (2022) Dermatologist-level classification of skin cancer using cascaded ensembling of convolutional neural network and handcrafted features based deep neural network. *IEEE Access* 10:17920–17932
37. Verma SS, Prasad A, Kumar A (2022) CovXmhc: High performance COVID-19 detection on X-ray images using Multi-Model classification. *Biomed Signal Process Control* 71:103272
38. Lakhani A, Mastoi QUA, Elhoseny M, Memon MS, Mohammed MA (2021) Deep neural network-based application partitioning and scheduling for hospitals and medical enterprises using IoT assisted mobile fog cloud. *Enterprise Inform Syst*. <https://doi.org/10.1080/17517575.2021.1883122>
39. Lakhani A, Mohammed MA, Rashid AN, Kadry S, Panityakul T, Abdulkareem KH, Thinnukool O (2021) Smart-contract aware ethereum and client-fog-cloud healthcare system. *Sensors* 21(12):4093
40. Lakhani A, Mohammed MA, Obaid OI, Chakraborty C, Abdulkareem KH, Kadry S (2022) Efficient deep-reinforcement learning aware resource allocation in SDN-enabled fog paradigm. *Autom Softw Eng* 29(1):1–25
41. Mutlag AA, Ghani MKA, Mohammed MA, Lakhani A, Mohd O, Abdulkareem KH, Garcia-Zapirain B (2021) Multi-agent systems in fog-cloud computing for critical healthcare task management model (CHTM) used for ECG monitoring. *Sensors* 21(20):6923
42. Lakhani A, Mohammed MA, Kozlov S, Rodrigues JJ (2021) Mobile-fog-cloud assisted deep reinforcement learning and blockchain-enable IoMT system for healthcare workflows. *Trans Emerging Telecommun Technol*. <https://doi.org/10.1002/ett.4363>
43. Mohammed MA, Ibrahim DA and Abdulkareem KH (2021) Bio-inspired robotics enabled schemes in blockchain-fog-cloud assisted IoMT environment. *Journal of King Saud University-Computer and Information Sciences*.
44. Murray NEA, Qam MB, Wilder-Smith A (2013) Epidemiology of dengue: past, present and future prospects. *Clin Epidemiol* 5:299

Publisher's Note Springer Nature remains neutral with regard to jurisdictional claims in published maps and institutional affiliations.

Springer Nature or its licensor holds exclusive rights to this article under a publishing agreement with the author(s) or other rightsholder(s); author self-archiving of the accepted manuscript version of this article is solely governed by the terms of such publishing agreement and applicable law.