

Influence of fluoride concentration and pH on corrosion behavior of titanium in artificial saliva

Alain Robin · Jeferson Paulino Meirelis

Received: 19 April 2006 / Accepted: 30 November 2006 / Published online: 21 February 2007
© Springer Science+Business Media B.V. 2007

Abstract Titanium (Ti) exhibits excellent corrosion resistance in most aqueous media due to the formation of a stable oxide film and is chosen for surgical and odontological implants for this resistance and its biocompatibility. Treatment with fluorides (F) is the main method to prevent plaque formation and dental caries. Toothpastes, mouthwashes and prophylactic gels can contain from 200 to 20,000 ppm F and have neutral to acidic character, which can affect the corrosion behavior of titanium devices present in the oral cavity. In this work the behavior of Ti has been evaluated in artificial saliva of pH 2, 5 and 7 and different fluoride concentrations (0, 1,000, 5,000 and 10,000 ppm F), through open-circuit potential measurements, potentiodynamic polarization and electrochemical impedance spectroscopy. Limits of pH value and fluoride concentration at which Ti corrosion behavior changed could be established. Active behavior was observed for pH 2 and 1,000–10,000 ppm F, and for pH 5 and 5,000 and 10,000 ppm F. The other conditions led to passive behavior. Decrease in corrosion resistance and less tendency for passivation were observed as fluoride concentration increased and pH decreased.

Keywords Titanium · Saliva · Fluoride · Acidity · Corrosion · Passivation

1 Introduction

Titanium (Ti) is widely used in restorative surgery such as orthopedic implants, pacemakers and heart valves, because it presents high corrosion resistance in physiological media and biocompatibility [1]. Its corrosion resistance is due to the spontaneous formation of an oxide film (TiO_2) on its surface [2], which exhibits high stability in biological fluids. Another interesting property of Ti is its high strength to density ratio. In orthodontics, Ti is employed as dental implants [1, 3, 4] and more recently, as brackets [5].

There is an increasing use of prophylactic products in dental treatments to prevent plaque and caries formation. Most of these products contain fluorides (F) at different concentration levels (e.g. 200 ppm F in bucal rinses and 1,000–1,500 ppm F in toothpastes and 10,000–20,000 ppm F in gels), and their pH can range from neutral to acidic values.

While numerous studies have been carried out on the electrochemical behavior of Ti in aqueous media, little work has dealt with the influence of both fluoride concentration and pH in artificial saliva [6–12]. Moreover, these studies were generally conducted under narrow ranges of fluoride concentration and pH and the data are dispersed and difficult to compare. Nevertheless, most of these studies agree that the corrosion resistance of Ti can be affected by the presence of fluorides, probably due to the formation of stable and soluble titanium fluoride or oxi-fluoride complexes [13, 14]. In some work low pH was shown to increase the corrosion rate of Ti in the presence of fluorides, due to hydrofluoric acid formation [7].

The aim of this study was to clarify the simultaneous effect of fluoride concentration and pH on the

A. Robin (✉) · J. P. Meirelis
Departamento de Engenharia de Materiais,
Escola de Engenharia de Lorena – Universidade de São
Paulo, CP 116-12600-000 Lorena, SP, Brazil
e-mail: alain@demar.faequil.br

electrochemical behavior of Ti in artificial saliva. The study was carried out in saliva of pH from 2 to 7 containing up to 10,000 ppm F, using open-circuit potential measurements, potentiodynamic polarization and electrochemical impedance spectroscopy.

2 Experimental procedure

Cylindrical test specimens (8 mm diameter \times 15 mm length) were machined from commercially pure Ti grade 1 ingot and mounted in PTFE holders. The Ti had a typical as-cast microstructure, with non-homogeneous size distribution of α phase grains. The cross-section of the electrode (0.5 cm² area) was mechanically ground with emery-paper up to 600 grit, rinsed with distilled water and dried with acetone.

The solution was Fusayama artificial saliva [15] with the following composition: 0.4 g NaCl + 0.4 g KCl + 0.795 g CaCl₂ · 2H₂O + 0.690 g NaH₂PO₄ · H₂O + 0.005 g Na₂S · 9H₂O + 1.0 g urea in 1,000 ml deionized water. Salivas with 1,000, 5,000 and 10,000 ppm F concentration were prepared using NaF addition. The pH of the salivas was then adjusted to 2, 5 and 7 using dilute HCl or NaOH solutions. The salivas were naturally aerated and the experiments were conducted without stirring. The temperature was maintained at 37 \pm 1 °C using a thermostatic bath. The counter electrode was a square-shaped platinum sheet of 18 cm² area. All potentials were referred to the saturated calomel electrode (SCE) potential (= +0.242 V/SHE).

Open-circuit potential and polarization measurements were performed using a PAR 273A potentiostat controlled with M352 Corrosion Software. The Electrochemical Impedance Spectroscopy (EIS) measurements were carried out at open-circuit potential using an Electrochemical Interface SOLARTRON mod. 1287A and a Frequency Response Analyser SOLARTRON mod. 1260 A, controlled by Ecorr/Zplot SOLARTRON mod. 125587S software.

Prior to impedance and polarization experiments the working electrodes were immersed in the saliva for 3 h, taking the moment of immersion as zero time. Then, impedance measurements at open-circuit potential were made using a sinusoidal signal of 10 mV amplitude and frequencies in the 0.1–100 kHz range. Cathodic and anodic polarization was then carried out potentiodynamically at a 0.16 mV s⁻¹ sweep rate. The sequence of experiments was generally performed in triplicate for each fluoride concentration/pH condition. After each run the samples were reground with emery papers to a 600-grit finish in order to remove any

product formed on the metal surface which could affect the following tests, rinsed with distilled water, dried and transferred quickly to the next saliva. Immersion tests were performed in saliva of pH 2 and pH 7 containing 1,000 ppm F and the surface of the Ti coupons was observed by scanning electron microscopy (SEM-LEO VP-1450).

3 Results and discussion

Figure 1a–c present the variation of the open-circuit potential (OCP) of Ti as a function of exposure time in saliva containing different fluoride concentrations and of pH 2, 5 and 7, respectively. Two distinct behaviors are noted depending on fluoride concentration and pH:

- (i) the OCPs shift in the more noble direction and stabilize with time. This behavior is observed for pH 2 without fluoride, pH 5 for 0 and 1,000 ppm F, and pH 7 from 0 to 10,000 ppm F. This suggests stability of the air-formed native oxide in these fluoride concentration/pH conditions and the passive state of Ti.
- (ii) the OCPs shift in the negative direction and stabilize at low potential values. This behavior is shown for pH 2 and 1,000–10,000 ppm F and pH 5 for 5,000 and 10,000 ppm F. This suggests dissolution of the air-formed oxide and surface activation.

These results show that a defined correlation between pH and fluoride concentration determines the active or passive character of Ti and that acidity associated with the presence of fluorides is favorable to Ti depassivation. Al-Mayouf [12], Schiff [9] and Nakagawa [7, 11] also observed both behaviors depending on fluoride concentration and pH.

Figure 2 shows the variation of the corrosion potential (OCP value measured at 3 h exposure time) as a function of fluoride concentration and pH. The Pourbaix' diagram of the Ti–H₂O system [16] is also drawn in Fig. 2. The conditions leading to the first behavior (i), correspond to TiO₂ stability, i.e. passivity state, whereas behavior (ii) is associated to Ti ions stability, i.e. active state.

The ranges of corrosion potential observed for the passive state, –0.430 to 0.200 V/SCE and for the active state, –1.130 to –0.870 V/SCE, are in accordance with those measured by Al-Mayouf [12], –0.35 to 0 V/SCE and about –0.95 V/SCE, and by Schiff [9], –0.40 to 0.05 V/SCE and –0.90 to –0.80 V/SCE. For conditions leading to a passive state, an increase in fluoride

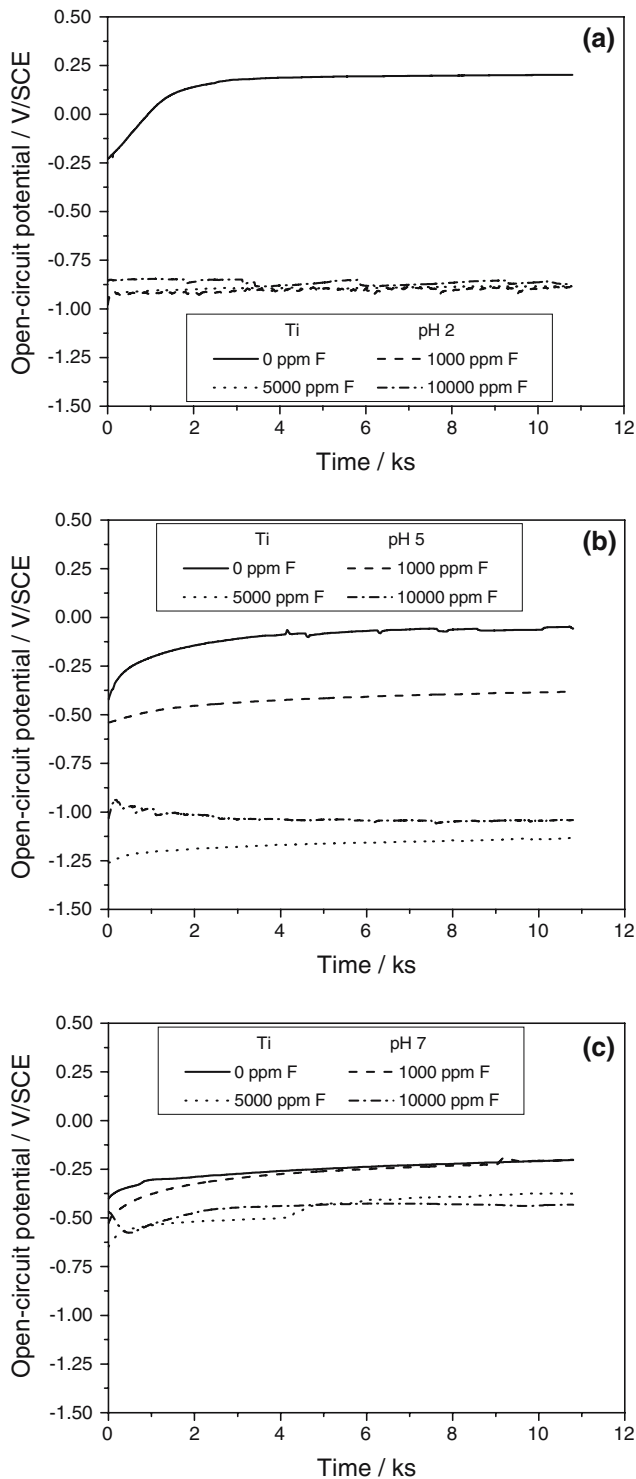

Fig. 1 Variation of Ti open-circuit potential in artificial saliva of (a) pH 2, (b) pH 5 and (c) pH 7, containing 0, 1,000, 5,000 and 10,000 ppm F

concentration, maintaining pH constant, shifts the corrosion potentials to more negative values (Fig. 2). This indicates a decrease in oxide stability.

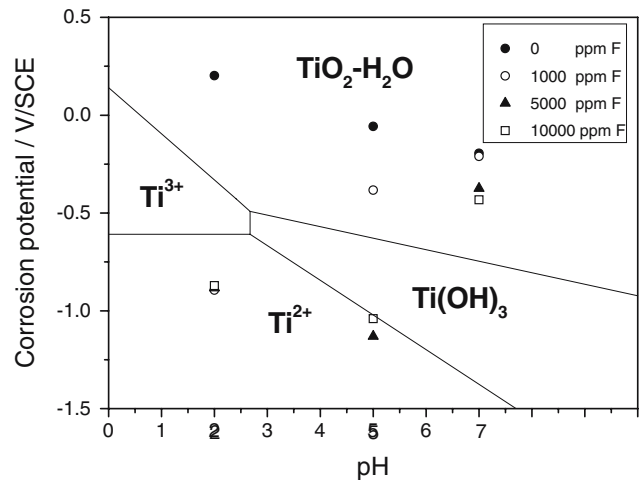

Fig. 2 Corrosion potential of Ti in artificial saliva as a function of fluoride concentration and pH and Pourbaix’ diagram of the Ti–H₂O system at 25 °C [16]

Figure 3a–c show the polarization curves of Ti in saliva containing different fluoride concentrations and of pH 2, 5 and 7 respectively. Two kinds of anodic polarization curve can be distinguished:

- (i) the anodic polarization curve shows no active–passive transition and is typical of a passive behavior. This is observed for pH 2 without fluoride, pH 5 for 0 and 1,000 ppm F, and pH 7 from 0 to 10,000 ppm F, which confirms the results obtained from the OCP measurements.
- (ii) an active–passive transition peak, followed by a passivation plateau is noted for the anodic polarization curves obtained for pH 2 and 1,000 to 10,000 ppm F and pH 5 for 5,000 and 10,000 ppm F. These results also corroborate the spontaneous active behavior of Ti in these conditions, pointed out from the OCP measurements, and show that Ti can be passivated under more oxidizing conditions.

For a given pH value, the anodic current density, in the active region (when present) as well as in the passive region, increases with increasing fluoride concentration (Fig. 3). This indicates reduction in corrosion resistance of Ti and in the stability of its passive film when fluoride concentration increases. Such observations were also made by Nakagawa [7] and Huang [17] for Ti and Ti-6Al-4V alloy, respectively. On the other hand, for a given fluoride concentration, pH increase tends to lower the anodic current density (Fig. 3), thus contributing to increased corrosion resistance and passive film stability.

The results of the present work related to passive or active state for Ti versus fluoride concentration and pH

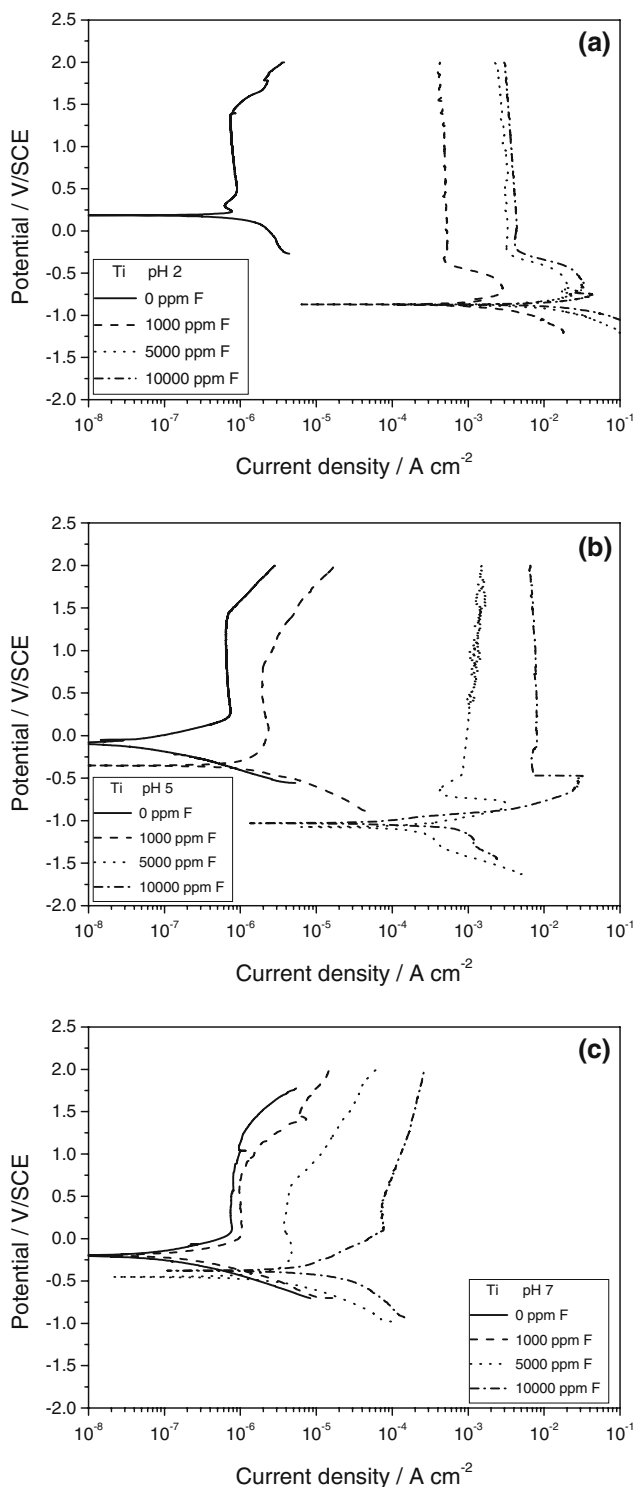

Fig. 3 Anodic and cathodic polarization curves of Ti in artificial saliva of (a) pH 2, (b) pH 5 and (c) pH 7, containing 0, 1,000, 5,000 and 10,000 ppm F

were compared with published data obtained in other fluoride concentration/pH combinations (Fig. 4). The 0 ppm F condition is represented in Fig. 4 as 1 ppm in order to include the corresponding result in the pH–log

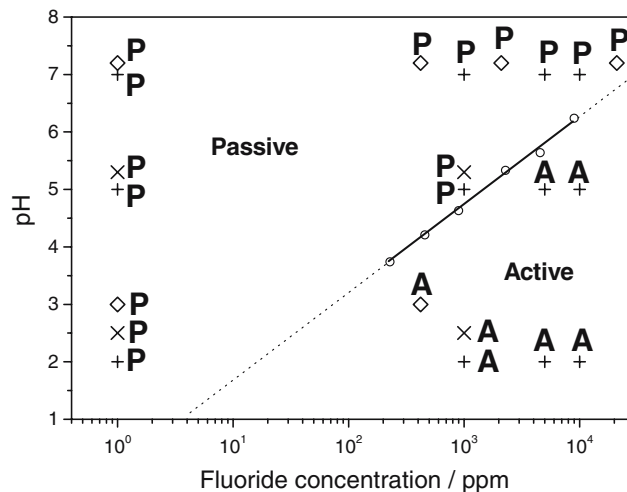

Fig. 4 State of Ti (P, passive; A, active) in artificial saliva as a function of fluoride concentration and pH, — Nakagawa [11]; \diamond , Al-Mayouf [12]; \times , Schiff [9]; +, this work

[F⁻] graph. The straight line in Fig. 4, obtained by Nakagawa from open-circuit measurements [11], separates the fluoride concentration/pH conditions for which this author found a passive state or an active state for Ti in artificial saliva. There is a good agreement between the results of Al-Mayouf [12], Schiff [9], those obtained in the present work and the results of Nakagawa [11].

Figure 5 shows the variation of the corrosion current density, obtained from the polarization curves of Fig. 3 by the extrapolation method, as a function of fluoride concentration and pH. For a given pH value the corrosion current density of Ti increases with increasing fluoride concentration and for a given fluoride concentration, pH decrease leads to an increase of the corrosion current density. Both tendencies reveal a

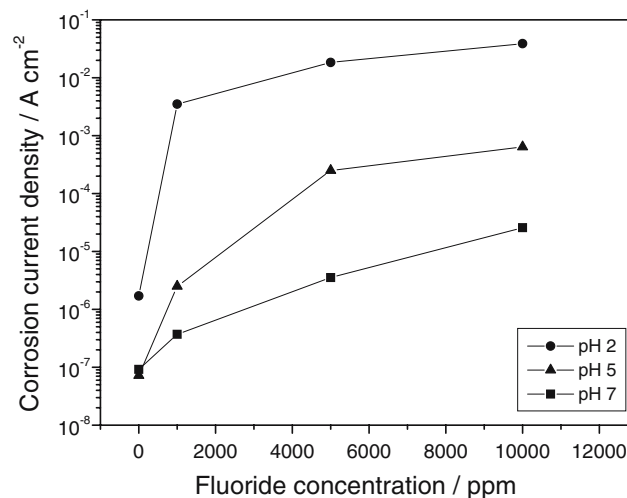

Fig. 5 Variation of Ti corrosion current density in artificial saliva as a function of fluoride concentration and pH

decrease in corrosion resistance. There is a good consistence between the corrosion data of Fig. 5 and the corrosion current densities reported by Al-Mayouf [12] and Schiff [9].

Immersion corrosion tests of Ti polished coupons (1 cm² area) were performed in saliva of pH 2 and 7 containing 1,000 ppm F. The superficial morphology of Ti tested in saliva of pH 7 is similar to that of untested Ti (Fig. 6a, b). No weight loss was detected after 7 days immersion. This is in accordance with the low corrosion current density measured in this solution, around 3.7 × 10⁻⁷ A cm⁻², which must lead to weight loss in the order of 10⁻⁵ g cm⁻² over 7 days, according to Faraday's law. The Ti coupons immersed in saliva of pH 2 for 2 days presented a very rough surface, indicative of severe general corrosion (Fig. 6c). Weight losses in the order of 0.1 g cm⁻² were measured after 2 days immersion, which corresponds to a corrosion current density of 3.5 × 10⁻³ A cm⁻², close to the value obtained from polarization measurement.

Figure 7 shows the variation of both critical and passive current densities deduced from Fig. 3 as a function of pH and fluoride concentration; the passive current density was measured at 1 V/SCE. Similarly to corrosion current density, the critical and passive current densities tend to increase with increasing fluoride concentration for a given pH, and with decreasing of pH for a given fluoride concentration. These behaviors depict less tendency for passivation and lower oxide film stability.

The electrochemical behavior of Ti [18], as well as Si [18, 19] and Nb [20], in acidic fluoride media was shown to be determined by the presence or not of HF and HF₂⁻ species. The concentrations of F⁻, HF and HF₂⁻ are dependent on both pH and total fluoride content and can be easily calculated from the equilibrium constants [19] of the following reactions:

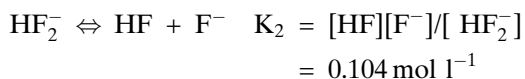
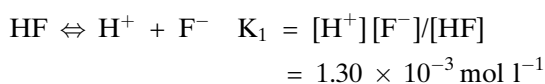

and the equality: [total F] = [F⁻] + [HF] + 2[HF₂⁻]

The calculations using our experimental conditions show that:

- at pH 7, F⁻ is the only species in solution.
- at pH 5, F⁻ is predominant for all fluoride concentrations. At pH 5, HF and HF₂⁻ have negligible concentrations when compared to F⁻ for 1,000 ppm

F, but significant concentrations for 5,000 and 10,000 ppm F.

- at pH 2, HF is predominant for all fluoride concentrations and HF₂⁻ is the second more abundant species for 5,000 and 10,000 ppm F. F⁻ and HF₂⁻ present similar concentrations for 1,000 ppm F.

It can be seen that the observed active behavior of Ti, that depends on both total fluoride concentration

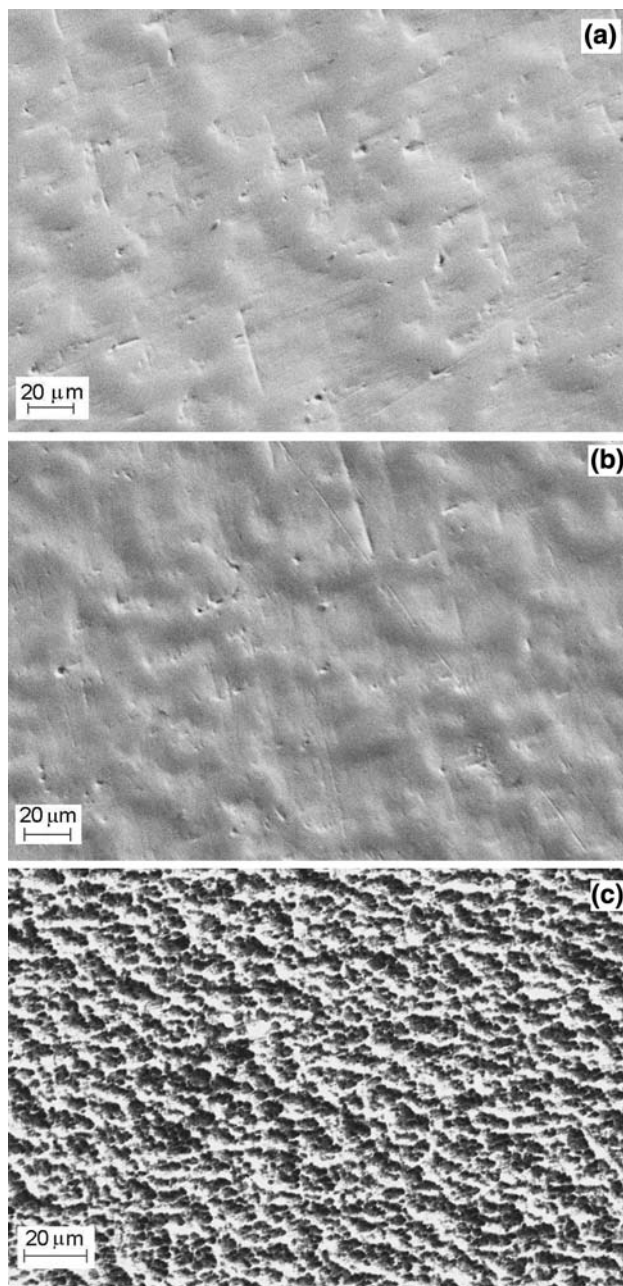

Fig. 6 SEM photographs of the surface of (a) untested Ti, (b) Ti tested for 7 days in artificial saliva of pH 7 containing 1,000 ppm F and (c) Ti tested for 2 days in artificial saliva of pH 2 containing 1,000 ppm F

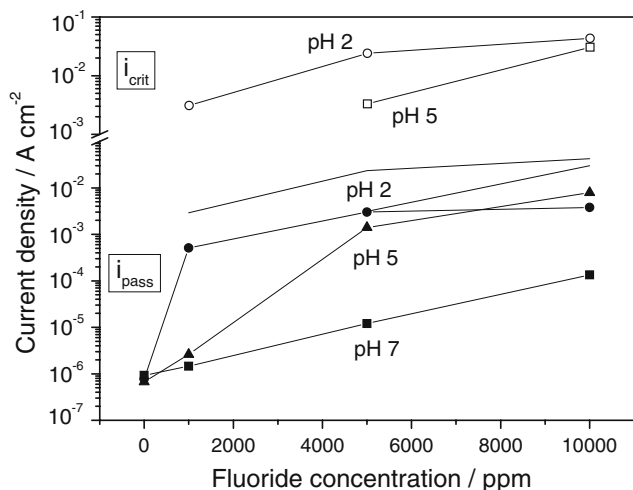
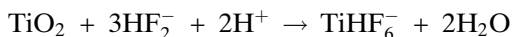

Fig. 7 Variation of Ti critical current density i_{crit} and passive current density i_{pass} (measured at 1 V/SCE) in artificial saliva as a function of fluoride concentration and pH

and pH, is related to the presence of significant concentration of HF and HF_2^- species, that dissolve the passivating oxide film. On the other hand, Ti is passive in the solutions that contain F^- only (pH 7/all fluoride concentrations) or negligible HF and HF_2^- concentrations (pH 5/1,000 ppm F). This indicates that F^- ions is inactive [18, 20]. Fovet [21] defined a critical pH value corresponding to the pH of TiO_2 oxide film dissolution, probably converted to TiHF_6^- ions. This critical pH was shown to decrease from neutral range for high fluoride concentrations to acidic range for low fluoride concentrations. The following reactions of TiO_2 dissolution can be proposed:



EIS experiments were carried out at OCP in artificial saliva for selected fluoride concentration/pH conditions, in order to observe the influence of both parameters on impedance diagrams. Figure 8a shows the Nyquist diagrams for Ti in saliva of pH 5 containing 0, 1,000 and 5,000 ppm F and in artificial saliva of pH 2 and 7 containing 1,000 ppm F. All the diagrams have capacitive semicircle, whose size decreases as fluoride concentration increases and as pH decreases. The spectrum obtained for 1,000 ppm F/pH 2 shows two well-defined semicircles and a straight line at low frequencies related to a diffusion process through the oxide layer. It can be noted that the impedances measured for the conditions leading to an active state of Ti (5,000 ppm F/pH 5 and

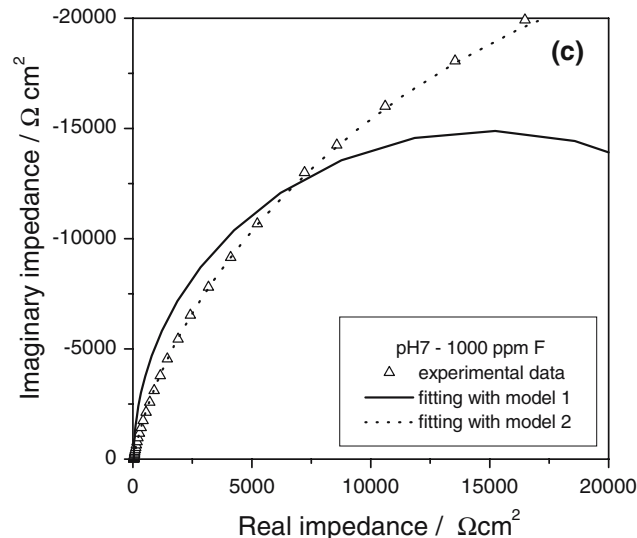
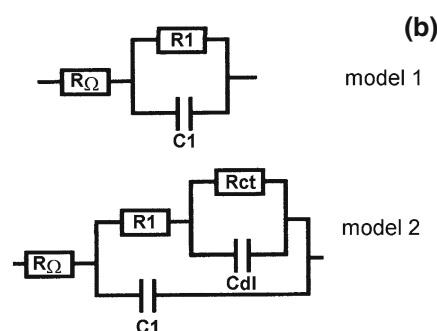
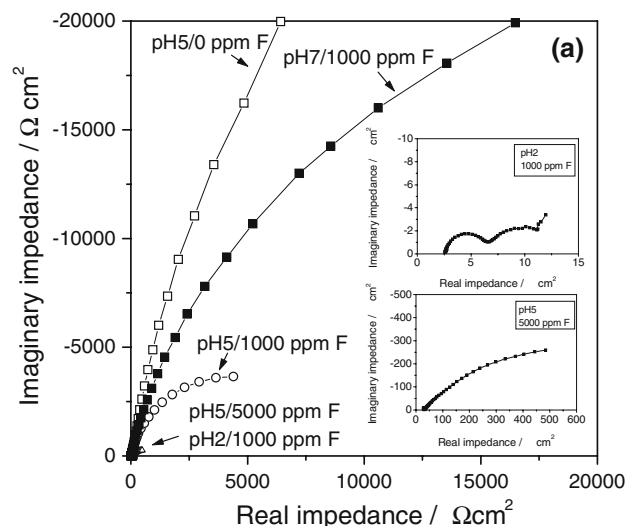

Fig. 8 (a) Nyquist diagrams of Ti at OCP in artificial saliva of pH 5 containing 0, 1,000 and 5,000 ppm F and of pH 2 and 7 containing 1,000 ppm F; (b) Equivalent circuits used for fitting the experimental impedance data: model 1, compact oxide layer; model 2, porous oxide layer; (c) Experimental and simulated data for Ti in artificial saliva of pH 7 containing 1,000 ppm F

1,000 ppm F/pH 2) are much lower than those measured for a passive state. These results depict a reduction in corrosion resistance of Ti with both

Table 1 Charge transfer resistance obtained from impedance measurements for selected fluoride concentration/pH conditions

pH	5		2		7
Fluoride concentration/ ppm	0	1,000	5,000	1,000	1,000
$R_{ct}/\Omega \text{ cm}^2$	117,560	8,500	1,340	6	79,820

fluoride concentration increase and pH decrease, in accordance with the study using potentiodynamic polarization. Nyquist diagrams of the same shape and same order of impedance values were obtained by Al-Mayouf [12] in saliva of pH 7.2 containing 420 and 2,100 ppm F (passive state) and of pH 3 containing 420 ppm F (active state).

The Ti/aqueous solution interface was described by several equivalent circuit models, depending on the structure of the oxide film. The existence of a compact oxide film was represented by an equivalent circuit with one time constant [22–24], whereas for a porous film, a circuit with two time constants was employed [12, 23–26]. Modified models of this latter circuit was used by Pan [26] to take into account the sealing of pores by corrosion products and by Ibris [10] in order to consider the contribution of space charge layer. Asumi [27] used two parallel RC circuits in series to represent titanium oxide film and adsorption/desorption of solution species.

Both models of compact and porous oxide film were tested to fit our experimental data. The components of these equivalent circuits (Fig. 8b) are: R_{Ω} resistance of the electrolyte, C_1 and R_1 capacitance and resistance of the oxide film, C_{dl} capacitance of the double layer and R_{ct} resistance of charge transfer. Instead of capacitances, constant phase elements (CPE) were employed in the fitting routine. The impedance of a CPE is given by: $Z_{CPE} = [(i\omega)^n \cdot C]^{-1}$, where C is the capacitance, ω the angular frequency and n is related to non-uniform current distribution due to surface roughness or inhomogeneity. In all cases, the second model fits the present data better (Fig. 8c), which shows the porous character of the oxide film on titanium. The porosity of the oxide film is enhanced by the presence of fluorides and low pH of the saliva, due to its dissolution. As expected, the charge transfer resistance R_{ct} obtained from the fitting (Table 1), or which is the same, the corrosion resistance, decreases with decreasing pH and/or increasing fluoride concentration.

4 Conclusions

This study of the behavior of Ti in Fusayama artificial saliva of pH 2, 5 and 7, without fluorides or containing 1,000, 5,000 and 10,000 ppm F, based on open-circuit

potential measurements, potentiodynamic polarization and electrochemical impedance spectroscopy shows that:

- Ti can present active or passive behavior depending on pH and fluoride concentration.
- A defined correlation between pH and fluoride concentration leads to depassivation of Ti.
- The stability of Ti in artificial saliva decreases at high concentrations of fluoride ($[F] \geq 1,000$ ppm at pH = 2 and $[F] \geq 5,000$ ppm at pH = 5). At pH = 7, Ti is stable at fluoride concentration up 10,000 ppm.

References

1. Jones FH (2001) Surf Sci Rep 42:75
2. ASM Handbook, Corrosion, Vol. 13 (ASM International, Materials Park, OH, 1993)
3. Strang R, Whitters CJ, Brown D, Clarke RL, Curtis RV, Hatton PV, Ireland AJ, Lloyd CH, McCabe JF, Nicholson JW, Scrimgeour SN, Setcos JC, Sherriff M, van Noort R, Watts DC, Woods D (1998) J Dent 26:191
4. Strang R, Whitters CJ, Brown D, Clarke RL, Curtis RV, Hatton PV, Ireland AJ, Lloyd CH, McCabe JF, Nicholson JW, Scrimgeour SN, Setcos JC, Sherriff M, van Noort R, Watts DC, Woods D (1998) J Dent 26:273
5. Gioka C, Bourael C, Zinelis S, Eliades T, Silikas N, Eliades G (2004) Dent Mater 20:693
6. Reclaru L, Meyer JM (1998) Biomaterials 19:85
7. Nakagawa M, Matsuya S, Shiraishi T, Ohta M (1999) J Dent Res 78:1568
8. de Mele MFL, Cortizo MC (2000) J Appl Electrochem 30:95
9. Schiff N, Grosgeat B, Lissac M, Dalard F (2002) Biomaterials 23:1995
10. Ibris N, Mirza Rosca JC (2002) J Electroanal Chem 526:53
11. Nakagawa M, Matsuya S, Udoh K (2002) Dent Mater J 21:83
12. Al-Mayouf AM, Al-Swayih AA, Al-Mobarak NA, Al-Jabab AS (2004) Mater Chem Phys 86:320
13. Boere G (1995) J Appl Biomater 6:283
14. Oda Y, Kawada E, Yoshinari M, Hasegawa K, Okabe T (1996) Jap J Dent Mater Dev 15:317
15. Baboian R (1995) Corrosion tests and standards: application and interpretation. ASTM, USA
16. Pourbaix M (1966) Atlas of electrochemical equilibria in aqueous solutions. Pergamon Press, New York
17. Huang HH (2003) Biomaterials 24:275
18. Frateur I, Catarrin S, Musiani M, Tribollet B (2000) J Electroanal Chem 482:202
19. Catarrin S, Frateur I, Musiani M, Tribollet B (2000) J Electrochem Soc 147:3277
20. Catarrin S, Musiani M, Tribollet B (2002) J Electrochem Soc 149:457
21. Fovet Y, Gal J-Y, Toumelin-Chemla F (2001) Talanta 53:1053
22. Shukla AK, Balasubramaniam R, Bhargava S (2005) Intermetallics 13:631
23. Gonzáles JEG, Mirza-Rosca JC (1999) J Electroanal Chem 471:109
24. Popa MV, Demetrescu I, Vasilescu E, Drob P, Lopez AS, Mirza-Rosca J, Vasilescu C, Ionita D (2004) Electrochim Acta 49:2113
25. Aziz-Kerrzo M, Conroy KG, Fenelon AM, Farrell ST, Breslin CB (2001) Biomaterials 22:1531
26. Pan J, Thierry D, Leygraf C (1996) Electrochim Acta 41:1143
27. Azumi K, Yasui N, Seo M (2000) Corr Sci 42:885