



Teaching design for additive manufacturing: efficacy of and engagement with lecture and laboratory approaches

L. E. J. Thomas-Seale¹ · Sanjeevan Kanagalingam¹ · J. C. Kirkman-Brown² · M. M. Attallah³ · D. M. Espino¹ · D. E. T. Shepherd¹

Accepted: 2 March 2022 / Published online: 8 August 2022
© The Author(s) 2022

Abstract

Additive manufacturing (AM) is projected to require 60,000 jobs in the UK by 2025, but there are a series of barriers to the industrial application. One of the most problematic is non-comprehensive knowledge in design for AM (DfAM). This study aims to test the effect of two undergraduate DfAM teaching approaches. A visual and aural approach (design lecture) and a kinaesthetic, problem-based learning (PBL) approach (manufacturing laboratory) were compared against technical and participant perspective criteria to assess the learning, engagement, and self-efficacy of the students. The participants were set a DfAM challenge; to redesign a bracket. The technical merits of the designs were evaluated after teaching through a design lecture alone or after a design lecture and manufacturing-laboratory. The participant's perspective was evaluated at the end of the study. The groups who undertook both the design lecture and manufacturing laboratory showed a mean technical mark of 100% for criteria (C) 13 ("Parts have been consolidated into one part"), 91.7% for C14 ("The bracket is hollowed where possible") and 100% for C16 ("Manufacture was successful"). These technical marks demonstrate a statistically significant increase over those of the groups who undertook the design lecture alone. The participant evaluation reinforced this result; the manufacturing laboratory was chosen more frequently in answer to questions on applicability (Q13 = 83%), preparedness (Q15 = 83%), and gaining confidence in DfAM (Q31 = 74%). This study demonstrates the importance of PBL in DfAM, both to increase technical aptitude of the student (creativity and manufacturing) and their perspective on their own learning and self-efficacy.

Keywords 3D printing · Additive manufacturing · Design · Problem-based learning · Pedagogy

✉ L. E. J. Thomas-Seale
l.e.j.thomas-seale@bham.ac.uk; lauren.ej.thomas.seale@gmail.com

¹ Department of Mechanical Engineering, School of Engineering, University of Birmingham, Edgbaston, Birmingham B15 2TT, UK

² Centre for Human Reproductive Science, Institute of Metabolism and Systems Research, College of Medical and Dental Sciences, University of Birmingham, Edgbaston, Birmingham B15 2TT, UK

³ School of Metallurgy and Materials, University of Birmingham, Edgbaston, Birmingham B15 2TT, UK

Introduction

The UK National Strategy 2018–2025 for Additive Manufacturing (AM) estimates that by 2025, 60,000 jobs will be supported by AM and associated economic knowledge (Additive Manufacturing UK, 2017). Yet, one of the key barriers to the industrial progression of additive manufacturing (AM) is fragmented knowledge of design for manufacturability across AM platforms, parameters and materials. Knowledge transfer of AM is predominately bottom-up, leading to not only an inefficient, but an application-specific knowledge base (Thomas-Seale et al., 2018). Whilst knowledge transfer between all the facets, is a well acknowledged requirement of efficient design (Kusiak, 1993), there is an inherent deficiency in the breadth and/or depth of design for AM (DfAM) knowledge held by design engineers.

Innovative and efficient DfAM is equally dependent on creative freedom, underpinned by knowledge of the manufacturing limitations. The enhanced complexity of geometric design enabled by AM is heavily promoted in the media. Whilst these endeavours inspire creative solutions, the emphasis of marketing campaigns, which portray optimum design efficiency, can give a sense that the field is more developed than it actually is. Conversely, in research literature the limitations of AM are well documented, and the associated design constraints are material, machine and process-specific (Thompson et al., 2016).

Thomas-Seale et al. (2018) demonstrated that education underpins the propagation of AM knowledge in industry. Thus, a sustainable solution to this barrier would be the integration of DfAM into undergraduate engineering programmes. However, the lack of comprehensive DfAM education in most undergraduate programmes is well-acknowledged, further requiring specialist education programmes to equip engineers with the DfAM skills (Ford & Despeisse, 2016). A recent review (Ford & Minshall, 2019) further identified that AM education research is disjointed, spanning multiple disciplines and pedagogical environments. For the purposes of this study, focus shall primarily be given to the critical analysis of engineering education research undertaken in a higher education (HE) setting.

The advantages and opportunities of teaching DfAM are well documented; for example as a prototyping technique (Carfagni et al., 2020; Pieterse & Nel, 2016), to teach AM fundamentals (Go & Hart, 2016) and for subject specific applications (Horowitz & Schultz, 2014). Several studies outline frameworks and strategies for implementation (Go & Hart, 2016; Stern et al., 2019) with a light-touch qualitative analysis of the participants outcomes. Studies with a higher pedagogic focus have quantified the positive outcomes (from the students' perspective) of integrating DfAM: supported innovation and learning motivations (Chiu et al., 2015), ideation (novelty and quality) (Hwang et al., 2020) and increased motivation, interest and ease of learning (Minetola et al., 2015). Chekurov et al. (2020) quantitatively assessed creativity resulting from a DfAM course, and the increase in creativity over 5 consecutive years. This study demonstrated a measurable increase in creativity through development of the course content, notably: an experimental AM community at the university, the increased presence of AM in the media and a physical part-library (Chekurov et al., 2020).

Fernandes and Simoes (2016) focussed specifically on learning styles and showed that the students ranked (unanimously highly) the importance of real-life 3D printing in teaching. More recently, Prabhu et al. (2020) explored the impact of teaching restrictive (e.g. geometric limitations) versus restrictive and opportunistic (e.g. enhanced geometric complexity) DfAM concepts on student creativity. Whilst the change in teaching content did not affect the students' creativity (uniqueness and usefulness), nor their self-evaluation;

teaching both restrictive and opportunistic design resulted in designs with higher “technical goodness” (Prabhu et al., 2020). To date, the outcomes of different teaching approaches for DfAM, on technical and participant perspective outcomes, have not been measured. This information is important, as it can guide academic faculty towards the most efficient and effective method of implementing DfAM into undergraduate programmes. This study shall address this gap in pedagogic research literature.

The study shall test the efficacy of and engagement with knowledge transfer of DfAM using different teaching modalities. The aim of this research is to investigate the difference in the participant’s technical aptitude and perspective after undertaking different DfAM teaching approaches; a lecture approach vs a lecture combined with a kinaesthetic and problem-based learning (PBL) laboratory approach.

Theory

Research hypothesis

With the view to integrating DfAM into the HE engineering syllabus, the foremost question is to identify the most efficient and effective method of doing so. Ideally, a full perspective of DfAM would be gained from a comprehensive and multi-modality learning environment. However, to incorporate the full breadth and depth of DfAM including material science, computation and machine design is a huge challenge (Go & Hart, 2016). This study will focus on DfAM related specifically to mechanical design and design for manufacturing, as would be covered in a traditional undergraduate mechanical engineering programme.

It is well acknowledged in the pedagogical literature, that a range of teaching strategies are required to engage with all students (Smith et al., 2005). The aim of capturing a diversity of students (in terms of motivation, attitudes, and response) requires consideration of learning styles, approaches to learning and intellectual development levels (Felder & Brent, 2005). This study will focus on learning styles, as a lens through which teaching approaches can be most easily adapted. However, it should be noted that a student’s approach to learning and their intellectual development, may also be something inherent to the student, or something influenced through the educational environment. These factors may also indirectly affect the outcomes of this study.

When considering engineering in HE, the modality of information, is very important. Engineering, whilst widely known for its mathematical and computational emphasis, remains a discipline which is highly focussed on spatial parameters for example: the breakdown of forces within a system, the three-dimensional modelling of a part, and the geometric implications of manufacturing on design. The importance of a “learning by doing” experience, such as a mechanics laboratory, is irreplaceable.

The research into the styles of learning is extensive (Coffield et al., 2004). Of these, the Dunn and Dunn model focuses on how methods of concentration and learning difficult information varies between learners (Dunn & Dunn, 1974; Jonassen & Grabowski, 1993). There are four learning modalities in the Dunn and Dunn learning style: auditory, visual, read–write and kinaesthetic (Jonassen & Grabowski, 1993). Considering these learning types, and with reference to the “learning by doing” experience for engineering students; the importance of kinaesthetic learning, is clear.

The positive impact of active or PBL is often the subject of pedagogical research. The well-known definition of Bonwell and Eison (1991) states that “active learning requires students to do meaningful learning activities and think about what they are doing”. Dym et al. (2005) highlight the importance of project-based learning “as one of the more effective ways for students to learn design by experiencing design as active participants”. Yet, neither definition specifically references a kinaesthetic approach. In the pedagogic literature specifically for design and engineering, the concept of a hands-on learning approach, is often associated with the terms active learning or project (or problem) based learning). Indeed, the positive impact of hands-on, active, PBL (and similar active learning environments) in education have been reported extensively, in STEM (Freeman et al., 2014) and engineering (Prince, 2004).

Using 3D printing to learn about other subjects, in the sense of being able to rapidly prototype artefacts, has been widely regarded as a positive teaching resource (Ford & Minshall, 2019). To date, the pedagogic literature on DfAM also reports a positive increase in student experience and outcomes (see introduction). However, teaching approaches in the university environment, are inherently constrained by resources and time, and therefore lectures have long persevered as the predominant modality for teaching. To establish whether the integration of a kinaesthetic PBL teaching approach (over lecture-based teaching in isolation) improves student learning outcomes, an exploration with reference to specific teaching approach is required. This study hypothesises that reinforcing DfAM teaching by incorporating a kinaesthetic PBL approach alongside the traditional lecture-based modality, will increase the technical aptitude of student participants. In addition, this study will measure student engagement and whether any student preferences were shown to a learning approach, and whether this was affected by the order of which the teaching session was undertaking (lecture then laboratory vs laboratory then lecture).

This study was designed to answer the following research questions (RQ):

RQ1) Does the inclusion of kinaesthetic PBL alongside lecture based DfAM teaching, increase the technical aptitude of student participants, against measures of design function, design for manufacturing, creativity and manufacturing?

RQ2) Do students show a preference towards a teaching approach and is this preference affected by the order in which the different teaching sessions were undertaken?

Study design

This study will compare the efficacy of knowledge transfer in a traditional lecture-based environment, and a lecture reinforced by a hands-on, PBL, laboratory approach. With respect to learning modalities, these two approaches represent an auditory and visually driven method (lecture) compared to a kinaesthetic focussed method (laboratory). Henceforth the teaching styles will be referred to as the lecture and laboratory format.

In a high student volume educational setting, accessible AM platforms are likely to be limited to polymer prototyping. For example, the common and inexpensive, fused deposition modelling (FDM) 3D printers. Interaction with an FDM platform, can offer students an awareness of the interdependency of materials and manufacturing parameters in a time and cost efficient manner. In turn, reinforcing the requirement to seek

this information early on in the design process. Thus, the laboratory teaching approach was designed utilising FDM 3D printers.

Outcome measures

The technical ability to utilise DfAM knowledge, transferred from either a lecture or both a lecture and laboratory teaching environment, was tested through a design challenge evaluated against marking criteria. The participants' perspectives of learning, engagement, and self-efficacy for the two teaching methods were evaluated using a student questionnaire at the end of the workshop, once the lecture, laboratory and design challenge were complete. This questionnaire was predominately composed of binary and Likert style questions. With reference to the research questions (RQ1 and RQ2), the outcome measures (OM) were looking to assess the difference in student outcomes between teaching approaches.

OM1) The technical merit (geometric design, the design for manufacturing and final the manufactured part(s)), measured through a design challenge, after either a lecture or both a lecture and laboratory teaching session.

OM2) Overall student teaching preferences through a questionnaire designed to measure learning, engagement, and self-efficacy, undertaken upon the completion of the whole study.

The quality of a questionnaire that measures participant outcomes, in clinical practise and research, can be assessed using the comprehensive checklist compiled by the Consensus-based standards for the selection of health measurement instruments (COSMIN) (Mokkink et al., 2016). The psychometric properties (measured using COSMIN) of student academic satisfaction measurement tools, are summarised in the systematic review by Rahmatpour et al. (2019). The measurements of quality include; internal consistency (interrelatedness of items), reliability, cross-cultural reliability, measurement error, content validity / hypothesis testing (extent to which the scale reflect what is being measured) and structural/construct validity (extent to which the scores reflect dimensionality of the construct) (Rahmatpour et al., 2019). With respect to this study, internal consistency (often measured using Cronbach's alpha), requires a minimum sample size of 200; in this study it could not be determined due to the sample size of $n = 24$. The reliability of the questionnaire was partially ascertained through one repeated question; however it could not be measured under different timings or cross-cultural conditions due logistical constraints of the study. The content validity (aim, population and expertise of investigators) and construct validity (factor extraction) of the study were examined.

Methodology

Teaching content

Twenty-four students were recruited into the study, of which the self-identifying gender ratio of male: female was 23:1. All students were registered on a BEng or MEng Mechanical Engineering programme (at the author's institution) and had completed at least their second year of studies. The study was undertaken after the UK summer exam period (May–June). Ethical approval for the study was granted by the author's

institution. In accordance, any identifying information has been kept confidential, and the data in this study has been fully anonymised. Due to the sole female participant, and the low proportion of female students registered on Mechanical Engineering programmes at the author's intuition, the ethical requirement to keep identifying information confidential means that the gender breakdown, will not be analysed any further.

The 24 students were split into two groups of 12. There were no criteria for splitting the students into groups; when required to work in a pair, they self-selected and they were randomly assigned to undertake the lecture or laboratory first. Prior to both the lecture and laboratory session, some topics that were presented via auditory and visual mediums. These topics included: agenda for the course and day, health and safety, ethics, purpose of the study, overview of additive manufacturing and basic principles of FDM.

The learning outcomes of the lecture and laboratory teaching sessions were the same, but were delivered in a different way. Seven key design constraints of FDM, the learning outcomes, and how the knowledge was translated through the lecture and laboratory environment, is outlined in Table 1 and Fig. 1. These key learning points were summarised in a hand-out at the end of the design lecture, and at the end of the worksheets for each laboratory task. In addition to this, the relevant functionality of the AM pre-build software Cura (Ultimaker, Utrecht, Netherlands) was demonstrated including: importing models, moving, rotating and scaling, customising parameters, enabling supports, brims and rafts.

The lecture teaching content was delivered purely by auditory and visual mediums, with the teacher encouraging verbal discussion. In a small group teaching environment, discussion was possible, however this component could not be easily scaled up to a larger scale teaching environment. The lecture content was delivered over a 2 hour period.

The laboratory teaching content was primarily administered through PBL utilising hands-on exercises. The laboratory content was delivered over a 6 hour period utilising FDM 3D printers (Replicator 2X, Makerbot Industries, USA; Duplicator i3, WanhaoUK, UK; Ingenium, Avatar 3D, UK). To begin the laboratory session, a demonstration of the 3D printer functionality was given, followed by a series of 7 manufacturing exercises, which are outlined in Table 1 to target each of the DfAM criteria. Whilst these exercises were being undertaken the workshop facilitators engaged the students in verbal discussion to support the learning outcomes. The teaching was supported by a small amount of visual and auditory media to ensure that all the content from the lecture was also mirrored in the laboratory.

Design challenge

The 12 students in each group were self-organised into pairs to complete the design project challenge. For the purpose of assessing these groups, they are denoted as follows. Groups 1–6 undertook the DfAM lecture and design project on the first day followed by the manufacturing laboratory on day 2. Groups 7–12 undertook the manufacturing laboratory on day 1, followed by the design lecture and then the design project on day 2. Thus prior to the design challenge, groups 1–6 has undertaken the lecture, and groups 7–12 had undertaken the laboratory and lecture.

The aim of the design challenge was to “redesign the interfacing brackets (Fig. 2a and b) for fused deposition modelling (FDM) so that it meets the functional dimensions labelled on the assembly drawing”, (Fig. 2c). The brackets were to be redesigned using the CAD software Solidworks (Dassault Systemes, Paris, France). The full design challenge can be found in Appendix A. To summarise the brief, the objectives included: the interfacing

Table 1 Key designs constraints, the learning outcomes, and teaching approach used in the lecture and laboratory environment

DfAM criteria	Learning outcomes	Lecture content	Laboratory content
Self-Supporting Features	Understand problems with overhanging features	Images of overhangs and cut-outs (e.g. Fig. 1a)	PBL: Trial and error printing exercise (Fig. 1a) with different orientations and temperatures
	Understand that (as a rule of thumb) self-supporting features > 45° machine and processing parameter dependent	Explanation of the rule of thumb Example images of when rule of thumb does not work – dependency on manufacturing parameters	Student learned in-situ through failing and inconsistency of the prints Display image examples of overhangs
Thermal Warping	Understand thermal warping, why it occurs and what impact it has	Images of thermal warping (e.g. Fig. 1b) plus verbal explanation	Inspecting parts that have failed due to thermal warping (e.g. Fig. 1b)
	Understand how thermal warping can be alleviated	Explain parameters effecting warping Outline solutions to alleviate warping	Explain why thermal warping occurs and how to overcome it
Geometric Constraints	Understand that resolution of features depends on the nozzle diameter and the precision of the extruder movements	Image of engineering drawing (Fig. 1c) compared to an image of the printed part	PBL: Print the part shown in the engineering drawing (Fig. 1c) and compare the manufacturability of the feature with respect to the feature size
	Understand that (as a rule of thumb) features should be 4 times the layer thickness or 2 mm	Explanation of the rule of thumb	Outline the parameters which effect resolution and the rule of thumb
	Understand that minimum feature size is machine and processing parameter dependent	Explain that the minimum feature is dependent on machine and manufacturing parameters	

Table 1 (continued)

DfAM criteria	Learning outcomes	Lecture content	Laboratory content
Tolerancing	Understand that tolerancing depends on the nozzle diameter, precision of the extruder movements, and heating and cooling of the polymer	Explain rule of thumb and then disprove rule of thumb by comparing engineering drawing (Fig. 1d) and an image of the actual dimensions of part	Print the part shown in the engineering drawing (Fig. 1d), measure the features with Vernier callipers and compare to the drawing
	Understand that tolerancing is difficult even with experience; tight tolerances will always require finishing	Explain that tolerancing is difficult across all AM modalities and therefore post-processing parts is another important consideration	Explain what parameters will affect resolution and discuss the inaccuracy of the rule of thumb
Orientation and Part Strength	Understand that (as a rule of thumb) cut-out features are undersized, solid feature are oversized but this is machine and processing parameter dependent		
	Understand that orientation effects the location of support material and the strength of the part	Explain that the strength of the part is orthotropic. Images of buckle printed (and failing) in different directions Explain that the location of supports effects functionality and surface finishing. Images of the table stand (Fig. 1e) were used to demonstrate this	Choose the orientation and print the part shown in Fig. 1e Use the pre-build software to orientate the part for strength and minimum support on functional faces
			Explain why the strength of part varies in different directions

Table 1 (continued)

DfAM criteria	Learning outcomes	Lecture content	Laboratory content
Topology optimisation	<p>Understand that parts can be geometrically optimised to reduce weight, material and cost whilst retaining function</p> <p>Understand that the part density can also be changed (using cellular structures or cut-out features) to reduce weight</p>	<p>Talk through an example of topology optimisation on a cantilever beam</p> <p>Explain the benefits of weight reduction, less material and less waste</p>	<p>Inspect the pre-printed topology optimised parts (Fig. 1f)</p> <p>Initiate discussion of geometry compared to the applied load</p>
Part consolidation	<p>Understand that part consolidation can be utilised for a number of reasons: reduce weight, material, waste, cost and assembly costs</p> <p>Understand that when combined with topology optimisation, part consolidation is useful for flow and heat transfer applications</p>	<p>Use images of the parts shown in Fig. 1f to demonstrate the topology optimised cantilever beam. Complement with images of topology optimised parts from industry</p> <p>Talk through industrial examples of part consolidation for aerodynamic applications</p> <p>Explain the benefits of less waste, cost and higher performance</p> <p>Use images of part shown in Fig. 1g to demonstrate how to consolidate a bending jig</p>	<p>Display images of parts which have been topology optimised in industry</p> <p>Inspect the pre-printed non-consolidated parts and consolidated parts (Fig. 1g)</p> <p>Initiate discussion on the benefits of part consolidation on weight and flow dynamics</p> <p>Display images of parts which have been consolidated in industry</p>

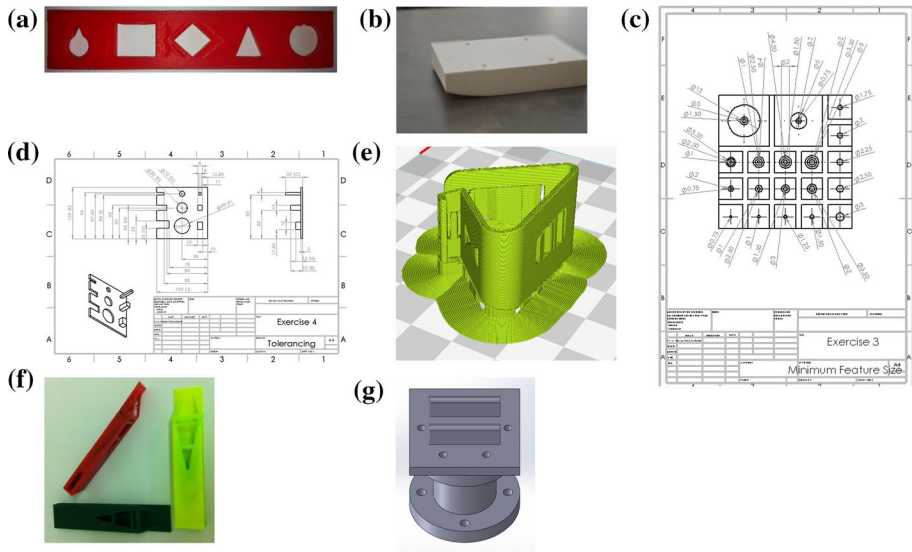

Fig. 1 Example of physical and computational learning aids; **a** part that demonstrates the dependency of cut-out shape on printing orientation, **b** a thermally warped part, **c** engineering drawing of a part with variable feature sizes, **d** engineering drawing of a part with variable cut-out sizes, **e** CAM of table-stand used to demonstrate dependency of support on printing orientation, **f** pre-printed topology optimised cantilever beams and **g** CAD of non-consolidated bending jig

surfaces, 4 holes with a specified diameter, self-supporting features, minimal support, reducing the impact of thermal warping, withstanding a horizontal load at a cut-out (A) at a specified height and minimising the mass of the part. In line with the significant geometric freedom afforded by AM, flexibility was given to the participant in terms of how they achieved this. The students submitted their design as CAD files with the orientation and support structures (including brim or a raft) set in the CAM (Cura, Ultimaker, Utrecht, Netherlands) files. The parts (including support material) were printed using a Makerbot Replicator 2X (MakerBot Industries, New York, USA) in Acrylonitrile butadiene styrene (ABS) (3D FilaPrint Ltd, Southend On Sea, UK). The dimensions of the print volume (246 mm × 152 mm × 155 mm), and a pre-set resolution in the X–Y plane (0.1 mm) and Z direction (0.4 mm) was given to the students. The other manufacturing parameters are shown in Table 2.

The teacher and teaching assistants were permitted to assist the students in the functionality of the software and clarification of any points in the design brief or lecture summary. However, the teacher and teaching assistant were not permitted to aid the students by applying any of the taught knowledge or their pre-existing knowledge to the design problem.

Evaluation

The design projects of all groups were evaluated against the marking scheme outlined in Table 3. An evaluation of the technical aspects of the designs was undertaken on the

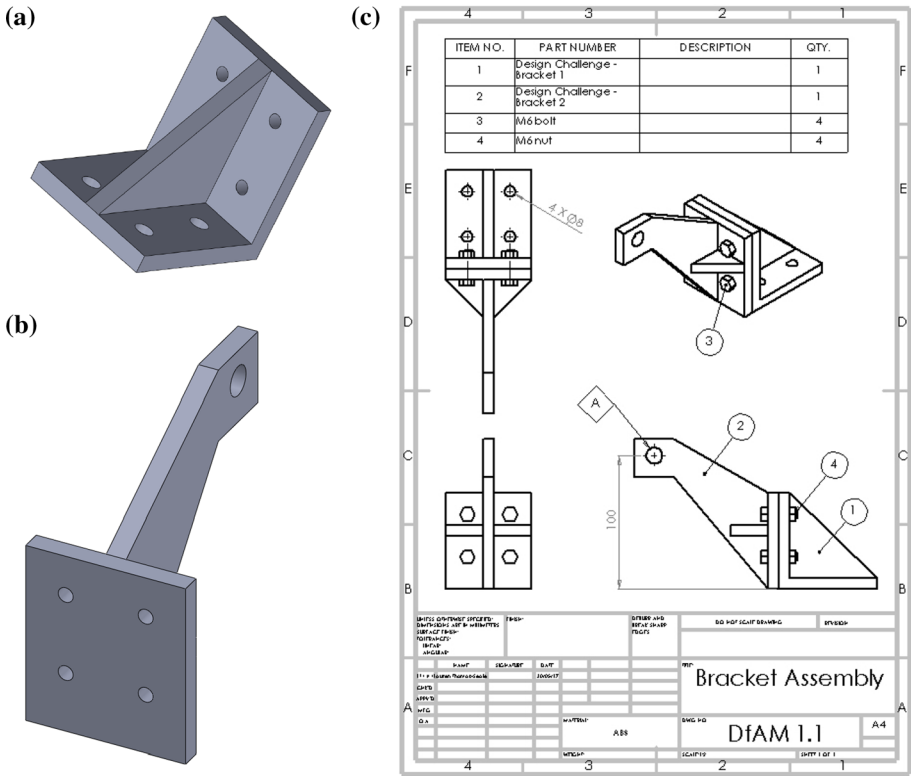

Fig. 2 Baseline CAD models of the two interfacing parts to be redesigned for FDM manufacturing; **a** Bracket 1, **b** Bracket 2 and **c** engineering drawing of the assembly including the functional dimensions

Table 2 FDM manufacturing parameters for ABS

Print setup	Parameter	Value
Infill	Infill density	100%
	Infill pattern	Lines
Material		ABS
	Printing temperature	230
Speed	Build plate temperature	110
	Diameter	1.75 mm
	Enable retraction	Yes
	Print speed	60 mm/s
	Infill speed	60 mm/s
	Wall speed	60 mm/s
	Support speed	70 mm/s
	Travel speed	90 mm/s
Cooling	Initial layer speed	30 mm/s
	Enable print cooling	Yes
	Minimum layer time	5 s

Table 3 Technical marking criteria

	Marking Criteria (C)	DfAM criteria category (see Table 1)
Function	1 The location and size of bolt holes have been matched between the interfacing part	Orientation and tolerances
	2 The surface next to the interfacing part is flush to the build platform	Orientation and tolerances
	3 A rafi/brim has been incorporated to avoid thermal warping	Thermal warping
	4 Feature at (A) is at the correct height (100 mm falls within cut-out) and self-supporting relative to build orientation	Orientation and geometric constraints
	5 The direction of load at (A) is parallel to in-plane direction of print	Orientation and part strength
	6 Fillets have been incorporated	Orientation and part strength
	7 Support structures are not required / not been put on functional surfaces	Self-supporting features and orientation
Design for Manufacturing	8 The main angles of the bracket are self-supporting	Self-supporting features and orientation
	9 Any cut-outs to reduce weight have self supporting angles	Topology optimisation and self-supporting features
	10 The part volume (inc. supports) falls inside the build volume	Design and manufacturing
	11 Wall thickness is above minimum size (2 mm)	Geometric constraints
	12 Part is saved in correct file format/orientation	Design and manufacturing
Creativity	13 Parts have been consolidated into one part	Part consolidation
	14 The bracket is hollowed where possible	Topology optimisation and thermal warping
	15 Did group seek inspiration from other sources?	Topology optimisation
Manufacturing	16 Manufacture was successful	Design and manufacturing
	17 Minimal/zero support was required	Self-supporting features and orientation
	18 Where parts have not been consolidated, they can be assembled	Design and manufacturing

digital submission files (CAD and CAM) and the 3D printed parts. The designs were evaluated against the learning objectives, specifically design for additive manufacturing, and not whether the design could functionally meet the loading requirements. Each marking criteria in Table 3 corresponds to the design criteria outlined in Table 1, and additionally the success of the manufactured parts.

The marking criteria were focussed on the geometric function, design for manufacturing, creativity and manufacture. The majority of the criteria (C) was evaluated through fully/partially or not met (100/50/0%) or not applicable (N/A). The manufacturing criteria C16 and C17 were evaluated as either fully or not met (100/0%). Each student was allocated the same mark for the design submitted by their group. The criteria were designed to not be subjective. The designs were double marked. The marks for each criteria were not weighted.

The participant evaluation was designed to ascertain the perspective from each student on the learning experience, engagement and their own self-efficacy. The participant evaluation questionnaire is shown in Table 4. The questions were predominantly answered through a self-assessment on a 5-point Likert scale (1—strongly disagree, 3—neutral, 5—strongly agree). Some questions were answered by choosing a modality of teaching (design lecture or manufacturing session) and two questions were answered through choosing a learning type (visual, aural, kinaesthetic, read-write).

Data analysis

All data were analysed between the groups sets (1–6 vs 7–12). The participant perspective evaluation was further analysed with respect to the total participant responses. All data is displayed in terms of the mean (mark or response) and standard deviation (where appropriate). The participant evaluation data were also analysed in terms of whether the students thought their primary learning type was kinaesthetic or one of the other three. The technical evaluation was undertaken by pairs of students, and thus could not be broken down into a mark for each student and compared against primary learning type.

SigmaPlot (Systat Software Inc., CA, USA) was used to evaluate the significance of the results. The difference between technical evaluations of the designs by Group 1–6 and 7–12, against each criterion and then the total mark, was statistically analysed using the Mann Whitney U test, applicable to continuous but not normally distributed data sets.

For the participants evaluation responses, the Likert scale was analysed using the mean and (sample) standard deviation (assuming that the constructs have a linear scale), and the binary responses (lecture vs laboratory) were analysed using one-sample Wilcoxon Signed-Rank. The difference between participant's responses between groups 1–6 and 7–12, for the Likert scale questions was analysed using the Mann Whitney U test and for binary responses using the Fisher Exact test. These statistical tests are all applicable to non-parametric data sets. Statistical significance for all tests was defined as $P \leq 0.05$.

To explore the validity of the construct, the responses for the Likert scale questions (Q1-10, Q16-21, Q26-30) were analysed using factor analysis (IBM SPSS Statistics (IBM, NY, USA)). Factors were explored through Principal Component Analysis (PCA) (De Winter & Dodou, 2016); eigenvalues above 1 were extracted, and a Varimax with Kaiser rotation was applied.

Table 4 Participant evaluation questionnaire

Participant Evaluation Question (Q)		
Response, Likert (L), Lecture or Laboratory (Lec/Lab), Visual, Audial Kinesthetic or Read-Write (AVKR)		
Learning	1	The workshop gave me a good working knowledge of DfAM for FDM L
	2	I think that we covered more content in the design lecture than the manufacturing session L
	3	I think that the manufacturing session went into greater detail than the design lecture L
	4	I understood more of the content in the design lecture than the manufacturing session L
	5	I retained more knowledge from the manufacturing session than the design lecture L
	6	I found the more diverse nature of the manufacturing session aided my learning L
	7	I felt informatively prepared for the design challenge L
	8	The workshop has given me a good working knowledge of DfAM for FDM L
	9	I think that DfAM requires additional information over traditional manufacturing L
	10	I think that DfAM is specific to each technology L
	11	The depth of my knowledge was aided more by - Lec/Lab
	12	The breadth of my knowledge was aided more by - Lec/Lab
	13	The applicability of my knowledge was aided more by - Lec/Lab
	14	I would feel more prepared to undertake an exam in DfAM through which learning style - Lec/Lab
	15	I would feel more prepared to undertake coursework in DfAM through which learning style - Lec/Lab
Engagement	16	I found the design lecture interesting L
	17	I found the manufacturing session interesting L
	18	I found the manufacturing session fun L
	19	I found the less structured format of the manufacturing session distracting L
	20	I found the self-learning aspects of the manufacturing challenging L
	21	I needed more help than was available during the manufacturing challenge L
	22	I felt more confident asking questions during the - Lec/Lab
	23	I felt more mentally engaged during the - Lec/Lab
	24	I felt more active during the - Lec/Lab
	25	The most efficient of the two sessions, in terms of knowledge translation was the - Lec/Lab

Table 4 (continued)

Self-Efficacy	Participant Evaluation Question (Q) Response, Likert (L), Lecture or Laboratory (Lec/Lab), Visual, Audial Kinesthetic or Read-Write (AVKR)	
26	I feel confident that I did a good job in the design challenge	L
27	I now feel confident in designing for FDM	L
28	I would feel confident in undertaking DfAM of more complex parts using the foundation knowledge from this work-shop	L
29	I would feel confident in adapting my knowledge of DfAM using FDM to other AM techniques	L
30	This workshop has increased my interest in a career involving additive manufacture	L
31	I gained the most confidence in DfAM for FDM from the -	Lec/Lab
32	I would class my primary type of learning as -	AVKR
33	I would class my secondary type of learning as -	AVKR

Results

Technical evaluation of the design challenge

Figures 3 and 4 show the mean technical marks for each criteria and images of the computational designs and manufactured parts submitted by each group (respectively). The technical evaluation was marked against the criteria which align to the key assessment points outlined in Table 1, with an additional category denoted “design and manufacturing” to encompass the required criteria such as the part falling within build volume, file format and final manufacturing success. The raw marks for each design under each marking criteria are shown in Appendix B, Table 6. Where marks were not in agreement, the marks have been averaged between the two markers, thus the values may vary from the standardised 100/50/0% to include 75/25%. Where detail is required to clearly justify a mark, it has been included in Appendix B, Table 7. The partially met category encompasses all marks from 75–25%. The mean and standard deviation of the marks for each marking criteria and in total for the participants in groups 1–6 ($n=12$) vs groups 7–12 ($n=12$) are shown in Fig. 3. Where the difference is statistically significant, the P value has been included.

The mean technical mark for C13 (parts have been consolidated into one part), C14 (the bracket is hollowed where possible) and C16 (manufacture was successful) were statistically higher for groups 7–12 than groups 1–6. Other outcomes of note include full technical marks for all groups for C5 (the direction of load (A) is parallel to in-plane direction of print), C10 (the part volume (including supports) falls inside the build volume) and C11 (wall thickness is above the minimum size of 2 mm). The mean technical mark for all groups was below 40% for C15 (did group seek inspiration from other sources?). There was no statistically significant difference between the group sets for the total mark (%).

Participant evaluation questionnaire

The raw data for the participant evaluation questionnaire, groups 1–6 and groups 7–12, is shown in Appendix C, Table 8. The mean response and standard deviations of Q1–10, Q16–21 and Q26–20 (the Likert Scale responses), for participants in groups 1–6 ($n=12$) vs groups 7–12 ($n=12$), are shown in Fig. 5a–c. Question 20 (“I found the self-learning aspects of the manufacturing challenging”) demonstrated a statistically significant difference, with group 7–12 giving a higher Likert scale response, i.e. an agreement, than group 1–6. There was no statistical difference between the responses of the participants in group 1–6 and 7–12 for any other Likert scale question.

The responses for the design and manufacturing questions (Q11–15, Q22–25 and Q31), for participants in groups 1–6 ($n=12$) vs groups 7–12 ($n=12$), are shown in Fig. 5d and e. There was no statistical significance between groups 1–6 and groups 7–12 for any of these questions. The primary learning type of the participants are shown in Fig. 5f. One student identified with both visual and aural as their primary learning type. A second analysis of the participant evaluation data of participants was undertaken. This time, the participants with a primary learning type of kinaesthetic ($n=11$) were analysed against participants which identified with another primary learning type ($n=13$). There was no statistical significance between the responses of these groups of participants.

When the responses was assessed across the total number of participants, some questions demonstrated a difference in mean response (where the population median was

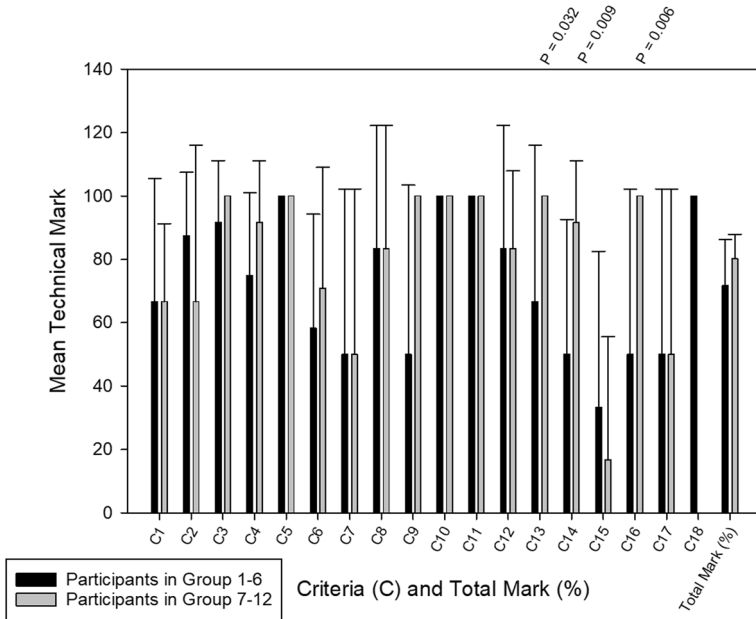

Fig. 3 The mean technical mark and standard deviation (and statistical significance where relevant) between the participants in groups 1–6 and group 7–12, against each criteria and total technical evaluation mark (as a percentage of the maximum possible mark)

assumed to be an equal number of responses for design/manufacturing) (Appendix C, Table 9). The total responses demonstrated a significant difference towards the number of participants who chose the manufacturing option in answer to questions: Q13 = 83% ($P=0.001$), Q15 = 83% ($P=0.001$), Q22 = 75% ($P=0.014$), Q24 = 83% ($P=0.001$) and Q31 = 74% ($P=0.022$).

Psychometric analysis

The participant evaluation questionnaire had 33-items, of which 21-items were measured through a 5-point Likert scale. The full sample size was 24, of which 21 questionnaires were completed in full. In this study, the Likert scale questions were aimed at one research question (RQ2—do students show a preference towards a teaching approach?) and were grouped into three themes (learning, engagement and self-efficacy).

The content validity (the degree to which the Likert scale measures the constructs) was assessed by comparing the aim, target population and concepts against the measurement items, sample population and expertise of the investigators (Rahmatpour et al., 2019). The development of the participant evaluation questions was undertaken by a team of investigators with a huge breadth of research and teaching experience encompassing mechanical and design engineering, and additive manufacturing, using both lectures and laboratory teaching approaches. Therefore, it is reasonable to assume that, based on experience, that the measures adequately reflect the research question (RQ2).

Table 5 Summary of factor analysis and hypothesised themes

Factor (F)	Question (Q)	Hypothesised Theme
F1	Q28 I would feel confident in undertaking DfAM of more complex parts using the foundation knowledge from this workshop	Self-Efficacy—Confidence
F2	Q27 I now feel confident in designing for FDM Q29 I would feel confident in adapting my knowledge of DfAM using FDM to other AM techniques Q5 I retained more knowledge from the manufacturing session than the design lecture Q6 I found the more diverse nature of the manufacturing session aided my learning Q3 I think that the manufacturing session went into greater detail than the design lecture Q2 I think that we covered more content in the design lecture than the manufacturing session Q7 I felt informatively prepared for the design challenge Q26 I feel confident that I did a good job in the design challenge	Learning—Style Knowledge retention
F3	Q8 The workshop has given me a good working knowledge of DfAM for FDM	Interest
F4	Q30 This workshop has increased my interest in a career involving additive manufacture Q16 I found the design lecture interesting	Learning—Specificity
F5	Q10 I think that DfAM is specific to each technology Q9 I think that DfAM requires additional information over traditional manufacturing	Engagement – Learning independence
F6	Q20 I found the self-learning aspects of the manufacturing challenging Q21 I needed more help than was available during the manufacturing challenge	











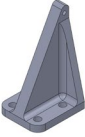

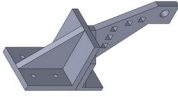

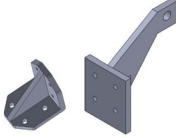
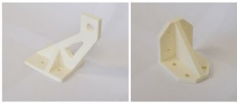
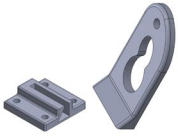





Group	Computational Design	Manufactured Part	Group	Computational Design	Manufactured Part
1			2		
3			4		
5			6		
7			8		
9			10		
11			12		

Fig. 4 The CAD and manufactured parts of Groups 1-12

Internal reliability was investigated through one repeated Likert scale question (Q1 and Q8), with slightly different phrasing. The means of the participants evaluations were similar, Q1=4.5 and Q8=4.4. However, the raw data (Tables 8 and 9 in Appendix C), show that several participants, changed their responses, between these questions.

To explore the construct validity (the degree to which the instrument is consistent with the hypothesis, (Mokkink et al., 2016)), the dimensionality was explored using principal component dimension reduction. This techniques was used to explore common dimensions between the variables. A sample size of $n=21$ (number of complete questionnaires) is very small for a factor analysis, however the minimum sample size for factor analysis has been researched extensively with contradictory outcomes (de Winter et al., 2009; Mundfrom et al., 2005). The inclusion of all variables led to a nonpositive definite matrix. Four variables were removed (Q1, Q4, Q18 and Q19), due to their similarity in phrasing and participant responses (to Q8, Q3, Q17 and Q20 respectively), to eliminate the linear dependency between variables. The analysis is summarised in Table 5; it extracted 6 factors and the rotated component matrix can be seen in Table 10 of Appendix C. It should be noted, that

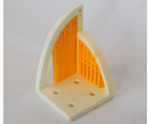
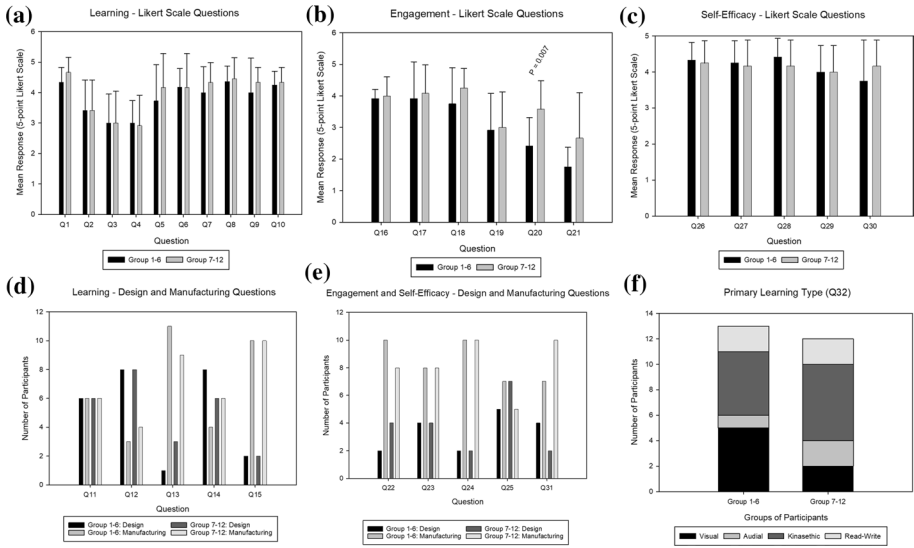

Fig. 5 Group 1–6 and 7–12 responses of the mean (and standard deviation) Likert scale questions for **a** Learning, **b** Engagement and **c** Self-Efficacy; Design and manufacturing questions for **d** Learning and **e** Engagement and Self-Efficacy; and **f** the primary learning type (one participant of group 1–6 identified with two learning types). The statistical significance has been included where relevant

the small sample size made the factor analysis extremely sensitive to changes in the number of variables.

The Likert scale questions were originally designed to explore the participant evaluation through three dimensions (learning, engagement and self-efficacy). However, the factor analysis shows that the results load onto 6 distinct factors. Whilst some of the original groupings of questions cluster onto similar factors, there are additional themes running throughout the participants interpretation of the questions. The hypothesised themes, based on the factor analysis, are outlined in Table 5 Factor (F) 1 is loaded by questions under the original self-efficacy theme, specifically confidence. F2 is loaded by three questions under the original theme of learning, specifically style. F3 and F4 were loaded by questions across the original themes, it is hypothesised that they represent the themes knowledge retention and interest, respectively. The variables loaded onto F5 represent learning specificity and onto F6 represent engagement in terms of independence of learning. It should be noted that Q17 did not load significantly onto any of the 6 extracted factors. Subject to the limitations of the psychometric analysis, the factor analysis has demonstrated that the majority of Likert scale questions load onto factors that relate to the original hypothesis (RQ2).

Discussion

Technical evaluation

The mean technical mark for C13 and C14, which were classified under creativity, were statistically higher for groups 7–12. This result shows that the students who completed the manufacturing laboratory and the lecture, demonstrated an increased frequency of creative features in their design. The final creativity design criteria (C15), concerned with “seeking inspiration”, had a mean technical mark for both group sets below 40%, i.e. very few participants sought inspiration from other sources. Interestingly, “creativity” as a design criterion, was not taught explicitly through either teaching format. Although it was implicit in the challenge to “redesign” the bracket, and through creative solutions demonstrated in the teaching media, the lack of explicit teaching on seeking inspiration meant that the concept did not translate efficiently to the participants.

Groups 7–12 also demonstrated a higher mean technical mark for C16, which was for the successful manufacture of the bracket. A combined lecture and laboratory approach was more effective at transferring DfAM knowledge, leading to successfully manufacturing an AM part. Of additional note, the technical marks for C5 (optimum load direction), C10 (max part volume) and C11 (minimum wall thickness) were 100% for all groups 1–12, indicating that both teaching modalities were equally effective at transferring this knowledge. These marking criteria C5, C11 and C10 were unambiguous with a clearly defined magnitude limit or direction.

Participant evaluation

The difference in the participants perspective on learning, engagement and self-efficacy with respect to the order in which they did the lecture and laboratory, or their learning type (kinaesthetic or otherwise) predominately showed no statistical significant difference. Question 20, “I found the self-learning aspects of the manufacturing challenging”, within the category of engagement, demonstrated a statistically significant difference between the responses of group 1–6 and 7–12. The mean of group 1–6’s responses (2.4 ± 0.26) were between neutral and disagree and group 7–12’s responses (3.58 ± 0.26) were between neutral and agree. Thus, the participants who undertook both the lecture and design challenge before the laboratory, found the self-learning aspects of the manufacturing session less challenging. This is likely to be attributed by the increased accumulation of knowledge prior to the manufacturing laboratory.

When analysing the total participant evaluation data, there was a statistically significant difference between the sample mean and the null hypothesis (assumed to be an equal number of responses) for some of the design and manufacturing questions. There was a bias towards manufacturing responses for questions on aiding applicability of knowledge, feeling prepared to undertake coursework, feeling active and confident to ask questions and gaining most confidence in DfAM. None of the teaching modality questions showed a response bias towards the design lecture. Feeling active and confident to ask questions during the laboratory, both attributes of engagement, can be attributed to the PBL approach. The applicability of knowledge, feeling prepared to undertaken coursework (learning) and gaining confidence in DfAM (self-efficacy) can

be considered as longer term, positive outcome which (from the participants perspective) were due to the manufacturing laboratory as opposed to the design lecture.

Psychometric analysis

In this study, the internal consistency could not be established due to sample size. However, whilst widely acknowledged as a measure of validity, it has been argued that since the Coefficient Alpha measures interrelatedness between items, it is measuring consistency between items, and not explicitly demonstrating that the construct measures what it was intended to measure (Knekta et al., 2019).

The application of a Likert scale to constructs which measure students evaluation of teaching approaches is common, however, the applicability of the approach should be noted. A Likert scale evaluates the constructs in non-linear manner, thus the data can-not be considered continuous along the scale. For example, the relative difference between the scale measuring “neutral” and “agree” compared to “agree” and “strongly agree” is highly dependent on both the question itself and the participant. Furthermore, wider generalisation of the results must be undertaken with caution, and full knowledge of how the sample population reflects the target population; limitations are imposed in terms of the particularly high male:female gender bias, the single (non-repeated) experiment, and the fact that the study was conducted at only one UK institution. Finally, layout of the questions (Hartley & Betts, 2010; Nicholls et al., 2006), scale (Courey & Lee, 2021), the wording of the questions and how the participant interprets that (Gee, 2017), have been shown to create a bias in questionnaire outcomes.

Although PCA is commonly applied as an exploratory factor analysis method, it is subject to limitations (De Winter & Dodou, 2016). The most restrictive limitation in this study, was the sample size of $n=21$. Whilst some research has investigated exploratory factor analysis with small samples sizes (Mundfrom et al., 2005), the widely accepted minimum is $n=50$ (de Winter et al., 2009). Any generalisations drawn from analysis of the Likert scale data, would need to consider this limiting factor. Furthermore, whilst in this study, some Likert scale questions were reverse worded to avoid bias, future work would need to consider the impact of reverse wording on the factor analysis (Zhang et al., 2016).

Study limitations

The main limitation in this study was the low number of participants ($n=24$), and the population from which they were drawn (one UK institution); this limits the generalisation of the conclusions. Whilst the statistical methods applied in the study are applicable to the non-parametric datasets, a small sample size, can affect the robustness of the analysis. This was particularly evident in the psychometric evaluation of the Likert scale participant evaluation, where the internal consistency could not be established, and the factor analysis used to explore construct validity was limited by the sample size $n=21$. Future research would require a much larger sample size, across multiple institutions, and time points. This would increase the significance of the research by enabling the results to be generalised over a wider population, and increase consistency, validity and reliability of the participant evaluation.

The study did not include a control set, thus the mean base-line knowledge of the students is unknown and the null hypothesis (and the population mean) for the design and manufacturing questions was assumed to be equal. Finally, it should be noted that the

teaching content in the lecture and laboratory environments was administered over different time durations. This was a necessity due to the increased amount of time needed to do hands-on experiments, however it gave the laboratory and lecture group a total of 8 h to process the teaching content, as opposed to 2 h for the group undertaking only the lecture prior to the design challenge.

Summary

With reference to RQ1, there was an increase in the technical merit of ‘creativity’ and ‘successful manufacture’ for students who had completed both the lecture and laboratory prior to the design challenge, compared to the null hypothesis. These technical results show that learning was reinforced for the participants who undertook both the laboratory and lecture, leading to increased knowledge transfer. With reference to RQ2, the final participant’s evaluation demonstrated that laboratory teaching modality resulted in feelings of increased knowledge applicability, preparedness and confidence in knowledge. There was no result, that indicated that design lecture in isolation led to increased technical nor participant evaluation outcomes.

The importance of PBL (project or problem) learning is well-recognised in pedagogic literature, for example Dym et al. (2005). In more recent studies the value of real-life 3D printing in teaching has been evaluated, with several studies noting the increased outcomes in creativity (Prabhu et al., 2020), novelty and quality (Hwang et al., 2020). This study contributes to the body of research knowledge in this area by exploring, more specifically, how DfAM teaching approach affects technical and participant perspective outcomes. Whilst reinforcing previous studies, which have noted the impact to creativity, this study has further demonstrated that DfAM laboratory teaching approach increases technical outcomes in terms of manufacturability and participant evaluations in terms of applicability, preparedness, active participation, confidence to ask questions and confidence in DfAM.

This study poses two questions that need to be established by future research. Firstly, the applicability of the results over a broader student population would need to be established through larger samples sizes across multiple institutions. This would also further ascertain the validity of the Likert scale questions against the research question. The second recommendation for future research would be to assess the cost against the benefit, of integrating a wider and more expensive suite of AM techniques and materials into DfAM teaching approaches. In this study two teaching approaches for DfAM were analysed. Yet, they only focussed on one FDM technique and thermoplastic material as means of cost and time efficient, knowledge translation. As described by Kolmos et al. (2016) the methodology utilised in this research, could be incorporated into an undergraduate programme through an add-on approach or integration with existing content. However, in contrast, Go and Hart (2016) describe AM as “truly multidisciplinary” and recommend that programmes embrace the breadth and depth of this educational context.

Conclusions

This study evaluated the technical merit and the perspective of 24 students undertaking a design challenge, after either a design lecture or both a design lecture and a manufacturing laboratory. The results of the study demonstrate a significant increase in technical aptitude

in the areas of creativity and manufacturing success for the participants who undertook both the lecture and laboratory prior to the technical assessment. Through evaluation of all the participants' perspectives, a higher proportion of students reported increased applicability, preparedness and confidence resulting from the laboratory as opposed to the lecture.

In summary, this research has demonstrated the importance of laboratory PBL in DfAM teaching, leading to increased technical merit in areas of creativity and manufacturability, and the student's perspective on their learning and self-efficacy. In the context of the economic potential that AM offers to industry; this study demonstrates that teaching DfAM in HE, using a real-life laboratory approach, will result in graduates with more confidence and a higher technical aptitude, who are better prepared to enter the rapidly developing landscape of industrial AM.

Appendix A

Design for Additive Manufacturing Workshop.

“Design Challenge”.

Group Number:

Day:

Gender.

Participant 1: Male/Female.

Participant 2: Male/Female.

Degree and Year.

Participant 1:

Participant 2:

Key Points.

- Not assessed
- No right or wrong design
- Work in pairs
- Collect two Solidworks part files
- Redesign the interlocking brackets parts for additive manufacture (Solidworks)
- Orientate the part(s) in the pre-build software, include support structures where appropriate (Cura)
- Submit the solidworks and cura files via pen drive transfer

Design Challenge

Aim: Redesign the interfacing brackets for fused deposition modelling (FDM) so that it meets the functional dimensions labelled on the assembly drawing.

- The $4 \times \phi 8$ holes will interface with another part
- Cut-out A should be at a height of 100 mm
- The load will be applied horizontally at cut-out A

Objectives

- (1) The faces and holes that will interface with another part and/or between brackets will need the highest possible tolerance and surface finish

- (2) The feature labelled (A) requires a self-supporting cut out, designed to whatever orientation you decided to manufacture in
- (3) The parts should require minimal finishing and use as little material as possible. I.e. incorporate the minimum number of additional supports. If supports are required ensure they are not on a functional surface.
- (4) Reduce the impact of thermal warping.
- (5) The part should be orientated so that it can withstand a horizontal load at A. I.e. ensure that the load will not be applied along the weakest plane.
- (6) Use your creativity to minimise the weight of the part, whilst fulfilling the overall aim.

Submission

Submit your redesigned Solidworks.prt file(s). There is no need to create an assembly document, but when manufactured your part or parts should assemble to meet the specification. Submit your cura project 0.3mf file (s) so that they are ready to be manufactured. Your project will be marked based on the manufacture of your parts using these a Mak-erbot Replicator 2X. Please save the following files into a folder named after your group number "Group #".

- Solidwork.prt file (s)
- Cura 0.3mf file (s)

Use a pen drive to transfer the folder to the workshop facilitator. Hand in this worksheet.

Appendix B

See Table 6, 7.

Table 6 Raw technical evaluation data

Marking criteria (C)	Group (2 participants per group, n=24)											
	1	2	3	4	5	6	7	8	9	10	11	12
DfAM criteria category (see Table 1)												
Geometric Function												
C1) The location and size of bolt holes have been matched between the inter-facing part	50	0	100	50	100	100	100	100	50	50	100	50
C2) The surface next to the interfacing part is flush to the build platform	100	100	75	50	100	100	100	0	0	100	100	100
C3) A raft/brim has been incorporated to avoid thermal warping	100	100	50	100	100	100	100	100	100	100	100	100
C4) Feature at (A) is at the correct height (100 mm falls within cut-out) and self-supporting relative to build orientation	100	50	50	100	100	50	100	100	100	100	100	50
C5) The direction of load (A) is parallel to in-plane direction of print	100	100	100	100	100	100	100	100	100	100	100	100
C6) Fillets have been incorporated	50	0	50	100	100	50	75	100	100	0	0	50
C7) Support structures are not required / not been put on functional surfaces	100	0	0	100	100	0	100	0	0	100	0	100

Table 6 (continued)

Marking criteria (C)	Group (2 participants per group, n=24)											
	1	2	3	4	5	6	7	8	9	10	11	12
DfAM criteria category (see Table 1)												
Design for Manufacturing												
C8) The main angles of the bracket are self-supporting	100	100	100	100	100	100	0	100	100	100	100	0
C9) Any cut-outs to reduce weight have self-supporting angles	N/A	0	0	100	N/A	100	100	100	100	100	N/A	N/A
C10) The part volume (inc. supports) falls inside the build volume	100	100	100	100	100	100	100	100	100	100	100	100
C11) Wall thickness is above minimum size (2 mm)	100	100	100	100	100	100	100	100	100	100	100	100
C12) Part is saved in correct file format/orientation	100	100	0	100	100	100	100	100	100	100	50	100
C13) Parts have been consolidated into one part	100	100	0	0	100	100	100	100	100	100	100	100
C14) The bracket is hollowed where possible	0	50	50	100	0	100	50	100	100	100	100	100
C15) Did group seek inspiration from other sources?	0	100	0	0	0	100	0	100	0	0	0	0
C16) Manufacture was successful	100	0	0	100	100	0	100	100	100	100	100	100
C17) Minimal/zero support was required	100	0	0	100	100	0	100	0	100	0	100	0
C18) Where parts have not been consolidated, they can be assembled	N/A	N/A	100	100	N/A	N/A	N/A	N/A	N/A	N/A	N/A	N/A

Table 6 (continued)

Marking criteria (C)	DfAM criteria category (see Table 1)	Group (2 participants per group, n=24)											
		1	2	3	4	5	6	7	8	9	10	11	12
Total mark		1300	1000	875	1500	1400	1200	1525	1350	1250	1400	1100	1400
Maximum possible mark		1600	1700	1800	1800	1600	1700	1700	1700	1700	1600	1600	1700
Total mark (%)		81.3	58.8	48.6	83.3	87.5	70.6	89.7	79.4	73.5	87.5	68.8	82.4

Table 7 Assessor notes about the technical marks allocated to each group

Group	Notes on the Marking Criteria (C): met (M), partially met (PM), not met (NM)
1	C1) PM: spacing between the bolt holes are incorrect; C6) PM: fillets incorporated in some places; C11) M: minimum wall thickness 2.76 mm
2	C1) NM: spacing between and diameters of the bolt holes are wrong; C4) PM: feature at (A) is at correct height but not self-supporting; C7) NM: support was required on feature at (A); C9) NM: cut-outs do not have self-supporting angles; C14) PM: bracket is hollowed in some places; C15) M: group sought inspiration from bracket designs; C16) NM: sagging on square cut-outs; C17) NM: a lot of support was required
3	C2) PM: 2 out of 3 interfacing surfaces were flush to the build platform; C3) PM: 1 out of 2 models incorporated a raft/brim; C4) PM: feature at (A) is at correct height but not self-supporting; C6) PM: fillets incorporated in some places; C7) NM: support was required but not included on feature at (A); C9) NM: cut-out does not have self-supporting structures; C12) NM: one part was not saved in the correct file format and the final CAD model of one design was not saved in the latest design; C14) PM: bracket is hollowed in some places; C16) NM: manufacture was not successful on the non self-supporting structures; C17) NM: support was required and not included
4	C1) PM: spacing between the bolt holes are incorrect; C2) PM: due to the design, not all interfacing surfaces are flush to the build platform
5	
6	C4) PM: feature at (A) is at correct height but not self-supporting; C6) PM: fillets incorporated in some places; C7) NM: support is required at (A); C8) The main angles of the bracket are not self-supporting; C15) M: group sought inspiration from nature (fish); C16) NM: sagging on feature (X); C17) NM: a lot of support was required
7	C6) PM: fillets incorporated in some places; C14) PM: bracket is hollowed in some places
8	C1) PM: spacing between the bolt holes are incorrect; C2) Interfacing surface is not flush to build platform; C7) NM: Support has been used on many (inc functional) surfaces; C11) M: minimum wall thickness is 2.13 mm; C15) M: group sought inspiration from topology optimised structures; C17) NM: extensive support was included
9	C1) PM: spacing between the bolt holes are incorrect; C2) Interfacing surface is not flush to build platform; C7) NM: Support has been used on many (inc functional) surfaces; C17) NM: a lot of support was included
10	C1) PM: spacing between the bolt holes are incorrect; C12) PM: part is not saved in the correct orientation in CAM file; C14) M: bracket has been hollowed from underneath
11	C4) M: the feature is self-supporting, support structures were added unnecessarily; C7) NM: Support structures have been put on functional features; C11) M: minimum wall thickness is 2 mm; C17) NM: extensive support was required
12	C1) PM: spacing between the bolt holes are incorrect; C4) PM: feature at (A) is self-supporting but at incorrect height; C6) PM: fillets incorporated in some places; C12) PM: part is not saved in the correct orientation in CAM file

Appendix C

See Tables 8, 9, 10.

Table 8 Raw Participant Perspective Evaluation Data: Strongly Agree (SA), Agree (A), Neutral (N), Strongly Disagree (SD), Design Lecture (DL), Manufacturing Laboratory (ML)

Participant Survey Questions (Q)	Participants in groups 1 to 6					Participants in groups 7 to 12				
	SA	A	N	D	SD	SA	A	N	D	SD
Learning										
Q1) The workshop gave me a good working knowledge of DfAM for FDM	4	8	0	0	0	0	8	4	0	0
Q2) I think that we covered more content in the design lecture than the manufacturing session	1	6	2	3	0	1	6	2	3	0
Q3) I think that the manufacturing session went into greater detail than the design lecture	0	5	2	5	0	1	3	3	5	0
Q4) I understood more of the content in the design lecture than the manufacturing session	0	3	6	3	0	1	2	4	5	0
Q5) I retained more knowledge from the manufacturing session than the design lecture	3	5	0	3	0	7	1	3	1	0
Q6) I found the more diverse nature of the manufacturing session aided my learning	3	7	1	0	0	6	4	0	2	0
Q7) I felt informatively prepared for the design challenge	3	7	1	1	0	5	6	1	0	0
Q8) The workshop has given me a good working knowledge of DfAM for FDM	4	7	0	0	0	6	4	1	0	0
Q9) I think that DfAM requires additional information over traditional manufacturing	4	6	1	0	1	4	8	0	0	0
Q10) I think that DfAM is specific to each technology	3	9	0	0	0	4	8	0	0	0
Q11) The depth of my knowledge was aided more by DfAM	DL	ML				DL	ML			
Q12) The breadth of my knowledge was aided more by DfAM	6	6				6	6			
Q13) The applicability of my knowledge was aided more by DfAM	8	3				8	4			
Q14) I would feel more prepared to undertake an exam in DfAM through which learning style	1	11				3	9			
Q15) I would feel more prepared to undertake coursework in DfAM through which learning style	8	4				6	6			
	2	10				2	10			

Table 8 (continued)

Participant Survey Questions (Q)	Participants in groups 1 to 6				Participants in groups 7 to 12					
	SA	A	N	D	SD	SA	A	N	D	SD
Engagement	SA	A	N	D	SD	SA	A	N	D	SD
Q16) I found the design lecture interesting	0	11	1	0	0	2	8	2	0	0
Q17) I found the manufacturing session interesting	4	5	2	0	1	4	6	1	1	0
Q18) I found the manufacturing session fun	3	5	3	0	1	4	7	1	0	0
Q19) I found the less structured format of the manufacturing session distracting	1	3	3	4	1	1	3	4	3	1
Q20) I found the self-learning aspects of the manufacturing challenging	0	2	2	7	1	2	4	5	1	0
Q21) I needed more help than was available during the manufacturing challenge	0	0	1	7	4	2	2	0	6	2
Q22) I felt more confident asking questions during the -	DL	ML			DL	ML				
Q23) I felt more mentally engaged during the -	2	10			4	8				
Q24) I felt more active during the -	4	8			4	8				
Q25) The most efficient of the two sessions, in terms of knowledge translation was the -	2	10			2	10				
	5	7			7	5				

Table 8 (continued)

Participant Survey Questions (Q)	Participants in groups 1 to 6				Participants in groups 7 to 12					
	SA	A	N	D	SD	SA	A	N	D	SD
Self-Efficacy	SA	A	N	D	SD	SA	A	N	D	SD
Q26) I feel confident that I did a good job in the design challenge	4	8	0	0	0	4	7	1	0	0
Q27) I now feel confident in designing for FDM	4	7	1	0	0	4	6	2	0	0
Q28) I would feel confident in undertaking DfAM of more complex parts using the foundation knowledge from this workshop	5	7	0	0	0	4	6	2	0	0
Q29) I would feel confident in adapting my knowledge of DfAM using FDM to other AM techniques	3	6	3	0	0	3	6	3	0	0
Q30) This workshop has increased my interest in a career involving additive manufacture	3	5	3	0	1	4	6	2	0	0
Q31) I gained the most confidence in DfAM for FDM from the -	DL	ML			DL	ML				
	4	7			2	10				
	Visual	Audial	Kinaesthetic	Read-Write	Visual	Audial	Kinaesthetic	Read-Write		
Q32) I would class my primary type of learning as	5	1	5	2	2	2	6	2		
Q33) I would class my secondary type of learning as	5	1	5	1	4	1	4	3		

The sample size is N = 12 for each set of groups, however, some questions were omitted by some participants. For Q32, one participant answered twice

Table 9 Cumulated Participant Perspective Evaluation Data: Strongly Agree (SA), Agree (A), Neutral (N), Strongly Disagree (SD), Design Lecture (DL), Manufacturing Laboratory (ML)

Participant survey questions (Q)	Participants in groups 1 to 12					Mean \pm standard deviation (Likert) or % of responses (Binary)
	SA	A	N	D	SD	
Learning						
Q1) The workshop gave me a good working knowledge of DfAM for FDM	12	12	0	0	0	4.5 \pm 0.5
Q2) I think that we covered more content in the design lecture than the manufacturing session	2	12	4	6	0	3.4 \pm 1.0
Q3) I think that the manufacturing session went into greater detail than the design lecture	1	8	5	10	0	3.0 \pm 1.0
Q4) I understood more of the content in the design lecture than the manufacturing session	1	5	10	8	0	3.0 \pm 0.9
Q5) I retained more knowledge from the manufacturing session than the design lecture	10	6	3	4	0	4.0 \pm 1.1
Q6) I found the more diverse nature of the manufacturing session aided my learning	9	11	1	2	0	4.2 \pm 0.9
Q7) I felt informatively prepared for the design challenge	8	13	2	1	0	4.2 \pm 0.8
Q8) The workshop has given me a good working knowledge of DfAM for FDM	10	11	1	0	0	4.4 \pm 0.6
Q9) I think that DfAM requires additional information over traditional manufacturing	8	14	1	0	1	4.2 \pm 0.9
Q10) I think that DfAM is specific to each technology	7	17	0	0	0	4.3 \pm 0.5
Q11) The depth of my knowledge was aided more by	DL	ML				DL ML
Q12) The breadth of my knowledge was aided more by	12	12				50.0 50.0
Q13) The applicability of my knowledge was aided more by	16	7				69.6 30.4
Q14) I would feel more prepared to undertake an exam in DfAM through which learning style	4	20				16.7 83.3
Q15) I would feel more prepared to undertake coursework in DfAM through which learning style	14	10				58.3 41.7
	4	20				16.7 83.3

Table 9 (continued)

Participant survey questions (Q)	Participants in groups 1 to 12				Mean \pm standard deviation (Likert) or % of responses (Binary)
	SA	A	N	D	
Engagement	SA	A	N	D	SD
Q16) I found the design lecture interesting	2	19	3	0	4.0 \pm 0.5
Q17) I found the manufacturing session interesting	8	11	3	1	4.0 \pm 1.0
Q18) I found the manufacturing session fun	7	12	4	0	4.0 \pm 0.9
Q19) I found the less structured format of the manufacturing session distracting	2	6	7	7	3.0 \pm 1.1
Q20) I found the self-learning aspects of the manufacturing challenging	2	6	7	8	3.0 \pm 1.1
Q21) I needed more help than was available during the manufacturing challenge	2	2	1	13	2.2 \pm 1.2
	DL	ML			DL ML
Q22) I felt more confident asking questions during the -	6	18			25.0 75.0
Q23) I felt more mentally engaged during the -	8	16			33.3 66.7
Q24) I felt more active during the -	4	20			16.7 83.3
Q25) The most efficient of the two sessions, in terms of knowledge translation was the -	12	12			50.0 50.0

Table 9 (continued)

Participant survey questions (Q)	Participants in groups 1 to 12						Mean \pm standard deviation (Likert) or % of responses (Binary)
	SA	A	N	D	SD	SD	
Self-Efficacy	SA	A	N	D	SD	SD	
Q26) I feel confident that I did a good job in the design challenge	8	15	1	0	0	0	4.3 \pm 0.6
Q27) I now feel confident in designing for FDM	8	13	3	0	0	0	4.2 \pm 0.7
Q28) I would feel confident in undertaking DfAM of more complex parts using the foundation knowledge from this workshop	9	13	2	0	0	0	4.3 \pm 0.6
Q29) I would feel confident in adapting my knowledge of DfAM using FDM to other AM techniques	6	12	6	0	0	0	4.0 \pm 0.7
Q30) This workshop has increased my interest in a career involving additive manufacture	7	11	5	0	1	1	4.0 \pm 1.0
Q31) I gained the most confidence in DfAM for FDM from the -	DL	ML			DL	ML	DL 26.1 ML 73.9
	6	17					
Q32) I would class my primary type of learning as	Visual	Audial	Kinaesthetic	Read-Write			
	7	3	11	4			
Q33) I would class my secondary type of learning as	9	2	9	4			

The sample size is N=24, however, some questions were omitted by some participants. For Q32, one participant answered twice

Table 10 Principal Component Factor Analysis (N= 21) of Likert scale Perspective Evaluation Data. The loading of the question onto each component (the Factors described in Table 5) is represented in bold

Question	Rotated component matrix (<i>converged in 7 iterations</i>)					
	Component					
	1	2	3	4	5	6
Q28	0.886	0.005	0.006	0.208	-0.155	-0.017
Q27	0.862	-0.023	0.295	0.016	0.077	0.113
Q29	0.829	-0.077	0.011	0.236	-0.026	0.001
Q5	-0.195	0.880	-0.007	0.272	0.096	-0.025
Q6	0.228	0.760	0.175	-0.145	-0.001	-0.016
Q3	-0.088	0.730	-0.060	-0.094	-0.166	-0.155
Q2	0.227	-0.551	0.522	0.308	-0.063	0.104
Q7	-0.020	0.240	0.923	-0.110	-0.106	-0.043
Q26	0.573	-0.117	0.705	0.092	-0.037	-0.111
Q8	0.168	-0.155	0.564	0.340	-0.311	0.243
Q30	0.282	0.212	0.028	0.706	-0.309	-0.130
Q16	0.066	-0.032	0.328	0.686	0.293	0.154
Q17	-0.311	0.317	0.181	-0.677	-0.101	-0.076
Q10	0.052	-0.095	-0.289	0.058	0.880	0.064
Q9	-0.108	0.018	0.023	0.001	0.826	0.040
Q20	0.133	0.020	-0.050	-0.048	0.116	0.877
Q21	-0.105	-0.225	0.078	0.127	-0.017	0.851

Acknowledgements The authors would like to acknowledge the support of Revathi Timms (Avatar 3D) in the facilitation of the laboratory workshop.

Author contributions All authors contributed to the study conception and design. Material preparation, data collection and analysis were performed by LTS and SK. The manuscript was written by LTS. All authors commented on previous versions of the manuscript. All authors read and approved the final manuscript.

Funding This study was supported by the Engineering and Physical Sciences Research Council (EP/N005309/1).

Data and material availability Not applicable.

Code availability Not applicable.

Declarations

Conflict of interest The authors have no relevant financial or non-financial interests to disclose. The authors have no conflicts of interest to declare that are relevant to the content of this article. All authors certify that they have no affiliations with or involvement in any organization or entity with any financial interest or non-financial interest in the subject matter or materials discussed in this manuscript. The authors have no financial or proprietary interests in any material discussed in this article.

Ethical approval Ethical approval for the research study (ERN_17-0637) was granted by the Science, Technology, Engineering and Mathematics Ethical Review Committee at The University of Birmingham.

Consent to participate All human volunteers gave informed consent, by signing against the following points: I know that I am under no obligation to take part in the study and I can withdraw at anytime. I understand and agree that the information obtained in this study will be stored and processed using computers and, after the study is completed, the research will be published in a scientific journal and then the raw information will be

deleted. I understand that this study is confidential but not anonymous. My name and email address shall be stored on a secure research drive. My age and gender will be stored in a separate file not linked to my name and email address. The results of the assessment that are in hard copy and this consent form shall be stored in a locked cupboard. I have read the Information Sheet that has been provided to me, and this Consent Form, and have been given the opportunity to ask questions about them. I am satisfied that I have all the information that I need to provide informed consent. I agree to participate in the study.

Consent for publication All human volunteers gave consent for publication, by signing against the following point: I understand and agree that the information obtained in this study will be stored and processed using computers and, after the study is completed, the research will be published in a scientific journal and then the raw information will be deleted.

Open Access This article is licensed under a Creative Commons Attribution 4.0 International License, which permits use, sharing, adaptation, distribution and reproduction in any medium or format, as long as you give appropriate credit to the original author(s) and the source, provide a link to the Creative Commons licence, and indicate if changes were made. The images or other third party material in this article are included in the article's Creative Commons licence, unless indicated otherwise in a credit line to the material. If material is not included in the article's Creative Commons licence and your intended use is not permitted by statutory regulation or exceeds the permitted use, you will need to obtain permission directly from the copyright holder. To view a copy of this licence, visit <http://creativecommons.org/licenses/by/4.0/>.

References

- Additive Manufacturing UK 2017. National Strategy 2018–2025.
- Bonwell, C. C. & Eison, J. A. Active learning: Creating excitement in the classroom. 1991 ASHE-ERIC Higher Education Reports. 1991.
- Carfagni, M., & Fiorineschi, Furferi R, Governi I, Rotini F, I. (2020). Usefulness of prototypes in conceptual design: students' view. *International Journal on Interactive Design and Manufacturing (IJIDeM)*, *14*, 1305–1319.
- Chekurov, S., Wang, M., Salmi, M., & Partanen, J. (2020). Development, implementation, and assessment of a creative additive manufacturing design assignment: interpreting improvements in student performance. *Education Sciences*, *10*, 15.
- Chiu, P. H. P., Lai, K. W. C., Fan, T. K. F. & Cheng, S. H. 2015. A pedagogical model for introducing 3D printing technology in a freshman level course based on a classic instructional design theory. In 2015 IEEE Frontiers in Education Conference (FIE), 21–24
- Coffield, F., Moseley, D., Hall, E., & Ecclestone, K. (2004). *Learning styles and pedagogy in Post-16 learning*. London: Learning and Skills Research Centre.
- Courey, K. A., & Lee, M. D. (2021). A model-based examination of scale effects in student evaluations of teaching. *Aera Open*, *7*, 14.
- De Winter, J. C. F., & Dodou, D. (2016). Common factor analysis versus principal component analysis: A comparison of loadings by means of simulations. *Communications in Statistics-Simulation and Computation*, *45*, 299–321.
- De Winter, J. C. F., Dodou, D., & Wieringa, P. A. (2009). Exploratory factor analysis with small sample sizes. *Multivariate Behavioral Research*, *44*, 147–181.
- Dunn, R., & Dunn, K. (1974). Learning style as a criterion for placement in alternative programs. *Phi Delta Kappan*, *56*, 275–278.
- Dym, C. L., Agogino, A. M., Eris, O., Frey, D. D., & Leifer, L. J. (2005). Engineering design thinking, teaching, and learning. *Journal of Engineering Education*, *94*, 103–120.
- Felder, R. M., & Brent, R. (2005). Understanding student differences. *Journal of Engineering Education*, *94*, 57–72.
- Fernandes, S. C. F. & Simoes, R. 2016. Collaborative use of different learning styles through 3D printing. In 2016 2nd International Conference of the Portuguese Society for Engineering Education (CISPEE), 20–21. 1–8.
- Ford, S., & Despeisse, M. (2016). Additive manufacturing and sustainability: An exploratory study of the advantages and challenges. *Journal of Cleaner Production*, *137*, 1573–1587.

- Ford, S., & Minshall, T. (2019). Invited review article: Where and how 3D printing is used in teaching and education. *Additive Manufacturing*, 25, 131–150.
- Freeman, S., Eddy, S. L., McDonough, M., Smith, M. K., Okoroafor, N., Jordt, H., & Wenderoth, M. P. (2014). Active learning increases student performance in science, engineering, and mathematics. *Proceedings of the National Academy of Sciences of the United States of America*, 111, 8410–8415.
- Gee, N. (2017). A study of student completion strategies in a Likert-type course evaluation survey. *Journal of Further and Higher Education*, 41, 340–350.
- Go, J., & Hart, A. J. (2016). A framework for teaching the fundamentals of additive manufacturing and enabling rapid innovation. *Additive Manufacturing*, 10, 76–87.
- Hartley, J., & Betts, L. R. (2010). Four layouts and a finding: The effects of changes in the order of the verbal labels and numerical values on Likert-type scales. *International Journal of Social Research Methodology*, 13, 17–27.
- Horowitz, S. S., & Schultz, P. H. (2014). Printing space: Using 3D printing of digital terrain models in geosciences education and research. *Journal of Geoscience Education*, 62, 138–145.
- Hwang, D., Lauff, C., Perez, K. B., Camburn, B., & Wood, K. (2020). Comparing the impacts of design principles for additive manufacturing on student and experienced designers. *International Journal of Engineering Education*, 36, 1862–1876.
- Jonassen, D. H., & Grabowski, B. L. (1993). *Handbook of individual differences, learning and instruction*. New Jersey: Lawrence Erlbaum Associates, Inc.
- Knekta, E., Runyon, C., & Eddy, S. (2019). One size doesn't fit all: Using factor analysis to gather validity evidence when using surveys in your research. *Cbe-Life Sciences Education*, 18, 14.
- Kolmos, A., Hadgraft, R. G., & Holgaard, J. E. (2016). Response strategies for curriculum change in engineering. *International Journal of Technology and Design Education*, 26, 391–411.
- Kusiak, A. 1993. *Concurrent Engineering*.
- Minetola, P., & Iuliano, I., Bassoli, E. & Gatto, A. (2015). Impact of additive manufacturing on engineering education – evidence from Italy. *Rapid Prototyping Journal*, 21, 535–555.
- Mokkink, L. B., Prinsen, C. A. C., Bouter, L. M., De Vet, H. C. W., & Terwee, C. B. (2016). The consensus-based standards for the selection of health measurement instruments (COSMIN) and how to select an outcome measurement instrument. *Brazilian Journal of Physical Therapy*, 20, 105–113.
- Mundfrom, D. J., Shaw, D. G., & Ke, T. L. (2005). Minimum sample size recommendations for conducting factor analyses. *International Journal of Testing*, 5, 159–168.
- Nicholls, M. E. R., & Orr, C. A., Okubo, M. & Loftus, A. (2006). Satisfaction guaranteed: The effect of spatial biases on responses to Likert scales. *Psychological Science*, 17, 1027–1028.
- Pieterse, F. F. & Nel, A. L. 2016. The advantages of 3D printing in undergraduate mechanical engineering research. In: 2016 IEEE Global Engineering Education Conference (EDUCON), 10–13
- Prabhu, R., Miller, S. R., Simpson, T. W., & Meisel, N. A. (2020). Teaching design freedom: Understanding the effects of variations in design for additive manufacturing education on students' creativity. *Journal of Mechanical Design*, 142, 147.
- Prince, M. (2004). Does active learning work? A review of the research. *Journal of Engineering Education*, 93, 223–231.
- Rahmatpour, P., Nia, H. S., & Peyrovi, H. (2019). Evaluation of psychometric properties of scales measuring student academic satisfaction: A Systematic review. *Journal of Education and Health Promotion*, 8, 15.
- Smith, K. A., Sheppard, S. D., Johnson, D. W., & Johnson, R. T. (2005). Pedagogies of engagement: Classroom-based practices. *Journal of Engineering Education*, 94, 87–101.
- Stern, A., Rosenthal, Y., Dresler, N., & Ashkenazi, D. (2019). Additive manufacturing: An education strategy for engineering students. *Additive Manufacturing*, 27, 503–514.
- Thomas-seale, L. E. J., Kirkman-brown, J. C., Attallah, M. M., Espino, D. M., & Shepherd, D. E. T. (2018). The barriers to the progression of additive manufacture: Perspectives from UK industry. *International Journal of Production Economics*, 198, 104–118.
- Thompson, M. K., Moroni, G., Vaneker, T., Fadel, G., Campbell, R. I., Gibson, I., Bernard, A., Schulz, J., Graf, P., Ahuja, B., & Martina, F. (2016). Design for additive manufacturing: Trends, opportunities, considerations, and constraints. *Cirp Annals-Manufacturing Technology*, 65, 737–760.
- Zhang, X. J., Noor, R., & Savalei, V. (2016). Examining the effect of reverse worded items on the factor structure of the need for cognition scale. *PLoS ONE*, 11, 15.