



Evaluation of the Importance of Gradually Releasing Stress Around Excavation Regions in Soil Media and the Effect of Liners Installation Time on Tunneling

Heisam Heidarzadeh · Reza Kamgar

Received: 14 August 2019 / Accepted: 16 December 2019 / Published online: 18 December 2019
© Springer Nature Switzerland AG 2019

Abstract Tunnels are structures which have vital roles in the development of societies. In the numerical models of underground cavities, such as tunnels, loading due to zone elimination is induced instantaneously in the soil mass, and it might cause a disturbance in the stress state especially around the excavation area. However, this is not compatible with the principles of elastoplastic constitutive models used in soil behavior simulations. Besides, the predicted load on the tunnel liner will be larger than the actual value in this kind of modeling. In other words, it causes the so-called overestimated design. Using an appropriate constitutive model could lead the numerical analyses to accurate results. In this research, loading increment in the simulation of soil behavior is evaluated according to experimental data. Next, a correct way for numerical simulation related to underground excavation is described according to gradually eliminating (incremental) stress around tunnels based on the numerical modeling in the finite-difference code called FLAC. Hence, the effect of releasing the stress on the results is illustrated by the stress paths and deformations around a tunnel. Finally, the installation time of the tunnel liner and its impact

on the numerical results are considered based on some experimental and field data. It is concluded that the use of software default in modeling the tunnel issues might lead to extreme oscillations in the stress paths, and it could affect the numerical results. Therefore, it is reasonable to utilize a proper way to release the stress around the excavation area gradually.

Keywords Numerical analysis · Constitutive model · Incremental loading · Stress release · Excavation · Tunnel liner

1 Introduction

With the development of cities, the needs for underground ways are felt more than ever. Hence, many researchers have been attracted to the investigation into tunnel issues. In order to analyze and design geotechnical engineering structures, there are two main methods including physical model experiments and numerical simulations (Afshani and Akagi 2015; Afshani et al. 2014). Gao et al. (2017) have analyzed some field data recorded in engineering activities on tunnels. For these purposes, the linear and nonlinear problems are solved using different numerical methods and constitutive models. Cai (2008) has shown that the results obtained with FLAC and Phase may be very different depending on the properties of the

H. Heidarzadeh (✉) · R. Kamgar
Department of Civil Engineering, Faculty of Technology and Engineering, Shahrekord University, Shahrekord, Iran
e-mail: heidarzadeh@sku.ac.ir

R. Kamgar
e-mail: kamgar@sku.ac.ir

materials and methods used for excavation. Zhang et al. (2008) have evaluated the effects of two-dimensional analyses instead of three-dimensional analyses on tunnels using the stress release ratio. The optimal time for installing the tunnel liner in a rock has been studied with a rock constitutive model in the FLAC software by Lee (2017).

Besides, the deformation of rocks and soils around tunnels is due to the turbulence of the conditions induced by tunneling and releasing the stress (Zhang et al. 2019). Time-dependent behavior of rock and soil, gradually releasing stress and deformation during the time are other issues that attracted the attention of many researchers (Aksoy et al. 2012; Do et al. 2016; Oliaei and Manafi 2015). Cao et al. (2018) have carried out a series of field experiments on a tunnel constructed on soft soil. They have found that tunnel behavior is a time-dependent problem, and therefore it needs to be considered the effect of time on the numerical analyses of tunnel issues, especially for the tunnel liner installation.

Xiao et al. (2016) have presented a new index based on the rate of energy release around the tunnel excavation region in order to evaluate rock stability. The stress release around the deep tunnels at the time of the liner installation has been investigated by Graziani et al. (2005). In addition, Dao (2009) has applied the convergence-confinement method to determine the stress and displacement of tunnels and to evaluate the effect of stress release of the rock surrounding them.

FLAC software (a finite-difference application) is one of the famous applications in geotechnical engineering that has been used by many researchers to analyze various geotechnical issues, including tunnel analysis and design (Oliaei and Kouzegaran 2017). But, in the majority of the common numerical softwares (applications), especially in FLAC software, it is not easily possible to model tunnels in view of the gradual stress release in the soil around the tunnels and their liner installation time. The interaction between soil and structure is an important issue that could be investigated in engineering problems such as tunneling (Kamgar et al. 2019a, b). In this paper, a proper method is described with a special focus at FLAC to release the stress gradually in the materials (rock and soil) surrounding tunnels and a proper way to consider the liner installation time. In summary, this research consists of three general sections. First, the

significance of the gradual stress release in numerical analyses has been evaluated to simulate tunnel excavations. The nature of the nonlinear and elastoplastic behavior of soil is examined by various researchers (Najma and Latifi 2017; Sadeghian and Latifi 2013; Jafarzadeh and Zamanian 2014; Jafarzadeh and Zamanian 2018). It is proved that the predicted results obtained by these constitutive models are dependent on the loading increments. In this regard, two constitutive models have been selected (i.e. Mohr–Coulomb as a very commonly used constitutive model in geotechnical engineering and Modified-Cam-Clay (MCC) (Roscoe and Burland 1968) as a well-known constitutive model in the framework of the critical state soil mechanics). These constitutive models are examined with various loading increments within the FLAC software. For this purpose, the experimental data provided by Gasparre (2005) on London's clay is used. Therefore, a numerical model of the triaxial test is constructed in the FLAC. This model is calibrated based on the experimental data, and the effect of loading increment size on the results obtained by both constitutive models is evaluated. In fact, it could be also considered as a kind of numerical model verification. It should be noted that the Modified-Cam-Clay model built-in (preexisting in) the FLAC software has a weak point which has been explained by Heidarzadeh (2019). Therefore, in this paper, the Modified-Cam-Clay model revised by Heidarzadeh (2019) in FLAC software is used, and it has been added to the software by coding with the FISH programming language. One of the advantages of the MCC revised by Heidarzadeh (2019) is that it requires only the initial pre-consolidation ratio to be entered in the revised model. But, the initial void ratio and the initial position of yield surface should be entered for each element (zone) in the MCC pre-existing in FLAC. It is noted that these parameters (i.e., initial void ratio and position of yield surface) are not independent and they have to be entered in agreement with each other in the use of the MCC pre-existing in FLAC.

In the second section, an appropriate method to model numerically underground excavation is described, and how to release the stress around the tunnels is investigated with a special emphasis on the FLAC software. The algorithm related to this purpose is presented in the “Appendix” section based on FISH programming within the FLAC software. Then, the tunnel constructed on the London's clay named

Eastbound (Addenbrooke et al. 1997; Hejazi et al. 2008) is modeled in FLAC, and the effect of the stress release on the numerical models is evaluated according to the stress paths and displacements occurred around the excavation region.

Finally, in the third section, the installation time of the tunnel liner is investigated considering the percentage of the stress release in the soil around the tunnel. The soil deformation around tunnels is due to the gradual increase of the load on the retaining system. Therefore, the effect of the installation time of the tunnel retaining-wall (liner) on the value of the ground settlement is investigated in this paper. Then, the results of the numerical analyses are compared with the field data reported in the literature (Addenbrooke et al. 1997; Standing et al. 1996).

Therefore, in this research, it has been attempted to introduce a correct method to model tunnels numerically with focus on the FLAC software. In addition, it has been illustrated that it is necessary to reach a certain result releasing gradually the stress around the excavation area. Otherwise, some oscillations might be occurred in results. Finally, a simple way has been described to take into account the installation time of lining.

2 Evaluation of the Effect of the Loading Increment Size on the Results (Sensitivity Analysis)

The results of the numerical analyses are essentially dependent on the constitutive model assigned to the materials. Basically, the nature of soil behavior is non-linear and elastoplastic. Also, the behavior predicted by elastoplastic constitutive models depends on the loading increment size. Therefore, at the outset, the behavior of the constitutive models used in this paper is examined for various loading increments; and so-called “sensitivity analysis” of these models related to the loading increment size is presented.

For this purpose, some experimental data on London’s clay provided by Gasparre (2005) have been taken into account. This soil has already been utilized by Addenbrooke et al. (1997) and Hejazi et al. (2008). Therefore, in addition to calibration of the constitutive models (Mohr–Coulomb and Modified-Cam-Clay) for the soil to model the tunnel excavation, the effect of the loading increment size on the results is

exhibited. The experimental data used for the sensitivity analysis has been obtained from an undrained triaxial test on normal-consolidated clay (pre-consolidation ratio of 1) with an initial confined effective stress of 600 kPa. This experimental sample has been named as “r25nc” by Gasparre (2005). The main reason for choosing this soil is that the tunnel intended in this research has been excavated into this soil and its field data is available. Therefore, in the next section, it could be somewhat possible to compare the results of numerical analyses with field-measured data. However, the main purpose of this paper is to exhibit the importance of the gradual stress release in numerical tunnel simulations.

The triaxial test has been modeled numerically in the FLAC using one single zone in axisymmetric configuration as it is explained comprehensively in the FLAC user guide (Itasca 2011) in the section of verification problems.

The parameters of the constitutive models for London’s clay have been presented in Table 1. These parameters have been calibrated based on the various oedometer and triaxial tests conducted by Gasparre (2005). In Table 1, ρ is the soil density, C' shows the cohesion, ϕ' is the internal friction angle, ψ shows the angle of dilatancy, K_{ave} is the average bulk modulus, ν is the Poisson’s ratio, N shows the interception of the normal consolidation line on the plane $e - \ln p'$, M is the slope of the critical state line on the plane $p' - q$. The parameters λ and κ indicate the slope of normal consolidation line and swelling (unloading) line on the plane $e - \ln p'$, respectively. Also, R_c is the pre-consolidation ratio.

A numerical model of the undrained triaxial test on London’s clay has been created in the FLAC software.

Table 1 The parameters of the constitutive models for London’s clay

Parameters of Mohr–Coulomb		Parameters of MCC	
ρ	1950 kg/m ³	ρ	1950 kg/m ³
C'	7 kPa	N	3.02
ϕ'	20.5°	M	0.83
ψ	4.8°	λ	0.164
K_{ave}	20,000 kPa	κ	0.068
ν	0.28	ν	0.28
–	–	R_c	1

The simulation results obtained by each constitutive model in various loading increments are studied. Figures 1, 2 show the numerical results in comparison with the experimental data. The loading increment has been applied based on the size of the axial strain increment. In these figures, the strain increments range from 0.005 to 0.0001. Based on Fig. 1, when the size of the strain increment is 0.005, the predicted values have oscillation and the results have very low accuracy. When the loading increments are chosen to be smaller, the amount of the oscillations decreases and the graphs converge toward a certain value.

A similar trend can be seen in Fig. 2 for the predictions done by the MCC constitutive model. According to this figure, the values predicted by the MCC constitutive model have reached approximately to a certain value after a strain increment about 0.001, and the excessive reduction in the strain increment will not have meaningful effect on the final results.

The reason for the large oscillation of the results predicted by the Mohr–Coulomb model, especially in the large loading increments, could be attributed to its yield surface. This is due to the reason that the yield surface of the Mohr–Coulomb model has hexagonal sharp edges in the deviatoric plane (octahedral). This weak point does not exist in the MCC constitutive model, because the MCC model does not have sharp corners.

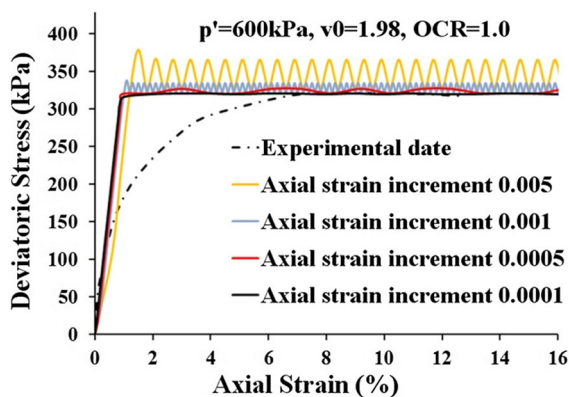

Fig. 1 The effect of the loading increment sizes on the numerical results obtained by the Mohr–Coulomb constitutive model (triaxial test data taken from (Gasparre 2005))

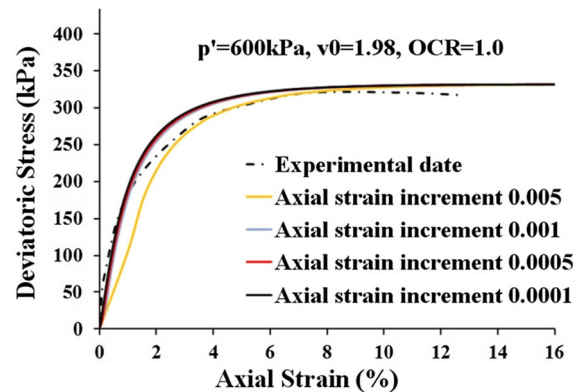

Fig. 2 The effect of the loading increment sizes on the numerical results obtained by the Modified Cam-Clay constitutive model (triaxial test data taken from (Gasparre 2005))

3 Numerical Model of the Tunnel

In order to model tunnel excavation and assess the effect of the gradual release of the stress around the excavation area on the numerical results, the tunnel named Eastbound in London's clay (Addenbrooke et al. 1997; Hejazi et al. 2008; Standing et al. 1996) has been intended and modeled in this paper. In this regard, the soil medium of dimension 100 m \times 70 m is considered to model the excavation of the tunnel in this area (see Fig. 3). The tunnel has a diameter of 4.77 m approximately. Its center is approximately located in depth of 20 m. Although the soil properties may vary slightly in depth, it is assumed that the soil parameters are the same as the values previously presented in Table 1. A concrete wall (liner) has been used to protect the walls of the tunnel from excessive deformations and downfall (failure). The used concrete liner properties have been presented in Table 2.

It should to be mentioned that London's clay is over-consolidated clay (with $OCR > 1.0$). Therefore, based on Gasparre (2005), the over consolidation ratio is varied along depth so that it could be assumed to be about 5–6 at the level of the tunnel. According to Hejazi et al. (2008), the groundwater table could be assumed at 2.5 m below the ground surface. However, the existence of the groundwater does not have any effect on the purpose of the present paper. Therefore, it could be ignored the groundwater table for simplification, in this study; because the main aim is to evaluate and illustrate the importance of releasing the stress around tunnel gradually."

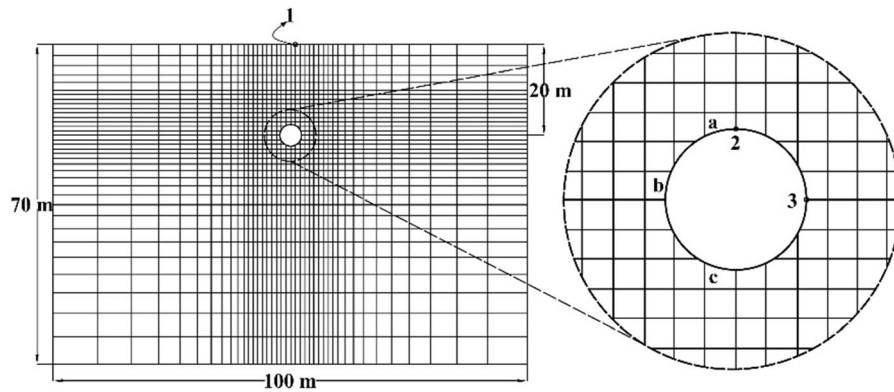

Fig. 3 A view of the meshed zone to analyze with FLAC software using the Finite-Difference Method (FDM)

Table 2 Properties of the concrete used in the tunnel liner

Density $\frac{\text{kg}}{\text{m}^3}$	Young modulus (GPa)	Poisson's ratio	Area m^2/m	Second moment of area m^4/m	Thickness (m)
2400	28	0.15	0.1	8.3×10^{-5}	0.1

In the MCC constitutive model (Roscoe and Burland 1968), the variation of the elastic moduli (i.e., bulk and shear moduli) with mean effective pressure is defined as follows:

$$K = \frac{vp'}{\kappa} \tag{1}$$

$$G = \frac{3(1 - 2v)vp'}{2(1 + v)\kappa} \tag{2}$$

where v is the specific volume, p' shows the mean effective stress, k is the slope of the swelling line (unloading line in isotopic consolidation test), v is the Poisson's ratio, K is the bulk modulus, and G shows the shear modulus. The dependence of the elastic moduli on the mean stress causes these moduli to increase with depth.

In order to increase the accuracy of the analyses performed by the Mohr–Coulomb constitutive model, based on Addenbrooke et al. (1997), the soil moduli have been defined in such a way that their values increase as the depth increases. According to the experimental data at different levels of stress, the relationship between the bulk modulus K and the depth h has been defined as follows:

$$K = 920h \tag{3}$$

where the parameter h shows depth (i.e. distance from the ground surface). The units of the parameters K and h in Eq. 3 are kPa and meter, respectively. Also, the shear modulus G could be estimated as:

$$G = \frac{3(1 - 2v)}{2(1 + v)} K \tag{4}$$

As shown in Fig. 3, the numerical model has been meshed in a way that the sizes of elements are smaller and denser in the area near the tunnel excavation, and the sizes of the elements enlarge by distance from the excavation region. It should be noted that both left and right sides of the numerical model are fixed in the x -direction (they can freely move in the y -direction). At the bottom of the model, all grid-points (nodes) should be necessarily fixed in the y -direction. However, it is not necessary that the bottom of the model be fixed in the x -direction.

During the process of analyses, the following steps have been taken into account. At first, after the definition of the constitutive model for the soil medium, initial analysis has been done to reach the initial equilibrium. Then, the tunnel has been excavated and the concrete liner has been installed. The stress release around the excavation region has been

carried out in various stages and the results are evaluated. It should be noted that the tunnel excavation is modeled in one stage (i.e. the entire excavation occurs simultaneously) by default in the majority of the numerical software in geotechnical engineering such as FLAC. In order to release gradually the stress around the excavation region in FLAC, it needs to use FISH programming as it is described in the following (for more details, see “Appendix”).

In order to study the effect of the tunnel excavation, as well as the effect of the gradually releasing stress on the results of analyses, the displacements of the several points and the stress paths of the several zones are investigated. According to Fig. 3, the point “1” is located above the center of the tunnel on the ground surface, and the point “2” is on the crown of the tunnel (the crest of the tunnel line). The vertical displacements of these points are also evaluated. In addition, the horizontal displacement of the point “3” is studied. This point is located at the center level of the tunnel at the right side of the tunnel wall (Fig. 3). The stress paths induced due to excavation are evaluated in zones named a, b, and c (see Fig. 3).

4 The Effect of the Number of the Stress Release Stages (Loading Increment Size) on the Numerical Analysis of the Tunnel

It should be noted that the number of steps (stages) in releasing the stress around the excavation region represents the incremental loading in the tunnel problem. Therefore, if the numbers of steps (stages) of the stress release increase, the loading increment sizes to model the tunnel excavation decrease. Therefore, it is expected to obtain more accurate results. Basically, constitutive models (especially elastoplastic constitutive models) are defined based on incremental loading, and the sizes of the increments affect the results. Therefore, the smaller loading increment leads to obtain more accurate results.

In order to study the effect of the incremental loading on the results of tunnel excavation, the required force for each node around the perimeter of the tunnel is determined in such a way that no change (in terms of stress and displacement) happens in the natural state of the earth when the soil around the excavation region is removed (see Fig. 4).

Fig. 4 Schematic diagram of the nodal forces intended to begin incremental loading (in tunnel excavation)

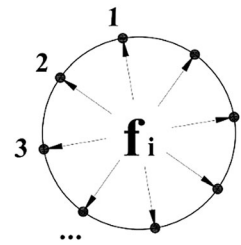

In Fig. 4, f_i shows the force on the i th node. It should be noted that the forces on the nodes ($f_1, f_2, f_3, \dots, f_i$) are not necessarily to each other. An overview on the components of the external forces (prior to starting loading due to tunnel excavation) is shown in Fig. 4. These forces are required to apply to the nodes around the excavation region to prevent any change in the stress and displacement conditions in the soil medium. For this purpose, at the same time as soil is removed from the excavation region, the forces f_i are applied to the nodes; therefore, the stress and deformation conditions in the soil do not alter. Then, according to the number of steps (stages) required to release the stress in the numerical model of tunnels, the amount of the forces f_i should be reduced in each stage until all the components f_i become zero. When all the components f_i are equal to zero, it means that the release of the stresses in the soil around the excavation region has been fully accomplished. It should be noted that the release of the stress around the tunnel excavation is done only with one stage (i.e. instantly and suddenly) by default in FLAC. These components f_i are determined by the described steps 5 and 7 in the “Appendix”.

Herein, it is assumed the tunnel-lining (liner) to be installed after releasing the stress by about 30%. This percentage of the stress release is just selected to evaluate the importance of the gradual stress release in the soil around the tunnel using the displacements and stress paths at some special points (see Fig. 3). In the next section, it could be seen that the lining probably is constructed in the Eastbound Tunnel (Addenbrooke et al. 1997; Hejazi et al. 2008; Standing et al. 1996) after releasing the stress about 30%.

Instantaneously releasing the stress as it is the software default (i.e. removal of the material to represent the excavation in one stage) causes severe turmoil (oscillation) in the stress paths of the zones around the tunnel to reach the equilibrium. This issue is obviously exhibited in Figs. 5, 6, 7, 8, 9 and 10.

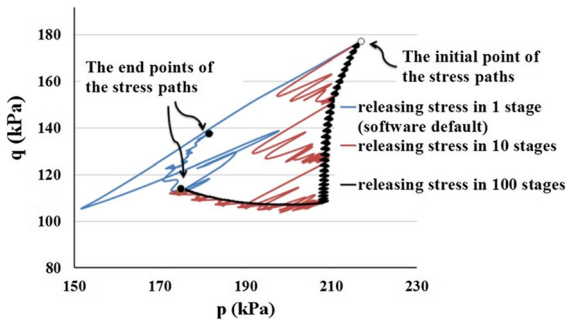

Fig. 5 Stress paths in the zone “a” due to different stages in releasing the stress around the tunnel (analyses done by Mohr-Coulomb)

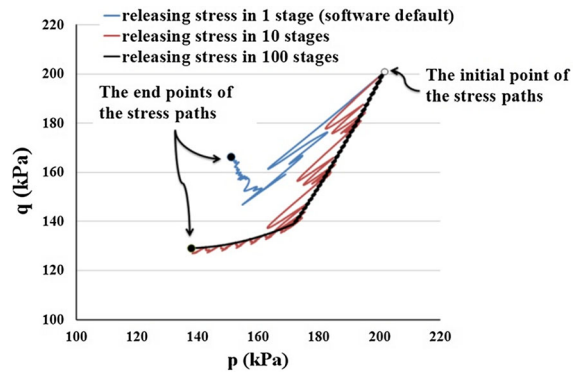

Fig. 8 Stress paths in the zone “a” due to different stages in releasing the stress around the tunnel (analyses done by Modified Cam-Clay)

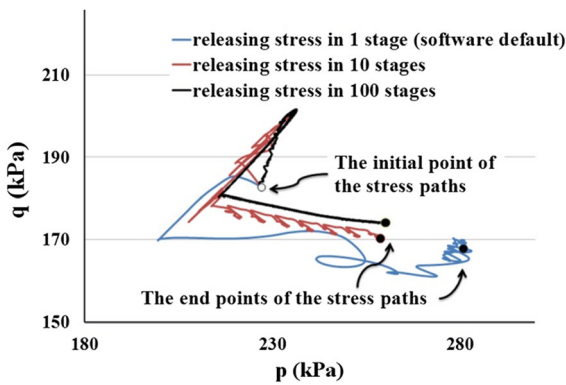

Fig. 6 Stress paths in the zone “b” due to different stages in releasing the stress around the tunnel (analyses done by Mohr-Coulomb)

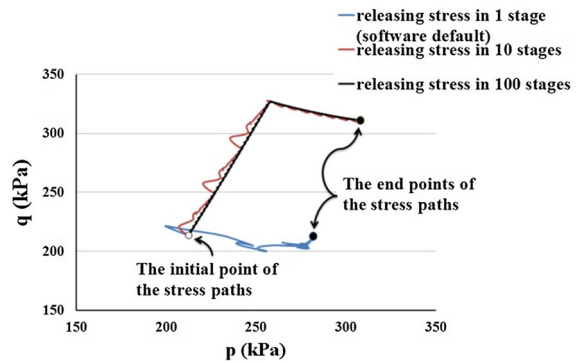

Fig. 9 Stress paths in the zone “b” due to different stages in releasing the stress around the tunnel (analyses done by Modified Cam-Clay)

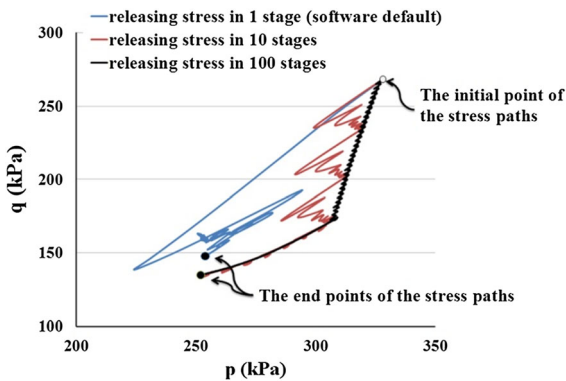

Fig. 7 Stress paths in the zone “c” due to different stages in releasing the stress around the tunnel (analyses done by Mohr-Coulomb)

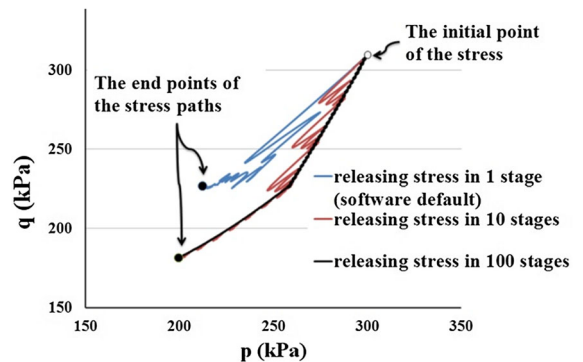

Fig. 10 Stress paths in the zone “c” due to different stages in releasing the stress around the tunnel (analyses done by Modified Cam-Clay)

However, the tunnel has been evaluated for various numbers of steps (stages) in releasing the stress. The effect of the incremental loading on the results of the

analysis is shown in Figs. 5, 6, 7, 8, 9, 10, 11, 12 and 13. As the default of the FLAC software, the first analysis has been done in one step (stage) and the

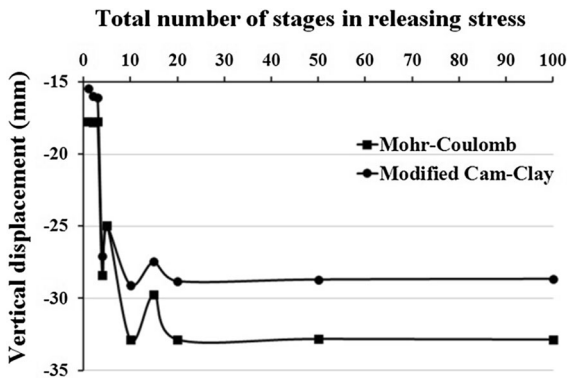

Fig. 11 The vertical displacement of the point 1 due to the different number of steps (stages) in releasing the stress (different loading increments)

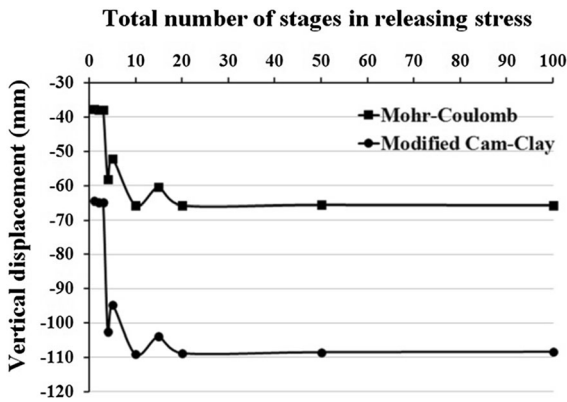

Fig. 12 The vertical displacement of the point 2 due to the different number of steps (stages) in releasing the stress (different loading increments)

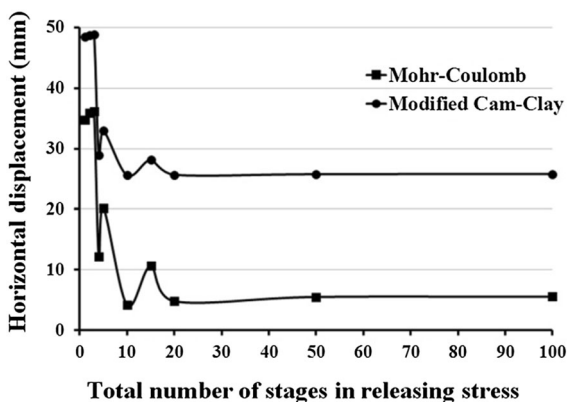

Fig. 13 The horizontal displacement of the point 3 due to the different number of steps (stages) in releasing the stress (different loading increments)

displacements and stress paths have been recorded at the key points and zones (the points 1, 2 and 3; zones *a*, *b* and *c*). After that, the problem has been examined again, but the stress release has been carried out in two steps (stages). Various analyses have been repeated with different numbers of the steps (stages) of the stress release, and their effects on the results have been studied.

The stress paths in the intended zones (*a*, *b*, *c*) obtained by the analyses using the Mohr–Coulomb constitutive model in the plane $q - p'$ in Figs. 5, 6 and 7. Also, Figs. 8, 9 and 10 show the stress paths in the intended zones obtained by the analyses using the Modified Cam-Clay constitutive model. In these figures, the stress paths for releasing the stress in one stage (software default), the stress release in 10 steps (stages), and 100 stages are presented as two instances. As it is clear, the more number of the stage to release the stress, the less oscillation in the stress paths occurs. In other words, with the increase in the number of the stages in the stress release, the stress paths become less disturbed (oscillated). As it is known, oscillation in the stress path might have a direct impact on the results of numerical analyses. If the oscillations in the stress path were minimized, the results of the analyses would be more stable and accurate.

According to Figs. 5, 6, 7, 8, 9 and 10, there is a change in the stress paths so that they deviate sometimes from their first path. This behaviour is because of the lining installation at that time. In other words, the lining installation could generally change the path of stress in the soil around the excavation area.

Besides, the above-mentioned concepts are completely obvious in Figs. 11, 12 and 13. Figure 11 shows the vertical displacement of the point “1” as a result of the various numbers of the steps (stages) in releasing the stress. Also, Fig. 12 shows the vertical displacement of the point “2”, and Fig. 13 depicts the horizontal displacement of the point “3” for the different number of the steps (stages) in releasing the stress. As it has been shown, the results change with an increase in the number of the steps of the stress release (i.e. decrease in the loading increment size). As the number of the steps in releasing the stress increases (and correspondingly the loading increment size decreases), the results converge toward a certain value in such a way that the size of the loading increment does not affect the obtained result. According to Figs. 11, 12 and 13, when the total number of stages in

releasing the stress in the considered issue becomes larger than 20, the results would be stable and have slight dependence on the increment size (the number of stages in releasing the stress).

4.1 Evaluation of the Liner Installation Time

The supporting structures to improve the bearing capacity of the soil mass should be installed during tunnel construction. If a rigid retaining structure is installed very soon, it will take more forces because the deformation of the materials around the excavation region is not large enough and it has not reached equilibrium condition, path 2 in Fig. 14. In Fig. 14, σ_r shows the radial stress, p_i is the pressure applied to the tunnel retaining-wall (liner), Δr shows the radial deformation, and r_i is the radius of the tunnel. When the liner is installed at the point A after a certain value in displacement, the system will be in equilibrium with smaller force on the tunnel liner (see path 1 in Fig. 14). If the curve of the radial stress σ_r reaches its minimum value (point B in Fig. 14), then the loosening behavior begins, and the pressure on the tunnel liner increases very rapidly. Based on Fig. 14, the pressure on the retaining structures will be minimal without the occurrence of the instability in the tunnel, if they are installed within the permissible deformation range (Pacher 1964).

It is obvious that there may be a short or long period of time between the tunnel excavation and the installation of the tunnel liner. During this time period, some stresses in the soil around the excavation region

will release, and it leads to a deformation in the tunnel walls before the liner installation. Therefore, it cannot be a correct assumption that the liner is installed as soon as excavation (without considering any stress release) or after fully releasing the stresses around the excavation area (as it is the default in many computational softwares, e.g. FLAC).

Therefore, despite the fact that the gradual release of the stress in the numerical models of tunnels increases the accuracy of the analyses, it makes possible to model the installation time of the tunnel liner (after releasing a certain percentage of the stress around the excavation region). In other words, the gradual release of the stress around the excavation area makes it possible to model the interval time between the excavation and installation of tunnel liner.

Figures 15 and 16 show the ground settlement due to tunnel excavation. In these figures, each curve refers to the installation time of the tunnel liner after a certain percentage of the stress release. The data obtained from field measurements have also been shown according to the literature (Addenbrooke et al. 1997; Standing et al. 1996).

Figure 15 shows the analyses using the Mohr–Coulomb constitutive model. It is observed that if the liner installation is performed after 20% of the stress release, the numerical ground settlement will be in agreement with the field data. In addition, Fig. 16 is obtained by numerical analyses using the MCC constitutive model. In this figure similar to Fig. 15, it could be concluded that if the liner is installed after 20% of releasing the stress, the predicted ground

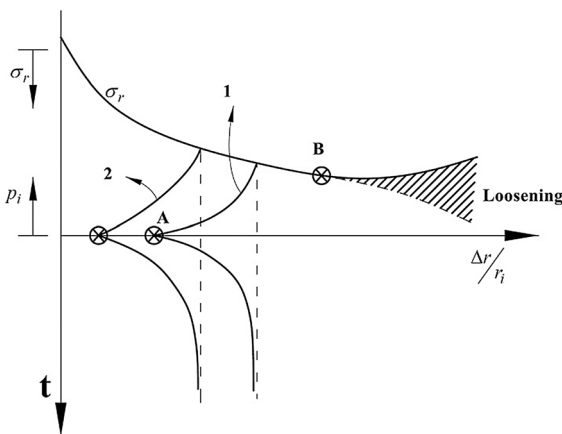

Fig. 14 The relationship between the pressure on the tunnel liner and the radial deformation (Dao 2009; Pacher 1964)

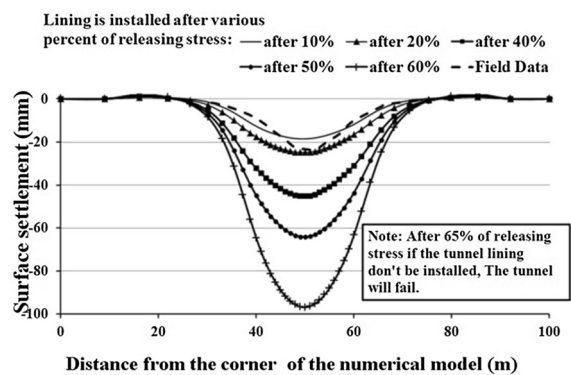

Fig. 15 Ground settlement due to tunnel excavation at the different installation times of the lining by the Mohr–Coulomb constitutive model (installation of the lining after releasing a certain percent of the stress around the excavation region)

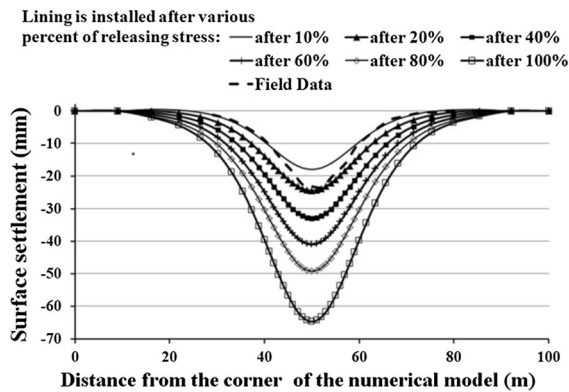

Fig. 16 Ground settlement due to tunnel excavation at the different installation times of the lining by the MCC constitutive model (installation of the lining after releasing a certain percent of the stress around the excavation region)

settlements will have a good match with the measured field data. It should be noted that the tunnel might fail if the tunnel liner does not be installed after 65% of releasing stress (based on the numerical analysis done using the Mohr–Coulomb constitutive model).

As it is shown in Figs. 15 and 16, if there is a long delay in installing the tunnel lining, the deformations will be high, and there is a possibility of complete failure and collapse. Therefore, by estimating the percentage of the stress release around the excavation region and installation of the tunnel-lining in an appropriate time, more suitable modeling can be performed to simulate the behavior of the tunnels and soil mass around it.

Besides, radial stress in the zone “a” (see Fig. 3) and its radial deformation towards the center of the tunnel has been recorded during excavation with 10 stages and 100 stages of releasing stress. Also, shear and axial forces of lining installed in this area have been taken during these analyses, and the results are exhibited in Fig. 17. In this figure, lining is installed after 20% of stress relaxation. As it could be seen in Fig. 17, when stress is released in 100 stages, the relaxation of the stress during the excavation occurred gradually and the forces are formed in the lining smoothly with the radial deformation of the tunnel. But if the stress does not release gradually enough (e.g. when the stress releases in 10 stages), the stress relaxation and forces in the lining encounter severe oscillations.

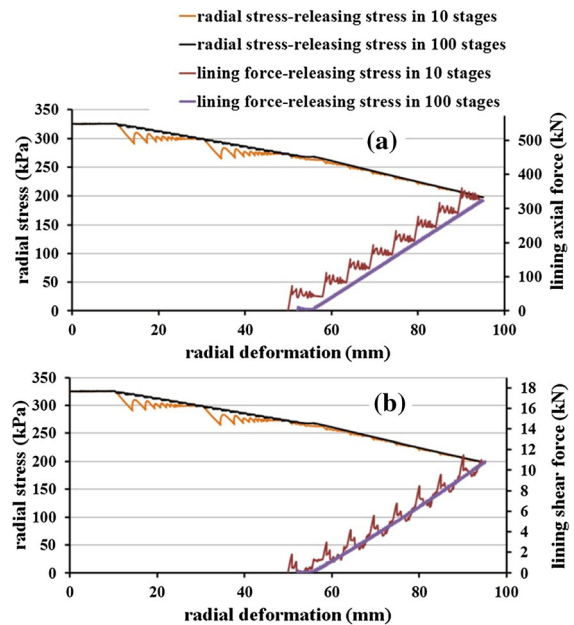

Fig. 17 Radial stress in the soil element near crown (zone a), lining shear and axial forces versus radial deformation in crown; **a** with lining axial force, **b** with lining shear force

5 Conclusion

The accuracy of the numerical modeling depends on the constitutive models used to simulate the behavior of materials. The more powerful models used in the analyses lead to more accurate results. On the other hand, the performance of the elastoplastic constitutive models is strongly dependent on the loading increment. The smaller sizes of the loading increments lead to more accurate predictions. Therefore, due to the incremental nature of the elastoplastic constitutive models used in soil behavior analyses, the loading increment should not be too large, since it would cause the computational errors. This issue should also be considered in the numerical model of tunnels, and loading should be done gradually so that the constitutive model could properly simulate the soil behavior. Therefore, in this paper, based on the FLAC software platform, an incremental loading method has been described to analyze the tunnel issues and the importance of this type of loading has been illustrated to reach acceptable results.

In summary, in this research, two constitutive models (i.e. Mohr–Coulomb and MCC) have been used to simulate the soil behavior during the excavation of a tunnel. At first, the importance of the

incremental loading with small increments has been demonstrated by the stress–strain curves obtained in the triaxial test on London’s clay. In order to illustrate the compatibility of the numerical results with the experimental observations, the data presented by Gasparre (2005) on the London’s clay have been used; and a comparison between the numerical analyses results and experimental data has been done. It has been shown that for large loading increments, the results are very inappropriate. Also, the simulations are more logical by reducing the size of loading increments. Also, it could be considered as a kind of verification of the numerical code (especially the constitutive model written by FISH programming in FLAC).

Besides, the importance of the incremental loading (gradual release of the stress) in the soil around the excavation region has been evaluated. For this purpose, the field data presented by Addenbrooke et al. (1997) and Hejazi et al. (2008) concerning the Eastbound Tunnel constructed on London’s clay has been utilized. First, the effects of the number of steps (stages) in releasing the stress on the displacement of different points and stress paths in various zones have been evaluated. In spite of the fact that the FLAC software divides each type of load into smaller ones, the simultaneous release of the whole stress due to excavation (as FLAC default) causes errors in the results. In addition, it has been concluded that the results converge toward a certain value by increase in the number of steps (stages) in releasing the stress (that is equivalent to the decrease in the loading increment sizes). Therefore, in the numerical model of tunnels, it is necessary to unload gradually (i.e. release gradually the stress in the soil around the excavation region). This leads to eliminating the effect of loading increment size on the results of the numerical computations.

In addition, the effect of the liner installation time on the deformation has been evaluated. The results showed that the gradual release of the stress allows the tunnel liner to be installed after releasing a certain percentage of the stresses around the tunnel. Therefore, the precision of the numerical simulation could be increased as it could be observed in comparison with some field data. The results of the simulations performed with the MCC and Mohr–Coulomb constitutive models in comparison with the field data indicate that the lining installation has been done

approximately when about 20% of the stress in the soil surrounding the tunnel region is released. It is also noted that if the lining installation was carried out late so that more than 50% of the stresses around the excavation region were released, the deformation around the tunnel would be very large and might lead to destruction (or collapse). Generally, it could improve the numerical simulation of the tunnel issues if the amount of the stress release is estimated appropriately. This kind of issue (the main subject of this study) could be raised and evaluated even on the other kind of excavation such as excavation for building, vertical excavation, retaining wall, etc.

Acknowledgements This work has been financially supported by the research deputy of Shahrekord University. The Grant Nos. were 97GRN1M1829 and 97GRN1M1709.

Appendix: The algorithm Used in FLAC by FISH Programming to Release the Stress

The general steps of the numerical model for the gradual release of the stress around the excavation region in the FLAC software.

For this purpose, it is necessary to use the possibility of programming in the FLAC software, which is executed in the FISH language. The intended algorithm has been listed as follows:

1. First, the overall soil medium (mass) is defined and run to reach the initial equilibrium.
2. The excavation region becomes vacant.
3. The nodes numbers on the boundary of the excavation region are specified.
4. The nodes on the excavation boundary along the x - and y - axes should be fixed.
5. Again, an analysis is performed to be formed (created) the reactions into the supports placed on the tunnel’s boundary nodes mentioned in the step 4.
6. The nodes on the tunnel’s boundary became free (the supports placed on the tunnel’s boundary are removed).

Note: It could be easily implemented in the FLAC software and does not require coding with FISH programming until step (6). Next steps should be done with coding by FISH language programming.

7. Two additional grid variables are intended for each node on the excavation boundary. For example, $ex_1(i,j)$ and $ex_2(i,j)$ are defined to save the horizontal and vertical forces of the nodes placed on the excavation boundary, respectively (that are calculated in step 5). The indices i and j are represented the coordinates of zones and grid-points (nodes) in x and y directions, respectively.
8. Also, the horizontal and vertical external forces of each node (which are calculated in step 5 and used in step 7) are stored in two other new variables such as xfa and yfa . These forces are applied to the corresponding nodes by *command* and *apply* commands in FISH programming.
9. After applying the opposite of the external forces computed in step 8 (xfa and yfa) to the boundary nodes, an analysis is performed to reach the initial equilibrium. Now, the system is ready to begin the unloading (excavation).
10. The number of steps (stages) to release the stress of the soil around the tunnel is specified.
11. Considering the number of the stages to release the stresses, the external forces of each boundary nodes are reduced. Then, the reduced forces are applied to the boundary nodes for each stage of the stress release.
12. In each stage, after applying the reduced forces on each node, the problem is analyzed to achieve equilibrium.
13. This operation is performed until the end of the loading (i.e. the reduced forces to be zero). It should be noted that from step 11 onwards, it could be placed in a loop. In addition, if the tunnel liner should also be considered, it can be controlled that the liner should be installed after releasing a certain (intended) percentage of the stress. In this way, it is possible to install the tunnel liner at the intended time (after a certain percentage of the stress release).

References

- Addenbrooke TI, Potts DM, Puzrin AM (1997) The influence of pre-failure soil stiffness on the numerical analysis of tunnel construction. *Géotechnique* 47(3):693–712. <https://doi.org/10.1680/geot.1997.47.3.693>
- Afshani A, Akagi H (2015) Artificial ground freezing application in shield tunneling. *Japn Geotech Soc Spec Publ* 3(2):71–75. <https://doi.org/10.3208/jgssp.v03.j01>
- Afshani A, Dobashi H, Komiya K, Akagi H (2014) Numerical analysis of the effect of EPB shield tunneling on soil stress-deformation behavior. *JSGE J Geotech* 2:224–238. https://doi.org/10.2208/journalofjsce.2.1_224
- Aksoy CO, Ogul K, Topal I, Ozer SC, Ozacar V, Posluk E (2012) Numerical modeling of non-deformable support in swelling and squeezing rock. *Int J Rock Mech Min Sci* 52:61–70. <https://doi.org/10.1016/j.ijrmms.2012.02.008>
- Cai M (2008) Influence of stress path on tunnel excavation response: numerical tool selection and modeling strategy. *Tunn Undergr Space Technol* 23(6):618–628. <https://doi.org/10.1016/j.tust.2007.11.005>
- Cao C, Shi C, Lei M, Peng L, Bai R (2018) Deformation characteristics and countermeasures of shallow and large-span tunnel under-crossing the existing highway in soft soil: a case study. *KSCE J Civil Eng* 22(8):3170–3181. <https://doi.org/10.1007/s12205-017-1586-6>
- Dao VH (2009) Tunnel design considering stress release effect. *Water Sci Eng* 2(3):87–95. <https://doi.org/10.3882/j.issn.1674-2370.2009.03.009>
- Do NA, Dias D, Oreste P (2016) 3D numerical investigation of mechanized twin tunnels in soft ground: influence of lagging distance between two tunnel faces. *Eng Struct* 109:117–125. <https://doi.org/10.1016/j.engstruct.2015.11.053>
- Gao SM, Jp C, Cq Z, Wang W (2017) Monitoring of three-dimensional additional stress and strain in shield segments of former tunnels in the construction of closely-spaced twin tunnels. *Geotech Geol Eng* 35(1):69–81. <https://doi.org/10.1007/s10706-016-0085-8>
- Gasparre A (2005) Advanced laboratory characterisation of London clay. Imperial College, London, p 598
- Graziani A, Boldini D, Ribacchi R (2005) Practical estimate of deformations and stress relief factors for deep tunnels supported by shotcrete. *Rock Mech Rock Eng* 38(5):345–372. <https://doi.org/10.1007/s00603-005-0059-2>
- Heidarzadeh H (2019) Evaluation of modified Cam-Clay constitutive model in FLAC and its development by FISH programming. *Eur J Environ Civil Eng*. <https://doi.org/10.1080/19648189.2018.1521752>
- Hejazi Y, Dias D, Kastner R (2008) Impact of constitutive models on the numerical analysis of underground constructions. *Acta Geotech* 3(4):251–258. <https://doi.org/10.1007/s11440-008-0056-1>
- Itasca (2011) Fast Lagrangian Analysis of Continua [FLAC]. Version 7.0. Itasca Consulting Group, Minneapolis, MN. <http://www.itascacg.com/>
- Jafarzadeh F, Zamanian M (2014) Effect of intermediate principal stress parameter on cyclic behavior of sand. *Sci Iran* 21(5):1566–1576
- Jafarzadeh F, Zamanian M (2018) Effect of anisotropy on the dynamic properties of the loose babolsar sand with cyclic hollow cylinder apparatus. *Sharif J Civil Eng* 34.2(22):103–112. <https://doi.org/10.24200/j30.2018.1371>
- Kamgar R, Bagherinejad MH, Heidarzadeh H (2019a) A new formulation for prediction of the shear capacity of FRP in

- strengthened reinforced concrete beams. *Soft Comput.* <https://doi.org/10.1007/s00500-019-04325-4>
- Kamgar R, Gholami F, Zarif Sanayei HR, Heidarzadeh H (2019b) Modified tuned liquid dampers for seismic protection of buildings considering soil-structure interaction effects. *Iran J Sci Technol Trans Civil Eng.* <https://doi.org/10.1007/s40996-019-00302-x>
- Lee SS (2017) Numerical model for shaley rock masses displaying long-term time dependent deformation (TDD) behavior and its application to a pedestrian tunnel constructed under Lake Ontario. *KSCE J Civil Eng* 21(7):2919–2931. <https://doi.org/10.1007/s12205-017-1359-2>
- Najma A, Latifi M (2017) Analytical definition of collapse surface in multiaxial space as a criterion for flow liquefaction occurrence. *Comput Geotech* 90:120–132. <https://doi.org/10.1016/j.compgeo.2017.06.005>
- Oliaei M, Kouzegaran S (2017) Efficiency of cellular geosynthetics for foundation reinforcement. *Geotext Geomembr* 45(2):11–22. <https://doi.org/10.1016/j.geotextmem.2016.11.001>
- Oliaei M, Manafi E (2015) Static analysis of interaction between twin-tunnels using discrete element method (DEM). *Sci Iran* 22(6):1964–1971
- Pacher F (1964) Deformationsmessungen im Versuchsstollen als Mittel zur Erforschung des Gebirgsverhaltens und zur Bemessung des Ausbaues. In: Müller L (ed) 14th symposium of the Austrian regional group (i.f.) of the international society for rock mechanics Salzburg. Springer, Berlin, pp 149–161. https://doi.org/10.1007/978-3-662-25703-6_12
- Roscoe KH, Burland JB (1968) On the generalized stress-strain behavior of ‘Wet Clay’. In: Heyman J, Leckie FA (eds) *Engineering plasticity*. Cambridge University Press, Cambridge
- Sadeghian S, Latifi M (2013) Using state parameter to improve numerical prediction of a generalized plasticity constitutive model. *Comput Geosci* 51:255–268. <https://doi.org/10.1016/j.cageo.2012.06.025>
- Standing JR, Nyren RJ, Longworth TI, Burland JB (1996) The measurement of ground movements due to tunnelling at two control sites along the Jubilee Line Extension. *International symposium on the geotechnical aspects of underground construction in soft ground*, Balkema, London, pp 751–756
- Xiao Q, Liu J, Lei S, Gao B (2016) A new method for calculating energy release rate in tunnel excavation subjected to high in situ stress. *Perspect Sci* 7:292–298. <https://doi.org/10.1016/j.pisc.2015.11.045>
- Zhang X-m, Liu X-f, He F (2008) Influence of stress releasing ratio and boundary scope on 2D FEM simulate. *J Coal Sci Eng (China)* 14(4):604–607. <https://doi.org/10.1007/s12404-008-0421-6>
- Zhang B, Hu H, Yu W, Liang S, Li J, Lu L (2019) Timeliness of creep deformation in the whole visco-elasto-plastic process of surrounding rocks of the tunnel. *Geotech Geol Eng* 37(2):1007–1014. <https://doi.org/10.1007/s10706-018-0668-7>

Publisher’s Note Springer Nature remains neutral with regard to jurisdictional claims in published maps and institutional affiliations.