

Yasushi Ohkusa · Kiyosu Taniguchi · Ichiro Okubo

Prediction of smallpox outbreak and evaluation of control-measure policy in Japan, using a mathematical model

Received: August 26, 2004 / Accepted: January 19, 2005

Abstract Since the September 11 terrorist attacks and moreover, since the anthrax exposure events in 2001 in the United States, bioterrorism attacks seem to be a real threat. Of course, the public health authorities in Japan have started to prepare control measures for such events. We report here our attempts, using a mathematical model, to estimate outbreak size and to examine the most effective measures; comparing ring vaccination (contact tracing, isolation, and vaccination among contacts) and mass vaccination of the susceptible population in the area. The basic framework of the mathematical model follows a model used in previous research. The initial susceptible population is assumed to be 30 million persons. Concerning the important parameters, such as the number of initial-exposure cases, R_0 (infectious power, or natural history) and, the starting day of intervention after the initial exposure, we checked the robustness of our conclusions by sensitivity analysis. We found that mass vaccination is preferable to ring vaccination when the values for the initial-exposure cases and R_0 are high and when the start of intervention by public health authorities is delayed. In the base-case situation, the mass vaccination strategy needs almost 30 million vaccine doses. On the other hand, though ring vaccination needs fewer doses, it needs fewer than 50000 doses in the worst-case scenario, that with larger first exposure, higher R_0 , or later start of public health authority intervention. This mathematical model can measure the prevalence of an infectious disease and can evaluate control measures for it before an outbreak. Especially, it is useful for the planning of the outbreaks of emerging diseases such as severe acute respiratory syndrome (SARS) or for bioterrorism attacks involving such diseases as smallpox. In further research, we will have to take into account the population people vaccinated of for smallpox, who account for about 70% of the total population in Japan.

Key words Smallpox · Vaccination · Mathematical model

Introduction

Since the September 11 terrorist attacks and, moreover, since the anthrax exposure events in 2001 in the United States, bioterrorism attacks seem to be a real threat. Of course, the public health authorities in Japan have started to prepare control measures for such events. It is very well known that a mathematical model is very useful for predicting the likelihood of a disease outbreak and for evaluating control-measure planning by a public health authority, and for evaluation of these measures after an outbreak.

Mathematical modeling is widely used in planning for responses to a pandemic,¹ and in the evaluation of control measures against severe acute respiratory syndrome (SARS),² and in the evaluation of vaccination policies.^{3,4} Especially, it is also widely used in planning responses to bioterrorism attacks in which smallpox could be used.^{5–8}

By using a mathematical model, we tried to estimate outbreak size (i.e. total number of patients, outbreak duration, peak of the outbreak, and so on) and to examine the most effective measures, comparing ring vaccination (contact tracing, isolation, and vaccination among contacts) and mass vaccination of the susceptible population in the area. We report our findings here. This issue is somewhat controversial, i.e., one study found that mass vaccination was more effective,⁷ while, on the contrary, another study concluded that ring vaccination was preferable.⁸

However, these studies did not take into account the human resources limitations of the public health authorities, whereas, on the other hand, a theoretical model for HIV has considered this viewpoint explicitly.⁹ However, this model ignored the deaths due to HIV, and thus, we cannot extend the model to smallpox. In this article, we report our model, in which we tried to take into account the human resources limitations of public health authorities for

Y. Ohkusa (✉) · K. Taniguchi · I. Okubo
National Institution of Infectious Disease, 1-23-1 Toyama, Shinjuku-ku, Tokyo 162-8640, Japan
Tel. +81-3-5285-1111 (ext. 2057); Fax +81-3-5285-1129
e-mail: ohkusa@nih.go.jp

Table 1. Base case setting

Parameters	Setting	Sources
Model	Markov	Previous research ⁵⁻⁸
R_0^a	1.5	Previous research ⁵
Duration of incubation period ^b	5-17	Previous research ⁵
Duration of prodromal period	2-3	Previous research ⁵
Duration of symptomatic period	11-15	Previous research ⁵
Number of initial-exposure cases	1	Previous research ⁷
Size of initially susceptible population	30 Million	Previous research ¹⁰
Mass vaccination		
Number of public health workers	5000	Previous research ⁷
Number of vaccination shots processed per day per public health worker	200	Previous research ⁷
Ring vaccination		
Number of contacts	50	Previous research ⁷
Maximum quarantine rate per day in the symptomatic period	0.5	Previous research ⁵
Number of vaccination shots processed per day per public health worker	200	Assumption

^a R_0 distribution follows data in previous research^{5,11}

^b The durations of the incubation, prodromal, and symptomatic periods are according to previous research⁵

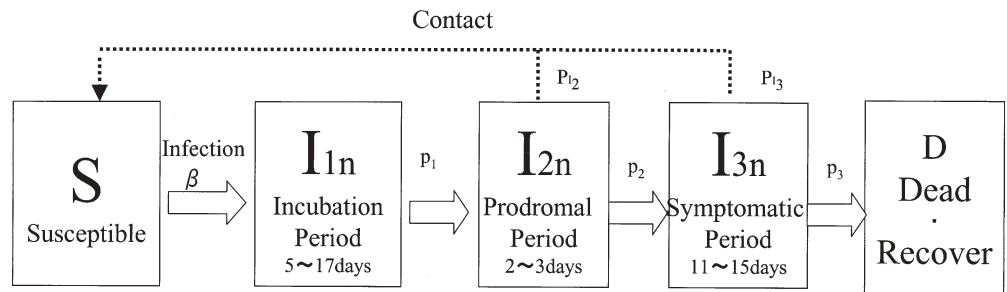
Fig. 1. Natural history of smallpox

dealing with smallpox. There is no report of this kind of research with mathematical models of control measures, (namely, mass or ring vaccination) for smallpox in Japan (S. Tokuraga: The research for technological foundation from the viewpoint of precautionary medicine [unpublished manuscript]; 2003). In this sense, this study could contribute to public health policy for the preparation of measures to deal with bioterrorism attacks using smallpox.

Materials and methods

Basic structure of the model

Some assumptions in the basic structure of the model are summarized in Table 1. We adopted the Markov model setting, following previous research,⁵⁻⁸ and the epidemiological characteristics, such as R_0 (infectious power, or natural history), were borrowed from previous research,⁵ the natural history of smallpox is shown in Fig. 1. In particular, we have assumed that the value for infectious power, R_0 , as in an actual case¹⁰ is 1.5, and that it is distributed potentially in the prodromal and mainly in the symptomatic period, previously reported.^{5,10} We also assume that the incubation

period lasts for 5 to 17 days, the prodromal period lasts for 2 to 3 days, and the symptomatic period lasts for 11 to 15 days, as in the base case. R_0 is the most commonly used and important number for infection control and is defined by the basic reproduction number (which means the number of persons who are infected from one patient if all the persons are susceptible). We have used the value of $R_0 = 1.5$, for the distribution of infectiousness, incubation, prodromal, or symptomatic period over each duration from the previous research.⁵

We have also assumed, as in the previous research, that there is one initial-exposure case, and we assume that the initial susceptible population is 30 million persons, that is, the total number of the population who were born after 1976, when vaccination for smallpox had ceased (S. Tokuraga: The research for technological foundation from the viewpoint of precautionary medicine [unpublished manuscript]; 2003).

Two control measures, mass and ring vaccination, are outlined in Figs. 2 and 3, respectively. Mass vaccination is performed by 5000 public health workers and each public health worker can process 200 vaccine shots per day.⁷ On the other hand, patients can be in contact with 200 persons per day until isolation, even if they are not infected. However, among 200 persons, the number of potential

Fig. 2. Mass vaccination

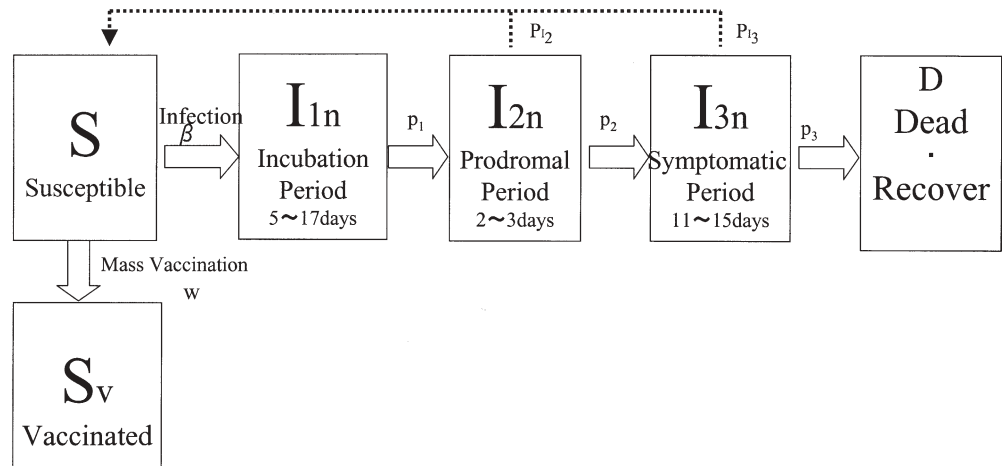
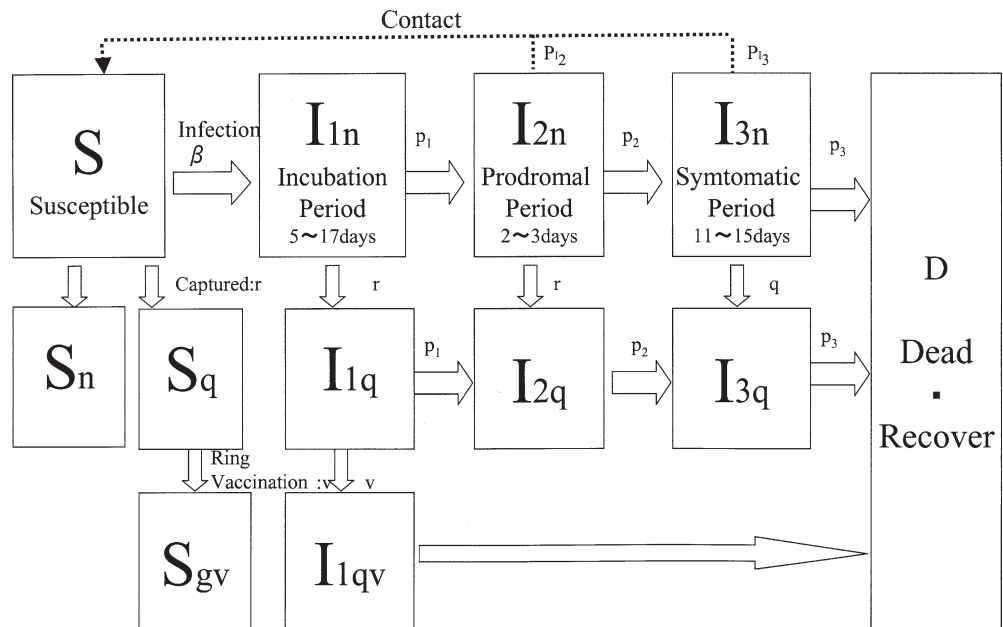

Fig. 3. Ring vaccination



susceptibles who were born after 1976 is just 50 persons. This contact number seems high, although it has been used in previous research.⁷ In fact, in the episode in which a SARS-infected tourist visited Japan,¹¹ the public health authority had traced more than 200 contacts per day. Therefore 200 contacts per day seems to be a somewhat moderate number in our experience.

In the ring vaccination, 200 vaccine shots can be performed per day per public health worker, but the workers have to trace the contacts. Because tracing probably needs more human resources than these required for vaccine shots only, we assume that each public health worker can trace two persons per day.

Mathematical model

The mathematical model consists of the components, shown in Figs. 1–3, and the equations shown in the Appendix.

Several population types are summarized in the Table in the Appendix. It is notable that, because those who recover and those who die will not again be in the susceptible population, they are identical from the model's perspective.

The non-contacted susceptible population (see Appendix) are those who do not contact with the infected population, those who contact with the infected population are removed from this category. The contacted persons are classified into four types. Namely, they must be either infected or not and either quarantined or not. Non-infected and quarantined people cannot be infected during the isolation. If they are not quarantined, they are as susceptible as non-contacted susceptible persons. The infected contacts do not have any infectious power during isolation, but if they are not quarantined, they have infectious power.

If no countermeasures are adopted. The number of newly infected persons is determined by the number of the non-isolated and infected contacts in the prodromal or symptomatic period, and R_0 multiplied by the proportion of

susceptibles in the total population ($\beta S(t)$). The symbols in parenthesis here are defined in the Appendix. We note that R_0 means the number of newly infected persons in total if contacts are all susceptible, and, thus, it is the sum of newly infected persons day by day. In other words, the number of persons newly infected from one patient is described as the product of infectious power in each stage of the prodromal or symptomatic period, and R_0 ($p_{1s}(s)R_0$ and $p_{2s}(s)R_0$). Equations for $S(t)$ (Eq. 1 in Appendix) or $I_{1n}(1, t)$, $I_{1qv}(1, t)$, $I_{1q}(1, t)$ (see Appendix) contain them.

The process is then developed into the next stage following the transition probability ($p_1(s)$, $p_2(s)$ or $p_3(s)$), and the remainder add 1 day within each stage. For instance, patients who are in the incubation period s days after the infection move to the prodromal stage at $p_1(s)$, and remain in the incubation period at $1 - p_1(s)$. Similarly, patients who are in the symptomatic period s days after the infection move to the dead or recovery stage at $p_3(s)$ or they remain in the symptomatic period at $1 - p_3(s)$. Besides 100% percent of patients in the symptomatic period are hospitalized and quarantined every day and, thus, they lose infectious power.

In ring vaccination, the public health authorities have to trace contacts, quarantine them, and perform shot vaccinations. We assume that they conduct contact tracing and isolation first. Thus, if there are many more contacts than there are staff of the public health authority, there may be some people who are not vaccinated even though they are quarantined. If more than 10000 contacts were to occur, the public health authority could not trace all contacts in 1 day, and, thus, some patients would not be isolated. Needless to say, this would depend on the size of the outbreak. Conversely, in mass vaccination, contact tracing is not required, and so the public health authorities can administer shots to 1 million persons per day. In Eq. 26 in the Appendix, the number of mass vaccinations per day per worker is described and W .

In the equations, the contacts (C) multiplied by the number of newly infected persons, divided by two multiplied by the number of public health workers is the rate of contacts captured (r). If this ratio is more than 1, r is limited to 1, and the remainder, which is the number of newly infected persons minus two times the number of public health workers, and not traced on that day. Even if this ratio is smaller than 1, but close to 1, some contacts captured by the health workers may not receive a vaccine shot. Formally, the proportion of ring vaccinations per day (v) is determined by

$$v = \frac{c \times \text{number of newly infected persons}}{200 \times \left(2 \times \text{number of public health workers} - c \times \text{number of newly infected} \right)}$$

Conversely, the number of mass vaccinations per day per worker is denoted by W , which is 200 times the number of public health workers.

Table 2. Setting of intervention model

Parameters	Setting	Sources
R_0	3,5,10	Previous research ^{5-8,11}
Starting day of intervention	30,45,60	Previous research ⁵
Number of initial-exposure cases	1000	Assumption

Starting day of intervention is defined as the number of days from the day that the initial-exposure case was exposed

Outcome indicator of control measures

We focus only on the cumulative number of patients, as the indicator of the outcome of control measures. In other words, we ignore the total number of deaths, even though this would seem to have a greater impact, because this number seems to be a proportion of the cumulative number of patients. Therefore a countermeasure that can avoid more patients than an other, alternative, measure is called effective.

Sensitivity analysis

We performed sensitivity analysis of the parameters summarized in Table 2, so as to confirm the robustness of the model and to take uncertainty of the parameters into consideration. Namely, R_0 values are assumed to be 3, 5, and 10, as used in previous research,^{5-8,10} in addition to the base case. R_0 values of more than 5 were also used in previous research (S. Tokunaga: The research for technological foundation from the viewpoint of precautionary medicine [unpublished manuscript]; 2003). As an intervention parameter, the starting date is assumed to be 30, 45, and 60 days after the initial case was exposed. The number of initial-exposed cases is assumed to be 1000, as in previous research,⁵ in addition to the base case.

Results

Figure 4 shows the estimated epidemic curve, which is the number of newly infected persons, in the base case, without any intervention. On the first day, one person is infected. Then there is no new patient during the incubation period of a few days in the first case. After that, the initial case has infectious power, and there is some probability of new cases. Note that, since R_0 is 1.5, and infectiousness is distributed among more than 10 days, the probability of a new infection is less than 0.2 in the earlier stage. From that time, second or third infections occur, and the number grows exponentially. The cumulative number of patients reached 122 on the final day, day 160 (Fig. 3).

Though it is not shown in Fig. 3, the peak came 2 years after the initial case was exposed, and the total number of patients reached about 17 million. Needless to say, if some intervention policy were to be implemented the course of

Fig. 4. Number of the newly infected person (without any intervention)

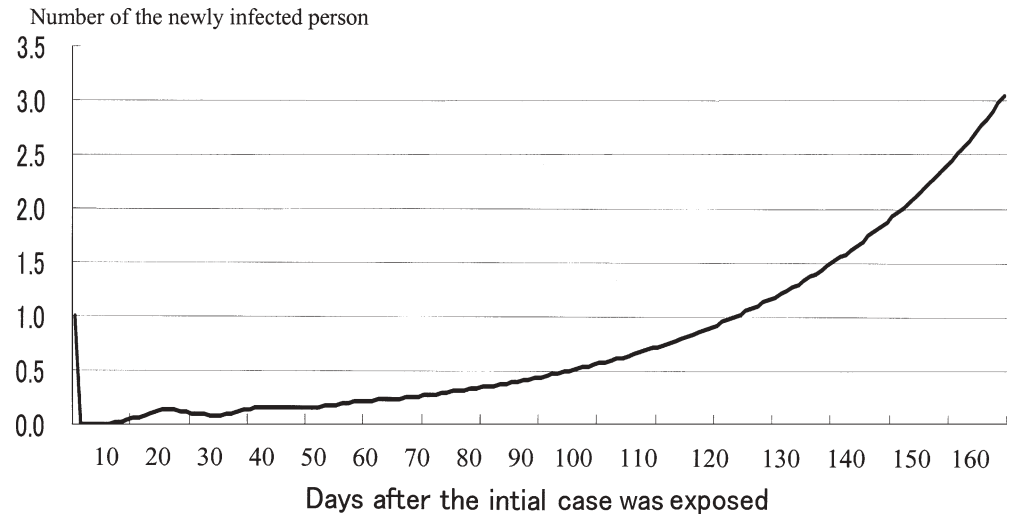

Table 3. Estimated numbers of infected persons in the mass-vaccination scenario

R_0	Number of people with initial exposure	Starting day of intervention	Number of patients			Number of vaccinations
			3 Months	6 Months	1 Year	
1.5	1	30	5.64	5.65	5.65	3.00×10^7
1.5	1	45	9.02	9.07	9.07	3.00×10^7
1.5	1	60	13.1	14.0	14.0	3.00×10^7
3	1	30	23.9	23.9	23.9	3.00×10^7
3	1	45	66.9	69.1	69.1	3.00×10^7
3	1	60	156	197	197	3.00×10^7
5	1	30	98.7	100	100	3.00×10^7
5	1	45	441	481	481	3.00×10^7
5	1	60	1.47×10^3	2.31×10^3	2.31×10^3	3.00×10^7
10	1	30	1.04×10^3	1.10×10^3	1.10×10^3	3.00×10^7
10	1	45	8.68×10^3	1.12×10^4	1.12×10^4	3.00×10^7
10	1	60	4.54×10^4	1.12×10^5	1.12×10^5	2.99×10^7
1.5	1000	30	5.64×10^3	5.65×10^3	5.65×10^3	3.00×10^7
1.5	1000	45	9.01×10^3	9.07×10^3	9.07×10^3	3.00×10^7
1.5	1000	60	1.31×10^4	1.40×10^4	1.40×10^4	3.00×10^7
3	1000	30	2.38×10^4	2.39×10^4	2.39×10^4	3.00×10^7
3	1000	45	6.67×10^4	6.89×10^4	6.89×10^4	2.99×10^7
3	1000	60	1.55×10^5	1.95×10^5	1.95×10^5	2.98×10^7
5	1000	30	9.81×10^4	9.93×10^4	9.93×10^4	2.99×10^7
5	1000	45	4.30×10^5	4.66×10^5	4.66×10^5	2.95×10^7
5	1000	60	1.39×10^6	2.01×10^6	2.01×10^6	2.79×10^7
10	1000	30	9.57×10^5	1.00×10^6	1.00×10^6	2.89×10^7
10	1000	45	5.58×10^6	5.96×10^6	5.96×10^6	2.40×10^7
10	1000	60	1.54×10^7	1.60×10^7	1.60×10^7	1.38×10^7

Number of patients (3 months/6 months/1 year) indicates the estimated number of patients at 3 months, 6 months, or 1 year after the initial case was exposed

prevalence would be affected and control may be achieved by adopting appropriate countermeasures such as quarantine and vaccination.

Table 3 summarizes the results for mass vaccination. Table 4 shows the results for ring vaccination. Each Table has 24 patterns of combinations of different R_0 values, and shows the number of initial-exposure cases, and the starting date of intervention. The numbers of patients in Tables 3 and 4 indicate the estimated numbers of patients 3 months, 6 months and 1 year after the initial case was exposed, and the necessary number of vaccination shots to be given.

In general, comparing Table 3 and Table 4, the total number of patients in the ring-vaccination scenario is smaller than that in the mass vaccination scenario for all patterns. Mass vaccination needs almost 30 million vaccine doses. Conversely, the necessary number of vaccine doses for ring vaccination is much smaller than that required for mass vaccination. If there is a larger number of initial cases, higher R_0 , and later start of intervention by the public health authority, more than 24 million vaccine doses are necessary. In such a scenario, mass vaccination is preferable to ring vaccination.

Table 4. Estimated numbers of infected persons in the ring-vaccination scenario

R_0	Number of people with initial exposure	Starting day of intervention	Number of patients			Number of vaccinations
			3 Months	6 Months	1 Year	
1.5	1	30	2.30	2.30	2.30	68
1.5	1	45	4.20	4.20	4.20	101
3	1	30	3.82	3.82	3.82	140
3	1	45	11.7	11.7	11.7	395
3	1	60	34.1	34.1	34.1	1.12×10^3
5	1	30	6.21	6.21	6.21	244
5	1	45	30.6	30.6	30.6	1.15×10^3
5	1	60	147	147	147	5.52×10^3
10	1	30	14.0	14.0	14.0	549
10	1	45	143	143	143	5.47×10^3
10	1	60	1.45×10^3	1.45×10^3	1.45×10^3	5.53×10^4
1.5	1000	30	2.35×10^3	2.35×10^3	2.35×10^3	0.55×10^5
1.5	1000	45	4.35×10^3	4.35×10^3	4.35×10^3	0.98×10^5
1.5	1000	60	7.33×10^3	7.33×10^3	7.33×10^3	1.72×10^5
3	1000	30	4.34×10^3	4.34×10^3	4.34×10^3	1.64×10^5
3	1000	45	1.62×10^4	1.62×10^4	1.62×10^4	7.93×10^5
3	1000	60	6.26×10^4	6.30×10^4	6.30×10^4	3.31×10^6
5	1000	30	8.97×10^3	8.97×10^3	8.97×10^3	4.26×10^5
5	1000	45	1.04×10^5	1.05×10^5	1.05×10^5	5.58×10^6
5	1000	60	8.27×10^5	1.37×10^7	2.12×10^7	1.81×10^7
10	1000	30	1.31×10^5	2.63×10^5	2.65×10^5	1.37×10^7
10	1000	45	9.82×10^6	2.91×10^7	2.91×10^7	3.32×10^6
10	1000	60	1.98×10^7	2.92×10^7	2.92×10^7	6.91×10^5

Number of patients (3 months/6 months/1 year) indicates the estimated number of patients at 3 months, 6 months, or 1 year after the initial case was exposed

Fig. 5. Cumulative number of patients in the mass-vaccination scenario ($R_0 = 1.5$, number of initial-exposed cases = 1000)

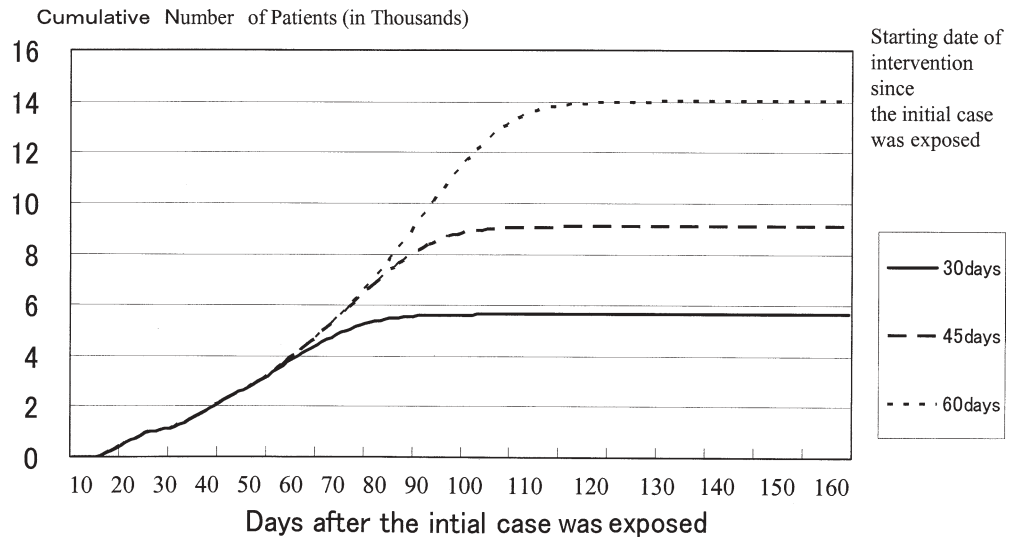

Figure 5 illustrates the movement of the cumulative number of patients in the mass vaccination scenario where, $R_0 = 1.5$, and where the number of initial-exposure cases is 1000. It clearly shows that the total number of patients would reach 14000 if intervention was delayed. Even if the public health authority could start intervention within 30 days after the initial case was exposed, the total number of patients would exceed 5000. On the other hand, as shown in Fig. 6, ring vaccination can dramatically reduce the total number of patients. Namely, even in the worst case of delay, the total number of patients would be lower than 7000. If the public authority could start intervention within 30 days

and it adopted ring vaccination, the total number of patients may be constrained to less than 2500. Therefore, we can conclude that ring vaccination is more effective when $R_0 = 1.5$ and the number of initial-exposure cases is 1000.

Figure 7 shows such relationships in more detail. The upper areas of the declining lines indicate that for the combination of R_0 and number of initial-exposure cases, mass vaccination is more effective than ring vaccination. The blue line indicates the combination in the scenario in which the starting date of intervention is 30 days after the initial case was exposed. The pink line and yellow line indicate the combinations for 45 and 60 days, respectively. Obviously,

Fig. 6. Cumulative number of patients in the case of ring vaccination scenario ($R_0 = 1.5$, number of initial-exposed cases = 1000)

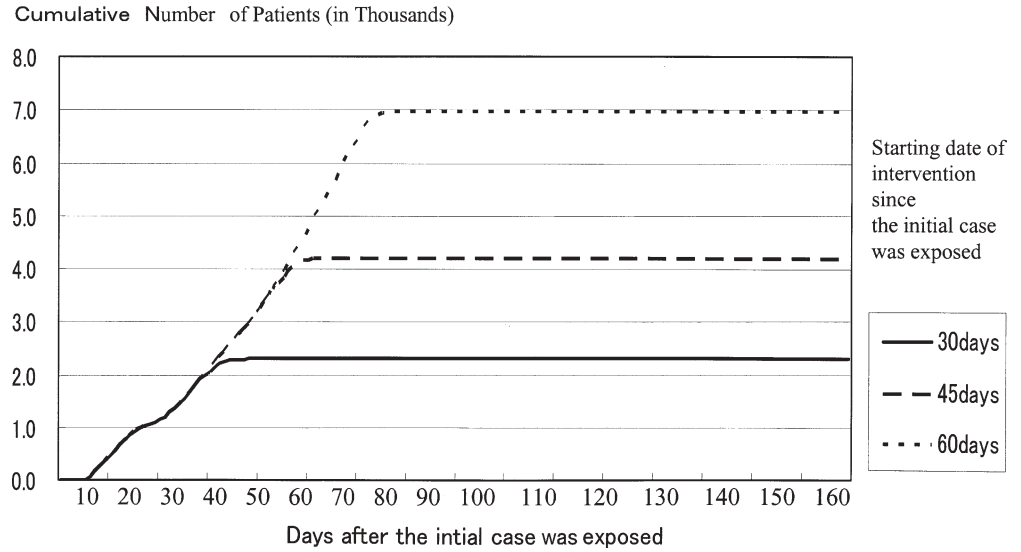
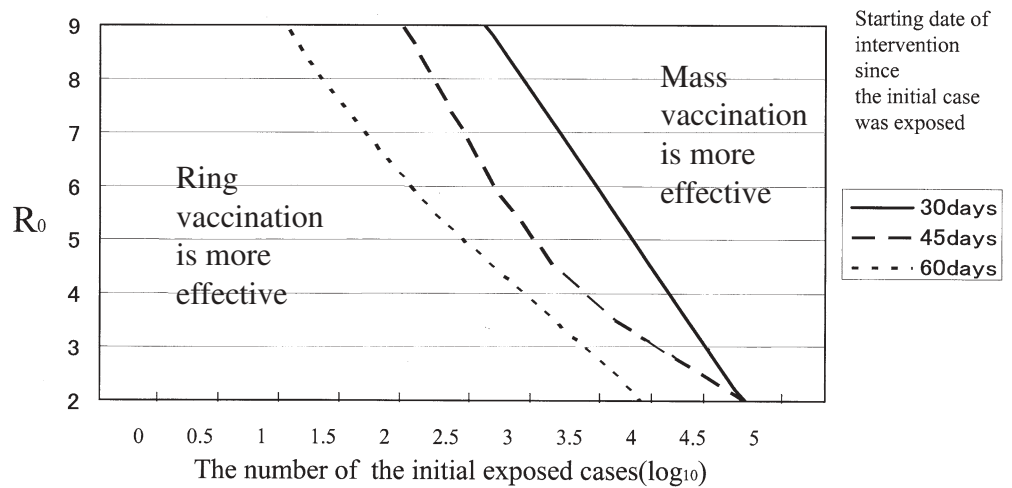

Fig. 7. Comparison of the two control measures



the later the intervention starts, the wider the area on the graph would be where mass vaccination is more effective. For instance, if the R_0 value is 9 and the number of initial-exposure cases is more than ten, mass vaccination would be more effective.

Discussion

We have considered, according to a mathematical model, which control measure, mass vaccination or ring vaccination, would be more effective to contain an epidemic of smallpox. We found that, if R_0 is higher, the number of initial-exposure cases is greater, or if the starting of intervention is delayed, the probability that mass vaccination is more effective than ring vaccination rises.

These results are qualitatively consistent with those in a previous study,⁷ but, quantitatively, there are large differences. Namely, the previous research found that, even if R_0

was 1, and the number of initial-exposure cases was less than 15, or if R_0 was 1.3 and the number of initial-exposure cases was 1, mass vaccination was more effective than ring vaccination. In our results, ring vaccination was definitely more effective with these parameters. On the other hand, if R_0 is 2 and the number of initial-exposure cases is 1, our result shows that ring vaccination is more effective, whereas the previous research concluded the opposite.

These two studies (i.e., the study reported by Kaplan et al.,⁷ and our present study) share a similar model framework and parameter settings, but there is a difference between them. In their study,⁷ the difference in the numbers of vaccinations represents only the difference between mass vaccination and ring vaccination. Besides, the ratio of the number of vaccinations in the mass- and ring-vaccination scenarios was fixed, as 3:1. In other words, they⁷ assumed that the public health authorities traced and captured contacts and then administered vaccination shots, and after that, they started searching for other contacts. On the other hand, we propose that the public health authorities trace

and capture contacts and then quarantine them, and after that, they start searching for other contacts. Vaccination is performed for the quarantined contacts after all contacts have been captured, because isolation stops further infections. Of course, vaccination can reduce the probability of disease onset in the infected period but not in the incubation period. This difference between the two models expands the area of the graph (Fig. 7) where ring vaccination is more effective than mass vaccination.

We have accounted for limitations in the numbers of public health workers and for priority setting for isolation and vaccination in the scenario for ring vaccination, factors that were not taken into account in the previous research.⁷ Therefore, our model seems to be more appropriate and realistic. Moreover, the results in the previous research⁷ that mass vaccination was more effective in regard to almost all parameters seems counter-intuitive. In this sense, our results may be more reliable.

Even though the value assumed for R_0 , the number of the initial-exposure cases, and the natural history probably make sense, because these numbers have also been adopted in other studies and they depend on the biological characteristics of the virus or on the type of terrorist action, there is no evidence in Japan about the starting date of intervention, the human resources of the public health authorities, or other parameters of policy action. We have simply borrowed these parameters from previous studies in other countries and so we have assumed that there are no differences among policies or the human resources of the public health authorities between these other countries and Japan. We examined the sensitivity of the starting date of intervention, and it can be seen that it affected the epidemic curve dramatically, as shown in Figs. 5 and 6. Unfortunately, there is no official documentation of a detailed action plan in the case of a bioterrorism attack or of past experience in a similar situation. Therefore, we have to keep this point in mind when we interpret the results. We also have to emphasize that obtaining reliable parameters of policies in Japan is an important task for further studies. For instance, the experience of contact tracing, when a SARS patient visited Japan in May 2003, may provide good data for such studies.¹¹

Moreover, we also need to mention the interpretation of our findings. As we limited the total number of patients as an outcome measure, we may have ignored important aspects of countermeasures. For instance, adverse effects of vaccination,^{12,13} psychological disorders due to the isolation of contacts,¹⁴ and so on. Therefore, our conclusion, which focuses only on the number of patients, may be biased if such ignored aspects are more important than the aspects we focused on. In principle, we have to evaluate all aspects of policy in their entirety but this seems to be a very difficult task, and it may be the next necessary step in this field. At least, we remind that this conclusion reflect only total number of patients when we interpret it.

Moreover, we have to take into account the heterogeneous population distribution or spatial spread of disease

due to the movement of infected persons to evaluate movement restrictions or other control measures, even though we have considered uniform and homogenous population distribution in our model.

Moreover, if the number of vaccination doses is severely limited, we have to choose either ring vaccination or priority vaccination for medical staff and public health workers. A mathematical model could provide the answers to those questions and such a model will be one of the most important issues for the planning of measures to be taken in the event of a bioterrorism attack.

Furthermore, though we ignored about 90 million people who were born before 1976 and were vaccinated before 1980, we have to take them into account. They may keep their immunity, protecting them from infection. They may play a key role in the control measures.

Acknowledgments This research was founded by Health and Labour Science Research Grants in 2003 for Special Research, titled "Extensive Coordination among Government Offices and Medical Institutions for Large Scale Outbreak", headed by Dr. I. Okubo, Tsukuba University. We thank Mr. Kunio Tsuyuhara, Osaka University, and Ms. Tamie Sugawara, Tsukuba University, for their helpful research assistance. Needless to say, any remaining errors are ours.

References

1. van Genugten MLL, Heijnen MLA, Jager JC. Pandemic influenza and health care demand in the Netherlands: scenario analysis. *Emerg Infect Dis* 2003;9:531-8.
2. Lipsitch M, Cohen T, et al. Transmission dynamics and control of severe acute respiratory syndrome. *Science* 2003;300:1884-5.
3. Brisson M, Edmunds WJ. Economic evaluation of vaccination programs: the impact of herd-immunity. *Med Decis Making* 2003;23:76-82.
4. Lieu TA, Cochi SL, Black SB, et al. Cost-effectiveness of a routine varicella vaccination program for US children. *JAMA* 1994;271:375-81.
5. Metlzer MI, Damon I, LeDuc JW, Miller JD. Modeling potential response to smallpox as a bioterrorist weapon. *Emerg Infect Dis* 2001;7:959-69.
6. Gani R, Leach S. Transmission potential of smallpox in contemporary population. *Nature* 2001;414:748-51.
7. Kaplan EH, Craft DL, Wein LM. Emergency response to a smallpox attack: the case for mass vaccination. *Proc Natl Acad Sci U S A* 2003;100:4346-51.
8. Halloran ME, Longini IM Jr., Nizam N, Yang Y. Containing bioterrorist smallpox. *Science* 2002;298:1428-32.
9. Brandeau ML, Zaric GS, Richter A. Resource allocation for control of infectious disease in multiple independent populations: beyond cost-effectiveness analysis. *J Health Econ* 2003;22:575-98.
10. Meack TM. Smallpox in Europe, 1950-1971. *J Infect Dis* 1972;125:161-9.
11. Taiwan tourist diagnosed with SARS in Japan. <http://cnews.canoe.ca/CNEWS/World/2003/06-26/119688-ap.html>. Canadian Press; 2003.
12. Thorpe LE, Mostashari F, Karpati AM, Schwartz SP, Manning SE, Marx MA, et al. Smallpox vaccination and cardiac deaths, New York City, 1947. *Emerg Infect Dis* 2004;10:917-20.
13. Meltzer M. Risks and benefits of preexposure and postexposure smallpox vaccination. *Emerg Infect Dis* 2003;9:1363-70.
14. Hawryluck L, Gold WL, Robinson S, Pogorski S, Galea S, Styra R. SARS control and psychological effects of quarantine, Toronto, Canada. *Emerg Infect Dis* 2004;10:1206-12.

Appendix

Classification of population	Symbol
Non-contacted susceptible (unvaccinated)	$S(t)$
Non-contacted susceptible (vaccinated)	$S_v(t)$
Recovered or dead	$D(t)$
Non-infected contacts quarantined (vaccinated)	$S_{qv}(s,t)$
Non-infected contacts quarantined (unvaccinated)	$S_q(s,t)$
Non-infected contacts unquarantined (susceptible)	$S_n(s,t)$
Infected contacts unquarantined in incubation period	$I_{1n}(s,t)$
Infected contacts unquarantined in prodromal period	$I_{2n}(s,t)$
Infected contacts unquarantined in symptomatic period	$I_{3n}(s,t)$
Infected contacts quarantined in incubation period who are vaccinated	$I_{1qv}(s,t)$
Infected contacts quarantined in incubation period who are not vaccinated	$I_{1q}(s,t)$
Infected contacts isolated in prodromal period	$I_{2q}(s,t)$
Infected contacts isolated in symptomatic period	$I_{3q}(s,t)$
R_0 /population	β
Distribution of infectiousness in day s of prodromal period	$p_{I_2}(s)$
Distribution of infectiousness in day s of symptomatic period	$p_{I_3}(s)$
Probability of transition from day s of incubation period to prodromal	$p_1(s)$
Probability of transition from day s of prodromal period to symptomatic	$p_2(s)$
Probability of transition from day s of symptomatic period to death or recovery	$p_3(s)$
Rate of ring vaccinations per day	v
Number of mass vaccinations per day per worker	W
Number of contacts per day	C
Rate of infected persons captured	q
Rate of contacts captured	r

Transition of non-contacted unvaccinated susceptible persons

$$S(t) = \left(1 - \sum_{s=1}^{N_2} p_{I_2}(s) \beta I_{2n}(s, t-1)\right) S(t-1) - C \sum_{s=1}^{N_2} I_{2n}(s, t) \quad (1)$$

$$+ (1-r) \left(1 - \beta \left(\sum_{s=1}^{N_2} p_{I_2}(s) I_{2n}(s, t-1) \sum_{s=1}^{N_1} p_{I_3}(s, t-1)\right)\right) S_n(N_1 + N_2, t) \\ + S_{qv}(N_1 + N_2, t-1) - W + S_q(N_1 + N_2, t-1) \quad (2)$$

Transition of those who recover or die

$$D(t) = D(t-1) + (1-r) \left(1 - q\right) \sum_{s=1}^{N_3} p_3(s) I_{3n}(s, t-1) + \sum_{s=1}^{N_3} p_3(s) I_{3q}(s, t-1) \quad (3)$$

Transition of non-infected quarantined contacts who are vaccinated

$$S_{qv}(1, t) = v \sum_{s=1}^{N_1} r q \left(C - p_{I_3}(s) \beta (S(t-1))\right) \quad (4)$$

$$+ \left(\sum_{j=1}^{N_1+N_2} S_n(j, t-1)\right) I_{3n}(s, t-1) + r \sum_{s=1}^{N_1} S_n(s, t-1) \quad (5)$$

$$S_{qv}(s, t) = S_{qv}(s-1, t-1) + e I_{1qv}(s-1, t-1) + v S_q(s-1, t-1) \quad (s = 2, \dots, N_1) \quad (6)$$

$$(7)$$

Transition of non-infected unquarantined contacts who are susceptible

$$S_n(1, t) = \sum_{s=1}^{N_1} \left(1 - r q\right) \left(C - p_{I_3}(s) \beta (S(t-1)) + \sum_{i=1}^{N_1+N_2} S_n(i, t-1)\right) I_{3n}(s, t-1) \quad (8)$$

$$S_n(s, t) = (1-r) \left(1 - \beta \left(\sum_{i=1}^{N_2} p_{I_2}(i) I_{2n}(i, t-1) + \sum_{i=1}^{N_1} p_{I_3}(i) I_{3n}(i, t-1)\right)\right) S_n(s-1, t-1) \quad (s = 2, \dots, N_1) \quad (9)$$

Transition of infected contacts, quarantined in incubation period, who are vaccinated

$$I_{1qv}(1, t) = r q v \beta \left(S(t-1) + \sum_{i=1}^{N_1+N_2} S_n(i, t-1)\right) \sum_{i=1}^{N_1} p_{I_3}(i) I_{3n}(i, t-1) + r I_{1n}(1, t-1) \quad (10)$$

$$I_{1qv}(s, t) = (1 - p_1(s-1)) (1 - e_0) I_{1qv}(s-1, t-1) + r I_{1n}(s-1, t-1) \\ + (1 - p_1(s-1)) v I_{1q}(s-1, t-1) \quad (s = 2, \dots, N_1) \quad (11)$$

Transition of infected contacts who are not quarantined in incubation period

$$I_{1n}(1,t) = (1-r)\beta \sum_{j=1}^{N_3} \left(\sum_{i=1}^{N_2} p I_2(i-1) I_{2n}(i-1, t-1) \right) + \sum_{i=1}^{N_3} p_{I_3}(i-1) I_{3n}(i-1, t-1) S_n(j, t-1) \\ + (1-qr) \sum_{j=1}^{N_3} p I_3(j) \beta \left(S(t-1) + \sum_{i=1}^{N_1+N_2} S_n(i, t-1) \right) I_{3n}(j, t-1) + \beta p_{I_2} I_{2n}(i, t-1) S(t-1) \quad (12)$$

$$I_{1n}(s,t) = (1-r)(1-p_i(s-1)) I_{1n}(s-1, t-1) \quad (s = 2, \dots, N_1) \quad (13)$$

Transition of infected contacts who are not isolated in prodromal period

$$I_{2n}(1,t) = (1-r) \sum_{i=1}^{N_1} p_i(i) I_{1n}(i, t-1) \quad (14)$$

$$I_{2n}(2,t) = (1-r)(1-p_2(1)) I_{2n}(1, t-1) \quad (15)$$

Transition of infected contacts who are not isolated in symptomatic period

$$I_{3n}(1,t) = (1-r) \sum_{i=1}^{N_3} p_2(i) I_{2n}(i, t-1) \quad (16)$$

$$I_{3n}(s,t) = (1-r)(1-q)(1-p_3(s)) I_{3n}(s-1, t-1) \quad (s = 2, \dots, N_3) \quad (17)$$

Transition of non-infected quarantined contacts who are not vaccinated

$$S_q(1,t) = (1-v)r q \sum_{i=1}^{N_3} \left(C - \beta p_{I_3}(i) (S(t-1) + \sum_{j=1}^{N_1+N_2} S_n(j, t-1)) \right) I_{3n}(j, t-1) \quad (18)$$

$$S_q(s,t) = (1-v) S_q(s-1, t-1) \quad (s = 2, \dots, N_1) \quad (19)$$

Transition of infected contacts, quarantined in incubation period, who are not vaccinated

$$I_{1q}(1,t) = (1-v)r q \beta \sum_{i=1}^{N_3} p_{I_3}(i) \left(S(t-1) + \sum_{j=1}^{N_1+N_2} S_n(j, t-1) \right) I_{3n}(j, t-1) \quad (20)$$

$$I_{1q}(s,t) = (1-p_{I_1}(s))(1-v) I_{1q}(s-1, t-1) \quad (s = 2, \dots, N_1) \quad (21)$$

Transition of infected contacts isolated in prodromal period

$$I_{2q}(1,t) = \sum_{s=1}^{N_1} p_{I_1}(s) (1-v) I_{1q}(s-1, t-1) \quad (22)$$

$$I_{2q}(2,t) = (1-p_{I_2}(s))(1-v) I_{2q}(1, t-1) \quad (23)$$

Transition of infected contacts isolated in symptomatic period

$$I_{3q}(1,t) = \sum_{i=1}^{N_3} p_2(i) I_{2q}(i, t-1) + r \sum_{i=1}^{N_3} p_2(i) I_{2n}(i, t-1) \quad (24)$$

$$I_{3q}(s,t) = (1-(1-r)(1-q)) I_{3n}(s-1, t-1) + (1-p_3(s-1)) I_{3q}(s-1, t-1) \quad (s = 2, \dots, N_3) \quad (25)$$

Transition of non-contacted susceptible persons who are vaccinated in mass-vaccination scenario

$$S_v(t) = W + S_v(t-1) \quad (26)$$