



# Domestic value added as an indicator for sustainability assessment: a case study on alternative drivetrains in the passenger car sector

F. Harzendorf<sup>1</sup> · C. Wulf<sup>1</sup> · M. Haase<sup>2</sup> · M. Baumann<sup>2</sup> · H. Ersoy<sup>2</sup> · P. Zapp<sup>1</sup>

Received: 28 December 2021 / Accepted: 5 September 2022 / Published online: 3 October 2022  
© The Author(s) 2022

## Abstract

To strengthen the economic pillar in sustainability assessment, the indicator ‘domestic value added’ is introduced. It aims at comparing established and less developed technologies regarding their prospective value added in a country. This is done by classifying a technology’s value added to the developed categories: domestic, potential domestic and non-domestic. Within this paper, two methods for assessing this indicator are introduced focussing on their applicability in a sustainability assessment context. Both methods are tested on a case study comparing two alternative drivetrain technologies for the passenger car sector (battery and fuel cell electric vehicle) to the conventionally used internal combustion engine. The first method is life cycle cost-based whereas the second is based on Input Output analysis. If a life cycle cost assessment is already available for the technology under assessment, the easier to implement life cycle cost-based approach is recommended, as the results are similar to the more complex Input Output-based approach. From the ‘domestic value added’ perspective, the battery electric vehicle is already more advantageous than the conventional internal combustion engine over the lifecycle. Fuel cell electric vehicles have the highest potential to increase their ‘domestic value added’ share in the future. This paper broadens the economic pillar in sustainability assessment by introducing a new indicator ‘domestic value added’ and giving practical information on how to prospectively assess it for existing and less developed technologies or innovations.

---

✉ F. Harzendorf  
f.harzendorf@fz-juelich.de

<sup>1</sup> Institute of Energy and Climate Research – Systems Analysis and Technology Evaluation (IEK-STE), Forschungszentrum Jülich, (FZJ), Jülich, Germany

<sup>2</sup> Institute for Technology Assessment and Systems Analysis (ITAS), Karlsruhe Institute of Technology (KIT), Karlsruhe, Germany

## Graphical abstract

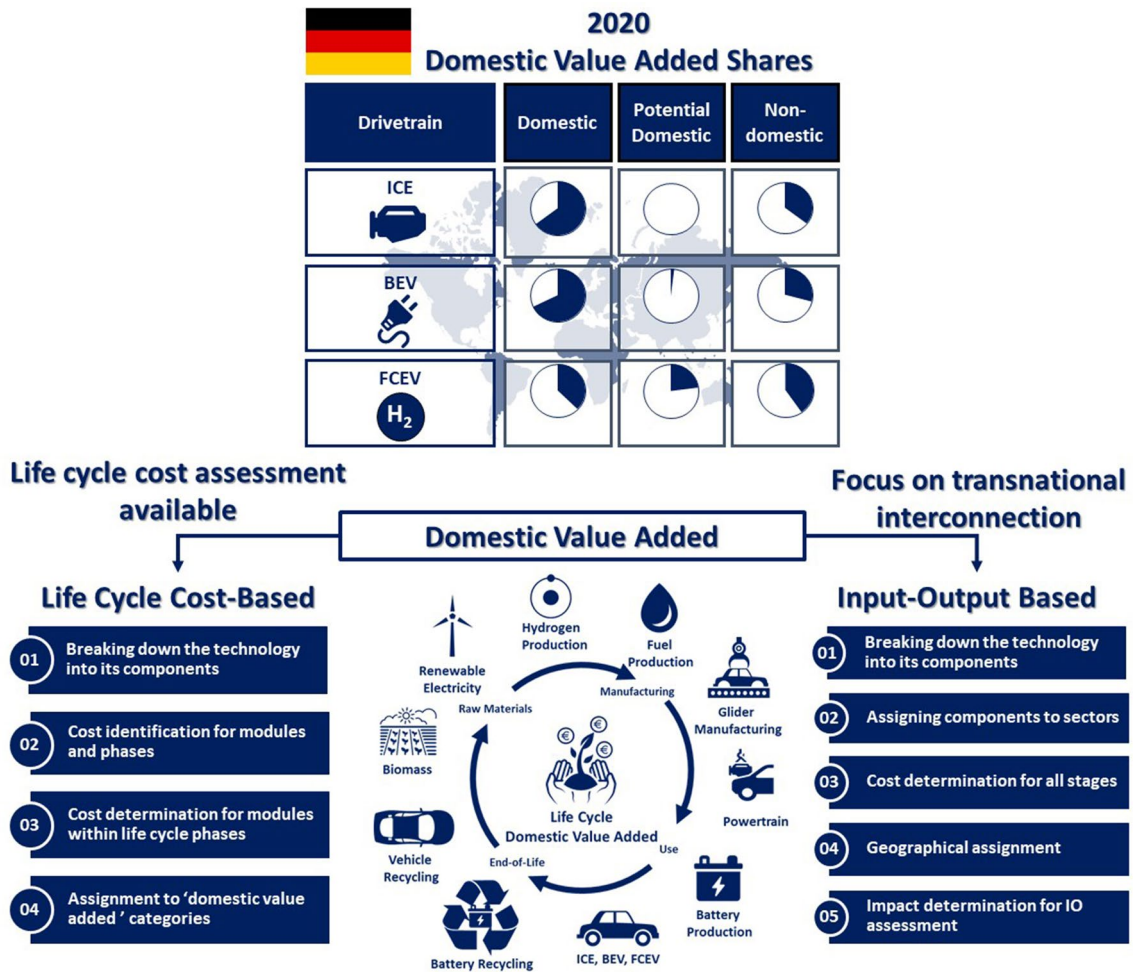

**Keywords** Life cycle sustainability assessment · Long-term economic impacts · Domestic value added · Prospective economic assessment · Drivetrain technology · Input Output analysis

### Abbreviations

BEV	Battery electric vehicle	OEM	Original equipment manufacturer
eol	End-of-life	VAT	Value added tax
FCEV	Fuel cell electric vehicle	WIOT	World Input Output database
GDP	Gross domestic product		
GOS	Gross operating surplus		
ICEV	Internal combustion engine vehicle		
IO	Input Output		
ISIC	International Standard Industrial Classification of All Economic Activities		
LCA	Life cycle assessment		
LCC	Life cycle costing		
LCI	Life cycle inventory		
LCSA	Life cycle sustainability assessments		
NPV	Net present value		
MRIO	Multiregional Input Output analysis		

### Introduction

With the overall goal of supporting a sustainable future, life cycle sustainability assessments (LCSA) are conducted for a broad number of products and technologies more frequently. However, this method/framework is still rather immature and developing. Recent publications pointed out that the low maturity of tools assessing economic and social aspects compared to environmental causes inconsistencies in LCSA results. For example, Wang et al. (2018) came to this conclusion using LCSA for assessing municipal solid

waste management innovation. Wulf et al. (2018) identified this disparity in the course of applying the UN Sustainability Development Goals for indicator selection within LCSA. The economic dimension of sustainability is often assessed with a low number of differing indicators compared to the ecological or social assessment. Furthermore, these indicators mostly incorporate the users economic goals and neglect long-term economic sustainability from the societies perspective (Wood & Hertwich, 2013). Moreover, many studies do not explain their (economic) indicator choice. One potential reason might be that LCSA is mainly evolving out of the Life Cycle Assessment (LCA) methodology, which is ecologically oriented (Finkbeiner et al., 2010). However, extension to LCSA asks for more interdisciplinary and holistic indicator choice to assess sustainability in its whole spectrum.

With the intention to broaden the economic dimension in LCSA, this paper introduces a newly developed indicator. To further establish long-term macroeconomic sustainability thinking in LCSA, the use of 'domestic value added' as an indicator is proposed. It compares technologies regarding their prospective value added in a country. 'Domestic value added' classifies a technology's value added to the categories domestic, potential domestic and non-domestic value added. Statements about where 'domestic value added' can in best case be realized within the country boundaries if framework conditions are set optimally, and potentials are exhausted becomes possible utilizing this indicator. Usually, an additional assessment step is needed to include the highly important information about potentials for decision support. The indicator furthermore identifies the different life cycle phases and component's share on the value added to allow for suggestions on future economic structures needed for a sustainable development. Two methods for assessing 'domestic value added' are introduced to facilitate its application. Both methods are presented and assessed especially considering their applicability for sustainability assessment within differing areas of application. Special attention is paid to give insights on how to assess the indicator when detailed data sources, like supplier quotations, are not available. A further focus lies on providing methodological approaches for prospectively assessing the 'domestic value added' of a less developed technology which might substitute an existing one. All of this is tested on a use case comparing the 'domestic value added' by a battery electric vehicle (BEV) and fuel cell electric vehicle (FCEV) drivetrain concept to the conventional internal combustion engine vehicle (ICEV).

The paper is structured as follows; first, an overview on economic indicators recently used in LCSA and the role of value added in available literature is presented. Based on the identified research gap the indicator 'domestic value added' is defined. For making it applicable in LCSA in a prospective way two methods for estimating 'domestic value added'

are thoroughly introduced. Moreover, their applicability is assessed by testing them on a case study on alternative drivetrains in the passenger car sector and comparing them. Finally, conclusions and an outlook are given.

## Background

The combination of LCA, Life Cycle Costing (LCC) and social LCA (S-LCA) as LCSA was, in the beginning, mainly developed by Klopffer and his colleagues (Klopffer, 2003, 2008; Klopffer & Grahl, 2014). According to them, raw material extraction, production, use of the product and its disposal are all part of a product's life cycle and need to be considered consistently for LCSA. The main goal is to identify and (hopefully) avoid trade-offs of impacts between systems and shifting of impacts between time periods. However, the focus of this approach is always on the technology or product level. The guidance document on LCSA by the UNEP/SETAC in 2011 concentrated on the technology level as well (Valdivia et al., 2011). In the same year, however, Guinée et al. (2011) proposed a different approach for life cycle-based sustainability assessment that broadens the scope of the assessment from product-oriented over a meso-level to an economy-wide (macroeconomic) analysis. In this framework, the LCC part is broadened by an Input Output (IO) analysis and partial equilibrium models on the meso-level up to a Multiregional Input Output (MRIO) analysis on a macroeconomic level.

However, up to now the economic dimension in LCSAs conducted usually covers the products life cycle costs and discounting them to their present value (Wulf et al., 2019). This also means that the meso- and macroeconomic perspective is often neglected. Just one-fifth of the economic indicators used in LCSAs conducted until the end of 2018 used macroeconomic indicators, such as effect on gross domestic product (GDP) growth, employment, tax, imports, exports, and research and development (Wulf et al., 2019). Visentin et al. (2020) and Alejandrino et al. (2021) obtained similar results in their reviews: The main economic indicators used in LCSA refer to internal costs, only few studies used, e.g. external environmental costs, net present value (NPV), profit, revenues or GDP as economic indicators. Amongst these review papers, only Alejandrino et al. (2021) mentioned 'added value' explicitly as economic indicator. Our literature review on economic indicators used in LCSA in recent years (2020 onwards) leads to a similar conclusion (see Table 1). Only few sources refer to economic indicators other than internal cost and to the macroeconomic perspective. For example, in Sen et al. (2020), the total import of goods and services, gross operating surplus (GOS) and GDP were used as indicators for the assessment of connected and automated heavy-duty trucks based on an IO model. In

**Table 1** Recent (2020 onwards) LCSA studies and related economic indicators

Author year	Title of study	Economic indicator		Comment
		category	Specification	
Sen et al. (2020)	Life cycle sustainability assessment of autonomous heavy-duty trucks	Macro-economic indicators	Total import of goods and services, GOS and GDP	LCSA
Ribeiro et al. (2020)	Framework for Life Cycle Sustainability Assessment of Additive Manufacturing	Cost oriented	Life cycle cost	LCSA
Aboushaqrah et al. (2021)	Selection of alternative fuel taxis: a hybridized approach of life cycle sustainability assessment and multi-criteria decision making with neutrosophic sets	Macro-economic indicators	Total tax, operating surplus, GDP	MRIO-based LCSA
Valente et al. (2021)	Comparative life cycle sustainability assessment of renewable and conventional hydrogen	Cost oriented	Levelized costs of hydrogen production	LCSA
Gulcimen et al.(2021)	Life cycle sustainability assessment of a light rail transit system: Integration of environmental, economic, and social impacts	Cost oriented	Internal and external costs	LCSA
Lamberts-Van Assche and Compernelle, 2022)	Economic feasibility studies for Carbon Capture and Utilization technologies: a tutorial review	Cost- and profit-oriented indicators	Capital cost, operating cost, levelized cost of production, NPV	Techno-economic assessment
Martinez- Hernandez et al. (2022)	Modelling to analyse the process and sustainability performance of forestry-based bioenergy systems	Cost oriented	Capital cost, operating cost, biomass cost, cost of production	LCSA
Soust-Verdaguer et al. (2022)	How to conduct consistent environmental, economic, and social assessment during the building design process. A BIM-based Life Cycle Sustainability Assessment method	Cost oriented	Life cycle cost	LCSA
Bhambhani et al. (2022)	Life cycle sustainability assessment framework for water sector resource recovery solutions: Strengths and weaknesses	Cost oriented	Life cycle cost	LCSA
Barke et al. (2022)	Comparison of conventional and electric passenger aircraft for short-haul flights – A life cycle sustainability assessment	Cost oriented	Life cycle cost	LCSA

Aboushaqrah et al. (2021), three macroeconomic indicators are assessed for the selection of alternative fuel taxis: total tax, operating surplus, and GDP.

Besides other possible macroeconomic indicators, Wood and Hertwich (2013) suggested to include the concept of 'value added' into the LCSA indicator set. In Wood and Hertwich's eyes, 'value added' is a suitable indicator as it addresses the full supply chain and economy-wide interactions as well as economy-wide implications that a technology has on multiple stakeholders (Wood & Hertwich, 2013).

To see how frequent 'value added' is used as an indicator in the field of sustainability assessment, a systematic literature review has been conducted. The database Scopus has been utilized with the key search items 'LCSA OR {Life Cycle Sustainability Assessment} OR {Sustainability Assessment} AND value added' including all sources covering this topic. The list is furthermore complemented by sources identified through backward search. In the following, the different sources are presented in a chronological order (see Table 2). Special attention is paid to the field of application, the underlying idea of the indicator and the methods used to assess it as well as the information gathered about future 'value added' potential. Thereby, future 'value added' potential is understood as the technology inherent 'value added' potential in a country in the future.

May and Brennan (2006) analysed the environmental, economic and social impacts of electricity generation systems from fossil fuels in Australia. In their publication, 'value added' is understood as 'the difference in value between what is sold and the non-labour, non-capital inputs that are purchased for its production' (May & Brennan, 2006). In the life cycle perspective, 'value added' consists of the sum of the 'value added' from each life cycle phase. Unfortunately, the authors did not state the origin of the data they used nor the method that was applied for calculating the indicator. Thomassen et al. (2009) included the indicator 'gross value added' for a trade-off assessment between economic and ecological aspects of a dairy farm. The 'gross value added' quantities are taken from a statistical report of the Netherlands. As in the case before, the article does not provide additional information about the underlying assumptions or calculation. Lu et al. (2014) used the indicator 'value added' for assessing the reusability of waste of electrical and electronic equipment. Again, the authors did not mention the indicator's definition nor the calculation method. Also, Jungmeier et al. (2016) used the indicator 'value added' in their LCSA of algae-based bio-refineries, without mentioning their calculation method as well as the underlying data. Corona et al. (2016) investigated the ecological and socio-economic effects due to the production of electricity by a concentrated solar power plant. For evaluating the economic effect on a meso- and macro-level, they utilized the indicators 'gross and net value added' within the MRIO.

'Gross value added' assesses the relevant effects of a concentrated solar power plant derived over its life cycle. 'Net value added' includes the effects through the displacement of other electricity technologies as a result of introducing a concentrated solar power plant. Based on this assessment, Corona and Guillermo (2019) approached the question of whether or not concentrated solar power plants increase the sustainability of the Spanish energy system. Here the 'net value added' approach introduced in Corona et al. (2016) is used. Konstantas et al. (2019) assessed life cycle cost and 'value added' for different products in the confectionary and frozen dessert sector out of an internal company perspective. 'Value added' due to the production and consumption of the products is calculated as the difference between the sale price and the total costs of bought-in materials and/or services from cradle to grave. Kucukvar et al. (2019) assessed the sustainability of the world food production industry on a country level. By using the indicator 'value added', they measured the long-term economic sustainability of nations based on historic data. They utilized MRIO to assess the direct, indirect (supply chain) and indirect (global) impacts. Additionally, they analysed whether utilizing different global databases for MRIO results in the same findings. Banacloche et al. (2020) assessed the socioeconomic and environmental impacts future investments in building and operating fusion power plants might have. They used a MRIO assessment method to identify total economic stimulation in the different economic sectors by an increase in the demand of goods and services, due to the investment and operation of the fusion power plant. Their analysis is based on detailed data from a research project. Mair-Bauernfeind et al. (2020) conducted a prospective sustainability assessment in order to assess what effect the substitution of a conventional steel-based car component by a wood-based one has on a passenger car's sustainability. To cover country-specific environmental and socioeconomic substitution effects they applied a MRIO assessment method. As the wood-based component was still on a low technology readiness level, the scenario of the MRIO analysis was based on replacing the basic and fabricated metals in the transport sector by wood and cork products of the same monetary value. Wohner et al. (2020) conducted an environmental and economic assessment of food-packaging systems with regard to food waste on tomato ketchup. 'Value added' was understood as the difference between selling a product and its production cost. Cost data was taken from the database Econinvent 3.5. Fernandez-Tirado and Parra-Lopez (2021) analysed the 'gross value added' and job creation due to the national biodiesel industry in Spain between 2005 and 2018 by utilizing an IO method. Several scenarios were analysed for guiding decision-makers in the planning and designing of regulations in this field. The 'value added' results were furthermore used in a consecutive LCSA study (Fernández-Tirado et al., 2021).

**Table 2** Overview of literature using 'value added' and related indicators in economic sustainability assessment and LCSA

Author year	Scope of study	Calculus method	Potential future 'value added'	Comment
May and Brennan(2006)	Environmental, economic, and social impacts of electricity generation systems from fossil fuels in Australia	–	–	Origin of data is not published, a definition of value added is available
Thomassen et al.(2009)	Trade-off assessment between economic and ecological aspects of a dairy farm in the Netherlands	–	–	Data is used from a report, they analyse the indicator 'gross value added'
Lu et al. (2014)	Reusability of waste of electrical and electronic equipment	–	–	Indicator definition is not specified, origin of data is not published
Jungmeier et al. (2016)	LCSA of algae-based bio-refineries	–	–	Origin of data is not published
Corona et al. (2016)	Assessment of ecological and socio-economic effects due to electricity production by a concentrated solar power plant	MRIO	–	Distinction between 'net and gross value added'
Corona and San Miguel (2019)	Whether or not concentrated solar power plants based on HYSOL technology increase the sustainability of the Spanish energy system	MRIO	–	'Net value added' introduced by Corona et al. 2016 is utilized
Konstantas et al. (2019)	Assessment of 'value added' for different products in the confectionary and frozen dessert sector out of an internal company perspective	Value added = sales price—total costs	–	Data is used from a variety of sources
Kucukvar et al. (2019)	Assessment of the sustainability of the world food production industry on a country level	MRIO	–	Assessment of direct, indirect (supply chain) and indirect (global) impacts, comparison of results from utilizing different MRIO databases
Banachloche et al. (2020)	Assessment of socioeconomic and environmental impacts future investments in building and operating fusion power plants might have	MRIO	–	Detailed data from research project is available
Mair-Bauernfeind et al. (2020)	Prospective sustainability assessment: substitution of a conventional steel-based car component by a wood-based in a passenger car	MRIO	–	Replacement of the basic and fabricated metals by wood and cork products for including substituted wood-based component
Wohner et al. (2020)	Environmental and economic assessment of food-packaging systems with a focus on food waste. Case study on tomato ketchup	Value added = revenues—costs	–	Data of Ecoinvent database was used
Fernandez-Tirado and Parra-Lopez (2021)	Assessment of 'value added' due to the national biodiesel industry in Spain between 2005 and 2018	IO	–	Several scenarios were analysed

Looking into the available literature, several findings can be summarized. Overall, ‘value added’ is rarely used as an indicator in LCSA. Employing Scopus, 1.1% of the results included ‘value added’ as an indicator. Older publications using ‘value added’ rarely explained their way of calculation. More recent publications mostly used IO analysis and mainly MRIO to answer their research questions. Many publications executed their assessment based on detailed cost information gained from quotations within the framework of research projects or historic data (Banacloche et al., 2020; Corona et al., 2016), which is not a representative boundary condition for other LCSAs. The fields of application were manifold. Most frequent was infrastructure assessment (Banacloche et al., 2020; Corona et al., 2016) and historical evaluation of certain industries (Fernández-Tirado & Parra-López, 2021; Konstantas et al., 2019; Kucukvar et al., 2019; May & Brennan, 2006). Besides Corona et al. (2016), all references utilized something like ‘gross value added’, while the mentioned publication additionally focused on ‘net value added’ including relevant effects resulting from the technology’s substitution. Only one source conducted an assessment for substituting a present technology with a technology not yet introduced in the market (Mair-Bauernfeind et al., 2020). However, this was modelled in a simplified way by just changing the underlying material and no adjustment to the cost.

Prospective assessment in terms of technology inherent potential for generating ‘value added’ in the country under assessment in the future has yet not been addressed. Based on this intensive literature review three hypotheses are deduced by the authors about why ‘value added’ is seldomly used as an indicator in LCSA:

- There is a lack of knowledge about how to assess the indicator in LCSA communities especially when dealing with data scarcity in an early design stage of a technology.
- The usually used IO method is complicated if applied in LCSA environment.
- The indicator ‘value added’ defined in the conventional way does not give enough new insights about a technology to justify the effort for applying it in LCSA.

This underlines the need for an easy to apply indicator and documented methods with additional information value about prospective ‘value added’ of a technology to strengthen the macroeconomic perspective in LCSA. With this paper the authors want to address the described white spot by introducing a new macroeconomic indicator including methods for assessing it in an LCSA environment.

## Methodology for novel indicator ‘domestic value added’

The last chapter made it obvious that ‘value added’ is seldomly included in the LCSA indicator set and hardly assessed within sustainability assessments at all. If it is addressed mostly IO or MRIO, both relatively complex approaches, are used. This might be one reason for not assessing ‘value added’ in the first place. Furthermore, indicators used in literature so far hardly assess the future ‘value added’ potential, which is crucial when thinking about introducing a new technology into the market and, for example, setting up subsidies for it.

With these shortcomings in mind, the indicator ‘domestic value added’ is designed and two methods are suggested to allow a broad application. First the term ‘value added’ needs to be defined as the literature review showed that it can be understood in different ways in the LCSA environment. Within this paper ‘value added’ is defined as the sum of unit profit, unit depreciation costs and unit labour costs of a product, component, service or process chain. It indicates the economic performance of an industry. This way long-term economic impacts are considered. Adding up the ‘value added’ of all industries in a country equals the GDP. ‘Domestic value added’ aims at assessing technologies concerning their (prospective) influence on the ‘value added’ in a country. This is done by estimating a technology’s ‘value added’ and classifying it to the categories: ‘domestic’, ‘potential domestic’ and ‘non-domestic value added’. Hereby, domestic means the ‘value added’ that is realized in the country under consideration. ‘Value added’ is assumed to be ‘potentially domestic’ when parts or manufacturing steps of a technology are (partly) imported, although similar competencies are available in the country considered. ‘Non-domestic value added’, is realized if the technology/ (intermediate) product is and will still be imported in the future. With this classification, ‘domestic value added’ makes it possible to assess the influence the decision for introducing a new technology has on the country’s economy in a long-term macroeconomic perspective and utilizes statements about the structural change in an economy. It allows a grounded estimation about how a technology can affect the overall welfare of a country, even before the technology is rolled out in the market.

Before two approaches for assessing the ‘domestic value added’ for a technology in the LCSA environment are presented, some general assumptions are introduced which are valid for both. To distinguish between an already established and a substituting technology the term ‘marginal technology’ is adopted from LCA inventories (Weidema et al., 1999). A ‘marginal technology’ is understood

as the technology that is affected by the introduction of a substituting technology. The substituting technology is in the following called ‘innovative technology’. To enable assumptions about future allocation to the country of origin the analysis of patents can be helpful. Baumann et al. (2021) provided a valuable tool for facilitating a patent search. Patents are useful as they can be seen as indicators for future industry engagement in specific fields. The origin of a company can be taken as an indicator for the country where future ‘value added’ might be realized. Thereon, the allocation to ‘domestic, non-domestic and potential domestic value added’ can be conducted for both methods. Defining several scenarios and assessing a bandwidth of possible outcomes can help both methods to get an indication about future ‘domestic value added’. In the following both methods are thoroughly introduced including suggestions for dealing with challenges in their application.

### Approach 1—life cycle cost-based method

The idea behind the first approach is to build up on already existing LCA and LCC assessments for the evaluation of a technologies present ‘domestic value added’. It is developed with the aim of providing an easy to apply indicator in the LCSA environment, thus lowering the barrier of the indicator’s application. It consists of four steps which are represented in Fig. 1.

First, the ‘marginal technology’ is split-up into its modules and all life cycle phases. Second, the acquisition costs, operational and end-of-life (eol) costs to pay for the ‘marginal technology’ are identified. Next, the acquisition cost is split-up into the modules of the ‘marginal technology’. Subsequently the ‘marginal technology’s’ modules acquisition costs are associated to material, manufacturing, and

overhead, based on the literature information. The operation and maintenance efforts are associated to material (repair parts), labour, insurance, and tax. Eol costs are split-up into costs for waste disposal and recycling. Within this paper material, manufacturing, overhead, repair, labour, insurance, tax, waste, and recycling are accumulated to the term ‘consisting parts over the lifetime’.

If information about the origin of the module’s raw material, the location of manufacturing, maintenance or waste and recycling is available, it can be used for the domestic or non-domestic assignment. Otherwise, the abilities of the country under consideration are analysed, including its mineral deposits, the located industries, and their capabilities. The following aspects can facilitate the assignment (examples refer to the technology itself):

- ‘Domestic value added’ is reasonable if, e.g. materials are domestically mined, the technology is produced and/or installed in the country under consideration, maintenance is conducted in the country, high transportation effort and cost would emerge to import the technology compared to the acquisition costs, recycling or waste treatment is done in the country under consideration or local content requirements exist.
- Aspects possibly indicating ‘non-domestic value added’ are either that the country does not have competence in the field needed (production, waste treatment, recycling, ...), or that transportation effort for the technology is low compared to the acquisition costs, or that no mineral deposits exist. For highly developed countries with high wages, mass produced components might be an indicator for ‘non-domestic value added’. An indicator for mass production can be that similar components are used in other technolo-

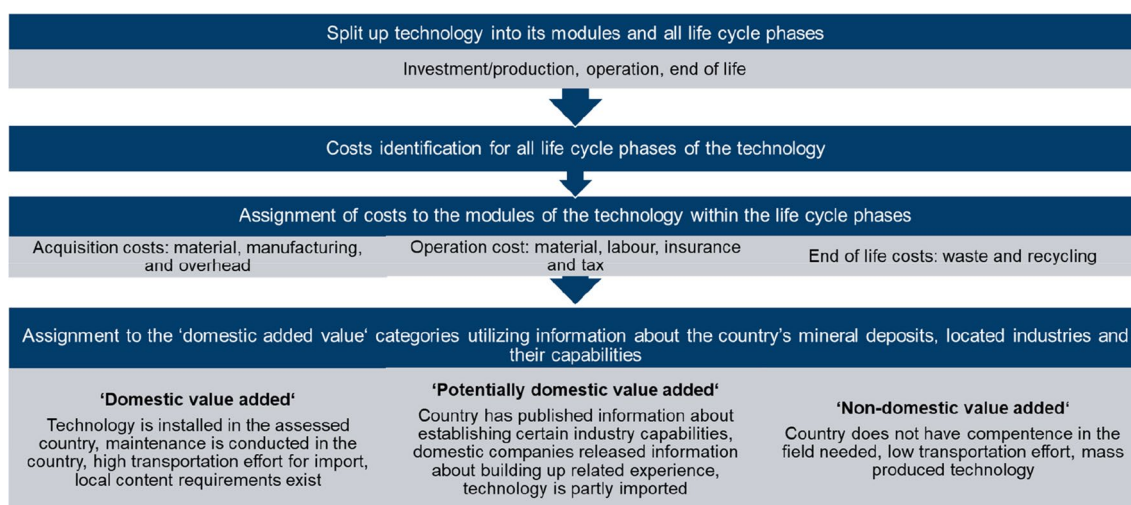

Fig. 1 Four-step approach for assessing ‘domestic value added’ of a technology for the life cycle cost—based method



gies. However, it could also be that automation in the production is established which is still located in the country.

- ‘Potential domestic value added’ is attributed if, e.g. a country has published information about fostering or establishing certain industry capabilities in the near future. Alternatively, companies release information about their intentions to build up related experiences within the country. It is furthermore assigned if the country has limited capacity in the needed technology skills.

If enough information is available, the four steps depicted in Fig. 1 are conducted for the ‘innovative technology’ as well. If this is not the case, the ‘innovative technology’ needs to be thoroughly compared against the ‘marginal’ one on a technical module level. Using analogies, differences, and technology readiness level a cost estimate becomes possible. However, this results in subjective and highly uncertain estimations. Scenario and expert elicitation can help to improve the propositions quality.

For evaluating future perspectives, first the acquisition, operational, and eol costs need to be adjusted for both, ‘marginal’ and ‘innovative technologies’, taking technical development into account. As described in the superordinated methods chapter, the analysis of patents can enable the possible future allocation to the country of origin. It is recommended to additionally conduct scenario analysis.

Equation (1) consolidates the calculation steps shown in Fig. 1. Whereby,  $va$  in € indicates the ‘value added’ split-up into ‘domestic’ (d), ‘potentially domestic’ (p-d) and ‘non-domestic’ (n-d) shares. The technology modules are represented by  $i$ , the life cycle phase is indicated by  $j$  (production, operation, and eol), the ‘consisting parts over the lifetime’ are represented by  $k$ . The cost per life cycle phase is depicted by  $p_j$  in € (production, operation, and eol).  $s_{i,j,k}$  in % is the share of the cost ( $p$ ) for each module ( $i$ ) in its life cycle phase ( $j$ ) and its ‘consisting parts over the lifetime’ ( $k$ ). Whereas  $sva_{i,j,k}$  in % stands for the share of the ‘value added’ per share of the cost ( $p$ ) for each module ( $i$ ) in its life cycle phase ( $j$ ) and its ‘consisting parts over the lifetime’ ( $k$ ).

$$\begin{pmatrix} va_d \\ va_{p-d} \\ va_{n-d} \end{pmatrix} = \sum_{i=1}^m \sum_{j=1}^n \sum_{k=1}^q p_j * s_{i,j,k} * \begin{pmatrix} sva_{d,i,j,k} \\ sva_{p-d,i,j,k} \\ sva_{n-d,i,j,k} \end{pmatrix} \quad (1)$$

The result of this approach is a comprehensible allocation of ‘domestic value added’ for the present and future of ‘marginal’ and ‘innovative technologies’. This approach is recommended if an LCA and LCC analysis already exist as a lot of allocation and cost information can be reused in this approach.

### Approach 2-IO-based method

The second method for estimating ‘domestic value added’ is based on an IO analysis which is nicely introduced in Miller & Blair (2009). Compared to the approaches and indicators found in the literature review (please compare Table 2) this approach expands on the prospective aspect. It allows to assess the most positive impact the investigated technology can have on the ‘value added’ in a country when all framework conditions are optimal, and potentials are exhausted. Usually, an additional assessment step is needed to include this highly important information for decision support. In addition, this method describes how to reasonably use available information from an LCI or s-LCA for using the IO method.

IO analysis describes the interconnections and interdependencies between industry sectors and product flows within a national economy, including freight flows in a detailed way and the rest of the world in a less detailed way. When a higher level of detail for resource flows through global supply chains is important, MRIOs are useful as they combine country’s IO tables. IO analysis is beneficial as it allows statements about so-called multipliers. A multiplier can assess direct and indirect effects on a sector’s output. Direct effects are those a technology change has on the direct suppliers. Indirect effects are induced by these demand changes in the supply chain beforehand. Furthermore, the IO system can be extended by factors of production to represent the effects on household income, employment, ‘value added’ and more, due to a change in demand. This is what is utilized in the approach presented here.

Mathematically expressed this can be described by Eq. (2). Its derivation is presented in basic literature, (e.g. Miller & Blair, 2009; UN Statistics Devision, 1999)).

$$D_{cba} = F\hat{x}^{-1}(I - Z\hat{x}^{-1})^{-1}y \quad (2)$$

The terminology of Stadler is used here (Stadler, 2021). Capital letters are used for matrixes; lower cases are used for vectors.  $D_{cba}$  indicates the total requirements (in this paper’s case the total ‘value added’ per industry sector in a respective country) for providing the final demand  $y$  (which is needed for the ‘marginal’ or ‘innovative technology’). Transaction matrix  $Z$  represents the inter-industry flows within and across countries. Its columns represent the monetary values of goods and services (inputs) from every sector required to produce the goods and services of one sector. Each row represents the distribution of goods and services production (outputs) of one sector to every sector of the economy.  $I$  is the identity matrix with size of  $Z$ .  $F$  is the factor of the production matrix. It includes linear relationships between ‘value added’, employment and

other social factors and flows between industry sectors.  $\hat{x}^{-1}$  depicts the diagonalized and inverted total industry output.

To utilize IO analysis for estimating a ‘marginal technology’s’ ‘domestic value added’ the technology’s direct demand in the different industry sectors in the different countries needs to be defined. For defining the demand vector for the present, the ‘marginal technology’ is split-up into its (main) modules and life cycle phases. The level of detail needs to allow a distinction between the ‘marginal’ and the ‘innovative technology’, as this is mostly the goal of the assessment. The LCI of an LCA can be used as an inspiration as it assesses the technology in a very detailed way. In a next step, each module needs to be assigned to industry or product groups defined in the databases (e.g. World Input Output Database—WIOD). Again, information and assumptions integrated in the LCI can be useful including the amount of material needed and the assumed production processes. Detailed technical description or the bill of materials can be useful for matching the technology’s main parts/modules to the industry or product groups mainly defined by the International Standard Industrial Classification of All Economic Activities ISIC (United Nations, 2008). Next, each module needs to be quantified by its costs. A last step is assigning each used industry and product group with its country of origin. Using comtrade.un.org, a database for product flows all over the world, can help indicating the products or industries most probable origin (United Nations, 2021). Banacloche et al. (2020) decided to do the assignment based on the country where the consisting part is produced as the supplier was a partner within the research project (Banacloche et al., 2020). As a result, a ‘marginal technology’s’ direct impact on

the demand in the different industry sectors in the different countries is defined. Herby, underlying direct and indirect interconnections between the industries within the transaction matrix can be utilized for assessing ‘domestic value added’. Two calculations have to be conducted for assessing all types of ‘domestic value added’, the first with today’s assignment to the countries and the second one assigning the ‘potential domestic’ category to the assessed country. Figure 2 recapitulates the five steps for defining the demand vector for the IO analysis estimating the ‘domestic value added’ of a ‘marginal technology’ in the present analysis. If available the demand vector for a s-LCA can be used as well.

For the ‘innovative technologies’, all steps have to be passed through as well. However, it can be more challenging as less information and experience is available. It can be helpful to compare both technologies on a technical level and identify underlying differences. Similarities can be modelled in a comparable way. For differences LCIs, literature expert knowledge and own assumptions can be the basis for their definition.

For estimating the possible future ‘domestic value added’, it has to be kept in mind that the transaction matrix represents today’s (the year’s they have been measured) economic structure and interconnections between industry sectors. This boundary condition results in the assumption that the economic structure in the future does not change from the structure that is inherent in the data, if the available transaction matrix  $Z$  is used. This is a highly arguable assumption as technology, relative prices, imports, and level of aggregation might or do change over time. A possible improvement can be gained by modifications of the underlying transaction matrix. RAS method, well known for data reconciliation,

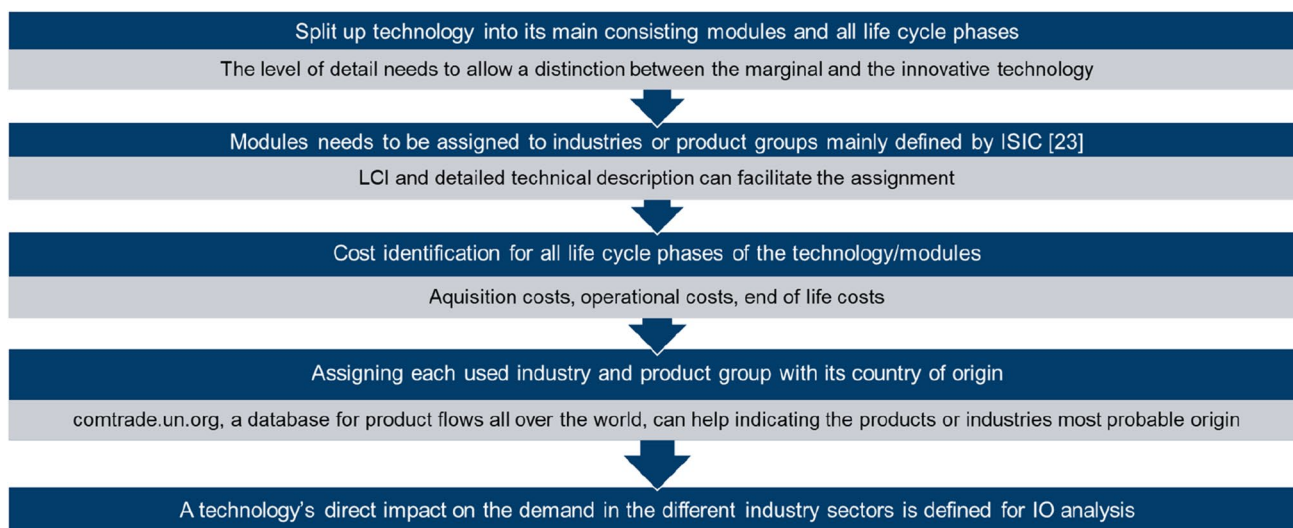

**Fig. 2** Five-step approach for defining the demand vector for an IO-based analysis estimating the ‘domestic value added’ of a technology

**Fig. 3** Field of application of both introduced methods assessing 'domestic value added'

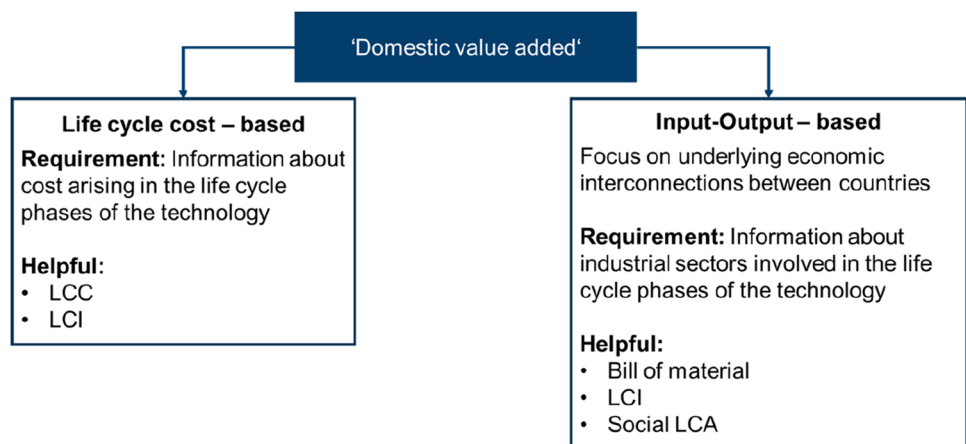

as one example can be helpful in this way (Miller & Blair, 2009). To utilize it, information about the column sum and row sum of the transaction matrix as well as the total industry output in the year under consideration is needed. RAS is an iterative scaling method, which multiplies each entry in today's transaction matrix with factors in a way that the column or row sum is equal to the one needed in the year of consideration. Alternately, columns and rows are adjusted until the algorithm converges to a matrix that is consistent with the required row and column totals. A more detailed description can be found in Miller & Blair (2009) or chapter IX of UN Statistics Division (1999). Several authors proved that this approach helps projecting the transaction matrix into the future (Miller & Blair, 2009). However, it is associated with high effort and relies on the availability of information about row and column sum as well as the overall industry output in the future.

After updating the transaction matrix, the future demand vector needs to be specified. To assess whether today's consisting parts might still be representative in the future, information about technology development is needed. Additionally, this information can help to see if today's modules assignment to industries and product groups will still be valid. Again, assumptions from the LCI can be helpful. In a best case, for quantifying the technology's costs, economies of scale and learning curve approaches for assessing future prices are available. For updating the origin of the modules, the analysis of patents can be helpful as introduced in the subordinate method chapter. Here scenario analysis is recommended as well. After conducting the IO-based analysis, a comprehensible allocation of 'domestic value added' for the present and future of 'marginal' and 'innovative technologies' is possible.

### Comparison of both methods

In the following the two introduced approaches for assessing the 'domestic value added' for a technology in the LCSA

environment are shortly compared regarding areas of application, required data and obtainable information. The first one is suitable for LCSA applications as it utilizes data and information already available in the assessment. It builds up on data from LCA or rather Life Cycle Inventory (LCI) and classic LCC assessment and this way lowers the barrier of the indicator's application. The underlying idea is to allocate costs to the life cycle phases of the technology.

The second approach relies on IO method. It is of interest when the underlying economic interconnections between countries are in the focus. For conducting the IO-based method information about the assignment of the technology/ its modules to industrial sectors is needed. The availability of a bill of material or a LCI as well as an already conducted s-LCA can supply this information. An s-LCA can be useful as its calculation is based on IO method and a demand vector for a technology needs to be defined for conducting it. For 'domestic value added' the classic IO approach is extended by a prospective perspective when assessing the potential 'domestic value added'.

The areas of application for the two methods are aggregated and depicted in Fig. 3. This shall help to identify a suitable estimation method for including 'domestic value added' into the LCSA for individual areas of application.

### Case study on alternative drivetrain technologies for the passenger car sector

In the following, both methods are applied to a case study on alternative drivetrains in the passenger car sector, focussing on the investment phase of drivetrain components. Beforehand overall assumptions of the case study are introduced. The goal of this application is to show differences and similarities with regards to data preparation and allocation as well as results when applying the different methods. Subsequently, a case study assessing 'domestic value added' over the entire life cycle of alternative drivetrain concepts using

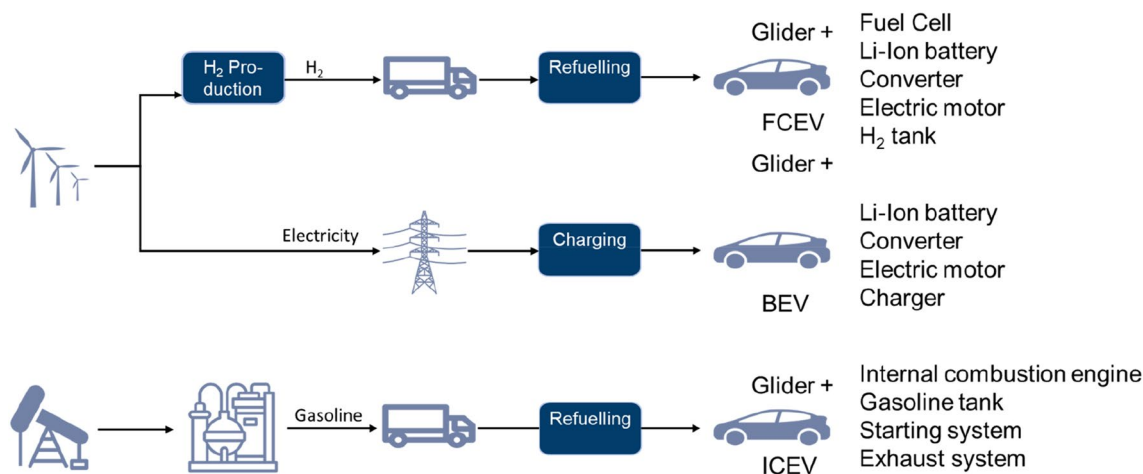

**Fig. 4** Depiction of different drivetrain technologies for passenger cars including the fuel supply chains (icons are taken from (Noun-Project, 2021))

the life cycle cost-based method is presented. Finally, the scientific contributions and limits of the introduced indicator and associated calculation methods are discussed.

### Introduction of the case study

Before the actual assessments are conducted the system under consideration is briefly introduced as shown in Fig. 4. Two different alternative drivetrain technologies for passenger cars are compared to the ‘marginal technology’, a conventional ICEV fueled with gasoline. The analysed alternative technologies are BEV and FCEV. The two considered life cycle phases of these technologies are the production of the passenger cars including the drivetrain components and their operation including the supply chains of the fuels. Due to a lack of data the eol phase is not assessed. For the carbon fibre tank and the fuel cell processes for recycling have not been implemented yet. These are energy and material intensive parts of the FCEV, but without a large roll-out of these parts no recycling processes is developed and implemented on an industrial scale. Currently, carbon fibre recycling is connected to a massive downcycling. As carbon fibre will need to be recycled in large amounts soon, new processes are under development, but they are not yet available for further assessments (He et al., 2022).

Hydrogen for the FCEV is produced by alkaline water electrolysis, which is powered by electricity from onshore wind. It is transported in high pressure trailers on trucks to the hydrogen refuelling station. For BEV the same type of electricity is used which is conducted via the electricity grid to the charging stations. The ICEV is fuelled with gasoline, which is produced in a refinery based on mineral oil. The same process chains are used as in Haase et al. (2021) which were first introduced by Wulf and Zapp (2021). Both

sources provide further technical details. The lifetime of all passenger cars is assumed to be 18 years with a mileage of 15,000 km/a (ADAC, 2021d). The fuel consumption for all passenger car types is based on ADAC sources (ICEV (ADAC, 2021d), BEV (ADAC, 2021c), FCEV (ADAC, 2021b)). For all three passenger car types the same power as well as the same glider is considered. Like Haase et al. (2021) a macroeconomic perspective is assumed for the average cost of raising capital on the financial market. An interest rate of 2.75% is considered as the average interest rate listed for Federal securities for Germany between 2003 and 2020 (Bundesbank, 2021). It is assumed that the passenger cars just differ in terms of the drivetrain and energy storage system. BEV and FCEV both rely on an electric motor and differ in the energy storage system. The BEV has a lithium-ion (Li-ion) battery system on board, which provides the electricity for the electric motor. Additional components include the charger and a converter. The FCEV has a much smaller Li-ion battery, which is only used as a buffer and for recuperation of braking energy. The main part of the energy is stored chemically as hydrogen, which is transformed to electricity in the fuel cell. Thus, also a hydrogen tank is necessary for the FCEV, which is made of carbon fibre and stores the hydrogen under pressure. The ICEV needs much less electrical equipment; instead, the internal combustion engine is its centre piece. Additionally, an exhaust gas system is needed as well as a simple tank for the gasoline and a starting system. The three technologies are compared with regards to the functional unit driven kilometre. Scope of the case study is the ‘domestic value added’ for Germany in 2020.

Due to better availability of data it is assumed in the case study that costs can be represented by prices. However, it needs to be kept in mind that prices are generally influenced

by strategic considerations of the company to find customers (establishing a new product, cash cow e.g.).

### Application of both methods

In the following the above-mentioned two methods are compared with a focus on the data preparation and their impact on differences in the results. For the comparison only the investment phase of the case study is in focus. The entire ICEV is assessed, a separate battery for a BEV and a separate fuel cell for FCEV are analysed. These three technologies/parts are chosen exemplarily to show different ways of preparing the demand vector of a technology for the IO-based method. In the following the assumptions and collected data for both approaches are presented, assessments are conducted, and results compared.

#### Assumptions and collected data: life cycle cost-based method

For assessing the investment phase of the entire ICEV with the life cycle cost-based method, the passenger car is split-up into glider, drivetrain, and energy storage. German passenger car purchasing price is considered including value added tax (VAT) (ADAC, 2021d). It is assumed that the glider costs are not influenced by the chosen drivetrain technology. Its absolute price is based on James et al. (2018) who assessed FCEVs. The drivetrain's part of the purchase price for ICEV is calculated as the difference between a passenger car's purchase and glider price. Underlying is the assumption that the fuel tank of the ICEV is included in the drivetrain and therefore not explicitly considered. Due to a lack of data, the glider price for the ICEV is distributed between material,

manufacturing and overhead similar to the rest of the fuel cell drivetrain system (FEV Consulting GmbH, 2020). The split-up for the ICEV drivetrain is assumed to be similar to the FCEV and adopted from a report (FEV Consulting GmbH, 2020). For the allocation to 'domestic', 'potential domestic' and 'non-domestic value-added' it is generally assumed, that manufacturing and overhead are realized in Germany.

The separate battery price is based on estimations reproduced from Nelson et al. (2019). For the battery the step of assigning the price to material, manufacturing and overhead is skipped, as a source is already available for the allocation to 'domestic', 'potential domestic' and 'non-domestic value added' (Ersoy et al., 2021). The allocation is based on a table indicating German industries ability or potential ability to manufacture batteries provided by VDMA (Michaelis, 2015).

The price for the separate fuel cell is based on Miotti et al. (2017). The split-up between material, manufacturing and overhead is taken from the FEV report (FEV Consulting GmbH, 2020). For FCEV it is known that passenger car's manufacturing has been stopped in Germany, therefore it is assumed that no fuel cell (part) is manufactured domestically. However, it is assumed that manufacturing and overhead can potentially be realized in Germany. All assumptions are summarized in Table 3.

#### Assumptions and collected data: IO-based method

For the IO-based method the purchase prices for the technologies/components under assessment are identified similarly. However, more technical background information and knowledge about the compared technologies is required for

**Table 3** Assumptions for assessing the 'domestic value added' of different drivetrain technologies in the German passenger car sector in 2020 for the life cycle costing-based method

	Unit	ICEV	Battery	Fuel cell
<i>Investment phase</i>				
Purchase price incl. VAT	€2020	27,703 (ADAC, 2021d)	5,915 (Nelson et al., 2019)	11,578 (Miotti et al., 2017)
Glider	%	70 (James et al. 2018)	–	–
Mat/ manu/ o	%	43/30/27 (FEV Consulting GmbH, 2020)	–	–
d/ p-d/ n-d	%	57/0/43 (Kraftfahrt Bundesamt, 2021)	–	–
Drivetrain	%	30	–	–
Mat/ manu/ o	%	43/30/27 (FEV Consulting GmbH, 2020)	–	43/30/27 (FEV Consulting GmbH, 2020)
d/ p-d/ n-d	%	57/0/43 (Kraftfahrt Bundesamt, 2021)	–	0/57/43 (Kraftfahrt Bundesamt, 2021)
Storage	%	–	–	–
Mat, manu, o	%	–	–	–
d/ p-d/ n-d	%	–	34/13/53 (Ersoy et al., 2021; Michaelis, 2015)	–

*mat* Material, *manu* Manufacturing, *o* Overhead, *d* Domestic, *p-d* Potential domestic, *n-d* Non-Domestic, *a* Own assumptions

the assignment to industry or product categories used in the transaction matrix. The technologies need to be split-up into their main consisting parts or even the different process steps for providing them.

Table 4 presents the assignment of the entire ICEV, the battery as well as the fuel cell to the ISICs Rev. 4 two digit industry sector and product definitions (see.

Table 5 for the sectors) (United Nations, 2008). For analysing the ICEV it is assumed that the sector ‘20 C29 manufacture of motor vehicles, trailers and semi-trailers’ is representative for a usual passenger car. Based on this assumptions Kaul et al. (2019) defined the needed advance inputs for this sector in Germany in 2015 based on the statistic information from the Federal Statistical Office of Germany. They assumed that 72% of the advance inputs come from within Germany. They did not assess the additional imports needed. This way of assigning a technology to the industry and product categories is only possible for a ‘marginal technology’, as it needs to be established and included in the statistics of a country. Moreover, the passenger car sector plays a special role as an entire category is defined for it in the IO tables. This circumstance is not necessarily transferable to other ‘marginal technologies’.

Argonne National Lab provides a detailed cost model for estimating Li-ion battery packs (Nelson et al., 2019). It allows to estimate material and manufacturing effort in a scalable way depending on the battery design and the number of items produced. With this model all manufacturing steps are individually included as well as the used material types and general overhead. This highly detailed model enables an easy assignment to the industry sector and product definitions (United Nations, 2008). The numbers used in the model have been compared and aligned to recent German publications assessing the battery module and pack assembly process (Heimes et al., 2018a, b) and the battery cell production (Heimes et al., 2018a, b).

For the fuel cell assignment supplementary material from Miotti et al. (2017) is utilized. It includes a detailed balance of plant cost calculation for fuel cells. The S12 2030 conservative scenario is used for this assessment. Concluding a bill of material like provided from Miotti et al. (2017) can be a valuable starting point for the assignment.

The last step is the indication of the country where the industry sector is originated. For the ICEV just the inputs needed from inside Germany have been mentioned by Kaul et al. (2019). Therefore, all inputs are assigned to Germany. For an overall assessment, the imports need to be included as well. For the battery assignment the VDMA report is utilized (Michaelis, 2015).

For activities not conducted domestically, mainly trade databases have been consulted to indicate the involved countries. Due to a lack of detailed data, it is assumed that the ‘potential domestic’ and ‘non-domestic’ shares are assigned

to the countries indicated in bold in Table 4. Similar to the first approach no ‘domestic value added’ is assumed for the fuel cell as no German company provided FCEV in 2020. Though, a VDMA report indicates potential for German suppliers and fuel cell manufacturer to establish in the fuel cell market (VDMA, 2018). This information is utilized for estimating the potential domestic shares. As Toyota and Hyundai (both Japanese) are the companies mainly producing and selling FCEVs it is assumed that today’s shares are associated to 100% to Japan (VDMA, 2018). For the future, it is positively assumed, that all steps can be conducted within Germany.

## Results

Figure 5 presents the ‘domestic value added’ for the investment phase of the entire ICEV, a separate battery and a separate fuel cell in a percentage depiction utilizing both calculation methods. Blue indicates today’s ‘domestic value added’, orange depicts ‘potential domestic value added’ and grey indicates ‘non-domestic value added’ of the investment into one of the assessed drivetrain components/technologies in Germany in 2020. It becomes visible that the entire ICEV has the highest share of ‘domestic value added’. However, on a percentage scale the investment into a separate fuel cell can potentially lead to an equivalent percentage of ‘domestic value added’ in the future, if all the steps being conducted in Japan today can be implemented in Germany in the future.

For ICEV and the fuel cell deviations between the two approaches are at max. 7%, which seems acceptable when keeping the accuracy of the underlying assumptions in mind. Both times IO-based assessment indicates slightly higher ‘domestic’ or ‘potential domestic value added’. One explanation is the assumption that, while all manufacturing and overhead expenditures are domestic in the life cycle cost-based approach, the entire material expenditures are categorized as non-domestic due to the limited amount of mining sites in Germany. However, this way underlying industry interconnections accounting for machinery produced in Germany, which is used for mining, and which will result in ‘domestic value added’ in the IO approach is not considered.

Interestingly for the battery, the life cycle cost-based method results deviate a lot from the IO-based result even though the same study has been used as the basis for both assessments. Both assessments are based on the report from VDMA including the table about German industries potential to conduct different activities to manufacture batteries (Michaelis, 2015). For the life cycle cost-based approach assumptions about the assignment to ‘domestic’, ‘potential domestic’ and ‘non-domestic value added’ related to this information. For the IO-based method this study was the basis for relating certain battery parts to industry sectors. A reason for the deviation could therefore be, that

**Table 4** Demand vector for ICEV, battery and fuel cell in 2020

	ICEV		Battery		Fuel cell	
	Share % (Kaul et al., 2019)	d/ p-d/ n-d%	Share % (Heimes et al., 2018a, b; Heimes et al., 2018a, b)	d/ p-d/ n-d%	Share %	d/ p-d/ n-d %
Purchase price incl. VAT, €-2020	27,703 (ADAC, 2021d)		5,915 (Nelson et al., 2019)		11,578 (Miotti et al., 2017)	
6 C13-C15	0.2	1/0/0			1.83	0/1/0 (J) (VDMA, 2018)
11 C20	0.5	1/0/0	21.73	24/52/24 (U, C, H, N, S) (BloombergNEF, 2020; Michaelis, 2015)		
13 C22	4.3	1/0/0	5.89	51/29/19 (F, E, P, I, N, NA, UK) (Michaelis, 2015; World Integrated Trade Solutions, 2019a, b)	35.42	0/1/0 (J) (VDMA, 2018)
14 C23		1/0/0	2.85	41/38/21 (EU, L, NA, Su, B) (Michaelis, 2015; World Integrated Trade Solutions, 2019a, b)		
15 C24	8.6	1/0/0	6.21	24/17/59 (DR, Ch, Ag, Au, So, R) (BloombergNEF, 2020; Michaelis, 2015)	6.27	0/1/0 (J) (VDMA, 2018)
16 C25	3.9	1/0/0	0.87	61/21/18 (C, U, P, I, F, B, CR, S, A) (Database, 2021; Michaelis, 2015; United Nations, 2021)	8.73	0/1/0 (J) (VDMA, 2018)
17 C26	0.2	1/0/0	3.58	59/23/17 (C, U) (Michaelis, 2015; United Nations, 2021)	15.8	0/1/0 (J) (VDMA, 2018)
18 C27	1.2	1/0/0	7.81	61/21/18 (C, NA, U, CR, F, P) (Michaelis, 2015; Solution, 2019)	1.94	0/1/0 (J) (VDMA, 2018)
19 C28	2.3	1/0/0	1.33	29/22/49 (C, NA, U, CR, F, P) (Michaelis, 2015; Solution, 2019)	22.67	0/1/0 (J) (VDMA, 2018)
20 C29	49.5	1/0/0				
23 C33	2.3	1/0/0	2.02	1/0/0		
24 D	0.6	1/0/0	3.11	1/0/0		
26 E37-E39			0.59	1/0/0		
27 F	0.4	1/0/0	0.02	1/0/0		
28 G45	5.6	1/0/0				
29 G46	2.9	1/0/0				
30 G47	1.3	1/0/0				
31 H49	1.4	1/0/0				
34 H52			0.01	1/0/0		
35 H53	0.4	1/0/0				
37 J58	0.2	1/0/0	1.33	1/0/0		
38 J59_J60	0.2	1/0/0				
39 J61	0.2	1/0/0				
40 J62_J63	0.7	1/0/0	0.01	35/43/22		
41 K64	0.8	1/0/0	0.34	1/0/0		
42 K65	0.2	1/0/0	0.93	1/0/0		

**Table 4** (continued)

	ICEV		Battery		Fuel cell	
	Share % (Kaul et al., 2019)	d/ p-d/ n-d%	Share % (Heimes et al., 2018a, b)	d/ p-d/ n-d%	Share %	d/ p-d/ n-d %
Purchase price incl. VAT, €-2020	27,703 (ADAC, 2021d)		5,915 (Nelson et al., 2019)		11,578 (Miotti et al., 2017)	
ISICs Rev. 4 (United Nations, 2008)						
43 K66			0.02	1/0/0		
44 L	1.5	1/0/0	0.01	1/0/0		
45 M69_M70	1.9	1/0/0	5.77	1/0/0		
46 M71	0.7	1/0/0	0.5	76/18/6		
47 M72		1/0/0	4.42	1/0/0		
48 M73	0.6	1/0/0	4.08	1/0/0		
49 M74_M75	0.4	1/0/0	0.07	1/0/0		
50 N	1.3	1/0/0	0.32	1/0/0		
51 O	0.5	1/0/0	0.56	1/0/0		
52 P	0.6	1/0/0				
Wage			9.79	1/0/0		
Depreciation			5.65	1/0/0		
Margin			10.19	1/0/0		

*d* domestic, *p-d* potential domestic, *n-d* non-domestic, *U* USA, *C* China, *H* Hong Kong, *N* Netherlands, *S* Switzerland, *F* France, *E* East Asia & Central Pacific, *P* Poland, *I* Italy, *NA* North America, *UK* United Kingdom, *EU* Europe and Central Asia, *L* Latin America and Caribbean, *Su* Sub-Saharan Africa, *B* Brazil, *DR* DR Congo, *Ch* Chile, *Ag* Argentina, *Au* Australia, *So* South Africa, *R* Russia, *B* Belgium, *CR* – Czech Republic, *A* Austria, *J* Japan

manufacturing steps and industry sectors cannot be assigned unambiguously. Or that the task of assigning the ‘domestic value added’ categories and the task of assigning industry sectors both lead to distortion as these deviations are higher than for the ICEV and fuel cell comparison.

### Life cycle cost-based assessment of alternative drivetrains for the passenger car sector

From the method comparison in can be concluded, that using the life cycle cost-based method most often slightly underestimates the ‘domestic’ or ‘potential domestic value added’ but is most of the times easier to conduct. For the passenger cars case study, a LCA and a LCC has already been conducted in Haase et al. (2021). These and mainly underlying reference are an optimal prerequisite for using the life cycle cost-based method for assessing the life cycle of entire passenger cars with different drivetrains with regards to ‘domestic value added’ in the following. In addition, the availability of LCA and LCC represents the majority cases when LCSA is applied.

As mentioned above, the passenger car is split-up into glider, drivetrain and energy storage for the investment phase. Mechanical workshop, insurance and tax, fuel and fuel station are distinguished within the operational phase. As introduced the eol phase is not assessed due to a lack of data. In the following only extensions to the already

introduced assumptions in the chapter for comparing the methods are presented in the text, Table 5 includes all values.

German passenger car purchasing prices are considered including VAT (ICEV (ADAC, 2021d), BEV (ADAC, 2021c), FCEV (ADAC, 2021b)). It is assumed that the glider cost is not influenced by the chosen drivetrain technology. The absolute glider price is therefore based on a source indicating the glider price for an FCEV (James et al., 2018). Due to a lack of data, the glider price is distributed between material, manufacturing and overhead similar to the rest of the fuel cell powertrain system for all gliders (FEV Consulting GmbH, 2020). For the allocation to domestic, potential domestic and non-domestic it is generally assumed, that manufacturing and overhead are realized in the same country. The ratio of passenger cars from German original equipment manufacturers (OEM) on the total amount of registered passenger cars is utilized to assign the price to the ‘domestic value added’ categories (Kraftfahrt Bundesamt, 2021). Both assumptions result in the distribution for BEV. For FCEV it is known that passenger car’s manufacturing has been stopped in Germany. However, it is assumed that the glider could be manufactured in Germany.

The FCEV drivetrain is assumed to consist of the fuel cell system and the electric motor/inverter (James et al., 2018). The BEV drivetrain price and distribution between material, manufacturing and overhead is adopted from a FEV report (FEV Consulting GmbH, 2018). The assumptions for



**Table 5** Assumptions for life cycle cost-based method estimating ‘domestic value added’ for different drivetrain technologies in the German passenger car sector in 2020

	Unit	ICEV	BEV	FCEV
Model	-	Golf	e-Golf	Toyota Mirai & Hyundai Nexo
Investment phase				
Purchase price incl. VAT	€2020	27,703 (ADAC, 2021d)	31,996 (ADAC, 2021c)	78,600 (ADAC, 2021b)
Glider	%	70 (James et al., 2018)	60 (James et al., 2018)	31 (James et al., 2018)
Mat/ manu/ o	%	43/30/27 (FEV Consulting GmbH, 2020)	43/30/27 (FEV Consulting GmbH, 2020)	43/30/27 (FEV Consulting GmbH, 2020)
d/ p-d/ n-d	%	36/0/64 (Kraftfahrt Bundesamt, 2021)	36/0/64 (Kraftfahrt Bundesamt, 2021)	0/36/64 (Kraftfahrt Bundesamt, 2021)
Drivetrain	%	30	17 (FEV Consulting GmbH, 2018)	41 (James et al., 2018)
Mat/ manu/ o	%	43/30/27 (FEV Consulting GmbH, 2020)	47/23/30 (FEV Consulting GmbH, 2018)	43/30/27 (FEV Consulting GmbH, 2020)
d/ p-d/ n-d	%	36/0/64 (Kraftfahrt Bundesamt, 2021)	34/0/66 (Kraftfahrt Bundesamt, 2021)	0/36/64 (Kraftfahrt Bundesamt, 2021)
Storage	%	-	22 (Ersoy et al., 2021; Schmidt et al., 2017a, b; Wentker et al., 2019)	24 (James et al., 2018)
Mat, manu, o	%	-	-	43/30/27 (FEV Consulting GmbH, 2020)
d/ p-d/ n-d	%	-	34/13/53 (Ersoy et al., 2021; Michaelis, 2015)	0/36/64 (Kraftfahrt Bundesamt, 2021)
Domestic value added d/ p-d/ n-d	€-ct 2020/km	4.77/0/8.4	5.35/0.43/9.36	0/12.9/22.62
Operational phase				
Mechanical workshop	€2020/a	950.84 (ADAC, 2021d)	577.73 (ADAC, 2021c)	1,026.14 (ADAC, 2021a)
d/ p-d/ n-d	%	100/0/0	100/0/0	100/0/0
Insurance & tax	€2020/a	1,145.13 (ADAC, 2021d)	934 (ADAC, 2021c)	1,881.26 (ADAC, 2021a)
d/ p-d/ n-d	%	100/0/0	100/0/0	100/0/0
Fuel	€-ct2020/km	2.77 (Mineralöl Wirtschafts Verband e.V., 2021)	4.48 (BDEW, 2021; Bundesnetzagentur, 2020)	5.62 [27]
d/ p-d/ n-d	%	20/0/80 <sup>a</sup> (Mineralöl Wirtschafts Verband e.V., 2021)	94/1.8/4.2 (Statista, 2021; Wallasch et al., 2019)	56/20/24 <sup>a</sup>
Fuel station	€-ct2020/km	0.86 (Mineralöl Wirtschafts Verband e.V., 2021)	2.66 (Kabus et al., 2020; Nationale Plattform Elektromobilität, 2015; Schroeder et al., 2012)	4.74 [27]
d/ p-d/ n-d	%	100/0/0	100/0/0	35/18/47 <sup>a</sup>
Domestic value added d/ p-d/ n-d	€-ct 2020/ km	14.72/0/2.22	16.97/0.08/0.19	24.2/1.99/3.55
Domestic value added over the life cycle d/ p-d/ n-d	€-ct 2020/km	19.5/0/10.59	22.32/0.5/9.54	24.2/14.89/25.18

mat material, manu manufacturing, o overhead, d domestic, p-d potential domestic, n-d non-domestic, a own assumptions

the allocation to ‘domestic’, ‘potential domestic’ and ‘non-domestic value added’ introduced for the glider are applied similarly for the drivetrain.

Both the hydrogen storage system and the small battery for the FCEV are included in the storage system price (James et al., 2018). Assumptions as for the glider are applied to allocate to ‘domestic’, ‘potential domestic’ and ‘non-domestic value added’ of the energy storage system of the FCEV.

For the operational phase, average prices for mechanical workshop, insurance and vehicle tax are used (ICEV (ADAC, 2021d), BEV (ADAC, 2021c), FCEV (ADAC, 2021a)). It was not possible to find data splitting the mechanical workshop price into labour and material. However, it is assumed that labour has the highest impact on the price and material is negligible. It is assumed, that passenger cars registered in Germany get their maintenance in Germany, therefore 100%

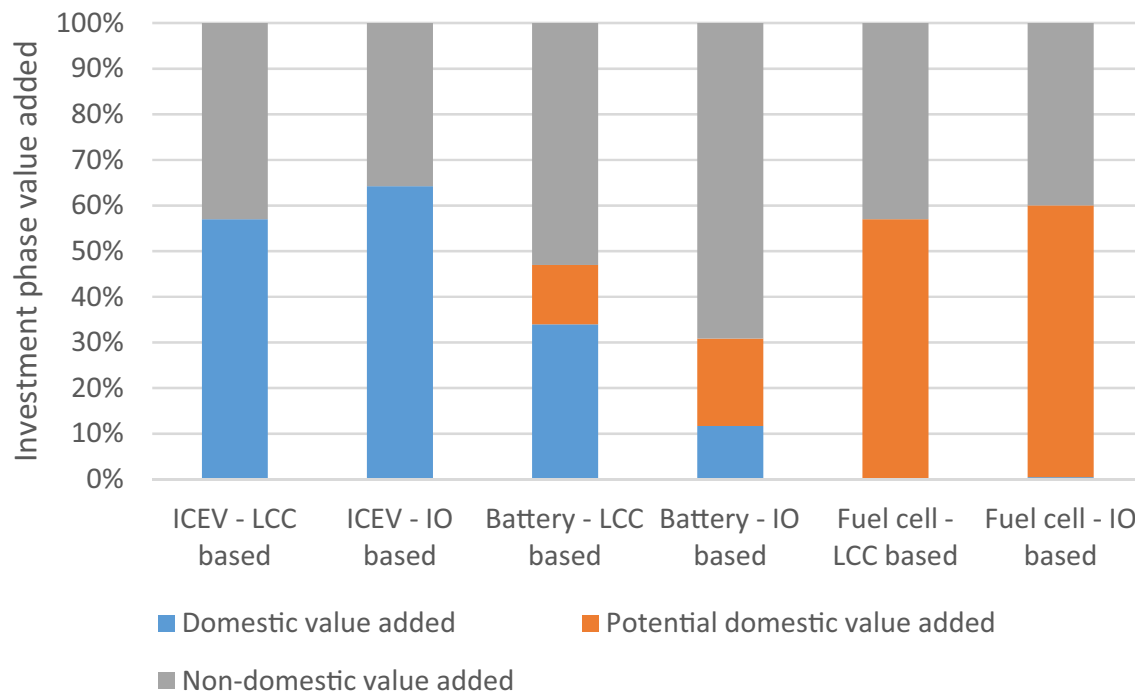

**Fig. 5** Comparison of ‘domestic value added’ category distribution resulting from the investment in different drivetrain components/technologies in the German passenger car sector in 2020 estimated by both methods

‘domestic value added’ is assumed. Insurance and vehicle tax are as well assumed to be 100% ‘domestic value added’, as those passenger cars have a German insurance contract. For all fuels no taxes other than VAT are considered. Including additional taxes would distort the analysis as they are defined by politics and represent tools to impact the market and support certain development but are not technologically inherent. The average price of gasoline over the last ten years (excluding tax and contribution margin) is assumed for the ICEV fuel (Mineralöl Wirtschafts Verband e.V., 2021). The source for BEV electricity, is an average household electricity price provided by onshore wind power (general household price distribution (BDEW, 2021), onshore wind price awarded (Bundesnetzagentur, 2020)). Green hydrogen, the assumed fuel for the FCEV, constitutes its price out of electricity provided by wind power and the electrolysis needed for the conversion into hydrogen (Wulf et al., 2022). Due to VAT and some refineries producing in Germany the distribution between ‘domestic’ and ‘non-domestic value added’ for gasoline is developed as depicted in Table 6. For household electricity price provided by onshore wind power, wind turbine’s direct investment cost is assumed to be domestic if the wind turbine OEM is originally from Germany (Statista, 2021). The incidental turbine investment cost as well as operation and maintenance costs are assumed to be domestic for turbines installed in Germany (Wallasch et al., 2019). Additionally, further electricity price elements are

included in the assignment (BDEW, 2021). For the production of green hydrogen, the onshore wind electricity assumptions are adopted. Unfortunately, no documented market for electrolysis exists. Based on the author’s knowledge it is assumed that its investment can be mainly attributed to ‘non-domestic value added’. The underlying price assumptions are described in Wulf et al., (2022).

For the ICEV fuel station the contribution margin of the gasoline price is assumed to be the price to operate the fuel station (Mineralöl Wirtschafts Verband e.V., 2021)). The price per kilometre for the BEV’s charging station constitutes out of its investment costs (Schroeder & Traber, 2012), its losses while operating (Nationale Plattform Elektromobilität, 2015) and further operational efforts (Kabus et al., 2020). It is furthermore assumed that only 30% battery charging is done on public charging stations (Kabus et al., 2020). Hydrogen fuel station price per kilometre constitutes out of transport, storage, and the operation of the fuel station. The underlying price assumptions are described in Wulf et al., (2022). It is assumed that both gasoline fuel station and electricity charging components are manufactured in Germany.

Therefore, 100% ‘domestic value-added’ is assumed. For hydrogen fuel stations it is more complex. As the market for these components is not as developed as for the other technologies, it is assumed, that investment is mainly non-domestic. According to experts, only minor parts are

produced in Germany. Lorries for transportation and compressors for storage are also not assumed to be produced in Germany. The authors suggest a detailed market analysis to get more accurate information. The operation of lorry, hydrogen fuel station and the storage system are assumed to be entirely domestic for hydrogen.

Based on these assumptions it is possible to calculate the ‘domestic value added’ categories in Germany for a kilometre ride considering the life cycle of a passenger car (excluding eol) in 2020. Figure 6 shows the results as percentages of the overall ‘domestic value added’. Blue indicates today’s ‘domestic value added’, orange depicts ‘potential domestic value added’ and grey indicates ‘non-domestic value added’ of a passenger car bought in Germany in 2020 with a certain drivetrain. Figure 6 can be understood as the lifetime ‘domestic value added’ distribution per Euro spend (excluding eol). It becomes visible that the BEV is most favourable in terms of ‘domestic value added’ in relative numbers. Closely followed by ICEV. For the used assumptions FCEV seems least attractive in terms of ‘domestic value added’. Even if the ‘potential domestic value’ share is additionally considered, this ranking of technologies is not changed. However, FCEV have the highest potential to increase their share of ‘domestic value added’ in the future. Based on the underlying assumptions the BEV seems to have the highest economic sustainability when consulting ‘domestic value added’ shares as the long-term economic indicator.

In absolute numbers ‘domestic value added’ is highest for FCEV, a bit lower for BEV and with slight distance the lowest for ICEV, please compare Fig. 7. Including ‘potential domestic value added’ into the consideration, the FCEV leads to the highest absolute amount by far. However, it also results in nearly twice the life cycle cost of a BEV and ICEV.

Moreover, it is interesting to see, that the overall price per kilometre for the ‘marginal technology’ is slightly lower than the BEV. Mock and Diaz (2021) come to similar conclusions in their white paper.

Figure 7 helps understanding why BEV seems to have the highest economic sustainability when consulting ‘domestic value added’ shares as the long-term economic indicator even though Germany has a vital automotive industry in the ICEV manufacturing sector and BEV capacities are just emerging. It depicts the ‘domestic value added’ distribution in absolute numbers per kilometre driven over the passenger car’s lifetime (excluding eol). Indicated in dashed black rectangles is the ‘value added’ resulting from the investment phase which represents the main ICEV manufacturing sector’s impact. It becomes visible, that more than half of the cost arising over the life cycle (excluding eol) emerge in the operational phase. And even though a vital manufacturing automotive industry exists, less than a third of the ‘value added’ is realized in Germany in the investment phase.

Both ways of presenting the ‘domestic value added’ (absolute and percentage) have their *raison d’être* but implications for the individual application need to be transparent. A percentage assessment is advised if different options are compared against each other. Utilizing an absolute presentation might be suitable for assessing a country’s economy allowing statements about indirect effects on employment. However, the results need to be considered with care, as a high ‘domestic value added’ can also be a result of the circumstance that the system under assessment is in general more expensive (e.g. FCEV in our example) and therefore leading to higher absolute results.

## Discussion of scientific contribution and limitations

The motivation of this paper is to overcome existing shortcomings in LCSA allowing to assess sustainability in a wider spectrum by strengthening the macroeconomic perspective. Based on the literature three shortcomings of the current state of the art have been identified, which resulted in the goal stated for this publication: develop and thoroughly introduce a novel indicator for prospectively assessing the value added of a technology with low barriers for application.

The literature showed that up to now, mostly IO method is utilized to assess value added in LCSA. However, a Scopus search showed that just 1.1% of conducted LCSA include this perspective. This paper’s contribution to changing the situation is threefold:

- The definition of ‘domestic value added’ makes it more attractive to conduct a cumbersome IO analysis as it allows a grounded estimation about how a technology can affect the overall welfare of a country, even before the technology is rolled out in the market.
- The introduced life cycle cost-based approach can be less complex and, in most cases, easier to conduct than the conventional IO-based approach, if an LCC and an LCA are already available. A decision support for choosing the most suitable approach for assessing ‘domestic value added’ for a certain research question is provided.
- The detailed description of both approaches especially touching upon how to deal with data scarcity reduces barriers for the indicator’s application.

However, in the application of the indicator limits of this work became visible. Even though approaches for dealing with data scarcity have been identified results are highly dependent on available data and the chosen underlying assumptions. Therefore, an assessment about the level of detail and the comprehensibility of the data and assumptions

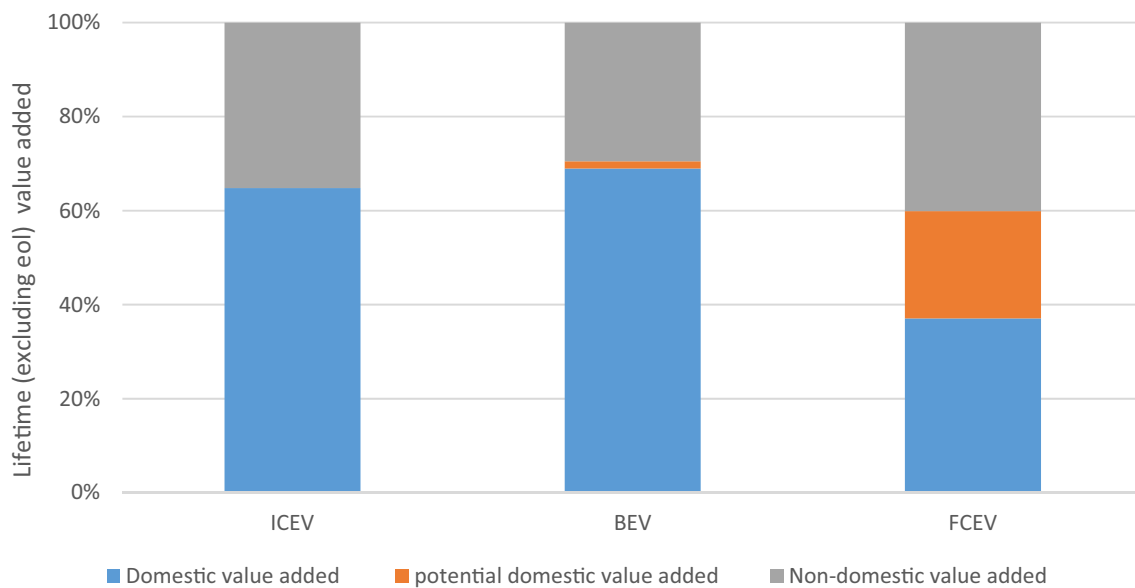

**Fig. 6** Estimated ‘domestic value added’ category distribution over the lifetime (excluding eol) resulting from the life cycle cost-based method for different drivetrain technologies in the German passenger car sector in 2020

being used as well as the level of divergence in underlying information is important for estimating the results quality.

Furthermore, the direct comparison of both methods showed large deviations in the results for the battery even though assumptions were based on the same source. A reason for the deviation could be, that manufacturing steps and industry sectors cannot be assigned unambiguously. Or that the task of assigning the ‘domestic value added’ categories and the task of assigning industry sectors lead to distortion as these deviations. This needs to be analysed in future research.

## Conclusion and outlook

The economic pillar in LCSA can and should be extended to a long-term sustainability perspective. The here developed indicator ‘domestic value added’ enables such an extension by assessing the ‘value added’ for a country due to a technology. This indicator furthermore allows statements about where ‘domestic value added’ can be realized within the country boundaries in best case if framework conditions are optimal and potentials are exhausted to their maximum. Usually, an additional assessment step is needed to include this highly important information for decision support. The literature review showed that indicators assessing the ‘value added’ of a technology are seldom used in LCSA. To change this situation and to offer a broader view on the economic sustainability, this paper presented two methods to estimate the indicator ‘domestic value added’. The first life cycle cost-based method is cumulated in a four-step sequence. It is easy to apply when

LCA and LCC data are already available. This way it facilitates the indicators application in LCSA. Applying it to a case study for comparing different drivetrains in the passenger car sector shows that its results are highly dependent on available data and the chosen underlying assumptions. However, a transparent presentation of these assumptions provides a good basis for discussion. An assessment about the level of detail and comprehensibility of the data and assumptions being used as well as the level of divergence in underlying information is important for estimating the results quality. In the second approach, IO analysis is utilized due to its capability of describing interconnections and interdependencies between industry sectors and product flows within national and international economies. Having this information inherently incorporated requires less assumptions for the cost assignment compared to the first approach. However, a more technological view is necessary if a certain level of detail is aspired to model the input needed for the technologies. The inherent information in the IO tables presents an average technology in the specific sector in a specific time, which mostly does not completely represent the assessed technology. Adjustments are cumbersome but can help improving the results accuracy. After the conduction of both methodologies a comprehensible allocation of ‘domestic value added’ for the present and future of ‘marginal’ and ‘innovative technologies’ is possible. Applied to a case study for an ICEV, a separate battery and a fuel cell it becomes clear that the life cycle cost-based method tends to neglect indirect effects on the ‘value added’ due to economic interconnections between countries. However, compared to inherent uncertainties these deviations are acceptable.

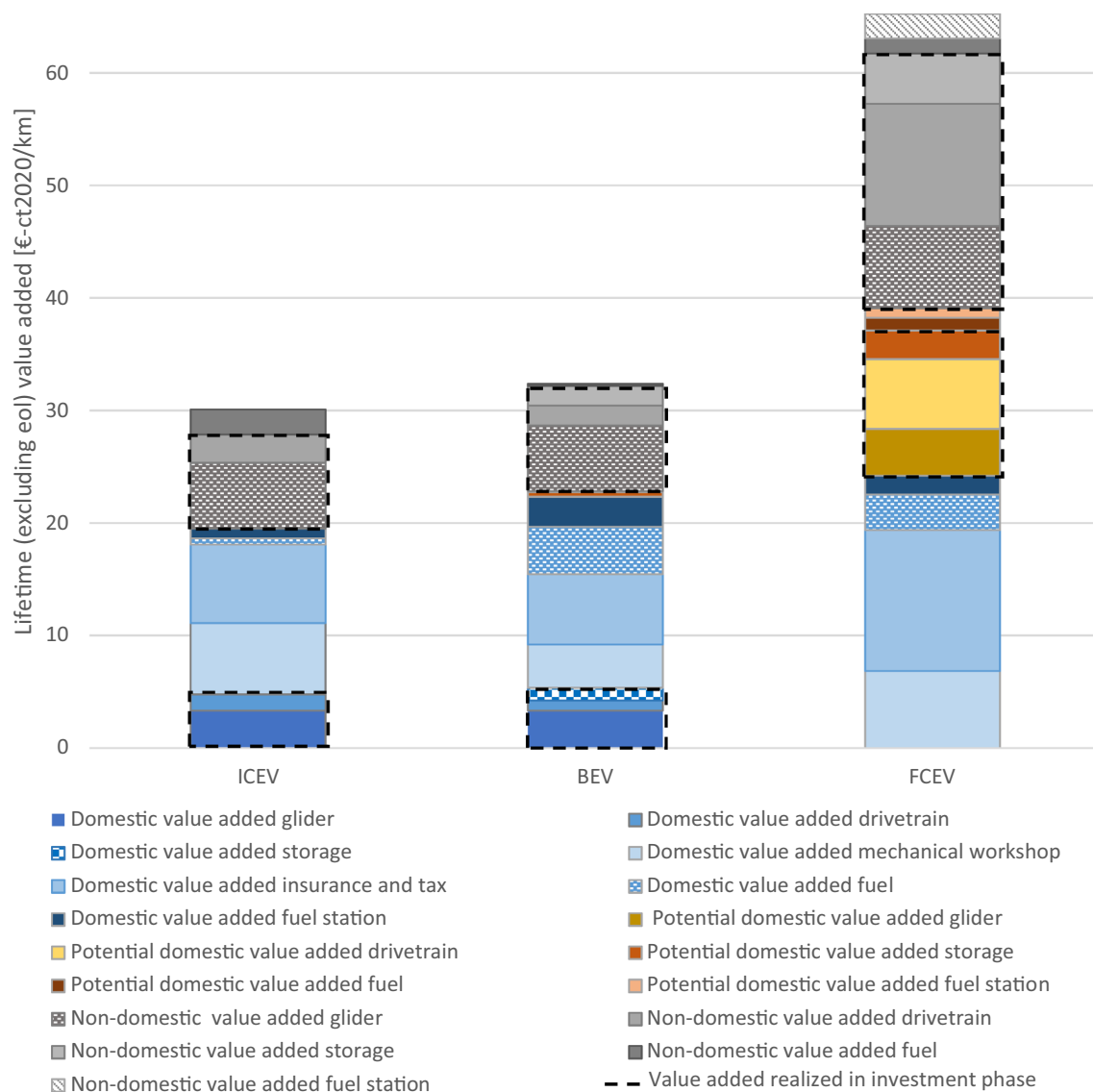

**Fig. 7** Estimated absolute lifetime 'value added' distribution resulting for different drivetrain technologies in the German passenger car sector in 2020 (black dashed indicates the investment/production phase) using the life cycle cost-based method

This paper takes a step forward towards integrating additional indicators into sustainability assessment by proposing and evaluating two methods for estimating the indicator 'domestic value added' for the first time. For further establishment of this indicator additional case studies are needed. They will help testing the methodologies. This way an assignment of a certain LCSA question to the best suitable method for assessing 'domestic value added' is facilitated. A focus within these case studies should lie on uncertainty assessment. This has been theoretically introduced within this work but due to the extensiveness of the already provided method development not applied to the case study. In a next step both approaches should be applied to a technology where historical data about 'domestic value added' and 'potential domestic value added'

is available, to improve the verification of these approaches. Additionally, a combination of both approaches might be reasonable for certain technologies. The direct comparison of both methods showed large deviations for the battery even though assumptions were based on the same source. For the future inherent ambiguity within the assignment and possible sources for distortions should be systematically assessed. The authors assume that differences between technologies and countries where these approaches are applied on have an influence on the results accuracy. Furthermore, it would be interesting to extend the indicator to 'net domestic value added' by including structural impacts, that the introduction of an 'innovative technology' can have on the 'marginal technology'.

## Appendix

See Table 6

**Table 6** Industry sectors in ISIC Rev. 4 (United Nations, 2008)

ISICs Rev. 4 (United Nations, 2008)	ICEV	Battery	Fuel cell
6 C13-C15 Manufacture of textiles, wearing apparel and leather products	0		2
11 C20 Manufacture of chemicals and chemical products	1	22	0
13 C22 Manufacture of rubber and plastic products	4	6	35
14 C23 Manufacture of other non-metallic mineral products		3	0
15 C24 Manufacture of basic metals	9	6	7
16 C25 Manufacture of fabricated metal products, except machinery and equipment	4	1	8
17 C26 Manufacture of computer, electronic and optical products	0	4	16
18 C27 Manufacture of electrical equipment	1	8	2
19 C28 Manufacture of machinery and equipment n.e.c	2	1	23
20 C29 Manufacture of motor vehicles, trailers and semi-trailers	50		0
23 C33 Repair and installation of machinery and equipment	2	2	0
24 D Electricity, gas, steam and air conditioning supply	1	3	0
26 E37-E39 Sewerage; waste collection, treatment and disposal activities; materials recovery; etc		1	0
27 F Construction	0	0	0
28 G45 Wholesale and retail trade and repair of motor vehicles and motorcycles	6		0
29 G46 Wholesale trade, except of motor vehicles and motorcycles	3		0
30 G47 Retail trade, except of motor vehicles and motorcycles	1		0
31 H49 Land transport and transport via pipelines	1		0
34 H52 Warehousing and support activities for transportation		0	0
35 H53 Postal and courier activities	0	0	0
37 J58 Publishing activities	0	1	0
38 J59_J60 Motion picture, video, and television program production, sound recording and music publishing activities; etc	0		0
39 J61 Telecommunications	0	0	0
40 J62_J63 Computer programming, consultancy, and related activities; information service activities	1	0	0
41 K64 Financial service activities, except insurance and pension funding	1	0	0
42 K65 Insurance, reinsurance, and pension funding, except compulsory social security	0	1	0
43 K66 Activities auxiliary to financial services and insurance activities		0	0
44 L Real estate activities	2	0	0
45 M69_M70 Legal and accounting activities; activities of head offices; management consultancy activities	2	6	0
46 M71 Architectural and engineering activities; technical testing and analysis	1	0	0
47 M72 Scientific research and development		4	0
48 M73 Advertising and market research	1	4	0
49 M74_M75 Other professional, scientific, and technical activities; veterinary activities	0	0	0
50 N Rental and leasing activities, employment activities, travel services, security, and services to buildings	1	0	0
51 O Public administration and defense; compulsory social security	1	1	0
52 P Education	1	0	0

**Author contribution** All authors contributed to the study conception and design. Material preparation, data collection and analysis were performed by FH. The first draft of the manuscript was written by FH and all authors commented on previous versions of the manuscript. All authors read and approved the final manuscript.

**Funding** Open Access funding enabled and organized by Projekt DEAL. This work contributes partially to the research performed within the Helmholtz Association project "Energy System 2050" and at CELEST (Center for Electrochemical Energy Storage Ulm-Karlsruhe) which is funded by the German Research Foundation (DFG) under Project ID 390874152 (POLiS Cluster of Excellence).

**Data availability** The literature data analysed during the current study is already included in the manuscript.

## Declarations

**Conflict of interest** The authors have no relevant financial or non-financial interests to disclose.

**Open Access** This article is licensed under a Creative Commons Attribution 4.0 International License, which permits use, sharing, adaptation, distribution and reproduction in any medium or format, as long as you give appropriate credit to the original author(s) and the source, provide a link to the Creative Commons licence, and indicate if changes were made. The images or other third party material in this article are included in the article's Creative Commons licence, unless indicated otherwise in a credit line to the material. If material is not included in the article's Creative Commons licence and your intended use is not permitted by statutory regulation or exceeds the permitted use, you will need to obtain permission directly from the copyright holder. To view a copy of this licence, visit <http://creativecommons.org/licenses/by/4.0/>.

## References

- Aboushaqrah NNM, Onat NC, Kucukvar M, Hamouda AMS, Kusakci AO, Ayvaz B (2021) Selection of alternative fuel taxis: a hybridized approach of life cycle sustainability assessment and multi-criteria decision making with neutrosophic sets. *Int J Sustain Transp ADAC* (2021a) Hyundai Nexo (ab 08/18). Retrieved from <https://www.adac.de/rund-ums-fahrzeug/autokatalog/marken-modelle/hyundai/nexo/1generation/288843/#kosten>
- ADAC (2021b) Toyota Mirai (12/15 - 12/20). Retrieved from <https://www.adac.de/rund-ums-fahrzeug/autokatalog/marken-modelle/toyota/mirai/ad1/251604/>
- ADAC (2021c) VW e-Golf (04/17 - 05/20). Retrieved from <https://www.adac.de/rund-ums-fahrzeug/autokatalog/marken-modelle/vw/golf/vii-facelift/266575/#kosten>
- ADAC (2021d) VW Golf 1.5 TSI OPF ACT IQ.Drive (01/19 - 08/19). Retrieved from <https://www.adac.de/rund-ums-fahrzeug/autokatalog/marken-modelle/vw/golf/vii-facelift/296758/#technische-daten>
- Alejandrino C, Mercante I, Bovea MD (2021) Life cycle sustainability assessment: Lessons learned from case studies. *Environ Impact Assess Rev* 87:106517. <https://doi.org/10.1016/j.eiar.2020.106517>
- Banaclache S, Gamarra AR, Lechon Y, Bustreo C (2020) Socioeconomic and environmental impacts of bringing the sun to earth: a sustainability analysis of a fusion power plant deployment. *Energy* 209:118460. <https://doi.org/10.1016/j.energy.2020.118460>
- Barke A, Thies C, Melo SP, Cerdas F, Herrmann C Spengler TS (2022) Comparison of conventional and electric passenger aircraft for short-haul flights – A life cycle sustainability assessment. *Procedia CIRP*, 105
- Baumann M, Domnik T, Haase M, Wulf C, Emmerich P, Rösch C, Zapp P, Naegler T, Weil M (2021) Comparative patent analysis for the identification of global research trends for the case of battery storage, hydrogen and bioenergy. *Technol Forecasting Soc Chang.* <https://doi.org/10.1016/j.techfore.2020.120505>
- BDEW (2021) BDEW-Strompreisanalyse Januar 2021 Haushalte und Industrie. Retrieved from [https://www.google.com/url?sa=t&rct=j&q=&esrc=s&source=web&cd=&ved=2ahUKEwi\\_kvOocHwAhXohP0HHTqnBrkQFJAANegQIFRAD&url=https%3A%2F%2Fwww.bdew.de%2Fmedia%2Fdocuments%2FBDEW-Strompreisanalyse\\_no\\_halbjaehrlich\\_Ba\\_online\\_28012021.pdf&usg=AOvVaw1g\\_V7\\_ceHk8GqhPFIWRe1D](https://www.google.com/url?sa=t&rct=j&q=&esrc=s&source=web&cd=&ved=2ahUKEwi_kvOocHwAhXohP0HHTqnBrkQFJAANegQIFRAD&url=https%3A%2F%2Fwww.bdew.de%2Fmedia%2Fdocuments%2FBDEW-Strompreisanalyse_no_halbjaehrlich_Ba_online_28012021.pdf&usg=AOvVaw1g_V7_ceHk8GqhPFIWRe1D)
- Bhambhani A, Van den Hoek JP, Kapelan Z (2022). Life cycle sustainability assessment framework for water sector resource recovery solutions: strengths and weaknesses. *Resour Conserv Recycl*, 180
- BloombergNEF (2020) China dominates the lithium-ion battery supply chain, but Europe is on the rise. Retrieved from <https://about.bnef.com/blog/china-dominates-the-lithium-ion-battery-supply-chain-but-europe-is-on-the-rise/>
- Kraftfahrt Bundesamt (2021) Personenkraftwagen am 1. Januar 2020 nach ausgewählten Merkmalen. Retrieved from [https://www.kba.de/DE/Statistik/Fahrzeuge/Bestand/Jahresbilanz/fz\\_b\\_jahresbilanz\\_archiv/2020/2020\\_b\\_barometer.html?nn=2601598](https://www.kba.de/DE/Statistik/Fahrzeuge/Bestand/Jahresbilanz/fz_b_jahresbilanz_archiv/2020/2020_b_barometer.html?nn=2601598)
- Bundesbank D (2021) Term structure of interest rates on listed Federal securities (method by Svensson) / residual maturity of 20.0 years / monthly data Retrieved from: [https://www.bundesbank.de/dynamic/action/en/statistics/time-series-databases/time-series-databases/745582/745582?tsId=BBSIS.M.I.ZST.ZI.EUR.S1311.B.A604.R20XX.R.A.A.\\_Z.\\_Z.A&tsTab=0&dateSelect=2021&listId=www\\_skms\\_it03a&id=0&startDate=2003&endDate=2020](https://www.bundesbank.de/dynamic/action/en/statistics/time-series-databases/time-series-databases/745582/745582?tsId=BBSIS.M.I.ZST.ZI.EUR.S1311.B.A604.R20XX.R.A.A._Z._Z.A&tsTab=0&dateSelect=2021&listId=www_skms_it03a&id=0&startDate=2003&endDate=2020)
- Bundesnetzagentur. (2020). Ergebnisse der Ausschreibungsrounds für Windenergie-Anlagen an Land 2020 (Oktober 2020). Retrieved from [https://www.bundesnetzagentur.de/DE/Sachgebiete/ElektrizitaetundGas/Unternehmen\\_Institutionen/Ausschreibungen/Wind\\_Onshore/BeendeteAusschreibungen/BeendeteAusschreibung\\_node.html](https://www.bundesnetzagentur.de/DE/Sachgebiete/ElektrizitaetundGas/Unternehmen_Institutionen/Ausschreibungen/Wind_Onshore/BeendeteAusschreibungen/BeendeteAusschreibung_node.html)
- Corona B, San Miguel G (2019) Life cycle sustainability analysis applied to an innovative configuration of concentrated solar power. *Int J Life Cycle Assess* 24(8):1444–1460. <https://doi.org/10.1007/s11367-018-1568-z>
- Corona B, Rúa C, d. I., & San Miguel, G. (2016) Socio-economic and environmental effects of concentrated solar power in Spain: a multiregional input output analysis. *Sol Energy Mater Sol Cells* 156:112–121. <https://doi.org/10.1016/j.solmat.2016.03.014>
- Database, UNC (2021) Imports of fabricated metal products in Germany Retrieved from <https://tradingeconomics.com/germany/imports>
- Ersoy H, Baumann M, Weil M (2021). Evaluation study of regional added value creation by lithium-ion battery energy storage (BES) towards 2050. In: Paper presented at the APEEN2021 virtual conference energy transition and sustainability
- Fernández-Tirado F, Parra-López C, Romero-Gámez M (2021) A multi-criteria sustainability assessment for biodiesel alternatives in Spain: life cycle assessment normalization and weighting. *Renew Energy* 164:1195–1203. <https://doi.org/10.1016/j.renene.2020.10.145>
- Fernández-Tirado F, Parra-López C (2021). Economic and social impacts of the biodiesel industry: Assessment and policy implications in Spain. 18(4). <https://doi.org/10.5424/sjar/2020184-16580>
- FEV Consulting GmbH (2018) Antrieb im Wandel? Implication of powertrain electrification on machinery and component supplier industry. Retrieved from [https://www.google.com/url?sa=t&rct=j&q=&esrc=s&source=web&cd=&ved=2ahUKEwj0z9TS\\_r7wAhXV\\_7sIHTz1DrkQFJAAegQIBRAD&url=http%3A%2F%2Fwww.fev.com%2Fmedia%2Fdocuments%2FAntrieb\\_im\\_Wandel.pdf&usg=AOvVaw1g\\_V7\\_ceHk8GqhPFIWRe1D](https://www.google.com/url?sa=t&rct=j&q=&esrc=s&source=web&cd=&ved=2ahUKEwj0z9TS_r7wAhXV_7sIHTz1DrkQFJAAegQIBRAD&url=http%3A%2F%2Fwww.fev.com%2Fmedia%2Fdocuments%2FAntrieb_im_Wandel.pdf&usg=AOvVaw1g_V7_ceHk8GqhPFIWRe1D)

- 2F%2Fgetpro.de%2Ffileadmin%2Fcontent%2FNews%2F2018%2F0118%2FVDMA\_Antrieb-im-Wandel\_Exec-Report.pdf&usg=AOvVaw1tQzfmCwVZQzpWsZMjIWKi
- FEV Consulting GmbH (2020) Impact of fuel cell technology on the machinery and component supplier industry. Retrieved from
- Finkbeiner M, Schau EM, Lehmann A, Traverso M (2010) Towards life cycle sustainability assessment. *Sustainability*, 2(10):3309–3322. Retrieved from <https://www.mdpi.com/2071-1050/2/10/3309>
- Guinée JB, Heijungs R, Huppes G, Zamagni A, Masoni P, Buonamici R, Rydberg T (2011) Life cycle assessment: past, present, and future. *Environ Sci Technol*, 45(1), 90–96. doi:<https://doi.org/10.1021/es101316v>
- Gulcimen, S., Aydogan, E. K., & Uzal, N. (2021). Life cycle sustainability assessment of a light rail transit system: integration of environmental, economic, and social impacts. *Integr Environ Assess Manag* 17
- Haase M, Wulf C, Baumann M, Ersoy H, Harzendorf F, Rösch C (2021). Comparative sustainability assessment of alternative technologies and fuels for individual motorized mobility In: paper presented at the 16th conference on sustainable development of energy, water and environment systems (SDEWES), Dubrovnik
- He D, Compston P, Morozov E, Doolan M (2022) Reducing down-cycling of carbon fibre by fibre architecture preservation: multi-layer fibre surface quality investigation. *Procedia CIRP* 105
- Heimes HH, Kampker A, Lienemann C, Locke M, Offermanns C, Michaelis S, Rahimzei E (2018a) Lithium-ion battery cell production process. Retrieved from [http://elektromobilitaet.vdma.org/documents/7411591/15357859/Production+LIB\\_eng/4d174210-0bad-7169-5fc0-20dc8dad7d3e](http://elektromobilitaet.vdma.org/documents/7411591/15357859/Production+LIB_eng/4d174210-0bad-7169-5fc0-20dc8dad7d3e)
- Heimes HH, Kampker A, Wessel S, Kehrer M, Michaelis S, Rahimzei E (2018b) Battery module and pack assembly process. Retrieved from [http://elektromobilitaet.vdma.org/documents/7411591/15357859/Production+module+and+pack\\_eng/6188ab6d-5411-e348-0f88-c9f0276079a4](http://elektromobilitaet.vdma.org/documents/7411591/15357859/Production+module+and+pack_eng/6188ab6d-5411-e348-0f88-c9f0276079a4)
- James BD, Huya-Kouadio JM, Houchins C, DeSantis DA (2018) Mass production cost estimation of direct H2 PEM fuel cell systems for transportation applications: 2018 update. Retrieved from
- Jungmeier G, Hingsamer M, Steiner D, Kaltenecker I, Kleinegriss D, Ree Rv, Jong Ed (2016) The approach of life cycle sustainability assessment of biorefineries.
- Kabus M, Nolting L, Mortimer BJ., Koj JC, Kuckshinrichs W, De Doncker RW, Praktiknjo A (2020) Environmental impacts of charging concepts for battery electric vehicles: a comparison of on-board and off-board charging systems based on a Life cycle assessment. *Energies*, 13(24): 6508 Retrieved from <https://www.mdpi.com/1996-1073/13/24/6508>
- Kaul, A., Hagedorn, M., Hartmann, S., Heilert, D., Harter, C., Olschewski, I., . . . Yoon, M. (2019). *Automobile Wertschöpfung 2030/2050*. Retrieved from
- Kloepffer W (2003) Life-Cycle based methods for sustainable product development. *Int J LCA*. <https://doi.org/10.1007/BF02978462>
- Kloepffer W (2008) Life cycle sustainability assessment of products. *Int J Life Cycle Assess*. 13 (2) 89–95. <https://link.springer.com/article/10.1065/lca2008.02.376>
- Kloepffer W, Grahl B (2014) From LCA to sustainability assessment. In: *Life cycle assessment (LCA): a guide to best practice*, Wiley, Weinheim, pp 357–374. <https://www.wiley.com/en-us/Life+Cycle+Assessment+%28LCA%29%3A+A+Guide+to+Best+Practice-p-9783527655649>
- Konstantas A, Stamford L, Azapagic A (2019) Economic sustainability of food supply chains: life cycle costs and value added in the confectionary and frozen desserts sectors. *Sci Total Environ*. <https://doi.org/10.1016/j.scitotenv.2019.03.274>
- Kucukvar M, Onat NC, Abdella GM, Tatari O (2019) Assessing regional and global environmental footprints and value added of the largest food producers in the world. *Resour Conserv Recycl* 144:187–197. <https://doi.org/10.1016/j.resconrec.2019.01.048>
- Lamberts-Van Assche, H., & Compennolle T (2022) Economic feasibility studies for carbon capture and utilization technologies: a tutorial review. *Clean Technol Environ Policy* 24
- Lu B, Li B, Wang L, Yang J, Liu J, Wang XV (2014) Reusability based on life cycle sustainability assessment: case study on WEEE. *Procedia CIRP* 15:473–478. <https://doi.org/10.1016/j.procir.2014.06.046>
- Mair-Bauernfeind C, Zimek M, Asada R, Bauernfeind D, Baumgartner RJ, Stern T (2020) Prospective sustainability assessment: the case of wood in automotive applications. *Int J Life Cycle Assess* 25(10):2027–2049. <https://doi.org/10.1007/s11367-020-01803-y>
- Martinez-Hernandes E, Sadhukhan J, Aburto J, Amezcua-Allier MA, Morse S, Murphy R (2022) Modelling to analyse the process and sustainability performance of forestry-based bioenergy systems. *Clean Technol Environ Policy*
- May JR, Brennan DJ (2006) Sustainability assessment of Australian electricity generation. *Process Saf Environ Prot* 84(2):131–142. <https://doi.org/10.1205/psep.04265>
- Michaelis S (2015) German engineering schlüssel zur batterieproduktion key to battery production. Retrieved from [https://www.google.com/url?sa=t&rct=j&q=&esrc=s&source=web&cd=&ved=2ahUKEwid0MSmk8TwAhWG\\_7sIHYN2Dw4QFjAAegQIBBAD&url=https%3A%2F%2Fbattprod.vdma.org%2Fdocuments%2F7411591%2F18744389%2F155169VDMA\\_Inhalt\\_Deutsch\\_Englisch\\_Screen\\_1499858859050.pdf%2F3df18f1a-1581-4f0c-a2ab-efc03917ba75&usg=AOvVaw0YOhmPQaj6MxUveFRDCQvt](https://www.google.com/url?sa=t&rct=j&q=&esrc=s&source=web&cd=&ved=2ahUKEwid0MSmk8TwAhWG_7sIHYN2Dw4QFjAAegQIBBAD&url=https%3A%2F%2Fbattprod.vdma.org%2Fdocuments%2F7411591%2F18744389%2F155169VDMA_Inhalt_Deutsch_Englisch_Screen_1499858859050.pdf%2F3df18f1a-1581-4f0c-a2ab-efc03917ba75&usg=AOvVaw0YOhmPQaj6MxUveFRDCQvt)
- Miller RE, Blair PD (2009) *Input-output analysis: foundations and extensions*, 2nd edn. Cambridge University Press, Cambridge
- Miotti M, Hofer J, Bauer C (2017) Integrated environmental and economic assessment of current and future fuel cell vehicles. *Int J Life Cycle Assess* 22(1):94–110. <https://doi.org/10.1007/s11367-015-0986-4>
- Mock P Diaz S (2021) Pathways to decarbonization: the European passenger car market in the years 2021 - 2035. Retrieved from <https://theicct.org/publications/decarbonize-EU-PVs-may2021>
- Nationale Plattform Elektromobilität (2015) *Ladeinfrastruktur für elektrofahrzeuge für deutschland statusbericht und handlungsempfehlungen 2015*. Retrieved from <https://www.acatech.de/publikation/ladeinfrastruktur-fuer-elektrofahrzeuge-in-deutschland-statusbericht-und-handlungsempfehlungen/>
- Nelson PA, Ahmed S, Gallagher KG, Dees DW (2019). *Modeling the performance and cost of lithium-ion batteries for electric-drive vehicles*, third edition. (ANL/CSE-19/2; Other: 150624 United States <https://doi.org/10.2172/1503280> Other: 150624 ANL English). Retrieved from <https://www.osti.gov/servlets/purl/1503280>
- Noun-Project (2021) Icons licenced by creative commons ccby: wind power by jacqueline fernandes from the noun project, car by ditto from the noun project, refinery by nareerat jaikaew from the noun project, oil well by iconsmind.com from the noun project, transmission tower from arthur shlain from the noun project.
- Ribeiro I, Matos F, Jacinto C, Salman H, Cardeal G, Carvalho H, Godina R, Pecas P.(2020). Framework for life cycle sustainability assessment of additive Manufacturing. *Sustainability* 12
- Schmidt O, Gambhir A, Staffell I, Hawkes A, Nelson J, Few S (2017a) Future cost and performance of water electrolysis: An expert elicitation study. *Int J Hydrog Energy* 42(52):30470–30492. <https://doi.org/10.1016/j.ijhydene.2017.10.045>
- Schmidt O, Hawkes A, Gambhir A, Staffell I (2017b) The future cost of electrical energy storage based on experience rates. *Nat Energy* 2(8):17110. <https://doi.org/10.1038/nenergy.2017.110>
- Schroeder A, Traber T (2012) The economics of fast charging infrastructure for electric vehicles. *Energy Policy* 43:136–144. <https://doi.org/10.1016/j.enpol.2011.12.041>



- Sen B, Kucukvar M, Onat NC, Tatari o (2020) Life cycle sustainability assessment of autonomous heavy-duty trucks. *Ind Ecol* 24
- Solution, WIT (2019) German mach and elec imports by country and region in US\$ thousand 2019. Retrieved from [https://wits.worldbank.org/CountryProfile/en/Country/DEU/Year/2019/TradeFlow/Import/Partner/ALL/Product/84-85\\_MachElec](https://wits.worldbank.org/CountryProfile/en/Country/DEU/Year/2019/TradeFlow/Import/Partner/ALL/Product/84-85_MachElec)
- Solutions WIT (2019a). German minerals imports by country and region in US\$ Thousand 2019a. Retrieved from [https://wits.worldbank.org/CountryProfile/en/Country/DEU/Year/2019a/TradeFlow/Import/Partner/all/Product/25-26\\_Minerals](https://wits.worldbank.org/CountryProfile/en/Country/DEU/Year/2019a/TradeFlow/Import/Partner/all/Product/25-26_Minerals)
- Solutions, WIT (2019b) german plastic or rubber exports by country and region in US\$ thousands 2019b. Retrieved from [https://wits.worldbank.org/CountryProfile/en/Country/DEU/Year/2019b/TradeFlow/Export/Partner/all/Product/39-40\\_PlastiRub](https://wits.worldbank.org/CountryProfile/en/Country/DEU/Year/2019b/TradeFlow/Export/Partner/all/Product/39-40_PlastiRub)
- Soust-Verdaguer B, Galeana IB, Llatas C, Montes MV, Hoxha E, Passer A (2022) How to conduct consistent environmental, economic, and social assessment during the building design process. A BIM-based life cycle sustainability assessment method. *J Build Eng* 45
- Stadler K (2021) Pymrio mathematical background. Retrieved from <https://pymrio.readthedocs.io/en/latest/math.html>
- Statista (2021) Marktanteile der windenergieanlagenhersteller in deutschland nach anzahl der betriebenen anlagen im jahr 2018. Retrieved from <https://de.statista.com/statistik/daten/studie/249114/umfrage/marktanteil-der-windenergieanlagenhersteller-in-deutschland-nach-anlagenzahl/#professional>
- Thomassen MA, Dolman MA, van Calker KJ, de Boer IJM (2009) Relating life cycle assessment indicators to gross value added for Dutch dairy farms. *Ecol Econ* 68(8):2278–2284. <https://doi.org/10.1016/j.ecolecon.2009.02.011>
- UN Statistics Devision (1999) Handbook of input-output table compilation and analysis. Retrieved from New York: <https://digitallibrary.un.org/record/370160?ln=en>
- United Nations (2008) International standard industrial classification of all economic activities (ISIC), Rev. 4. Retrieved from New York: [https://www.google.com/url?sa=t&rct=j&q=&esrc=s&source=web&cd=&ved=2ahUKEwiE0MXbp5LwAhVghPOHHRjuD2RMQFjAAegQIAxAD&url=https%3A%2F%2Ffunstats.un.org%2Funds%2Fpublication%2Fseriesm%2Fseriesm\\_4rev4e.pdf&usg=AOvVaw3unSq5SJCkALtrreuRz0gW](https://www.google.com/url?sa=t&rct=j&q=&esrc=s&source=web&cd=&ved=2ahUKEwiE0MXbp5LwAhVghPOHHRjuD2RMQFjAAegQIAxAD&url=https%3A%2F%2Ffunstats.un.org%2Funds%2Fpublication%2Fseriesm%2Fseriesm_4rev4e.pdf&usg=AOvVaw3unSq5SJCkALtrreuRz0gW)
- United Nations (2021) United nations comtrade database. Retrieved from <https://comtrade.un.org/>
- Valdivia S, Ciroth A, Finkbeiner M, Hildenbrand J, Kloepffer W, Mazijn B, Prakash S, Sonnemann G, Traverso M, Ugaya CML, Vickery-Niedermaier G (2011) Towards a life cycle sustainability assessment - making informed choices on products. Retrieved from Paris, France: <https://www.lifecycleinitiative.org/starting-life-cycle-thinking/life-cycle-approaches/life-cycle-sustainability-assessment/>
- Valente A, Iribarren D, Dufour J (2021) Comparative life cycle sustainability assessment of renewable and conventional hydrogen. *Sci Total Environ* 756:144132. <https://doi.org/10.1016/j.scitotenv.2020.144132>
- VDMA (2018) Fuel cell industry guide germany 2018 german manufacturers well positioned in the growing global market. Retrieved from [https://www.google.com/url?sa=t&rct=j&q=&esrc=s&source=web&cd=&ved=2ahUKEwiCiojy0MbwAhUP\\_rsIHTemDBwQFjAAegQIBRAD&url=https%3A%2F%2Fbz.vdma.org%2Fdocuments%2F266669%2F26136325%2FVDMA%2520AG%2520BZ%2520Branchenf%25C3%25BChrer%2520D%25202018\\_1524652028283.pdf%2F2Ffaeb2d9-90b1-3010-d58f-c9fa9f84fb10&usg=AOvVaw2VbN2AtA76-WwSNS3btFEm](https://www.google.com/url?sa=t&rct=j&q=&esrc=s&source=web&cd=&ved=2ahUKEwiCiojy0MbwAhUP_rsIHTemDBwQFjAAegQIBRAD&url=https%3A%2F%2Fbz.vdma.org%2Fdocuments%2F266669%2F26136325%2FVDMA%2520AG%2520BZ%2520Branchenf%25C3%25BChrer%2520D%25202018_1524652028283.pdf%2F2Ffaeb2d9-90b1-3010-d58f-c9fa9f84fb10&usg=AOvVaw2VbN2AtA76-WwSNS3btFEm)
- Mineralöl Wirtschafts Verband e.V (2021) Preiszusammensetzung. Retrieved from <https://www.mwv.de/statistiken/preiszusammensetzung/>
- Visentin C, da Silva Trentin AW, Braun AB Thomé, A. (2020). Life cycle sustainability assessment: A systematic literature review through the application perspective, indicators, and methodologies. *J Clean Prod* 270
- Wallasch A-K, Lüers S, Heyken M, Rehfeldt K (2019) Vorbereitung und begleitung bei der erstellung eines erfahrungsberichts gemäss §97 erneuerbare-energien-gesetz. Retrieved from [https://www.google.com/url?sa=t&rct=j&q=&esrc=s&source=web&cd=&ved=2ahUKEwiVz7CGm8LwAhWRgf0HHcV5AQMqFjAAegQIAxAD&url=https%3A%2F%2Fwww.erneuerbare-energien.de%2FEE%2FRedaktion%2FDE%2FDownloads%2Fbmwi\\_de%2Fdeutsche-windguard-vorbereitung-begleitung-erfahrungsbericht-eeg.pdf%3F\\_\\_blob%3DpublicationFile%26v%3D7&usg=AOvVaw0OCcyvLyNY3CNqJk8LXcP1](https://www.google.com/url?sa=t&rct=j&q=&esrc=s&source=web&cd=&ved=2ahUKEwiVz7CGm8LwAhWRgf0HHcV5AQMqFjAAegQIAxAD&url=https%3A%2F%2Fwww.erneuerbare-energien.de%2FEE%2FRedaktion%2FDE%2FDownloads%2Fbmwi_de%2Fdeutsche-windguard-vorbereitung-begleitung-erfahrungsbericht-eeg.pdf%3F__blob%3DpublicationFile%26v%3D7&usg=AOvVaw0OCcyvLyNY3CNqJk8LXcP1)
- Wang J, Maier SD, Horn R, Holländer R, Aschemann R (2018) Development of an ex-ante sustainability assessment methodology for municipal solid waste management innovations. *Sustainability* 10:3208. <https://doi.org/10.3390/su10093208>
- Weidema BP, Frees N, Nielsen A-M (1999) Marginal production technologies for life cycle inventories. *Int J Life Cycle Assess* 4(1):48–56. <https://doi.org/10.1007/BF02979395>
- Wentker M, Greenwood M, Leker J (2019) A bottom-up approach to lithium-ion battery cost modeling with a focus on cathode active materials. *Energies*, 12(3): 504. Retrieved from <https://www.mdpi.com/1996-1073/12/3/504>
- Wohner B, Gabriel VH, Krenn B, Krauter V, Tacker M (2020) Environmental and economic assessment of food-packaging systems with a focus on food waste. Case study on tomato ketchup. *Sci Total Environ*, 738
- Wood R, Hertwich EG (2013) Economic modelling and indicators in life cycle sustainability assessment. *Int J Life Cycle Assess* 18(9):1710–1721. <https://doi.org/10.1007/s11367-012-0463-2>
- Wulf C, Werker J, Zapp P, Schreiber A, Schlör H, Kuckshinrichs W (2018). Sustainable Development Goals as a Guideline for Indicator Selection in Life Cycle Sustainability Assessment. *Procedia CIRP*, 69:59–65. <https://doi.org/10.1016/j.procir.2017.11.144>
- Wulf C, Werker J, Ball C, Zapp P, Kuckshinrichs W (2019). Review of sustainability assessment approaches based on life cycles. *Sustainability*, 11(20): 5717. Retrieved from <https://www.mdpi.com/2071-1050/11/20/5717>
- Wulf C, Zapp P, Schreiber A, Kuckshinrichs W (2022) Integrated life cycle sustainability assessment – hydrogen production as a showcase for an emerging methodology. In J. Kasprzak (Ed.), *Towards sustainable future. current challenges and prospects in the life cycle management - LCM 2019*, Springer, Heidelberg
- Wulf C, Zapp P (2021) Sustainability assessment of innovative energy technologies—hydrogen from wind power as a fuel for mobility applications. *J Sustain Dev Energy Water Environ Syst*. <https://doi.org/10.13044/j.sdewes.d8.0371>

**Publisher's Note** Springer Nature remains neutral with regard to jurisdictional claims in published maps and institutional affiliations.