



Spectral Theory for Interacting Particle Systems Solvable by Coordinate Bethe Ansatz

Alexei Borodin^{1,2}, Ivan Corwin^{1,3,4,5}, Leonid Petrov^{2,6,7}, Tomohiro Sasamoto⁸

¹ Department of Mathematics, Massachusetts Institute of Technology, 77 Massachusetts Avenue, Cambridge, MA 02139-4307, USA

² Institute for Information Transmission Problems, Bolshoy Karetny per. 19, Moscow 127994, Russia.
E-mail: borodin@math.mit.edu E-mail: lenia.petrov@gmail.com

³ Department of Mathematics, Columbia University, 2990 Broadway, New York, NY 10027, USA.
E-mail: ivan.corwin@gmail.com

⁴ Clay Mathematics Institute, 10 Memorial Blvd., Suite 902, Providence, RI 02903, USA

⁵ Institut Henri Poincaré, 11 Rue Pierre et Marie Curie, 75005 Paris, France

⁶ Department of Mathematics, University of Virginia, 141 Cabell Drive, Kerchof Hall, P.O. Box 400137, Charlottesville, VA 22904-4137, USA

⁷ Department of Mathematics, Northeastern University, 360 Huntington Ave., Boston, MA 02115, USA

⁸ Department of Physics, Tokyo Institute of Technology, 2-12-1 Ookayama, Meguro-ku, Tokyo 152-8550, Japan. E-mail: sasamoto@phys.titech.ac.jp

Received: 2 January 2015 / Accepted: 10 April 2015

Published online: 19 July 2015 – © Springer-Verlag Berlin Heidelberg 2015

Abstract: We develop spectral theory for the q -Hahn stochastic particle system introduced recently by Povolotsky. That is, we establish a Plancherel type isomorphism result that implies completeness and biorthogonality statements for the Bethe ansatz eigenfunctions of the system. Owing to a Markov duality with the q -Hahn TASEP (a discrete-time generalization of TASEP with particles' jump distribution being the orthogonality weight for the classical q -Hahn orthogonal polynomials), we write down moment formulas that characterize the fixed time distribution of the q -Hahn TASEP with general initial data. The Bethe ansatz eigenfunctions of the q -Hahn system degenerate into eigenfunctions of other (not necessarily stochastic) interacting particle systems solvable by the coordinate Bethe ansatz. This includes the ASEP, the (asymmetric) six-vertex model, and the Heisenberg XXZ spin chain (all models are on the infinite lattice). In this way, each of the latter systems possesses a spectral theory, too. In particular, biorthogonality of the ASEP eigenfunctions, which follows from the corresponding q -Hahn statement, implies symmetrization identities of Tracy and Widom (for ASEP with either step or step Bernoulli initial configuration) as corollaries. Another degeneration takes the q -Hahn system to the q -Boson particle system (dual to q -TASEP) studied in detail in our previous paper (2013). Thus, at the spectral theory level we unify two discrete-space regularizations of the Kardar–Parisi–Zhang equation/stochastic heat equation, namely, q -TASEP and ASEP.

Contents

1. Introduction	1168
2. Definition of Eigenfunctions	1175
3. Plancherel Formulas	1180
4. Spectral Biorthogonality of Eigenfunctions	1193
5. The q -Hahn System and Coordinate Bethe Ansatz	1201

6. Conjugated q -Hahn Operator	1214
7. Application to ASEP	1218
8. Application to Six-Vertex Model and XXZ Spin Chain	1228
9. Appendix. Further Degenerations	1239
References	1243

1. Introduction

How to decompose functions onto distinguished bases—harmonic analysis—is a central theme touching many fields of mathematics. In this work we will answer this question for a class of bases that arise from the coordinate Bethe ansatz on \mathbb{Z} , and in so doing tie together (through various degenerations of our results) certain problems in probability, quantum integrable systems, symmetric functions and combinatorics. By working at a high algebraic level, our results are achieved through relatively soft methods (some of which do not survive various degenerations), such as contour deformations and residue computations.

The most basic instance of harmonic analysis—Fourier analysis—involves decomposing $L^2(\mathbb{R})$ functions onto exponentials (or sine/cosines). Exponential functions are distinguished for many reasons. In particular, they are eigenfunctions for the Laplacian on \mathbb{R} (as well as for the whole algebra of differential operators with constant coefficients that commute with the Laplacian). In a different direction, they are the characters of the (abelian) additive group of reals. Harmonic analysis generalizes in many directions, the simplest such involving higher dimensional $L^2(\mathbb{R}^k)$ functions. Still in the abelian setting, \mathbb{R}^k may also be replaced by a locally compact abelian group.

Generalizing into the non-commutative setting of representations of Lie groups/algebras over real, complex, finite or p -adic fields, symmetric spaces, and further yet, to Hecke algebras of different sorts, the role of exponentials (or multivariate exponentials) is played by a hierarchy of symmetric polynomials and their limits that arise as characters and spherical functions. Like the exponentials, these polynomials are eigenfunctions for certain families of commuting operators. The operators, however, are generally non-local in variables indices, so unlike the (local) k -dimensional Laplacian, these operators mix all k -coordinates in non-trivial manners.

Locality is considered to be essential for physical models of the real world (with the notable exception of Coulomb and gravitational interactions), and it is highly desirable within models for equilibrium and non-equilibrium statistical and quantum mechanical systems. Thus, it is of paramount importance to discover such systems (described by Hamiltonians that often can be considered as versions of the Laplacian) whose eigenfunctions are explicit and form nice functional bases.

Early examples of such local, diagonalizable systems include the Heisenberg XXX and XXZ spin chains, as well as the transfer matrix for the six-vertex (or square ice) model. The coordinate Bethe ansatz, introduced in pioneering work of Bethe [8], provides means to write down eigenfunctions for these Hamiltonians. It is worth noting that most presently known examples solvable by the coordinate Bethe ansatz are one-dimensional.

Motivated by the study of finite volume statistical or quantum mechanical systems, research in this area dealt primarily with the problem of diagonalizing these operators acting on finite lattices with particular types of boundary conditions. These boundary conditions introduce restrictions on the eigenfunctions, which go by the name of Bethe equations and typically are hard to analyze.

The motivation behind the present work is more probabilistic—we seek to study fluctuation limit theorems for (stochastic) interacting particle systems and random growth processes on \mathbb{Z} whose stochastic generators can be diagonalized via coordinate Bethe ansatz. While in physics it is typical to first consider finite systems and then take the limit of infinite system size, working directly on \mathbb{Z} (or \mathbb{R}) is quite natural probabilistically. Moreover, certain Markov dualities enable us to reduce considerations involving infinite particle systems to those involving a finite (though arbitrarily large) number of particles.

Working on \mathbb{Z} simplifies the coordinate Bethe ansatz as there are no boundary conditions, and hence no Bethe equations. On the other hand, there are now infinitely many eigenfunctions and the challenge becomes to figure out which ones participate in the diagonalization and with respect to which (spectral or Plancherel) measure. Results of this kind (generalized by the present work) regarding the XXX/XXZ model and quantum delta Bose gas go back to early work of Babbitt–Thomas [3], Babbitt–Gutkin [2], Gutkin [29], Oxford [47], Heckman–Opdam [31].

In this paper we develop the above mentioned theory for what at the moment looks like the most general class of eigenfunctions diagonalizing vertex type models (and their degenerations) arising from the quantum affine algebra $U_q(\widehat{sl_2})$. In particular, these (and their degenerations) diagonalize Povolotsky’s q -Hahn Boson system, the q -Boson system of [15, 52], the six-vertex model, the Heisenberg XXZ and XXX spin chains (equivalently, the asymmetric simple exclusion process), Van Diejen’s discrete delta Bose gas [63], a semi-discrete delta Bose gas from [10] and the continuous delta Bose gas. Using our results along with methods developed in related works (e.g. [10–12]) in the past few years, it is possible to access very precise asymptotic information about some of these systems (for various types of initial data) and probe universal limits as well as new phenomena.

The eigenfunctions we study are interesting in their own right. They form a one-parameter generalizations of the Hall–Littlewood symmetric polynomials. Interestingly, this is a different direction of generalization than that of the celebrated Macdonald symmetric polynomials. A particular degeneration ($v = 0$) is, however, closely related to $t = 0$ Macdonald symmetric polynomials [9] (also known as q -Whittaker functions). It remains a mystery as to whether these two classes of symmetric polynomials (one arising in relation to non-local operators and the other in relation to local operators) can be united under a single generalization.

1.1. Main results for the q -Hahn system eigenfunctions. The q -Hahn system introduced by Povolotsky [48] is a discrete-time stochastic Markov dynamics on k -particle configurations on \mathbb{Z} (where $k \geq 1$ is arbitrary) in which multiple particles at a site are allowed (in fact, it is a totally asymmetric zero-range process, see [38] for a general background). At each step of the q -Hahn system dynamics, independently at every occupied site $i \in \mathbb{Z}$ with $y_i \geq 1$ particles, one randomly selects $s_i \in \{0, 1, \dots, y_i\}$ particles according to the probability distribution

$$\varphi_{q, \mu, v}(s_i | y_i) = \mu^{s_i} \frac{(v/\mu; q)_{s_i} (\mu; q)_{y_i - s_i}}{(v; q)_{y_i}} \frac{(q; q)_{y_i}}{(q; q)_{s_i} (q; q)_{y_i - s_i}},$$

$$(a; q)_n := \prod_{j=1}^n (1 - aq^{j-1}),$$

where $0 < q < 1$ and $0 \leq \nu \leq \mu < 1$ are three parameters of the model. These selected s_i particles are immediately moved to the left (i.e., to site $i - 1$). This update occurs in parallel for each site. See Fig. 6 in Sect. 5.2, left panel.

Configurations can be encoded by vectors $\vec{n} = (n_1 \geq \dots \geq n_k)$, $n_i \in \mathbb{Z}$, where n_i is the position of the i -th particle from the right. We denote by \mathbb{W}^k the space of all such vectors. Therefore, the backward Markov transition operator $\mathcal{H}_{q,\mu,\nu}^{\text{bwd}}$ of the q -Hahn stochastic process acts on the space of compactly supported functions in the spatial variables \vec{n} . We denote the latter space by \mathcal{W}^k . The left and right eigenfunctions of the operator $\mathcal{H}_{q,\mu,\nu}^{\text{bwd}}$ are, respectively¹

$$\begin{aligned} \Psi_{\vec{z}}^{\ell}(\vec{n}) &= \sum_{\sigma \in S(k)} \prod_{1 \leq B < A \leq k} \frac{z_{\sigma(A)} - qz_{\sigma(B)}}{z_{\sigma(A)} - z_{\sigma(B)}} \prod_{j=1}^k \left(\frac{1 - z_{\sigma(j)}}{1 - \nu z_{\sigma(j)}} \right)^{-n_j}; \\ \Psi_{\vec{z}}^r(\vec{n}) &= (-1)^k (1 - q)^k q^{\frac{k(k-1)}{2}} \mathfrak{m}_{q,\nu}(\vec{n}) \\ &\quad \times \sum_{\sigma \in S(k)} \prod_{1 \leq B < A \leq k} \frac{z_{\sigma(A)} - q^{-1}z_{\sigma(B)}}{z_{\sigma(A)} - z_{\sigma(B)}} \prod_{j=1}^k \left(\frac{1 - z_{\sigma(j)}}{1 - \nu z_{\sigma(j)}} \right)^{n_j}, \end{aligned} \tag{1.1}$$

where $\vec{z} = (z_1, \dots, z_k) \in (\mathbb{C} \setminus \{1, \nu^{-1}\})^k$, and $\mathfrak{m}_{q,\nu}(\vec{n})$ is an explicit quantity given in (2.13). Here and below $S(k)$ is the symmetric group of all permutations of $\{1, 2, \dots, k\}$. The corresponding eigenvalues are $\text{ev}_{\mu,\nu}(\vec{z}) := \prod_{j=1}^k \frac{1 - \mu z_j}{1 - \nu z_j}$. Eigenfunctions (1.1) were obtained in [48] by applying the coordinate Bethe ansatz (a procedure dating back to [8]) to the operator $\mathcal{H}_{q,\mu,\nu}^{\text{bwd}}$. These eigenfunctions are also related to a deformation of an affine Hecke algebra [56]. The latter object also leads to a stochastic interacting particle system which is a continuous-time limit of the q -Hahn system. Remarkably, the q -Hahn eigenfunctions depend only on the parameters (q, ν) , thus making μ an additional free parameter. This implies that for fixed q and ν the operators $(\mathcal{H}_{q,\mu,\nu}^{\text{bwd}})_{\mu \in [\nu, 1]}$ form a commuting family.

Let $\mathcal{F}^{q,\nu}$ be the *direct q -Hahn transform* which takes a function $f \in \mathcal{W}^k$ in the spatial variables \vec{n} and produces a function in the spectral variables \vec{z} according to

$$(\mathcal{F}^{q,\nu} f)(\vec{z}) = \langle f, \Psi_{\vec{z}}^r \rangle_{\mathcal{W}^k} = \sum_{\vec{n} \in \mathbb{W}^k} f(\vec{n}) \Psi_{\vec{z}}^r(\vec{n}).$$

The pairing above is the (obvious) bilinear pairing in the space \mathcal{W}^k (2.2). The function $\mathcal{F}^{q,\nu} f$ is a symmetric Laurent polynomial in $(1 - z_j)/(1 - \nu z_j)$, $j = 1, \dots, k$. We denote the space of such Laurent polynomials by $\mathcal{C}_{\vec{z}}^k$.

Let $\mathcal{J}^{q,\nu}$ be the *inverse q -Hahn transform* which maps Laurent polynomials $G \in \mathcal{C}_{\vec{z}}^k$ to functions from \mathcal{W}^k according to the following nested contour integration formula:

$$\begin{aligned} (\mathcal{J}^{q,\nu} G)(\vec{n}) &= \oint_{\gamma_1} \frac{dz_1}{2\pi \mathbf{i}} \dots \oint_{\gamma_k} \frac{dz_k}{2\pi \mathbf{i}} \prod_{1 \leq A < B \leq k} \frac{z_A - z_B}{z_A - qz_B} \\ &\quad \prod_{j=1}^k \frac{1}{(1 - z_j)(1 - \nu z_j)} \left(\frac{1 - z_j}{1 - \nu z_j} \right)^{-n_j} G(\vec{z}). \end{aligned}$$

¹ Note that the eigenfunctions do not belong to the space \mathcal{W}^k .

The contour γ_k is a small circle around 1, γ_A contains $q\gamma_B$ contour for all $B > A$, and all contours do not contain v^{-1} (see also Definition 2.1). One can interpret $\mathcal{J}^{q,v}$ as a bilinear pairing $\langle G, \Psi^\ell(\vec{n}) \rangle_{\mathcal{C}_z^k}$, where $\Psi^\ell(\vec{n})$ is viewed as a function in \vec{z} . This pairing is defined in terms of integration in which all variables belong to the same contour (and not to various nested contours), see Sect. 2.2.

The main results of the present paper concerning the q -Hahn eigenfunctions (1.1) are the following:

1. **(Plancherel formulas)** The transforms $\mathcal{F}^{q,v}$ and $\mathcal{J}^{q,v}$ are mutual inverses in the sense that $\mathcal{J}^{q,v}\mathcal{F}^{q,v}$ acts as the identity on \mathcal{W}^k , and $\mathcal{F}^{q,v}\mathcal{J}^{q,v}$ is the identity map on \mathcal{C}_z^k .
2. **(Plancherel isomorphism theorem)** The two function spaces \mathcal{W}^k and \mathcal{C}_z^k are isomorphic as linear spaces with bilinear forms $(f, g) \mapsto \langle f, \mathcal{P}^{-1}g \rangle_{\mathcal{W}^k}$ and $(F, G) \mapsto \langle F, G \rangle_{\mathcal{C}_z^k}$, where \mathcal{P} is the operator in \mathcal{W}^k which swaps left and right eigenfunctions: $(\mathcal{P}^{-1}\Psi_z^\ell)(\vec{n}) = \Psi_z^r(\vec{n})$. The map \mathcal{P} also has a simple independent definition, see (2.17) below.
3. **(Completeness of the Bethe ansatz)** Any compactly supported function $f(\vec{n})$ can be expressed through the eigenfunctions as

$$f(\vec{n}) = \oint_{\gamma_1} \frac{dz_1}{2\pi\mathbf{i}} \cdots \oint_{\gamma_k} \frac{dz_k}{2\pi\mathbf{i}} \prod_{1 \leq A < B \leq k} \frac{z_A - z_B}{z_A - qz_B} \prod_{j=1}^k \frac{1}{(1 - z_j)(1 - \nu z_j)} \left(\frac{1 - z_j}{1 - \nu z_j} \right)^{-n_j} \sum_{\vec{y} \in \mathbb{W}^k} f(\vec{y}) \Psi_z^r(\vec{y}).$$

4. **(Spatial biorthogonality)** The left and right eigenfunctions are biorthogonal viewed as elements of \mathcal{C}_z^k : $\langle \Psi^\ell(\vec{n}), \Psi^r(\vec{m}) \rangle_{\mathcal{C}_z^k} = \mathbf{1}_{\vec{m}=\vec{n}}$.²
5. **(Spectral biorthogonality)** Viewed as functions in the spatial variables, the left and right eigenfunctions are biorthogonal in the following formal way:

$$\sum_{\vec{n} \in \mathbb{W}^k} \Psi_z^r(\vec{n}) \Psi_w^\ell(\vec{n}) \mathbf{V}(\vec{z}) \mathbf{V}(\vec{w}) = (-1)^{\frac{k(k-1)}{2}} \prod_{j=1}^k (1 - z_j)(1 - \nu z_j) \prod_{A \neq B} (z_A - qz_B) \det[\delta(z_i - w_j)]_{i,j=1}^k,$$

where $\mathbf{V}(\vec{z}) = \prod_{1 \leq i < j \leq k} (z_i - z_j)$ is the Vandermonde determinant. The above identity should be understood in a certain integrated sense. The simplest such interpretation is to multiply both sides by Laurent polynomials (not necessarily symmetric) in $(1 - z_i)/(1 - \nu z_i)$ and $(1 - w_j)/(1 - \nu w_j)$, respectively, and integrate all z_i and w_j over a small circle around 1.

We establish the spatial Plancherel formula (that $\mathcal{J}^{q,v}\mathcal{F}^{q,v}$ is the identity map on the space of compactly supported functions in the spatial variables \vec{n}) in Theorem 3.4. Our argument relies on residue considerations involving shrinking (to 1) or expanding (to v^{-1}) of integration contours in $\mathcal{J}^{q,v}$. The nested contour form of the integration in $\mathcal{J}^{q,v}$ is especially well adapted to this proof (there are other ways to write down $\mathcal{J}^{q,v}$, see Sect. 3.2).

² Here and below $\mathbf{1}_{\{\dots\}}$ denotes the indicator function.

The spectral Plancherel formula (that $\mathcal{F}^{q,\nu} \mathcal{J}^{q,\nu}$ is the identity map on C_z^k , see Theorem 3.9) is derived from the spectral biorthogonality (Theorems 4.3 and 4.4). The latter statement follows from the existence of one-parameter family of commuting operators $(\mathcal{H}_{q,\mu,\nu}^{\text{bwd}})_{\mu \in [v,1]}$ with different eigenvalues, which produces many relations satisfied by the eigenfunctions (1.1).

The Plancherel isomorphism theorem is a direct consequence of the two Plancherel formulas. The need of the swapping operator \mathcal{P} is evident since the natural basis of indicator functions $\{\mathbf{1}_{\vec{x}}(\vec{n})\}_{\vec{x} \in \mathbb{W}^k}$ in \mathcal{W}^k is orthogonal, and the left and right eigenfunctions are biorthogonal in C_z^k .

The completeness of the Bethe ansatz for the q -Hahn system (Corollary 3.10) and the spatial biorthogonality of the eigenfunctions (Corollary 3.13) readily follow from the spatial Plancherel formula.

One immediate application of our main results is the solution of the forward and backward Kolmogorov equations for the q -Hahn stochastic process with general initial data. By a duality result of [22], the q -Hahn backward Kolmogorov equations govern evolution of q -moments of the q -Hahn Totally Asymmetric Simple Exclusion Process (TASEP). The latter system (first introduced in [48]) is a discrete-time three-parameter generalization of the usual continuous-time TASEP with particles' jump distribution being the orthogonality weight for the classical q -Hahn orthogonal polynomials (Sect. 5.2). Consequently, this provides nested contour integral expressions for q -moments of the q -Hahn TASEP with general initial data (see Sect. 5.7).

In principle, one could use moment formulas to address asymptotic questions about the q -Hahn TASEP with various types of initial data and obtain results of Kardar–Parisi–Zhang (KPZ) universality type. See [66] for the treatment of the q -Hahn TASEP with step initial condition (based on the moment and Fredholm determinantal formulas of [22]), and also [1, 11–13, 23, 27, 43, 60–62] for other systems (note that most of these models are diagonalized by degenerations of the q -Hahn eigenfunctions, cf. Sect. 1.2 below). We do not pursue large time asymptotic problems in the present paper.

1.2. Degenerations and limits of q -Hahn eigenfunctions. After establishing the main results concerning the eigenfunctions (1.1), we turn our attention to studying their degenerations, and discuss various systems that are diagonalized by these. We explore two ways to degenerate these eigenfunctions (corresponding to two arrows starting from the “ q -Hahn” block on Fig. 1):

The first way is to set $\nu = 0$. Then the eigenfunctions (1.1) turn into the Bethe ansatz eigenfunctions of the (stochastic) q -Boson particle system introduced in [52]. This system is dual to the q -TASEP of [10] (see [16]). When $\nu = 0$, the q -Hahn stochastic process itself becomes the system dual to the discrete-time geometric q -TASEP of [9]. A continuous-time limit of the latter is the q -TASEP.

The spectral theory for the q -Boson eigenfunctions is the main subject of our previous paper [15]. Though results of the present paper imply the main results of [15], the ideas of the proofs in the two papers differ significantly (see Remarks 3.8 and 4.12 for details).

The q -Boson system admits a scaling limit to a semi-discrete delta Bose gas considered previously by Van Diejen [63], as well as to another semi-discrete delta Bose gas that describes the evolution of moments of the semi-discrete stochastic heat equation (or equivalently, the O’Connell–Yor semi-discrete directed polymer partition function [44, 46]). See [15] for details. We briefly describe the corresponding limits of the q -Boson eigenfunctions in Sects. 9.2 and 9.4.

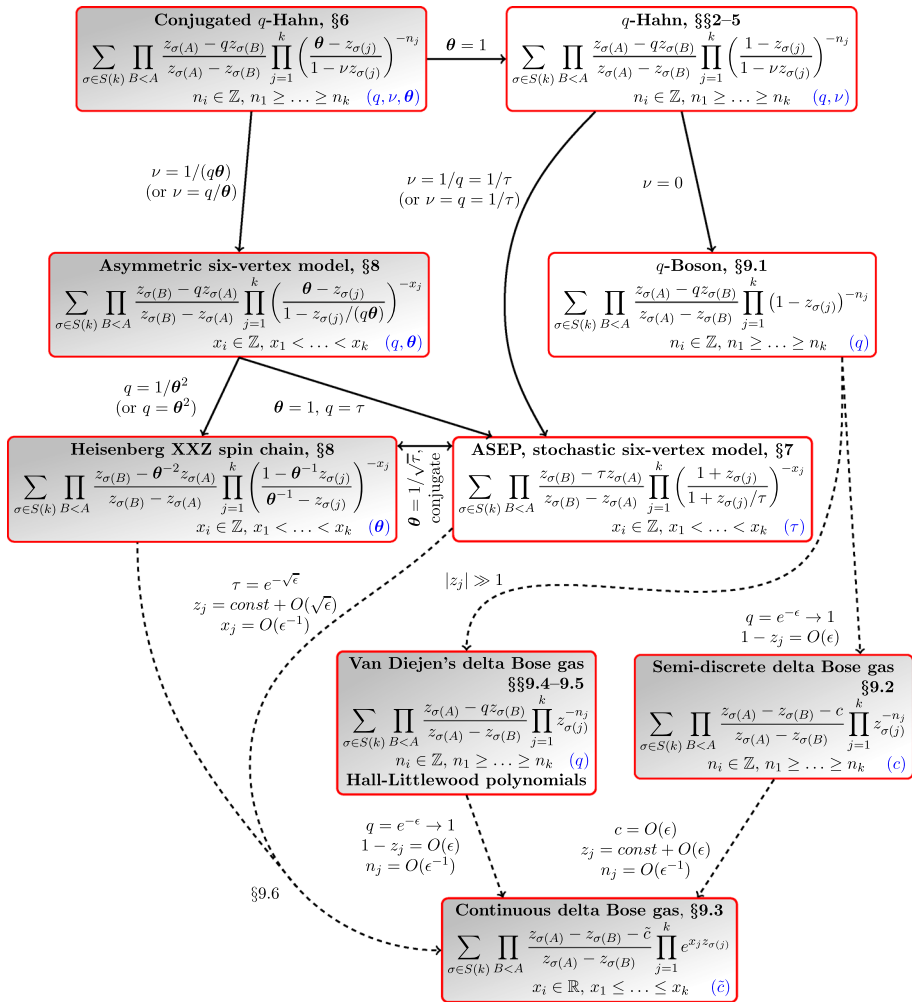

Fig. 1. A hierarchy of eigenfunctions of Hall–Littlewood type (about the name see Remark 6.2) possessing a Plancherel theory. All functions arise via coordinate Bethe ansatz for various integrable particle systems. Only the left eigenfunctions are written down. The use of the spatial variables n_j vs. x_j reflects literature conventions that are not uniform throughout. *Shading of boxes* indicates particle systems that are not necessarily stochastic (however, they may be dual to stochastic processes such as the semi-discrete stochastic heat equation or the continuous stochastic heat equation/KPZ equation). *Solid arrows* mean straightforward degenerations of eigenfunctions, and *dashed arrows* correspond to scaling limits, which are briefly discussed in Sect. 9

The second way is to set $\nu = 1/q$. As we explain in Sect. 7, under this degeneration the eigenfunctions (1.1) turn into the eigenfunctions of the ASEP, another well-studied stochastic interacting particle system [55] in which particles living on the lattice \mathbb{Z} (at most one particle at a site) randomly jump to the left by one at rate q or to the right by one at rate p . Then the remaining parameter q in (1.1) would mean the ratio p/q (which is sometimes denoted by τ).³ The weak ordering of the spatial variables $\vec{n} = (n_1 \geq$

³ However, the ASEP itself does not seem to be a degeneration of either the q -Hahn system or the q -Hahn TASEP (note that the ASEP is self-dual in various senses, cf. [16, 21, 38, 53]).

$\dots \geq n_k$) should be replaced by the strict one because the constant $m_{q,v}(\vec{n})|_{v=1/q}$ in the right eigenfunction vanishes unless $n_1 > \dots > n_k$. These strictly ordered spatial variables encode locations of the ASEP particles.

All our main results for the q -Hahn eigenfunctions produce the corresponding results for the ASEP eigenfunctions. However, this degeneration is not always straightforward: For instance, all nested contours in the inverse transform $\mathcal{J}^{q,v}$ and in the spatial Plancherel formula should be replaced by a single small contour around a singularity.

Some parts of the ASEP spectral theory have been already established. Namely, the spatial Plancherel formula for the ASEP is equivalent to Tracy–Widom’s solution of the ASEP master equation [59] (see also [54] for two-particle case). Moreover, the spectral Plancherel formula for the ASEP implies as corollaries the symmetrization identities first obtained by Tracy and Widom as [59, (1.6)] (for ASEP with the step initial condition) and [61, (9)] (for the step Bernoulli initial condition).⁴ These symmetrization identities served as a crucial step towards Fredholm determinantal formulas for the ASEP [58] and ultimately to proving its KPZ universality [60, 62] (see also [13] for a recent application of these symmetrization identities to the six-vertex model).

In Sect. 8 we consider two other (non-stochastic) models with strictly ordered spatial variables, namely, the (asymmetric) six-vertex model and the Heisenberg XXZ spin chain [5] (both on the infinite lattice \mathbb{Z}). Eigenfunctions of these two models are similar to the ASEP ones, and, moreover, arise as degenerations of eigenfunctions of the q -Hahn transition operator conjugated by the multiplication operator $(const)^{n_1+\dots+n_k}$ (with a suitable choice of the constant). This conjugated q -Hahn operator is no longer stochastic. As we explain in Sect. 6, the spectral theory in the conjugated case is essentially equivalent to the one for the stochastic q -Hahn transition operator. In this way we arrive at spectral theory results for the six-vertex and the XXZ models. We also comment on Plancherel formulas for the XXZ model, which already appeared in the works of Thomas, Babbitt, and Gutkin [2, 3, 29].

Both ways to degenerate the eigenfunctions (1.1) described above are unified again at the level of the continuous delta Bose gas. The latter system is dual [6], [10, §6] to the stochastic heat equation, or, via the Hopf–Cole transform, to the KPZ equation. That is, eigenfunctions of both the semi-discrete delta Bose gases mentioned above, as well as the ASEP eigenfunctions, admit scaling limits to the continuous delta Bose gas eigenfunctions (see Sects. 9.3, 9.5, and 9.6). In this way, our results for the q -Hahn eigenfunctions provide a unification (at the spectral theory level) of two discrete-space regularizations of the Kardar–Parisi–Zhang equation/stochastic heat equation, namely, ASEP and q -TASEP.

1.3. Further directions and connections. Let us mention (very briefly) other connections, as well as possible directions of further study.

The stochastic q -Boson process (which is a continuous-time degeneration of the q -Hahn system) is dual to the q -TASEP. The latter dynamics was invented in [10] is a one-dimensional marginal of a certain dynamics on interlacing integer arrays related to Macdonald processes. The results about Macdonald processes developed in [10, 14]

⁴ In fact, the q -Hahn spectral Plancherel formula also provides certain symmetrization identities generalizing the Tracy–Widom ones. These identities at the q -Hahn level turn out to be significantly more complicated, and it remains unclear whether it is possible to use them in any asymptotic analysis. See, however, the use of similar identities in [35] at the q -Boson level for finding the distribution of the leftmost particle’s position in the q -Boson process.

provide another way of establishing moment formulas for the q -TASEP besides the duality approach used in [16]. Since then, other dynamics on interlacing arrays with q -TASEP (and other integrable interacting particle systems) as one-dimensional marginals were introduced, cf. [17,42,45]. See also [9] for more discussion on intrinsic connections between q -TASEPs and Macdonald processes (and also Macdonald difference operators).

An intriguing problem is to find suitable dynamics on interlacing arrays (or maybe another dynamical model on two-dimensional particle configurations) with the q -Hahn TASEP as a one-dimensional marginal. This could potentially provide a “ q -Hahn extension” of Macdonald processes.

The spectral theory at the q -Hahn level also generalizes the setup of the six-vertex model (and the related ASEP and XXZ models). The coordinate Bethe ansatz approach to the six-vertex model initially performed by Lieb [5,36] was greatly generalized to what is now known as the algebraic Bethe ansatz, cf. [26,51]. It would be of interest to construct an algebraic lifting of the Bethe ansatz for the q -Hahn system. See also [52] on the algebraic nature of the q -Boson Hamiltonian.

1.4. Outline. The outline and scope of the paper is represented graphically on Fig. 1. In Sect. 2 we describe the eigenfunctions of the q -Hahn stochastic particle system, and introduce other necessary notation. In Sect. 3 we present detailed statements of our main results, and prove the spatial Plancherel formula. In Sect. 4 we prove the spectral biorthogonality of the q -Hahn eigenfunctions which implies the spectral Plancherel formula. In Sect. 6 we briefly describe modifications of our main results corresponding to a conjugated q -Hahn operator (which is no longer stochastic). In Sect. 7 we describe a spectral theory for the ASEP eigenfunctions (which is a degeneration of the q -Hahn theory), and match it to the work of Tracy and Widom on exact formulas for the ASEP [59,61]. In Sect. 8 (using formulas from Sect. 6), we explain how the eigenfunctions of the conjugated q -Hahn operator degenerate to eigenfunctions of the (asymmetric) six-vertex model and of the Heisenberg XXZ spin chain, and produce spectral theory results for the latter two systems. In Sect. 9 we briefly describe further degenerations of the q -Hahn eigenfunctions.

2. Definition of Eigenfunctions

The results in this and the next sections depend on two parameters (q, ν) , with $|q| < 1$ and $0 \leq \nu < 1$, and on a fixed integer $k \geq 1$.

2.1. Spatial and spectral variables. We will deal with k -particle configurations on the lattice \mathbb{Z} . Ordered positions of particles are encoded by a vector $\vec{n} \in \mathbb{W}^k$, where \mathbb{W}^k is the Weyl chamber:

$$\mathbb{W}^k := \{\vec{n} = (n_1, \dots, n_k) : n_1 \geq \dots \geq n_k, n_i \in \mathbb{Z}\}. \quad (2.1)$$

We will refer to $\vec{n} = (n_1, \dots, n_k)$ as to the *spatial variables*.

By \mathcal{W}^k denote the space of all compactly supported functions $f: \mathbb{W}^k \rightarrow \mathbb{C}$. The space \mathcal{W}^k carries a natural symmetric bilinear pairing

$$\langle f, g \rangle_{\mathcal{W}^k} := \sum_{\vec{n} \in \mathbb{W}^k} f(\vec{n})g(\vec{n}). \quad (2.2)$$

Define the map $\Xi: \mathbb{C} \rightarrow \mathbb{C}$ by

$$\Xi(z) := \frac{1 - z}{1 - \nu z}. \tag{2.3}$$

Note that this is an involution (i.e., $\Xi(\Xi(z)) = z$) which swaps pairs of points $0 \leftrightarrow 1$ and $\nu^{-1} \leftrightarrow \infty$ in $\overline{\mathbb{C}} := \mathbb{C} \cup \{\infty\}$. Note that when $\nu = 0$ (so $\nu^{-1} = \infty$), the map Ξ reduces to $z \mapsto 1 - z$, which preserves ∞ .

For any two points $a \neq b \in \overline{\mathbb{C}}$, by $\mathcal{C}^k(a, b)$ denote the space of symmetric functions $G(z_1, \dots, z_k)$ on \mathbb{C}^k which are Laurent polynomials in

$$\frac{1 - a^{-1}z_1}{1 - b^{-1}z_1}, \dots, \frac{1 - a^{-1}z_k}{1 - b^{-1}z_k}.$$

By agreement, if $a = \infty$, then the factor $1 - a^{-1}z_j$ is not present; if $a = 0$, then the same factor should be replaced simply by $(-z_j)$.

We will need two particular cases:

- the space $\mathcal{C}_z^k := \mathcal{C}^k(1, \nu^{-1})$ of symmetric functions in variables denoted by z_1, \dots, z_k such that these functions are Laurent polynomials in the expressions $\frac{1 - z_1}{1 - \nu z_1}, \dots, \frac{1 - z_k}{1 - \nu z_k}$;
- the space $\mathcal{C}_\xi^k := \mathcal{C}^k(0, \infty)$ of symmetric Laurent polynomials in variables which we will denote by ξ_1, \dots, ξ_k .

Note that the involution Ξ interchanges the spaces \mathcal{C}_z^k and \mathcal{C}_ξ^k by swapping the variables $z_j \leftrightarrow \xi_j$.

We will refer to either the variables $\vec{z} = (z_1, \dots, z_k)$ or $\vec{\xi} = (\xi_1, \dots, \xi_k)$ (related to the corresponding spaces of symmetric Laurent polynomials) as to the *spectral variables*.

2.2. Bilinear pairing in spectral variables. Here we introduce symmetric bilinear pairings on spaces of functions in spectral variables (both \vec{z} and $\vec{\xi}$). First, we need to define integration contours and a (complex-valued) Plancherel spectral measure.

Definition 2.1 (Contours). Let $\gamma_1, \dots, \gamma_k$ be positively oriented, closed contours chosen so that they all contain 1 and do not contain ν^{-1} , so that the γ_A contour contains the image of q times the γ_B contour for all $B > A$, and so that γ_k is a small enough circle around 1 that does not contain q . Let γ be a positively oriented closed contour which contains 1, does not contain ν^{-1} , and also contains its own image under the multiplication by q . See Fig. 2.

Clearly, it is possible to choose such contours for all $q \in \mathbb{C}$ with $|q| < 1$. One way to see this possibility for complex q is to consider the spiral $\{q^{2\alpha}\}_{\alpha \in \mathbb{R}_{\geq 0}}$, and modify the contours on Fig. 2 appropriately.

Definition 2.2 (Plancherel measure). For each partition⁵ $\lambda \vdash k$ define

$$dm_\lambda^{(q)}(\vec{w}) := \frac{(1 - q)^k (-1)^k q^{-\frac{k^2}{2}}}{m_1! m_2! \dots} \det \left[\frac{1}{w_i q^{\lambda_i} - w_j} \right]_{i,j=1}^{\ell(\lambda)} \prod_{j=1}^{\ell(\lambda)} w_j^{\lambda_j} q^{\frac{\lambda_j^2}{2}} \frac{dw_j}{2\pi i}, \tag{2.4}$$

⁵ That is, $\lambda = (\lambda_1 \geq \lambda_2 \geq \dots \geq 0)$, $\lambda_i \in \mathbb{Z}$, with $\lambda_1 + \lambda_2 + \dots = k$. The number of nonzero components in λ will be denoted by $\ell(\lambda)$.

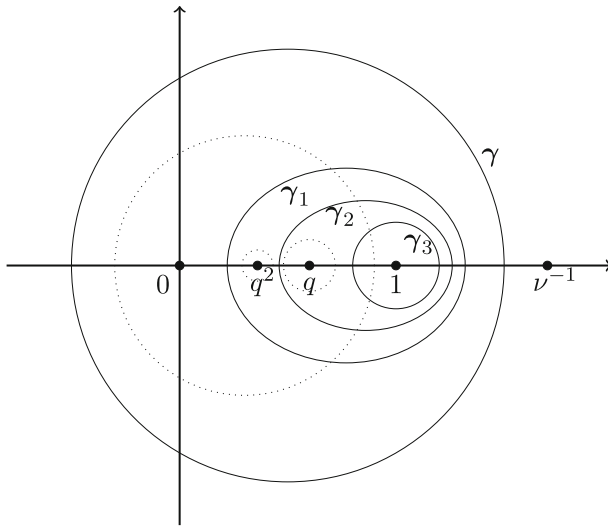

Fig. 2. A possible choice of integration contours $\gamma_1, \gamma_2, \gamma_3$, and γ for $k = 3$ and $0 < q < 1$. Contours $q\gamma_1, q^2\gamma_1$, and $q\gamma_2$ are shown dotted

where $\vec{w} = (w_1, \dots, w_{\ell(\lambda)}) \in \mathbb{C}^{\ell(\lambda)}$, and m_j is the number of components of λ equal to j (so that $\lambda = 1^{m_1}2^{m_2} \dots$).

The object (2.4) may be viewed as a (complex-valued) Plancherel measure (see Remark 3.12 below).

If $\lambda \vdash k$, we will use the notation

$$\begin{aligned} \vec{w} \circ \lambda := & (w_1, qw_1, \dots, q^{\lambda_1-1}w_1, w_2, qw_2, \dots, q^{\lambda_2-1}w_2, \dots, w_{\lambda_{\ell(\lambda)}}, \\ & \times qw_{\lambda_{\ell(\lambda)}}, \dots, q^{\lambda_{\ell(\lambda)}-1}w_{\lambda_{\ell(\lambda)}}) \in \mathbb{C}^k. \end{aligned} \tag{2.5}$$

The bilinear pairing on the space \mathcal{C}_z^k is defined as

$$\begin{aligned} \langle F, G \rangle_{\mathcal{C}_z^k} := & \sum_{\lambda \vdash k} \oint_{\gamma_k} \dots \oint_{\gamma_k} dm_{\lambda}^{(q)}(\vec{w}) \prod_{j=1}^{\ell(\lambda)} \frac{1}{(w_j; q)_{\lambda_j} (vw_j; q)_{\lambda_j}} \\ & \times F(\vec{w} \circ \lambda) G(\vec{w} \circ \lambda), \quad F, G \in \mathcal{C}_z^k. \end{aligned} \tag{2.6}$$

Here $(a; q)_n := (1 - a)(1 - aq) \dots (1 - aq^{n-1})$ denotes the q -Pochhammer symbol as usual.

Remark 2.3. The same pairing can be rewritten in a simpler form in terms of integration over the large contour γ (this follows from Proposition 3.2 below):

$$\langle F, G \rangle_{\mathcal{C}_z^k} = \oint_{\gamma} \dots \oint_{\gamma} dm_{(1^k)}^{(q)}(\vec{z}) \prod_{j=1}^k \frac{1}{(1 - z_j)(1 - vz_j)} F(\vec{z}) G(\vec{z}), \quad F, G \in \mathcal{C}_z^k. \tag{2.7}$$

The Plancherel measure $dm_{(1^k)}^{(q)}(\vec{z})$ in (2.7) is simplified (with the help of the Cauchy determinant identity) to

$$dm_{(1^k)}^{(q)}(\vec{z}) = \frac{1}{k!} \frac{(-1)^{\frac{k(k-1)}{2}} \mathbf{V}(\vec{z})^2}{\prod_{i \neq j} (z_i - qz_j)} \prod_{j=1}^k \frac{dz_j}{2\pi \mathbf{i}}, \tag{2.8}$$

where $\mathbf{V}(\vec{z}) = \prod_{1 \leq i < j \leq k} (z_i - z_j)$ is the Vandermonde determinant.

There is a corresponding bilinear pairing on the space \mathcal{C}_ξ^k as well. One can define it by making a change of variables Ξ in (2.7):

$$\begin{aligned} \langle F, G \rangle_{\mathcal{C}_\xi^k} &:= \frac{1}{k!(2\pi \mathbf{i})^k (v-1)^k} \left(\frac{1-v}{1-qv} \right)^{k(k-1)} \\ &\times \oint_{\mathcal{Y}} \dots \oint_{\mathcal{Y}} \prod_{i \neq j} \frac{\xi_i - \xi_j}{\mathcal{S}_{q,v}(\xi_i, \xi_j)} \prod_{j=1}^k \frac{d\xi_j}{\xi_j} F(\vec{\xi}) G(\vec{\xi}), \end{aligned} \tag{2.9}$$

where $F, G \in \mathcal{C}_\xi^k$, and

$$\mathcal{S}_{q,v}(\xi_1, \xi_2) := \frac{1-q}{1-qv} + \frac{q-v}{1-qv} \xi_2 + \frac{v(1-q)}{1-qv} \xi_1 \xi_2 - \xi_1. \tag{2.10}$$

Here we have used

$$\begin{aligned} \frac{\Xi(\xi_1) - \Xi(\xi_2)}{\Xi(\xi_1) - q\Xi(\xi_2)} &= -\frac{1-v}{1-qv} \frac{\xi_1 - \xi_2}{\mathcal{S}_{q,v}(\xi_1, \xi_2)}, \\ \frac{1}{(1-\Xi(\xi))(1-v\Xi(\xi))} d\Xi(\xi) &= \frac{d\xi}{(v-1)\xi}. \end{aligned}$$

In (2.9), \mathcal{Y} can be taken to be the same contour containing 0 and 1 and not containing v^{-1} as in (2.7) because Ξ swaps $0 \leftrightarrow 1$ and $v^{-1} \leftrightarrow \infty$ (note that this also means that Ξ does not change the orientation of the contour \mathcal{Y}). Our definitions imply

$$\langle \Xi F, \Xi G \rangle_{\mathcal{C}_\xi^k} = \langle F, G \rangle_{\mathcal{C}_z^k}, \quad F, G \in \mathcal{C}_z^k.$$

In what follows we will use both forms (2.6) and (2.7) of the pairing $\langle \cdot, \cdot \rangle_{\mathcal{C}_z^k}$, or the equivalent pairing $\langle \cdot, \cdot \rangle_{\mathcal{C}_\xi^k}$ (2.9), depending on convenience.

Remark 2.4. The cross-term (2.10) can be written in the form $\mathcal{S}_{q,v}(\xi_1, \xi_2) = \alpha \xi_1 \xi_2 + \beta \xi_2 + \gamma - \xi_1$, where $\alpha = \frac{v(1-q)}{1-qv}$, $\beta = \frac{q-v}{1-qv}$, and $\gamma = \frac{1-q}{1-qv}$ are the parameters from [48] (also used in [22]). Note that this means that $\alpha + \beta + \gamma = 1$ (see, however, Sect. 6 below on how to overcome this restriction). We do not use the parameters α, β , and γ in the notation of the present paper.

2.3. *Left and right eigenfunctions.* Here we define certain distinguished functions on $\mathbb{C}^k \times \mathbb{W}^k$ which are crucial to Plancherel isomorphism theorems between the spaces \mathcal{W}^k and \mathcal{C}_z^k (Theorems 3.4 and 3.9 below). These functions are right and left Bethe ansatz eigenfunctions (sometimes also called Bethe wave functions) of the q -Hahn operator which depends on parameters (q, ν) , as well as on an additional parameter μ (see Sect. 5 below for more details). They were introduced by Povolotsky [48].

We will use the *left eigenfunctions* written in the following form:

$$\Psi_z^\ell(\vec{n}) := \sum_{\sigma \in S(k)} \prod_{1 \leq B < A \leq k} \frac{z_{\sigma(A)} - qz_{\sigma(B)}}{z_{\sigma(A)} - z_{\sigma(B)}} \prod_{j=1}^k \left(\frac{1 - z_{\sigma(j)}}{1 - \nu z_{\sigma(j)}} \right)^{-n_j}. \tag{2.11}$$

To write down the right eigenfunctions, we will need additional notation. For each k -tuple $\vec{n} = (n_1 \geq \dots \geq n_k) \in \mathbb{W}^k$, let $\vec{c}(\vec{n}) = (c_1, \dots, c_{M(\vec{n})})$ denote its *cluster sizes*, so that

$$\begin{aligned} n_1 = n_2 = \dots = n_{c_1} > n_{c_1+1} = \dots = n_{c_1+c_2} > \dots > n_{c_1+\dots+c_{M(\vec{n})-1}+1} \\ = \dots = n_{c_1+\dots+c_{M(\vec{n})}} \end{aligned} \tag{2.12}$$

(of course, $c_1 + \dots + c_{M(\vec{n})} = k$). For example, if $\vec{n} = (5, 5, 3, -1, -1)$, then $\vec{c}(\vec{n}) = (2, 1, 2)$.

Next, for $\vec{n} \in \mathbb{W}^k$, define

$$\mathfrak{m}_{q,\nu}(\vec{n}) := \prod_{j=1}^{M(\vec{n})} \frac{(v; q)_{c_j}}{(q; q)_{c_j}}. \tag{2.13}$$

This product is related to the stationary measures of the q -Hahn stochastic particle system, see [22,48].

The *right eigenfunctions* are, by definition,

$$\begin{aligned} \Psi_z^r(\vec{n}) := & (-1)^k (1 - q)^k q^{\frac{k(k-1)}{2}} \mathfrak{m}_{q,\nu}(\vec{n}) \\ & \times \sum_{\sigma \in S(k)} \prod_{1 \leq B < A \leq k} \frac{z_{\sigma(A)} - q^{-1}z_{\sigma(B)}}{z_{\sigma(A)} - z_{\sigma(B)}} \prod_{j=1}^k \left(\frac{1 - z_{\sigma(j)}}{1 - \nu z_{\sigma(j)}} \right)^{n_j}. \end{aligned} \tag{2.14}$$

Note that as functions in \vec{z} , the left and right eigenfunctions belong to the space \mathcal{C}_z^k of symmetric Laurent polynomials in $\frac{1-z_i}{1-\nu z_i}$. Indeed, this is because $\mathbf{V}(\vec{z})\Psi_z^r(\vec{n})$ and $\mathbf{V}(\vec{z})\Psi_z^\ell(\vec{n})$ are skew-symmetric Laurent polynomials, and thus are divisible by the Vandermonde determinant $\mathbf{V}(\vec{z})$ with the ratios still in \mathcal{C}_z^k .

Remark 2.5. The constant $(-1)^k (1 - q)^k q^{\frac{k(k-1)}{2}}$ in front of $\Psi_z^r(\vec{n})$ (not depending on \vec{n}) helps to make certain formulas below look nicer.

The functions Ψ_z^ℓ and Ψ_z^r arise as left and right eigenfunctions of the q -Hahn Markov transition operator, see Propositions 5.9 and 5.13 below.

The q -Hahn stochastic particle system is PT-invariant, i.e., invariant under joint space-reflection and time-reversal (see Sect. 5.5 below). This PT-symmetry translates into a certain property of the eigenfunctions which we are about to explain.

Let \mathcal{R} be the reflection operator acting on \mathcal{W}^k as

$$(\mathcal{R}f)(n_1, \dots, n_k) := f(-n_k, \dots, -n_1). \tag{2.15}$$

This is an involution, i.e., $\mathcal{R}^{-1} = \mathcal{R}$. One can readily check that the eigenfunctions satisfy

$$\begin{aligned} (\mathcal{R}\Psi_z^\ell)(\vec{n}) &= (-1)^k (1-q)^{-k} m_{q,v}^{-1}(\vec{n}) \Psi_z^r(\vec{n}); \\ (\mathcal{R}\Psi_z^r)(\vec{n}) &= (-1)^k (1-q)^k m_{q,v}(\vec{n}) \Psi_z^\ell(\vec{n}). \end{aligned} \tag{2.16}$$

Therefore, the operator on \mathcal{W}^k defined as

$$(\mathcal{P}f)(\vec{n}) := (-1)^k (1-q)^{-k} m_{q,v}^{-1}(\vec{n}) (\mathcal{R}f)(\vec{n}) \tag{2.17}$$

swaps left and right eigenfunctions:

$$(\mathcal{P}\Psi_z^r)(\vec{n}) = \Psi_z^\ell(\vec{n}), \quad (\mathcal{P}^{-1}\Psi_z^\ell)(\vec{n}) = \Psi_z^r(\vec{n}). \tag{2.18}$$

Observe that $m_{q,v}(\vec{n})$ is invariant under the reflection \mathcal{R} . Note also that the operators \mathcal{R} and \mathcal{P} are symmetric with respect to $\langle \cdot, \cdot \rangle_{\mathcal{W}^k}$ in the sense that $\langle f, \mathcal{R}g \rangle_{\mathcal{W}^k} = \langle \mathcal{R}f, g \rangle_{\mathcal{W}^k}$, and the same for \mathcal{P} .

For future use, let us record how the eigenfunctions look in the other spectral variables ξ_j (see Sect. 2.1). We have

$$\Psi_{\Xi(\xi)}^\ell(\vec{n}) = \left(-\frac{1-qv}{1-v} \right)^{\frac{k(k-1)}{2}} \sum_{\sigma \in S(k)} \prod_{1 \leq B < A \leq k} \frac{S_{q,v}(\xi_{\sigma(A)}, \xi_{\sigma(B)})}{\xi_{\sigma(A)} - \xi_{\sigma(B)}} \prod_{j=1}^k \xi_{\sigma(j)}^{-n_j}; \tag{2.19}$$

$$\begin{aligned} \Psi_{\Xi(\xi)}^r(\vec{n}) &= (-1)^k (1-q)^k m_{q,v}(\vec{n}) \left(\frac{1-qv}{1-v} \right)^{\frac{k(k-1)}{2}} \\ &\times \sum_{\sigma \in S(k)} \prod_{1 \leq B < A \leq k} \frac{S_{q,v}(\xi_{\sigma(B)}, \xi_{\sigma(A)})}{\xi_{\sigma(A)} - \xi_{\sigma(B)}} \prod_{j=1}^k \xi_{\sigma(j)}^{n_j}. \end{aligned} \tag{2.20}$$

Here $S_{q,v}$ is given by (2.10).

3. Plancherel Formulas

3.1. *Direct and inverse transforms.* The direct q -Hahn transform $\mathcal{F}^{q,v}$ takes functions f from the space \mathcal{W}^k (of compactly supported functions on the Weyl chamber \mathbb{W}^k) to functions $\mathcal{F}^{q,v}f \in \mathcal{C}_z^k$ via the bilinear pairing on \mathcal{W}^k :

$$(\mathcal{F}^{q,v}f)(\vec{z}) := \langle f, \Psi_z^r \rangle_{\mathcal{W}^k} = \sum_{\vec{n} \in \mathbb{W}^k} f(\vec{n}) \Psi_z^r(\vec{n}). \tag{3.1}$$

The (candidate) inverse q -Hahn transform $\mathcal{J}^{q,v}$ takes functions G from the space \mathcal{C}_z^k to functions $\mathcal{J}^{q,v}G \in \mathcal{W}^k$, and is defined as

$$\begin{aligned} (\mathcal{J}^{q,v}G)(\vec{n}) &:= \oint_{\gamma_1} \frac{dz_1}{2\pi\mathbf{i}} \dots \oint_{\gamma_k} \frac{dz_k}{2\pi\mathbf{i}} \prod_{A < B} \frac{z_A - z_B}{z_A - qz_B} \\ &\times \prod_{j=1}^k \frac{1}{(1-z_j)(1-vz_j)} \left(\frac{1-z_j}{1-vz_j} \right)^{-n_j} G(\vec{z}). \end{aligned} \tag{3.2}$$

The integration is performed over nested contours as in Definition 2.1.

It is obvious that $\mathcal{F}^{q,\nu}$ maps \mathcal{W}^k to \mathcal{C}_z^k . To see that $\mathcal{J}^{q,\nu}$ maps \mathcal{C}_z^k to \mathcal{W}^k requires simple residue calculus. Indeed, if $n_k \leq -M$ for a sufficiently large M (this bound of course depends on $G(\vec{z})$), then the integrand in (3.2) is regular at $z_k = 1$, and thus the integral vanishes. On the other hand, if $n_1 \geq M'$ for some other sufficiently large M' , then the integrand is regular outside the z_1 contour (namely, it is regular at points $z_1 = \infty$ and ν^{-1}), and thus the integral also vanishes. This implies that $\mathcal{J}^{q,\nu}G$ has a finite support in \vec{n} .

Remark 3.1. It is convenient for us to work with the function spaces \mathcal{W}^k and \mathcal{C}_z^k , because it eliminates analytic issues (such as proving convergence in (3.1)). It seems plausible that the maps $\mathcal{F}^{q,\nu}$ and $\mathcal{J}^{q,\nu}$ can be extended to larger function spaces, but we do not focus on this question in Sects. 3 and 4. See, however, arguments in the proof of Proposition 5.18 below which we need for applications of our main results.

3.2. *Operator $\mathcal{J}^{q,\nu}$ and bilinear pairing in \mathcal{C}_z^k .* The operator $\mathcal{J}^{q,\nu}$ can be expressed through the bilinear pairing in the space \mathcal{C}_z^k with the help of the left eigenfunction $\Psi_z^\ell(\vec{n})$ (cf. (3.1)):

$$(\mathcal{J}^{q,\nu}G)(\vec{n}) = \langle G, \Psi^\ell(\vec{n}) \rangle_{\mathcal{C}_z^k}, \tag{3.3}$$

where $\Psi^\ell(\vec{n})$ is viewed as the function in \mathcal{C}_z^k which maps \vec{z} to $\Psi_z^\ell(\vec{n})$.

Expanding the definition of the bilinear pairing (given by (2.6) or (2.7)), we can write

$$\begin{aligned} (\mathcal{J}^{q,\nu}G)(\vec{n}) &= \oint_{\mathcal{Y}} \dots \oint_{\mathcal{Y}} dm_{(1^k)}^{(q)}(\vec{z}) \prod_{j=1}^k \frac{1}{(1-z_j)(1-\nu z_j)} \Psi_z^\ell(\vec{n}) G(\vec{z}) \\ &= \sum_{\lambda \vdash k} \oint_{\mathcal{Y}_k} \dots \oint_{\mathcal{Y}_k} dm_\lambda^{(q)}(\vec{w}) \prod_{j=1}^{\ell(\lambda)} \frac{1}{(w_j; q)_{\lambda_j} (\nu w_j; q)_{\lambda_j}} \Psi_{\vec{w} \circ \lambda}^\ell(\vec{n}) G(\vec{w} \circ \lambda). \end{aligned} \tag{3.4}$$

$$\tag{3.5}$$

The equivalence of formulas (3.2), (3.4), and (3.5) for the (candidate) inverse transform $\mathcal{J}^{q,\nu}$ follows from the next proposition:

Proposition 3.2. *Let $G: \mathbb{C}^k \rightarrow \mathbb{C}$ be a symmetric function.⁶ Consider contours $\mathcal{Y}_1, \dots, \mathcal{Y}_k$ and \mathcal{Y} as in Definition 2.1.*

- (1) *If there exist deformations D_j^{large} of \mathcal{Y}_j to \mathcal{Y} ⁷ so that for all $z_1, \dots, z_{j-1}, z_{j+1}, \dots, z_k$ with $z_i \in \mathcal{Y}$ for $1 \leq i < j$ and $z_i \in \mathcal{Y}_i$ for $j < i \leq k$, the function $z_j \mapsto \mathbf{V}(\vec{z})G(z_1, \dots, z_j, \dots, z_k)$ is holomorphic in a neighborhood of the area swept out by the deformation D_j^{large} , then the nested contour integral formula (3.2) for $(\mathcal{J}^{q,\nu}G)(\vec{n})$ can be rewritten in the form (3.4).*
- (2) *If there exist deformations D_j^{small} of \mathcal{Y}_j to \mathcal{Y}_k so that for all $z_1, \dots, z_{j-1}, z_{j+1}, \dots, z_k$ with $z_i \in \mathcal{Y}_i$ for $1 \leq i < j$ and $z_i \in \mathcal{Y}_k$ for $j < i \leq k$, the function $z_j \mapsto \mathbf{V}(\vec{z})G(z_1, \dots, z_j, \dots, z_k)$ is holomorphic in a neighborhood of the area*

⁶ In this proposition we do not require G to belong to \mathcal{C}_z^k .

⁷ That is, $D_j^{\text{large}}(t)$ is a family of contours which continuously depend on an additional parameter $t \in [0, 1]$ such that $D_j^{\text{large}}(0) = \mathcal{Y}_j$ and $D_j^{\text{large}}(1) = \mathcal{Y}$.

swept out by the deformation D_j^{small} , then the nested contour integral formula (3.2) for $(\mathcal{J}^{q,v}G)(\vec{n})$ can be rewritten in the form (3.5).

Note that if $G \in \mathcal{C}_z^k$, then it clearly satisfies the conditions of both parts of the proposition.

Proof. This proposition is essentially contained in [15] except for the additional factors $(1 - \nu z_j)^{-1}$ in (3.2) and (3.4), and $(\nu w_j; q)_{\lambda_j}^{-1}$ in (3.5). Since $0 \leq \nu < 1$ and thus the pole at ν^{-1} lies outside all contours $\gamma_1, \dots, \gamma_k$, and γ , these new factors do not affect the proofs given in [15]. (Another way to say the same would be to incorporate these new factors inside the function $G(\vec{z})$).

Part 1 of the proposition is [15, Lemma 3.3]. Its proof is fairly straightforward: deform contours $\gamma_1, \gamma_2, \dots, \gamma_k$ (in this order) to γ using deformations D_j^{large} . Now the integration is over the same contour γ , so the integral is invariant under permutations of the z_j 's. Rewriting

$$\prod_{1 \leq A < B \leq k} \frac{z_A - z_B}{z_A - qz_B} = \prod_{1 \leq A \neq B \leq k} \frac{z_A - z_B}{z_A - qz_B} \prod_{1 \leq B < A \leq k} \frac{z_A - qz_B}{z_A - z_B},$$

we note that the symmetrization of the integrand over the whole symmetric group $S(k)$ gives $G(\vec{z})$ times $\Psi_z^\ell(\vec{n})$ (2.11), times the corresponding Plancherel measure, see (2.8). The factor $1/k!$ in (2.8) comes from the symmetrization.

Part 2 of the proposition is [15, Lemma 3.4] (see also [15, Proposition 7.4] and [10, Proposition 3.2.1]). Its proof is not nearly as straightforward as that of part 1, as it involves keeping track of multiple residues arising in the course of deformations of the γ_j 's to γ_k . We omit the proof here. \square

Remark 3.3. Similar direct and inverse q -Hahn transforms can be defined in the other spectral variables $\vec{\xi} = (\xi_1, \dots, \xi_k)$, cf. Sect. 2.1. These transforms will go between the spaces \mathcal{W}^k and \mathcal{C}_ξ^k (recall that the latter is isomorphic to \mathcal{C}_z^k by means of Ξ).

The direct transform $\mathcal{W}^k \rightarrow \mathcal{C}_\xi^k$ looks as $f \mapsto \langle f, \Xi \Psi_z^r \rangle_{\mathcal{W}^k}$ (cf. (3.1)), where $\Xi \Psi_z^r$ is the image of Ψ^r under Ξ applied in each variable. Writing the corresponding inverse transform $\mathcal{C}_\xi^k \rightarrow \mathcal{W}^k$ amounts to making the change of variables Ξ under the integral in the definition of $\mathcal{J}^{q,v}$. This can be done similarly to (2.9) if one uses formula (3.4) for $\mathcal{J}^{q,v}$.

Analogs of our main results below (Theorems 3.4 and 3.9) will clearly hold for these transforms relative to the space \mathcal{C}_ξ^k , too. In fact, we will employ the variables $\vec{\xi}$ to prove the spectral Plancherel formula (Theorem 3.9).

3.3. The spatial Plancherel formula. The composition $\mathcal{K}^{q,v} := \mathcal{J}^{q,v} \mathcal{F}^{q,v}$ maps the space \mathcal{W}^k of compactly supported functions in spatial variables to itself via

$$\begin{aligned} (\mathcal{K}^{q,v} f)(\vec{n}) &= (\mathcal{J}^{q,v} \mathcal{F}^{q,v} f)(\vec{n}) \\ &= \oint_{\gamma_1} \frac{dz_1}{2\pi \mathbf{i}} \cdots \oint_{\gamma_k} \frac{dz_k}{2\pi \mathbf{i}} \prod_{1 \leq A < B \leq k} \frac{z_A - z_B}{z_A - qz_B} \\ &\quad \times \prod_{j=1}^k \frac{1}{(1 - z_j)(1 - \nu z_j)} \left(\frac{1 - z_j}{1 - \nu z_j} \right)^{-n_j} \langle f, \Psi_z^r \rangle_{\mathcal{W}^k}. \end{aligned} \tag{3.6}$$

Theorem 3.4. *The direct q -Hahn transform $\mathcal{F}^{q,v}$ induces an isomorphism between the space \mathcal{W}^k and its image inside \mathcal{C}_z^k , with the inverse given by $\mathcal{J}^{q,v}$. Equivalently, $\mathcal{K}^{q,v}$ (3.6) acts as the identity operator on \mathcal{W}^k . Moreover, $\mathcal{F}^{q,v}$ acts on the bilinear pairing as follows:*

$$\langle f, g \rangle_{\mathcal{W}^k} = \langle \mathcal{F}^{q,v} f, \mathcal{F}^{q,v}(\mathcal{P}g) \rangle_{\mathcal{C}_z^k} \quad \text{for all } f, g \in \mathcal{W}^k. \tag{3.7}$$

Here \mathcal{P} is the operator (2.17) in \mathcal{W}^k which turns each right eigenfunction into the corresponding left one.

The rest of this subsection is devoted to the proof of the theorem. In Sect. 3.5 below we present two immediate corollaries of this theorem.

First, we note that (3.7) readily follows from the fact that $\mathcal{K}^{q,v} = \text{Id}$ on \mathcal{W}^k . Fix $\vec{y} \in \mathbb{W}^k$, and let $g(\vec{n}) := \mathbf{1}_{\vec{n}=\vec{y}}$. Then it follows from (2.18) that $(\mathcal{F}^{q,v}(\mathcal{P}g))(\vec{z}) = \langle \Psi_z^r, \mathcal{P}g \rangle_{\mathcal{W}^k} = \langle \mathcal{P}\Psi_z^r, g \rangle_{\mathcal{W}^k} = \Psi_z^\ell(\vec{y})$. If $\mathcal{K}^{q,v} = \text{Id}$, then we can write using (3.3):

$$\langle f, g \rangle_{\mathcal{W}^k} = f(\vec{y}) = (\mathcal{J}^{q,v} \mathcal{F}^{q,v} f)(\vec{y}) = \langle \mathcal{F}^{q,v} f, \Psi_z^\ell(\vec{y}) \rangle_{\mathcal{C}_z^k} = \langle \mathcal{F}^{q,v} f, \mathcal{F}^{q,v}(\mathcal{P}g) \rangle_{\mathcal{C}_z^k}.$$

The case of general $g \in \mathcal{W}^k$ follows by linearity of our bilinear pairings. About the need for the operator \mathcal{P} in (3.7) see also Remark 3.14 below.

Our goal now is to show that $\mathcal{K}^{q,v} = \text{Id}$ on \mathcal{W}^k . It suffices to prove this operator identity on a function $f(\vec{n}) = \mathbf{1}_{\vec{n}=\vec{y}}$ for any fixed $\vec{y} \in \mathbb{W}^k$. Then in (3.6) we have $\langle f, \Psi_z^r \rangle_{\mathcal{W}^k} = \Psi_z^r(\vec{y})$, so we need to show that

$$\begin{aligned} & \oint_{\gamma_1} \frac{dz_1}{2\pi \mathbf{i}} \cdots \oint_{\gamma_k} \frac{dz_k}{2\pi \mathbf{i}} \prod_{1 \leq A < B \leq k} \frac{z_A - z_B}{z_A - qz_B} \prod_{j=1}^k \frac{1}{(1 - z_j)(1 - \nu z_j)} \left(\frac{1 - z_j}{1 - \nu z_j} \right)^{-n_j} \Psi_z^r(\vec{y}) \\ &= \mathbf{1}_{\vec{y}=\vec{n}}. \end{aligned} \tag{3.8}$$

We note that using (3.4)–(3.5), one can rewrite (3.8) in terms of integration over z_1, \dots, z_k belonging to one and the same contour (large γ or small γ_k), cf. (3.18)–(3.21) below.

To prove (3.8), rewrite the right eigenfunction in the following way:

$$\Psi_z^r(\vec{y}) = (-1)^k (1-q)^k m_{q,v}(\vec{y}) \sum_{\sigma \in S(k)} \prod_{1 \leq A < B \leq k} \frac{z_{\sigma(A)} - qz_{\sigma(B)}}{z_{\sigma(A)} - z_{\sigma(B)}} \prod_{j=1}^k \left(\frac{1 - z_j}{1 - \nu z_j} \right)^{y_{\sigma^{-1}(j)}}. \tag{3.9}$$

We will show that each summand in (3.8) corresponding to a fixed permutation $\sigma \in S(k)$ above vanishes unless $\vec{n} = \vec{y}$:

Lemma 3.5. *Let $\vec{n}, \vec{y} \in \mathbb{W}^k$. Then for any fixed $\sigma \in S(k)$, we have*

$$\begin{aligned} & \oint_{\gamma_1} \frac{dz_1}{2\pi \mathbf{i}} \cdots \oint_{\gamma_k} \frac{dz_k}{2\pi \mathbf{i}} \prod_{A < B} \frac{z_A - z_B}{z_A - qz_B} \frac{z_{\sigma(A)} - qz_{\sigma(B)}}{z_{\sigma(A)} - z_{\sigma(B)}} \\ & \times \prod_{j=1}^k \frac{1}{(1 - z_j)(1 - \nu z_j)} \left(\frac{1 - z_j}{1 - \nu z_j} \right)^{-n_j + y_{\sigma^{-1}(j)}} = 0 \end{aligned} \tag{3.10}$$

unless $\vec{y} = \vec{n}$.

Proof. We will split the proof into several parts.

I. Shrinking and expanding contours. Observe the following properties of the integral in (3.10) coming from the presence of powers of $(1 - z_j)/(1 - \nu z_j)$:

- (1) If it is possible to shrink the contour γ_j to 1 (without picking any residues in the process), then in order for the left-hand side of (3.10) to be nonzero, we must have

$$-n_j + y_{\sigma^{-1}(j)} \leq 0.$$

- (2) If it is possible to expand the contour γ_j to ν^{-1} (without picking any residues in the process; note that the integrand is regular at infinity and thus has to residue there), then in order for the left-hand side of (3.10) to be nonzero, we must have

$$-n_j + y_{\sigma^{-1}(j)} \geq 0.$$

Which of the contours can be shrunk or expanded is determined by the product over inversions in the permutation σ :

$$\begin{aligned} \prod_{A < B} \frac{z_A - z_B}{z_A - qz_B} \frac{z_{\sigma(A)} - qz_{\sigma(B)}}{z_{\sigma(A)} - z_{\sigma(B)}} &= \text{sgn}(\sigma) \prod_{A < B} \frac{z_{\sigma(A)} - qz_{\sigma(B)}}{z_A - qz_B} \\ &= \text{sgn}(\sigma) \prod_{A < B: \sigma(A) > \sigma(B)} \frac{z_{\sigma(A)} - qz_{\sigma(B)}}{z_A - qz_B}. \end{aligned} \tag{3.11}$$

Namely:

- (1) If for some $i \in \{1, 2, \dots, k\}$ one has $\sigma(i) > \sigma(1), \sigma(2), \dots, \sigma(i - 1)$ (that is, if the position i corresponds to the *running maximum* in the permutation word σ), then the contour $\gamma_{\sigma(i)}$ can be shrunk to 1, and so $n_{\sigma(i)} \geq y_i$ (or else the left-hand side of (3.10) vanishes).

Indeed, this condition means that all numbers $s \in \{1, 2, \dots, k\}$ with $s > \sigma(i)$ lie to the right of $\sigma(i)$ in the permutation word $\sigma = (\sigma(1), \sigma(2), \dots, \sigma(k))$. Therefore, the product $\prod_{A < B} (z_{\sigma(A)} - qz_{\sigma(B)})$ in the numerator in left-hand side of (3.11) contains all terms of the form $(z_{\sigma(i)} - qz_{\sigma(i)+1}), (z_{\sigma(i)} - qz_{\sigma(i)+2}), \dots$. These terms cancel with the corresponding terms in the denominator, and so the integrand in (3.10) does not have poles at $z_{\sigma(i)} = qz_{\sigma(i)+1}, qz_{\sigma(i)+2}, \dots, qz_k$. Thus, it is possible to shrink the contour $\gamma_{\sigma(i)}$ to 1.

- (2) If for some $i \in \{1, 2, \dots, k\}$ one has $\sigma(i) < \sigma(i + 1), \sigma(i + 2), \dots, \sigma(k)$ (that is, if the position i corresponds to the *running minimum* in the permutation word read from right to left), then the contour $\gamma_{\sigma(i)}$ can be expanded to ν^{-1} , and so $n_{\sigma(i)} \leq y_i$ (or else the left-hand side of (3.10) vanishes).

The argument is similar to the case above: one can expand the contour $\gamma_{\sigma(i)}$ if the integrand does not have a pole at $z_{\sigma(i)} = q^{-1}z_s$ for all $s < \sigma(i)$.

II. Arrow diagram of a permutation. We will represent components of the vectors $\vec{n} = (n_1 \geq n_2 \geq \dots \geq n_k)$ and $\vec{y} = (y_1 \geq y_2 \geq \dots \geq y_k)$ graphically at two consecutive levels. We will draw an arrow from a to b if we know that $a \geq b$. The condition $\vec{n}, \vec{y} \in \mathbb{W}^k$ can be pictured by the following arrows (independently of the permutation σ):

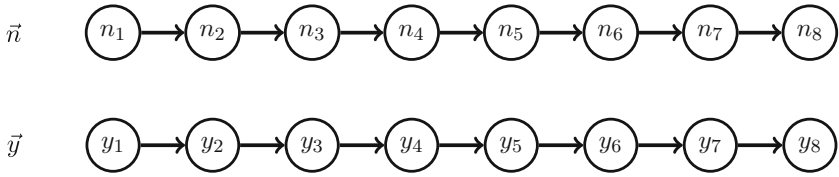

(Here and below we make illustrations for $k = 8$.) It is convenient to relabel nodes in the upper row by $1, 2, \dots, k$, and in the lower row by $\sigma(1), \sigma(2), \dots, \sigma(k)$. There are additional arrows between the lower and the upper level coming from expanding or shrinking the integration contours. These arrows will be drawn as follows (cf. Fig. 3):

- (1) If $\sigma(i)$ is the running maximum at the lower level, connect it to i at the upper level by a (red) dashed arrow connecting i on the upper level (which is at position i) with i on the lower level (at position $\sigma(i)$). This corresponds to $n_{\sigma(i)} \geq y_i$.
- (2) If $\sigma(i)$ is the running minimum at the lower level when the lower level is read from right to left, connect it to i at the upper level by a (blue) solid arrow from i on the lower level (at position $\sigma(i)$) to i on the upper level (the latter is at position i). This corresponds to $n_{\sigma(i)} \leq y_i$.

To complete the proof of the lemma, we need to show that such an arrow diagram always implies that $\vec{n} = \vec{y}$. (It is instructive and not difficult to check that the diagram on Fig. 3 indeed implies the desired condition for our running example.)

III. One independent cycle of σ and regions B_α . Let us partition $\{1, 2, \dots, k\} = C_1 \sqcup C_2 \sqcup \dots \sqcup C_r$ according to the representation of σ as a product of independent cycles. That is, each C_α satisfies $\sigma(C_\alpha) = C_\alpha$, and is a minimal (i.e., indecomposable) subset with this property.

Fix one of such parts C_α . It is convenient to argue in terms of the graph of the permutation σ . Such a graph is simply a collection of points $(i, \sigma(i))$, $i = 1, \dots, k$, on the plane (see Fig. 4).

Define a region B_α in the same plane as

$$B_\alpha := \{ \text{points } (a, b) : \text{there exist } i, j \in C_\alpha \text{ such that } a \geq i, b \leq \sigma(i) \text{ and } a \leq j, b \geq \sigma(j) \}.$$

Note that B_α can be represented as an intersection of two sets: the first set is a union of southeast cones attached to each point $(i, \sigma(i))$ with $i \in C_\alpha$, the second set is the analogous union of northwest cones (see Fig. 4).

Let us show that set B_α contains the whole diagonal $\{(a, a) : \min C_\alpha \leq a \leq \max C_\alpha\}$. We need to prove that (1) there exists a southeast cone covering (a, a) , i.e., a number $i \in C_\alpha$ such that $i \leq a$ and $\sigma(i) \geq a$; and (2) there exists a northwest cone covering

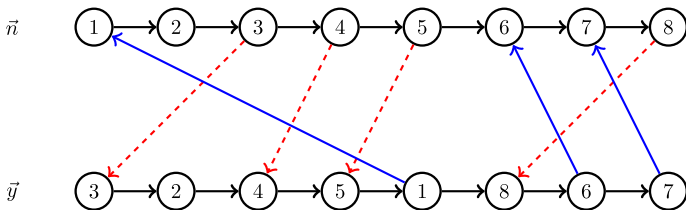

Fig. 3. Arrow diagram for $\sigma = (3, 2, 4, 5, 1, 8, 6, 7)$

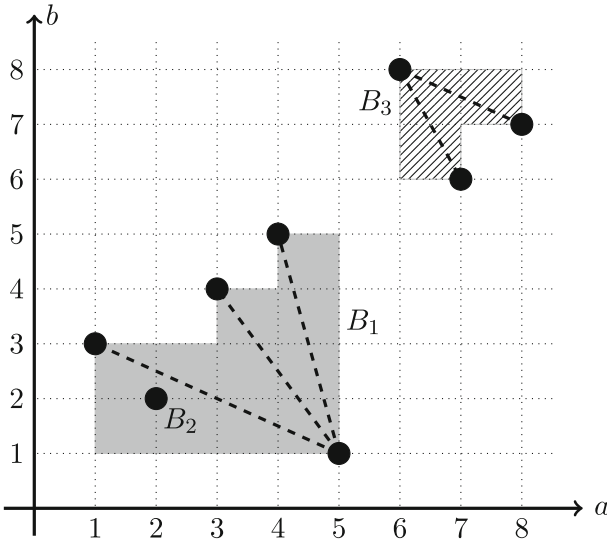

Fig. 4. Graph of the permutation $\sigma = (3, 2, 4, 5, 1, 8, 6, 7)$. Its decomposition into independent cycles looks as $\{1, 2, \dots, 8\} = \{1, 3, 4, 5\} \sqcup \{2\} \sqcup \{6, 7, 8\}$. The regions B_1, B_2 , and B_3 are shown (note that $B_2 = \{(2, 2)\} \subset B_1$). Dashed lines corresponding to intersections of arrows in the arrow diagram are also shown

(a, a) , i.e., a number $j \in C_\alpha$ such that $j \geq a$ and $\sigma(j) \leq a$. If $a = \min C_\alpha$, then $i = a$ and $j = \sigma^{-1}(a)$ would suffice, and case $a = \max C_\alpha$ is analogous. Assume that $\min C_\alpha < a < \max C_\alpha$, and that such i (corresponding to a covering southeast cone) does not exist. Then for all $i \in C_\alpha$, the fact that $i \leq a$ would imply that $\sigma(i) \leq a$, too. This is not possible because C_α is an indecomposable subset with the property $\sigma(C_\alpha) = C_\alpha$. The existence of a covering northwest cone is established similarly.

IV. Region B . Define the region B on the graph of the permutation σ to be the union of all the regions B_α corresponding to independent cycles of σ . That is,

$$B = \{\text{points } (a, b) : \text{there exist } i \text{ and } j \text{ such that } i \leq a, \sigma(i) \geq b \text{ and } j \geq a, \sigma(j) \leq b\}.$$

One readily sees that running maxima $\sigma(i)$ in the permutation word σ correspond to northwest corners $(i, \sigma(i))$ on the boundary of B ; and running minima $\sigma(j)$ of word σ read from right to left correspond to southeast corners $(j, \sigma(j))$ on the boundary of B . (This description of corners on the boundary does not always hold for the individual parts B_α .)

Let $B = \tilde{B}_1 \sqcup \dots \sqcup \tilde{B}_s$ be the decomposition of the region B into connected subregions. Each $\tilde{B}_l, l = 1, \dots, s$ is a union of some of the B_α 's, $\alpha \in \{1, \dots, r\}$ (hence $s \leq r$). In more detail, parts B_α and B_β belong to the same connected subregion \tilde{B}_l if and only if the independent cycles C_α and C_β “intersect” in the sense that $[\min C_\alpha, \max C_\alpha] \cap [\min C_\beta, \max C_\beta] \neq \emptyset$. For example, on Fig. 4 we have $B = (B_1 \cup B_2) \sqcup B_3$.

Since each \tilde{B}_l is connected, it must contain the whole corresponding diagonal $\{(a, a) : m_l \leq a \leq M_l\}$, where

$$m_l := \min_{(a,b) \in \tilde{B}_l} a = \min_{(a,b) \in \tilde{B}_l} b, \quad M_l := \max_{(a,b) \in \tilde{B}_l} a = \max_{(a,b) \in \tilde{B}_l} b. \quad (3.12)$$

V. Dashed lines and intersections of arrows. Let us connect a northwest boundary corner $(i, \sigma(i))$ to a southeast boundary corner $(j, \sigma(j))$ by a *dashed line* if $i < j$ and $\sigma(i) > \sigma(j)$, see Fig. 4. Clearly, each dashed line must intersect the diagonal. While boundary corners correspond to arrows between the lower and the upper level in the arrow diagram as on Fig. 3, these dashed lines correspond to intersections of two such arrows. It then readily follows from the arrow diagram that if a northwest corner $(i, \sigma(i))$ is connected to a southeast corner $(j, \sigma(j))$ by a dashed line, then

$$n_{\sigma(j)} = n_{\sigma(j)+1} = \dots = n_{\sigma(i)} = y_i = y_{i+1} = \dots = y_j.$$

These equalities involve all y 's with labels belonging to the orthogonal projection of the dashed line onto the horizontal coordinate line; and all n 's with labels belonging to the analogous vertical projection.

Now take any of the connected subregions \tilde{B}_l of B , where $l \in \{1, \dots, s\}$. Note that the northwest corners $(i, \sigma(i))$ on the boundary of \tilde{B}_l must be located on or above the diagonal, while the southeast boundary corners $(j, \sigma(j))$ must be located on or below the diagonal. Since \tilde{B}_l is connected and contains the whole corresponding diagonal from m_l to M_l (3.12), we conclude that one can get from any (northwest or southeast) boundary corner of \tilde{B}_l to *any other* boundary corner along the dashed lines. This implies that

$$n_{m_l} = n_{m_l+1} = \dots = n_{M_l} = y_{m_l} = y_{m_l+1} = \dots = y_{M_l}.$$

Because this has to hold for each connected subregion \tilde{B}_l , we see that $\vec{n} = \vec{y}$, and this completes the proof of the lemma. \square

Let $\vec{n} \in \mathbb{W}^k$, and $\vec{c} = \vec{c}(\vec{n})$ denote its cluster sizes (as in Sect. 2.3). We say that $\sigma \in S(k)$ *permutes within the clusters* of \vec{n} if σ stabilizes the sets

$$\{1, 2, \dots, c_1\}, \{c_1 + 1, \dots, c_1 + c_2\}, \dots, \{c_1 + \dots + c_{M(\vec{n})-1} + 1, \dots, k\}.$$

Denote the set of all such permutations by $S_{\vec{n}}(k)$. Every $\sigma \in S_{\vec{n}}(k)$ can be represented a product of $M(\vec{n})$ permutations $\sigma_1, \dots, \sigma_{M(\vec{n})}$, where each σ_i fixes all elements of $\{1, 2, \dots, k\}$ except those corresponding to the i -th cluster of \vec{n} . We will denote the indexes within the i -th cluster by $C_i(\vec{n})$, and write $\sigma_i \in S_{\vec{n},i}(k)$. For example, if $k = 5$ and $n_1 = n_2 = n_3 > n_4 = n_5$, the permutation $\sigma \in S_{\vec{n}}(k)$ must stabilize the sets $C_1(\vec{n}) = \{1, 2, 3\}$ and $C_2(\vec{n}) = \{4, 5\}$; $S_{\vec{n},1}(k)$ is the set of all permutations of $\{1, 2, 3\}$, and $S_{\vec{n},2}(k)$ is the set of all permutations of $\{4, 5\}$.

Let us assume that $\vec{y} = \vec{n}$ in (3.10). By considering the arrow diagram of σ as in the proof of Lemma 3.5, one readily sees that the integral in (3.10) vanishes unless $\sigma \in S_{\vec{n}}(k)$. We will now compute the sum of these integrals over all $\sigma \in S_{\vec{n}}(k)$.

Lemma 3.6. *For any $\vec{n} \in \mathbb{W}^k$,*

$$\begin{aligned} & \sum_{\sigma \in S_{\vec{n}}(k)} \oint_{\gamma_1} \frac{dz_1}{2\pi i} \dots \oint_{\gamma_k} \frac{dz_k}{2\pi i} \prod_{A < B} \frac{z_A - z_B}{z_A - qz_B} \frac{z_{\sigma(A)} - qz_{\sigma(B)}}{z_{\sigma(A)} - z_{\sigma(B)}} \\ & \times \prod_{j=1}^k \frac{1}{(1 - z_j)(1 - vz_j)} \left(\frac{1 - z_j}{1 - vz_j} \right)^{-n_j + n_{\sigma^{-1}(j)}} \\ & = (-1)^k (1 - q)^{-k} \frac{(q; q)_{c_1} \dots (q; q)_{c_{M(\vec{n})}}}{(v; q)_{c_1} \dots (v; q)_{c_{M(\vec{n})}}}. \end{aligned} \tag{3.13}$$

Proof. We have

$$\begin{aligned} & \sum_{\sigma \in S_{\vec{n}}(k)} \prod_{1 \leq A < B \leq k} \frac{z_{\sigma(A)} - qz_{\sigma(B)}}{z_{\sigma(A)} - z_{\sigma(B)}} \prod_{j=1}^k \left(\frac{1 - z_j}{1 - \nu z_j} \right)^{-n_j + n_{\sigma^{-1}(j)}} \\ &= \prod_{1 \leq i < j \leq M(\vec{n})} \prod_{\substack{A \in C_i(\vec{n}) \\ B \in C_j(\vec{n})}} \frac{z_A - qz_B}{z_A - z_B} \cdot \prod_{i=1}^{M(\vec{n})} \sum_{\sigma_i \in S_{\vec{n},i}(k)} \prod_{\substack{1 \leq A < B \leq k \\ A, B \in C_i(\vec{n})}} \frac{z_{\sigma_i(A)} - qz_{\sigma_i(B)}}{z_{\sigma_i(A)} - z_{\sigma_i(B)}}. \end{aligned}$$

For the second product in the right-hand side above we may use the symmetrization identity [40, III.1(1.4)] which states that for any $\ell \geq 1$,

$$\sum_{\omega \in S(\ell)} \frac{z_{\omega(A)} - qz_{\omega(B)}}{z_{\omega(A)} - z_{\omega(B)}} = \frac{(q; q)_{\ell}}{(1 - q)^{\ell}}. \tag{3.14}$$

Thus, the left-hand side of (3.13) takes the form

$$\begin{aligned} & \frac{(q; q)_{c_1} \cdots (q; q)_{c_{M(\vec{n})}}}{(1 - q)^k} \oint_{\gamma_1} \frac{dz_1}{2\pi \mathbf{i}} \cdots \oint_{\gamma_k} \frac{dz_k}{2\pi \mathbf{i}} \prod_{i=1}^{M(\vec{n})} \\ & \times \prod_{\substack{1 \leq A < B \leq k \\ A, B \in C_i(\vec{n})}} \frac{z_A - z_B}{z_A - qz_B} \prod_{j=1}^k \frac{1}{(1 - z_j)(1 - \nu z_j)}. \end{aligned}$$

Now in the integral the integration variables corresponding to different clusters $C_i(\vec{n})$ are independent, so the integral reduces to a product of $M(\vec{n})$ smaller nested contour integrals of the same form. Each of these integrals is computed as follows:

$$\oint_{\gamma_1} \frac{dz_1}{2\pi \mathbf{i}} \cdots \oint_{\gamma_{\ell}} \frac{dz_{\ell}}{2\pi \mathbf{i}} \prod_{1 \leq A < B \leq \ell} \frac{z_A - z_B}{z_A - qz_B} \prod_{j=1}^{\ell} \frac{1}{(1 - z_j)(1 - \nu z_j)} = \frac{(-1)^{\ell}}{(\nu; q)_{\ell}},$$

this is a particular case $\vec{n} = (0, 0, \dots, 0)$ and $c = 1$ of Proposition 3.7 below. In this way we arrive at the desired right-hand side of (3.13). \square

The next proposition is an explicit evaluation of a certain nested contour integral. A particular case of it is used in the proof of Lemma 3.6 above. In its full generality this statement is employed in connection with the Tracy–Widom symmetrization identities in Sect. 7.6 below (see also Sect. 5.8).

Proposition 3.7. *For any $c \in \mathbb{C} \setminus \{\nu^{-1}, q^{-1}\nu^{-1}, \dots, q^{-(k-1)}\nu^{-1}\}$ and any $\vec{n} \in \mathbb{W}^k$, we have*

$$\begin{aligned} & \oint_{\gamma_1} \frac{dz_1}{2\pi \mathbf{i}} \cdots \oint_{\gamma_k} \frac{dz_k}{2\pi \mathbf{i}} \prod_{1 \leq A < B \leq k} \frac{z_A - z_B}{z_A - qz_B} \prod_{j=1}^k \left(\frac{1 - z_j}{1 - \nu z_j} \right)^{-n_j} \frac{1}{(1 - z_j)(1 - c\nu z_j)} \\ &= \frac{(-1)^k \nu^{n_1 + n_2 + \dots + n_k}}{(c\nu; q)_k} \prod_{j=1}^k \left(\frac{1 - cq^{j-1}}{1 - c\nu q^{j-1}} \right)^{n_j} \mathbf{1}_{n_k \geq 0}. \end{aligned}$$

Here the integration contours $\gamma_1, \dots, \gamma_k$ are as in Definition 2.1, with an additional condition that they do not contain $c^{-1}\nu^{-1}$ (this is possible because of our restrictions on c ; this could mean that each contour is a union of several disjoint simple contours).

By the very definition of the inverse q -Hahn transform (3.2), the left-hand side of the above identity can be interpreted as $(\mathcal{J}^{q,\nu}G)(\vec{n})$, where $G(\vec{z}) = \prod_{j=1}^k \frac{1-\nu z_j}{1-c\nu z_j}$. Note however that this function G does not belong to C_z^k (cf. the argument in Proposition 5.18 below).

Proof. First, note that the integrand has zero residue at $z_k = 1$ unless $n_k \geq 0$, so let us assume $n_k \geq 0$ (hence $n_j \geq 0$ for all j). This implies that there is no pole at $z_j = \nu^{-1}$ for all j .

Thus, the only pole of the integrand in z_1 outside the integration contour is at $z_1 = c^{-1}\nu^{-1}$.⁸ So, we may evaluate the integral over z_1 by taking minus the residue at $z_1 = c^{-1}\nu^{-1}$:

$$\begin{aligned} & \oint_{\gamma_1} \frac{dz_1}{2\pi i} \cdots \oint_{\gamma_k} \frac{dz_k}{2\pi i} \prod_{1 \leq A < B \leq k} \frac{z_A - z_B}{z_A - qz_B} \prod_{j=1}^k \left(\frac{1 - z_j}{1 - \nu z_j} \right)^{-n_j} \prod_{j=1}^k \frac{1}{(1 - z_j)(1 - c\nu z_j)} \\ &= - \left(-\frac{1}{c\nu(1 - c^{-1}\nu^{-1})} \right) \left(\frac{1 - c}{1 - c\nu} \right)^{n_1} \nu^{n_1} \oint_{\gamma_2} \frac{dz_2}{2\pi i} \cdots \oint_{\gamma_k} \frac{dz_k}{2\pi i} \prod_{j=2}^k \frac{1 - c\nu z_j}{1 - qc\nu z_j} \\ & \quad \times \prod_{2 \leq A < B \leq k} \frac{z_A - z_B}{z_A - qz_B} \prod_{j=2}^k \left(\frac{1 - z_j}{1 - \nu z_j} \right)^{-n_j} \prod_{j=2}^k \frac{1}{(1 - z_j)(1 - c\nu z_j)} \\ &= -\frac{1}{1 - c\nu} \left(\frac{1 - c}{1 - c\nu} \right)^{n_1} \nu^{n_1} \times \oint_{\gamma_2} \frac{dz_2}{2\pi i} \cdots \oint_{\gamma_k} \frac{dz_k}{2\pi i} \\ & \quad \times \prod_{2 \leq A < B \leq k} \frac{z_A - z_B}{z_A - qz_B} \prod_{j=2}^k \left(\frac{1 - z_j}{1 - \nu z_j} \right)^{-n_j} \prod_{j=2}^k \frac{1}{(1 - z_j)(1 - qc\nu z_j)}. \end{aligned}$$

We obtained a constant times a similar integral in $k - 1$ variables z_2, z_3, \dots, z_k , but with c replaced by qc . Continuing an inductive evaluation of the integrals, we get the desired result. \square

Now, looking at (3.9) and (2.13), we see that Lemmas 3.5 and 3.6 imply identity (3.8), and thus the proof of Theorem 3.4 is completed.

Remark 3.8. Our proof of the spatial (direct) Plancherel formula differs from the one given for $\nu = 0$ in [15, §3.2] (and it is not clear if the proof from [15] can be directly adapted to the case $\nu \neq 0$). In the latter proof, a statement analogous to Lemma 3.5 was established via a so-called contour shift argument (also used, in particular, in the work of Heckman and Opdam [31], and dating back to Helgason [32]). The contour shift argument in [15] employed the PT-symmetry property of the underlying q -Boson particle system (this property replaces the Hermitian symmetry used in contour shift arguments in earlier works). Instead of such an argument, above we have presented a direct combinatorial argument which took care of summands corresponding to each $\sigma \in S(k)$ in (3.9) separately. Note that our proof of Lemma 3.5 did not involve the PT-symmetry. On the other hand, the computation of the constant we performed in Lemma 3.6 is done somewhat in the spirit of [15].

⁸ If $c \neq 0$, the integrand is regular at infinity. If $c = 0$, then this only pole will be at $c^{-1}\nu^{-1} = \infty$.

3.4. *The spectral Plancherel formula.* In this subsection, we assume in addition that $0 < q < 1$.

The composition $\mathcal{M}^{q,\nu} := \mathcal{F}^{q,\nu} \mathcal{J}^{q,\nu}$ of the q -Hahn transforms (the order is reversed comparing to $\mathcal{K}^{q,\nu} = \mathcal{J}^{q,\nu} \mathcal{F}^{q,\nu}$, cf. Sect. 3.3) maps the space \mathcal{C}_z^k (Sect. 2.1) to itself. It acts as

$$\begin{aligned}
 (\mathcal{M}^{q,\nu} G)(\vec{w}) &= (\mathcal{F}^{q,\nu} \mathcal{J}^{q,\nu} G)(\vec{w}) \\
 &= \sum_{\vec{n} \in \mathbb{W}^k} \Psi_{\vec{w}}^r(\vec{n}) \oint_{\gamma_1} \frac{dz_1}{2\pi\mathbf{i}} \cdots \oint_{\gamma_k} \frac{dz_k}{2\pi\mathbf{i}} \prod_{A < B} \frac{z_A - z_B}{z_A - qz_B} \\
 &\quad \times \prod_{j=1}^k \frac{1}{(1 - z_j)(1 - \nu z_j)} \left(\frac{1 - z_j}{1 - \nu z_j} \right)^{-n_j} G(\vec{z}). \tag{3.15}
 \end{aligned}$$

Theorem 3.9. *The inverse q -Hahn transform $\mathcal{J}^{q,\nu}$ induces an isomorphism between the space \mathcal{C}_z^k and its image inside \mathcal{W}^k , with the inverse given by $\mathcal{F}^{q,\nu}$. Equivalently, $\mathcal{M}^{q,\nu}$ acts as the identity operator on \mathcal{C}_z^k . Moreover, $\mathcal{J}^{q,\nu}$ acts on the bilinear pairing as follows:*

$$\langle F, G \rangle_{\mathcal{C}_z^k} = \langle \mathcal{J}^{q,\nu} F, \mathcal{P}^{-1}(\mathcal{J}^{q,\nu} G) \rangle_{\mathcal{W}^k} \quad \text{for all } F, G \in \mathcal{C}_z^k. \tag{3.16}$$

Here \mathcal{P} is the operator (2.17) in \mathcal{W}^k which turns each right eigenfunction into the corresponding left one.

Proof. First, if $\mathcal{M}^{q,\nu} = \text{Id}$ on \mathcal{C}_z^k , then one can obtain (3.16) in a way similar to (3.7) in the proof of the spatial Plancherel formula (Theorem 3.4).

To establish the main part of the theorem, rewrite the nested contour integral in (3.15) in terms of integration over the large contour γ :⁹

$$\begin{aligned}
 (\mathcal{M}^{q,\nu} G)(\vec{w}) &= \sum_{\vec{n} \in \mathbb{W}^k} \Psi_{\vec{w}}^r(\vec{n}) \oint_{\gamma} \cdots \oint_{\gamma} \frac{d\vec{z}}{(2\pi\mathbf{i})^k} \frac{1}{k!} \frac{(-1)^{\frac{k(k-1)}{2}} \mathbf{V}(\vec{z})^2}{\prod_{i \neq j} (z_i - qz_j)} \Psi_{\vec{z}}^\ell(\vec{n}) G(\vec{z}) \\
 &\quad \times \prod_{j=1}^k \frac{1}{(1 - z_j)(1 - \nu z_j)}.
 \end{aligned}$$

To show that the right-hand side is equal to $G(\vec{w})$, it suffices to establish the following integrated version of the above identity: For any $F \in \mathcal{C}_z^k$,

$$\begin{aligned}
 \oint_{\gamma} \cdots \oint_{\gamma} \frac{d\vec{w}}{(2\pi\mathbf{i})^k} F(\vec{w}) G(\vec{w}) &= \oint_{\gamma} \cdots \oint_{\gamma} \frac{d\vec{w}}{(2\pi\mathbf{i})^k} F(\vec{w}) \frac{(-1)^{\frac{k(k-1)}{2}}}{k!} \sum_{\vec{n} \in \mathbb{W}^k} \Psi_{\vec{w}}^r(\vec{n}) \\
 &\quad \times \oint_{\gamma} \cdots \oint_{\gamma} \frac{d\vec{z}}{(2\pi\mathbf{i})^k} \frac{\mathbf{V}(\vec{z})^2}{\prod_{i \neq j} (z_i - qz_j)} \Psi_{\vec{z}}^\ell(\vec{n}) G(\vec{z}) \prod_{j=1}^k \frac{1}{(1 - z_j)(1 - \nu z_j)}.
 \end{aligned}$$

It is possible to interchange the summation and the integration in the \vec{w} variables (because of the finitely many nonzero terms in the sum). Thus, we must show that

⁹ This is possible because $G \in \mathcal{C}_z^k$, see (3.4) and Proposition 3.2. See also (2.8) for an explicit expression for the Plancherel measure corresponding to the large contour.

$$\oint_{\mathcal{Y}} \cdots \oint_{\mathcal{Y}} \frac{d\vec{w}}{(2\pi\mathbf{i})^k} F(\vec{w})G(\vec{w}) = \frac{(-1)^{\frac{k(k-1)}{2}}}{k!} \sum_{\vec{n} \in \mathbb{W}^k} \oint_{\mathcal{Y}} \cdots \oint_{\mathcal{Y}} \frac{d\vec{w}}{(2\pi\mathbf{i})^k} \oint_{\mathcal{Y}} \cdots \oint_{\mathcal{Y}} \frac{d\vec{z}}{(2\pi\mathbf{i})^k} \\ \times \frac{\mathbf{V}(\vec{z})^2}{\prod_{i \neq j} (z_i - qz_j)} \Psi_{\vec{w}}^r(\vec{n}) \Psi_{\vec{z}}^\ell(\vec{n}) F(\vec{w})G(\vec{z}) \prod_{j=1}^k \frac{1}{(1-z_j)(1-\nu z_j)}. \tag{3.17}$$

This statement follows from the spectral biorthogonality of the eigenfunctions, which we prove independently as Theorem 4.3 below. Indeed, applying that theorem with the following two test functions¹⁰

$$G(\vec{z})\mathbf{V}(\vec{z}) \frac{1}{\prod_{i \neq j} (z_i - qz_j)} \prod_{j=1}^k \frac{1}{(1-z_j)(1-\nu z_j)} \quad \text{and} \quad F(\vec{w}) \frac{1}{\mathbf{V}(\vec{w})},$$

one can rewrite the right-hand side of (3.17) as

$$\frac{(-1)^{\frac{k(k-1)}{2}}}{k!} (-1)^{\frac{k(k-1)}{2}} \oint_{\mathcal{Y}} \cdots \oint_{\mathcal{Y}} \frac{d\vec{w}}{(2\pi\mathbf{i})^k} G(\vec{w}) \sum_{\sigma \in S(k)} \text{sgn}(\sigma) F(\sigma\vec{w}) \frac{\mathbf{V}(\vec{w})}{\mathbf{V}(\sigma\vec{w})},$$

where $\sigma\vec{w} = (w_{\sigma(1)}, \dots, w_{\sigma(k)})$. The ratio of Vandermonde determinants gives $\text{sgn}(\sigma)$, and so we arrive at the left-hand side of (3.17). This completes the proof of the spectral Plancherel formula. \square

3.5. Completeness and spatial biorthogonality. Here we record two immediate corollaries of the spatial Plancherel formula (Theorem 3.4). The first is the *completeness* of the coordinate Bethe ansatz for the q -Hahn stochastic particle system (discussed in Sect. 5 below).

Corollary 3.10. *Any function $f \in \mathcal{W}^k$ can be expanded as*

$$f(\vec{n}) = \sum_{\lambda \vdash k} \oint_{\mathcal{Y}_k} \cdots \oint_{\mathcal{Y}_k} dm_{\lambda}^{(q)}(\vec{w}) \prod_{j=1}^{\ell(\lambda)} \frac{1}{(w_j; q)_{\lambda_j} (\nu w_j; q)_{\lambda_j}} \Psi_{\vec{w} \circ \lambda}^{\ell}(\vec{n}) \langle f, \Psi_{\vec{w} \circ \lambda}^r \rangle_{\mathcal{W}^k} \tag{3.18}$$

$$= \sum_{\lambda \vdash k} \oint_{\mathcal{Y}_k} \cdots \oint_{\mathcal{Y}_k} dm_{\lambda}^{(q)}(\vec{w}) \prod_{j=1}^{\ell(\lambda)} \frac{1}{(w_j; q)_{\lambda_j} (\nu w_j; q)_{\lambda_j}} \Psi_{\vec{w} \circ \lambda}^r(\vec{n}) \langle \Psi_{\vec{w} \circ \lambda}^{\ell}, f \rangle_{\mathcal{W}^k}. \tag{3.19}$$

We also have expansions

$$f(\vec{n}) = \oint_{\mathcal{Y}} \cdots \oint_{\mathcal{Y}} dm_{(1^k)}^{(q)}(\vec{z}) \prod_{j=1}^k \frac{1}{(1-z_j)(1-\nu z_j)} \Psi_{\vec{z}}^{\ell}(\vec{n}) \langle f, \Psi_{\vec{z}}^r \rangle_{\mathcal{W}^k} \tag{3.20}$$

$$= \oint_{\mathcal{Y}} \cdots \oint_{\mathcal{Y}} dm_{(1^k)}^{(q)}(\vec{z}) \prod_{j=1}^k \frac{1}{(1-z_j)(1-\nu z_j)} \Psi_{\vec{z}}^r(\vec{n}) \langle \Psi_{\vec{z}}^{\ell}, f \rangle_{\mathcal{W}^k}. \tag{3.21}$$

¹⁰ These functions do not belong to \mathcal{C}_z^k , but they satisfy the conditions of Theorem 4.3: the second function times $\mathbf{V}(\vec{w}) \prod_{j=1}^k (1-w_j)^{-M} (1-\nu w_j)^M$ is holomorphic in the closed exterior of the contour \mathcal{Y} (including ∞); and the first function times $\mathbf{V}(\vec{z})$ is holomorphic between \mathcal{Y} and \mathcal{Y}' (about the latter contour see Definition 4.1).

Proof. The expansion (3.18) follows by applying $\mathcal{K}^{q,\nu}$ to the function f due to Theorem 3.4 and formula (3.5).

The swapping of the left and right eigenfunctions in (3.19) can be achieved by writing (3.18) for the function $\mathcal{P}f$ (for the definition of \mathcal{P} , see Sect. 2.3), which gives $\langle \mathcal{P}f, \Psi_{\vec{w}\circ\lambda}^r \rangle_{\mathcal{W}^k} = \langle f, \mathcal{P}\Psi_{\vec{w}\circ\lambda}^r \rangle_{\mathcal{W}^k} = \langle f, \Psi_{\vec{w}\circ\lambda}^\ell \rangle_{\mathcal{W}^k}$ in the left-hand side. Then (3.19) follows by applying \mathcal{P}^{-1} to both sides of that identity for $\mathcal{P}f$.

Expansions (3.20) and (3.21) follow from formula (3.4). \square

Remark 3.11. The spatial Plancherel formula in the form (3.8) (or (3.20) with $f(\vec{n}) = \mathbf{1}_{\vec{n}=\vec{x}}$) is equivalent to the statement conjectured in [48, §4.1].

Remark 3.12. One can say that expansions (3.18)–(3.19) correspond to integrating against a (complex-valued) measure which is supported on a disjoint sum of subspaces (or contours and strings of specializations, cf. (2.5)). Since such an integration corresponds to the inverse transform $\mathcal{J}^{q,\nu}$ (see Sect. 3.2), this measure may be called the *Plancherel measure*. Note that this measure does not depend on ν . This object has already appeared as a Plancherel measure in the treatment of the $\nu = 0$ case in [15].

This should be compared to other models with Hermitian Hamiltonians such as the XXZ spin chain [2,3,29] (see also Sect. 8 below) and the continuous delta Bose gas [31,47], where the corresponding Plancherel measures are positive on suitably chosen contours.

The second corollary is the following *spatial biorthogonality* of eigenfunctions with respect to the bilinear pairing $\langle \cdot, \cdot \rangle_{\mathcal{C}_z^k}$ (so that the spatial variables play the role of labels of these functions).

Corollary 3.13. *For any $\vec{n}, \vec{m} \in \mathbb{W}^k$, regarding $\Psi^\ell(\vec{n})$ and $\Psi^r(\vec{m})$ as elements of \mathcal{C}_z^k (i.e., $\Psi^\ell(\vec{n})$ acts as $\vec{z} \mapsto \Psi_z^\ell(\vec{n})$, and same for $\Psi^r(\vec{m})$), we have*

$$\begin{aligned} & \langle \Psi^\ell(\vec{n}), \Psi^r(\vec{m}) \rangle_{\mathcal{C}_z^k} \\ &= \sum_{\lambda \vdash k} \oint_{\gamma_k} \dots \oint_{\gamma_k} dm_\lambda^{(q)}(\vec{w}) \prod_{j=1}^{\ell(\lambda)} \frac{1}{(w_j; q)_{\lambda_j} (\nu w_j; q)_{\lambda_j}} \Psi_{\vec{w}\circ\lambda}^\ell(\vec{n}) \Psi_{\vec{w}\circ\lambda}^r(\vec{m}) \\ &= \oint_{\gamma} \dots \oint_{\gamma} dm_{(1^k)}^{(q)}(\vec{z}) \prod_{j=1}^k \frac{1}{(1-z_j)(1-\nu z_j)} \Psi_z^\ell(\vec{n}) \Psi_z^r(\vec{m}) \\ &= \mathbf{1}_{\vec{m}=\vec{n}}. \end{aligned}$$

Proof. This immediately follows by taking $f(\vec{x}) = \mathbf{1}_{\vec{x}=\vec{n}}$ and $g(\vec{x}) = \mathbf{1}_{\vec{x}=\vec{m}}$ in (3.7). Note that the contour integral expressions for the pairing $\langle \Psi^\ell(\vec{n}), \Psi^r(\vec{m}) \rangle_{\mathcal{C}_z^k}$ come directly from its definition, cf. Sect. 2.2. \square

Remark 3.14. Corollary 3.13 implies that the left and right eigenfunctions are biorthogonal as elements of the space \mathcal{C}_z^k . On the other hand, each $\Psi^r(\vec{m})$ is the image of $f(\vec{n}) = \mathbf{1}_{\vec{n}=\vec{m}}$ (viewed as an element of \mathcal{W}^k) under the direct transform $\mathcal{F}^{q,\nu}$ (3.1). The indicator functions are orthogonal with respect to the bilinear pairing in \mathcal{W}^k . Thus, it is natural that to map the pairing $\langle \cdot, \cdot \rangle_{\mathcal{W}^k}$ to the pairing $\langle \cdot, \cdot \rangle_{\mathcal{C}_z^k}$ we need a twisting operator \mathcal{P} as in (3.7) and (3.16). (One could avoid using the operator \mathcal{P} in (3.7) and (3.16) by taking a twisted bilinear pairing $\langle f, g \rangle_{\widetilde{\mathcal{W}}^k} = \langle f, \mathcal{P}^{-1}g \rangle_{\mathcal{W}^k}$ in the space \mathcal{W}^k instead.)

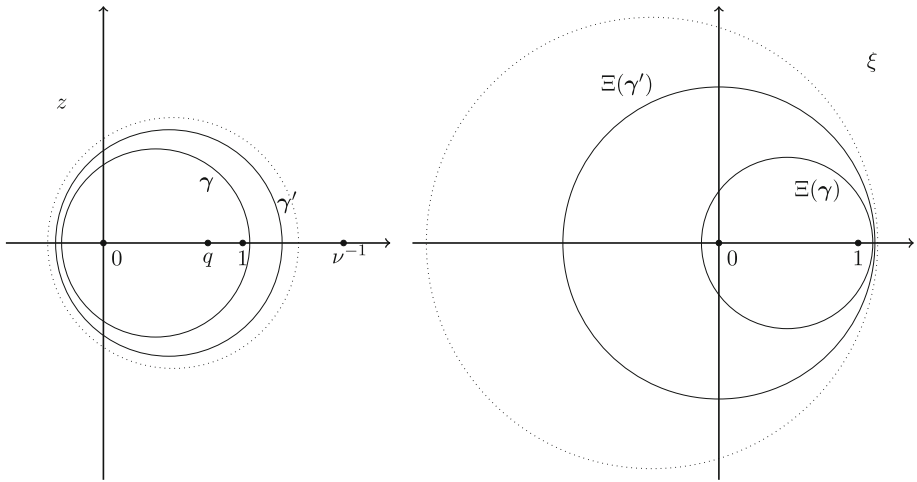

Fig. 5. A possible choice of the integration contours γ and γ' in the z variables (left), and the corresponding contours $\Xi(\gamma)$ and $\Xi(\gamma')$ in the ξ variables (right). Contours $q^{-1}\gamma$ and $\Xi(q^{-1}\gamma)$ are shown dotted

4. Spectral Biorthogonality of Eigenfunctions

In this section we establish a statement about the *spectral biorthogonality* of the left and right eigenfunctions, when spectral variables are treated as labels of the eigenfunctions (Theorem 4.3). We prove the spectral biorthogonality independently, as the spectral Plancherel formula (Theorem 3.9) was deduced from Theorem 4.3.

In this section we work under an additional assumption $0 < q < 1$ (the same assumption was made in Sect. 3.4). We also fix $0 \leq \nu < 1$, and integer $k \geq 1$.

4.1. Contour γ' .

Definition 4.1. Recall the contour γ from Definition 2.1. Let γ' be a positively oriented contour containing γ , contained inside $q^{-1}\gamma$, and not containing ν^{-1} , such that for all $z \in \gamma$ and all $w \in \gamma'$ one has

$$\left| \frac{1 - z}{1 - \nu z} \right| < \left| \frac{1 - w}{1 - \nu w} \right|. \tag{4.1}$$

See Fig. 5 for an example of such a contour.

Lemma 4.2. *Contours γ and γ' satisfying Definition 4.1 exist.*

Proof. The case $\nu = 0$ is simpler (and can be obtained in the limit $\nu \searrow 0$), so in the proof we assume that $0 < \nu < 1$.

Take the contour γ to be the positively oriented closed circle which intersects the real line at points $-\epsilon$ and $r + \nu^{-1}(1 - r)$, where $\epsilon > 0$ and $0 < r < 1$ are parameters of the contour. The map Ξ (2.3) turns γ into a positively oriented closed circle which intersects the real line at points

$$c_1 = -\frac{1-r}{rv} \quad \text{and} \quad c_2 = \frac{1+\epsilon}{1+v\epsilon}.$$

Next, the intersection points of the contour $\Xi(q^{-1}\gamma)$ with the real axis are

$$d_1 = \frac{1-qv-r(1-v)}{(1-q-r(1-v))v} \quad \text{and} \quad d_2 = \frac{q+\epsilon}{q+v\epsilon}.$$

First, assume that $q \leq v$. Then we will construct the contours γ, γ' corresponding to $r = 1 - \epsilon$, and ϵ small enough. Then

$$\begin{aligned} c_1 &= -v^{-1}\epsilon + O(\epsilon^2), & c_2 &= 1 + (1-v)\epsilon + O(\epsilon^2), \\ d_1 &= \frac{1-q}{v-q} - q \frac{(1-v)^2}{(q-v)^2v} \epsilon + O(\epsilon^2), & d_2 &= 1 + (1-v)q^{-1}\epsilon + O(\epsilon^2). \end{aligned}$$

Thus, $|c_1| < |c_2| < |d_2| < |d_1|$. (If $q = v$, then d_1 behaves as $const + \epsilon^{-1}$, and the inequalities continue to hold.) Take $\Xi(\gamma')$ to be the circle which intersects the real line at points $\pm(c_2 + \epsilon^2)$. This contour does not intersect $\Xi(q^{-1}\gamma)$, and $|\xi| < |\zeta|$ for all $\xi \in \Xi(\gamma)$ and $\zeta \in \Xi(\gamma')$. Thus, the contours γ and γ' satisfy Definition 4.1 because under Ξ condition $|\xi| < |\zeta|$ turns into (4.1).

For $q > v$, we will construct the desired contours with $r = 1/(1+v) + \epsilon$ and $\epsilon > 0$ small enough. We have

$$\begin{aligned} c_1 &= -1 + (v + v^{-1} + 2)\epsilon + O(\epsilon^2), & c_2 &= 1 + (1-v)\epsilon + O(\epsilon^2), \\ d_1 &= \frac{q(1+v) - 2}{q(1+v) - 2v} + \frac{(v^2 - 1)^2 q}{v(q(1+v) - 2v)^2} \epsilon + O(\epsilon^2), & d_2 &= 1 + (1-v)q^{-1}\epsilon + O(\epsilon^2). \end{aligned}$$

If $q < 2v/(1+v)$, one can check that $d_1 > 1$, and so $|c_1| < |c_2| < |d_2| < |d_1|$. If $q > 2v/(1+v)$, we similarly have $d_1 < -1$, and so $|c_1| < |c_2| < |d_2| < |d_1|$. If $q = 2v/(1+v)$, then d_1 behaves as $const - 2(1+v)^{-1}\epsilon^{-1}$, and so the desired inequalities hold. In all cases, as $\Xi(\gamma')$ we take the circle intersecting the real line at points $\pm(c_2 + \epsilon^2)$, and thus we obtain the desired contours. \square

4.2. Formulations of spectral biorthogonality. We will prove spectral biorthogonality for test functions from a wider class than \mathcal{C}_z^k . In particular, this is needed in the proof of the spectral Plancherel formula (Theorem 3.9).

Theorem 4.3. *Let the function $F(\vec{z})$ be such that for M large enough,*

$$\mathbf{V}(\vec{z})F(\vec{z}) \prod_{j=1}^k \left(\frac{1-z_j}{1-vz_j} \right)^{-M}$$

is holomorphic in the closed exterior of the contour γ (including ∞). Let $G(\vec{w})$ be such that $\mathbf{V}(\vec{w})G(\vec{w})$ is holomorphic in a neighborhood of the closed region between the contours γ and γ' (Definition 4.1). Then

$$\begin{aligned}
& \sum_{\vec{n} \in \mathbb{W}^k} \left(\oint_{\mathcal{Y}} \cdots \oint_{\mathcal{Y}} \frac{d\vec{z}}{(2\pi\mathbf{i})^k} \Psi_{\vec{z}}^r(\vec{n}) \mathbf{V}(\vec{z}) F(\vec{z}) \right) \left(\oint_{\mathcal{Y}} \cdots \oint_{\mathcal{Y}} \frac{d\vec{w}}{(2\pi\mathbf{i})^k} \Psi_{\vec{w}}^\ell(\vec{n}) \mathbf{V}(\vec{w}) G(\vec{w}) \right) \\
&= \oint_{\mathcal{Y}} \cdots \oint_{\mathcal{Y}} \frac{d\vec{z}}{(2\pi\mathbf{i})^k} (-1)^{\frac{k(k-1)}{2}} \prod_{j=1}^k (1 - z_j)(1 - \nu z_j) \\
&\quad \times \prod_{A \neq B} (z_A - \nu z_B) \sum_{\sigma \in S(k)} \operatorname{sgn}(\sigma) F(\vec{z}) G(\sigma \vec{z}). \tag{4.2}
\end{aligned}$$

Here $\sigma \vec{z} = (z_{\sigma(1)}, \dots, z_{\sigma(k)})$. (See Proposition 4.5 below about the convergence of the series in \vec{n} in the left-hand side.)

To make certain formulas and arguments below shorter, let us rewrite Theorem 4.3 using the other spectral variables ξ_j (see Sect. 2.1). Changing the variables in $\Psi_{\vec{z}}^\ell$, $\Psi_{\vec{z}}^r$, and multiplying them by Vandermonde determinants, denote

$$\Phi_{\xi}^\ell(\vec{n}) := \sum_{\sigma \in S(k)} \operatorname{sgn}(\sigma) \prod_{1 \leq B < A \leq k} \mathcal{S}_{q,\nu}(\xi_{\sigma(A)}, \xi_{\sigma(B)}) \prod_{j=1}^k \xi_{\sigma(j)}^{-n_j}; \tag{4.3}$$

$$\Phi_{\xi}^r(\vec{n}) := m_{q,\nu}(\vec{n}) \left(\frac{1-q}{1-\nu} \right)^k \sum_{\sigma \in S(k)} \operatorname{sgn}(\sigma) \prod_{1 \leq B < A \leq k} \mathcal{S}_{q,\nu}(\xi_{\sigma(B)}, \xi_{\sigma(A)}) \prod_{j=1}^k \xi_{\sigma(j)}^{n_j}, \tag{4.4}$$

where $\mathcal{S}_{q,\nu}$ is given in (2.10).

Theorem 4.4. For any functions¹¹ $F(\xi)$ and $G(\zeta)$ such that for M large enough, $\mathbf{V}(\xi)F(\xi) \prod_{j=1}^k \xi_j^{-M}$ is holomorphic in the closed exterior of $\Xi(\mathcal{Y})$, and such that $\mathbf{V}(\zeta)G(\zeta)$ is holomorphic in a neighborhood of the closed region between $\Xi(\mathcal{Y})$ and $\Xi(\mathcal{Y}')$, we have

$$\begin{aligned}
& \sum_{\vec{n} \in \mathbb{W}^k} \left(\oint_{\Xi(\mathcal{Y})} \cdots \oint_{\Xi(\mathcal{Y})} \frac{d\vec{\xi}}{(2\pi\mathbf{i})^k} \Phi_{\vec{\xi}}^r(\vec{n}) F(\vec{\xi}) \right) \left(\oint_{\Xi(\mathcal{Y})} \cdots \oint_{\Xi(\mathcal{Y})} \frac{d\vec{\zeta}}{(2\pi\mathbf{i})^k} \Phi_{\vec{\zeta}}^\ell(\vec{n}) G(\vec{\zeta}) \right) \\
&= \oint_{\Xi(\mathcal{Y})} \cdots \oint_{\Xi(\mathcal{Y})} \frac{d\vec{\xi}}{(2\pi\mathbf{i})^k} \prod_{j=1}^k \xi_j \prod_{1 \leq A \neq B \leq k} \mathcal{S}_{q,\nu}(\xi_A, \xi_B) \sum_{\sigma \in S(k)} \operatorname{sgn}(\sigma) F(\vec{\xi}) G(\sigma \vec{\xi}). \tag{4.5}
\end{aligned}$$

(See Proposition 4.5 below about the convergence of the series in \vec{n} in the left-hand side.) Identity (4.5) is equivalent to (4.2).

Proof of equivalence of Theorems 4.3 and 4.4. From (2.19)–(2.20) we readily have

$$\begin{aligned}
& \mathbf{V}(\Xi(\xi)) \mathbf{V}(\Xi(\zeta)) \Psi_{\Xi(\xi)}^r(\vec{n}) \Psi_{\Xi(\zeta)}^\ell(\vec{n}) \\
&= \frac{(-1)^{\frac{k(k+1)}{2}} (1-\nu)^k (1-q\nu)^{k(k-1)}}{\prod_{j=1}^k (1-\nu\xi_j)^{k-1} (1-\nu\zeta_j)^{k-1}} \Phi_{\xi}^r(\vec{n}) \Phi_{\zeta}^\ell(\vec{n}). \tag{4.6}
\end{aligned}$$

¹¹ Slightly abusing the notation, we are using the same letters for test functions in both (4.2) and (4.5).

Here we have used

$$\frac{\mathbf{V}(\Xi(\vec{\xi}))}{\mathbf{V}(\vec{\xi})} = \frac{(v-1)^{\frac{k(k-1)}{2}}}{\prod_{j=1}^k (1-v\xi_j)^{k-1}}.$$

Next, the change of variables $\vec{z} = \Xi(\vec{\xi})$, $\vec{w} = \Xi(\vec{\zeta})$ in the left-hand side of (4.2) yields

$$d\vec{z}d\vec{w} = \frac{(v-1)^{2k}}{\prod_{j=1}^k (1-v\xi_j)^2(1-v\zeta_j)^2} d\vec{\xi}d\vec{\zeta}, \tag{4.7}$$

and in the right-hand side the change of variables gives

$$\begin{aligned} & (-1)^{\frac{k(k-1)}{2}} \prod_{j=1}^k (1-z_j)(1-vz_j) \prod_{A \neq B} (z_A - qz_B) d\vec{z} \\ &= (-1)^{\frac{k(k-1)}{2}} (v-1)^{3k} (1-qv)^{k(k-1)} \prod_{j=1}^k \frac{\xi_j}{(1-v\xi_j)^{2k+2}} \prod_{A \neq B} \mathcal{S}_{q,v}(\xi_A, \xi_B) d\vec{\xi}. \end{aligned} \tag{4.8}$$

Clearly, this change of variables turns test functions in (4.2) into test functions in (4.5). Next, by multiplying G by a suitable power of $\prod_{j=1}^k (1-v\zeta_j)$ (which preserves its necessary properties), one can readily match the left-hand side (product of (4.6) and (4.7)) with the right-hand side (4.8). \square

Proposition 4.5. *Both infinite series in \vec{n} in left-hand sides of (4.2) and (4.5) converge for the corresponding choices of test functions F and G .*

Proof. Let us illustrate why the statement holds in the $\vec{\xi}$ variables (the statement in the \vec{z} variables is completely analogous).

Assume that $n_k < -M$, where M is a sufficiently large positive integer (which depends on the test function F). Then in the left-hand side of (4.5) the integral of $(\Phi_{\vec{\xi}}^r(\vec{n})\mathbf{V}(\vec{\xi})^{-1})\mathbf{V}(\vec{\xi})F(\vec{\xi})$ vanishes. Indeed, this is because each summand in the Laurent polynomial $\Phi_{\vec{\xi}}^r(\vec{n})\mathbf{V}(\vec{\xi})^{-1}$ contains a factor of the form ξ_j^{-m} for some $1 \leq j \leq k$ and m sufficiently large, and thus the expression

$$\xi_j^{-m}\mathbf{V}(\vec{\xi})F(\vec{\xi}) = (\xi_1 \dots \xi_{j-1}\xi_{j+1} \dots \xi_k)^m (\xi_1 \dots \xi_k)^{-m}\mathbf{V}(\vec{\xi})F(\vec{\xi})$$

is holomorphic in the variable ξ_j in the exterior of the integration contour $\Xi(\boldsymbol{\gamma})$. Performing the integration in ξ_j first, we see that the integral of this summand (coming from $\Phi_{\vec{\xi}}^r(\vec{n})\mathbf{V}(\vec{\xi})^{-1}$) vanishes.

This implies that it is possible to perform the summation over \vec{n} in the left-hand side of (4.5) such that $n_k \geq -M$. Next, let us deform the $\vec{\zeta}$ contours from $\Xi(\boldsymbol{\gamma})$ to $\Xi(\boldsymbol{\gamma}')$. Because of the properties of $G(\vec{\zeta})$, this will not change the integral over $\vec{\zeta}$ in the left-hand side of (4.5). Now we can interchange the summation over \vec{n} with the integration over $\vec{\xi}$ and $\vec{\zeta}$ because the sum over \vec{n} inside the integral will converge uniformly, thanks to (4.1). Therefore, the sum converged before the interchange, too. This implies the desired claim. \square

Remark 4.6. The identity (4.2) can be formally rewritten as

$$\begin{aligned} \langle \Psi_{\vec{z}}^r, \Psi_{\vec{w}}^\ell \rangle_{\mathcal{W}^k} \mathbf{V}(\vec{z}) \mathbf{V}(\vec{w}) &= (-1)^{\frac{k(k-1)}{2}} \prod_{j=1}^k (1 - z_j)(1 - v z_j) \\ &\times \prod_{A \neq B} (z_A - q z_B) \det[\delta(z_i - w_j)]_{i,j=1}^k, \end{aligned} \tag{4.9}$$

where $\delta(z)$ is the Dirac delta function supported at $z = 0$. Similarly, (4.5) corresponds to the following formal identity:

$$\langle \Phi_{\vec{\xi}}^r, \Phi_{\vec{\zeta}}^\ell \rangle_{\mathcal{W}^k} = \prod_{j=1}^k \xi_j \prod_{A \neq B} \mathcal{S}_{q,v}(\xi_A, \xi_B) \det[\delta(\xi_i - \zeta_j)]_{i,j=1}^k. \tag{4.10}$$

Remark 4.7. If one restricts the class of test functions in (4.2) to (not necessarily symmetric) Laurent polynomials in variables $\frac{1-z_j}{1-vz_j}$ and $\frac{1-w_j}{1-vw_j}$, respectively, then the only singularities of the integrands in both sides would be 1 and v^{-1} . Thus, the contour γ of integration in (4.2) can be changed to either a positively oriented small circle around 1 (we denoted this contour by γ_k , see Definition 2.1), or to a negatively oriented small circle around v^{-1} .

Likewise, if one restricts (4.5) to (not necessarily symmetric) Laurent polynomials ξ_1, \dots, ξ_k and ζ_1, \dots, ζ_k , then the integration contours $\Xi(\gamma)$ can be replaced by small positively oriented circles around 0.

We prove Theorem 4.3 (in the equivalent form of Theorem 4.4) in Sect. 4.3 below.

4.3. Proof of the spectral biorthogonality. Denote the left-hand side of (4.5) by $\text{LHS}[F(\vec{\xi})G(\vec{\zeta})]$. It is helpful to regard $\text{LHS}[\dots]$ as a linear functional acting on functions in $\vec{\xi}$ and $\vec{\zeta}$ (in other words, a generalized function, or a distribution), cf. the notation in (4.9)–(4.10).

Lemma 4.8. *For any symmetric polynomial $p(\xi_1, \dots, \xi_k)$,*

$$\text{LHS}[p(\vec{\xi})F(\vec{\xi})G(\vec{\zeta})] = \text{LHS}[F(\vec{\xi})p(\vec{\zeta})G(\vec{\zeta})].$$

Proof. We will use the fact that the functions $\Phi_{\vec{\xi}}^r(\vec{n})$ and $\Phi_{\vec{\zeta}}^\ell(\vec{n})$ are eigenfunctions of the q -Hahn operator $\mathcal{H}_{q,\mu,v}^{\text{bwd}}$ with an *additional free parameter* μ . Their eigenvalues are (see Sect. 5 below; note that here we use the spectral variables $\vec{\xi}$)

$$\text{ev}_{\mu,v}(\Xi(\vec{\xi})) = \prod_{j=1}^k \frac{1 - \mu - \xi_j(v - \mu)}{1 - v},$$

because $\Phi_{\vec{\xi}}^r(\vec{n})$ and $\Phi_{\vec{\zeta}}^\ell(\vec{n})$ differ from $\Psi_{\vec{z}}^r(\vec{n})$, $\Psi_{\vec{w}}^\ell(\vec{n})$ by a change of variables and by multiplicative factors not depending on the spatial variables \vec{n} .

Using the notation with Dirac delta functions (4.10), we have

$$\begin{aligned} \text{ev}_{\mu,v}(\Xi(\vec{\zeta})) \langle \Phi_{\vec{\xi}}^r, \Phi_{\vec{\zeta}}^\ell \rangle_{\mathcal{W}^k} &= \langle \Phi_{\vec{\xi}}^r, \mathcal{H}_{q,\mu,v}^{\text{bwd}} \Phi_{\vec{\zeta}}^\ell \rangle_{\mathcal{W}^k} = \langle (\mathcal{H}_{q,\mu,v}^{\text{bwd}})^{\text{transpose}} \Phi_{\vec{\xi}}^r, \Phi_{\vec{\zeta}}^\ell \rangle_{\mathcal{W}^k} \\ &= \text{ev}_{\mu,v}(\Xi(\vec{\xi})) \langle \Phi_{\vec{\xi}}^r, \Phi_{\vec{\zeta}}^\ell \rangle_{\mathcal{W}^k}. \end{aligned} \tag{4.11}$$

This is readily extended to a rigorous formula like in Theorem 4.4 because with our test functions F and G the corresponding sum over \vec{n} in (4.5) converges (see Proposition 4.5).

The eigenvalues depend on an additional free parameter μ . Extracting coefficients of various powers of μ in (4.11), we see that the statement of the lemma holds when p is an elementary symmetric polynomial

$$p(\xi_1, \dots, \xi_k) = e_m(\xi_1, \dots, \xi_k) = \sum_{i_1 < \dots < i_m} \xi_{i_1} \dots \xi_{i_m}, \quad m = 1, \dots, k.$$

Writing (4.11) for products of eigenvalues with different free parameters μ_i , we get the same statement for any products of elementary symmetric polynomials. Finally, an arbitrary symmetric polynomial is a linear combination of such products, cf. [40, I.2]. \square

Lemma 4.9. *For any $j = 1, \dots, k$,*

$$\begin{aligned} \text{LHS}[(\varsigma_j - \xi_1) \dots (\varsigma_j - \xi_k) F(\vec{\xi}) G(\vec{\varsigma})] &= 0, \\ \text{LHS}[F(\vec{\xi})(\xi_j - \varsigma_1) \dots (\xi_j - \varsigma_k) G(\vec{\varsigma})] &= 0. \end{aligned}$$

Proof. Apply Lemma 4.8 with the symmetric polynomial $(\varsigma_j - \xi_1) \dots (\varsigma_j - \xi_k)$ in $\vec{\xi}$ (here ς_j is viewed as a parameter of the polynomial). Under $\text{LHS}[\dots]$, this polynomial in $\vec{\xi}$ can be replaced by the polynomial $(\varsigma_j - \varsigma_1) \dots (\varsigma_j - \varsigma_k) \equiv 0$ in $\vec{\varsigma}$, which proves the first claim. The second claim is analogous. \square

Lemma 4.10. *For any test functions $F(\vec{\xi}), G(\vec{\varsigma})$ as in Theorem 4.4, integers $1 \leq j \leq k$ and $N \geq 1$, there exists $N_1 \geq N$ such that*

$$\text{LHS}[F(\vec{\xi})G(\vec{\varsigma})] = \sum_{m=N}^{N_1} \text{LHS}[F^{(m)}(\vec{\xi})G(\vec{\varsigma})\varsigma_j^m],$$

where $F^{(m)}(\vec{\xi})$ are finite linear combinations of functions of the form $F(\vec{\xi})\xi_1^{-i_1} \dots \xi_k^{-i_k}$, where $i_1, \dots, i_k \geq 0$.

Proof. Lemma 4.9 written as

$$\text{LHS}[(1 - \varsigma_j/\xi_1) \dots (1 - \varsigma_j/\xi_k) F(\vec{\xi}) G(\vec{\varsigma})] = 0$$

allows to express $\text{LHS}[F(\vec{\xi})G(\vec{\varsigma})]$ as a linear combination of quantities of the form

$$\text{LHS}[F(\vec{\xi})\xi_1^{-i_1} \dots \xi_k^{-i_k} G(\vec{\varsigma})\varsigma_j^m],$$

with $m \geq 1$ and $i_1, \dots, i_k \geq 0$. A repeated application of this procedure allows to shift the power of ς_j past any $N \geq 1$. \square

By Runge’s theorem, it is possible to approximate any function $G(\vec{\varsigma})$ satisfying the condition of Theorem 4.4 by finite linear combinations of powers $\varsigma_1^{x_1} \dots \varsigma_k^{x_k}$ (uniformly in $\varsigma_1, \dots, \varsigma_k$ belonging to the closed region between the contours $\Xi(\mathcal{Y})$ and $\Xi(\mathcal{Y}')$). Thus, we may prove the spectral biorthogonality by computing $\text{LHS}[F(\vec{\xi})\varsigma_1^{x_1} \dots \varsigma_k^{x_k}]$. Moreover, since Φ_ς^ℓ involved in (4.5) is skew-symmetric in $\varsigma_1, \dots, \varsigma_k$, we may assume that $x_1 \geq \dots \geq x_k$. Finally, by using Lemma 4.10 we may shift powers of $\varsigma_k, \varsigma_{k-1}, \dots, \varsigma_1$ (in this order) so that all gaps between x_i and x_{i+1} ($i = 1, \dots, k - 1$) are arbitrarily large. Thus, it remains to compute the left-hand side of (4.5) in the following case:

Lemma 4.11. *Let $x_1 > x_2 > \dots > x_k$, and $x_i - x_{i+1} > 2k$ for all $i = 1, \dots, k - 1$. Then the identity (4.5) holds for arbitrary $F(\vec{\xi})$ (satisfying the condition of Theorem 4.4) and for $G(\vec{\zeta}) = \zeta_1^{x_1} \dots \zeta_k^{x_k}$.*

Proof. First, note that for this choice of G , the sum over \vec{n} in the left-hand of (4.5) is finite. We have

$$\begin{aligned} & \sum_{\vec{n} \in \mathbb{W}^k} \oint_{\Xi(\gamma)} \dots \oint_{\Xi(\gamma)} \frac{d\vec{\zeta}}{(2\pi\mathbf{i})^k} \zeta_1^{x_1} \dots \zeta_k^{x_k} \Phi_{\vec{\xi}}^r(\vec{n}) \Phi_{\vec{\zeta}}^\ell(\vec{n}) \\ &= \sum_{\sigma \in S(k)} \operatorname{sgn}(\sigma) \sum_{\omega \in S(k)} \operatorname{sgn}(\omega) \sum_{\vec{n} \in \mathbb{W}^k} m_{q,v}(\vec{n}) \left(\frac{1-q}{1-v}\right)^k \oint_{\Xi(\gamma)} \dots \oint_{\Xi(\gamma)} \frac{d\vec{\zeta}}{(2\pi\mathbf{i})^k} \\ & \quad \times \prod_{B < A} \mathcal{S}_{q,v}(\zeta_{\sigma(A)}, \zeta_{\sigma(B)}) \mathcal{S}_{q,v}(\xi_{\omega(B)}, \xi_{\omega(A)}) \prod_{j=1}^k \zeta_j^{-n_{\sigma^{-1}(j)}+x_j} \xi_{\omega(j)}^{n_j}. \end{aligned}$$

The product $\prod_{B < A} \mathcal{S}_{q,v}(\zeta_{\sigma(A)}, \zeta_{\sigma(B)})$ is a polynomial in each of the variables ζ_j of degree $k - 1$. In order for the above integral in ζ_j 's not to vanish, all powers $x_j - n_{\sigma^{-1}(j)}$, $j = 1, \dots, k$, must range from $-k$ to -1 . Because of the large gaps between the x_j 's and the inequalities $n_1 \geq \dots \geq n_k$, this implies that σ must be the identity permutation (i.e., the contribution of all other permutations is zero). This also implies that the n_j 's must be distinct. For distinct n_j 's, $m_{q,v}(\vec{n}) \left(\frac{1-q}{1-v}\right)^k = 1$ (see (2.13)).

After restricting to $\sigma = id$, the conditions $n_1 \geq n_2 \geq \dots \geq n_k$ will be automatic (otherwise the integral vanishes), so we will be able to drop the assumption $\vec{n} \in \mathbb{W}^k$ and sum over all $\vec{n} \in \mathbb{Z}^k$. Therefore, continuing the above formula, we have

$$\begin{aligned} &= \sum_{\omega \in S(k)} \operatorname{sgn}(\omega) \prod_{B < A} \mathcal{S}_{q,v}(\xi_{\omega(B)}, \xi_{\omega(A)}) \\ & \quad \times \sum_{\vec{n} \in \mathbb{Z}^k} \prod_{j=1}^k \xi_{\omega(j)}^{n_j} \oint_{\Xi(\gamma)} \dots \oint_{\Xi(\gamma)} \frac{d\vec{\zeta}}{(2\pi\mathbf{i})^k} \prod_{B < A} \mathcal{S}_{q,v}(\zeta_A, \zeta_B) \prod_{j=1}^k \zeta_j^{-n_j+x_j}. \end{aligned}$$

The integration over $\vec{\zeta}$ may be interpreted as taking the coefficient of $\zeta_1^{n_1} \dots \zeta_k^{n_k}$ in the product

$$\zeta_1^{x_1+1} \dots \zeta_k^{x_k+1} \prod_{B < A} \mathcal{S}_{q,v}(\zeta_A, \zeta_B). \tag{4.12}$$

Then each such coefficient of $\zeta_1^{n_1} \dots \zeta_k^{n_k}$ is multiplied by $\xi_{\omega(1)}^{n_1} \dots \xi_{\omega(k)}^{n_k}$, and the summation over all possible powers $\vec{n} \in \mathbb{Z}^k$ is performed. Therefore, the result of this summation is a substitution $\zeta_j \rightarrow \xi_{\omega(j)}$ in (4.12). Therefore, we have

$$\begin{aligned} & \sum_{\vec{n} \in \mathbb{W}^k} \oint_{\Xi(\gamma)} \dots \oint_{\Xi(\gamma)} \frac{d\vec{\zeta}}{(2\pi\mathbf{i})^k} \zeta_1^{x_1} \dots \zeta_k^{x_k} \Phi_{\vec{\xi}}^r(\vec{n}) \Phi_{\vec{\zeta}}^\ell(\vec{n}) \\ &= \sum_{\omega \in S(k)} \operatorname{sgn}(\omega) \prod_{B < A} \mathcal{S}_{q,v}(\xi_{\omega(B)}, \xi_{\omega(A)}) \prod_{B < A} \mathcal{S}_{q,v}(\xi_{\omega(A)}, \xi_{\omega(B)}) \xi_{\omega(1)}^{x_1+1} \dots \xi_{\omega(k)}^{x_k+1}. \end{aligned}$$

After multiplying both sides of the above identity by $F(\vec{\xi})$ and integrating over the variables ξ_j , we readily get (4.5). \square

This completes the proof of the spectral biorthogonality (Theorems 4.3 and 4.4).

Remark 4.12. The sum over \vec{n} in the spectral biorthogonality statement (4.10) can be written as

$$\sum_{\vec{n} \in \mathbb{W}^k} C(\vec{n}) \Phi_{\xi}^{\ell}(\vec{n}) (\mathcal{R} \Phi_{\xi}^{\ell})(\vec{n}), \tag{4.13}$$

where \mathcal{R} is the space reflection operator (2.15), and $C(\vec{n})$ is a certain constant not depending on \vec{n} times $m_{q,v}(\vec{n})$ (2.13).

It may seem strange that our proof of the spectral biorthogonality (in other words, the computation of the sum (4.13)) does not involve the explicit value of the constant $C(\vec{n})$ (except in the case when all n_j 's are distinct). On the other hand, the proof heavily relies on Lemma 4.9, a statement made possible by the presence of a free parameter μ in the operator and not in the eigenfunctions.

It seems plausible (and was checked for $k = 2$) that Lemma 4.9 *alone* determines the value of the constant $C(\vec{n})$ for all \vec{n} 's (up to an overall factor not depending on \vec{n}).

Note also that the proof of the spectral biorthogonality for $v = 0$ given in [15, §6] is very different, and it employs the explicit value of the corresponding constant $C(\vec{n})$.

4.4. Degenerate spectral biorthogonality. A spectral biorthogonality statement similar to Theorems 4.3 and 4.4 should hold for all eigenfunctions which appear in completeness results (3.18)–(3.19) of Corollary 3.10. Namely, these eigenfunctions are indexed by spectral variables which form strings $\vec{z} = \vec{z}' \circ \lambda$, $\vec{w} = \vec{w}' \circ \varkappa$, where λ and \varkappa are two partitions of k (recall the definition of strings (2.5)).¹² We conjecture that for such \vec{z} and \vec{w} , Theorem 4.3 should reduce to

$$\begin{aligned} \langle \Psi_{\vec{z}}^r, \Psi_{\vec{w}}^{\ell} \rangle_{\mathcal{W}^k} \mathbf{V}(\vec{z}) \mathbf{V}(\vec{w}) &= \mathbf{1}_{\lambda = \varkappa} \cdot (-1)^{\frac{k(k-1)}{2}} \prod_{j=1}^k (1 - z_j)(1 - v z_j) \\ &\times \prod_{A \neq B}^{\sim} (z_A - q z_B) \det[\delta(z_i - w_j)]_{i,j=1}^k, \end{aligned} \tag{4.14}$$

where $\prod_{A \neq B}^{\sim} (z_A - q z_B)$ means that we omit factors which are identically zero by the very definition of \vec{z} . Formal identity (4.14) should be understood in an integral sense similar to Theorem 4.3. (However, it is not clear which test functions or integration contours should be used.) The change of variables Ξ (see Sect. 2.1) would turn (4.14) into a conjectural degenerate version of Theorem 4.4 (i.e., into a statement in the other spectral variables $\vec{\xi}$ and $\vec{\zeta}$).

Using ideas similar to the proof of Theorem 4.4 in Sect. 4.3, one could easily show that if $\lambda \neq \varkappa$, the left-hand side of (4.14) vanishes. We have checked (4.14) for $k = 2$ and $\lambda = \varkappa = (2)$, which yields

$$\begin{aligned} \sum_{n_1 \geq n_2} \Psi_{z', qz'}^r(n_1, n_2) \Psi_{w', qw'}^{\ell}(n_1, n_2) (z' - qz') (w' - qw') \\ = -(1 - z')(1 - qz')(1 - vz')(1 - vqz')(z' - q^2z') \delta(z' - w'). \end{aligned}$$

¹² Note that if $\lambda \neq (1^k)$, then $\vec{z} = \vec{z}' \circ \lambda$ depends on (independent) spectral variables $z'_1, \dots, z'_{\ell(\lambda)}$ whose number is strictly less than k .

Note that in this case we have simplified the determinant in the right-hand side of (4.14) as

$$\begin{aligned} \det[\delta(z_i - w_j)]_{i,j=1}^2 &= \delta(z' - w')\delta(qz' - qw') - \delta(z' - qw')\delta(qz' - w') \\ &= \delta(z' - w'), \end{aligned}$$

because the second summand always vanishes. This formal identity for $k = 2$ was checked on test functions which are Laurent polynomials in $\Xi(z')$ and $\Xi(w')$, and the integration contours in z' and w' were small positively oriented circles around 1 (cf. Remark 4.7).

We note that in the physics literature such degenerate orthogonality has appeared in the context of continuous delta Bose gas [19, 24]. See also appendices A and B and references in section II of [25]. In the case of attractive delta Bose gas, one needs to use all eigenfunctions corresponding to all various strings (indexed by partitions λ) for the completeness of the Bethe ansatz. In our situation due to the other completeness results (3.20)–(3.21), it is possible to work only with eigenfunctions corresponding to $\lambda = (1^k)$, whose spectral orthogonality is Theorems 4.3 and 4.4.

5. The q -Hahn System and Coordinate Bethe Ansatz

In this section we discuss connections of the eigenfunctions to the q -Hahn stochastic particle system (about the name see Sect. 5.2 below) introduced by Povolotsky [48]. Namely, we briefly recall the coordinate Bethe ansatz computations leading to the eigenfunctions described in Sect. 2.3. Our Plancherel formulas in Sects. 3.3 and 3.4 give rise to moment formulas for the q -Hahn TASEP (also introduced in [48]) with an arbitrary initial condition (Sect. 5.6), and also to certain new symmetrization identities (Sect. 5.8). In this section we will sometimes call the q -Hahn particle system the q -Hahn zero-range process to distinguish it from the q -Hahn TASEP.

Definitions, constructions and results in this section depend on parameters $0 < q < 1$ and $0 \leq \nu \leq \mu < 1$.

5.1. The q -Hahn system. The (k -particle) q -Hahn system's state space is the set \mathbb{W}^k (2.1) of spatial variables $\vec{n} = (n_1 \geq \dots \geq n_k)$. Here each n_j is the location of the j -th rightmost particle on \mathbb{Z} . We will need another encoding of such k -particle configurations. Namely, let $y_i \geq 0$ denote the number of particles at the site $i \in \mathbb{Z}$. If $\vec{n} \in \mathbb{W}^k$, then for $\vec{y} = \vec{y}(\vec{n}) = (y_i)_{i \in \mathbb{Z}}$ we have $\sum_{i \in \mathbb{Z}} y_i = k$, and only finitely many of the coordinates of \vec{y} are nonzero. Denote by \mathbb{Y}^k the space of all such vectors \vec{y} . We thus have a bijection between \mathbb{Y}^k and \mathbb{W}^k .

For $s_i \in \{0, 1, \dots, y_i\}$, denote

$$\begin{aligned} \vec{y}_{i,i-1}^{s_i} &:= (y_0, y_1, \dots, y_{i-1} + s_i, y_i - s_i, y_{i+1}, \dots, y_N). \\ \vec{y}_{i,i+1}^{s_i} &:= (y_0, y_1, \dots, y_{i-1}, y_i - s_i, y_{i+1} + s_i, \dots, y_N). \end{aligned}$$

That is, the configuration $\vec{y}_{i,i-1}^{s_i}$ is obtained by taking s_i particles from the site i and moving them to the site $i - 1$ (in $\vec{y}_{i,i+1}^{s_i}$, s_i particles are moved to the site $i + 1$).

We will also use the following notation for $\vec{n} \in \mathbb{W}^k$: For $I \subseteq \{1, \dots, k\}$, let \vec{n}_I^\pm denote the vector \vec{n} with n_i replaced by $n_i \pm 1$ for all $i \in I$. The modified vectors \vec{n}_I^\pm do not necessarily belong to \mathbb{W}^k .

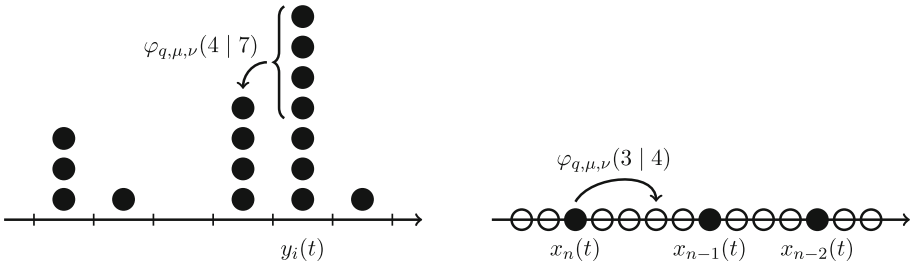

Fig. 6. A possible transition at one site of the q -Hahn zero-range process (left) and the q -Hahn TASEP (right) processes

Definition 5.1 (A deformed Binomial distribution). For $|q| < 1$, $0 \leq \nu \leq \mu < 1$ and integers $0 \leq j \leq m$, define

$$\varphi_{q, \mu, \nu}(j | m) := \mu^j \frac{(v/\mu; q)_j (\mu; q)_{m-j}}{(v; q)_m} \frac{(q; q)_m}{(q; q)_j (q; q)_{m-j}}.$$

This definition can be also extended to include the case $m = +\infty$:

$$\varphi_{q, \mu, \nu}(j | +\infty) := \mu^j \frac{(v/\mu; q)_j (\mu; q)_\infty}{(q; q)_j (v; q)_\infty}.$$

It was shown in [48] (see also [4, 22] and [34, (3.6.2)], cf. Sect. 5.2 below) that for $m = \{0, 1, \dots\} \cup \{+\infty\}$,

$$\sum_{j=0}^m \varphi_{q, \mu, \nu}(j | m) = 1.$$

Clearly, for the parameters (q, μ, ν) satisfying conditions stated at the beginning of this section, we have $\varphi_{q, \mu, \nu}(j | m) \geq 0$ for all meaningful j and m .

Definition 5.2 (The q -Hahn system [48]). The k -particle q -Hahn stochastic particle system on the lattice \mathbb{Z} is a discrete-time Markov chain on \mathbb{Y}^k (equivalently, on \mathbb{W}^k) defined as follows. At each time step $t \rightarrow t + 1$ and independently at each site $i \in \mathbb{Z}$, select $s_i \in \{0, 1, \dots, y_i\}$ particles at random with probability $\varphi_{q, \mu, \nu}(s_i | y_i)$. After this selection is made at every $i \in \mathbb{Z}$ (note that $s_i = y_i = 0$ for all except a finite number of i), transfer s_i particles from each side i to its left neighbor $i - 1$. See Fig. 6, left.

The (backward) Markov transition operator of the q -Hahn system can be written as follows. Define for each $i \in \mathbb{Z}$ the one-site transition operator as

$$([\mathcal{A}_{q, \mu, \nu}^{\text{bwd}}]_i f)(\vec{y}) := \sum_{s_i=0}^{y_i} \varphi_{q, \mu, \nu}(s_i | y_i) f(\vec{y}_{i, i-1}^{s_i}).$$

Then the global transition operator is

$$(\mathcal{H}_{q, \mu, \nu}^{\text{bwd}} f)(\vec{y}) := \dots [\mathcal{A}_{q, \mu, \nu}^{\text{bwd}}]_{-1} [\mathcal{A}_{q, \mu, \nu}^{\text{bwd}}]_0 [\mathcal{A}_{q, \mu, \nu}^{\text{bwd}}]_1 [\mathcal{A}_{q, \mu, \nu}^{\text{bwd}}]_2 \dots f(\vec{y}).$$

The operators $[\mathcal{A}_{q, \mu, \nu}^{\text{bwd}}]_i$ and $\mathcal{H}_{q, \mu, \nu}^{\text{bwd}}$ act on functions on \mathbb{Y}^k which correspond to compactly supported functions on \mathbb{W}^k (via the bijection between \mathbb{Y}^k and \mathbb{W}^k). Recall that the latter functions constitute the space \mathcal{W}^k , cf. Sect. 2.1. For such functions f , the action of the operators $[\mathcal{A}_{q, \mu, \nu}^{\text{bwd}}]_i$ is trivial for all but a finite number of $i \in \mathbb{Z}$.

Remark 5.3. The order of operators $[\mathcal{A}_{q,\mu,v}^{\text{bwd}}]_i$ in the definition of $\mathcal{H}_{q,\mu,v}^{\text{bwd}}$ above should be understood according to

$$[\mathcal{A}_{q,\mu,v}^{\text{bwd}}]_i [\mathcal{A}_{q,\mu,v}^{\text{bwd}}]_{i+1} f(\vec{y}) = \left([\mathcal{A}_{q,\mu,v}^{\text{bwd}}]_i \left([\mathcal{A}_{q,\mu,v}^{\text{bwd}}]_{i+1} f \right) \right) (\vec{y}).$$

Note that the order of the $[\mathcal{A}_{q,\mu,v}^{\text{bwd}}]_i$'s matters because the one-site operators do not act independently.

5.2. Particle hopping distribution and q -Hahn orthogonality weights. The particle hopping distribution $\varphi_{q,\mu,v}$ (Sect. 5.1) is related to the orthogonality weight for the q -Hahn orthogonal polynomials (about the latter objects, e.g., see [34, §3.6] and references therein). The orthogonality weight for the q -Hahn polynomials is defined as

$$\text{wt}_{q,\alpha,\beta}(x | N) = (\alpha\beta q)^{-x} \frac{(\alpha q; q)_x (q^{-N}; q)_x}{(q; q)_x (\beta^{-1} q^{-N}; q)_x}, \quad x = 0, 1, \dots, N.$$

These q -Hahn weights sum to

$$\sum_{x=0}^N \text{wt}_{q,\alpha,\beta}(x | N) = (\alpha q)^{-N} \frac{(q^2 \alpha \beta; q)_N}{(q \beta; q)_N}.$$

Indeed, this follows from the orthogonality relation for the q -Hahn polynomials [34, (3.6.2)] for $m = n = 0$.

One can readily write down the following relation between $\varphi_{q,\mu,v}$ (Definition 5.1) and the q -Hahn weight function:

$$\varphi_{q,\mu,v}(j | m) = \frac{\mu^m}{v^{m-j}} \frac{(v/\mu; q)_m}{(v; q)_m} \text{wt}_{q^{-1}, q\mu^{-1}, q\mu v^{-1}}(m - j | m), \quad j = 0, 1, \dots, m. \quad (5.1)$$

The above understanding that the two-parameter family of particle hopping distributions $\varphi_{q,\mu,v}$ (depending on μ, v) is essentially equivalent to the two-parameter family of orthogonality weights $\text{wt}_{q,\alpha,\beta}$ (depending on α, β) for the q -Hahn orthogonal polynomials is the reason for the name “ q -Hahn” for the stochastic particle system of Definition 5.2.

5.3. The q -Hahn TASEP and Markov duality. Here we recall the definition of the q -Hahn TASEP process (given in [48]) and its Markov duality relation to the q -Hahn zero-range process (established in [22], see also [4]).

Definition 5.4 (*The q -Hahn TASEP*). Fix an integer $N \geq 1$. The q -Hahn TASEP is a discrete-time Markov process system with state space

$$\mathbb{X}_N := \{\vec{x} = (x_0, x_1, \dots, x_N) : +\infty = x_0 > x_1 > x_2 > \dots > x_N, x_j \in \mathbb{Z}\}.$$

By agreement, $x_0 = +\infty$ is a virtual particle, introduced to simplify the notation.

At each time step $t \rightarrow t + 1$, each of the particles $x_n(t)$, $1 \leq n \leq N$, independently jumps to the right by j_n , where $j_n \in \{0, 1, \dots, x_{n-1}(t) - x_n(t) - 1\}$, with probability $\varphi_{q,\mu,v}(j_n | x_{n-1}(t) - x_n(t) - 1)$. See Fig. 6, right.

Remark 5.5. We consider the q -Hahn TASEP with a finite number of particles. However, since the dynamics of each particle x_n depends only on the dynamics of x_{n-1}, \dots, x_1 , our considerations can be extended to dynamics on semi-infinite configurations (having a rightmost particle). In doing so, one should restrict the class of distributions allowed as initial conditions for the q -Hahn TASEP. We do not investigate such an extension here.

Let \mathbb{Y}_N denote the subset of $\bigsqcup_{k \geq 1} \mathbb{Y}^k$ consisting of configurations such that $y_i = 0$ unless $1 \leq i \leq N$. Define the function $H : \mathbb{X}_N \times \bigsqcup_{k \geq 1} \mathbb{Y}^k \rightarrow \mathbb{R}$ by

$$H(\vec{x}, \vec{y}) := \begin{cases} \prod_{i=1}^N q^{y_i(x_i+i)}, & \vec{y} \in \mathbb{Y}_N; \\ 0, & \text{otherwise.} \end{cases}$$

Theorem 5.6. [22] *The function $H(\vec{x}, \vec{y})$ serves as a Markov duality functional between the q -Hahn TASEP and the q -Hahn zero-range process in the following sense:*

$$\mathbb{E}_{\vec{x}_0}^{\text{TASEP}} H(\vec{x}(t), \vec{y}_0) = \mathbb{E}_{\vec{y}_0}^{\text{ZRP}} H(\vec{x}_0, \vec{y}(t)), \quad \vec{x}_0 \in \mathbb{X}_N, \quad \vec{y}_0 \in \mathbb{Y}_N, \quad t = 0, 1, 2, \dots \tag{5.2}$$

Here in the left-hand side the expectation is taken over the N -particle q -Hahn TASEP started from the initial configuration \vec{x}_0 , and in the right-hand side the expectation is taken over the q -Hahn zero-range process started from the initial configuration \vec{y}_0 .

This result generalizes known dualities for the continuous and discrete time q -TASEPs [9, 16]. In Sect. 5.6 below we rewrite Theorem 5.6 in a form of q -Hahn evolution equations, and use our spatial Plancherel formula (Theorem 3.4) to solve these equations.

5.4. Coordinate Bethe ansatz integrability and the left (= backward) eigenfunctions. It is possible to write the action of the q -Hahn transition operator in terms of a free operator subject to certain two-body boundary conditions. This was done in [48], see also [22]. This and the next subsection are essentially citations from these two papers.

Denote by $\nabla_{\mu, \nu}^{\text{bwd}}$ the operator acting on functions in one variable as

$$\nabla_{\mu, \nu}^{\text{bwd}} f(n) := \frac{\mu - \nu}{1 - \nu} f(n - 1) + \frac{1 - \mu}{1 - \nu} f(n).$$

Also, let the *free backward operator* be defined by

$$\left(\mathcal{L}_{q, \mu, \nu}^{\text{bwd}} u \right) (\vec{n}) := \prod_{i=1}^k [\nabla_{\mu, \nu}^{\text{bwd}}]_i u(\vec{n}).$$

Here $[\nabla_{\mu, \nu}^{\text{bwd}}]_i$ denotes the operator $\nabla_{\mu, \nu}^{\text{bwd}}$ acting on the variable n_i . This operator acts on compactly supported functions on the whole \mathbb{Z}^k (so we drop the assumption that the coordinates n_j are ordered). Note that the operators $[\nabla_{\mu, \nu}^{\text{bwd}}]_i$ for different i act independently, so the order of their product in the definition of $\mathcal{L}_{q, \mu, \nu}^{\text{bwd}}$ does not matter.

Definition 5.7. We say that a function u on \mathbb{Z}^k satisfies the $(k - 1)$ *backward two-body boundary conditions* if

$$\left(\nu(1 - q)u(\vec{n}_{i, i+1}^-) + (q - \nu)u(\vec{n}_{i+1}^-) + (1 - q)u(\vec{n}) - (1 - q\nu)u(\vec{n}_i^-) \right) \Big|_{\vec{n} \in \mathbb{Z}^k : n_i = n_{i+1}} = 0 \tag{5.3}$$

for all $1 \leq i \leq k - 1$. Denote by $\mathcal{B}_{q, \nu}^{\text{bwd}}$ the operator in the left-hand side of (5.3).

The notion of integrability of the q -Hahn particle system listed in the next proposition dates back to Bethe [8].

Proposition 5.8 (Coordinate Bethe ansatz integrability). *If $u: \mathbb{Z}^k \rightarrow \mathbb{C}$ satisfies the $(k-1)$ backward boundary conditions (5.3), then for all $\vec{n} \in \mathbb{W}^k$,*

$$(\mathcal{L}_{q,\mu,\nu}^{\text{bwd}} u)(\vec{n}) = (\mathcal{H}_{q,\mu,\nu}^{\text{bwd}} u)(\vec{n}).$$

This proposition allows to construct eigenfunctions for the backward operator $\mathcal{H}_{q,\mu,\nu}^{\text{bwd}}$ by employing the coordinate Bethe ansatz. See, e.g., [15, §2.3] for a detailed description of this procedure.

As a first step for the Bethe ansatz, we find eigenfunctions for the one-particle free operators $[\nabla_{\mu,\nu}^{\text{bwd}}]_i$. These clearly are given by power functions, which we will write in the following form ($n \in \mathbb{Z}$, $z \in \overline{\mathbb{C}} \setminus \{1, \nu^{-1}\}$):

$$f_z^{\text{bwd}}(n) := \left(\frac{1-z}{1-\nu z} \right)^{-n}, \quad \nabla_{\mu,\nu}^{\text{bwd}} f_z^{\text{bwd}} = \frac{1-\mu z}{1-\nu z} f_z^{\text{bwd}}.$$

Any linear combination of these functions of the form

$$\Psi_{\vec{z}}^{\text{bwd}}(\vec{n}) = \sum_{\sigma \in S(k)} L_{\sigma}(\vec{z}) \prod_{j=1}^k f_{z_{\sigma(j)}}^{\text{bwd}}(n_j)$$

is an eigenfunction of the free operator $\mathcal{L}_{q,\mu,\nu}^{\text{bwd}}$ with the eigenvalue

$$\text{ev}_{\mu,\nu}(\vec{z}) := \prod_{j=1}^k \frac{1-\mu z_j}{1-\nu z_j}. \quad (5.4)$$

The next step is to select (among all possible linear combinations $\Psi_{\vec{z}}^{\text{bwd}}(\vec{n})$) the eigenfunctions which satisfy the boundary conditions of Definition 5.7. This can be done by taking (cf. [15, Lemma 2.8])

$$L_{\sigma}(\vec{z}) = \text{sgn}(\sigma) \prod_{1 \leq B < A \leq k} S(z_{\sigma(A)}, z_{\sigma(B)}),$$

$$S(z_1, z_2) := \frac{(\mathcal{B}_{q,\nu}^{\text{bwd}}(f_{z_1}^{\text{bwd}} \otimes f_{z_2}^{\text{bwd}}))(n, n)}{(f_{z_1}^{\text{bwd}} \otimes f_{z_2}^{\text{bwd}})(n, n)}. \quad (5.5)$$

A direct computation yields

$$(\mathcal{B}_{q,\nu}^{\text{bwd}}(f_{z_1}^{\text{bwd}} \otimes f_{z_2}^{\text{bwd}}))(n_1, n_2) = \frac{(1-\nu)^2}{(1-\nu z_1)(1-\nu z_2)} (z_1 - qz_2) f_{z_1}^{\text{bwd}}(n_1) f_{z_2}^{\text{bwd}}(n_2),$$

$$n_1, n_2 \in \mathbb{Z}.$$

Note that if $n_1 = n_2$, then $z_1 - qz_2$ is the only part of the above expression which is not symmetric in $z_1 \leftrightarrow z_2$.

Therefore, we can take

$$L_{\sigma}(\vec{z}) = \prod_{1 \leq B < A \leq k} \frac{z_{\sigma(A)} - qz_{\sigma(B)}}{z_{\sigma(A)} - z_{\sigma(B)}}.$$

Note that this expression differs from the one in (5.5) by a factor depending only on \vec{z} and not on \vec{n} , and the sign $\text{sgn}(\sigma)$ in (5.5) is absorbed into the Vandermonde in the denominator. With the above choice of L_σ , we arrive at the following *backward eigenfunctions* ($\vec{n} \in \mathbb{Z}^k, z_1, \dots, z_k \in \mathbb{C} \setminus \{1, v^{-1}\}$):

$$\Psi_{\vec{z}}^{\text{bwd}}(\vec{n}) := \sum_{\sigma \in S(k)} \prod_{1 \leq B < A \leq k} \frac{z_{\sigma(A)} - qz_{\sigma(B)}}{z_{\sigma(A)} - z_{\sigma(B)}} \prod_{j=1}^k \left(\frac{1 - z_{\sigma(j)}}{1 - vz_{\sigma(j)}} \right)^{-n_j}.$$

Proposition 5.9 [48, §4]. *The function $\Psi_{\vec{z}}^{\text{bwd}}$ is an eigenfunction of the backward free operator $\mathcal{L}_{q,\mu,v}^{\text{bwd}}$ with the eigenvalue $\text{ev}_{\mu,v}(\vec{z})$ (5.4). Moreover, it satisfies the $(k - 1)$ two-body backward boundary conditions (5.3). Consequently, $\Psi_{\vec{z}}^{\text{bwd}}(\vec{n})$ restricted to $\vec{n} \in \mathbb{W}^k$ is an eigenfunction of the backward true q -Hahn operator $\mathcal{H}_{q,\mu,v}^{\text{bwd}}$, with the eigenvalue $\text{ev}_{\mu,v}(\vec{z})$.*

The eigenfunctions $\Psi_{\vec{z}}^{\text{bwd}}$ constructed above coincide with the left eigenfunctions $\Psi_{\vec{z}}^\ell$ (2.11).

It seems remarkable that the eigenfunctions depend only on two of the parameters q, μ , and v entering the operator $\mathcal{H}_{q,\mu,v}^{\text{bwd}}$.¹³ In other words, all operators $\mathcal{H}_{q,\mu,v}^{\text{bwd}}$ with the same parameters (q, v) have the same eigenfunctions. This observation points to a similarity of the q -Hahn stochastic particle system with other integrable models, cf. the presence of commuting transfer matrices in various solvable lattice models [5].

5.5. PT-symmetry and the right (= forward) eigenfunctions. The q -Hahn transition operator $\mathcal{H}_{q,\mu,v}^{\text{bwd}}$ is not Hermitian symmetric. To obtain eigenfunctions of its transpose, another property called PT-symmetry should be employed. A manifestation of PT-symmetry is the relation between the left and right eigenfunctions listed in the end of Sect. 2.3.

Let

$$\mathcal{H}_{q,\mu,v}^{\text{fwd}} := (\mathcal{H}_{q,\mu,v}^{\text{bwd}})^{\text{transpose}}, \quad \mathcal{H}_{q,\mu,v}^{\text{cfwd}} := \mathfrak{m}_{q,v}^{-1} \mathcal{H}_{q,\mu,v}^{\text{fwd}} \mathfrak{m}_{q,v},$$

where $\mathfrak{m}_{q,v}$ is the diagonal operator of multiplication by $\mathfrak{m}_{q,v}(\vec{n})$ given by (2.13). Recall also the space reflection operator \mathcal{R} (2.15).

Proposition 5.10 (PT-symmetry). *We have*

$$\mathcal{H}_{q,\mu,v}^{\text{cfwd}} = \mathcal{R} \mathcal{H}_{q,\mu,v}^{\text{bwd}} \mathcal{R}^{-1} \quad \text{and} \quad \mathcal{H}_{q,\mu,v}^{\text{fwd}} = (\mathfrak{m}_{q,v} \mathcal{R}) \mathcal{H}_{q,\mu,v}^{\text{bwd}} (\mathfrak{m}_{q,v} \mathcal{R})^{-1}.$$

Proof. See [48, §3], and also [49]. \square

This means that the action of the conjugated forward operator $\mathcal{H}_{q,\mu,v}^{\text{cfwd}}$ is the same as that of $\mathcal{H}_{q,\mu,v}^{\text{bwd}}$, but in the opposite space (i.e., lattice) direction. It thus suffices to construct the Bethe ansatz eigenfunctions for the conjugated forward operator $\mathcal{H}_{q,\mu,v}^{\text{cfwd}}$. This is done very similarly to the case of the operator $\mathcal{H}_{q,\mu,v}^{\text{bwd}}$, see Sect. 5.4 above. Let us record the necessary modifications. The one-particle operator and the free operator (corresponding to $\mathcal{H}_{q,\mu,v}^{\text{cfwd}}$) are

$$\nabla_{\mu,v}^{\text{fwd}} f(n) := \frac{\mu - v}{1 - v} f(n + 1) + \frac{1 - \mu}{1 - v} f(n), \quad \left(\mathcal{L}_{q,\mu,v}^{\text{cfwd}} u \right) (\vec{n}) := \prod_{i=1}^k [\nabla_{\mu,v}^{\text{fwd}}]_i u(\vec{n}).$$

¹³ Recall that this property greatly helped us to derive the spectral biorthogonality of the eigenfunctions (Theorem 4.3).

Definition 5.11. We say that a function u on \mathbb{Z}^k satisfies the $(k - 1)$ forward two-body boundary conditions if

$$\left(v(1 - q)u(\vec{n}_{i,i+1}^+) + (q - v)u(\vec{n}_i^+) + (1 - q)u(\vec{n}) - (1 - qv)u(\vec{n}_{i+1}^+) \right) \Big|_{\vec{n} \in \mathbb{Z}^k : n_i = n_{i+1}} = 0 \tag{5.6}$$

for all $1 \leq i \leq k - 1$.

Proposition 5.12 (Coordinate Bethe ansatz integrability). *If $u : \mathbb{Z}^k \rightarrow \mathbb{C}$ satisfies the $(k - 1)$ forward boundary conditions (5.6), then for all $\vec{n} \in \mathbb{W}^k$,*

$$(\mathcal{L}_{q,\mu,v}^{\text{cfwd}} u)(\vec{n}) = (\mathcal{H}_{q,\mu,v}^{\text{cfwd}} u)(\vec{n}).$$

Continuing to apply the coordinate Bethe ansatz similarly to Sect. 5.4, we arrive at the eigenfunctions

$$\Psi_{\vec{z}}^{\text{cfwd}}(\vec{n}) := \sum_{\sigma \in S(k)} \prod_{1 \leq B < A \leq k} \frac{z_{\sigma(A)} - q^{-1}z_{\sigma(B)}}{z_{\sigma(A)} - z_{\sigma(B)}} \prod_{j=1}^k \left(\frac{1 - vz_{\sigma(j)}}{1 - z_{\sigma(j)}} \right)^{-n_j}$$

which satisfy:

Proposition 5.13. *The function $\Psi_{\vec{z}}^{\text{cfwd}}$ is an eigenfunction of the free operator $\mathcal{L}_{q,\mu,v}^{\text{cfwd}}$ with the eigenvalue $\text{ev}_{\mu,v}(\vec{z})$ (5.4). Moreover, it satisfies the $(k - 1)$ two-body forward boundary conditions (5.6). Consequently, $\Psi_{\vec{z}}^{\text{cfwd}}(\vec{n})$ restricted to $\vec{n} \in \mathbb{W}^k$ is an eigenfunction of $\mathcal{H}_{q,\mu,v}^{\text{cfwd}}$, with the eigenvalue $\text{ev}_{\mu,v}(\vec{z})$.*

Returning to the forward operator $\mathcal{H}_{q,\mu,v}^{\text{fwd}}$, we get its eigenfunctions

$$\Psi_{\vec{z}}^{\text{fwd}}(\vec{n}) := (-1)^k (1 - q)^k q^{\frac{k(k-1)}{2}} \mathfrak{m}_{q,v}(\vec{n}) \Psi_{\vec{z}}^{\text{cfwd}}(\vec{n}).$$

It then follows from Proposition 5.10 that $\mathcal{H}_{q,\mu,v}^{\text{fwd}} \Psi_{\vec{z}}^{\text{fwd}} = \text{ev}_{\mu,v}(\vec{z}) \Psi_{\vec{z}}^{\text{fwd}}$. The eigenfunctions $\Psi_{\vec{z}}^{\text{fwd}}$ coincide with the right eigenfunctions $\Psi_{\vec{z}}^r$ (2.14) (the constant not depending on \vec{n} in front of $\Psi_{\vec{z}}^{\text{fwd}}$ is chosen to make certain formulas simpler).

5.6. Solving backward and forward evolution equations for the q -Hahn system. It is possible to solve the backward and forward Kolmogorov equations (with compactly supported initial conditions) associated to the q -Hahn system $\vec{n}(t)$. The backward equation governs the evolution of expectations of deterministic functions in the spatial variables $\vec{n}(t)$, and the forward equation corresponds to the evolution of measures on the state space \mathbb{W}^k .

Proposition 5.14 (Backward evolution equation). *For any $f_0 \in \mathcal{W}^k$, the backward equation with initial condition*

$$\begin{cases} f(t + 1; \vec{n}) = (\mathcal{H}_{q,\mu,v}^{\text{bwd}} f)(t; \vec{n}), & t \in \mathbb{Z}_{\geq 0}; \\ f(0, \vec{n}) = f_0(\vec{n}), \end{cases} \tag{5.7}$$

has a unique solution given by

$$\begin{aligned}
 f(t; \vec{n}) &= ((\mathcal{H}_{q,\mu,v}^{\text{bwd}})^t f_0)(\vec{n}) \\
 &= \sum_{\lambda \vdash k} \oint_{\mathcal{Y}_k} \dots \oint_{\mathcal{Y}_k} dm_{\lambda}^{(q)}(\vec{w}) \prod_{j=1}^{\ell(\lambda)} \frac{1}{(w_j; q)_{\lambda_j} (vw_j; q)_{\lambda_j}} \\
 &\quad \times (\mathbf{ev}_{\mu,v}(\vec{w} \circ \lambda))^t \Psi_{\vec{w} \circ \lambda}^{\ell}(\vec{n}) \langle f_0, \Psi_{\vec{w} \circ \lambda}^r \rangle_{\mathcal{W}^k} \\
 &= \oint_{\mathcal{Y}_1} \frac{dz_1}{2\pi \mathbf{i}} \dots \oint_{\mathcal{Y}_k} \frac{dz_k}{2\pi \mathbf{i}} \prod_{1 \leq A < B \leq k} \frac{z_A - z_B}{z_A - qz_B} \prod_{j=1}^k \left(\frac{1 - \mu z_j}{1 - \nu z_j} \right)^t \\
 &\quad \times \prod_{j=1}^k \frac{1}{(1 - z_j)(1 - \nu z_j)} \left(\frac{1 - z_j}{1 - \nu z_j} \right)^{-n_j} \langle f_0, \Psi_z^r \rangle_{\mathcal{W}^k}.
 \end{aligned} \tag{5.8}$$

Consequently, (5.8) provides an expression for the expectations

$$f(t; \vec{n}) = \mathbb{E}[f_0(\vec{n}(t)) \mid \vec{n}(0) = \vec{n}] \tag{5.9}$$

for any $f_0 \in \mathcal{W}^k$.

Proposition 5.15 (Forward evolution equation). *For any $f_0 \in \mathcal{W}^k$, the forward equation with initial condition*

$$\begin{cases} f(t + 1; \vec{n}) = (\mathcal{H}_{q,\mu,v}^{\text{fwd}} f)(t; \vec{n}), & t \in \mathbb{Z}_{\geq 0}; \\ f(0, \vec{n}) = f_0(\vec{n}), \end{cases} \tag{5.10}$$

has a unique solution given by

$$\begin{aligned}
 f(t; \vec{n}) &= ((\mathcal{H}_{q,\mu,v}^{\text{fwd}})^t f_0)(\vec{n}) \\
 &= \sum_{\lambda \vdash k} \oint_{\mathcal{Y}_k} \dots \oint_{\mathcal{Y}_k} dm_{\lambda}^{(q)}(\vec{w}) \prod_{j=1}^{\ell(\lambda)} \frac{1}{(w_j; q)_{\lambda_j} (\nu w_j; q)_{\lambda_j}} \\
 &\quad \times (\mathbf{ev}_{\mu,v}(\vec{w} \circ \lambda))^t \Psi_{\vec{w} \circ \lambda}^r(\vec{n}) \langle \Psi_{\vec{w} \circ \lambda}^{\ell}, f_0 \rangle_{\mathcal{W}^k} \\
 &= (-1)^k (1 - q)^k m_{q,\nu}(\vec{n}) \oint_{\mathcal{Y}_1} \frac{dz_1}{2\pi \mathbf{i}} \dots \oint_{\mathcal{Y}_k} \frac{dz_k}{2\pi \mathbf{i}} \prod_{1 \leq A < B \leq k} \frac{z_A - z_B}{z_A - qz_B} \\
 &\quad \times \prod_{j=1}^k \left(\frac{1 - \mu z_j}{1 - \nu z_j} \right)^t \prod_{j=1}^k \frac{1}{(1 - z_j)(1 - \nu z_j)} \left(\frac{1 - z_j}{1 - \nu z_j} \right)^{n_{k+1-j}} \langle \Psi_z^{\ell}, f_0 \rangle_{\mathcal{W}^k}.
 \end{aligned} \tag{5.11}$$

Consequently, the transition probabilities of the q -Hahn particle system

$$P_{\vec{y}}(t; \vec{x}) := \text{Prob} \{ \vec{n}(t) = \vec{x} \mid \vec{n}(0) = \vec{y} \}, \quad t = 0, 1, \dots,$$

are given by any of the two formulas in the right-hand side of (5.11), with $\vec{n} = \vec{x}$ and $f_0(\vec{n}) = \mathbf{1}_{\vec{n}=\vec{y}}$.

Proof of Propositions 5.14 and 5.15. The uniqueness in both cases is evident because both operators $\mathcal{H}_{q,\mu,\nu}^{\text{bwd}}$ and $\mathcal{H}_{q,\mu,\nu}^{\text{fwd}}$ are triangular. The rest follows by applying $\mathcal{H}_{q,\mu,\nu}^{\text{bwd}}$ or $\mathcal{H}_{q,\mu,\nu}^{\text{fwd}}$, respectively, to appropriate identities of Corollary 3.10. To rewrite integral expressions with the large contours γ in nested form, we have used Proposition 3.2. To get the second formula in Proposition 5.15, we also employed the swapping operator \mathcal{P} discussed in Sect. 2.3. \square

For the formulas (5.8)–(5.11) to be more explicit, one would need to express the initial conditions $f_0(\vec{n})$ through the eigenfunctions, which will allow to effectively compute the bilinear pairings $\langle \cdot, \cdot \rangle_{\mathcal{W}^k}$ in (5.8)–(5.11). We do not expect that this can be done explicitly for generic $f_0(\vec{n})$. We will discuss this issue in more detail for particular choices of $f_0(\vec{n})$ in Sect. 5.7 below.

5.7. Nested contour integral formulas for the q -Hahn TASEP. Recall the N -particle q -Hahn TASEP discussed in Sect. 5.3, $N \geq 1$. Utilizing its duality with the q -Hahn stochastic particle system (Theorem 5.6), it is possible to provide moment formulas for the q -Hahn TASEP started from an arbitrary initial configuration. The argument here essentially repeats the one in [15, §4.3].

Let us fix $k \geq 1$. Define \mathbb{W}_N^k to be the (finite) subset of \mathbb{W}^k determined by the inequalities $N \geq n_1 \geq \dots \geq n_k \geq 1$.¹⁴ Let us define for (possibly random) initial data $\vec{x}(0)$ for the q -Hahn TASEP,

$$h_0(\vec{n}) := \mathbb{E} \left[\prod_{i=1}^k q^{x_{n_i}(0)+n_i} \right] \tag{5.12}$$

if $\vec{n} \in \mathbb{W}_N^k$, and $h_0(\vec{n}) = 0$ otherwise. Above the expectation is taken with respect to possibly random $\vec{x}(0)$, and we assume that it exists. Then it follows from Theorem 5.6 that the function

$$h(t; \vec{n}) := \mathbb{E} \left[\prod_{i=1}^k q^{x_{n_i}(t)+n_i} \right] \tag{5.13}$$

(with the expectation taken with respect to the q -Hahn TASEP, as well as with respect to the possibly random $\vec{x}(0)$), solves the backward evolution equation (5.7) with initial condition $h(0; \vec{n}) = h_0(\vec{n})$. Proposition 5.14 then immediately implies the following:

Corollary 5.16. *For the q -Hahn TASEP with initial data $\vec{x}(0)$, the q -moments (5.13) at any time $t = 0, 1, 2, \dots$ are given by (5.8) with $f_0(\vec{n}) = h_0(\vec{n})$ defined in (5.12).*

The nested contour integral formulas (5.8) involve the pairing $\langle h_0, \Psi_{\vec{z}}^t \rangle_{\mathcal{W}^k}$ of the initial condition with the right eigenfunction. An immediate application of the spectral Plancherel formula (Theorem 3.9) shows that when $h_0(\vec{n})$ itself can be written as $(\mathcal{J}^{q,\nu} G)(\vec{n})$ for some $G \in \mathcal{C}_{\vec{z}}^k$, then this pairing has the form $\langle h_0, \Psi_{\vec{z}}^t \rangle_{\mathcal{W}^k} = G(\vec{z})$. So, for such special initial conditions one would get simpler formulas for the q -moments of the q -Hahn TASEP (5.8), which could be useful for further asymptotic analysis.

Let us apply this idea to the half-stationary (and, in particular, to the step) initial condition in the q -Hahn TASEP. Let us fix $\rho \in [0, 1)$, and consider independent random variables X_i with the common distribution

¹⁴ Under the bijection of \mathbb{W}^k with \mathbb{Y}^k (Sect. 5.1), \mathbb{W}_N^k corresponds to $\mathbb{Y}_N \cap \mathbb{Y}^k$ (the set \mathbb{Y}_N is defined in Sect. 5.3).

$$\text{Prob}(X_i = n) = \rho^n \frac{(v; q)_n}{(q; q)_n} \frac{(\rho; q)_\infty}{(\rho v; q)_\infty}, \quad n = 0, 1, 2, \dots \tag{5.14}$$

The fact that these probabilities sum to one follows from the q -Binomial theorem. This distribution corresponds to the product stationary measure of the q -Hahn particle system, cf. [22, 48].

The half-stationary initial condition is, by definition,

$$x_1(0) = -1 - X_1, \text{ and } x_i(0) = x_{i-1}(0) - 1 - X_i \text{ for } i > 1.$$

When $\rho = 0$, the half stationary initial condition reduces to the step initial condition $x_i(0) = -i, i = 1, 2, \dots$

Proposition 5.17. *Let $0 \leq \rho < q^k$. Then for any $\vec{n} \in \mathbb{W}^k$, we have for the half-stationary initial data:*

$$h_0^{\text{half}}(\vec{n}) = \prod_{j=1}^k \mathbf{1}_{0 < n_j \leq N} \left(\frac{1 - \rho v q^{-j}}{1 - \rho q^{-j}} \right)^{n_j}.$$

In particular, the step initial data corresponds to $h_0^{\text{step}}(\vec{n}) = \prod_{j=1}^k \mathbf{1}_{0 < n_j \leq N}$.

Proof. First, note that if X has distribution (5.14), then by the q -Binomial theorem

$$\begin{aligned} \mathbb{E} \left[q^{-mX} \right] &= \sum_{n=0}^{\infty} (\rho/q^m)^n \frac{(v; q)_n}{(q; q)_n} \frac{(\rho; q)_\infty}{(\rho v; q)_\infty} = \frac{(\rho; q)_\infty}{(\rho v; q)_\infty} \frac{(\rho v q^{-m}; q)_\infty}{(\rho q^{-m}; q)_\infty} \\ &= \prod_{j=1}^m \frac{1 - \rho v q^{-j}}{1 - \rho q^{-j}} \end{aligned}$$

for all $m = 0, 1, 2, \dots$ such that $\rho < q^m$ (otherwise the above series obviously diverges). Next, observe that for the half-stationary initial data, we have (with the understanding that $n_{k+1} = 0$)

$$\prod_{i=1}^k q^{x_{n_i}(0) + n_i} = \prod_{i=1}^k \prod_{m=n_{i+1}+1}^{n_i} q^{-iX_m}.$$

The random variables X_m in the above product are independent, so taking the expectation as above yields the desired result. \square

In fact, we will extend the functions $h_0^{\text{half}}(\vec{n})$ and $h_0^{\text{step}}(\vec{n})$ obtained in the previous proposition to (non-compactly supported) $h_0^{\text{step}}(\vec{n}) := \prod_{j=1}^k \mathbf{1}_{n_j > 0}$, and similarly for $h_0^{\text{half}}(\vec{n})$. By the triangular nature of the q -Hahn operator $\mathcal{H}_{q, \mu, v}^{\text{bwd}}$, this will not affect the values of the q -moments $h^{\text{step}}(t; \vec{n})$ and $h^{\text{half}}(t; \vec{n})$ if $\vec{n} \in \mathbb{W}_N^k$.

Our next goal is to employ the idea discussed after Corollary 5.16, and write down the moment formulas for the q -Hahn TASEP with half-stationary initial condition. Note that formulas corresponding to the step initial data (see Corollary 5.19 below) were obtained in [22].

Proposition 5.18. *Consider any $0 \leq \rho < q^k$. There exist positively oriented closed contours $\gamma_1, \dots, \gamma_k$ and $\tilde{\gamma}_1, \dots, \tilde{\gamma}_k$ which both satisfy the conditions of Definition 2.1, do not include ρ/q , and, moreover, for all $z \in \gamma_i$ and $w \in \tilde{\gamma}_i$ one has $|\Xi(z)| < |\Xi(w)|$ (recall the map Ξ (2.3)).*

Moreover, for any $\vec{z} \in \mathbb{C}^k$ such that $z_i \in \gamma_i$ ($1 \leq i \leq k$),

$$(\mathcal{F}^{q,\nu} h_0^{\text{half}})(\vec{z}) = (-1)^k q^{\frac{k(k-1)}{2}} (\rho \nu q^{-1}; q^{-1})_k \prod_{j=1}^k \frac{1 - z_j}{z_j - \rho/q}. \tag{5.15}$$

Proof. The existence of such contours can be readily obtained similarly to Sect. 4.1.

Assume that $\rho > 0$ as the case $\rho = 0$ is simpler and can be obtained by analogy. Let $G(\vec{z})$ denote the right-hand side of (5.15). Proposition 3.7 with $c = q/(\nu\rho)$ after a shift of n_j 's by one implies that

$$h_0^{\text{half}}(\vec{n}) = (\mathcal{J}^{q,\nu} G)(\vec{n}). \tag{5.16}$$

Since this function G does not belong to \mathcal{C}_z^k , above we have extended the definition of $\mathcal{J}^{q,\nu}$ by requiring that the contours $\gamma_1, \dots, \gamma_k$ must not include the point $c^{-1}\nu^{-1} = \rho/q$.

We show that (5.16) implies (5.15) using the spectral Plancherel formula (Theorem 3.9) plus an approximation argument.

Let $G_m \in \mathcal{C}_z^k$ be a sequence of functions so that as $m \rightarrow \infty$, $G_m(\vec{z})$ converges to $G(\vec{z})$ uniformly over \vec{z} with $z_i \in \gamma_i$. As G_m one could simply take truncations of the Laurent series for $G(\vec{z})$ in variables $\Xi(\vec{z})$. Theorem 3.9 implies that

$$G_m(\vec{z}) = (\mathcal{F}^{q,\nu} \mathcal{J}^{q,\nu} G_m)(\vec{z}) = \sum_{\vec{n} \in \mathbb{W}^k} \Psi_{\vec{z}}^t(\vec{n}) (\mathcal{J}^{q,\nu} G_m)(\vec{n}). \tag{5.17}$$

for all \vec{z} with $z_i \in \gamma_i$ (in fact, the sum goes only over \vec{n} with all parts nonnegative because G and G_m do not have a pole at $z_k = 1$, cf. the statement of Proposition 3.7). Consider the term corresponding to \vec{n} in the summation above. Call \vec{w} the integration variables involved in the definition of $(\mathcal{J}^{q,\nu} G_m)(\vec{n})$. Clearly, these integration variables \vec{w} can be chosen so that $w_i \in \tilde{\gamma}_i$. With this choice of the variables \vec{w} and \vec{z} , the \vec{n} term can be bounded uniformly in m by a constant times $\delta^{n_1 + \dots + n_k}$ for some $\delta < 1$ (which is the maximal ratio of $|\Xi(z_i)/\Xi(w_i)|$ over $z_i \in \gamma_i, w_i \in \tilde{\gamma}_i$ for all $1 \leq i \leq k$). This bound implies that we can take $m \rightarrow \infty$ in (5.17), and thus $(\mathcal{F}^{q,\nu} \mathcal{J}^{q,\nu} G)(\vec{z}) = G(\vec{z})$ as desired. \square

Corollary 5.19. *For the half-stationary initial data with $0 < \rho < q^k$,*

$$\begin{aligned} & \mathbb{E}^{\text{half}} \left[\prod_{i=1}^k q^{x_{n_i}(t) + n_i} \right] \\ &= (-1)^k q^{\frac{k(k-1)}{2}} (\rho \nu q^{-1}; q^{-1})_k \oint_{\gamma_1} \frac{dz_1}{2\pi \mathbf{i}} \dots \oint_{\gamma_k} \frac{dz_k}{2\pi \mathbf{i}} \prod_{1 \leq A < B \leq k} \frac{z_A - z_B}{z_A - qz_B} \\ & \quad \times \prod_{j=1}^k \left(\frac{1 - \mu z_j}{1 - \nu z_j} \right)^t \prod_{j=1}^k \frac{1}{(z_j - \rho/q)(1 - \nu z_j)} \left(\frac{1 - z_j}{1 - \nu z_j} \right)^{-n_j}. \end{aligned} \tag{5.18}$$

Here the integration contours are as in Definition 2.1 with an additional restriction that they do not include ρ/q (this is possible due to the restriction on ρ).

In particular, for the step initial data (case $\rho = 0$ of the above formula),

$$\mathbb{E}^{\text{step}} \left[\prod_{i=1}^k q^{x_{n_i}(t)+n_i} \right] = (-1)^k q^{\frac{k(k-1)}{2}} \oint_{\mathcal{Y}_1} \frac{dz_1}{2\pi\mathbf{i}} \cdots \oint_{\mathcal{Y}_k} \frac{dz_k}{2\pi\mathbf{i}} \prod_{1 \leq A < B \leq k} \frac{z_A - z_B}{z_A - qz_B} \\ \times \prod_{j=1}^k \left(\frac{1 - \mu z_j}{1 - \nu z_j} \right)^t \prod_{j=1}^k \frac{1}{z_j(1 - \nu z_j)} \left(\frac{1 - z_j}{1 - \nu z_j} \right)^{-n_j}. \quad (5.19)$$

Here the integration contours must not include 0.

Proof. This immediately follows from Markov duality (Theorem 5.6) combined with Proposition 5.14 allowing to solve backward evolution equations for the q -Hahn stochastic particle system. \square

Remark 5.20. Formula (5.19) serves as a starting point towards a Fredholm determinantal expression for a q -Laplace transform of the position of any particle $x_n(t)$ in the q -Hahn TASEP started from the step initial condition [22]. To get a Fredholm determinant, one must use moments (5.19) for all $k = 1, 2, \dots$. Thus, in the half-stationary case, the restriction $\rho < q^k$ in (5.18) (i.e., the lack of finiteness of moments) presents an impediment to getting a Fredholm determinantal formula.

5.8. *Symmetrization identities from the spectral Plancherel theorem.* The spectral Plancherel formula (Theorem 3.9) implies a family of nontrivial identities involving the summation over the symmetric group $S(k)$. (This symmetrization comes from the definition of the eigenfunctions, cf. (2.11), (2.14).)

Proposition 5.21. For any $G \in C_z^k$ and $\vec{\xi} = (\xi_1, \dots, \xi_k) \in (\mathbb{C} \setminus \{0\})^k$,

$$\sum_{\sigma \in S(k)} \prod_{B < A} \frac{S_{q,\nu}(\xi_{\sigma(B)}, \xi_{\sigma(A)})}{\xi_{\sigma(A)} - \xi_{\sigma(B)}} \left(\sum_{\vec{n} \in \mathbb{W}^k} m_{q,\nu}(\vec{n})(\mathcal{J}^{q,\nu} G)(\vec{n}) \prod_{j=1}^k \xi_{\sigma(j)}^{n_j} \right) \\ = (q - 1)^{-k} \left(\frac{1 - \nu}{1 - q\nu} \right)^{\frac{k(k-1)}{2}} G(\Xi(\vec{\xi})), \quad (5.20)$$

where Ξ , $S_{q,\nu}$, and $m_{q,\nu}$ are given in (2.3), (2.10), and (2.13), respectively.

Note that the sum over \vec{n} in the left-hand side of (5.20) is finite.

Proof. Theorem 3.9 states that the operator $\mathcal{M}^{q,\nu} = \mathcal{F}^{q,\nu} \mathcal{J}^{q,\nu}$ (3.15) acts as the identity operator in the space C_z^k of symmetric Laurent polynomials in the variables $\frac{1-z_j}{1-\nu z_j}$. Expanding this statement, we can write

$$G(\vec{z}) = (\mathcal{F}^{q,\nu} \mathcal{J}^{q,\nu} G)(\vec{z}) = \sum_{\vec{n} \in \mathbb{W}^k} \Psi_z^t(\vec{n})(\mathcal{J}^{q,\nu} G)(\vec{n}) \\ = (-1)^k (1 - q)^k q^{\frac{k(k-1)}{2}} \sum_{\sigma \in S(k)} \prod_{B < A} \frac{z_{\sigma(A)} - q^{-1}z_{\sigma(B)}}{z_{\sigma(A)} - z_{\sigma(B)}} \sum_{\vec{n} \in \mathbb{W}^k} m_{q,\nu}(\vec{n})(\mathcal{J}^{q,\nu} G)(\vec{n}) \\ \times \prod_{j=1}^k \left(\frac{1 - z_{\sigma(j)}}{1 - \nu z_{\sigma(j)}} \right)^{n_j}.$$

The change of variables Ξ (2.3) yields the desired formula. \square

Let us illustrate Proposition 5.21 with two examples. For the first (simplest possible) example, take $G(\vec{z}) \equiv 1$. Then one can readily check (similarly to the proof of Proposition 3.7) that

$$(\mathcal{J}^{q,\nu}G)(\vec{n}) = \frac{(-1)^k}{(\nu; q)_k} \mathbf{1}_{n_1=\dots=n_k=0}.$$

Thus, the summation over \vec{n} in the left-hand side of (5.20) reduces to a single term, and the whole identity becomes

$$\sum_{\sigma \in S(k)} \prod_{B < A} \frac{\mathcal{S}_{q,\nu}(\xi_{\sigma(B)}, \xi_{\sigma(A)})}{\xi_{\sigma(A)} - \xi_{\sigma(B)}} = \frac{(q; q)_k}{(1-q)^k} \left(\frac{1-\nu}{1-q\nu} \right)^{\frac{k(k-1)}{2}},$$

which (under the change of variables Ξ) is the classical symmetrization identity listed as (3.14) above.

The second example is given in the following corollary:

Corollary 5.22. *For any $k \geq 1$, any $c \in \mathbb{C} \setminus \{\nu^{-1}, q^{-1}\nu^{-1}, \dots, q^{-(k-1)}\nu^{-1}\}$, and any $\xi_1, \dots, \xi_k \in \mathbb{C} \setminus \{0\}$ with $|\xi_i| < \left| \frac{1-c\nu q^{j-1}}{\nu(1-cq^{j-1})} \right|$ for $1 \leq i, j \leq k$,*

$$\begin{aligned} & \sum_{\sigma \in S(k)} \prod_{B < A} \frac{\mathcal{S}_{q,\nu}(\xi_{\sigma(B)}, \xi_{\sigma(A)})}{\xi_{\sigma(A)} - \xi_{\sigma(B)}} \left(\sum_{n_1 \geq \dots \geq n_k \geq 0} m_{q,\nu}(\vec{n}) \prod_{j=1}^k \left(\nu \xi_{\sigma(j)} \frac{1-cq^{j-1}}{1-c\nu q^{j-1}} \right)^{n_j} \right) \\ &= (c\nu; q)_k \left(\frac{1-\nu}{1-q} \right)^k \left(\frac{1-\nu}{1-q\nu} \right)^{\frac{k(k-1)}{2}} \prod_{j=1}^k \frac{1}{(1-c\nu) - \nu \xi_j (1-c)}. \end{aligned} \tag{5.21}$$

In particular, for $c = \infty$,

$$\begin{aligned} & \sum_{\sigma \in S(k)} \prod_{B < A} \frac{\mathcal{S}_{q,\nu}(\xi_{\sigma(B)}, \xi_{\sigma(A)})}{\xi_{\sigma(A)} - \xi_{\sigma(B)}} \left(\sum_{n_1 \geq \dots \geq n_k \geq 0} m_{q,\nu}(\vec{n}) \prod_{j=1}^k \xi_{\sigma(j)}^{n_j} \right) \\ &= \left(\frac{1-\nu}{1-q} \right)^k \left(\frac{q(1-\nu)}{1-q\nu} \right)^{\frac{k(k-1)}{2}} \prod_{j=1}^k \frac{1}{1-\xi_j}, \end{aligned} \tag{5.22}$$

provided that $|\xi_j| < 1$ for $1 \leq j \leq k$.

Proof. Observe that our restrictions on c and the ξ_j 's ensures that both sides of (5.21) are well defined. If c is real and $c > q^{-(k-1)}\nu^{-1}$, the statement follows from Proposition 3.7 plus approximation considerations similar to Sect. 5.7 which allow to work with the function $G(\vec{z}) = \prod_{j=1}^k \frac{1-\nu z_j}{1-c\nu z_j}$ not belonging to the space \mathcal{C}_z^k . (Note that the restriction $c > q^{-(k-1)}\nu^{-1}$ corresponds to the restriction $\rho < q^k$ in Proposition 5.18.) For other values of c , identity (5.21) holds because its both sides are rational functions in c (indeed, the summation over \vec{n} in the left-hand side also results in a rational function, cf. Remark 5.23 below). Finally, the identity (5.22) is a limit of (5.21) as $c \rightarrow \infty$. \square

Remark 5.23. For general parameters q and ν it is not clear how to evaluate the sum over \vec{n} in the left-hand side of (5.22) (or (5.21)) in a closed form. The reason is that the quantities $m_{q,\nu}(\vec{n})$ (2.13) depend on the structure of clusters of \vec{n} . The part of the sum corresponding to each fixed cluster structure of \vec{n} (they are indexed by partitions λ of

k) reduces to a sum of several geometric sequences. For example, for $k = 4$ the terms corresponding to the cluster structure $\lambda = (3, 1)$ are

$$\sum_{m_1 > m_2 \geq 0} \left((\xi_1 \xi_2 \xi_3)^{m_1} \xi_4^{m_2} + \xi_1^{m_1} (\xi_2 \xi_3 \xi_4)^{m_2} \right) = \frac{\xi_1(1 + \xi_2 \xi_3 - 2\xi_1 \xi_2 \xi_3)}{(1 - \xi_1)(1 - \xi_1 \xi_2 \xi_3)(1 - \xi_1 \xi_2 \xi_3 \xi_4)}$$

(we assumed $\sigma = id$ to simplify the notation). The whole sum $\sum_{n_1 \geq \dots \geq n_k \geq 0} m_{q,v}(\vec{n}) \xi_1^{n_1} \dots \xi_k^{n_k}$ is a rational function in the ξ_j 's with the common denominator $(1 - \xi_1)(1 - \xi_1 \xi_2) \dots (1 - \xi_1 \dots \xi_k)$, and it is not clear whether it is possible to express the numerator of this rational function in a closed form.

However, for certain special values of q and v , the coefficients $m_{q,v}(\vec{n})$ simplify, which allows to sum the series in \vec{n} in a closed form. Then identities (5.21)–(5.22) reduce to Tracy–Widom symmetrization identities, see Sect. 7.6 below.

6. Conjugated q -Hahn Operator

In this section we briefly discuss analogues of our main results for the q -Hahn transition operator conjugated in a certain manner. The conjugated operator is no longer stochastic, but the main results can be readily extended to its eigenfunctions. Under a certain degeneration (which we discuss in Sect. 8 below), these eigenfunctions become related to the six-vertex model and the Heisenberg XXZ quantum spin chain. Relations between eigenfunctions of various models are indicated on Fig. 1.

6.1. *Analogues of main results.* Let \mathcal{G}_θ , where $\theta \in \mathbb{C} \setminus \{0\}$, be the dilation operator acting on \mathcal{W}^k by

$$(\mathcal{G}_\theta f)(\vec{n}) := \theta^{n_1 + \dots + n_k} f(\vec{n}), \tag{6.1}$$

and consider the *conjugated q -Hahn operator* $\mathcal{G}_\theta^{-1} \mathcal{H}_{q,\mu,v}^{\text{bwd}} \mathcal{G}_\theta$. Note that for $\theta \neq 1$ this operator is no longer stochastic. As in the stochastic $\theta = 1$ case (cf. Sect. 5.5), the conjugated operator $\mathcal{G}_\theta^{-1} \mathcal{H}_{q,\mu,v}^{\text{bwd}} \mathcal{G}_\theta$ is not Hermitian symmetric.

Let us explain how our main results (Plancherel formulas, spectral biorthogonality, symmetrization identities) can be extended to left and right eigenfunctions ($\mathcal{G}_\theta^{-1} \Psi_z^\ell$ and $\mathcal{G}_\theta \Psi_z^r$, respectively) of the conjugated q -Hahn operator. All modified results below in this section are equivalent to the corresponding results in Sects. 3, 4, and 5.

A slightly different notation for the modified functions turns out to be convenient (cf. (2.11) and (2.14)):

$$\Psi_z^{\ell;\theta}(\vec{n}) := \sum_{\sigma \in S(k)} \prod_{B < A} \frac{z_{\sigma(A)} - qz_{\sigma(B)}}{z_{\sigma(A)} - z_{\sigma(B)}} \prod_{j=1}^k \left(\frac{\theta - z_{\sigma(j)}}{1 - \nu z_{\sigma(j)}} \right)^{-n_j}, \tag{6.2}$$

$$\begin{aligned} \Psi_z^{r;\theta}(\vec{n}) &:= (-1)^k (1 - q)^k q^{\frac{k(k-1)}{2}} m_{q,v,\theta}(\vec{n}) \\ &\times \sum_{\sigma \in S(k)} \prod_{B < A} \frac{z_{\sigma(A)} - q^{-1}z_{\sigma(B)}}{z_{\sigma(A)} - z_{\sigma(B)}} \prod_{j=1}^k \left(\frac{\theta - z_{\sigma(j)}}{1 - \nu z_{\sigma(j)}} \right)^{n_j}, \end{aligned} \tag{6.3}$$

where $m_{q,v,\theta}(\vec{n}) := \prod_{j=1}^{M(\vec{n})} \frac{(\theta v; q)_{c_j}}{(q; q)_{c_j}}$, cf. (2.13). The restrictions on parameters are $0 < q < 1$ and $0 \leq \mu \leq \theta v < 1$. When $\theta = 1$, the functions (6.2)–(6.3) become the eigenfunctions Ψ_z^ℓ and Ψ_z^r studied in the previous sections.

Proposition 6.1. *The functions $\Psi_{\bar{z}}^{\ell;\theta}$ and $\Psi_{\bar{z}}^{r;\theta}$ are respectively the left and right eigenfunctions of the conjugated q -Hahn operator $\mathcal{G}_{\theta}^{-1}\mathcal{H}_{q,\mu,\theta v}^{\text{bwd}}\mathcal{G}_{\theta}$. The eigenvalue of either $\Psi_{\bar{z}}^{\ell;\theta}$ or $\Psi_{\bar{z}}^{r;\theta}$ is equal to $\prod_{j=1}^k \frac{1-\mu z_j/\theta}{1-\nu z_j}$.*

Proof. One can readily check that

$$\Psi_{\bar{z}}^{\ell;\theta}(\vec{n}) = \theta^{-n_1-\dots-n_k} \Psi_{\bar{z}/\theta}^{\ell}(\vec{n})|_{v \rightarrow \theta v}, \quad \Psi_{\bar{z}}^{r;\theta}(\vec{n}) = \theta^{n_1+\dots+n_k} \Psi_{\bar{z}/\theta}^r(\vec{n})|_{v \rightarrow \theta v},$$

so the claim follows by considering the functions $\mathcal{G}_{\theta}^{-1}\Psi_{\bar{z}}^{\ell}$ and $\mathcal{G}_{\theta}\Psi_{\bar{z}}^r$ and rescaling the spectral variables $z_j \rightarrow z_j/\theta$ and the parameter $\nu \rightarrow \theta\nu$. \square

Note that the eigenfunctions $\Psi_{\bar{z}}^{\ell;\theta}$ and $\Psi_{\bar{z}}^{r;\theta}$ (6.2)–(6.3) can be constructed by applying the coordinate Bethe ansatz to the conjugated operator $\mathcal{G}_{\theta}^{-1}\mathcal{H}_{q,\mu,\theta v}^{\text{bwd}}\mathcal{G}_{\theta}$ similarly to what was done in Sects. 5.4 and 5.5.

Remark 6.2. Note that replacing $\frac{\theta-z}{1-\nu z}$ in (6.2)–(6.3) by a generic linear fractional expression $\frac{az+b}{cz+d}$ does not introduce further generality. Indeed, the third independent parameter coming from a generic expression could be absorbed by rescaling the spectral variables \bar{z} . Thus, the conjugated q -Hahn eigenfunctions (6.2)–(6.3) are essentially the most general rational symmetric functions which can be obtained from the Hall–Littlewood polynomials [40, Ch. III]

$$P_{\lambda}(z_1, \dots, z_k; t) = \text{const}_{\lambda,k} \cdot \sum_{\sigma \in S(k)} \prod_{B < A} \frac{z_{\sigma(B)} - t z_{\sigma(A)}}{z_{\sigma(B)} - z_{\sigma(A)}} z_{\sigma(1)}^{\lambda_1} \cdots z_{\sigma(k)}^{\lambda_k},$$

$$\lambda_1 \geq \dots \geq \lambda_k \geq 0, \quad \lambda_i \in \mathbb{Z}$$

by replacing the power terms $z_{\sigma(j)}^{\lambda_j}$ by arbitrary linear fractional expressions (raised to powers λ_j). See also Sect. 9.4 and [63] for a discussion of an interacting particle system diagonalized by the Hall–Littlewood polynomials.

Define the modified map $\Xi_{\theta}(z) := \frac{\theta-z}{1-\nu z}$ (cf. (2.3)). One readily checks that it is an involution, too: $\Xi_{\theta}(\Xi_{\theta}(z)) = z$. Let $\mathcal{C}_{z;\theta}^k$ be the space of symmetric Laurent polynomials in the variables $\Xi_{\theta}(z_1), \dots, \Xi_{\theta}(z_k)$. The map Ξ_{θ} is an isomorphism between $\mathcal{C}_{z;\theta}^k$ and the space \mathcal{C}_{ξ}^k of symmetric Laurent polynomials in the variables ξ_1, \dots, ξ_k . In this way the functions (6.2)–(6.3) induce the following functions in the variables $\vec{\xi}$ (cf. (4.3)–(4.4)):

$$\Phi_{\vec{\xi}}^{\ell;\theta}(\vec{n}) := \sum_{\sigma \in S(k)} \text{sgn}(\sigma) \prod_{B < A} \mathcal{S}_{q,v,\theta}(\xi_{\sigma(A)}, \xi_{\sigma(B)}) \prod_{j=1}^k \xi_{\sigma(j)}^{-n_j}; \tag{6.4}$$

$$\Phi_{\vec{\xi}}^{r;\theta}(\vec{n}) := m_{q,v,\theta}(\vec{n}) \left(\frac{1-q}{1-\theta v} \right)^k \sum_{\sigma \in S(k)} \text{sgn}(\sigma) \prod_{B < A} \mathcal{S}_{q,v,\theta}(\xi_{\sigma(B)}, \xi_{\sigma(A)}) \prod_{j=1}^k \xi_{\sigma(j)}^{n_j}, \tag{6.5}$$

where

$$\mathcal{S}_{q,v,\theta}(\xi_1, \xi_2) := \frac{\theta(1-q)}{1-q\theta v} + \frac{q-\theta v}{1-q\theta v} \xi_2 + \frac{\nu(1-q)}{1-q\theta v} \xi_1 \xi_2 - \xi_1. \tag{6.6}$$

One can readily check that

$$\begin{aligned} \Psi_{\Xi_\theta(\vec{\xi})}^{\ell;\theta}(\vec{n}) &= \frac{1}{\mathbf{V}(\vec{\xi})} \left(\frac{1 - q\theta v}{1 - \theta v} \right)^{\frac{k(k-1)}{2}} \Phi_{\vec{\xi}}^{\ell;\theta}(\vec{n}), \\ \Psi_{\Xi_\theta(\vec{\xi})}^{r;\theta}(\vec{n}) &= \frac{(-1)^{\frac{k(k+1)}{2}}}{\mathbf{V}(\vec{\xi})} (1 - \theta v)^k \left(\frac{1 - q\theta v}{1 - \theta v} \right)^{\frac{k(k-1)}{2}} \Phi_{\vec{\xi}}^{r;\theta}(\vec{n}). \end{aligned} \tag{6.7}$$

(this should be compared to formulas (2.19)–(2.20)).

Remark 6.3. The quadratic cross-term $\mathcal{S}_{q,v,\theta}(\xi_1, \xi_2)$ depends on three parameters, and so one may also parametrize the eigenfunctions by $\alpha = \frac{v(1-q)}{1-q\theta v}$, $\beta = \frac{q-\theta v}{1-q\theta v}$, and $\gamma = \frac{\theta(1-q)}{1-q\theta v}$, where now $\alpha + \beta + \gamma$ is not necessarily equal to 1 (cf. Remark 2.4). We see that the cross-term $\mathcal{S}_{q,v,\theta}$ now takes a “generic” form, which is another indication towards the claim discussed in Remark 6.2 above.

Note also that formulas expressing (q, v, θ) through (α, β, γ) involve solving quadratic equations which greatly simplify when $\alpha + \beta + \gamma = 1$.

Definition 6.4. The modified transforms are defined as

$$\begin{aligned} (\mathcal{F}^{q,v,\theta} f)(\vec{z}) &:= \sum_{\vec{n} \in \mathbb{W}^k} f(\vec{n}) \Psi_{\vec{z}}^{r;\theta}(\vec{n}), \tag{6.8} \\ (\mathcal{J}^{q,v,\theta} G)(\vec{n}) &:= \oint_{\gamma_1^\theta} \frac{dz_1}{2\pi i} \cdots \oint_{\gamma_k^\theta} \frac{dz_k}{2\pi i} \prod_{A < B} \frac{z_A - z_B}{z_A - qz_B} \\ &\quad \times \prod_{j=1}^k \frac{1}{(\theta - z_j)(1 - vz_j)} \left(\frac{\theta - z_j}{1 - vz_j} \right)^{-n_j} G(\vec{z}). \end{aligned} \tag{6.9}$$

The integration contours are as follows: γ_k^θ is a small positively oriented contour around θ not containing $q\theta$, γ_A^θ contains $q\gamma_B^\theta$ for all $1 \leq A < B \leq k$, and, moreover, v^{-1} is outside all contours (cf. Definition 2.1 of contours corresponding to the case $\theta = 1$).

The operator $\mathcal{F}^{q,v,\theta}$ takes functions from \mathcal{W}^k to $\mathcal{C}_{z;\theta}^k$, and the operator $\mathcal{J}^{q,v,\theta}$ acts in the opposite direction.

Theorem 6.5 (Plancherel isomorphisms; cf. Theorems 3.4 and 3.9). *The maps $\mathcal{F}^{q,v,\theta}$ and $\mathcal{J}^{q,v,\theta}$ are mutual inverses in the sense that $\mathcal{K}^{q,v,\theta} = \mathcal{J}^{q,v,\theta} \mathcal{F}^{q,v,\theta}$ acts as the identity operator on \mathcal{W}^k , and $\mathcal{M}^{q,v,\theta} = \mathcal{F}^{q,v,\theta} \mathcal{J}^{q,v,\theta}$ coincides with the identity operator on $\mathcal{C}_{z;\theta}^k$.*

We will need a modified version of identity (3.18) with $f(\vec{n}) = \mathbf{1}_{\vec{n}=\vec{x}}$:

$$\sum_{\lambda \vdash k} \oint_{\gamma_k^\theta} \cdots \oint_{\gamma_1^\theta} \theta^{-k} dm_\lambda^{(q)}(\vec{w}) \prod_{j=1}^{\ell(\lambda)} \frac{1}{(w_j/\theta; q)_{\lambda_j} (vw_j; q)_{\lambda_j}} \Psi_{\vec{w} \circ \lambda}^{\ell;\theta}(\vec{x}) \Psi_{\vec{w} \circ \lambda}^{r;\theta}(\vec{y}) = \mathbf{1}_{\vec{x}=\vec{y}} \tag{6.10}$$

for all $\vec{x}, \vec{y} \in \mathbb{W}^k$. Identity (6.10) follows from (3.18) via a change of variables $w_j \rightarrow w_j/\theta$ plus the change of parameter $v \rightarrow \theta v$ (note that $dm_\lambda^{(q)}(\vec{w}/\theta) = \theta^{-k} dm_\lambda^{(q)}(\vec{w})$). Note that (6.10) is equivalent to the statement that $\mathcal{K}^{q,v,\theta}$ is the identity operator (here one should use an analogue of Proposition 3.2).

Remark 6.6. One can define a bilinear pairing on the space $\mathcal{C}_{z;\theta}^k$ similarly to (2.6) which would correspond to the standard bilinear pairing (2.2) on \mathcal{W}^k in the sense of (3.7) and (3.16). We will not write down the corresponding formulas.

We record the spectral biorthogonality statements using the formal notation as in Remark 4.6:

Theorem 6.7 (Spectral biorthogonality; cf. Theorems 4.3 and 4.4). *In the spectral coordinates \vec{z} and $\vec{\xi}$, one has, respectively,*

$$\sum_{\vec{n} \in \mathbb{W}^k} \Psi_z^{r;\theta}(\vec{n}) \Psi_w^{\ell;\theta}(\vec{n}) \mathbf{V}(\vec{z}) \mathbf{V}(\vec{w}) = (-1)^{\frac{k(k-1)}{2}} \prod_{j=1}^k (\theta - z_j)(1 - v z_j) \times \prod_{A \neq B} (z_A - q z_B) \det[\delta(z_i - w_j)]_{i,j=1}^k, \quad (6.11)$$

$$\sum_{\vec{n} \in \mathbb{W}^k} \Phi_{\xi}^{r;\theta}(\vec{n}) \Phi_{\zeta}^{\ell;\theta}(\vec{n}) = \prod_{j=1}^k \xi_j \prod_{A \neq B} \mathcal{S}_{q,v,\theta}(\xi_A, \xi_B) \det[\delta(\xi_i - \zeta_j)]_{i,j=1}^k. \quad (6.12)$$

Identity (6.11) holds with test functions which are Laurent polynomials (not necessarily symmetric) in $\frac{\theta - z_j}{1 - v z_j}$ and $\frac{\theta - w_j}{1 - v w_j}$, respectively, with the integration contours being small positively oriented circles around θ (or negatively oriented circles around v^{-1}).

Similarly, identity (6.12) holds with test functions which are Laurent polynomials in ξ_j and ζ_j , respectively, and with integration contours being any positively oriented circles around 0.

Note that the above theorem also works with more general test functions under the right choice of integration contours. The appropriate statements can be readily formulated similarly to Sect. 4.2, but we will not write them down.

6.2. Symmetrization identities. We will now give θ -modified analogues of the symmetrization identities of Corollary 5.22. Recall that these identities were based on an explicit computation of the inverse transform of a certain function $G(\vec{z})$. The corresponding θ -modified integral looks as follows:

Proposition 6.8 (cf. Proposition 3.7). *For any $c \in \mathbb{C} \setminus \{\theta^{-1}v^{-1}, q^{-1}\theta^{-1}v^{-1}, \dots, q^{-(k-1)}\theta^{-1}v^{-1}\}$ and any $\vec{n} \in \mathbb{W}^k$, we have*

$$\begin{aligned} (\mathcal{J}^{q,v,\theta} G)(\vec{n}) &= \oint_{\gamma_1^\theta} \frac{dz_1}{2\pi i} \cdots \oint_{\gamma_k^\theta} \frac{dz_k}{2\pi i} \prod_{1 \leq A < B \leq k} \frac{z_A - z_B}{z_A - q z_B} \\ &\quad \times \prod_{j=1}^k \left(\frac{\theta - z_j}{1 - v z_j} \right)^{-n_j} \frac{1}{(\theta - z_j)(1 - cv z_j)} \\ &= \frac{(-1)^k v^{n_1+n_2+\dots+n_k}}{(c\theta v; q)_k} \prod_{j=1}^k \left(\frac{1 - cq^{j-1}}{1 - c\theta v q^{j-1}} \right)^{n_j} \mathbf{1}_{n_k \geq 0}, \end{aligned}$$

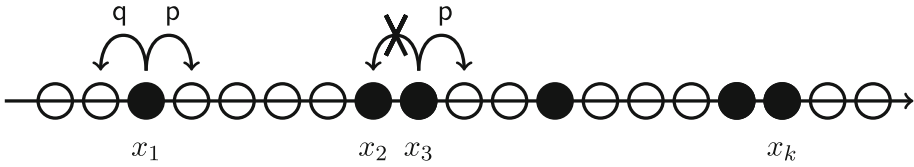

Fig. 7. The ASEP particle system

where $G(\vec{z}) := \prod_{j=1}^k \frac{1-vz_j}{1-cvz_j}$. Here the integration contours $\gamma_1^\theta, \dots, \gamma_k^\theta$ are as in (6.9) with an additional condition that they do not contain $c^{-1}v^{-1}$ (this is possible because of our restrictions on c , but this could also mean that each contour is a union of several disjoint simple contours).

The symmetrization identities (analogues of Corollary 5.22) we obtain in the θ -modified case turn out to be equivalent to the ones for $\theta = 1$ (up to rescaling of v and of the ξ_j 's). Therefore, we will not write them down.

One could also readily formulate an analogue of Proposition 5.21 for the general function $G(\vec{z})$, but we will not do that.

7. Application to ASEP

In this section we discuss a degeneration of the q -Hahn eigenfunctions to those of the ASEP. Note that in contrast with the previous section, we work at the level of stochastic particle systems (cf. Fig. 1). Our main results of Sects. 3, 4, and 5 carry over to the ASEP case (with certain modifications which are not always straightforward). This in particular leads to different proofs of seminal results for the ASEP first obtained by Tracy and Widom [59,61].

7.1. ASEP and its Bethe ansatz eigenfunctions. Let $k \geq 1$ be an integer. The k -particle ASEP is a continuous-time stochastic particle system on \mathbb{Z} . Its state space

$$\tilde{\mathbb{W}}^k := \{\vec{x} = (x_1 < x_2 < \dots < x_k) : x_i \in \mathbb{Z}\} \tag{7.1}$$

consists of ordered k -tuples of distinct integers.¹⁵

Each particle in the ASEP has an independent exponential clock with mean 1. When the clock of a particle rings, it immediately tries to jump to the right with probability $p > 0$, or to the left with probability $q > 0$, where $p + q = 1$ (note that this q differs from the parameter q in the q -Hahn system). If the destination of the jump is already occupied, then the jump is blocked (see Fig. 7). We assume that $p < q$ and denote $\tau := p/q$, so $\tau \in (0, 1)$ and $p = \frac{\tau}{1+\tau}$, $q = \frac{1}{1+\tau}$.

By $\tilde{\mathcal{W}}^k$ denote the space of all compactly supported functions on $\tilde{\mathbb{W}}^k$. The Markov generator of the ASEP acts on $\tilde{\mathcal{W}}^k$ as follows (here we use notation similar to \tilde{n}_i^\pm in Sect. 5.1):

$$(\mathcal{H}_\tau^{\text{ASEP}} f)(\vec{x}) = \sum_i p(f(\vec{x}_i^+) - f(\vec{x})) + \sum_j q(f(\vec{x}_j^-) - f(\vec{x})), \tag{7.2}$$

¹⁵ Our ordering of distinct coordinates in $\vec{x} \in \tilde{\mathbb{W}}^k$ differs from the one for the space \mathbb{W}^k (Sect. 2.1). This is done to better reflect the notation for the ASEP used in [16,59]. We continue to use this ordering in Sect. 8 as well.

where the sums are taken over all i and j for which the resulting configurations \vec{x}_i^+ and \vec{x}_j^- , respectively, belong to $\tilde{\mathbb{W}}^k$.

Let \mathcal{R} be the reflection operator whose action on $\tilde{\mathbb{W}}^k$ is given by (2.15). One can readily see that

$$\mathcal{H}_\tau^{\text{ASEP}} = \mathcal{R}(\mathcal{H}_\tau^{\text{ASEP}})^{\text{transpose}}\mathcal{R}^{-1}, \tag{7.3}$$

because both the matrix transposition and the conjugation by the space reflection \mathcal{R} switch the roles of \mathfrak{p} and \mathfrak{q} . This means that the ASEP is PT-symmetric (as in Proposition 5.10), but with the corresponding \mathfrak{m} being the identity operator.¹⁶

The application of the coordinate Bethe ansatz to the ASEP dates back at least to the work of Gwa and Spohn [30], and was continued by Schütz [54] and by Tracy and Widom [59]. One of the formulations of this integrability is that the true generator $\mathcal{H}_\tau^{\text{ASEP}}$ is equivalent (in the exact same sense as in Proposition 5.8) to the following free generator

$$\begin{aligned} (\mathcal{L}_\tau^{\text{ASEP}} u)(\vec{x}) &:= \sum_{i=1}^k [\nabla_\tau^{\text{ASEP}}]_i u(\vec{x}), \\ (\nabla_\tau^{\text{ASEP}} u)(y) &:= \mathfrak{p}u(y+1) + \mathfrak{q}u(y-1) - u(y), \quad y \in \mathbb{Z}, \end{aligned} \tag{7.4}$$

plus $k - 1$ two-body boundary conditions

$$\left(\mathfrak{p}u(\vec{x}_i^+) + \mathfrak{q}u(\vec{x}_{i+1}^-) - u(\vec{x}) \right) \Big|_{\vec{x} \in \mathbb{Z}^k : x_{i+1} = x_i + 1} = 0 \tag{7.5}$$

for all $1 \leq i \leq k - 1$.

This reduction of the operator $\mathcal{H}_\tau^{\text{ASEP}}$ allows to construct its eigenfunctions in the same way as in Sects. 5.4 and 5.5. This leads to the following left (= backward) eigenfunctions

$$\Psi_z^{\text{ASEP}}(\vec{x}) := \sum_{\sigma \in S(k)} \prod_{1 \leq B < A \leq k} \frac{z_{\sigma(B)} - \tau z_{\sigma(A)}}{z_{\sigma(B)} - z_{\sigma(A)}} \prod_{j=1}^k \left(\frac{1 + z_{\sigma(j)}}{1 + z_{\sigma(j)}/\tau} \right)^{-x_j}, \quad \vec{x} \in \tilde{\mathbb{W}}^k. \tag{7.6}$$

The right (= forward) eigenfunctions are related to the above ones by a reflection, and they are

$$(\mathcal{R}\Psi_z^{\text{ASEP}})(\vec{x}) = \sum_{\sigma \in S(k)} \prod_{1 \leq B < A \leq k} \frac{z_{\sigma(A)} - \tau z_{\sigma(B)}}{z_{\sigma(A)} - z_{\sigma(B)}} \prod_{j=1}^k \left(\frac{1 + z_{\sigma(j)}}{1 + z_{\sigma(j)}/\tau} \right)^{x_j}, \quad \vec{x} \in \tilde{\mathbb{W}}^k. \tag{7.7}$$

Note also that (up to a constant factor plus a change of the spectral variables) the eigenfunctions $\mathcal{R}\Psi_z^{\text{ASEP}}$ are obtained from Ψ_z^{ASEP} by replacing $\tau \rightarrow \tau^{-1}$. Let us summarize the properties of eigenfunctions:

¹⁶ The property $\mathfrak{m} \equiv 1$ is related to the fact that Bernoulli measures are stationary for the ASEP [38]. Also note the relation between \mathfrak{m} (2.13) and the stationary gaps distribution (5.14) in the q -Hahn case.

Proposition 7.1. *For all $z_1, \dots, z_k \in \mathbb{C} \setminus \{-1, -\tau\}$, the function Ψ_z^{ASEP} is an eigenfunction of the free ASEP generator $\mathcal{L}_\tau^{\text{ASEP}}$ with the eigenvalue*

$$-\frac{(1-\tau)^2}{1+\tau} \sum_{j=1}^k \frac{1}{(1+z_j)(1+\tau/z_j)} \tag{7.8}$$

Moreover, Ψ_z^{ASEP} satisfies the $(k-1)$ two-body boundary conditions (7.5). Consequently, $\Psi_z^{\text{ASEP}}(\vec{x})$ restricted to $\vec{x} \in \widetilde{\mathbb{W}}^k$ is an eigenfunction of the true ASEP generator $\mathcal{H}_\tau^{\text{ASEP}}$ with the same eigenvalue (7.8).

Similarly, $\mathcal{R}\Psi_z^{\text{ASEP}}$ is an eigenfunction of $(\mathcal{H}_\tau^{\text{ASEP}})^{\text{transpose}}$ with eigenvalue (7.8).

Let us also write down the eigenfunctions (7.6)–(7.7) in terms of the other spectral variables $\vec{\xi}$. Consider the linear fractional map

$$\Xi_{\text{ASEP}}(z) := \frac{1+z}{1+z/\tau}, \quad \Xi_{\text{ASEP}}^{-1}(\xi) = -\frac{1-\xi}{1-\xi/\tau}. \tag{7.9}$$

For $z_j = \Xi_{\text{ASEP}}^{-1}(\xi_j)$, one has

$$\frac{z_B - \tau z_A}{z_B - z_A} = \frac{\mathcal{S}_{\text{ASEP}}(\xi_A, \xi_B)}{\xi_B - \xi_A},$$

where

$$\mathcal{S}_{\text{ASEP}}(\xi_1, \xi_2) := \tau - (1+\tau)\xi_1 + \xi_1\xi_2 = (1+\tau)(\mathfrak{p} - \xi_1 + \mathfrak{q}\xi_1\xi_2) \tag{7.10}$$

is the corresponding cross-term (up to a constant factor it is the same as in [59]).

Define

$$\Phi_{\vec{\xi}}^{\text{ASEP}}(\vec{x}) := \sum_{\sigma \in S(k)} \text{sgn}(\sigma) \prod_{1 \leq B < A \leq k} \mathcal{S}_{\text{ASEP}}(\xi_{\sigma(A)}, \xi_{\sigma(B)}) \prod_{j=1}^k \xi_{\sigma(j)}^{-x_j}, \tag{7.11}$$

and note that

$$(\mathcal{R}\Phi_{\vec{\xi}}^{\text{ASEP}})(\vec{x}) = (-1)^{\frac{k(k-1)}{2}} \sum_{\sigma \in S(k)} \text{sgn}(\sigma) \prod_{1 \leq B < A \leq k} \mathcal{S}_{\text{ASEP}}(\xi_{\sigma(B)}, \xi_{\sigma(A)}) \prod_{j=1}^k \xi_{\sigma(j)}^{x_j}. \tag{7.12}$$

Clearly, the eigenfunctions Ψ_z^{ASEP} and $\Phi_{\vec{\xi}}^{\text{ASEP}}$ are related in the following way:

$$\Psi_{\Xi_{\text{ASEP}}^{-1}(\vec{\xi})}^{\text{ASEP}}(\vec{x}) = (\mathbf{V}(\vec{\xi}))^{-1} \Phi_{\vec{\xi}}^{\text{ASEP}}(\vec{x}), \quad (\mathcal{R}\Psi_{\Xi_{\text{ASEP}}^{-1}(\vec{\xi})}^{\text{ASEP}})(\vec{x}) = (\mathbf{V}(\vec{\xi}))^{-1} (\mathcal{R}\Phi_{\vec{\xi}}^{\text{ASEP}})(\vec{x}),$$

where $\mathbf{V}(\vec{\xi})$ is the Vandermonde determinant.

The eigenvalues (7.8) in the coordinates $\vec{\xi}$ take a simpler form

$$\text{ev}_{\text{ASEP}}(\vec{\xi}) := \sum_{j=1}^k (\mathfrak{p}\xi_j^{-1} + \mathfrak{q}\xi_j - 1). \tag{7.13}$$

7.2. Relation to q -Hahn eigenfunctions. There are two different ways to specialize the parameters (q, ν) in the q -Hahn eigenfunctions which lead to the ASEP eigenfunctions. Indeed, the ASEP cross-term $\mathcal{S}_{\text{ASEP}}$ (7.10) has only one nontrivial linear term, while the corresponding q -Hahn system's cross-term $\mathcal{S}_{q,\nu}$ (2.10) has two linear terms. Thus, there are two ways to specialize $\mathcal{S}_{q,\nu}$ into $\mathcal{S}_{\text{ASEP}}$ by forcing one of the linear terms in $\mathcal{S}_{q,\nu}$ to vanish:¹⁷

First degeneration. If $q = 1/\nu = \tau$ (where τ is the ASEP parameter), then

$$\begin{aligned} ((1 - q\nu)\mathcal{S}_{q,\nu}(\xi_1, \xi_2))|_{q=\tau, \nu=\tau^{-1}} &= \frac{1 - \tau}{\tau} (\tau - (1 + \tau)\xi_2 + \xi_1\xi_2) \\ &= \frac{1 - \tau}{\tau} \mathcal{S}_{\text{ASEP}}(\xi_2, \xi_1). \end{aligned} \quad (7.14)$$

In this case note that for all $\vec{n} \in \mathbb{W}^k$,

$$m_{q,\nu}(\vec{n})|_{q=\tau, \nu=\tau^{-1}} = \begin{cases} (-\tau)^{-k}, & \text{if } n_1 > \dots > n_k; \\ 0, & \text{otherwise.} \end{cases} \quad (7.15)$$

One can readily check that for any integers $x_1 \leq x_2 \leq \dots \leq x_k$ we have (formally extending the definition of the ASEP eigenfunctions to weakly increasing sequences of indices)

$$\begin{aligned} \Psi_{\vec{z}}^{\text{ASEP}}(x_1, \dots, x_k) &= \Psi_{-\vec{z}}^\ell(x_k, \dots, x_1)|_{q=\nu^{-1}=\tau}, \\ (\mathcal{R}\Psi_{\vec{z}}^{\text{ASEP}})(x_1, \dots, x_k) \cdot \mathbf{1}_{x_1 < \dots < x_k} &= (\tau^{-1} - 1)^{-k} \Psi_{-\vec{z}}^r(x_k, \dots, x_1)|_{q=\nu^{-1}=\tau} \\ \Phi_{\vec{\xi}}^{\text{ASEP}}(x_1, \dots, x_k) &= (1 - \tau^{-1})^{-\frac{k(k-1)}{2}} \\ &\quad \times ((1 - q\nu)^{\frac{k(k-1)}{2}} \Phi_{\vec{\xi}}^\ell(x_k, \dots, x_1))|_{q=\nu^{-1}=\tau} \\ (\mathcal{R}\Phi_{\vec{\xi}}^{\text{ASEP}})(x_1, \dots, x_k) \cdot \mathbf{1}_{x_1 < \dots < x_k} &= (\tau^{-1} - 1)^{-\frac{k(k-1)}{2}} \\ &\quad \times ((1 - q\nu)^{\frac{k(k-1)}{2}} \Phi_{\vec{\xi}}^r(x_k, \dots, x_1))|_{q=\nu^{-1}=\tau}. \end{aligned} \quad (7.16)$$

We will mainly work in the \vec{z} spectral variables, the third and fourth formulas for $\Phi_{\vec{\xi}}^{\text{ASEP}}$ above are given for illustration.

Second degeneration. If $q = \nu = 1/\tau$, then

$$\mathcal{S}_{q,\nu}(\xi_1, \xi_2)|_{q=\nu=1/\tau} = \frac{1}{1 + \tau} (\tau - (1 + \tau)\xi_1 + \xi_1\xi_2) = \frac{1}{1 + \tau} \mathcal{S}_{\text{ASEP}}(\xi_1, \xi_2). \quad (7.17)$$

In this case $m_{q,\nu}(\vec{n}) = 1$ for all $\vec{n} \in \mathbb{W}^k$, so this second way of degeneration does not lead to any formulas with strictly ordered spatial variables. Therefore, our main results (Plancherel formulas, spectral biorthogonality) for $q = \nu = \tau^{-1}$ will not directly imply any formulas for the ASEP particle system.

On the other hand, for $q = \nu = \tau^{-1}$ one also could write down formulas relating the q -Hahn and the ASEP eigenfunctions similarly to (7.16). Thus, our main results would

¹⁷ Clearly, multiplying cross-terms by constants is allowed as it reduces to constant multiplicative factors in front of the eigenfunctions.

imply certain other identities for the ASEP eigenfunctions, but with *weakly ordered* spatial coordinates. One could readily write down such statements because the degeneration $q = \nu$ does not involve problems with integration contours as in the case $q = \nu^{-1}$, see Sect. 7.4 below. The role of some of these identities remains unclear, and we will not pursue this direction except for symmetrization identities (see Sect. 7.6 below).

See Fig. 1 on how the ASEP eigenfunctions fit into the general picture of Hall-Littlewood type eigenfunctions of Bethe ansatz solvable particle systems.

7.3. Spectral biorthogonality of the ASEP eigenfunctions. Let us obtain an ASEP analogue of the spectral biorthogonality statement of Theorem 4.3. Let $\tilde{\gamma}_{-1}$ denote a small positively oriented closed circle around (-1) which does not encircle $(-\tau)$. Let also $\tilde{\gamma}'_{-1}$ be circle around (-1) containing $\tilde{\gamma}_{-1}$ such that for all $z \in \tilde{\gamma}_{-1}$, $w \in \tilde{\gamma}'_{-1}$, one has

$$\left| \frac{1+z}{1+z/\tau} \right| < \left| \frac{1+w}{1+w/\tau} \right|.$$

The existence of $\tilde{\gamma}'_{-1}$ can be established similarly to Sect. 4.1.

Theorem 7.2. *Let $F(\bar{z})$ be a function such that for M large enough,*

$$\mathbf{V}(\bar{z})F(\bar{z}) \prod_{j=1}^k \left(\frac{1+z_j}{1+z_j/\tau} \right)^{-M}$$

is holomorphic in the closed exterior of the contour $\tilde{\gamma}_{-1}$ (including ∞). Let $G(\bar{w})$ be such that $\mathbf{V}(\bar{w})G(\bar{w})$ is holomorphic in the closed region between $\tilde{\gamma}_{-1}$ and $\tilde{\gamma}'_{-1}$. Then

$$\begin{aligned} & \sum_{\bar{x} \in \tilde{\mathbb{W}}^k} \left(\oint_{\tilde{\gamma}_{-1}} \cdots \oint_{\tilde{\gamma}_{-1}} \frac{d\bar{z}}{(2\pi\mathbf{i})^k} (\mathcal{R}\Psi_{\bar{z}}^{\text{ASEP}})(\bar{x}) \mathbf{V}(\bar{z})F(\bar{z}) \right) \\ & \quad \times \left(\oint_{\tilde{\gamma}'_{-1}} \cdots \oint_{\tilde{\gamma}'_{-1}} \frac{d\bar{w}}{(2\pi\mathbf{i})^k} \Psi_{\bar{w}}^{\text{ASEP}}(\bar{x}) \mathbf{V}(\bar{w})G(\bar{w}) \right) \\ & = \oint_{\tilde{\gamma}_{-1}} \cdots \oint_{\tilde{\gamma}_{-1}} \frac{d\bar{z}}{(2\pi\mathbf{i})^k} (-1)^{\frac{k(k-1)}{2}} \prod_{j=1}^k \frac{(1+z_j)(1+z_j/\tau)}{1-1/\tau} \prod_{A \neq B} (z_A - \tau z_B) \\ & \quad \times \sum_{\sigma \in S(k)} \text{sgn}(\sigma) F(\bar{z})G(\sigma\bar{z}). \end{aligned}$$

Proof. If the test functions $F(\bar{z})$ and $G(\bar{w})$ are Laurent polynomials in $\frac{1+z_j}{1+z_j/\tau}$ and $\frac{1+w_j}{1+w_j/\tau}$, respectively, then the statement readily follows from the spectral biorthogonality for the q -Hahn eigenfunctions. Indeed, for Laurent polynomials one can let the integration contours in Theorem 4.3 to be small positively oriented closed circles γ_k around 1 (see Remark 4.7). Then, using (7.16), we can specialize $q = \tau$, $\nu = 1/\tau$, and this will turn contours γ_k into our contours $\tilde{\gamma}_{-1}$. Note also that the negation of all variables \bar{z} and \bar{w} introduces an extra factor of $(-1)^k$ in the right-hand side.

For more general test functions satisfying the above properties, one can readily see that the series in \bar{x} in the spectral biorthogonality identity converges similarly to Proposition 4.5. Then the desired claim follows by approximating test functions by Laurent polynomials, by virtue of Runge’s theorem. \square

One could also readily formulate an analogue of Theorem 4.4 concerning the eigenfunctions Φ_{ξ}^{ASEP} , but we will not write it down.

7.4. *Plancherel formulas for the ASEP.* By $\mathcal{C}_{z;\text{ASEP}}^k$ let us denote the space of symmetric Laurent polynomials in $\frac{1+z_j}{1+z_j/\tau}$, $1 \leq j \leq k$. Define the following direct and (candidate) inverse transforms:

$$(\mathcal{F}^{\text{ASEP}} f)(\vec{z}) := \sum_{\vec{x} \in \widetilde{\mathbb{W}}^k} f(\vec{x}) (\mathcal{R}\Psi_{\vec{z}}^{\text{ASEP}})(\vec{x}), \tag{7.18}$$

$$(\mathcal{J}^{\text{ASEP}} G)(\vec{x}) := \oint_{\tilde{\gamma}_{-1}} \frac{dz_1}{2\pi i} \cdots \oint_{\tilde{\gamma}_{-1}} \frac{dz_k}{2\pi i} \prod_{B < A} \frac{z_A - z_B}{z_A - \tau z_B} \times \prod_{j=1}^k \frac{1 - 1/\tau}{(1 + z_j)(1 + z_j/\tau)} \left(\frac{1 + z_j}{1 + z_j/\tau} \right)^{-x_j} G(\vec{z}). \tag{7.19}$$

The contours $\tilde{\gamma}_{-1}$ are small positive circles around (-1) . The operator $\mathcal{F}^{\text{ASEP}}$ takes functions from $\widetilde{\mathcal{W}}^k$ to $\mathcal{C}_{z;\text{ASEP}}^k$, and the operator $\mathcal{J}^{\text{ASEP}}$ acts in the opposite direction.

Since all integration contours in (7.19) are the same and G is symmetric, we can symmetrize that formula (cf. the proof of Proposition 3.2), and rewrite the ASEP inverse transform as

$$(\mathcal{J}^{\text{ASEP}} G)(\vec{x}) = \oint_{\tilde{\gamma}_{-1}} \cdots \oint_{\tilde{\gamma}_{-1}} dm_{(1^k)}^{(\tau)}(\vec{z}) \prod_{j=1}^k \frac{1 - 1/\tau}{(1 + z_j)(1 + z_j/\tau)} \Psi_{\vec{z}}^{\text{ASEP}}(\vec{x}) G(\vec{z}), \tag{7.20}$$

where $dm_{(1^k)}^{(\tau)}(\vec{z})$ is the Plancherel measure (Definition 2.2, see also (2.8)) with q replaced by τ as it should be under our degeneration.

Theorem 7.3 (The spatial Plancherel formula). *The map $\mathcal{K}^{\text{ASEP}} = \mathcal{J}^{\text{ASEP}} \mathcal{F}^{\text{ASEP}}$ acts as the identity operator on $\widetilde{\mathcal{W}}^k$. Equivalently, for any $\vec{x}, \vec{y} \in \widetilde{\mathbb{W}}^k$,*

$$\oint_{\tilde{\gamma}_{-1}} \cdots \oint_{\tilde{\gamma}_{-1}} dm_{(1^k)}^{(\tau)}(\vec{z}) \prod_{j=1}^k \frac{1 - 1/\tau}{(1 + z_j)(1 + z_j/\tau)} \Psi_{\vec{z}}^{\text{ASEP}}(\vec{x}) (\mathcal{R}\Psi_{\vec{z}}^{\text{ASEP}})(\vec{y}) = \mathbf{1}_{\vec{x}=\vec{y}}.$$

Proof. We aim to start with the corresponding q -Hahn Plancherel formula (3.8). It is not immediately clear, however, how to put $q = 1/\nu = \tau$ in this formula (which involves nested contour integration) because the integration contours $\gamma_1, \dots, \gamma_{k-1}$ must contain q , but not ν^{-1} , see Definition 2.1.

Instead, using the second part of Proposition 3.2 let us rewrite (3.8) in a form which involves integration over small circles around 1 (cf. Corollary 3.10):

$$\sum_{\lambda \vdash k} \oint_{\gamma_k} \cdots \oint_{\gamma_k} dm_{\lambda}^{(q)}(\vec{w}) \prod_{j=1}^{\ell(\lambda)} \frac{1}{(w_j; q)_{\lambda_j} (\nu w_j; q)_{\lambda_j}} \Psi_{\vec{w}\circ\lambda}^{\ell} (x_k, \dots, x_1) \times \Psi_{\vec{w}\circ\lambda}^r (y_k, \dots, y_1) = \mathbf{1}_{\vec{x}=\vec{y}}. \tag{7.21}$$

Here $dm_{\lambda}^{(q)}(\vec{w})$ are Plancherel measures corresponding to various partitions of k (Definition 2.2). Now we can readily put $q = \tau$ and $\nu = \tau^{-1}$ in (7.21), and thus it remains to derive the desired identity from this.

For any $\vec{x}, \vec{y} \in \widetilde{\mathbb{W}}^k$, it turns out that *all contributions of all partitions $\lambda \neq (1^k)$ vanish in (7.21)* after this substitution. This would imply the desired claim up to setting $z_j = -w_j, j = 1, \dots, k$ (note that the negation of all integration variables would introduce an additional factor of $(-1)^k$) with the help of the relations (7.16) between the q -Hahn and the ASEP eigenfunctions.

Let us now prove that only the contribution of $\lambda \neq (1^k)$ survives. If $\lambda \neq (1^k)$, then $\lambda_1 \geq 2$, and so in $\vec{z} = \vec{w} \circ \lambda$ (2.5) we have $z_2 = \tau w_1$ and $z_1 = w_1$, where w_1 is an independent integration variable. The term

$$\frac{1}{(w_1; \tau)_{\lambda_1} (w_1/\tau; \tau)_{\lambda_1}}$$

in the integrand thus contains $1/(1 - w_1)^2$. Expanding $\Psi_{\vec{w} \circ \lambda}^{\ell}(x_k, \dots, x_1) \Psi_{\vec{w} \circ \lambda}^r(y_k, \dots, y_1)$ as a sum over pairs of permutations $\sigma, \omega \in S(k)$, we obtain the following factors containing powers of $(1 - w_1)$:

$$\begin{aligned} & \left(\frac{1 - w_1}{1 - w_1/\tau} \right)^{-x_{k+1-\sigma^{-1}(1)}} \left(\frac{1 - w_1 \tau}{1 - w_1} \right)^{-x_{k+1-\sigma^{-1}(2)}} \\ & \times \left(\frac{1 - w_1}{1 - w_1/\tau} \right)^{y_{k+1-\omega^{-1}(1)}} \left(\frac{1 - \tau w_1}{1 - w_1} \right)^{y_{k+1-\omega^{-1}(2)}}. \end{aligned} \tag{7.22}$$

Moreover, cross-terms coming from these eigenfunctions can be written as (here $\vec{z} = \vec{w} \circ \lambda$)

$$\prod_{A, B: \sigma^{-1}(B) < \sigma^{-1}(A)} \frac{z_A - \tau z_B}{z_A - z_B} \prod_{A, B: \omega^{-1}(B) < \omega^{-1}(A)} \frac{z_A - \tau^{-1} z_B}{z_A - z_B}.$$

Assume first that $\sigma^{-1}(1) < \sigma^{-1}(2)$. Then the cross-terms above contain factor $z_2 - \tau z_1 = \tau w_1 - \tau w_1 = 0$, and thus the contribution of this permutation σ vanishes. If, on the other hand, $\sigma^{-1}(1) > \sigma^{-1}(2)$, then by the strict ordering of $\vec{x} \in \widetilde{\mathbb{W}}^k, -x_{k+1-\sigma^{-1}(1)} > -x_{k+1-\sigma^{-1}(2)}$. This means that the first two factors of (7.22) contribute a strictly positive power of $(1 - w_1)$. Similarly one can check that the second two factors of (7.22) either contribute a strictly positive power of $(1 - w_1)$, too, or the whole contribution of ω vanishes due to the cross-term. Overall, this means that for any $\lambda \neq (1^k)$ the whole integrand in (7.21) is regular at $w_1 = 1$, and thus the integral vanishes.

It follows that in (7.21) we are left with $\lambda = (1^k)$, and now that identity readily implies the claim. \square

Remark 7.4. Consider the large contour analogue of (7.21) which reads for any $\vec{x}, \vec{y} \in \widetilde{\mathbb{W}}^k$ (cf. Corollary 3.10):

$$\oint_{\gamma} \dots \oint_{\gamma} dm_{(1^k)}^{(q)}(\vec{z}) \prod_{j=1}^k \frac{1}{(1 - z_j)(1 - \nu z_j)} \Psi_{\vec{z}}^{\ell}(x_k, \dots, x_1) \Psi_{\vec{z}}^r(y_k, \dots, y_1) = \mathbf{1}_{\vec{x}=\vec{y}}, \tag{7.23}$$

where the contour γ is as in Definition 2.1. One cannot simply put $q = 1/\nu = \tau$ in (7.23) because of the constraints on the contour γ . Instead, the left-hand side of (7.23) can be expanded as a sum over residues of the integrand. There will be one term corresponding to taking all residues at $z_1 = \dots = z_k = 1$ (this term coincides with the term in the left-hand side of (7.21) with $\lambda = (1^k)$), and other terms in which some of the residues are taken at $z_j = q^{d_j}$, $1 \leq j \leq k$ for certain integers $d_j > 1$ (note that at least one of the residues must be taken at 1). These additional residues at powers of q come from the denominator in $d\mathfrak{m}_{(1^k)}^{(q)}(\vec{z})$ (2.8). Then in this expansion one can take the desired specialization $q = 1/\nu = \tau$.

The proof of Theorem 7.3 a posteriori implies that under this specialization, the contribution of all additional residues at powers of q vanishes. This means that the large contour formula (7.23) leads to the same ASEP formula with small integration contours. It is not clear whether it is possible to rewrite the resulting formula of Theorem 7.3 in terms of integration over any large contours.

Theorem 7.5 (The spectral Plancherel formula). *The map $\mathcal{M}^{\text{ASEP}} = \mathcal{F}^{\text{ASEP}} \mathcal{J}^{\text{ASEP}}$ acts as the identity operator on $\mathcal{C}_{z; \text{ASEP}}^k$.*

Proof. This follows from the spectral biorthogonality (Theorem 7.2) in a way similar to Theorem 4.3. \square

Remark 7.6. One could equip spaces $\tilde{\mathcal{W}}^k$ and $\mathcal{C}_{z; \text{ASEP}}^k$ with suitable bilinear pairings which correspond to each other under the spatial and the spectral Plancherel isomorphism theorems (7.3 and 7.5), but we will not write these pairings down.

7.5. Transition probabilities for the ASEP. The spatial Plancherel formula for ASEP (Theorem 7.3) was first obtained by Tracy and Widom as [59, Theorem 2.1]. Let us match our formula to their result. The identity from Theorem 7.3 can be rewritten using (7.19) in the following form:

$$\oint_{\tilde{\gamma}_{-1}} \frac{dz_1}{2\pi \mathbf{i}} \dots \oint_{\tilde{\gamma}_{-1}} \frac{dz_k}{2\pi \mathbf{i}} \prod_{B < A} \frac{z_A - z_B}{z_A - \tau z_B} \prod_{j=1}^k \frac{1 - 1/\tau}{(1 + z_j)(1 + z_j/\tau)} \left(\frac{1 + z_j}{1 + z_j/\tau} \right)^{-x_j} \times (\mathcal{R}\Psi_{\vec{z}}^{\text{ASEP}})(\vec{y}) = \mathbf{1}_{\vec{x}=\vec{y}}. \tag{7.24}$$

For $\sigma \in S(k)$, denote by

$$\mathbf{A}_\sigma(\vec{z}) := \prod_{B < A} \frac{z_A - z_B}{z_A - \tau z_B} \prod_{B < A} \frac{z_{\sigma(A)} - \tau z_{\sigma(B)}}{z_{\sigma(A)} - z_{\sigma(B)}} = \prod_{B < A: \sigma(B) > \sigma(A)} \left(-\frac{z_{\sigma(A)} - \tau z_{\sigma(B)}}{z_{\sigma(B)} - \tau z_{\sigma(A)}} \right)$$

the term which arises from the cancellation of two double products, one inside the integral, and another coming from $(\mathcal{R}\Psi_{\vec{z}}^{\text{ASEP}})$ (the minus sign is the ratio of two expressions without τ). Then (7.24) takes the form

$$\sum_{\sigma \in S(k)} \oint_{\tilde{\gamma}_{-1}} \dots \oint_{\tilde{\gamma}_{-1}} \mathbf{A}_\sigma(\vec{z}) \prod_{j=1}^k \frac{1 - 1/\tau}{(1 + z_j)(1 + z_j/\tau)} \left(\frac{1 + z_j}{1 + z_j/\tau} \right)^{-x_j + y_{\sigma^{-1}(j)}} \frac{dz_j}{2\pi \mathbf{i}} = \mathbf{1}_{\vec{x}=\vec{y}}. \tag{7.25}$$

Under the change of variables Ξ_{ASEP} (7.9), we have

$$A_\sigma(\Xi_{\text{ASEP}}^{-1}(\vec{\xi})) = \prod_{A < B: \sigma(A) > \sigma(B)} S_{\sigma(A)\sigma(B)},$$

$$S_{\alpha\beta} = -\frac{\rho + q\xi_\alpha\xi_\beta - \xi_\alpha}{\rho + q\xi_\alpha\xi_\beta - \xi_\beta} = -\frac{S_{\text{ASEP}}(\xi_\alpha, \xi_\beta)}{S_{\text{ASEP}}(\xi_\beta, \xi_\alpha)},$$

so A_σ is exactly the same product over inversions in the permutation σ as in [59, §2]. Thus, we may rewrite (7.25) in the coordinates $\vec{\xi}$ as follows:

$$\sum_{\sigma \in S(k)} \oint_{\vec{\gamma}_0} \dots \oint_{\vec{\gamma}_0} A_\sigma(\Xi_{\text{ASEP}}^{-1}(\vec{\xi})) \prod_{j=1}^k \xi_{\sigma(j)}^{-x_{\sigma(j)}+y_j-1} \frac{d\xi_j}{2\pi\mathbf{i}} = \mathbf{1}_{\vec{x}=\vec{y}}, \tag{7.26}$$

where the integration contours $\vec{\gamma}_0$ are now small positively oriented closed circles around 0. This is exactly Tracy–Widom’s formula [59, (2.3)] for time $t = 0$ up to swapping $\vec{x} \leftrightarrow \vec{y}$.

Moreover, for any $t > 0$, the quantities [59, (2.3)] are transition probabilities for the ASEP:

$$\mathbb{P}(\text{from } \vec{x} \text{ to } \vec{y} \text{ in time } t)$$

$$= \sum_{\sigma \in S(k)} \oint_{\vec{\gamma}_0} \dots \oint_{\vec{\gamma}_0} A_\sigma(\Xi_{\text{ASEP}}^{-1}(\vec{\xi})) e^{t \cdot \text{ev}_{\text{ASEP}}(\vec{\xi})} \prod_{j=1}^k \xi_{\sigma(j)}^{-x_{\sigma(j)}+y_j-1} \frac{d\xi_j}{2\pi\mathbf{i}},$$

which are solutions to the forward Kolmogorov equation for the ASEP. This explains the appearance of the eigenvalues (7.13) under the integral above (cf. Proposition 5.15).

Let us look at contributions of individual permutations σ to formulas (7.25) and (7.26) (each of them is equivalent to Theorem 7.3). Recall that in the q -Hahn setting we have proved a similar identity (3.8) by showing that the contribution of each individual $\sigma \neq id$ vanishes (Lemma 3.5).

This is not the case for the ASEP: For example, if $k = 3, \sigma = (321)$ is the transposition $1 \leftrightarrow 3, \vec{x} = (0, 1, 2), \vec{y} = (-2, -1, 0)$, then

$$\oint_{\vec{\gamma}_{-1}} \dots \oint_{\vec{\gamma}_{-1}} A_\sigma(\vec{z}) \prod_{j=1}^3 \frac{1 - 1/\tau}{(1 + z_j)(1 + z_j/\tau)} \left(\frac{1 + z_j}{1 + z_j/\tau} \right)^{-x_j+y_{\sigma^{-1}(j)}} \frac{dz_j}{2\pi\mathbf{i}} = -\frac{(1 + \tau)^2}{\tau^4},$$

which is nonzero.

In fact, the above contribution is compensated by the summand corresponding to $\sigma = (312)$, which has the opposite sign. The original proof of (7.26) in [59] employs nontrivial combinatorics to determine such cancellations in general.

7.6. Tracy–Widom symmetrization identities. The Tracy–Widom symmetrization identity for the ASEP [59, (1.6)] can be obtained as a corollary of our main results. In an exactly similar manner one could get a generalization corresponding to the step Bernoulli (i.e., half-stationary) initial condition, first obtained as [61, (9)]. Both combinatorial identities served as crucial steps towards the asymptotic analysis of the ASEP, see [13, 16, 23, 61]. To shorten the formulas, we will only focus on the step case, i.e., on the identity [59, (1.6)] which is equivalent to

$$\begin{aligned} & \sum_{\sigma \in S(k)} \prod_{i < j} \frac{\mathcal{S}_{\text{ASEP}}(\xi_{\sigma(i)}, \xi_{\sigma(j)})}{\xi_{\sigma(j)} - \xi_{\sigma(i)}} \frac{\xi_{\sigma(2)} \xi_{\sigma(3)}^2 \cdots \xi_{\sigma(k)}^{k-1}}{(1 - \xi_{\sigma(1)} \xi_{\sigma(2)} \cdots \xi_{\sigma(k)})(1 - \xi_{\sigma(2)} \cdots \xi_{\sigma(k)}) \cdots (1 - \xi_{\sigma(k)})} \\ &= \frac{\tau^{\frac{k(k-1)}{2}}}{\prod_{j=1}^k (1 - \xi_j)}. \end{aligned} \tag{7.27}$$

This identity can be derived from the spectral Plancherel formula for the ASEP (Theorem 7.5) in a way similar to Sect. 5.8, but a shorter way to achieve it is to simply specialize the existing (q, ν) identity (5.22). We will consider both ways to specialize the parameters as in Sect. 7.2.

First degeneration. For $q = 1/\nu = \tau$, the sum over \vec{n} in (5.22) becomes (see (7.15))

$$\begin{aligned} & \sum_{n_1 \geq \cdots \geq n_k \geq 0} m_{q,\nu}(\vec{n}) \prod_{j=1}^k \xi_{\sigma(j)}^{n_j} = (-\tau)^{-k} \sum_{n_1 > \cdots > n_k \geq 0} \prod_{j=1}^k \xi_{\sigma(j)}^{n_j} \\ &= (-\tau)^{-k} \frac{\xi_{\sigma(1)}^{k-1} \xi_{\sigma(2)}^{k-2} \cdots \xi_{\sigma(k-1)}}{(1 - \xi_{\sigma(1)})(1 - \xi_{\sigma(1)} \xi_{\sigma(2)}) \cdots (1 - \xi_{\sigma(1)} \cdots \xi_{\sigma(k)})}. \end{aligned}$$

Using (7.14), we can readily rewrite (5.22) as (7.27) (note that it involves multiplying the permutation σ over which we are summing by the permutation $j \leftrightarrow k + 1 - j$, $1 \leq j \leq k$).

Second degeneration. For $q = \nu = 1/\tau$, we have in (5.22):

$$\begin{aligned} & \sum_{n_1 \geq \cdots \geq n_k \geq 0} m_{q,\nu}(\vec{n}) \prod_{j=1}^k \xi_{\sigma(j)}^{n_j} = \sum_{n_1 \geq \cdots \geq n_k \geq 0} \prod_{j=1}^k \xi_{\sigma(j)}^{n_j} \\ &= \frac{1}{(1 - \xi_{\sigma(1)})(1 - \xi_{\sigma(1)} \xi_{\sigma(2)}) \cdots (1 - \xi_{\sigma(1)} \cdots \xi_{\sigma(k)})}. \end{aligned}$$

Therefore, with the help of (7.17), we can rewrite (5.22) as

$$\begin{aligned} & \sum_{\sigma \in S(k)} \prod_{B < A} \frac{\mathcal{S}_{\text{ASEP}}(\xi_{\sigma(B)}, \xi_{\sigma(A)})}{\xi_{\sigma(A)} - \xi_{\sigma(B)}} \frac{1}{(1 - \xi_{\sigma(1)})(1 - \xi_{\sigma(1)} \xi_{\sigma(2)}) \cdots (1 - \xi_{\sigma(1)} \cdots \xi_{\sigma(k)})} \\ &= \prod_{j=1}^k \frac{1}{1 - \xi_j}, \end{aligned}$$

which is equivalent to identity [59, (1.7)], and can be obtained from (7.27) by interchanging $\mathbf{p} \leftrightarrow \mathbf{q}$ and renaming $\xi_i \rightarrow \xi_{k+1-i}^{-1}$.

We see that while all results under the first degeneration $q = 1/\nu = \tau$ are directly relevant to the ASEP (as discussed earlier in this section), the second degeneration $q = \nu = 1/\tau$ provides a symmetrization identity for the ASEP, too (however, the two identities thus obtained are equivalent to each other). A similar effect can be observed in identities like [61, (9)] (corresponding to the step Bernoulli initial condition) which follow from the q -Hahn level identity (5.21).

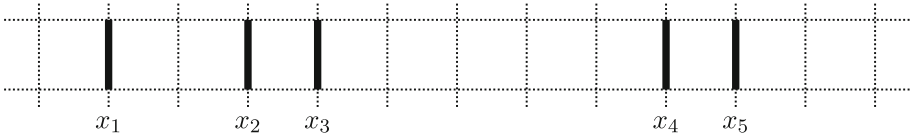

Fig. 8. A configuration of vertical lines in one “slice” of the six-vertex model

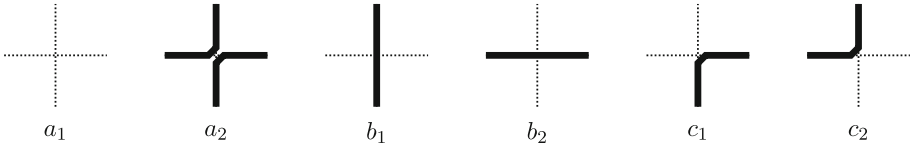

Fig. 9. Boltzmann weights that depend on the configuration of lines at a vertex

8. Application to Six-Vortex Model and XXZ Spin Chain

In this section we briefly explain how the eigenfunctions of the conjugated q -Hahn operator are related to eigenfunctions of the transfer matrix of the (asymmetric) six-vertex model. The six-vertex model is one of the most well-known solvable models in statistical physics. Its first solution was obtained by Lieb [36]. See also the book by Baxter [5] and the lecture notes by Reshetikhin [51] for details and perspectives. In Sect. 8.3 we describe the connection to eigenfunctions of the Heisenberg XXZ quantum spin chain (which is a certain degeneration of the six-vertex model). Then we discuss how our main results are applied to eigenfunctions of the six-vertex model and the XXZ spin chain.

8.1. *Transfer matrix and its eigenfunctions.* We will work only in “infinite volume” (i.e., on the lattice \mathbb{Z}), which is similar to the setup of the rest of the present paper. In the *line representation* of the six-vertex model, configurations $\vec{x} \in \tilde{\mathbb{W}}^k$ (see (7.1)) encode locations of vertical lines in a horizontal slice of the infinite square grid. We assume that there are k such vertical lines, see Fig. 8 (one of the properties of the six-vertex model is that the number of vertical lines is preserved).

Define the *Boltzmann weights* at each vertex of the square grid depending on the configuration of lines at this vertex, see Fig. 9. Here $a_1, a_2, b_1, b_2, c_1,$ and c_2 are some *positive* real parameters. All other configurations of lines at a vertex are forbidden.

Broadly speaking, the *six-vertex model* on a *finite* subset of the square grid assigns the weight $W(\text{conf}) = a_1^{\#[a_1]} a_2^{\#[a_2]} b_1^{\#[b_1]} b_2^{\#[b_2]} c_1^{\#[c_1]} c_2^{\#[c_2]}$ to each allowed configuration *conf* of lines inside this subset (with certain specified boundary conditions). Here $\#[a_1]$ is the number of vertices of type a_1 inside this finite subset, etc. Since weights of all configurations are positive, this can be interpreted as a probabilistic model (i.e., one can speak about random configuration of lines).

We will not define the six-vertex model in our infinite setting (see [13]). Instead we focus on the corresponding transfer matrix which is well-defined for configurations such that there are finitely many lines on each horizontal slice. We put $a_1 = 1$, as this is the weight of the empty line configuration, the only one that repeats infinitely often.

The rows and columns of the *transfer matrix* $T_k(\vec{x}, \vec{y})$ are indexed by line configurations $\vec{x}, \vec{y} \in \tilde{\mathbb{W}}^k$. We assume that these configurations are put on top of each other (see the picture below). Define

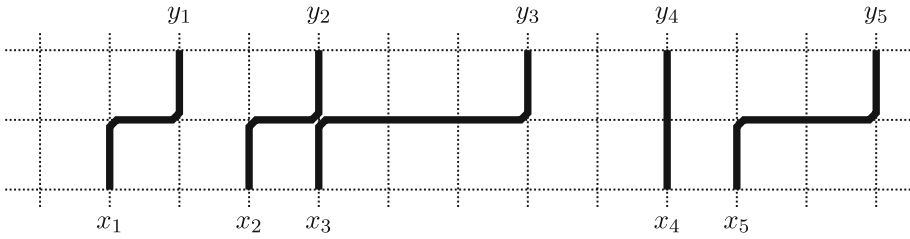

Fig. 10. Two consecutive “slices” of the six-vertex model defining an element of the transfer matrix

$$T_k(\vec{x}, \vec{y}) := \begin{cases} a_2^{\#[a_2]} b_1^{\#[b_1]} b_2^{\#[b_2]} c_1^{\#[c_1]} c_2^{\#[c_2]}, & \text{if there is a configuration of horizontal lines connecting } \vec{x} \text{ to } \vec{y} \text{ (such a configuration is unique if it exists);} \\ 0, & \text{otherwise.} \end{cases}$$

For example, the configuration of lines on Fig. 10 represents a particular element of the transfer matrix equal to $T_k(\vec{x}, \vec{y}) = a_2 b_1 b_2^3 c_1^3 c_2^3$.

Remark 8.1. The transfer matrix (and the corresponding six-vertex model) possesses a clear asymmetry because of the very different roles played by a_1 and a_2 vertices.

Following the coordinate Bethe ansatz approach of [5,36], the eigenfunctions of the transfer matrix can be computed (note that no Bethe equations are needed as we work on the infinite lattice). Let us define

$$\mathcal{S}_{6V}(\xi_1, \xi_2) := 1 - \frac{a_2 + b_1 b_2 - c_1 c_2}{b_1} \xi_1 + \frac{a_2 b_2}{b_1} \xi_1 \xi_2, \tag{8.1}$$

and

$$\Phi_{\vec{\xi}}^{6V}(\vec{x}) := \sum_{\sigma \in S(k)} \text{sgn}(\sigma) \prod_{1 \leq B < A \leq k} \mathcal{S}_{6V}(\xi_{\sigma(A)}, \xi_{\sigma(B)}) \prod_{j=1}^k \xi_{\sigma(j)}^{-x_j}, \quad \vec{x} \in \widetilde{\mathbb{W}}^k. \tag{8.2}$$

Proposition 8.2 [13]. *For all sufficiently small complex ξ_j 's (such that the series in \vec{x} below converges), the functions (8.2) are eigenfunctions of the transposed transfer matrix T_k in the sense that*

$$\sum_{\vec{x} \in \widetilde{\mathbb{W}}^k} \Phi_{\vec{\xi}}^{6V}(\vec{x}) T_k(\vec{x}, \vec{y}) = \left(\prod_{j=1}^k \frac{b_1 + (c_1 c_2 - b_1 b_2) \xi_j}{1 - b_2 \xi_j} \right) \Phi_{\vec{\xi}}^{6V}(\vec{y}), \quad \vec{y} \in \widetilde{\mathbb{W}}^k.$$

The eigenfunctions of the transposed transfer matrix correspond to left eigenfunctions in the notation of the rest of the paper. One could similarly write down the statement for the right eigenfunctions:

Corollary 8.3 [13]. *For all sufficiently small complex ξ_j 's (such that the series in \vec{y} below converges), the eigenfunctions of the transfer matrix T_k are*

$$(\mathcal{R}\Phi_{\vec{\xi}}^{6V})(\vec{x}) = (-1)^{\frac{k(k-1)}{2}} \sum_{\sigma \in S(k)} \text{sgn}(\sigma) \prod_{1 \leq B < A \leq k} \mathcal{S}_{6V}(\xi_{\sigma(B)}, \xi_{\sigma(A)}) \prod_{j=1}^k \xi_{\sigma(j)}^{x_j}, \tag{8.3}$$

in the sense that

$$\sum_{\vec{y} \in \widetilde{\mathbb{W}}^k} T_k(\vec{x}, \vec{y})(\mathcal{R}\Phi_{\xi}^{6V})(\vec{y}) = \left(\prod_{j=1}^k \frac{b_1 + (c_1c_2 - b_1b_2)\xi_j}{1 - b_2\xi_j} \right) (\mathcal{R}\Phi_{\xi}^{6V})(\vec{x}), \quad \vec{x} \in \widetilde{\mathbb{W}}^k,$$

where \mathcal{R} is the space reflection operator (2.15).

Proof. This follows from Proposition 8.2 and a simple symmetry relation for the transfer matrix: $T_k((y_1, \dots, y_k), (x_1, \dots, x_k)) = T_k((-x_k, \dots, -x_1), (-y_k, \dots, -y_1))$. \square

8.2. Connection to eigenfunctions of the conjugated q -Hahn operator.

8.2.1. *Matching the cross-terms.* We will now match the eigenfunctions of the six-vertex model to certain degenerations of the eigenfunctions of the conjugated q -Hahn operator. This degeneration is very similar to the passage from the q -Hahn eigenfunctions to the ASEP eigenfunctions (see Sect. 7.2).

Recall that the conjugated q -Hahn eigenfunctions $\Phi_{\xi}^{\ell; \theta}(\vec{n})$ (6.4) are given by the same formula as (8.2), but with a different cross-term (6.6). Slightly rewriting this cross-term, we arrive at

$$\frac{1 - q\theta v}{\theta(1 - q)} \mathcal{S}_{q, v, \theta}(\xi_1, \xi_2) = 1 - \frac{1 - q\theta v}{\theta(1 - q)} \xi_1 + \frac{q - \theta v}{\theta(1 - q)} \xi_2 + \frac{v}{\theta} \xi_1 \xi_2. \tag{8.4}$$

We can set $v = 1/(q\theta)$ or $v = q/\theta$ to kill one of the linear terms in (8.4), and arrive at an expression which one can hope to match to (8.1). We will not consider the second degeneration because it leads to weakly ordered spatial variables (see the discussion in Sect. 7.2). Thus, we are left with

$$\left(\frac{1 - q\theta v}{\theta(1 - q)} \mathcal{S}_{q, v, \theta}(\xi_1, \xi_2) \right) \Big|_{v=1/(q\theta)} = 1 - \frac{1 + q^{-1}}{\theta} \xi_2 + \frac{q^{-1}}{\theta^2} \xi_1 \xi_2, \tag{8.5}$$

and so for any $x_1 \leq \dots \leq x_k$:

$$\begin{aligned} & \left(\left(-\frac{1 - q\theta v}{\theta(1 - q)} \right)^{\frac{k(k-1)}{2}} \Phi_{\xi}^{\ell; \theta}(x_k, \dots, x_1) \right) \Big|_{v=1/(q\theta)} \\ &= \sum_{\sigma \in S(k)} \text{sgn}(\sigma) \prod_{B < A} \left(1 - \frac{1 + q^{-1}}{\theta} \xi_{\sigma(A)} + \frac{q^{-1}}{\theta^2} \xi_{\sigma(A)} \xi_{\sigma(B)} \right) \prod_{j=1}^k \xi_{\sigma(j)}^{-x_j}. \end{aligned} \tag{8.6}$$

It is now possible to match the cross-term in the right-hand side of (8.6) to the six-vertex cross-term (8.1). Let us denote (we include $a_1 = 1$ in formulas below for symmetry)

$$\Delta := \frac{a_1 a_2 + b_1 b_2 - c_1 c_2}{2\sqrt{a_1 a_2 b_1 b_2}}, \quad \delta := \frac{a_2 b_2}{a_1 b_1}. \tag{8.7}$$

Proposition 8.4. *If the pair of parameters (θ, q) takes one of the two values (θ_{\pm}, q_{\pm}) , where*

$$\begin{aligned}\theta_{\pm} &:= \frac{1}{\sqrt{\delta}} \left(\Delta \pm \sqrt{\Delta^2 - 1} \right); \\ q_{\pm} &:= -1 + 2\Delta^2 \mp 2\Delta\sqrt{\Delta^2 - 1},\end{aligned}\tag{8.8}$$

then for any integers $x_1 \leq \dots \leq x_k$:

$$\begin{aligned}\left(\left(-\frac{1 - q\theta v}{\theta(1 - q)} \right)^{\frac{k(k-1)}{2}} \Phi_{\xi}^{\ell; \theta}(x_k, \dots, x_1) \right) \Big|_{v=1/(q\theta)} &= \Phi_{\xi}^{6V}(x_1, \dots, x_k), \\ \left(\left(\frac{1 - q\theta v}{\theta(1 - q)} \right)^{\frac{k(k-1)}{2}} \Phi_{\xi}^{r; \theta}(x_k, \dots, x_1) \right) \Big|_{v=1/(q\theta)} &= (\mathcal{R}\Phi_{\xi}^{6V})(x_1, \dots, x_k) \cdot \mathbf{1}_{x_1 < \dots < x_k}.\end{aligned}\tag{8.9}$$

This degeneration of eigenfunctions should be compared to the ASEP setting (second two formulas in (7.16)).

Proof. The values (8.8) are obtained by matching coefficients in cross-terms in (8.6) and (8.1), which leads to a quadratic equation. Formulas (8.9) then follow from (6.4)–(6.5). \square

One can readily see that for the solutions (8.8) we have $q_+q_- = 1$, and, moreover,

- If $\Delta > 1$, then $0 < q_+ < 1$ and $\theta_{\pm} > 0$;
- If $-1 < \Delta < 1$, then q_{\pm} are complex numbers lying on the unit circle. They have nonzero imaginary part except $\Delta = 0$ when $q_- = q_+ = -1$. The numbers θ_{\pm} also have nonzero imaginary part;
- If $\Delta < -1$, then $0 < q_- < 1$ and $\theta_{\pm} < 0$;
- If $\Delta = \pm 1$, then $q_+ = q_- = 1$ and $\theta_+ = \theta_- = \pm \delta^{-1/2}$.

Remark 8.5. (Stochastic six-vertex model) If $\Delta > 1$, then it is possible to choose $\delta > 0$ so that $\theta_+ = 1$. This means that the eigenfunctions of the transfer matrix of the six-vertex model coincide with those of the ASEP (see Fig. 1). Moreover, the transfer matrix itself can be interpreted as a Markov transition operator associated with a certain discrete-time stochastic particle system—the (asymmetric) stochastic six-vertex model. This model is studied in detail in [13]. All results from Sect. 7 (Plancherel isomorphisms, spectral biorthogonality, symmetrization identities) thus apply to eigenfunctions of the stochastic six-vertex model.

8.2.2. *A change of spectral variables.* In the rest of the paper we will assume that $\Delta \neq \pm 1$. Then there exists a change of spectral variables $\bar{\xi} \rightarrow \bar{z}$ similar to the involution Ξ_{θ} from Sect. 6.1, which leads to a linear cross-term in the eigenfunctions. More precisely, set

$$\Xi^{6V}(z) := \frac{\theta - z}{1 - z/(q\theta)}.$$

Note that this map is an involution (in contrast with Ξ^{ASEP} from Sect. 7.1).

Definition 8.6. Whenever we want to take parameters (q, θ) depending on the parameters (Δ, δ) (8.7) of the six-vertex model, we will set

$$(q, \theta) := \begin{cases} (q_+, \theta_+) & \text{if } \Delta > 1 \text{ or } -1 < \Delta < 1; \\ (q_-, \theta_-) & \text{if } \Delta < -1, \end{cases} \tag{8.10}$$

where q_{\pm} and θ_{\pm} are defined in (8.8).

Define

$$\Psi_{\vec{z}}^{6V}(\vec{x}) := \sum_{\sigma \in S(k)} \prod_{B < A} \frac{z_{\sigma(B)} - q z_{\sigma(A)}}{z_{\sigma(B)} - z_{\sigma(A)}} \prod_{j=1}^k \left(\frac{\theta - z_{\sigma(j)}}{1 - z_{\sigma(j)}/(q\theta)} \right)^{-x_j}, \quad \vec{x} \in \widetilde{\mathbb{W}}^k. \tag{8.11}$$

The reflection of the above function gives

$$(\mathcal{R}\Psi_{\vec{z}}^{6V})(\vec{x}) = \sum_{\sigma \in S(k)} \prod_{B < A} \frac{z_{\sigma(A)} - q z_{\sigma(B)}}{z_{\sigma(A)} - z_{\sigma(B)}} \prod_{j=1}^k \left(\frac{\theta - z_{\sigma(j)}}{1 - z_{\sigma(j)}/(q\theta)} \right)^{x_j}. \tag{8.12}$$

Then one can readily check that the functions (8.11)–(8.12) are related to (8.2) and (8.3) as follows:

$$\begin{aligned} \Psi_{\Xi^{6V}(\vec{\xi})}^{6V}(\vec{x}) &= (q\theta)^{\frac{k(k-1)}{2}} (\mathbf{V}(\vec{\xi}))^{-1} \Phi_{\vec{\xi}}^{6V}(\vec{x}), \\ &\times (\mathcal{R}\Psi_{\Xi^{6V}(\vec{\xi})}^{6V})(\vec{x}) = (q\theta)^{\frac{k(k-1)}{2}} (\mathbf{V}(\vec{\xi}))^{-1} (\mathcal{R}\Phi_{\vec{\xi}}^{6V})(\vec{x}), \end{aligned}$$

where, as usual, $\mathbf{V}(\vec{\xi})$ is the Vandermonde determinant. Also, the functions (8.11)–(8.12) arise from the conjugated q -Hahn eigenfunctions (6.2)–(6.3) as

$$\begin{aligned} \Psi_{\vec{z}}^{6V}(x_1, \dots, x_k) &= \Psi_{\vec{z}}^{\ell; \theta}(x_k, \dots, x_1)|_{v=1/(q\theta)}; \\ (\mathcal{R}\Psi_{\vec{z}}^{6V})(x_1, \dots, x_k) \cdot \mathbf{1}_{x_1 < \dots < x_k} &= (q^{-1} - 1)^{-k} \Psi_{\vec{z}}^{r; \theta}(x_k, \dots, x_1)|_{v=1/(q\theta)}, \end{aligned} \tag{8.13}$$

where $x_1 \leq \dots \leq x_k$. The degeneration of eigenfunctions (8.13) should be compared to the first two formulas in (7.16).

8.3. Heisenberg XXZ spin chain. Consider the transfer matrix T_k (where k is the number of vertical lines in the configuration) defined in Sect. 8.1, and let

$$a_1 = a_2 = 1, \quad b_1 = b_2 = \epsilon b, \quad c_1 = c_2 = 1 - \epsilon c,$$

where $\epsilon > 0$ is a small parameter, $b > 0$, and $c \in \mathbb{R}$. Then one readily sees that

$$T_k(\vec{x}, \vec{y}) = \mathbf{1}_{\vec{y}=\vec{x}+1} + \epsilon b \cdot \widetilde{\mathcal{H}}_{\Delta}^{\text{XXZ}}(\vec{x}, \vec{y}) + O(\epsilon^2), \quad \vec{x}, \vec{y} \in \widetilde{\mathbb{W}}^k, \tag{8.14}$$

where $\vec{x} + 1$ means increasing all coordinates by 1, and $\widetilde{\mathcal{H}}_{\Delta}^{\text{XXZ}}$ is the following matrix:

$$\widetilde{\mathcal{H}}_{\Delta}^{\text{XXZ}}(\vec{x}, \vec{y} + 1) = \sum_i (\mathbf{1}_{\vec{y}=\vec{x}_i^-} - \Delta \cdot \mathbf{1}_{\vec{y}=\vec{x}}) + \sum_j (\mathbf{1}_{\vec{y}=\vec{x}_j^+} - \Delta \cdot \mathbf{1}_{\vec{y}=\vec{x}}), \quad \Delta = \frac{c}{b} \tag{8.15}$$

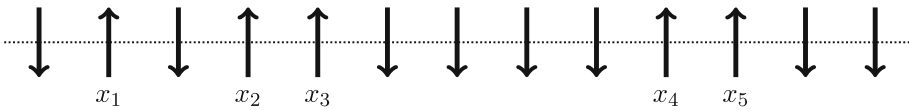

Fig. 11. A configuration of spins in the XXZ spin chain

(the notation \vec{x}_i^\pm is as in Sect. 7.1). The sums above are taken over all i and j such that \vec{x}_i^- and \vec{x}_j^+ , respectively, belong to $\tilde{\mathbb{W}}^k$. Note that Δ above is simply the $\epsilon \rightarrow 0$ limit of the corresponding six-vertex parameter Δ (8.7). In the same limit, the second parameter δ of the six-vertex eigenfunctions turns into 1.

We thus arrive at the Hamiltonian of the (spin- $\frac{1}{2}$) Heisenberg XXZ quantum spin chain on the infinite lattice:

$$(\mathcal{H}_\Delta^{\text{XXZ}} f)(\vec{x}) = \sum_i (f(\vec{x}_i^-) - \Delta f(\vec{x})) + \sum_j (f(\vec{x}_j^+) - \Delta f(\vec{x})) \tag{8.16}$$

(both sums are over allowed configurations as in (8.15)). The operator $\mathcal{H}_\Delta^{\text{XXZ}}$ acts on (compactly supported) functions in k variables $\vec{x} \in \tilde{\mathbb{W}}^k$, according to the transfer matrix T_k in (8.14). The integers x_1, \dots, x_k are traditionally understood as encoding positions of up spins (or magnons), and all other lattice points correspond to down spins, see Fig. 11 (note that $\mathcal{H}_\Delta^{\text{XXZ}}$ preserves the number of up spins).

Remark 8.7. On a finite lattice with periodic boundary, $\mathcal{H}_\Delta^{\text{XXZ}}$ can be rewritten in a more traditional way involving nearest-neighbor quantum interactions. Namely, encode spin configurations on a finite lattice $\{1, \dots, L\}$ by vectors in $(\mathbb{C}^2)^{\otimes L}$, where the basis in \mathbb{C}^2 consists of vectors $|\uparrow\rangle$ and $|\downarrow\rangle$. Let σ^x, σ^y , and σ^z be the Pauli matrices acting in \mathbb{C}^2

$$\sigma^x = \begin{pmatrix} 0 & 1 \\ 1 & 0 \end{pmatrix} \quad \sigma^y = \begin{pmatrix} 0 & -i \\ i & 0 \end{pmatrix} \quad \sigma^z = \begin{pmatrix} 1 & 0 \\ 0 & -1 \end{pmatrix}.$$

The XXZ spin chain Hamiltonian on the finite lattice is the following operator in $(\mathbb{C}^2)^{\otimes L}$:

$$-\frac{1}{2} \sum_{j=1}^L (\sigma_j^x \sigma_{j+1}^x + \sigma_j^y \sigma_{j+1}^y + \Delta \sigma_j^z \sigma_{j+1}^z), \quad \sigma_{L+1}^a \equiv \sigma_1^a. \tag{8.17}$$

Here σ_j^a ($a \in \{x, y, z\}$) denotes the operator acting as σ^a in the j -th copy of \mathbb{C}^2 (and trivially in all other copies).

The operator (8.17) preserves the number of up spins. When restricted to the subspace of $(\mathbb{C}^2)^{\otimes L}$ corresponding to exactly k up spins, (8.17) coincides (up to an additive constant) with the analogue of $\mathcal{H}_\Delta^{\text{XXZ}}$ (8.16) on the finite lattice with periodic boundary.

The eigenfunctions of the XXZ spin chain can be computed independently by applying the coordinate Bethe ansatz to the operator $\mathcal{H}_\Delta^{\text{XXZ}}$. This was first performed in [8] for $\Delta = 1$ and [69, 70] for all Δ , see also [5] for a general perspective. On the other hand, these are simply the six-vertex eigenfunctions specialized at $\delta = 1$. In this case one readily checks that $q = 1/\theta^2$, and so, for example, (8.11) turns into

$$\Psi_{\vec{z}}^{\text{XXZ}}(\vec{x}) = \sum_{\sigma \in S(k)} \prod_{B < A} \frac{z_{\sigma(B)} - \theta^{-2} z_{\sigma(A)}}{z_{\sigma(B)} - z_{\sigma(A)}} \prod_{j=1}^k \left(\frac{1 - \theta^{-1} z_{\sigma(j)}}{\theta^{-1} - z_{\sigma(j)}} \right)^{-x_j}, \quad \vec{x} \in \tilde{\mathbb{W}}^k, \tag{8.18}$$

where θ is related to Δ via (8.8) which can be restated as follows (taking into account the agreement of Definition 8.6):

$$\Delta = \frac{1}{2} \left(\theta + \frac{1}{\theta} \right) = \frac{1}{2} \left(\frac{1}{\sqrt{q}} + \sqrt{q} \right). \tag{8.19}$$

In the same way (8.12) turns into

$$(\mathcal{R}\Psi_{\vec{z}}^{\text{XXZ}})(\vec{x}) = \sum_{\sigma \in S(k)} \prod_{B < A} \frac{z_{\sigma(A)} - \theta^{-2} z_{\sigma(B)}}{z_{\sigma(A)} - z_{\sigma(B)}} \prod_{j=1}^k \left(\frac{1 - \theta^{-1} z_{\sigma(j)}}{\theta^{-1} - z_{\sigma(j)}} \right)^{x_j}. \tag{8.20}$$

Note that the cross-term (8.5) in the $\vec{\xi}$ variables becomes $1 - 2\Delta\xi_2 + \xi_1\xi_2$ for the XXZ model. One can also readily specialize the eigenfunctions (8.2) and (8.3), but we will not use them.

Plancherel formulas for the XXZ eigenfunctions were obtained in [2,3,29]. Those formulas involved real and positive Plancherel measures governing Plancherel decompositions, as it should be for a model with a Hermitian symmetric Hamiltonian (cf. Remark 3.12). In Sects. 8.4 and 8.5 below we discuss other Plancherel formulas for the XXZ model which follow from our main results of Sects. 3–5.

Remark 8.8. If $|\Delta| > 1$, then the XXZ Hamiltonian $\mathcal{H}_{\Delta}^{\text{XXZ}}$ is conjugate to the stochastic ASEP generator $\mathcal{H}_{\tau}^{\text{ASEP}}$ (7.2):

$$\frac{1}{2\Delta} \mathcal{G}_{\theta} \mathcal{H}_{\Delta}^{\text{XXZ}} \mathcal{G}_{\theta}^{-1} = \mathcal{H}_{\tau}^{\text{ASEP}}, \quad \tau = 1/\theta^2, \quad \begin{cases} \theta > 1 & \text{if } \Delta > 1; \\ \theta < -1 & \text{if } \Delta < -1, \end{cases}$$

where θ is related to Δ as in (8.19), and the operator \mathcal{G}_{θ} is defined in (6.1). This property was noted in [54].

In the case $|\Delta| < 1$, one could also perform a similar conjugation, but this will lead to complex parameter τ in the ASEP generator, so the latter will no longer be stochastic. We will discuss the relevant results for the eigenfunctions in Sect. 8.5 below.

8.4. Case $|\Delta| > 1$, real q and θ . Observe that the six-vertex and XXZ eigenfunctions ((8.11) and (8.18), respectively) can be both obtained from the ASEP eigenfunctions (7.6) by applying the dilation operator \mathcal{G}_a with suitable $a \neq 0$ and by possibly rescaling the \vec{z} variables (cf. Fig. 1).¹⁸ These operations do not change the cross-term parameter of the eigenfunctions, so the six-vertex parameter q and the XXZ parameter θ^{-2} are the same as the ASEP parameter τ . So if $|\Delta| > 1$, then all these parameters are real and between 0 and 1. One issue which arises for $\Delta < -1$ is that the parameter θ in six-vertex or XXZ eigenfunctions is negative, but this is readily resolved by applying the dilation \mathcal{G}_{-1} and negating the variables \vec{z} .

Therefore, all ASEP results, namely, spectral biorthogonality (Theorem 7.2), Plancherel formulas (Theorems 7.3 and 7.5), and symmetrization identities (Sect. 7.6), are readily seen to be equivalent to the corresponding results for the six-vertex and XXZ eigenfunctions for $|\Delta| > 1$.

For example, the XXZ Plancherel formula takes the following form (cf. (7.24)):

¹⁸ This relation between XXZ and ASEP also extends to their generators, see Remark 8.8.

Theorem 8.9. For $|\Delta| > 1$ and any $\vec{x}, \vec{y} \in \widetilde{\mathbb{W}}^k$,

$$\oint_{\vec{\gamma}_\theta} \frac{dz_1}{2\pi i} \cdots \oint_{\vec{\gamma}_\theta} \frac{dz_k}{2\pi i} \prod_{B < A} \frac{z_A - z_B}{z_A - \theta^{-2} z_B} \times \prod_{j=1}^k \frac{1 - \theta^{-2}}{(1 - \theta^{-1} z_j)(\theta^{-1} - z_j)} \left(\frac{1 - \theta^{-1} z_j}{\theta^{-1} - z_j} \right)^{-x_j} (\mathcal{R}\Psi_{\vec{z}}^{\text{XXZ}})(\vec{y}) = \mathbf{1}_{\vec{x}=\vec{y}}. \tag{8.21}$$

The integration contours $\vec{\gamma}_\theta$ are positively oriented small circles around θ . The parameter $\theta \in \mathbb{R}$ is related to Δ via (8.19), and, moreover, $|\theta| > 1$.

In the case $|\Delta| > 1$ the Plancherel formulas in [2, 3, 29] (stated in our spectral variables \vec{z}) involve string specializations $\vec{z} = \vec{w} \circ \lambda$ (2.5) corresponding to partitions $\lambda \vdash k$ (as in, e.g., (3.18)–(3.19)). Moreover, the integration in those XXZ Plancherel formulas is performed over circles centered at 0 with radii θ^ℓ , $\ell = 0, 1, \dots$ (and the Plancherel measures understood in a suitable way are positive on such contours). It seems plausible that our Plancherel formula (8.21) (which involves integration over small circles around θ and no string specializations) can be brought to a form with large integration contours, and then matched to formulas existing in the literature cited above. Indeed, in the process of contour deformation (from small to large contours), one would need to pick residues corresponding to poles of the integrand in (8.21) at $z_A = \theta^{-2} z_B$, $B < A$. This should lead to a residue expansion employing string specializations (as in Proposition 3.2, see also [15, §7.2]). We do not pursue this computation here.

We will not write down other XXZ or six-vertex formulas with real parameters (q, θ) .

8.5. Case $|\Delta| < 1$, complex q and θ . When $|\Delta| < 1$, the cross-term parameters in our models (θ^{-2} in XXZ or q in the six-vertex model) become complex numbers of modulus 1. For definiteness, we will consider only the XXZ case.¹⁹ We start with the conjugated q -Hahn eigenfunctions with complex q , $|q| = 1$ (they can be treated similarly to the q -Boson ones with complex q discussed in [15, §5]), and then specialize them to the XXZ eigenfunctions by putting $q = \theta^{-2}$, $v = \theta$ (cf. Fig. 1).

Fix an integer $k \geq 1$ (this is the number of particles in our particle system), and assume that $q \in \mathbb{C}$, $|q| = 1$, and $q^j \neq 1$ for all $j = 1, 2, \dots, k - 1$.²⁰ The conjugated q -Hahn eigenfunctions $\Psi_{\vec{z}}^{\ell; \theta}$ and $\Psi_{\vec{z}}^{r; \theta}$ (6.2)–(6.3), as well as the corresponding direct transform $\mathcal{F}^{q, v, \theta}$ (6.8), are defined in the same way as for real q . Recall that the integration contours $\gamma_1^\theta, \dots, \gamma_k^\theta$ used in the definition of the inverse transform $\mathcal{J}^{q, v, \theta}$ (6.9) are such that γ_k^θ is a small positively oriented contour around θ not containing θq , γ_A^θ contains $q\gamma_B^\theta$ for all $1 \leq A < B \leq k$, and, moreover, v^{-1} is outside all contours. For complex q satisfying our assumptions, and possibly complex θ , these contours exist but differ from the ones in the real case, see Fig. 12 (and Fig. 2 for the real case).

With these modifications the spatial Plancherel formula (i.e., the first half of Theorem 6.5 stating that $\mathcal{K}^{q, v, \theta} = \mathcal{J}^{q, v, \theta} \mathcal{F}^{q, v, \theta}$ acts as the identity operator on \mathcal{W}^k) continues to hold. In this statement we can set $q = \theta^{-2}$ (where $\theta \in \mathbb{C}$, $|\theta| = 1$, and $\theta^{2j} \neq 1$ for all $j = 1, \dots, k - 1$) right away, and the spatial Plancherel theorem will continue to hold.

¹⁹ The six-vertex formulas will be equivalent to the ones for the XXZ spin chain (cf. the beginning of Sect. 8.4). Similarly one could also write formulas for the ASEP eigenfunctions with complex τ of modulus 1.

²⁰ In particular, this condition excludes the case $\Delta = 0$.

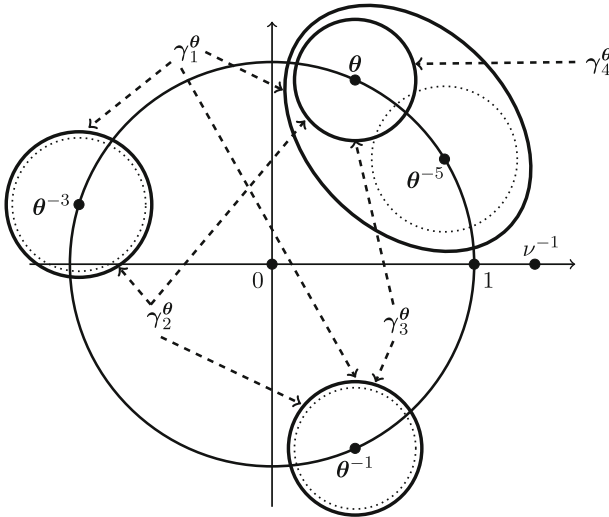

Fig. 12. A possible choice of integration contours $\gamma_1^\theta, \gamma_2^\theta, \gamma_3^\theta, \gamma_4^\theta$ for $k = 4$ and $q = \theta^{-2}$, where θ is on the unit circle. In the picture, θ is relatively close to $e^{i\pi/3}$, so $\theta q^3 = \theta^{-5}$ is close to θ . The contour γ_4^θ is a single small circle around θ . The contour γ_3^θ is a union of γ_4^θ and a slightly larger contour around $\theta q = \theta^{-1}$ (so γ_3^θ contains $q\gamma_4^\theta$). The contour γ_2^θ is a union of γ_3^θ and a yet slightly larger contour around $\theta q^2 = \theta^{-3}$ (so γ_2^θ contains both $q\gamma_3^\theta$ and $q\gamma_4^\theta$). The contour $q\gamma_2^\theta$ intersects, γ_4^θ , so the contour γ_1^θ must be a union of circles around θ^{-1}, θ^{-3} , and of an ellipse around θ and $\theta q^3 = \theta^{-5}$ which contains γ_4^θ (in this way, γ_1^θ contains $q\gamma_2^\theta, q\gamma_3^\theta$, and $q\gamma_4^\theta$). The images of circles under multiplication by $q = \theta^{-2}$ are shown dotted

Now we must further specialize $\nu = \theta$. This requires deforming all contours to γ_k^θ , because the “nested” integration contours $\gamma_1^\theta, \dots, \gamma_k^\theta$ must not contain $\nu^{-1} = \theta^{-1} = q\theta$ (for real q a similar obstacle was encountered in the ASEP case, see the proof of Theorem 7.3). The required contour deformation can be performed using an analogue of the second part of Proposition 3.2 which requires one modification. Let us fix a small positively oriented circle γ_k^θ around θ which does not contain $q\theta = \theta^{-1}$. The image of this contour γ_k^θ under the multiplication by some power of q can intersect with γ_k^θ (as this happens on Fig. 12), and this affects which residues are contributing when contours are deformed to γ_k^θ . Define the following subsets of the contour γ_k^θ for $\ell \geq 1$ (see Fig 13):

$$\Gamma_\ell(\theta^{-2}) := \{z \in \gamma_k^\theta : \text{for all } 1 \leq j < \ell, \theta^{-2j}z \text{ is outside } \gamma_k^\theta\}.$$

Proposition 8.10. *The inverse transform $\mathcal{J}^{\theta^{-2}, \nu, \theta}$ can be written in the following form:*

$$\begin{aligned} (\mathcal{J}^{\theta^{-2}, \nu, \theta} G)(\vec{n}) &= \sum_{\lambda \vdash k} \oint_{\Gamma_{\lambda_1}(\theta^{-2})} \dots \oint_{\Gamma_{\lambda_{\ell(\lambda)}}(\theta^{-2})} \theta^{-k} dm_\lambda^{(\theta^{-2})}(\vec{w}) \\ &\times \prod_{j=1}^{\ell(\lambda)} \frac{1}{(w_j/\theta; \theta^{-2})_{\lambda_j} (\nu w_j; \theta^{-2})_{\lambda_j}} \Psi_{\vec{w} \circ \lambda}^{\ell; \theta}(\vec{n}) G(w \circ \lambda). \end{aligned} \tag{8.22}$$

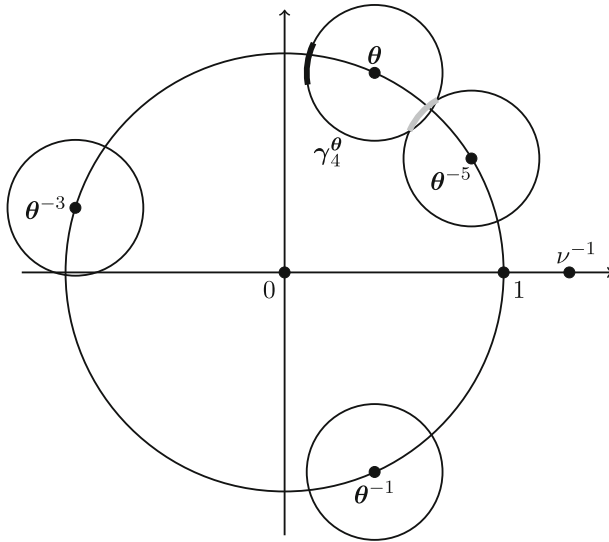

Fig. 13. Integration contours in Proposition 8.10 for $k = 4$ and θ relatively close to $e^{i\pi/3}$. The contour γ_4^θ is a fixed circle around θ . The contours $\Gamma_1(\theta^{-2})$, $\Gamma_2(\theta^{-2})$, $\Gamma_3(\theta^{-2})$ are all equal to γ_4^θ , i.e., they are full circles. The contour $\Gamma_4(\theta^{-2})$ is γ_4^θ without the *thick black arc*, because for z in this arc, points $q^3 z = \theta^{-6} z$ are inside γ_4^θ (this is the *thick gray arc* of the contour $\theta^{-6}\gamma_4^\theta$)

Consequently, the spatial Plancherel formula looks as

$$\sum_{\lambda \vdash k} \oint_{\Gamma_{\lambda_1}(\theta^{-2})} \cdots \oint_{\Gamma_{\lambda_{\ell(\lambda)}}(\theta^{-2})} \theta^{-k} dm_\lambda^{(\theta^{-2})}(\vec{w}) \prod_{j=1}^{\ell(\lambda)} \times \frac{1}{(w_j/\theta; \theta^{-2})_{\lambda_j} (vw_j; \theta^{-2})_{\lambda_j}} \Psi_{\vec{w} \circ \lambda}^{\ell; \theta}(\vec{n}) \Psi_{\vec{w} \circ \lambda}^{r; \theta}(\vec{m}) = \mathbf{1}_{\vec{n}=\vec{m}}. \tag{8.23}$$

Here $\vec{n}, \vec{m} \in \mathbb{W}^k$, and in both formulas in the eigenfunctions we set $q = \theta^{-2}$.

Proof. The first expression follows from the same argument as in [15, Lemma 5.1]. This implies the form of the spatial Plancherel theorem given in the second formula. \square

Remark 8.11. When θ is a root of unity, $\theta^{-2j} z$ and z may belong to the same contour for some j , so some of the contours $\Gamma_\ell(\theta^{-2})$ would be empty. On the other hand, formulas (8.22)–(8.23) contain expressions of the form $\theta^{-2j} z_A - z_B$ in the denominator, which leads to additional singularities. While we expect that these issues can be resolved by a suitable regularization, we do not pursue this direction here.

We can now put $v = \theta$ in the Plancherel formula (8.23). One can readily check that the conjugated q -Hahn eigenfunctions are related to the XXZ eigenfunctions (8.18) and (8.20) as

$$\begin{aligned} \Psi_z^{\ell; \theta}(x_k, \dots, x_1)|_{q=\theta^{-2}, v=\theta} &= \Psi_z^{\text{XXZ}}(x_1, \dots, x_k), \\ \Psi_z^{r; \theta}(x_k, \dots, x_1)|_{q=\theta^{-2}, v=\theta} &= \mathbf{1}_{x_1 < \dots < x_k} \cdot (\theta^2 - 1)^k (\mathcal{R} \Psi_z^{\text{XXZ}})(x_1, \dots, x_k) \end{aligned}$$

for all integers $x_1 \leq \dots \leq x_k$. Thus, we arrive at the following spatial Plancherel formula for the XXZ spin chain with $|\Delta| < 1$:

Theorem 8.12. *For any $\vec{x}, \vec{y} \in \tilde{\mathbb{W}}^k$:*

$$\sum_{\lambda \vdash k} \oint_{\Gamma_{\lambda_1}(\theta^{-2})} \dots \oint_{\Gamma_{\lambda_{\ell(\lambda)}}(\theta^{-2})} (\theta - \theta^{-1})^k d\mathbf{m}_{\lambda}^{(\theta^{-2})}(\vec{w}) \times \prod_{j=1}^{\ell(\lambda)} \frac{1}{(1 - w_j \theta)(1 - w_j \theta^{1-2\lambda_j})(w_j/\theta; \theta^{-2})_{\lambda_j-1}^2} \Psi_{\vec{w} \circ \lambda}^{\text{XXZ}}(\vec{x})(\mathcal{R}\Psi_{\vec{w} \circ \lambda}^{\text{XXZ}})(\vec{y}) = \mathbf{1}_{\vec{x}=\vec{y}}. \tag{8.24}$$

Moreover, if the contour γ_k^θ around θ is so small that $\Gamma_k(\theta^{-2})$ coincides with the full circle γ_k^θ , then the above formula simplifies to

$$\oint_{\gamma_k^\theta} \dots \oint_{\gamma_k^\theta} d\mathbf{m}^{(\theta^{-2})}(\vec{z}) \prod_{j=1}^k \frac{1 - \theta^{-2}}{(\theta^{-1} - z_j)(1 - \theta^{-1} z_j)} \Psi_{\vec{z}}^{\text{XXZ}}(\vec{x})(\mathcal{R}\Psi_{\vec{z}}^{\text{XXZ}})(\vec{y}) = \mathbf{1}_{\vec{x}=\vec{y}}. \tag{8.25}$$

Note that the second formula in the theorem is the same as the XXZ Plancherel formula (8.21) for $|\Delta| > 1$ (i.e., for real θ).

Proof. The first claim directly follows by putting $\nu = \theta$ in (8.23). The second formula is established in the same way as the corresponding ASEP result (Theorem 7.3). The property that all integration contours are full circles around θ is crucial for the vanishing of all summands in the right-hand side of (8.24) except for the one corresponding to $\lambda = (1^k)$. \square

In the case $|\Delta| < 1$, Plancherel formulas for the XXZ model existing in the literature [2, 29] involve integration over so-called Chebyshev circles. These are certain circular arcs in the spectral variables $\vec{\xi}$, which in the variables \vec{z} translate to rays starting at the origin. Plancherel measures (understood in a suitable way) are positive on such contours. It seems plausible that one can deform the integration contours in (8.24) or (8.25) so that these Plancherel measures become positive on the new contours, and then match the resulting formulas to the ones in the literature. We do not explore this direction here.

We expect that the spectral Plancherel formula and the spectral biorthogonality statement for XXZ eigenfunctions hold (with some modifications) in the case $|\Delta| < 1$ (and thus complex θ), but we do not pursue this direction here.

Acknowledgements. This project was initiated at the Simons Symposium on the Kardar–Parisi–Zhang Equation. The authors appreciate illuminating and helpful comments and discussions with Donald Babbitt, Vadim Gorin, Alexander Povolotsky, Larry Thomas, Craig Tracy, and Harold Widom. We are also grateful to anonymous reviewers for suggestions on improving the presentation of our results. A.B. was partially supported by the NSF grant DMS-1056390. I.C. was partially supported by the NSF through DMS-1208998 as well as by Microsoft Research and MIT through the Schramm Memorial Fellowship, by the Clay Mathematics Institute through the Clay Research Fellowship, and by the Institute Henri Poincaré through the Poincaré Chair. T.S. was partially supported by KAKENHI 22740054 and the Sumitomo Foundation.

9. Appendix. Further Degenerations

The eigenfunctions discussed in the present paper admit further scaling limits (in other words, degenerations), all the way to the Bethe ansatz eigenfunctions of the continuous delta Bose gas. These degenerations correspond to dashed arrows on Fig. 1, and in this appendix we briefly discuss them. We will focus on the “Boson side” (as in Sect. 5.1) and on the corresponding left eigenfunctions (the right eigenfunctions scale in a very similar way). That is, we will not describe in detail the “TASEP side” dual to the “Boson side” as in Sect. 5.3.

Remark 9.1. In principle, limit relations between various Bethe ansatz eigenfunctions we present in this appendix could be used to establish Plancherel theorems for them. However, for more degenerate eigenfunctions these results are already known, see the corresponding references for each case below.

9.1. q -Boson eigenfunctions. If we set $\nu = 0$ in the q -Hahn TASEP (Sect. 5.3), we obtain the discrete-time geometric q -TASEP of [9]. If we further pass to continuous time (with the help of the parameter μ), we arrive at the q -TASEP introduced in [10]. As shown in [16], the dual process to the q -TASEP (in the same way as in Sect. 5.3) is the stochastic q -Boson particle system of [52].

The generator of the stochastic q -Boson particle system is equivalent to the following free generator

$$(\mathcal{L}^{q\text{-Boson}}u)(\vec{n}) = (1 - q) \sum_{j=1}^k (\nabla_j u)(\vec{n}), \quad (\nabla f)(x) := f(x - 1) - f(x),$$

subject to two-body boundary conditions

$$(\nabla_i - q\nabla_{i+1})u|_{\vec{n} \in \mathbb{Z}^k : n_i = n_{i+1}} = 0$$

for any $1 \leq i \leq k - 1$. Note that the above boundary conditions are simply the $\nu = 0$ degenerations of the q -Hahn boundary conditions (5.3).

The (left) eigenfunctions of the q -Boson particle system are the $\nu = 0$ degenerations of the q -Hahn eigenfunctions $\Psi_z^\ell(\vec{n})$ (2.11):

$$\Psi_z^{\ell, q\text{-Boson}}(\vec{n}) = \sum_{\sigma \in S(k)} \prod_{1 \leq B < A \leq k} \frac{z_{\sigma(A)} - qz_{\sigma(B)}}{z_{\sigma(A)} - z_{\sigma(B)}} \prod_{j=1}^k (1 - z_{\sigma(j)})^{-n_j}, \quad \vec{n} \in \mathbb{W}^k. \tag{9.1}$$

They depend on a parameter $q \in (0, 1]$ and on our discrete spatial variables \vec{n} . These eigenfunctions can be constructed by applying the coordinate Bethe ansatz to the q -Boson generator, see [15, §2.3]. Note that the system dual to the discrete-time geometric q -TASEP also possesses the same eigenfunctions (9.1).

The Plancherel spectral theory corresponding to the q -Boson eigenfunctions was developed in [15] using different ideas, see Remarks 3.8 and 4.12 for details. On the other hand, main results of [15] can be obtained as a rather straightforward $\nu = 0$ degeneration of the corresponding results of the present paper.

9.2. *q-Boson* \rightarrow *Semi-discrete delta Bose gas*. In a scaling limit, the *q*-Boson generator converges to a certain semi-discrete delta Bose gas operator governing evolution of the moments of the semi-discrete stochastic heat equation. The latter equation is satisfied by the partition function of the O’Connell–Yor semi-discrete directed polymer introduced in [46] (see also [44]). Details on passing from the *q*-TASEP level to the semi-discrete polymer level are discussed in [10], [15, §6.3], [16], see also [18] for a brief general account.

The semi-discrete delta Bose gas operator (related to the semi-discrete stochastic heat equation via a duality) is equivalent to the following free operator

$$(\mathcal{L}^{S-D}u)(\vec{n}) = \sum_{j=1}^k (\nabla_j u)(\vec{n})$$

(with the same ∇_i as in Sect. 9.1) subject to two-body boundary conditions

$$(\nabla_i - \nabla_{i+1} - c)u \Big|_{\vec{n} \in \mathbb{Z}^k : n_i = n_{i+1}} = 0$$

for any $1 \leq i \leq k - 1$. Here $c \in \mathbb{R} \setminus \{0\}$ is the so-called coupling constant which is a parameter of the model.

The coordinate Bethe ansatz yields the following eigenfunctions at the semi-discrete polymer level (they depend on c and on discrete spatial variables):

$$\Psi_{\vec{z}}^{\ell, S-D}(\vec{n}) = \sum_{\sigma \in S(k)} \prod_{B < A} \frac{z_{\sigma(A)} - z_{\sigma(B)} - c}{z_{\sigma(A)} - z_{\sigma(B)}} \prod_{j=1}^k z_{\sigma(j)}^{-n_j}, \quad \vec{n} \in \mathbb{W}^k. \tag{9.2}$$

The above eigenfunctions appeared earlier in [57]. Plancherel theory and completeness of the Bethe ansatz for the above setting is discussed in [15, §6.3].

One can readily check the following convergence of eigenfunctions (9.1) to (9.2):

$$\lim_{\epsilon \rightarrow 0} (\epsilon/c)^{n_1 + \dots + n_k} \left(\Psi_{\vec{z}}^{\ell, q\text{-Boson}}(\vec{n}) \Big|_{q=e^{-\epsilon}, z_j=e^{-w_j \epsilon/c} } \right) = \Psi_{\vec{w}}^{\ell, S-D}(\vec{n}).$$

9.3. *Semi-discrete delta Bose gas* \rightarrow *Continuous delta Bose gas*. A further degeneration of the semi-discrete delta Bose gas described in Sect. 9.2 takes us to the level of continuous delta Bose gas [10, 11, 16, 43]. The latter system is also referred to as the Lieb–Liniger system, and it is dual [6, 10, §6] to the stochastic heat equation, or, via the Hopf–Cole transform, to the KPZ equation.

It is standard in physics literature (e.g., see [20, 24]) to reduce the continuous delta Bose gas operator to the following free operator

$$(\mathcal{L}^{KPZ}u)(x_1, \dots, x_k) = \frac{1}{2} \sum_{j=1}^k \frac{\partial^2}{\partial x_j^2} u(x_1, \dots, x_k), \quad x_1 \leq \dots \leq x_k, \quad x_i \in \mathbb{R}, \tag{9.3}$$

subject to two-body boundary conditions (here $\tilde{c} \in \mathbb{R} \setminus \{0\}$ is the coupling constant)

$$\left(\frac{\partial}{\partial x_i} - \frac{\partial}{\partial x_{i+1}} - \tilde{c} \right) u \Big|_{\vec{x} \in \mathbb{R}^k : x_i + 0 = x_{i+1}} = 0 \tag{9.4}$$

for any $1 \leq i \leq k - 1$ (where $x_i + 0 = x_{i+1}$ means the limit as $x_i \rightarrow x_{i+1}$ from below). To our knowledge, this reduction has not been rigorously justified. The system (9.3)–(9.4) is referred to as the Yang system (of type A) in [31], and dates back to [67, 68]. See also [28, 31] for other root systems.

Applying the coordinate Bethe ansatz to (9.3)–(9.4), one constructs the eigenfunctions (note that they depend on \tilde{c} and on continuous spatial variables)

$$\Psi_{\tilde{z}}^{\ell, \text{KPZ}}(\vec{x}) = \sum_{\sigma \in S(k)} \prod_{B < A} \frac{z_{\sigma(A)} - z_{\sigma(B)} - \tilde{c}}{z_{\sigma(A)} - z_{\sigma(B)}} \prod_{j=1}^k e^{x_j z_{\sigma(j)}}, \quad x_1 \leq \dots \leq x_k, \quad x_i \in \mathbb{R}. \tag{9.5}$$

These eigenfunctions were first written down by Lieb and Liniger [37]. The corresponding spatial Plancherel formula was proven in various forms in [31, 47, 50]. There are also certain accounts of spectral biorthogonality results for the eigenfunctions (9.5) in the physics literature, e.g., see [19, 24, 25]. Details on the spatial Plancherel formula in the language similar to the rest of the present paper can be found in [15, §7.1]. See also [10, Remark 6.2.5] for more historical background (in particular, concerning completeness of the Bethe ansatz).

One can readily check the following convergence of eigenfunctions (9.2) to (9.5):

$$\begin{aligned} \lim_{\epsilon \rightarrow 0} g^{\sum_{j=1}^k \lceil -x_j \frac{g}{\epsilon} \rceil} \left(\Psi_{\tilde{z}}^{\ell, \text{S-D}} \left(\lceil -x_k \frac{g}{\epsilon} \rceil, \dots, \lceil -x_1 \frac{g}{\epsilon} \rceil \right) \Big|_{c = -\epsilon \tilde{c}, z_j = g + w_j \epsilon} \right) \\ = \Psi_{\tilde{w}}^{\ell, \text{KPZ}}(x_1, \dots, x_k). \end{aligned}$$

Here $x_i \in \mathbb{R}$ are as above, and $g > 0$ is an arbitrary fixed constant. The notation $\lceil \dots \rceil$ means integer part. Note that the rescaling of the spectral variables is performed around a point $g \neq 0$, i.e., not around a singularity of the multiplicative terms $z_{\sigma(j)}^{-n_j}$ in (9.2). This situation is different from the rescaling of the spectral variables in Sect. 9.2 and in Sect. 9.4 below.

9.4. q -Boson \rightarrow Van Diejen’s delta Bose gas. Another scaling [15, §6.2] of the q -Boson generator (Sect. 9.1) takes us to a semi-discrete delta Bose gas studied by Van Diejen [63] (other models of a similar nature are discussed in [64, 65]). The limiting operator is equivalent to the following free operator subject to two-body boundary conditions (we use notation of Sect. 5.1)

$$(\mathcal{L}^{\text{VD}} u)(\vec{n}) = \sum_{j=1}^k u(\vec{n}_j^-), \quad \left(u(\vec{n}_i^-) - qu(\vec{n}_{i+1}^-) \right) \Big|_{\vec{n} \in \mathbb{Z}^k: n_i = n_{i+1}} = 0$$

for any $1 \leq i \leq k - 1$.

Applying the coordinate Bethe ansatz, one arrives at the following eigenfunctions:

$$\Psi_{\tilde{z}}^{\ell, \text{VD}}(\vec{n}) = \sum_{\sigma \in S(k)} \prod_{B < A} \frac{z_{\sigma(A)} - qz_{\sigma(B)}}{z_{\sigma(A)} - z_{\sigma(B)}} \prod_{j=1}^k z_{\sigma(j)}^{-n_j}, \quad \vec{n} \in \mathbb{W}^k, \tag{9.6}$$

depending on $q \in (0, 1]$ and on discrete spatial variables. One can readily identify these eigenfunctions with the Hall–Littlewood symmetric polynomials [40, Ch. III].

Spatial Plancherel formula corresponding to the eigenfunctions (9.6) (and thus the completeness of the Bethe ansatz) was obtained in [63], it is essentially equivalent to a similar statement for Macdonald’s spherical functions [39,41]. See also [15, §6.2] for the spectral biorthogonality statement which is implied by the Cauchy identity for the Hall–Littlewood polynomials [40, Ch. III].

One can readily check the following convergence of the q -Boson eigenfunctions (9.1) to those of Van Diejen’s model (9.6):

$$\lim_{\epsilon \rightarrow 0} (-\epsilon)^{-n_1 - \dots - n_k} \left(\Psi_z^{\ell, q\text{-Boson}}(\vec{n}) \Big|_{z_j = w_j/\epsilon} \right) = \Psi_w^{\ell, \text{VD}}(\vec{n}).$$

9.5. *Van Diejen’s delta Bose gas \rightarrow Continuous delta Bose gas.* A rigorous treatment of convergence of Van Diejen’s semi-discrete delta Bose gas (Sect. 9.4) to the continuous delta Bose gas (Sect. 9.3) is performed in [63].

Let us record the convergence of the corresponding eigenfunctions, (9.6) to (9.5):

$$\lim_{\epsilon \rightarrow 0} \left(\Psi_z^{\ell, \text{VD}}([x_1 \frac{\tilde{c}}{\epsilon}], \dots, [x_k \frac{\tilde{c}}{\epsilon}]) \Big|_{q=e^{-\epsilon}, z_j=e^{-w_j\epsilon/\tilde{c}}} \right) = \Psi_w^{\ell, \text{KPZ}}(x_1, \dots, x_k),$$

where $x_i \in \mathbb{R}$ and $x_1 \leq \dots \leq x_k$. We assumed that $\tilde{c} > 0$, but a similar statement can be readily written down for $\tilde{c} < 0$. Note that here (as in Sect. 9.3) the spectral variables are rescaled around 1, which is not a singularity of the factors $z_{\sigma(j)}^{-n_j}$ in (9.6). One could also insert an arbitrary fixed constant g around which the spectral variables are rescaled, but we will not write this down.

9.6. *ASEP/XXZ \rightarrow Continuous delta Bose gas.* Convergence of the ASEP to the KPZ equation (equivalently, to the logarithm of the stochastic heat equation) was established in various senses in [1,7]. See also [33] for a brief account related to the corresponding “Boson side”.

The ASEP eigenfunctions (7.6) converge to the continuous delta Bose ones (9.5) in the following way. Let $g \in \mathbb{R}$ be an arbitrary fixed constant such that $\frac{\tilde{c}}{g(1-g)} > 0$, $\tau = e^{-\sqrt{\tilde{c}}}$, $z_j = (g^{-1} - 1)e^{w_j\sqrt{\tilde{c}}}$, and

$$x_j = \left[\frac{y_j}{\epsilon} \cdot \frac{\tilde{c}}{g(1-g)} \right], \quad j = 1, \dots, k.$$

Here $\vec{x} = (x_1 < \dots < x_k)$, $x_i \in \mathbb{Z}$ are the spatial variables for the ASEP, and $\vec{y} = (y_1 \leq \dots \leq y_k)$, $y_i \in \mathbb{R}$ are the spatial variables for the continuous delta Bose gas. Then we have

$$\tau^{x_j(1-g)} \left(\frac{1 + z_{\sigma(j)}}{1 + z_{\sigma(j)}/\tau} \right)^{-x_j} \sim e^{\frac{1}{2}y_j\tilde{c}} e^{y_j w_{\sigma(j)}}, \quad j = 1, \dots, k.$$

Therefore, under the scaling just described, we have

$$\lim_{\epsilon \rightarrow 0} \tau^{(1-g)(x_1 + \dots + x_k)} \Psi_z^{\text{ASEP}}(\vec{x}) = e^{\frac{1}{2}\tilde{c}(y_1 + \dots + y_k)} \Psi_w^{\ell, \text{KPZ}}(\vec{y}). \tag{9.7}$$

Note that as in Sects. 9.3 and 9.5 above, the spectral variables are rescaled away from the singularity.

The XXZ eigenfunctions are related to the ASEP ones in a straightforward way (cf. Remark 8.8), and their convergence to the eigenfunctions at the continuous delta Bose level is very similar to (9.7). We will not write down this statement.

References

1. Amir, G., Corwin, I., Quastel, J.: Probability distribution of the free energy of the continuum directed random polymer in $1 + 1$ dimensions. *Commun. Pure Appl. Math.* **64**(4), 466–537 (2011). [arXiv:1003.0443](#) [math.PR]
2. Babbitt, D., Gutkin, E.: The Plancherel formula for the infinite XXZ Heisenberg spin chain. *Lett. Math. Phys.* **20**, 91–99 (1990)
3. Babbitt, D.L. Thomas: Ground state representation of the infinite one-dimensional Heisenberg ferromagnet. II. An explicit Plancherel formula. *Commun. Math. Phys.* **54**, 255–278 (1977)
4. Barraquand, G.: A short proof of a symmetry identity for the (q, μ, ν) -deformed Binomial distribution. *Electron. Commun. Probab.* **19**(50), 1–3 (2014). [arXiv:1404.4265](#) [math.PR]
5. R.J. Baxter: *Exactly Solved Models in Statistical Mechanics*. Courier Dover Publications, Mineola (2007)
6. Bertini, L.N., Cancrini, I.: The stochastic heat equation: Feynman–Kac formula and intermittence. *J. Stat. Phys.* **78**(5–6), 1377–1401 (1995)
7. Bertini, L., Giacomin, G.: Stochastic Burgers and KPZ equations from particle systems. *Commun. Math. Phys.* **183**, 571–607 (1997)
8. Bethe, H.: Zur Theorie der Metalle. I. Eigenwerte und Eigenfunktionen der linearen Atomkette (On the theory of metals. I. Eigenvalues and eigenfunctions of the linear atom chain). *Zeitschrift Fur Physik* **71**, 205–226 (1931)
9. Borodin, A., Corwin, I.: Discrete time q -TASEPs. *Intern. Math. Res. Notices* (2013). [arXiv:1305.2972](#) [math.PR]. doi:[10.1093/imrn/rnt206](#)
10. Borodin, A., Corwin, I.: Macdonald processes. *Probab. Theory Relat. Fields* **158**(1–2), 225–400 (2014). [arXiv:1111.4408](#) [math.PR]
11. Borodin, A., Corwin, I., Ferrari, P.: Free energy fluctuations for directed polymers in random media in $1 + 1$ dimension. *Commun. Pure Appl. Math.* **67**(7), 1129–1214 (2014). [arXiv:1204.1024](#) [math.PR]
12. Borodin, A., Corwin, I., Ferrari, P., Veto, B.: Height fluctuations for the stationary KPZ equation (2014). [arXiv:1407.6977](#) [math.PR]
13. Borodin, A., Corwin, I., Gorin, V.: Stochastic six-vertex model. (2014). [arXiv:1407.6729](#) [math.PR]
14. Borodin, A., Corwin, I., Gorin, V., Shakirov, S.: Observables of Macdonald processes (2013). [arXiv:1306.0659](#) [math.PR]
15. Borodin, A., Corwin, I., Petrov, L., Sasamoto, T.: Spectral theory for the q -Boson particle system. *Composit. Math.* **151**(1), 1–67 (2015). [arXiv:1308.3475](#) [math-ph]
16. Borodin, A., Corwin, I., Sasamoto, T.: From duality to determinants for q -TASEP and ASEP. *Ann. Probab.* **42**(6), 2314–2382 (2014). [arXiv:1207.5035](#) [math.PR]
17. Borodin, A., Petrov, L.: Nearest neighbor Markov dynamics on Macdonald processes. *Adv. Math.* (2013, to appear). [arXiv:1305.5501](#) [math.PR]
18. Borodin, A., Petrov, L.: Integrable probability: From representation theory to Macdonald processes. *Probab. Surv.* **11**, 1–58 (2014). [arXiv:1310.8007](#) [math.PR]
19. Calabrese, P., Caux, J.S.: Dynamics of the attractive 1D Bose gas: analytical treatment from integrability. *J. Stat. Mech.* P08032 (2007)
20. Calabrese, P., Le Doussal, P., Rosso, A.: Free-energy distribution of the directed polymer at high temperature. *Eur. Phys. Lett.* **90**(2), 20002 (2010)
21. Carinci, G., Giardinà, C., Redig, F., Sasamoto, T.: A generalized asymmetric exclusion process with $U_q(\mathfrak{sl}_2)$ stochastic duality (2014). [arXiv:1407.3367](#) [math.PR]
22. Corwin, I.: The q -Hahn Boson process and q -Hahn TASEP. *Int. Math. Res. Notices* (2014). [arXiv:1401.3321](#) [math.PR]. doi:[10.1093/imrn/rnu094](#)
23. Corwin, I., Quastel, J.: Crossover distributions at the edge of the rarefaction fan. *Ann. Probab.* **41**(3A), 1243–1314 (2013). [arXiv:1006.1338](#) [math.PR]
24. Dotsenko, V.: Bethe ansatz derivation of the Tracy–Widom distribution for one-dimensional directed polymers. *Eur. Phys. Lett.* **90**(20003) (2010)
25. Dotsenko, V.: Universal randomness. *Physics-Usppekhi* **54**(3), 259–280, (2011). [arXiv:1009.3116](#) [cond-mat.stat-mech]
26. Faddeev, L.: How Algebraic Bethe Ansatz works for integrable model. *Les-Houches lectures* (1996). [arXiv:hep-th/9605187](#)
27. Ferrari, P., Veto, B.: Tracy–Widom asymptotics for q -TASEP. *Ann. Inst. Henri Poincaré Probab. Stat.* (2013, to appear). [arXiv:1310.2515](#) [math.PR]
28. Gaudin, M.: Boundary energy of a Bose gas in one dimension. *Phys. Rev. A* **4**, 386–394 (1971)
29. Gutkin, E.: Heisenberg-Ising spin chain: Plancherel decomposition and Chebyshev polynomials. Calogero–Moser–Sutherland Models. CRM Series in Mathematical Physics, pp. 177–192 (2000)
30. Gwa, L.-H.H., Spohn: Bethe solution for the dynamical-scaling exponent of the noisy Burgers equation. *Phys. Rev. A* **46**, 844–854 (1992)

31. Heckman, G.J., Opdam, E.M.: Yang's system of particles and Hecke algebras. *Ann. Math.* **145**(1), 139–173 (1997)
32. Helgason, S.: An analogue of the Paley–Wiener theorem for the Fourier transform on certain symmetric spaces. *Math. Ann.* **165**, 297–308 (1966)
33. Imamura, T., Sasamoto, T., Spohn, H.: KPZ, ASEP and Delta-Bose gas. *J. Phys. Conf. Ser.* **297**, 012–016 (2011)
34. Koekoek, R., Swarttouw, R.F.: The Askey-scheme of hypergeometric orthogonal polynomials and its q -analogue. Tech. report, Delft University of Technology and Free University of Amsterdam (1996)
35. Korhonen, M., Lee, E.: The transition probability and the probability for the left-most particle's position of the q -TAZRP. *J. Math. Phys.* **55**, 013301 (2013). [arXiv:1308.4769](https://arxiv.org/abs/1308.4769) [math-ph]
36. Lieb, E.H.: The residual entropy of square ice. *Phys. Rev.* **162**, 162–172 (1967)
37. Lieb, E.H., Liniger, W.: Exact analysis of an interacting Bose gas. I. The general solution and the ground state. *Phys. Rev. Lett.* **130**, 1605–1616 (1963)
38. Liggett, T.: *Interacting Particle Systems*. Springer, New York (1985)
39. Macdonald, I.G.: Spherical functions of p -adic type. *Publ. Ramanujan Inst.* **2** (1971)
40. Macdonald, I.G.: *Symmetric Functions and Hall Polynomials*, 2nd edn. Oxford University Press, Oxford (1995)
41. Macdonald, I.G.: Orthogonal polynomials associated with root systems. *Sem. Lothar. Combin.* **45**(B45a) (2000)
42. Matveev, K., Petrov, L.: q -randomized Robinson–Schensted–Knuth correspondences and random polymers (2015). [arXiv:1504.00666](https://arxiv.org/abs/1504.00666) [math.PR]
43. Moreno Flores, G.R., Quastel, J., Remenik, D.: In preparation (2015)
44. O'Connell, N.: Directed polymers and the quantum Toda lattice. *Ann. Probab.* **40**(2), 437–458 (2012). [arXiv:0910.0069](https://arxiv.org/abs/0910.0069) [math.PR]
45. O'Connell, N., Pei, Y.: A q -weighted version of the Robinson–Schensted algorithm. *Electron. J. Probab.* **18**(95), 1–25 (2013). [arXiv:1212.6716](https://arxiv.org/abs/1212.6716) [math.CO]
46. O'Connell, N., Yor, M.: Brownian analogues of Burke's theorem. *Stoch. Proc. Appl.* **96**(2), 285–304 (2001)
47. Oxford, S.: The Hamiltonian of the quantized nonlinear Schrödinger equation. Ph.D. thesis, UCLA (1979)
48. Povolotsky, A.: On integrability of zero-range chipping models with factorized steady state. *J. Phys. A* **46**(465205) (2013). [arXiv:1308.3250](https://arxiv.org/abs/1308.3250) [math-ph]
49. Povolotsky, A., Priezhev, V.: Determinant solution for the totally asymmetric exclusion process with parallel update. *J. Stat. Mech.* **7**, P07002 (2006)
50. Prolhac, S., Spohn, H.: The propagator of the attractive delta-Bose gas in one dimension. *J. Math. Phys.* **52**, 122106 (2011). [arXiv:1109.3404](https://arxiv.org/abs/1109.3404) [math-ph]
51. Reshetikhin, N.: Lectures on the integrability of the 6-vertex model. *Lect. Notes Les Houches Summer School* **89**, 197–266 (2008). [arXiv:1010.5031](https://arxiv.org/abs/1010.5031) [math-ph]
52. Sasamoto, T., Wadati, M.: Exact results for one-dimensional totally asymmetric diffusion models. *J. Phys. A* **31**, 6057–6071 (1998)
53. Schütz, G.: Duality relations for asymmetric exclusion processes. *J. Stat. Phys.* **86**, 12651287 (1997)
54. Schütz, G.: Exact solution of the master equation for the asymmetric exclusion process. *J. Stat. Phys.* **88**, 427–445 (1997)
55. Spitzer, F.: Interaction of Markov processes. *Adv. Math.* **5**(2), 246–290 (1970)
56. Takeyama, Y.: A deformation of affine Hecke algebra and integrable stochastic particle system. *J. Phys. A* **47**(46), 465203 (2014). [arXiv:1407.1960](https://arxiv.org/abs/1407.1960) [math-ph]
57. Takeyama, Y.: A discrete analogue of period delta Bose gas and affine Hecke algebra. *Funkcialaj Ekvacioj* **57**(1), 107–118 (2014). [arXiv:1209.2758](https://arxiv.org/abs/1209.2758) [math-ph]
58. Tracy, C., Widom, H.: A Fredholm determinant representation in ASEP. *J. Stat. Phys.* **132**(2), 291–300 (2008). [arXiv:0804.1379](https://arxiv.org/abs/0804.1379) [math.PR]
59. Tracy, C., Widom, H.: Integral formulas for the asymmetric simple exclusion process. *Commun. Math. Phys.* **279**, 815–844 (2008). [arXiv:0704.2633](https://arxiv.org/abs/0704.2633) [math.PR] [Erratum: *Commun. Math. Phys.* **304**, 875–878 (2011)]
60. Tracy, C., Widom, H.: Asymptotics in ASEP with step initial condition. *Commun. Math. Phys.* **290**, 129–154 (2009). [arXiv:0807.1713](https://arxiv.org/abs/0807.1713) [math.PR]
61. Tracy, C., Widom, H.: On ASEP with step Bernoulli initial condition. *J. Stat. Phys.* **137**, 825–838 (2009). [arXiv:0907.5192](https://arxiv.org/abs/0907.5192) [math.PR]
62. Tracy, C., Widom, H.: Total current fluctuations in ASEP. *J. Math. Phys.* **50**(9), 095–204 (2009). [arXiv:0902.0821](https://arxiv.org/abs/0902.0821) [math.PR]
63. Van Diejen, J.F.: On the Plancherel formula for the (discrete) Laplacian in a Weyl chamber with repulsive boundary conditions at the walls. *Ann. Inst. H. Poincaré* **5**(1), 135–168 (2004)
64. Van Diejen, J.F., Emsiz, E.: Diagonalization of the infinite q -Boson. *J. Funct. Anal.* **266**(9), 5801–5817 (2014). [arXiv:1308.2237](https://arxiv.org/abs/1308.2237) [math-ph]

65. Van Diejen, J.F., Emsiz, E.: The semi-infinite q -Boson system with boundary interaction. *Lett. Math. Phys.* **104**(1), 103–113 (2014). [arXiv:1308.2242](https://arxiv.org/abs/1308.2242) [math-ph]
66. Veto, B.: TracyWidom limit of q -Hahn TASEP (2014). [arXiv:1407.2787](https://arxiv.org/abs/1407.2787) [math.PR]
67. Yang, C.N.: Some exact results for the many body problem in one dimension with repulsive delta function interaction. *Phys. Rev. Lett.* **19**, 1312–1314 (1967)
68. Yang, C.N.: S matrix for the one dimensional N -body problem with repulsive or attractive delta-function interaction. *Phys. Rev.* **168**, 1920–1923 (1968)
69. Yang, C.N., Yang, C.P.: One dimensional chain of anisotropic spin-spin interaction. *Phys. Rev.* **150**, 321–327, 327–339 (1966)
70. Yang, C.N., Yang, C.P.: One dimensional chain of anisotropic spin-spin interaction. *Phys. Rev.* **151**, 258–264 (1966)

Communicated by H. Spohn