

## Hydrothermal synthesis of fine oxide powders

SHIGEYUKI SŌMIYA\* and RUSTUM ROY

Tokyo Institute of Technology, and Teikyo University of Science and Technology, 3-7-19 Seijo, Setagaya, Tokyo 157-0066, Japan

Materials Research Laboratory, University Park, PA 16802, USA

MS received 29 August 2000

**Abstract.** This is a review and an overview on hydrothermal synthesis of fine oxide powders. The term hydrothermal today includes methods which involve water at pressures (from 1 atm–several kilobars) and high temperatures from 100–10,000°C. Hydrothermal is one of the best methods to produce pure fine oxide powders. The authors describe (i) hydrothermal decomposition, (ii) hydrothermal metal oxidation, (iii) hydrothermal reaction, (iv) hydrothermal precipitation and hydrothermal hydrolysis, (v) hydrothermal electrochemical, (vi) reactive electrode submerged arc, (vii) hydrothermal microwave, (viii) hydrothermal sonochemical, etc and also ideal and real powders.

**Keywords.** Hydrothermal; synthesis; fine powders; oxide powders.

### 1. Introduction to powder preparation

Inorganic powders are among the most important factors in many fields of materials such as ceramics, catalysts, medicines, food, etc. There are many papers and books related to powders preparation by many authors (Veale 1972; Kato and Yamaguchi 1983; Vincenzini 1983; Brinker *et al* 1984; Johnson Jr. 1987; Messing *et al* 1987; Segal 1989; Ganguli and Chatterjee 1997; Chemical Society of Japan 1985, for examples). Powder preparation is a most important step among the processing steps in ceramics. Therefore there are many reports on this topic worldwide, some of these being mentioned here. Table 1 (Sōmiya and Akiba 1999) shows varieties of preparative methods for fine ceramic powders.

### 2. Hydrothermal synthesis

The term 'hydrothermal' came from the earth sciences, where it implied a regime of high temperatures and water pressures. Table 2 (Morey 1953; Walker 1953; Eitel 1966; Laudise 1970; Lobachev 1971; Sōmiya 1983, 1989, 1994; Stambaugh 1983; Demianets *et al* 1984; Rabenau 1985; Brice 1986; Dawson 1988; Byrappa 1991; Rouxed *et al* 1994) shows the place of hydrothermal synthesis among others. Major differences between hydrothermal processing and other technologies are shown in table 3 (Dawson 1988; Segal 1989; Johnson Jr. 1987; Sōmiya and Akiba 1999). For typical H–T research one needs a

high temperature, high-pressure apparatus called 'autoclaves' or 'bombs'. A great deal of early experimental work was done using the Morey bomb (Morey 1953) and Tuttle-Roy test tube bomb (Tem-Press) which are shown in figures 1 and 2 respectively. Hydrothermal synthesis involves H<sub>2</sub>O both as a catalyst and occasionally as a component of solid phases in the synthesis at elevated temperature (> 100°C) and pressure (> a few atmosphere). At present, one can get many kinds of autoclaves to cover different *p*–*t* ranges and volumes. In the US there are 3 types of companies. (i) Tem-Press: They are the best source for research vessels of all kinds including test tube bombs and gas intensifiers for specialized gases, A, H<sub>2</sub>, O<sub>2</sub>, NH<sub>3</sub>, etc. (ii) Autoclave Engineers: They make a complete line of lab-scale valves, tubing, collars, all fittings for connections, etc and they also make very large autoclaves (1–3 m) for quartz and other chemical processes and (iii) Parr Instrument: They make simple, low-pressure, low-temperature (300°C, 1000 bars) laboratory scale type of autoclaves, 50 ml–1 l for low temperature reactions, including vessels lined Teflon, etc.

For hydrothermal experiments the requirements for starting materials are (i) accurately known composition, (ii) as homogeneous as possible, (iii) as pure as possible and (iv) as fine as possible, etc.

#### 2.1 Some results in different categories (Hydrothermal decomposition)

2.1a *Ilmenite (Ismail and Somiya 1983)*: Ilmenite is a very stable mineral, with a composition of FeTiO<sub>3</sub>. Extraction of TiO<sub>2</sub> from such ores has potential. 10 m

\*Author for correspondence

KOH or 10 M NaOH mixed with ilmenite in the ratio 5 : 3 (of ilmenite to water) was reacted under hydrothermal conditions at 500°C, 300 kg/cm<sup>2</sup>. Ilmenite was decomposed completely after 63 h. If the ratio of ilmenite to water was 5 : 4, at the same condition, 39 h was necessary to decompose the ilmenite. Reactions were as follows: In the case of KOH solution,

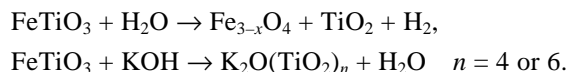

## 2.2 Hydrothermal metal oxidation

2.2a *Zr metal (Yoshimura et al 1984)*: 10–50 g Zr metal powder was reacted with water to form the oxide.

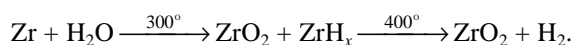

At 300°C under 98 MPa, ZrO<sub>2</sub> and ZrH<sub>x</sub> appeared. Above

400°C under 98 MPa, ZrH<sub>x</sub> disappeared and only ZrO<sub>2</sub> was formed. Figures 3 and 4 show ZrO<sub>2</sub> powders formation by hydrothermal oxidation.

2.2b *Al metal (Toraya et al 1984)*: Al metal was reacted with water under 100 MPa between 200°C and 700°C for 0 to 6 h. AlOOH appeared between 100°C and α-Al<sub>2</sub>O<sub>3</sub> between 500°C and 700°C.

2.2c *Ti metal (Yoshimura et al 1987)*: Ti metal powder reacted with water in the ratio 1 : 2 in a gold capsule, heated under hydrothermal condition of 100 MPa for 3 h up to 700°C. Figure 5 shows the results.

## 2.3 Hydrothermal reactions

There are many papers, for example (Tani et al 1981, 1983; Nishizawa et al 1982; Yoshimura and Sōmiya

**Table 1.** Methods for fine ceramic powders.

1) Mechanical (powder mixing)	a) Ball milling b) Attrition milling c) Vibration milling
2) Thermal decomposition	a) Heating (evaporation) b) Spray drying c) Flame spraying d) Plasma spraying e) Vapour phase (CVD) f) Freeze drying (cryochemical) g) Hot kerosene drying h) Hot petroleum drying i) Combustion j) Laser beam k) Electron beam l) Sputtering
3) Precipitation or hydrolysis	a) Neutralization and precipitation b) Homogeneous precipitation c) Coprecipitation d) Salts solution e) Alkoxides f) Sol-gel
4) Hydrothermal	a) Precipitation (coprecipitation) b) Crystallization c) Decomposition d) Oxidation e) Synthesis f) Electrochemical g) Mechanochemical h) RESA (reactive electrode submerged arc)
	Hydrothermal + microwave Hydrothermal + ultrasonic
5) Melting and rapid quenching	

**Table 2.** Hydrothermal synthesis.

Hydrothermal crystal growth
Hydrothermal treatment
Hydrothermal alternation
Hydrothermal dehydration
Hydrothermal extraction
Hydrothermal reaction sintering
Hydrothermal sintering
Corrosion reaction
Hydrothermal oxidation
Hydrothermal precipitation— hydrothermal crystallization
Hydrothermal decomposition
Hydrothermal hydrolysis— hydrothermal precipitation
Hydrothermal electrochemical reaction
Hydrothermal mechanochemical reaction
Hydrothermal + ultrasonic
Hydrothermal + microwave

**Table 3.** Major differences of powders and processing between hydrothermal and other technology for powder preparation based on studies mainly by Dawson, Segal, Johnson Jr. and Sōmiya.

1) Powders are formed directly from solution
2) Powders are anhydrous, crystalline or amorphous. It depends on producing of hydrothermal powder temperature
3) It is able to control particle size by hydrothermal temperature
4) It is able to control particle shape by starting materials
5) It is able to control chemical, composition, stoichiometry, etc
6) Powders are highly reactive in sintering
7) Many cases, powders do not need calcination
8) Many cases, powders do not need milling process

1984; Komarneni *et al* 1986; Haberko *et al* 1991, 1995) on hydrothermal reactions.  $ZrCl_4$  solution with  $NH_4OH$  formed hydrated zirconia. Then it was washed with distilled water and dried for 48 h at  $120^\circ C$ . This starting material with various solutions was put into a Pt or Au tube under 100 MPa at  $300^\circ C$  for 24 h. The results are

shown in table 4 (Tani *et al* 1981, 1983). Clearly we have excellent  $ZrO_2$  less than 40 nm (figure 6).

2.4 Hydrothermal precipitation or hydrothermal hydrolysis

2.4a Alumina: One of the industrial application of this process is ordinary alumina production. In figure 7 is shown the Bayer process (Riman 1999).

2.4b Zirconia: Hydrothermal homogeneous precipitation is one of the best methods to produce zirconia powders. One Japanese company attempted to produce zirconia powders by this method. The process, properties of the powders and microstructure of the sintered body are shown in table 5 and figures 8, 9 and 10 respectively (Hishinuma *et al* 1988; Sōmiya *et al* 1991).

2.5 Hydrothermal electrochemical method

Figure 11 shows an apparatus of the hydrothermal electrochemical method. For preparing  $BaTiO_3$ , Ti and Pt

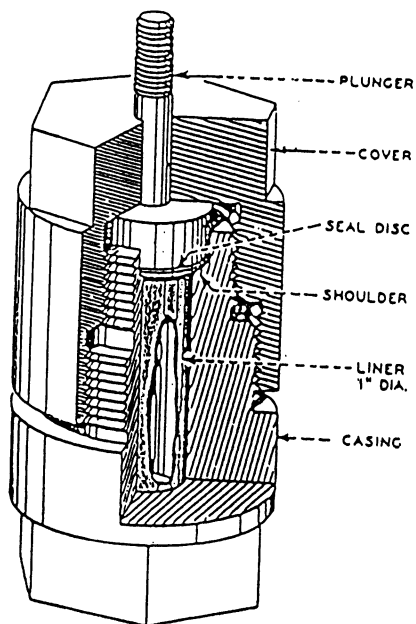

Figure 1. Autoclave with flat plate closure (after Morey 1953).

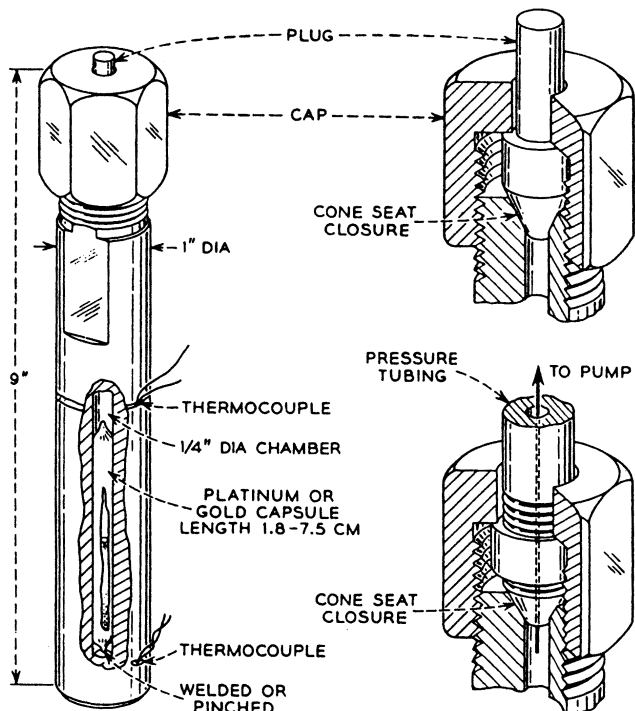

Figure 2. Reaction vessel with a cold-cone seat closure (Tem-press).

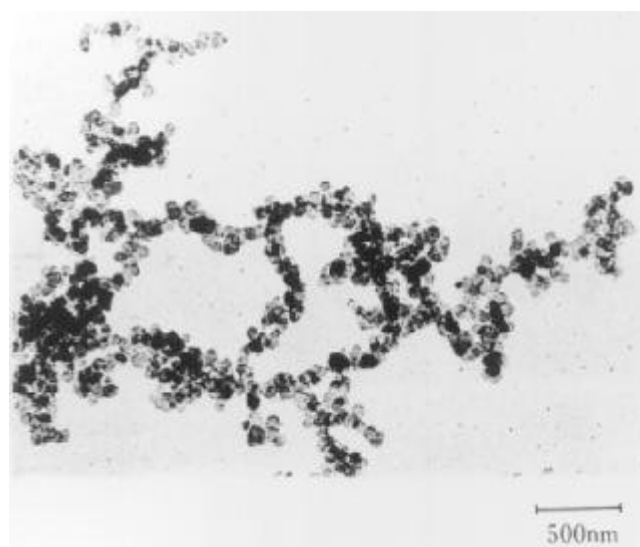

Figure 3. TEM of zirconia powder by hydrothermal oxidation (100 MPa  $500^\circ C$  3 h  $Zr/O = 0.33$ ).

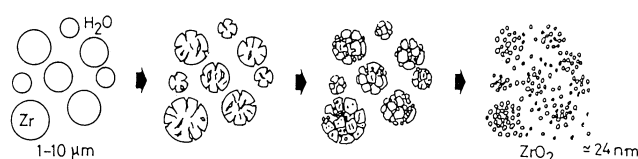

Figure 4. Schematic illustration of hydrothermal oxidation of zirconia powder.

plates were used as working electrode of anode and counter electrode of cathode respectively. Solution of Ba-nitrate 0.1 N or 0.5 N and temperature up to 250°C were used for the experiment. Current density was 100 mA/cm<sup>2</sup>. Under these conditions we were able to get BaTiO<sub>3</sub> powder. Powder of BaTiO<sub>3</sub> by this process is shown in figure 12. ZrO<sub>2</sub> was also produced by this method. In the case of ZrO<sub>2</sub>, Zr plates were used (Yoo *et al* 1988; Yoshimura *et al* 1989a).

### 2.6 Reactive electrode submerged arc (RESA)

RESA (Kumar and Roy 1988, 1989) is totally a new process for making powders. RESA provides access to extremely high temperatures ( $\approx 10,000^\circ\text{K}$ ) with 1 atm H<sub>2</sub>O (possibly more in the nano-environment) pressures. It allows one to change liquids very easily. Figure 13 shows the apparatus and figure 14 some resulting powders.

**Table 4.** Phases present and crystallite size of products by hydrothermal reaction at 100 MPa for 24 h.

Mineralizer	Temperature (°C)	Average crystallite size (nm)	
		Tetragonal ZrO <sub>2</sub> (nm)	Monoclinic ZrO <sub>2</sub> (nm)
KF (8 wt%)	200	Not detected	16
KF (8 wt%)	300	Not detected	20
NaOH (30 wt%)	300	Not detected	40
H <sub>2</sub> O	300	15	17
LiCl (15 wt%)	300	15	19
KBi (10 wt%)	300	13	15

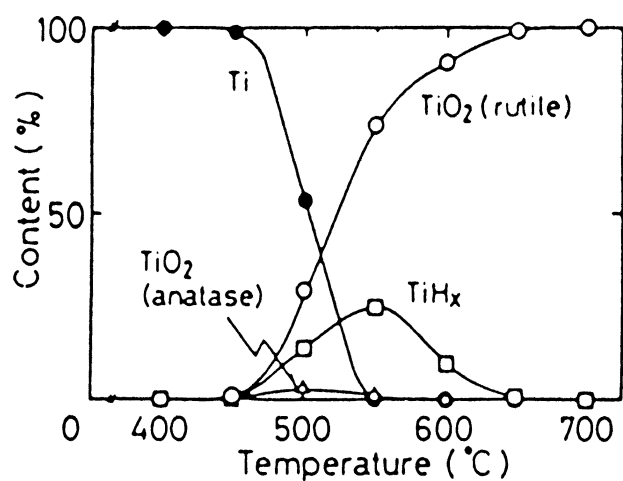

**Figure 5.** Variation of amount of products with temperature by the hydrothermal oxidation of Ti in the closed system under 100 MPa for 3 h.

### 2.7 Hydrothermal mechanochemical process

Ba(OH)<sub>2</sub> and FeCl<sub>3</sub> were used as starting materials. The precipitate was crystallized hydrothermally in an apparatus combined with an attritor and ambient water pressure. The starting solutions with the precipitate and stainless

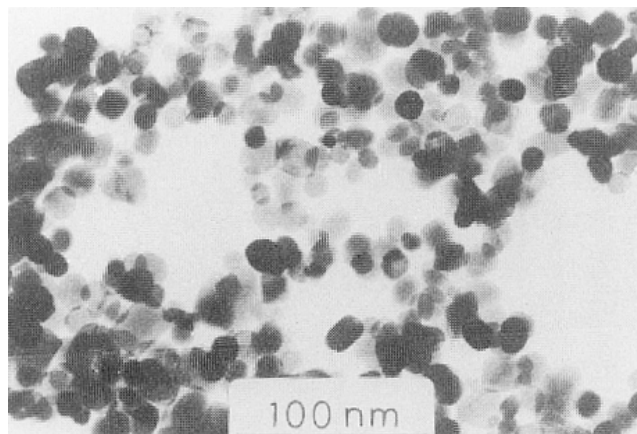

**Figure 6.** TEM of monoclinic zirconia powder by hydrothermal reaction under 400°C, 100 MPa for 24 h using 8 wt% KF solution.

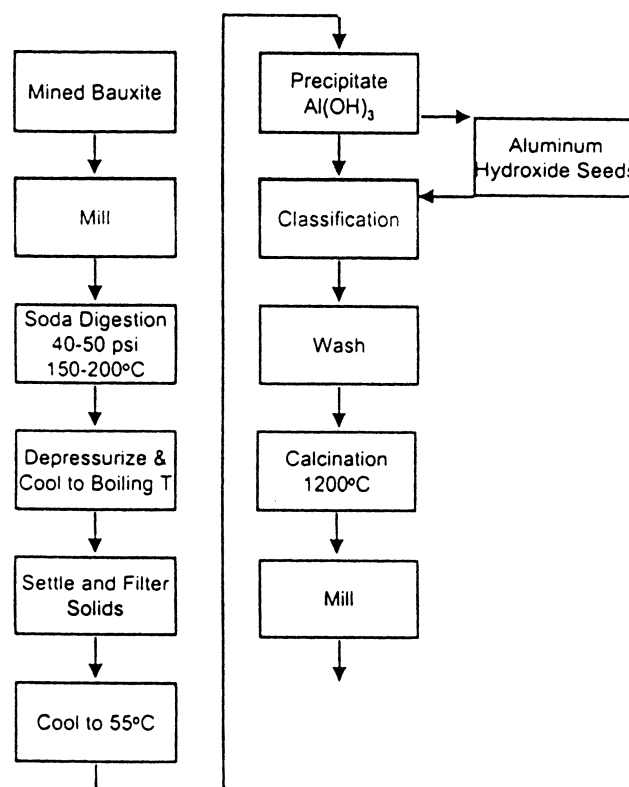

**Figure 7.** Bayer process (Riman).

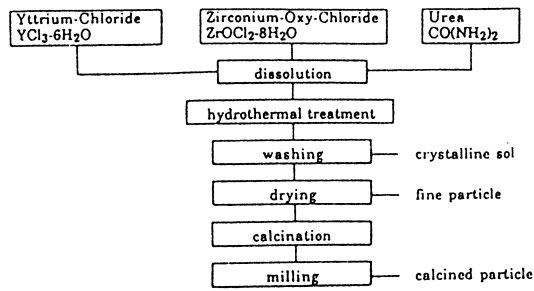

**Figure 8.**  $\text{ZrO}_2$  by hydrothermal homogeneous precipitation process.

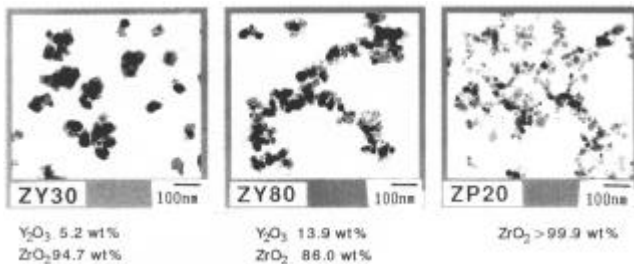
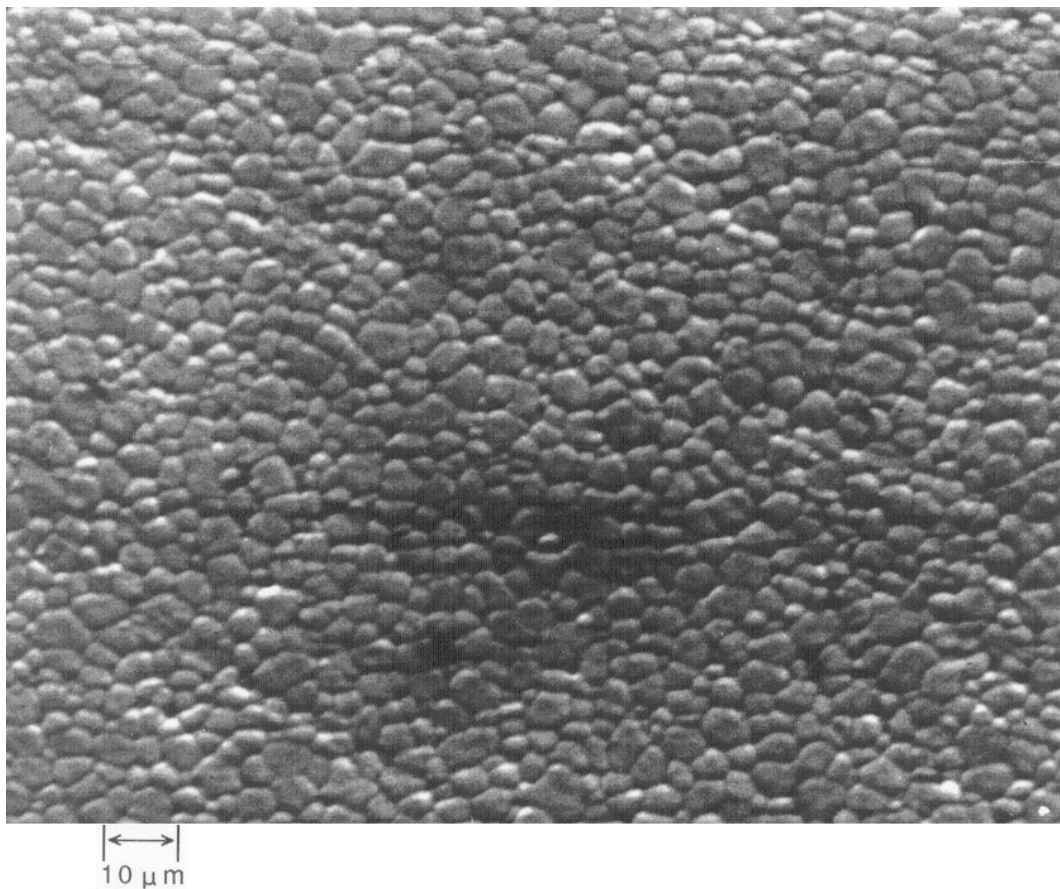

**Figure 9.** TEM of hydrothermal homogeneous precipitation zirconia powder (Chichibu Onoda Cement Corp.).

steel balls of 5 mm dia. were set in a teflon beaker. The teflon propellor was rotated in the beaker under  $200^\circ\text{C}$  and 2 MPa. Rotating speed of the propellor was from 0 to 107 rpm. The number of balls was 200, 500 and 700. X-ray diffraction profiles are shown in figure 15 (Yoshimura *et al* 1989b).

## 2.8 Hydrothermal microwave process

Komarneni and his coworkers have developed this process in a long series of papers (Komarneni *et al* 1992, 1993, 1994, 1995). Hydrothermal microwave treatment of 0.5 M  $\text{TiCl}_4$  was done in 1 M HCl to form  $\text{TiO}_2$ . The system operated at a 2.45 GHz frequency. The vessel is Teflon and it is able to operate up to 200 psi. The parameters used are temperature, pressure, time, concentration of metal solution, pH, etc. The key result being crystallization reactions which lead to faster kinetics by one or two orders of magnitude compared to the conventional hydrothermal processing.

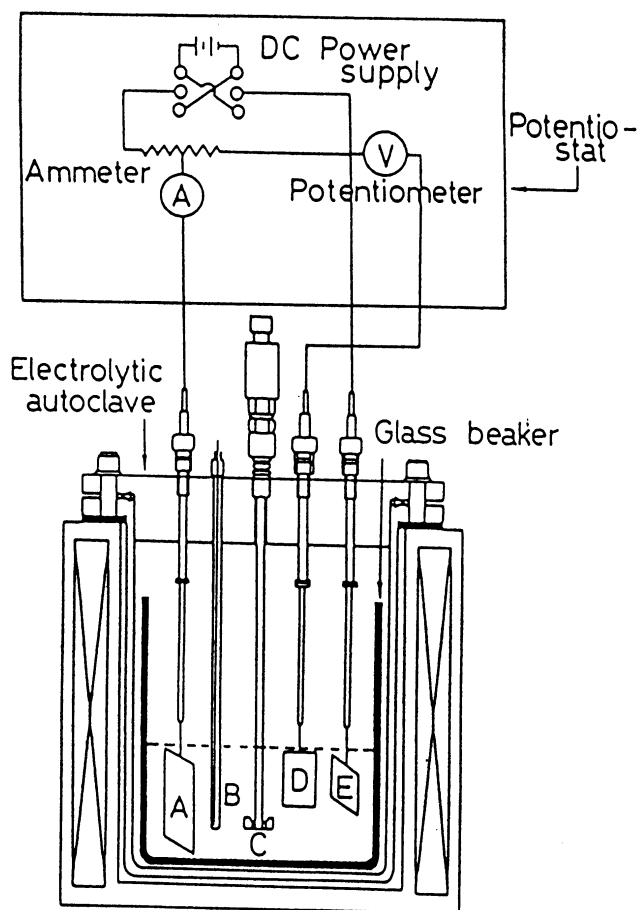

**Figure 10.** TEM of the zirconia sintered at  $1400^\circ\text{C}$  for 2 h.

**Table 5.** Typical characteristics of ZrO<sub>2</sub> powders by hydrothermal homogeneous precipitation.

Powder	ZY30	ZY80	ZP20
Chemical composition			
ZrO <sub>2</sub> (wt%)	94.7	86.0	> 99.9
Y <sub>2</sub> O <sub>3</sub>	5.2	13.9	–
Al <sub>2</sub> O <sub>3</sub>	0.010	0.010	0.005
SiO <sub>2</sub>	0.010	0.010	0.005
Fe <sub>2</sub> O <sub>3</sub>	0.005	0.005	0.005
Na <sub>2</sub> O	0.001	0.001	0.001
Cl <sup>-</sup>	< 0.01	< 0.01	< 0.01
Ignition loss	1.5	1.5	8.0
Crystallite size (nm)	22	22	20
Average particle size <sup>†</sup> (μm)	0.5	0.5	1.5
Specific surface area <sup>‡</sup> (m <sup>2</sup> /g)	20	25	95
Sintered specimens	1400°C × 2 h	1500°C × 2 h	
Bulk density (g/cm <sup>3</sup> )	6.05	5.85	
Bending strength <sup>†††</sup> (MPa)	1000	300	
Fracture toughness <sup>††††</sup> (MPam <sup>1/2</sup> )	6.0	2.5	
Vicker's hardness (GPa)	12.5	11.0	
Thermal expansion 20 ~ 1000°C (× 10 <sup>-6</sup> /°C)	11.0	10.6	

<sup>†</sup>Photo sedimentation method; <sup>‡</sup>B.E.T. method (N<sub>2</sub>); <sup>†††</sup>3-Point bending method; and <sup>††††</sup>M.I. method.



**Figure 11.** Schematic illustration of the electrochemical cell and circuit arrangements for anodic oxidation of Ti metal plate under hydrothermal condition. (A) Counter electrode (Pt plate), cathode, (B) thermocouple, (C) stirrer, (D) reference electrode (Pt plate) and (E) working electrode (Ti plate), anode.

**Table 6.** Ideal powder.

1. Fine powder less than 1 μm
2. Soft or no agglomeration
3. Narrow particle size distribution
4. Morphology, sphere
5. Chemical composition controllable
6. Microstructure controllable
7. Uniformity
8. Free flowing
9. Less defects, dense particle
10. Less stress
11. Reactivity, sinterability
12. Crystallinity
13. Reproducibility
14. Process controllable

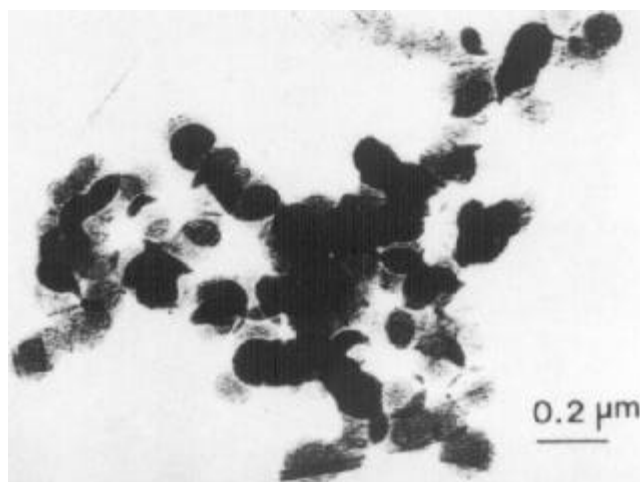

**Figure 12.** TEM of BaTiO<sub>3</sub> powders prepared by hydrothermal electrochemical method (250°C, 0.5 N Ba(NO<sub>3</sub>)<sub>2</sub>, Ti plate used).

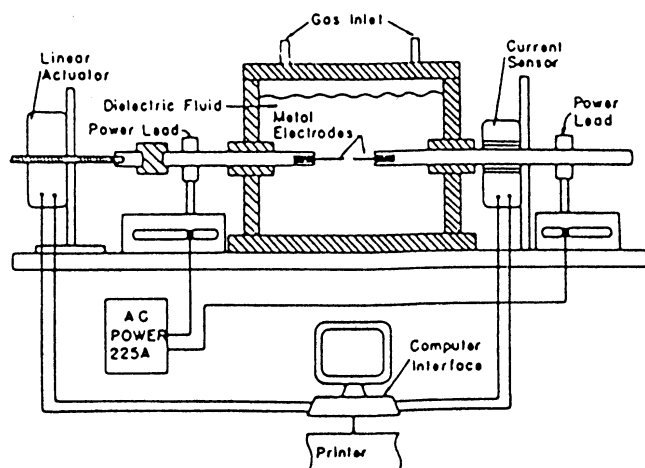

**Figure 13.** Schematic of microprocessor-controlled RESA apparatus for fine-powder preparation (Kumar and Roy).

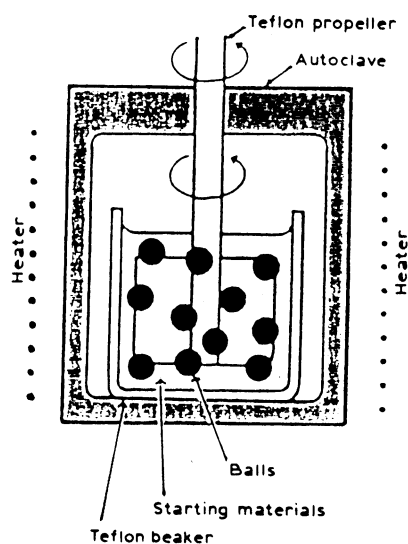

**Figure 14.** Experimental apparatus for hydrothermal mechanochemical reactions.

### 2.9 Hydrothermal sonochemical method

Ultrasonic waves are often used in analytical chemistry for dissolving powder to make solution (Milia 1995). Hydrothermal sonochemical method is a new field for synthesis of materials.

### 3. Ideal powders and real powders

Preparation of ideal powders and real powders by hydrothermal processing are shown in tables 6 and 7. Hydrothermal powders are close to ideal powders (Sōmiya 1994).

### 4. Conclusion

This paper describes hydrothermal fine powders. This hydrothermal fine powders are very close to the ideal fine powder.

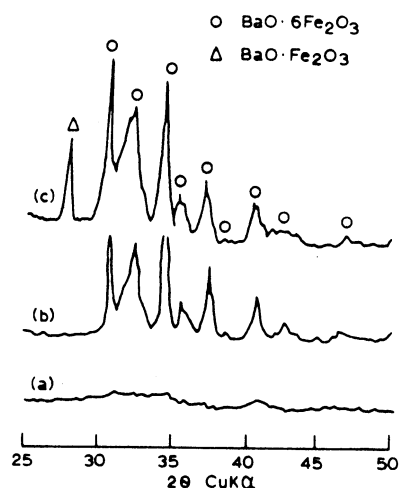

**Figure 15.** X-ray diffraction profiles of (a) starting materials, (b) material fabricated at 200°C under 2 MPa for 4 h without rotation and (c) material fabricated at 200°C for 4 h using 200 balls 37 rpm.

**Table 7.** Characteristics of hydrothermal powders.

Grain size: fine grain less than 1 μm
Coagulation: No or weak agglomeration
Crystallinity: Single crystal in general. It depends on preparation temperature
Flow ability: forming is good
Homogeneity: good
Sinterability: good
Pores in grain: no pore
Particle size distribution: narrow
Able to synthesize low temperature form and/or metastable form
Able to make composites like organic and inorganic mixture
Able to make a material which has a very high vapour pressure

### References

- Autoclave Engineers, Catalogue
- Brice L C 1986 *Hydrothermal growth, crystal growth processes* (Glasgow: Blackie Halsted Press) p. 194
- Brinker C J *et al* (eds) 1984 *Better ceramics through chemistry I* (Amsterdam: North Holland) p. 398
- Byrappa K (ed.) 1991 *Hydrothermal growth of crystals, progress in crystal growth and characterization of materials* (Oxford: Pergamon Press)
- Chemical Society of Japan (ed.) 1985 *Ultra fine powders—Science and application* (Tokyo: Gakkai Publication Centre) p. 211
- Dawson W J 1988 *Am. Ceram. Soc. Bull.* **67** 1973
- Demianets L N *et al* 1984 *Growth and synthesis in hydrothermal solutions, Modern crystallography III, Crystal growth* (eds) A A Chernov *et al* (Berlin: Springer-Verlag) p. 380
- Eitel W 1966 *Silicate science* (New York: Academic Press) **Vol. IV** p.149
- Ganguli D and Chatterjee M 1997 *Ceramic powder prepara-*

- tion: *A handbook* (The Netherlands: Kluwer Academic Publishers) p. 221
- Haberko K *et al* 1991 *J. Am. Ceram. Soc.* **74** 2622
- Haberko K *et al* 1995 *J. Am. Ceram. Soc.* **78** 3397
- Hishinuma K *et al* 1988 *Advances in ceramics, Science and technology of zirconia III* (Westerville, Ohio: Am. Ceram. Soc.) **Vol. 24** p. 201
- Ismail M G M U and Sōmiya S 1983 *Proc. Int. symp. on hydrothermal reactions* (Tokyo: Gakujutsu Bunken Fukyu Kai) p. 669
- Johnson Jr. D W 1987 *Advances in ceramics* (eds) G L Messing *et al* (Westerville, Ohio: Am. Ceram. Soc.) **Vol. 21** p.3
- Kato A and Yamaguchi T 1983 *New ceramic powder handbook* (Tokyo: Tokyo Science Forum) p. 558
- Komarneni S *et al* 1986 *Advanced ceramic materials* (Westerville, Ohio: Am. Ceram. Soc.) **1** p. 87
- Komarneni S *et al* 1992 *Mater. Res. Bull.* **27** 1393
- Komarneni S *et al* 1993 *J. Mater. Res.* **8** 3176
- Komarneni S *et al* 1994 *J. Mater. Chem.* **4** 1903
- Komarneni S *et al* 1995 *J. Mater. Res.* **10** 1687
- Kumar A and Roy R 1988 *J. Mater. Res.* **3** 1373
- Kumar A and Roy R 1989 *J. Am. Ceram. Soc.* **72** 354
- Laudise R A 1970 *Hydrothermal growth, The growth of single crystals* (New Jersey: Prentice Hall Inc.) p. 275
- Lobachev A N (ed.) 1971 *Hydrothermal synthesis of crystals* (New York: Consultant Bureau) p. 152
- Messing G L *et al* (eds) 1987 *Ceramic powder science, Advances in ceramics* (Westerville, Ohio: Am. Ceram. Soc.) **Vol. 21** p. 825
- Milia A M 1995 *Sonochemistry and cavitation* (Luxemburg: Gordon and Breach Publishers) p. 543
- Morey G W 1953 *J. Am. Ceram. Soc.* **36** 279
- Nishizawa H *et al* 1982 *J. Am. Ceram. Soc.* **65** 343
- Parr Instrument Co. Catalogue
- Rabenau A 1985 *Angew. Chem. Int. Ed. Engl.* **24** 1026
- Riman R 1999 *The textbook ceramic powder technologies, 101st Annual meeting* (Westerville, Ohio: Am. Ceram. Soc.)
- Rouxed J *et al* 1994 *Soft chemistry routes to new materials—Chimie douce* (Switzerland: Trans. Tech.) p. 394
- Sōmiya S (ed.) 1983 *Proc. first int. symp. on hydrothermal reactions* (Tokyo: Gakujutsu Bunken Fukyu Kai) p. 965
- Sōmiya S (ed.) 1989 *Hydrothermal reactions for material science and engineering, An overview of research in Japan* (London: Elsevier Applied Science) p. 505
- Sōmiya S 1994 *Advanced materials 1993, VI Trans. MRS-Japan frontiers in materials science and engineering* (Amsterdam: Elsevier Science BV) **Vol. 19B** p. 1105
- Sōmiya S and Akiba T 1999 *Trans. MRS-Tokyo, Japan* **24** 531
- Sōmiya S *et al* 1991 *Hydrothermal growth of crystals, Progress in crystal growth and characterization of materials* (Oxford: Pergamon Press) **Vol. 21** p. 195
- Segal D 1989 *Chemical synthesis of advanced ceramic materials* (Cambridge: Cambridge University Press) p. 182
- Stambaugh E P 1983 *New/improved ceramic, magnetic and electronic oxides by hydrothermal processing, 85th Annual meeting* (Chicago, IL: Am. Ceram. Soc.)
- Tani E *et al* 1981 *J. Am. Ceram. Soc.* **64** C-181
- Tani E *et al* 1983 *J. Am. Ceram. Soc.* **66** 11
- Tem-Press Div. Leco Corp. Catalogue
- Toraya H *et al* 1984 *Advances in ceramics, Science and technology of zirconia II* (Westerville, Ohio: Am. Ceram. Soc.) **Vol. 12** p. 806
- Veale C R 1972 *Fine powder preparation, Properties and uses* (London: Applied Science Publishers) p. 147
- Vincenzini P (ed.) 1983 *Ceramic powders* (Amsterdam: Elsevier Scientific Co.) p. 1025
- Walker A C 1953 *J. Am. Ceram. Soc.* **36** 250
- Yoo S E *et al* 1988 *Sintering 87* (eds) S Sōmiya *et al* (London: Elsevier Applied Science) p. 108
- Yoshimura M and Sōmiya S 1984 Rep. Res. Lab. Eng. Mat. Tokyo Inst. of Technology No. 9 p. 53
- Yoshimura M *et al* 1981 *Preparation of zirconia fine powders by the reactions between zirconium metal and high temperature-high pressure solutions, 8th AIRAPT conf. 1988* (Sweden: 8th AIRAPT Committee) p. 793
- Yoshimura M *et al* 1987 Rep. Res. Lab. Eng. Mat. Tokyo Inst. of Technology No. 12 p. 59
- Yoshimura M *et al* 1989a Rep. Res. Lab. Eng. Mat. Tokyo Inst. Technology No. 14 p. 21
- Yoshimura M *et al* 1989b *J. Ceram. Soc. Jap. Int. Ed.* **97** 14