

Radiotracers in Fabric-Washing Studies

B. E. GORDON, Shell Development Company, Emeryville, California 94608

Abstract

This report is directed toward the application of radiotracers to larger-scale, practical laundering experiments with the use of washing machines and Tergotometers with fully built detergents. Such applications have not been widely reported because of the difficulty in setting up the experiments, in handling the large numbers of samples which are generated, and performing the many computations.

A brief description of the useful properties of *beta*-emitting radioisotopes is presented, followed by a discussion of the effect of these properties on two methods of detection; geiger and liquid scintillation counting. The advantages and limitations of each are described, which lead to the conclusion that, for fabric analysis, liquid scintillation counting is preferred. The combination of the modern liquid scintillation counter with a computer provides a highly efficient analytical scheme for the analysis of fabrics containing labeled species.

The severe problem of radiochemical purity, which has long hampered radiotracer experiments, is next discussed together with some recommendations for overcoming the problem. Finally, the applications of tagged compounds to two aspects of fabric washing are described. The first is a study of adsorptivity and rinsability of some anionic surfactants on cotton fabric after laundering in an automatic washing machine. The second is some results of a continuing study of detergency by using a multicomponent, double-labeled radioactive soil.

Introduction

THE APPLICATION OF RADIOTRACERS to the solution of problems in detergency goes back many years (1-3). A substantial number of papers have demonstrated that many difficult and subtle problems can be successfully attacked by the proper use of radioactive compounds and methods of radio-assay. Notwithstanding the demonstrated success of this approach, particularly to fabric washing (4,5), it is somewhat surprising that it has not become more widespread. This has not occurred in spite of evidence (2,5) that the use of carbon-black soils and reflectance measurements could give erroneous soil-removal values. In addition, the recent extensive studies of Wagg and Britt (6) and Fort et al. (7) have supported the early prediction by Hensley (3) that radioactive soils would permit studies with soil types closer to natural soils than had been possible previously. Both groups of investigators worked with model systems in order to gain insight into the mechanism and kinetics of detergency. Proposals to consider the routine use of radioisotopes in practical detergent-screening and evaluation tests have not been common.

The purpose of this report is to describe two advances in radiochemical methodology which suggest that this technique may have reached a stage of development where it should be so considered. Of necessity, the work has been done almost entirely in

TABLE I
Energy and Range of Isotopes of Interest in Fabric Washing

Isotope	E _{Max} (Mev)	Range, mm (density = 1)
³ H	0.018	0.008
¹⁴ C	0.155	0.30
³⁵ S	0.167	0.34
⁴⁵ Ca	0.25	0.60
³⁶ Cl	0.71	2.5
³² P	1.7	7.9

the author's laboratory during the last two years. This is not to indicate that other laboratories have not been active in applying radioisotopes to fabric washing but rather that the development of new radiochemical techniques which had resulted over the years from a wide variety of tracer applications in the author's laboratory logically led to their application to fabric washing when the need for making such studies arose.

It seems that at least two factors have inhibited the growth of radiotracers: limited availability of radiochemically pure, tagged compounds and problems of the analyses of laundered fabrics, particularly the large numbers resulting from large-scale screening and evaluation experiments. The two recent developments which have mitigated these obstacles are improvements in counting methodology and development of methods for measuring radiochemical purity.

Counting Methodology

Before these developments are discussed, a brief description of the salient properties of the radioisotopes is in order. Curiously, practically all the radioactive elements in fabric-washing studies are β -emitters, i.e., they emit a high-speed electron from the nucleus during disintegration. Because electrons are charged, they interact readily with matter forming ion pairs (in gases) or excited molecules (in condensed phase). The consequences of this interaction are both good and bad, good because the excited species may be readily detected and bad because the electrons have limited penetrating power, hence the efficiency of detection may be low because of absorption.

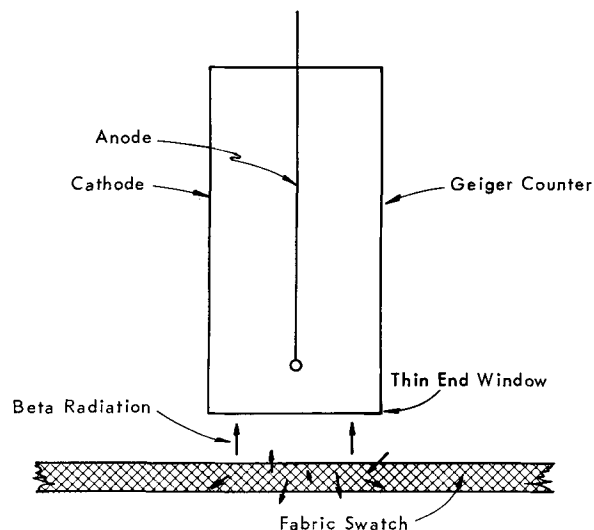

FIG. 1. End-window counting of fabric.

TABLE II
Variation of Soil after Laundering

Swatch no.	Piece	mg Soil/Piece	Ratio A/B
1	A	4.37	0.91
	B	4.78	
2	A	3.54	0.72
	B	4.91	
3	A	4.96	1.28
	B	3.87	

Table I presents a list of isotopes in this work together with their maximum energy and the range in mm of this maximum. It is clear that, for tritium, carbon-14, and sulfur-35, the range is so small that most fabrics, being thicker than this, will absorb all but that fraction of radiation originating from levels near the surface of the fabric. The situation is in fact somewhat worse than this. The *beta* decay of a radioisotope results in a continuum of β^- energies from zero to a maximum energy. Thus, when an atom of a particular radioisotope decays, the emitted β^- particle will have an energy between zero and E_{\max} with, of course, the range appropriate to its energy. Thus the average range is much lower than E_{\max} , and absorption by the fabric is more severe.

This property of *beta* emitters has a profound effect on the method of detection. Until recently the most widely used method was end-window geiger counting (Fig. 1). This method of counting has been and still is extremely valuable, but it has some disadvantages. First, it is virtually useless for tritium because the end window of the counter is too thick for these weak β^- particles to penetrate. Second, if the fabric on which the labeled compound is deposited is less than infinitely thick (less than the range indicated in Table I) for the isotope, then small variations in thickness will result in large variations in observed count-rate. Finally, if the distribution of the labeled compound on the fabric is uneven or varies between replicates, then variations in count rate will result even though the quantity of material on the fabric is the same. To show that uneven distribution of sebum after laundering is common, Table II presents the ratio of activities on the two halves of some 10×10 -cm cotton swatches after washing. The radioactive soil before laundering had been uniformly distributed on the swatches by carefully pipetting a solution of the soil onto each piece. Although end-window geiger counting is difficult in double-label analysis and has reduced counting efficiency, it does have the advantage of requiring relatively inexpensive instrumentation.

An effort has been under way in recent years to adapt liquid scintillation counting to this general area (8-10). Such counting has been the method of choice for β^- analysis among radiochemists and biochemists for several years. The reasons become obvious from a description of the method. The sample is placed inside a vial in a solution which, because of its composition, converts some of the *beta* particle energy to photons (scintillations), which are then detected by photomultiplier tubes. Because the sample is inside the detector rather than outside as in geiger counting,

TABLE III
Comparison of Counting Efficiencies. %

Isotope	Geiger, end window	Liquid scintillation
^3H	0	20-40
^{14}C	1-5	70-90
^{35}S	1-5	70-90
^{32}P	20-50	95-100

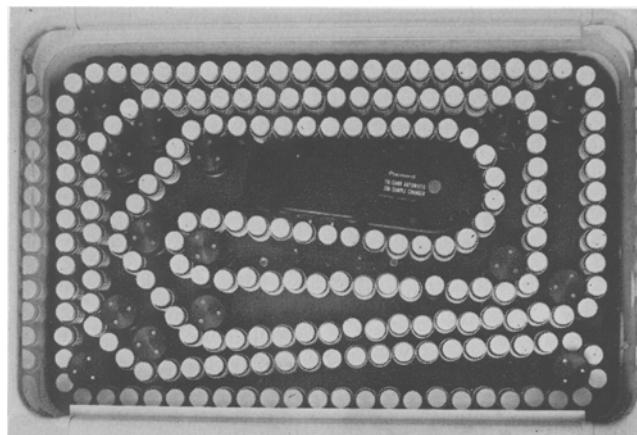

FIG. 2. Sample changer for liquid scintillation counter.

there is no loss by absorption if the samples are dissolved and little self-absorption if an insoluble sample is of small-particle size. Because there are no windows to penetrate, tritium is as readily analyzed as carbon-14; because the sample detector arrangement is essentially 4π , rather than 2π , problems in geometry are minimal.

The latter considerations indicate that liquid scintillation counting is considerably more sensitive than end-window geiger counting, and indeed this is the case, as indicated by Table III, which compares the sensitivity of the two methods for counting fabric swatches. This difference in efficiencies is not trivial because the use of labeled soils in large-scale detergent studies can consume either millicuries or curies of activity, depending upon the method of analysis. The cost could increase from hundreds to tens of thousands of dollars.

Another advantage of liquid scintillation counting is the ability to determine more than one isotope in a sample because the intensity of the scintillation is proportional to the β^- energy. The modern liquid scintillation counter can readily differentiate between intensities because it is, in fact, a spectrometer. Isotopes differing in E_{\max} by about 20-25% can be so analyzed. Recourse to Table I permits one to determine which isotopic pairs can be differentiated (e.g., $^3\text{H}/^{14}\text{C}$, $^3\text{H}/^{35}\text{S}$, $^{14}\text{C}/^{45}\text{Ca}$, etc.). Use of this feature

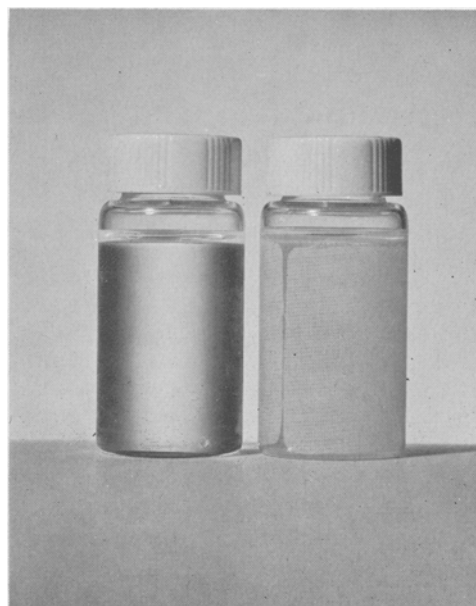

FIG. 3. Vial with and without fabric.

TABLE IV
Effect of Cloth on Count Rate

Grams of cloth	Counts per minute
0	12,200
0.1	12,500
0.2	12,200
0.3	12,100
0.5	12,400
1.0	10,700

in fabric-washing studies has been the subject of recent publications (10,11).

A most important characteristic of the modern liquid scintillation counter is its ability automatically to process large numbers of samples. The sample changer shown in Fig. 2 has a capacity for 200 samples, which are counted without attention over any extended period (nights, week-ends, holidays, etc.). By coupling the output of the counter to an IBM computer via a card punch, all calculations required to reduce the counting data (i.e., counts per minute) to detergency data (i.e., percentage of soil removed) can be done automatically (9-11). This is no small advantage when one considers that detergency studies can generate as many as 1,000 samples per week. It should be noted that end-window geiger counting can also be automated via appropriate equipment with a proportionate increase in cost.

Now with this enormous sample and data-handling capability, recent developments (8,11) have been directed toward applying this technique to fabric-washing studies. Two questions had to be answered. First, would liquid scintillation counting work in the presence of swatches of fabric, soiled and washed? Second, could automatic methods of standardization be applied to such systems so that counting data could be reduced to detergency data without additional sample handling?

It is not unreasonable to suppose that the presence of fabric would be a problem because the emission of scintillation photons from a counting vial should be impeded by the presence of fabric in the vial. Fig. 3 shows a conventional solution ready for counting (clear) and a solution containing 0.5 g of cotton cloth. One expected the latter vial to show a reduced count rate.

Table IV demonstrates that, up to 0.3 g of cotton, this was not so when the radioactivity was in solution. To test whether one could recover, quantitatively, labeled surfactant present on the cloth, an experiment was run to compare the radioactivity yield of surfactant on the cloth with that in solution. Cotton diapers and towels were the test fabrics, and the scintillation solvent was dioxane with 10% water. For comparison, toluene was included as another scintillation solvent. This experiment therefore tested for loss of activity owing to self-absorption.

Table V demonstrates the quantitative recovery of radioactive surfactant by using dioxane. The low recovery when toluene scintillator was used argues

TABLE V
Test for Self-Absorption on Impregnated Swatches

Labelled surfactant	Measured Specific Activity		
	In solution	Impregnated diaper	Impregnated towel
Alkyl sulfate- ³⁵ S ^a	14.7 × 10 ⁶	14.5 × 10 ⁶	14.3 × 10 ⁶
LAS - ³ H ^a	16.6 × 10 ⁷	16.2 × 10 ⁷	16.7 × 10 ⁷
Alkyl sulfate- ³⁵ S ^b	13.9 × 10 ⁶	10.3 × 10 ⁶	

^a Dioxane-based scintillator.
^b Toluene-based scintillator.

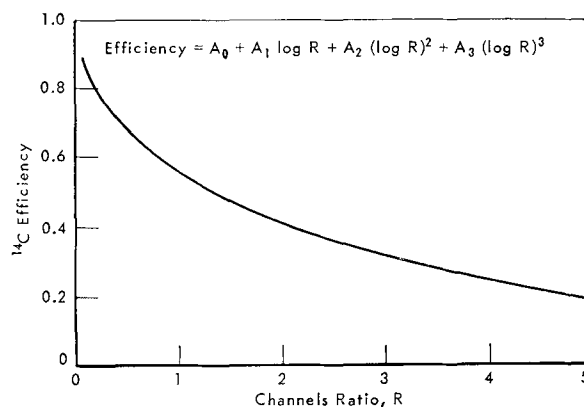

FIG. 4. PHSM calibration.

that the scintillator solvent must extract the labeled material to obtain quantitative data. This finding was later applied to other fabric-washing programs involving labeled artificial soils, wherein toluene scintillator was found to be the best solvent.

After the demonstration of the accuracy of liquid scintillation analysis of fabrics it became necessary to convert the counting data to values meaningful in fabric-washing studies, i.e., surfactant residue, soil remaining or removed, etc. For this purpose, counting data, usually obtained as counts per minute (cpm), must be normalized to a common value, in this case disintegrations per minute (dpm). This requires that one determine the efficiency of counting because

$$\text{dpm} = \frac{\text{cpm}}{\text{Eff}}$$

There are three ways currently in use to obtain the counting efficiency of a sample. The internal standard method (ISM) requires the addition of a known amount of a radioactive standard to the sample after the latter had been counted, and a second count. This is not an automatic technique and so was not considered for routine service. The second method, the pulse-height shift method (PHSM) of Baille (12) depends on the shift of the β^- spectrum of a radioisotope with a change in efficiency. Therefore by dividing the β^- spectrum into two appropriately selected energy channels (the modern counter has three), the efficiency was found to vary monotonically with the ratio of count rates in the two channels. This

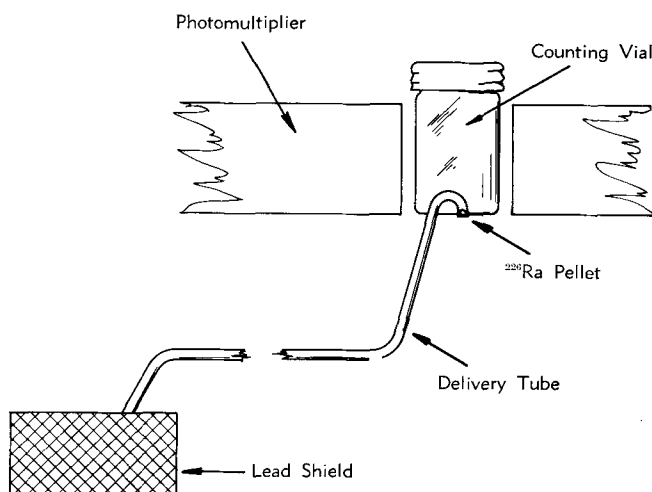

FIG. 5. External standard delivery system.

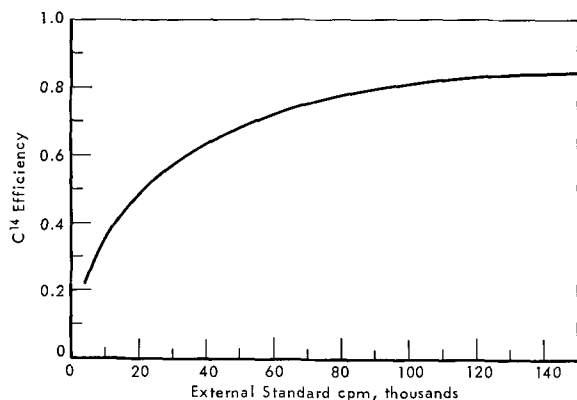

FIG. 6. ESM calibration.

is illustrated in Fig. 4. The algebraic expression for the curve was programmed so that the solution for the efficiency from the ratio was performed on a digital computer (IBM 7040).

The third and most recent automatic method of determining the efficiency is the external standard method (ESM). The ESM depends upon the fact that a radioactive source external to the counting vial will produce scintillations in the solution. The frequency of these scintillations (i.e., the count rate) is proportional to the counting efficiency of any β emitter, provided that the appropriate energy channels for the β -emitter and external standard are chosen. The desirable features of this method over previous methods are that one channel is required for each isotope plus one for the standard (the PHSM requires two for each isotope). This is an advantage in double-label applications; at low count-rates the ESM is inherently superior to the PHSM. The operation is automatic by counting the sample first, printing out the data, injecting the pellet of external standard to a position alongside the vial, counting again, and printing out these data. The sample is then changed, and the cycle is repeated. Recently a double source has been introduced into one make of counter to reduce volume and other geometrical effects. Fig. 5 presents a schematic of the ESM.

Fig. 6 presents a typical calibration curve for the determination of efficiency. As in the PHSM above, the analytical function of this calibration was obtained by a curve-fitting program, and a suitable program was written to determine the efficiency for each sample and to perform other essential calculations.

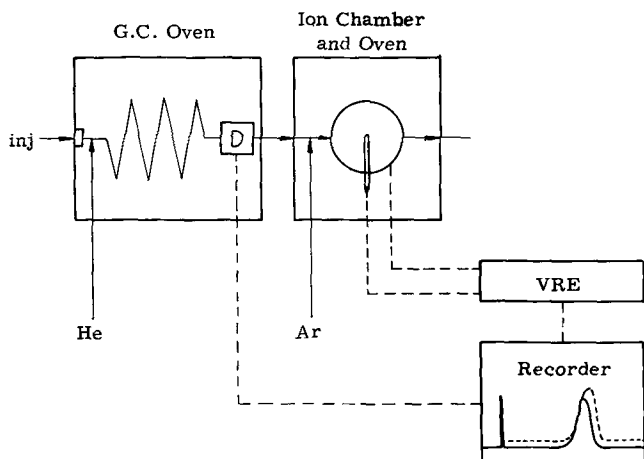

FIG. 7. Gas-liquid radiochromatography instrumentation.

TABLE VI
Properties of Isotopes and Labeled Compounds

Isotope	Weight per millicurie of isotope, g	Fraction of molecules labeled at 1 μ C/mM ^a
³ H	1.02×10^{-7}	0.34×10^{-7}
¹⁴ C	2.1×10^{-4}	2×10^{-5}
³⁶ Cl	3.1×10^{-2}	1×10^{-3}
³² P	3.5×10^{-9}	0.1×10^{-9}
³⁵ S	2.3×10^{-8}	0.6×10^{-9}

^a One radioactive atom per labeled molecule is assumed.

Thus these advances in liquid scintillation counters and counting methods have made possible the application of labeled compounds to the large-scale, fabric-washing studies which are essential in detergent screening and reformulation. The automatic sample and data-handling features now permit one to carry out such programs at high speed and low cost.

Radiochemical Purity

The second major obstacle to widespread application of radioisotopes to fabric-washing studies has been the questionable radiochemical purity of commercially available radioactive compounds. The seriousness of this problem was set forth in 1965 when a report was made on the radiochemical purity of a number of commercially available compounds (13)—radiochemical rather than chemical purity. There is a profound difference between the two, which stems from the fact that, at the specific activities normally used in tracer work, only a small fraction of the molecules in a compound are tagged.

Table VI presents two kinds of data which may help in understanding the problem. Isotopes of interest in detergency are presented. The mass of one millicurie of each isotope is very low. Since one millicurie has a high decay rate (i.e., 2.2×10^9 dpm), one normally works with microcurie (2.2×10^6 dpm) and nanocurie (2.2×10^3 dpm) levels. The weights are correspondingly lower. The last column presents the fraction of molecules labeled in a preparation of 1 microcurie/mM. Thus, in the case of carbon-14, the prepared compound could be 99.998% chemically pure and 0% radiochemically pure. For tritium and sulfur-35 the situation is more drastic. Here the compounds can be 99.9999% chemically pure, but radiochemically they may be grossly impure.

It is clear then that the normal criteria for purity, such as UV, IR, freezing point, and mass spectrometry, are usually unsuited for determining radiochemical purity at this specific activity. Some highly efficient separation tool, coupled to a method for the radioassay of the separated components, is needed. This method, gas-liquid radiochromatography (GLRC), is shown in Fig. 7. Such an apparatus was first described by Kokes (14) and has been studied by others (15). Briefly, it involves separating the various components on a GLC column and passing the effluent through a

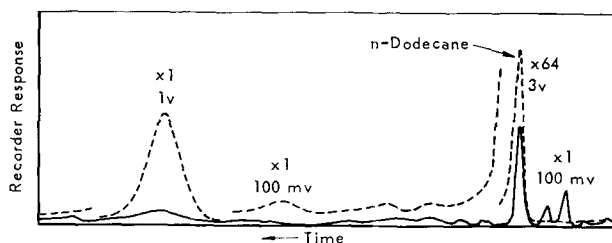
FIG. 8. Dodecane-1-¹⁴C before purification. Dashed line indicates radioactivity.

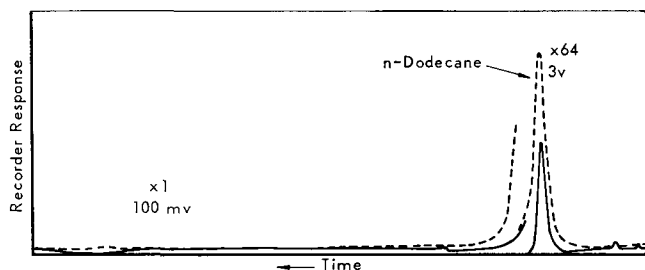

FIG. 9. Dodecane-1-¹⁴C after purification. Dashed line indicates radioactivity.

radioactivity detector, such as an ion chamber or proportional flow counter. The output signals, one from the GLC mass detector and one from the ion chamber, are presented to a dual-pen recorder.

This technique was applied (13) to a series of purchased compounds which, in every case, required purification. Fig. 8 shows ¹⁴C labeled dodecane as received, and Fig. 9 shows this same compound after purification by preparative scale GLC. The double peak in Fig. 9 is a change in sensitivity. Extraneous radioactivity has disappeared. The results of a series of such analyses are shown in Table VII, which contains considerable information. It compares, for example, the amount ordered with the amount received. Also to be noted are the values under the next to last column, the amount of activity which came through the column. Without exception this is less than the total activity before passing through the GLC. Thus an appreciable loss is owing to radioactive polymer which never emerges from the column. In all cases the compounds listed in Table VII were better than 98% chemically pure, most were 99+%.

In the past year labeled-compound manufacturers, having been forced to recognize the severity of the problem, have made significant progress in improving the radiochemical purity. Recent analyses (10), involving an artificial soil, are presented in Table VIII. As can be seen, only the cholesterol and octadecanol were grossly impure, and the former was purified by column chromatography, the latter by GLC. Several years of experience, some bitter, with this problem have suggested some guidelines to be considered when tagged organic compounds are to be used in experimental work. These follow.

1. Use GLC for analysis and purification wherever possible, other chromatographic techniques if not.
2. Purify reactants and products.
3. Prepare compound at the specific activity to be used in the problem if chromatographic purification cannot be used.
4. Consider the degree of radiochemical purity required from the end-use point of view.

Point 4 merits some comment. If a labeled compound is to be used in an experiment where only a

TABLE VIII
Purification of Artificial Soil Components

Compound	Radiochemical purity as purchased	Final purity
Tristearin- ³ H	92.9	92.9
Stearic acid- ¹⁴ C	98.7	98.7
Oleic acid- ¹⁴ C	99.2	99.2
Octadecanol- ¹⁴ C	82	>99
Cholesterol- ¹⁴ C	~50	>99

gross fractional change in the quantity of activity is of interest, then high radiochemical purity is not required. If however a small fraction of the total activity is to be followed, as is so often the case in surface chemistry, then radiochemical purity must be high. In any case the purchaser of labeled compounds should request the supplier to demonstrate the degree of radiochemical purity of the labeled material. Ahrens (16) stated, in an editorial, that in the future all papers accepted for publication which included work with radioactive compounds would have to describe the steps taken to ensure radiochemical purity. This is a most encouraging sign, and it is to be hoped that other journals will follow this lead.

Recent Applications

Among the applications of radiotracers to fabric washing which employ these recent developments in counting methodology and purity analysis, two are of interest (8,11). Both involve practical laundering conditions, either by Terg-o-Tometer (U.S. Testing Co., Inc., Hoboken, N. J.) or automatic washing machine. First was a study of rinsability and adsorptivity of some anionic surfactants in built detergents. The surfactants are shown in Fig. 10. The purpose of two batches of LAS, one tagged with ³⁵S and one with ³H, was to permit some competition studies to be run between LAS and primary alcohol sulfates. A number of questions were answered in this study (8). However a few results are repeated simply to demonstrate the ease with which radiotracers permit one to solve fairly difficult analytical problems.

First was the determination of the build-up of surfactant on fabric with repeated washings in an automatic washer. Table IX shows this build-up to be virtually complete after two cycles, both for LAS and primary alcohol sulfates.

Second was the composition of surfactant on fabric when two surfactants were present in the built deter-

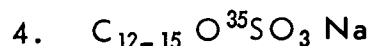
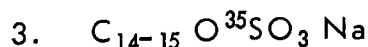
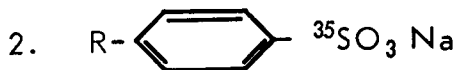
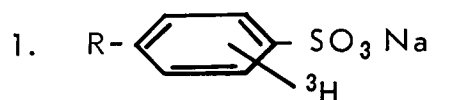

TABLE VII
Radiochemical Purity of Some Commercial ¹⁴C-Hydrocarbons

Compound	Stated activity, μc	Total act. by scint. count, μc	Total act. by GLRC, μc	Act. present in pure compound, μc
n-Undecane- ¹⁴ C	100	82	53	44
n-Dodecane- ¹⁴ C(I)	230	331	248	22
n-Dodecane- ¹⁴ C(II)	270	269	252	143
n-Dodecane- ¹⁴ C(III)	500	500	426	238
n-Tridecane- ¹⁴ C	100	68	53	51
n-Tetradecane- ¹⁴ C	100	62	53	44
n-Pentadecane- ¹⁴ C	100	80	34	25
1-Dodecene- ¹⁴ C	100	16	2.4	0.08

FIG. 10. Labeled surfactants.

TABLE IX
Effect of Multiple Washings on Surfactant Buildup

Surfactant	Cloth	Residual surfactant, ppm, wash			
		1	2	3	4
C ₁₄₋₁₆ Sulfate- ³⁵ S	Diapers	948	1101	979	1064
	Towels	930	1034	931	1036
Alkyl benzene sulfonate- ³⁵ S	Diapers	1124	1408	1375	1500
	Towels	830	1029	1027	1046

TABLE X
Composition of Residual Surfactant on Cotton^a

Wash no.	Cloth	Residual Surfactant, ppm		
		Alkyl sulfate	LAS	Total
1	Diaper	623	706	1329
	Towel	491	589	1080
2	Diaper	702	818	1520
	Towel	496	608	1104

^a Wash solution contained alkyl sulfate (³⁵S)/LAS (³H) in 50/50 weight ratio.

gent in a 1/1 weight ratio. Table X shows that the surfactant composition on the laundered fabric is approximately in the same ratio as in the detergent.

Finally, it was of interest to determine whether the surfactant residue on fabric after laundering was reversibly or irreversibly deposited. Fig. 11 presents the results of an experiment wherein some diapers with tagged surfactant deposited on the surface were washed (in an automatic washing machine) with an untagged built detergent. Since Table IX has shown that a constant amount of surfactant is maintained with repeated washings, the sharp decline in Fig. 11 demonstrates reversibility.

The other application of tracers to practical laundering studies has been in the routine screening of various detergent formulations by using a radioactive artificial soil (10), the composition of which is shown in Table XI.

The doubly labeled soil permits one to follow the low polarity fraction (³H) independently of the high polarity fraction (¹⁴C). A multicomponent soil is employed, rather than a single component, more closely to approximate natural soil. That is however no argument for this particular formula but simply demonstrates the possibilities of the radiotracer approach.

One justification for a multicomponent, labeled soil would be selective removal of the different components. A simple experiment was run wherein the ratio of ¹⁴C to ³H activity was determined before and

TABLE XI
Composition of Artificial Soil

Compound	% wt	Label
Lubricating oil:		
Shellflex 371-N	25	³ H
Tristearin	10	³ H
Peanut oil	20	Unlabeled
Stearic acid	15	¹⁴ C
Oleic acid	15	¹⁴ C
Octadecanol	8	¹⁴ C
Cholesterol	7	¹⁴ C

TABLE XII
Selectivity of Soil Removal, ¹⁴C/³H Ratio^a

Surfactant	Cotton		Nylon		Dacron		Dacron/Cotton	
	60	120	60	120	60	120	60	120
LPA-9	0.70	0.63	0.38	0.35	0.25	0.34	0.68	0.61
LAS	0.65	0.65	0.53	0.52	0.51	0.57	0.66	0.58
ZA-9.5	0.70	0.64	0.42	0.33	0.33	0.36	0.66	0.59

^a Starting ratios: cotton = 0.82, Nylon = 0.77, Dacron = 0.81, Dacron/cotton = 0.82.

TABLE XIII
Redeposition of Soil on Cotton

Surfactant ^a	Redeposition of Soil, %wt of Component in Wash Water					
	Hydrocarbon	Tri-stearin	Stearic acid	Oleic acid	Octadecanol	Cholesterol
LPA-S ₁	1.2	0.4	1.0	1.3	1.1	0.2
LPA-S ₂	1.4	0.7	0.7	1.5	1.6	0.2
LAS	1.1	0.8	0.5	1.7	1.3	0.3
LPA-12	1.1	0.5	0.6	1.0	1.1	0.5

^a LPA-S₁—linear primary alcohol sulfate, 0.225 g/l.
LPA-S₂—linear primary alcohol sulfate, 0.30 g/l.
LAS —linear alkylbenzene sulfonate, 0.3 g/l.
LPA-12—linear primary alcohol-12 EO, 0.15 g/l.

TABLE XIV
Precision of ESM

Fabric	Tritium fraction mg/g	¹⁴ C Fraction mg/g
Cotton	Mean	13.12
	σ	1.2%
Nylon	Mean	12.63
	σ	2.2%
Dacron	Mean	12.97
	σ	1.3%
Dacron/Cotton	Mean	13.09
	σ	1.5%

after laundering in a Tergometer by using three built detergents; one linear primary alcohol ethoxylated to a 9 EO level (LPA-9), one anionic (LAS), and one normal alcohol ethoxylated to 9.5 EO (ZA-9.5). The experiment was run with four fabrics, and the results appear in Table XII.

Clearly the ratios are lower after than before washing, indicating preferential removal of the polar components. Furthermore, the synthetics behave differently from cotton containing fibers, and the anionic surfactant is different from the nonionics for synthetics. Thus the argument for a multicomponent soil appears to be valid.

With use of this radioactive soil, the removal of individual components in the complete soil was also reported (10), and the double-label approach reduced the work by half. Redeposition, which is easily measured with tracers, was determined on cotton, and the results are shown in Table XIII.

These data were obtained during the studies with individually labeled components and simply meant placing an extra unsoiled swatch in the Tergometer beaker (10).

Practical detergency screening studies which compare various formulations and other parameters (temperature, hardness, fabric, soil, etc.) have generally

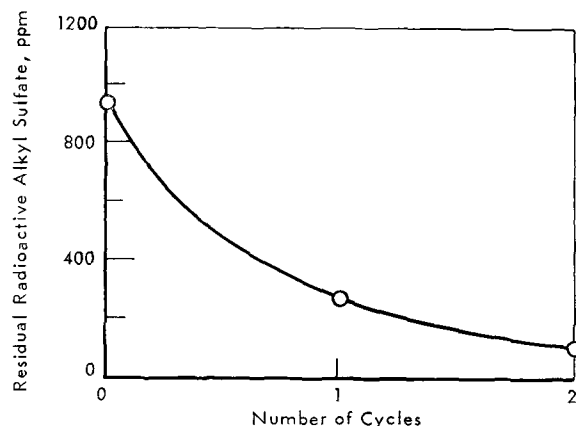

FIG. 11. Surfactant exchange on diaper containing tagged C₁₄₋₁₆ sulfate with untagged C₁₄₋₁₆ sulfate in solution.

required massive programs that involved large numbers of replicates in order to obtain reasonable standard deviations. The radiotracer approach offers the hope that good precision can be achieved with smaller numbers of replicates.

Table XIV shows the expected standard deviation of a single determination, based on the analyses of a number of carefully soiled replicates. This high analytical precision removes one of the main sources of error in detergent evaluation, that is, the measurement of residual soil on the washed fabric. Furthermore, since residual radioactivity is a direct measure of the quantity of residual soil, the method is accurate. Table XIV does not reflect, of course, the maldistribution of soil on a swatch or garment after laundering so, to obtain a truer value for the average detergency, one must still analyze some replicates. Improvement of this situation is currently under study and will be reported on at a later time.

Advantages and Limitations

A brief statement of the advantages and limitations of radiotracers in practical fabric-washing studies is in order. The advantages are complete analytical selectivity regardless of the systems under study, short analytical method development, ability to trace any component of a built detergent, ability to trace any component or fraction of a multicomponent soil, applicability to large-scale practical laundering tests (i.e., Tergotometer, washing machines), excellent precision (accuracy and high sensitivity), complete

automation of sample and data processing (i.e., low cost per analysis).

The limitations follow. Equipment is expensive. Radiochemical purity must be ascertained. For multicomponent organic soil only two tracers are available, tritium and carbon-14. Strongly colored fabrics cannot be directly analyzed for residues by liquid scintillation counting. Notwithstanding these limitations, radiochemical methodology has now reached a level of sophistication which warrants the serious consideration of this technique as a routine tool by those actively studying the effectiveness of built detergents for washing fabrics.

REFERENCES

1. Harris, J. C., and W. H. Yanko, *ASTM Bulletin* 158, 49 (1949).
2. Ashcraft, E. B., *ASTM Special Technical Bulletin* 215, 30 (1956).
3. Hensley, J. W., and C. G. Inks, *ASTM Special Technical Bulletin* 268, 27 (1959).
4. Meader, A. L. Jr., and B. A. Fries, *Ind. Eng. Chem.* 44, 1636 (1952).
5. Lambert, J. M., J. H. Roecker, J. J. Pescatore, G. Segura and S. Stigman, *Nucleonics* 12, No. 2, 40 (1954).
6. Wagg, R. E., and C. J. Britt, *J. Textile Inst. Trans.* 53, T 205 (1962).
7. Fort, T. Jr., H. R. Billica and T. H. Grindstaff, *Textile Res. J.* 36, 99 (1966).
8. Gordon, B. E., G. A. Gillies, W. T. Shebs, G. M. Hartwig and G. R. Edwards, *JAOCS* 43, 232 (1966).
9. Gordon, B. E., W. T. Shebs, D. H. Lee and R. U. Bonnar, *Ibid.* 43, 525 (1966).
10. Gordon, B. E., J. Roddewig and W. T. Shebs, *Ibid.* 44, 289 (1967).
11. Gordon, B. E., W. T. Shebs and R. U. Bonnar, *Ibid.* 44, 711 (1967).
12. Baille, L. A., *Int. J. Appl. Radiation and Isotopes* 8, 1 (1960).
13. Muhs, M. A., E. L. Bastin and B. E. Gordon, *Ibid.* 16, 537 (1965).
14. Kokes, R. J., H. Tobin and P. H. Emmett, *J. Am. Chem. Soc.* 77, 5860 (1955).
15. Wolfgang, R., and F. S. Rowland, *Anal. Chem.* 30, 903 (1958).
16. Ahrens, E. H. Jr., *J. Lipid Res.* 7, No. 2, Editorial, March (1966).

