

Acoustic emission from graphite/epoxy composite laminates with special reference to delamination

LEIF CARLSSON, BO NORRBOM

The Aeronautical Research Institute of Sweden, S-161 11 Bromma, Sweden

The primary object of this study was to investigate acoustic emission (AE) techniques for the detection of progressive damage in graphite/epoxy composite laminates. The AE signals were monitored during the uniaxial loading of symmetrical eight-ply laminates with three different stacking sequences. The peak value and the weighted cumulative count were determined as a function of applied axial stress. Both the peak value data and the cumulative count data are characterized by a pronounced increase at first-ply failure as determined by the Tsai—Hill anisotropic strength criterion, followed by a continuous emission until delamination or final fracture occurs. At the onset of delamination, a pronounced deflection was noted in the accumulated AE signal. Plastic deformation of the matrix generated no significant AE.

1. Introduction

A fundamental problem in the use of composite materials in structural design is the complexity of the microstructural damage growth when the materials are loaded to failure. This is due to the complicated structure of the material and to the fact that the laminae in a composite laminate are in a state of combined stress. The material may also contain defects introduced in fabrication or damage introduced during use. Identification of the type of defect in a composite is necessary in order to estimate the residual strength of the element or structure, since different types of defect affect the strength differently.

In order to identify the type of damage in composites, which involves fibre failure, transverse failure and delamination, non-destructive testing methods such as the ultrasonic C-scan and radiographic techniques [1] are applied. The acoustic emission (AE) technique which is based on the detection of elastic surface stress waves caused by dissipation of elastic energy due to the opening of a crack or plastic deformation, also shows great promise for the detection of the type of damage.

White and Tretout [2] used AE monitoring to study the failure mechanism in carbon-fibre-

reinforced epoxy plates subjected to bending. Applying frequency analysis to the AE signal, they found different frequency signatures for the different modes of failure. Becht *et al.* [3], on the other hand, applied amplitude distribution analysis to distinguish between different failure modes of various fibre-reinforced composites. It was found that failure of the fibres generated higher energy AE than transverse failure. The same conclusion was reached by Pipes *et al.* [4] who found that the amplitudes of AEs from boron—aluminium composite material may be ranked in the following order: fibre tension, transverse tension and in-plane shear. Kim and Hahn [5] applied strain gauge and AE techniques to detect transverse matrix cracking in graphite/epoxy laminates. While the strain gauge technique was good for only cracks that initiated under the gauge the acoustic emission technique was found reliable for detecting the first-ply failure regardless of crack location.

It is also possible to predict failure in composite laminates from basic laminae properties and a knowledge of the stacking sequence. In particular, to predict fibre failure or transverse failure in composite laminates it is common to use anisotropic

strength criteria. The maximum stress and strain-criteria, the "Tsai-Hill criterion" and the "Tsai-Wu criterion" [6] are commonly used to predict the strength of the laminate on the basis of the strengths of the individual plies within the laminate. A relatively little understood mode of failure of composite laminates is, however, delamination, i.e. failure of the interface between two adjacent plies. At present there is no universally accepted theory which enables the designer to predict the delamination resistance of a particular laminate.

This paper is concerned with the acoustic emission response of graphite/epoxy composite laminates under uniaxial tension. Three different stacking sequences were investigated in order to study the effects on the acoustic emission response of deformation and of failure mode, with special emphasis on delamination failure. Since both delamination and transverse failure involve matrix cracking, the procedure to characterize the source generating the signal is not trivial. However, if the energy released in delamination failure is a significant portion of the energy released in transverse failure, it may be possible to use the AE technique in order to separate the AE generating mechanism.

2. Experimental procedure

2.1. Materials and mechanical testing

The AE generated during uniaxial loading of three different symmetrical 8-ply graphite/epoxy laminates made from prepreg material Fiberite Hy-E-1034 was monitored. The fibre content was about 65 vol%. The lay-ups were vacuum bagged and cured in an autoclave according to the manufacturers recommendations.

A test section of length 55 mm, width 24 mm and thickness 1.05 mm was chosen for all specimens. In order to facilitate the visual observation of edge delamination the edges of the samples were painted with white "liquid paper" paint. End tabs made of cold setting epoxy resin mixed with micro-balloons were used to ensure test section failures and a uniform distribution of stress. A 100 kN Amsler hydraulic testing machine with low background noise was used for the static testing where a clip-on extensometer gauge was used in order to measure the axial strain in the sample.

2.2. Acoustic emission monitoring

A Brüel and Kjaer (B and K) model type 8313 piezoelectric transducer was used for AE signal detection. The transducer was attached to the

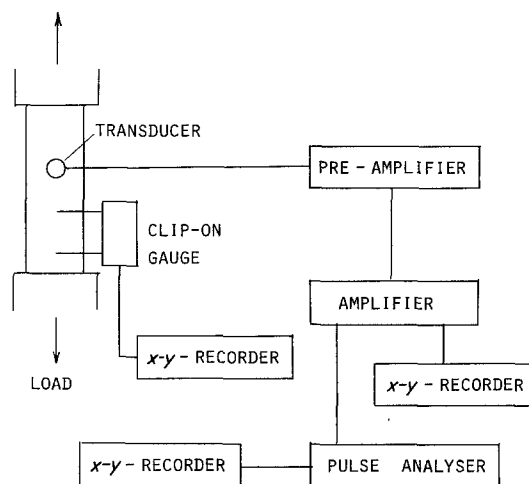

Figure 1 The experimental set-up.

specimen using a steel clamp. The AE signals detected by the transducer were sent to a pre-amplifier (B and K type 2637) and amplified 40 dB. Next, these signals were again amplified by a wide band condition amplifier (B and K type 2638). A weighted cumulative signal count was obtained with a pulse analyser (B and K type 4429). Fig. 1 is a schematic diagram of the instrumentation used.

The x - y recorder attached to the amplifier was used to record the positive peak value of single pulses as a function of applied load. The pulse analyser was used in the "weight" mode. For a single pulse, the time during which the signal level exceeds four preset trigger levels, having an amplitude relationship 1, 2, 4 and 8, was measured and multiplied by the amplitude difference between these levels. This measure is thus an approximation of the area under the curve of pulse level against time. The x - y recorder attached to the pulse analyser recorded the accumulated value of the areas under the pulses as a function of applied load, and, the x - y recorder attached to the clip-on gauge recorded axial strain against load.

3. Influence of stacking sequence; specimen design

Although there is considerable disagreement between various investigators, recent literature [7-9] indicates that a stress singularity exists in the interlaminar normal and shear stress field at the intersection of the free edge and the interface. Delamination may thus occur at the edges due to induced interlaminar normal and shear stresses [10-12]. The relative importance of the inter-

laminar normal and shear stress is not clear, but early investigations [11, 13] indicate that the interlaminar normal stress σ_z is responsible for observed differences in delamination tendency. Consequently a high positive value of σ_z decrease the laminate strength.

In order to vary the tendency for edge delamination, one laminate was made with a $[0/\pm 45/90]_S$ stacking sequence, corresponding to a tensile interlaminar normal stress and another with a $[90/\pm 45/0]_S$ stacking sequence corresponding to a compressive interlaminar normal stress when loaded in uniaxial tension.

A third laminate was made with a $[\pm 45/\pm 45]_S$ stacking sequence. A recent analysis of $[\pm 45]_S$ laminates [7] showed compressive interlaminar normal stresses and a high interlaminar shear stress along the ± 45 interface near the edge. Delamination at the edge was not expected because an earlier investigation showed that the failure of a $[\pm 45]_S$ laminate is insensitive to the state of stress and strain at the edge due to the moderate shear coupling characteristics [12] and because of the compressive interlaminar normal stress σ_z . The large in-plane shearing stresses that are developed in this laminate tend to deform the matrix of the composite plastically. Measuring the AE response of this laminate consequently permitted the effect on the AE response of plastic deformation in the matrix to be studied.

4. Results and discussion

4.1. Mechanical characterization

To determine the stress at first-ply failure (FPF) the Tsai–Hill criterion, which is a good predictor of FPF [6] was applied to the laminates under consideration. It has the following form:

$$\frac{\sigma_1^2}{X^2} - \frac{\sigma_1\sigma_2}{X^2} + \frac{\sigma_2^2}{Y^2} + \frac{\tau_{12}^2}{S^2} = 1 \quad (1)$$

where σ_1 , σ_2 and τ_{12} are, respectively, the stress in the fibre direction, the stress in the transverse direction and the shear stress in the 1–2 plane. The corresponding strengths are denoted by X , Y and S .

The stresses σ_1 , σ_2 and τ_{12} were calculated as a function of the axial stress σ_x using classical lamination theory [6] with the following elastic constants: $E_1 = 143\,000$ MPa, $E_2 = 11\,000$ MPa, $G_{12} = 4000$ MPa and $\nu_{12} = 0.35$. The experimental strength values obtained for a unidirectional laminate made from the same prepreg material were:

$X = 1460 \pm 40$ MPa, $Y = 53 \pm 5$ MPa and $S = 104 \pm 10$ MPa (based on five samples).

For the $[0/\pm 45/90]_S$ and the $[90/\pm 45/0]_S$ laminates, FPF was predicted to occur in the 90 degree ply at a stress $\sigma_x = 290 \pm 30$ MPa. For the $[\pm 45/\pm 45]_S$ laminate, FPF was predicted to occur at $\sigma_x = 194 \pm 20$ MPa. Note that simultaneous failure of all plies is predicted to occur for this laminate.

4.2. Acoustic characterization

The AE signals recorded during deformation were analysed to determine the peak value of the pulses and the accumulated area under the pulses as a function of axial stress (calculated from initial cross-sectional area). The axial strain was also recorded as a function of axial stress. Figs. 2 to 4 show a typical data set for the $[0/\pm 45/90]_S$ laminate.

Two distinct regions are seen in the peak value data (Fig. 2) and the weighted cumulative count data (Fig. 3) during deformation:

1. An initial rise in the peak value and a corresponding sudden increase in the weighted cumulative count at a stress of about 290 MPa, apparently corresponding to the FPF, followed by an approximately linear increase in the weighted cumulative count.

2. A region with a rapid increase in AE activity commencing at about 440 MPa, indicated by high peaks in the AE peak value and a marked increase in slope of the weighted cumulative count. This increase is due to the onset of edge delamination as found by visual inspection during deformation.

The axial strain (Fig. 4) shows an approximately linear dependence on the stress although, at the onset of delamination, a very small jump in strain is noticed.

Some of the $[0/\pm 45/90]_S$ laminates showed a somewhat different behaviour with respect to AE. Fig. 5 shows a region before the onset of delamination with reduced emission activity, indicated by a reduction in the slope of the graph of the weighted cumulative signal before the propagation of edge delamination. The reduced emission activity may be attributed to plastic deformation in the matrix prior to delamination crack propagation. Plastic deformation is known to cause only small amplitude AE [4, 14], which is also confirmed by the results for the $[\pm 45/\pm 45]_S$ laminate in the present study.

The corresponding data for the $[90/\pm 45/0]_S$

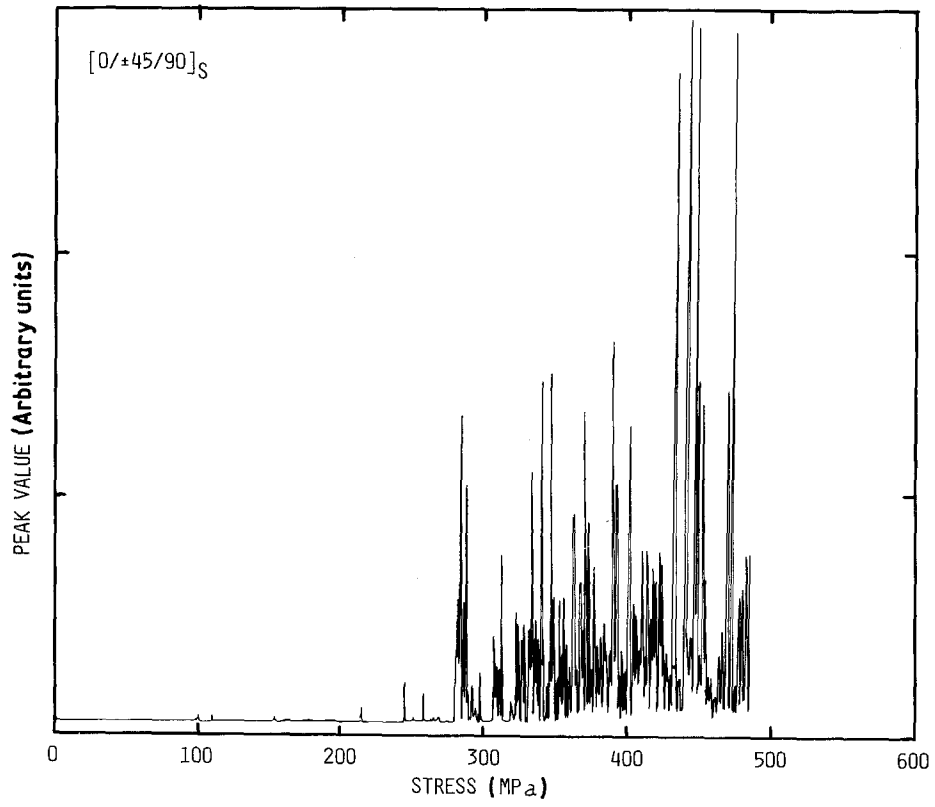

Figure 2 Peak value of AE bursts for a $[0/\pm 45/90]_S$ laminate as a function of axial stress.

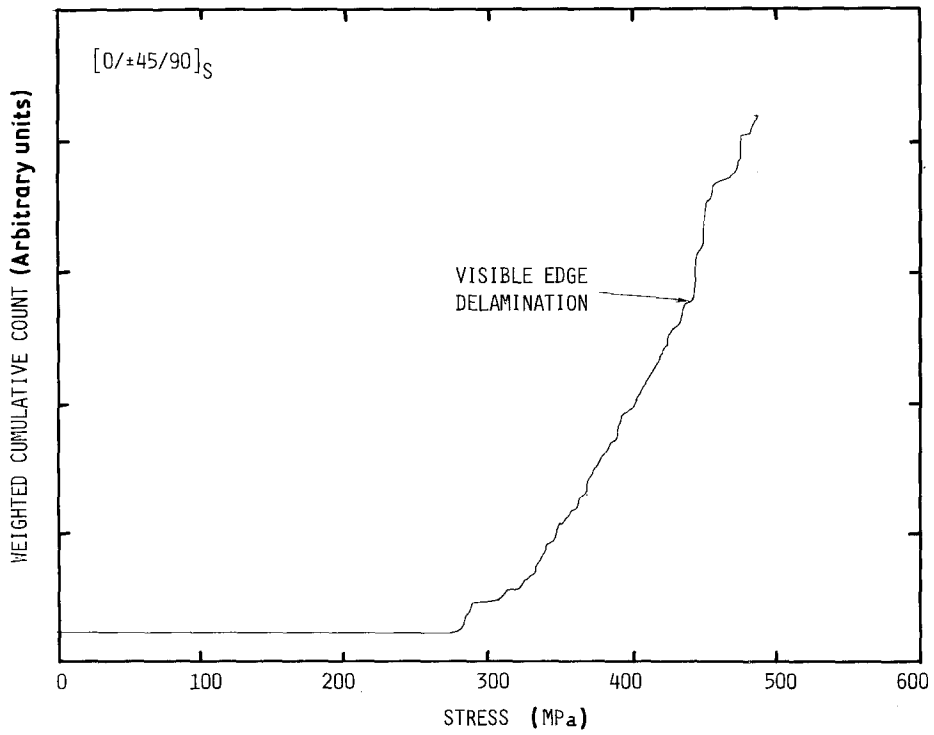

Figure 3 Weighted cumulative AE count for a $[0/\pm 45/90]_S$ laminate as a function of axial stress.

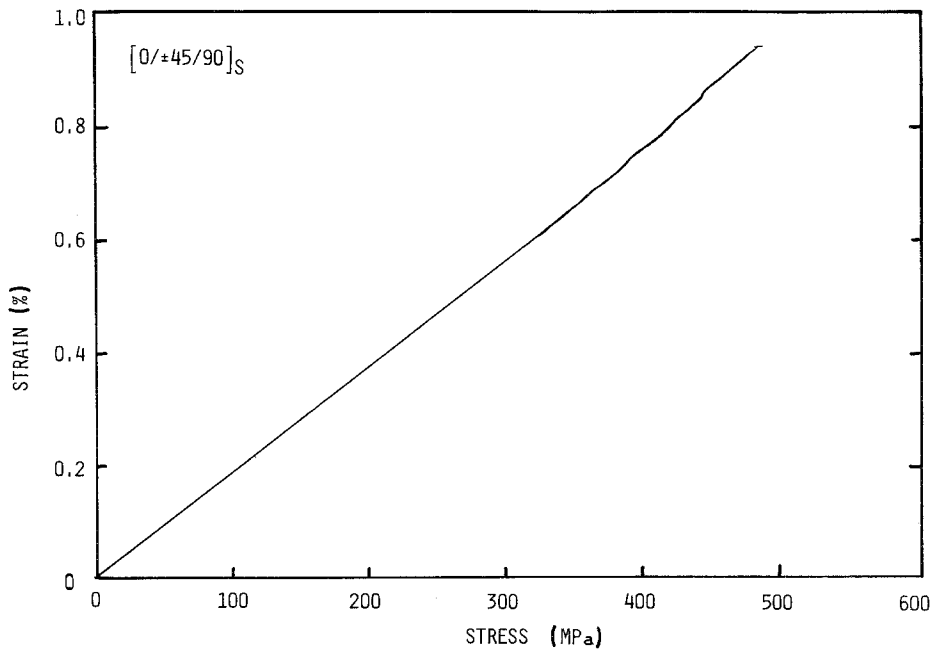

Figure 4 Axial strain as a function of axial stress for a $[0/\pm 45/90]_S$ laminate.

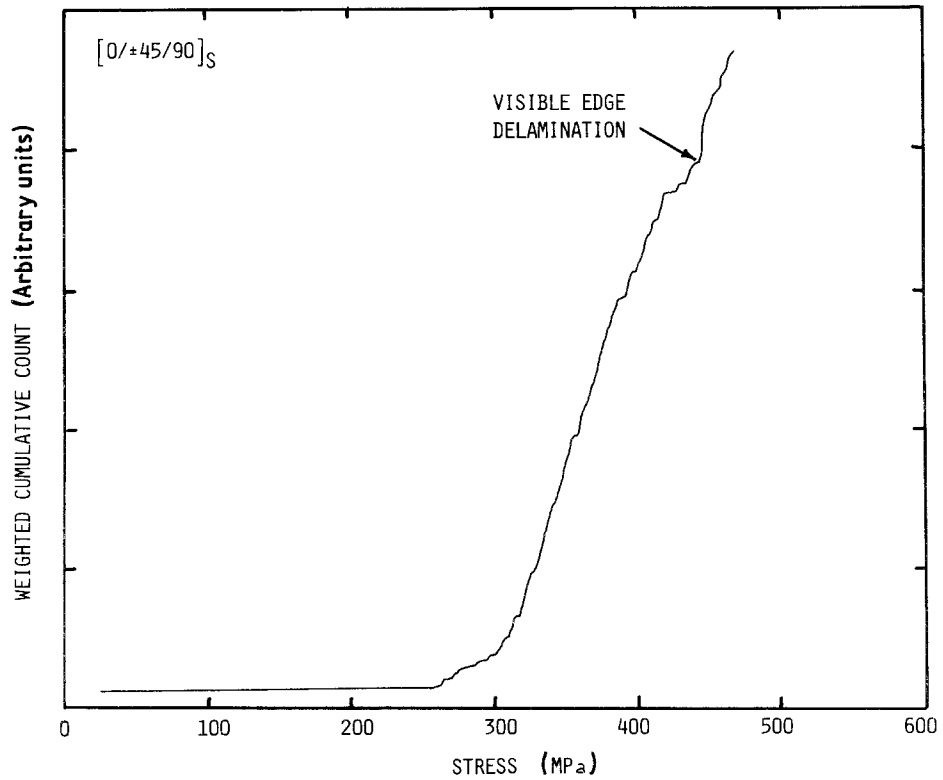

Figure 5 Weighted cumulative AE count for a $[0/\pm 45/90]_S$ laminate as a function of axial stress.

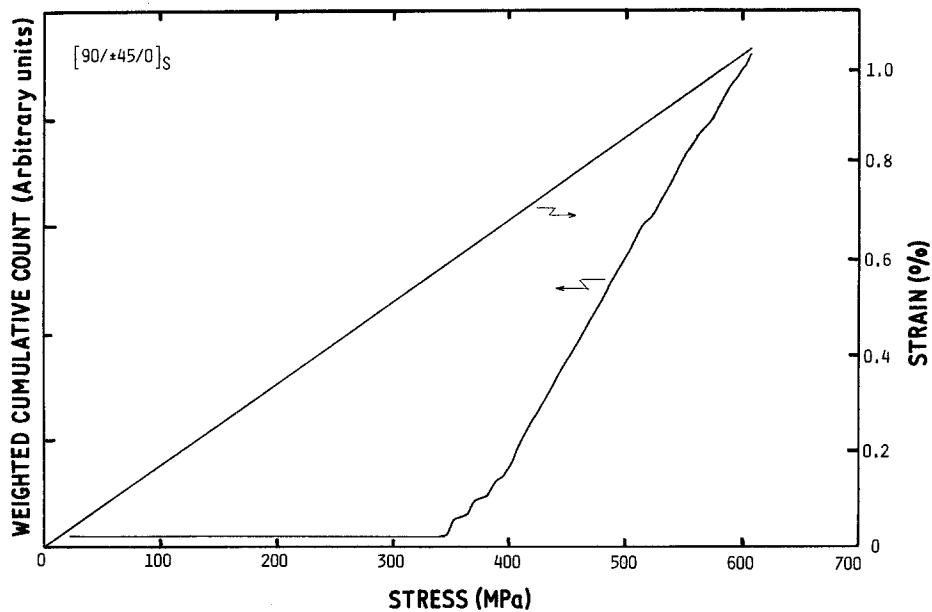

Figure 6 Weighted cumulative AE count and axial strain for a $[90/\pm 45/0]_S$ laminate as a function of axial stress.

laminates are shown in Fig. 6. The weighted cumulative count shows an almost linear dependence on the axial stress after FPF occurs at about 330 MPa indicating a continuous failure process. The strain increases approximately linearly with stress up to failure. As expected, no delamination occurred before ultimate failure, in contrast to the behaviour of the $[0/\pm 45/90]_S$ laminate.

The data for the $[\pm 45/\pm 45]_S$ laminate are shown in Fig. 7. A large amount of plastic deformation in shear precedes ultimate failure. No significant AE activity was recorded before ultimate failure, which involved some fibre fractures. This confirms the earlier statement that plastic deformation causes only small amplitude AE. In this laminate also, no edge delamination was observed before FPF which for this laminate coincided with final fracture.

The results presented here suggest that in the $[0/\pm 45/90]_S$ and the $[90/\pm 45/0]_S$ laminates a continuous damage process occurs from the initiation of FPF until delamination or final rupture, due to the almost linear cumulative count against axial stress relationships observed in Figs. 3, 5 and 6. This is in agreement with a thorough microscopic investigation by Kim [15], who studied transverse cracking in graphite/epoxy laminates subjected to static loading. The number of transverse cracks counted in 50 mm along the free edge of the laminate was denoted "crack density". In laminates where edge delamination occurred before

final failure, the crack density increased continuously with stress level from FPF until the onset of delamination at which stage transverse crack arrest was observed. On the other hand, in the laminates which did not reveal delamination, the number of transverse cracks increased continuously after FPF until final failure.

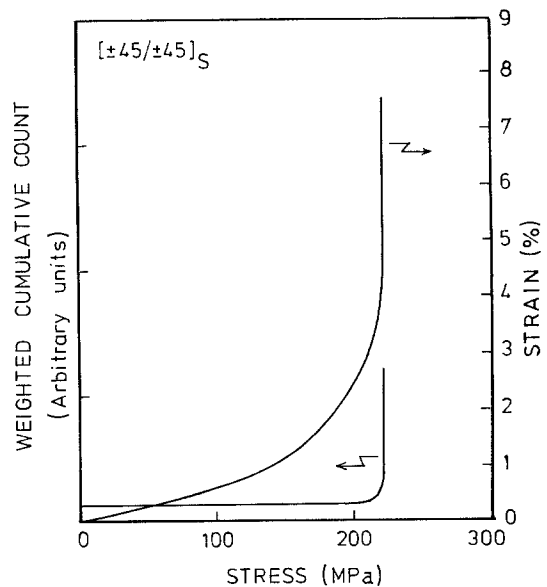

Figure 7 Weighted cumulative AE count and axial strain for a $[\pm 45/\pm 45]_S$ laminate as a function of axial stress.

5. Conclusions

The purpose of the present AE study was to obtain information about basic failure mechanisms in composite laminates. The acoustic emission signature obtained in this paper by the weighted cumulative count seems to be able to predict first-ply failure as well as delamination failure in composite laminates. This technique thus shows great promise as a non-destructive testing technique for composite materials since it gives information concerning both the first-ply failure where an initial rise in the AE peak value and a corresponding sudden increase in the weighted cumulative count is noted, and the delamination failure characterized by high peaks in the AE peak value and a marked increase in slope of the weighted cumulative count.

References

1. G. P. SENDECKYJ, G. E. MADDOX and N. A. TRACY, Proceedings of the 1978 International Conference on Composite Materials, Toronto, Canada, April 1978 (ICCM/2, New York, 1978) p. 1037.
2. R. G. WHITE and H. TRETOUT, *Composites* **10** (1979) 101.
3. J. BECHT, H. J. SCHWALBE and J. EISENBLAETTER, *ibid.* **7** (1976) 245.
4. R. B. PIPES, N. J. BALLINTYN, W. R. SCOTT and J. M. CARLYLE, ASTM STP 617 (American Society for Testing and Materials, Philadelphia, 1977) p. 153.
5. R. Y. KIM and H. T. HAHN, *J. Comp. Mater.* **13** (1979) 2.
6. R. M. JONES, "Mechanics of Composite Materials", (Scripta Book Co., Washington, DC, 1975).
7. J. D. WHITCOMB, I. S. RAJU and J. G. GOREE, *Comp. Struct.* **15** (1982) 23.
8. S. S. WANG and I. CHOI, *J. Appl. Mech.* **49** (1982) 541.
9. R. I. ZWIERS, T. C. T. TING and R. L. SPILKER, *ibid.* **49** (1982) 561.
10. R. B. PIPES and N. J. PAGANO, *J. Comp. Mater.* **4** (1970) 538.
11. N. J. PAGANO and R. B. PIPES, *Int. J. Mech. Sci.* **15** (1973) 679.
12. R. B. PIPES, B. E. KAMINSKI and N. J. PAGANO, ASTM STP 521 (American Society for Testing and Materials, Philadelphia, 1973) p. 218.
13. N. J. PAGANO and R. B. PIPES, *J. Comp. Mater.* **5** (1971) 50.
14. D. A. DORNFIELD and E. DIEI, *J. Eng. Mater. Technol.* **104** (1982) 145.
15. R. Y. KIM, "Experimental assessment of static and fatigue damage of graphite/epoxy laminates" in "Advances in Composite Materials" Vol. 2 (Pergamon Press, Oxford, 1980) p. 1015.

*Received 4 January
and accepted 20 January 1983*