

# Chapter 6

## Nonlinear Stimulated Scattering

In this chapter, the first section reviews the various kinds of light scattering phenomena in the nature and points out the difference between stimulated scattering (nonlinear scattering) and spontaneous scattering (linear scattering). The stimulated scattering is belonging to the third-order nonlinear optics effects. The second and third sections will study two stimulated scattering phenomena respectively: the stimulated Raman scattering and the stimulated Brillouin scattering. We will introduce their classical theoretical models, and finally give their related experimental methods.

### 6.1 Introduction to Light Scattering

#### 6.1.1 Classification of Light Scattering

Light scattering is a phenomenon that when the light passes through the medium, the part of the light energy deviate the original propagation direction to occur the light energy redistribution. The light energy can be described as the product of photon energy  $\hbar\omega$  and photon number  $N$ , i.e.,  $\varepsilon = \hbar\omega N$ . That means the light scattering not only change the space distribution of the photon number, but also can produce the new lights at the frequency different with the frequency of original light. Therefore, we can also say that the light scattering is a phenomenon of the light redistribution on the frequency spectrum.

Light scattering is arising from the inhomogeneous distribution of medium properties (mainly the refractive index of medium), namely there exists the so called "scattering centers". According to the different reasons inducing the heterogeneity of medium, the light scattering can be divided into different categories.

If the medium is consisted of the pure matter with the same component (such as same molecules and atoms), according to the different reason to form the scattering

center, the scattering can be divided into several kinds. In addition, there also exist other kinds of light scatterings produced by doping external particles or due to structure defects. Below we adopt the classical concept that the electric dipoles induce the secondary radiation under the action of the external light electric field to introduce several light scatterings with different mechanism in the nature.

### 1. Rayleigh Scattering

The medium is composed with the identical molecules and atoms, but the density of molecules or atoms has the random fluctuation in the space scale far less than the light wavelength. Under the action of the external light electric field, the fluctuation can be regarded as the forced oscillation of the electric dipoles, which produce the secondary radiation with a non-uniform space distribution, it is called Rayleigh scattering. The property of this light scattering is that: the frequency of scattering light is the same as that of input light; the relation between the scattering-light intensity and the input-light wavelength is  $I_{scatt} \propto 1/\lambda^4$ . From this formula we can see, the wavelength shorter, the scattering-light intensity stronger. The blue color of the sunny sky is just due to this reason.

### 2. Rayleigh-wing Scattering

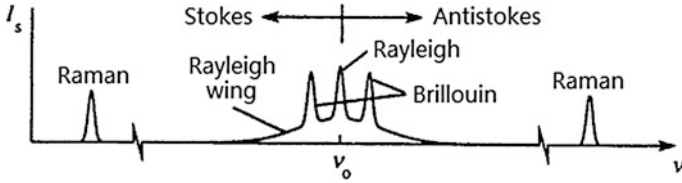
Some organic liquids are composed with the anisotropic molecules (for example carbon disulfide, nitrobenzene, benzene etc.), because the orientation fluctuation of anisotropic molecules and the intermolecular thermal collision, in the scattering spectrum, accept Rayleigh scattering at the wavelength coincident with the wavelength of input light, it also exists the continuous spectrum broadening on the two sides of the center wavelength, i.e. it occurs the continuous frequency shift phenomenon, this light scattering is called the Rayleigh-wing scattering.

### 3. Raman Scattering

This kind scattering mainly happens in the molecular component medium. When an external light field at certain frequency inputs the medium, it will induce the forced oscillation of molecular electrical dipole. Because the molecular vibration (or rotation) frequency modulates the forced oscillation frequency of molecular electrical dipole, the frequency of electrical dipole generated second radiation light (scattering light) has a certain movement relative to the frequency of input light. The scattering light with the red shift of frequency is called Stokes scattering light; and the scattering light with the blue shift of frequency is called Anti-stokes scattering light.

### 4. Brillouin Scattering

In the pure mediums, there are always the thermal motion, to lead the fluctuate variation of the medium density (or refractive index). Under the action of light electric field, via the electrostriction effect, to lead the periodic variation of medium density (or refractive index); it is equivalent to exist an acoustic wave field that can scatter the incident light. The frequency shift quantity of scattering light is equal to the phonon frequency; its magnitude is related with scattering angle, the frequency



**Fig. 6.1** Several spectrums of light scattering in the pure medium

of incident photon and the velocity of acoustic wave field. The Brillouin scattering also has the Stokes and Anti-stokes two kinds of scattering lights.

Figure 6.1 gives several spectrums of light scattering in the pure medium.

### 5. Tyndall Scattering and Mie Scattering

Above introduced are several light scatterings in pure medium consisted of molecules or atoms.

In addition, there are the extraneous impurities, particles, etc. in the medium and the structure defects of the medium all can cause the light scattering. For example, the impurities, stones, bubbles, stripes, dislocations etc. in solid glass and crystal can form the scattering centers. The everyday scattering behavior of suspended impurities, dusts and aerosols in air and liquid are also belong to this kind phenomenon. In these phenomena, the frequency of the scattering light is same as the frequency of the incident light. The relationship between the scattered light intensity and the light wavelength is  $I_s \propto \lambda^\eta$ , in which  $\eta$  is relative to  $\lambda/a_0$ ,  $a_0$  is the radius of the scattering particle. There are three kinds of cases:

When  $a_0 \gg \lambda$ ,  $\eta \rightarrow 0$ , the scattering light intensity is independent of the incident light wavelength, this kind scattering is called Tyndall scattering. The white cloud in the sky is just the result of this scattering.

When  $a_0 \approx \lambda$ , i.e., the size of  $a_0$  is in the order of magnitude of  $\lambda$ , the  $\eta$  takes the oscillating value with change of  $\lambda/a_0$ . This scattering is called as Mie scattering.

When  $a_0 \ll \lambda$ , then  $\eta \rightarrow -4$ ,  $I_s \propto \lambda^{-4}$ , this is the case of Rayleigh scattering.

### 6.1.2 Stimulated Radiation Light Scattering Characteristics

Spontaneous radiation light scattering is caused by interaction of the spontaneous radiation light (nature light) with the medium. Because the intensity of nature light is too weak, when it acts with the medium, do not change the optical properties of the medium, so the scattering light is still the spontaneous radiation light. However, the stimulated radiation light scattering is caused by interaction of the stimulated radiation light (laser) with the medium, the intensity of laser is very high, it can changes the optical properties of the medium (such as refractive index), the scattering light is still a stimulated light. The stimulated radiation light scattering has several kinds, including the stimulated Raman scattering (SRS), the stimulated

Brillouin scattering (SBS), the stimulated Rayleigh-wing scattering, and the stimulated Kerr scattering, etc. The stimulated radiation light scattering is one of third-order nonlinear optics effects.

The stimulated radiation light scattering in comparison with the spontaneous radiation light scattering has the following new properties:

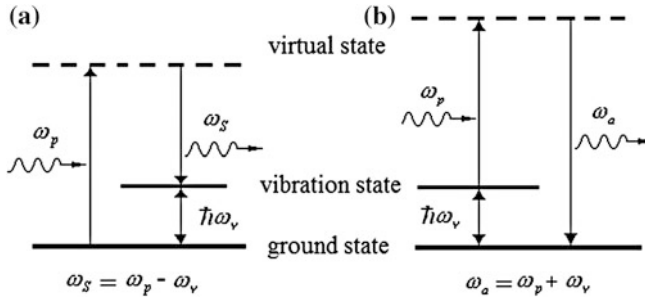
- (1) **High Gain**  
The stimulated scattering outputted light intensity is possible to reach the same order of magnitude of the incident light intensity, even more strong. Because it has a high amplification ability, the stimulated scattering light could use up the incident light energy.
- (2) **High Directionality**  
The divergence angle of forward and backward stimulated scattering light can reach the same of divergence angle of incident laser, for example to reach milliradian, even to reach the diffraction limitation.
- (3) **High Monochromaticity**  
The width of scattered spectrum is obvious narrow down. It can produce the monochromatic light with the spectrum width as same as the spectrum width of incident laser or narrower.
- (4) **Pulsewidth Compression**  
The pulsewidth of stimulated radiation scattering light pulse can reach the date much smaller than the pulsewidth of incident laser pulse.
- (5) **Threshold Value**  
When the intensity of incident laser is larger than a threshold intensity, the coherence, directivity and intensity will be obvious enhanced.
- (6) **High Order Scattering**  
When increasing the input intensity or the medium length, the more high-order Stokes and anti-Stokes scattering lights will occur.
- (7) **Phase Conjugation**  
The phase of the backward stimulated scattering light has a conjugation relation with the phase of the incident light, the backward scattering can be used to generate phase conjugation wave. It has a higher nonlinear reflectivity; it does not need to consider the phase match.

## 6.2 Stimulated Raman Scattering

### 6.2.1 Physical Picture of Stimulated Raman Scattering

#### 1. Spectral Characteristic of Stimulated Raman Scattering

In 1928 Raman discovered the spontaneous Raman scattering. In the scattering spectrum, except the original frequency component  $\omega_a$ , it also appears the new frequency component  $\omega_s$  (Stokes lane) and  $\omega_a$  (anti-Stokes lane), and  $\omega_s < \omega_0 < \omega_a$ ;



**Fig. 6.2** Energy-level diagrams for explaining Raman scattering **a** Stokes scattering; **b** Anti-Stokes scattering

In general, the anti-Stokes line is weaker than the Stokes line in several orders of magnitude. We can use the energy-level diagram Fig. 6.2 to explain the formation process of Raman scattering.

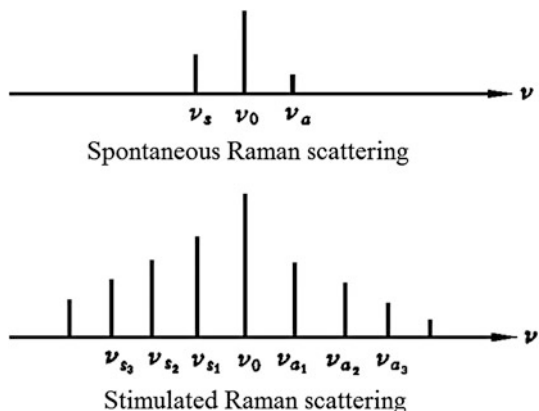
The process of Raman scattering is: the molecule in the ground state absorbs the photon of pump light at frequency  $\omega_p$  jumping to a virtual state, and then transits from that virtual state to the vibration (or rotation) state of the molecule, at same time launching a Stokes photon at frequency  $\omega_s$ , as shown in Fig. 6.2a. On the other hand, the molecule located at the vibration (or rotation) state absorbs a photon of pump light at  $\omega_p$  jumping to another virtual state, then transits from that virtual state to the ground state, at same time launching an anti-Stokes photon at frequency  $\omega_a$  as shown in Fig. 6.2b. Because in the thermal equilibrium case, the molecular number in the ground state is much greater than the molecular number in the vibration state, so the number of the photon at frequency  $\omega_s$  is much greater than the number of the photon at frequency  $\omega_a$ , therefore the Stokes scattering light intensity is much stronger than the anti-Stokes scattering light intensity.

The stimulated Raman scattering spectrogram has different characteristic in comparison with the spontaneous Raman scattering spectrogram: the spontaneous Raman scattering spectrogram only has two first-order scattering spectral lines, but on the stimulated Raman scattering spectrogram, there are many high order scattering spectral lines, as shown in Fig. 6.3.

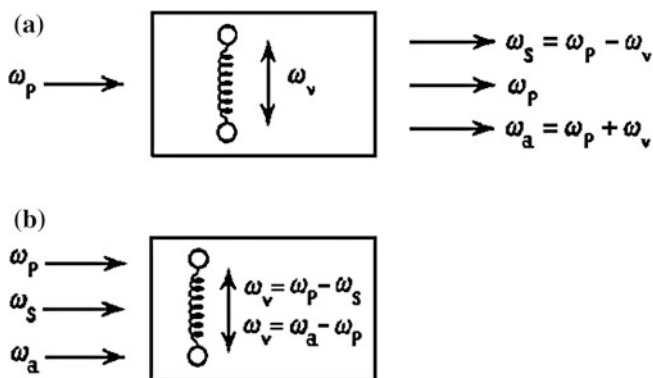
## 2. Classical Oscillator Picture of Stimulated Raman Scattering

Now we give a classical oscillator picture for explaining the formation of stimulated Raman scattering, as shown in Fig. 6.4.

Figure 6.4a shows that when a pump light at frequency  $\omega_p$  inputs into the medium consisted of the molecules at the intrinsic vibration frequency  $\omega_v$ , it induces the molecular polarization to form an electrical dipole, and generates the forced oscillation at frequency  $\omega_p$ , which induces the secondary radiation, the frequency of radiation light is modulated by molecular vibration frequency, so that it occurs the frequency shift, to produce a Stokes scattering light at the frequency of  $\omega_s = \omega_p - \omega_v$  and an anti-Stokes scattering light at the frequency of  $\omega_a = \omega_p + \omega_v$ .



**Fig. 6.3** Comparison of spectrograms of the spontaneous Raman scattering and the stimulated Raman scattering



**Fig. 6.4** Classical oscillator picture for explaining the formation of stimulated Raman scattering: **a** the frequency of electrical-dipole secondary radiation is modulated by the frequency of medium molecular vibration to generate the Stokes scattering light; **b** the difference frequency between the pump light and the Stokes light further intensifies the medium molecular vibration to increase the Stokes light

Figure 6.4b shows that the original pump light and Stokes light (anti-Stokes light) together input the medium to form the light at the difference frequency of  $\omega_v = \omega_p - \omega_s$  (or  $\omega_v = \omega_p - \omega_a$ ), the difference frequency light intensifies the molecular vibration of medium, thereby further generate the Stokes light at frequency  $\omega_s$  (or the anti-Stokes light at frequency  $\omega_a$ ), this positive feedback action similar to avalanche makes the Stokes light (or the anti-Stokes light) further increases.

### 3. Photon Picture of Stimulated Raman Scattering

Using the frequency and the wave vector to represent the incident photon  $(\omega_p, \mathbf{k}_p)$ , the Stoke scattering photon  $(\omega_s, \mathbf{k}_s)$ , the anti-Stokes photon  $(\omega_a, \mathbf{k}_a)$  and the Raman vibration of medium  $(\omega_v, \mathbf{k}_v)$ , the Stokes light and the anti-Stokes light of first-order stimulated Raman scattering must obey the following energy and momentum conservation relationships:

$$\begin{aligned}\omega_s &= \omega_p - \omega_v \\ \omega_a &= \omega_p + \omega_v,\end{aligned}\tag{6.2.1}$$

$$\begin{aligned}\mathbf{k}_s &= \mathbf{k}_p - \mathbf{k}_v \\ \mathbf{k}_a &= \mathbf{k}_p + \mathbf{k}_v.\end{aligned}\tag{6.2.2}$$

The stimulated Stokes scattering light and the stimulated anti-Stokes scattering light are concurrence, but two scattering lights in general are non-collinear. In the phase matching condition, their propagation directions satisfy the vector relationship, as shown in Fig. 6.5.

That is to say, the first-order anti-Stokes scattering light is generated by interaction between the pump light and the first-order Stokes scattering light in the third-order nonlinear process. Three of them satisfy the following wave-vector matching condition:

$$\Delta \mathbf{k} = 2\mathbf{k}_p - \mathbf{k}_s - \mathbf{k}_a = 0.\tag{6.2.3}$$

According to wave-vector relation showed in Fig. 6.5 we have

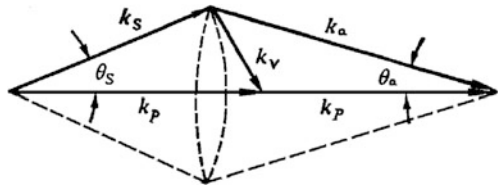
$$k_s \cos \theta_s + k_a \cos \theta_a = 2k_p.\tag{6.2.4}$$

The refractive indexes of the Stokes scattering light and the anti-Stokes scattering light can be denoted as the sum of the linear refractive index and the non-linear refractive index, respectively:

$$n_s = n_p + \Delta n_s,\tag{6.2.5}$$

$$n_a = n_p + \Delta n_a.\tag{6.2.6}$$

**Fig. 6.5** Vector diagram of the propagation directions of stimulated Raman scattering lights



Because  $\cos \theta \approx 1 - \frac{\theta^2}{2}$ ,  $k = \frac{\omega}{c} n$ , from Eqs. (6.2.4) to (6.2.6), we obtain

$$\left(1 + \frac{\Delta n_s}{n_p}\right) \left(1 - \frac{\theta_s^2}{2}\right) \omega_s + \left(1 + \frac{\Delta n_a}{n_p}\right) \left(1 - \frac{\theta_a^2}{2}\right) \omega_a = 2\omega_p. \quad (6.2.7)$$

On the other hand, the three light frequencies have to satisfy the energy conservation condition:

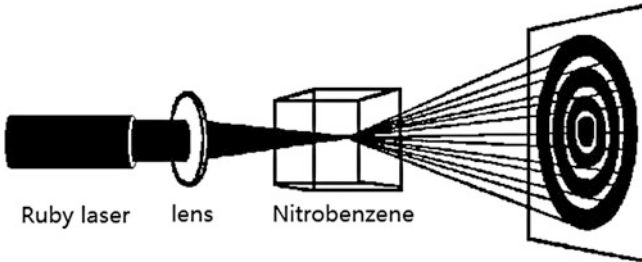
$$\omega_s + \omega_a = 2\omega_p. \quad (6.2.8)$$

Let Eqs. (6.2.7) minus (6.2.8), assuming  $\theta_s^2 \approx \theta_a^2 = \theta^2$ , and  $2(\Delta n_s \omega_s + \Delta n_a \omega_a) \theta^2$  can be neglected because it is much smaller than  $n_p(\omega_s + \omega_a) \theta^2$ , so we obtain the divergence angle of the first-order anti-Stokes scattering light:

$$\theta^2 \cong \frac{2(\Delta n_s \omega_s + \Delta n_a \omega_a)}{n_p(\omega_s + \omega_a)}. \quad (6.2.9)$$

Visible, both the first-order Raman scattering Stokes light and the anti-Stokes light are outputted along a same cone angle  $\theta$ , which is the intersection angle between the scattering light and the incident pump light. In the same way, we can understand the different high-order Raman scattering lights will output along the different cone angles.

An experiment showed that when a Ruby laser beam focuses into a Nitrobenzene sample, on the output screen in the far field of scattering light can see a ring-shape transverse structure, as shown in Fig. 6.6. The each-order Raman scattering lights (including Stokes and anti-Stokes lights) respectively start from the focal point and output in different cone angle to form the rings with different radius on the screen. The first-order Raman scattering light has maximum intensity located at the center of rings. The high-order Raman scattering light is corresponding to the larger and weaker rings.



**Fig. 6.6** Experiment for observing the angle distribution of stimulated Raman scattering lights



The stimulated Raman scattering has many important applications, for example, it can be used for frequency shift of laser outputted light for broadening the output frequency region; it can be used for the Raman amplifier and the wavelength division multiplexing device in fiber communication. Using backward stimulated scattering can obtain the phase conjugation light to realize the high efficient image aberration self-compensating; in addition, one can use silicon ring waveguide to make a Raman scattering laser to output the Stokes laser beam etc.

## 6.2.2 Classical Theory of Stimulated Raman Scattering

### 1. Gain Factor of Stokes Scattering Light Field

Now we introduce the classical theory of stimulated Raman scattering [1–5]. At first we use nonlinear coupled equations to analyze the stimulated Raman scattering process. In the isotropic medium, a pump light field  $\mathbf{E}_p(\omega_p)$  at frequency  $\omega_p$  inputs the medium, which interacts with the medium to produce the Stokes scattering light field  $\mathbf{E}_s(\omega_s)$  at frequency  $\omega_s$ , these two lights propagate all along z-direction. Under the phase matching condition, the nonlinear coupled equation for  $\mathbf{E}_s(z, \omega_s)$  is

$$\frac{d\mathbf{E}_s(z)}{dz} = \frac{i\omega_s}{2\varepsilon_0 c n_s} \mathbf{P}^{(3)}(z). \quad (6.2.10)$$

The photon's energy and momentum conservation relationships for Stokes Raman scattering are

$$\begin{aligned} \omega_s &= \omega_p - \omega_p + \omega_s, \\ \mathbf{k}_s &= \mathbf{k}_p - \mathbf{k}_p + \mathbf{k}_s. \end{aligned}$$

The nonlinear polarization is given by

$$\mathbf{P}^{(3)}(z) = 6\varepsilon_0 \chi_R^{(3)}(\omega_s; \omega_p, -\omega_p, \omega_s) |\mathbf{E}_p|^2 \mathbf{E}_s(z). \quad (6.2.11)$$

where  $\chi_R^{(3)}(\omega_s; \omega_p, -\omega_p, \omega_s)$  is the susceptibility for Stokes Raman scattering light, it is simply expressed as  $\chi_R^{(3)}(\omega_s)$ , which can be divided into the real and imaginary two parts:

$$\chi_R^{(3)}(\omega_s) = \chi_R^{(3)}(\omega_s)' + i\chi_R^{(3)}(\omega_s)'''. \quad (6.2.12)$$

The real part reflects the refractive-index change (phase change), the imaginary part reflects the absorption coefficient change (energy change). Because we only study the energy exchange relation in the scattering process, in following discuss we only maintain the imaginary part items.

Substituting Eq. (6.2.11) into Eq. (6.2.10), and taking the imaginary part of susceptibility  $i\chi_R^{(3)''}(\omega_s)$ , we obtain

$$\frac{d\mathbf{E}_s(z)}{dz} = -\frac{3\omega_s}{cn_s}\chi_R^{(3)''}(\omega_s)|\mathbf{E}_p|^2\mathbf{E}_s(z). \quad (6.2.13)$$

Using  $I_p = \frac{1}{2}\varepsilon_0cn_p|\mathbf{E}_p|^2$  to replace  $|\mathbf{E}_p|^2$  by the light intensity  $I_p$ , we solve Eq. (6.2.13) to obtain

$$\mathbf{E}_s(z) = \mathbf{E}_{s0}\exp\left[-\frac{6\omega_s}{\varepsilon_0c^2n_pn_s}\chi_R''(\omega_s)I_pz\right] = \mathbf{E}_{s0}e^{\frac{1}{2}gz}, \quad (6.2.14)$$

where  $g$  factor is

$$g = -\frac{12\omega_s}{\varepsilon_0c^2n_pn_s}\chi_R''(\omega_s). \quad (6.2.15)$$

We can see that if  $\chi_R'' < 0$   $g$  is a gain factor. Below we will see that  $\chi_R''$  indeed is smaller than zero, so the Stokes scattering light field is exponential increase along  $z$ -direction.

## 2. Formula Derivation of Susceptibility for Stimulated Raman Scattering

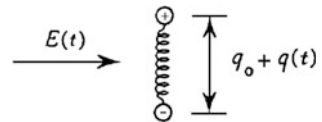
Now we start derivate the expression of  $\chi_R^{(3)}$  in detail. We suppose that the medium is consisted of molecules (or atoms), each molecule (atom) is similar to an electrical dipole, and there are  $N$  non-interactional electrical dipoles in per unit volume of the medium. When an additional light field  $\mathbf{E}(z, t)$  inputs the medium, and interacts with electrical dipoles to lead them forced oscillation. The length of electrical dipole is denoted by  $q(t)$ , when forced oscillation of electrical dipole, the length of electrical dipole is changed with time respect to its equilibrium-state length  $q_0$ . So  $q(t)$  is a function of time, as shown in Fig. 6.7.

The classical motion equation for describing the forced oscillation of molecular electrical dipole is

$$\frac{\partial^2 q(t)}{\partial t^2} + 2\gamma\frac{\partial q(t)}{\partial t} + \omega_v^2 q(t) = \frac{\mathbf{F}(z, t)}{m}, \quad (6.2.16)$$

where  $\omega_v$  is the resonance frequency of electrical dipole,  $\gamma$  is the relaxation rate (attenuation constant) of electrical dipole,  $\mathbf{F}(z, t)$  is the acting force of external electrical field,  $m$  is the mass of electrical dipole molecule.

**Fig. 6.7** Molecular electrical dipole model for describing the stimulated Raman scattering



Under the action of light field, the polarization of electrical dipole is

$$p(z, t) = \varepsilon \mathbf{E}(z, t). \quad (6.2.17)$$

The relationship of the dielectric coefficient  $\varepsilon$  and the electrical-dipole susceptibility  $\alpha$  is

$$\varepsilon = \varepsilon_0(1 + \alpha), \quad (6.2.18)$$

The electrical-dipole susceptibility  $\alpha$  is a function of the time:

$$\alpha(t) = \alpha_0 + \left( \frac{\partial \alpha}{\partial q} \right)_0 q(t), \quad (6.2.19)$$

where the first item  $\alpha_0$  is the linear susceptibility of electrical dipole in the equilibrium state, the second item is the nonlinear susceptibility of electrical dipole. Considering Eqs. (6.2.17) and (6.2.18), the static electricity energy of electrical dipole is

$$W = \frac{1}{2} [p(z, t) \cdot \mathbf{E}(z, t)] = \frac{1}{2} \varepsilon_0(1 + \alpha) \langle \mathbf{E}^2(z, t) \rangle, \quad (6.2.20)$$

where  $\langle \rangle$  denotes the time average value of total light field intensity in an optical period (it is possible containing several frequency components).

The electrical field force induced in external field is the derivative of electrostatic energy to the length change of electrical dipole. Utilizing Eqs. (6.2.20) and (6.3.19), we obtain

$$F(z, t) = \frac{dW}{dq} = \frac{\varepsilon_0}{2} \left( \frac{\partial \alpha}{\partial q} \right)_0 \langle \mathbf{E}^2(z, t) \rangle. \quad (6.2.21)$$

In order to find the average value of field intensity, assuming the total light field in medium is the sum of pump light field and Stokes light field:

$$\mathbf{E}(z, t) = \mathbf{E}_p e^{i(k_p z - \omega_p t)} + \mathbf{E}_s e^{i(k_s z - \omega_s t)} + c.c. \quad (6.2.22)$$

Because the total light field has two light fields at different frequencies, so in  $\langle \mathbf{E}^2(z, t) \rangle$  there are several items with different frequencies, we omit high frequency items containing  $2\omega_p$ ,  $2\omega_s$  and  $\omega_p + \omega_s$  etc., only maintain the low frequency items containing  $\omega_p - \omega_s$ , than we have

$$\langle \mathbf{E}^2(z, t) \rangle \approx 2\mathbf{E}_p \mathbf{E}_s^* e^{i(Kz - \Omega t)} + c.c., \quad (6.2.23)$$

where  $\mathbf{K}$  and  $\Omega$  are defined as respectively:

$$\mathbf{K} = \mathbf{k}_p - \mathbf{k}_s, \Omega = \omega_p - \omega_s. \quad (6.2.24)$$

From Eq. (6.2.21), the dipole received force is

$$F(z, t) = \varepsilon_0 \left( \frac{\partial \alpha}{\partial q} \right)_0 [\mathbf{E}_p \mathbf{E}_s^* e^{i(Kz - \Omega t)} + c.c.]. \quad (6.2.25)$$

In order to solve dipole motion Eq. (6.2.16), we can use a testing solution:

$$\mathbf{q}(t) = \mathbf{q}(\Omega) e^{i(Kz - \Omega t)} + c.c. \quad (6.2.26)$$

Substituting Eqs. (6.2.26) and (6.2.25) into Eq. (6.2.16), we obtain

$$-\Omega^2 \mathbf{q}(\Omega) - 2i\Omega\gamma \mathbf{q}(\Omega) + \omega_v^2 \mathbf{q}(\Omega) = \frac{\varepsilon_0}{m} \left( \frac{\partial \alpha}{\partial q} \right)_0 \mathbf{E}_p \mathbf{E}_s^*. \quad (6.2.27)$$

Thus we obtain the electrical dipole vibration amplitude:

$$\mathbf{q}(\Omega) = \frac{(\varepsilon_0/m) (\partial \alpha / \partial q)_0 \mathbf{E}_p \mathbf{E}_s^*}{\omega_v^2 - \Omega^2 - 2i\Omega\gamma}. \quad (6.2.28)$$

Now we are going to find the third-order polarization and susceptibility. According to Eqs. (6.2.18) and (6.2.19), the total polarization of medium is

$$\begin{aligned} \mathbf{P}(z, t) &= N\mathbf{p}(z, t) = \varepsilon_0 N(1 + \alpha)\mathbf{E}(z, t) \\ &= \varepsilon_0 N \left[ 1 + \alpha_0 + \left( \frac{\partial \alpha}{\partial q} \right)_0 \mathbf{q}(z, t) \right] \mathbf{E}(z, t). \end{aligned} \quad (6.2.29)$$

Equation (6.2.29) includes the first-order polarization (linear polarization) and the third-order polarization of medium. In which the first-order polarization is

$$\mathbf{P}^{(1)} = \varepsilon_0 N(1 + \alpha_0)\mathbf{E}(z, t). \quad (6.2.30)$$

According to Eqs. (6.2.29), (6.2.26) and (6.2.22), the third-order polarization is

$$\mathbf{P}^{(3)}(z, t) = \varepsilon_0 N \left( \frac{\partial \alpha}{\partial q} \right)_0 [\mathbf{q}(\Omega) e^{i(Kz - \Omega t)} + c.c.] \times [\mathbf{E}_p e^{i(k_p z - \omega_p t)} + \mathbf{E}_s e^{i(k_s z - \omega_s t)} + c.c.]. \quad (6.2.31)$$

So the nonlinear polarization contains several different frequency difference components, in which the Stokes light at frequency  $\omega_s$  induced nonlinear polarization of medium can be expressed as

$$\mathbf{P}_s^{(3)}(z, t) = \mathbf{P}^{(3)}(\omega_s) e^{i(k_s z - \omega_s t)}. \quad (6.2.32)$$

If only taking the items containing phase  $e^{i(k_s z - \omega_s t)}$  in the various products of Eq. (6.2.31), (utilize  $\mathbf{k}_s = \mathbf{k}_p - \mathbf{K}$  and  $\omega_s = \omega_p - \Omega$ ), the third-order nonlinear polarization amplitude for Stokes light is given by

$$\mathbf{P}^{(3)}(\omega_s) = \varepsilon_0 N \left( \frac{\partial \alpha}{\partial q} \right)_0 \mathbf{q}^*(\Omega) \mathbf{E}_p. \quad (6.2.33)$$

Taking conjugated complex of electrical dipole amplitude Eq. (6.2.28), and then substituting it into Eq. (6.2.33), we obtain

$$\mathbf{P}^{(3)}(\omega_s) = \frac{\varepsilon_0^2 (N/m) (\partial \alpha / \partial q)_0^2 |\mathbf{E}_p|^2}{\omega_v^2 - \Omega^2 + 2i\Omega\gamma} \mathbf{E}_s(\omega). \quad (6.2.34)$$

Substituting Eq. (6.2.34) into Eq. (6.2.32), and utilizing  $\mathbf{E}_s(z, t) = \mathbf{E}_s(\omega) e^{i(k_s z - \omega_s t)}$ , the time-domain Stokes polarization is given by

$$\mathbf{P}_s^{(3)}(z, t) = \frac{\varepsilon_0^2 (N/m) (\partial \alpha / \partial q)_0^2 |\mathbf{E}_p|^2}{\omega_v^2 - \Omega^2 + 2i\Omega\gamma} \mathbf{E}_s(z, t). \quad (6.2.35)$$

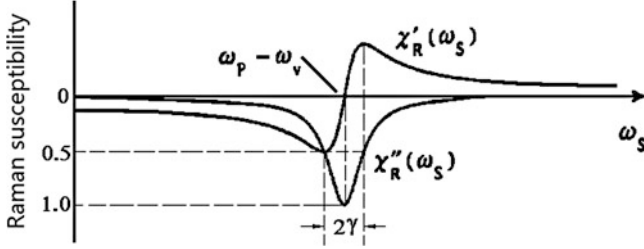
Now comparing Eq. (6.2.35) with third-order nonlinear polarization definition Eq. (6.2.11) we obtain the third-order nonlinear susceptibility formula:

$$\chi_R^{(3)}(\omega_s) = \frac{\varepsilon_0 (N/6m) (\partial \alpha / \partial q)_0^2}{\omega_v^2 - (\omega_p - \omega_s)^2 + 2i(\omega_p - \omega_s)\gamma}. \quad (6.2.36)$$

Considering the near resonance condition  $\Omega = \omega_p - \omega_s \approx \omega_v$ , then Eq. (6.2.36) also can be expressed as

$$\chi_R^{(3)}(\omega_s) \cong \frac{\varepsilon_0 (N/12m\omega_v) (\partial \alpha / \partial q)_0^2}{(\omega_s - \omega_p + \omega_v) + i\gamma}. \quad (6.2.37)$$

According to the definition  $\chi_R^{(3)}(\omega_s) = \chi_R'(\omega_s) + i\chi_R''(\omega_s)$ , the above third-order nonlinear susceptibility can be divided into the real part and the imaginary part, respectively:



**Fig. 6.8** Curves of real part and imaginary part of the nonlinear susceptibility induced by the stimulated Raman scattering light

$$\chi_R'(\omega_s) \cong \frac{\varepsilon_0 N (\partial\alpha/\partial q)_0^2 (\omega_v - \omega_p + \omega_p)}{12 m \omega_v [(\omega_s - \omega_p + \omega_v)^2 + \gamma^2]}, \quad (6.2.38)$$

$$\chi_R''(\omega_s) \cong \frac{-\varepsilon_0 N (\partial\alpha/\partial q)_0^2 \gamma}{12 m \omega_v [(\omega_s - \omega_p + \omega_v)^2 + \gamma^2]}. \quad (6.2.39)$$

Figure 6.8 draws the curves of real part and imaginary part of the nonlinear susceptibility induced by the stimulated Raman scattering light.

We can see that Raman scattering Stokes light induced nonlinear susceptibility imaginary part is a negative value, according to Eq. (6.2.15), the Stokes field at  $\omega_s$  has a positive gain factor  $g$ , which is given by

$$g = \frac{\omega_s N (\partial\alpha/\partial q)_0^2 \gamma}{c^2 n_p n_s m \omega_v [(\omega_s - \omega_p + \omega_v)^2 + \gamma^2]}. \quad (6.2.40)$$

Therefore stimulated Raman scattering Stokes light field is continues increased in propagation process along z-direction.

In same way we can analyze the propagation law of anti-Stokes light field, as long as replacing  $\omega_s$  by  $\omega_a$  in Eq. (6.2.36). So the anti-Stokes light induced nonlinear susceptibility is given by

$$\chi_R^{(3)}(\omega_a) = \frac{\varepsilon_0 (N/6 m) (\partial\alpha/\partial q)_0^2}{\omega_v^2 - (\omega_p - \omega_a)^2 + 2i(\omega_p - \omega_a)\gamma}. \quad (6.2.41)$$

Because the anti-Stokes Raman scattering has following energy and momentum conservation relationships:

$$\begin{aligned} \omega_a &= \omega_p + \omega_p - \omega_s, \\ \mathbf{k}_a &= \mathbf{k}_p + \mathbf{k}_p - \mathbf{k}_s. \end{aligned}$$

Then we have

$$\omega_p - \omega_s = -(\omega_p - \omega_a), \quad (6.2.42)$$

namely

$$\chi_R^{(3)}(\omega_a) = \chi_R^{(3)}(\omega_s)^*. \quad (6.2.43)$$

Under near resonance condition, Eq. (6.2.41) becomes

$$\chi_R^{(3)}(\omega_a) \cong -\frac{\varepsilon_0(N/12 m\omega_v)(\partial\alpha/\partial q)_0^2}{(\omega_a - \omega_p - \omega_v) + i\gamma}. \quad (6.2.44)$$

The real part and the imaginary part are expressed respectively as

$$\chi_R'(\omega_a) \cong \frac{-\varepsilon_0 N (\partial\alpha/\partial q)_0^2 (\omega_a - \omega_p - \omega_v)}{12 m\omega_v [(\omega_a - \omega_p - \omega_v)^2 + \gamma^2]}, \quad (6.2.45)$$

and

$$\chi_R''(\omega_a) \cong \frac{\varepsilon_0 N (\partial\alpha/\partial q)_0^2 \gamma}{12 m\omega_v [(\omega_a - \omega_p - \omega_v)^2 + \gamma^2]}. \quad (6.2.46)$$

Similar to Eq. (6.2.15), the anti-Stokes field amplitude is

$$E_a(z) = E_{a0} \exp\left(\frac{1}{2} g I_p z\right). \quad (6.2.47)$$

where

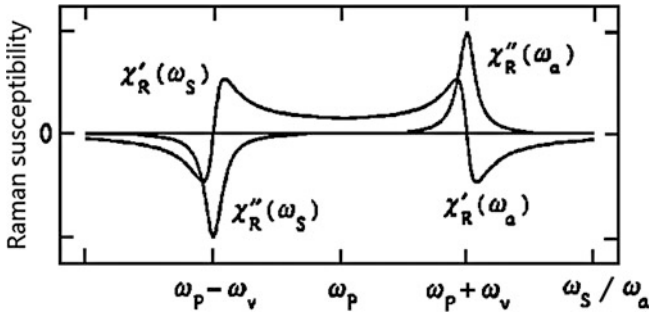
$$g = -\frac{\omega_a N (\partial\alpha/\partial q)_0^2 \gamma}{c^2 n_p n_a m\omega_v [(\omega_a - \omega_p - \omega_v)^2 + \gamma^2]}. \quad (6.2.48)$$

Because this  $g$  factor is negative value, the anti-Stokes field is attenuated with increase of  $z$ .

Figure 6.9 draws the relation between Stokes and Anti-stokes stimulated Raman scattering nonlinear susceptibility frequency spectrums.

### 6.2.3 Experiments of Stimulated Raman Scattering

People have been observed the stimulated Raman scattering (SRS) effect in many materials, including the liquid (for example benzene, CS<sub>2</sub>, CCl<sub>4</sub>, acetone, etc.),



**Fig. 6.9** Relation between Stokes and anti-Stokes stimulated Raman scattering nonlinear susceptibility frequency spectrums

solid (for example diamond, calcite, lithium niobate, nitrate barium, etc.), gas ( $H_2$ ,  $D_2$ ,  $N_2$ ,  $CH_4$ ,  $SF_6$ , etc.), semiconductor (such as InSb, etc. spin inversion Raman scattering). The basic requirements of working mediums for generating SRS: ① high transparency to SRS light and pump light; ② with larger scattering cross section; ③ it can sustain the stronger incident pump light intensity.

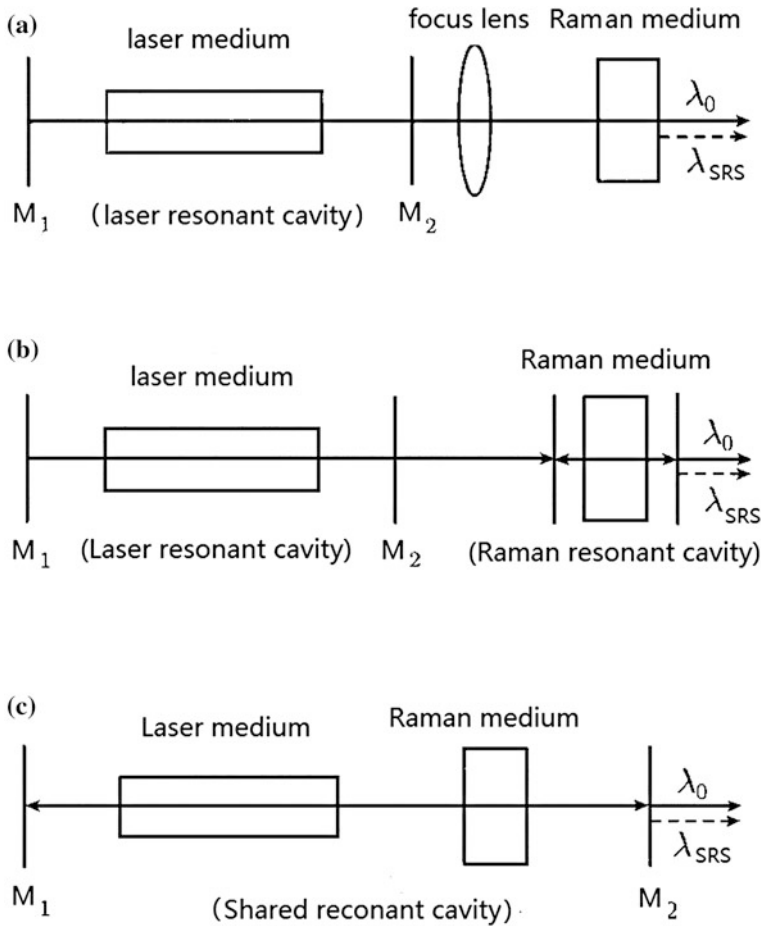
According to the different working medium, application requirement and experimental condition, one can adopt three kinds of different experimental setups to generate SRS, as shown in Fig. 6.10. The first setup is that, the incident laser via focus lens one-way passing through the Raman medium. When the focused pump light beam and the scattering light beam form a tenuous effective gain area in the medium, it can observe the forward and backward scattering lights. Second setup is that, the Raman medium is placed alone in a resonant cavity outside the pump laser cavity, the SRS light back and forth oscillation in the cavity. When the total gain of SRS achieves greater than the various losses, it can output a stable SRS light beam. The third setup is that, the Raman medium is placed within the pump laser cavity, the shared resonant cavity offers the feedback for laser and SRS light; and let them output to outside the cavity.

## 6.3 Stimulated Brillouin Scattering

### 6.3.1 Physical Picture of Stimulated Brillouin Scattering

The Brillouin scattering originates from the interaction between the light electric field and the acoustic wave field in molecular medium or solid medium, namely the interaction between photons and phonons. It is different with the spontaneous Brillouin scattering, the produce process of stimulated Brillouin scattering is: under the action of laser electric field, through the electrostriction effect to lead the periodic change of medium density (and the refractive index), to induce an acoustic wave field (similar to the motion grating). When the incident light passes through





**Fig. 6.10** Experimental setups for producing the stimulated Raman scattering: **a** One-way traveling wave amplification type; **b** Raman resonant cavity type; **c** Laser and Raman shared resonant cavity type

the acoustic wave field, it generates a maximum of diffraction with a frequency shift in a certain direction, i.e. the scattering light. The frequency shift quantity of scattering light is related with the motion velocity of acoustic wave field in the medium and the propagation direction of scattering light.

If denoting the photons and the phonon by frequency and wave vector: the incident pump photon ( $\omega_p, \mathbf{k}_p$ ), the Stokes scattering photon ( $\omega_s, \mathbf{k}_s$ ), the anti-Stokes photon ( $\omega_a, \mathbf{k}_a$ ) and the induced phonon ( $\omega_b, \mathbf{k}_b$ ), the Stokes scattering light and anti-Stokes scattering light of first-order stimulated Brillouin scattering must satisfy the energy and momentum conservation conditions respectively, i.e.,

For the Stokes scattering:

$$\begin{aligned}\omega_p &= \omega_s + \omega_b \\ \mathbf{k}_p &= \mathbf{k}_s + \mathbf{k}_b,\end{aligned}\quad (6.3.1)$$

For the anti-Stokes scattering:

$$\begin{aligned}\omega_a &= \omega_p + \omega_b \\ \mathbf{k}_a &= \mathbf{k}_p + \mathbf{k}_b.\end{aligned}\quad (6.3.2)$$

In the Stokes scattering case, from Eq. (6.3.1) we can see, there is a part of incident-light- field energy translating into induced acoustic-wave-field energy in the medium. Stokes scattering can be divided into two kinds of the forward scattering and the backward scattering. Their wave vector relations for momentum conservation are shown in Fig. 6.11.

The relationship between the wave vector  $k_b$  and the frequency  $\omega_b$  of acoustic wave is  $\omega_b = k_b v_b$ ,  $v_b$  is the velocity of acoustic wave. Because acoustic velocity  $v_b$  is smaller than light velocities  $v_p$  and  $v_s$  in several orders of magnitude, i.e.,  $v_b \ll v_p, v_s$ , so we can regard  $v_s \approx v_p$  and  $k_s \approx k_p$ , and then from Fig. 6.11 can see

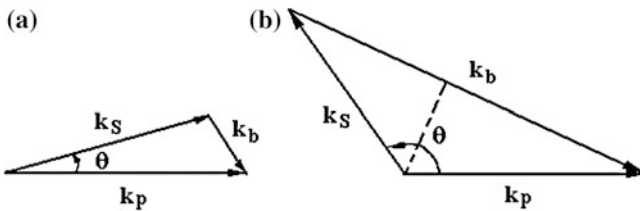
$$\frac{1}{2}k_b \approx k_p \sin \frac{\theta}{2}, \quad (6.3.3)$$

where  $k_b = \frac{\omega_b}{v_b}$ ,  $k_p = \frac{\omega_p n_p}{c}$ , then using Eq. (6.3.1), we have

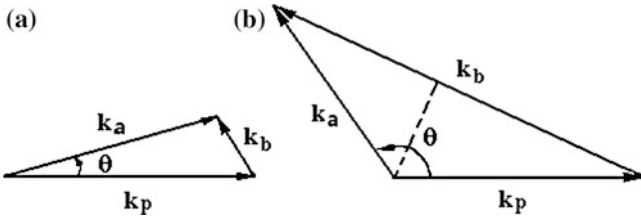
$$\omega_p - \omega_s = \omega_b = \frac{2\omega_p n_p v_b}{c} \sin \frac{\theta}{2}, \quad (6.3.4)$$

where  $\theta$  is the intersection angle between wave vector of scattering light  $\mathbf{k}_s$  and the wave vector of incident light  $\mathbf{k}_p$ . When  $\theta = 0$ ,  $\omega_b = 0$ , so  $\omega_p = \omega_s$ , i.e., without Brillouin frequency shift; when  $\theta = \pi$ , the Brillouin frequency shift takes a maximum  $\omega_{b\max}$ , i.e.,

$$\omega_p - \omega_s = \omega_{b\max} = \frac{2\omega_p n_p v_b}{c}. \quad (6.3.5)$$



**Fig. 6.11** Wave vector relations for momentum conservation of the stimulated Brillouin scattering: **a** Forward scattering; **b** Backward scattering



**Fig. 6.12** Wave vector relations for momentum conservation of the stimulated Brillouin anti-stokes scattering: **a** forward scattering; **b** backward scattering

We can see that the backward Brillouin Stokes scattering has maximum frequency shift. In this case the direction of acoustic wave field is the same as the direction of incident light field, but the direction of scattering light field is the reverse direction of the incident light field, these three fields are collinear. When we measure out the backward Brillouin scattering frequency shift  $\omega_p - \omega_s$ , using Eq. (6.3.5) we can calculate the acoustic velocity of the medium.

In the anti-Stokes scattering case, the wave vector relation for momentum conservation is shown in Fig. 6.12.

The frequency shift value of anti-Stokes light respect to the incident light is also

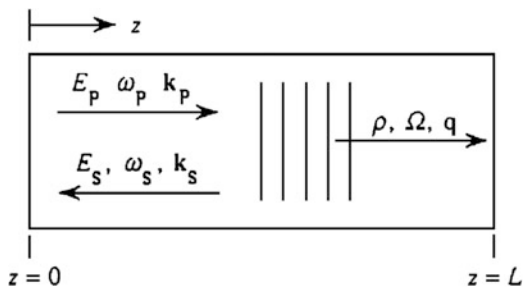
$$\omega_a - \omega_p = \omega_b = \frac{2\omega_p n_p v_b}{c} \sin \frac{\theta}{2}. \tag{6.3.6}$$

Visible, when  $\theta = \pi$ , the frequency shift value of backward Brillouin anti-Stokes scattering is a maximum, but the direction of the acoustic wave field in medium is reverse to the direction of the incident light.

### 6.3.2 Classical Theory of Stimulated Brillouin Scattering

This section theoretically analyzes the backward stimulated Brillouin scattering process as shown in Fig. 6.13 [6–8]. The pump light propagates along z-direction in the medium, the propagation direction of Stokes scattering light is reversed with the

**Fig. 6.13** Schematic diagram of the backward stimulated Brillouin stokes scattering process. The propagation directions of the pump light field ( $E_p, \omega_p, k_p$ ), the Brillouin scattering Stokes wave field ( $E_s, \omega_s, k_s$ ) and the acoustic wave field ( $\rho, \Omega, q$ ) are collinear



direction of pump light. The pump light field  $(E_p, \omega_p, k_p)$  interacts with the acoustic wave field  $(\rho, \Omega, q)$ , generating stimulated Brillouin scattering Stokes wave field  $(E_s, \omega_s, k_s)$ , where  $\rho$  is the density of medium, the frequency and the wave vector of phonon are  $\Omega = \omega_p - \omega_s$  and  $q = 2k_p$  respectively.

The material density changed with time is given by

$$\rho(z, t) = \rho_0 + \Delta\rho = \rho_0 + [\tilde{\rho}(z, t)e^{i(qz - \Omega t)} + c.c.]. \quad (6.3.7)$$

where  $\rho_0$  is the average material density; the second item in right side of equation is density change with time;  $\tilde{\rho}(z, t)$  is the amplitude of acoustic wave.

The total light field in Brillouin medium is expressed as

$$\mathbf{E}(z, t) = \mathbf{E}_p(z, t) + \mathbf{E}_s(z, t), \quad (6.3.8)$$

where

$$E_p(z, t) = \mathbf{A}_p(z, t)e^{i(k_p z - \omega_p t)} + c.c., \quad (6.3.9)$$

$$E_s(z, t) = \mathbf{A}_s(z, t)e^{i(-k_s z - \omega_s t)} + c.c.. \quad (6.3.10)$$

The material density change is satisfied the acoustic wave equation:

$$\frac{\partial^2 \rho}{\partial t^2} - \Gamma \nabla^2 \frac{\partial \rho}{\partial t} - v_b^2 \nabla^2 \rho = -\nabla \cdot \mathbf{F}, \quad (6.3.11)$$

where  $v_b$  is the acoustic velocity;  $\Gamma$  is the damping parameter;  $\mathbf{F}$  is electric field force (it is origin from the electrostriction stress).

The electrostriction coefficient is defined as

$$\gamma_e = \rho \frac{\partial \varepsilon}{\partial \rho}. \quad (6.3.12)$$

The light field energy density is

$$W = \frac{1}{2}(\mathbf{P} \cdot \mathbf{E}) = \frac{1}{2}\varepsilon \langle \mathbf{E}^2 \rangle, \quad (6.3.13)$$

where  $\langle \mathbf{E}^2 \rangle$  denotes the average value of light intensity in an optical period.

The light field energy density change is due to the density compress induced change of dielectric coefficient:

$$\Delta W = \frac{1}{2} \Delta \varepsilon \langle \mathbf{E}^2 \rangle = \frac{1}{2} \left( \frac{\partial \varepsilon}{\partial \rho} \Delta \rho \right) \langle \mathbf{E}^2 \rangle = \frac{1}{2} \gamma_e \frac{\Delta \rho}{\rho} \langle \mathbf{E}^2 \rangle. \quad (6.3.14)$$

The light field energy density change is equal to that the electrostriction pressure  $p_e$  compresses the material to do the work in unit volume:

$$\Delta W = p_e \frac{\Delta V}{V} = -p_e \frac{\Delta \rho}{\rho}. \quad (6.3.15)$$

In Eq. (6.3.15) the minus sign is because that the compression of material volume leads increase of density of material.

To compare Eqs. (6.3.14) and (6.3.15) we can get the pressure:

$$p_e = -\frac{1}{2} \gamma_e \langle \mathbf{E}^2 \rangle. \quad (6.3.16)$$

Then the electric field force  $\mathbf{F}$  is

$$\mathbf{F} = -\nabla p_e = \frac{1}{2} \gamma_e \nabla \langle \mathbf{E}^2 \rangle. \quad (6.3.17)$$

Substituting the field expression Eq. (6.3.8) into Eq. (6.3.17), taking the item at low frequency  $\Omega = \omega_p - \omega_s$ , we obtain the divergence of external force:

$$\nabla \cdot \mathbf{F} = -\gamma_e q^2 [A_p \mathbf{A}_s^* e^{i(qz - \Omega t)} + c.c.]. \quad (6.3.18)$$

To substitute Eqs. (6.3.7) and (6.3.18) into the acoustic Eq. (6.3.11), considering the acoustic wave amplitude in space and time slow-variation-amplitude approximation, neglecting the items containing the space and time second derivative to  $\rho$ , and eliminating the phase factor of field, we obtain

$$(\Omega_B^2 - \Omega^2 - i\Omega\Gamma_B) \tilde{\rho} - 2i\Omega \frac{\partial \tilde{\rho}}{\partial t} - 2iqv_b^2 \frac{\partial \tilde{\rho}}{\partial z} = \gamma_e q^2 A_p \mathbf{A}_s^*, \quad (6.3.19)$$

where

$$\Gamma_B = q^2 \Gamma \quad (6.3.20)$$

is the Brillouin line width,  $\Gamma_B = 1/\tau_b$ ,  $\tau_b$  is the lifetime of phonon.  $\Omega = \omega_p - \omega_s$  is the frequency of phonon;  $\Omega_B = |q|v_b$  is Brillouin frequency, where  $q = k_b \approx 2k_p$ . Because of the strong damping, the propagation distance of phonon is very short. The item containing  $\partial \rho / \partial z$  can be neglected. Considering the steady state case, the item containing  $\partial \rho / \partial t$  is zero, thus the acoustic wave amplitude is given by

$$\tilde{\rho}(z, t) = \gamma_e q^2 \frac{A_p \mathbf{A}_s^*}{\Omega_B^2 - \Omega^2 - i\Omega\Gamma_B}. \quad (6.3.21)$$

For nonlinear light field wave equation, we can also adopt the slowly-varying-amplitude approximation and the steady state condition, and satisfy the phase matching condition, and then the wave equations for the incident light field amplitude and the Stokes scattering light field amplitude are given by respectively:

$$\frac{dE_p}{dz} = \frac{i\omega_p}{2\varepsilon_0cn_p} P_p^{(3)}(z), \quad (6.3.22)$$

$$\frac{dE_s}{dz} = -\frac{i\omega_s}{2\varepsilon_0cn_s} P_s^{(3)}(z). \quad (6.3.23)$$

Because the total polarization is

$$\mathbf{P} = \varepsilon\mathbf{E} = (\varepsilon_L + \Delta\varepsilon)\mathbf{E} = \mathbf{P}_L + \mathbf{P}_{NL}, \quad (6.3.24)$$

where the nonlinear polarization is

$$\mathbf{P}_{NL} = \mathbf{P}^{(3)} = \Delta\varepsilon\mathbf{E}. \quad (6.3.25)$$

According to Eqs. (6.3.25) and (6.3.12), and  $|\Delta\rho| = \tilde{\rho}$ , then we have

$$\mathbf{P}^{(3)} = \Delta\varepsilon\mathbf{E} = \frac{\partial\varepsilon}{\partial\rho}\Delta\rho\mathbf{E} = \frac{\gamma_e}{\rho_0}\tilde{\rho}\mathbf{E}. \quad (6.3.26)$$

The incident pump light and the Stokes scattering light induced nonlinear polarizations can be expressed as respectively

$$\mathbf{P}_p^{(3)} = \mathbf{p}_p^{(3)} e^{i(k_p z - \omega_p t)} + c.c., \quad (6.3.27)$$

$$\mathbf{P}_s^{(3)} = \mathbf{p}_s^{(3)} e^{i(-k_s z - \omega_s t)} + c.c. \quad (6.3.28)$$

Form Eqs. (6.3.26) to (6.3.21), the polarization wave amplitude is

$$\mathbf{p}_p^{(3)} = \frac{\gamma_e}{\rho_0}\tilde{\rho}\mathbf{A}_s = \frac{q^2\gamma_e^2}{\rho_0} \frac{|A_s|^2 A_p}{\Omega_B^2 - \Omega^2 - i\Omega\Gamma_B}, \quad (6.3.29)$$

$$\mathbf{p}_s^{(3)} = \frac{\gamma_e}{\rho_0}\tilde{\rho}^* A_p = \frac{q^2\gamma_e^2}{\rho_0} \frac{|A_p|^2 A_s}{\Omega_B^2 - \Omega^2 + i\Omega\Gamma_B}. \quad (6.3.30)$$

Substituting the field expressions (6.3.9) and (6.3.10), the polarization wave amplitude expressions (6.3.29) and (6.3.30) into field Eqs. (6.3.22) and (6.3.23);

using Eq. (6.3.26); and setting  $\omega_p \approx \omega_s \approx \omega$  and  $n_p \approx n_s \approx n$ , we can obtain a group of field amplitude coupled equations:

$$\frac{dA_p}{dz} = \frac{i\omega q^2 \gamma_e^2}{2\varepsilon_0 cn \rho_0} \frac{|A_s|^2 A_p}{\Omega_B^2 - \Omega^2 - i\Omega \Gamma_B}, \quad (6.3.31)$$

$$\frac{dA_s}{dz} = -\frac{i\omega q^2 \gamma_e^2}{2\varepsilon_0 cn \rho_0} \frac{|A_p|^2 A_s}{\Omega_B^2 - \Omega^2 + i\Omega \Gamma_B}. \quad (6.3.32)$$

Using the relationship of light intensity and field amplitude:

$$I_p(z) = \frac{1}{2} \varepsilon_0 cn |A_p|^2, \quad (6.3.33)$$

$$I_s(z) = \frac{1}{2} \varepsilon_0 cn |A_s|^2, \quad (6.3.34)$$

From Eqs. (6.3.31) to (6.3.32) we can obtain

$$\frac{dI_p}{dz} = -g I_p I_s, \quad (6.3.35)$$

$$\frac{dI_s}{dz} = -g I_p I_s. \quad (6.3.36)$$

where  $g$  is the gain factor of Brillouin scattering. Setting  $\Omega_B + \Omega \approx 2\Omega$  and  $\Omega_B - \Omega \approx 0$ ,  $g$  can be approximately expressed as

$$g = g_0 \frac{(\Gamma_B/2)^2}{(\Omega_B - \Omega)^2 + (\Gamma_B/2)^2}. \quad (6.3.37)$$

When  $\Omega = \Omega_B$ ,  $g = g_0$ ,  $g_0$  is the gain factor at center of spectrum line:

$$g_0 = \frac{\omega q^2 \gamma_e^2}{\varepsilon_0^2 n^2 c^2 \rho_0 \Omega \Gamma_B}. \quad (6.2.38)$$

Because  $\Omega = \Omega_B = qv_b$ ,  $q = 2k_p$ , so

$$g_0 = \frac{4\gamma_e^2 \omega^2}{\varepsilon_0^2 n v_b c^3 \rho_0 \Gamma_B}. \quad (6.3.39)$$

According to the Boundary condition in Fig. 6.13, assuming the pump light intensity is a constant, i.e.,  $I_p = \text{constant}$ , the solution of Eq. (6.3.36) is

$$I_s(z) = I_s(L)e^{gI_p(L-z)}. \quad (6.3.40)$$

We can see that the Brillouin scattering Stokes wave in the medium is reverse propagation and exponential increase.

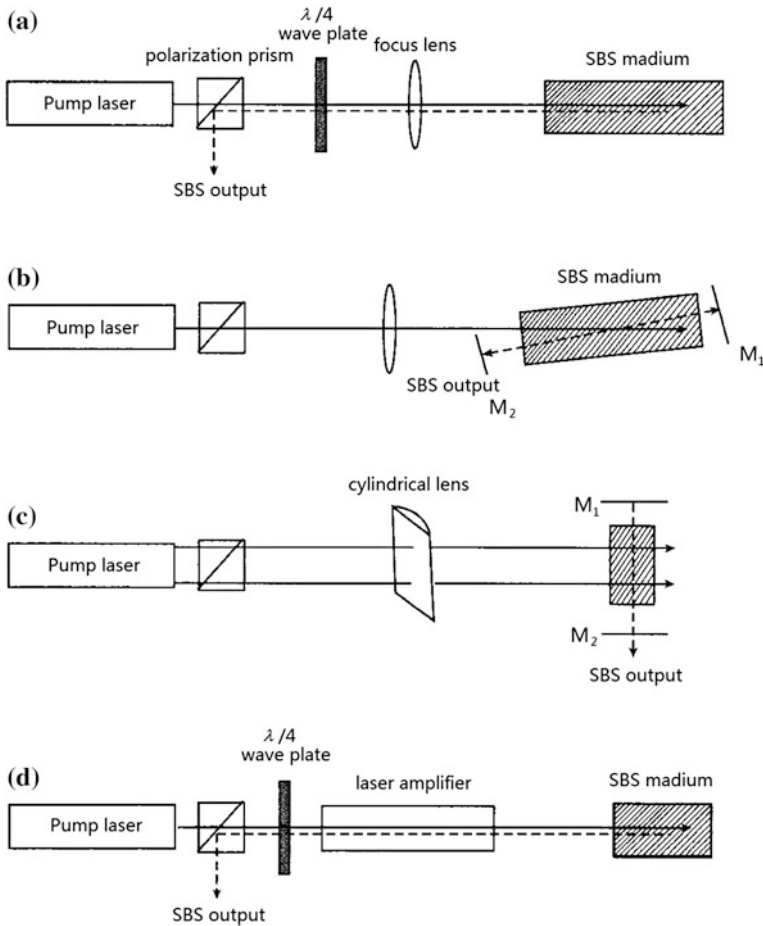
### 6.3.3 Experiments of Stimulated Brillouin Scattering

The requirements to the working medium of stimulated Brillouin scattering are: ① high transparency in pump light frequency area; ② with higher mass density and larger electrostriction coefficient; ③ it can sustain the higher focused laser power do not be damage. Actually, almost all common optical medium can be used for generating the SBS light, including the solid medium (crystalline quartz, fused quartz, optical glass, optical fiber, organic crystal, polymer material etc.), the liquid medium (carbon disulfide, benzene, acetone, carbon tetrachloride, glycerin, water, etc.), the gas medium ( $\text{H}_2$ ,  $\text{N}_2$ ,  $\text{CH}_4$ ,  $\text{CO}_2$  etc.), in general these gases is in high pressure state for increasing the density of gas. Because the frequency range of Brillouin scattering is very small (smaller than  $1 \text{ cm}^{-1}$  order of magnitude), the pump light source for generating SBS usually is used the pulsed laser with spectral width less than  $1 \text{ cm}^{-1}$ .

Figure 6.14 shows the several experimental setups for realizing SBS. Figure 6.14a is a common setup. The pump light via a lens focuses into the medium and one-way passes through it to produce a backward Brillouin scattering. In order to prevent the backward SBS return to laser to affect the normal work, an optical isolator consisted of a polarizing prism and a  $\lambda/4$  wave plate is placed between the laser and the scattering medium. After the polarization plane of backward SBS light rotates  $90^\circ$ , it outputs from the polarizing prism. In the setup in Fig. 6.14b, a SBS medium is placed into an optical resonant cavity. The axis of cavity deflects a small angle respect to the pump light, it can generate a SBS light near the reverse direction ( $\theta \approx \pi$ ). The feedback of light cavity can decrease the threshold of pump light; it also can realize the tuning of frequency shift through adjusting the angle. Figure 6.14c is placing the scattering medium into a light cavity, its axis is perpendicular to the direction of pump light, a thicker pump light via a cylindrical lens from edgewise focuses into scattering medium, and produces SBS light with angle  $\theta = \pi/2$ . In Fig. 6.14d, the backward SBS light produced by the scattering medium is amplified via a laser amplifier and then outputs from a polarization lens with  $90^\circ$ -rotated polarization. This setup is frequently used for the experiment that uses a backward SBS to produce the phase conjugation light.

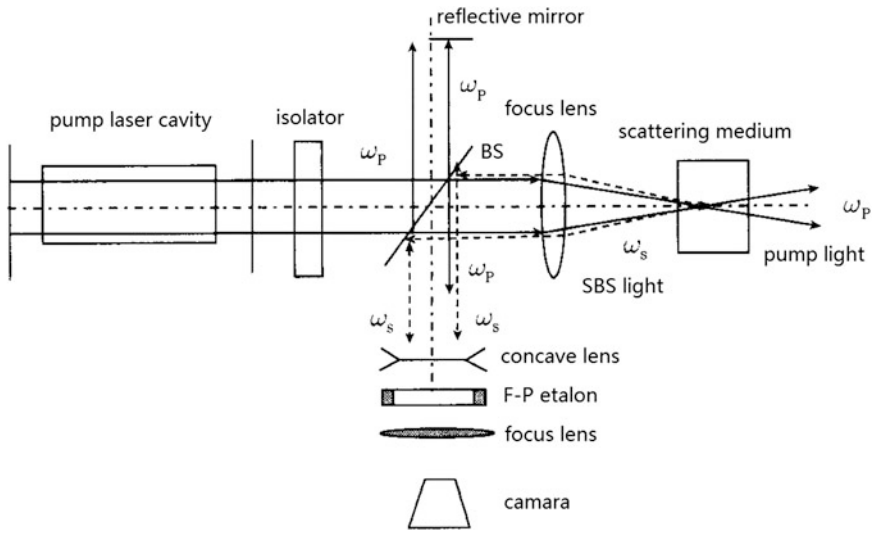
In comparison with the stimulated Raman scattering, the stimulated Brillouin scattering has smaller frequency shift, in order to measure it, except using the high resolution spectrograph, it usually uses an F-P etalon to process the spectrum



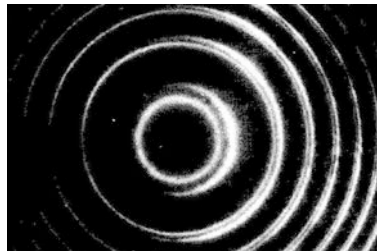


**Fig. 6.14** Experimental setups for the stimulated Raman scattering: **a** the pump light one-way passes through medium to generate a backward SBS that outputs from the side of a polarization lens; **b** the medium placed in a resonant cavity generating a near backward SBS output; **c** the medium placed in resonant cavity generating SBS outputted along  $90^\circ$  direction; **d** the backward SBS passes through a laser amplifier and outputs from side of polarization lens

photograph analysis. Figure 6.15 shows an experimental setup for measuring the frequency shift of the backward SBS light respect to the pump light by using an F-P etalon. Using a planar beam splitter with part reflectivity to make a backward SBS light beam and a half of pump light beam sampling from another plane reflector together pass through a concave lens, interference imaging on the F-P etalon respectively, to form interference ring with double ring structure. In which a group of complete ring is formed by the SBS light; another group of half ring is formed by the pump light. If know the free spectral region of the etalon, then the frequency shift of SBS can be determined from the interval between two groups of rings.



**Fig. 6.15** Experimental setup for measuring the frequency shift of backward SBS using an F-P etalon



**Fig. 6.16** The photo of the interference ring of the dimethyl-sulfoxide backward SBS light (whole ring) and the interference ring of 532 nm-pump light (half ring) taken by an F-P etalon. From the interval of two interference rings can determine the frequency shift of SBS

Figure 6.16 shows a ring-shape interference photo of the backward SBS light of the dimethyl sulfoxide liquid (whole ring) and the 532 nm-pump laser (half ring) taken on a 3 mm-thick quartz glass etalon.

### Review Questions of Chapter 6

1. Which types do light scattering has? What are origins and characteristics of these light scatterings?
2. What is the difference between the stimulated radiation scattering and the spontaneous radiation scattering?
3. Please describe the classical physical picture of the stimulated Raman scattering generation. How to determine the propagation directions of Stokes scattering

light and anti-Stokes scattering light? How to experimentally demonstrate the stimulated Raman scattering?

4. Using classical theory method to derive the formula of stimulated Raman scattering nonlinear susceptibility. Please show the frequency spectrum characteristics of the real part and imaginary part of susceptibility for Stokes scattering and anti-Stokes scattering respectively.
5. Please describe the classical physical picture of the stimulated Brillouin scattering generation. Please discuss the propagation law of the pump light, the scattering light and the acoustic wave. How to experimentally demonstrate the stimulated Brillouin scattering?
6. Using classical theory method to derive the nonlinear polarization formulae of the stimulated Brillouin Stokes scattering and anti-Stokes scattering. Please discuss their propagation directions and gains.
7. From point of view of energy and momentum conservation to discuss: what are different physical mechanisms and properties of SRS and SBS?

## References

1. G. Eckhardt, R.W. Hellwarth et al., Stimulated Raman scattering from organic liquids. *Phys. Rev. Lett.* **9**(11), 455–457 (1962)
2. E. Garmire, E. Pandarese, C.H. Townes, Coherently driven molecular vibrations and light modulation. *Phys. Rev. Lett.* **11**(4), 160–163 (1963)
3. N. Bloembergen, Y.R. Shen, Coupling between vibrations and light waves in Raman laser media. *Phys. Rev. Lett.* **12**(18), 504–507 (1964)
4. Y.R. Shen, N. Bloembergen, Theory of stimulated Brillouin and Raman scattering. *Phys. Rev.* **137**(6A), A1786–A1805 (1965)
5. R.W. Boyd, *Nonlinear Optics* (Academic Press, 1992)
6. R.Y. Chiao, C.H. Townes, B.P. Stoicheff, Stimulated Brillouin scattering and coherent generation of intense hypersonic waves. *Phys. Rev. Lett.* **12**(21), 592–595 (1964)
7. C.L. Tang, Saturation and spectral characteristics of the Stokes emission in the stimulated Brillouin process. *J. Appl. Phys.* **37**(8), 2945–2956 (1966)
8. M. Maier, Quasisteady state in the stimulated Brillouin scattering of liquids. *Phys. Rev.* **166**(1), 113–119 (1968)