

Martin Aigner · Günter M. Ziegler

Proofs from THE BOOK

Sixth Edition

 Springer

Martin Aigner
Günter M. Ziegler

Proofs from THE BOOK

Sixth Edition

Martin Aigner
Günter M. Ziegler

Proofs from **THE BOOK**

Sixth Edition

Including Illustrations by Karl H. Hofmann

 Springer

Martin Aigner
Institut für Mathematik
Freie Universität Berlin
Berlin, Germany

Günter M. Ziegler
Institut für Mathematik
Freie Universität Berlin
Berlin, Germany

ISBN 978-3-662-57264-1 ISBN 978-3-662-57265-8 (eBook)
<https://doi.org/10.1007/978-3-662-57265-8>

Library of Congress Control Number: 2018940433

© Springer-Verlag GmbH Germany, part of Springer Nature 1998, 2001, 2004, 2010, 2014, 2018
This work is subject to copyright. All rights are reserved by the Publisher, whether the whole or part of the material is concerned, specifically the rights of translation, reprinting, reuse of illustrations, recitation, broadcasting, reproduction on microfilms or in any other physical way, and transmission or information storage and retrieval, electronic adaptation, computer software, or by similar or dissimilar methodology now known or hereafter developed.

The use of general descriptive names, registered names, trademarks, service marks, etc. in this publication does not imply, even in the absence of a specific statement, that such names are exempt from the relevant protective laws and regulations and therefore free for general use.

The publisher, the authors and the editors are safe to assume that the advice and information in this book are believed to be true and accurate at the date of publication. Neither the publisher nor the authors or the editors give a warranty, express or implied, with respect to the material contained herein or for any errors or omissions that may have been made. The publisher remains neutral with regard to jurisdictional claims in published maps and institutional affiliations.

Printed on acid-free paper

This Springer imprint is published by the registered company Springer-Verlag GmbH, DE part of Springer Nature.
The registered company address is: Heidelberger Platz 3, 14197 Berlin, Germany

Preface

Paul Erdős liked to talk about The Book, in which God maintains the perfect proofs for mathematical theorems, following the dictum of G. H. Hardy that there is no permanent place for ugly mathematics. Erdős also said that you need not believe in God but, as a mathematician, you should believe in The Book. A few years ago, we suggested to him to write up a first (and very modest) approximation to The Book. He was enthusiastic about the idea and, characteristically, went to work immediately, filling page after page with his suggestions. Our book was supposed to appear in March 1998 as a present to Erdős' 85th birthday. With Paul's unfortunate death in the summer of 1996, he is not listed as a co-author. Instead this book is dedicated to his memory.

We have no definition or characterization of what constitutes a proof from The Book: all we offer here is the examples that we have selected, hoping that our readers will share our enthusiasm about brilliant ideas, clever insights and wonderful observations. We also hope that our readers will enjoy this despite the imperfections of our exposition. The selection is to a great extent influenced by Paul Erdős himself. A large number of the topics were suggested by him, and many of the proofs trace directly back to him, or were initiated by his supreme insight in asking the right question or in making the right conjecture. So to a large extent this book reflects the views of Paul Erdős as to what should be considered a proof from The Book.

A limiting factor for our selection of topics was that everything in this book is supposed to be accessible to readers whose backgrounds include only a modest amount of technique from undergraduate mathematics. A little linear algebra, some basic analysis and number theory, and a healthy dollop of elementary concepts and reasonings from discrete mathematics should be sufficient to understand and enjoy everything in this book.

We are extremely grateful to the many people who helped and supported us with this project — among them the students of a seminar where we discussed a preliminary version, to Benno Artmann, Stephan Brandt, Stefan Felsner, Eli Goodman, Torsten Heldmann, and Hans Mielke. We thank Margrit Barrett, Christian Bressler, Ewgenij Gawrilow, Michael Joswig, Elke Pose, and Jörg Rambau for their technical help in composing this book. We are in great debt to Tom Trotter who read the manuscript from first to last page, to Karl H. Hofmann for his wonderful drawings, and most of all to the late great Paul Erdős himself.

Berlin, March 1998

Martin Aigner · Günter M. Ziegler



Paul Erdős



"The Book"

Preface to the Sixth Edition

The idea to this project was born during some leisurely discussions at the Mathematisches Forschungsinstitut in Oberwolfach with the incomparable Paul Erdős in the mid-1990s. It is now nearly twenty years ago that we presented the first edition of our book on occasion of the International Congress of Mathematicians in Berlin 1998. At that time we could not possibly imagine the wonderful and lasting response our book about The Book would have, with all the warm letters, interesting comments and suggestions, new editions, and as of now thirteen translations. It is no exaggeration to say that it has become a part of our lives.

In addition to numerous improvements and smaller changes, many of them suggested by our readers, for the present sixth edition we wrote an entirely new chapter with Gurvits's proof of Van der Waerden's permanent conjecture, used this to derive asymptotics for the number of Latin squares, added a new, fourth proof for the Euler theorem $\sum_{n \geq 1} \frac{1}{n^2} = \pi^2/6$, and present a new geometric explanation for Heath-Brown's involution proof for the Fermat two squares theorem.

We thank everyone who helped and encouraged us over all these years. For the second edition this included Stephan Brandt, Christian Elsholtz, Jürgen Elstrodt, Daniel Grieser, Roger Heath-Brown, Lee L. Keener, Christian Lebœuf, Hanfried Lenz, Nicolas Puech, John Scholes, Bernulf Weißbach, and *many* others. The third edition benefitted especially from input by David Bevan, Anders Björner, Dietrich Braess, John Cosgrave, Hubert Kalf, Günter Pickert, Alistair Sinclair, and Herb Wilf. For the fourth edition, we were particularly indebted to Oliver Deiser, Anton Dochtermann, Michael Harbeck, Stefan Hougardy, Hendrik W. Lenstra, Günter Rote, Moritz W. Schmitt, and Carsten Schultz for their contributions. For the fifth edition, we gratefully acknowledged ideas and suggestions by Ian Agol, France Dacar, Christopher Deninger, Michael D. Hirschhorn, Franz Lemmermeyer, Raimund Seidel, Tord Sjödin, and John M. Sullivan, as well as help from Marie-Sophie Litz, Miriam Schlöter, and Jan Schneider. For the present sixth edition, very valuable hints were provided by France Dacar again, as well as by David Benko, Jan Peter Schäfermeyer, and Yuliya Semikina.

Moreover, we thank Ruth Allewelt at Springer in Heidelberg and Christoph Eyrich, Torsten Heldmann, and Elke Pose in Berlin for their continuing support throughout these years. And finally, this book would certainly not look the same without the original design suggested by Karl-Friedrich Koch, and the superb new drawings provided again and again by Karl H. Hofmann.

Berlin, March 2018

Martin Aigner · Günter M. Ziegler

Table of Contents

Number Theory _____ 1

- 1. Six proofs of the infinity of primes 3
- 2. Bertrand's postulate 9
- 3. Binomial coefficients are (almost) never powers 15
- 4. Representing numbers as sums of two squares 19
- 5. The law of quadratic reciprocity 27
- 6. Every finite division ring is a field 35
- 7. The spectral theorem and Hadamard's determinant problem 39
- 8. Some irrational numbers 47
- 9. Four times $\pi^2/6$ 55

Geometry _____ 65

- 10. Hilbert's third problem: decomposing polyhedra 67
- 11. Lines in the plane and decompositions of graphs 77
- 12. The slope problem 83
- 13. Three applications of Euler's formula 89
- 14. Cauchy's rigidity theorem 95
- 15. The Borromean rings don't exist 99
- 16. Touching simplices 107
- 17. Every large point set has an obtuse angle 111
- 18. Borsuk's conjecture 117

Analysis _____ 125

- 19. Sets, functions, and the continuum hypothesis 127
- 20. In praise of inequalities 143
- 21. The fundamental theorem of algebra 151
- 22. One square and an odd number of triangles 155

23. A theorem of Pólya on polynomials	163
24. Van der Waerden's permanent conjecture	169
25. On a lemma of Littlewood and Offord	179
26. Cotangent and the Herglotz trick	183
27. Buffon's needle problem	189
Combinatorics	193
28. Pigeon-hole and double counting	195
29. Tiling rectangles	207
30. Three famous theorems on finite sets	213
31. Shuffling cards	219
32. Lattice paths and determinants	229
33. Cayley's formula for the number of trees	235
34. Identities versus bijections	241
35. The finite Kakeya problem	247
36. Completing Latin squares	253
Graph Theory	259
37. Permanents and the power of entropy	261
38. The Dinitz problem	271
39. Five-coloring plane graphs	277
40. How to guard a museum	281
41. Turán's graph theorem	285
42. Communicating without errors	291
43. The chromatic number of Kneser graphs	301
44. Of friends and politicians	307
45. Probability makes counting (sometimes) easy	311
About the Illustrations	321
Index	323

Number Theory



- 1**
Six proofs
of the infinity of primes 3
- 2**
Bertrand's postulate 9
- 3**
Binomial coefficients
are (almost) never powers 15
- 4**
Representing numbers
as sums of two squares 19
- 5**
The law of
quadratic reciprocity 27
- 6**
Every finite division ring
is a field 35
- 7**
The spectral theorem
and Hadamard's
determinant problem 39
- 8**
Some irrational numbers 47
- 9**
Four times $\pi^2/6$ 55

"Irrationality and π "

Six proofs of the infinity of primes

Chapter 1



It is only natural that we start these notes with probably the oldest Book Proof, usually attributed to Euclid (*Elements IX, 20*). It shows that the sequence of primes does not end.

■ **Euclid's Proof.** For any finite set $\{p_1, \dots, p_r\}$ of primes, consider the number $n = p_1 p_2 \cdots p_r + 1$. This n has a prime divisor p . But p is not one of the p_i : otherwise p would be a divisor of n and of the product $p_1 p_2 \cdots p_r$, and thus also of the difference $n - p_1 p_2 \cdots p_r = 1$, which is impossible. So a finite set $\{p_1, \dots, p_r\}$ cannot be the collection of *all* prime numbers. \square

Before we continue let us fix some notation. $\mathbb{N} = \{1, 2, 3, \dots\}$ is the set of natural numbers, $\mathbb{Z} = \{\dots, -2, -1, 0, 1, 2, \dots\}$ the set of integers, and $\mathbb{P} = \{2, 3, 5, 7, \dots\}$ the set of primes.

In the following, we will exhibit various other proofs (out of a much longer list) which we hope the reader will like as much as we do. Although they use different view-points, the following basic idea is common to all of them: The natural numbers grow beyond all bounds, and every natural number $n \geq 2$ has a prime divisor. These two facts taken together force \mathbb{P} to be infinite. The next proof is due to Christian Goldbach (from a letter to Leonhard Euler 1730), the third proof is apparently folklore, the fourth one is by Euler himself, the fifth proof was proposed by Harry Fürstenberg, while the last proof is due to Paul Erdős.

■ **Second Proof.** Let us first look at the *Fermat numbers* $F_n = 2^{2^n} + 1$ for $n = 0, 1, 2, \dots$. We will show that any two Fermat numbers are relatively prime; hence there must be infinitely many primes. To this end, we verify the recursion

$$\prod_{k=0}^{n-1} F_k = F_n - 2 \quad (n \geq 1),$$

from which our assertion follows immediately. Indeed, if m is a divisor of, say, F_k and F_n ($k < n$), then m divides 2, and hence $m = 1$ or 2. But $m = 2$ is impossible since all Fermat numbers are odd.

To prove the recursion we use induction on n . For $n = 1$ we have $F_0 = 3$ and $F_1 - 2 = 3$. With induction we now conclude

$$\begin{aligned} \prod_{k=0}^n F_k &= \left(\prod_{k=0}^{n-1} F_k \right) F_n = (F_n - 2) F_n = \\ &= (2^{2^n} - 1)(2^{2^n} + 1) = 2^{2^{n+1}} - 1 = F_{n+1} - 2. \quad \square \end{aligned}$$

$$\begin{aligned} F_0 &= 3 \\ F_1 &= 5 \\ F_2 &= 17 \\ F_3 &= 257 \\ F_4 &= 65537 \\ F_5 &= 641 \cdot 6700417 \end{aligned}$$

The first few Fermat numbers

Lagrange's theorem

If G is a finite (multiplicative) group and U is a subgroup, then $|U|$ divides $|G|$.

■ **Proof.** Consider the binary relation

$$a \sim b : \iff ba^{-1} \in U.$$

It follows from the group axioms that \sim is an equivalence relation. The equivalence class containing an element a is precisely the coset

$$Ua = \{xa : x \in U\}.$$

Since clearly $|Ua| = |U|$, we find that G decomposes into equivalence classes, all of size $|U|$, and hence that $|U|$ divides $|G|$. □

In the special case when U is a cyclic subgroup $\{a, a^2, \dots, a^m\}$ we find that m (the smallest positive integer such that $a^m = 1$, called the *order* of a) divides the size $|G|$ of the group. In particular, we have $a^{|G|} = 1$.

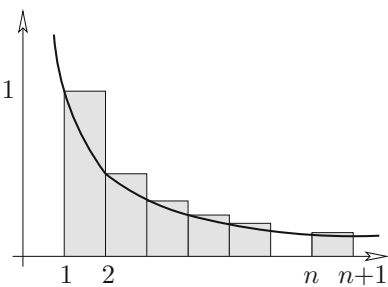

Steps above the function $f(t) = \frac{1}{t}$

■ **Third Proof.** Suppose \mathbb{P} is finite and p is the largest prime. We consider the so-called *Mersenne number* $2^p - 1$ and show that any prime factor q of $2^p - 1$ is bigger than p , which will yield the desired conclusion. Let q be a prime dividing $2^p - 1$, so we have $2^p \equiv 1 \pmod{q}$. Since p is prime, this means that the element 2 has order p in the multiplicative group $\mathbb{Z}_q \setminus \{0\}$ of the field \mathbb{Z}_q . This group has $q - 1$ elements. By Lagrange's theorem (see the box) we know that the order of every element divides the size of the group, that is, we have $p \mid q - 1$, and hence $p < q$. □

Now let us look at a proof that uses elementary calculus.

■ **Fourth Proof.** Let $\pi(x) := \#\{p \leq x : p \in \mathbb{P}\}$ be the number of primes that are less than or equal to the real number x . We number the primes $\mathbb{P} = \{p_1, p_2, p_3, \dots\}$ in increasing order. Consider the natural logarithm $\log x$, defined as $\log x = \int_1^x \frac{1}{t} dt$.

Now we compare the area below the graph of $f(t) = \frac{1}{t}$ with an upper step function. (See also the appendix on page 12 for this method.) Thus for $n \leq x < n + 1$ we have

$$\begin{aligned} \log x &\leq 1 + \frac{1}{2} + \frac{1}{3} + \dots + \frac{1}{n-1} + \frac{1}{n} \\ &\leq \sum \frac{1}{m}, \text{ where the sum extends over all } m \in \mathbb{N} \text{ which have} \\ &\quad \text{only prime divisors } p \leq x. \end{aligned}$$

Since every such m can be written in a *unique* way as a product of the form $\prod_{p \leq x} p^{k_p}$, we see that the last sum is equal to

$$\prod_{\substack{p \in \mathbb{P} \\ p \leq x}} \left(\sum_{k \geq 0} \frac{1}{p^k} \right).$$

The inner sum is a geometric series with ratio $\frac{1}{p}$, hence

$$\log x \leq \prod_{\substack{p \in \mathbb{P} \\ p \leq x}} \frac{1}{1 - \frac{1}{p}} = \prod_{\substack{p \in \mathbb{P} \\ p \leq x}} \frac{p}{p-1} = \prod_{k=1}^{\pi(x)} \frac{p_k}{p_k-1}.$$

Now clearly $p_k \geq k + 1$, and thus

$$\frac{p_k}{p_k-1} = 1 + \frac{1}{p_k-1} \leq 1 + \frac{1}{k} = \frac{k+1}{k},$$

and therefore

$$\log x \leq \prod_{k=1}^{\pi(x)} \frac{k+1}{k} = \pi(x) + 1.$$

Everybody knows that $\log x$ is not bounded, so we conclude that $\pi(x)$ is unbounded as well, and so there are infinitely many primes. □

■ **Fifth Proof.** After analysis it's topology now! Consider the following curious topology on the set \mathbb{Z} of integers. For $a, b \in \mathbb{Z}, b > 0$, we set

$$N_{a,b} = \{a + nb : n \in \mathbb{Z}\}.$$

Each set $N_{a,b}$ is a two-way infinite arithmetic progression. Now call a set $O \subseteq \mathbb{Z}$ *open* if either O is empty, or if to every $a \in O$ there exists some $b > 0$ with $N_{a,b} \subseteq O$. Clearly, the union of open sets is open again. If O_1, O_2 are open, and $a \in O_1 \cap O_2$ with $N_{a,b_1} \subseteq O_1$ and $N_{a,b_2} \subseteq O_2$, then $a \in N_{a,b_1 b_2} \subseteq O_1 \cap O_2$. So we conclude that any finite intersection of open sets is again open. So, this family of open sets induces a bona fide topology on \mathbb{Z} .

Let us note two facts:

(A) Any nonempty open set is infinite.

(B) Any set $N_{a,b}$ is closed as well.

Indeed, the first fact follows from the definition. For the second we observe

$$N_{a,b} = \mathbb{Z} \setminus \bigcup_{i=1}^{b-1} N_{a+i,b},$$

which proves that $N_{a,b}$ is the complement of an open set and hence closed.

So far the primes have not yet entered the picture — but here they come. Since any number $n \neq 1, -1$ has a prime divisor p , and hence is contained in $N_{0,p}$, we conclude

$$\mathbb{Z} \setminus \{1, -1\} = \bigcup_{p \in \mathbb{P}} N_{0,p}.$$

Now if \mathbb{P} were finite, then $\bigcup_{p \in \mathbb{P}} N_{0,p}$ would be a finite union of closed sets (by (B)), and hence closed. Consequently, $\{1, -1\}$ would be an open set, in violation of (A). \square

■ **Sixth Proof.** Our final proof goes a considerable step further and demonstrates not only that there are infinitely many primes, but also that the series $\sum_{p \in \mathbb{P}} \frac{1}{p}$ diverges. The first proof of this important result was given by Euler (and is interesting in its own right), but our proof, devised by Erdős, is of compelling beauty.

Let p_1, p_2, p_3, \dots be the sequence of primes in increasing order, and assume that $\sum_{p \in \mathbb{P}} \frac{1}{p}$ converges. Then there must be a natural number k such that $\sum_{i \geq k+1} \frac{1}{p_i} < \frac{1}{2}$. Let us call p_1, \dots, p_k the *small* primes, and p_{k+1}, p_{k+2}, \dots the *big* primes. For an arbitrary natural number N we therefore find

$$\sum_{i \geq k+1} \frac{N}{p_i} < \frac{N}{2}. \quad (1)$$



“Pitching flat rocks, infinitely”

Let N_b be the number of positive integers $n \leq N$ which are divisible by at least one big prime, and N_s the number of positive integers $n \leq N$ which have only small prime divisors. We are going to show that for a suitable N

$$N_b + N_s < N,$$

which will be our desired contradiction, since by definition $N_b + N_s$ would have to be equal to N .

To estimate N_b note that $\lfloor \frac{N}{p_i} \rfloor$ counts the positive integers $n \leq N$ which are multiples of p_i . Hence by (1) we obtain

$$N_b \leq \sum_{i \geq k+1} \left\lfloor \frac{N}{p_i} \right\rfloor < \frac{N}{2}. \quad (2)$$

Let us now look at N_s . We write every $n \leq N$ which has only small prime divisors in the form $n = a_n b_n^2$, where a_n is the square-free part. Every a_n is thus a product of *different* small primes, and we conclude that there are precisely 2^k different square-free parts. Furthermore, as $b_n \leq \sqrt{n} \leq \sqrt{N}$, we find that there are at most \sqrt{N} different square parts, and so

$$N_s \leq 2^k \sqrt{N}.$$

Since (2) holds for *any* N , it remains to find a number N with $2^k \sqrt{N} \leq \frac{N}{2}$ or $2^{k+1} \leq \sqrt{N}$, and for this $N = 2^{2k+2}$ will do. \square

Appendix: Infinitely many more proofs



Issai Schur

Our collection of proofs for the infinitude of primes contains several other old and new treasures, but there is one of very recent vintage that is quite different and deserves special mention. Let us try to identify sequences S of integers such that the set of primes \mathbb{P}_S that divide some member of S is infinite. Every such sequence would then provide its own proof for the infinity of primes. The Fermat numbers F_n studied in the second proof form such a sequence, while the powers of 2 don't. Many more examples are provided by a theorem of Issai Schur, who showed in 1912 that for every nonconstant polynomial $p(x)$ with integer coefficients the set of all nonzero values $\{p(n) \neq 0 : n \in \mathbb{N}\}$ is such a sequence. For the polynomial $p(x) = x$, Schur's result gives us Euclid's theorem. As another example, for $p(x) = x^2 + 1$ we get that the "squares plus one" contain infinitely many different prime factors.

The following result due to Christian Elsholtz is a real gem: It generalizes Schur's theorem, the proof is just clever counting, and it is in a certain sense best possible.

Let $S = (s_1, s_2, s_3, \dots)$ be a sequence of integers. We say that

- S is *almost injective* if every value occurs at most c times for some constant c ,
- S is of *subexponential growth* if $|s_n| \leq 2^{2^{f(n)}}$ for all n , where $f: \mathbb{N} \rightarrow \mathbb{R}_+$ is a function with $\frac{f(n)}{\log_2 n} \rightarrow 0$.

Theorem. *If the sequence $S = (s_1, s_2, s_3, \dots)$ is almost injective and of subexponential growth, then the set \mathbb{P}_S of primes that divide some member of S is infinite.*

■ **Proof.** We may assume that $f(n)$ is monotonely increasing. Otherwise, replace $f(n)$ by $F(n) = \max_{i \leq n} f(i)$; you can easily check that with this $F(n)$ the sequence S again satisfies the subexponential growth condition.

Let us suppose for a contradiction that $\mathbb{P}_S = \{p_1, \dots, p_k\}$ is finite. For $n \in \mathbb{N}$, let

$$s_n = \varepsilon_n p_1^{\alpha_1} \cdots p_k^{\alpha_k}, \quad \text{with } \varepsilon_n \in \{1, 0, -1\}, \alpha_i \geq 0,$$

where the $\alpha_i = \alpha_i(n)$ depend on n . (For $s_n = 0$ we can put $\alpha_i = 0$ for all i .) Then

$$2^{\alpha_1 + \cdots + \alpha_k} \leq |s_n| \leq 2^{2^{f(n)}} \quad \text{for } s_n \neq 0,$$

and thus by taking the binary logarithm

$$0 \leq \alpha_i \leq \alpha_1 + \cdots + \alpha_k \leq 2^{f(n)} \quad \text{for } 1 \leq i \leq k.$$

Hence there are not more than $2^{f(n)} + 1$ different possible values for each $\alpha_i = \alpha_i(n)$. Since f is monotone, this gives a first estimate

$$\#\{\text{distinct } |s_n| \neq 0 \text{ for } n \leq N\} \leq (2^{f(N)} + 1)^k \leq 2^{(f(N)+1)k}.$$

On the other hand, since S is almost injective only c terms in the sequence can be equal to 0, and each nonzero absolute value can occur at most $2c$ times, so we get the lower estimate

$$\#\{\text{distinct } |s_n| \neq 0 \text{ for } n \leq N\} \geq \frac{N - c}{2c}.$$

Altogether, this gives

$$\frac{N - c}{2c} \leq 2^{k(f(N)+1)}.$$

Taking again the logarithm with base 2 on both sides, we obtain

$$\log_2(N - c) - \log_2(2c) \leq k(f(N) + 1) \quad \text{for all } N.$$

This, however, is plainly false for large N , as k and c are constants, so $\frac{\log_2(N - c)}{\log_2 N}$ goes to 1 for $N \rightarrow \infty$, while $\frac{f(N)}{\log_2 N}$ goes to 0. \square

In place of 2 we could take any other base larger than 1; for example, $|s_n| \leq e^{e^{f(n)}}$ leads to the same class of sequences.

Can one relax the conditions? At least neither of them is superfluous.

That we need the “almost injective” condition can be seen from sequences S like $(2, 2, 2, \dots)$ or $(1, 2, 2, 4, 4, 4, 4, 8, \dots)$, which satisfy the growth condition, while $\mathbb{P}_S = \{2\}$ is finite.

As for the subexponential growth condition, let us remark that it cannot be weakened to a requirement of the form $\frac{f(n)}{\log_2 n} \leq \varepsilon$ for a fixed $\varepsilon > 0$. To see this, one analyzes the sequence of all numbers of the form $p_1^{\alpha_1} \cdots p_k^{\alpha_k}$ arranged in increasing order, where p_1, \dots, p_k are fixed primes and k is large. This sequence S grows roughly like $2^{2^{f(n)}}$ with $\frac{f(n)}{\log_2 n} \approx \frac{1}{k}$, while \mathbb{P}_S is finite by construction.

References

- [1] B. ARTMANN: *Euclid — The Creation of Mathematics*, Springer-Verlag, New York 1999.
- [2] C. ELSHOLTZ: *Prime divisors of thin sequences*, Amer. Math. Monthly **119** (2012), 331-333.
- [3] P. ERDŐS: *Über die Reihe $\sum \frac{1}{p}$* , Mathematica, Zutphen B **7** (1938), 1-2.
- [4] L. EULER: *Introductio in Analysin Infinitorum*, Tomus Primus, Lausanne 1748; Opera Omnia, Ser. 1, Vol. 8.
- [5] H. FÜRSTENBERG: *On the infinitude of primes*, Amer. Math. Monthly **62** (1955), 353.
- [6] I. SCHUR: *Über die Existenz unendlich vieler Primzahlen in einigen speziellen arithmetischen Progressionen*, Sitzungsberichte der Berliner Math. Gesellschaft **11** (1912), 40-50.



We have seen that the sequence of prime numbers $2, 3, 5, 7, \dots$ is infinite. To see that the size of its gaps is not bounded, let $N := 2 \cdot 3 \cdot 5 \cdots p$ denote the product of all prime numbers that are smaller than $k + 2$, and note that none of the k numbers

$$N + 2, N + 3, N + 4, \dots, N + k, N + (k + 1)$$

is prime, since for $2 \leq i \leq k + 1$ we know that i has a prime factor that is smaller than $k + 2$, and this factor also divides N , and hence also $N + i$. With this recipe, we find, for example, for $k = 10$ that none of the ten numbers

$$2312, 2313, 2314, \dots, 2321$$

is prime.

But there are also upper bounds for the gaps in the sequence of prime numbers. A famous bound states that “the gap to the next prime cannot be larger than the number we start our search at.” This is known as Bertrand's postulate, since it was conjectured and verified empirically for $n < 3\,000\,000$ by Joseph Bertrand. It was first proved for all n by Pafnuty Chebyshev in 1850. A much simpler proof was given by the Indian genius Ramanujan. Our Book Proof is by Paul Erdős: it is taken from Erdős' first published paper, which appeared in 1932, when Erdős was 19.

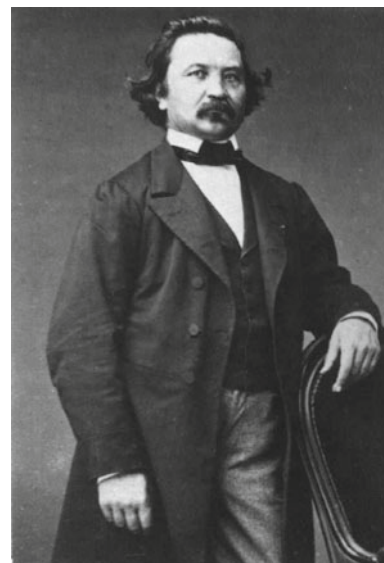

Joseph Bertrand

Bertrand's postulate

For every $n \geq 1$, there is some prime number p with $n < p \leq 2n$.

■ **Proof.** We will estimate the size of the binomial coefficient $\binom{2n}{n}$ carefully enough to see that if it didn't have any prime factors in the range $n < p \leq 2n$, then it would be “too small.” Our argument is in five steps.

(1) We first prove Bertrand's postulate for $n \leq 511$. For this one does not need to check 511 cases: it suffices (this is “Landau's trick”) to check that

$$2, 3, 5, 7, 13, 23, 43, 83, 163, 317, 521$$

is a sequence of prime numbers, where each is smaller than twice the previous one. Hence every interval $\{y : n < y \leq 2n\}$, with $n \leq 511$, contains one of these 11 primes.

Beweis eines Satzes von Tschebyschef.

Von P. ERDŐS in Budapest.

Für den zuerst von TSCHEBYSCHEF bewiesenen Satz, laut dessen es zwischen einer natürlichen Zahl und ihrer zweifachen stets wenigstens eine Primzahl gibt, liegen in der Literatur mehrere Beweise vor. Als einfachsten kann man ohne Zweifel den Beweis von RAMANUJAN¹⁾ bezeichnen. In seinem Werk *Vorlesungen über Zahlentheorie* (Leipzig, 1927), Band I, S. 66–68 gibt Herr LANDAU einen besonders einfachen Beweis für einen Satz über die Anzahl der Primzahlen unter einer gegebenen Grenze, aus welchem unmittelbar folgt, daß für ein geeignetes q zwischen einer natürlichen Zahl und ihrer q -fachen stets eine Primzahl liegt. Für die augenblicklichen Zwecke des Herrn LANDAU kommt es nicht auf die numerische Bestimmung der im Beweis auftretenden Konstanten an; man überzeugt sich aber durch eine numerische Verfolgung des Beweises leicht, daß q jedenfalls größer als 2 ausfällt.

In den folgenden Zeilen werde ich zeigen, daß man durch eine Verschärfung der dem LANDAUSCHEN Beweis zugrunde liegenden Ideen zu einem Beweis des oben erwähnten TSCHEBYSCHESCHEN Satzes gelangen kann, der — wie mir scheint — an Einfachheit nicht hinter dem RAMANUJANSCHEN Beweis steht. Griechische Buchstaben natürliche Zahlen bezeichnen; die Bezeichnung p ist für Primzahlen vorbehalten.

1. Der Binomialkoeffizient

$$\binom{2a}{a} = \frac{(2a)!}{(a!)^2}$$

¹⁾ S. RAMANUJAN, A Proof of Bertrand's Postulate, *Journal of the Indian Mathematical Society*, 11 (1919), S. 181–182 — *Collected Papers of Srinivasa Ramanujan* (Cambridge, 1927), S. 208–209.

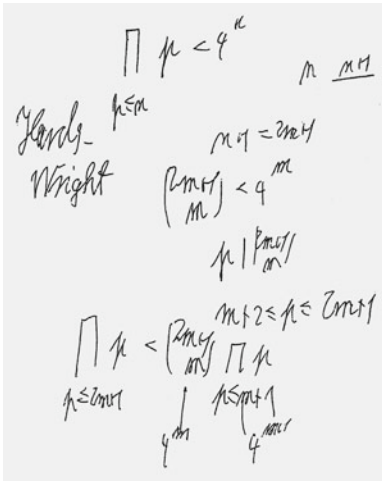

(2) Next we prove that

$$\prod_{p \leq x} p \leq 4^{x-1} \quad \text{for all real } x \geq 2, \tag{1}$$

where our notation — here and in the following — is meant to imply that the product is taken over all *prime* numbers $p \leq x$. The proof that we present for this fact uses induction on the number of these primes. It is not from Erdős' original paper, but it is also due to Erdős (see the margin), and it is a true Book Proof. First we note that if q is the largest prime with $q \leq x$, then

$$\prod_{p \leq x} p = \prod_{p \leq q} p \quad \text{and} \quad 4^{q-1} \leq 4^{x-1}.$$

Thus it suffices to check (1) for the case where $x = q$ is a prime number. For $q = 2$ we get “ $2 \leq 4$,” so we proceed to consider odd primes $q = 2m + 1$. (Here we may assume, by induction, that (1) is valid for all integers x in the set $\{2, 3, \dots, 2m\}$.) For $q = 2m + 1$ we split the product and compute

$$\prod_{p \leq 2m+1} p = \prod_{p \leq m+1} p \cdot \prod_{m+1 < p \leq 2m+1} p \leq 4^m \binom{2m+1}{m} \leq 4^m 2^{2m} = 4^{2m}.$$

All the pieces of this “one-line computation” are easy to see. In fact,

$$\prod_{p \leq m+1} p \leq 4^m$$

holds by induction. The inequality

$$\prod_{m+1 < p \leq 2m+1} p \leq \binom{2m+1}{m}$$

follows from the observation that $\binom{2m+1}{m} = \frac{(2m+1)!}{m!(m+1)!}$ is an integer, where the primes that we consider all are factors of the numerator $(2m + 1)!$, but not of the denominator $m!(m + 1)!$. Finally

$$\binom{2m+1}{m} \leq 2^{2m}$$

holds since

$$\binom{2m+1}{m} \quad \text{and} \quad \binom{2m+1}{m+1}$$

are two (equal!) summands that appear in

$$\sum_{k=0}^{2m+1} \binom{2m+1}{k} = 2^{2m+1}.$$

(3) From Legendre's theorem (see the box) we get that $\binom{2n}{n} = \frac{(2n)!}{n!n!}$ contains the prime factor p exactly

$$\sum_{k \geq 1} \left(\left\lfloor \frac{2n}{p^k} \right\rfloor - 2 \left\lfloor \frac{n}{p^k} \right\rfloor \right)$$

Legendre's theorem

The number $n!$ contains the prime factor p exactly

$$\sum_{k \geq 1} \left\lfloor \frac{n}{p^k} \right\rfloor$$

times.

■ **Proof.** Exactly $\lfloor \frac{n}{p} \rfloor$ of the factors of $n! = 1 \cdot 2 \cdot 3 \cdots n$ are divisible by p , which accounts for $\lfloor \frac{n}{p} \rfloor$ p -factors. Next, $\lfloor \frac{n}{p^2} \rfloor$ of the factors of $n!$ are even divisible by p^2 , which accounts for the next $\lfloor \frac{n}{p^2} \rfloor$ prime factors p of $n!$, etc. □

times. Here each summand is at most 1, since it satisfies

$$\left\lfloor \frac{2n}{p^k} \right\rfloor - 2 \left\lfloor \frac{n}{p^k} \right\rfloor < \frac{2n}{p^k} - 2 \left(\frac{n}{p^k} - 1 \right) = 2,$$

and it is an integer. Furthermore the summands vanish whenever $p^k > 2n$.

Thus $\binom{2n}{n}$ contains p exactly

$$\sum_{k \geq 1} \left(\left\lfloor \frac{2n}{p^k} \right\rfloor - 2 \left\lfloor \frac{n}{p^k} \right\rfloor \right) \leq \max\{r : p^r \leq 2n\}$$

times. Hence the largest power of p that divides $\binom{2n}{n}$ is not larger than $2n$.

In particular, primes $p > \sqrt{2n}$ appear at most once in $\binom{2n}{n}$.

Furthermore — and this, according to Erdős, is the key fact for his proof — primes p that satisfy $\frac{2}{3}n < p \leq n$ do not divide $\binom{2n}{n}$ at all! Indeed, $3p > 2n$ implies (for $n \geq 3$, and hence $p \geq 3$) that p and $2p$ are the only multiples of p that appear as factors in the numerator of $\frac{(2n)!}{n!n!}$, while we get two p -factors in the denominator.

(4) Now we are ready to estimate $\binom{2n}{n}$, benefitting from a suggestion by Raimund Seidel, which nicely improves Erdős' original argument. For $n \geq 3$, using an estimate from page 14 for the lower bound, we get

$$\frac{4^n}{2n} \leq \binom{2n}{n} \leq \prod_{p \leq \sqrt{2n}} 2n \cdot \prod_{\sqrt{2n} < p \leq \frac{2}{3}n} p \cdot \prod_{n < p \leq 2n} p.$$

Now, there are no more than $\sqrt{2n}$ primes in the first factor; hence using (1) for the second factor and letting $P(n)$ denote the number of primes between n and $2n$ we get

$$\frac{4^n}{2n} < ((2n)^{\sqrt{2n}}) \cdot (4^{\frac{2}{3}n}) \cdot (2n)^{P(n)},$$

that is,

$$4^{\frac{n}{3}} < (2n)^{\sqrt{2n}+1+P(n)}. \tag{2}$$

(5) Taking the logarithm to base 2, the last inequality is turned into

$$P(n) > \frac{2n}{3 \log_2(2n)} - (\sqrt{2n} + 1). \tag{3}$$

It remains to verify that the right-hand side of (3) is positive for n large enough. We show that this is the case for $n = 2^9 = 512$ (actually, it holds from $n = 468$ onward). By writing $2n - 1 = (\sqrt{2n} - 1)(\sqrt{2n} + 1)$ and cancelling the $(\sqrt{2n} + 1)$ -factor it suffices to show

$$\sqrt{2n} - 1 > 3 \log_2(2n) \quad \text{for } n \geq 2^9. \tag{4}$$

For $n = 2^9$, (4) becomes $31 > 30$, and comparing the derivatives $(\sqrt{x} - 1)' = \frac{1}{2\sqrt{x}}$ and $(3 \log_2 x)' = \frac{3}{\log 2} \frac{1}{x}$ we see that $\sqrt{x} - 1$ grows faster than $3 \log_2 x$ for $x > (\frac{6}{\log 2})^2 \approx 75$ and thus certainly for $x \geq 2^{10} = 1024$. \square

Examples such as

$$\binom{26}{13} = 2^3 \cdot 5^2 \cdot 7 \cdot 17 \cdot 19 \cdot 23$$

$$\binom{28}{14} = 2^3 \cdot 3^3 \cdot 5^2 \cdot 17 \cdot 19 \cdot 23$$

$$\binom{30}{15} = 2^4 \cdot 3^2 \cdot 5 \cdot 17 \cdot 19 \cdot 23 \cdot 29$$

illustrate that “very small” prime factors $p < \sqrt{2n}$ can appear as higher powers in $\binom{2n}{n}$, “small” primes with $\sqrt{2n} < p \leq \frac{2}{3}n$ appear at most once, while factors in the gap with $\frac{2}{3}n < p \leq n$ don't appear at all.

One can extract even more from this type of estimates: Comparing the derivatives of both sides, one can sharpen (4) to

$$\sqrt{2n} - 1 \geq \frac{21}{4} \log_2(2n) \quad \text{for } n \geq 2^{11},$$

which with a little arithmetic and (3) implies

$$P(n) \geq \frac{2}{7} \frac{n}{\log_2(2n)}.$$

This is not that bad an estimate: the “true” number of primes in this range is roughly $n/\log n$. This follows from the “prime number theorem,” which says that the limit

$$\lim_{n \rightarrow \infty} \frac{\#\{p \leq n : p \text{ is prime}\}}{n/\log n}$$

exists, and equals 1. This famous result was first proved by Hadamard and de la Vallée-Poussin in 1896; Selberg and Erdős found an elementary proof (without complex analysis tools, but still long and involved) in 1948.

On the prime number theorem itself the final word, it seems, is still not in: for example a proof of the Riemann hypothesis (see page 64), one of the major unsolved open problems in mathematics, would also give a substantial improvement for the estimates of the prime number theorem. But also for Bertrand's postulate, one could expect dramatic improvements. In fact, the following is a famous unsolved problem:

Is there always a prime between n^2 and $(n+1)^2$?

For additional information see [3, p. 19] and [4, pp. 248, 257].

Appendix: Some estimates

Estimating via integrals

There is a very simple-but-effective method of estimating sums by integrals (as already encountered on page 4). For estimating the *harmonic numbers*

$$H_n = \sum_{k=1}^n \frac{1}{k}$$

we draw the figure in the margin and derive from it

$$H_n - 1 = \sum_{k=2}^n \frac{1}{k} < \int_1^n \frac{1}{t} dt = \log n$$

by comparing the area below the graph of $f(t) = \frac{1}{t}$ ($1 \leq t \leq n$) with the area of the dark shaded rectangles, and

$$H_n - \frac{1}{n} = \sum_{k=1}^{n-1} \frac{1}{k} > \int_1^n \frac{1}{t} dt = \log n$$

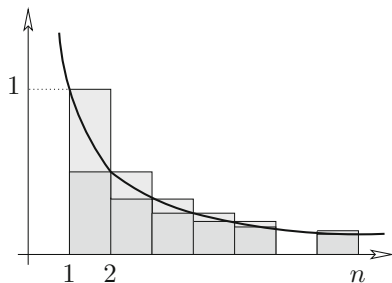

by comparing with the area of the large rectangles (including the lightly shaded parts). Taken together, this yields

$$\log n + \frac{1}{n} < H_n < \log n + 1.$$

In particular, $\lim_{n \rightarrow \infty} H_n \rightarrow \infty$, and the order of growth of H_n is given by $\lim_{n \rightarrow \infty} \frac{H_n}{\log n} = 1$. But much better estimates are known (see [2]), such as

$$H_n = \log n + \gamma + \frac{1}{2n} - \frac{1}{12n^2} + \frac{1}{120n^4} + O\left(\frac{1}{n^6}\right),$$

where $\gamma \approx 0.5772$ is "Euler's constant."

Here $O\left(\frac{1}{n^6}\right)$ denotes a function $f(n)$ such that $f(n) \leq c\frac{1}{n^6}$ holds for some constant c .

Estimating factorials — Stirling's formula

The same method applied to

$$\log(n!) = \log 2 + \log 3 + \dots + \log n = \sum_{k=2}^n \log k$$

yields

$$\log((n-1)!) < \int_1^n \log t \, dt < \log(n!),$$

where the integral is easily computed:

$$\int_1^n \log t \, dt = \left[t \log t - t \right]_1^n = n \log n - n + 1.$$

Thus we get a lower estimate on $n!$

$$n! > e^{n \log n - n + 1} = e\left(\frac{n}{e}\right)^n$$

and at the same time an upper estimate

$$n! = n(n-1)! < ne^{n \log n - n + 1} = en\left(\frac{n}{e}\right)^n.$$

Here a more careful analysis is needed to get the asymptotics of $n!$, as given by *Stirling's formula*

$$n! \sim \sqrt{2\pi n} \left(\frac{n}{e}\right)^n.$$

And again there are more precise versions available, such as

$$n! = \sqrt{2\pi n} \left(\frac{n}{e}\right)^n \left(1 + \frac{1}{12n} + \frac{1}{288n^2} - \frac{139}{5140n^3} + O\left(\frac{1}{n^4}\right)\right).$$

Here $f(n) \sim g(n)$ means that

$$\lim_{n \rightarrow \infty} \frac{f(n)}{g(n)} = 1.$$

Estimating binomial coefficients

Just from the definition of the binomial coefficients $\binom{n}{k}$ as the number of k -subsets of an n -set, we know that the sequence $\binom{n}{0}, \binom{n}{1}, \dots, \binom{n}{n}$ of binomial coefficients

$$\begin{array}{cccccccc}
 & & & & 1 & & & & \\
 & & & & 1 & & 1 & & \\
 & & & 1 & 2 & 1 & & & \\
 & & 1 & 3 & 3 & 1 & & & \\
 & 1 & 4 & 6 & 4 & 1 & & & \\
 1 & 1 & 5 & 10 & 10 & 5 & 1 & & \\
 1 & 1 & 6 & 15 & 20 & 15 & 6 & 1 & \\
 1 & 1 & 7 & 21 & 35 & 35 & 21 & 7 & 1
 \end{array}$$

Pascal's triangle

- sums to $\sum_{k=0}^n \binom{n}{k} = 2^n$

- is symmetric: $\binom{n}{k} = \binom{n}{n-k}$.

From the functional equation $\binom{n}{k} = \frac{n-k+1}{k} \binom{n}{k-1}$ one easily finds that for every n the binomial coefficients $\binom{n}{k}$ form a sequence that is symmetric and *unimodal*: it increases towards the middle, so that the middle binomial coefficients are the largest ones in the sequence:

$$1 = \binom{n}{0} < \binom{n}{1} < \dots < \binom{n}{\lfloor n/2 \rfloor} = \binom{n}{\lceil n/2 \rceil} > \dots > \binom{n}{n-1} > \binom{n}{n} = 1.$$

Here $\lfloor x \rfloor$ resp. $\lceil x \rceil$ denotes the number x rounded down resp. rounded up to the nearest integer.

From the asymptotic formulas for the factorials mentioned above one can obtain very precise estimates for the sizes of binomial coefficients. However, we will only need very weak and simple estimates in this book, such as the following: $\binom{n}{k} \leq 2^n$ for all k , while for $n \geq 2$ we have

$$\binom{n}{\lfloor n/2 \rfloor} \geq \frac{2^n}{n},$$

with equality only for $n = 2$. In particular, for $n \geq 1$,

$$\binom{2n}{n} \geq \frac{4^n}{2n}.$$

This holds since $\binom{n}{\lfloor n/2 \rfloor}$, a middle binomial coefficient, is the largest entry in the sequence $\binom{n}{0} + \binom{n}{1} + \binom{n}{2} + \dots + \binom{n}{n-1}$, whose sum is 2^n , and whose average is thus $\frac{2^n}{n}$.

On the other hand, we note the upper bound for binomial coefficients

$$\binom{n}{k} = \frac{n(n-1)\cdots(n-k+1)}{k!} \leq \frac{n^k}{k!} \leq \frac{n^k}{2^{k-1}},$$

which is a reasonably good estimate for the “small” binomial coefficients at the tails of the sequence, when n is large (compared to k).

References

- [1] P. ERDŐS: *Beweis eines Satzes von Tschebyschef*, Acta Sci. Math. (Szeged) 5 (1930-32), 194-198.
- [2] R. L. GRAHAM, D. E. KNUTH & O. PATASHNIK: *Concrete Mathematics. A Foundation for Computer Science*, Addison-Wesley, Reading MA 1989.
- [3] G. H. HARDY & E. M. WRIGHT: *An Introduction to the Theory of Numbers*, Fifth edition, Oxford University Press 1979.
- [4] P. RIBENBOIM: *The New Book of Prime Number Records*, Springer-Verlag, New York 1989.

Binomial coefficients are (almost) never powers



There is an epilogue to Bertrand's postulate which leads to a beautiful result on binomial coefficients. In 1892 Sylvester strengthened Bertrand's postulate in the following way:

If $n \geq 2k$, then at least one of the numbers $n, n-1, \dots, n-k+1$ has a prime divisor p greater than k .

Note that for $n = 2k$ we obtain precisely Bertrand's postulate. In 1934, Erdős gave a short and elementary Book Proof of Sylvester's result, running along the lines of his proof of Bertrand's postulate. There is an equivalent way of stating Sylvester's theorem:

The binomial coefficient

$$\binom{n}{k} = \frac{n(n-1)\cdots(n-k+1)}{k!} \quad (n \geq 2k)$$

always has a prime factor $p > k$.

With this observation in mind, we turn to another one of Erdős' jewels:

When is $\binom{n}{k}$ equal to a power m^ℓ ?

The case $k = \ell = 2$ leads to a classical topic. Multiplying $\binom{n}{2} = m^2$ by 8 and rearranging terms gives $(2n-1)^2 - 2(2m)^2 = 1$, which is a special case of *Pell's equation*, $x^2 - 2y^2 = 1$. One learns in number theory that this equation has infinitely many positive solutions (x_k, y_k) , which are given by $x_k + y_k\sqrt{2} = (3 + 2\sqrt{2})^k$ for $k \geq 1$. The smallest examples are $(x_1, y_1) = (3, 2)$, $(x_2, y_2) = (17, 12)$, and $(x_3, y_3) = (99, 70)$, yielding $\binom{2}{2} = 1^2$, $\binom{9}{2} = 6^2$, and $\binom{50}{2} = 35^2$.

For $k = 2$ and $\ell > 2$ there are no further solutions, and for $k = 3$ it is known that $\binom{n}{3} = m^\ell$ has the unique solution $n = 50$, $m = 140$, $\ell = 2$, see Györy [3]. But now we are at the end of the line. For $k \geq 4$ and any $\ell \geq 2$ no solutions exist, and this is what Erdős proved by an ingenious argument.

Theorem. *The equation $\binom{n}{k} = m^\ell$ has no integer solutions with $\ell \geq 2$ and $4 \leq k \leq n-4$.*

■ **Proof.** Note first that we may assume $n \geq 2k$ because of $\binom{n}{k} = \binom{n}{n-k}$. Suppose the theorem is false, and that $\binom{n}{k} = m^\ell$. The proof, by contradiction, proceeds in the following four steps.

(1) By Sylvester's theorem, there is a prime factor p of $\binom{n}{k}$ greater than k , hence p^ℓ divides $n(n-1)\cdots(n-k+1)$. Clearly, only one of the factors $n-i$ can be a multiple of any such $p > k$, and we conclude $p^\ell \mid n-i$, and therefore

$$n \geq p^\ell > k^\ell \geq k^2.$$

(2) Consider any factor $n-j$ of the numerator and write it in the form $n-j = a_j m_j^\ell$, where a_j is not divisible by any nontrivial ℓ -th power. We note by (1) that a_j has only prime divisors less than or equal to k . We want to show next that $a_i \neq a_j$ for $i \neq j$. Assume to the contrary that $a_i = a_j$ for some $i < j$. Then $m_i \geq m_j + 1$ and

$$\begin{aligned} k &> (n-i) - (n-j) = a_j(m_i^\ell - m_j^\ell) \geq a_j((m_j+1)^\ell - m_j^\ell) \\ &> a_j \ell m_j^{\ell-1} \geq \ell(a_j m_j^\ell)^{1/2} \geq \ell(n-k+1)^{1/2} \\ &\geq \ell\left(\frac{n}{2}+1\right)^{1/2} > n^{1/2}, \end{aligned}$$

which contradicts $n > k^2$ from above.

(3) Next we prove that the a_i 's are the integers $1, 2, \dots, k$ in some order. (According to Erdős, this is the crux of the proof.) Since we already know that they are all distinct, it suffices to prove that

$$a_0 a_1 \cdots a_{k-1} \text{ divides } k!.$$

Substituting $n-j = a_j m_j^\ell$ into the equation $\binom{n}{k} = m^\ell$, we obtain

$$a_0 a_1 \cdots a_{k-1} (m_0 m_1 \cdots m_{k-1})^\ell = k! m^\ell.$$

Cancelling the common factors of $m_0 \cdots m_{k-1}$ and m yields

$$a_0 a_1 \cdots a_{k-1} u^\ell = k! v^\ell$$

with $\gcd(u, v) = 1$. It remains to show that $v = 1$. If not, then v contains a prime divisor p . Since $\gcd(u, v) = 1$, p must be a prime divisor of $a_0 a_1 \cdots a_{k-1}$ and hence is less than or equal to k . By the theorem of Legendre (see page 8) we know that $k!$ contains p to the power $\sum_{i \geq 1} \lfloor \frac{k}{p^i} \rfloor$. We now estimate the exponent of p in $n(n-1)\cdots(n-k+1)$. Let i be a positive integer, and let $b_1 < b_2 < \cdots < b_s$ be the multiples of p^i among $n, n-1, \dots, n-k+1$. Then $b_s = b_1 + (s-1)p^i$ and hence

$$(s-1)p^i = b_s - b_1 \leq n - (n-k+1) = k-1,$$

which implies

$$s \leq \left\lfloor \frac{k-1}{p^i} \right\rfloor + 1 \leq \left\lfloor \frac{k}{p^i} \right\rfloor + 1.$$

So for each i the number of multiples of p^i among $n, \dots, n-k+1$, and hence among the a_j 's, is bounded by $\lfloor \frac{k}{p^i} \rfloor + 1$. This implies that the exponent of p in $a_0 a_1 \cdots a_{k-1}$ is at most

$$\sum_{i=1}^{\ell-1} \left(\left\lfloor \frac{k}{p^i} \right\rfloor + 1 \right)$$

with the reasoning that we used for Legendre's theorem in Chapter 2. The only difference is that this time the sum stops at $i = \ell - 1$, since the a_j 's contain no ℓ -th powers.

Taking both counts together, we find that the exponent of p in v^ℓ is at most

$$\sum_{i=1}^{\ell-1} \left(\left\lfloor \frac{k}{p^i} \right\rfloor + 1 \right) - \sum_{i \geq 1} \left\lfloor \frac{k}{p^i} \right\rfloor \leq \ell - 1,$$

and we have our desired contradiction, since v^ℓ is an ℓ -th power.

This suffices already to settle the case $\ell = 2$. Indeed, since $k \geq 4$ one of the a_i 's must be equal to 4, but the a_i 's contain no squares. So let us now assume that $\ell \geq 3$.

(4) Since $k \geq 4$, we must have $a_{i_1} = 1, a_{i_2} = 2, a_{i_3} = 4$ for some i_1, i_2, i_3 , that is,

$$n - i_1 = m_1^\ell, \quad n - i_2 = 2m_2^\ell, \quad n - i_3 = 4m_3^\ell.$$

We claim that $(n - i_2)^2 \neq (n - i_1)(n - i_3)$. If not, put $b = n - i_2$ and $n - i_1 = b - x, n - i_3 = b + y$, where $0 < |x|, |y| < k$. Hence

$$b^2 = (b - x)(b + y) \quad \text{or} \quad (y - x)b = xy,$$

where $x = y$ is plainly impossible. Now we have by part (1)

$$|xy| = b|y - x| \geq b > n - k > (k - 1)^2 \geq |xy|,$$

which is absurd.

So we have $m_2^2 \neq m_1 m_3$, where we assume $m_2^2 > m_1 m_3$ (the other case being analogous), and proceed to our last chains of inequalities. We obtain

$$\begin{aligned} 2(k-1)n &> n^2 - (n-k+1)^2 > (n-i_2)^2 - (n-i_1)(n-i_3) \\ &= 4[m_2^{2\ell} - (m_1 m_3)^\ell] \geq 4[(m_1 m_3 + 1)^\ell - (m_1 m_3)^\ell] \\ &\geq 4\ell m_1^{\ell-1} m_3^{\ell-1}. \end{aligned}$$

Since $\ell \geq 3$ and $n > k^\ell \geq k^3 > 6k$, this yields

$$\begin{aligned} 2(k-1)nm_1 m_3 &> 4\ell m_1^{\ell-1} m_3^{\ell-1} = \ell(n-i_1)(n-i_3) \\ &> \ell(n-k+1)^2 > 3\left(n - \frac{n}{6}\right)^2 > 2n^2. \end{aligned}$$

We see that our analysis so far agrees

with $\binom{50}{3} = 140^2$, as

$$50 = 2 \cdot 5^2$$

$$49 = 1 \cdot 7^2$$

$$48 = 3 \cdot 4^2$$

and $5 \cdot 7 \cdot 4 = 140$.

Now since $m_i \leq n^{1/\ell} \leq n^{1/3}$ we finally obtain

$$kn^{2/3} \geq km_1m_3 > (k-1)m_1m_3 > n,$$

or $k^3 > n$. With this contradiction, the proof is complete. \square

References

- [1] P. ERDŐS: *A theorem of Sylvester and Schur*, J. London Math. Soc. **9** (1934), 282-288.
- [2] P. ERDŐS: *On a diophantine equation*, J. London Math. Soc. **26** (1951), 176-178.
- [3] K. GYŐRY: *On the diophantine equation $\binom{n}{k} = x^l$* , Acta Arithmetica **80** (1997), 289-295.
- [4] J. J. SYLVESTER: *On arithmetical series*, Messenger of Math. **21** (1892), 1-19, 87-120; Collected Mathematical Papers Vol. 4, 1912, 687-731.

Representing numbers as sums of two squares

Chapter 4



Which numbers can be written as sums of two squares?

This question is as old as number theory, and its solution is a classic in the field. The “hard” part of the solution is to see that every prime number of the form $4m + 1$ is a sum of two squares. G. H. Hardy writes that this *two square theorem* of Fermat “is ranked, very justly, as one of the finest in arithmetic.” Nevertheless, one of our Book Proofs below is quite recent.

Let’s start with some “warm-ups.” First, we need to distinguish between the prime $p = 2$, the primes of the form $p = 4m + 1$, and the primes of the form $p = 4m + 3$. Every prime number belongs to exactly one of these three classes. At this point we may note (using a method “à la Euclid”) that there are infinitely many primes of the form $4m + 3$. In fact, if there were only finitely many, then we could take p_k to be the largest prime of this form. Setting

$$N_k := 2^2 \cdot 3 \cdot 5 \cdots p_k - 1$$

(where $p_1 = 2, p_2 = 3, p_3 = 5, \dots$ denotes the sequence of all primes), we find that N_k is congruent to $3 \pmod{4}$, so it must have a prime factor of the form $4m + 3$, and this prime factor is larger than p_k — contradiction.

Our first lemma characterizes the primes for which -1 is a square in the field \mathbb{Z}_p (which is reviewed in the box on the next page). It will also give us a quick way to derive that there are infinitely many primes of the form $4m + 1$.

Lemma 1. *For primes $p = 4m + 1$ the equation $s^2 \equiv -1 \pmod{p}$ has two solutions $s \in \{1, 2, \dots, p-1\}$, for $p = 2$ there is one such solution, while for primes of the form $p = 4m + 3$ there is no solution.*

■ **Proof.** For $p = 2$ take $s = 1$. For odd p , we construct the equivalence relation on $\{1, 2, \dots, p-1\}$ that is generated by identifying every element with its additive inverse and with its multiplicative inverse in \mathbb{Z}_p . Thus the “general” equivalence classes will contain four elements

$$\{x, -x, \bar{x}, -\bar{x}\}$$

since such a 4-element set contains both inverses for all its elements. However, there are smaller equivalence classes if some of the four numbers are not distinct:

$$\begin{aligned} 1 &= 1^2 + 0^2 \\ 2 &= 1^2 + 1^2 \\ 3 &= \\ 4 &= 2^2 + 0^2 \\ 5 &= 2^2 + 1^2 \\ 6 &= \\ 7 &= \\ 8 &= 2^2 + 2^2 \\ 9 &= 3^2 + \\ 10 &= 3^2 + \\ 11 &= \\ &\vdots \end{aligned}$$

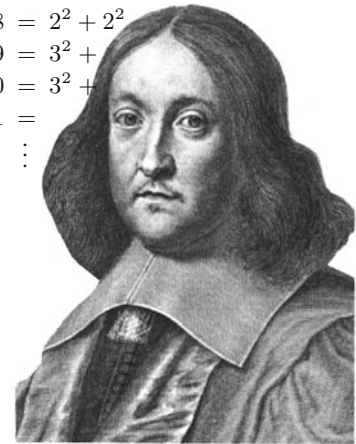

Pierre de Fermat

For $p = 11$ the partition is
 $\{1, 10\}, \{2, 9, 6, 5\}, \{3, 8, 4, 7\}$;
 for $p = 13$ it is
 $\{1, 12\}, \{2, 11, 7, 6\}, \{3, 10, 9, 4\},$
 $\{5, 8\}$: the pair $\{5, 8\}$ yields the two
 solutions of $s^2 \equiv -1 \pmod{13}$.

- $x \equiv -x$ is impossible for odd p .
- $x \equiv \bar{x}$ is equivalent to $x^2 \equiv 1$. This has two solutions, namely $x = 1$ and $x = p - 1$, leading to the equivalence class $\{1, p - 1\}$ of size 2.
- $x \equiv -\bar{x}$ is equivalent to $x^2 \equiv -1$. This equation may have no solution or two distinct solutions $x_0, p - x_0$: in this case the equivalence class is $\{x_0, p - x_0\}$.

The set $\{1, 2, \dots, p-1\}$ has $p-1$ elements, and we have partitioned it into quadruples (equivalence classes of size 4), plus one or two pairs (equivalence classes of size 2). For $p-1 = 4m+2$ we find that there is only the one pair $\{1, p-1\}$, the rest is quadruples, and thus $s^2 \equiv -1 \pmod{p}$ has no solution. For $p-1 = 4m$ there has to be the second pair, and this contains the two solutions of $s^2 \equiv -1$ that we were looking for. \square

Lemma 1 says that every odd prime dividing a number $M^2 + 1$ must be of the form $4m + 1$. This implies that there are infinitely many primes of this form: Otherwise, look at $(2 \cdot 3 \cdot 5 \cdots q_k)^2 + 1$, where q_k is the largest such prime. The same reasoning as above yields a contradiction.

Prime fields

If p is a prime, then the set $\mathbb{Z}_p = \{0, 1, \dots, p-1\}$ with addition and multiplication defined “modulo p ” forms a finite field. We will need the following simple properties:

- For $x \in \mathbb{Z}_p$, $x \neq 0$, the additive inverse (for which we usually write $-x$) is given by $p - x \in \{1, 2, \dots, p-1\}$. If $p > 2$, then x and $-x$ are different elements of \mathbb{Z}_p .
- Each $x \in \mathbb{Z}_p \setminus \{0\}$ has a unique multiplicative inverse $\bar{x} \in \mathbb{Z}_p \setminus \{0\}$, with $x\bar{x} \equiv 1 \pmod{p}$.
 The definition of primes implies that the map $\mathbb{Z}_p \rightarrow \mathbb{Z}_p$, $z \mapsto xz$ is injective for $x \neq 0$. Thus on the finite set $\mathbb{Z}_p \setminus \{0\}$ it must be surjective as well, and hence for each x there is a unique $\bar{x} \neq 0$ with $x\bar{x} \equiv 1 \pmod{p}$.
- The squares $0^2, 1^2, 2^2, \dots, h^2$ define different elements of \mathbb{Z}_p , for $h = \lfloor \frac{p}{2} \rfloor$.
 This is since $x^2 \equiv y^2$, or $(x+y)(x-y) \equiv 0$, implies that $x \equiv y$ or that $x \equiv -y$. The $1 + \lfloor \frac{p}{2} \rfloor$ elements $0^2, 1^2, \dots, h^2$ are called the *squares* in \mathbb{Z}_p .

+	0	1	2	3	4
0	0	1	2	3	4
1	1	2	3	4	0
2	2	3	4	0	1
3	3	4	0	1	2
4	4	0	1	2	3

·	0	1	2	3	4
0	0	0	0	0	0
1	0	1	2	3	4
2	0	2	4	1	3
3	0	3	1	4	2
4	0	4	3	2	1

Addition and multiplication in \mathbb{Z}_5

At this point, let us note “on the fly” that for *all* primes there are solutions for $x^2 + y^2 \equiv -1 \pmod{p}$. In fact, there are $\lfloor \frac{p}{2} \rfloor + 1$ distinct squares x^2 in \mathbb{Z}_p , and there are $\lfloor \frac{p}{2} \rfloor + 1$ distinct numbers of the form $-(1 + y^2)$. These two sets of numbers are too large to be disjoint, since \mathbb{Z}_p has only p elements, and thus there must exist x and y with $x^2 \equiv -(1 + y^2) \pmod{p}$.

Lemma 2. *No number $n = 4m + 3$ is a sum of two squares.*

■ **Proof.** The square of any even number is $(2k)^2 = 4k^2 \equiv 0 \pmod{4}$, while squares of odd numbers yield $(2k+1)^2 = 4(k^2+k)+1 \equiv 1 \pmod{4}$. Thus any sum of two squares is congruent to 0, 1 or 2 (mod 4). □

This is enough evidence for us that the primes $p = 4m + 3$ are “bad.” Thus, we proceed with “good” properties for primes of the form $p = 4m + 1$. On the way to the main theorem, the following is the key step.

Proposition. *Every prime of the form $p = 4m + 1$ is a sum of two squares, that is, it can be written as $p = x^2 + y^2$ for some natural numbers $x, y \in \mathbb{N}$.*

We shall present here two proofs of this result — both of them elegant and surprising. The first proof features a striking application of the “pigeon-hole principle” (which we have already used “on the fly” before Lemma 2; see Chapter 28 for more), as well as a clever move to arguments “modulo p ” and back. The idea is due to the Norwegian number theorist Axel Thue.

■ **Proof.** Consider the pairs (x', y') of integers with $0 \leq x', y' \leq \sqrt{p}$, that is, $x', y' \in \{0, 1, \dots, \lfloor \sqrt{p} \rfloor\}$. There are $(\lfloor \sqrt{p} \rfloor + 1)^2$ such pairs. Using the estimate $\lfloor x \rfloor + 1 > x$ for $x = \sqrt{p}$, we see that we have more than p such pairs of integers. Thus for any $s \in \mathbb{Z}$, it is impossible that all the values $x' - sy'$ produced by the pairs (x', y') are distinct modulo p . That is, for every s there are two distinct pairs

$$(x', y'), (x'', y'') \in \{0, 1, \dots, \lfloor \sqrt{p} \rfloor\}^2$$

with $x' - sy' \equiv x'' - sy'' \pmod{p}$. Now we take differences: We have $x' - x'' \equiv s(y' - y'') \pmod{p}$. Thus if we define $x := |x' - x''|$, $y := |y' - y''|$, then we get

$$(x, y) \in \{0, 1, \dots, \lfloor \sqrt{p} \rfloor\}^2 \quad \text{with} \quad x \equiv \pm sy \pmod{p}.$$

Also we know that not both x and y can be zero, because the pairs (x', y') and (x'', y'') are distinct.

Now let s be a solution of $s^2 \equiv -1 \pmod{p}$, which exists by Lemma 1. Then $x^2 \equiv s^2 y^2 \equiv -y^2 \pmod{p}$, and so we have produced

$$(x, y) \in \mathbb{Z}^2 \quad \text{with} \quad 0 < x^2 + y^2 < 2p \quad \text{and} \quad x^2 + y^2 \equiv 0 \pmod{p}.$$

But p is the only number between 0 and $2p$ that is divisible by p . Thus $x^2 + y^2 = p$: done! □

Our second proof for the proposition — also clearly a Book Proof — was discovered by Roger Heath-Brown in 1971 and appeared in 1984. (A condensed “one-sentence version” was given by Don Zagier.) It is so elementary that we don’t even need to use Lemma 1.

Heath-Brown’s argument features three linear involutions: a quite obvious one, a hidden one, and a trivial one that gives “the final blow.” The second, unexpected, involution corresponds to some hidden structure on the set of integral solutions of the equation $4xy + z^2 = p$.

For $p = 13$, $\lfloor \sqrt{p} \rfloor = 3$ we consider $x', y' \in \{0, 1, 2, 3\}$. For $s = 5$, the sum $x' - sy' \pmod{13}$ assumes the following values:

$x' \backslash y'$	0	1	2	3
0	0	8	3	11
1	1	9	4	12
2	2	10	5	0
3	3	11	6	1

■ **Proof.** We study the set

$$S := \{(x, y, z) \in \mathbb{Z}^3 : 4xy + z^2 = p, \quad x > 0, \quad y > 0\}.$$

This set is finite. Indeed, $x \geq 1$ and $y \geq 1$ implies $y \leq \frac{p}{4}$ and $x \leq \frac{p}{4}$. So there are only finitely many possible values for x and y , and given x and y , there are at most two values for z .

1. The first linear involution is given by

$$f : S \longrightarrow S, \quad (x, y, z) \longmapsto (y, x, -z),$$

that is, “interchange x and y , and negate z .” This clearly maps S to itself, and it is an *involution*: Applied twice, it yields the identity. Also, f has no fixed points, since $z = 0$ would imply $p = 4xy$, which is impossible. Furthermore, f maps the solutions in

$$T := \{(x, y, z) \in S : z > 0\}$$

to the solutions in $S \setminus T$, which satisfy $z < 0$. Also, f reverses the signs of $x - y$ and of z , so it maps the solutions in

$$U := \{(x, y, z) \in S : (x - y) + z > 0\}$$

to the solutions in $S \setminus U$. For this we have to see that there is no solution with $(x - y) + z = 0$, but there is none since this would give $p = 4xy + z^2 = 4xy + (x - y)^2 = (x + y)^2$.

What do we get from the study of f ? The main observation is that since f maps the sets T and U to their complements, it also interchanges the elements in $T \setminus U$ with these in $U \setminus T$. That is, there is the same number of solutions in U that are not in T as there are solutions in T that are not in U — so T and U have the same cardinality.

2. The second involution that we study is an involution on the set U :

$$g : U \longrightarrow U, \quad (x, y, z) \longmapsto (x - y + z, y, 2y - z).$$

First we check that indeed this is a well-defined map: If $(x, y, z) \in U$, then $x - y + z > 0, y > 0$ and $4(x - y + z)y + (2y - z)^2 = 4xy + z^2$, so $g(x, y, z) \in S$. By $(x - y + z) - y + (2y - z) = x > 0$ we find that indeed $g(x, y, z) \in U$.

Also g is an involution: $g(x, y, z) = (x - y + z, y, 2y - z)$ is mapped by g to $((x - y + z) - y + (2y - z), y, 2y - (2y - z)) = (x, y, z)$.

And finally g has exactly one fixed point:

$$(x, y, z) = g(x, y, z) = (x - y + z, y, 2y - z)$$

implies that $y = z$, but then $p = 4xy + y^2 = (4x + y)y$, which holds only for $y = z = 1$ and $x = \frac{p-1}{4}$.

But if g is an involution on U that has exactly one fixed point, then *the cardinality of U is odd*.

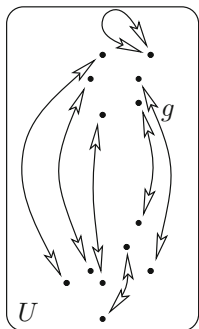
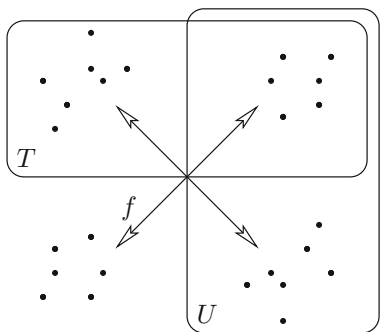

3. The third, trivial, involution that we study is the involution on T that interchanges x and y :

$$h : T \longrightarrow T, \quad (x, y, z) \longmapsto (y, x, z).$$

This map is clearly well-defined, and an involution. We combine now our knowledge derived from the other two involutions: The cardinality of T is equal to the cardinality of U , which is odd. But if h is an involution on a finite set of odd cardinality, then it *has a fixed point*: There is a point $(x, y, z) \in T$ with $x = y$, that is, a solution of

$$p = 4x^2 + z^2 = (2x)^2 + z^2. \quad \square$$

Roger Heath-Brown came up with this proof in 1971, after studying an account of Liouville’s papers on identities for parity functions. The second involution seems magical, and it was presented without an explanation how one could come up with it. There is, however, a geometric interpretation that beautifully visualizes and “explains” the involution and yields something like a “proof without words”: We will summarize it (for $p = 37$) in a full-page picture on the next page. This version of the proof was apparently found by Alexander Spivak, a Moscow mathematics teacher, who presented it in a 2007 lecture for the “Mathematics Circle” for highschool students at Moscow State University.

■ **Proof.** Again we fix a prime number $p = 4n + 1$ and consider the set of solutions

$$T = \{(x, y, z) \in \mathbb{N}^3 : 4xy + z^2 = p\}.$$

Each element of this set gives rise to a *winged square*: This is the figure consisting of a square and four rectangles in the plane that you get if you start with a square of side length z and at each vertex attach a rectangle of side-lengths x and y in a rotation-symmetric way, such that the edge of length x points away from the square, while the edge of length y runs along the side of the square.

We consider two winged squares “the same” if they are congruent. One way to make this unique, such that the representation of the winged square depends only on its boundary curve, is to require that the L formed by the two edges in the upper right-hand corner is at least as high as it is wide. If this condition is not satisfied, then a mirror image (reflected, e.g., in a vertical axis), will repair this. So each solution in T corresponds to a *unique* winged square of area $4xy + z^2 = p$, and indeed this is reversible: From each winged square we can read off a solution.

Taking the union of the square and the four rectangles, we get for each winged square what we will call a unique *winged shape*: This is a polyomino of area p with four-fold rotation symmetry, which has twelve vertices: eight convex ones with inner right angle and four non-convex ones with outer right angle. (We can’t get a square shape, since p is a prime, so it can’t be a square number.) Again we will consider winged shapes “the same” if they are congruent, so we might assume that the L shape in the upper right-hand corner is at least as high as it is wide.

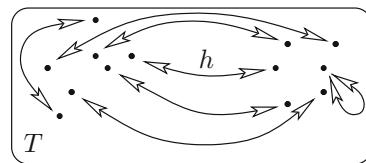

On a finite set of odd cardinality, every involution has at least one fixed point.

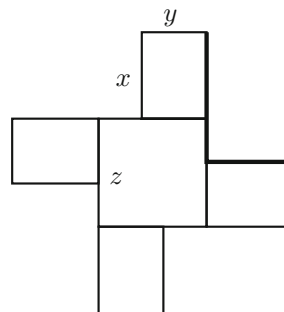

The winged square of area $4xy + z^2 = 73$ that corresponds to $(x, y, z) = (4, 3, 5)$, with the L shape highlighted ...

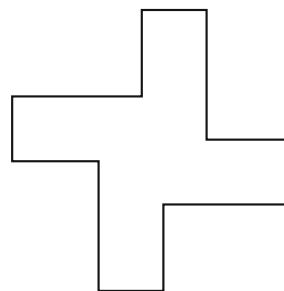

... and its winged shape.

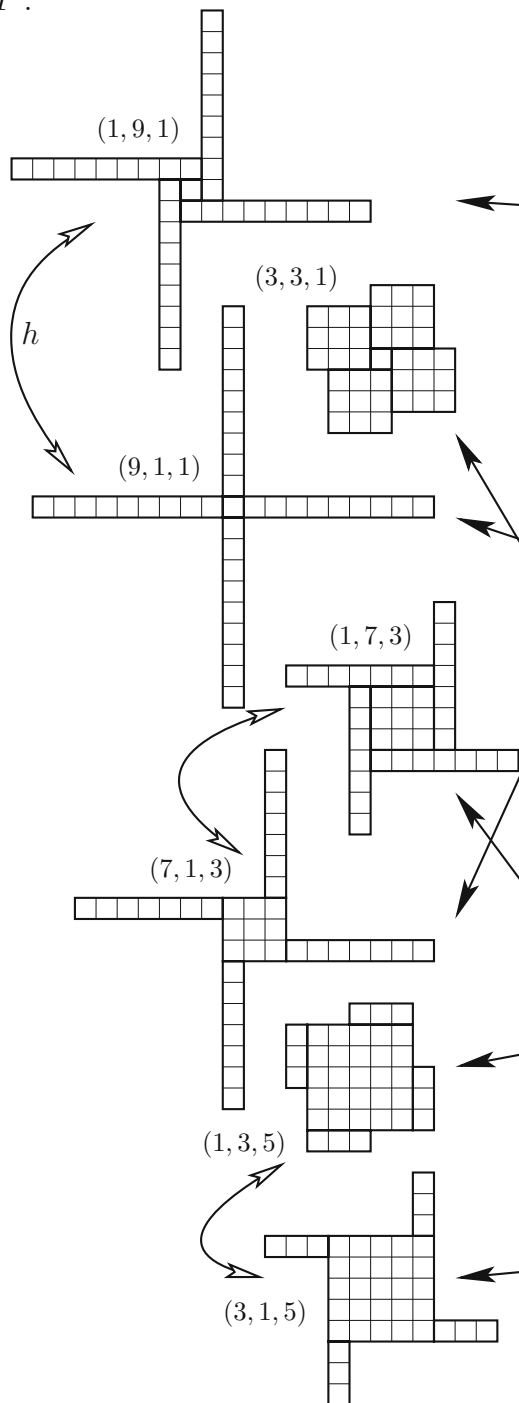
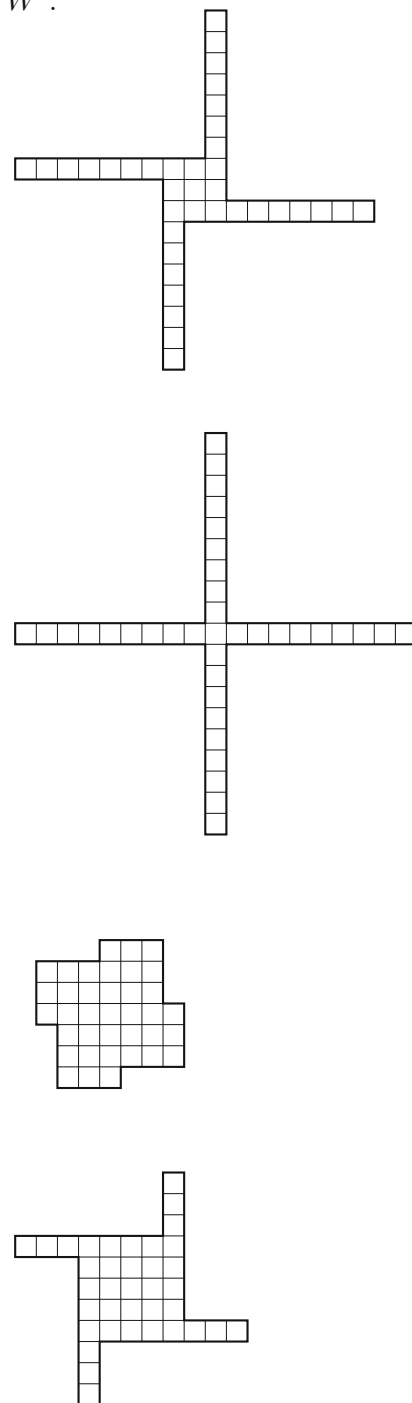
$T :$  $W :$ 

Spivak's proof, for $n = 9$ and $p = 37$, where the set T of winged squares has cardinality 7, while the set W of winged shapes has cardinality 4.

Now we are getting very close to the punch line: For each winged shape we get *either one or two* winged squares, by simultaneously drawing, in a rotation-symmetric way, vertical and horizontal lines to the interior starting at the non-convex vertices. We get *only one* solution if the shape has the symmetry of a square, that is, if the two arms of the L shapes have the same length. This happens exactly if $y = z$, but then $p = 4xz + z^2 = (4x + z)z$; assuming that p is a prime, this implies that $z = 1$ and $x = n$. In other words: Exactly one winged shape yields a single winged square, while all other winged shapes yield two winged squares each. Consequently, *the number $|T|$ of winged squares is odd.*

However, the winged squares with non-square rectangles (with $x \neq y$) come in pairs, as we can always flip the four rectangular wings between vertical and horizontal format (that is, exchange x and y). As $|T|$ is odd, this implies that there is an odd number of winged squares whose wings are squares, that is, T contains an odd number of triples (x, y, z) with $x = y$, and hence at least one, and this yields a solution to $(2x)^2 + z^2 = p$. \square

In *any* representation of $p = 4n + 1$ as a sum of two squares, one of the squares is even, the other one is odd. Thus the involution proof yields more than just that p can be written as a sum of two squares: The number of these representations in positive integers is *odd*. (The representation is actually unique, see [3].) Also note that the proofs we have presented are not effective: Try to find x and y for a ten digit prime! Efficient ways to find such representations are discussed in [1] and [8].

The following theorem completely answers the question which started this chapter.

Theorem. *A natural number n can be represented as a sum of two squares if and only if every prime factor of the form $p = 4m + 3$ appears with an even exponent in the prime decomposition of n .*

■ **Proof.** Call a number n *representable* if it is a sum of two squares, that is, if $n = x^2 + y^2$ for some $x, y \in \mathbb{N}_0$. The theorem is a consequence of the following five facts.

- (1) $1 = 1^2 + 0^2$ and $2 = 1^2 + 1^2$ are representable. Every prime of the form $p = 4m + 1$ is representable.
- (2) The product of any two representable numbers $n_1 = x_1^2 + y_1^2$ and $n_2 = x_2^2 + y_2^2$ is representable: $n_1 n_2 = (x_1 x_2 + y_1 y_2)^2 + (x_1 y_2 - x_2 y_1)^2$.
- (3) If n is representable, $n = x^2 + y^2$, then also $n z^2$ is representable, by $n z^2 = (x z)^2 + (y z)^2$.

Facts (1), (2) and (3) together yield the “if” part of the theorem.

- (4) If $p = 4m + 3$ is a prime that divides a representable number $n = x^2 + y^2$, then p divides both x and y , and thus p^2 divides n . In fact, if we had $x \not\equiv 0 \pmod{p}$, then we could find \bar{x} such that $x\bar{x} \equiv 1 \pmod{p}$, multiply the equation $x^2 + y^2 \equiv 0$ by \bar{x}^2 , and thus we would obtain that

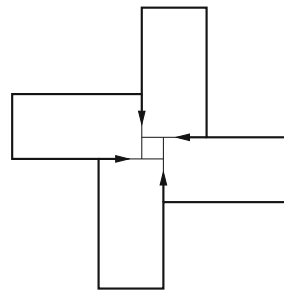

The second winged square derived from the winged shape of area 73 in the margin on page 23. It represents the solution $(6, 3, 1)$.

$1 + y^2 \bar{x}^2 = 1 + (\bar{x}y)^2 \equiv 0 \pmod{p}$, which is impossible for $p = 4m + 3$ by Lemma 1.

- (5) If n is representable, and $p = 4m + 3$ divides n , then p^2 divides n , and n/p^2 is representable. This follows from (4), and completes the proof. \square

Two remarks close our discussion:

- If a and b are two natural numbers that are relatively prime, then there are infinitely many primes of the form $am + b$ ($m \in \mathbb{N}$) — this is a famous (and difficult) theorem of Dirichlet. More precisely, one can show that the number of primes $p \leq x$ of the form $p = am + b$ is described very accurately for large x by the function $\frac{1}{\varphi(a)} \frac{x}{\log x}$, where $\varphi(a)$ denotes the number of b with $1 \leq b < a$ that are relatively prime to a . (This is a substantial refinement of the prime number theorem, which we had discussed on page 12.)
- This means that the primes for fixed a and varying b appear essentially at the same rate. Nevertheless, for example for $a = 4$ one can observe a rather subtle, but still noticeable and persistent tendency towards “more” primes of the form $4m + 3$. The difference between the counts of primes of the form $4m + 3$ and those of the form $4m + 1$ changes sign infinitely often. Nevertheless, if you look for a large random x , then chances are that there are more primes $p \leq x$ of the form $p = 4m + 3$ than of the form $p = 4m + 1$. This effect is known as “Chebyshev’s bias”; see Riesel [4] and Rubinstein and Sarnak [5].

References

- [1] F. W. CLARKE, W. N. EVERITT, L. L. LITTLEJOHN & S. J. R. VORSTER: *H. J. S. Smith and the Fermat Two Squares Theorem*, Amer. Math. Monthly **106** (1999), 652-665.
- [2] D. R. HEATH-BROWN: *Fermat’s two squares theorem*, Invariant (1984), 2-5. \LaTeX version, with appendix on history, January 2008, at eprints.maths.ox.ac.uk/677/1/invariant.pdf.
- [3] I. NIVEN & H. S. ZUCKERMAN: *An Introduction to the Theory of Numbers*, Fifth edition, Wiley, New York 1972.
- [4] H. RIESEL: *Prime Numbers and Computer Methods for Factorization*, Second edition, Progress in Mathematics **126**, Birkhäuser, Boston MA 1994.
- [5] M. RUBINSTEIN & P. SARNAK: *Chebyshev’s bias*, Experimental Mathematics **3** (1994), 173-197.
- [6] A. SPIVAK: *Winged squares* [in Russian], Lecture notes for the mathematical circle at Moscow State University, 15th lecture 2007, mmmf.msu.ru/lect/spivak/summa_sq.pdf.
- [7] A. THUE: *Et par antydninger til en taltheoretisk metode*, Kra. Vidensk. Selsk. Forh. **7** (1902), 57-75.
- [8] S. WAGON: *Editor’s corner: The Euclidean algorithm strikes again*, Amer. Math. Monthly **97** (1990), 125-129.
- [9] D. ZAGIER: *A one-sentence proof that every prime $p \equiv 1 \pmod{4}$ is a sum of two squares*, Amer. Math. Monthly **97** (1990), 144.

The law of quadratic reciprocity

Chapter 5



Which famous mathematical theorem has been proved most often? Pythagoras would certainly be a good candidate or the fundamental theorem of algebra, but the champion is without doubt the law of quadratic reciprocity in number theory. In an admirable monograph Franz Lemmermeyer lists as of the year 2000 no fewer than 196 proofs. Many of them are of course only slight variations of others, but the array of different ideas is still impressive, as is the list of contributors. Carl Friedrich Gauss gave the first complete proof in 1801 and followed up with seven more. A little later Ferdinand Gotthold Eisenstein added five more — and the ongoing list of provers reads like a Who is Who of mathematics.

With so many proofs present the question which of them belongs in the Book can have no easy answer. Is it the shortest, the most unexpected, or should one look for the proof that had the greatest potential for generalizations to other and deeper reciprocity laws? We have chosen two proofs (based on Gauss' third and sixth proofs), of which the first may be the simplest and most pleasing, while the other is the starting point for fundamental results in more general structures.

As in the previous chapter we work “modulo p ”, where p is an odd prime; \mathbb{Z}_p is the field of residues upon division by p , and we usually (but not always) take these residues as $0, 1, \dots, p-1$. Consider some $a \not\equiv 0 \pmod{p}$, that is, $p \nmid a$. We call a a *quadratic residue* modulo p if $a \equiv b^2 \pmod{p}$ for some b , and a *quadratic nonresidue* otherwise. The quadratic residues are therefore $1^2, 2^2, \dots, (\frac{p-1}{2})^2$, and so there are $\frac{p-1}{2}$ quadratic residues and $\frac{p-1}{2}$ quadratic nonresidues. Indeed, if $i^2 \equiv j^2 \pmod{p}$ with $1 \leq i, j \leq \frac{p-1}{2}$, then $p \mid i^2 - j^2 = (i-j)(i+j)$. As $2 \leq i+j \leq p-1$ we have $p \mid i-j$, that is, $i \equiv j \pmod{p}$.

At this point it is convenient to introduce the so-called *Legendre symbol*. Let $a \not\equiv 0 \pmod{p}$, then

$$\left(\frac{a}{p}\right) := \begin{cases} 1 & \text{if } a \text{ is a quadratic residue,} \\ -1 & \text{if } a \text{ is a quadratic nonresidue.} \end{cases}$$

The story begins with Fermat's “little theorem”: For $a \not\equiv 0 \pmod{p}$,

$$a^{p-1} \equiv 1 \pmod{p}. \quad (1)$$

In fact, since $\mathbb{Z}_p^* = \mathbb{Z}_p \setminus \{0\}$ is a group with multiplication, the set $\{1a, 2a, 3a, \dots, (p-1)a\}$ runs again through all nonzero residues,

$$(1a)(2a) \cdots ((p-1)a) \equiv 1 \cdot 2 \cdots (p-1) \pmod{p},$$

and hence by dividing by $(p-1)!$, we get $a^{p-1} \equiv 1 \pmod{p}$.



Carl Friedrich Gauss

For $p = 13$, the quadratic residues are $1^2 \equiv 1$, $2^2 \equiv 4$, $3^2 \equiv 9$, $4^2 \equiv 3$, $5^2 \equiv 12$, and $6^2 \equiv 10$; the nonresidues are 2, 5, 6, 7, 8, 11.

Alternatively, this is just $a^{|G|} = 1$ for the group $G = \mathbb{Z}_p^*$ (see the box on Lagrange's theorem, p. 4).

In other words, the polynomial $x^{p-1} - 1 \in \mathbb{Z}_p[x]$ has as roots all nonzero residues. Next we note that

$$x^{p-1} - 1 = (x^{\frac{p-1}{2}} - 1)(x^{\frac{p-1}{2}} + 1).$$

Suppose $a \equiv b^2 \pmod{p}$ is a quadratic residue. Then by Fermat's little theorem $a^{\frac{p-1}{2}} \equiv b^{p-1} \equiv 1 \pmod{p}$. Hence the quadratic residues are precisely the roots of the first factor $x^{\frac{p-1}{2}} - 1$, and the $\frac{p-1}{2}$ nonresidues must thus be the roots of the second factor $x^{\frac{p-1}{2}} + 1$. Comparing this to the definition of the Legendre symbol, we obtain the following important tool.

For example, for $p = 17$ and $a = 3$ we have $3^8 = (3^4)^2 = 81^2 \equiv (-4)^2 \equiv -1 \pmod{17}$, while for $a = 2$ we get $2^8 = (2^4)^2 \equiv (-1)^2 \equiv 1 \pmod{17}$. Hence 2 is a quadratic residue, while 3 is a nonresidue.

Euler's criterion. For $a \not\equiv 0 \pmod{p}$,

$$\left(\frac{a}{p}\right) \equiv a^{\frac{p-1}{2}} \pmod{p}.$$

This gives us at once the important *product rule*

$$\left(\frac{ab}{p}\right) = \left(\frac{a}{p}\right)\left(\frac{b}{p}\right), \quad (2)$$

since this obviously holds for the right-hand side of Euler's criterion. The product rule is extremely helpful when one tries to compute Legendre symbols: Since any integer is a product of ± 1 and primes we only have to compute $\left(\frac{-1}{p}\right)$, $\left(\frac{2}{p}\right)$, and $\left(\frac{q}{p}\right)$ for odd primes q .

By Euler's criterion $\left(\frac{-1}{p}\right) = 1$ if $p \equiv 1 \pmod{4}$, and $\left(\frac{-1}{p}\right) = -1$ if $p \equiv 3 \pmod{4}$, something we have already seen in the previous chapter. The case $\left(\frac{2}{p}\right)$ will follow from the Lemma of Gauss below: $\left(\frac{2}{p}\right) = 1$ if $p \equiv \pm 1 \pmod{8}$, while $\left(\frac{2}{p}\right) = -1$ if $p \equiv \pm 3 \pmod{8}$.

Euler, Legendre, and Gauss did lots of calculations with quadratic residues and, in particular, studied the relations between q being a quadratic residue modulo p and p being a quadratic residue modulo q , when p and q are odd primes. Euler and Legendre thus discovered the following remarkable theorem, but they managed to prove it only in special cases. However, Gauss was successful: On April 8, 1796 he was proud to record in his diary the first full proof.

Law of quadratic reciprocity. Let p and q be different odd primes.

Then

$$\left(\frac{q}{p}\right)\left(\frac{p}{q}\right) = (-1)^{\frac{p-1}{2}\frac{q-1}{2}}.$$

If $p \equiv 1 \pmod{4}$ or $q \equiv 1 \pmod{4}$, then $\frac{p-1}{2}$ (resp. $\frac{q-1}{2}$) is even, and therefore $(-1)^{\frac{p-1}{2}\frac{q-1}{2}} = 1$; thus $\left(\frac{q}{p}\right) = \left(\frac{p}{q}\right)$. When $p \equiv q \equiv 3 \pmod{4}$, we have $\left(\frac{p}{q}\right) = -\left(\frac{q}{p}\right)$. Thus for odd primes we get $\left(\frac{p}{q}\right) = \left(\frac{q}{p}\right)$ unless both p and q are congruent to 3 (mod 4).

Example: $\left(\frac{3}{17}\right) = \left(\frac{17}{3}\right) = \left(\frac{2}{3}\right) = -1$, so 3 is a nonresidue mod 17.

First proof. The key to our first proof (which is Gauss' third) is a counting formula that soon came to be called the *Lemma of Gauss*:

Lemma of Gauss. Suppose $a \not\equiv 0 \pmod{p}$. Take the numbers $1a, 2a, \dots, \frac{p-1}{2}a$ and reduce them modulo p to the residue system smallest in absolute value, $ia \equiv r_i \pmod{p}$ with $-\frac{p-1}{2} \leq r_i \leq \frac{p-1}{2}$ for all i . Then

$$\left(\frac{a}{p}\right) = (-1)^s, \text{ where } s = \#\{i : r_i < 0\}.$$

■ **Proof.** Suppose u_1, \dots, u_s are the residues smaller than 0, and that $v_1, \dots, v_{\frac{p-1}{2}-s}$ are those greater than 0. Then the numbers $-u_1, \dots, -u_s$ are between 1 and $\frac{p-1}{2}$, and are all different from the v_j s (see the margin); hence $\{-u_1, \dots, -u_s, v_1, \dots, v_{\frac{p-1}{2}-s}\} = \{1, 2, \dots, \frac{p-1}{2}\}$. Therefore

$$\prod_i (-u_i) \prod_j v_j = \frac{p-1}{2}!,$$

which implies

$$(-1)^s \prod_i u_i \prod_j v_j \equiv \frac{p-1}{2}! \pmod{p}.$$

Now remember how we obtained the numbers u_i and v_j ; they are the residues of $1a, \dots, \frac{p-1}{2}a$. Hence

$$\frac{p-1}{2}! \equiv (-1)^s \prod_i u_i \prod_j v_j \equiv (-1)^s \frac{p-1}{2}! a^{\frac{p-1}{2}} \pmod{p}.$$

Cancelling $\frac{p-1}{2}!$ together with Euler's criterion gives

$$\left(\frac{a}{p}\right) \equiv a^{\frac{p-1}{2}} \equiv (-1)^s \pmod{p},$$

and therefore $\left(\frac{a}{p}\right) = (-1)^s$, since p is odd. □

With this we can easily compute $\left(\frac{2}{p}\right)$: Since $1 \cdot 2, 2 \cdot 2, \dots, \frac{p-1}{2} \cdot 2$ are all between 1 and $p-1$, we have

$$s = \#\{i : \frac{p-1}{2} < 2i \leq p-1\} = \frac{p-1}{2} - \#\{i : 2i \leq \frac{p-1}{2}\} = \lceil \frac{p-1}{4} \rceil.$$

Check that s is even precisely for $p = 8k \pm 1$.

The Lemma of Gauss is the basis for many of the published proofs of the quadratic reciprocity law. The most elegant may be the one suggested by Ferdinand Gotthold Eisenstein, who had learned number theory from Gauss' famous *Disquisitiones Arithmeticae* and made important contributions to "higher reciprocity theorems" before his premature death at age 29. His proof is just counting lattice points!

If $-u_i = v_j$, then $u_i + v_j \equiv 0 \pmod{p}$. Now $u_i \equiv ka, v_j \equiv la \pmod{p}$ implies $p \mid (k+l)a$. As p and a are relatively prime, p must divide $k+l$ which is impossible, since $k+l \leq p-1$.

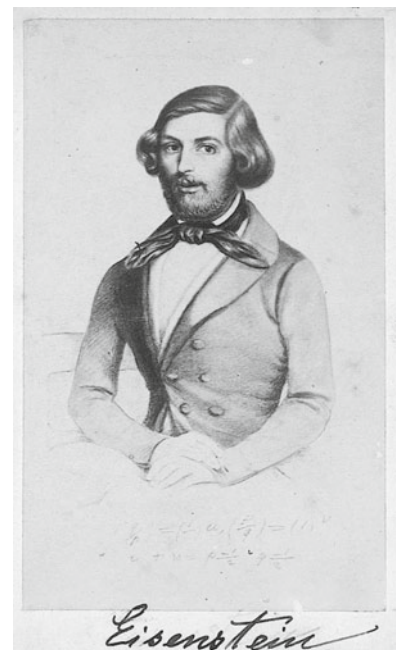

Let p and q be odd primes, and consider $\left(\frac{q}{p}\right)$. Suppose iq is a multiple of q that reduces to a negative residue $r_i < 0$ in the Lemma of Gauss. This means that there is a unique integer j such that $-\frac{p}{2} < iq - jp < 0$. Note that $0 < j < \frac{q}{2}$ since $0 < i < \frac{p}{2}$. In other words, $\left(\frac{q}{p}\right) = (-1)^s$, where s is the number of lattice points (x, y) , that is, pairs of integers x, y satisfying

$$0 < py - qx < \frac{p}{2}, \quad 0 < x < \frac{p}{2}, \quad 0 < y < \frac{q}{2}. \quad (3)$$

Similarly, $\left(\frac{p}{q}\right) = (-1)^t$ where t is the number of lattice points (x, y) with

$$0 < qx - py < \frac{q}{2}, \quad 0 < x < \frac{p}{2}, \quad 0 < y < \frac{q}{2}. \quad (4)$$

Now look at the rectangle with side lengths $\frac{p}{2}, \frac{q}{2}$, and draw the two lines parallel to the diagonal $py = qx$, $y = \frac{q}{p}x + \frac{1}{2}$ or $py - qx = \frac{p}{2}$, respectively, $y = \frac{q}{p}(x - \frac{1}{2})$ or $qx - py = \frac{q}{2}$.

The figure shows the situation for $p = 17, q = 11$.

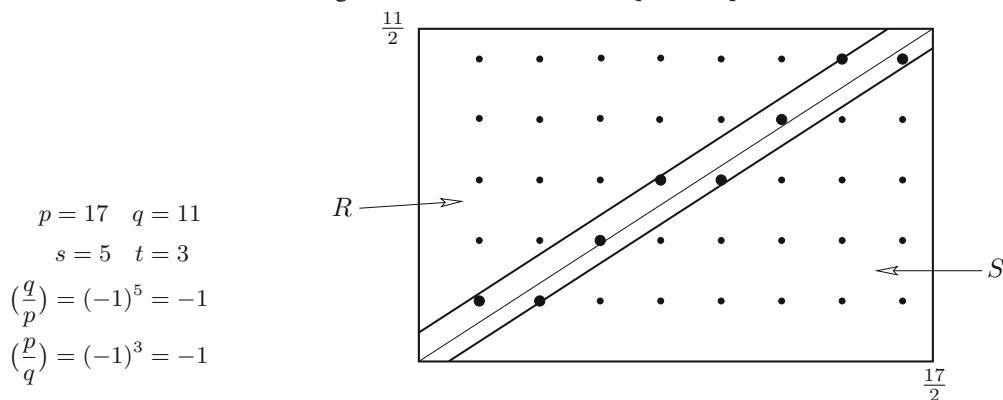

The proof is now quickly completed by the following three observations:

1. There are no lattice points on the diagonal and the two parallels. This is so because $py = qx$ would imply $p|x$, which cannot be. For the parallels observe that $py - qx$ is an integer while $\frac{p}{2}$ and $\frac{q}{2}$ are not.
2. The lattice points observing (3) are precisely the points in the upper strip $0 < py - qx < \frac{p}{2}$, and those of (4) the points in the lower strip $0 < qx - py < \frac{q}{2}$. Hence the number of lattice points in the two strips is $s + t$.
3. The outer regions $R : py - qx > \frac{p}{2}$ and $S : qx - py > \frac{q}{2}$ contain the same number of points. To see this consider the map $\varphi : R \rightarrow S$ which maps (x, y) to $(\frac{p+1}{2} - x, \frac{q+1}{2} - y)$ and check that φ is an involution.

Since the total number of lattice points in the rectangle is $\frac{p-1}{2} \cdot \frac{q-1}{2}$, we infer that $s + t$ and $\frac{p-1}{2} \cdot \frac{q-1}{2}$ have the same parity, and so

$$\left(\frac{q}{p}\right)\left(\frac{p}{q}\right) = (-1)^{s+t} = (-1)^{\frac{p-1}{2} \cdot \frac{q-1}{2}}. \quad \square$$

Second proof. Our second choice does not use Gauss' lemma, instead it employs so-called "Gauss sums" in finite fields. Gauss invented them in his study of the equation $x^p - 1 = 0$ and the arithmetical properties of the field $\mathbb{Q}(\zeta)$ (called cyclotomic field), where ζ is a p -th root of unity. They have been the starting point for the search for higher reciprocity laws in general number fields.

Let us first collect a few facts about finite fields.

A. Let p and q be different odd primes, and consider the finite field F with q^{p-1} elements. Its prime field is \mathbb{Z}_q , whence $qa = 0$ for any $a \in F$. This implies that $(a + b)^q = a^q + b^q$, since any binomial coefficient $\binom{q}{i}$ is a multiple of q for $0 < i < q$, and thus 0 in F . Note that Euler's criterion is an equation $\left(\frac{p}{q}\right) = p^{\frac{q-1}{2}}$ in the prime field \mathbb{Z}_q .

B. The multiplicative group $F^* = F \setminus \{0\}$ is cyclic of size $q^{p-1} - 1$ (see the box on the next page). Since by Fermat's little theorem p is a divisor of $q^{p-1} - 1$, there exists an element $\zeta \in F$ of order p , that is, $\zeta^p = 1$, and ζ generates the subgroup $\{\zeta, \zeta^2, \dots, \zeta^p = 1\}$ of F^* . Note that any ζ^i ($i \neq p$) is again a generator. Hence we obtain the polynomial decomposition $x^p - 1 = (x - \zeta)(x - \zeta^2) \cdots (x - \zeta^p)$.

Now we can go to work. Consider the *Gauss sum*

$$G := \sum_{i=1}^{p-1} \binom{i}{p} \zeta^i \in F,$$

where $\binom{i}{p}$ is the Legendre symbol. For the proof we derive two different expressions for G^q and then set them equal.

First expression. We have

$$G^q = \sum_{i=1}^{p-1} \binom{i}{p}^q \zeta^{iq} = \sum_{i=1}^{p-1} \binom{i}{p} \zeta^{iq} = \left(\frac{q}{p}\right) \sum_{i=1}^{p-1} \binom{iq}{p} \zeta^{iq} = \left(\frac{q}{p}\right) G, \quad (5)$$

where the first equality follows from $(a + b)^q = a^q + b^q$, the second uses that $\left(\frac{i}{p}\right)^q = \binom{i}{p}$ since q is odd, the third one is derived from (2), which yields $\binom{i}{p} = \left(\frac{q}{p}\right) \binom{iq}{p}$, and the last one holds since iq runs with i through all nonzero residues modulo p .

Example: Take $p = 3$, $q = 5$. Then $G = \zeta - \zeta^2$ and $G^5 = \zeta^5 - \zeta^{10} = \zeta^2 - \zeta = -(\zeta - \zeta^2) = -G$, corresponding to $\left(\frac{5}{3}\right) = \left(\frac{2}{3}\right) = -1$.

Second expression. Suppose we can prove

$$G^2 = (-1)^{\frac{p-1}{2}} p, \quad (6)$$

then we are quickly done. Indeed,

$$G^q = G(G^2)^{\frac{q-1}{2}} = G(-1)^{\frac{p-1}{2} \frac{q-1}{2}} p^{\frac{q-1}{2}} = G \left(\frac{p}{q}\right) (-1)^{\frac{p-1}{2} \frac{q-1}{2}}. \quad (7)$$

Equating the expressions in (5) and (7) and cancelling G , which is nonzero by (6), we find $\left(\frac{q}{p}\right) = \left(\frac{p}{q}\right) (-1)^{\frac{p-1}{2} \frac{q-1}{2}}$, and thus

$$\left(\frac{q}{p}\right) \left(\frac{p}{q}\right) = (-1)^{\frac{p-1}{2} \frac{q-1}{2}}.$$

The multiplicative group of a finite field is cyclic

Let F^* be the multiplicative group of the field F , with $|F^*| = n$. Writing $\text{ord}(a)$ for the order of an element, that is, the smallest positive integer k such that $a^k = 1$, we want to find an element $a \in F^*$ with $\text{ord}(a) = n$. If $\text{ord}(b) = d$, then by Lagrange's theorem, d divides n (see the margin on page 4). Classifying the elements according to their order, we have

$$n = \sum_{d|n} \psi(d), \text{ where } \psi(d) = \#\{b \in F^* : \text{ord}(b) = d\}. \quad (8)$$

If $\text{ord}(b) = d$, then every element b^i ($i = 1, \dots, d$) satisfies $(b^i)^d = 1$ and is therefore a root of the polynomial $x^d - 1$. But, since F is a field, $x^d - 1$ has at most d roots, and so the elements $b, b^2, \dots, b^d = 1$ are precisely these roots. In particular, every element of order d is of the form b^i .

On the other hand, it is easily checked that $\text{ord}(b^i) = \frac{d}{(i,d)}$, where (i,d) denotes the greatest common divisor of i and d . Hence $\text{ord}(b^i) = d$ if and only if $(i,d) = 1$, that is, if i and d are relatively prime. Denoting Euler's function by $\varphi(d) = \#\{i : 1 \leq i \leq d, (i,d) = 1\}$, we thus have $\psi(d) = \varphi(d)$ whenever $\psi(d) > 0$. Looking at (8) we find

$$n = \sum_{d|n} \psi(d) \leq \sum_{d|n} \varphi(d).$$

But, as we are going to show that

$$\sum_{d|n} \varphi(d) = n, \quad (9)$$

we must have $\psi(d) = \varphi(d)$ for all d . In particular, $\psi(n) = \varphi(n) \geq 1$, and so there is an element of order n .

The following (folklore) proof of (9) belongs in the Book as well. Consider the n fractions

$$\frac{1}{n}, \frac{2}{n}, \dots, \frac{k}{n}, \dots, \frac{n}{n},$$

reduce them to lowest terms $\frac{k}{n} = \frac{i}{d}$ with $1 \leq i \leq d$, $(i,d) = 1$, $d|n$, and check that the denominator d appears precisely $\varphi(d)$ times.

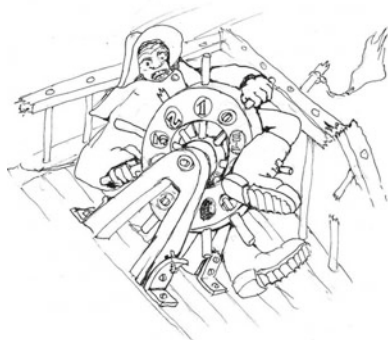

“Even in total chaos
we can hang on
to the cyclic group”

It remains to verify (6), and for this we first make two simple observations:

- $\sum_{i=1}^p \zeta^i = 0$ and thus $\sum_{i=1}^{p-1} \zeta^i = -1$. Just note that $-\sum_{i=1}^p \zeta^i$ is the coefficient of x^{p-1} in $x^p - 1 = \prod_{i=1}^p (x - \zeta^i)$, and thus 0.
- $\sum_{k=1}^{p-1} \binom{k}{p} = 0$ and thus $\sum_{k=1}^{p-2} \binom{k}{p} = -\binom{-1}{p}$, since there are equally many quadratic residues and nonresidues.

We have

$$G^2 = \left(\sum_{i=1}^{p-1} \left(\frac{i}{p}\right) \zeta^i \right) \left(\sum_{j=1}^{p-1} \left(\frac{j}{p}\right) \zeta^j \right) = \sum_{i,j} \left(\frac{ij}{p}\right) \zeta^{i+j}.$$

Setting $j \equiv ik \pmod{p}$ we find

$$G^2 = \sum_{i,k} \left(\frac{k}{p}\right) \zeta^{i(1+k)} = \sum_{k=1}^{p-1} \left(\frac{k}{p}\right) \sum_{i=1}^{p-1} \zeta^{(1+k)i}.$$

For $k = p-1 \equiv -1 \pmod{p}$ this gives $\left(\frac{-1}{p}\right)(p-1)$, since $\zeta^{1+k} = 1$. Move $k = p-1$ in front and write

$$G^2 = \left(\frac{-1}{p}\right)(p-1) + \sum_{k=1}^{p-2} \left(\frac{k}{p}\right) \sum_{i=1}^{p-1} \zeta^{(1+k)i}.$$

Euler's criterion: $\left(\frac{-1}{p}\right) = (-1)^{\frac{p-1}{2}}$

Since ζ^{1+k} is a generator of the group for $k \neq p-1$, the inner sum equals $\sum_{i=1}^{p-1} \zeta^i = -1$ for all $k \neq p-1$ by our first observation. Hence the second summand is $-\sum_{k=1}^{p-2} \left(\frac{k}{p}\right) = \left(\frac{-1}{p}\right)$ by our second observation. It follows that $G^2 = \left(\frac{-1}{p}\right)p$ and thus with Euler's criterion $G^2 = (-1)^{\frac{p-1}{2}}p$, which completes the proof. \square

For $p = 3, q = 5, G^2 = (\zeta - \zeta^2)^2 = \zeta^2 - 2\zeta^3 + \zeta^4 = \zeta^2 - 2 + \zeta = -3 = (-1)^{\frac{3-1}{2}}3$, since $1 + \zeta + \zeta^2 = 0$.

References

- [1] A. BAKER: *A Concise Introduction to the Theory of Numbers*, Cambridge University Press, Cambridge 1984.
- [2] F. G. EISENSTEIN: *Geometrischer Beweis des Fundamentaltheorems für die quadratischen Reste*, J. Reine Angewandte Mathematik **28** (1844), 186-191.
- [3] C. F. GAUSS: *Theorema arithmetici demonstratio nova*, Comment. Soc. regiae sci. Göttingen **XVI** (1808), 69; Werke II, 1-8 (contains the 3rd proof).
- [4] C. F. GAUSS: *Theorematis fundamentalis in doctrina de residuis quadraticis demonstrationes et amplicationes novae (1818)*, Werke II, 47-64 (contains the 6th proof).
- [5] F. LEMMERMEYER: *Reciprocity Laws*, Springer-Verlag, Berlin 2000.



“What’s up?”

*“I’m pushing 196 proofs
for quadratic reciprocity”*

Every finite division ring is a field

Chapter 6



Rings are important structures in modern algebra. If a ring R has a multiplicative unit element 1 and every nonzero element has a multiplicative inverse, then R is called a *division ring*. So, all that is missing in R from being a field is the commutativity of multiplication. The best-known example of a noncommutative division ring is the ring of quaternions discovered by Hamilton. But, as the chapter title says, every such division ring must of necessity be infinite. If R is finite, then the axioms force the multiplication to be commutative.

This result which is now a classic has caught the imagination of many mathematicians, because, as Herstein writes: “It is so unexpectedly interrelating two seemingly unrelated things, the number of elements in a certain algebraic system and the multiplication of that system.”

Theorem. *Every finite division ring is commutative.*

This beautiful theorem which is usually attributed to MacLagan Wedderburn has been proved by many people using a variety of different ideas. Wedderburn himself gave three proofs in 1905, and another proof was given by Leonard E. Dickson in the same year. More proofs were later given by Emil Artin, Hans Zassenhaus, Nicolas Bourbaki, and many others. One proof stands out for its simplicity and elegance. It was found by Ernst Witt in 1931 and combines two elementary ideas towards a glorious finish.

■ **Proof.** Our first ingredient comes from a blend of linear algebra and basic group theory. For an arbitrary element $s \in R$, let C_s be the set $\{x \in R : xs = sx\}$ of elements which commute with s ; C_s is called the *centralizer* of s . Clearly, C_s contains 0 and 1 and is a sub-division ring of R . The *center* Z is the set of elements which commute with all elements of R , thus $Z = \bigcap_{s \in R} C_s$. In particular, all elements of Z commute, 0 and 1 are in Z , and so Z is a *finite field*. Let us set $|Z| = q$.

We can regard R and C_s as vector spaces over the field Z and deduce that $|R| = q^n$, where n is the dimension of the vector space R over Z , and similarly $|C_s| = q^{n_s}$ for suitable integers $n_s \geq 1$.

Now let us assume that R is not a field. This means that for *some* $s \in R$ the centralizer C_s is not all of R , or, what is the same, $n_s < n$.

On the set $R^* := R \setminus \{0\}$ we consider the relation

$$r' \sim r \quad :\Leftrightarrow \quad r' = x^{-1}rx \quad \text{for some } x \in R^*.$$



Ernst Witt

It is easy to check that \sim is an equivalence relation. Let

$$A_s := \{x^{-1}sx : x \in R^*\}$$

be the equivalence class containing s . We note that $|A_s| = 1$ precisely when s is in the center Z . So by our assumption, there are classes A_s with $|A_s| \geq 2$. Consider now for $s \in R^*$ the map $f_s : x \mapsto x^{-1}sx$ from R^* onto A_s . For $x, y \in R^*$ we find

$$\begin{aligned} x^{-1}sx = y^{-1}sy &\iff (yx^{-1})s = s(yx^{-1}) \\ &\iff yx^{-1} \in C_s^* \iff y \in C_s^*x, \end{aligned}$$

for $C_s^* := C_s \setminus \{0\}$, where $C_s^*x = \{zx : z \in C_s^*\}$ has size $|C_s^*|$. Hence any element $x^{-1}sx$ is the image of precisely $|C_s^*| = q^{n_s} - 1$ elements in R^* under the map f_s , and we deduce $|R^*| = |A_s| |C_s^*|$. In particular, we note that

$$\frac{|R^*|}{|C_s^*|} = \frac{q^n - 1}{q^{n_s} - 1} = |A_s| \quad \text{is an integer for all } s.$$

We know that the equivalence classes partition R^* . We now group the central elements Z^* together and denote by A_1, \dots, A_t the equivalence classes containing more than one element. By our assumption we know $t \geq 1$. Since $|R^*| = |Z^*| + \sum_{k=1}^t |A_k|$, we have proved the so-called *class formula*

$$q^n - 1 = q - 1 + \sum_{k=1}^t \frac{q^n - 1}{q^{n_k} - 1}, \quad (1)$$

where we have $1 < \frac{q^n - 1}{q^{n_k} - 1} \in \mathbb{N}$ for all k .

With (1) we have left abstract algebra and are back to the natural numbers. Next we claim that $q^{n_k} - 1 \mid q^n - 1$ implies $n_k \mid n$. Indeed, write $n = an_k + r$ with $0 \leq r < n_k$, then $q^{n_k} - 1 \mid q^{an_k+r} - 1$ implies

$$q^{n_k} - 1 \mid (q^{an_k+r} - 1) - (q^{n_k} - 1) = q^{n_k}(q^{(a-1)n_k+r} - 1),$$

and thus $q^{n_k} - 1 \mid q^{(a-1)n_k+r} - 1$, since q^{n_k} and $q^{n_k} - 1$ are relatively prime. Continuing in this way we find $q^{n_k} - 1 \mid q^r - 1$ with $0 \leq r < n_k$, which is only possible for $r = 0$, that is, $n_k \mid n$. In summary, we note

$$n_k \mid n \quad \text{for all } k. \quad (2)$$

Now comes the second ingredient: the complex numbers \mathbb{C} . Consider the polynomial $x^n - 1$. Its roots in \mathbb{C} are called the *n-th roots of unity*. Since $\lambda^n = 1$, all these roots λ have $|\lambda| = 1$ and lie therefore on the unit circle of the complex plane. In fact, they are precisely the numbers $\lambda_k = e^{\frac{2k\pi i}{n}} = \cos(2k\pi/n) + i \sin(2k\pi/n)$, $0 \leq k \leq n - 1$ (see the box on the next page). Some of the roots λ satisfy $\lambda^d = 1$ for $d < n$; for example, the root $\lambda = -1$ satisfies $\lambda^2 = 1$. For a root λ , let d be the smallest positive exponent with $\lambda^d = 1$, that is, d is the order of λ in the group of the roots of unity. Then $d \mid n$, by Lagrange's theorem ("the order of every element of

a group divides the order of the group” — see the box in Chapter 1). Note that there are roots of order n , such as $\lambda_1 = e^{\frac{2\pi i}{n}}$.

Roots of unity

Any complex number $z = x + iy$ may be written in the “polar” form

$$z = re^{i\varphi} = r(\cos \varphi + i \sin \varphi),$$

where $r = |z| = \sqrt{x^2 + y^2}$ is the distance of z to the origin, and φ is the angle measured from the positive x -axis. The n -th roots of unity are therefore of the form

$$\lambda_k = e^{\frac{2k\pi i}{n}} = \cos(2k\pi/n) + i \sin(2k\pi/n), \quad 0 \leq k \leq n-1,$$

since for all k

$$\lambda_k^n = e^{2k\pi i} = \cos(2k\pi) + i \sin(2k\pi) = 1.$$

We obtain these roots geometrically by inscribing a regular n -gon into the unit circle. Note that $\lambda_k = \zeta^k$ for all k , where $\zeta = e^{\frac{2\pi i}{n}}$. Thus the n -th roots of unity form a cyclic group $\{\zeta, \zeta^2, \dots, \zeta^{n-1}, \zeta^n = 1\}$ of order n .

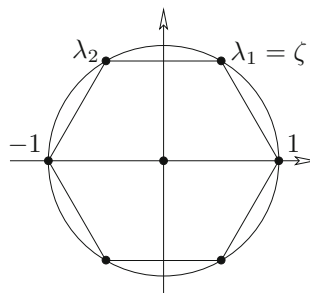
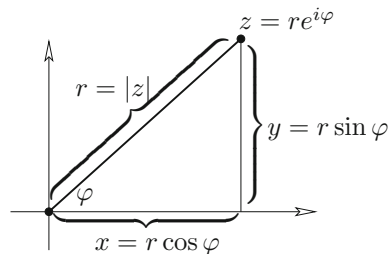

The roots of unity for $n = 6$

Now we group all roots of order d together and set

$$\phi_d(x) := \prod_{\lambda \text{ of order } d} (x - \lambda).$$

Note that the definition of $\phi_d(x)$ is independent of n . Since every root has some order d , we conclude that

$$x^n - 1 = \prod_{d|n} \phi_d(x). \quad (3)$$

Here is the crucial observation: The *coefficients* of the polynomials $\phi_n(x)$ are *integers* (that is, $\phi_n(x) \in \mathbb{Z}[x]$ for all n), where in addition the constant coefficient is either 1 or -1 .

Let us carefully verify this claim. For $n = 1$ we have 1 as the only root, and so $\phi_1(x) = x - 1$. Now we proceed by induction, where we assume $\phi_d(x) \in \mathbb{Z}[x]$ for all $d < n$, and that the constant coefficient of $\phi_d(x)$ is 1 or -1 . By (3),

$$x^n - 1 = p(x) \phi_n(x) \quad (4)$$

where $p(x) = \sum_{j=0}^{\ell} p_j x^j$, $\phi_n(x) = \sum_{k=0}^{n-\ell} a_k x^k$, with $p_0 = 1$ or $p_0 = -1$.

Since $-1 = p_0 a_0$, we see $a_0 \in \{1, -1\}$. Suppose we already know that $a_0, a_1, \dots, a_{k-1} \in \mathbb{Z}$. Computing the coefficient of x^k on both sides of (4)

we find

$$\sum_{j=0}^k p_j a_{k-j} = \sum_{j=1}^k p_j a_{k-j} + p_0 a_k \in \mathbb{Z}.$$

By assumption, all a_0, \dots, a_{k-1} (and all p_j) are in \mathbb{Z} . Thus $p_0 a_k$ and hence a_k must also be integers, since p_0 is 1 or -1 .

We are ready for the *coup de grâce*. Let $n_k | n$ be one of the numbers appearing in (1). Then

$$x^n - 1 = \prod_{d|n} \phi_d(x) = (x^{n_k} - 1) \phi_n(x) \prod_{d|n, d \nmid n_k, d \neq n} \phi_d(x).$$

We conclude that in \mathbb{Z} we have the divisibility relations

$$\phi_n(q) | q^n - 1 \quad \text{and} \quad \phi_n(q) | \frac{q^n - 1}{q^{n_k} - 1}. \quad (5)$$

Since (5) holds for all k , we deduce from the class formula (1)

$$\phi_n(q) | q - 1,$$

but this cannot be. Why? We know $\phi_n(x) = \prod (x - \lambda)$ where λ runs through all roots of $x^n - 1$ of order n . Let $\tilde{\lambda} = a + ib$ be one of those roots. By $n > 1$ (because of $R \neq \mathbb{Z}$) we have $\tilde{\lambda} \neq 1$, which implies that the real part a is smaller than 1. Now $|\tilde{\lambda}|^2 = a^2 + b^2 = 1$, and hence

$$\begin{aligned} |q - \tilde{\lambda}|^2 &= |q - a - ib|^2 = (q - a)^2 + b^2 \\ &= q^2 - 2aq + a^2 + b^2 = q^2 - 2aq + 1 \\ &> q^2 - 2q + 1 \quad (\text{because of } a < 1) \\ &= (q - 1)^2, \end{aligned}$$

and so $|q - \tilde{\lambda}| > q - 1$ holds for *all* roots of order n . This implies

$$|\phi_n(q)| = \prod_{\lambda} |q - \lambda| > q - 1,$$

which means that $\phi_n(q)$ cannot be a divisor of $q - 1$, contradiction and end of proof. \square

References

- [1] L. E. DICKSON: *On finite algebras*, Nachrichten der Akad. Wissenschaften Göttingen Math.-Phys. Klasse (1905), 1-36; Collected Mathematical Papers Vol. III, Chelsea Publ. Comp, The Bronx, NY 1975, 539-574.
- [2] J. H. M. WEDDERBURN: *A theorem on finite algebras*, Trans. Amer. Math. Soc. **6** (1905), 349-352.
- [3] E. WITT: *Über die Kommutativität endlicher Schiefkörper*, Abh. Math. Sem. Univ. Hamburg **8** (1931), 413.

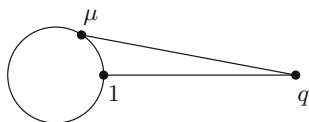

$$|q - \mu| > |q - 1|$$



The spectral theorem and Hadamard's determinant problem

A fundamental theorem of linear algebra asserts that every symmetric real matrix A can be diagonalized. That is, for every such matrix A there is a nonsingular real matrix Q such that

$$Q^{-1}AQ = \begin{pmatrix} \lambda_1 & & & & & \\ & \lambda_1 & & & & \\ & & \lambda_2 & & & \\ & & & \ddots & & \\ & & & & \lambda_2 & \\ & & & & & \ddots & \\ & & & & & & \lambda_t & \\ & & & & & & & \lambda_t \end{pmatrix}$$

is in diagonal form. The (real) λ_i 's are the eigenvalues of A , and the columns of Q form a basis of eigenvectors. We will make use of this result in several chapters to come.

What's more, the matrix Q can be chosen to be an *orthogonal* matrix, which means that $Q^T = Q^{-1}$, or equivalently that the columns of Q form an orthonormal basis with respect to the usual inner product.

Theorem 1. *For every real symmetric matrix A there is a real orthogonal matrix Q such that $Q^T A Q$ is diagonal.*

Moving Q and Q^T to the right-hand side we may equivalently express the theorem as a representation of A as a linear combination of matrices P_i that correspond to projections onto the eigenspaces C_{λ_i} ,

$$\begin{aligned} A &= \lambda_1 P_1 + \dots + \lambda_t P_t, \\ I_n &= P_1 + \dots + P_t, \end{aligned}$$

with $P_i P_j = \delta_{ij} P_i$ for all i and j . In this form the statement is usually called the *spectral theorem*.

The standard proofs of the theorem proceed by induction on the order of A (with some care in the presence of multiple eigenvalues), construct the basis of eigenvectors step by step, and use the fact that the characteristic polynomial splits into linear factors over the field \mathbb{C} of complex numbers.

The following proof due to Herb Wilf does it in one stroke and is truly inspired. It is very different from the usual proofs: It does not even refer to the eigenvalues, but instead employs an elegant compactness argument in a surprising way.

■ **Proof.** We start with some preliminary facts. Let $O(n) \subseteq \mathbb{R}^{n \times n}$ be the set of real orthogonal matrices of order n . Since

$$(PQ)^{-1} = Q^{-1}P^{-1} = Q^T P^T = (PQ)^T$$

for $P, Q \in O(n)$, we see that the set $O(n)$ is a group. Regarding any matrix in $\mathbb{R}^{n \times n}$ as a vector in \mathbb{R}^{n^2} , we find that $O(n)$ is a compact set. Indeed, as the columns of an orthogonal matrix $Q = (q_{ij})$ are unit vectors, we have $|q_{ij}| \leq 1$ for all i and j , thus $O(n)$ is bounded. Furthermore, the set $O(n)$ is defined as a subset of \mathbb{R}^{n^2} by the equations

$$x_{i1}x_{j1} + x_{i2}x_{j2} + \cdots + x_{in}x_{jn} = \delta_{ij} \quad \text{for } 1 \leq i, j \leq n,$$

The Heine–Borel theorem

Every closed and bounded subset of a vector space \mathbb{R}^N is compact.

hence it is closed, and thus compact.

For any real square matrix A let $\text{Od}(A) = \sum_{i \neq j} a_{ij}^2$ be the sum of the squares of the *off-diagonal* entries. Suppose we can prove the following.

Lemma. *If A is a real symmetric $n \times n$ matrix that is not diagonal, that is, $\text{Od}(A) > 0$, then there exists $U \in O(n)$ such that $\text{Od}(U^T A U) < \text{Od}(A)$.*

Given the lemma, the theorem follows in three quick steps. Let A be a real symmetric $n \times n$ matrix.

(A) Consider the map $f_A : O(n) \rightarrow \mathbb{R}^{n \times n}$ with $f_A(P) := P^T A P$. The map f_A is continuous on the compact set $O(n)$, and so the image $f_A(O(n))$ is compact.

(B) The function $\text{Od} : f_A(O(n)) \rightarrow \mathbb{R}$ is continuous, hence it assumes a minimum, say at $D = Q^T A Q \in f_A(O(n))$.

(C) The value $\text{Od}(D)$ must be zero, and hence D is a *diagonal* matrix as required.

Indeed, if $\text{Od}(D) > 0$, then applying the Lemma we find $U \in O(n)$ with $\text{Od}(U^T D U) < \text{Od}(D)$. But

$$U^T D U = U^T Q^T A Q U = (QU)^T A (QU)$$

is in $f_A(O(n))$ (remember $O(n)$ is a group!) with Od -value smaller than that of D — contradiction, and end of proof.

It remains to prove the lemma, and for this we use a very clever method attributed to Carl Gustav Jacob Jacobi. Suppose that $a_{rs} \neq 0$ for some $r \neq s$. Then we claim that the matrix U that agrees with the identity matrix except that $u_{rr} = u_{ss} = \cos \vartheta$, $u_{rs} = \sin \vartheta$, $u_{sr} = -\sin \vartheta$ does the job, for some choice of the (real) angle ϑ :



Jacques Hadamard

Using (1) we find

$$b_{rs} = (a_{rr} - a_{ss}) \sin \vartheta \cos \vartheta + a_{rs}(\cos^2 \vartheta - \sin^2 \vartheta).$$

For $\vartheta = 0$ this becomes a_{rs} , while for $\vartheta = \frac{\pi}{2}$ it is $-a_{rs}$. Hence by the intermediate value theorem there is some ϑ_0 between 0 and $\frac{\pi}{2}$ such that $b_{rs} = 0$, and we are through. \square

So this was beautiful, and we want to immediately apply the theorem to a famous (and unsolved) problem.

The Hadamard determinant problem

How large can $\det A$ be on the set of all real $n \times n$ matrices $A = (a_{ij})$ with $|a_{ij}| \leq 1$ for all i and j ?

Since the determinant is a continuous function in the a_{ij} (considered as variables) and the matrices form a compact set in \mathbb{R}^{n^2} , this maximum must exist. Furthermore, the maximum is attained for some matrix all of whose entries are $+1$ or -1 , because the function $\det A$ is linear in each single entry a_{ij} (if we keep all other entries fixed). Thus we can start with any matrix A and move one entry after the other to $+1$ or to -1 , in every single step not decreasing the determinant, until we arrive at a ± 1 -matrix. In the search for the largest determinant we may thus assume that all entries of A are ± 1 .

Here is the trick: Instead of A we consider the matrix $B = A^T A = (b_{ij})$. That is, if $c_j = (a_{1j}, a_{2j}, \dots, a_{nj})^T$ denotes the j -th column vector of A , then $b_{ij} = \langle c_i, c_j \rangle$, the inner product of c_i and c_j . In particular,

$$b_{ii} = \langle c_i, c_i \rangle = n \text{ for all } i,$$

and

$$\text{trace } B = \sum_{i=1}^n b_{ii} = n^2, \quad (2)$$

which will come in handy in a moment.

Now we can go to work. First of all, from $B = A^T A$ we get $|\det A| = \sqrt{\det B}$. Since multiplication of a column of A by -1 turns $\det A$ into $-\det A$, we see that the maximum problem for $\det A$ is the same as for $\det B$. Furthermore, we may assume that A is nonsingular, and hence that B is nonsingular as well.

Since $B = A^T A$ is a symmetric matrix the spectral theorem tells us that for some $Q \in O(n)$,

$$Q^T B Q = Q^T A^T A Q = (A Q)^T (A Q) = \begin{pmatrix} \lambda_1 & & & & \\ & \ddots & & & \\ & & 0 & & \\ & & & \ddots & \\ & & & & \lambda_n \end{pmatrix}, \quad (3)$$

where the λ_i are the eigenvalues of B . Now, if d_j denotes the j -th column vector of AQ (which is nonzero since A is nonsingular), then

$$\lambda_j = \langle d_j, d_j \rangle = \sum_{i=1}^n d_{ij}^2 > 0.$$

Thus $\lambda_1, \dots, \lambda_n$ are positive real numbers and

$$\det B = \lambda_1 \cdots \lambda_n, \quad \text{trace } B = \sum_{i=1}^n \lambda_i.$$

Whenever such a product and sum of positive numbers turn up, it is always a good idea to try the arithmetic-geometric mean inequality (see Chapter 20). In our case this gives with (2)

$$\det B = \lambda_1 \cdots \lambda_n \leq \left(\frac{\sum_{i=1}^n \lambda_i}{n} \right)^n = \left(\frac{\text{trace } B}{n} \right)^n = n^n, \quad (4)$$

and out comes Hadamard's upper bound

$$|\det A| \leq n^{n/2}. \quad (5)$$

When do we have equality in (5) or, what is the same, in (4)? Easy enough: if and only if the geometric mean of the λ_i 's equals the arithmetic mean, or equivalently, if and only if $\lambda_1 = \cdots = \lambda_n = \lambda$. But then $\text{trace } B = n\lambda = n^2$, and so $\lambda_1 = \cdots = \lambda_n = n$. Looking at (3) this means $Q^T B Q = nI_n$, where I_n is the $n \times n$ identity matrix. Now recall $Q^T = Q^{-1}$, multiply by Q on the left, by Q^{-1} on the right, to obtain

$$B = nI_n.$$

Going back to A this means that

$$|\det A| = n^{n/2} \iff \langle c_i, c_j \rangle = 0 \text{ for } i \neq j. \quad (6)$$

Matrices A with ± 1 -entries that achieve equality in (5) are aptly called *Hadamard matrices*. So an $n \times n$ matrix A with ± 1 -entries is a Hadamard matrix if and only if

$$A^T A = A A^T = nI_n.$$

This leads to another unsolved and apparently very difficult problem:

For which n does a Hadamard matrix of size $n \times n$ exist?

A short argument shows that if n is greater than 2, then it must be a multiple of 4. Indeed, suppose that A is an $n \times n$ Hadamard matrix, $n \geq 2$, whose rows are the vectors r_1, \dots, r_n . Clearly, multiplication of any row or column by -1 gives another Hadamard matrix. So we may assume that the first row consists of 1's only. Since $\langle r_1, r_i \rangle = 0$ for $i \neq 1$, every other

Statements (5) and (6) form an instance of *Hadamard's inequality*: The absolute value of the determinant of a matrix is at most the product of the lengths of its columns, with equality if and only if the columns are pairwise orthogonal.

row must contain $\frac{n}{2}$ 1's and $\frac{n}{2}$ -1 's; in particular, n must be even. Assume now that $n > 2$ and consider rows r_2 and r_3 , and denote by a, b, c, d the numbers of columns that have $\begin{smallmatrix} +1 & +1 \\ +1 & -1 \end{smallmatrix}$, $\begin{smallmatrix} +1 & -1 \\ -1 & +1 \end{smallmatrix}$, and $\begin{smallmatrix} -1 & +1 \\ -1 & -1 \end{smallmatrix}$ in rows 2 and 3, respectively. Then from $\langle r_1, r_2 \rangle = 0$ and $\langle r_1, r_3 \rangle = 0$ we get

$$a + b = c + d = a + c = b + d = \frac{n}{2},$$

which gives $b = c, a = d$. But from $\langle r_2, r_3 \rangle = 0$ we also have $a + d = b + c$, resulting in $2a = 2b$. We conclude that $a = b = c = d = \frac{n}{4}$. Thus the order of the Hadamard matrix is either $n = 1$ or $n = 2$, or $n = a + b + c + d = 4a$, a multiple of 4.

Does a Hadamard matrix exist for all $n = 4a$? No one knows. The answer is yes for n up to the current record $n = 664$, and for certain infinite series such as the powers of 2 (see the box). But the general answer seems at present out of reach.

For $n = 4$, with the numbering $C_1 = \emptyset$, $C_2 = \{1\}$, $C_3 = \{2\}$, $C_4 = \{1, 2\}$ this yields the matrix

$$\begin{pmatrix} 1 & 1 & 1 & 1 \\ 1 & -1 & 1 & -1 \\ 1 & 1 & -1 & -1 \\ 1 & -1 & -1 & 1 \end{pmatrix}$$

$$\begin{pmatrix} 1 & 1 \\ -1 & 1 \end{pmatrix} \begin{pmatrix} 1 & 1 & 1 \\ 1 & -1 & 1 \\ 1 & -1 & -1 \end{pmatrix} \begin{pmatrix} 1 & 1 & 1 & 1 \\ 1 & -1 & 1 & -1 \\ 1 & 1 & -1 & -1 \\ 1 & -1 & -1 & 1 \end{pmatrix}$$

Optimal matrices for $n = 2, 3$, and 4, with determinants 2, 4, and 16.

Hadamard matrices exist for all $n = 2^m$

Consider an m -set X and index the 2^m subsets $C \subseteq X$ in any way C_1, \dots, C_{2^m} . The matrix $A = (a_{ij})$ is defined as

$$a_{ij} = (-1)^{|C_i \cap C_j|}.$$

We want to verify $\langle r_i, r_j \rangle = 0$ for $i \neq j$. From the definition,

$$\langle r_i, r_j \rangle = \sum_k (-1)^{|C_i \cap C_k| + |C_j \cap C_k|}. \quad (*)$$

Now, as $C_i \neq C_j$ there exists an element $a \in X$ with $a \in C_i \setminus C_j$ or $a \in C_j \setminus C_i$; suppose $a \in C_i \setminus C_j$. Half the subsets of X contain a , and half do not. Let C run through all subsets that contain a , then the pairs $\{C, C \setminus a\}$ will comprise all subsets of X . But for each such pair $\{C, C \setminus a\}$, $|C_i \cap C| + |C_j \cap C|$ and $|C_i \cap (C \setminus a)| + |C_j \cap (C \setminus a)|$ have different parity, and so the corresponding terms in (*) will sum to 0. But then the whole sum is 0, as required.

For $n = 4a$ we have thus reduced the original problem to the existence of Hadamard matrices. But how large can $\det A$ be when n is *not* a multiple of 4? This is again a hard problem, but maybe we can find a good *lower* bound for the maximum. Here is a method that often proves successful — and it does in our case.

Let us look at *all* 2^{n^2} matrices with ± 1 -entries and consider some averages of the determinant. The arithmetic mean $\frac{1}{2^{n^2}} \sum_A \det A$ is 0 (clear?), so this is no big help. But if we consider the *mean square average* instead,

$$D_n := \sqrt{\frac{\sum_A (\det A)^2}{2^{n^2}}},$$

then things brighten up. Clearly,

$$\max_A \det A \geq D_n,$$

so this will give us a lower bound for the maximum.

The following stunningly simple calculation of D_n^2 probably appeared first in an article by George Szekeres and Paul Turán. We learnt it from a beautiful paper of Herb Wilf who heard it from Mark Kac. In the words of Mark Kac: “Just write $(\det A)^2$ out twice, interchange summation, and everything simplifies.” So we want to do just that.

From the definition of the determinant we get

$$\begin{aligned} D_n^2 &= \frac{1}{2^{n^2}} \sum_A \left(\sum_{\pi} (\text{sign } \pi) a_{1\pi(1)} a_{2\pi(2)} \cdots a_{n\pi(n)} \right)^2 \\ &= \frac{1}{2^{n^2}} \sum_A \sum_{\sigma} \sum_{\tau} (\text{sign } \sigma)(\text{sign } \tau) a_{1\sigma(1)} a_{1\tau(1)} \cdots a_{n\sigma(n)} a_{n\tau(n)}, \end{aligned}$$

where σ and τ run independently through all permutations of $\{1, \dots, n\}$.

Interchange of summation yields

$$D_n^2 = \frac{1}{2^{n^2}} \sum_{\sigma, \tau} (\text{sign } \sigma)(\text{sign } \tau) \left(\sum_A a_{1\sigma(1)} a_{1\tau(1)} \cdots a_{n\sigma(n)} a_{n\tau(n)} \right).$$

This doesn't look too promising, but wait. Look at a fixed pair (σ, τ) . The inner sum \sum_A is really a summation over n^2 variables, one for each a_{ij} :

$$\sum_{a_{11}=\pm 1} \sum_{a_{12}=\pm 1} \cdots \sum_{a_{nn}=\pm 1} a_{1\sigma(1)} a_{1\tau(1)} \cdots a_{n\sigma(n)} a_{n\tau(n)}. \quad (7)$$

Suppose $\sigma(i) = k \neq \tau(i)$. Then every summand contains a_{ik} , and therefore the whole sum has the factor $\sum_{a_{ik}=\pm 1} a_{ik} = 0$, and hence is 0 as well. The only way that the sum fails to be 0 is when $\sigma = \tau$, and everything simplifies indeed: For $\sigma = \tau$, the inner product is 1 as is the term $(\text{sign } \sigma)^2$. The sum in (7) is therefore

$$\sum_{a_{11}=\pm 1} \cdots \sum_{a_{nn}=\pm 1} 1 = 2^{n^2},$$

and wrapping things up we obtain

$$D_n^2 = \frac{1}{2^{n^2}} \sum_{\sigma} 2^{n^2} = n!,$$

and thus the following result.

Theorem 2. *There exists an $n \times n$ matrix with entries ± 1 whose determinant is greater than $\sqrt{n!}$.*

It is a characteristic feature of averaging that, while we learn that such a matrix exists, we have no clue how to construct it efficiently. But, surprisingly, the bound is quite good. Invoking Stirling's formula from page 13 we have

$$\sqrt{n!} \sim (2\pi n)^{\frac{1}{4}} \left(\frac{n}{e}\right)^{\frac{n}{2}},$$

and this is not too bad in comparison to the upper bound $n^{n/2}$.

Using the biquadratic mean average Szekeres and Turán got the even better lower bound $\frac{1}{4}\sqrt{n!}\sqrt{n}$, but the correct growth for the maximum as n goes to infinity is still not known.

References

- [1] J. HADAMARD: *Résolution d'une question relative aux déterminants*, *Bulletin des Sciences Mathématiques* **17** (1893), 240-246.
- [2] G. SZEKERES & P. TURÁN: *An extremal problem in the theory of determinants*, in: "Collected Papers of Paul Turán" (P. Erdős, ed.), Akadémiai Kiadó, Budapest 1990, Vol. 1, pp. 81-87.
- [3] H. WILF: *An algorithm-inspired proof of the spectral theorem in E^n* , *Amer. Math. Monthly* **88** (1981), 49-50.
- [4] H. WILF: *Some examples of combinatorial averaging*, *Amer. Math. Monthly* **92** (1985), 250-261.



“ π is irrational”

This was already conjectured by Aristotle, when he claimed that diameter and circumference of a circle are not commensurable. The first proof of this fundamental fact was given by Johann Heinrich Lambert in 1766. In fact, Lambert even showed that $\tan r$ is irrational for rational $r \neq 0$; the irrationality of π follows from this since $\tan \frac{\pi}{4} = 1$. Our Book Proof is due to Ivan Niven, 1947: an extremely elegant one-page proof that needs only elementary calculus. Its idea is powerful, and quite a bit more can be derived from it, as was shown by Iwamoto and Koksma, respectively:

- π^2 is irrational and
- e^r is irrational for rational $r \neq 0$.

Niven’s method does, however, have its roots and predecessors: It can be traced back to the classical paper by Charles Hermite from 1873 which first established that e is transcendental, that is, that e is not a zero of a polynomial with rational coefficients.

Before we treat π we will look at e and its powers, and see that these are irrational. This is much easier, and we thus also follow the historical order in the development of the results.

To start with, it is rather easy to see (as did Fourier in 1815) that $e = \sum_{k \geq 0} \frac{1}{k!}$ is irrational. Indeed, if we had $e = \frac{a}{b}$ for integers a and $b > 0$, then we would get

$$n!be = n!a$$

for every $n \geq 0$. But this cannot be true, because on the right-hand side we have an integer, while the left-hand side with

$$e = \left(1 + \frac{1}{1!} + \frac{1}{2!} + \dots + \frac{1}{n!}\right) + \left(\frac{1}{(n+1)!} + \frac{1}{(n+2)!} + \frac{1}{(n+3)!} + \dots\right)$$

decomposes into an integral part

$$bn! \left(1 + \frac{1}{1!} + \frac{1}{2!} + \dots + \frac{1}{n!}\right)$$

and a second part

$$b \left(\frac{1}{(n+1)} + \frac{1}{(n+1)(n+2)} + \frac{1}{(n+1)(n+2)(n+3)} + \dots \right)$$



Charles Hermite

$$e := 1 + \frac{1}{1} + \frac{1}{2} + \frac{1}{6} + \frac{1}{24} + \dots = 2.718281828\dots$$

$$e^x := 1 + \frac{x}{1} + \frac{x^2}{2} + \frac{x^3}{6} + \frac{x^4}{24} + \dots = \sum_{k \geq 0} \frac{x^k}{k!}$$

Geometric series

For the infinite geometric series

$$Q = \frac{1}{q} + \frac{1}{q^2} + \frac{1}{q^3} + \dots$$

with $q > 1$ we clearly have

$$qQ = 1 + \frac{1}{q} + \frac{1}{q^2} + \dots = 1 + Q$$

and thus

$$Q = \frac{1}{q-1}.$$

which is *approximately* $\frac{b}{n}$, so that for large n it certainly cannot be integral: It is larger than $\frac{b}{n+1}$ and smaller than $\frac{b}{n}$, as one can see from a comparison with a geometric series:

$$\begin{aligned} \frac{1}{n+1} &< \frac{1}{n+1} + \frac{1}{(n+1)(n+2)} + \frac{1}{(n+1)(n+2)(n+3)} + \dots \\ &< \frac{1}{n+1} + \frac{1}{(n+1)^2} + \frac{1}{(n+1)^3} + \dots = \frac{1}{n}. \end{aligned}$$

Now one might be led to think that this simple multiply-by- $n!$ trick is not even sufficient to show that e^2 is irrational. This is a stronger statement: $\sqrt{2}$ is an example of a number which is irrational, but whose square is not.

From John Cosgrave we have learned that with two nice ideas/observations (let's call them "tricks") one can get two steps further nevertheless: Each of the tricks is sufficient to show that e^2 is irrational, the combination of both of them even yields the same for e^4 . The first trick may be found in a one page paper by J. Liouville from 1840 — and the second one in a two page "addendum" which Liouville published on the next two journal pages.

Why is e^2 irrational? What can we derive from $e^2 = \frac{a}{b}$? According to Liouville we should write this as

$$be = ae^{-1},$$

substitute the series

$$e = 1 + \frac{1}{1} + \frac{1}{2} + \frac{1}{6} + \frac{1}{24} + \frac{1}{120} + \dots$$

and

$$e^{-1} = 1 - \frac{1}{1} + \frac{1}{2} - \frac{1}{6} + \frac{1}{24} - \frac{1}{120} \pm \dots,$$

and then multiply by $n!$, for a sufficiently large even n . Then we see that $n!be$ is nearly integral:

$$n!b \left(1 + \frac{1}{1} + \frac{1}{2} + \frac{1}{6} + \dots + \frac{1}{n!} \right)$$

is an integer, and the rest

$$n!b \left(\frac{1}{(n+1)!} + \frac{1}{(n+2)!} + \dots \right)$$

is approximately $\frac{b}{n}$: It is larger than $\frac{b}{n+1}$ but smaller than $\frac{b}{n}$, as we have seen above.

At the same time $n!ae^{-1}$ is nearly integral as well: Again we get a large integral part, and then a rest

$$(-1)^{n+1}n!a \left(\frac{1}{(n+1)!} - \frac{1}{(n+2)!} + \frac{1}{(n+3)!} \mp \dots \right),$$

SUR L'IRRATIONALITÉ DU NOMBRE

$$e = 2,718\dots;$$

PAR J. LIOUVILLE.

On prouve dans les éléments que le nombre e , base des logarithmes népériens, n'a pas une valeur rationnelle. On devrait, ce me semble, ajouter que la même méthode prouve aussi que e ne peut pas être racine d'une équation du second degré à coefficients rationnels, en sorte que l'on ne peut pas avoir $ae + \frac{b}{c} = c$, a étant un entier positif et b, c , des entiers positifs ou négatifs. En effet, si l'on remplace dans cette équation e et $\frac{1}{c}$ ou e^{-1} par leurs développements déduits de celui de e^x , puis qu'on multiplie les deux membres par $1.2.3\dots n$, on trouvera aisément

$$\frac{a}{n+1} \left(1 + \frac{1}{n+2} + \dots \right) \pm \frac{b}{n+1} \left(1 - \frac{1}{n+2} + \dots \right) = \mu,$$

μ étant un entier. On peut toujours faire en sorte que le facteur

$$\pm \frac{b}{n+1}$$

soit positif; il suffira de supposer n pair si b est < 0 et n impair si b est > 0 ; en prenant de plus n très grand, l'équation que nous venons d'écrire conduira dès lors à une absurdité; car son premier membre étant essentiellement positif et très petit, sera compris entre 0 et 1 , et ne pourra pas être égal à un entier μ . Donc, etc.

Liouville's paper

and this is approximately $(-1)^{n+1} \frac{a}{n}$. More precisely: for even n the rest is larger than $-\frac{a}{n}$, but smaller than

$$-a \left(\frac{1}{n+1} - \frac{1}{(n+1)^2} + \frac{1}{(n+1)^3} - \dots \right) = -\frac{a}{n+1} \left(1 - \frac{1}{n} \right) < 0.$$

But this cannot be true, since for large even n it would imply that $n!ae^{-1}$ is just a bit smaller than an integer, while $n!be$ is a bit larger than an integer, so $n!ae^{-1} = n!be$ cannot hold. \square

In order to show that e^4 is irrational, we now courageously assume that $e^4 = \frac{a}{b}$ were rational, and write this as

$$be^2 = ae^{-2}.$$

We could now try to multiply this by $n!$ for some large n , and collect the non-integral summands, but this leads to nothing useful: The sum of the remaining terms on the left-hand side will be approximately $b \frac{2^{n+1}}{n}$, on the right side $(-1)^{n+1} a \frac{2^{n+1}}{n}$, and both will be very large if n gets large.

So one has to examine the situation a bit more carefully, and make two little adjustments to the strategy: First we will not take an *arbitrary* large n , but a large power of two, $n = 2^m$; and secondly we will not multiply by $n!$, but by $\frac{n!}{2^{n-1}}$. Then we need a little lemma, a special case of Legendre's theorem (see page 10): For any $n \geq 1$ the integer $n!$ contains the prime factor 2 at most $n-1$ times — with equality if (and only if) n is a power of two, $n = 2^m$.

This lemma is not hard to show: $\lfloor \frac{n}{2} \rfloor$ of the factors of $n!$ are even, $\lfloor \frac{n}{4} \rfloor$ of them are divisible by 4, and so on. So if 2^k is the largest power of two which satisfies $2^k \leq n$, then $n!$ contains the prime factor 2 exactly

$$\left\lfloor \frac{n}{2} \right\rfloor + \left\lfloor \frac{n}{4} \right\rfloor + \dots + \left\lfloor \frac{n}{2^k} \right\rfloor \leq \frac{n}{2} + \frac{n}{4} + \dots + \frac{n}{2^k} = n \left(1 - \frac{1}{2^k} \right) \leq n-1$$

times, with equality in both inequalities exactly if $n = 2^k$.

Let's get back to $be^2 = ae^{-2}$. We are looking at

$$b \frac{n!}{2^{n-1}} e^2 = a \frac{n!}{2^{n-1}} e^{-2} \tag{1}$$

and substitute the series

$$e^2 = 1 + \frac{2}{1} + \frac{4}{2} + \frac{8}{6} + \dots + \frac{2^r}{r!} + \dots$$

and

$$e^{-2} = 1 - \frac{2}{1} + \frac{4}{2} - \frac{8}{6} \pm \dots + (-1)^r \frac{2^r}{r!} + \dots$$

For $r \leq n$ we get integral summands on both sides, namely

$$b \frac{n!}{2^{n-1}} \frac{2^r}{r!} \quad \text{resp.} \quad (-1)^r a \frac{n!}{2^{n-1}} \frac{2^r}{r!},$$

where for $r > 0$ the denominator $r!$ contains the prime factor 2 at most $r - 1$ times, while $n!$ contains it exactly $n - 1$ times. (So for $r > 0$ the summands are even.)

And since n is even (we assume that $n = 2^m$), the series that we get for $r \geq n + 1$ are

$$2b\left(\frac{2}{n+1} + \frac{4}{(n+1)(n+2)} + \frac{8}{(n+1)(n+2)(n+3)} + \cdots\right)$$

resp.

$$2a\left(-\frac{2}{n+1} + \frac{4}{(n+1)(n+2)} - \frac{8}{(n+1)(n+2)(n+3)} \pm \cdots\right).$$

These series will for large n be roughly $\frac{4b}{n}$ resp. $-\frac{4a}{n}$, as one sees again by comparison with geometric series. For large $n = 2^m$ this means that the left-hand side of (1) is a bit larger than an integer, while the right-hand side is a bit smaller — contradiction! \square

So we know that e^4 is irrational; to show that e^3 , e^5 etc. are irrational as well, we need heavier machinery (that is, a bit of calculus), and a new idea — which essentially goes back to Charles Hermite, and for which the key is hidden in the following simple lemma.

Lemma. For some fixed $n \geq 1$, let

$$f(x) = \frac{x^n(1-x)^n}{n!}.$$

- (i) The function $f(x)$ is a polynomial of the form $f(x) = \frac{1}{n!} \sum_{i=0}^{2n} c_i x^i$, where the coefficients c_i are integers.
- (ii) For $0 < x < 1$ we have $0 < f(x) < \frac{1}{n!}$.
- (iii) The derivatives $f^{(k)}(0)$ and $f^{(k)}(1)$ are integers for all $k \geq 0$.

■ **Proof.** Parts (i) and (ii) are clear.

For (iii) note that by (i) the k -th derivative $f^{(k)}$ vanishes at $x = 0$ unless $n \leq k \leq 2n$, and in this range $f^{(k)}(0) = \frac{k!}{n!} c_k$ is an integer. From $f(x) = f(1-x)$ we get $f^{(k)}(x) = (-1)^k f^{(k)}(1-x)$ for all x , and hence $f^{(k)}(1) = (-1)^k f^{(k)}(0)$, which is an integer. \square

Theorem 1. e^r is irrational for every $r \in \mathbb{Q} \setminus \{0\}$.

■ **Proof.** It suffices to show that e^s cannot be rational for a positive integer s (if $e^{\frac{s}{t}}$ were rational, then $(e^{\frac{s}{t}})^t = e^s$ would be rational, too). Assume that $e^s = \frac{a}{b}$ for integers $a, b > 0$, and let n be so large that $n! > as^{2n+1}$. Put

$$F(x) := s^{2n} f(x) - s^{2n-1} f'(x) + s^{2n-2} f''(x) \mp \cdots + f^{(2n)}(x),$$

where $f(x)$ is the function of the lemma.

The estimate $n! > e(\frac{n}{e})^n$ yields an explicit n that is “large enough.”

$F(x)$ may also be written as an infinite sum

$$F(x) = s^{2n} f(x) - s^{2n-1} f'(x) + s^{2n-2} f''(x) \mp \dots,$$

since the higher derivatives $f^{(k)}(x)$, for $k > 2n$, vanish. From this we see that the polynomial $F(x)$ satisfies the identity

$$F'(x) = -s F(x) + s^{2n+1} f(x).$$

Thus differentiation yields

$$\frac{d}{dx} [e^{sx} F(x)] = s e^{sx} F(x) + e^{sx} F'(x) = s^{2n+1} e^{sx} f(x)$$

and hence

$$N := b \int_0^1 s^{2n+1} e^{sx} f(x) dx = b [e^{sx} F(x)]_0^1 = aF(1) - bF(0).$$

This is an integer, since part (iii) of the lemma implies that $F(0)$ and $F(1)$ are integers. However, part (ii) of the lemma yields estimates for the size of N from below and from above,

$$0 < N = b \int_0^1 s^{2n+1} e^{sx} f(x) dx < b s^{2n+1} e^s \frac{1}{n!} = \frac{a s^{2n+1}}{n!} < 1,$$

which shows that N cannot be an integer: contradiction. □

Now that this trick was so successful, we use it once more.

Theorem 2. π^2 is irrational.

■ **Proof.** Assume that $\pi^2 = \frac{a}{b}$ for integers $a, b > 0$. We now use the polynomial

$$F(x) := b^n \left(\pi^{2n} f(x) - \pi^{2n-2} f^{(2)}(x) + \pi^{2n-4} f^{(4)}(x) \mp \dots \right),$$

which satisfies $F''(x) = -\pi^2 F(x) + b^n \pi^{2n+2} f(x)$.

From part (iii) of the lemma we get that $F(0)$ and $F(1)$ are integers. Elementary differentiation rules yield

$$\begin{aligned} \frac{d}{dx} [F'(x) \sin \pi x - \pi F(x) \cos \pi x] &= (F''(x) + \pi^2 F(x)) \sin \pi x \\ &= b^n \pi^{2n+2} f(x) \sin \pi x \\ &= \pi^2 a^n f(x) \sin \pi x, \end{aligned}$$

π is not rational, but it does have “good approximations” by rationals — some of these were known since antiquity:

$$\begin{aligned} \frac{22}{7} &= 3.142857142857\dots \\ \frac{355}{113} &= 3.141592920353\dots \\ \frac{104348}{33215} &= 3.141592653921\dots \\ \pi &= 3.141592653589\dots \end{aligned}$$

and thus we obtain

$$\begin{aligned} N := \pi \int_0^1 a^n f(x) \sin \pi x dx &= \left[\frac{1}{\pi} F'(x) \sin \pi x - F(x) \cos \pi x \right]_0^1 \\ &= F(0) + F(1), \end{aligned}$$

which is an integer. Furthermore N is positive since it is defined as the

integral of a function that is positive (except on the boundary). However, if we choose n so large that $\frac{\pi a^n}{n!} < 1$, then from part (ii) of the lemma we obtain

$$0 < N = \pi \int_0^1 a^n f(x) \sin \pi x \, dx < \frac{\pi a^n}{n!} < 1,$$

a contradiction. □

Here comes our final irrationality result.

Theorem 3. *For every odd integer $n \geq 3$, the number*

$$A(n) := \frac{1}{\pi} \arccos \left(\frac{1}{\sqrt{n}} \right)$$

is irrational.

We will need this result for Hilbert's third problem (see Chapter 10) in the cases $n = 3$ and $n = 9$. For $n = 2$ and $n = 4$ we have $A(2) = \frac{1}{4}$ and $A(4) = \frac{1}{3}$, so the restriction to odd integers is essential. These values are easily derived by appealing to the diagram in the margin, in which the statement " $\frac{1}{\pi} \arccos \left(\frac{1}{\sqrt{n}} \right)$ is irrational" is equivalent to saying that the polygonal arc constructed from $\frac{1}{\sqrt{n}}$, all of whose chords have the same length, never closes into itself.

We leave it as an exercise for the reader to show that $A(n)$ is rational *only* for $n \in \{1, 2, 4\}$. For that, distinguish the cases when $n = 2^r$, and when n is not a power of 2.

■ **Proof.** We use the addition theorem

$$\cos \alpha + \cos \beta = 2 \cos \frac{\alpha + \beta}{2} \cos \frac{\alpha - \beta}{2}$$

from elementary trigonometry, which for $\alpha = (k + 1)\varphi$ and $\beta = (k - 1)\varphi$ yields

$$\cos (k + 1)\varphi = 2 \cos \varphi \cos k\varphi - \cos (k - 1)\varphi. \quad (2)$$

For the angle $\varphi_n = \arccos \left(\frac{1}{\sqrt{n}} \right)$, which is defined by $\cos \varphi_n = \frac{1}{\sqrt{n}}$ and $0 \leq \varphi_n \leq \pi$, this yields representations of the form

$$\cos k\varphi_n = \frac{A_k}{\sqrt{n}^k},$$

where A_k is an integer that is not divisible by n , for all $k \geq 0$. In fact, we have such a representation for $k = 0, 1$ with $A_0 = A_1 = 1$, and by induction on k using (2) we get for $k \geq 1$

$$\cos (k + 1)\varphi_n = 2 \frac{1}{\sqrt{n}} \frac{A_k}{\sqrt{n}^k} - \frac{A_{k-1}}{\sqrt{n}^{k-1}} = \frac{2A_k - nA_{k-1}}{\sqrt{n}^{k+1}}.$$

Thus we obtain $A_{k+1} = 2A_k - nA_{k-1}$. If $n \geq 3$ is odd, and A_k is not divisible by n , then we find that A_{k+1} cannot be divisible by n , either.

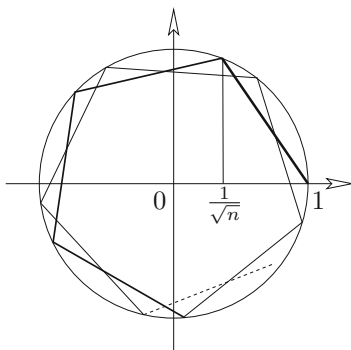

Now assume that

$$A(n) = \frac{1}{\pi} \varphi_n = \frac{k}{\ell}$$

is rational (with integers $k, \ell > 0$). Then $\ell \varphi_n = k\pi$ yields

$$\pm 1 = \cos k\pi = \frac{A_\ell}{\sqrt{n}^\ell}.$$

Thus $\sqrt{n}^\ell = \pm A_\ell$ is an integer, with $\ell \geq 2$, and hence $n \mid \sqrt{n}^\ell$. With $\sqrt{n}^\ell \mid A_\ell$ we find that n divides A_ℓ , a contradiction. \square

References

- [1] C. HERMITE: *Sur la fonction exponentielle*, Comptes rendus de l'Académie des Sciences (Paris) **77** (1873), 18-24; Œuvres de Charles Hermite, Vol. III, Gauthier-Villars, Paris 1912, pp. 150-181.
- [2] Y. IWAMOTO: *A proof that π^2 is irrational*, J. Osaka Institute of Science and Technology **1** (1949), 147-148.
- [3] J. F. KOKSMA: *On Niven's proof that π is irrational*, Nieuw Archief voor Wiskunde (2) **23** (1949), 39.
- [4] J. LIOUVILLE: *Sur l'irrationalité du nombre $e = 2,718\dots$* , Journal de Mathématiques Pures et Appl. (1) **5** (1840), 192; *Addition*, 193-194.
- [5] I. NIVEN: *A simple proof that π is irrational*, Bulletin Amer. Math. Soc. **53** (1947), 509.



We know that the infinite series $\sum_{n \geq 1} \frac{1}{n}$ does not converge. Indeed, in Chapter 1 we have seen that even the series $\sum_{p \in \mathbb{P}} \frac{1}{p}$ diverges.

However, the sum of the reciprocals of the squares converges (although very slowly, as we will also see), and it produces an interesting value.

Euler's series

$$\sum_{n \geq 1} \frac{1}{n^2} = \frac{\pi^2}{6}.$$

This is a classical, famous and important result by Leonhard Euler from 1734. One of its key interpretations is that it yields the first nontrivial value $\zeta(2)$ of Riemann's zeta function (see the appendix on page 62). This value is irrational, as we have seen in Chapter 8.

But not only the result has a prominent place in mathematics history, there are also a number of extremely elegant and clever proofs that have their history: For some of these the joy of discovery and rediscovery has been shared by many. In this chapter, we present four such proofs.

■ **Proof.** The first proof appears as an exercise in William J. LeVeque's number theory textbook from 1956. But he says: "I haven't the slightest idea where that problem came from, but I'm pretty certain that it wasn't original with me."

The proof consists in two different evaluations of the double integral

$$I := \int_0^1 \int_0^1 \frac{1}{1-xy} dx dy.$$

For the first one, we expand $\frac{1}{1-xy}$ as a geometric series, decompose the summands as products, and integrate effortlessly:

$$\begin{aligned} I &= \int_0^1 \int_0^1 \sum_{n \geq 0} (xy)^n dx dy = \sum_{n \geq 0} \int_0^1 \int_0^1 x^n y^n dx dy \\ &= \sum_{n \geq 0} \left(\int_0^1 x^n dx \right) \left(\int_0^1 y^n dy \right) = \sum_{n \geq 0} \frac{1}{n+1} \frac{1}{n+1} \\ &= \sum_{n \geq 0} \frac{1}{(n+1)^2} = \sum_{n \geq 1} \frac{1}{n^2} = \zeta(2). \end{aligned}$$



1	=	1.000000
$1 + \frac{1}{4}$	=	1.250000
$1 + \frac{1}{4} + \frac{1}{9}$	=	1.361111
$1 + \frac{1}{4} + \frac{1}{9} + \frac{1}{16}$	=	1.423611
$1 + \frac{1}{4} + \frac{1}{9} + \frac{1}{16} + \frac{1}{25}$	=	1.463611
$1 + \frac{1}{4} + \frac{1}{9} + \frac{1}{16} + \frac{1}{25} + \frac{1}{36}$	=	1.491388
$\pi^2/6$	=	1.644934.

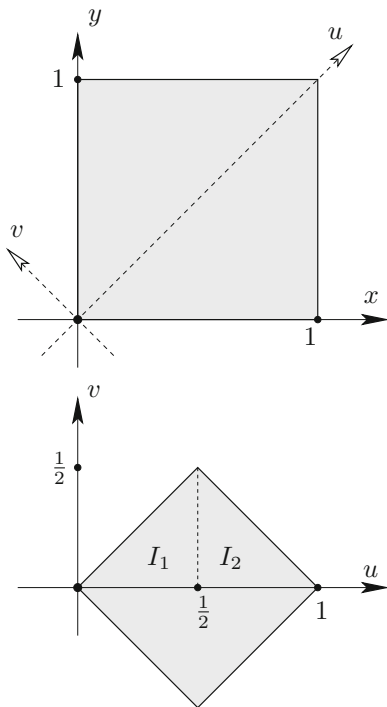

This evaluation also shows that the double integral (over a positive function with a pole at $x = y = 1$) is finite. Note that the computation is also easy and straightforward if we read it backwards — thus the evaluation of $\zeta(2)$ leads one to the double integral I .

The second way to evaluate I comes from a change of coordinates: in the new coordinates given by $u := \frac{y+x}{2}$ and $v := \frac{y-x}{2}$ the domain of integration is a square of side length $\frac{1}{2}\sqrt{2}$, which we get from the old domain by first rotating it by 45° and then shrinking it by a factor of $\sqrt{2}$. Substitution of $x = u - v$ and $y = u + v$ yields

$$\frac{1}{1-xy} = \frac{1}{1-u^2+v^2}.$$

To transform the integral, we have to replace $dx dy$ by $2 du dv$, to compensate for the fact that our coordinate transformation reduces areas by a constant factor of 2 (which is the Jacobi determinant of the transformation; see the box on the next page). The new domain of integration, and the function to be integrated, are symmetric with respect to the u -axis, so we just need to compute two times (another factor of 2 arises here!) the integral over the upper half domain, which we split into two parts in the most natural way:

$$I = 4 \int_0^{1/2} \left(\int_0^u \frac{dv}{1-u^2+v^2} \right) du + 4 \int_{1/2}^1 \left(\int_0^{1-u} \frac{dv}{1-u^2+v^2} \right) du.$$

Using $\int \frac{dx}{a^2+x^2} = \frac{1}{a} \arctan \frac{x}{a} + C$, this becomes

$$I = 4 \int_0^{1/2} \frac{1}{\sqrt{1-u^2}} \arctan \left(\frac{u}{\sqrt{1-u^2}} \right) du + 4 \int_{1/2}^1 \frac{1}{\sqrt{1-u^2}} \arctan \left(\frac{1-u}{\sqrt{1-u^2}} \right) du.$$

These integrals can be simplified and finally evaluated by substituting $u = \sin \theta$ resp. $u = \cos \theta$. But we proceed more directly, by computing that the derivative of $g(u) := \arctan \left(\frac{u}{\sqrt{1-u^2}} \right)$ is $g'(u) = \frac{1}{\sqrt{1-u^2}}$, while the derivative of $h(u) := \arctan \left(\frac{1-u}{\sqrt{1-u^2}} \right) = \arctan \left(\sqrt{\frac{1-u}{1+u}} \right)$ is $h'(u) = -\frac{1}{2} \frac{1}{\sqrt{1-u^2}}$. So we may use $\int_a^b f'(x)f(x)dx = \left[\frac{1}{2}f(x)^2 \right]_a^b = \frac{1}{2}f(b)^2 - \frac{1}{2}f(a)^2$ and get

$$\begin{aligned} I &= 4 \int_0^{1/2} g'(u)g(u) du + 4 \int_{1/2}^1 -2h'(u)h(u) du \\ &= 2 \left[g(u)^2 \right]_0^{1/2} - 4 \left[h(u)^2 \right]_{1/2}^1 \\ &= 2g\left(\frac{1}{2}\right)^2 - 2g(0)^2 - 4h(1)^2 + 4h\left(\frac{1}{2}\right)^2 \\ &= 2\left(\frac{\pi}{6}\right)^2 - 0 - 0 + 4\left(\frac{\pi}{6}\right)^2 = \frac{\pi^2}{6}. \end{aligned} \quad \square$$

This proof extracted the value of Euler’s series from an integral via a rather simple coordinate transformation. An ingenious proof of this type — with an entirely nontrivial coordinate transformation — was later discovered by Beukers, Calabi and Kolk. The point of departure for that proof is to split the sum $\sum_{n \geq 1} \frac{1}{n^2}$ into the even terms and the odd terms. Clearly the even terms $\frac{1}{2^2} + \frac{1}{4^2} + \frac{1}{6^2} + \dots = \sum_{k \geq 1} \frac{1}{(2k)^2}$ sum to $\frac{1}{4}\zeta(2)$, so the odd terms $\frac{1}{1^2} + \frac{1}{3^2} + \frac{1}{5^2} + \dots = \sum_{k \geq 0} \frac{1}{(2k+1)^2}$ make up three quarters of the total sum $\zeta(2)$. Thus Euler’s series is equivalent to

$$\sum_{k \geq 0} \frac{1}{(2k+1)^2} = \frac{\pi^2}{8}.$$

■ **Proof.** As above, we may express this as a double integral, namely

$$J = \int_0^1 \int_0^1 \frac{1}{1-x^2y^2} dx dy = \sum_{k \geq 0} \frac{1}{(2k+1)^2}.$$

So we have to compute this integral J . And for this Beukers, Calabi and Kolk proposed the new coordinates

$$u := \arccos \sqrt{\frac{1-x^2}{1-x^2y^2}} \quad v := \arccos \sqrt{\frac{1-y^2}{1-x^2y^2}}.$$

To compute the double integral, we may ignore the boundary of the domain, and consider x, y in the range $0 < x < 1$ and $0 < y < 1$. Then u, v will lie in the triangle $u > 0, v > 0, u + v < \pi/2$. The coordinate transformation can be inverted explicitly, which leads one to the substitution

$$x = \frac{\sin u}{\cos v} \quad \text{and} \quad y = \frac{\sin v}{\cos u}.$$

It is easy to check that these formulas define a bijective coordinate transformation between the interior of the unit square $S = \{(x, y) : 0 \leq x, y \leq 1\}$ and the interior of the triangle $T = \{(u, v) : u, v \geq 0, u + v \leq \pi/2\}$.

Now we have to compute the Jacobi determinant of the coordinate transformation, and magically it turns out to be

$$\det \begin{pmatrix} \frac{\cos u}{\cos v} & \frac{\sin u \sin v}{\cos^2 v} \\ \frac{\sin u \sin v}{\cos^2 u} & \frac{\cos v}{\cos u} \end{pmatrix} = 1 - \frac{\sin^2 u \sin^2 v}{\cos^2 u \cos^2 v} = 1 - x^2 y^2.$$

But this means that the integral that we want to compute is transformed into

$$J = \int_0^{\pi/2} \int_0^{\pi/2-u} 1 du dv,$$

which is just the area $\frac{1}{2}(\frac{\pi}{2})^2 = \frac{\pi^2}{8}$ of the triangle T . □

The Substitution Formula

To compute a double integral

$$I = \int_S f(x, y) dx dy.$$

we may perform a substitution of variables

$$x = x(u, v) \quad y = y(u, v),$$

if the correspondence of $(u, v) \in T$ to $(x, y) \in S$ is bijective and continuously differentiable. Then I equals

$$\int_T f(x(u, v), y(u, v)) \left| \frac{d(x, y)}{d(u, v)} \right| du dv,$$

where $\frac{d(x, y)}{d(u, v)}$ is the Jacobi determinant:

$$\frac{d(x, y)}{d(u, v)} = \det \begin{pmatrix} \frac{dx}{du} & \frac{dx}{dv} \\ \frac{dy}{du} & \frac{dy}{dv} \end{pmatrix}.$$

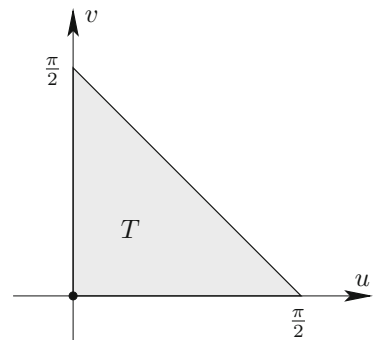
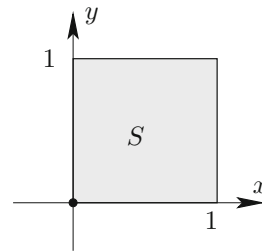

Beautiful — even more so, as the same method of proof extends to the computation of $\zeta(2k)$ in terms of a $2k$ -dimensional integral, for all $k \geq 1$. We refer to the original paper of Beuker, Calabi and Kolk [2], and to Chapter 26, where we'll achieve this on a different path, using the Herglotz trick and Euler's original approach.

After these two proofs via coordinate transformation we can't resist the temptation to present another, entirely different and completely elementary proof for $\sum_{n \geq 1} \frac{1}{n^2} = \frac{\pi^2}{6}$. It appears in a sequence of exercises in the problem book by the twin brothers Akiva and Isaak Yaglom, whose Russian original edition appeared in 1954. Versions of this beautiful proof were rediscovered and presented by F. Holme (1970), I. Papadimitriou (1973), and by Ransford (1982) who attributed it to John Scholes.

■ **Proof.** The first step is to establish a remarkable relation between values of the (squared) cotangent function. Namely, for all $m \geq 1$ one has

$$\cot^2\left(\frac{\pi}{2m+1}\right) + \cot^2\left(\frac{2\pi}{2m+1}\right) + \cdots + \cot^2\left(\frac{m\pi}{2m+1}\right) = \frac{2m(2m-1)}{6}. \quad (1)$$

To establish this, we start with the relation $e^{ix} = \cos x + i \sin x$. Taking the n -th power $e^{inx} = (e^{ix})^n$, we get

$$\cos nx + i \sin nx = (\cos x + i \sin x)^n.$$

The imaginary part of this is

$$\sin nx = \binom{n}{1} \sin x \cos^{n-1} x - \binom{n}{3} \sin^3 x \cos^{n-3} x \pm \cdots \quad (2)$$

Now we let $n = 2m + 1$, while for x we will consider the m different values $x = \frac{r\pi}{2m+1}$, for $r = 1, 2, \dots, m$. For each of these values we have $nx = r\pi$, and thus $\sin nx = 0$, while $0 < x < \frac{\pi}{2}$ implies that for $\sin x$ we get m distinct positive values.

In particular, we can divide (2) by $\sin^n x$, which yields

$$0 = \binom{n}{1} \cot^{n-1} x - \binom{n}{3} \cot^{n-3} x \pm \cdots,$$

that is,

$$0 = \binom{2m+1}{1} \cot^{2m} x - \binom{2m+1}{3} \cot^{2m-2} x \pm \cdots$$

for each of the m distinct values of x . Thus for the polynomial of degree m

$$p(t) := \binom{2m+1}{1} t^m - \binom{2m+1}{3} t^{m-1} \pm \cdots + (-1)^m \binom{2m+1}{2m+1}$$

we know m distinct roots

$$a_r = \cot^2\left(\frac{r\pi}{2m+1}\right) \quad \text{for } r = 1, 2, \dots, m.$$

The roots are distinct because $\cot^2 x = \cot^2 y$ implies $\sin^2 x = \sin^2 y$ and thus $x = y$ for $x, y \in \{\frac{r\pi}{2m+1} : 1 \leq r \leq m\}$.

For $m = 1, 2, 3$ this yields

$$\cot^2 \frac{\pi}{3} = \frac{1}{3}$$

$$\cot^2 \frac{\pi}{5} + \cot^2 \frac{2\pi}{5} = 2$$

$$\cot^2 \frac{\pi}{7} + \cot^2 \frac{2\pi}{7} + \cot^2 \frac{3\pi}{7} = 5$$

Hence the polynomial coincides with

$$p(t) = \binom{2m+1}{1} \left(t - \cot^2\left(\frac{\pi}{2m+1}\right)\right) \cdots \left(t - \cot^2\left(\frac{m\pi}{2m+1}\right)\right).$$

Comparison of the coefficients of t^{m-1} in $p(t)$ now yields that the sum of the roots is

$$a_1 + \cdots + a_r = \frac{\binom{2m+1}{3}}{\binom{2m+1}{1}} = \frac{2m(2m-1)}{6},$$

which proves (1).

We also need a second identity, of the same type,

$$\csc^2\left(\frac{\pi}{2m+1}\right) + \csc^2\left(\frac{2\pi}{2m+1}\right) + \cdots + \csc^2\left(\frac{m\pi}{2m+1}\right) = \frac{2m(2m+2)}{6}, \quad (3)$$

for the cosecant function $\csc x = \frac{1}{\sin x}$. But

$$\csc^2 x = \frac{1}{\sin^2 x} = \frac{\cos^2 x + \sin^2 x}{\sin^2 x} = \cot^2 x + 1,$$

so we can derive (3) from (1) by adding m to both sides of the equation.

Now the stage is set, and everything falls into place. We use that in the range $0 < y < \frac{\pi}{2}$ we have

$$0 < \sin y < y < \tan y,$$

and thus

$$0 < \cot y < \frac{1}{y} < \csc y,$$

which implies

$$\cot^2 y < \frac{1}{y^2} < \csc^2 y.$$

Now we take this double inequality, apply it to each of the m distinct values of x , and add the results. Using (1) for the left-hand side, and (3) for the right-hand side, we obtain

$$\frac{2m(2m-1)}{6} < \left(\frac{2m+1}{\pi}\right)^2 + \left(\frac{2m+1}{2\pi}\right)^2 + \cdots + \left(\frac{2m+1}{m\pi}\right)^2 < \frac{2m(2m+2)}{6},$$

that is,

$$\frac{\pi^2}{6} \frac{2m}{2m+1} \frac{2m-1}{2m+1} < \frac{1}{1^2} + \frac{1}{2^2} + \cdots + \frac{1}{m^2} < \frac{\pi^2}{6} \frac{2m}{2m+1} \frac{2m+2}{2m+1}.$$

Both the left-hand and the right-hand side converge to $\frac{\pi^2}{6}$ for $m \rightarrow \infty$: end of proof. \square

So how fast does $\sum \frac{1}{n^2}$ converge to $\pi^2/6$? For this we have to estimate the difference

$$\frac{\pi^2}{6} - \sum_{n=1}^m \frac{1}{n^2} = \sum_{n=m+1}^{\infty} \frac{1}{n^2}.$$

Comparison of coefficients:

If $p(t) = c(t - a_1) \cdots (t - a_m)$, then the coefficient of t^{m-1} is $-c(a_1 + \cdots + a_m)$.

$$0 < a < b < c$$

implies

$$0 < \frac{1}{c} < \frac{1}{b} < \frac{1}{a}$$

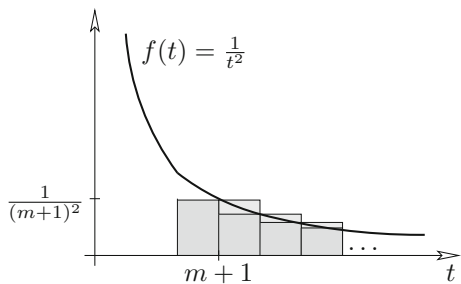

This is very easy with the technique of “comparing with an integral” that we have reviewed already in the appendix to Chapter 2 (page 12). It yields

$$\sum_{n=m+1}^{\infty} \frac{1}{n^2} < \int_m^{\infty} \frac{1}{t^2} dt = \frac{1}{m}$$

for an upper bound and

$$\sum_{n=m+1}^{\infty} \frac{1}{n^2} > \int_{m+1}^{\infty} \frac{1}{t^2} dt = \frac{1}{m+1}$$

for a lower bound on the “remaining summands” — or even

$$\sum_{n=m+1}^{\infty} \frac{1}{n^2} > \int_{m+\frac{1}{2}}^{\infty} \frac{1}{t^2} dt = \frac{1}{m+\frac{1}{2}}$$

if you are willing to do a slightly more careful estimate, using that the function $f(t) = \frac{1}{t^2}$ is convex.

This means that our series does not converge too well; if we sum the first one thousand summands, then we expect an error in the third digit after the decimal point, while for the sum of the first one million summands, $m = 1000000$, we expect to get an error in the sixth decimal digit, and we do. However, then comes a big surprise: to an accuracy of 45 digits,

$$\begin{aligned} \pi^2/6 &= 1.644934066848226436472415166646025189218949901, \\ \sum_{n=1}^{10^6} \frac{1}{n^2} &= 1.644933066848726436305748499979391855885616544. \end{aligned}$$

So the sixth digit after the decimal point is wrong (too small by 1), but *the next six digits are right!* And then one digit is wrong (too large by 5), then again five are correct. This surprising discovery is quite recent, due to Roy D. North from Colorado Springs, 1988. (In 1982, Martin R. Powell, a school teacher from Amersham, Bucks, England, failed to notice the full effect due to the insufficient computing power available at the time.) It is too strange to be purely coincidental ... A look at the error term, which again to 45 digits reads

$$\sum_{n=10^6+1}^{\infty} \frac{1}{n^2} = 0.000000999999500000166666666666663333333333357,$$

reveals that clearly there is a pattern. You might try to rewrite this last number as

$$+ 10^{-6} - \frac{1}{2}10^{-12} + \frac{1}{6}10^{-18} - \frac{1}{30}10^{-30} + \frac{1}{42}10^{-42} + \dots$$

where the coefficients $(1, -\frac{1}{2}, \frac{1}{6}, 0, -\frac{1}{30}, 0, \frac{1}{42})$ of 10^{-6i} form the beginning of the sequence of *Bernoulli numbers* that we’ll meet again in Chapter 26. We refer our readers to the article by Borwein, Borwein & Dilcher [3] for more such surprising “coincidences” — and for proofs.

And if only to repeat the point that it pays of to look for gems hidden in exercise sections of books, in particular if they are written by brothers, here's our last proof for Euler's Theorem, as sketched in Exercise 11 of page 381 of the book "Pi and the AGM" by the brothers Jonathan and Peter Borwein. It establishes that you can get Euler's Theorem by "squaring" in an ingenious way the Gregory–Leibniz series

$$\sum_{n=0}^{\infty} \frac{(-1)^n}{2n+1} = 1 - \frac{1}{3} + \frac{1}{5} - \frac{1}{7} \pm \dots = \frac{\pi}{4}.$$

■ **Proof.** The first trick in this proof is to consider the Gregory–Leibniz series in doubly-infinite form $\sum_{n=-\infty}^{\infty} \frac{(-1)^n}{2n+1}$. As for negative $n = -k < 0$ we get the same terms as for $n = k - 1 \geq 0$, since $\frac{(-1)^{-k}}{2(-k)+1} = \frac{(-1)^{k-1}}{2(k-1)+1}$, we infer that $\sum_{n=-N}^N \frac{(-1)^n}{2n+1}$ converges to $\pi/2$ with $N \rightarrow \infty$, and thus the square of this sum converges to $\pi^2/4$. You may write this as

$$\lim_{N \rightarrow \infty} \sum_{m,n=-N}^N \frac{(-1)^m}{2m+1} \frac{(-1)^n}{2n+1} = \frac{\pi^2}{4}.$$

The double sum may be interpreted as the sum of all entries of a square matrix of size $(2N+1) \times (2N+1)$, and we know that for $N \rightarrow \infty$ this sum of all entries tends to $\pi^2/4$. We want to know, however, that the sum of only the *diagonal* entries, for $m = n$, also tends to $\pi^2/4$,

$$\lim_{N \rightarrow \infty} \sum_{n=-N}^N \frac{1}{(2n+1)^2} = \frac{\pi^2}{4},$$

because then $\sum_{n=0}^{\infty} \frac{1}{(2n+1)^2} = \pi^2/8$ will follow, and this, as we know, is equivalent to Euler's theorem. So let's show that the sum of all off-diagonal terms tends to 0! We write δ_N for this sum, and use a prime to denote that the diagonal terms with $m = n$ are deleted, so

$$\begin{aligned} \delta_N &= \sum'_{m,n=-N}^N \frac{(-1)^{m+n}}{(2m+1)(2n+1)} \\ &= \sum'_{m,n=-N}^N (-1)^{m+n} \left(\frac{1}{2m-2n} \frac{1}{2m+1} - \frac{1}{2m-2n} \frac{1}{2n+1} \right) \\ &= \sum'_{m,n=-N}^N (-1)^{m+n} \left(\frac{1}{2m-2n} \frac{1}{2m+1} - \frac{1}{2n-2m} \frac{1}{2m+1} \right) \\ &= \sum'_{m,n=-N}^N (-1)^{m+n} \frac{1}{m-n} \frac{1}{2m+1} \\ &= \sum_{m=-N}^N \frac{1}{2m+1} \left(\sum'_{n=-N}^N \frac{(-1)^{m-n}}{m-n} \right). \end{aligned}$$

Prove the Gregory–Leibniz identity, for example by integrating the geometric series $1 - x^2 + x^4 \pm \dots = \frac{1}{1+x^2}$ and then evaluating at 1.

Here we use that $\frac{1}{k\ell} = \frac{1}{k-\ell} \left(\frac{1}{\ell} - \frac{1}{k} \right)$, for $k \neq \ell$. This replaces $\frac{1}{k\ell}$ by two summands that are not symmetric in k and ℓ .

For this we have interchanged $m \leftrightarrow n$ in the second part of the double sum.

We only need to show that the terms

$$c_{m,N} := \sum_{n=-N}^N \frac{(-1)^{m-n}}{m-n}$$

are small enough in absolute value. What do we know about them? It is easy to see that $c_{-m,N} = -c_{m,N}$, so in particular $c_{0,N} = 0$. Thus we may assume that $m > 0$, and note that the summands for $n = m + k$ and $n = m - k$ cancel as long as they are in the range between $-N$ and N , that is, for $1 \leq k \leq N - m$. Thus $c_{m,N}$ equals the alternating sum of fractions of decreasing size given by the remaining terms, where the largest one occurs for $n = m - (N - m) - 1 = 2m - N - 1$, that is $m - n = N - m + 1$. Hence

$$c_{m,N} = (-1)^{N-m+1} \left(\frac{1}{N-m+1} - \frac{1}{N-m+2} \pm \cdots \pm \frac{1}{m+N} \right),$$

which implies that

$$|c_{m,N}| \leq \frac{1}{N-m+1}.$$

This finally yields

$$\begin{aligned} |\delta_N| &\leq \sum_{m=-N}^N \left| \frac{1}{2m+1} \right| |c_{m,N}| \leq \sum_{m=-N}^N \frac{1}{2|m|-1} |c_{m,N}| \\ &\leq 2 \sum_{m=1}^N \frac{1}{m} |c_{m,N}| \leq 2 \sum_{m=1}^N \frac{1}{m} \frac{1}{N-m+1} \\ &= 2 \sum_{m=1}^N \frac{1}{N+1} \left(\frac{1}{m} + \frac{1}{N-m+1} \right) \\ &= 2 \frac{1}{N+1} (H_N + H_N) < 4 \frac{\log N + 1}{N+1}, \end{aligned}$$

Here we use that $\frac{1}{k\ell} = \frac{1}{k+\ell} \left(\frac{1}{\ell} + \frac{1}{k} \right)$ for positive k and ℓ .

We got the estimate $H_N < \log N + 1$ for the harmonic numbers on page 13.

and this goes to 0 as N goes to infinity. \square

Appendix: The Riemann zeta function

The *Riemann zeta function* $\zeta(s)$ is defined for real $s > 1$ by

$$\zeta(s) := \sum_{n \geq 1} \frac{1}{n^s}.$$

Our estimates for H_n (see page 12) imply that the series for $\zeta(1)$ diverges, but for any real $s > 1$ it does converge. The zeta function has a canonical continuation to the entire complex plane (with one simple pole at $s = 1$), which can be constructed using power series expansions. The resulting complex function is of utmost importance for the theory of prime numbers. Let us mention four diverse connections:

(1) The remarkable identity

$$\zeta(s) = \prod_p \frac{1}{1 - p^{-s}}$$

is due to Euler. It encodes the basic fact that every natural number has a unique (!) decomposition into prime factors; using this, Euler's identity is a simple consequence of the geometric series expansion

$$\frac{1}{1 - p^{-s}} = 1 + \frac{1}{p^s} + \frac{1}{p^{2s}} + \frac{1}{p^{3s}} + \dots$$

The irrationality of $\zeta(2) = \frac{\pi^2}{6}$ together with Euler's identity implies, again, that there are infinitely many primes ...

(2) The following marvelous argument of Don Zagier computes $\zeta(4)$ from $\zeta(2)$. Consider the function

$$f(m, n) = \frac{2}{m^3 n} + \frac{1}{m^2 n^2} + \frac{2}{mn^3}$$

for integers $m, n \geq 1$. It is easily verified that for all m and n ,

$$f(m, n) - f(m + n, n) - f(m, m + n) = \frac{2}{m^2 n^2}.$$

Let us sum this equation over all $m, n \geq 1$. If $i \neq j$, then (i, j) is either of the form $(m + n, n)$ or of the form $(m, m + n)$, for $m, n \geq 1$. Thus, in the sum on the left-hand side all terms $f(i, j)$ with $i \neq j$ cancel, and so

$$\sum_{n \geq 1} f(n, n) = \sum_{n \geq 1} \frac{5}{n^4} = 5\zeta(4)$$

remains. For the right-hand side one obtains

$$\sum_{m, n \geq 1} \frac{2}{m^2 n^2} = 2 \sum_{m \geq 1} \frac{1}{m^2} \cdot \sum_{n \geq 1} \frac{1}{n^2} = 2\zeta(2)^2,$$

and out comes the equality

$$5\zeta(4) = 2\zeta(2)^2.$$

With $\zeta(2) = \frac{\pi^2}{6}$ we thus get $\zeta(4) = \frac{\pi^4}{90}$.

Another derivation via Bernoulli numbers appears in Chapter 26.

(3) It has been known for a long time that $\zeta(s)$ is a rational multiple of π^s , and hence irrational, if s is an *even* integer $s \geq 2$; see Chapter 26. In contrast, the irrationality of $\zeta(3)$ was proved by Roger Apéry only in 1979. Despite considerable effort the picture is rather incomplete about $\zeta(s)$ for the other odd integers, $s = 2t + 1 \geq 5$. However, Keith Ball and Tanguy Rivoal proved that infinitely many of the values $\zeta(2t + 1)$ are irrational. And indeed, although it is not known for any single odd value $s \geq 5$ that $\zeta(s)$ is irrational, Wadim Zudilin has proved that at least one of the four values $\zeta(5)$, $\zeta(7)$, $\zeta(9)$, and $\zeta(11)$ is irrational. We refer to the beautiful survey by Fischler.

(4) The location of the complex zeros of the zeta function is the subject of the “Riemann hypothesis”: one of the most famous and important unresolved conjectures in all of mathematics. It claims that all the nontrivial zeros $s \in \mathbb{C}$ of the zeta function satisfy $\operatorname{Re}(s) = \frac{1}{2}$. (The zeta function vanishes at all the negative even integers, which are referred to as the “trivial zeros.”)

Surprisingly, Jeff Lagarias showed that the Riemann hypothesis is equivalent to the following elementary statement: For all $n \geq 1$,

$$\sum_{d|n} d \leq H_n + \exp(H_n) \log(H_n),$$

with equality only for $n = 1$, where H_n is again the n -th harmonic number.

References

- [1] K. BALL & T. RIVOAL: *Irrationalité d’une infinité de valeurs de la fonction zêta aux entiers impairs*, *Inventiones math.* **146** (2001), 193-207.
- [2] F. BEUKERS, J. A. C. KOLK & E. CALABI: *Sums of generalized harmonic series and volumes*, *Nieuw Archief voor Wiskunde* (4) **11** (1993), 217-224.
- [3] J. M. BORWEIN & P. B. BORWEIN: *Pi and the AGM*, *Canadian Math. Soc. Series of Monographs and Advanced Texts*, Wiley, New York 1987.
- [4] J. M. BORWEIN, P. B. BORWEIN & K. DILCHER: *Pi, Euler numbers, and asymptotic expansions*, *Amer. Math. Monthly* **96** (1989), 681-687.
- [5] S. FISCHLER: *Irrationalité de valeurs de zêta (d’après Apéry, Rivoal, ...)*, *Bourbaki Seminar*, No. 910, November 2002; *Astérisque* **294** (2004), 27-62.
- [6] J. C. LAGARIAS: *An elementary problem equivalent to the Riemann hypothesis*, *Amer. Math. Monthly* **109** (2002), 534-543.
- [7] W. J. LEVEQUE: *Topics in Number Theory, Vol. I*, Addison-Wesley, Reading MA 1956.
- [8] A. M. YAGLOM & I. M. YAGLOM: *Challenging mathematical problems with elementary solutions*, Vol. II, Holden-Day, Inc., San Francisco, CA 1967.
- [9] D. ZAGIER: *Values of zeta functions and their applications*, *Proc. First European Congress of Mathematics*, Vol. II (Paris 1992), *Progress in Math.* **120**, Birkhäuser, Basel 1994, pp. 497-512.
- [10] W. ZUDILIN: *Arithmetic of linear forms involving odd zeta values*, *J. Théorie Nombres Bordeaux* **16** (2004), 251-291.

Geometry

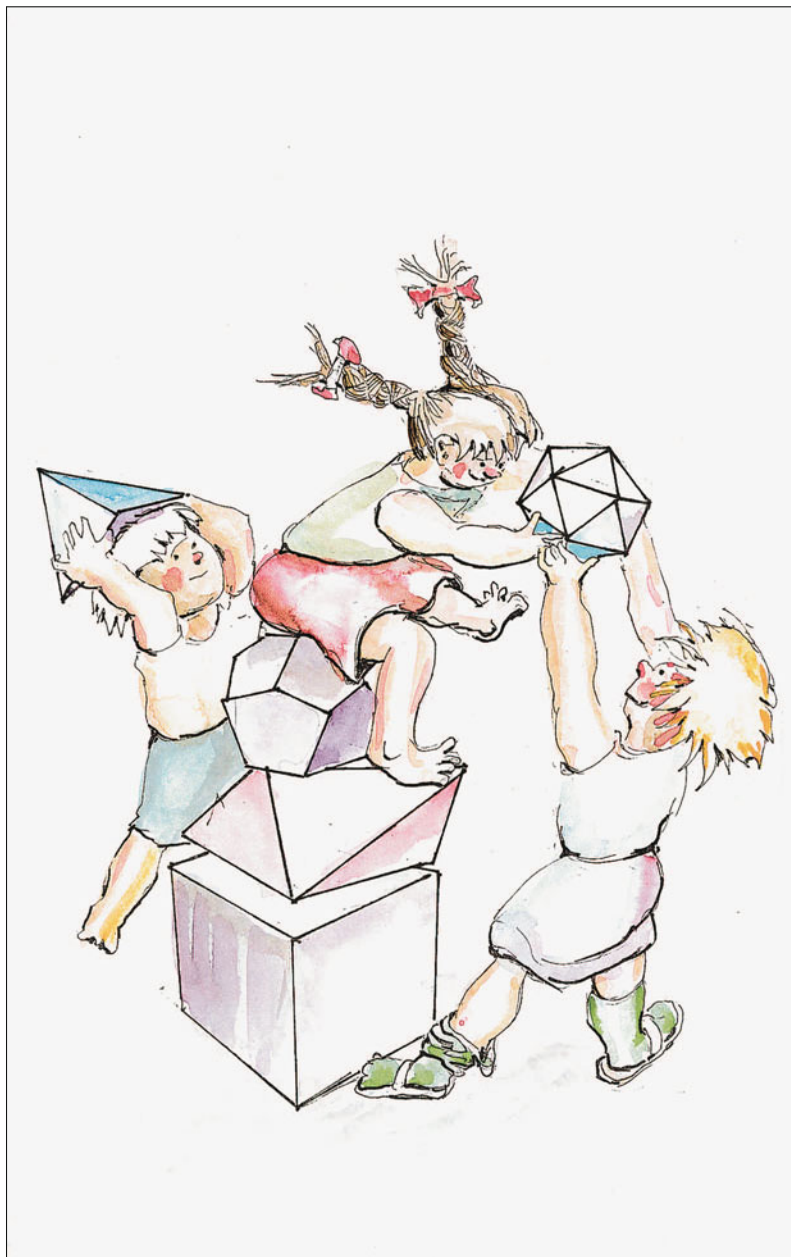

- 10**
Hilbert's third problem:
decomposing polyhedra 67
- 11**
Lines in the plane
and decompositions of graphs 77
- 12**
The slope problem 83
- 13**
Three applications
of Euler's formula 89
- 14**
Cauchy's rigidity theorem 95
- 15**
The Borromean rings
don't exist 99
- 16**
Touching simplices 107
- 17**
Every large point set
has an obtuse angle 111
- 18**
Borsuk's conjecture 117

"Platonic solids — child's play!"

Hilbert's third problem: decomposing polyhedra

Chapter 10



In his legendary address to the International Congress of Mathematicians at Paris in 1900 David Hilbert asked — as the third of his twenty-three problems — to specify

“two tetrahedra of equal bases and equal altitudes which can in no way be split into congruent tetrahedra, and which cannot be combined with congruent tetrahedra to form two polyhedra which themselves could be split up into congruent tetrahedra.”

This problem can be traced back to two letters of Carl Friedrich Gauss from 1844 (published in Gauss' collected works in 1900). If tetrahedra of equal volume could be split into congruent pieces, then this would give one an “elementary” proof of Euclid's theorem XII.5 that pyramids with the same base and height have the same volume. It would thus provide an elementary definition of the volume for polyhedra (that would not depend on continuity arguments). A similar statement is true in plane geometry: the Bolyai–Gerwien Theorem [1, Sect. 2.7] states that planar polygons are both *equidecomposable* (can be dissected into congruent triangles) and *equicomplementable* (can be made equidecomposable by adding congruent triangles) if and only if they have the same area.

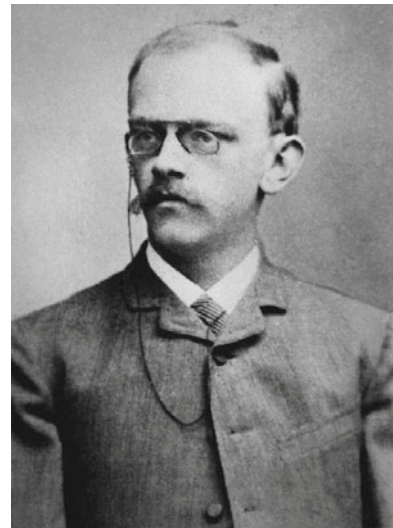

David Hilbert

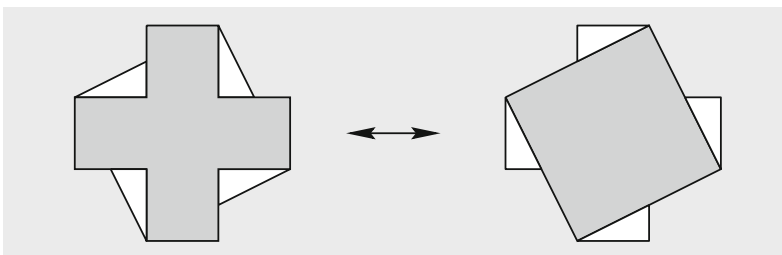

The cross is equicomplementable with a square of the same area: By adding the same four triangles we can make them equidecomposable (indeed: congruent).

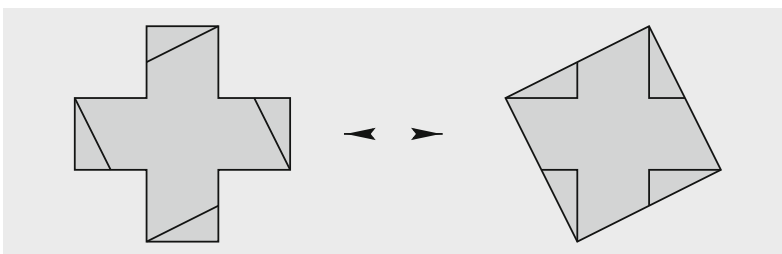

In fact, the cross and the square are even equidecomposable.

Hilbert — as we can see from his wording of the problem — did expect that there is no analogous theorem for dimension three, and he was right. In fact, the problem was completely solved by Hilbert's student Max Dehn in two papers: The first one, exhibiting non-equidecomposable tetrahedra of equal base and height, appeared already in 1900, the second one, also covering equicomplementability, appeared in 1902. However, Dehn's papers are not easy to understand, and it takes effort to see whether Dehn did not fall into a subtle trap which ensnared others: a very elegant but unfortunately wrong proof was found by Raoul Bricard (in 1896!), by Herbert Meschkowski (1960), and probably by others. However, Dehn's proof was reworked by others, clarified and redone, and after combined efforts of several authors one arrived at the "classical proof", as presented in Boltianskii's book on Hilbert's third problem and also in earlier editions of this one.

In the following, however, we take advantage of a decisive simplification that was found by V. F. Kagan from Odessa already in 1903: His integrality argument, which we here present as the "cone lemma", yields a "pearl lemma" (given here in a recent version, due to Benko), and from this we derive a correct and complete proof for "Bricard's condition" (as claimed in Bricard's 1896 paper). Once we apply this to some examples we easily obtain the solution of Hilbert's third problem.

The appendix to this chapter provides some basics about polyhedra.

As above we call two polyhedra P and Q *equidecomposable* if they can be decomposed into finite sets of polyhedra P_1, \dots, P_n and Q_1, \dots, Q_n such that P_i and Q_i are congruent for all i . Two polyhedra are *equicomplementable* if there are equidecomposable polyhedra $P = P'_1 \cup \dots \cup P'_n$ and $\tilde{Q} = Q'_1 \cup \dots \cup Q'_n$ that also have decompositions involving P and Q of the form $\tilde{P} = P \cup P'_1 \cup P'_2 \cup \dots \cup P'_m$ and $\tilde{Q} = Q \cup Q'_1 \cup Q'_2 \cup \dots \cup Q'_m$, where P'_k is congruent to Q'_k for all k . (See the large figure to the right for an illustration.) A theorem of Gerling from 1844 [1, §12] implies that for these definitions it does not matter whether we admit reflections when considering congruences, or not.

For polygons in the plane, equidecomposability and equicomplementability are defined analogously.

Clearly, equidecomposable objects are equicomplementable (this is the case $m = 0$), but the converse is far from clear. We will use "Bricard's condition" as our tool to certify — as Hilbert proposed — that certain tetrahedra of equal volume are not equicomplementable, and in particular not equidecomposable.

Before we really start to work with three-dimensional polyhedra, let us derive the pearl lemma, which is equally interesting also for planar decompositions. It refers to the *segments* in a decomposition: In any decomposition the edges of one piece may be subdivided by vertices or edges of other pieces; the pieces of this subdivision we call segments. Thus in the two-dimensional case any endpoint of a segment is given by some vertex. In the three-dimensional case the end of a segment may also be given by a crossing of two edges. However, in any case all the interior points of a segment belong to the same set of edges of pieces.

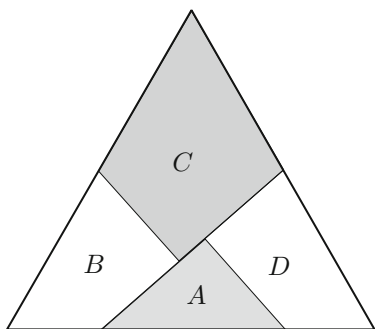
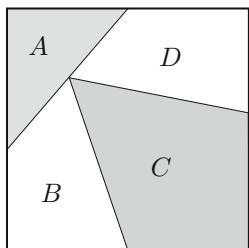

This equidecomposition of a square and an equilateral triangle into four pieces is due to Henry Dudeney (1902).

The short segment in the middle of the equilateral triangle is the intersection of pieces A and C , but it is not an edge of any one of the pieces.

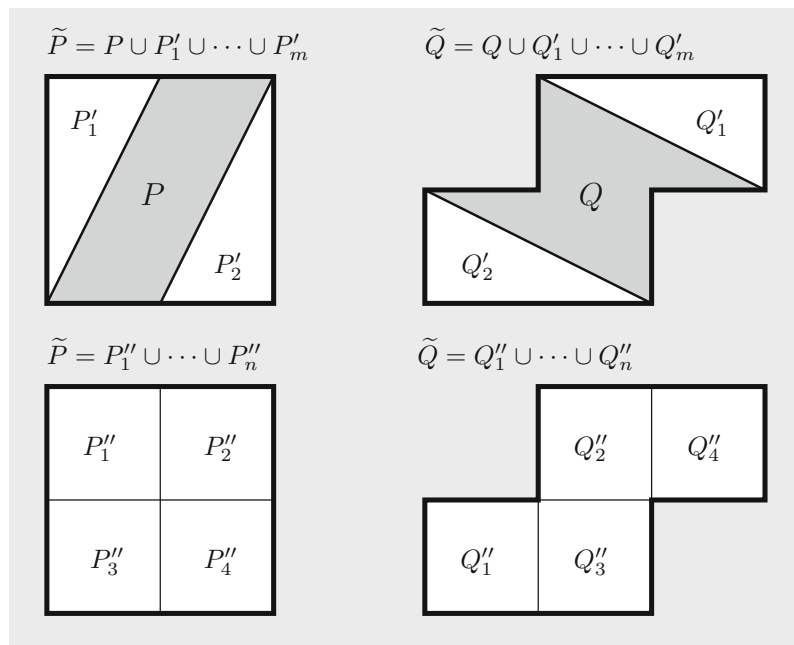

For a parallelogram P and a nonconvex hexagon Q that are equicomplementary, this figure illustrates the four decompositions we refer to.

The Pearl Lemma. *If P and Q are equidecomposable, then one can place a positive numbers of pearls (that is, assign positive integers) to all the segments of the decompositions $P = P_1 \cup \dots \cup P_n$ and $Q = Q_1 \cup \dots \cup Q_n$ in such a way that each edge of a piece P_k receives the same number of pearls as the corresponding edge of Q_k .*

■ **Proof.** Assign a variable x_i to each segment in the decomposition of P and a variable y_j to each segment in the decomposition of Q . Now we have to find positive integer values for the variables x_i and y_j in such a way that the x_i -variables corresponding to the segments of any edge of some P_k yield the same sum as the y_j -variables assigned to the segments of the corresponding edge of Q_k . This yields conditions that require that “some x_i -variables have the same sum as some y_j -values”, namely

$$\sum_{i:s_i \subseteq e} x_i - \sum_{j:s'_j \subseteq e'} y_j = 0$$

where the edge $e \subseteq P_k$ decomposes into the segments s_i , while the corresponding edge $e' \subseteq Q_k$ decomposes into the segments s'_j . This is a linear equation with integer coefficients.

We note, however, that positive real values satisfying all these requirements exist, namely the (real) lengths of the segments! Thus we are done, in view of the following lemma. □

The polygons P and Q considered in the figure above are, indeed, equidecomposable. The figure to the right illustrates this, and shows a possible placement of pearls.

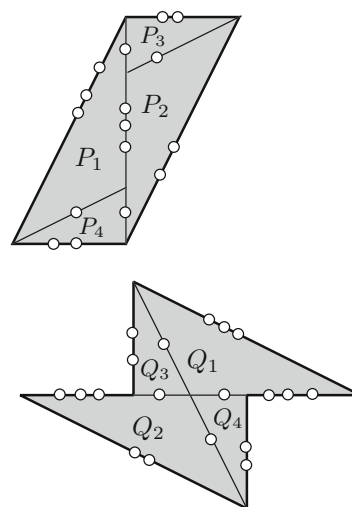

The Cone Lemma. *If a system of homogeneous linear equations with integer coefficients has a positive **real** solution, then it also has a positive **integer** solution.*

■ **Proof.** The name of this lemma stems from the interpretation that the set

$$C = \{\mathbf{x} \in \mathbb{R}^N : A\mathbf{x} = \mathbf{0}, \mathbf{x} > \mathbf{0}\}$$

given by an integer matrix $A \in \mathbb{Z}^{M \times N}$ describes a (relatively open) rational cone. We have to show that if this is nonempty, then it also contains integer points: $C \cap \mathbb{N}^N \neq \emptyset$.

If C is nonempty, then so is $\bar{C} := \{\mathbf{x} \in \mathbb{R}^N : A\mathbf{x} = \mathbf{0}, \mathbf{x} \geq \mathbf{1}\}$, since for any positive vector a suitable multiple will have all coordinates equal to or larger than 1. (Here $\mathbf{1}$ denotes the vector with all coordinates equal to 1.) It suffices to verify that $\bar{C} \subseteq C$ contains a point with *rational* coordinates, since then multiplication with a common denominator for all coordinates will yield an integer point in $\bar{C} \subseteq C$.

There are many ways to prove this. We follow a well-trodden path that was first explored by Fourier and Motzkin [8, Lecture 1]: By “Fourier–Motzkin elimination” we show that the lexicographically smallest solution to the system

$$A\mathbf{x} = \mathbf{0}, \mathbf{x} \geq \mathbf{1}$$

exists, and that it is rational if the matrix A is integral.

Indeed, any linear equation $\mathbf{a}^T \mathbf{x} = 0$ can be equivalently enforced by two inequalities $\mathbf{a}^T \mathbf{x} \geq 0$, $-\mathbf{a}^T \mathbf{x} \geq 0$. (Here \mathbf{a} denotes a column vector and \mathbf{a}^T its transpose.) Thus it suffices to prove that any system of the type

$$A\mathbf{x} \geq \mathbf{b}, \mathbf{x} \geq \mathbf{1}$$

with integral A and \mathbf{b} has a lexicographically smallest solution, which is rational, provided that the system has any real solution at all.

For this we argue with induction on N . The case $N = 1$ is clear. For $N > 1$ look at all the inequalities that involve x_N . If $\mathbf{x}' = (x_1, \dots, x_{N-1})$ is fixed, these inequalities give lower bounds on x_N (among them $x_N \geq 1$) and possibly also upper bounds. So we form a new system $A'\mathbf{x}' \geq \mathbf{b}$, $\mathbf{x}' \geq \mathbf{1}$ in $N - 1$ variables, which contains all the inequalities from the system $A\mathbf{x} \geq \mathbf{b}$ that do not involve x_N , as well as all the inequalities obtained by requiring that all upper bounds on x_N (if there are any) are larger or equal to all the lower bounds on x_N (which include $x_N \geq 1$). This system in $N - 1$ variables has a solution, and thus by induction it has a lexicographically minimal solution \mathbf{x}'_* , which is rational. And then the smallest x_N compatible with this solution \mathbf{x}'_* is easily found, it is determined by a linear equation or inequality with integer coefficients, and thus it is rational as well. \square

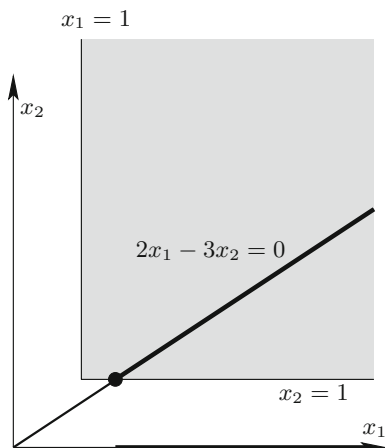

Example: Here \bar{C} is given by $2x_1 - 3x_2 = 0$, $x_i \geq 1$. Eliminating x_2 yields $x_1 \geq \frac{3}{2}$. The lexicographically minimal solution to the system is $(\frac{3}{2}, 1)$.

Now we focus on decompositions of three-dimensional polyhedra. The *dihedral angles*, that is, the angles between adjacent facets, play a decisive role in the following theorem.

Theorem. (“Bricard’s condition”)

If three-dimensional polyhedra P and Q with dihedral angles $\alpha_1, \dots, \alpha_r$ resp. β_1, \dots, β_s are equidecomposable, then there are positive integers m_i, n_j and an integer k with

$$m_1\alpha_1 + \dots + m_r\alpha_r = n_1\beta_1 + \dots + n_s\beta_s + k\pi.$$

The same holds more generally if P and Q are equicomplementable.

■ **Proof.** Let us first assume that P and Q are equidecomposable, with decompositions $P = P_1 \cup \dots \cup P_n$ and $Q = Q_1 \cup \dots \cup Q_n$, where P_i is congruent to Q_i . We assign a positive number of pearls to every segment in both decompositions, according to the pearl lemma.

Let Σ_1 be the sum of all the dihedral angles at all the pearls in the pieces of the decomposition of P . If an edge of a piece P_i contains several pearls, then the dihedral angle at this edge will appear several times in the sum Σ_1 . If a pearl is contained in several pieces, then several angles are added for this pearl, but they are all measured in the plane through the pearl that is orthogonal to the corresponding segment. If the segment is contained in an edge of P , the addition yields the (interior) dihedral angle α_j at the edge. The addition yields the angle π in the case that the segment lies in the boundary of P but not on an edge. If the pearl/the segment lies in the interior of P , then the sum of dihedral angles yields 2π or π . (The latter case occurs in case the pearl lies in the interior of a face of a piece P_i .)

Thus we get a representation

$$\Sigma_1 = m_1\alpha_1 + \dots + m_r\alpha_r + k_1\pi$$

for positive integers m_j ($1 \leq j \leq r$) and nonnegative k_1 . Similarly for the sum Σ_2 of all the angles at the pearls of the decomposition of Q we get

$$\Sigma_2 = n_1\beta_1 + \dots + n_s\beta_s + k_2\pi$$

for positive integers n_j ($1 \leq j \leq s$) and nonnegative k_2 .

However, we can also obtain the sums Σ_1 and Σ_2 by adding all the contributions in the individual pieces P_i and Q_i . Since P_i and Q_i are congruent, we measure the same dihedral angles at the corresponding edges, and the Pearl Lemma guarantees that we get the same number of pearls from the decompositions of P resp. Q at the corresponding edges. Thus we get $\Sigma_1 = \Sigma_2$, which yields Bricard’s condition (with $k = k_2 - k_1 \in \mathbb{Z}$) for the case of equidecomposability.

Now let us assume that P and Q are equicomplementable, that is, that we have decompositions

$$\tilde{P} = P \cup P'_1 \cup \dots \cup P'_m \quad \text{and} \quad \tilde{Q} = Q \cup Q'_1 \cup \dots \cup Q'_m,$$

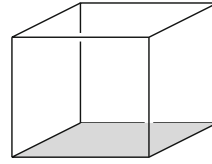

In a cube, all dihedral angles are $\frac{\pi}{2}$.

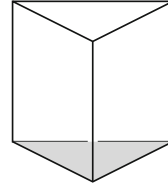

For a prism over an equilateral triangle, we get the dihedral angles $\frac{\pi}{3}$ and $\frac{\pi}{2}$.

where P'_i and Q'_i are congruent, and such that \tilde{P} and \tilde{Q} are equidecomposable, as

$$\tilde{P} = P''_1 \cup \dots \cup P''_n \quad \text{and} \quad \tilde{Q} = Q''_1 \cup \dots \cup Q''_n,$$

where P''_i and Q''_i are congruent (as in the figure on page 69). Again, using the pearl lemma, we place pearls to all the segments in all four decompositions, where we impose the extra condition that each edge of \tilde{P} gets the same total number of pearls in both decompositions, and similarly for \tilde{Q} . (The proof of the pearl lemma via the cone lemma allows for such extra restrictions!) We also compute the sums of angles at pearls Σ'_1 and Σ'_2 as well as Σ''_1 and Σ''_2 .

The angle sums Σ''_1 and Σ''_2 refer to decompositions of different polyhedra, \tilde{P} and \tilde{Q} , into *the same set of pieces*, hence we get $\Sigma''_1 = \Sigma''_2$ as above.

The angle sums Σ'_1 and Σ'_2 refer to different decompositions of *the same polyhedron*, \tilde{P} . Since we have put the same number of pearls onto the edges in both decompositions, the argument above yields $\Sigma'_1 = \Sigma''_1 + \ell_1\pi$ for an integer $\ell_1 \in \mathbb{Z}$. The same way we also get $\Sigma'_2 = \Sigma''_2 + \ell_2\pi$ for an integer $\ell_2 \in \mathbb{Z}$. Thus we conclude that

$$\Sigma'_2 = \Sigma'_1 + \ell\pi \quad \text{for } \ell = \ell_2 - \ell_1 \in \mathbb{Z}.$$

However, Σ'_1 and Σ'_2 refer to decompositions of \tilde{P} resp. \tilde{Q} into the same pieces, *except* that the first one uses P as a piece, while the second uses Q . Thus subtracting the contributions of P'_i resp. Q'_i from both sides, we obtain the desired conclusion: the contributions of P and Q to the respective angle sums,

$$m_1\alpha_1 + \dots + m_r\alpha_r \quad \text{and} \quad n_1\beta_1 + \dots + n_s\beta_s,$$

where m_j counts the pearls on edges with dihedral angle α_j in P and n_j counts the pearls on edges with dihedral angle β_j in Q , differ by an integer multiple of π , namely by $\ell\pi$. \square

From Bricard's condition we now get a complete solution for Hilbert's third problem: We just have to compute the dihedral angles for some examples.

Example 1. For a regular tetrahedron T_0 with edge lengths ℓ , we calculate the dihedral angle from the sketch. The midpoint M of the base triangle divides the height AE of the base triangle by 1:2, and since $|AE| = |DE|$, we find $\cos \alpha = \frac{1}{3}$, and thus

$$\alpha = \arccos \frac{1}{3}.$$

Thus we find that a *regular tetrahedron cannot be equidecomposable or equicomplementable with a cube*. Indeed, all the dihedral angles in a cube equal $\frac{\pi}{2}$, so Bricard's condition requires that

$$m_1 \arccos \frac{1}{3} = n_1 \frac{\pi}{2} + k\pi$$

for positive integers m_1, n_1 and an integer k . But this cannot hold, since we know from Theorem 3 of Chapter 8 that $\frac{1}{\pi} \arccos \frac{1}{3}$ is irrational.

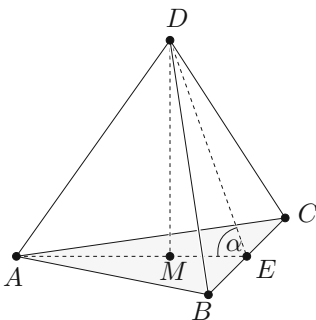

Example 2. Let T_1 be a tetrahedron spanned by three orthogonal edges AB , AC , AD of length u . This tetrahedron has three dihedral angles that are right angles, and three more dihedral angles of equal size φ , which we calculate from the sketch as

$$\cos \varphi = \frac{|AE|}{|DE|} = \frac{\frac{1}{2}\sqrt{2}u}{\frac{1}{2}\sqrt{3}\sqrt{2}u} = \frac{1}{\sqrt{3}}.$$

It follows that

$$\varphi = \arccos \frac{1}{\sqrt{3}}.$$

Thus the only dihedral angles occurring in T_1 are π , $\frac{\pi}{2}$, and $\arccos \frac{1}{\sqrt{3}}$. From this Bricard's condition tells us that this tetrahedron as well is not equicomplementable with a cube of the same volume, this time using that

$$\frac{1}{\pi} \arccos \frac{1}{\sqrt{3}}$$

is irrational, as we proved in Chapter 8 (take $n = 3$ in Theorem 3).

Example 3. Finally, let T_2 be a tetrahedron with three consecutive edges AB , BC and CD that are mutually orthogonal (an "orthoscheme") and of the same length u .

It is easy to calculate the angles in such a tetrahedron (three of them equal $\frac{\pi}{2}$, two of them equal $\frac{\pi}{4}$, and one of them is $\frac{\pi}{3}$), if we use that the cube of side length u can be decomposed into six tetrahedra of this type (three congruent copies, and three mirror images). Thus all dihedral angles in T_2 are rational multiples of π , and thus with the same proofs as above (in particular, the irrationality results that we have quoted from Chapter 8) Bricard's Condition implies that T_2 is not equidecomposable, and not even equicomplementable, with T_0 or T_1 .

This solves Hilbert's third problem, since T_1 and T_2 have congruent bases and the same height.

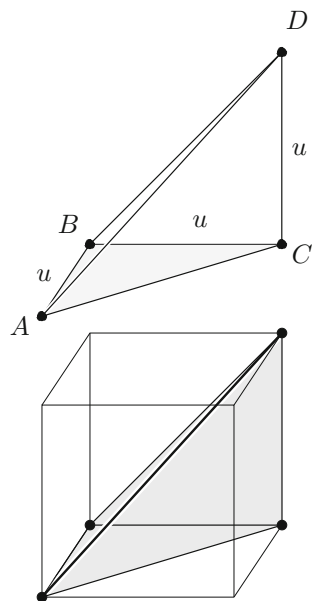
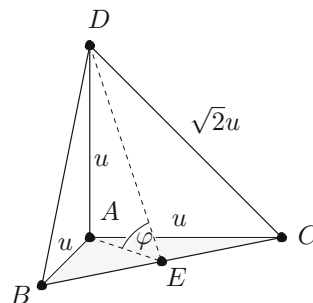

Appendix: Polytopes and polyhedra

A *convex polytope* in \mathbb{R}^d is the convex hull of a finite set $S = \{s_1, \dots, s_n\}$, that is, a set of the form

$$P = \text{conv}(S) := \left\{ \sum_{i=1}^n \lambda_i s_i : \lambda_i \geq 0, \sum_{i=1}^n \lambda_i = 1 \right\}.$$

Polytopes are certainly familiar objects: Prime examples are given by convex *polygons* (2-dimensional convex polytopes) and by convex *polyhedra* (3-dimensional convex polytopes).

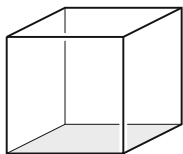
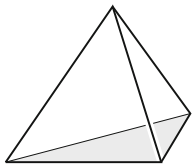

Familiar polytopes:
tetrahedron and cube

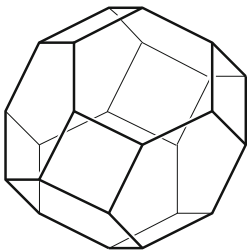

The permutahedron has 24 vertices,
36 edges and 14 facets.

There are several types of polyhedra that generalize to higher dimensions in a natural way. For example, if the set S is affinely independent of cardinality $d + 1$, then $\text{conv}(S)$ is a d -dimensional *simplex* (or d -*simplex*). For $d = 2$ this yields a triangle, for $d = 3$ we obtain a tetrahedron. Similarly, squares and cubes are special cases of d -cubes, such as the *unit d -cube* given by

$$C_d = [0, 1]^d \subseteq \mathbb{R}^d.$$

General polytopes are defined as finite unions of convex polytopes. In this book nonconvex polyhedra will appear in connection with Cauchy's rigidity theorem in Chapter 14, and nonconvex polygons in connection with Pick's theorem in Chapter 13, and again when we discuss the art gallery theorem in Chapter 40.

Convex polytopes can, equivalently, be defined as the bounded solution sets of finite systems of linear inequalities. Thus every convex polytope $P \subseteq \mathbb{R}^d$ has a representation of the form

$$P = \{\mathbf{x} \in \mathbb{R}^d : A\mathbf{x} \leq \mathbf{b}\}$$

for some matrix $A \in \mathbb{R}^{m \times d}$ and a vector $\mathbf{b} \in \mathbb{R}^m$. In other words, P is the solution set of a system of m linear inequalities

$$\mathbf{a}_i^T \mathbf{x} \leq b_i,$$

where \mathbf{a}_i^T is the i -th row of A . Conversely, every bounded such solution set is a convex polytope, and can thus be represented as the convex hull of a finite set of points.

For polygons and polyhedra, we have the familiar concepts of *vertices*, *edges*, and *2-faces*. For higher-dimensional convex polytopes, we can define their faces as follows: a *face* of P is a subset $F \subseteq P$ of the form

$$P \cap \{\mathbf{x} \in \mathbb{R}^d : \mathbf{a}^T \mathbf{x} = b\},$$

where $\mathbf{a}^T \mathbf{x} \leq b$ is a linear inequality that is valid for all points $\mathbf{x} \in P$.

All the faces of a polytope are themselves polytopes. The set V of vertices (0-dimensional faces) of a convex polytope is also the inclusion-minimal set such that $\text{conv}(V) = P$. Assuming that $P \subseteq \mathbb{R}^d$ is a d -dimensional convex polytope, the *facets* (the $(d-1)$ -dimensional faces) determine a minimal set of hyperplanes and thus of halfspaces that contain P , and whose intersection is P . In particular, this implies the following fact that we will need later: Let F be a facet of P , denote by H_F the hyperplane it determines, and by H_F^+ and H_F^- the two closed half-spaces bounded by H_F . Then one of these two halfspaces contains P (and the other one doesn't).

The *graph* $G(P)$ of the convex polytope P is given by the set V of vertices, and by the edge set E of 1-dimensional faces. If P has dimension 3, then this graph is planar, and gives rise to the famous "Euler polyhedron formula" (see Chapter 13).

Two polytopes $P, P' \subseteq \mathbb{R}^d$ are *congruent* if there is some length-preserving affine map that takes P to P' . Such a map may reverse the orientation of space, as does the reflection of P in a hyperplane, which takes P to a *mirror image* of P . They are *combinatorially equivalent* if there is a bijection from the faces of P to the faces of P' that preserves dimension and inclusions between the faces. This notion of combinatorial equivalence is much weaker than congruence: for example, our figure shows a unit cube and a “skew” cube that are combinatorially equivalent (and thus we would call any one of them “a cube”), but they are certainly not congruent.

A polytope (or a more general subset of \mathbb{R}^d) is called *centrally symmetric* if there is some point $x_0 \in \mathbb{R}^d$ such that

$$x_0 + x \in P \iff x_0 - x \in P.$$

In this situation we call x_0 the *center* of P .

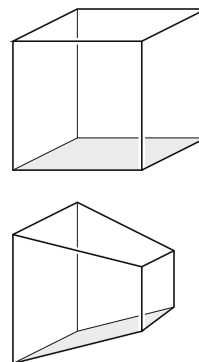

Combinatorially equivalent polytopes

References

- [1] V. G. BOLTJANSKII: *Hilbert's Third Problem*, V. H. Winston & Sons (Halsted Press, John Wiley & Sons), Washington DC 1978.
- [2] D. BENKO: *A new approach to Hilbert's third problem*, Amer. Math. Monthly, **114** (2007), 665-676.
- [3] M. DEHN: *Ueber raumgleiche Polyeder*, Nachrichten von der Königl. Gesellschaft der Wissenschaften, Mathematisch-physikalische Klasse (1900), 345-354.
- [4] M. DEHN: *Ueber den Rauminhalt*, Mathematische Annalen **55** (1902), 465-478.
- [5] C. F. GAUSS: “*Congruenz und Symmetrie*”: *Briefwechsel mit Gerling*, pp. 240-249 in: *Werke*, Band VIII, Königl. Gesellschaft der Wissenschaften zu Göttingen; B. G. Teubner, Leipzig 1900.
- [6] D. HILBERT: *Mathematical Problems*, Lecture delivered at the International Congress of Mathematicians at Paris in 1900, Bulletin Amer. Math. Soc. **8** (1902), 437-479.
- [7] B. KAGAN: *Über die Transformation der Polyeder*, Mathematische Annalen **57** (1903), 421-424.
- [8] G. M. ZIEGLER: *Lectures on Polytopes*, Graduate Texts in Mathematics **152**, Springer, New York 1995/1998.

Lines in the plane and decompositions of graphs

Chapter 11



Perhaps the best-known problem on configurations of lines was raised by Sylvester in 1893 in a column of mathematical problems.

QUESTIONS FOR SOLUTION.

11851. (PROFESSOR SYLVESTER.)—Prove that it is not possible to arrange any finite number of real points so that a right line through every two of them shall pass through a third, unless they all lie in the same right line.

Whether Sylvester himself had a proof is in doubt, but a correct proof was given by Tibor Gallai [Grünwald] some 40 years later. Therefore the following theorem is commonly attributed to Sylvester and Gallai. Subsequent to Gallai's proof several others appeared, but the following argument due to L. M. Kelly may be "simply the best."

Theorem 1. *In any configuration of n points in the plane, not all on a line, there is a line which contains exactly two of the points.*

■ **Proof.** Let \mathcal{P} be the given set of points and consider the set \mathcal{L} of all lines which pass through at least two points of \mathcal{P} . Among all pairs (P, ℓ) with P not on ℓ , choose a pair (P_0, ℓ_0) such that P_0 has the smallest distance to ℓ_0 , with Q being the point on ℓ_0 closest to P_0 (that is, on the line through P_0 vertical to ℓ_0).

Claim. *This line ℓ_0 does it!*

If not, then ℓ_0 contains at least three points of \mathcal{P} , and thus two of them, say P_1 and P_2 , lie on the same side of Q . Let us assume that P_1 lies between Q and P_2 , where P_1 possibly coincides with Q . The figure on the right shows the configuration. It follows that the distance of P_1 to the line ℓ_1 determined by P_0 and P_2 is smaller than the distance of P_0 to ℓ_0 , and this contradicts our choice for ℓ_0 and P_0 . □

In the proof we have used metric axioms (shortest distance) and order axioms (P_1 lies between Q and P_2) of the real plane. Do we really need these properties beyond the usual incidence axioms of points and lines? Well, some additional condition is required, as the famous Fano plane depicted in the margin demonstrates. Here $\mathcal{P} = \{1, 2, \dots, 7\}$ and \mathcal{L} consists of the 7 three-point lines as indicated in the figure, including the "line" $\{4, 5, 6\}$. Any two points determine a unique line, so the incidence axioms are satisfied, but there is no 2-point line. The Sylvester–Gallai theorem therefore shows that the Fano configuration cannot be embedded into the real plane such that the seven collinear triples lie on real lines: there must always be a "crooked" line.



J. J. Sylvester

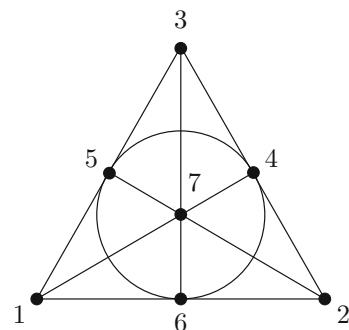
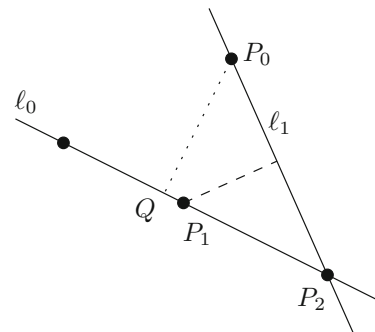

However, it was shown by Coxeter that the order axioms will suffice for a proof of the Sylvester–Gallai theorem. Thus one can devise a proof that does not use any metric properties — see also the proof that we will give in Chapter 13, using Euler’s formula.

Armed with Theorem 1, we may ask how many such two-point lines every n -point configuration in the plane must contain. After many partial results, the definitive answer was given very recently by Ben Green and Terence Tao: There is a constant n_0 such that every configuration of $n \geq n_0$ points, not all on a line, contains at least $n/2$ two-point lines, and this is best possible — if n is even. In the case when n is odd, they prove that there are even at least $3\lfloor n/4 \rfloor$ such lines, and again this is best possible.

The Sylvester–Gallai theorem directly implies another famous result on points and lines in the plane, due to Paul Erdős and Nicolaas G. de Bruijn. But in this case the result holds more generally for arbitrary point-line systems, as was observed already by Erdős and de Bruijn. We will discuss the more general result in a moment.

Theorem 2. *Let \mathcal{P} be a set of $n \geq 3$ points in the plane, not all on a line. Then the set \mathcal{L} of lines passing through at least two points contains at least n lines.*

■ **Proof.** For $n = 3$ there is nothing to show. Now we proceed by induction on n . Let $|\mathcal{P}| = n + 1$. By the previous theorem there exists a line $\ell_0 \in \mathcal{L}$ containing exactly two points P and Q of \mathcal{P} . Consider the set $\mathcal{P}' = \mathcal{P} \setminus \{Q\}$ and the set \mathcal{L}' of lines determined by \mathcal{P}' . If the points of \mathcal{P}' do not all lie on a single line, then by induction $|\mathcal{L}'| \geq n$ and hence $|\mathcal{L}| \geq n + 1$ because of the additional line ℓ_0 in \mathcal{L} . If, on the other hand, the points in \mathcal{P}' are all on a single line, then we have the “pencil” which results in precisely $n + 1$ lines. \square

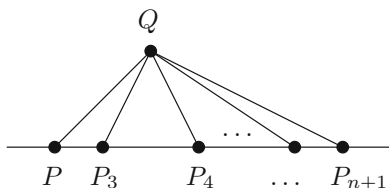

Now, as promised, here is the general result, which applies to much more general “incidence geometries.”

Theorem 3. *Let X be a set of $n \geq 3$ elements, and let A_1, \dots, A_m be proper subsets of X , such that every pair of elements of X is contained in precisely one set A_i . Then $m \geq n$ holds.*

■ **Proof.** The following proof, variously attributed to Motzkin or Conway, is almost one-line and truly inspired. For $x \in X$ let r_x be the number of sets A_i containing x . (Note that $2 \leq r_x < m$ by the assumptions.) Now if $x \notin A_i$, then $r_x \geq |A_i|$ because the $|A_i|$ sets containing x and an element of A_i must be distinct. Suppose $m < n$, then $m|A_i| < nr_x$ and thus $m(n - |A_i|) > n(m - r_x)$ for $x \notin A_i$, and we find

$$1 = \sum_{x \in X} \frac{1}{n} = \sum_{x \in X} \sum_{A_i: x \notin A_i} \frac{1}{n(m - r_x)} > \sum_{A_i} \sum_{x: x \notin A_i} \frac{1}{m(n - |A_i|)} = \sum_{A_i} \frac{1}{m} = 1,$$

which is absurd. \square

There is another very short proof for this theorem that uses linear algebra. Let B be the *incidence matrix* of $(X; A_1, \dots, A_m)$, that is, the rows in B are indexed by the elements of X , the columns by A_1, \dots, A_m , where

$$B_{xA} := \begin{cases} 1 & \text{if } x \in A \\ 0 & \text{if } x \notin A. \end{cases}$$

Consider the product BB^T . For $x \neq x'$ we have $(BB^T)_{xx'} = 1$, since x and x' are contained in precisely one set A_i , hence

$$BB^T = \begin{pmatrix} r_{x_1}-1 & 0 & \dots & 0 \\ 0 & r_{x_2}-1 & & \vdots \\ \vdots & & \ddots & 0 \\ 0 & \dots & 0 & r_{x_n}-1 \end{pmatrix} + \begin{pmatrix} 1 & 1 & \dots & 1 \\ 1 & 1 & & \vdots \\ \vdots & & \ddots & 1 \\ 1 & \dots & 1 & 1 \end{pmatrix}$$

where r_x is defined as above. Since the first matrix is positive definite (it has only positive eigenvalues) and the second matrix is positive semi-definite (it has the eigenvalues n and 0), we deduce that BB^T is positive definite and thus, in particular, invertible, implying $\text{rank}(BB^T) = n$. It follows that the rank of the $n \times m$ matrix B is at least n , and we conclude that indeed $n \leq m$, since the rank cannot exceed the number of columns.

Let us go a little beyond and turn to graph theory. (We refer to the review of basic graph concepts in the appendix to this chapter.) A moment's thought shows that the following statement is really the same as Theorem 3:

If we decompose a complete graph K_n into m cliques different from K_n , such that every edge is in a unique clique, then $m \geq n$.

Indeed, let X correspond to the vertex set of K_n and the sets A_i to the vertex sets of the cliques, then the statements are identical.

Our next task is to decompose K_n into complete bipartite graphs such that again every edge is in exactly one of these graphs. There is an easy way to do this. Number the vertices $\{1, 2, \dots, n\}$. First take the complete bipartite graph joining 1 to all other vertices. Thus we obtain the graph $K_{1,n-1}$ which is called a *star*. Next join 2 to 3, \dots , n , resulting in a star $K_{1,n-2}$. Going on like this, we decompose K_n into stars $K_{1,n-1}, K_{1,n-2}, \dots, K_{1,1}$. This decomposition uses $n - 1$ complete bipartite graphs. Can we do better, that is, use fewer graphs? No, as the following result of Ron Graham and Henry O. Pollak says:

Theorem 4. *If K_n is decomposed into complete bipartite subgraphs H_1, \dots, H_m , then $m \geq n - 1$.*

The interesting thing is that, in contrast to the Erdős–de Bruijn theorem, no combinatorial proof for this result is known! All of them use linear algebra in one way or another. Of the various more or less equivalent ideas let us look at the proof due to Tverberg, which may be the most transparent.

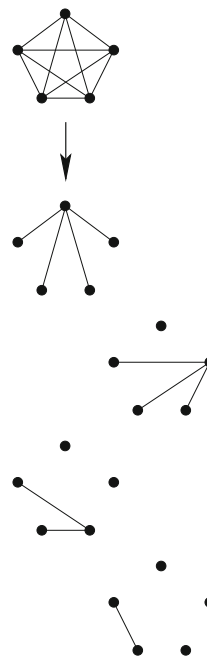

A decomposition of K_5 into 4 complete bipartite subgraphs

■ **Proof.** Let the vertex set of K_n be $\{1, \dots, n\}$, and let L_j, R_j be the defining vertex sets of the complete bipartite graph H_j , $j = 1, \dots, m$. To every vertex i we associate a variable x_i . Since H_1, \dots, H_m decompose K_n , we find

$$\sum_{i < j} x_i x_j = \sum_{k=1}^m \left(\sum_{a \in L_k} x_a \cdot \sum_{b \in R_k} x_b \right). \quad (1)$$

Now suppose the theorem is false, $m < n - 1$. Then the system of linear equations

$$\begin{aligned} x_1 + \dots + x_n &= 0, \\ \sum_{a \in L_k} x_a &= 0 \quad (k = 1, \dots, m) \end{aligned}$$

has fewer equations than variables, hence there exists a nontrivial solution c_1, \dots, c_n . From (1) we infer

$$\sum_{i < j} c_i c_j = 0.$$

But this implies

$$0 = (c_1 + \dots + c_n)^2 = \sum_{i=1}^n c_i^2 + 2 \sum_{i < j} c_i c_j = \sum_{i=1}^n c_i^2 > 0,$$

a contradiction, and the proof is complete. \square

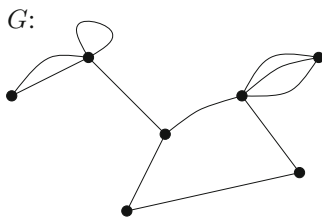

A graph G with 7 vertices and 11 edges. It has one loop, one double edge and one triple edge.

Appendix: Basic graph concepts

Graphs are among the most basic of all mathematical structures. Correspondingly, they have many different versions, representations, and incarnations. Abstractly, a *graph* is a pair $G = (V, E)$, where V is the set of *vertices*, E is the set of *edges*, and each edge $e \in E$ “connects” two vertices $v, w \in V$. We consider only finite graphs, where V and E are finite.

Usually, we deal with *simple graphs*: Then we do not admit *loops*, i. e., edges for which both ends coincide, and no *multiple edges* that have the same set of endvertices. Vertices of a graph are called *adjacent* or *neighbors* if they are the endvertices of an edge. A vertex and an edge are called *incident* if the edge has the vertex as an endvertex.

Here is a little picture gallery of important (simple) graphs:

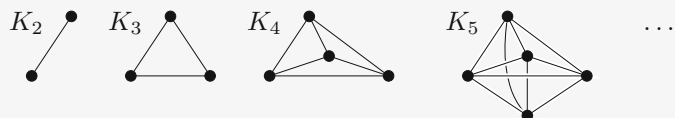

The *complete graphs* K_n on n vertices and $\binom{n}{2}$ edges

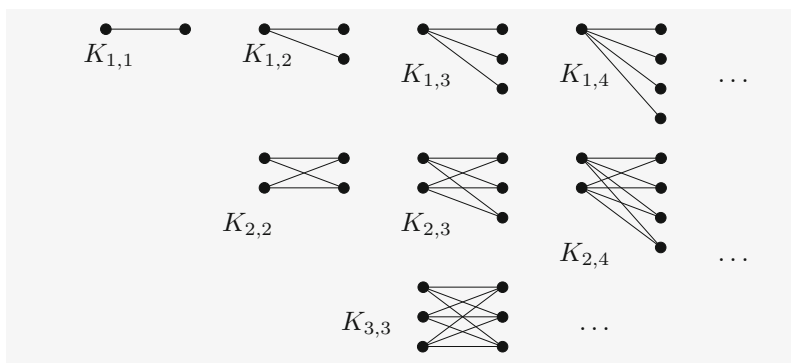

The complete bipartite graphs $K_{m,n}$ with $m + n$ vertices and mn edges

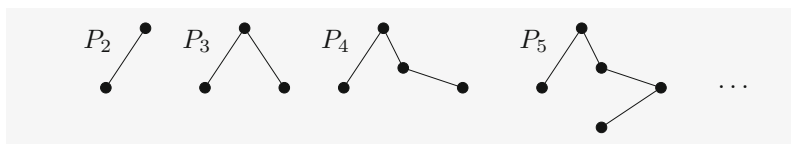

The paths P_n with n vertices

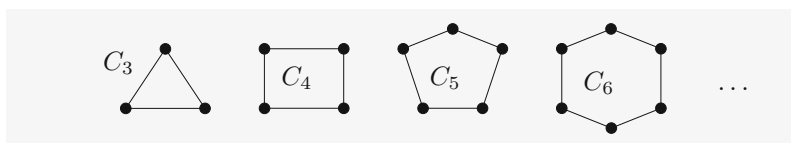

The cycles C_n with n vertices

Two graphs $G = (V, E)$ and $G' = (V', E')$ are considered *isomorphic* if there are bijections $V \rightarrow V'$ and $E \rightarrow E'$ that preserve the incidences between edges and their endvertices. (It is a major unsolved problem whether there is an efficient test to decide whether two given graphs are isomorphic.) This notion of isomorphism allows us to talk about *the* complete graph K_5 on 5 vertices, etc.

$G' = (V', E')$ is a *subgraph* of $G = (V, E)$ if $V' \subseteq V$, $E' \subseteq E$, and every edge $e \in E'$ has the same endvertices in G' as in G . G' is an *induced subgraph* if, additionally, *all* edges of G that connect vertices of G' are also edges of G' .

Many notions about graphs are quite intuitive: for example, a graph G is *connected* if every two distinct vertices are connected by a path in G , or equivalently, if G cannot be split into two nonempty subgraphs whose vertex sets are disjoint. Any graph decomposes into its *connected components*.

We end this survey of basic graph concepts with a few more pieces of terminology: A *clique* in G is a complete subgraph. An *independent set* in G is an induced subgraph without edges, that is, a subset of the vertex set such that no two vertices are connected by an edge of G . A graph is a *forest* if it does not contain any cycles. A *tree* is a connected forest. Finally, a graph $G = (V, E)$ is *bipartite* if it is isomorphic to a subgraph of a complete bipartite graph, that is, if its vertex set can be written as a union $V = V_1 \cup V_2$ of two independent sets.

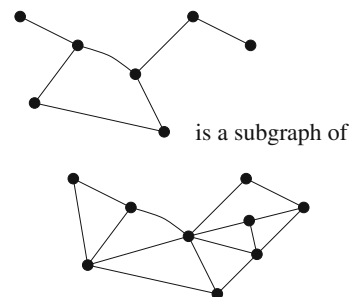

References

- [1] N. G. DE BRUIJN & P. ERDŐS: *On a combinatorial problem*, Proc. Kon. Ned. Akad. Wetensch. **51** (1948), 1277-1279.
- [2] H. S. M. COXETER: *A problem of collinear points*, Amer. Math. Monthly **55** (1948), 26-28 (contains Kelly's proof).
- [3] P. ERDŐS: *Problem 4065 — Three point collinearity*, Amer. Math. Monthly **51** (1944), 169-171 (contains Gallai's proof).
- [4] R. L. GRAHAM & H. O. POLLAK: *On the addressing problem for loop switching*, Bell System Tech. J. **50** (1971), 2495-2519.
- [5] B. GREEN & T. TAO: *On sets defining few ordinary lines*, Discrete Comput. Geometry **50** (2013), 409-468.
- [6] J. J. SYLVESTER: *Mathematical Question 11851*, The Educational Times **46** (1893), 156.
- [7] H. TVERBERG: *On the decomposition of K_n into complete bipartite graphs*, J. Graph Theory **6** (1982), 493-494.



Try for yourself — before you read much further — to construct configurations of points in the plane that determine “relatively few” slopes. For this we assume, of course, that the $n \geq 3$ points do not all lie on one line. Recall from Chapter 11 on “Lines in the plane” the theorem of Erdős and de Bruijn: the n points will determine at least n different lines. But of course many of these lines may be parallel, and thus determine the same slope.

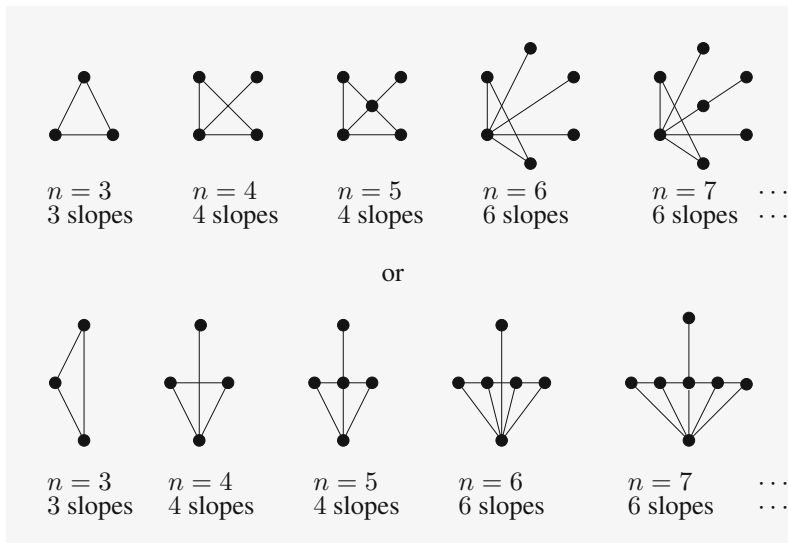

A little experimentation for small n will probably lead you to a sequence such as the two depicted here.

After some attempts at finding configurations with fewer slopes you might conjecture — as Scott did in 1970 — the following theorem.

Theorem. *If $n \geq 3$ points in the plane do not lie on one single line, then they determine at least $n - 1$ different slopes, where equality is possible only if n is odd and $n \geq 5$.*

Our examples above — the drawings represent the first few configurations in two infinite sequences of examples — show that the theorem as stated is *best possible*: for any odd $n \geq 5$ there is a configuration with n points that determines exactly $n - 1$ different slopes, and for any other $n \geq 3$ we have a configuration with exactly n slopes.

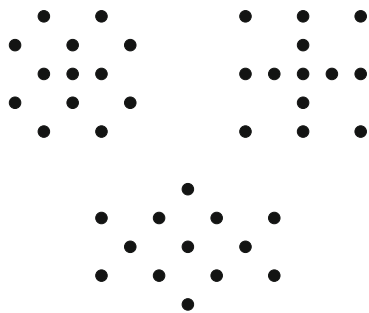

Three pretty sporadic examples from the Jamison–Hill catalogue

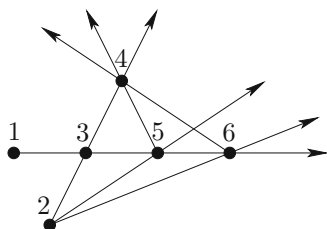

This configuration of $n = 6$ points determines $t = 6$ different slopes.

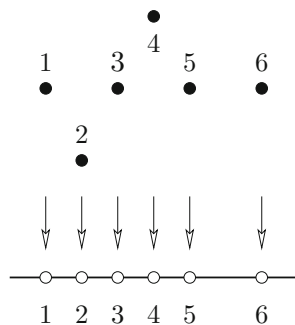

Here a vertical starting direction yields $\pi_0 = 123456$.

However, the configurations that we have drawn above are by far not the only ones. For example, Jamison and Hill described four infinite families of configurations, each of them consisting of configurations with an odd number n of points that determine only $n - 1$ slopes (“slope-critical configurations”). Furthermore, they listed 102 “sporadic” examples that do not seem to fit into an infinite family, most of them found by extensive computer searches.

Conventional wisdom might say that extremal problems tend to be very difficult to solve exactly if the extreme configurations are so diverse and irregular. Indeed, there is a lot that can be said about the structure of slope-critical configurations (see [2]), but a classification seems completely out of reach. However, the theorem above has a simple proof, which has two main ingredients: a reduction to an efficient combinatorial model due to Eli Goodman and Ricky Pollack, and a beautiful argument in this model by which Peter Ungar completed the proof in 1982.

■ **Proof.** (1) First we notice that it suffices to show that every “even” set of $n = 2m$ points in the plane ($m \geq 2$) determines at least n slopes. This is so since the case $n = 3$ is trivial, and for any set of $n = 2m + 1 \geq 5$ points (not all on a line) we can find a subset of $n - 1 = 2m$ points, not all on a line, which already determines $n - 1$ slopes.

Thus for the following we consider a configuration of $n = 2m$ points in the plane that determines $t \geq 2$ different slopes.

(2) The combinatorial model is obtained by constructing a periodic sequence of permutations. For this we start with some direction in the plane that is not one of the configuration’s slopes, and we number the points $1, \dots, n$ in the order in which they appear in the 1-dimensional projection in this direction. Thus the permutation $\pi_0 = 123\dots n$ represents the order of the points for our starting direction.

Next let the direction perform a counterclockwise motion, and watch how the projection and its permutation change. Changes in the order of the projected points appear exactly when the direction passes over one of the configuration’s slopes.

But the changes are far from random or arbitrary: By performing a 180° rotation of the direction, we obtain a sequence of permutations

$$\pi_0 \rightarrow \pi_1 \rightarrow \pi_2 \rightarrow \dots \rightarrow \pi_{t-1} \rightarrow \pi_t$$

which has the following special properties:

- The sequence starts with $\pi_0 = 123\dots n$ and ends with $\pi_t = n\dots 321$.
- The length t of the sequence is the number of slopes of the point configuration.
- In the course of the sequence, every pair $i < j$ is switched exactly once. This means that on the way from $\pi_0 = 123\dots n$ to $\pi_t = n\dots 321$, only *increasing* substrings are reversed.

- Every move consists in the reversal of one or more disjoint increasing substrings (corresponding to the one or more lines that have the direction which we pass at this point).

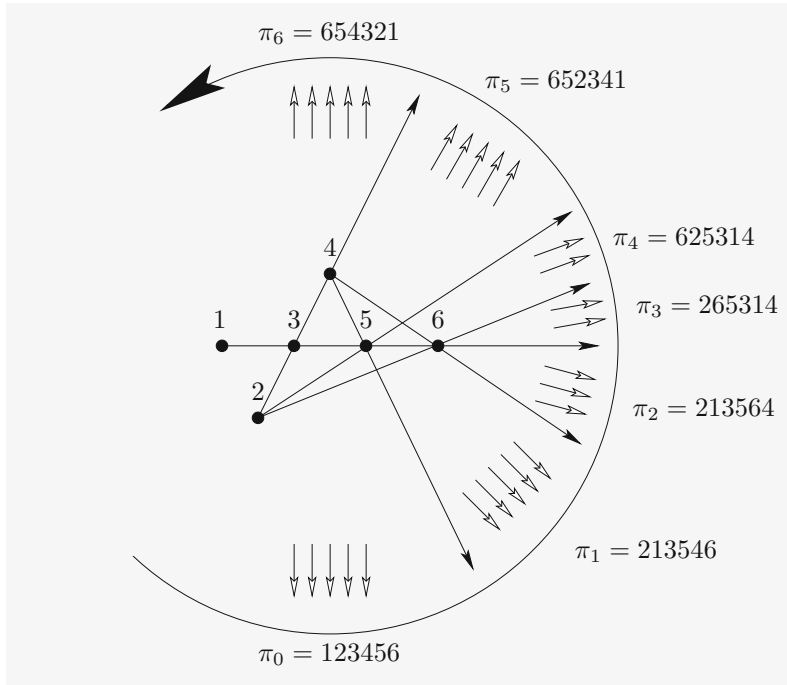

Getting the sequence of permutations for our small example

By continuing the circular motion around the configuration, one can view the sequence as a part of a two-way infinite, periodic sequence of permutations

$$\cdots \rightarrow \pi_{-1} \rightarrow \pi_0 \rightarrow \cdots \rightarrow \pi_t \rightarrow \pi_{t+1} \rightarrow \cdots \rightarrow \pi_{2t} \rightarrow \cdots$$

where π_{i+t} is the reverse of π_i for all i , and thus $\pi_{i+2t} = \pi_i$ for all $i \in \mathbb{Z}$. We will show that every sequence with the above properties (and $t \geq 2$) must have length $t \geq n$.

(3) The proof's key is to divide each permutation into a "left half" and a "right half" of equal size $m = \frac{n}{2}$, and to count the letters that cross the imaginary barrier between the left half and the right half.

Call $\pi_i \rightarrow \pi_{i+1}$ a *crossing move* if one of the substrings it reverses does involve letters from both sides of the barrier. The crossing move has *order* d if it moves $2d$ letters across the barrier, that is, if the crossing string has exactly d letters on one side and at least d letters on the other side. Thus in our example

$$\pi_2 = \underline{213}:564 \rightarrow \overline{265}:314 = \pi_3$$

is a crossing move of order $d = 2$ (it moves 1, 3, 5, 6 across the barrier, which we mark by ":"),

$$652:\underline{341} \rightarrow \overline{654}:321$$

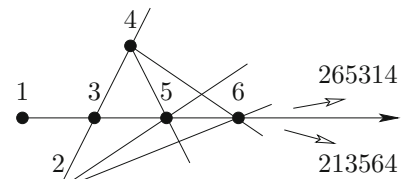

A crossing move

is crossing of order $d = 1$, while for example

$$625:314 \longrightarrow 6\overline{52}:3\overline{41}$$

is not a crossing move.

In the course of the sequence $\pi_0 \rightarrow \pi_1 \rightarrow \dots \rightarrow \pi_t$, each of the letters $1, 2, \dots, n$ has to cross the barrier at least once. This implies that, if the orders of the c crossing moves are d_1, d_2, \dots, d_c , then we have

$$\sum_{i=1}^c 2d_i = \#\{\text{letters that cross the barrier}\} \geq n.$$

This also implies that we have at least two crossing moves, since a crossing move with $2d_i = n$ occurs only if all the points are on one line, i. e. for $t = 1$. Geometrically, a crossing move corresponds to the direction of a line of the configuration that has less than m points on each side.

(4) A *touching move* is a move that reverses some string that is adjacent to the central barrier, but does not cross it. For example,

$$\pi_4 = 625:314 \longrightarrow 6\overline{52}:3\overline{41} = \pi_5$$

is a touching move. Geometrically, a touching move corresponds to the slope of a line of the configuration that has exactly m points on one side, and hence at most $m - 2$ points on the other side.

Moves that are neither touching nor crossing will be called *ordinary moves*. For this

$$\pi_1 = 213:546 \longrightarrow 213:5\overline{64} = \pi_2$$

is an example. So every move is either crossing, or touching, or ordinary, and we can use the letters T, C, O to denote the types of moves. $C(d)$ will denote a crossing move of order d . Thus for our small example we get

$$\pi_0 \xrightarrow{T} \pi_1 \xrightarrow{O} \pi_2 \xrightarrow{C(2)} \pi_3 \xrightarrow{O} \pi_4 \xrightarrow{T} \pi_5 \xrightarrow{C(1)} \pi_6,$$

or even shorter we can record this sequence as $T, O, C(2), O, T, C(1)$.

(5) To complete the proof, we need the following two facts:

Between any two crossing moves, there is at least one touching move.

Between any crossing move of order d and the next touching move, there are at least $d - 1$ ordinary moves.

In fact, after a crossing move of order d the barrier is contained in a symmetric decreasing substring of length $2d$, with d letters on each side of the barrier. For the next crossing move the central barrier must be brought into an increasing substring of length at least 2. But only touching moves affect whether the barrier is in an increasing substring. This yields the first fact.

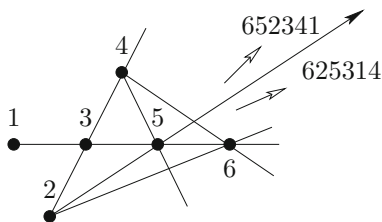

A touching move

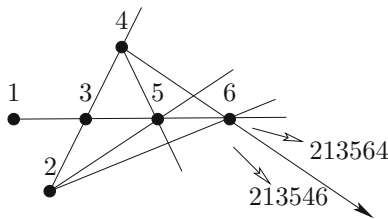

An ordinary move

For the second fact, note that with each ordinary move (reversing some *increasing* substrings) the decreasing $2d$ -string can get shortened by only one letter on each side. And, as long as the decreasing string has at least 4 letters, a touching move is impossible. This yields the second fact.

If we construct the sequence of permutations starting with the same initial projection but using a clockwise rotation, then we obtain the reversed sequence of permutations. Thus the sequence that we do have recorded must also satisfy the opposite of our second fact:

Between a touching move and the next crossing move, of order d , there are at least $d - 1$ ordinary moves.

(6) The T - O - C -pattern of the infinite sequence of permutations, as derived in (2), is obtained by repeating over and over again the T - O - C -pattern of length t of the sequence $\pi_0 \rightarrow \cdots \rightarrow \pi_t$. Thus with the facts of (5) we see that in the infinite sequence of moves, each crossing move of order d is embedded into a T - O - C -pattern of the type

$$T, \underbrace{O, O, \dots, O}_{\geq d-1}, C(d), \underbrace{O, O, \dots, O}_{\geq d-1}, \quad (*)$$

of length $1 + (d - 1) + 1 + (d - 1) = 2d$.

In the infinite sequence, we may consider a finite segment of length t that starts with a touching move. This segment consists of substrings of the type (*), plus possibly extra inserted T 's. This implies that its length t satisfies

$$t \geq \sum_{i=1}^c 2d_i \geq n,$$

which completes the proof. \square

References

- [1] J. E. GOODMAN & R. POLLACK: *A combinatorial perspective on some problems in geometry*, *Congressus Numerantium* **32** (1981), 383-394.
- [2] R. E. JAMISON & D. HILL: *A catalogue of slope-critical configurations*, *Congressus Numerantium* **40** (1983), 101-125.
- [3] P. R. SCOTT: *On the sets of directions determined by n points*, *Amer. Math. Monthly* **77** (1970), 502-505.
- [4] P. UNGAR: *$2N$ noncollinear points determine at least $2N$ directions*, *J. Combinatorial Theory, Ser. A* **33** (1982), 343-347.

Three applications of Euler's formula

Chapter 13



A graph is *planar* if it can be drawn in the plane \mathbb{R}^2 without crossing edges (or, equivalently, on the 2-dimensional sphere S^2). We talk of a *plane* graph if such a drawing is already given and fixed. Any such drawing decomposes the plane or sphere into a finite number of connected regions, including the outer (unbounded) region, which are referred to as *faces*. Euler's formula exhibits a beautiful relation between the number of vertices, edges and faces that is valid for any plane graph. Euler mentioned this result for the first time in a letter to his friend Goldbach in 1750, but he did not have a complete proof at the time. Among the many proofs of Euler's formula, we present a pretty and "self-dual" one that gets by without induction. It can be traced back to von Staudt's book "Geometrie der Lage" from 1847.

Euler's formula. If G is a connected plane graph with n vertices, e edges and f faces, then

$$n - e + f = 2.$$

■ **Proof.** Let $T \subseteq E$ be the edge set of a spanning tree for G , that is, of a minimal subgraph that connects all the vertices of G . This graph does not contain a cycle because of the minimality assumption.

We now need the *dual graph* G^* of G : To construct it, put a vertex into the interior of each face of G , and connect two such vertices of G^* by edges that correspond to common boundary edges between the corresponding faces. If there are several common boundary edges, then we draw several connecting edges in the dual graph. (Thus G^* may have multiple edges even if the original graph G is simple.)

Consider the collection $T^* \subseteq E^*$ of edges in the dual graph that corresponds to edges in $E \setminus T$. The edges in T^* connect all the faces, since T does not have a cycle; but also T^* does not contain a cycle, since otherwise it would separate some vertices of G inside the cycle from vertices outside (and this cannot be, since T is a spanning subgraph, and the edges of T and of T^* do not intersect). Thus T^* is a spanning tree for G^* .

For every tree the number of vertices is one larger than the number of edges. To see this, choose one vertex as the root, and direct all edges "away from the root": this yields a bijection between the non-root vertices and the edges, by matching each edge with the vertex it points at. Applied to the tree T this yields $n = e_T + 1$, while for the tree T^* it yields $f = e_{T^*} + 1$. Adding both equations we get $n + f = (e_T + 1) + (e_{T^*} + 1) = e + 2$. □



Leonhard Euler

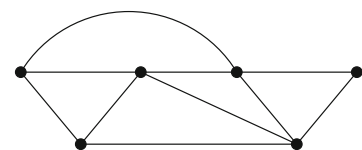

A plane graph G : $n = 6, e = 10, f = 6$

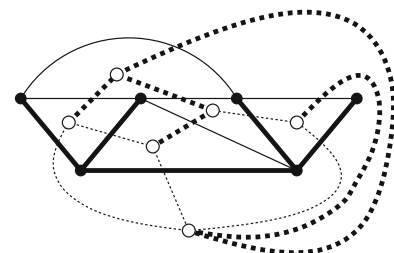

Dual spanning trees in G and in G^*

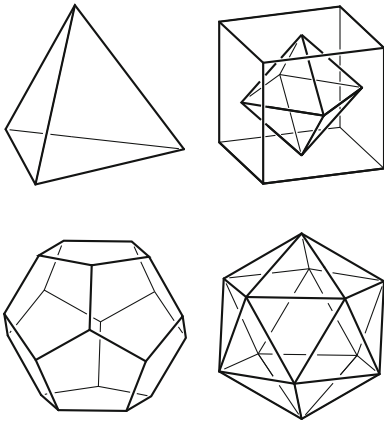

The five platonic solids

Euler's formula thus produces a strong *numerical* conclusion from a *geometric-topological* situation: the numbers of vertices, edges, and faces of a finite graph G satisfy $n - e + f = 2$ whenever the graph is *or can be* drawn in the plane or on a sphere.

Many well-known and classical consequences can be derived from Euler's formula. Among them are the classification of the regular convex polyhedra (the platonic solids), the fact that K_5 and $K_{3,3}$ are not planar (see below), and the five-color theorem that every planar map can be colored with at most five colors such that no two adjacent countries have the same color. But for this we have a much better proof, which does not even need Euler's formula — see Chapter 39.

This chapter collects three other beautiful proofs that have Euler's formula at their core. The first two — a proof of the Sylvester–Gallai theorem, and a theorem on two-colored point configurations — use Euler's formula in clever combination with other arithmetic relationships between basic graph parameters. Let us first look at these parameters.

The *degree* of a vertex is the number of edges that end in the vertex, where loops count double. Let n_i denote the number of vertices of degree i in G . Counting the vertices according to their degrees, we obtain

$$n = n_0 + n_1 + n_2 + n_3 + \cdots \quad (1)$$

On the other hand, every edge has two ends, so it contributes 2 to the sum of all degrees, and we obtain

$$2e = n_1 + 2n_2 + 3n_3 + 4n_4 + \cdots \quad (2)$$

You may interpret this identity as counting in two ways the ends of the edges, that is, the edge-vertex incidences. The *average degree* \bar{d} of the vertices is therefore

$$\bar{d} = \frac{2e}{n}.$$

Next we count the faces of a plane graph according to their number of sides: a k -*face* is a face that is bounded by k edges (where an edge that on both sides borders the same region has to be counted twice!). Let f_k be the number of k -faces. Counting all faces we find

$$f = f_1 + f_2 + f_3 + f_4 + \cdots \quad (3)$$

Counting the edges according to the faces of which they are sides, we get

$$2e = f_1 + 2f_2 + 3f_3 + 4f_4 + \cdots \quad (4)$$

As before, we can interpret this as double-counting of edge-face incidences. Note that the average number of sides of faces is given by

$$\bar{f} = \frac{2e}{f}.$$

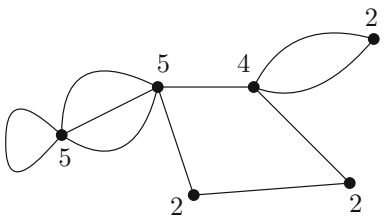

Here the degree is written next to each vertex. Counting the vertices of given degree yields $n_2 = 3$, $n_3 = 0$, $n_4 = 1$, $n_5 = 2$.

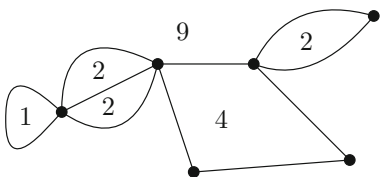

The number of sides is written into each region. Counting the faces with a given number of sides yields $f_1 = 1$, $f_2 = 3$, $f_4 = 1$, $f_9 = 1$, and $f_i = 0$ otherwise.

Let us deduce from this — together with Euler's formula — quickly that the complete graph K_5 and the complete bipartite graph $K_{3,3}$ are not planar. For a hypothetical plane drawing of K_5 we calculate $n = 5$, $e = \binom{5}{2} = 10$, thus $f = e + 2 - n = 7$ and $\bar{f} = \frac{2e}{f} = \frac{20}{7} < 3$. But if the average number of sides is smaller than 3, then the embedding would have a face with at most two sides, which cannot be.

Similarly for $K_{3,3}$ we get $n = 6$, $e = 9$, and $f = e + 2 - n = 5$, and thus $\bar{f} = \frac{2e}{f} = \frac{18}{5} < 4$, which cannot be since $K_{3,3}$ is simple and bipartite, so all its cycles have length at least 4.

It is no coincidence, of course, that the equations (3) and (4) for the f_i 's look so similar to the equations (1) and (2) for the n_i 's. They are transformed into each other by the dual graph construction $G \rightarrow G^*$ explained above.

From the double counting identities, we get the following important "local" consequences of Euler's formula.

Proposition. *Let G be any simple plane graph with $n > 2$ vertices. Then*

- (A) G has at most $3n - 6$ edges.
- (B) G has a vertex of degree at most 5.
- (C) *If the edges of G are two-colored, then there is a vertex of G with at most two color-changes in the cyclic order of the edges around the vertex.*

■ **Proof.** For each of the three statements, we may assume that G is connected.

(A) Every face has at least 3 sides (since G is simple), so (3) and (4) yield

$$f = f_3 + f_4 + f_5 + \dots$$

and

$$2e = 3f_3 + 4f_4 + 5f_5 + \dots$$

and thus $2e - 3f \geq 0$. Euler's formula now gives

$$3n - 6 = 3e - 3f \geq e.$$

(B) By part (A), the average degree \bar{d} satisfies

$$\bar{d} = \frac{2e}{n} \leq \frac{6n - 12}{n} < 6.$$

So there must be a vertex of degree at most 5.

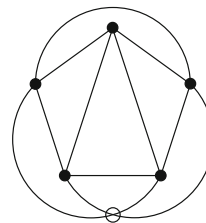

K_5 drawn with one crossing

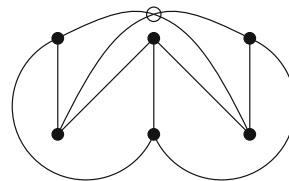

$K_{3,3}$ drawn with one crossing

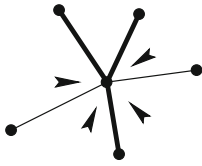

Arrows point to the corners with color changes.

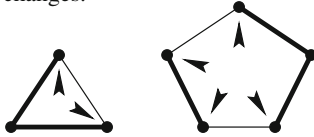

(C) Let c be the number of corners where color changes occur. Suppose the statement is false, then we have $c \geq 4n$ corners with color changes, since at every vertex there is an even number of changes. Now every face with $2k$ or $2k + 1$ sides has at most $2k$ such corners, so we conclude that

$$\begin{aligned} 4n \leq c &\leq 2f_3 + 4f_4 + 4f_5 + 6f_6 + 6f_7 + 8f_8 + \cdots \\ &\leq 2f_3 + 4f_4 + 6f_5 + 8f_6 + 10f_7 + \cdots \\ &= 2(3f_3 + 4f_4 + 5f_5 + 6f_6 + 7f_7 + \cdots) \\ &\quad - 4(f_3 + f_4 + f_5 + f_6 + f_7 + \cdots) \\ &= 4e - 4f \end{aligned}$$

using again (3) and (4). So we have $e \geq n + f$, again contradicting Euler's formula. \square

1. The Sylvester–Gallai theorem, revisited

It was first noted by Norman Steenrod, it seems, that part (B) of the proposition yields a strikingly simple proof of the Sylvester–Gallai theorem (see Chapter 11).

The Sylvester–Gallai theorem. *Given any set of $n \geq 3$ points in the plane, not all on one line, there is always a line that contains exactly two of the points.*

■ **Proof.** (Sylvester–Gallai via Euler)

If we embed the plane \mathbb{R}^2 in \mathbb{R}^3 near the unit sphere S^2 as indicated in our figure, then every point in \mathbb{R}^2 corresponds to a pair of antipodal points on S^2 , and the lines in \mathbb{R}^2 correspond to great circles on S^2 . Thus the Sylvester–Gallai theorem amounts to the following:

Given any set of $n \geq 3$ pairs of antipodal points on the sphere, not all on one great circle, there is always a great circle that contains exactly two of the antipodal pairs.

Now we dualize, replacing each pair of antipodal points by the corresponding great circle on the sphere. That is, instead of points $\pm v \in S^2$ we consider the orthogonal circles given by $C_v := \{x \in S^2 : \langle x, v \rangle = 0\}$. (This C_v is the equator if we consider v as the north pole of the sphere.)

Then the Sylvester–Gallai problem asks us to prove:

Given any collection of $n \geq 3$ great circles on S^2 , not all of them passing through one point, there is always a point that is on exactly two of the great circles.

But the arrangement of great circles yields a simple plane graph on S^2 , whose vertices are the intersection points of two of the great circles, which divide the great circles into edges. All the vertex degrees are even, and they are at least 4 — by construction. Thus part (B) of the proposition yields the existence of a vertex of degree 4. That's it! \square

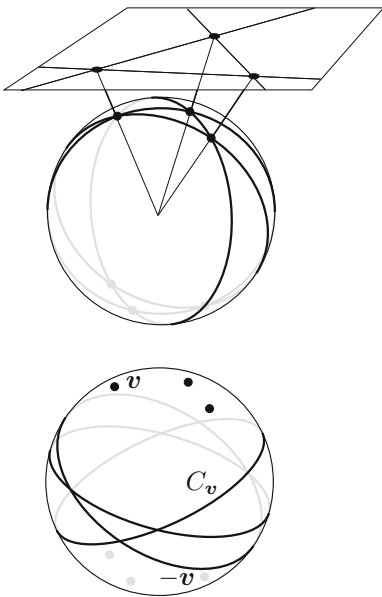

2. Monochromatic lines

The following proof of a “colorful” relative of the Sylvester–Gallai theorem is due to Don Chakerian.

Theorem. *Given any finite configuration of “black” and “white” points in the plane, not all on one line, there is always a “monochromatic” line: a line that contains at least two points of one color and none of the other.*

■ **Proof.** As for the Sylvester–Gallai problem, we transfer the problem to the unit sphere and dualize it there. So we must prove:

Given any finite collection of “black” and “white” great circles on the unit sphere, not all passing through one point, there is always an intersection point that lies either only on white great circles, or only on black great circles.

Now the (positive) answer is clear from part (C) of the proposition, since in every vertex where great circles of different colors intersect, we always have at least 4 corners with sign changes. □

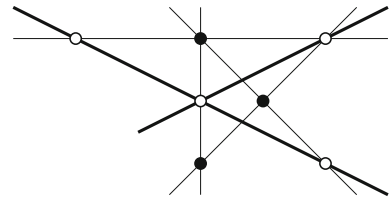

3. Pick's theorem

Pick's theorem from 1899 is a beautiful and surprising result in itself, but it is also a “classical” consequence of Euler's formula. For the following, call a convex polygon $P \subseteq \mathbb{R}^2$ *elementary* if its vertices are integral (that is, they lie in the *lattice* \mathbb{Z}^2), but if it does not contain any further lattice points.

Lemma. *Every elementary triangle $\Delta = \text{conv}\{p_0, p_1, p_2\} \subseteq \mathbb{R}^2$ has area $A(\Delta) = \frac{1}{2}$.*

■ **Proof.** Both the parallelogram P with corners $p_0, p_1, p_2, p_1 + p_2 - p_0$ and the lattice \mathbb{Z}^2 are symmetric with respect to the map

$$\sigma : x \mapsto p_1 + p_2 - x,$$

which is the reflection with respect to the center of the segment from p_1 to p_2 . Thus the parallelogram $P = \Delta \cup \sigma(\Delta)$ is elementary as well, and its integral translates tile the plane. Hence $\{p_1 - p_0, p_2 - p_0\}$ is a basis of the lattice \mathbb{Z}^2 , it has determinant ± 1 , P is a parallelogram of area 1, and Δ has area $\frac{1}{2}$. (For an explanation of these terms see the box on the next page.) □

Theorem. *The area of any (not necessarily convex) polygon $Q \subseteq \mathbb{R}^2$ with integral vertices is given by*

$$A(Q) = n_{int} + \frac{1}{2}n_{bd} - 1,$$

where n_{int} and n_{bd} are the numbers of integral points in the interior respectively on the boundary of Q .

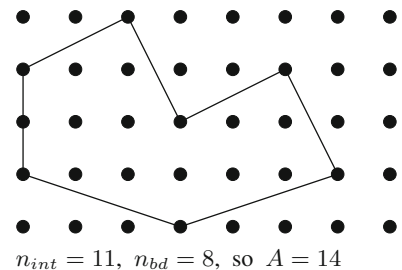
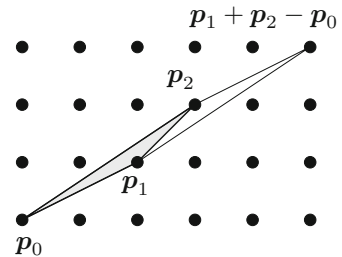

Lattice bases

A *basis* of \mathbb{Z}^2 is a pair of linearly independent vectors e_1, e_2 such that

$$\mathbb{Z}^2 = \{\lambda_1 e_1 + \lambda_2 e_2 : \lambda_1, \lambda_2 \in \mathbb{Z}\}.$$

Let $e_1 = \begin{pmatrix} a \\ b \end{pmatrix}$ and $e_2 = \begin{pmatrix} c \\ d \end{pmatrix}$, then the area of the parallelogram spanned by e_1 and e_2 is given by $A(e_1, e_2) = |\det(e_1, e_2)| = |\det \begin{pmatrix} a & c \\ b & d \end{pmatrix}|$. If $f_1 = \begin{pmatrix} r \\ s \end{pmatrix}$ and $f_2 = \begin{pmatrix} t \\ u \end{pmatrix}$ is another basis, then there exists an invertible \mathbb{Z} -matrix Q with $\begin{pmatrix} r & t \\ s & u \end{pmatrix} = \begin{pmatrix} a & c \\ b & d \end{pmatrix} Q$. Since $QQ^{-1} = \begin{pmatrix} 1 & 0 \\ 0 & 1 \end{pmatrix}$, and the determinants are integers, it follows that $|\det Q| = 1$, and hence $|\det(f_1, f_2)| = |\det(e_1, e_2)|$. Therefore all basis parallelograms have the same area 1, since $A\left(\begin{pmatrix} 1 \\ 0 \end{pmatrix}, \begin{pmatrix} 0 \\ 1 \end{pmatrix}\right) = 1$.

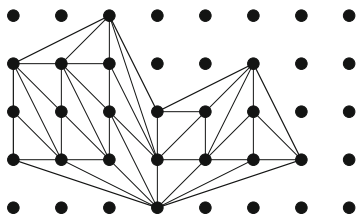

■ **Proof.** Every such polygon can be triangulated using all the n_{int} lattice points in the interior, and all the n_{bd} lattice points on the boundary of Q . (This is not quite obvious, in particular if Q is not required to be convex, but the argument given in Chapter 40 on the art gallery problem proves this.)

Now we interpret the triangulation as a plane graph, which subdivides the plane into one unbounded face plus $f - 1$ triangles of area $\frac{1}{2}$, so

$$A(Q) = \frac{1}{2}(f - 1).$$

Every triangle has three sides, where each of the e_{int} interior edges bounds two triangles, while the e_{bd} boundary edges appear in one single triangle each. So $3(f - 1) = 2e_{int} + e_{bd}$ and thus $f = 2(e - f) - e_{bd} + 3$. Also, there is the same number of boundary edges and vertices, $e_{bd} = n_{bd}$. These two facts together with Euler's formula yield

$$\begin{aligned} f &= 2(e - f) - e_{bd} + 3 \\ &= 2(n - 2) - n_{bd} + 3 = 2n_{int} + n_{bd} - 1, \end{aligned}$$

and thus

$$A(Q) = \frac{1}{2}(f - 1) = n_{int} + \frac{1}{2}n_{bd} - 1. \quad \square$$

References

- [1] G. D. CHAKERIAN: *Sylvester's problem on collinear points and a relative*, Amer. Math. Monthly **77** (1970), 164-167.
- [2] D. EPPSTEIN: *Nineteen proofs of Euler's formula: $V - E + F = 2$* , in: The Geometry Junkyard, <http://www.ics.uci.edu/~eppstein/junkyard/euler/>.
- [3] G. PICK: *Geometrisches zur Zahlenlehre*, Sitzungsberichte Lotos (Prag), Natur-med. Verein für Böhmen **19** (1899), 311-319.
- [4] K. G. C. VON STAUDT: *Geometrie der Lage*, Verlag der Fr. Korn'schen Buchhandlung, Nürnberg 1847.
- [5] N. E. STEENROD: *Solution 4065/Editorial Note*, Amer. Math. Monthly **51** (1944), 170-171.



A famous result that depends on Euler's formula (specifically, on part (C) of the proposition in the previous chapter) is Cauchy's rigidity theorem for 3-dimensional polyhedra.

For the notions of congruence and of combinatorial equivalence that are used in the following we refer to the appendix on polytopes and polyhedra in the chapter on Hilbert's third problem, see page 73.

Theorem. *If two 3-dimensional convex polyhedra P and P' are combinatorially equivalent with corresponding facets being congruent, then also the angles between corresponding pairs of adjacent facets are equal (and thus P is congruent to P').*

The illustration in the margin shows two 3-dimensional polyhedra that are combinatorially equivalent, such that the corresponding faces are congruent. But they are not congruent, and only one of them is convex. Thus the assumption of convexity is essential for Cauchy's theorem!

■ **Proof.** The following is essentially Cauchy's original proof. Assume that two convex polyhedra P and P' with congruent faces are given. We color the edges of P as follows: an edge is black (or "positive") if the corresponding interior angle between the two adjacent facets is larger in P' than in P ; it is white (or "negative") if the corresponding angle is smaller in P' than in P .

The black and the white edges of P together form a 2-colored plane graph on the surface of P , which by radial projection, assuming that the origin is in the interior of P , we may transfer to the surface of the unit sphere. If P and P' have unequal corresponding facet-angles, then the graph is nonempty. With part (C) of the proposition in the previous chapter we find that there is a vertex p that is adjacent to at least one black or white edge, such that there are at most two changes between black and white edges (in cyclic order).

Now we intersect P with a small sphere S_ε (of radius ε) centered at the vertex p , and we intersect P' with a sphere S'_ε of the same radius ε centered at the corresponding vertex p' . In S_ε and S'_ε we find convex spherical polygons Q and Q' such that corresponding arcs have the same lengths, because of the congruence of the facets of P and P' , and since we have chosen the same radius ε .



Augustin Cauchy

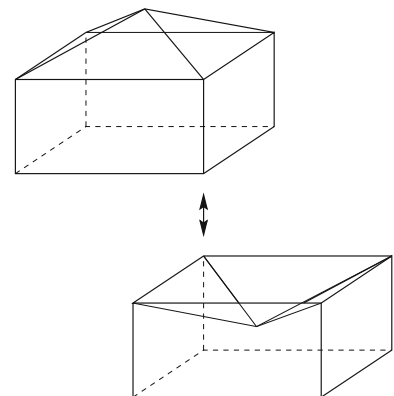

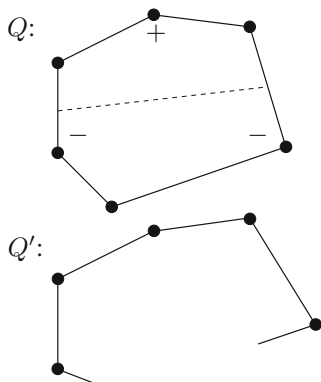

Now we mark by + the angles of Q for which the corresponding angle in Q' is larger, and by - the angles whose corresponding angle of Q' is smaller. That is, when moving from Q to Q' the + angles are “opened,” the - angles are “closed,” while all side lengths and the unmarked angles stay constant.

From our choice of p we know that *some* + or - sign occurs, and that in cyclic order there are at most two +/− changes. If only one type of signs occurs, then the lemma below directly gives a contradiction, saying that one edge must change its length. If both types of signs occur, then (since there are only two sign changes) there is a “separation line” that connects the midpoints of two edges and separates all the + signs from all the - signs. Again we get a contradiction from the lemma below, since the separation line cannot be both longer and shorter in Q' than in Q . \square

Cauchy's arm lemma.

If Q and Q' are convex (planar or spherical) n -gons, labeled as in the figure,

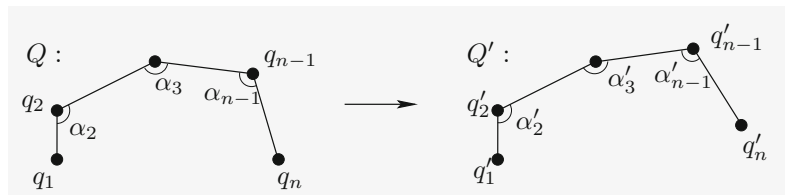

such that $\overline{q_i q_{i+1}} = \overline{q'_i q'_{i+1}}$ holds for the lengths of corresponding edges for $1 \leq i \leq n - 1$, and $\alpha_i \leq \alpha'_i$ holds for the sizes of corresponding angles for $2 \leq i \leq n - 1$, then the “missing” edge length satisfies

$$\overline{q_1 q_n} \leq \overline{q'_1 q'_n},$$

with equality if and only if $\alpha_i = \alpha'_i$ holds for all i .

It is interesting that Cauchy's original proof of the lemma was false: a continuous motion that opens angles and keeps side-lengths fixed may destroy convexity — see the figure! On the other hand, both the lemma and its proof given here, from a letter by I. J. Schoenberg to S. K. Zaremba, are valid both for planar and for spherical polygons.

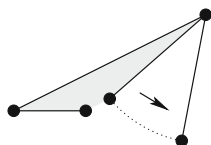

■ **Proof.** We use induction on n . The case $n = 3$ is easy: If in a triangle we increase the angle γ between two sides of fixed lengths a and b , then the length c of the opposite side also increases. Analytically, this follows from the cosine theorem

$$c^2 = a^2 + b^2 - 2ab \cos \gamma$$

in the planar case, and from the analogous result

$$\cos c = \cos a \cos b + \sin a \sin b \cos \gamma$$

in spherical trigonometry. Here the lengths a, b, c are measured on the surface of a sphere of radius 1, and thus have values in the interval $[0, \pi]$.

Now let $n \geq 4$. If for any $i \in \{2, \dots, n-1\}$ we have $\alpha_i = \alpha'_i$, then the corresponding vertex can be cut off by introducing the diagonal from q_{i-1} to q_{i+1} resp. from q'_{i-1} to q'_{i+1} , with $\overline{q_{i-1}q_{i+1}} = \overline{q'_{i-1}q'_{i+1}}$, so we are done by induction. Thus we may assume $\alpha_i < \alpha'_i$ for $2 \leq i \leq n-1$.

Now we produce a new polygon Q^* from Q by replacing α_{n-1} by the largest possible angle $\alpha_{n-1}^* \leq \alpha'_{n-1}$ that keeps Q^* convex. For this we replace q_n by q_n^* , keeping all the other q_i , edge lengths, and angles from Q .

If indeed we can choose $\alpha_{n-1}^* = \alpha'_{n-1}$ keeping Q^* convex, then we get $\overline{q_1q_n} < \overline{q_1q_n^*} \leq \overline{q'_1q'_n}$, using the case $n = 3$ for the first step and induction as above for the second.

Otherwise after a nontrivial move that yields

$$\overline{q_1q_n^*} > \overline{q_1q_n} \tag{1}$$

we “get stuck” in a situation where q_2, q_1 and q_n^* are collinear, with

$$\overline{q_2q_1} + \overline{q_1q_n^*} = \overline{q_2q_n^*}. \tag{2}$$

Now we compare this Q^* with Q' and find

$$\overline{q_2q_n^*} \leq \overline{q'_2q'_n} \tag{3}$$

by induction on n (ignoring the vertex q_1 resp. q'_1). Thus we obtain

$$\overline{q'_1q'_n} \stackrel{(*)}{\geq} \overline{q'_2q'_n} - \overline{q'_1q'_2} \stackrel{(3)}{\geq} \overline{q_2q_n^*} - \overline{q_1q_2} \stackrel{(2)}{=} \overline{q_1q_n^*} \stackrel{(1)}{>} \overline{q_1q_n},$$

where $(*)$ is just the triangle inequality, and all other relations have already been derived. \square

We have seen an example which shows that Cauchy's theorem is not true for *nonconvex* polyhedra. The special feature of this example is, of course, that a noncontinuous “flip” takes one polyhedron to the other, keeping the facets congruent while the dihedral angles “jump.” One can ask for more:

Could there be, for some nonconvex polyhedron, a continuous deformation that would keep the facets flat and congruent?

It was conjectured that no triangulated surface, convex or not, admits such a motion. So, it was quite a surprise when in 1977 — more than 160 years after Cauchy's work — Robert Connelly presented counterexamples: closed triangulated spheres embedded in \mathbb{R}^3 (without self-intersections) that are flexible, with a continuous motion that keeps all the edge lengths constant, and thus keeps the triangular faces congruent.

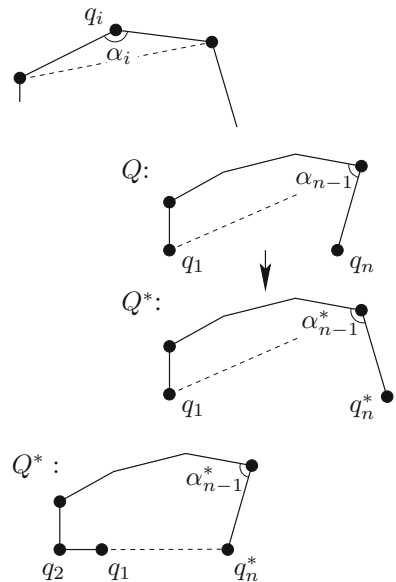

A beautiful example of a flexible surface constructed by Klaus Steffen: The dashed lines represent the nonconvex edges in this “cut-out” paper model. Fold the normal lines as “mountains” and the dashed lines as “valleys.” The edges in the model have lengths 5, 10, 11, 12 and 17 units.

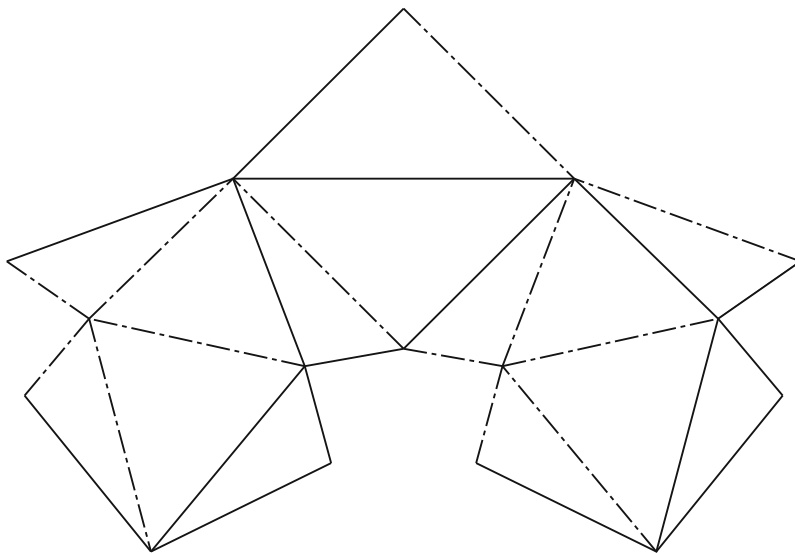

The rigidity theory of surfaces has even more surprises in store: Idjad Sabitov managed to prove that when any such flexing surface moves, the *volume* it encloses must be constant. His proof is beautiful also in its use of the algebraic machinery of polynomials and determinants (outside the scope of this book).

References

- [1] A. CAUCHY: *Sur les polygones et les polyèdres, seconde mémoire*, J. École Polytechnique XVIe Cahier, Tome IX (1813), 87-98; Œuvres Complètes, IIe Série, Vol. 1, Paris 1905, 26-38.
- [2] R. CONNELLY: *A counterexample to the rigidity conjecture for polyhedra*, Inst. Haut. Etud. Sci., Publ. Math. **47** (1978), 333-338.
- [3] R. CONNELLY: *The rigidity of polyhedral surfaces*, Mathematics Magazine **52** (1979), 275-283.
- [4] I. KH. SABITOV: *The volume as a metric invariant of polyhedra*, Discrete Comput. Geometry **20** (1998), 405-425.
- [5] J. SCHOENBERG & S.K. ZAREMBA: *On Cauchy's lemma concerning convex polygons*, Canadian J. Math. **19** (1967), 1062-1071.

The Borromean rings don't exist

Chapter 15



The “Borromean rings” — three rings arranged so that no two of them are linked, but the configuration cannot be taken apart without breaking one of the rings — form a classic artistic symbol, which appeared in the coat of arms of the aristocratic Borromeo family since the middle of the 15th century.

The Borromean rings are also one of the most tantalizing and enigmatic “impossible figures” of mathematics. They can easily be built as a geometric object in such a way that two of the rings are perfectly round circles of the same size; it seems, however, that then the third ring is represented by an ellipse, at best. Thus it is natural to ask:



Can the Borromean rings be built from three perfect circles?

As mathematical objects, the Borromean rings belong to the theory of knots and links, which very attractively connects geometry, topology, and combinatorics. We all have a geometric picture of what knots (closed curves in space) and links (arrangements of several such curves) look like, and we can draw them in the plane. We also have intuitive notions of when two knots or links are “the same” (equivalent), when a knot or link is “trivial,” when two circles are linked, etc.: The appendix to this chapter provides a review of the essential terms and definitions, including the fact that two diagrams present the same link or knot if and only if they can be transformed into each other by a finite sequence of “Reidemeister moves.”

Knot theory as we know it today started in 1867, when the physicist William Thomson, now known as Lord Kelvin, came up with his “vortex theory,” according to which atoms could be explained as knots in the “ether” background of the universe. Kelvin’s theory was immensely popular at the time and led to considerable efforts in the enumeration and classification of knots and links. Kelvin’s coauthor and colleague, the Scottish physicist Peter Guthrie Tait, published the first knot tables in 1876. He displayed and discussed the following links:

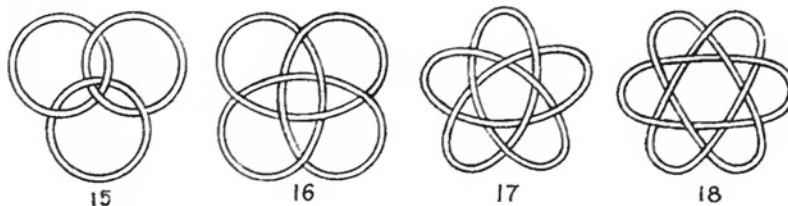

In this display, No. 15 shows the Borromean Rings, while No. 18 is an apparently different link that, however, shares the same characteristics: It consists of three closed curves that are pairwise not linked, whereas the whole diagram does not seem to come apart, it represents a nontrivial link. Tait indeed claimed that the links No. 15 and No. 18 were not equivalent, apparently based on the assumption that any *alternating* diagram of a link (where along any string under- and over-crossings alternate) has a minimal number of crossings among all possible diagrams. This long-standing “Tait conjecture” was proved more than 100 years later, by Thistlethwaite, Kauffman, and Murasugi in 1987. (Tait’s examples No. 16 and 17 have only one component, so they are knots. All four examples fall into a larger family that has been described and studied as the “Turk’s head links.”)

In 1892, the geometer Hermann Brunn introduced a much more general family of objects that we now call *Brunnian links*: k -component links in which any subcollection of $k - 1$ of the components is trivial. Tait’s links No. 15 (the Borromean rings) and No. 18 are examples.

Back to the Borromean rings: Indeed they *cannot* be built from three perfect circles. The first proof for this appeared in 1987 in a long differential geometry paper by Michael F. Freedman and Richard Skora. Their beautiful geometric idea, “getting movies from spherical domes,” is very powerful: It solves the problem not only for the Borromean rings, but shows that any Brunnian link built from perfect circles is trivial. It can also be generalized to links formed by k -spheres in $(2k + 1)$ -dimensional space. Our presentation is based on a short unpublished note “Circle links” by Ian Agol.

Theorem 1. *If a link consists of disjoint perfect circles that are pairwise not linked, then the link is trivial.*

■ **Proof.** Moving each of the circles just a little bit, we may assume that they lie in planes that are distinct, no two of the planes are parallel, and none of the planes spanned by one of the circles contains the center of a second circle. (This first preparatory step is not necessary, but it simplifies some later parts of the proof quite a bit.)

There are several different ways to define what it means that two disjoint circles in \mathbb{R}^3 are *linked*. Let us here use the following: Two circles are linked if one of them intersects (and not only touches) the disk spanned by the other one exactly once.

Let the circles be $C, C' \subseteq \mathbb{R}^3$, let D, D' be the flat disks they bound, and let H, H' be the planes they span. If C' intersects the disk D in one point, then this point lies both in $D \subseteq H$ as well as on $C' \subseteq D' \subseteq H'$, so in particular it lies in the intersection of the two planes H and H' , which is a line, $L := H \cap H'$. As this line lies in the plane H and contains a point in the interior of the disk D , it intersects C in exactly two points. The circle C' intersects the plane H once in the interior of D , so there has to be a second intersection point, which lies again on the line L , but outside D .

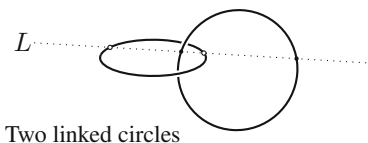

Two linked circles

We conclude that there are two pairs of intersection points given by $C \cap L$ and $C' \cap L$, and these two pairs alternate on the line L . In particular, we find in this situation that also C intersects the disk D' in one point.

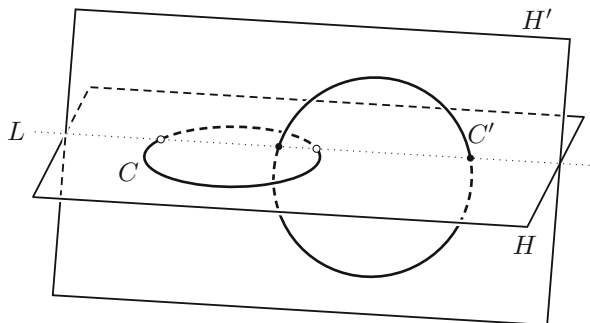

It turns out that this “alternating property” characterizes linked circles: If two circles C, C' are not linked, then one of them misses (or only touches) the disk spanned by the other one. In that case we find fewer than four points of $C \cup C'$ on the line L , or the four points do not alternate.

For the proof of the theorem we now take a configuration of n circles in \mathbb{R}^3 that are pairwise not linked and erect *spherical domes* above the disks spanned by the circles. This entails a bold step into the fourth dimension, since we add an extra coordinate. Don't worry about how to visualize this — in the end we will look at these dome functions defined on lines, so all arguments can be visualized and verified in planar diagrams.

The spherical domes are constructed as follows: For any circle $C \subseteq \mathbb{R}^3$ with center c and radius r there is a 2-dimensional hemisphere $S \subseteq \mathbb{R}^4$, which may be obtained as the graph

$$\{(x, h(x)) \in \mathbb{R}^3 \times \mathbb{R} : x \in D\}$$

of the function

$$h : D \rightarrow \mathbb{R}, \quad h(x) := \sqrt{r^2 - |x - c|^2}$$

on the closed disk D spanned by the circle C . The dome S is *orthogonal above* D in the following sense: If we project it to \mathbb{R}^3 by the orthogonal projection $\pi : \mathbb{R}^4 \rightarrow \mathbb{R}^3, (x, t) \mapsto x$, that “forgets the last coordinate,” then the image of the dome will be the disk D .

Claim. *If two disjoint circles $C, C' \subseteq \mathbb{R}^3$ are not linked, then their spherical domes $S, S' \subseteq \mathbb{R}^3 \times \mathbb{R}$ do not intersect.*

Proof of the Claim. We prove that if the domes S, S' above the discs D, D' spanned by two disjoint circles $C, C' \subseteq \mathbb{R}^3$ intersect, then the circles are linked. For this, let (x_0, t_0) be a point in the intersection $S \cap S'$. As (x_0, t_0) lies in S , we get $x_0 \in D$. Similarly, as (x_0, t_0) lies in S' , we get that $x_0 \in D'$. Hence x_0 lies in the line L , and it also lies on $D \cap D'$, where both “lifting functions” h and h' are defined.

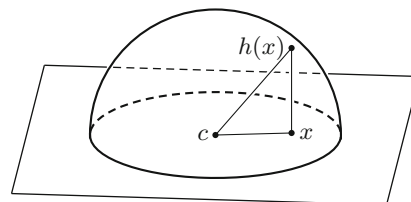

$$|x - c|^2 + |h(x) - 0|^2 = r^2$$

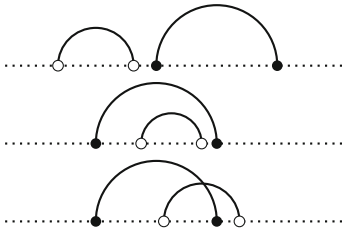

The half-circles above L intersect if and only if their end points alternate on the line L .

The lifting functions h, h' describe spherical domes defined on D resp. D' . Restricted to the line L , the functions h and h' define perfect half-circles, with domain of definition $D \cap L$ resp. $D' \cap L$. (This is the crucial point in the proof: Above an ellipse one cannot build a dome that restricts to half-circle arcs.)

Since the half-circles above $D \cap L$ resp. $D' \cap L$ intersect, their pairs of end points $S \cap L$ and $S' \cap L$ alternate on L , as illustrated in the margin. Hence the circles C and C' are linked. This finishes the proof of the claim.

Back to the configuration of disjoint perfect circles in \mathbb{R}^3 that are pairwise not linked. Freedman and Skora's brilliant idea was to use the disjoint domes guaranteed by the claim in order to construct a "movie" that *shows us* how to separate the circles in the link by a continuous motion. For this, we identify the original space \mathbb{R}^3 , which contains the link, with the slice $\mathbb{R}^3 \times \{0\}$ of the space $\mathbb{R}^3 \times \mathbb{R}$ that contains the domes; that is, the extra coordinate t is interpreted as time, and we start our movie at $t = 0$ with the original link. If we now continuously increase the fourth (time) coordinate, then what we see in time slices $\mathbb{R}^3 \times \{t\}$ is a movie in which each of the circles shrinks to a point, and then disappears.

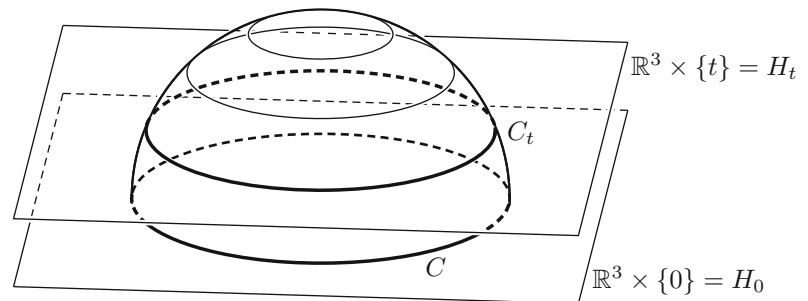

Here is a key observation: While a circle shrinks in this movie, *the center of the circle and the plane spanned by the circle do not change*. Furthermore, the circles stay disjoint since the domes are disjoint by the claim, and thus they remain pairwise non-linked.

We can stop the shrinking for each circle at some time when the circle is so small that it does not any more intersect a plane that is spanned by any one of the other circles. Moreover, also the disk spanned by this little circle does not intersect any of the other circle planes — neither at the point of time where we stop its shrinking, nor at any later time.

Thus the movie will end with all circles shrunk so far that they have disjoint spanning disks: The circles are completely separate, and thus the link is trivial. \square

In particular, we have just proved that any Brunnian link built from perfect circles can be taken apart in a motion which maintains perfect circles along the way. It remains an open problem, however, whether each of the circles could keep its size in such a motion picture.

With Theorem 1, we have established that the Borromean rings cannot be built from perfect circles — assuming that we know that the Borromean rings form a nontrivial link. Do we know that? It is by no means easy to prove rigorously for *any* knot or link that it is nontrivial . . . However, the eminent knot theorist Ralph Fox has invented a strikingly simple method to achieve this — reportedly he designed it “in an effort to make the subject accessible to everyone” while teaching knot theory to undergraduates at Haverford College in 1956. Its first published trace can be found in an exercise of a 1963 knot theory textbook by Crowell and Fox. Thirty years later Ollie Nanyes observed that Fox’s method also solves the problem for the Borromean rings.

Theorem 2. *The Borromean rings are nontrivial, and they are also not equivalent to Tait’s link No. 18.*

■ **Proof.** For every $n \geq 2$, a *Fox n -labeling* of a link diagram labels each arc of the diagram by an integer modulo n , such that at each crossing the two integers a and c of the arcs that end at the crossing and the label b of the arc of the overpass satisfy the *crossing relation*

$$a + c \equiv 2b \pmod{n}.$$

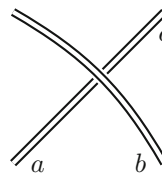

The crossing relation

Each link diagram has n *trivial* n -labelings, which use the same label for all the arcs of the diagram, so we are interested in *nontrivial* labelings, which use at least two different labels. For example, any link that consists of two disjoint “far away” parts in the plane has at least n^2 different Fox n -labelings. Now we observe a crucial fact:

Claim. *If two diagrams represent equivalent links, then they have the same number of Fox n -labelings.*

As explained in the appendix to this chapter, the diagrams for equivalent links are connected by continuous deformations and a finite sequence of Reidemeister moves of types I, II, and III; so all we have to check is that Reidemeister moves don’t change the number of Fox n -labelings. This is apparent from the following sketches, where in each of the separate drawings all the relations among the labels of different arcs are forced by the crossing relations:

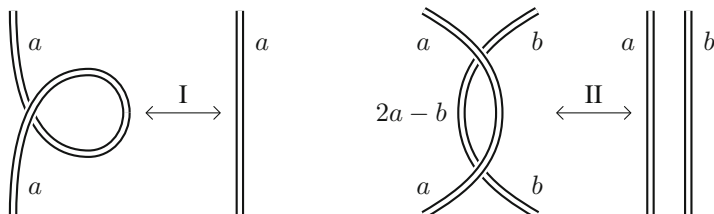

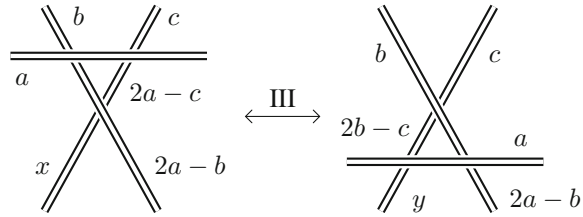

In particular, for arbitrary labels a , b , and c , the Reidemeister moves of type III the crossing relations finally force us to put labels

$$x \equiv 2(2a - b) - (2a - c) \equiv c + 2a - 2b$$

before the move and

$$y \equiv 2a - (2b - c) \equiv c + 2a - 2b$$

after the move. This establishes the Claim!

Now we simply have to count the labelings. The interesting observations will occur for odd $n \geq 3$.

For the *Borromean rings* we claim that all Fox n -labelings are trivial if $n \geq 3$ is odd: If in the standard diagram for the Borromean rings the outer arcs get the labels a , b , and c (as sketched in the margin), then the outer crossings force the inner arcs to have labels $2b - a$, $2c - b$, and $2a - c$, and at the inner crossings of the diagram we need that

$$2(2b - a) \equiv c + (2a - c), \quad 2(2c - b) \equiv a + (2b - a), \quad 2(2a - c) \equiv b + (2c - b),$$

that is $4a \equiv 4b \equiv 4c$, and hence $a \equiv b \equiv c \pmod{n}$, as n is odd. (For every even $n \geq 2$, nontrivial labelings exist.) In particular, the Borromean rings have only the trivial Fox 3-labelings or 5-labelings.

For *Tait's link No. 18*, a very similar calculation, with the labels a, b, c, d, e , and f assigned to the outer arcs, leads to inner labels $2a - b$, $2b - c$, $2c - d$, etc., and then finally to the conditions

$$a - d \equiv 4(b - c), \quad b - e \equiv 4(c - d), \quad c - f \equiv 4(d - e), \quad \dots \pmod{n}.$$

For $n = 3$, this yields $a - b + c - d \equiv 0$, $b - c + d - e \equiv 0$, etc., and we quickly derive that $a \equiv b \equiv \dots \equiv f$, so again there are only the trivial 3-labelings.

However, for $n = 5$ we find that we have to solve the equations $a + b \equiv c + d$, $b + c \equiv d + e$, etc., and this leads us to the solutions with arbitrary $a \equiv c \equiv e$ and $b \equiv d \equiv f$ (and no others). Thus there are $5^2 = 25$ Fox 5-labelings for this link.

The *trivial three component link* clearly has n^3 Fox n -labelings, that is, it has 27 Fox 3-labelings and 125 Fox 5-labelings.

Thus the Borromean rings, Tait's link No. 18, and the trivial link with three components have different numbers of Fox 5-labelings (5, 25, and 125, respectively), so they are nonequivalent links. \square

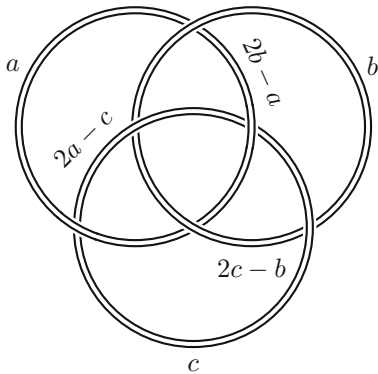

Labels for the Borromean rings

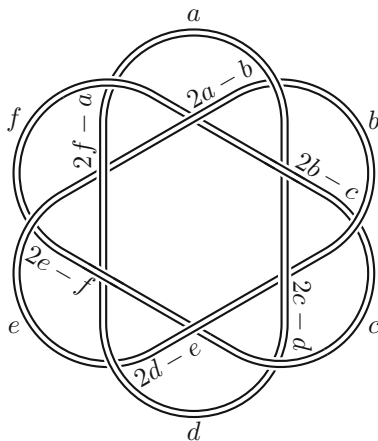

Labels for Tait's link No. 18

Appendix: Basic notions on knots and links

Topologists define a *knot* as the image of a continuous embedding of a circle in \mathbb{R}^3 ; a differential geometer might add that we are not interested in “wild” knots, but only in “tame” ones that are smooth curves. A *link* is obtained from a smooth embedding of a disjoint union of disjoint circles, known as the *components* of the link. Knots and links can also be treated as combinatorial objects, as any projection of a smooth knot or link to the plane along a sufficiently “generic” direction leads to a representation by a *diagram*, that is, a drawing of the knot or link by smooth curves in the plane with only a finite number of crossings, at which exactly two different parts of the knot or link cross — and where we indicate an over- or under-pass by a “trompe l’œil”-like fashion.

When are two knots, or two links, “the same”? Topologically, two links L and L' are defined to be *equivalent* if there is an orientation-preserving homeomorphism between (\mathbb{R}^3, L) and (\mathbb{R}^3, L') , that is, a continuous and bijective map $h : \mathbb{R}^3 \rightarrow \mathbb{R}^3$ with a continuous inverse such that $h(L) = L'$. Geometrically, we can describe this by a continuous deformation of space that moves L to L' . Such deformations might be hard to describe and analyze, but in 1926 Kurt Reidemeister proved a very useful combinatorial characterization: Two diagrams drawn in the plane describe equivalent knots or links if and only if one can be obtained from the other by continuous deformations and a finite number of local operations that are now known as the *Reidemeister moves* of types I, II, and III.

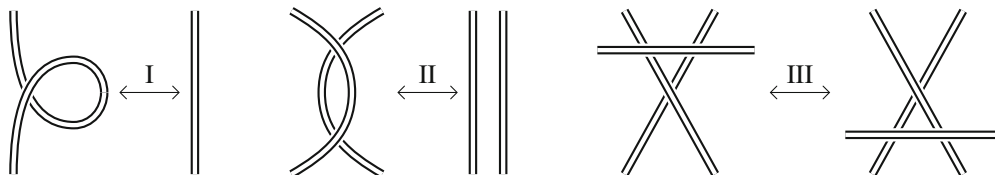

The “if” part of Reidemeister’s theorem is quite obvious. For the “only if” direction one studies a smooth deformation of L to L' , where also the directions and curvatures along the curves are required to change continuously. If we then maintain a “general position” projection to a plane, this will give us a continuous deformation of one diagram to the other with only a finite number of Reidemeister-type moves on the way.

A knot is *trivial* if it is equivalent to a perfect (geometric) circle in \mathbb{R}^3 , or equivalently, if it admits a spanning disk whose interior is disjoint from the knot. More generally, a link with k components is *trivial* if it is equivalent to a link formed by k “far apart” circles that have disjoint spanning disks.

References

- [1] H. BRUNN: *Über Verkettung*, Sitzungsberichte der Bayerischen Akad. Wiss. Math.-Phys. Klasse **22** (1892), 77–99.
- [2] M. EPPLE: *Die Entstehung der Knotentheorie*, Vieweg, Braunschweig/Wiesbaden 1999.
- [3] R. H. FOX: *A quick trip through knot theory*, in: “Topology of 3-manifolds and Related Topics” (M. K. Fort, ed.), Prentice-Hall Inc., 1962, pp. 120-167.
- [4] M. FREEDMAN & R. SKORA: *Strange actions on groups of spheres*, J. Differential Geometry **25** (1987), 75-98.
- [5] O. NANYES: *An elementary proof that the Borromean rings are nonsplittable*, Amer. Math. Monthly **100** (1993), 786-789.
- [6] K. REIDEMEISTER: *Elementare Begründung der Knotentheorie*, Abh. Math. Sem. Univ. Hamburg **5** (1926), 24-32.
- [7] P. G. TAIT: *On knots*, Transactions Royal Soc. Edinburgh **28** (1876-77), 145-190.



How many d -dimensional simplices can be positioned in \mathbb{R}^d so that they touch in such a way that all their pairwise intersections are $(d - 1)$ -dimensional?

This is an old and very natural question. We shall call $f(d)$ the answer to this problem, and record $f(1) = 2$, which is trivial. For $d = 2$ the configuration of four triangles in the margin shows $f(2) \geq 4$. There is no similar configuration with five triangles, because from this the dual graph construction, which for our example with four triangles yields a planar drawing of K_4 , would give a planar embedding of K_5 , which is impossible (see page 91). Thus we have

$$f(2) = 4.$$

In three dimensions, $f(3) \geq 8$ is quite easy to see. For that we use the configuration of eight triangles depicted on the right. The four shaded triangles are joined to some point x below the “plane of drawing,” which yields four tetrahedra that touch the plane from below. Similarly, the four white triangles are joined to some point y above the plane of drawing. So we obtain a configuration of eight touching tetrahedra in \mathbb{R}^3 , that is, $f(3) \geq 8$.

In 1965, Baston wrote a book proving $f(3) \leq 9$, and in 1991 it took Zaks another book to establish

$$f(3) = 8.$$

With $f(1) = 2$, $f(2) = 4$ and $f(3) = 8$, it doesn't take much inspiration to arrive at the following conjecture, first posed by Bagemihl in 1956.

Conjecture. *The maximal number of pairwise touching d -simplices in a configuration in \mathbb{R}^d is*

$$f(d) = 2^d.$$

The lower bound, $f(d) \geq 2^d$, is easy to verify “if we do it right.” This amounts to a heavy use of affine coordinate transformations, and to an induction on the dimension that establishes the following stronger result, due to Joseph Zaks [4].

Theorem 1. *For every $d \geq 2$, there is a family of 2^d pairwise touching d -simplices in \mathbb{R}^d together with a transversal line that hits the interior of every single one of them.*

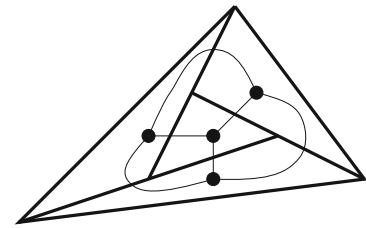

$f(2) \geq 4$

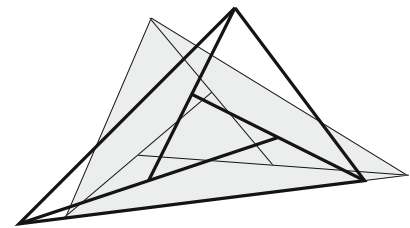

$f(3) \geq 8$

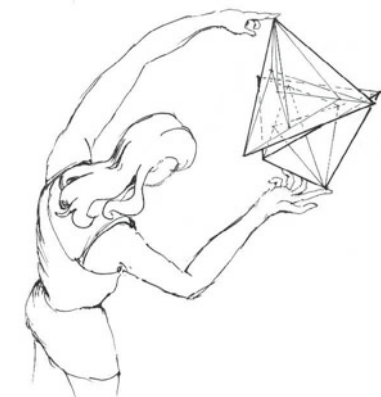

“Touching simplices”

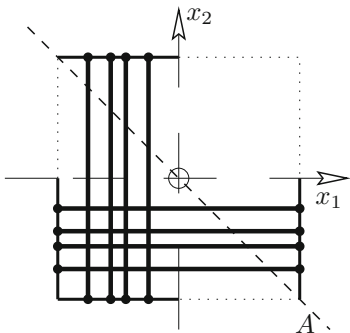
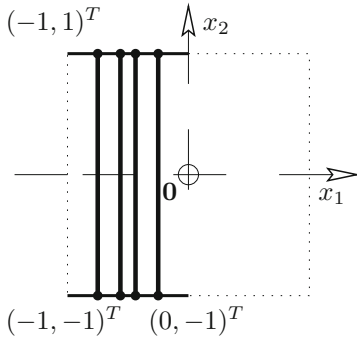
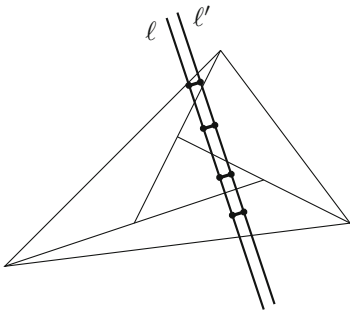
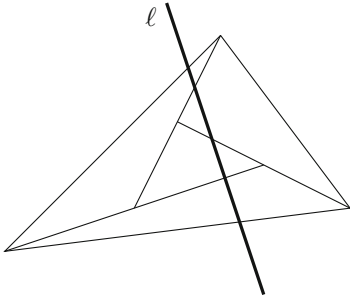

■ **Proof.** For $d = 2$ the family of four triangles that we had considered does have such a transversal line. Now consider any d -dimensional configuration of touching simplices that has a transversal line ℓ . Any nearby parallel line ℓ' is a transversal line as well. If we choose ℓ' and ℓ parallel and close enough, then each of the simplices contains an orthogonal (shortest) connecting interval between the two lines. Only a bounded part of the lines ℓ and ℓ' is contained in the simplices of the configuration, and we may add two connecting segments outside the configuration, such that the rectangle spanned by the two outside connecting lines (that is, their convex hull) contains all the other connecting segments. Thus, we have placed a “ladder” such that each of the simplices of the configuration has one of the ladder’s steps in its interior, while the four ends of the ladder are outside the configuration.

Now the main step is that we perform an (affine) coordinate transformation that maps \mathbb{R}^d to \mathbb{R}^d , and takes the rectangle spanned by the ladder to the rectangle (half-square) as shown in the figure below, given by

$$R^1 = \{(x_1, x_2, 0, \dots, 0)^T : -1 \leq x_1 \leq 0; -1 \leq x_2 \leq 1\}.$$

Thus the configuration of touching simplices Σ^1 in \mathbb{R}^d which we obtain has the x_1 -axis as a transversal line, and it is placed such that each of the simplices contains a segment

$$S^1(\alpha) = \{(\alpha, x_2, 0, \dots, 0)^T : -1 \leq x_2 \leq 1\}$$

in its interior (for some α with $-1 < \alpha < 0$), while the origin $\mathbf{0}$ is outside all simplices.

Now we produce a second copy Σ^2 of this configuration by reflecting the first one in the hyperplane given by $x_1 = x_2$. This second configuration has the x_2 -axis as a transversal line, and each simplex contains a segment

$$S^2(\beta) = \{(x_1, \beta, 0, \dots, 0)^T : -1 \leq x_1 \leq 1\}$$

in its interior, with $-1 < \beta < 0$. But each segment $S^1(\alpha)$ intersects each segment $S^2(\beta)$, and thus the interior of each simplex of Σ^1 intersects each simplex of Σ^2 in its interior. Thus if we add a new $(d + 1)$ -st coordinate x_{d+1} , and take Σ to be

$$\{\text{conv}(P_i \cup \{-e_{d+1}\}) : P_i \in \Sigma^1\} \cup \{\text{conv}(P_j \cup \{e_{d+1}\}) : P_j \in \Sigma^2\},$$

then we get a configuration of touching $(d + 1)$ -simplices in \mathbb{R}^{d+1} . Furthermore, the antidiagonal

$$A = \{(x, -x, 0, \dots, 0)^T : x \in \mathbb{R}\} \subseteq \mathbb{R}^d$$

intersects all segments $S^1(\alpha)$ and $S^2(\beta)$. We can “tilt” it a little, and obtain a line

$$L_\varepsilon = \{(x, -x, 0, \dots, 0, \varepsilon x)^T : x \in \mathbb{R}\} \subseteq \mathbb{R}^{d+1},$$

which for all small enough $\varepsilon > 0$ intersects all the simplices of Σ . This completes our induction step. \square

In contrast to this exponential lower bound, tight upper bounds are harder to get. A naive inductive argument (considering all the facet hyperplanes in a touching configuration separately) yields only

$$f(d) \leq \frac{2}{3}(d+1)!,$$

and this is quite far from the lower bound of Theorem 1. However, Micha Perles found the following “magical” proof for a much better bound.

Theorem 2. For all $d \geq 1$, we have $f(d) < 2^{d+1}$.

■ **Proof.** Given a configuration of r touching d -simplices P_1, P_2, \dots, P_r in \mathbb{R}^d , first enumerate the different hyperplanes H_1, H_2, \dots, H_s spanned by facets of the P_i , and for each of them arbitrarily choose a positive side H_i^+ , and call the other side H_i^- .

For example, for the 2-dimensional configuration of $r = 4$ triangles depicted on the right we find $s = 6$ hyperplanes (which are lines for $d = 2$).

From these data, we construct the B -matrix, an $r \times s$ matrix with entries in $\{+1, -1, 0\}$, as follows:

$$B_{ij} := \begin{cases} +1 & \text{if } P_i \text{ has a facet in } H_j, \text{ and } P_i \subseteq H_j^+, \\ -1 & \text{if } P_i \text{ has a facet in } H_j, \text{ and } P_i \subseteq H_j^-, \\ 0 & \text{if } P_i \text{ does not have a facet in } H_j. \end{cases}$$

For example, the 2-dimensional configuration in the margin gives rise to the matrix

$$B = \begin{pmatrix} 1 & 0 & 1 & 0 & 1 & 0 \\ -1 & -1 & 1 & 0 & 0 & 0 \\ -1 & 1 & 0 & 1 & 0 & 0 \\ 0 & -1 & -1 & 0 & 0 & 1 \end{pmatrix}.$$

Three properties of the B -matrix are worth recording. First, since every d -simplex has $d + 1$ facets, we find that every row of B has exactly $d + 1$ nonzero entries, and thus has exactly $s - (d + 1)$ zero entries. Secondly, we are dealing with a configuration of pairwise touching simplices, and thus for every pair of rows we find one column in which one row has a $+1$ entry, while the entry in the other row is -1 . That is, the rows are different *even if we disregard their zero entries*. Thirdly, the rows of B “represent” the simplices P_i , via

$$P_i = \bigcap_{j: B_{ij}=1} H_j^+ \cap \bigcap_{j: B_{ij}=-1} H_j^-. \quad (*)$$

Now we derive from B a new matrix C , in which every row of B is replaced by all the row vectors that one can generate from it by replacing all the zeros by either $+1$ or -1 . Since each row of B has $s - d - 1$ zeros, and B has r rows, the matrix C has $2^{s-d-1}r$ rows.

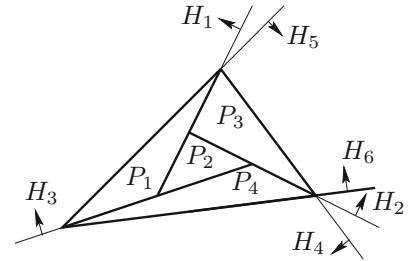

For our example, this matrix C is a 32×6 matrix that starts

$$C = \begin{pmatrix} 1 & 1 & 1 & 1 & 1 & 1 \\ 1 & 1 & 1 & 1 & 1 & -1 \\ 1 & 1 & 1 & -1 & 1 & 1 \\ 1 & 1 & 1 & -1 & 1 & -1 \\ 1 & -1 & 1 & 1 & 1 & 1 \\ 1 & -1 & 1 & 1 & 1 & -1 \\ 1 & -1 & 1 & -1 & 1 & 1 \\ 1 & -1 & 1 & -1 & 1 & -1 \\ \hline -1 & -1 & 1 & 1 & 1 & 1 \\ -1 & -1 & 1 & 1 & 1 & -1 \\ \vdots & \vdots & \vdots & \vdots & \vdots & \vdots \end{pmatrix},$$

where the first eight rows of C are derived from the first row of B , the second eight rows come from the second row of B , etc.

The point now is that all the rows of C are different: If two rows are derived from the same row of B , then they are different since their zeros have been replaced differently; if they are derived from different rows of B , then they differ no matter how the zeros have been replaced. But the rows of C are ± 1 -vectors of length s , and there are only 2^s different such vectors. Thus since the rows of C are distinct, C can have at most 2^s rows, that is,

$$2^{s-d-1}r \leq 2^s.$$

However, not all possible ± 1 -vectors appear in C , which yields a strict inequality $2^{s-d-1}r < 2^s$, and thus $r < 2^{d+1}$. To see this, we note that every row of C represents an intersection of halfspaces — just as for the rows of B before, via the formula (*). This intersection is a subset of the simplex P_i , which was given by the corresponding row of B . Let us take a point $x \in \mathbb{R}^d$ that does not lie on any of the hyperplanes H_j , and not in any of the simplices P_i . From this x we derive a ± 1 -vector that records for each j whether $x \in H_j^+$ or $x \in H_j^-$. This ± 1 -vector does not occur in C , because its halfspace intersection according to (*) contains x and thus is not contained in any simplex P_i . \square

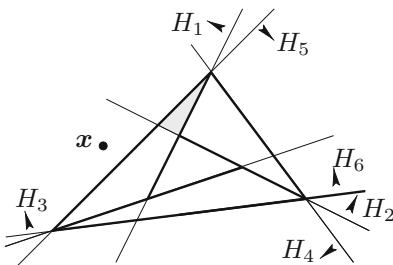

The first row of the C -matrix represents the shaded triangle, while the second row corresponds to an empty intersection of the halfspaces. The point x leads to the vector

$$(1 \quad -1 \quad 1 \quad 1 \quad -1 \quad 1)$$

that does not appear in the C -matrix.

References

- [1] F. BAGEMIHL: *A conjecture concerning neighboring tetrahedra*, Amer. Math. Monthly **63** (1956) 328-329.
- [2] V. J. D. BASTON: *Some Properties of Polyhedra in Euclidean Space*, Pergamon Press, Oxford 1965.
- [3] M. A. PERLES: *At most 2^{d+1} neighborly simplices in E^d* , Annals of Discrete Math. **20** (1984), 253-254.
- [4] J. ZAKS: *Neighborly families of 2^d d -simplices in E^d* , Geometriae Dedicata **11** (1981), 279-296.
- [5] J. ZAKS: *No Nine Neighborly Tetrahedra Exist*, Memoirs Amer. Math. Soc. No. 447, Vol. 91, 1991.

Every large point set has an obtuse angle

Chapter 17



Around 1950 Paul Erdős conjectured that every set of more than 2^d points in \mathbb{R}^d determines at least one *obtuse angle*, that is, an angle that is strictly greater than $\frac{\pi}{2}$. In other words, any set of points in \mathbb{R}^d which only has acute angles (including right angles) has size at most 2^d . This problem was posed as a “prize question” by the Dutch Mathematical Society — but solutions were received only for $d = 2$ and for $d = 3$.

For $d = 2$ the problem is easy: The five points may determine a convex pentagon, which always has an obtuse angle (in fact, at least one angle of at least 108°). Otherwise we have one point contained in the convex hull of three others that form a triangle. But this point “sees” the three edges of the triangle in three angles that sum to 360° , so one of the angles is at least 120° . (The second case also includes situations where we have three points on a line, and thus a 180° angle.)

Unrelated to this, Victor Klee asked a few years later — and Erdős spread the question — how large a point set in \mathbb{R}^d could be and still have the following “antipodality property”: For *any* two points in the set there is a strip (bounded by two parallel hyperplanes) that contains the point set, and that has the two chosen points on different sides on the boundary.

Then, in 1962, Ludwig Danzer and Branko Grünbaum solved both problems in one stroke: They sandwiched both maximal sizes into a chain of inequalities, which starts and ends in 2^d . Thus the answer is 2^d both for Erdős’ and for Klee’s problem.

In the following, we consider (finite) sets $S \subseteq \mathbb{R}^d$ of points, their convex hulls $\text{conv}(S)$, and general convex polytopes $Q \subseteq \mathbb{R}^d$. (See the appendix on polytopes on page 73 for the basic concepts.) We assume that these sets have the full dimension d , that is, they are not contained in a hyperplane. Two convex sets *touch* if they have at least one boundary point in common, while their interiors do not intersect. For any set $Q \subseteq \mathbb{R}^d$ and any vector $s \in \mathbb{R}^d$ we denote by $Q + s$ the image of Q under the translation that moves $\mathbf{0}$ to s . Similarly, $Q - s$ is the translate obtained by the map that moves s to the origin.

Don’t be intimidated: This chapter is an excursion into d -dimensional geometry, but the arguments in the following do not require any “high-dimensional intuition,” since they all can be followed, visualized (and thus *understood*) in three dimensions, or even in the plane. Hence, our figures will illustrate the proof for $d = 2$ (where a “hyperplane” is just a line), and you could create your own pictures for $d = 3$ (where a “hyperplane” is a plane).

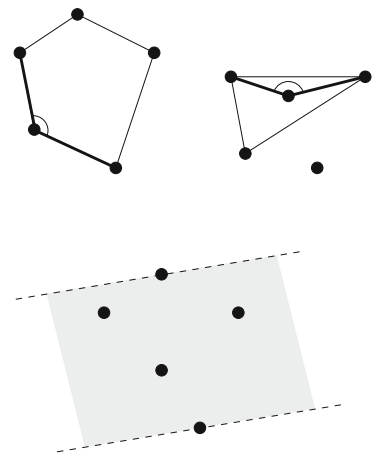

Theorem 1. For every d , one has the following chain of inequalities:

$$\begin{aligned}
2^d &\stackrel{(1)}{\leq} \max \{ \#S \mid S \subseteq \mathbb{R}^d, \angle(\mathbf{s}_i, \mathbf{s}_j, \mathbf{s}_k) \leq \frac{\pi}{2} \text{ for every } \{\mathbf{s}_i, \mathbf{s}_j, \mathbf{s}_k\} \subseteq S \} \\
&\stackrel{(2)}{\leq} \max \left\{ \#S \mid \begin{array}{l} S \subseteq \mathbb{R}^d \text{ such that for any two points } \{\mathbf{s}_i, \mathbf{s}_j\} \subseteq S \\ \text{there is a strip } \mathcal{S}(i, j) \text{ that contains } S, \text{ with } \mathbf{s}_i \text{ and } \mathbf{s}_j \\ \text{lying in the parallel boundary hyperplanes of } \mathcal{S}(i, j) \end{array} \right\} \\
&\stackrel{(3)}{=} \max \left\{ \#S \mid \begin{array}{l} S \subseteq \mathbb{R}^d \text{ such that the translates } P - \mathbf{s}_i, \mathbf{s}_i \in S, \text{ of} \\ \text{the convex hull } P := \text{conv}(S) \text{ intersect in a common} \\ \text{point, but they only touch} \end{array} \right\} \\
&\stackrel{(4)}{\leq} \max \left\{ \#S \mid \begin{array}{l} S \subseteq \mathbb{R}^d \text{ such that the translates } Q + \mathbf{s}_i \text{ of some } d\text{-} \\ \text{dimensional convex polytope } Q \subseteq \mathbb{R}^d \text{ touch pairwise} \end{array} \right\} \\
&\stackrel{(5)}{=} \max \left\{ \#S \mid \begin{array}{l} S \subseteq \mathbb{R}^d \text{ such that the translates } Q^* + \mathbf{s}_i \text{ of some} \\ d\text{-dimensional centrally symmetric convex polytope} \\ Q^* \subseteq \mathbb{R}^d \text{ touch pairwise} \end{array} \right\} \\
&\stackrel{(6)}{\leq} 2^d.
\end{aligned}$$

■ **Proof.** We have six claims (equalities and inequalities) to verify. Let's get going.

(1) Take $S := \{0, 1\}^d$ to be the vertex set of the standard unit cube in \mathbb{R}^d , and choose $\mathbf{s}_i, \mathbf{s}_j, \mathbf{s}_k \in S$. By symmetry we may assume that $\mathbf{s}_j = \mathbf{0}$ is the zero vector. Hence the angle can be computed from

$$\cos \angle(\mathbf{s}_i, \mathbf{s}_j, \mathbf{s}_k) = \frac{\langle \mathbf{s}_i, \mathbf{s}_k \rangle}{\|\mathbf{s}_i\| \|\mathbf{s}_k\|}$$

which is clearly nonnegative. Thus S is a set with $|S| = 2^d$ that has no obtuse angles.

(2) If S contains no obtuse angles, then for any $\mathbf{s}_i, \mathbf{s}_j \in S$ we may define $H_{ij} + \mathbf{s}_i$ and $H_{ij} + \mathbf{s}_j$ to be the parallel hyperplanes through \mathbf{s}_i resp. \mathbf{s}_j that are orthogonal to the edge $[\mathbf{s}_i, \mathbf{s}_j]$. Here $H_{ij} = \{\mathbf{x} \in \mathbb{R}^d : \langle \mathbf{x}, \mathbf{s}_i - \mathbf{s}_j \rangle = 0\}$ is the hyperplane through the origin that is orthogonal to the line through \mathbf{s}_i and \mathbf{s}_j , and $H_{ij} + \mathbf{s}_j = \{\mathbf{x} + \mathbf{s}_j : \mathbf{x} \in H_{ij}\}$ is the translate of H_{ij} that passes through \mathbf{s}_j , etc. Hence the strip between $H_{ij} + \mathbf{s}_i$ and $H_{ij} + \mathbf{s}_j$ consists, besides \mathbf{s}_i and \mathbf{s}_j , exactly of all the points $\mathbf{x} \in \mathbb{R}^d$ such that the angles $\angle(\mathbf{s}_i, \mathbf{s}_j, \mathbf{x})$ and $\angle(\mathbf{s}_j, \mathbf{s}_i, \mathbf{x})$ are nonobtuse. Thus the strip contains all of S .

(3) P is contained in the halfspace of $H_{ij} + \mathbf{s}_j$ that contains \mathbf{s}_i if and only if $P - \mathbf{s}_j$ is contained in the halfspace of H_{ij} that contains $\mathbf{s}_i - \mathbf{s}_j$. A property “an object is contained in a halfspace” is not destroyed if we translate both the object and the halfspace by the same amount (namely by $-\mathbf{s}_j$). Similarly, P is contained in the halfspace of $H_{ij} + \mathbf{s}_i$ that contains \mathbf{s}_j if and only if $P - \mathbf{s}_i$ is contained in the halfspace of H_{ij} that contains $\mathbf{s}_j - \mathbf{s}_i$.

Putting both statements together, we find that the polytope P is contained in the strip between $H_{ij} + \mathbf{s}_i$ and $H_{ij} + \mathbf{s}_j$ if and only if $P - \mathbf{s}_i$ and $P - \mathbf{s}_j$ lie in different halfspaces with respect to the hyperplane H_{ij} .

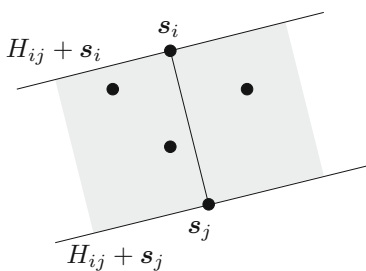

This correspondence is illustrated by the sketch in the margin.

Furthermore, from $s_i \in P = \text{conv}(S)$ we get that the origin $\mathbf{0}$ is contained in all the translates $P - s_i$ ($s_i \in S$). Thus we see that the sets $P - s_i$ all intersect in $\mathbf{0}$, but they only touch: their interiors are pairwise disjoint, since they lie on opposite sides of the corresponding hyperplanes H_{ij} .

(4) This we get for free: “the translates must touch pairwise” is a weaker condition than “they intersect in a common point, but only touch.” Similarly, we can relax the conditions by letting P be an arbitrary convex d -polytope in \mathbb{R}^d . Furthermore, we may replace S by $-S$.

(5) Here “ \geq ” is trivial, but that is not the interesting direction for us. We have to start with a configuration $S \subseteq \mathbb{R}^d$ and an arbitrary d -polytope $Q \subseteq \mathbb{R}^d$ such that the translates $Q + s_i$ ($s_i \in S$) touch pairwise. The claim is that in this situation we can use

$$Q^* := \{ \frac{1}{2}(x - y) \in \mathbb{R}^d : x, y \in Q \}$$

instead of Q . But this is not hard to see: First, Q^* is d -dimensional, convex, and centrally symmetric. One can check that Q^* is a polytope (its vertices are of the form $\frac{1}{2}(q_i - q_j)$, for vertices q_i, q_j of Q), but this is not important for us.

Now we will show that $Q + s_i$ and $Q + s_j$ touch if and only if $Q^* + s_i$ and $Q^* + s_j$ touch. For this we note, in the footsteps of Minkowski, that

$$\begin{aligned} (Q^* + s_i) \cap (Q^* + s_j) &\neq \emptyset \\ \iff \exists q'_i, q''_i, q'_j, q''_j \in Q : \frac{1}{2}(q'_i - q''_i) + s_i &= \frac{1}{2}(q'_j - q''_j) + s_j \\ \iff \exists q'_i, q''_i, q'_j, q''_j \in Q : \frac{1}{2}(q'_i + q''_j) + s_i &= \frac{1}{2}(q'_j + q''_i) + s_j \\ \iff \exists q_i, q_j \in Q : q_i + s_i = q_j + s_j \\ \iff (Q + s_i) \cap (Q + s_j) &\neq \emptyset, \end{aligned}$$

where in the third (and crucial) equivalence “ \iff ” we use that every $q \in Q$ can be written as $q = \frac{1}{2}(q + q)$ to get “ \Leftarrow ”, and that Q is convex and thus $\frac{1}{2}(q'_i + q''_j), \frac{1}{2}(q'_j + q''_i) \in Q$ to see “ \Rightarrow ”.

Thus the passage from Q to Q^* (known as *Minkowski symmetrization*) preserves the property that two translates $Q + s_i$ and $Q + s_j$ intersect. That is, we have shown that for any convex set Q , two translates $Q + s_i$ and $Q + s_j$ intersect if and only if the translates $Q^* + s_i$ and $Q^* + s_j$ intersect.

The following characterization shows that Minkowski symmetrization also preserves the property that two translates touch:

$Q + s_i$ and $Q + s_j$ touch if and only if they intersect, while $Q + s_i$ and $Q + s_j + \varepsilon(s_j - s_i)$ do not intersect for any $\varepsilon > 0$.

(6) Assume that $Q^* + s_i$ and $Q^* + s_j$ touch. For every intersection point

$$x \in (Q^* + s_i) \cap (Q^* + s_j)$$

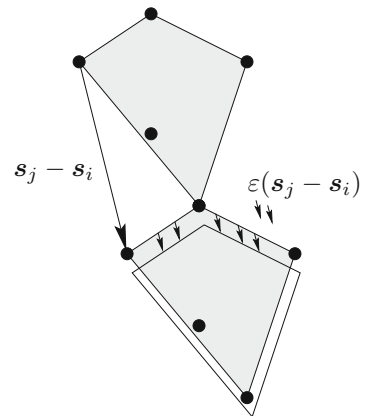
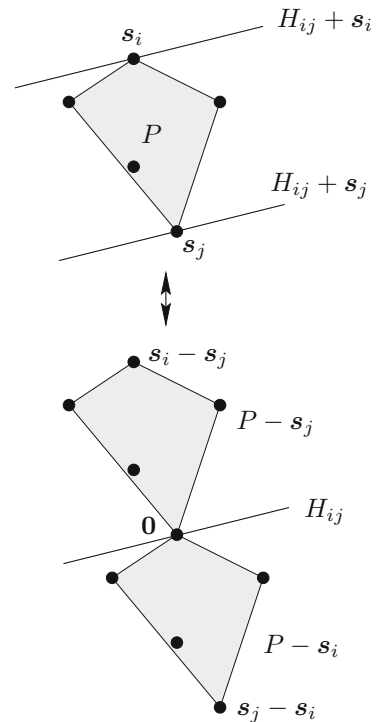

we have

$$\mathbf{x} - \mathbf{s}_i \in Q^* \quad \text{and} \quad \mathbf{x} - \mathbf{s}_j \in Q^*,$$

thus, since Q^* is centrally symmetric,

$$\mathbf{s}_i - \mathbf{x} = -(\mathbf{x} - \mathbf{s}_i) \in Q^*,$$

and hence, since Q^* is convex,

$$\frac{1}{2}(\mathbf{s}_i - \mathbf{s}_j) = \frac{1}{2}((\mathbf{x} - \mathbf{s}_j) + (\mathbf{s}_i - \mathbf{x})) \in Q^*.$$

We conclude that $\frac{1}{2}(\mathbf{s}_i + \mathbf{s}_j)$ is contained in $Q^* + \mathbf{s}_j$ for all i . Consequently, for $P := \text{conv}(S)$ we get

$$P_j := \frac{1}{2}(P + \mathbf{s}_j) = \text{conv} \left\{ \frac{1}{2}(\mathbf{s}_i + \mathbf{s}_j) : \mathbf{s}_i \in S \right\} \subseteq Q^* + \mathbf{s}_j,$$

which implies that the sets $P_j = \frac{1}{2}(P + \mathbf{s}_j)$ can only touch.

Finally, the sets P_j are contained in P , because all the points \mathbf{s}_i , \mathbf{s}_j and $\frac{1}{2}(\mathbf{s}_i + \mathbf{s}_j)$ are in P , since P is convex. But the P_j are just smaller, scaled, translates of P , contained in P . The scaling factor is $\frac{1}{2}$, which implies that

$$\text{vol}(P_j) = \frac{1}{2^d} \text{vol}(P),$$

since we are dealing with d -dimensional sets. This means that at most 2^d sets P_j fit into P , and hence $|S| \leq 2^d$.

This completes our proof: the chain of inequalities is closed. \square

...but that's not the end of the story. Danzer and Grünbaum asked the following natural question:

*What happens if one requires all angles to be **acute** rather than just nonobtuse, that is, if right angles are forbidden?*

They constructed configurations of $2d - 1$ points in \mathbb{R}^d with only acute angles, conjecturing that this may be best possible. Grünbaum proved that this is indeed true for $d \leq 3$. But twenty-one years later, in 1983, Paul Erdős and Zoltan Füredi showed that the conjecture is false — quite dramatically, if the dimension is high! Their proof is a great example for the power of probabilistic arguments; see Chapter 45 for an introduction to the “probabilistic method.” Our version of the proof uses a slight improvement in the choice of the parameters due to our reader David Bevan.

Theorem 2. *For every $d \geq 2$, there is a set $S \subseteq \{0, 1\}^d$ of $2 \lfloor \frac{\sqrt{6}}{9} (\frac{2}{\sqrt{3}})^d \rfloor$ points in \mathbb{R}^d (vertices of the unit d -cube) that determine only acute angles. In particular, in dimension $d = 34$ there is a set of $72 > 2 \cdot 34 - 1$ points with only acute angles.*

■ **Proof.** Set $m := \lfloor \frac{\sqrt{6}}{9} (\frac{2}{\sqrt{3}})^d \rfloor$, and pick $3m$ vectors

$$\mathbf{x}(1), \mathbf{x}(2), \dots, \mathbf{x}(3m) \in \{0, 1\}^d$$

by choosing all their coordinates independently and randomly, to be either 0 or 1, with probability $\frac{1}{2}$ for each alternative. (You may toss a perfect coin $3md$ times for this; however, if d is large you may get bored by this soon.)

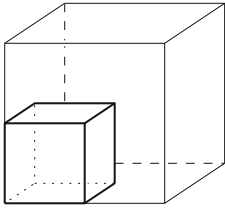

Scaling factor $\frac{1}{2}$, $\text{vol}(P_j) = \frac{1}{8} \text{vol}(P)$

We have seen above that all angles determined by 0/1-vectors are nonobtuse. Three vectors $\mathbf{x}(i)$, $\mathbf{x}(j)$, $\mathbf{x}(k)$ determine a right angle with apex $\mathbf{x}(j)$ if and only if the scalar product $\langle \mathbf{x}(i) - \mathbf{x}(j), \mathbf{x}(k) - \mathbf{x}(j) \rangle$ vanishes, that is, if we have

$$x(i)_\ell - x(j)_\ell = 0 \quad \text{or} \quad x(k)_\ell - x(j)_\ell = 0 \quad \text{for each coordinate } \ell.$$

We call (i, j, k) a *bad triple* if this happens. (If $\mathbf{x}(i) = \mathbf{x}(j)$ or $\mathbf{x}(j) = \mathbf{x}(k)$, then the angle is not defined, but also then the triple (i, j, k) is certainly bad.)

The probability that one specific triple is bad is exactly $(\frac{3}{4})^d$: Indeed, it will be good if and only if, for one of the d coordinates ℓ , we get

$$\begin{array}{l} \text{either} \quad x(i)_\ell = x(k)_\ell = 0, \quad x(j)_\ell = 1, \\ \text{or} \quad \quad x(i)_\ell = x(k)_\ell = 1, \quad x(j)_\ell = 0. \end{array}$$

This leaves us with six bad options out of eight equally likely ones, and a triple will be bad if and only if one of the bad options (with probability $\frac{3}{4}$) happens for each of the d coordinates.

The number of triples we have to consider is $3\binom{3m}{3}$, since there are $\binom{3m}{3}$ sets of three vectors, and for each of them there are three choices for the apex. Of course the probabilities that the various triples are bad are not independent: but *linearity of expectation* (which is what you get by averaging over all possible selections; see the appendix) yields that the *expected* number of bad triples is exactly $3\binom{3m}{3}(\frac{3}{4})^d$. This means — and this is the point where the probabilistic method shows its power — that there is *some* choice of the $3m$ vectors such that there are at most $3\binom{3m}{3}(\frac{3}{4})^d$ bad triples, where

$$3\binom{3m}{3}(\frac{3}{4})^d < 3\frac{(3m)^3}{6}(\frac{3}{4})^d = m^3(\frac{9}{\sqrt{6}})^2(\frac{3}{4})^d \leq m,$$

by the choice of m .

But if there are not more than m bad triples, then we can remove m of the $3m$ vectors $\mathbf{x}(i)$ in such a way that the remaining $2m$ vectors don't contain a bad triple, that is, they determine acute angles only. \square

The “probabilistic construction” of a large set of 0/1-points without right angles can be easily implemented. David Bevan has thus constructed a set of 31 0/1-points in dimension $d = 15$ that determines only acute angles.

Very recently, Balázs Gerencsér and Viktor Harangi, building on ideas of an anonymous Ukrainian enthusiast, managed to construct such “acute-angled sets” of size $2^{d-1} + 1$ for all dimensions d , which however do not anymore consist of 0/1 vectors. As we have seen above, the size $2^{d-1} + 1$ is optimal up to a factor of 2.

Appendix: Three tools from probability

Here we gather three basic tools from discrete probability theory which will come up several times: random variables, linearity of expectation and Markov's inequality.

Let (Ω, p) be a finite *probability space*, that is, Ω is a finite set and $p = \text{Prob}$ is a map from Ω into the interval $[0, 1]$ with $\sum_{\omega \in \Omega} p(\omega) = 1$. A *random variable* X on Ω is a mapping $X : \Omega \rightarrow \mathbb{R}$. We define a probability space on the image set $X(\Omega)$ by setting $p(X = x) := \sum_{X(\omega)=x} p(\omega)$. A simple example is an unbiased dice (all $p(\omega) = \frac{1}{6}$) with $X =$ “the number on top when the dice is thrown.”

The *expectation* EX of X is the average to be expected, that is,

$$EX = \sum_{\omega \in \Omega} p(\omega)X(\omega).$$

Now suppose X and Y are two random variables on Ω , then the sum $X + Y$ is again a random variable, and we obtain

$$\begin{aligned} E(X + Y) &= \sum_{\omega} p(\omega)(X(\omega) + Y(\omega)) \\ &= \sum_{\omega} p(\omega)X(\omega) + \sum_{\omega} p(\omega)Y(\omega) = EX + EY. \end{aligned}$$

Clearly, this can be extended to any finite linear combination of random variables — this is what is called the *linearity of expectation*. Note that it needs no assumption that the random variables have to be “independent” in any sense!

Our third tool concerns random variables X which take only nonnegative values, shortly denoted $X \geq 0$. Let

$$\text{Prob}(X \geq a) = \sum_{\omega: X(\omega) \geq a} p(\omega)$$

be the probability that X is at least as large as some $a > 0$. Then

$$EX = \sum_{\omega: X(\omega) \geq a} p(\omega)X(\omega) + \sum_{\omega: X(\omega) < a} p(\omega)X(\omega) \geq a \sum_{\omega: X(\omega) \geq a} p(\omega),$$

and we have proved *Markov's inequality*

$$\text{Prob}(X \geq a) \leq \frac{EX}{a}.$$

References

- [1] L. DANZER & B. GRÜNBAUM: *Über zwei Probleme bezüglich konvexer Körper von P. Erdős und von V. L. Klee*, Math. Zeitschrift **79** (1962), 95-99.
- [2] P. ERDŐS & Z. FÜREDI: *The greatest angle among n points in the d -dimensional Euclidean space*, Annals of Discrete Math. **17** (1983), 275-283.
- [3] B. GERENCSÉR & V. HARANGI: *Acute sets of exponentially optimal size*, Discrete Comput. Geometry (2018), to appear.
- [4] H. MINKOWSKI: *Dichteste gitterförmige Lagerung kongruenter Körper*, Nachrichten Ges. Wiss. Göttingen, Math.-Phys. Klasse 1904, 311-355.



Karol Borsuk's paper "Three theorems on the n -dimensional euclidean sphere" from 1933 is famous because it contained an important result (conjectured by Stanisław Ulam) that is now known as the Borsuk–Ulam theorem:

Every continuous map $f : S^d \rightarrow \mathbb{R}^d$ maps two antipodal points of the sphere S^d to the same point in \mathbb{R}^d .

We will see the full power of this theorem in a graph theory application in Chapter 43. The paper is famous also because of a problem posed at its end, which became known as Borsuk's Conjecture:

Can every set $S \subseteq \mathbb{R}^d$ of bounded diameter $\text{diam}(S) > 0$ be partitioned into at most $d + 1$ sets of smaller diameter?



Karol Borsuk

The bound $d + 1$ is best possible: If S is a regular d -dimensional simplex, or just the set of its $d + 1$ vertices, then no part of a diameter-reducing partition can contain more than one of the simplex vertices. If $f(d)$ denotes the smallest number such that every bounded set $S \subseteq \mathbb{R}^d$ has a diameter-reducing partition into $f(d)$ parts, then the example of a regular simplex establishes

$$f(d) \geq d + 1.$$

Borsuk's conjecture was proved for the case when S is a sphere (by Borsuk himself), for smooth bodies S (using the Borsuk–Ulam theorem), for $d \leq 3, \dots$ but the general conjecture remained open. The best available upper bound for $f(d)$ was established by Oded Schramm, who showed that

$$f(d) \leq (1.23)^d$$

for all large enough d . This bound looks quite weak compared with the conjecture " $f(d) = d + 1$," but it suddenly seemed reasonable when Jeff Kahn and Gil Kalai dramatically disproved Borsuk's conjecture in 1993. Sixty years after Borsuk's paper, Kahn and Kalai proved that

$$f(d) \geq (1.2)^{\sqrt{d}}$$

holds for large enough d , making judicious use of a combinatorial-geometric method of Peter Frankl and Richard Wilson.

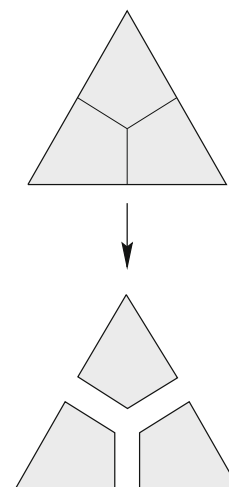

Any d -simplex can be split into $d + 1$ pieces, each of smaller diameter.



A. Nilli

A Book version of the Kahn–Kalai proof was provided by A. Nilli: Brief and self-contained, it yields an explicit counterexample to Borsuk's conjecture in dimension $d = 946$. We present here a modification of this proof, due to Andrei M. Raigorodskii and to Bernulf Weißbach, which reduces the dimension to $d = 561$, and even to $d = 560$. Using a novel method, involving special graphs, Andriy V. Bondarenko lowered this to $d = 65$. In fact, he showed that $f(d) > d + 1$ holds for every $d \geq 65$. His method, however, does not yield an exponential lower bound in d . The current “record” is $d = 64$, due to Thomas Jenrich.

Theorem. *Let $q = p^m$ be a prime power, $n := 4q - 2$, and $d := \binom{n}{2} = (2q - 1)(4q - 3)$. Then there is a set $S \subseteq \{+1, -1\}^d$ of 2^{n-2} points in \mathbb{R}^d such that every partition of S , whose parts have smaller diameter than S , has at least*

$$\frac{2^{n-2}}{\sum_{i=0}^{q-2} \binom{n-1}{i}}$$

parts. For $q = 9$ this implies that the Borsuk conjecture is false in dimension $d = 561$. Furthermore, $f(d) > (1.2)^{\sqrt{d}}$ holds for all large enough d .

■ **Proof.** The construction of the set S proceeds in four steps.

(1) Let q be a prime power, set $n = 4q - 2$, and let

$$Q := \left\{ \mathbf{x} \in \{+1, -1\}^n : x_1 = 1, \#\{i : x_i = -1\} \text{ is even} \right\}.$$

This Q is a set of 2^{n-2} vectors in \mathbb{R}^n . We will see that $\langle \mathbf{x}, \mathbf{y} \rangle \equiv 2 \pmod{4}$ holds for all vectors $\mathbf{x}, \mathbf{y} \in Q$. We will call \mathbf{x}, \mathbf{y} *nearly-orthogonal* if $|\langle \mathbf{x}, \mathbf{y} \rangle| = 2$. We will prove that any subset $Q' \subseteq Q$ which contains no nearly-orthogonal vectors must be “small”: $|Q'| \leq \sum_{i=0}^{q-2} \binom{n-1}{i}$.

$$\begin{aligned} \mathbf{x} &= \begin{pmatrix} 1 \\ -1 \\ -1 \\ 1 \\ -1 \end{pmatrix} \Rightarrow \\ \mathbf{x}^T &= (1 \ -1 \ -1 \ 1 \ -1) \\ \mathbf{x}\mathbf{x}^T &= \begin{pmatrix} 1 & -1 & -1 & 1 & -1 \\ -1 & 1 & 1 & -1 & 1 \\ -1 & 1 & 1 & -1 & 1 \\ 1 & -1 & -1 & 1 & -1 \\ -1 & 1 & 1 & -1 & 1 \end{pmatrix} \end{aligned}$$

Vectors, matrices, and scalar products

In our notation all vectors $\mathbf{x}, \mathbf{y}, \dots$ are column vectors; the transposed vectors $\mathbf{x}^T, \mathbf{y}^T, \dots$ are thus row vectors. The matrix product $\mathbf{x}\mathbf{x}^T$ is a matrix of rank 1, with $(\mathbf{x}\mathbf{x}^T)_{ij} = x_i x_j$.

If \mathbf{x}, \mathbf{y} are column vectors, then their *scalar product* is

$$\langle \mathbf{x}, \mathbf{y} \rangle = \sum_i x_i y_i = \mathbf{x}^T \mathbf{y}.$$

We will also need scalar products for matrices $X, Y \in \mathbb{R}^{n \times n}$ which can be interpreted as vectors of length n^2 , and thus their scalar product is

$$\langle X, Y \rangle := \sum_{i,j} x_{ij} y_{ij}.$$

(2) From Q , we construct the set

$$R := \{\mathbf{x}\mathbf{x}^T : \mathbf{x} \in Q\}$$

of 2^{n-2} symmetric $n \times n$ matrices of rank 1. We interpret them as vectors with n^2 components, $R \subseteq \mathbb{R}^{n^2}$. We will show that there are only acute angles between these vectors: they have positive scalar products, which are at least 4. Furthermore, if $R' \subseteq R$ contains no two vectors with minimal scalar product 4, then $|R'|$ is “small”: $|R'| \leq \sum_{i=0}^{q-2} \binom{n-1}{i}$.

(3) From R , we obtain the set of points in $\mathbb{R}^{\binom{n}{2}}$ whose coordinates are the subdiagonal entries of the corresponding matrices:

$$S := \{(\mathbf{x}\mathbf{x}^T)_{i>j} : \mathbf{x}\mathbf{x}^T \in R\}.$$

Again, S consists of 2^{n-2} points. The maximal distance between these points is precisely obtained for the nearly-orthogonal vectors $\mathbf{x}, \mathbf{y} \in Q$. We conclude that a subset $S' \subseteq S$ of smaller diameter than S must be “small”: $|S'| \leq \sum_{i=0}^{q-2} \binom{n-1}{i}$.

(4) Estimates: From (3) we see that one needs at least

$$g(q) := \frac{2^{4q-4}}{\sum_{i=0}^{q-2} \binom{4q-3}{i}}$$

parts in every diameter-reducing partition of S . Thus

$$f(d) \geq \max\{g(q), d + 1\} \quad \text{for } d = (2q - 1)(4q - 3).$$

Therefore, whenever we have $g(q) > (2q - 1)(4q - 3) + 1$, then we have a counterexample to Borsuk's conjecture in dimension $d = (2q - 1)(4q - 3)$. We will calculate below that $g(9) > 562$, which yields the counterexample in dimension $d = 561$, and that

$$g(q) > \frac{e}{64q^2} \left(\frac{27}{16}\right)^q,$$

which yields the asymptotic bound $f(d) > (1.2)^{\sqrt{d}}$ for d large enough.

Details for (1): We start with some harmless divisibility considerations.

Lemma. *The function $P(z) := \binom{z-2}{q-2}$ is a polynomial of degree $q - 2$. It yields integer values for all integers z . The integer $P(z)$ is divisible by p if and only if z is not congruent to 0 or 1 modulo q .*

■ **Proof.** For this we write the binomial coefficient as

$$P(z) = \binom{z-2}{q-2} = \frac{(z-2)(z-3)\cdots(z-q+1)}{(q-2)(q-3)\cdots 2 \cdot 1} \quad (*)$$

and compare the number of p -factors in the denominator and in the numerator. The denominator has the same number of p -factors as $(q - 2)!$,

Claim. If $a \equiv b \not\equiv 0 \pmod{q}$, then a and b have the same number of p -factors.

■ **Proof.** We have $a = b + sp^m$, where b is not divisible by $p^m = q$. So every power p^k that divides b satisfies $k < m$, and thus it also divides a . The statement is symmetric in a and b . \square

or as $(q-1)!$, since $q-1$ is not divisible by p . Indeed, by the claim in the margin we get an integer with the same number of p -factors if we take *any* product of $q-1$ integers, one from each nonzero residue class modulo q .

Now if z is congruent to 0 or 1 \pmod{q} , then the numerator is also of this type: All factors in the product are from different residue classes, and the only classes that do not occur are the zero class (the multiples of q), and the class either of -1 or of $+1$, but neither $+1$ nor -1 is divisible by p . Thus denominator and numerator have the same number of p -factors, and hence the quotient is not divisible by p .

On the other hand, if $z \not\equiv 0, 1 \pmod{q}$, then the numerator of $(*)$ contains one factor that is divisible by $q = p^m$. At the same time, the product has no factors from two adjacent nonzero residue classes: one of them represents numbers that have no p -factors at all, the other one has fewer p -factors than $q = p^m$. Hence there are more p -factors in the numerator than in the denominator, and the quotient is divisible by p . \square

Now we consider an arbitrary subset $Q' \subseteq Q$ that does not contain any nearly-orthogonal vectors. We want to establish that Q' must be “small.”

Claim 1. If \mathbf{x}, \mathbf{y} are distinct vectors from Q , then $\frac{1}{4}(\langle \mathbf{x}, \mathbf{y} \rangle + 2)$ is an integer in the range

$$-(q-2) \leq \frac{1}{4}(\langle \mathbf{x}, \mathbf{y} \rangle + 2) \leq q-1.$$

Both \mathbf{x} and \mathbf{y} have an even number of (-1) -components, so the number of components in which \mathbf{x} and \mathbf{y} differ is even, too. Thus

$$\langle \mathbf{x}, \mathbf{y} \rangle = (4q-2) - 2\#\{i : x_i \neq y_i\} \equiv -2 \pmod{4}$$

for all $\mathbf{x}, \mathbf{y} \in Q$, that is, $\frac{1}{4}(\langle \mathbf{x}, \mathbf{y} \rangle + 2)$ is an integer.

From $\mathbf{x}, \mathbf{y} \in \{+1, -1\}^{4q-2}$ we see that $-(4q-2) \leq \langle \mathbf{x}, \mathbf{y} \rangle \leq 4q-2$, that is, $-(q-1) \leq \frac{1}{4}(\langle \mathbf{x}, \mathbf{y} \rangle + 2) \leq q$. The lower bound never holds with equality, since $x_1 = y_1 = 1$ implies that $\mathbf{x} \neq -\mathbf{y}$. The upper bound holds with equality only if $\mathbf{x} = \mathbf{y}$.

Claim 2. For any $\mathbf{y} \in Q'$, the polynomial in n variables x_1, \dots, x_n of degree $q-2$ given by

$$F_{\mathbf{y}}(\mathbf{x}) := P\left(\frac{1}{4}(\langle \mathbf{x}, \mathbf{y} \rangle + 2)\right) = \binom{\frac{1}{4}(\langle \mathbf{x}, \mathbf{y} \rangle + 2) - 2}{q-2}$$

satisfies that $F_{\mathbf{y}}(\mathbf{x})$ is divisible by p for every $\mathbf{x} \in Q' \setminus \{\mathbf{y}\}$, but not for $\mathbf{x} = \mathbf{y}$.

The representation by a binomial coefficient shows that $F_{\mathbf{y}}(\mathbf{x})$ is an integer-valued polynomial. For $\mathbf{x} = \mathbf{y}$, we get $F_{\mathbf{y}}(\mathbf{y}) = 1$. For $\mathbf{x} \neq \mathbf{y}$, the Lemma yields that $F_{\mathbf{y}}(\mathbf{x})$ is not divisible by p if and only if $\frac{1}{4}(\langle \mathbf{x}, \mathbf{y} \rangle + 2)$ is congruent to 0 or 1 \pmod{q} . By Claim 1, this happens only if $\frac{1}{4}(\langle \mathbf{x}, \mathbf{y} \rangle + 2)$ is either 0 or 1, that is, if $\langle \mathbf{x}, \mathbf{y} \rangle \in \{-2, +2\}$. So \mathbf{x} and \mathbf{y} must be nearly-orthogonal for this, which contradicts the definition of Q' .

Claim 3. *The same is true for the polynomials $\overline{F}_{\mathbf{y}}(\mathbf{x})$ in the $n - 1$ variables x_2, \dots, x_n that are obtained as follows: Expand $F_{\mathbf{y}}(\mathbf{x})$ into monomials and remove the variable x_1 , and reduce all higher powers of other variables, by substituting $x_1 = 1$, and $x_i^2 = 1$ for $i > 1$. The polynomials $\overline{F}_{\mathbf{y}}(\mathbf{x})$ have degree at most $q - 2$.*

The vectors $\mathbf{x} \in Q \subseteq \{+1, -1\}^n$ all satisfy $x_1 = 1$ and $x_i^2 = 1$. Thus the substitutions do not change the values of the polynomials on the set Q . They also do not increase the degree, so $\overline{F}_{\mathbf{y}}(\mathbf{x})$ has degree at most $q - 2$.

Claim 4. *There is no linear relation (with rational coefficients) between the polynomials $\overline{F}_{\mathbf{y}}(\mathbf{x})$, that is, the polynomials $\overline{F}_{\mathbf{y}}(\mathbf{x})$, $\mathbf{y} \in Q'$, are linearly independent over \mathbb{Q} . In particular, they are distinct.*

Assume that there is a relation of the form $\sum_{\mathbf{y} \in Q'} \alpha_{\mathbf{y}} \overline{F}_{\mathbf{y}}(\mathbf{x}) = 0$ such that not all coefficients $\alpha_{\mathbf{y}}$ are zero. After multiplication with a suitable scalar we may assume that all the coefficients are integers, but not all of them are divisible by p . But then for every $\mathbf{y} \in Q'$ the evaluation at $\mathbf{x} := \mathbf{y}$ yields that $\alpha_{\mathbf{y}} \overline{F}_{\mathbf{y}}(\mathbf{y})$ is divisible by p , and hence so is $\alpha_{\mathbf{y}}$, since $\overline{F}_{\mathbf{y}}(\mathbf{y})$ is not.

Claim 5. *$|Q'|$ is bounded by the number of squarefree monomials of degree at most $q - 2$ in $n - 1$ variables, which is $\sum_{i=0}^{q-2} \binom{n-1}{i}$.*

By construction the polynomials $\overline{F}_{\mathbf{y}}$ are squarefree: none of their monomials contains a variable with higher degree than 1. Thus each $\overline{F}_{\mathbf{y}}(\mathbf{x})$ is a linear combination of the squarefree monomials of degree at most $q - 2$ in the $n - 1$ variables x_2, \dots, x_n . Since the polynomials $\overline{F}_{\mathbf{y}}(\mathbf{x})$ are linearly independent, their number (which is $|Q'|$) cannot be larger than the number of monomials in question.

Details for (2): The first column of $\mathbf{x}\mathbf{x}^T$ is \mathbf{x} . Thus for distinct $\mathbf{x} \in Q$ we obtain distinct matrices $M(\mathbf{x}) := \mathbf{x}\mathbf{x}^T$. We interpret these matrices as vectors of length n^2 with components $x_i x_j$. A simple computation

$$\begin{aligned} \langle M(\mathbf{x}), M(\mathbf{y}) \rangle &= \sum_{i=1}^n \sum_{j=1}^n (x_i x_j)(y_i y_j) \\ &= \left(\sum_{i=1}^n x_i y_i \right) \left(\sum_{j=1}^n x_j y_j \right) = \langle \mathbf{x}, \mathbf{y} \rangle^2 \geq 4 \end{aligned}$$

shows that the scalar product of $M(\mathbf{x})$ and $M(\mathbf{y})$ is minimized if and only if $\mathbf{x}, \mathbf{y} \in Q$ are nearly-orthogonal.

Details for (3): Let $U(\mathbf{x}) \in \{+1, -1\}^d$ denote the vector of all sub-diagonal entries of $M(\mathbf{x})$. Since $M(\mathbf{x}) = \mathbf{x}\mathbf{x}^T$ is symmetric with diagonal values $+1$, we see that $M(\mathbf{x}) \neq M(\mathbf{y})$ implies $U(\mathbf{x}) \neq U(\mathbf{y})$.

$$M(\mathbf{x}) = \begin{pmatrix} 1 & & & & & \\ & 1 & & & & \\ & & \ddots & & & \\ & & & \ddots & & \\ & & & & \ddots & \\ & & & & & 1 \end{pmatrix}$$

Furthermore,

$$4 \leq \langle M(\mathbf{x}), M(\mathbf{y}) \rangle = 2\langle U(\mathbf{x}), U(\mathbf{y}) \rangle + n,$$

that is,

$$\langle U(\mathbf{x}), U(\mathbf{y}) \rangle \geq -\frac{n}{2} + 2,$$

with equality if and only if \mathbf{x} and \mathbf{y} are nearly-orthogonal. Since all the vectors $U(\mathbf{x}) \in S$ have the same length

$$\sqrt{\langle U(\mathbf{x}), U(\mathbf{x}) \rangle} = \sqrt{\binom{n}{2}},$$

this means that the maximal distance between points $U(\mathbf{x}), U(\mathbf{y}) \in S$ is achieved exactly when \mathbf{x} and \mathbf{y} are nearly-orthogonal.

Details for (4): For $q = 9$ we have $g(9) \approx 758.31$, which is greater than $d + 1 = \binom{34}{2} + 1 = 562$.

To obtain a general bound for large d , we use monotonicity and unimodality of the binomial coefficients and the estimates $n! > e(\frac{n}{e})^n$ and $n! < en(\frac{n}{e})^n$ (see the appendix to Chapter 2) and derive

$$\sum_{i=0}^{q-2} \binom{4q-3}{i} < q \binom{4q}{q} = q \frac{(4q)!}{q!(3q)!} < q \frac{e 4q \left(\frac{4q}{e}\right)^{4q}}{e \left(\frac{q}{e}\right)^q e \left(\frac{3q}{e}\right)^{3q}} = \frac{4q^2}{e} \left(\frac{256}{27}\right)^q.$$

Thus we conclude

$$f(d) \geq g(q) = \frac{2^{4q-4}}{\sum_{i=0}^{q-2} \binom{4q-3}{i}} > \frac{e}{64q^2} \left(\frac{27}{16}\right)^q.$$

From this, with

$$d = (2q-1)(4q-3) = 5q^2 + (q-3)(3q-1) \geq 5q^2 \quad \text{for } q \geq 3,$$

$$q = \frac{5}{8} + \sqrt{\frac{d}{8} + \frac{1}{64}} > \sqrt{\frac{d}{8}}, \quad \text{and} \quad \left(\frac{27}{16}\right)^{\sqrt{\frac{1}{8}}} > 1.2032,$$

we get

$$f(d) > \frac{e}{13d} (1.2032)^{\sqrt{d}} > (1.2)^{\sqrt{d}} \quad \text{for all large enough } d. \quad \square$$

A counterexample of dimension 560 is obtained by noting that for $q = 9$ the quotient $g(q) \approx 758$ is *much* larger than the dimension $d(q) = 561$. Thus one gets a counterexample for $d = 560$ by taking only the “three fourths” of the points in S that satisfy $x_{21} + x_{31} + x_{32} = -1$.

Borsuk's conjecture is known to be true for $d \leq 3$, but it has not been verified for any larger dimension. In contrast to this, it *is* true up to $d = 8$ if we restrict ourselves to subsets $S \subseteq \{1, -1\}^d$, as constructed above (see [9]). In either case it is quite possible that counterexamples can be found in quite small dimensions.

References

- [1] A. V. BONDARENKO: *On Borsuk's conjecture for two-distance sets*, Discrete Comput. Geometry **51** (2014), 509–515.
- [2] K. BORSUK: *Drei Sätze über die n -dimensionale euklidische Sphäre*, Fundamenta Math. **20** (1933), 177-190.
- [3] P. FRANKL & R. WILSON: *Intersection theorems with geometric consequences*, Combinatorica **1** (1981), 357-368.
- [4] T. JENRICH & A. E. BROUWER: *A 64-dimensional counterexample to Borsuk's conjecture*, Electronic J. Combinatorics **21** (2014), #P4.29.
- [5] J. KAHN & G. KALAI: *A counterexample to Borsuk's conjecture*, Bulletin Amer. Math. Soc. **29** (1993), 60-62.
- [6] A. NILLI: *On Borsuk's problem*, in: "Jerusalem Combinatorics '93" (H. Barcelo and G. Kalai, eds.), Contemporary Mathematics **178**, Amer. Math. Soc. 1994, 209-210.
- [7] A. M. RAIGORODSKII: *On the dimension in Borsuk's problem*, Russian Math. Surveys (6) **52** (1997), 1324-1325.
- [8] O. SCHRAMM: *Illuminating sets of constant width*, Mathematika **35** (1988), 180-199.
- [9] B. WEISSBACH: *Sets with large Borsuk number*, Beiträge zur Algebra und Geometrie/Contributions to Algebra and Geometry **41** (2000), 417-423.
- [10] G. M. ZIEGLER: *Coloring Hamming graphs, optimal binary codes, and the 0/1-Borsuk problem in low dimensions*, Lecture Notes in Computer Science **2122**, Springer-Verlag 2001, 164-175.

Analysis



- 19**
Sets, functions,
and the continuum hypothesis 127
- 20**
In praise of inequalities 143
- 21**
The fundamental theorem
of algebra 151
- 22**
One square
and an odd number of triangles 155
- 23**
A theorem of Pólya
on polynomials 163
- 24**
Van der Waerden's
permanent conjecture 169
- 25**
On a lemma
of Littlewood and Offord 179
- 26**
Cotangent
and the Herglotz trick 183
- 27**
Buffon's needle problem 189

"Hilbert's seaside resort hotel"

Sets, functions, and the continuum hypothesis

Chapter 19



Set theory, founded by Georg Cantor in the second half of the 19th century, has profoundly transformed mathematics. Modern day mathematics is unthinkable without the concept of a set, or as David Hilbert put it: “Nobody will drive us from the paradise (of set theory) that Cantor has created for us.”

One of Cantor’s basic concepts is the notion of the *size* or *cardinality* of a set M , denoted by $|M|$. For finite sets, this presents no difficulties: we just count the number of elements and say that M is an n -set or has size n , if M contains precisely n elements. Thus two finite sets M and N have equal size, $|M| = |N|$, if they contain the same number of elements.

To carry this notion of *equal size* over to infinite sets, we use the following suggestive thought experiment for finite sets. Suppose a number of people board a bus. When will we say that the number of people is the same as the number of available seats? Simple enough, we let all people sit down. If everyone finds a seat, and no seat remains empty, then and only then do the two sets (of the people and of the seats) agree in number. In other words, the two sizes are the same if there is a *bijection* of one set onto the other.

This is then our definition: Two arbitrary sets M and N (finite or infinite) are said to be of *equal size* or *cardinality*, if and only if there exists a bijection from M onto N . Clearly, this notion of equal size is an equivalence relation, and we can thus associate a number, called *cardinal number*, to every class of equal-sized sets. For example, we obtain for finite sets the cardinal numbers $0, 1, 2, \dots, n, \dots$ where n stands for the class of n -sets, and, in particular, 0 for the *empty set* \emptyset . We further observe the obvious fact that a proper subset of a finite set M invariably has smaller size than M .

The theory becomes very interesting (and highly non-intuitive) when we turn to infinite sets. Consider the set $\mathbb{N} = \{1, 2, 3, \dots\}$ of natural numbers. We call a set M *countable* if it can be put in one-to-one correspondence with \mathbb{N} . In other words, M is countable if we can list the elements of M as m_1, m_2, m_3, \dots . But now a strange phenomenon occurs. Suppose we add to \mathbb{N} a new element x . Then $\mathbb{N} \cup \{x\}$ is still countable, and hence has equal size with \mathbb{N} !

This fact is delightfully illustrated by “Hilbert’s hotel.” Suppose a hotel has countably many rooms, numbered $1, 2, 3, \dots$ with guest g_i occupying room i ; so the hotel is fully booked. Now a new guest x arrives asking for a room, whereupon the hotel manager tells him: Sorry, all rooms are taken. No problem, says the new arrival, just move guest g_1 to room 2, g_2 to room 3, g_3 to room 4, and so on, and I will then take room 1. To the

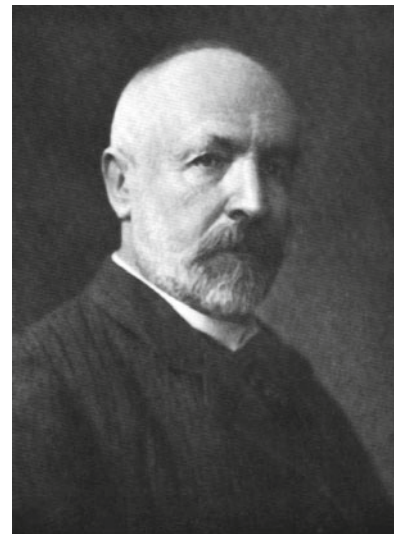

Georg Cantor

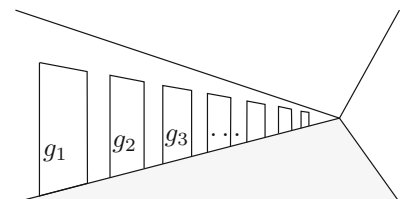

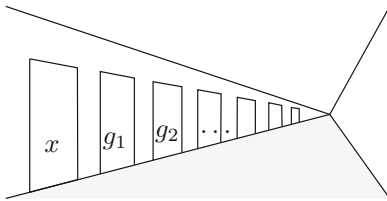

manager’s surprise (he is not a mathematician) this works; he can still put up all guests plus the new arrival x !

Now it is clear that he can also put up another guest y , and another one z , and so on. In particular, we note that, in contrast to finite sets, it may well happen that a proper subset of an *infinite* set M has the same size as M . In fact, as we will see, this is a characterization of infinity: A set is infinite if and only if it has the same size as some proper subset.

Let us leave Hilbert’s hotel and look at our familiar number sets. The set \mathbb{Z} of integers is again countable, since we may enumerate \mathbb{Z} in the form $\mathbb{Z} = \{0, 1, -1, 2, -2, 3, -3, \dots\}$. It may come more as a surprise that the rationals can be enumerated in a similar way.

Theorem 1. *The set \mathbb{Q} of rational numbers is countable.*

■ **Proof.** By listing the set \mathbb{Q}^+ of positive rationals as suggested in the figure in the margin, but leaving out numbers already encountered, we see that \mathbb{Q}^+ is countable, and hence so is \mathbb{Q} by listing 0 at the beginning and $-\frac{p}{q}$ right after $\frac{p}{q}$. With this listing

$$\mathbb{Q} = \{0, 1, -1, 2, -2, \frac{1}{2}, -\frac{1}{2}, \frac{1}{3}, -\frac{1}{3}, 3, -3, 4, -4, \frac{3}{2}, -\frac{3}{2}, \dots\}. \quad \square$$

Another way to interpret the figure is the following statement:

The union of countably many countable sets M_n is again countable.

Indeed, set $M_n = \{a_{n1}, a_{n2}, a_{n3}, \dots\}$ and list

$$\bigcup_{n=1}^{\infty} M_n = \{a_{11}, a_{21}, a_{12}, a_{13}, a_{22}, a_{31}, a_{41}, a_{32}, a_{23}, a_{14}, \dots\}$$

precisely as before.

Let us contemplate Cantor’s enumeration of the positive rationals a bit more. Looking at the figure we obtained the sequence

$$\frac{1}{1}, \frac{2}{1}, \frac{1}{2}, \frac{1}{3}, \frac{2}{2}, \frac{3}{1}, \frac{4}{1}, \frac{3}{2}, \frac{2}{3}, \frac{1}{4}, \frac{1}{5}, \frac{2}{4}, \frac{3}{3}, \frac{4}{2}, \frac{5}{1}, \dots$$

and then had to strike out the duplicates such as $\frac{2}{2} = \frac{1}{1}$ or $\frac{2}{4} = \frac{1}{2}$.

But there is a listing that is even more elegant and systematic, and which contains no duplicates — found only quite recently by Neil Calkin and Herbert Wilf. Their new list starts as follows:

$$\frac{1}{1}, \frac{1}{2}, \frac{2}{1}, \frac{1}{3}, \frac{3}{2}, \frac{2}{3}, \frac{3}{1}, \frac{4}{3}, \frac{3}{5}, \frac{5}{2}, \frac{5}{3}, \frac{3}{4}, \frac{4}{1}, \dots$$

Here the denominator of the n -th rational number equals the numerator of the $(n + 1)$ -st number. In other words, the n -th fraction is $b(n)/b(n + 1)$, where $(b(n))_{n \geq 0}$ is a sequence that starts with

$$(1, 1, 2, 1, 3, 2, 3, 1, 4, 3, 5, 2, 5, 3, 4, 1, 5, \dots).$$

This sequence has first been studied by a German mathematician, Moritz Abraham Stern, in a paper from 1858, and is has become known as “Stern’s diatomic series.”

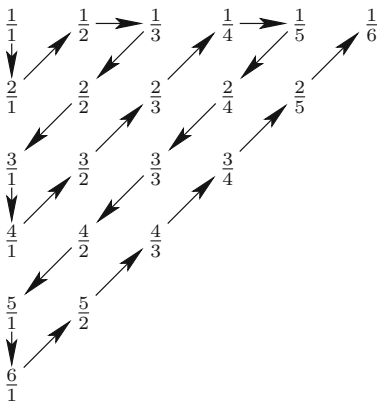

How do we obtain this sequence, and hence the Calkin–Wilf listing of the positive fractions? Consider the infinite binary tree in the margin. We immediately note its recursive rule:

- $\frac{1}{1}$ is on top of the tree, and
- every node $\frac{i}{j}$ has two sons: the left son is $\frac{i}{i+j}$ and the right son is $\frac{i+j}{j}$.

We can easily check the following four properties:

- (1) All fractions in the tree are reduced, that is, if $\frac{r}{s}$ appears in the tree, then r and s are relatively prime.

This holds for the top $\frac{1}{1}$, and then we use induction downward. If r and s are relatively prime, then so are r and $r + s$, as well as s and $r + s$.

- (2) Every reduced fraction $\frac{r}{s} > 0$ appears in the tree.

We use induction on the sum $r + s$. The smallest value is $r + s = 2$, that is $\frac{r}{s} = \frac{1}{1}$, and this appears at the top. If $r > s$, then $\frac{r-s}{s}$ appears in the tree by induction, and so we get $\frac{r}{s}$ as its right son. Similarly, if $r < s$, then $\frac{r}{s-r}$ appears, which has $\frac{r}{s}$ as its left son.

- (3) Every reduced fraction appears exactly once.

The argument is similar. If $\frac{r}{s}$ appears more than once, then $r \neq s$, since any node in the tree except the top is of the form $\frac{i}{i+j} < 1$ or $\frac{i+j}{j} > 1$. But if $r > s$ or $r < s$, then we argue by induction as before.

Every positive rational appears therefore exactly once in our tree, and we may write them down listing the numbers level-by-level from left to right. This yields precisely the initial segment shown above.

- (4) The denominator of the n -th fraction in our list equals the numerator of the $(n + 1)$ -st.

This is certainly true for $n = 0$, or when the n -th fraction is a left son. Suppose the n -th number $\frac{r}{s}$ is a right son. If $\frac{r}{s}$ is at the right boundary, then $s = 1$, and the successor lies at the left boundary and has numerator 1. Finally, if $\frac{r}{s}$ is in the interior, and $\frac{r'}{s'}$ is the next fraction in our sequence, then $\frac{r}{s}$ is the right son of $\frac{r-s}{s}$, $\frac{r'}{s'}$ is the left son of $\frac{r'}{s'-r'}$, and by induction the denominator of $\frac{r-s}{s}$ is the numerator of $\frac{r'}{s'-r'}$, so we get $s = r'$.

Well, this is nice, but there is even more to come. There are two natural questions:

- Does the sequence $(b(n))_{n \geq 0}$ have a “meaning”? That is, does $b(n)$ count anything simple?
- Given $\frac{r}{s}$, is there an easy way to determine the successor in the listing?

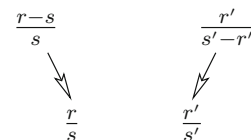
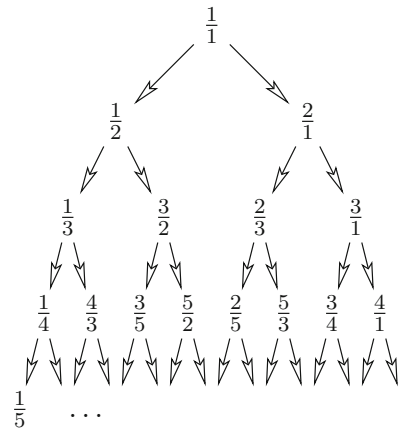

To answer the first question, we work out that the node $b(n)/b(n + 1)$ has the two sons $b(2n + 1)/b(2n + 2)$ and $b(2n + 2)/b(2n + 3)$. By the set-up of the tree we obtain the recursions

$$b(2n + 1) = b(n) \quad \text{and} \quad b(2n + 2) = b(n) + b(n + 1). \quad (1)$$

With $b(0) = 1$ the sequence $(b(n))_{n \geq 0}$ is completely determined by (1). So, is there a “nice” “known” sequence which obeys the same recursion? Yes, there is. We know that any number n can be uniquely written as a sum of distinct powers of 2 — this is the usual binary representation of n . A *hyper-binary* representation of n is a representation of n a sum of powers of 2, where every power 2^k appears at most *twice*. Let $h(n)$ be the number of such representations for n . You are invited to check that the sequence $h(n)$ obeys the recursion (1), and this gives $b(n) = h(n)$ for all n .

Incidentally, we have proved a surprising fact: Let $\frac{r}{s}$ be a reduced fraction, there exists precisely one integer n with $r = h(n)$ and $s = h(n + 1)$.

Let us look at the second question. We have in our tree

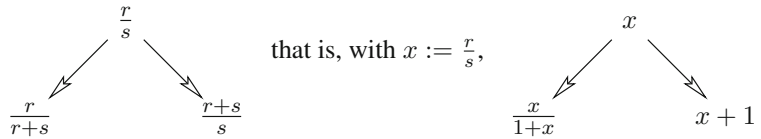

We now use this to generate an even larger infinite binary tree (without a root) as follows:

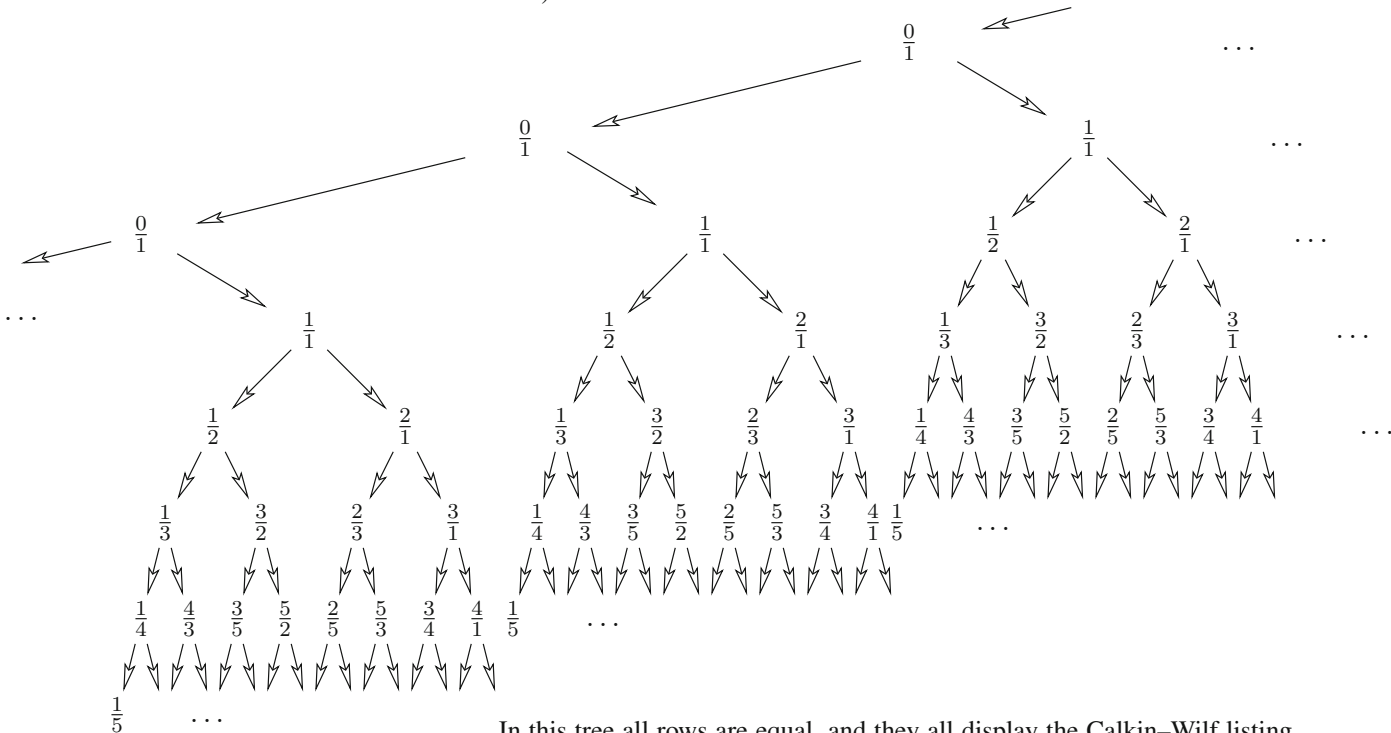

In this tree all rows are equal, and they all display the Calkin–Wilf listing of the positive rationals (starting with an additional $\frac{0}{1}$).

For example, $h(6) = 3$, with the hyper-binary representations

- $6 = 4 + 2$
- $6 = 4 + 1 + 1$
- $6 = 2 + 2 + 1 + 1$.

So how does one get from one rational to the next? To answer this, we first record that for every rational x its right son is $x + 1$, the right grand-son is $x + 2$, so the k -fold right son is $x + k$. Similarly, the left son of x is $\frac{x}{1+x}$, whose left son is $\frac{x}{1+2x}$, and so on: The k -fold left son of x is $\frac{x}{1+kx}$.

Now to find how to get from $\frac{s}{t} = x$ to the “next” rational $f(x)$ in the listing, we have to analyze the situation depicted in the margin. In fact, if we consider any nonnegative rational number x in our infinite binary tree, then it is the k -fold right son of the left son of some rational $y \geq 0$ (for some $k \geq 0$), while $f(x)$ is given as the k -fold left son of the right son of the same y . Thus with the formulas for k -fold left sons and k -fold right sons, we get

$$x = \frac{y}{1+y} + k,$$

as claimed in the figure in the margin. Here $k = \lfloor x \rfloor$ is the integral part of x , while $\frac{y}{1+y} = \{x\}$ is the fractional part. And from this we obtain

$$f(x) = \frac{y+1}{1+k(y+1)} = \frac{1}{\frac{1}{y+1} + k} = \frac{1}{k+1 - \frac{y}{y+1}} = \frac{1}{\lfloor x \rfloor + 1 - \{x\}}.$$

Thus we have obtained a beautiful formula for the successor $f(x)$ of x , first found by Moshe Newman:

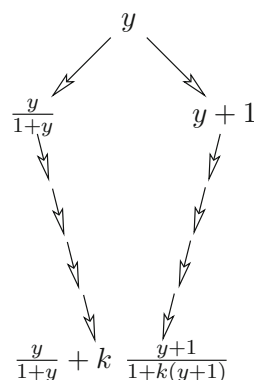

The function

$$x \mapsto f(x) = \frac{1}{\lfloor x \rfloor + 1 - \{x\}}$$

generates the Calkin–Wilf sequence

$$\frac{1}{1} \mapsto \frac{1}{2} \mapsto \frac{2}{1} \mapsto \frac{1}{3} \mapsto \frac{3}{2} \mapsto \frac{2}{3} \mapsto \frac{3}{1} \mapsto \frac{1}{4} \mapsto \frac{4}{3} \mapsto \dots$$

which contains every positive rational number exactly once.

The Calkin–Wilf–Newman way to enumerate the positive rationals has a number of additional remarkable properties. For example, one may ask for a fast way to determine the n -th fraction in the sequence, say for $n = 10^6$. Here it is:

To find the n -th fraction in the Calkin–Wilf sequence, express n as a binary number $n = (b_k b_{k-1} \dots b_1 b_0)_2$, and then follow the path in the Calkin–Wilf tree that is determined by its digits, starting at $\frac{s}{t} = \frac{0}{1}$.

Here $b_i = 1$ means “take the right son,” that is, “add the denominator to the numerator,” while $b_i = 0$ means “take the left son,” that is, “add the numerator to the denominator.”

The figure in the margin shows the resulting path for $n = 25 = (11001)_2$: So the 25th number in the Calkin–Wilf sequence is $\frac{7}{5}$. The reader could easily work out a similar scheme that computes for a given fraction $\frac{s}{t}$ (the binary representation of) its position n in the Calkin–Wilf sequence.

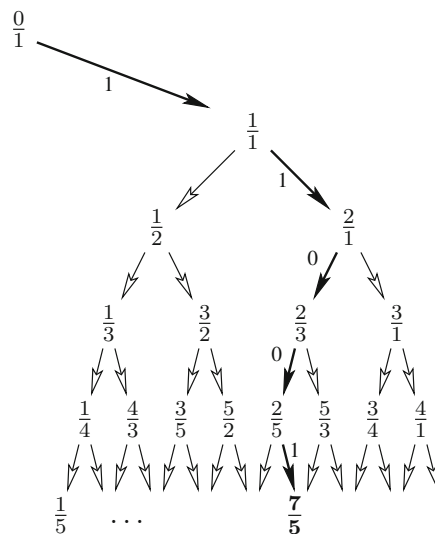

Let us move on to the real numbers \mathbb{R} . Are they still countable? No, they are not, and the means by which this is shown — Cantor’s *diagonalization method* — is not only of fundamental importance for all of set theory, but certainly belongs into The Book as a rare stroke of genius.

Theorem 2. *The set \mathbb{R} of real numbers is **not** countable.*

■ **Proof.** Any subset N of a countable set $M = \{m_1, m_2, m_3, \dots\}$ is *at most countable* (that is, finite or countable). In fact, just list the elements of N as they appear in M . Accordingly, if we can find a subset of \mathbb{R} which is not countable, then a fortiori \mathbb{R} cannot be countable. The subset M of \mathbb{R} we want to look at is the interval $(0, 1]$ of all positive real numbers r with $0 < r \leq 1$. Suppose, to the contrary, that M is countable, and let $M = \{r_1, r_2, r_3, \dots\}$ be a listing of M . We write r_n as its unique *infinite* decimal expansion without an infinite sequence of zeros at the end:

$$r_n = 0.a_{n1}a_{n2}a_{n3}\dots$$

where $a_{ni} \in \{0, 1, \dots, 9\}$ for all n and i . For example, $0.7 = 0.6999\dots$ Consider now the doubly infinite array

$$\begin{array}{rcl} r_1 & = & 0.a_{11}a_{12}a_{13}\dots \\ r_2 & = & 0.a_{21}a_{22}a_{23}\dots \\ & & \vdots \\ r_n & = & 0.a_{n1}a_{n2}a_{n3}\dots \\ & & \vdots \end{array}$$

For every n , let b_n be the least element of $\{1, 2\}$ that is different from a_{nn} . Then $b = 0.b_1b_2b_3\dots b_n\dots$ is a real number in our set M and hence must have an index, say $b = r_k$. But this cannot be, since b_k is different from a_{kk} . And this is the whole proof! □

Let us stay with the real numbers for a moment. We note that all four types of intervals $(0, 1)$, $(0, 1]$, $[0, 1)$ and $[0, 1]$ have the same size. As an example, we verify that $(0, 1]$ and $(0, 1)$ have equal cardinality. The map $f : (0, 1] \rightarrow (0, 1)$, $x \mapsto y$ defined by

$$y := \begin{cases} \frac{3}{2} - x & \text{for } \frac{1}{2} < x \leq 1, \\ \frac{3}{4} - x & \text{for } \frac{1}{4} < x \leq \frac{1}{2}, \\ \frac{3}{8} - x & \text{for } \frac{1}{8} < x \leq \frac{1}{4}, \\ \vdots & \end{cases}$$

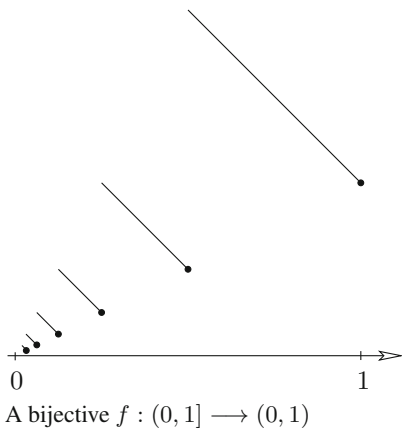

does the job. Indeed, the map is bijective, since the range of y in the first line is $\frac{1}{2} \leq y < 1$, in the second line $\frac{1}{4} \leq y < \frac{1}{2}$, in the third line $\frac{1}{8} \leq y < \frac{1}{4}$, and so on.

Next we find that *any* two intervals (of finite length > 0) have equal size by considering the central projection as in the figure. Even more is true: Every interval (of length > 0) has the same size as the whole real line \mathbb{R} . To see this, look at the bent open interval $(0, 1)$ and project it onto \mathbb{R} from the center S .

So, in conclusion, any open, half-open, closed (finite or infinite) interval of length > 0 has the same size, and we denote this size by c , where c stands for *continuum* (a name sometimes used for the interval $[0, 1]$).

That finite and infinite intervals have the same size may come expected on second thought, but here is a fact that is downright counter-intuitive.

Theorem 3. *The set \mathbb{R}^2 of all ordered pairs of real numbers (that is, the real plane) has the same size as \mathbb{R} .*

The theorem is due to Cantor 1878, as is the idea to merge the decimal expansions of two reals into one. The variant of Cantor's method that we are going to present is again from The Book. Abraham Fraenkel attributes the trick, which directly yields a bijection, to Julius König.

■ **Proof.** It suffices to prove that the set of all pairs (x, y) , $0 < x, y \leq 1$, can be mapped bijectively onto $(0, 1]$. Consider the pair (x, y) and write x, y in their unique non-terminating decimal expansion as in the following example:

$$\begin{array}{r} x = 0.3 \quad 01 \quad 2 \quad 007 \quad 08 \quad \dots \\ y = 0.009 \quad 2 \quad 05 \quad 1 \quad 0008 \quad \dots \end{array}$$

Note that we have separated the digits of x and y into groups by always going to the next nonzero digit, inclusive. Now we associate to (x, y) the number $z \in (0, 1]$ by writing down the first x -group, after that the first y -group, then the second x -group, and so on. Thus, in our example, we obtain

$$z = 0.3 \ 009 \ 01 \ 2 \ 2 \ 05 \ 007 \ 1 \ 08 \ 0008 \ \dots$$

Since neither x nor y exhibits only zeros from a certain point on, we find that the expression for z is again a non-terminating decimal expansion. Conversely, from the expansion of z we can immediately read off the preimage (x, y) , and the map is bijective — end of proof. \square

As $(x, y) \mapsto x + iy$ is a bijection from \mathbb{R}^2 onto the complex numbers \mathbb{C} , we conclude that $|\mathbb{C}| = |\mathbb{R}| = c$. Why is the result $|\mathbb{R}^2| = |\mathbb{R}|$ so unexpected? Because it goes against our intuition of *dimension*. It says that the 2-dimensional plane \mathbb{R}^2 (and, in general, by induction, the n -dimensional space \mathbb{R}^n) can be mapped bijectively onto the 1-dimensional line \mathbb{R} . Thus dimension is not generally preserved by bijective maps. If, however, we require the map and its inverse to be continuous, then the dimension is preserved, as was first shown by Luitzen Brouwer.

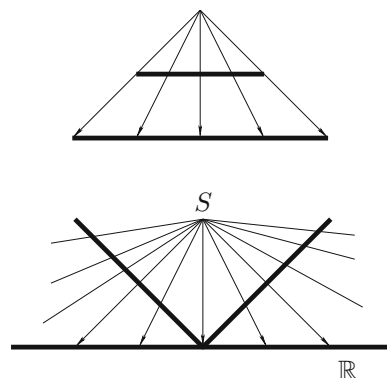

Let us go a little further. So far, we have the notion of equal size. When will we say that M is at most as large as N ? Mappings provide again the key. We say that the cardinal number \mathfrak{m} is *less than or equal to* \mathfrak{n} , if for sets M and N with $|M| = \mathfrak{m}$, $|N| = \mathfrak{n}$, there exists an *injection* from M into N . Clearly, the relation $\mathfrak{m} \leq \mathfrak{n}$ is independent of the representative sets M and N chosen. For finite sets this corresponds again to our intuitive notion: An m -set is at most as large as an n -set if and only if $m \leq n$.

Now we are faced with a basic problem. We would certainly like to have that the usual laws concerning inequalities also hold for cardinal numbers. But is this true for infinite cardinals? In particular, is it true that $\mathfrak{m} \leq \mathfrak{n}$, $\mathfrak{n} \leq \mathfrak{m}$ imply $\mathfrak{m} = \mathfrak{n}$?

The affirmative answer to this question is provided by the famous Cantor–Bernstein theorem, which Cantor announced in 1883. The first complete proof was presented by Felix Bernstein in Cantor’s seminar in 1897. Further proofs were given by Richard Dedekind, Ernst Zermelo, and others. Our proof is due to Julius König (1906).



“Cantor and Bernstein painting”

Theorem 4. *If each of two sets M and N can be mapped injectively into the other, then there is a bijection from M to N , that is, $|M| = |N|$.*

■ **Proof.** We may certainly assume that M and N are disjoint — if not, then we just replace N by a new copy.

Now f and g map back and forth between the elements of M and those of N . One way to bring this potentially confusing situation into perfect clarity and order is to align $M \cup N$ into chains of elements: Take an arbitrary element $m_0 \in M$, say, and from this generate a chain of elements by applying f , then g , then f again, then g , and so on. The chain may close up (this is Case 1) if we reach m_0 again in this process, or it may continue with distinct elements indefinitely. (The first “duplicate” in the chain cannot be an element different from m_0 , by injectivity.)

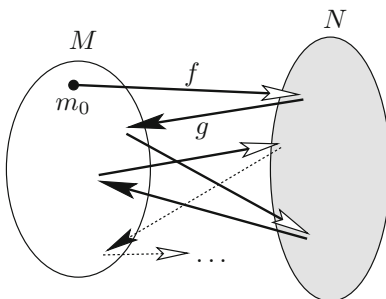

If the chain continues indefinitely, then we try to follow it backwards: From m_0 to $g^{-1}(m_0)$ if m_0 is in the image of g , then to $f^{-1}(g^{-1}(m_0))$ if $g^{-1}(m_0)$ is in the image of f , and so on. Three more cases may arise here: The process of following the chain backwards may go on indefinitely (Case 2), it may stop in an element of M that does not lie in the image of g (Case 3), or it may stop in an element of N that does not lie in the image of f (Case 4).

Thus $M \cup N$ splits perfectly into four types of chains, whose elements we may label in such a way that a bijection is simply given by putting $F : m_i \mapsto n_i$. We verify this in the four cases separately:

Case 1. Finite cycles on $2k + 2$ distinct elements ($k \geq 0$)

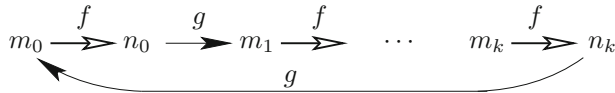

Case 2. Two-way infinite chains of distinct elements

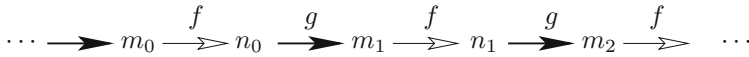

Case 3. The one-way infinite chains of distinct elements that start at the elements $m_0 \in M \setminus g(N)$



Case 4. The one-way infinite chains of distinct elements that start at the elements $n_0 \in N \setminus f(M)$

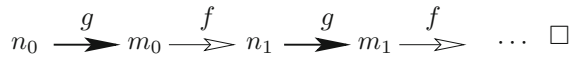

What about the other relations governing inequalities? As usual, we set $\mathfrak{m} < \mathfrak{n}$ if $\mathfrak{m} \leq \mathfrak{n}$, but $\mathfrak{m} \neq \mathfrak{n}$. We have just seen that for any two cardinals \mathfrak{m} and \mathfrak{n} at most one of the three possibilities

$$\mathfrak{m} < \mathfrak{n}, \quad \mathfrak{m} = \mathfrak{n}, \quad \mathfrak{m} > \mathfrak{n}$$

holds, and it follows from the theory of cardinal numbers that, in fact, precisely one relation is true. (See the appendix to this chapter, Proposition 2.) Furthermore, the Cantor–Bernstein Theorem tells us that the relation $<$ is transitive, that is, $\mathfrak{m} < \mathfrak{n}$ and $\mathfrak{n} < \mathfrak{p}$ imply $\mathfrak{m} < \mathfrak{p}$. Thus the cardinalities are arranged in linear order starting with the finite cardinals $0, 1, 2, 3, \dots$. Invoking the usual Zermelo–Fraenkel axiom system, we easily find that any infinite set M contains a countable subset. In fact, M contains an element, say m_1 . The set $M \setminus \{m_1\}$ is not empty (since it is infinite) and hence contains an element m_2 . Considering $M \setminus \{m_1, m_2\}$ we infer the existence of m_3 , and so on. So, the size of a countable set is the *smallest infinite cardinal*, usually denoted by \aleph_0 (pronounced “aleph zero”).



“The smallest infinite cardinal”

As a corollary to $\aleph_0 \leq \mathfrak{m}$ for any infinite cardinal \mathfrak{m} , we can immediately prove “Hilbert’s hotel” for any infinite cardinal number \mathfrak{m} , that is, we have $|M \cup \{x\}| = |M|$ for any infinite set M . Indeed, M contains a subset $N = \{m_1, m_2, m_3, \dots\}$. Now map x onto m_1 , m_1 onto m_2 , and so on, keeping the elements of $M \setminus N$ fixed. This gives the desired bijection.

With this we have also proved a result announced earlier: *Every infinite set has the same size as some proper subset.*

As another consequence of the Cantor–Bernstein theorem we may prove that the set $\mathcal{P}(\mathbb{N})$ of all subsets of \mathbb{N} has cardinality c . As noted above, it suffices to show that $|\mathcal{P}(\mathbb{N}) \setminus \{\emptyset\}| = |(0, 1]|$. An example of an injective map is

$$\begin{aligned} f: \mathcal{P}(\mathbb{N}) \setminus \{\emptyset\} &\longrightarrow (0, 1], \\ A &\longmapsto \sum_{i \in A} 10^{-i}, \end{aligned}$$

while

$$\begin{aligned} g: (0, 1] &\longrightarrow \mathcal{P}(\mathbb{N}) \setminus \{\emptyset\}, \\ 0.b_1b_2b_3\dots &\longmapsto \{b_i 10^i : i \in \mathbb{N}\} \end{aligned}$$

defines an injection in the other direction.

Up to now we know the cardinal numbers $0, 1, 2, \dots, \aleph_0$, and further that the cardinality c of \mathbb{R} is bigger than \aleph_0 . The passage from \mathbb{Q} with $|\mathbb{Q}| = \aleph_0$ to \mathbb{R} with $|\mathbb{R}| = c$ immediately suggests the next question:

Is $c = |\mathbb{R}|$ the next infinite cardinal number after \aleph_0 ?

Now, of course, we have the problem whether there *is* a next larger cardinal number, or in other words, whether \aleph_1 has a meaning at all. It does — the proof for this is outlined in the appendix to this chapter.

The statement $c = \aleph_1$ became known as the *continuum hypothesis*. The question whether the continuum hypothesis is true presented for many decades one of the supreme challenges in all of mathematics. The answer, finally given by Kurt Gödel and Paul Cohen, takes us to the limit of logical thought. They showed that the statement $c = \aleph_1$ is *independent* of the Zermelo–Fraenkel axiom system, in the same way as the parallel axiom is independent of the other axioms of Euclidian geometry. There are models where $c = \aleph_1$ holds, and there are other models of set theory where $c \neq \aleph_1$ holds.

In the light of this fact it is quite interesting to ask whether there are other conditions (from analysis, say) which are equivalent to the continuum hypothesis. Indeed, it is natural to ask for an analysis example, since historically the first substantial applications of Cantor’s set theory occurred in analysis, specifically in complex function theory. In the following we want to present one such instance and its extremely elegant and simple solution by Paul Erdős. In 1962 John E. Wetzel, a young instructor at the University of Illinois, asked the following question:

Let $\{f_\alpha\}$ be a family of pairwise distinct analytic functions on the complex numbers such that for each $z \in \mathbb{C}$ the set of values $\{f_\alpha(z)\}$ is at most countable (that is, it is either finite or countable); let us call this property (P_0) .
Does it then follow that the family itself is at most countable?

Very shortly afterwards Erdős showed that, surprisingly, the answer depends on the continuum hypothesis.

Theorem 5. *If $c > \aleph_1$, then every family $\{f_\alpha\}$ satisfying (P_0) is countable. If, on the other hand, $c = \aleph_1$, then there exists some family $\{f_\alpha\}$ with property (P_0) which has size c .*

For the proof we need some basic facts on cardinal and ordinal numbers. For readers who are unfamiliar with these concepts, this chapter has an appendix where all the necessary results are collected.

■ **Proof.** Assume first $c > \aleph_1$. We shall show that for any family $\{f_\alpha\}$ of size \aleph_1 of analytic functions there exists a complex number z_0 such that all \aleph_1 values $f_\alpha(z_0)$ are distinct. Consequently, if a family of functions satisfies (P_0) , then it must be countable.

To see this, we make use of our knowledge of ordinal numbers. First, we well-order the family $\{f_\alpha\}$ according to the initial ordinal number ω_1 of \aleph_1 . This means by Proposition 1 of the appendix that the index set runs through all ordinal numbers α which are smaller than ω_1 . Next we show that the set of pairs (α, β) , $\alpha < \beta < \omega_1$, has size \aleph_1 . Since any $\beta < \omega_1$ is a countable ordinal, the set of pairs (α, β) , $\alpha < \beta$, is countable for every fixed β . Taking the union over all \aleph_1 -many β , we find from Proposition 6 of the appendix that the set of all pairs (α, β) , $\alpha < \beta$, has size \aleph_1 .

Consider now for any pair $\alpha < \beta$ the set

$$S(\alpha, \beta) = \{z \in \mathbb{C} : f_\alpha(z) = f_\beta(z)\}.$$

We claim that each set $S(\alpha, \beta)$ is countable. To verify this, consider the disks C_k of radius $k = 1, 2, 3, \dots$ around the origin in the complex plane. If f_α and f_β agree on infinitely many points in some C_k , then f_α and f_β are identical by a well-known result on analytic functions. Hence f_α and f_β agree only in finitely many points in each C_k , and hence in at most countably many points altogether. Now we set

$$S := \bigcup_{\alpha < \beta} S(\alpha, \beta).$$

Again by Proposition 6, we find that S has size \aleph_1 , as each set $S(\alpha, \beta)$ is countable. And here is the punch line: Because, as we know, \mathbb{C} has size c , and c is larger than \aleph_1 by assumption, there exists a complex number z_0 not in S , and for this z_0 all \aleph_1 values $f_\alpha(z_0)$ are distinct.

Next we assume $c = \aleph_1$. Consider the set $D \subseteq \mathbb{C}$ of complex numbers $p + iq$ with rational real and imaginary part. Since for each p the set $\{p + iq : q \in \mathbb{Q}\}$ is countable, we find that D is countable. Furthermore, D is a *dense* set in \mathbb{C} : Every open disk in the complex plane contains some point of D . Let $\{z_\alpha : 0 \leq \alpha < \omega_1\}$ be a well-ordering of \mathbb{C} . We shall now construct a family $\{f_\beta : 0 \leq \beta < \omega_1\}$ of \aleph_1 -many distinct analytic functions such that

$$f_\beta(z_\alpha) \in D \text{ whenever } \alpha < \beta. \quad (1)$$

Any such family satisfies the condition (P_0) . Indeed, each point $z \in \mathbb{C}$ has some index, say $z = z_\alpha$. Now, for all $\beta > \alpha$, the values $\{f_\beta(z_\alpha)\}$ lie in the *countable* set D . Since α is a countable ordinal number, the functions f_β with $\beta \leq \alpha$ will contribute at most countably further values $f_\beta(z_\alpha)$, so that the set of all values $\{f_\beta(z_\alpha)\}$ is likewise at most countable. Hence, if we can construct a family $\{f_\beta\}$ satisfying (1), then the second part of the theorem is proved.

The construction of $\{f_\beta\}$ is by transfinite induction. For f_0 we may take any analytic function, for example $f_0 = \text{constant}$. Suppose f_β has already been constructed for all $\beta < \gamma$. Since γ is a countable ordinal, we may reorder $\{f_\beta : 0 \leq \beta < \gamma\}$ into a sequence g_1, g_2, g_3, \dots . The same re-ordering of $\{z_\alpha : 0 \leq \alpha < \gamma\}$ yields a sequence w_1, w_2, w_3, \dots . We shall now construct a function f_γ satisfying for each n the conditions

$$f_\gamma(w_n) \in D \quad \text{and} \quad f_\gamma(w_n) \neq g_n(w_n). \quad (2)$$

The second condition will ensure that all functions f_γ ($0 \leq \gamma < \omega_1$) are distinct, and the first condition is just (1), implying (P_0) by our previous argument. Notice that the condition $f_\gamma(w_n) \neq g_n(w_n)$ is once more a diagonalization argument.

To construct f_γ , we write

$$\begin{aligned} f_\gamma(z) &:= \varepsilon_0 + \varepsilon_1(z - w_1) + \varepsilon_2(z - w_1)(z - w_2) \\ &\quad + \varepsilon_3(z - w_1)(z - w_2)(z - w_3) + \dots \end{aligned}$$

If γ is a finite ordinal, then f_γ is a polynomial and hence analytic, and we can certainly choose numbers ε_i such that (2) is satisfied. Now suppose γ is a countable ordinal, then

$$f_\gamma(z) = \sum_{n=0}^{\infty} \varepsilon_n(z - w_1) \cdots (z - w_n). \quad (3)$$

Note that the values of ε_m ($m \geq n$) have no influence on the value $f_\gamma(w_n)$, hence we may choose the ε_n step by step. If the sequence (ε_n) converges to 0 sufficiently fast, then (3) defines an analytic function. Finally, since D is a dense set, we may choose this sequence (ε_n) so that f_γ meets the requirements of (2), and the proof is complete. \square

Appendix: On cardinal and ordinal numbers

Let us first discuss the question whether to each cardinal number there exists a next larger one. As a start we show that to every cardinal number \mathfrak{m} there always is a cardinal number \mathfrak{n} larger than \mathfrak{m} . To do this we employ again a version of Cantor's diagonalization method.

Let M be a set, then we claim that the set $\mathcal{P}(M)$ of all subsets of M has larger size than M . By letting $m \in M$ correspond to $\{m\} \in \mathcal{P}(M)$, we see that M can be mapped bijectively onto a subset of $\mathcal{P}(M)$, which implies $|M| \leq |\mathcal{P}(M)|$ by definition. It remains to show that $\mathcal{P}(M)$ can not be mapped bijectively onto a subset of M . Suppose, on the contrary, $\varphi : N \rightarrow \mathcal{P}(M)$ is a bijection of $N \subseteq M$ onto $\mathcal{P}(M)$. Consider the subset $U \subseteq N$ of all elements of N which are not contained in their image under φ , that is, $U = \{m \in N : m \notin \varphi(m)\}$. Since φ is a bijection, there exists $u \in N$ with $\varphi(u) = U$. Now, either $u \in U$ or $u \notin U$, but both alternatives are impossible! Indeed, if $u \in U$, then $u \notin \varphi(u) = U$ by the definition of U , and if $u \notin U = \varphi(u)$, then $u \in U$, contradiction.

Most likely, the reader has seen this argument before. It is the old barber riddle: "A barber is the man who shaves all men who do not shave themselves. Does the barber shave himself?"

To get further in the theory we introduce another great concept of Cantor's, ordered sets and ordinal numbers. A set M is *ordered* by $<$ if the relation $<$ is transitive, and if for any two distinct elements a and b of M we either have $a < b$ or $b < a$. For example, we can order \mathbb{N} in the usual way according to magnitude, $\mathbb{N} = \{1, 2, 3, 4, \dots\}$, but, of course, we can also order \mathbb{N} the other way round, $\mathbb{N} = \{\dots, 4, 3, 2, 1\}$, or $\mathbb{N} = \{1, 3, 5, \dots, 2, 4, 6, \dots\}$ by listing first the odd numbers and then the even numbers.

Here is the seminal concept. An ordered set M is called *well-ordered* if every nonempty subset of M has a first element. Thus the first and third orderings of \mathbb{N} above are well-orderings, but not the second ordering. The fundamental *well-ordering theorem*, implied by the axioms (including the axiom of choice), now states that every set M admits a well-ordering. From now on, we only consider sets endowed with a well-ordering.

Let us say that two well-ordered sets M and N are *similar* (or of the *same order-type*) if there exists a bijection φ from M on N which respects the ordering, that is, $m <_M n$ implies $\varphi(m) <_N \varphi(n)$. Note that any ordered set which is similar to a well-ordered set is itself well-ordered.

Similarity is obviously an equivalence relation, and we can thus speak of an *ordinal number* α belonging to a class of similar sets. For finite sets, any two orderings are similar well-orderings, and we use again the ordinal number n for the class of n -sets. Note that, by definition, two similar sets have the same cardinality. Hence it makes sense to speak of the *cardinality* $|\alpha|$ of an ordinal number α . Note further that any subset of a well-ordered set is also well-ordered under the induced ordering.

As we did for cardinal numbers, we now compare ordinal numbers. Let M be a well-ordered set, $m \in M$, then $M_m = \{x \in M : x < m\}$ is called the (*initial*) *segment* of M determined by m ; N is a segment of M if $N = M_m$



"A legend talks about St. Augustin who, walking along the seashore and contemplating infinity, saw a child trying to empty the ocean with a small shell..."

The well-ordered sets $\mathbb{N} = \{1, 2, 3, \dots\}$ and $\mathbb{N} = \{1, 3, 5, \dots, 2, 4, 6, \dots\}$ are *not* similar: the first ordering has only one element without an immediate predecessor, while the second one has two.

The ordinal number of $\{1, 2, 3, \dots\}$ is smaller than the ordinal number of $\{1, 3, 5, \dots, 2, 4, 6, \dots\}$.

for some m . Thus, in particular, M_m is the empty set when m is the first element of M . Now let μ and ν be the ordinal numbers of the well-ordered sets M and N . We say that μ is *smaller* than ν , $\mu < \nu$, if M is similar to a segment of N . Again, we have the transitive law that $\mu < \nu$, $\nu < \pi$ implies $\mu < \pi$, since under a similarity mapping a segment is mapped onto a segment.

Clearly, for finite sets, $m < n$ corresponds to the usual meaning. Let us denote by ω the ordinal number of $\mathbb{N} = \{1, 2, 3, 4, \dots\}$ ordered according to magnitude. By considering the segment \mathbb{N}_{n+1} we find $n < \omega$ for any finite n . Next we see that $\omega \leq \alpha$ holds for any infinite ordinal number α . Indeed, if the infinite well-ordered set M has ordinal number α , then M contains a first element m_1 , the set $M \setminus \{m_1\}$ contains a first element m_2 , $M \setminus \{m_1, m_2\}$ contains a first element m_3 . Continuing in this way, we produce the sequence $m_1 < m_2 < m_3 < \dots$ in M . If $M = \{m_1, m_2, m_3, \dots\}$, then M is similar to \mathbb{N} , and hence $\alpha = \omega$. If, on the other hand, $M \setminus \{m_1, m_2, \dots\}$ is nonempty, then it contains a first element m , and we conclude that \mathbb{N} is similar to the segment M_m , that is, $\omega < \alpha$ by definition.

We now state (without the proofs, which are not difficult) three basic results on ordinal numbers. The first says that any ordinal number μ has a “standard” representative well-ordered set W_μ .

Proposition 1. *Let μ be an ordinal number and denote by W_μ the set of ordinal numbers smaller than μ . Then the following holds:*

- (i) *The elements of W_μ are pairwise comparable.*
- (ii) *If we order W_μ according to magnitude, then W_μ is well-ordered and has ordinal number μ .*

Proposition 2. *Any two ordinal numbers μ and ν satisfy precisely one of the relations $\mu < \nu$, $\mu = \nu$, or $\mu > \nu$.*

Proposition 3. *Every set of ordinal numbers (ordered according to magnitude) is well-ordered.*

After this excursion to ordinal numbers we come back to cardinal numbers. Let \mathfrak{m} be a cardinal number, and denote by $O_{\mathfrak{m}}$ the set of all ordinal numbers μ with $|\mu| = \mathfrak{m}$. By Proposition 3 there is a *smallest* ordinal number $\omega_{\mathfrak{m}}$ in $O_{\mathfrak{m}}$, which we call the *initial ordinal number* of \mathfrak{m} . As an example, ω is the initial ordinal number of \aleph_0 .

With these preparations we can now prove a basic result for this chapter.

Proposition 4. *For every cardinal number \mathfrak{m} there is a definite next larger cardinal number.*

■ **Proof.** We already know that there is some larger cardinal number \mathfrak{n} . Consider now the set \mathcal{K} of all cardinal numbers larger than \mathfrak{m} and at most as large as \mathfrak{n} . We associate to each $\mathfrak{p} \in \mathcal{K}$ its initial ordinal number $\omega_{\mathfrak{p}}$. Among these initial numbers there is a smallest (Proposition 3), and the corresponding cardinal number is then the smallest in \mathcal{K} , and thus is the desired next larger cardinal number to \mathfrak{m} . □

Proposition 5. *Let the infinite set M have cardinality \mathfrak{m} , and let M be well-ordered according to the initial ordinal number $\omega_{\mathfrak{m}}$. Then M has no last element.*

■ **Proof.** Indeed, if M had a last element m , then the segment M_m would have an ordinal number $\mu < \omega_{\mathfrak{m}}$ with $|\mu| = \mathfrak{m}$, contradicting the definition of $\omega_{\mathfrak{m}}$. \square

What we finally need is a considerable strengthening of the result that the union of countably many countable sets is again countable. In the following result we consider *arbitrary* families of countable sets.

Proposition 6. *Suppose $\{A_{\alpha}\}$ is a family of size \mathfrak{m} of countable sets A_{α} , where \mathfrak{m} is an infinite cardinal. Then the union $\bigcup_{\alpha} A_{\alpha}$ has size at most \mathfrak{m} .*

■ **Proof.** We may assume that the sets A_{α} are pairwise disjoint, since this can only increase the size of the union. Let M with $|M| = \mathfrak{m}$ be the index set, and well-order it according to the initial ordinal number $\omega_{\mathfrak{m}}$. We now replace each $\alpha \in M$ by a countable set $B_{\alpha} = \{\alpha, b_{\alpha 2}, b_{\alpha 3}, \dots\}$, ordered according to ω , and call the new set \widetilde{M} . Then \widetilde{M} is again well-ordered by setting $b_{\alpha i} < b_{\beta j}$ for $\alpha < \beta$ and $b_{\alpha i} < b_{\alpha j}$ for $i < j$. Let $\widetilde{\mu}$ be the ordinal number of \widetilde{M} . Since M is a subset of \widetilde{M} , we have $\mu \leq \widetilde{\mu}$ by an earlier argument. If $\mu = \widetilde{\mu}$, then M is similar to \widetilde{M} , and if $\mu < \widetilde{\mu}$, then M is similar to a segment of \widetilde{M} . Now, since the ordering $\omega_{\mathfrak{m}}$ of M has no last element (Proposition 5), we see that M is in both cases similar to the union of countable sets B_{β} , and hence of the same cardinality.

The rest is easy. Let $\varphi : \bigcup B_{\beta} \rightarrow M$ be a bijection, and suppose that $\varphi(B_{\beta}) = \{\alpha_1, \alpha_2, \alpha_3, \dots\}$. Replace each α_i by A_{α_i} and consider the union $\bigcup A_{\alpha_i}$. Since $\bigcup A_{\alpha_i}$ is the union of *countably* many countable sets (and hence countable), we see that B_{β} has the same size as $\bigcup A_{\alpha_i}$. In other words, there is a bijection from B_{β} to $\bigcup A_{\alpha_i}$ for all β , and hence a bijection ψ from $\bigcup B_{\beta}$ to $\bigcup A_{\alpha}$. But now $\psi\varphi^{-1}$ gives the desired bijection from M to $\bigcup A_{\alpha}$, and thus $|\bigcup A_{\alpha}| = \mathfrak{m}$. \square

References

- [1] L. E. J. BROUWER: *Beweis der Invarianz der Dimensionszahl*, Math. Annalen **70** (1911), 161-165.
- [2] N. CALKIN & H. WILF: *Recounting the rationals*, Amer. Math. Monthly **107** (2000), 360-363.
- [3] G. CANTOR: *Ein Beitrag zur Mannigfaltigkeitslehre*, Journal für die reine und angewandte Mathematik **84** (1878), 242-258.
- [4] P. COHEN: *Set Theory and the Continuum Hypothesis*, W. A. Benjamin, New York 1966.
- [5] P. ERDŐS: *An interpolation problem associated with the continuum hypothesis*, Michigan Math. J. **11** (1964), 9-10.
- [6] E. KAMKE: *Theory of Sets*, Dover Books 1950.
- [7] M. A. STERN: *Ueber eine zahlentheoretische Funktion*, Journal für die reine und angewandte Mathematik **55** (1858), 193-220.



"Infinitely many more cardinals"

*Without infinite cardinal
K. Kofman 1978*



Analysis abounds with inequalities, as witnessed for example by the famous book “Inequalities” by Hardy, Littlewood and Pólya. Let us single out two of the most basic inequalities with two applications each, and let us listen in to George Pólya, who was himself a champion of the Book Proof, about what he considers the most appropriate proofs.

Our first inequality is variously attributed to Cauchy, Schwarz and/or to Buniakowski:

Theorem I (Cauchy–Schwarz inequality)

Let $\langle \mathbf{a}, \mathbf{b} \rangle$ be an inner product on a real vector space V (with the norm $|\mathbf{a}|^2 := \langle \mathbf{a}, \mathbf{a} \rangle$). Then

$$\langle \mathbf{a}, \mathbf{b} \rangle^2 \leq |\mathbf{a}|^2 |\mathbf{b}|^2$$

holds for all vectors $\mathbf{a}, \mathbf{b} \in V$, with equality if and only if \mathbf{a} and \mathbf{b} are linearly dependent.

■ **Proof.** The following (folklore) proof is probably the shortest. Consider the quadratic function

$$|x\mathbf{a} + \mathbf{b}|^2 = x^2|\mathbf{a}|^2 + 2x\langle \mathbf{a}, \mathbf{b} \rangle + |\mathbf{b}|^2$$

in the variable x . We may assume $\mathbf{a} \neq \mathbf{0}$. If $\mathbf{b} = \lambda\mathbf{a}$, then clearly $\langle \mathbf{a}, \mathbf{b} \rangle^2 = |\mathbf{a}|^2 |\mathbf{b}|^2$. If, on the other hand, \mathbf{a} and \mathbf{b} are linearly independent, then $|x\mathbf{a} + \mathbf{b}|^2 > 0$ for all x , and thus the discriminant $\langle \mathbf{a}, \mathbf{b} \rangle^2 - |\mathbf{a}|^2 |\mathbf{b}|^2$ is less than 0. \square

Our second example is the *inequality of the harmonic, geometric and arithmetic mean*:

Theorem II (Harmonic, geometric and arithmetic mean)

Let a_1, \dots, a_n be positive real numbers, then

$$\frac{n}{\frac{1}{a_1} + \dots + \frac{1}{a_n}} \leq \sqrt[n]{a_1 a_2 \dots a_n} \leq \frac{a_1 + \dots + a_n}{n}$$

with equality in both cases if and only if all a_i 's are equal.

■ **Proof.** The following beautiful nonstandard induction proof is attributed to Cauchy (see [8]). Let $P(n)$ be the statement of the second inequality, written in the form

$$a_1 a_2 \dots a_n \leq \left(\frac{a_1 + \dots + a_n}{n} \right)^n.$$

For $n = 2$, we have $a_1 a_2 \leq \left(\frac{a_1 + a_2}{2}\right)^2 \iff (a_1 - a_2)^2 \geq 0$, which is true. Now we proceed in the following two steps:

$$\text{(A)} \quad P(n) \implies P(n-1)$$

$$\text{(B)} \quad P(n) \text{ and } P(2) \implies P(2n)$$

which will clearly imply the full result.

To prove **(A)**, set $A := \sum_{k=1}^{n-1} \frac{a_k}{n-1}$, then

$$\left(\prod_{k=1}^{n-1} a_k\right) A \stackrel{P(n)}{\leq} \left(\frac{\sum_{k=1}^{n-1} a_k + A}{n}\right)^n = \left(\frac{(n-1)A + A}{n}\right)^n = A^n$$

$$\text{and hence } \prod_{k=1}^{n-1} a_k \leq A^{n-1} = \left(\frac{\sum_{k=1}^{n-1} a_k}{n-1}\right)^{n-1}.$$

For **(B)**, we see

$$\begin{aligned} \prod_{k=1}^{2n} a_k &= \left(\prod_{k=1}^n a_k\right) \left(\prod_{k=n+1}^{2n} a_k\right) \stackrel{P(n)}{\leq} \left(\sum_{k=1}^n \frac{a_k}{n}\right)^n \left(\sum_{k=n+1}^{2n} \frac{a_k}{n}\right)^n \\ &\stackrel{P(2)}{\leq} \left(\sum_{k=1}^{2n} \frac{a_k}{2n}\right)^{2n} = \left(\frac{\sum_{k=1}^{2n} a_k}{2n}\right)^{2n}. \end{aligned}$$

The condition for equality is derived just as easily.

The left-hand inequality, between the harmonic and the geometric mean, follows now by considering $\frac{1}{a_1}, \dots, \frac{1}{a_n}$. \square

■ **Another Proof.** Of the many other proofs of the arithmetic-geometric mean inequality (the monograph [2] lists more than fifty), let us single out a particularly striking one by Horst Alzer, with some shortenings due to France Dacar. As a matter of fact, this proof yields the stronger inequality

$$a_1^{p_1} a_2^{p_2} \cdots a_n^{p_n} \leq p_1 a_1 + p_2 a_2 + \cdots + p_n a_n$$

for any positive numbers $a_1, \dots, a_n, p_1, \dots, p_n$ with $\sum_{i=1}^n p_i = 1$. Let us denote the expression on the left side by G , and on the right side by A . Fix $c > 0$ and define the function $f(t) := \frac{1}{c} - \frac{1}{t}$ on $\mathbb{R}_{>0}$. Since $f(t) < 0$ for $t < c$ and $f(t) > 0$ for $t > c$, we get the inequality

$$\int_c^x f(t) dt \geq 0$$

for every $x > 0$, with equality if and only if $x = c$.

Now

$$0 \leq \int_c^x f(t) dt = \left[\frac{t}{c} - \log t\right]_c^x = \frac{x}{c} - 1 - \log \frac{x}{c},$$

Note that we have proved the inequality $x \geq 1 + \log x$ for $x > 0$ on the side.

and setting $c = G$ and $x = a_i$ we conclude that

$$\frac{a_i}{G} - 1 \geq \log a_i - \log G \quad \text{for } i = 1, 2, \dots, n. \quad (1)$$

Multiplying this inequality by p_i and summing over all i gives

$$\sum_{i=1}^n p_i \frac{a_i}{G} - \sum_{i=1}^n p_i \geq \sum_{i=1}^n p_i \log a_i - \sum_{i=1}^n p_i \log G.$$

With $\sum_{i=1}^n p_i = 1$, the left side equals $\frac{A}{G} - 1$, while the right side is

$$\log \left(\prod_{i=1}^n a_i^{p_i} \right) - \log G = \log G - \log G = 0.$$

We conclude $\frac{A}{G} - 1 \geq 0$, which is $A \geq G$. In the case of equality, all inequalities in (1) must be equalities, which implies $a_1 = \dots = a_n = G$. \square

■ **Still another Proof.** There is another nice proof, due to Michael D. Hirschhorn. It uses Bernoulli's inequality, which says

$$(1+t)^{n+1} \geq 1 + (n+1)t \quad \text{for real } t \geq -1.$$

Suppose $a_1, a_2, \dots, a_{n+1} > 0$ and set

$$t = \frac{\frac{a_1 + \dots + a_{n+1}}{n+1}}{\frac{a_1 + \dots + a_n}{n}} - 1.$$

By Bernoulli,

$$\begin{aligned} \left(\frac{\frac{a_1 + \dots + a_{n+1}}{n+1}}{\frac{a_1 + \dots + a_n}{n}} \right)^{n+1} &\geq 1 + (n+1) \left(\frac{\frac{a_1 + \dots + a_{n+1}}{n+1}}{\frac{a_1 + \dots + a_n}{n}} - 1 \right) \\ &= 1 + n \frac{a_1 + \dots + a_{n+1}}{a_1 + \dots + a_n} - (n+1) \\ &= \frac{n a_{n+1}}{a_1 + \dots + a_n}, \end{aligned}$$

which translates into

$$\left(\frac{a_1 + \dots + a_{n+1}}{n+1} \right)^{n+1} \geq a_{n+1} \left(\frac{a_1 + \dots + a_n}{n} \right)^n,$$

and the arithmetic-geometric mean inequality follows by induction. \square

Our first application is a beautiful result of Laguerre (see [8]) concerning the location of roots of polynomials.

Theorem 1. *Suppose all roots of the polynomial $x^n + a_{n-1}x^{n-1} + \dots + a_0$ are real. Then the roots are contained in the interval with the endpoints*

$$-\frac{a_{n-1}}{n} \pm \frac{n-1}{n} \sqrt{a_{n-1}^2 - \frac{2n}{n-1}a_{n-2}}.$$

■ **Proof.** Let y be one of the roots and y_1, \dots, y_{n-1} the others. Then the polynomial is $(x-y)(x-y_1)\dots(x-y_{n-1})$. Thus by comparing coefficients

$$\begin{aligned} -a_{n-1} &= y + y_1 + \dots + y_{n-1}, \\ a_{n-2} &= y(y_1 + \dots + y_{n-1}) + \sum_{i < j} y_i y_j, \end{aligned}$$

and so

$$a_{n-1}^2 - 2a_{n-2} - y^2 = \sum_{i=1}^{n-1} y_i^2.$$

By Cauchy's inequality applied to (y_1, \dots, y_{n-1}) and $(1, \dots, 1)$,

$$\begin{aligned} (a_{n-1} + y)^2 &= (y_1 + y_2 + \dots + y_{n-1})^2 \\ &\leq (n-1) \sum_{i=1}^{n-1} y_i^2 \\ &= (n-1)(a_{n-1}^2 - 2a_{n-2} - y^2), \end{aligned}$$

or

$$y^2 + \frac{2a_{n-1}}{n}y + \frac{2(n-1)}{n}a_{n-2} - \frac{n-2}{n}a_{n-1}^2 \leq 0.$$

Thus y (and hence all y_i) lie between the two roots of the quadratic function, and these roots are our bounds. \square

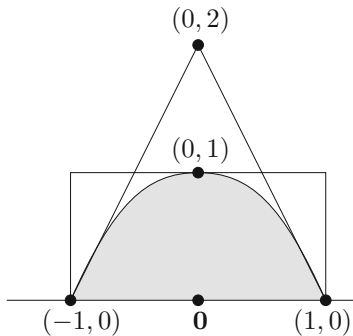

For our second application we start from a well-known elementary property of a parabola. Consider the parabola described by $f(x) = 1 - x^2$ between $x = -1$ and $x = 1$. We associate to $f(x)$ the *tangential triangle* and the *tangential rectangle* as in the figure.

We find that the shaded area

$$A = \int_{-1}^1 (1 - x^2) dx$$

is equal to $\frac{4}{3}$, and the areas T and R of the triangle and rectangle are both equal to 2. Thus $\frac{T}{A} = \frac{3}{2}$ and $\frac{R}{A} = \frac{3}{2}$.

In a beautiful paper, Paul Erdős and Tibor Gallai asked what happens when $f(x)$ is an arbitrary n -th degree real polynomial with $f(x) > 0$ for $-1 < x < 1$, and $f(-1) = f(1) = 0$. The area A is then $\int_{-1}^1 f(x) dx$.

Suppose that $f(x)$ assumes in $(-1, 1)$ its maximum value at b , then $R = 2f(b)$. Computing the tangents at -1 and at 1 , it is readily seen (see the box below) that

$$T = \frac{2f'(1)f'(-1)}{f'(1) - f'(-1)}, \tag{2}$$

respectively $T = 0$ for $f'(1) = f'(-1) = 0$.

The tangential triangle

The area T of the tangential triangle is precisely y_0 , where (x_0, y_0) is the point of intersection of the two tangents. The equation of these tangents are $y = f'(-1)(x + 1)$ and $y = f'(1)(x - 1)$, hence

$$x_0 = \frac{f'(1) + f'(-1)}{f'(1) - f'(-1)},$$

and thus

$$y_0 = f'(1) \left(\frac{f'(1) + f'(-1)}{f'(1) - f'(-1)} - 1 \right) = 2 \frac{f'(1)f'(-1)}{f'(1) - f'(-1)}.$$

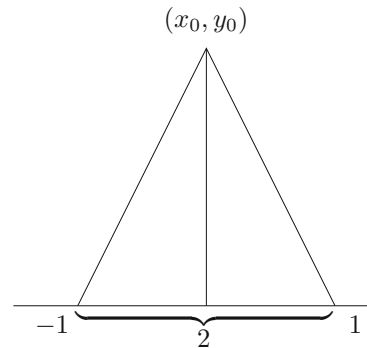

In general, there are no nontrivial bounds for $\frac{T}{A}$ and $\frac{R}{A}$. To see this, take $f(x) = 1 - x^{2n}$. Then $T = 2n$, $A = \frac{4n}{2n+1}$, and thus $\frac{T}{A} > n$. Similarly, $R = 2$ and $\frac{R}{A} = \frac{2n+1}{2n}$, which approaches 1 with n to infinity.

But, as Erdős and Gallai showed, for polynomials which have only real roots such bounds do indeed exist.

Theorem 2. *Let $f(x)$ be a real polynomial of degree $n \geq 2$ with only real roots, such that $f(x) > 0$ for $-1 < x < 1$ and $f(-1) = f(1) = 0$. Then*

$$\frac{2}{3}T \leq A \leq \frac{2}{3}R,$$

and equality holds in both cases only for $n = 2$.

Erdős and Gallai established this result with an intricate induction proof. In the review of their paper, which appeared on the first page of the first issue of the Mathematical Reviews in 1940, George Pólya explained how the first inequality can also be proved by the inequality of the arithmetic and geometric mean — a beautiful example of a conscientious review and a Book Proof at the same time.

Mathematical Reviews

Vol. 1, No. 1 JANUARY, 1940 Pages 1-32

Erdős, P. and Grünwald, T. On polynomials with only real roots. *Ann. of Math.* 40, 537-548 (1939). [MF 93]

Es sei $f(x)$ ein Polynom mit nur reellen Wurzeln,

$$f(-1) = f(1) = 0, \quad 0 < f(x) \leq f(\mu) \quad \text{für } -1 < x < 1,$$

wobei $-1 < \mu < 1$, so dass μ die Stelle des Maximums von $f(x)$ im Intervall $(-1, 1)$ bedeutet. Dann ist

$$\frac{2f'(1)f'(-1)}{f'(1) - f'(-1)} \leq \int_{-1}^1 f(x) dx \leq \frac{2}{3} \cdot 2f(\mu),$$

■ **Proof of $\frac{2}{3}T \leq A$.** Since $f(x)$ has only real roots, and none of them in the open interval $(-1, 1)$, it can be written — apart from a constant positive factor which cancels out in the end — in the form

$$f(x) = (1 - x^2) \prod_i (\alpha_i - x) \prod_j (\beta_j + x) \quad (3)$$

with $\alpha_i \geq 1, \beta_j \geq 1$. Hence

$$A = \int_{-1}^1 (1 - x^2) \prod_i (\alpha_i - x) \prod_j (\beta_j + x) dx.$$

By making the substitution $x \mapsto -x$, we find that also

$$A = \int_{-1}^1 (1 - x^2) \prod_i (\alpha_i + x) \prod_j (\beta_j - x) dx,$$

and hence by the inequality of the arithmetic and the geometric mean (note that all factors are ≥ 0)

$$\begin{aligned} A &= \int_{-1}^1 \frac{1}{2} \left[(1 - x^2) \prod_i (\alpha_i - x) \prod_j (\beta_j + x) + \right. \\ &\quad \left. (1 - x^2) \prod_i (\alpha_i + x) \prod_j (\beta_j - x) \right] dx \\ &\geq \int_{-1}^1 (1 - x^2) \left(\prod_i (\alpha_i^2 - x^2) \prod_j (\beta_j^2 - x^2) \right)^{1/2} dx \\ &\geq \int_{-1}^1 (1 - x^2) \left(\prod_i (\alpha_i^2 - 1) \prod_j (\beta_j^2 - 1) \right)^{1/2} dx \\ &= \frac{4}{3} \left(\prod_i (\alpha_i^2 - 1) \prod_j (\beta_j^2 - 1) \right)^{1/2}. \end{aligned}$$

Let us compute $f'(1)$ and $f'(-1)$. (We may assume $f'(-1), f'(1) \neq 0$, since otherwise $T = 0$ and the inequality $\frac{2}{3}T \leq A$ becomes trivial.) By (3) we see

$$f'(1) = -2 \prod_i (\alpha_i - 1) \prod_j (\beta_j + 1),$$

and similarly

$$f'(-1) = 2 \prod_i (\alpha_i + 1) \prod_j (\beta_j - 1).$$

Hence we conclude

$$A \geq \frac{2}{3} (-f'(1)f'(-1))^{1/2}.$$

Applying now the inequality of the harmonic and the geometric mean to $-f'(1)$ and $f'(1)$, we arrive by (2) at the conclusion

$$A \geq \frac{2}{3} \frac{2}{\frac{1}{-f'(1)} + \frac{1}{f'(1)}} = \frac{4}{3} \frac{f'(1)f'(-1)}{f'(1) - f'(-1)} = \frac{2}{3}T,$$

which is what we wanted to show. By analyzing the case of equality in all our inequalities the reader can easily supply the last statement of the theorem. \square

The reader is invited to search for an equally inspired proof of the second inequality in Theorem 2.

Well, analysis is inequalities after all, but here is an example from graph theory where the use of inequalities comes in quite unexpected. In Chapter 41 we will discuss Turán's theorem. In the simplest case it takes on the following form.

Theorem 3. *Suppose G is a graph on n vertices without triangles. Then G has at most $\frac{n^2}{4}$ edges, and equality holds only when n is even and G is the complete bipartite graph $K_{n/2, n/2}$.*

■ **First proof.** This proof, using Cauchy's inequality, is due to Mantel. Let $V = \{1, \dots, n\}$ be the vertex set and E the edge set of G . By d_i we denote the degree of i , hence $\sum_{i \in V} d_i = 2|E|$ (see page 199 in the chapter on double counting). Suppose ij is an edge. Since G has no triangles, we find $d_i + d_j \leq n$ since no vertex is a neighbor of both i and j .

It follows that

$$\sum_{ij \in E} (d_i + d_j) \leq n|E|.$$

Note that d_i appears exactly d_i times in the sum, so we get

$$n|E| \geq \sum_{ij \in E} (d_i + d_j) = \sum_{i \in V} d_i^2,$$

and hence with Cauchy's inequality applied to the vectors (d_1, \dots, d_n) and $(1, \dots, 1)$,

$$n|E| \geq \sum_{i \in V} d_i^2 \geq \frac{(\sum d_i)^2}{n} = \frac{4|E|^2}{n},$$

and the result follows. In the case of equality we find $d_i = d_j$ for all i, j , and further $d_i = \frac{n}{2}$ (since $d_i + d_j = n$). Since G is triangle-free, $G = K_{n/2, n/2}$ is immediately seen from this. \square

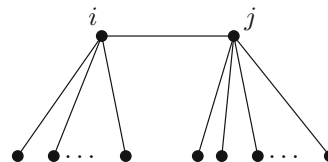

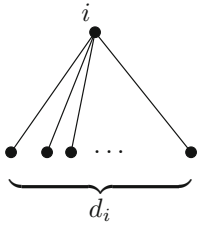

■ **Second proof.** The following proof of Theorem 3, using the inequality of the arithmetic and the geometric mean, is a folklore Book Proof. Let α be the size of a largest independent set A , and set $\beta = n - \alpha$. Since G is triangle-free, the neighbors of a vertex i form an independent set, and we infer $d_i \leq \alpha$ for all i .

The set $B = V \setminus A$ of size β meets every edge of G . Counting the edges of G according to their endvertices in B , we obtain $|E| \leq \sum_{i \in B} d_i$. The inequality of the arithmetic and geometric mean now yields

$$|E| \leq \sum_{i \in B} d_i \leq \alpha\beta \leq \left(\frac{\alpha + \beta}{2}\right)^2 = \frac{n^2}{4},$$

and again the case of equality is easily dealt with. □

References

- [1] H. ALZER: *A proof of the arithmetic mean-geometric mean inequality*, Amer. Math. Monthly **103** (1996), 585.
- [2] P. S. BULLEN, D. S. MITRINOVICS & P. M. VASIĆ: *Means and their Inequalities*, Reidel, Dordrecht 1988.
- [3] P. ERDŐS & T. GRÜNWARD: *On polynomials with only real roots*, Annals Math. **40** (1939), 537-548.
- [4] G. H. HARDY, J. E. LITTLEWOOD & G. PÓLYA: *Inequalities*, Cambridge University Press, Cambridge 1952.
- [5] M. D. HIRSCHORN, *The AM-GM inequality*, Math. Intelligencer (4)**29** (2007), 7.
- [6] W. MANTEL: *Problem 28*, Wiskundige Opgaven **10** (1906), 60-61.
- [7] G. PÓLYA: *Review of [3]*, Mathematical Reviews **1** (1940), 1.
- [8] G. PÓLYA & G. SZEGŐ: *Problems and Theorems in Analysis, Vol. I*, Springer-Verlag, Berlin Heidelberg New York 1972/78; Reprint 1998.

The fundamental theorem of algebra

Chapter 21



Every nonconstant polynomial with complex coefficients has at least one root in the field of complex numbers.

Gauss called this theorem, for which he gave four different proofs, the “fundamental theorem of algebraic equations.” It is without doubt one of the milestones in the history of mathematics. As Reinhold Remmert writes in his pertinent survey: “It was the possibility of proving this theorem in the complex domain that, more than anything else, paved the way for a general recognition of complex numbers.”

Some of the greatest names have contributed to the subject, from Gauss and Cauchy to Liouville and Laplace. An article of Netto and Le Vavasour lists nearly a hundred proofs. The proof that we present is one of the most elegant and certainly the shortest. It follows an argument of d’Alembert and Argand and uses only some elementary properties of polynomials and complex numbers. We are indebted to France Dacar and to Tord Sjödín for a polished version of the proof. Essentially the same argument appears also in the papers of Fefferman [3] and Redheffer [5], and doubtlessly in some others.

We need three facts that one learns in a first-year calculus course.

- (A) Polynomial functions are continuous.
- (B) Any complex number of absolute value 1 has an m -th root for any $m \geq 1$.
- (C) Cauchy’s minimum principle: A continuous real-valued function f on a compact set S assumes a minimum in S .

Now let $p(z) = \sum_{k=0}^n c_k z^k$ be a complex polynomial of degree $n \geq 1$. As the first and decisive step we prove what is variously called d’Alembert’s lemma or Argand’s inequality.

Lemma. *If $p(a) \neq 0$, then every disk D around a contains an interior point b with $|p(b)| < |p(a)|$.*

■ **Proof.** We first claim that without loss of generality we may assume that $a = 0$ and $p(a) = 1$. Indeed, if this is not the case, then we define another polynomial $q(z) := \frac{p(z+a)}{p(a)}$, which satisfies $q(0) = 1$. Now assume

It has been commented upon that the “Fundamental theorem of algebra” is not really fundamental, that it is not necessarily a theorem since sometimes it serves as a definition, and that in its classical form it is not a result from algebra, but rather from analysis.



Jean Le Rond d’Alembert

that every disk D of radius R around the origin contains a point b with $|q(b)| < 1$. Then the disk D_a of radius R around the point a contains the point $a + b$ such that $|p(a + b)| < |p(a)|$ as claimed.

We may thus assume that $p(z) = 1 + c_1z + c_2z^2 + \cdots + c_nz^n$, and letting $m \geq 1$ be the smallest index with $c_m \neq 0$ we may write $p(z)$ in the form

$$p(z) = 1 + c_mz^m + z^{m+1}(c_{m+1} + \cdots + c_nz^{n-m-1}) = 1 + c_mz^m + r(z).$$

In the first step we find $0 < \rho < 1$ such that

$$|r(z)| < |c_mz^m| < 1 \quad \text{for all } 0 < |z| \leq \rho. \quad (1)$$

To get the first inequality we note that for $|z| < 1$

$$|r(z)| \leq |z|^{m+1}(|c_{m+1}| + \cdots + |c_n|) < |c_m||z^m| = |c_mz^m|,$$

provided that

$$0 < |z| < \frac{|c_m|}{|c_{m+1}| + \cdots + |c_n|} =: \rho_1.$$

The second inequality holds if $|z| < |c_m|^{-\frac{1}{m}} =: \rho_2$; hence we conclude that (1) is valid for every ρ with $0 < \rho < \min\{\rho_1, \rho_2, 1\}$.

We come to our second ingredient, m -th roots of unity. Fix a constant ρ as in (1) with $\rho < R$, where R is the radius of the disk D around $a = 0$. Let ζ be an m -th root of $\frac{-\bar{c}_m}{|c_m|}$, where \bar{c}_m is the complex conjugate of c_m , and set $b := \rho\zeta$. We claim that b is a desired point in D with $|p(b)| < 1$. First of all, b is in D since $|b| = \rho < R$, and further by $|c_m|^2 = c_m\bar{c}_m$ we have

$$c_mb^m = -c_m\rho^m \frac{\bar{c}_m}{|c_m|} = -|c_m|\rho^m.$$

Looking at (1) we have $|r(b)| < |c_mb^m| = |c_m|\rho^m < 1$, and hence

$$|p(b)| \leq |1 + c_mb^m| + |r(b)| = 1 - |c_m|\rho^m + |r(b)| < 1,$$

and we are done. \square

The rest is easy. Clearly, $p(z)z^{-n}$ approaches the leading coefficient c_n of $p(z)$ as $|z|$ goes to infinity. Hence $|p(z)|$ goes to infinity as well with $|z| \rightarrow \infty$. Consequently, there exists $R_1 > 0$ such that $|p(z)| > |p(0)|$ for all points z on the circle $\{z : |z| = R_1\}$. Furthermore, our third fact (C) tells us that in the compact set $D_1 = \{z : |z| \leq R_1\}$ the continuous real-valued function $|p(z)|$ attains the minimum value at some point z_0 . Because of $|p(z)| > |p(0)|$ for z on the boundary of D_1 , z_0 must lie in the interior. But by d'Alembert's lemma this minimum value $|p(z_0)|$ must be 0 — and this is the whole proof.

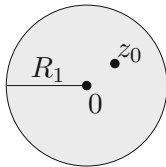

References

- [1] J. D'ALEMBERT: *Recherches sur le calcul intégral*, Histoire de l'Académie Royale des Sciences et Belles Lettres (1746), 182-224.
- [2] R. ARGAND: *Réflexions sur la nouvelle théorie d'analyse*, Annales de Mathématiques **5** (1814), 197-209.
- [3] C. FEFFERMAN: *An easy proof of the fundamental theorem of algebra*, Amer. Math. Monthly **74** (1967), 854-855.
- [4] E. NETTO & R. LE VAVASSEUR: *Les fonctions rationnelles*, Enc. Sciences Math. Pures Appl. **12** (1907), 1-232.
- [5] R. M. REDHEFFER: *What! Another note just on the fundamental theorem of algebra?* Amer. Math. Monthly **71** (1964), 180-185.
- [6] R. REMMERT: *The fundamental theorem of algebra*, Chapter 4 in: "Numbers" (H. D. Ebbinghaus et al., eds.), Graduate Texts in Mathematics **123**, Springer, New York 1991.



"What's up this time?"

"Well, I'm shlepping
100 proofs for the
Fundamental Theorem of Algebra"



"Proofs from the Book:
one for the Fundamental Theorem,
one for Quadratic Reciprocity!"

One square and an odd number of triangles

Chapter 22



Suppose we want to dissect a square into n triangles of equal area. When n is even, this is easily accomplished. For example, you could divide the horizontal sides into $\frac{n}{2}$ segments of equal length and draw a diagonal in each of the $\frac{n}{2}$ rectangles:

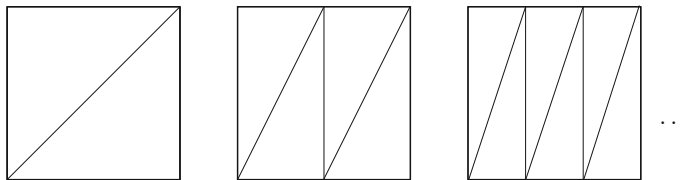

But now assume n is odd. Already for $n = 3$ this causes problems, and after some experimentation you will probably come to think that it might not be possible. So let us pose the general problem:

Is it possible to dissect a square into an odd number n of triangles of equal area?

Now, this looks like a classical question of Euclidean geometry, and one could have guessed that surely the answer must have been known for a long time (if not to the Greeks). But when Fred Richman and John Thomas popularized the problem in the 1960s they found to their surprise that no one knew the answer or a reference where this would be discussed.

Well, the answer is “no” not only for $n = 3$, but for any odd n . But how should one prove a result like this? By scaling we may, of course, restrict ourselves to the unit square with vertices $(0, 0)$, $(1, 0)$, $(0, 1)$, $(1, 1)$. Any argument must therefore somehow make use of the fact that the area of the triangles in a dissection is $\frac{1}{n}$, where n is odd. The following proof due to Paul Monsky, with initial work of John Thomas, is a stroke of genius and totally unexpected: It uses an algebraic tool, valuations, to construct a striking coloring of the plane, and combines this with some elegant and stunningly simple combinatorial reasonings. And what’s more: at present no other proof is known!

Before we state the theorem let us prepare the ground by a quick study of valuations. Everybody is familiar with the absolute value function $|x|$ on the rationals \mathbb{Q} (or the reals \mathbb{R}). It maps \mathbb{Q} to the nonnegative reals such that for all x and y ,

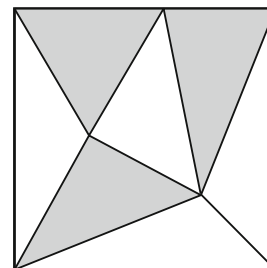

There are dissections of squares into an odd number of triangles whose areas are *nearly* equal.

- (i) $|x| = 0$ if and only if $x = 0$,
- (ii) $|xy| = |x||y|$, and
- (iii) $|x + y| \leq |x| + |y|$ (the triangle inequality).

The triangle inequality makes \mathbb{R} into a metric space and gives rise to the familiar notions of convergence. It was a great discovery around 1900 that besides the absolute value there are other natural “value functions” on \mathbb{Q} that satisfy the conditions (i) to (iii).

Let p be a prime number. Any rational number $r \neq 0$ can be written uniquely in the form

$$r = p^k \frac{a}{b}, \quad k \in \mathbb{Z}, \quad (1)$$

where a and $b > 0$ are relatively prime to p . Define the p -adic value

$$|r|_p := p^{-k}, \quad |0|_p = 0. \quad (2)$$

Conditions (i) and (ii) are obviously satisfied, and for (iii) we obtain the even stronger inequality

$$(iii') \quad |x + y|_p \leq \max\{|x|_p, |y|_p\} \quad (\text{the non-Archimedean property}).$$

Indeed, let $r = p^k \frac{a}{b}$ and $s = p^\ell \frac{c}{d}$, where we may assume that $k \geq \ell$, that is, $|r|_p = p^{-k} \leq p^{-\ell} = |s|_p$. Then we get

$$\begin{aligned} |r + s|_p &= \left| p^k \frac{a}{b} + p^\ell \frac{c}{d} \right|_p = \left| p^\ell \left(p^{k-\ell} \frac{a}{b} + \frac{c}{d} \right) \right|_p \\ &= p^{-\ell} \left| \frac{p^{k-\ell} ad + bc}{bd} \right|_p \leq p^{-\ell} = \max\{|r|_p, |s|_p\}, \end{aligned}$$

since the denominator bd is relatively prime to p . We also see from this that

$$(iv) \quad |x + y|_p = \max\{|x|_p, |y|_p\} \quad \text{whenever } |x|_p \neq |y|_p,$$

but we will prove below that this property is quite generally implied by (iii').

Any function $v : K \rightarrow \mathbb{R}_{\geq 0}$ on a field K that satisfies

- (i) $v(x) = 0$ if and only if $x = 0$,
- (ii) $v(xy) = v(x)v(y)$, and
- (iii') $v(x + y) \leq \max\{v(x), v(y)\}$ (non-Archimedean property)

for all $x, y \in K$ is called a *non-Archimedean real valuation* of K .

For every such valuation v we have $v(1) = v(1)v(1)$, hence $v(1) = 1$; and $1 = v(1) = v((-1)(-1)) = [v(-1)]^2$, so $v(-1) = 1$. Thus from (ii) we get $v(-x) = v(x)$ for all x and $v(x^{-1}) = v(x)^{-1}$ for $x \neq 0$.

Every field has the *trivial* valuation that maps every nonzero element onto 1, and if v is a real non-Archimedean valuation, then so is v^t for any positive real number t . So for \mathbb{Q} we have the p -adic valuations and their powers, and a famous theorem of Ostrowski states that any nontrivial real non-Archimedean valuation of \mathbb{Q} is of this form.

Example: $|\frac{3}{4}|_2 = 4$,
 $|\frac{6}{7}|_2 = |2|_2 = \frac{1}{2}$, and
 $|\frac{3}{4} + \frac{6}{7}|_2 = |\frac{45}{28}|_2 = |\frac{1}{4} \cdot \frac{45}{7}|_2$
 $= 4 = \max\{|\frac{3}{4}|_2, |\frac{6}{7}|_2\}.$

As announced, let us verify that the important property

$$(iv) \quad v(x + y) = \max\{v(x), v(y)\} \text{ if } v(x) \neq v(y)$$

holds for any non-Archimedean valuation. Indeed, suppose that we have $v(x) < v(y)$. Then

$$\begin{aligned} v(y) &= v((x + y) - x) \leq \max\{v(x + y), v(x)\} = v(x + y) \\ &\leq \max\{v(x), v(y)\} = v(y) \end{aligned}$$

where (iii') yields the inequalities, the first equality is clear, and the other two follow from $v(x) < v(y)$. Thus $v(x + y) = v(y) = \max\{v(x), v(y)\}$.

Monsky's beautiful approach to the square dissection problem used an extension of the 2-adic valuation $|x|_2$ to a valuation v of \mathbb{R} , where "extension" means that we require $v(x) = |x|_2$ whenever x is in \mathbb{Q} . Such a non-Archimedean real extension exists, but this is not standard algebra fare. In the following, we present Monsky's argument in a version due to Hendrik Lenstra that requires much less; it only needs a valuation v that takes values in an arbitrary "ordered group", not necessarily in $(\mathbb{R}_{>0}, \cdot, <)$, such that $v(\frac{1}{2}) > 1$. The definition and the existence of such a valuation will be provided in the appendix to this chapter.

Here we just note that any valuation with $v(\frac{1}{2}) > 1$ satisfies $v(\frac{1}{n}) = 1$ for odd integers n . Indeed, $v(\frac{1}{2}) > 1$ means that $v(2) < 1$, and thus $v(2k) < 1$ by (iii') and induction on k . From this we get $v(2k + 1) = 1$ from (iv), and thus again $v(\frac{1}{2k+1}) = 1$ from (ii).

Monsky's Theorem. *It is not possible to dissect a square into an odd number of triangles of equal area.*

■ **Proof.** In the following we construct a specific three-coloring of the plane with amazing properties. One of them is that the area of any triangle whose vertices have three different colors — which in the following is called a *rainbow triangle* — has a v -value larger than 1, so the area cannot be $\frac{1}{n}$ for odd n . And then we verify that any dissection of the unit square must contain such a rainbow triangle, and the proof will be complete.

The coloring of the points (x, y) of the real plane will be constructed by looking at the entries of the triple $(x, y, 1)$ that have the maximal value under the valuation v . This maximum may occur once or twice or even three times. The color (blue, or green, or red) will record the coordinate of $(x, y, 1)$ in which the maximal v -value occurs first:

$$(x, y) \text{ is colored } \begin{cases} \text{blue} & \text{if } v(x) \geq v(y), v(x) \geq v(1), \\ \text{green} & \text{if } v(x) < v(y), v(y) \geq v(1), \\ \text{red} & \text{if } v(x) < v(1), v(y) < v(1). \end{cases}$$

The property (iv) together with $v(-x) = v(x)$ also implies that $v(a \pm b_1 \pm b_2 \pm \dots \pm b_\ell) = v(a)$ if $v(a) > v(b_i)$ for all i .

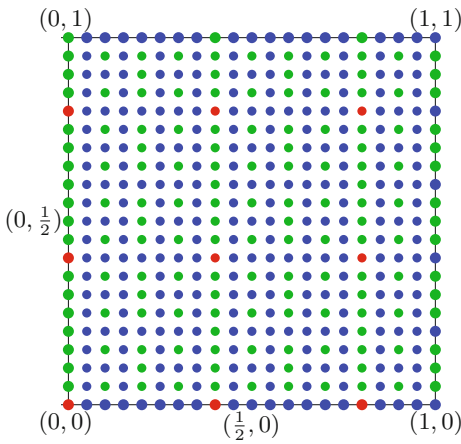

This assigns a unique color to each point in the plane. The figure in the margin shows the color for each point in the unit square whose coordinates are fractions of the form $\frac{k}{20}$.

The following statement is the first step to the proof.

Lemma 1. For any blue point $p_b = (x_b, y_b)$, green point $p_g = (x_g, y_g)$, and red point $p_r = (x_r, y_r)$, the v -value of the determinant

$$\det \begin{pmatrix} x_b & y_b & 1 \\ x_g & y_g & 1 \\ x_r & y_r & 1 \end{pmatrix}$$

is at least 1.

■ **Proof.** The determinant is a sum of six terms. One of them is the product of the entries of the main diagonal, $x_b y_g 1$. By construction of the coloring each of the diagonal entries compared to the other entries in the row has a maximal v -value, so comparing with the last entry in each row (which is 1) we get

$$v(x_b y_g 1) = v(x_b)v(y_g)v(1) \geq v(1)v(1)v(1) = 1.$$

Any of the other five summands of the determinant is a product of three matrix entries, one from each row (with a sign that as we know is irrelevant for the v -value). It picks at least one matrix entry below the main diagonal, whose v -value is strictly smaller than that of the diagonal entry in the same row, and at least one matrix entry above the main diagonal, whose v -value is not larger than that of the diagonal entry in the same row. Thus all of the five other summands of the determinant have a v -value that is strictly smaller than the summand corresponding to the main diagonal. Thus by property (iv) of non-Archimedean valuations, we find that the v -value of the determinant is given by the summand corresponding to the main diagonal,

$$v\left(\det \begin{pmatrix} x_b & y_b & 1 \\ x_g & y_g & 1 \\ x_r & y_r & 1 \end{pmatrix}\right) = v(x_b y_g 1) \geq 1. \quad \square$$

Corollary. Any line of the plane receives at most two different colors. The area of a rainbow triangle cannot be 0, and it cannot be $\frac{1}{n}$ for odd n .

■ **Proof.** The area of the triangle with vertices at a blue point p_b , a green point p_g , and a red point p_r is the absolute value of

$$\frac{1}{2}((x_b - x_r)(y_g - y_r) - (x_g - x_r)(y_b - y_r)),$$

which up to the sign is half the determinant of Lemma 1.

The three points cannot lie on a line since the determinant cannot be 0, as $v(0) = 0$. The area of the triangle cannot be $\frac{1}{n}$, since in this case we would get $\pm \frac{2}{n}$ for the determinant, thus

$$v\left(\pm \frac{2}{n}\right) = v\left(\frac{1}{2}\right)^{-1}v\left(\frac{1}{n}\right) < 1$$

because of $v\left(\frac{1}{2}\right) > 1$ and $v\left(\frac{1}{n}\right) = 1$, contradicting Lemma 1. □

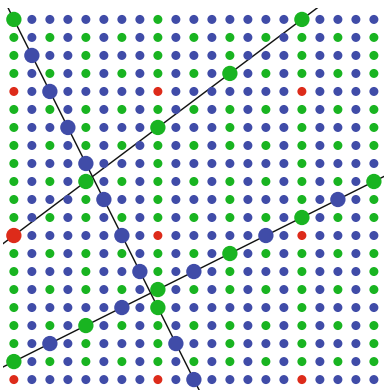

And why did we construct this coloring? Because we are now going to show that in *any* dissection of the unit square $S = [0, 1]^2$ into triangles (equal-sized or not!) there must always be a rainbow triangle, which according to the corollary cannot have area $\frac{1}{n}$ for odd n . Thus the following lemma will complete the proof of Monsky's theorem.

Lemma 2. *Every dissection of the unit square $S = [0, 1]^2$ into finitely many triangles contains an odd number of rainbow triangles, and thus at least one.*

■ **Proof.** The following counting argument is truly inspired. The idea is due to Emanuel Sperner, and will reappear with “Sperner's Lemma” in Chapter 28.

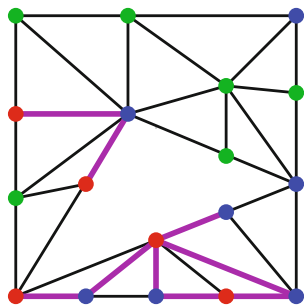

Consider the segments between neighboring vertices in a given dissection. A segment is called a *red-blue segment* if one endpoint is red and the other is blue. For the example in the figure, the red-blue segments are drawn in purple.

We make two observations, repeatedly using the fact from the corollary that on any line there can be points of at most two colors.

(A) The bottom line of the square contains an *odd* number of red-blue segments, since $(0, 0)$ is red and $(1, 0)$ is blue, and all vertices in between are red or blue. So on the walk from the red end to the blue end of the bottom line, there must be an odd number of changes between red and blue. The other boundary lines of the square contain no red-blue segments.

(B) If a triangle T has at most two colors at its vertices, then it contains an *even* number of red-blue segments on its boundary. However, every rainbow triangle has an *odd* number of red-blue segments on its boundary.

Indeed, there is an odd number of red-blue segments between a red vertex and a blue vertex of a triangle, but an even number (if any) between any vertices with a different color combination. Thus a rainbow triangle has an odd number of red-blue segments in its boundary, while any other triangle has an even number (two or zero) of vertex pairs with the color combination red and blue.

Now let us count the boundary red-blue segments summed over all triangles in the dissection. Since every red-blue segment in the interior of the square is counted twice, and there is an odd number on the boundary of S , this count is *odd*. Hence we conclude from (B) that there must be an odd number of rainbow triangles. □

Appendix: Extending valuations

It is not at all obvious that an extension of a non-Archimedean real valuation from one field to a larger one is always possible. But it can be done, not only from \mathbb{Q} to \mathbb{R} , but generally from any field K to a field L that contains K . (This is known as “Chevalley’s theorem”; see for example the book by Jacobson [1].)

In the following, we establish much less — but enough for our application to odd dissections. Indeed, in our proof for Monsky’s theorem we have not used the addition for values of $v : \mathbb{R} \rightarrow \mathbb{R}_{\geq 0}$; we have used only the multiplication and the order on $\mathbb{R}_{\geq 0}$. Hence for our argument it is sufficient if the nonzero values of v lie in a (multiplicatively written) *ordered abelian group* $(G, \cdot, <)$. That is, the elements of G are linearly ordered, and $a < b$ in G implies $ac < bc$ for any $a, b, c \in G$. As we assume that the group is written multiplicatively, the neutral element of G is denoted by 1. For the definition of a valuation, we adjoin a special element 0 with the understanding that $0 \notin G$, $0a = 0$, and $0 < a$ hold for all $a \in G$. Of course, the prime example of an ordered abelian group is $(\mathbb{R}_{>0}, \cdot, <)$ with the usual linear order, and the prime example for $\{0\} \cup G$ is $(\mathbb{R}_{\geq 0}, \cdot)$.

Definition. Let K be a field. A *non-Archimedean valuation* v with values in an ordered abelian group G is a map $v : K \rightarrow \{0\} \cup G$ with

- (i) $v(x) = 0 \iff x = 0$,
- (ii) $v(xy) = v(x)v(y)$,
- (iii') $v(x + y) \leq \max\{v(x), v(y)\}$, and
- (iv) $v(x + y) = \max\{v(x), v(y)\}$ whenever $v(x) \neq v(y)$

for all $x, y \in K$.

The fourth condition in this description is again implied by the first three. And among the simple consequences we record that if $v(x) < 1$, $x \neq 0$, then $v(x^{-1}) = v(x)^{-1} > 1$.

So here is what we will establish:

Theorem. *The field of real numbers \mathbb{R} has a non-Archimedean valuation to an ordered abelian group*

$$v : \mathbb{R} \rightarrow \{0\} \cup G$$

such that $v(\frac{1}{2}) > 1$.

■ **Proof.** We first relate any valuation on a field to a subring of the field. (All the subrings that we consider contain 1.) Suppose $v : K \rightarrow \{0\} \cup G$ is a valuation; let

$$R := \{x \in K : v(x) \leq 1\}, \quad U := \{x \in K : v(x) = 1\}.$$

It is immediate that R is a subring of K , called the *valuation ring* corresponding to v . Furthermore, $v(xx^{-1}) = v(1) = 1$ implies that $v(x) = 1$

if and only if $v(x^{-1}) = 1$. Thus U is the set of units (invertible elements) of R . In particular, U is a subgroup of K^\times , where we write $K^\times := K \setminus \{0\}$ for the multiplicative group of K . Finally, with $R^{-1} := \{x^{-1} : x \neq 0\}$ we have $K = R \cup R^{-1}$. Indeed, if $x \notin R$ then $v(x) > 1$ and therefore $v(x^{-1}) < 1$, thus $x^{-1} \in R$. The property $K = R \cup R^{-1}$ already characterizes all possible valuation rings in a given field.

Lemma. *A proper subring $R \subseteq K$ is a valuation ring with respect to some valuation v into some ordered group G if and only if $K = R \cup R^{-1}$.*

■ **Proof.** We have seen one direction. Suppose now $K = R \cup R^{-1}$. How should we construct the group G ? If $v : K \rightarrow \{0\} \cup G$ is a valuation corresponding to R , then $v(x) < v(y)$ holds if and only if $v(xy^{-1}) < 1$, that is, if and only if $xy^{-1} \in R \setminus U$. Also, $v(x) = v(y)$ if and only if $xy^{-1} \in U$, or $xU = yU$ as cosets in the factor group K^\times/U .

Hence the natural way to proceed goes as follows. Take the quotient group $G := K^\times/U$, and define an order relation on G by setting

$$xU < yU \iff xy^{-1} \in R \setminus U.$$

It is a nice exercise to check that this indeed makes G into an ordered group. The map $v : K \rightarrow \{0\} \cup G$ is then defined in the most natural way:

$$v(0) := 0, \quad \text{and} \quad v(x) := xU \text{ for } x \neq 0.$$

It is easy to verify conditions (i) to (iii') for v , and that R is the valuation ring corresponding to v . □

In order to establish the theorem, it thus suffices to find a valuation ring $B \subseteq \mathbb{R}$ such that $\frac{1}{2} \notin B$.

Claim. *Any inclusion-maximal subring $B \subseteq \mathbb{R}$ with the property $\frac{1}{2} \notin B$ is a valuation ring.*

First we should perhaps note that a maximal subring $B \subseteq \mathbb{R}$ with the property $\frac{1}{2} \notin B$ exists. This is not quite trivial — but it does follow with a routine application of Zorn's lemma, which is reviewed in the box. Indeed, if we have an ascending chain of subrings $B_i \subseteq \mathbb{R}$ that don't contain $\frac{1}{2}$, then this chain has an upper bound, given by the union of all the subrings B_i , which again is a subring and does not contain $\frac{1}{2}$.

$\mathbb{Z} \subseteq \mathbb{R}$ is such a subring with $\frac{1}{2} \notin \mathbb{Z}$, but it is not maximal.

Zorn's Lemma

The Lemma of Zorn is of fundamental importance in algebra and other parts of mathematics when one wants to construct maximal structures. It also plays a decisive role in the logical foundations of mathematics.

Lemma. *Suppose P_\leq is a nonempty partially ordered set with the property that every ascending chain $(a_i)_\leq$ has an upper bound b , such that $a_i \leq b$ for all i . Then P_\leq contains a maximal element M , meaning that there is no $c \in P$ with $M < c$.*

To prove the Claim, let us assume that $B \subseteq \mathbb{R}$ is a maximal subring not containing $\frac{1}{2}$. If B is not a valuation ring, then there is some element $\alpha \in \mathbb{R} \setminus (B \cup B^{-1})$. We denote by $B[\alpha]$ the subring generated by $B \cup \alpha$, that is, the set of all real numbers that can be written as polynomials in α with coefficients in B . Let $2B \subseteq B$ be the subset of all elements of the form $2b$, for $b \in B$. Now $2B$ is a subset of B , so we have $2B[\alpha] \subseteq B[\alpha]$ and $2B[\alpha^{-1}] \subseteq B[\alpha^{-1}]$. If we had $2B[\alpha] \neq B[\alpha]$ or $2B[\alpha^{-1}] \neq B[\alpha^{-1}]$, then due to $1 \in B$ this would imply that $\frac{1}{2} \notin B[\alpha]$ resp. $\frac{1}{2} \notin B[\alpha^{-1}]$, contradicting the maximality of $B \subseteq \mathbb{R}$ as a subring that does not contain $\frac{1}{2}$. Thus we get that $2B[\alpha] = B[\alpha]$ and $2B[\alpha^{-1}] = B[\alpha^{-1}]$. This implies that $1 \in B$ can be written in the form

$$1 = 2u_0 + 2u_1\alpha + \cdots + 2u_m\alpha^m \quad \text{with } u_i \in B, \quad (1)$$

and similarly as

$$1 = 2v_0 + 2v_1\alpha^{-1} + \cdots + 2v_n\alpha^{-n} \quad \text{with } v_i \in B, \quad (2)$$

which after multiplication by α^n and subtraction of $2v_0\alpha^n$ from both sides yields

$$(1 - 2v_0)\alpha^n = 2v_1\alpha^{n-1} + \cdots + 2v_{n-1}\alpha + 2v_n. \quad (3)$$

Let us assume that these representations are chosen such that m and n are as small as possible. We may also assume that $m \geq n$, otherwise we exchange α with α^{-1} , and (1) with (2).

Now multiply (1) by $1 - 2v_0$ and add $2v_0$ on both sides of the equation, to get

$$1 = 2(u_0(1 - 2v_0) + v_0) + 2u_1(1 - 2v_0)\alpha + \cdots + 2u_m(1 - 2v_0)\alpha^m.$$

But if in this equation we substitute for the term $(1 - 2v_0)\alpha^m$ the expression given by equation (3) multiplied by α^{m-n} , then this results in an equation that expresses $1 \in B$ as a polynomial in $2B[\alpha]$ of degree at most $m - 1$. This contradiction to the minimality of m establishes the Claim. \square

References

- [1] N. JACOBSON: *Lectures in Abstract Algebra, Part III: Theory of Fields and Galois Theory*, Graduate Texts in Mathematics 32, Springer, New York 1975.
- [2] P. MONSKY: *On dividing a square into triangles*, Amer. Math. Monthly **77** (1970), 161-164.
- [3] F. RICHMAN & J. THOMAS: *Problem 5471*, Amer. Math. Monthly **74** (1967), 329.
- [4] S. K. STEIN & S. SZABÓ: *Algebra and Tiling: Homomorphisms in the Service of Geometry*, Carus Math. Monographs **25**, MAA, Washington DC 1994.
- [5] J. THOMAS: *A dissection problem*, Math. Magazine **41** (1968), 187-190.

A theorem of Pólya on polynomials

Chapter 23



Among the many contributions of George Pólya to analysis, the following has always been Erdős' favorite, both for the surprising result and for the beauty of its proof. Suppose that

$$f(z) = z^n + b_{n-1}z^{n-1} + \cdots + b_0$$

is a complex polynomial of degree $n \geq 1$ with leading coefficient 1. Associate with $f(z)$ the set

$$\mathcal{C} := \{z \in \mathbb{C} : |f(z)| \leq 2\},$$

that is, \mathcal{C} is the set of points which are mapped under f into the circle of radius 2 around the origin in the complex plane. So for $n = 1$ the domain \mathcal{C} is just a circular disk of diameter 4.

By an astoundingly simple argument, Pólya revealed the following beautiful property of this set \mathcal{C} :

Take any line L in the complex plane and consider the orthogonal projection \mathcal{C}_L of the set \mathcal{C} onto L . Then the total length of any such projection never exceeds 4.

What do we mean by the total length of the projection \mathcal{C}_L being at most 4? We will see that \mathcal{C}_L is a finite union of disjoint intervals I_1, \dots, I_t , and the condition means that $\ell(I_1) + \cdots + \ell(I_t) \leq 4$, where $\ell(I_j)$ is the usual length of an interval.

By rotating the plane we see that it suffices to consider the case when L is the real axis of the complex plane. With these comments in mind, let us state Pólya's result.

Theorem 1. *Let $f(z)$ be a complex polynomial of degree at least 1 and leading coefficient 1. Set $\mathcal{C} = \{z \in \mathbb{C} : |f(z)| \leq 2\}$ and let \mathcal{R} be the orthogonal projection of \mathcal{C} onto the real axis. Then there are intervals I_1, \dots, I_t on the real line which together cover \mathcal{R} and satisfy*

$$\ell(I_1) + \cdots + \ell(I_t) \leq 4.$$

Clearly the bound of 4 in the theorem is attained for $n = 1$. To get more of a feeling for the problem let us look at the polynomial $f(z) = z^2 - 2$, which also attains the bound of 4. If $z = x + iy$ is a complex number, then x is its orthogonal projection onto the real line. Hence

$$\mathcal{R} = \{x \in \mathbb{R} : x + iy \in \mathcal{C} \text{ for some } y\}.$$



George Pólya

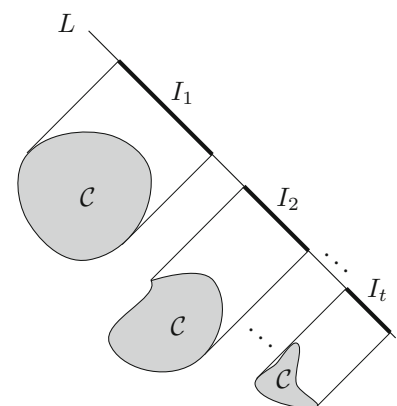

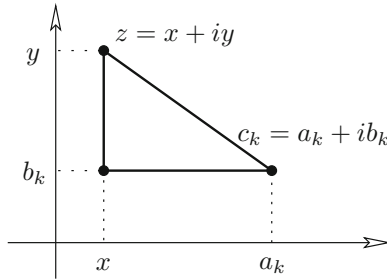
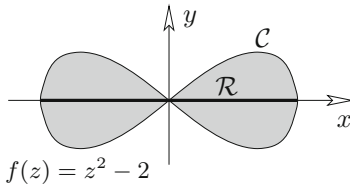

The reader can easily prove that for $f(z) = z^2 - 2$ we have $x + iy \in \mathcal{C}$ if and only if

$$(x^2 + y^2)^2 \leq 4(x^2 - y^2).$$

It follows that $x^4 \leq (x^2 + y^2)^2 \leq 4x^2$, and thus $x^2 \leq 4$, that is, $|x| \leq 2$. On the other hand, any $z = x \in \mathbb{R}$ with $|x| \leq 2$ satisfies $|z^2 - 2| \leq 2$, and we find that \mathcal{R} is precisely the interval $[-2, 2]$ of length 4.

As a first step towards the proof write $f(z) = (z - c_1) \cdots (z - c_n)$ with $c_k = a_k + ib_k$, and consider the *real* polynomial $p(x) = (x - a_1) \cdots (x - a_n)$. Let $z = x + iy \in \mathcal{C}$, then by the theorem of Pythagoras

$$|x - a_k|^2 + |y - b_k|^2 = |z - c_k|^2$$

and hence $|x - a_k| \leq |z - c_k|$ for all k , that is,

$$|p(x)| = |x - a_1| \cdots |x - a_n| \leq |z - c_1| \cdots |z - c_n| = |f(z)| \leq 2.$$

Thus we find that \mathcal{R} is contained in the set $\mathcal{P} = \{x \in \mathbb{R} : |p(x)| \leq 2\}$, and if we can show that this latter set is covered by intervals of total length at most 4, then we are done. Accordingly, our main Theorem 1 will be a consequence of the following result.

Theorem 2. *Let $p(x)$ be a real polynomial of degree $n \geq 1$ with leading coefficient 1, and all roots real. Then the set $\mathcal{P} = \{x \in \mathbb{R} : |p(x)| \leq 2\}$ can be covered by intervals of total length at most 4.*

As Pólya shows in his paper [2], Theorem 2 is, in turn, a consequence of the following famous result due to Chebyshev. To make this chapter self-contained, we have included a proof in the appendix (following the beautiful exposition by Pólya and Szegő).

Chebyshev's Theorem.

Let $p(x)$ be a real polynomial of degree $n \geq 1$ with leading coefficient 1. Then

$$\max_{-1 \leq x \leq 1} |p(x)| \geq \frac{1}{2^{n-1}}.$$

Let us first note the following immediate consequence.

Corollary. *Let $p(x)$ be a real polynomial of degree $n \geq 1$ with leading coefficient 1, and suppose that $|p(x)| \leq 2$ for all x in the interval $[a, b]$. Then $b - a \leq 4$.*

■ **Proof.** Consider the substitution $y = \frac{2}{b-a}(x - a) - 1$. This maps the x -interval $[a, b]$ onto the y -interval $[-1, 1]$. The corresponding polynomial

$$q(y) = p\left(\frac{b-a}{2}(y + 1) + a\right)$$

has leading coefficient $\left(\frac{b-a}{2}\right)^n$ and satisfies

$$\max_{-1 \leq y \leq 1} |q(y)| = \max_{a \leq x \leq b} |p(x)|.$$



Pavnuty Chebyshev on a Soviet stamp from 1946

By Chebyshev's theorem we deduce

$$2 \geq \max_{a \leq x \leq b} |p(x)| \geq \left(\frac{b-a}{2}\right)^n \frac{1}{2^{n-1}} = 2\left(\frac{b-a}{4}\right)^n,$$

and thus $b - a \leq 4$, as desired. \square

This corollary brings us already very close to the statement of Theorem 2. If the set $\mathcal{P} = \{x : |p(x)| \leq 2\}$ is an interval, then the length of \mathcal{P} is at most 4. The set \mathcal{P} may, however, not be an interval, as in the example depicted here, where \mathcal{P} consists of two intervals.

What can we say about \mathcal{P} ? Since $p(x)$ is a continuous function, we know at any rate that \mathcal{P} is the union of disjoint closed intervals I_1, I_2, \dots , and that $p(x)$ assumes the value 2 or -2 at each endpoint of an interval I_j . This implies that there are only finitely many intervals I_1, \dots, I_t , since $p(x)$ can assume any value only finitely often.

Pólya's wonderful idea was to construct another polynomial $\tilde{p}(x)$ of degree n , again with leading coefficient 1, such that $\tilde{\mathcal{P}} = \{x : |\tilde{p}(x)| \leq 2\}$ is an interval of length at least $\ell(I_1) + \dots + \ell(I_t)$. The corollary then proves $\ell(I_1) + \dots + \ell(I_t) \leq \ell(\tilde{\mathcal{P}}) \leq 4$, and we are done.

■ Proof of Theorem 2. Consider $p(x) = (x - a_1) \cdots (x - a_n)$ with $\mathcal{P} = \{x \in \mathbb{R} : |p(x)| \leq 2\} = I_1 \cup \dots \cup I_t$, where we arrange the intervals I_j such that I_1 is the leftmost and I_t the rightmost interval. First we claim that any interval I_j contains a root of $p(x)$. We know that $p(x)$ assumes the values 2 or -2 at the endpoints of I_j . If one value is 2 and the other -2 , then there is certainly a root in I_j . So assume $p(x) = 2$ at both endpoints (the case -2 being analogous). Suppose $b \in I_j$ is a point where $p(x)$ assumes its minimum in I_j . Then $p'(b) = 0$ and $p''(b) \geq 0$. If $p''(b) = 0$, then b is a multiple root of $p'(x)$, and hence a root of $p(x)$ by Fact 1 from the box on the next page. If, on the other hand, $p''(b) > 0$, then we deduce $p(b) \leq 0$ from Fact 2 from the same box. Hence either $p(b) = 0$, and we have our root, or $p(b) < 0$, and we obtain a root in the interval from b to either endpoint of I_j .

Here is the final idea of the proof. Let I_1, \dots, I_t be the intervals as before, and suppose the rightmost interval I_t contains m roots of $p(x)$, counted with their multiplicities. If $m = n$, then I_t is the only interval (by what we just proved), and we are finished. So assume $m < n$, and let d be the distance between I_{t-1} and I_t as in the figure. Let b_1, \dots, b_m be the roots of $p(x)$ which lie in I_t and c_1, \dots, c_{n-m} the remaining roots. We now write $p(x) = q(x)r(x)$ where $q(x) = (x - b_1) \cdots (x - b_m)$ and $r(x) = (x - c_1) \cdots (x - c_{n-m})$, and set $p_1(x) = q(x + d)r(x)$. The polynomial $p_1(x)$ is again of degree n with leading coefficient 1. For $x \in I_1 \cup \dots \cup I_{t-1}$ we have $|x + d - b_i| < |x - b_i|$ for all i , and hence $|q(x + d)| < |q(x)|$. It follows that

$$|p_1(x)| \leq |p(x)| \leq 2 \quad \text{for } x \in I_1 \cup \dots \cup I_{t-1}.$$

If, on the other hand, $x \in I_t$, then we find $|r(x - d)| \leq |r(x)|$ and thus

$$|p_1(x - d)| = |q(x)| |r(x - d)| \leq |p(x)| \leq 2,$$

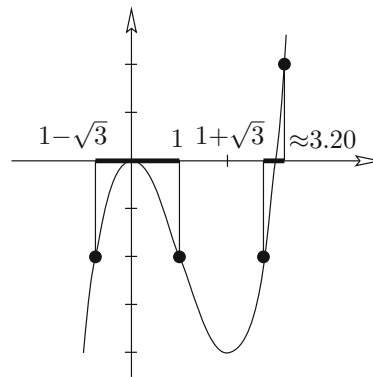

For the polynomial $p(x) = x^2(x - 3)$ we get $\mathcal{P} = [1 - \sqrt{3}, 1] \cup [1 + \sqrt{3}, \approx 3.20]$

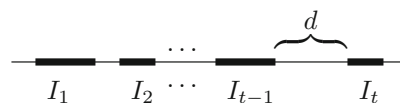

which means that $I_t - d \subseteq \mathcal{P}_1 = \{x : |p_1(x)| \leq 2\}$.

In summary, we see that \mathcal{P}_1 contains $I_1 \cup \cdots \cup I_{t-1} \cup (I_t - d)$ and hence has total length at least as large as \mathcal{P} . Notice now that with the passage from $p(x)$ to $p_1(x)$ the intervals I_{t-1} and $I_t - d$ merge into a single interval. We conclude that the intervals J_1, \dots, J_s of $p_1(x)$ making up \mathcal{P}_1 have total length at least $\ell(I_1) + \cdots + \ell(I_t)$, and that the rightmost interval J_s contains more than m roots of $p_1(x)$. Repeating this procedure at most $t - 1$ times, we finally arrive at a polynomial $\tilde{p}(x)$ with $\tilde{\mathcal{P}} = \{x : |\tilde{p}(x)| \leq 2\}$ being an interval of length $\ell(\tilde{\mathcal{P}}) \geq \ell(I_1) + \cdots + \ell(I_t)$, and the proof is complete. \square

Two facts about polynomials with real roots

Let $p(x)$ be a nonconstant polynomial with only real roots.

Fact 1. *If b is a multiple root of $p'(x)$, then b is also a root of $p(x)$.*

■ **Proof.** Let $b_1 < \cdots < b_r$ be the roots of $p(x)$ with multiplicities s_1, \dots, s_r , $\sum_{j=1}^r s_j = n$. From $p(x) = (x - b_j)^{s_j} h(x)$ we infer that b_j is a root of $p'(x)$ if $s_j \geq 2$, and the multiplicity of b_j in $p'(x)$ is $s_j - 1$. Furthermore, there is a root of $p'(x)$ between b_1 and b_2 , another root between b_2 and b_3, \dots , and one between b_{r-1} and b_r , and all these roots must be *single* roots, since $\sum_{j=1}^r (s_j - 1) + (r - 1)$ counts already up to the degree $n - 1$ of $p'(x)$. Consequently, the *multiple* roots of $p'(x)$ can only occur among the roots of $p(x)$. \square

Fact 2. *We have $p'(x)^2 \geq p(x)p''(x)$ for all $x \in \mathbb{R}$.*

■ **Proof.** If $x = a_i$ is a root of $p(x)$, then there is nothing to show. Assume then x is not a root. The product rule of differentiation yields

$$p'(x) = \sum_{k=1}^n \frac{p(x)}{x - a_k}, \quad \text{that is,} \quad \frac{p'(x)}{p(x)} = \sum_{k=1}^n \frac{1}{x - a_k}.$$

Differentiating this again we have

$$\frac{p''(x)p(x) - p'(x)^2}{p(x)^2} = - \sum_{k=1}^n \frac{1}{(x - a_k)^2} < 0. \quad \square$$

Appendix: Chebyshev's theorem

Theorem. Let $p(x)$ be a real polynomial of degree $n \geq 1$ with leading coefficient 1. Then

$$\max_{-1 \leq x \leq 1} |p(x)| \geq \frac{1}{2^{n-1}}.$$

Before we start, let us look at some examples where we have equality. The margin depicts the graphs of polynomials of degrees 1, 2 and 3, where we have equality in each case. Indeed, we will see that for every degree there is precisely one polynomial with equality in Chebyshev's theorem.

■ **Proof.** Consider a real polynomial $p(x) = x^n + a_{n-1}x^{n-1} + \dots + a_0$ with leading coefficient 1. Since we are interested in the range $-1 \leq x \leq 1$, we set $x = \cos \vartheta$ and denote by $g(\vartheta) := p(\cos \vartheta)$ the resulting polynomial in $\cos \vartheta$,

$$g(\vartheta) = (\cos \vartheta)^n + a_{n-1}(\cos \vartheta)^{n-1} + \dots + a_0. \quad (1)$$

The proof proceeds now in the following two steps which are both classical results and interesting in their own right.

(A) We express $g(\vartheta)$ as a so-called *cosine polynomial*, that is, a polynomial of the form

$$g(\vartheta) = b_n \cos n\vartheta + b_{n-1} \cos(n-1)\vartheta + \dots + b_1 \cos \vartheta + b_0 \quad (2)$$

with $b_k \in \mathbb{R}$, and show that its leading coefficient is $b_n = \frac{1}{2^{n-1}}$.

(B) Given any cosine polynomial $h(\vartheta)$ of order n (meaning that λ_n is the highest nonvanishing coefficient)

$$h(\vartheta) = \lambda_n \cos n\vartheta + \lambda_{n-1} \cos(n-1)\vartheta + \dots + \lambda_0, \quad (3)$$

we show $|\lambda_n| \leq \max |h(\vartheta)|$, which when applied to $g(\vartheta)$ will then prove the theorem.

Proof of (A). To pass from (1) to the representation (2), we have to express all powers $(\cos \vartheta)^k$ as cosine polynomials. For example, the addition theorem for the cosine gives

$$\cos 2\vartheta = \cos^2 \vartheta - \sin^2 \vartheta = 2 \cos^2 \vartheta - 1,$$

so that $\cos^2 \vartheta = \frac{1}{2} \cos 2\vartheta + \frac{1}{2}$. To do this for an arbitrary power $(\cos \vartheta)^k$ we go into the complex numbers, via the relation $e^{ix} = \cos x + i \sin x$. The e^{ix} are the complex numbers of absolute value 1 (see the box on complex unit roots on page 37). In particular, this yields

$$e^{in\vartheta} = \cos n\vartheta + i \sin n\vartheta. \quad (4)$$

On the other hand,

$$e^{in\vartheta} = (e^{i\vartheta})^n = (\cos \vartheta + i \sin \vartheta)^n. \quad (5)$$

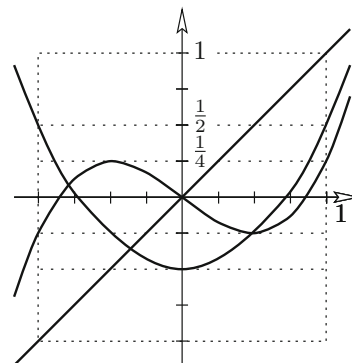

The polynomials $p_1(x) = x$, $p_2(x) = x^2 - \frac{1}{2}$ and $p_3(x) = x^3 - \frac{3}{4}x$ achieve equality in Chebyshev's theorem.

Equating the real parts in (4) and (5) we obtain by $i^{4\ell+2} = -1$, $i^{4\ell} = 1$ and $\sin^2 \theta = 1 - \cos^2 \theta$

$$\begin{aligned} \cos n\vartheta &= \sum_{\ell \geq 0} \binom{n}{4\ell} (\cos \vartheta)^{n-4\ell} (1 - \cos^2 \vartheta)^{2\ell} \\ &\quad - \sum_{\ell \geq 0} \binom{n}{4\ell+2} (\cos \vartheta)^{n-4\ell-2} (1 - \cos^2 \vartheta)^{2\ell+1}. \end{aligned} \quad (6)$$

We conclude that $\cos n\vartheta$ is a polynomial in $\cos \vartheta$,

$$\cos n\vartheta = c_n (\cos \vartheta)^n + c_{n-1} (\cos \vartheta)^{n-1} + \cdots + c_0. \quad (7)$$

From (6) we obtain for the highest coefficient

$$c_n = \sum_{\ell \geq 0} \binom{n}{4\ell} + \sum_{\ell \geq 0} \binom{n}{4\ell+2} = 2^{n-1}.$$

$\sum_{k \geq 0} \binom{n}{2k} = 2^{n-1}$ holds for $n > 0$:
Every subset of $\{1, 2, \dots, n-1\}$ yields
an even sized subset of $\{1, 2, \dots, n\}$ if
we add the element n “if needed.”

Now we turn our argument around. Assuming by induction that for $k < n$, $(\cos \vartheta)^k$ can be expressed as a cosine polynomial of order k , we infer from (7) that $(\cos \vartheta)^n$ can be written as a cosine polynomial of order n with leading coefficient $b_n = \frac{1}{2^{n-1}}$.

Proof of (B). Let $h(\vartheta)$ be a cosine polynomial of order n as in (3), and assume without loss of generality $\lambda_n > 0$. Now we set $m(\vartheta) := \lambda_n \cos n\vartheta$ and find

$$m\left(\frac{k}{n}\pi\right) = (-1)^k \lambda_n \quad \text{for } k = 0, 1, \dots, n.$$

Suppose, for a proof by contradiction, that $\max |h(\vartheta)| < \lambda_n$. Then

$$m\left(\frac{k}{n}\pi\right) - h\left(\frac{k}{n}\pi\right) = (-1)^k \lambda_n - h\left(\frac{k}{n}\pi\right)$$

is positive for even k and negative for odd k in the range $0 \leq k \leq n$. We conclude that $m(\vartheta) - h(\vartheta)$ has at least n roots in the interval $[0, \pi]$. But this cannot be since $m(\vartheta) - h(\vartheta)$ is a cosine polynomial of order $n-1$, and thus has at most $n-1$ roots.

The proof of **(B)** and thus of Chebyshev’s theorem is complete. \square

The energetic reader is now invited to complete the analysis, showing that $g_n(\vartheta) := \frac{1}{2^{n-1}} \cos n\vartheta$ is the *only* cosine polynomial of order n with leading coefficient 1 that achieves the equality $\max |g(\vartheta)| = \frac{1}{2^{n-1}}$.

The polynomials $T_n(x) = \cos n\vartheta$, $x = \cos \vartheta$, are called the *Chebyshev polynomials* (of the first kind); thus $\frac{1}{2^{n-1}} T_n(x)$ is the unique monic polynomial of degree n where equality holds in Chebyshev’s theorem.

References

- [1] P. L. CEBYCEV: *Œuvres*, Vol. I, Acad. Imperiale des Sciences, St. Petersburg 1899, pp. 387-469.
- [2] G. PÓLYA: *Beitrag zur Verallgemeinerung des Verzerrungssatzes auf mehrfach zusammenhängenden Gebieten*, Sitzungsber. Preuss. Akad. Wiss. Berlin (1928), 228-232; Collected Papers Vol. I, MIT Press 1974, 347-351.
- [3] G. PÓLYA & G. SZEGŐ: *Problems and Theorems in Analysis, Vol. II*, Springer-Verlag, Berlin Heidelberg New York 1976; Reprint 1998.

Van der Waerden's permanent conjecture

Chapter 24



Suppose $M = (m_{ij})$ is a real $n \times n$ matrix. If in the usual representation of the determinant we omit the signs of the permutations, we get the *permanent* per M ,

$$\text{per } M := \sum_{\sigma} m_{1\sigma(1)} m_{2\sigma(2)} \cdots m_{n\sigma(n)},$$

where σ runs through all permutations of $\{1, 2, \dots, n\}$.

In contrast to the determinant, which can be quickly calculated (e.g. by Gaussian elimination), computation of the permanent is provably difficult. Therefore a lot of research about permanents concerned bounds and approximation; the book by Minc [7] gives an excellent overview of the subject.

We consider in this chapter the most famous theorem about permanents and its fabulous recent proof. A real matrix $M = (m_{ij})$ is called *doubly stochastic* if its entries are nonnegative, with each row sum and column sum equal to 1. In 1926 Bartel L. van der Waerden asked whether

$$\text{per } M \geq \frac{n!}{n^n}$$

holds for every doubly stochastic $n \times n$ matrix, the minimum being attained only by the matrix $M = (m_{ij})$, where $m_{ij} = \frac{1}{n}$ for all i and j .

This “Van der Waerden conjecture” remained unsolved for over fifty years, until it was confirmed (more or less independently and more or less simultaneously) by G. P. Egorychev and D. I. Falikman in 1981. The paper [5] by Jacobus van Lint gives a very readable account of the history of the conjecture and the proofs.

The arguments of Egorychev and Falikman were rather involved, so it was a great surprise when in 2007 Leonid Gurvits presented a short, elegant, and completely different proof. In fact, he proved a stronger statement that included other previous results in this area as well.

Theorem. Let $M = (m_{ij})$ be a doubly stochastic $n \times n$ matrix. Then

$$\text{per } M \geq \frac{n!}{n^n},$$

and equality holds if and only if $m_{ij} = \frac{1}{n}$ for all i and j .



Bartel Leendert van der Waerden

However, in 1969 Van der Waerden told his compatriot Van Lint that he had never heard of such a conjecture nor of his name being attached to it ...

$$\text{per} \begin{pmatrix} \frac{1}{n} & \cdots & \frac{1}{n} \\ \vdots & \ddots & \vdots \\ \frac{1}{n} & \cdots & \frac{1}{n} \end{pmatrix} = \frac{n!}{n^n}.$$

For our presentation of the proof we follow closely the beautiful exposition of Gurvits' work by Monique Laurent and Alexander Schrijver in [4].

For example, for $M = \begin{pmatrix} a & b \\ c & d \end{pmatrix}$ we get

$$\begin{aligned} p_M(x_1, x_2) &= (ax_1 + bx_2)(cx_1 + dx_2) \\ &= acx_1^2 + (ad + bc)x_1x_2 + bdx_2^2. \end{aligned}$$

As first step let us translate matrices into polynomials. To every $n \times n$ matrix $M = (m_{ij})$ we associate the polynomial $p_M(x) \in \mathbb{R}[x_1, \dots, x_n]$,

$$p_M(x) = p_M(x_1, \dots, x_n) := \prod_{i=1}^n \left(\sum_{j=1}^n m_{ij} x_j \right).$$

Since every term picks a variable from each row, $p_M(x)$ is *homogeneous* of degree n , meaning that every monomial $x_1^{k_1} \cdots x_n^{k_n}$ has total degree $k_1 + \cdots + k_n = n$. Note that $p_M(x)$ may be the zero-polynomial with all coefficients equal to 0, which happens for example if M has a zero row. It is convenient to include this case and still regard $p_M(x) \equiv 0$ as homogeneous of degree n , when the set of variables is clear.

Next we define for $p(x) \in \mathbb{R}[x_1, \dots, x_n]$ its *derivative in x_n* :

$$p'(x_1, \dots, x_{n-1}) := \left. \frac{\partial p(x)}{\partial x_n} \right|_{x_n=0}.$$

Observe that if p is homogeneous of degree n in n variables, then p' is homogeneous of degree $n - 1$ in $n - 1$ variables. Indeed, since exactly the monomials of $p(x)$ that are linear in x_n survive in p' , the degree decreases by 1.

In general, we define for $i = 0, 1, \dots, n$

$$q_i(x_1, \dots, x_i) := \left. \frac{\partial^{(n-i)} p(x)}{\partial x_n \cdots \partial x_{i+1}} \right|_{x_n=x_{n-1}=\cdots=x_{i+1}=0}.$$

For the polynomial in the margin above, we obtain $q_1(x_1) = (ad + bc)x_1$ and $q_0 = ad + bc$.

In this way we get a chain $(q_n, q_{n-1}, \dots, q_0)$, where $q_n = p$ and $q_{i-1} = q'_i$ for $1 \leq i \leq n$, and finally q_0 is the coefficient of $x_1 x_2 \cdots x_n$ in p . Furthermore, if p is homogeneous of degree n , then q_i is homogeneous of degree i .

Let us look at the chain generated by $p_M(x)$,

$$p_M(x) = q_n, \dots, q_i, \dots, q_0.$$

The following two facts will be important:

A. *per M is the coefficient of $x_1 x_2 \cdots x_n$ in q_n , thus $q_0 = \text{per } M$.*

This holds by the definition of the permanent.

B. *For $i = 1, \dots, n$ we have*

$$\deg_i q_i \leq \min\{i, \lambda_M(i)\}, \quad (1)$$

where $\deg_j q_i$ denotes the degree of x_j in $q_i(x_1, \dots, x_i)$ and $\lambda_M(i)$ records the number of nonzero entries in the i th column of M .

Indeed, we have $\deg_i q_i \leq i$, because q_i is homogeneous of degree i , while $\deg_i q_i \leq \deg_i q_n \leq \lambda_M(i)$ is clear from the definition of $p_M(x)$.

Here comes the main idea of the proof: We associate a parameter to every polynomial p and bound it from below when passing from p to p' .

Before going on, let us fix some notation. We will let \mathbb{R}_+ denote the nonnegative reals, and $p(x) \in \mathbb{R}_+[x_1, \dots, x_n]$ means that all coefficients of $p(x)$ are nonnegative. For a complex number $z \in \mathbb{C}$, let $\operatorname{Re}(z)$ and $\operatorname{Im}(z)$ be the real and the imaginary part, respectively. Let $\mathbb{C}_+ = \{z \in \mathbb{C} : \operatorname{Re}(z) \geq 0\}$ and $\mathbb{C}_{++} = \{z \in \mathbb{C} : \operatorname{Re}(z) > 0\}$ denote closed and open right complex half-planes. The notation extends to \mathbb{R}_+^n and \mathbb{C}_+^n , etc. Thus, for example, $z = (z_1, \dots, z_n) \in \mathbb{C}_{++}^n$ holds if $\operatorname{Re}(z_i) > 0$ for all i .

For every polynomial $p(x) \in \mathbb{R}_+[x_1, \dots, x_n]$ define the *capacity* $\operatorname{cap}(p)$ by

$$\operatorname{cap}(p) := \inf \left\{ p(x) : x \in \mathbb{R}_+^n, \prod_{i=1}^n x_i = 1 \right\}.$$

In particular, $\operatorname{cap}(p) \geq 0$ as p has only nonnegative coefficients, and if p is the constant polynomial $p(x) \equiv c$, then $\operatorname{cap}(p) = c$.

We also need the function $g : \mathbb{N}_0 \rightarrow \mathbb{R}$, defined by $g(0) := 1$ and

$$g(k) := \left(\frac{k-1}{k} \right)^{k-1} \quad \text{for } k \geq 1.$$

Using $1+x \leq e^x$ twice, which holds strictly except for $x=0$, we get

$$\frac{g(k+1)}{g(k)} = \frac{k}{k+1} \left(\frac{k^2}{k^2-1} \right)^{k-1} < e^{-\frac{1}{k+1}} e^{\frac{1}{k^2-1}(k-1)} = 1$$

for $k \geq 1$. Thus g is non-increasing, $g(0) = g(1) > g(2) > \dots$.

Writing $g(k) = \left(1 - \frac{1}{k}\right)^{k-1}$, we see that $\lim_{k \rightarrow \infty} g(k) = \frac{1}{e}$.

Call a polynomial $p(x) \in \mathbb{R}[x_1, \dots, x_n]$ *H-stable* if it has no roots in \mathbb{C}_{++}^n .

The following result is the key step. We postpone its proof for the moment and show first how it immediately implies the Theorem.

Gurvits' Proposition.

If $p(x) \in \mathbb{R}_+[x_1, \dots, x_n]$ is *H-stable* and homogeneous of degree n , then either $p' \equiv 0$, or p' is *H-stable* and homogeneous of degree $n-1$. In either case

$$\operatorname{cap}(p') \geq \operatorname{cap}(p) \cdot g(\deg_n p).$$

■ **Proof of the Theorem.** Let $M = (m_{ij})$ be a doubly stochastic $n \times n$ matrix. We already know that $p_M(x)$ is homogeneous of degree n .

Claim 1. $p_M(x)$ is *H-stable*.

Suppose x is a root of $p_M(x)$. From $p_M(x) = \prod_{i=1}^n \left(\sum_{j=1}^n m_{ij} x_j \right) = 0$ it follows that $\sum_{j=1}^n m_{ij} x_j = 0$ for some i , thus $\sum_{j=1}^n m_{ij} \operatorname{Re}(x_j) = 0$. But this precludes $x \in \mathbb{C}_{++}^n$, since $m_{i\ell} > 0$ for some ℓ .

Recall for this that $m_{ij} \geq 0$ and $\sum_{i=1}^n m_{ij} = 1$.

Claim 2. $\operatorname{cap}(p_M) = 1$.

Take any $x \in \mathbb{R}_+^n$ with $\prod_{j=1}^n x_j = 1$. By the inequality of the arithmetic and the geometric mean (see Chapter 20) we have

The AM-GM inequality: For $a_1, \dots, a_n, p_1, \dots, p_n \in \mathbb{R}_+$ with $\sum_{i=1}^n p_i = 1$ we get

$$\sum_{i=1}^n p_i a_i \geq a_1^{p_1} \dots a_n^{p_n}.$$

$$\begin{aligned} p_M(x) &= \prod_{i=1}^n \left(\sum_{j=1}^n m_{ij} x_j \right) \geq \prod_{i=1}^n \prod_{j=1}^n x_j^{m_{ij}} = \prod_{j=1}^n \prod_{i=1}^n x_j^{m_{ij}} \\ &= \prod_{j=1}^n x_j^{\sum_{i=1}^n m_{ij}} = \prod_{j=1}^n x_j = 1, \end{aligned}$$

and thus $\text{cap}(p_M) \geq 1$.

On the other hand,

$$p_M(1, 1, \dots, 1) = \prod_{i=1}^n \left(\sum_{j=1}^n m_{ij} \right) = \prod_{i=1}^n 1 = 1,$$

which proves Claim 2.

Since $p_M(x)$ is H-stable, we may apply Gurvits' Proposition repeatedly to conclude that all the polynomials q_i are H-stable, and obtain for each i that

$$\text{cap}(q_{i-1}) \geq \text{cap}(q_i) g(\deg_i q_i) \geq \text{cap}(q_i) g(\min\{i, \lambda_M(i)\}), \quad (2)$$

where the second inequality follows from (1) and the fact that g is non-increasing.

Iterating (2) we get, starting with $\text{cap}(p_M) = 1$, that

$$\begin{aligned} \text{per } M = q_0 &\geq \prod_{i=1}^n g(\min\{i, \lambda_M(i)\}) \geq \prod_{i=1}^n g(i) \\ &= \prod_{i=1}^n \left(\frac{i-1}{i} \right)^{i-1} = \prod_{i=1}^n i \frac{(i-1)^{i-1}}{i^i} = \frac{n!}{n^n}, \end{aligned} \quad (3)$$

which is our desired inequality.

It remains to prove the uniqueness part. Suppose that $\text{per } M = \frac{n!}{n^n}$, where we may assume that $n \geq 2$. From the fact that we have equality in (3), we conclude that $i \leq \lambda_M(i)$ for all i , and hence $n = \lambda_M(n)$. By symmetry, we conclude that all entries of M are nonzero. Thus it suffices to prove, again by symmetry, that all entries in the *last* column are equal to $\frac{1}{n}$.

Since we have equality in Gurvits's Proposition applied to p_M and p'_M , and since $\text{cap}(p_M) = 1$, we find

$$\inf_y p'_M(y) = \text{cap}(p'_M) = g(n) = \left(\frac{n-1}{n} \right)^{n-1},$$

where y ranges over all $y \in \mathbb{R}_+^{n-1}$ with $\prod_{j=1}^{n-1} y_j = 1$. Take any such y .

In the following chain of inequalities the indices i and k range from 1 to n , while j goes from 1 to $n-1$. From

$$p_M(x) = \prod_{i=1}^n \left(\sum_{j=1}^n m_{ij} x_j \right)$$

we infer that

$$p'_M(y) = \left. \frac{\partial p_M(x)}{\partial x_n} \right|_{x=(y,0)} = \sum_k m_{kn} \prod_{i \neq k} \left(\sum_j m_{ij} y_j \right)$$

Here we make use of the Leibniz rule for differentiating products:
 $(f_1 f_2 \cdots f_n)' = \sum_k f'_k \prod_{i \neq k} f_i$.

and thus obtain the following chain:

$$\begin{aligned} p'_M(y) &= \sum_k m_{kn} \prod_{i \neq k} \left(\sum_j m_{ij} y_j \right) \\ &\stackrel{\text{AM-GM}}{\geq} \prod_k \prod_{i \neq k} \left(\sum_j m_{ij} y_j \right)^{m_{kn}} \\ &= \prod_i \prod_{k \neq i} \left(\sum_j m_{ij} y_j \right)^{m_{kn}} \\ &= \prod_i \left(\sum_j m_{ij} y_j \right)^{1-m_{in}} \\ &= \prod_i \left[(1-m_{in}) \sum_j \frac{m_{ij}}{1-m_{in}} y_j \right]^{1-m_{in}} \\ &\stackrel{\text{AM-GM}}{\geq} \prod_i \left[(1-m_{in})^{1-m_{in}} \prod_j y_j^{m_{ij}} \right] \\ &= \prod_i (1-m_{in})^{1-m_{in}} \prod_j \prod_i y_j^{m_{ij}} \\ &= \prod_i (1-m_{in})^{1-m_{in}} \underbrace{\prod_j y_j}_{=1} \\ &\geq \left(\frac{n-1}{n} \right)^{n-1}. \end{aligned}$$

Note that $m_{in} \neq 1$, since $n \geq 2$ and the i -th row has no zeros.

For the last inequality in this chain we exploit the log-convexity of the function x^x for $x > 0$. For this recall that a real function f is *convex* if $\frac{1}{n}(f(x_1) + \cdots + f(x_n)) \geq f\left(\frac{x_1 + \cdots + x_n}{n}\right)$; a function $f(x)$ is *log-convex* if $\log f(x)$ is convex. Then $\frac{1}{n} \sum_i \log f(x_i) \geq \log f\left(\frac{x_1 + \cdots + x_n}{n}\right)$, or $f(x_1) \cdots f(x_n) \geq f\left(\frac{x_1 + \cdots + x_n}{n}\right)^n$. For the function x^x we have

$$x_1^{x_1} x_2^{x_2} \cdots x_n^{x_n} \geq \left(\frac{x_1 + \cdots + x_n}{n} \right)^{\sum_i x_i}$$

with equality if and only if $x_1 = x_2 = \cdots = x_n$. In our case $x_i = 1 - m_{in}$ with $x_1 + \cdots + x_n = n - 1$, thus $\left(\frac{x_1 + \cdots + x_n}{n} \right)^{\sum_i x_i} \geq \left(\frac{n-1}{n} \right)^{n-1}$.

And here is the punch line: Since this chain of inequalities holds for every such y , and since $\inf p'_M(y) = \left(\frac{n-1}{n} \right)^{n-1}$, the last inequality (which is independent of y) must be an equality, and from this we conclude that $1 - m_{1n} = \cdots = 1 - m_{nn}$, that is, $m_{1n} = \cdots = m_{nn} = \frac{1}{n}$. \square

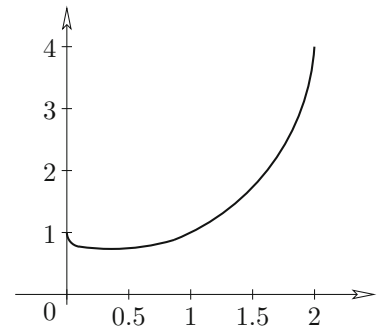

The function $f(x) = x^x$ is log-convex

In our work towards a proof of Gurvits's proposition, assume now that the polynomial $p(x) \in \mathbb{R}_+[x_1, \dots, x_n]$ is H-stable and homogeneous of degree n . We already know that $p'(x_1, \dots, x_{n-1})$ is homogeneous of degree $n - 1$.

Lemma 1. *For each $x \in \mathbb{C}_+^n$,*

$$|p(x)| \geq |p(\operatorname{Re}(x))|.$$

We may assume that $x \in \mathbb{C}_{++}^n$ by continuity. Since $p(x)$ is H-stable, we have $p(\operatorname{Re}(x)) \neq 0$. Fix x and consider the set $\{p(x + s\operatorname{Re}(x)) : s \in \mathbb{C}\}$ as a function of s . As $p(x)$ is homogeneous of degree n , we may write

$$p(x + s\operatorname{Re}(x)) = p(\operatorname{Re}(x)) \prod_{i=1}^n (s - b_i),$$

for some complex numbers b_1, \dots, b_n . Since $p(x + b_i\operatorname{Re}(x)) = 0$ for each i , we infer that $x + b_i\operatorname{Re}(x) \notin \mathbb{C}_{++}$, which implies that

$$\operatorname{Re}(x + b_i\operatorname{Re}(x)) = \operatorname{Re}(x)(1 + \operatorname{Re}(b_i)) \leq 0,$$

hence $\operatorname{Re}(b_i) \leq -1$, and thus $|b_i| \geq 1$.

It follows that

$$|p(x)| = |p(x + 0 \cdot \operatorname{Re}(x))| = |p(\operatorname{Re}(x))| \prod_{i=1}^n |b_i| \geq |p(\operatorname{Re}(x))|,$$

as claimed. \square

Lemma 2. *Let $y \in \mathbb{C}_{++}^{n-1}$ and $\prod_{j=1}^{n-1} \operatorname{Re}(y_j) = 1$. Then*

$$\operatorname{cap}(p) \leq \frac{p(\operatorname{Re}(y), t)}{t} \quad \text{for every } t > 0.$$

For the proof set $\lambda := t^{-\frac{1}{n}}$ and $\bar{x} := \lambda(\operatorname{Re}(y), t) \in \mathbb{R}_{++}^n$. Then

$$\prod_{i=1}^n \bar{x}_i = \lambda^n \left(\underbrace{\prod_{j=1}^{n-1} \operatorname{Re}(y_j)}_{=1} \right) t = 1,$$

and thus, using that $p(x)$ is homogeneous of degree n ,

$$\operatorname{cap}(p) \leq p(\bar{x}) = \lambda^n p(\operatorname{Re}(y), t) = \frac{p(\operatorname{Re}(y), t)}{t}. \quad \square$$

Suppose $y \in \mathbb{C}_{++}^{n-1}$ and set $\bar{y} = \frac{1}{\lambda}y$, where $\lambda = \left[\prod_{j=1}^{n-1} \operatorname{Re}(y_j) \right]^{\frac{1}{n-1}}$. Then $\prod_{j=1}^{n-1} \operatorname{Re}(\bar{y}_j) = 1$, and $p'(y) = \lambda^{n-1}p'(\bar{y})$. Hence y is a root of p' if and only if \bar{y} is.

■ Proof Gurvits' Proposition. It now suffices to show (by scaling, see the margin) that for $y \in \mathbb{C}_{++}^{n-1}$ with $\prod_{j=1}^{n-1} \operatorname{Re}(y_j) = 1$ the following two conditions hold:

(I) *If $p'(y) = 0$, then $p' \equiv 0$.*

(II) *If $y \in \mathbb{R}_{++}^{n-1}$, then $p'(y) \geq \operatorname{cap}(p) \cdot g(\deg_n p)$.*

Case 1. $p(y, 0) = 0$.

We have $p(\operatorname{Re}(y), 0) = 0$ by Lemma 1. Furthermore,

$$p'(y) = \lim_{t \searrow 0} \frac{p(y, t) - p(y, 0)}{t} = \lim_{t \searrow 0} \frac{p(y, t)}{t},$$

and similarly

$$p'(\operatorname{Re}(y)) = \lim_{t \searrow 0} \frac{p(\operatorname{Re}(y), t)}{t}.$$

Since $p(\operatorname{Re}(y), t) \leq |p(y, t)|$, again by Lemma 1, we infer from Lemma 2 that

$$\operatorname{cap}(p) \leq \lim_{t \searrow 0} \frac{p(\operatorname{Re}(y), t)}{t} = p'(\operatorname{Re}(y)) \leq \lim_{t \searrow 0} \frac{|p(y, t)|}{t} = |p'(y)|.$$

If $p'(y) = 0$, then $p'(\operatorname{Re}(y)) = 0$, and thus $p' \equiv 0$ since all coefficients of p' are nonnegative. This proves (I) in this case, and (II) is trivially true since $g(k) \leq 1$ for all k .

Case 2. $p(y, t)$ has degree at most 1 as a polynomial in t .

Since $p(\operatorname{Re}(y), t) \leq |p(y, t)|$ for all $t > 0$ by Lemma 1, we conclude that $p(\operatorname{Re}(y), t)$ also has degree at most 1 in t . Thus

$$p'(y) = \lim_{t \rightarrow \infty} \frac{p(y, t)}{t}, \quad p'(\operatorname{Re}(y)) = \lim_{t \rightarrow \infty} \frac{p(\operatorname{Re}(y), t)}{t},$$

and Lemma 2 tells us that

$$\operatorname{cap}(p) \leq \lim_{t \rightarrow \infty} \frac{p(\operatorname{Re}(y), t)}{t} = p'(\operatorname{Re}(y)) \leq \lim_{t \rightarrow \infty} \frac{|p(y, t)|}{t} = |p'(y)|,$$

and we infer (I) and (II) as before.

Case 3. $p(y, 0) \neq 0$, and $p(y, t)$ has degree at least 2 in t .

This implies that $k := \deg_n p \geq 2$, and we can write

$$p(y, t) = p(y, 0) \prod_{i=1}^k (1 + a_i t) \tag{4}$$

for some complex numbers a_1, \dots, a_k . Hence

$$p'(y) = p(y, 0) \sum_{i=1}^k a_i$$

where not all a_i are equal to 0, since $p(y, t)$ has degree at least 2 in t .

The following result is the heart of the proof.

Claim. *If $a_i \neq 0$, then the inverse a_i^{-1} is a nonnegative linear combination of the complex numbers y_1, \dots, y_{n-1} .*

Remember that

$$p'(x) = \frac{\partial p(x)}{\partial x_n} \Big|_{x_n=0}.$$

To see this we need the famous Lemma of Farkas from linear optimization. (See for example Schrijver [8, Sect. 7.3].)

Farkas Lemma. Let $A \in \mathbb{R}^{r \times s}$ be a real matrix and $b \in \mathbb{R}^r$ a vector. Then exactly one of the following alternatives holds:

- (i) $Ax = b$, $x \in \mathbb{R}^s$, $x \geq 0$ is solvable,
- (ii) $A^T z > 0$, $z \in \mathbb{R}^r$, $b^T z < 0$ is solvable.

For our problem take $r = 2$, $s = n - 1$, and such an $a_i \neq 0$, and set

$$A = \begin{pmatrix} \operatorname{Re}(y_1) & \cdots & \operatorname{Re}(y_{n-1}) \\ \operatorname{Im}(y_1) & \cdots & \operatorname{Im}(y_{n-1}) \end{pmatrix}, \quad b = \begin{pmatrix} \operatorname{Re}(a_i^{-1}) \\ \operatorname{Im}(a_i^{-1}) \end{pmatrix}.$$

Alternative (i) is exactly what we want:

$$a_i^{-1} = x_1 y_1 + \cdots + x_{n-1} y_{n-1}, \quad x \in \mathbb{R}_+^{n-1}. \quad (5)$$

Assume the opposite: Let $z = \begin{pmatrix} c \\ d \end{pmatrix}$ be a solution and set $\lambda = c - id \in \mathbb{C}$. Then

$$\begin{aligned} (A^T z)_j &= \operatorname{Re}(y_j) \operatorname{Re}(\lambda) - \operatorname{Im}(y_j) \operatorname{Im}(\lambda) = \operatorname{Re}(y_j \lambda) > 0, \\ b^T z &= \operatorname{Re}(a_i^{-1} \lambda) < 0. \end{aligned}$$

This means that $(\lambda y, -\lambda a_i^{-1})$ lies in \mathbb{C}_{++}^n . However, by (4)

$$p(\lambda y, -\lambda a_i^{-1}) = \lambda^n p(y, -a_i^{-1}) = 0,$$

contradicting the H-stability of $p(x)$. This proves the claim.

Since $y \in \mathbb{C}_{++}^{n-1}$, we have $\operatorname{Re}(a_i^{-1}) > 0$ in (5) and thus $\operatorname{Re}(a_i) > 0$ for all nonzero a_i . Looking at (4), we conclude that $p'(y) \neq 0$, which proves (I).

To see (II), pick $y \in \mathbb{R}_+^{n-1}$ with $\prod_{j=1}^{n-1} y_j = 1$. In this case all nonzero a_i are positive reals by (5), thus $\sum_{i=1}^k a_i > 0$, and $\frac{p'(y)}{p(y,0)} = \sum_{i=1}^k a_i > 0$. Set $t = \frac{k}{k-1} \frac{p(y,0)}{p'(y)} > 0$. Using once more the AM-GM inequality we infer

$$\begin{aligned} \frac{p(y,t)}{p(y,0)} &= \prod_{i=1}^k (1 + a_i t) \leq \left[\frac{1}{k} \sum_{i=1}^k (1 + a_i t) \right]^k \\ &= \left[\frac{1}{k} \left(k + \frac{p'(y)}{p(y,0)} t \right) \right]^k = \left[1 + \frac{1}{k-1} \right]^k = \left(\frac{k}{k-1} \right)^k. \end{aligned}$$

Lemma 2 applied to $t = \frac{k}{k-1} \frac{p(y,0)}{p'(y)}$ therefore gives

$$\begin{aligned} \operatorname{cap}(p) &\leq \frac{p(y,t)}{t} = p'(y) \frac{k-1}{k} \frac{p(y,t)}{p(y,0)} \\ &\leq p'(y) \frac{k-1}{k} \left(\frac{k}{k-1} \right)^k = \frac{p'(y)}{g(k)}, \end{aligned}$$

or $p'(y) \geq \operatorname{cap}(p) \cdot g(k)$, and the proof is complete. \square

References

- [1] G. P. EGORYCHEV: *Proof of the van der Waerden conjecture for permanents (in Russian)*, Sibirsk. Mat. Zh. (6)22 (1981), 65–71; English translation: Siberian Math. J. 22 (1981), 854-859.
- [2] D. I. FALIKMAN: *Proof of the van der Waerden conjecture regarding the permanent of a doubly stochastic matrix (in Russian)*, Mat. Zametki 29 (1981) 931–938; English translation: Math. Notes 29 (1981), 475-479.
- [3] L. GURVITS: *Van der Waerden/Schrijver–Valiant like conjectures and stable (aka hyperbolic) homogeneous polynomials: One theorem for all*, Electronic J. Combinatorics 15 (2008), R66.
- [4] M. LAURENT & A. SCHRIJVER: *On Leonid Gurvits's proof for permanents*, Amer. Math. Monthly 117 (2010), 903-911.
- [5] J. H. VAN LINT: *The van der Waerden conjecture: Two proofs in one year*, Math. Intelligencer (2)4 (1982), 72-77.
- [6] J. H. VAN LINT & R. M. WILSON: *A Course in Combinatorics*, Second edition, Cambridge University Press, 2001.
- [7] H. MINC: *Permanents*, Encyclopedia of Mathematics and its Applications, Vol. 6, Addison-Wesley, Reading MA 1978; reissued by Cambridge University Press 1984.
- [8] A. SCHRIJVER: *Theory of Linear and Integer Programming*, John Wiley & Sons, Chichester 1986.

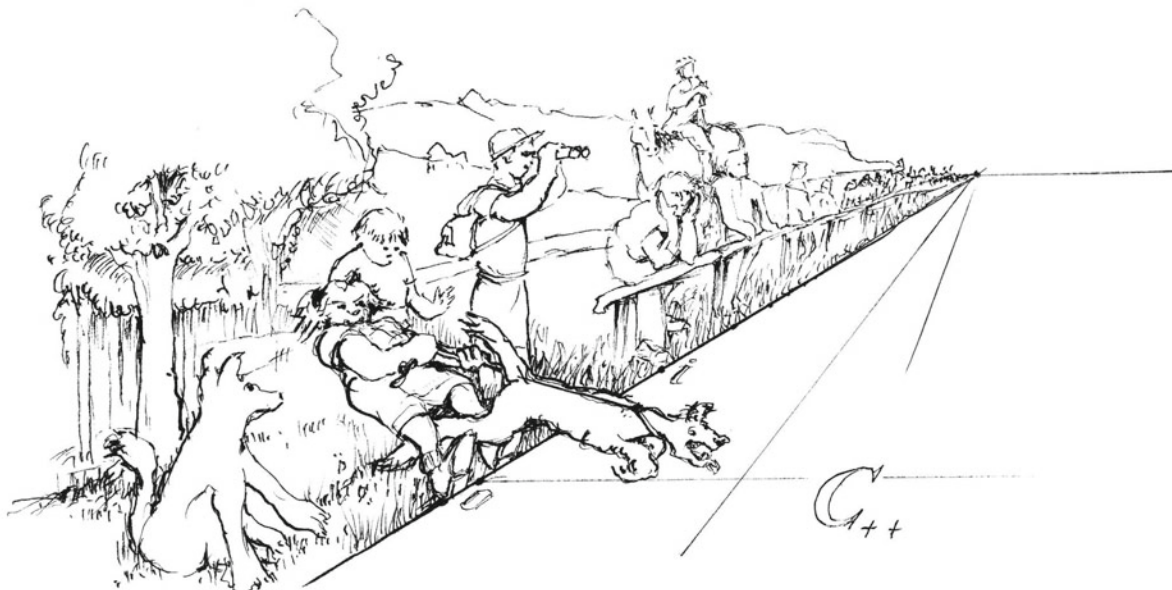

“An H -stable crowd views \mathbb{C}_{++} ”

On a lemma of Littlewood and Offord



In their work on the distribution of roots of algebraic equations, Littlewood and Offord proved in 1943 the following result:

Let a_1, a_2, \dots, a_n be complex numbers with $|a_i| \geq 1$ for all i , and consider the 2^n linear combinations $\sum_{i=1}^n \varepsilon_i a_i$ with $\varepsilon_i \in \{1, -1\}$. Then the number of sums $\sum_{i=1}^n \varepsilon_i a_i$ which lie in the interior of any circle of radius 1 is not greater than

$$c \frac{2^n}{\sqrt{n}} \log n \quad \text{for some constant } c > 0.$$

A few years later Paul Erdős improved this bound by removing the $\log n$ term, but what is more interesting, he showed that this is, in fact, a simple consequence of the theorem of Sperner (see page 213).

To get a feeling for his argument, let us look at the case when all a_i are real. We may assume that all a_i are positive (by changing a_i to $-a_i$ and ε_i to $-\varepsilon_i$ whenever $a_i < 0$). Now suppose that a set of combinations $\sum \varepsilon_i a_i$ lies in the interior of an interval of length 2. Let $N = \{1, 2, \dots, n\}$ be the index set. For every $\sum \varepsilon_i a_i$ we set $I := \{i \in N : \varepsilon_i = 1\}$. Now if $I \subsetneq I'$ for two such sets, then we conclude that

$$\sum \varepsilon'_i a_i - \sum \varepsilon_i a_i = 2 \sum_{i \in I' \setminus I} a_i \geq 2,$$

which is a contradiction. Hence the sets I form an antichain, and we conclude from the theorem of Sperner that there are at most $\binom{n}{\lfloor n/2 \rfloor}$ such combinations. By Stirling's formula (see page 13) we have

$$\binom{n}{\lfloor n/2 \rfloor} \leq c \frac{2^n}{\sqrt{n}} \quad \text{for some } c > 0.$$

For n even and all $a_i = 1$ we obtain $\binom{n}{n/2}$ combinations $\sum_{i=1}^n \varepsilon_i a_i$ that sum to 0. Looking at the interval $(-1, 1)$ we thus find that the binomial number gives the *exact* bound.

In the same paper Erdős conjectured that $\binom{n}{\lfloor n/2 \rfloor}$ was the right bound for complex numbers as well (he could only prove $c 2^n n^{-1/2}$ for some c) and indeed that the same bound is valid for vectors $\mathbf{a}_1, \dots, \mathbf{a}_n$ with $|\mathbf{a}_i| \geq 1$ in a real Hilbert space, when the circle of radius 1 is replaced by an open ball of radius 1.



John E. Littlewood

Sperner's theorem. *Any antichain of subsets of an n -set has size at most $\binom{n}{\lfloor n/2 \rfloor}$.*

Erdős was right, but it took twenty years until Gyula Katona and Daniel Kleitman independently came up with a proof for the complex numbers (or, what is the same, for the plane \mathbb{R}^2). Their proofs used explicitly the 2-dimensionality of the plane, and it was not at all clear how they could be extended to cover finite dimensional real vector spaces.

But then in 1970 Kleitman proved the full conjecture on Hilbert spaces with an argument of stunning simplicity. In fact, he proved even more. His argument is a prime example of what you can do when you find the right induction hypothesis.

A word of comfort for all readers who are not familiar with the notion of a Hilbert space: We do not really need general Hilbert spaces. Since we only deal with finitely many vectors \mathbf{a}_i , it is enough to consider the real space \mathbb{R}^d with the usual scalar product. Here is Kleitman's result.

Theorem. *Let $\mathbf{a}_1, \dots, \mathbf{a}_n$ be vectors in \mathbb{R}^d , each of length at least 1, and let R_1, \dots, R_k be k open regions of \mathbb{R}^d , where $|\mathbf{x} - \mathbf{y}| < 2$ for any \mathbf{x}, \mathbf{y} that lie in the same region R_i . Then the number of linear combinations $\sum_{i=1}^n \varepsilon_i \mathbf{a}_i$, $\varepsilon_i \in \{1, -1\}$, that can lie in the union $\bigcup_i R_i$ of the regions is at most the sum of the k largest binomial coefficients $\binom{n}{j}$. In particular, we get the bound $\binom{n}{\lfloor n/2 \rfloor}$ for $k = 1$.*

Before turning to the proof note that the bound is exact for

$$\mathbf{a}_1 = \dots = \mathbf{a}_n = \mathbf{a} = (1, 0, \dots, 0)^T.$$

Indeed, for even n we obtain $\binom{n}{n/2}$ sums equal to 0, $\binom{n}{n/2-1}$ sums equal to $(-2)\mathbf{a}$, $\binom{n}{n/2+1}$ sums equal to $2\mathbf{a}$, and so on. Choosing balls of radius 1 around

$$-2^{\lceil \frac{k-1}{2} \rceil} \mathbf{a}, \dots, (-2)\mathbf{a}, \mathbf{0}, 2\mathbf{a}, \dots, 2^{\lfloor \frac{k-1}{2} \rfloor} \mathbf{a},$$

we obtain

$$\binom{n}{\lfloor \frac{n-k+1}{2} \rfloor} + \dots + \binom{n}{\frac{n-2}{2}} + \binom{n}{\frac{n}{2}} + \binom{n}{\frac{n+2}{2}} + \dots + \binom{n}{\lfloor \frac{n+k-1}{2} \rfloor}$$

sums lying in these k balls, and this is our promised expression, since the largest binomial coefficients are centered around the middle (see page 14). A similar reasoning works when n is odd.

■ **Proof.** We may assume, without loss of generality, that the regions R_i are disjoint, and will do so from now on. The key to the proof is the recursion of the binomial coefficients, which tells us how the largest binomial coefficients of n and $n-1$ are related. Set $r = \lfloor \frac{n-k+1}{2} \rfloor$, $s = \lfloor \frac{n+k-1}{2} \rfloor$, then $\binom{n}{r}, \binom{n}{r+1}, \dots, \binom{n}{s}$ are the k largest binomial coefficients for n . The recursion $\binom{n}{i} = \binom{n-1}{i} + \binom{n-1}{i-1}$ implies

$$\begin{aligned}
 \sum_{i=r}^s \binom{n}{i} &= \sum_{i=r}^s \binom{n-1}{i} + \sum_{i=r}^s \binom{n-1}{i-1} \\
 &= \sum_{i=r}^s \binom{n-1}{i} + \sum_{i=r-1}^{s-1} \binom{n-1}{i} \quad (1) \\
 &= \sum_{i=r-1}^s \binom{n-1}{i} + \sum_{i=r}^{s-1} \binom{n-1}{i},
 \end{aligned}$$

and an easy calculation shows that the first sum adds the $k + 1$ largest binomial coefficients $\binom{n-1}{i}$, and the second sum the largest $k - 1$.

Kleitman's proof proceeds by induction on n , the case $n = 1$ being trivial. In the light of (1) we need only show for the induction step that the linear combinations of $\mathbf{a}_1, \dots, \mathbf{a}_n$ that lie in k disjoint regions can be mapped *bijectionally* onto combinations of $\mathbf{a}_1, \dots, \mathbf{a}_{n-1}$ that lie in $k + 1$ or $k - 1$ regions.

Claim. *At least one of the translated regions $R_j - \mathbf{a}_n$ is disjoint from all the translated regions $R_1 + \mathbf{a}_n, \dots, R_k + \mathbf{a}_n$.*

To prove this, consider the hyperplane $H = \{x : \langle \mathbf{a}_n, \mathbf{x} \rangle = c\}$ orthogonal to \mathbf{a}_n , which contains all translates $R_i + \mathbf{a}_n$ on the side that is given by $\langle \mathbf{a}_n, \mathbf{x} \rangle \geq c$, and which touches the closure of some region, say $R_j + \mathbf{a}_n$. Such a hyperplane exists since the regions are bounded. Now $|\mathbf{x} - \mathbf{y}| < 2$ holds for any $\mathbf{x} \in R_j$ and \mathbf{y} in the closure of R_j , since R_j is open. We want to show that $R_j - \mathbf{a}_n$ lies on the other side of H . Suppose, on the contrary, that $\langle \mathbf{a}_n, \mathbf{x} - \mathbf{a}_n \rangle \geq c$ for some $\mathbf{x} \in R_j$, that is, $\langle \mathbf{a}_n, \mathbf{x} \rangle \geq |\mathbf{a}_n|^2 + c$.

Let $\mathbf{y} + \mathbf{a}_n$ be a point where H touches $R_j + \mathbf{a}_n$, then \mathbf{y} is in the closure of R_j , and $\langle \mathbf{a}_n, \mathbf{y} + \mathbf{a}_n \rangle = c$, that is, $\langle \mathbf{a}_n, -\mathbf{y} \rangle = |\mathbf{a}_n|^2 - c$. Hence

$$\langle \mathbf{a}_n, \mathbf{x} - \mathbf{y} \rangle \geq 2|\mathbf{a}_n|^2,$$

and we infer from the Cauchy–Schwarz inequality

$$2|\mathbf{a}_n|^2 \leq \langle \mathbf{a}_n, \mathbf{x} - \mathbf{y} \rangle \leq |\mathbf{a}_n| |\mathbf{x} - \mathbf{y}|,$$

and thus (with $|\mathbf{a}_n| \geq 1$) we get $2 \leq 2|\mathbf{a}_n| \leq |\mathbf{x} - \mathbf{y}|$, a contradiction.

The rest is easy. We classify the combinations $\sum \varepsilon_i \mathbf{a}_i$ which come to lie in $R_1 \cup \dots \cup R_k$ as follows. Into Class 1 we put all $\sum_{i=1}^n \varepsilon_i \mathbf{a}_i$ with $\varepsilon_n = -1$ and all $\sum_{i=1}^n \varepsilon_i \mathbf{a}_i$ with $\varepsilon_n = 1$ lying in R_j , and into Class 2 we throw in the remaining combinations $\sum_{i=1}^n \varepsilon_i \mathbf{a}_i$ with $\varepsilon_n = 1$, not in R_j . It follows that the combinations $\sum_{i=1}^n \varepsilon_i \mathbf{a}_i$ corresponding to Class 1 lie in the $k + 1$ disjoint regions $R_1 + \mathbf{a}_n, \dots, R_k + \mathbf{a}_n$ and $R_j - \mathbf{a}_n$, and the combinations $\sum_{i=1}^{n-1} \varepsilon_i \mathbf{a}_i$ corresponding to Class 2 lie in the $k - 1$ disjoint regions $R_1 - \mathbf{a}_n, \dots, R_k - \mathbf{a}_n$ without $R_j - \mathbf{a}_n$. By induction, Class 1 contains at most $\sum_{i=r-1}^s \binom{n-1}{i}$ combinations, while Class 2 contains at most $\sum_{i=r}^{s-1} \binom{n-1}{i}$ combinations — and by (1) this is the whole proof, straight from The Book. \square

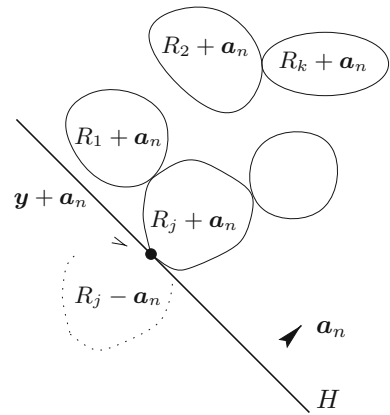

References

- [1] P. ERDŐS: *On a lemma of Littlewood and Offord*, Bulletin Amer. Math. Soc. **51** (1945), 898-902.
- [2] G. KATONA: *On a conjecture of Erdős and a stronger form of Sperner's theorem*, Studia Sci. Math. Hungar. **1** (1966), 59-63.
- [3] D. KLEITMAN: *On a lemma of Littlewood and Offord on the distribution of certain sums*, Math. Zeitschrift **90** (1965), 251-259.
- [4] D. KLEITMAN: *On a lemma of Littlewood and Offord on the distributions of linear combinations of vectors*, Advances Math. **5** (1970), 155-157.
- [5] J. E. LITTLEWOOD & A. C. OFFORD: *On the number of real roots of a random algebraic equation III*, Mat. USSR Sb. **12** (1943), 277-285.



What is the most interesting formula involving elementary functions? In his beautiful article [2], whose exposition we closely follow, Jürgen Elstrodt nominates as a first candidate the partial fraction expansion of the cotangent function:

$$\pi \cot \pi x = \frac{1}{x} + \sum_{n=1}^{\infty} \left(\frac{1}{x+n} + \frac{1}{x-n} \right) \quad (x \in \mathbb{R} \setminus \mathbb{Z}).$$

This elegant formula was proved by Euler in §178 of his *Introductio in Analysin Infinitorum* from 1748 and it certainly counts among his finest achievements. We can also write it even more elegantly as

$$\pi \cot \pi x = \lim_{N \rightarrow \infty} \sum_{n=-N}^N \frac{1}{x+n} \quad (1)$$

but one has to note that the evaluation of the sum $\sum_{n \in \mathbb{Z}} \frac{1}{x+n}$ is a bit dangerous, since the sum is only conditionally convergent, so its value depends on the “right” order of summation.

We shall derive (1) by an argument of stunning simplicity which is attributed to Gustav Herglotz — the “Herglotz trick.” To get started, set

$$f(x) := \pi \cot \pi x, \quad g(x) := \lim_{N \rightarrow \infty} \sum_{n=-N}^N \frac{1}{x+n},$$

and let us try to derive enough common properties of these functions to see in the end that they must coincide . . .

(A) The functions f and g are defined for all non-integral values and are continuous there.

For the cotangent function $f(x) = \pi \cot \pi x = \pi \frac{\cos \pi x}{\sin \pi x}$, this is clear (see the figure). For $g(x)$, we first use the identity $\frac{1}{x+n} + \frac{1}{x-n} = -\frac{2x}{n^2-x^2}$ to rewrite Euler’s formula as

$$\pi \cot \pi x = \frac{1}{x} - \sum_{n=1}^{\infty} \frac{2x}{n^2-x^2}. \quad (2)$$

Thus for **(A)** we have to prove that for every $x \notin \mathbb{Z}$ the series

$$\sum_{n=1}^{\infty} \frac{1}{n^2-x^2}$$

converges uniformly in a neighborhood of x .

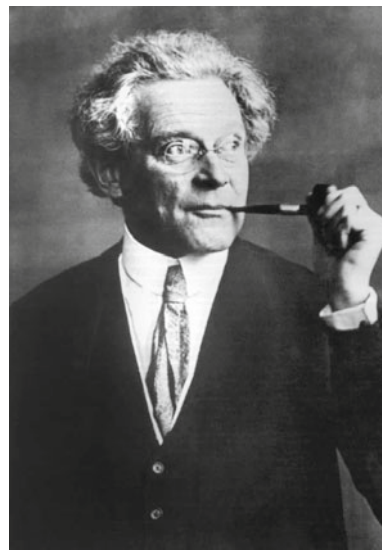

Gustav Herglotz

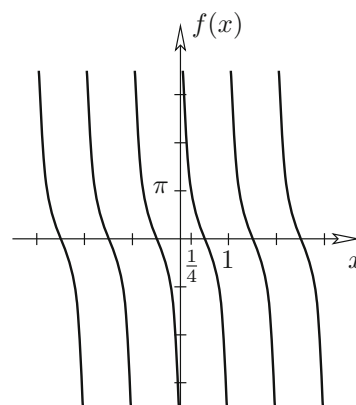

The function $f(x) = \pi \cot \pi x$

For this, we don't get any problem with the first term, for $n = 1$, or with the terms with $2n - 1 \leq x^2$, since there is only a finite number of them. On the other hand, for $n \geq 2$ and $2n - 1 > x^2$, that is $n^2 - x^2 > (n - 1)^2 > 0$, the summands are bounded by

$$0 < \frac{1}{n^2 - x^2} < \frac{1}{(n - 1)^2},$$

and this bound is not only true for x itself, but also for values in a neighborhood of x . Finally the fact that $\sum \frac{1}{(n-1)^2}$ converges (to $\frac{\pi^2}{6}$, see page 55) provides the uniform convergence needed for the proof of **(A)**.

(B) Both f and g are *periodic* of period 1, that is, $f(x + 1) = f(x)$ and $g(x + 1) = g(x)$ hold for all $x \in \mathbb{R} \setminus \mathbb{Z}$.

Since the cotangent has period π , we find that f has period 1 (see again the figure above). For g we argue as follows. Let

$$g_N(x) := \sum_{n=-N}^N \frac{1}{x+n},$$

then

$$\begin{aligned} g_N(x+1) &= \sum_{n=-N}^N \frac{1}{x+1+n} = \sum_{n=-N+1}^{N+1} \frac{1}{x+n} \\ &= g_{N-1}(x) + \frac{1}{x+N} + \frac{1}{x+N+1}. \end{aligned}$$

Hence $g(x+1) = \lim_{N \rightarrow \infty} g_N(x+1) = \lim_{N \rightarrow \infty} g_{N-1}(x) = g(x)$.

(C) Both f and g are *odd* functions, that is, we have $f(-x) = -f(x)$ and $g(-x) = -g(x)$ for all $x \in \mathbb{R} \setminus \mathbb{Z}$.

The function f obviously has this property, and for g we just have to observe that $g_N(-x) = -g_N(x)$.

The final two facts constitute the Herglotz trick: First we show that f and g satisfy the same functional equation, and secondly that $h := f - g$ can be continuously extended to all of \mathbb{R} .

(D) The two functions f and g satisfy the same functional equation: $f(\frac{x}{2}) + f(\frac{x+1}{2}) = 2f(x)$ and $g(\frac{x}{2}) + g(\frac{x+1}{2}) = 2g(x)$.

For $f(x)$ this results from the addition theorems for the sine and cosine functions:

Addition theorems:

$$\sin(x+y) = \sin x \cos y + \cos x \sin y$$

$$\cos(x+y) = \cos x \cos y - \sin x \sin y$$

$$\implies \sin(x + \frac{\pi}{2}) = \cos x$$

$$\cos(x + \frac{\pi}{2}) = -\sin x$$

$$\sin x = 2 \sin \frac{x}{2} \cos \frac{x}{2}$$

$$\cos x = \cos^2 \frac{x}{2} - \sin^2 \frac{x}{2}.$$

$$\begin{aligned} f(\frac{x}{2}) + f(\frac{x+1}{2}) &= \pi \left[\frac{\cos \frac{\pi x}{2}}{\sin \frac{\pi x}{2}} - \frac{\sin \frac{\pi x}{2}}{\cos \frac{\pi x}{2}} \right] \\ &= 2\pi \frac{\cos(\frac{\pi x}{2} + \frac{\pi x}{2})}{\sin(\frac{\pi x}{2} + \frac{\pi x}{2})} = 2f(x). \end{aligned}$$

The functional equation for g follows from

$$g_N\left(\frac{x}{2}\right) + g_N\left(\frac{x+1}{2}\right) = 2g_{2N}(x) + \frac{2}{x + 2N + 1}.$$

which in turn follows from

$$\frac{1}{\frac{x}{2} + n} + \frac{1}{\frac{x+1}{2} + n} = 2\left(\frac{1}{x + 2n} + \frac{1}{x + 2n + 1}\right).$$

Now let us look at

$$h(x) = f(x) - g(x) = \pi \cot \pi x - \left(\frac{1}{x} - \sum_{n=1}^{\infty} \frac{2x}{n^2 - x^2}\right). \quad (3)$$

We know by now that h is a continuous function on $\mathbb{R} \setminus \mathbb{Z}$ that satisfies the properties **(B)**, **(C)**, **(D)**. What happens at the integral values? From the sine and cosine series expansions, or by applying de l'Hospital's rule twice, we find

$$\lim_{x \rightarrow 0} \left(\cot x - \frac{1}{x}\right) = \lim_{x \rightarrow 0} \frac{x \cos x - \sin x}{x \sin x} = 0,$$

$$\begin{aligned} \cos x &= 1 - \frac{x^2}{2!} + \frac{x^4}{4!} - \frac{x^6}{6!} \pm \dots \\ \sin x &= x - \frac{x^3}{3!} + \frac{x^5}{5!} - \frac{x^7}{7!} \pm \dots \end{aligned}$$

and hence also

$$\lim_{x \rightarrow 0} \left(\pi \cot \pi x - \frac{1}{x}\right) = 0.$$

But since the last sum $\sum_{n=1}^{\infty} \frac{2x}{n^2 - x^2}$ in (3) converges to 0 with $x \rightarrow 0$, we have in fact $\lim_{x \rightarrow 0} h(x) = 0$, and thus by periodicity

$$\lim_{x \rightarrow n} h(x) = 0 \quad \text{for all } n \in \mathbb{Z}.$$

In summary, we have shown the following:

(E) By setting $h(x) := 0$ for $x \in \mathbb{Z}$, h becomes a continuous function on all of \mathbb{R} that shares the properties given in **(B)**, **(C)** and **(D)**.

We are ready for the *coup de grâce*. Since h is a periodic continuous function, it possesses a maximum m . Let x_0 be a point in $[0, 1]$ with $h(x_0) = m$. It follows from **(D)** that

$$h\left(\frac{x_0}{2}\right) + h\left(\frac{x_0+1}{2}\right) = 2m,$$

and hence that $h\left(\frac{x_0}{2}\right) = m$. Iteration gives $h\left(\frac{x_0}{2^n}\right) = m$ for all n , and hence $h(0) = m$ by continuity. But $h(0) = 0$, and so $m = 0$, that is, $h(x) \leq 0$ for all $x \in \mathbb{R}$. As $h(x)$ is an *odd* function, $h(x) < 0$ is impossible, hence $h(x) = 0$ for all $x \in \mathbb{R}$, and Euler's theorem is proved. \square

A great many corollaries can be derived from (1), the most famous of which concerns the values of Riemann's zeta function at even positive integers (see the appendix to Chapter 9),

$$\zeta(2k) = \sum_{n=1}^{\infty} \frac{1}{n^{2k}} \quad (k \in \mathbb{N}). \quad (4)$$

So to finish our story let us see how Euler — a few years later, in 1755 — treated the series (4). We start with formula (2). Multiplying (2) by x and setting $y = \pi x$ we find for $|y| < \pi$:

$$\begin{aligned} y \cot y &= 1 - 2 \sum_{n=1}^{\infty} \frac{y^2}{\pi^2 n^2 - y^2} \\ &= 1 - 2 \sum_{n=1}^{\infty} \frac{y^2}{\pi^2 n^2} \frac{1}{1 - \left(\frac{y}{\pi n}\right)^2}. \end{aligned}$$

The last factor is the sum of a geometric series, hence

$$\begin{aligned} y \cot y &= 1 - 2 \sum_{n=1}^{\infty} \sum_{k=1}^{\infty} \left(\frac{y}{\pi n}\right)^{2k} \\ &= 1 - 2 \sum_{k=1}^{\infty} \left(\frac{1}{\pi^{2k}} \sum_{n=1}^{\infty} \frac{1}{n^{2k}}\right) y^{2k}, \end{aligned}$$

and we have proved the remarkable result:

For all $k \in \mathbb{N}$, the coefficient of y^{2k} in the power series expansion of $y \cot y$ equals

$$[y^{2k}] y \cot y = -\frac{2}{\pi^{2k}} \sum_{n=1}^{\infty} \frac{1}{n^{2k}} = -\frac{2}{\pi^{2k}} \zeta(2k). \quad (5)$$

There is another, perhaps much more “canonical,” way to obtain a series expansion of $y \cot y$. We know from analysis that $e^{iy} = \cos y + i \sin y$, and thus

$$\cos y = \frac{e^{iy} + e^{-iy}}{2}, \quad \sin y = \frac{e^{iy} - e^{-iy}}{2i},$$

which yields

$$y \cot y = iy \frac{e^{iy} + e^{-iy}}{e^{iy} - e^{-iy}} = iy \frac{e^{2iy} + 1}{e^{2iy} - 1}.$$

We now substitute $z = 2iy$, and get

$$y \cot y = \frac{z}{2} \frac{e^z + 1}{e^z - 1} = \frac{z}{2} + \frac{z}{e^z - 1}. \quad (6)$$

Thus all we need is a power series expansion of the function $\frac{z}{e^z - 1}$; note that this function is defined and continuous on all of \mathbb{R} (for $z = 0$ use the power series of the exponential function, or alternatively de l’Hospital’s rule, which yields the value 1). We write

$$\frac{z}{e^z - 1} =: \sum_{n \geq 0} B_n \frac{z^n}{n!}. \quad (7)$$

The coefficients B_n are known as the *Bernoulli numbers*. The left-hand side of (6) is an *even* function (that is, $f(z) = f(-z)$), and thus we see that $B_n = 0$ for odd $n \geq 3$, while $B_1 = -\frac{1}{2}$ corresponds to the term of $\frac{z}{2}$ in (6).

From

$$\left(\sum_{n \geq 0} B_n \frac{z^n}{n!}\right)(e^z - 1) = \left(\sum_{n \geq 0} B_n \frac{z^n}{n!}\right)\left(\sum_{n \geq 1} \frac{z^n}{n!}\right) = z$$

we obtain by comparing coefficients for z^n :

$$\sum_{k=0}^{n-1} \frac{B_k}{k!(n-k)!} = \begin{cases} 1 & \text{for } n = 1, \\ 0 & \text{for } n \neq 1. \end{cases} \tag{8}$$

We may compute the Bernoulli numbers recursively from (8). The value $n = 1$ gives $B_0 = 1$, $n = 2$ yields $\frac{B_0}{2} + B_1 = 0$, that is $B_1 = -\frac{1}{2}$, and so on.

Now we are almost done: The combination of (6) and (7) yields

$$y \cot y = \sum_{k=0}^{\infty} B_{2k} \frac{(2iy)^{2k}}{(2k)!} = \sum_{k=0}^{\infty} \frac{(-1)^k 2^{2k} B_{2k}}{(2k)!} y^{2k},$$

and out comes, with (5), Euler’s formula for $\zeta(2k)$:

$$\sum_{n=1}^{\infty} \frac{1}{n^{2k}} = \frac{(-1)^{k-1} 2^{2k-1} B_{2k}}{(2k)!} \pi^{2k} \quad (k \in \mathbb{N}). \tag{9}$$

Looking at our table of the Bernoulli numbers, we thus obtain once again the sum $\sum \frac{1}{n^2} = \frac{\pi^2}{6}$ from Chapter 9, and further

$$\sum_{n=1}^{\infty} \frac{1}{n^4} = \frac{\pi^4}{90}, \quad \sum_{n=1}^{\infty} \frac{1}{n^6} = \frac{\pi^6}{945}, \quad \sum_{n=1}^{\infty} \frac{1}{n^8} = \frac{\pi^8}{9450},$$

$$\sum_{n=1}^{\infty} \frac{1}{n^{10}} = \frac{\pi^{10}}{93555}, \quad \sum_{n=1}^{\infty} \frac{1}{n^{12}} = \frac{691 \pi^{12}}{638512875}, \quad \dots$$

The Bernoulli number $B_{10} = \frac{5}{66}$ that gets us $\zeta(10)$ looks innocuous enough, but the next value $B_{12} = -\frac{691}{2730}$, needed for $\zeta(12)$, contains the large prime factor 691 in the numerator. Euler had first computed some values $\zeta(2k)$ without noticing the connection to the Bernoulli numbers. Only the appearance of the strange prime 691 put him on the right track.

Incidentally, since $\zeta(2k)$ converges to 1 for $k \rightarrow \infty$, equation (9) tells us that the numbers $|B_{2k}|$ grow very fast — something that is not clear from the first few values.

In contrast to all this, one knows very little about the values of the Riemann zeta function at the odd integers $k \geq 3$; see page 64.

n	0	1	2	3	4	5	6	7	8
B_n	1	$-\frac{1}{2}$	$\frac{1}{6}$	0	$-\frac{1}{30}$	0	$\frac{1}{42}$	0	$-\frac{1}{30}$

The first few Bernoulli numbers

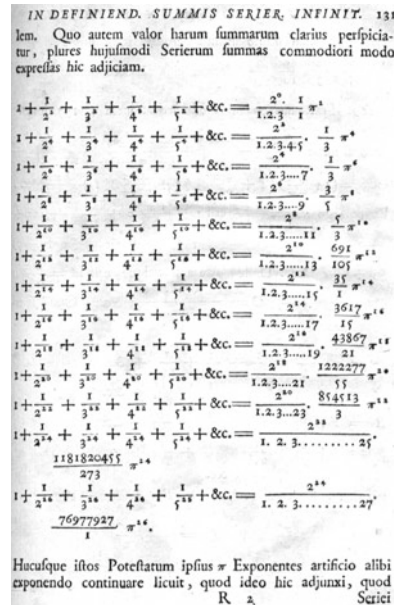

Page 131 of Euler’s 1748 “Introductio in Analysin Infinitorum”

References

- [1] S. BOCHNER: *Book review of "Gesammelte Schriften" by Gustav Herglotz*, Bulletin Amer. Math. Soc. **1** (1979), 1020-1022.
- [2] J. ELSTRODT: *Partialbruchzerlegung des Kotangens, Herglotz-Trick und die Weierstraßsche stetige, nirgends differenzierbare Funktion*, Math. Semesterberichte **45** (1998), 207-220.
- [3] L. EULER: *Introductio in Analysin Infinitorum*, Tomus Primus, Lausanne 1748; Opera Omnia, Ser. 1, Vol. 8. In English: *Introduction to Analysis of the Infinite*, Book I (translated by J. D. Blanton), Springer-Verlag, New York 1988.
- [4] L. EULER: *Institutiones calculi differentialis cum ejus usu in analysi finitorum ac doctrina serierum*, Petersburg 1755; Opera Omnia, Ser. 1, Vol. 10.

Buffon's needle problem

Chapter 27



A French nobleman, Georges Louis Leclerc, Comte de Buffon, posed the following problem in 1777:

Suppose that you drop a short needle on ruled paper — what is then the probability that the needle comes to lie in a position where it crosses one of the lines?

The probability depends on the distance d between the lines of the ruled paper, and it depends on the length ℓ of the needle that we drop — or rather it depends only on the ratio $\frac{\ell}{d}$. A *short* needle for our purpose is one of length $\ell \leq d$. In other words, a short needle is one that cannot cross two lines at the same time (and will come to touch two lines only with probability zero). The answer to Buffon's problem may come as a surprise: It involves the number π .

Theorem (“Buffon's needle problem”)

If a short needle, of length ℓ , is dropped on paper that is ruled with equally spaced lines of distance $d \geq \ell$, then the probability that the needle comes to lie in a position where it crosses one of the lines is exactly

$$p = \frac{2\ell}{\pi d}.$$

The result means that from an experiment one can get approximate values for π : If you drop a needle N times, and get a positive answer (an intersection) in P cases, then $\frac{P}{N}$ should be approximately $\frac{2\ell}{\pi d}$, that is, π should be approximated by $\frac{2\ell N}{dP}$. The most extensive (and exhaustive) test was perhaps done by Lazzarini in 1901, who allegedly even built a machine in order to drop a stick 3408 times (with $\frac{\ell}{d} = \frac{5}{6}$). He found that it came to cross a line 1808 times, which yields the approximation $\pi \approx 2 \cdot \frac{5}{6} \frac{3408}{1808} = 3.1415929\dots$, which is correct to six digits of π , and much too good to be true! (The values that Lazzarini chose lead directly to the well-known approximation $\pi \approx \frac{355}{113}$; see page 51. This explains the more than suspicious choices of 3408 and $\frac{5}{6}$, where $\frac{5}{6} \cdot 3408$ is a multiple of 355. See [5] for a discussion of Lazzarini's hoax.)

The needle problem can be solved by evaluating an integral. We will do that below, and by this method we will also solve the problem for a long needle. But the Book Proof, presented by E. Barbier in 1860, needs no integrals. It just drops a different needle . . .



Le Comte de Buffon

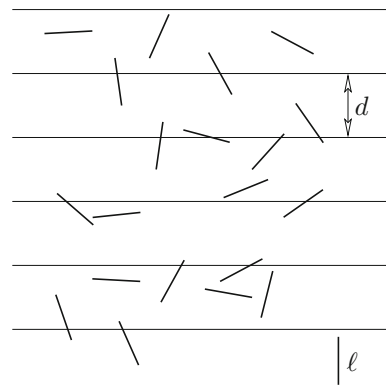

If you drop *any* needle, short or long, then the expected number of crossings will be

$$E = p_1 + 2p_2 + 3p_3 + \cdots,$$

where p_1 is the probability that the needle will come to lie with exactly one crossing, p_2 is the probability that we get exactly two crossings, p_3 is the probability for three crossings, etc. The probability that we get at least one crossing, which Buffon's problem asks for, is thus

$$p = p_1 + p_2 + p_3 + \cdots$$

(Events where the needle comes to lie exactly on a line, or with an endpoint on one of the lines, have probability zero — so they can be ignored throughout our discussion.)

On the other hand, if the needle is *short* then the probability of more than one crossing is zero, $p_2 = p_3 = \cdots = 0$, and thus we get $E = p$: The probability that we are looking for is just the expected number of crossings. This reformulation is extremely useful, because now we can use linearity of expectation (cf. page 116). Indeed, let us write $E(\ell)$ for the expected number of crossings that will be produced by dropping a straight needle of length ℓ . If this length is $\ell = x + y$, and we consider the “front part” of length x and the “back part” of length y of the needle separately, then we get

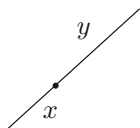

$$E(x + y) = E(x) + E(y),$$

since the crossings produced are always just those produced by the front part, plus those of the back part.

By induction on n this “functional equation” implies that $E(nx) = nE(x)$ for all $n \in \mathbb{N}$, and then that $mE(\frac{n}{m}x) = E(m\frac{n}{m}x) = E(nx) = nE(x)$, so that $E(rx) = rE(x)$ holds for all *rational* $r \in \mathbb{Q}$. Furthermore, $E(x)$ is clearly monotone in $x \geq 0$, from which we get that $E(x) = cx$ for all $x \geq 0$, where $c = E(1)$ is some constant.

But what is the constant?



For that we use needles of different shape. Indeed, let's drop a “polygonal” needle of total length ℓ , which consists of straight pieces. Then the number of crossings it produces is (with probability 1) the sum of the numbers of crossings produced by its straight pieces. Hence, the expected number of crossings is again

$$E = c\ell,$$

by linearity of expectation. (For that it is not even important whether the straight pieces are joined together in a rigid or in a flexible way!)

The key to Barbier's solution of Buffon's needle problem is to consider a needle that is a perfect circle C of diameter d , which has length $x = d\pi$. Such a needle, if dropped onto ruled paper, produces exactly two intersections, always!

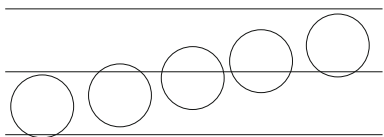

The circle can be approximated by polygons. Just imagine that together with the circular needle C we are dropping an inscribed polygon P_n , as well as a circumscribed polygon P^n . Every line that intersects P_n will also intersect C , and if a line intersects C then it also hits P^n . Thus the expected numbers of intersections satisfy

$$E(P_n) \leq E(C) \leq E(P^n).$$

Now both P_n and P^n are polygons, so the number of crossings that we may expect is “ c times length” for both of them, while for C it is 2, whence

$$c \ell(P_n) \leq 2 \leq c \ell(P^n). \tag{1}$$

Both P_n and P^n approximate C for $n \rightarrow \infty$. In particular,

$$\lim_{n \rightarrow \infty} \ell(P_n) = d\pi = \lim_{n \rightarrow \infty} \ell(P^n),$$

and thus for $n \rightarrow \infty$ we infer from (1) that

$$c d\pi \leq 2 \leq c d\pi,$$

which gives $c = \frac{2}{\pi} \frac{1}{d}$. □

But we *could* also have done it by calculus! The trick to obtain an “easy” integral is to first consider the slope of the needle; let’s say it drops to lie with an angle of α away from horizontal, where α will be in the range $0 \leq \alpha \leq \frac{\pi}{2}$. (We will ignore the case where the needle comes to lie with negative slope, since that case is symmetric to the case of positive slope, and produces the same probability.) A needle that lies with angle α has height $\ell \sin \alpha$, and the probability that such a needle crosses one of the horizontal lines of distance d is $\frac{\ell \sin \alpha}{d}$. Thus we get the probability by averaging over the possible angles α , as

$$p = \frac{2}{\pi} \int_0^{\pi/2} \frac{\ell \sin \alpha}{d} d\alpha = \frac{2}{\pi} \frac{\ell}{d} [-\cos \alpha]_0^{\pi/2} = \frac{2}{\pi} \frac{\ell}{d}.$$

For a long needle, we get the same probability $\frac{\ell \sin \alpha}{d}$ as long as $\ell \sin \alpha \leq d$, that is, in the range $0 \leq \alpha \leq \arcsin \frac{d}{\ell}$. However, for larger angles α the needle *must* cross a line, so the probability is 1. Hence we compute

$$\begin{aligned} p &= \frac{2}{\pi} \left(\int_0^{\arcsin(d/\ell)} \frac{\ell \sin \alpha}{d} d\alpha + \int_{\arcsin(d/\ell)}^{\pi/2} 1 d\alpha \right) \\ &= \frac{2}{\pi} \left(\frac{\ell}{d} [-\cos \alpha]_0^{\arcsin(d/\ell)} + \left(\frac{\pi}{2} - \arcsin \frac{d}{\ell} \right) \right) \\ &= 1 + \frac{2}{\pi} \left(\frac{\ell}{d} \left(1 - \sqrt{1 - \frac{d^2}{\ell^2}} \right) - \arcsin \frac{d}{\ell} \right) \end{aligned}$$

for $\ell \geq d$.

So the answer isn’t that pretty for a longer needle, but it provides us with a nice exercise: Show (“just for safety”) that the formula yields $\frac{2}{\pi}$ for $\ell = d$, that it is strictly increasing in ℓ , and that it tends to 1 for $\ell \rightarrow \infty$.

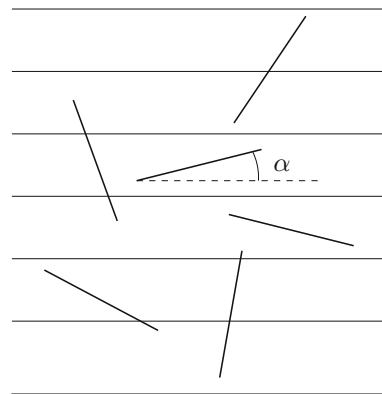
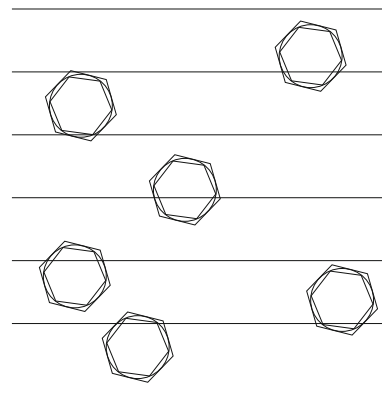
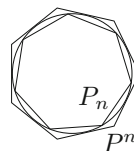

References

- [1] E. BARBIER: *Note sur le problème de l'aiguille et le jeu du joint couvert*, J. Mathématiques Pures et Appliquées (2) **5** (1860), 273-286.
- [2] L. BERGGREN, J. BORWEIN & P. BORWEIN, EDs.: *Pi: A Source Book*, Springer-Verlag, New York 1997.
- [3] G. L. LECLERC, COMTE DE BUFFON: *Essai d'arithmétique morale*, Appendix to "Histoire naturelle générale et particulière," Vol. 4, 1777.
- [4] D. A. KLAIN & G.-C. ROTA: *Introduction to Geometric Probability*, "Lezioni Lincee," Cambridge University Press 1997.
- [5] T. H. O'BEIRNE: *Puzzles and Paradoxes*, Oxford University Press, London 1965.



"Got a problem?"

Combinatorics



- 28**
Pigeon-hole and double counting 195
- 29**
Tiling rectangles 207
- 30**
Three famous theorems on finite sets 213
- 31**
Shuffling cards 219
- 32**
Lattice paths and determinants 229
- 33**
Cayley's formula for the number of trees 235
- 34**
Identities versus bijections 241
- 35**
The finite Kakeya problem 247
- 36**
Completing Latin squares 253

"A melancholic Latin square"



Some mathematical principles, such as the two in the title of this chapter, are so obvious that you might think they would only produce equally obvious results. To convince you that “It ain’t necessarily so” we illustrate them with examples that were suggested by Paul Erdős to be included in *The Book*. We will encounter instances of them also in later chapters.

Pigeon-hole principle

If n objects are placed in r boxes, where $r < n$, then at least one of the boxes contains more than one object.

Well, this is indeed obvious, there is nothing to prove. In the language of mappings our principle reads as follows: Let N and R be two finite sets with

$$|N| = n > r = |R|,$$

and let $f : N \rightarrow R$ be a mapping. Then there exists some $a \in R$ with $|f^{-1}(a)| \geq 2$. We may even state a stronger inequality: There exists some $a \in R$ with

$$|f^{-1}(a)| \geq \left\lceil \frac{n}{r} \right\rceil. \quad (1)$$

In fact, otherwise we would have $|f^{-1}(a)| < \frac{n}{r}$ for all a , and hence $n = \sum_{a \in R} |f^{-1}(a)| < r \frac{n}{r} = n$, which cannot be.

1. Numbers

Claim. *Consider the numbers $1, 2, 3, \dots, 2n$, and take any $n + 1$ of them. Then there are two among these $n + 1$ numbers which are relatively prime.*

This is again obvious. There must be two numbers which are only 1 apart, and hence relatively prime.

But let us now turn the condition around.

Claim. *Suppose again $A \subseteq \{1, 2, \dots, 2n\}$ with $|A| = n + 1$. Then there are always two numbers in A such that one divides the other.*



“The pigeon-holes from a bird’s perspective”

Both results are no longer true if one replaces $n+1$ by n : For this consider the sets $\{2, 4, 6, \dots, 2n\}$, respectively $\{n+1, n+2, \dots, 2n\}$.

This is not so clear. As Erdős told us, he put this question to young Lajos Pósa during dinner, and when the meal was over, Lajos had the answer. It has remained one of Erdős' favorite "initiation" questions to mathematics. The (affirmative) solution is provided by the pigeon-hole principle. Write every number $a \in A$ in the form $a = 2^k m$, where m is an odd number between 1 and $2n - 1$. Since there are $n + 1$ numbers in A , but only n different odd parts, there must be two numbers in A with the *same* odd part. Hence one is a multiple of the other. \square

2. Sequences

Here is another one of Erdős' favorites, contained in a paper of Erdős and Szekeres on Ramsey problems.

Claim. *In any sequence $a_1, a_2, \dots, a_{mn+1}$ of $mn+1$ distinct real numbers, there exists an increasing subsequence*

$$a_{i_1} < a_{i_2} < \dots < a_{i_{m+1}} \quad (i_1 < i_2 < \dots < i_{m+1})$$

of length $m + 1$, or a decreasing subsequence

$$a_{j_1} > a_{j_2} > \dots > a_{j_{n+1}} \quad (j_1 < j_2 < \dots < j_{n+1})$$

of length $n + 1$, or both.

This time the application of the pigeon-hole principle is not immediate. Associate to each a_i the number t_i which is the length of a *longest increasing* subsequence starting at a_i . If $t_i \geq m + 1$ for some i , then we have an increasing subsequence of length $m + 1$. Suppose then that $t_i \leq m$ for all i . The function $f : a_i \mapsto t_i$ mapping $\{a_1, \dots, a_{mn+1}\}$ to $\{1, \dots, m\}$ tells us by (1) that there is some $s \in \{1, \dots, m\}$ such that $f(a_i) = s$ for $\frac{mn}{m} + 1 = n + 1$ numbers a_i . Let $a_{j_1}, a_{j_2}, \dots, a_{j_{n+1}}$ ($j_1 < \dots < j_{n+1}$) be these numbers. Now look at two consecutive numbers $a_{j_i}, a_{j_{i+1}}$. If $a_{j_i} < a_{j_{i+1}}$, then we would obtain an increasing subsequence of length s starting at $a_{j_{i+1}}$, and consequently an increasing subsequence of length $s + 1$ starting at a_{j_i} , which cannot be since $f(a_{j_i}) = s$. We thus obtain a decreasing subsequence $a_{j_1} > a_{j_2} > \dots > a_{j_{n+1}}$ of length $n + 1$. \square

The reader may have fun in proving that for mn numbers the statement remains no longer true in general.

This simple-sounding result on monotone subsequences has a highly nonobvious consequence on the *dimension of graphs*. We don't need here the notion of dimension for general graphs, but only for complete graphs K_n . It can be phrased in the following way. Let $N = \{1, \dots, n\}$, $n \geq 3$, and consider m permutations π_1, \dots, π_m of N . We say that the permutations π_i *represent* K_n if to every three distinct numbers i, j, k there exists a permutation π in which k comes *after* both i and j . The dimension of K_n is then the smallest m for which a representation π_1, \dots, π_m exists.

As an example we have $\dim(K_3) = 3$ since any one of the three numbers must come last, as in $\pi_1 = (1, 2, 3)$, $\pi_2 = (2, 3, 1)$, $\pi_3 = (3, 1, 2)$. What

about K_4 ? Note first $\dim(K_n) \leq \dim(K_{n+1})$: just delete $n + 1$ in a representation of K_{n+1} . So, $\dim(K_4) \geq 3$, and, in fact, $\dim(K_4) = 3$, by taking

$$\pi_1 = (1, 2, 3, 4), \quad \pi_2 = (2, 4, 3, 1), \quad \pi_3 = (1, 4, 3, 2).$$

It is not quite so easy to prove $\dim(K_5) = 4$, but then, surprisingly, the dimension stays at 4 up to $n = 12$, while $\dim(K_{13}) = 5$. So $\dim(K_n)$ seems to be a pretty wild function. Well, it is not! With n going to infinity, $\dim(K_n)$ is, in fact, a very well-behaved function — and the key for finding a lower bound is the pigeon-hole principle. We claim

$$\dim(K_n) \geq \log_2 \log_2 n. \quad (2)$$

Since, as we have seen, $\dim(K_n)$ is a monotone function in n , it suffices to verify (2) for $n = 2^{2^p} + 1$, that is, we have to show that

$$\dim(K_n) \geq p + 1 \quad \text{for } n = 2^{2^p} + 1.$$

Suppose, on the contrary, $\dim(K_n) \leq p$, and let π_1, \dots, π_p be representing permutations of $N = \{1, 2, \dots, 2^{2^p} + 1\}$. Now we use our result on monotone subsequences p times. In π_1 there exists a monotone subsequence A_1 of length $2^{2^{p-1}} + 1$ (it does not matter whether increasing or decreasing). Look at this set A_1 in π_2 . Using our result again, we find a monotone subsequence A_2 of A_1 in π_2 of length $2^{2^{p-2}} + 1$, and A_2 is, of course, also monotone in π_1 . Continuing, we eventually find a subsequence A_p of size $2^{2^0} + 1 = 3$ which is monotone in *all* permutations π_i . Let $A_p = (a, b, c)$, then either $a < b < c$ or $a > b > c$ in *all* π_i . But this cannot be, since there must be a permutation where b comes after a and c . \square

The right asymptotic growth was provided by Joel Spencer (upper bound) and by Füredi, Hajnal, Rödl and Trotter (lower bound):

$$\dim(K_n) = \log_2 \log_2 n + \left(\frac{1}{2} + o(1)\right) \log_2 \log_2 \log_2 n.$$

But this is not the whole story: In 1999, Morris and Hoşten found a method which, in principle, establishes the *precise* value of $\dim(K_n)$. Using their result and a computer one can obtain the values given in the margin. This is truly astounding! Just consider how many permutations of size 1422564 there are. How does one decide whether 7 or 8 of them are required to represent $K_{1422564}$?

$$\begin{aligned} \pi_1: & 1 \ 2 \ 3 \ 5 \ 6 \ 7 \ 8 \ 9 \ 10 \ 11 \ 12 \ 4 \\ \pi_2: & 2 \ 3 \ 4 \ 8 \ 7 \ 6 \ 5 \ 12 \ 11 \ 10 \ 9 \ 1 \\ \pi_3: & 3 \ 4 \ 1 \ 11 \ 12 \ 9 \ 10 \ 6 \ 5 \ 8 \ 7 \ 2 \\ \pi_4: & 4 \ 1 \ 2 \ 10 \ 9 \ 12 \ 11 \ 7 \ 8 \ 5 \ 6 \ 3 \end{aligned}$$

These four permutations represent K_{12}

$$\begin{aligned} \dim(K_n) \leq 4 & \iff n \leq 12 \\ \dim(K_n) \leq 5 & \iff n \leq 81 \\ \dim(K_n) \leq 6 & \iff n \leq 2646 \\ \dim(K_n) \leq 7 & \iff n \leq 1422564 \end{aligned}$$

3. Sums

Paul Erdős attributes the following nice application of the pigeon-hole principle to Andrew Vázsonyi and Marta Sved:

Claim. *Suppose we are given n integers a_1, \dots, a_n , which need not be distinct. Then there is always a set of consecutive numbers $a_{k+1}, a_{k+2}, \dots, a_\ell$ whose sum $\sum_{i=k+1}^\ell a_i$ is a multiple of n .*

For the proof we set $N = \{0, 1, \dots, n\}$ and $R = \{0, 1, \dots, n-1\}$. Consider the map $f : N \rightarrow R$, where $f(m)$ is the remainder of $a_1 + \dots + a_m$ upon division by n . Since $|N| = n+1 > n = |R|$, it follows that there are two sums $a_1 + \dots + a_k$, $a_1 + \dots + a_\ell$ ($k < \ell$) with the *same* remainder, where the first sum may be the empty sum denoted by 0. It follows that

$$\sum_{i=k+1}^{\ell} a_i = \sum_{i=1}^{\ell} a_i - \sum_{i=1}^k a_i$$

has remainder 0 — end of proof. \square

Let us turn to the second principle: counting in two ways. By this we mean the following.

Double counting

Suppose that we are given two finite sets R and C and a subset $S \subseteq R \times C$. Whenever $(p, q) \in S$, then we say p and q are incident. If r_p denotes the number of elements that are incident to $p \in R$, and c_q denotes the number of elements that are incident to $q \in C$, then

$$\sum_{p \in R} r_p = |S| = \sum_{q \in C} c_q. \quad (3)$$

Again, there is nothing to prove. The first sum classifies the pairs in S according to the first entry, while the second sum classifies the same pairs according to the second entry.

There is a useful way to picture the set S . Consider the matrix $A = (a_{pq})$, the *incidence matrix* of S , where the rows and columns of A are indexed by the elements of R and C , respectively, with

$$a_{pq} = \begin{cases} 1 & \text{if } (p, q) \in S \\ 0 & \text{if } (p, q) \notin S. \end{cases}$$

With this set-up, r_p is the sum of the p -th row of A and c_q is the sum of the q -th column. Hence the first sum in (3) adds the entries of A (that is, counts the elements in S) by rows, and the second sum by columns.

The following example should make this correspondence clear. Let $R = C = \{1, 2, \dots, 8\}$, and set $S = \{(i, j) : i \text{ divides } j\}$. We then obtain the matrix in the margin, which only displays the 1's.

$R \setminus C$	1	2	3	4	5	6	7	8
1	1	1	1	1	1	1	1	1
2		1		1		1		1
3			1			1		
4				1				1
5					1			
6						1		
7							1	
8								1

4. Numbers again

Look at the table on the left. The number of 1's in column j is precisely the number of divisors of j ; let us denote this number by $t(j)$. Let us ask how

large this number $t(j)$ is on the *average* when j ranges from 1 to n . Thus, we ask for the quantity

$$\bar{t}(n) = \frac{1}{n} \sum_{j=1}^n t(j).$$

n	1	2	3	4	5	6	7	8
$\bar{t}(n)$	1	$\frac{3}{2}$	$\frac{5}{3}$	2	2	$\frac{7}{3}$	$\frac{16}{7}$	$\frac{5}{2}$

The first few values of $\bar{t}(n)$

How large is $\bar{t}(n)$ for arbitrary n ? At first glance, this seems hopeless. For prime numbers p we have $t(p) = 2$, while for 2^k we obtain a large number $t(2^k) = k + 1$. So, $t(n)$ is a wildly jumping function, and we surmise that the same is true for $\bar{t}(n)$. Wrong guess, the opposite is true! Counting in two ways provides an unexpected and simple answer.

Consider the matrix A (as above) for the integers 1 up to n . Counting by columns we get $\sum_{j=1}^n t(j)$. How many 1's are in row i ? Easy enough, the 1's correspond to the multiples of i : $1i, 2i, \dots$, and the last multiple not exceeding n is $\lfloor \frac{n}{i} \rfloor i$. Hence we obtain

$$\bar{t}(n) = \frac{1}{n} \sum_{j=1}^n t(j) = \frac{1}{n} \sum_{i=1}^n \lfloor \frac{n}{i} \rfloor \leq \frac{1}{n} \sum_{i=1}^n \frac{n}{i} = \sum_{i=1}^n \frac{1}{i},$$

where the error in each summand, when passing from $\lfloor \frac{n}{i} \rfloor$ to $\frac{n}{i}$, is less than 1. Now the last sum is the n -th harmonic number H_n , so we obtain $H_n - 1 < \bar{t}(n) \leq H_n$, and together with the estimates of H_n on page 13 this gives

$$\log n - 1 < H_n - 1 - \frac{1}{n} < \bar{t}(n) \leq H_n < \log n + 1.$$

Thus we have proved the remarkable result that, while $t(n)$ is totally erratic, the average $\bar{t}(n)$ behaves beautifully: It differs from $\log n$ by less than 1.

5. Graphs

Let G be a finite simple graph with vertex set V and edge set E . We have defined in Chapter 13 the *degree* $d(v)$ of a vertex v as the number of edges which have v as an end-vertex. In the example of the figure, the vertices 1, 2, ..., 7 have degrees 3, 2, 4, 3, 3, 2, 3, respectively.

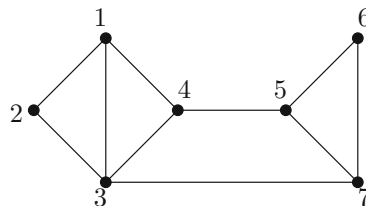

Almost every book in graph theory starts with the following result (that we have already encountered in Chapters 13 and 20):

$$\sum_{v \in V} d(v) = 2|E|. \tag{4}$$

For the proof consider $S \subseteq V \times E$, where S is the set of pairs (v, e) such that $v \in V$ is an end-vertex of $e \in E$. Counting S in two ways gives on the one hand $\sum_{v \in V} d(v)$, since every vertex contributes $d(v)$ to the count, and on the other hand $2|E|$, since every edge has two ends. \square

As simple as the result (4) appears, it has many important consequences, some of which will be discussed as we go along. We want to single out in

this section the following beautiful application to an *extremal problem* on graphs. Here is the problem:

Suppose $G = (V, E)$ has n vertices and contains no cycle of length 4 (denoted by C_4), that is, no subgraph . How many edges can G have at most?

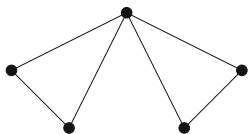

As an example, the graph in the margin on 5 vertices contains no 4-cycle and has 6 edges. The reader may easily show that on 5 vertices the maximal number of edges is 6, and that this graph is indeed the only graph on 5 vertices with 6 edges that has no 4-cycle.

Let us tackle the general problem. Let G be a graph on n vertices without a 4-cycle. As above we denote by $d(u)$ the degree of u . Now we count the following set S in two ways: S is the set of pairs $(u, \{v, w\})$ where u is adjacent to v and to w , with $v \neq w$. In other words, we count all occurrences of

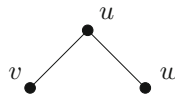

Summing over u , we find $|S| = \sum_{u \in V} \binom{d(u)}{2}$. On the other hand, every pair $\{v, w\}$ has at most one common neighbor (by the C_4 -condition). Hence $|S| \leq \binom{n}{2}$, and we conclude

$$\sum_{u \in V} \binom{d(u)}{2} \leq \binom{n}{2}$$

or

$$\sum_{u \in V} d(u)^2 \leq n(n-1) + \sum_{u \in V} d(u). \quad (5)$$

Next (and this is quite typical for this sort of extremal problems) we apply the Cauchy–Schwarz inequality to the vectors $(d(u_1), \dots, d(u_n))$ and $(1, 1, \dots, 1)$, obtaining

$$\left(\sum_{u \in V} d(u) \right)^2 \leq n \sum_{u \in V} d(u)^2,$$

and hence by (5)

$$\left(\sum_{u \in V} d(u) \right)^2 \leq n^2(n-1) + n \sum_{u \in V} d(u).$$

Invoking (4) we find

$$4|E|^2 \leq n^2(n-1) + 2n|E|$$

or

$$|E|^2 - \frac{n}{2}|E| - \frac{n^2(n-1)}{4} \leq 0.$$

Solving the corresponding quadratic equation we thus obtain the following result of Istvan Reiman.

Theorem. *If the graph G on n vertices contains no 4-cycles, then*

$$|E| \leq \left\lfloor \frac{n}{4} (1 + \sqrt{4n - 3}) \right\rfloor. \tag{6}$$

For $n = 5$ this gives $|E| \leq 6$, and the graph above shows that equality can hold.

Counting in two ways has thus produced in an easy way an upper bound on the number of edges. But how good is the bound (6) in general? The following beautiful example [2] [3] [6] shows that it is almost sharp. As is often the case in such problems, finite geometry leads the way.

In presenting the example we assume that the reader is familiar with the finite field \mathbb{Z}_p of integers modulo a prime p (see page 20). Consider the 3-dimensional vector space X over \mathbb{Z}_p . We construct from X the following graph G_p . The vertices of G_p are the one-dimensional subspaces $[v] := \text{span}_{\mathbb{Z}_p}\{v\}$, $\mathbf{0} \neq v \in X$, and we connect two such subspaces $[v] \neq [w]$ by an edge if

$$\langle v, w \rangle = v_1w_1 + v_2w_2 + v_3w_3 = 0.$$

Note that it does not matter which vector $\neq \mathbf{0}$ we take from the subspace. In the language of geometry, the vertices are the *points* of the projective plane over \mathbb{Z}_p , and $[w]$ is adjacent to $[v]$ if w lies on the *polar line* of v .

As an example, the graph G_2 has no 4-cycle and contains 9 edges, which almost reaches the bound 10 given by (6). We want to show that this is true for any prime p .

Let us first prove that G_p satisfies the C_4 -condition. If $[u]$ is a common neighbor of $[v]$ and $[w]$, then u is a solution of the linear equations

$$\begin{aligned} v_1x + v_2y + v_3z &= 0 \\ w_1x + w_2y + w_3z &= 0. \end{aligned}$$

Since v and w are linearly independent, we infer that the solution space has dimension 1, and hence that the common neighbor $[u]$ is unique.

Next, we ask how many vertices G_p has. It's double counting again. The space X contains $p^3 - 1$ vectors $\neq \mathbf{0}$. Since every one-dimensional subspace contains $p - 1$ vectors $\neq \mathbf{0}$, we infer that X has $\frac{p^3-1}{p-1} = p^2 + p + 1$ one-dimensional subspaces, that is, G_p has $n = p^2 + p + 1$ vertices. Similarly, any two-dimensional subspace contains $p^2 - 1$ vectors $\neq \mathbf{0}$, and hence $\frac{p^2-1}{p-1} = p + 1$ one-dimensional subspaces.

It remains to determine the number of edges in G_p , or, what is the same by (4), the degrees. By the construction of G_p , the vertices adjacent to $[u]$ are the solutions of the equation

$$u_1x + u_2y + u_3z = 0. \tag{7}$$

The solution space of (7) is a two-dimensional subspace, and hence there are $p + 1$ vertices adjacent to $[u]$. But beware, it may happen that u itself is a solution of (7). In this case there are only p vertices adjacent to $[u]$.

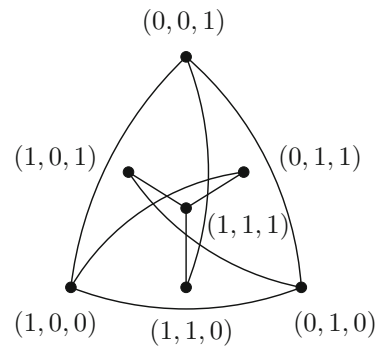

The graph G_2 : its vertices are all seven nonzero triples (x, y, z) .

In summary, we obtain the following result: If \mathbf{u} lies on the conic given by $x^2 + y^2 + z^2 = 0$, then $d([\mathbf{u}]) = p$, and, if not, then $d([\mathbf{u}]) = p + 1$. So it remains to find the number of one-dimensional subspaces on the conic

$$x^2 + y^2 + z^2 = 0.$$

Let us anticipate the result which we shall prove in a moment.

Claim. *There are precisely p^2 solutions (x, y, z) of the equation $x^2 + y^2 + z^2 = 0$, and hence (excepting the zero solution) precisely $\frac{p^2-1}{p-1} = p + 1$ vertices in G_p of degree p .*

With this, we complete our analysis of G_p . There are $p + 1$ vertices of degree p , hence $(p^2 + p + 1) - (p + 1) = p^2$ vertices of degree $p + 1$. Using (4), we obtain

$$\begin{aligned} |E| &= \frac{(p+1)p}{2} + \frac{p^2(p+1)}{2} = \frac{(p+1)^2 p}{2} \\ &= \frac{(p+1)p}{4} (1 + (2p+1)) = \frac{p^2+p}{4} (1 + \sqrt{4p^2 + 4p + 1}). \end{aligned}$$

Setting $n = p^2 + p + 1$, the last equation reads

$$|E| = \frac{n-1}{4} (1 + \sqrt{4n-3}),$$

and we see that this almost agrees with (6).

Now to the proof of the claim. The following argument is a beautiful application of linear algebra involving symmetric matrices and their eigenvalues. We will encounter the same method in Chapter 44, which is no coincidence: both proofs are from the same paper by Erdős, Rényi and Sós.

We represent the one-dimensional subspaces of X as before by vectors $\mathbf{v}_1, \mathbf{v}_2, \dots, \mathbf{v}_{p^2+p+1}$, any two of which are linearly independent. Similarly, we may represent the two-dimensional subspaces by the *same* set of vectors, where the subspace corresponding to $\mathbf{u} = (u_1, u_2, u_3)$ is the set of solutions of the equation $u_1x + u_2y + u_3z = 0$ as in (7). (Of course, this is just the duality principle of linear algebra.) Hence, by (7), a one-dimensional subspace, represented by \mathbf{v}_i , is contained in the two-dimensional subspace, represented by \mathbf{v}_j , if and only if $\langle \mathbf{v}_i, \mathbf{v}_j \rangle = 0$.

Consider now the matrix $A = (a_{ij})$ of size $(p^2+p+1) \times (p^2+p+1)$, defined as follows: The rows and columns of A correspond to $\mathbf{v}_1, \dots, \mathbf{v}_{p^2+p+1}$ (we use the same numbering for rows and columns) with

$$a_{ij} := \begin{cases} 1 & \text{if } \langle \mathbf{v}_i, \mathbf{v}_j \rangle = 0, \\ 0 & \text{otherwise.} \end{cases}$$

A is thus a real symmetric matrix, and we have $a_{ii} = 1$ if $\langle \mathbf{v}_i, \mathbf{v}_i \rangle = 0$, that is, precisely when \mathbf{v}_i lies on the conic $x^2 + y^2 + z^2 = 0$. Thus, all that remains to show is that

$$\text{trace } A = p + 1.$$

$$A = \begin{pmatrix} 0 & 1 & 1 & 1 & 0 & 0 & 0 \\ 1 & 0 & 1 & 0 & 1 & 0 & 0 \\ 1 & 1 & 0 & 0 & 0 & 1 & 0 \\ 1 & 0 & 0 & 1 & 0 & 0 & 1 \\ 0 & 1 & 0 & 0 & 1 & 0 & 1 \\ 0 & 0 & 1 & 0 & 0 & 1 & 1 \\ 0 & 0 & 0 & 1 & 1 & 1 & 0 \end{pmatrix}$$

The matrix for G_2

From linear algebra we know that the trace equals the sum of the eigenvalues. And here comes the trick: While A looks complicated, the matrix A^2 is easy to analyze. We note two facts:

- Any row of A contains precisely $p + 1$ 1's. This implies that $p + 1$ is an eigenvalue of A , since $A\mathbf{1} = (p + 1)\mathbf{1}$, where $\mathbf{1}$ is the vector consisting of 1's.
- For any two distinct rows v_i, v_j there is exactly one column with a 1 in both rows (the column corresponding to the unique subspace spanned by v_i, v_j).

Using these facts we find

$$A^2 = \begin{pmatrix} p+1 & 1 & \cdots & 1 \\ 1 & p+1 & & \vdots \\ \vdots & & \ddots & \\ 1 & \cdots & & p+1 \end{pmatrix} = pI + J,$$

where I is the identity matrix and J is the all-ones-matrix. Now, J has the eigenvalue $p^2 + p + 1$ (of multiplicity 1) and 0 (of multiplicity $p^2 + p$). Hence A^2 has the eigenvalues $p^2 + 2p + 1 = (p + 1)^2$ of multiplicity 1 and p of multiplicity $p^2 + p$. Since A is real and symmetric, hence diagonalizable, we find that A has the eigenvalue $p + 1$ or $-(p + 1)$ and $p^2 + p$ eigenvalues $\pm\sqrt{p}$. From Fact 1 above, the first eigenvalue must be $p + 1$. Suppose that \sqrt{p} has multiplicity r , and $-\sqrt{p}$ multiplicity s , then

$$\text{trace } A = (p + 1) + r\sqrt{p} - s\sqrt{p}.$$

But now we are home: Since the trace is an integer, we must have $r = s$, so $\text{trace } A = p + 1$. \square

6. Sperner's Lemma

In 1912, Luitzen Brouwer published his famous fixed point theorem:

Every continuous function $f: B^n \rightarrow B^n$ of an n -dimensional ball to itself has a fixed point (a point $\mathbf{x} \in B^n$ with $f(\mathbf{x}) = \mathbf{x}$).

For dimension 1, that is for an interval, this follows easily from the intermediate value theorem, but for higher dimensions Brouwer's proof needed some sophisticated machinery. It was therefore quite a surprise when in 1928 young Emanuel Sperner (he was 23 at the time) produced a simple combinatorial result from which both Brouwer's fixed point theorem and the invariance of the dimension under continuous bijective maps could be deduced. And what's more, Sperner's ingenious lemma is matched by an equally beautiful proof — it is just double counting.

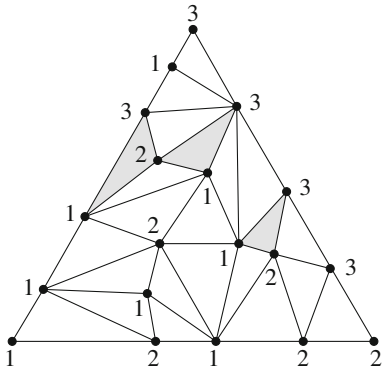

The tricolored triangles are shaded.

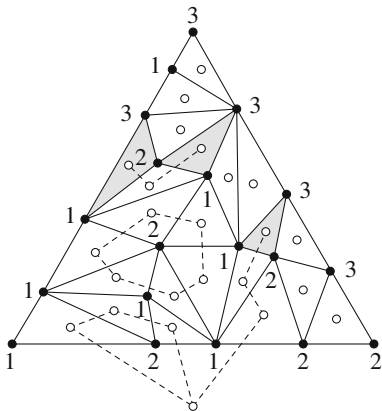

We discuss Sperner's lemma, and Brouwer's theorem as a consequence, for the first interesting case, that of dimension $n = 2$. The energetic reader should find it not too difficult to extend the proofs to higher dimensions (by induction on the dimension).

Sperner's Lemma.

Suppose that some "big" triangle with vertices V_1, V_2, V_3 is triangulated (that is, decomposed into a finite number of "small" triangles that fit together edge-by-edge).

Assume that the vertices in the triangulation get "colors" from the set $\{1, 2, 3\}$ such that V_i receives the color i (for each i), and only the colors i and j are used for vertices along the edge from V_i to V_j (for $i \neq j$), while the interior vertices are colored arbitrarily with 1, 2 or 3.

Then in the triangulation there must be a small "tricolored" triangle, which has all three different vertex colors.

■ **Proof.** We will prove a stronger statement: The number of tricolored triangles is not only nonzero, it is always *odd*.

Consider the dual graph to the triangulation, but don't take all its edges — only those which cross an edge that has endvertices with the (different) colors 1 and 2. Thus we get a "partial dual graph" which has degree 1 at all vertices that correspond to tricolored triangles, degree 2 for all triangles in which the two colors 1 and 2 appear, and degree 0 for triangles that do not have both colors 1 and 2. Thus only the tricolored triangles correspond to vertices of odd degree (of degree 1).

However, the vertex of the dual graph which corresponds to the outside of the triangulation has odd degree: in fact, along the big edge from V_1 to V_2 , there is an odd number of changes between 1 and 2. Thus an odd number of edges of the partial dual graph crosses this big edge, while the other big edges cannot have both 1 and 2 occurring as colors.

Now since the number of odd-degree vertices in any finite graph is even (by equation (4)), we find that the number of small triangles with three different colors (corresponding to odd inside vertices of our dual graph) is odd. □

With this lemma, it is easy to derive Brouwer's theorem.

■ **Proof of Brouwer's fixed point theorem (for $n = 2$).** Let Δ be the triangle in \mathbb{R}^3 with vertices $e_1 = (1, 0, 0)$, $e_2 = (0, 1, 0)$, and $e_3 = (0, 0, 1)$. It suffices to prove that every continuous map $f: \Delta \rightarrow \Delta$ has a fixed point, since Δ is homeomorphic to the two-dimensional ball B_2 .

We use $\delta(\mathcal{T})$ to denote the maximal length of an edge in a triangulation \mathcal{T} . One can easily construct an infinite sequence of triangulations $\mathcal{T}_1, \mathcal{T}_2, \dots$ of Δ such that the sequence of maximal diameters $\delta(\mathcal{T}_k)$ converges to 0. Such a sequence can be obtained by explicit construction, or inductively, for example by taking \mathcal{T}_{k+1} to be the barycentric subdivision of \mathcal{T}_k .

For each of these triangulations, we define a 3-coloring of their vertices v by setting $\lambda(v) := \min\{i : f(v)_i < v_i\}$, that is, $\lambda(v)$ is the smallest index i such that the i -th coordinate of $f(v) - v$ is negative. If this smallest index i does not exist, then we have found a fixed point and are done: To see this,

note that every $\mathbf{v} \in \Delta$ lies in the plane $x_1 + x_2 + x_3 = 1$, hence $\sum_i v_i = 1$. So if $f(\mathbf{v}) \neq \mathbf{v}$, then at least one of the coordinates of $f(\mathbf{v}) - \mathbf{v}$ must be negative (and at least one must be positive).

Let us check that this coloring satisfies the assumptions of Sperner's lemma. First, the vertex e_i must receive color i , since the only possible negative component of $f(e_i) - e_i$ is the i -th component. Moreover, if \mathbf{v} lies on the edge opposite to e_i , then $v_i = 0$, so the i -th component of $f(\mathbf{v}) - \mathbf{v}$ cannot be negative, and hence \mathbf{v} does not get the color i .

Sperner's lemma now tells us that in each triangulation \mathcal{T}_k there is a tri-colored triangle $\{\mathbf{v}^{k:1}, \mathbf{v}^{k:2}, \mathbf{v}^{k:3}\}$ with $\lambda(\mathbf{v}^{k:i}) = i$. The sequence of points $(\mathbf{v}^{k:1})_{k \geq 1}$ need not converge, but since the simplex Δ is compact some subsequence has a limit point. After replacing the sequence of triangulations \mathcal{T}_k by the corresponding subsequence (which for simplicity we also denote by \mathcal{T}_k) we can assume that $(\mathbf{v}^{k:1})_k$ converges to a point $\mathbf{v} \in \Delta$. Now the distance of $\mathbf{v}^{k:2}$ and $\mathbf{v}^{k:3}$ from $\mathbf{v}^{k:1}$ is at most the mesh length $\delta(\mathcal{T}_k)$, which converges to 0. Thus the sequences $(\mathbf{v}^{k:2})$ and $(\mathbf{v}^{k:3})$ converge to the same point \mathbf{v} .

But where is $f(\mathbf{v})$? We know that the first coordinate $f(\mathbf{v}^{k:1})$ is smaller than that of $\mathbf{v}^{k:1}$ for all k . Now since f is continuous, we derive that the first coordinate of $f(\mathbf{v})$ is smaller or equal to that of \mathbf{v} . The same reasoning works for the second and third coordinates. Thus none of the coordinates of $f(\mathbf{v}) - \mathbf{v}$ is positive — and we have already seen that this contradicts the assumption $f(\mathbf{v}) \neq \mathbf{v}$. \square

References

- [1] L. E. J. BROUWER: *Über Abbildungen von Mannigfaltigkeiten*, Math. Annalen **71** (1912), 97-115.
- [2] W. G. BROWN: *On graphs that do not contain a Thomsen graph*, Canadian Math. Bull. **9** (1966), 281-285.
- [3] P. ERDŐS, A. RÉNYI & V. SÓS: *On a problem of graph theory*, Studia Sci. Math. Hungar. **1** (1966), 215-235.
- [4] P. ERDŐS & G. SZEKERES: *A combinatorial problem in geometry*, Compositio Math. (1935), 463-470.
- [5] S. HOŞTEN & W. D. MORRIS: *The order dimension of the complete graph*, Discrete Math. **201** (1999), 133-139.
- [6] I. REIMAN: *Über ein Problem von K. Zarankiewicz*, Acta Math. Acad. Sci. Hungar. **9** (1958), 269-273.
- [7] J. SPENCER: *Minimal scrambling sets of simple orders*, Acta Math. Acad. Sci. Hungar. **22** (1971), 349-353.
- [8] E. SPERNER: *Neuer Beweis für die Invarianz der Dimensionszahl und des Gebietes*, Abh. Math. Sem. Hamburg **6** (1928), 265-272.
- [9] W. T. TROTTER: *Combinatorics and Partially Ordered Sets: Dimension Theory*, John Hopkins University Press, Baltimore and London 1992.



Some mathematical theorems exhibit a special feature: The statement of the theorem is elementary and easy, but to prove it can turn out to be a tantalizing task — unless you open some magic door and everything becomes clear and simple.

One such example is the following result due to Nicolaas de Bruijn:

Theorem. *Whenever a rectangle is tiled by rectangles all of which have at least one side of integer length, then the tiled rectangle has at least one side of integer length.*

By a tiling we mean a covering of the big rectangle R with rectangles T_1, \dots, T_m that have pairwise disjoint interior, as in the picture to the right. Actually, de Bruijn proved the following result about packing copies of an $a \times b$ rectangle into a $c \times d$ rectangle: If a, b, c, d are integers, then each of a and b must divide one of c or d . This is implied by two applications of the more general theorem above to the given figure, scaled down first by a factor of $\frac{1}{a}$, and then scaled down by a factor of $\frac{1}{b}$. Each small rectangle has then one side equal to 1, and so $\frac{c}{a}$ or $\frac{d}{a}$ must be an integer.

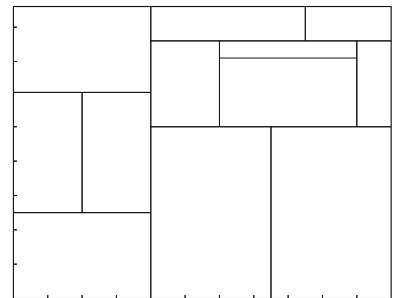

The big rectangle has side lengths 11 and 8.5.

Almost everybody's first attempt is to try induction on the number of small rectangles. Induction can be made to work, but it has to be performed very carefully, and it is not the most elegant option one can come up with. Indeed, in a delightful paper Stan Wagon surveys no less than fourteen different proofs out of which we have selected three; none of them needs induction. The first proof, essentially due to de Bruijn himself, makes use of a very clever calculus trick. The second proof by Richard Rochberg and Sherman Stein is a discrete version of the first proof, which makes it simpler still. But the champion may be the third proof suggested by Mike Paterson. It is just counting in two ways and almost one-line.

In the following we assume that the big rectangle R is placed parallel to the x, y -axes with $(0, 0)$ as the lower left-hand corner. The small rectangles T_i have then sides parallel to the axes as well.

■ **First Proof.** Let T be any rectangle in the plane, where T extends from a to b along the x -axis and from c to d along the y -axis. Here is de Bruijn's trick. Consider the double integral over T ,

$$\int_c^d \int_a^b e^{2\pi i(x+y)} dx dy. \quad (1)$$

Since

$$\int_c^d \int_a^b e^{2\pi i(x+y)} dx dy = \int_a^b e^{2\pi i x} dx \cdot \int_c^d e^{2\pi i y} dy,$$

it follows that the integral (1) is 0 if and only if at least one of $\int_a^b e^{2\pi i x} dx$ or $\int_c^d e^{2\pi i y} dy$ is equal to 0.

We are going to show that

$$\int_a^b e^{2\pi i x} dx = 0 \iff b - a \text{ is an integer.} \quad (2)$$

$$\iint_R f(x, y) = \sum_i \iint_{T_i} f(x, y)$$

Additivity of the integral

But then we will be done! Indeed, by the assumption on the tiling, each \iint_{T_i} is equal to 0, and so by additivity of the integral, $\iint_R = 0$ as well, whence R has an integer side.

It remains to verify (2). From

$$\begin{aligned} \int_a^b e^{2\pi i x} dx &= \frac{1}{2\pi i} e^{2\pi i x} \Big|_a^b = \frac{1}{2\pi i} (e^{2\pi i b} - e^{2\pi i a}) \\ &= \frac{e^{2\pi i a}}{2\pi i} (e^{2\pi i(b-a)} - 1), \end{aligned}$$

we conclude that

$$\int_a^b e^{2\pi i x} dx = 0 \iff e^{2\pi i(b-a)} = 1.$$

From $e^{2\pi i x} = \cos 2\pi x + i \sin 2\pi x$ we see that the last equation is, in turn, equivalent to

$$\cos 2\pi(b-a) = 1 \text{ and } \sin 2\pi(b-a) = 0.$$

Since $\cos x = 1$ holds if and only if x is an integer multiple of 2π , we must have $b - a \in \mathbb{Z}$, and this also implies $\sin 2\pi(b-a) = 0$. \square

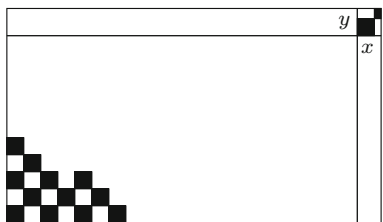

The amount of black in the corner rectangle is $\min(x, \frac{1}{2}) \cdot \min(y, \frac{1}{2}) + \max(x - \frac{1}{2}, 0) \cdot \max(y - \frac{1}{2}, 0)$, and this is always greater than $\frac{1}{2}xy$.

■ **Second Proof.** Color the plane in a checkerboard fashion with black/white squares of size $\frac{1}{2} \times \frac{1}{2}$, starting with a black square at $(0, 0)$.

By the assumption on the tiling every small rectangle T_i must receive an equal amount of black and white, and therefore the big rectangle R too contains the same amount of black and white.

But this implies that R must have an integer side, since otherwise it can be split into four pieces, three of which have equal amounts of black and white, while the piece in the upper right-hand corner does not. Indeed, if $x = a - [a]$, $y = b - [b]$, so that $0 < x, y < 1$, then the amount of black is always greater than that of white.

This is illustrated in the figure in the margin. \square

■ **Third proof.** Let C be the set of corners in the tiling for which both coordinates are integral (so, for example, $(0, 0) \in C$), and let T be the set of tiles. Form a bipartite graph G on the vertex set $C \cup T$ by joining each corner $c \in C$ to all the tiles of which it is a corner. The hypothesis implies that each tile is joined to 0, 2, or 4 corners in C , since if one corner is in C , then so is also the other end of any integer side. Now look at C . Any $c \in C$ which is not a corner of R is joined to an *even* number of tiles, but the vertex $(0, 0)$ is joined to only *one* tile. As the number of odd-degree vertices in any finite graph is even (as we have just observed on page 204), there must be another $c \in C$ of odd degree, and c can only be one of the other vertices of R — end of proof. \square

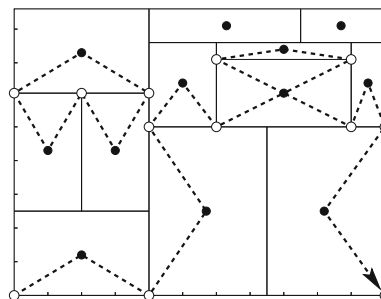

Here the bipartite graph G is drawn with vertices in C white, vertices in T black, and dashed edges.

All three proofs can quite easily be adapted to also yield an n -dimensional version of de Bruijn’s result: Whenever an n -dimensional box R is tiled by boxes all of which have at least one integer side, then R has an integer side. However, we want to keep our discussion in the plane (for this chapter), and look at a “companion result” to de Bruijn’s, due to Max Dehn (many years earlier), which sounds quite similar, but asks for different ideas.

Theorem. A rectangle can be tiled with squares if and only if the ratio of its side lengths is a rational number.

One half of the theorem is immediate. Suppose the rectangle R has side lengths α and β with $\frac{\alpha}{\beta} \in \mathbb{Q}$, that is, $\frac{\alpha}{\beta} = \frac{p}{q}$ with $p, q \in \mathbb{N}$. Setting $s := \frac{\alpha}{p} = \frac{\beta}{q}$, we can easily tile R with copies of the $s \times s$ square as shown in the margin.

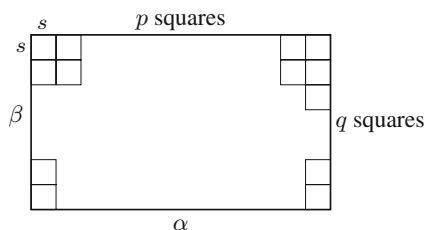

For the proof of the converse Max Dehn used an elegant argument that he had already successfully employed in his solution of Hilbert’s third problem (see Chapter 10). In fact, the two papers appeared in successive years in the *Mathematische Annalen*.

■ **Proof.** Suppose R is tiled by squares of possibly different sizes. By scaling we may assume that R is an $a \times 1$ rectangle. Let us assume $a \notin \mathbb{Q}$ and derive a contradiction from this. The first step is to extend the sides of the squares to the full width resp. height of R as in the figure.

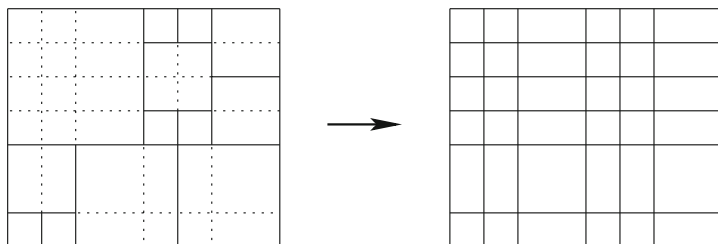

R is now decomposed into a number of small rectangles; let a_1, a_2, \dots, a_M be their side lengths (in any order), and consider the set

$$A := \{1, a, a_1, \dots, a_M\} \subseteq \mathbb{R}.$$

Next comes a linear algebra part. We define $V(A)$ as the vector space of all linear combinations of the numbers in A with rational coefficients. Note that $V(A)$ contains all side lengths of the squares in the original tiling, since any such side length is the sum of some a_i 's. As the number a is not rational, we may extend $\{1, a\}$ to a basis B of $V(A)$,

$$B = \{b_1 = 1, b_2 = a, b_3, \dots, b_m\}.$$

Define the function $f : B \rightarrow \mathbb{R}$ by

$$f(1) := 1, \quad f(a) := -1, \quad \text{and} \quad f(b_i) := 0 \quad \text{for } i \geq 3,$$

Linear extension:

$$f(q_1 b_1 + \dots + q_m b_m) := q_1 f(b_1) + \dots + q_m f(b_m)$$

for $q_1, \dots, q_m \in \mathbb{Q}$.

and extend it linearly to $V(A)$.

The following definition of “area” of rectangles finishes the proof in three quick steps: For $c, d \in V(A)$ the area of the $c \times d$ rectangle is defined as

$$\text{area}\left(\begin{array}{|c|} \hline \square \\ \hline \end{array} d\right) = f(c)f(d).$$

$$(1) \quad \text{area}\left(\begin{array}{|c|c|} \hline \square & \square \\ \hline \end{array} d\right) = \text{area}\left(\begin{array}{|c|} \hline \square \\ \hline \end{array} d\right) + \text{area}\left(\begin{array}{|c|} \hline \square \\ \hline \end{array} d\right).$$

This follows immediately from the linearity of f . The analogous result holds, of course, for vertical strips.

$$(2) \quad \text{area}(R) = \sum_{\text{squares}} \text{area}\left(\begin{array}{|c|} \hline \square \\ \hline \end{array}\right), \text{ where the sum runs through the squares in the tiling.}$$

Just note that by (1) $\text{area}(R)$ equals the sum of the areas of all small rectangles in the extended tiling. Since any such rectangle is in exactly one square of the original tiling, we see (again by (1)) that this sum is also equal to the right-hand side of (2).

(3) We have

$$\text{area}(R) = f(a)f(1) = -1,$$

whereas for a square of side length t , $\text{area}\left(\begin{array}{|c|} \hline \square \\ \hline \end{array}\right) = f(t)^2 \geq 0$, and so

$$\sum_{\text{squares}} \text{area}\left(\begin{array}{|c|} \hline \square \\ \hline \end{array}\right) \geq 0,$$

and this is our desired contradiction. □

For those who want to go for further excursions into the world of tilings the beautiful survey paper [1] by Federico Ardila and Richard Stanley is highly recommended.

References

- [1] F. ARDILA & R. P. STANLEY: *Tilings*, Math. Intelligencer (4)32 (2010), 32-43.
- [2] N. G. DE BRUIJN: *Filling boxes with bricks*, Amer. Math. Monthly 76 (1969), 37-40.
- [3] M. DEHN: *Über die Zerlegung von Rechtecken in Rechtecke*, Mathematische Annalen 57 (1903), 314-332.
- [4] S. WAGON: *Fourteen proofs of a result about tiling a rectangle*, Amer. Math. Monthly 94 (1987), 601-617.

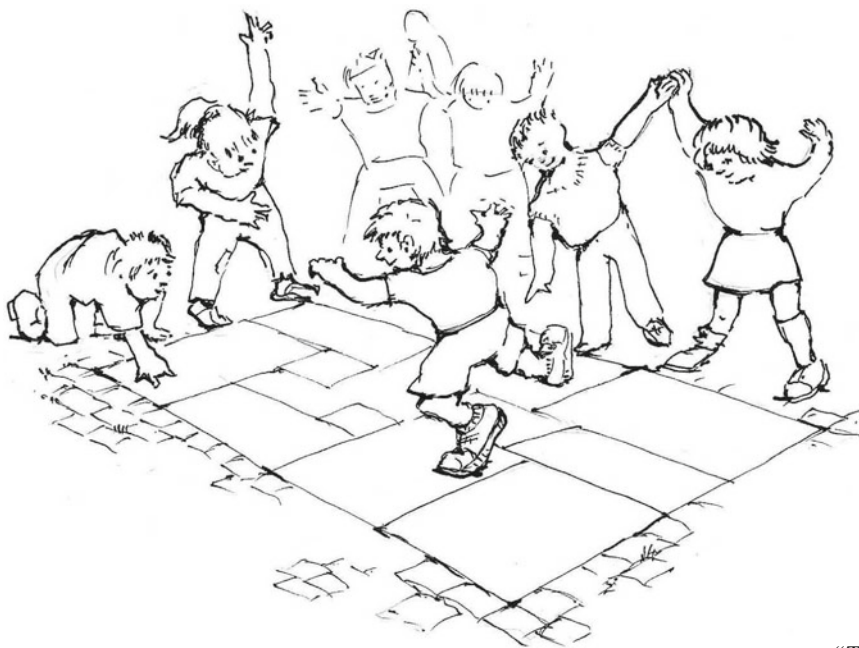

*“The new hopscotch:
Don’t hit the integers!”*

Three famous theorems on finite sets

Chapter 30



In this chapter we are concerned with a basic theme of combinatorics: properties and sizes of special families \mathcal{F} of subsets of a finite set $N = \{1, 2, \dots, n\}$. We start with two results which are classics in the field: the theorems of Sperner and of Erdős–Ko–Rado. These two results have in common that they were reproved many times and that each of them initiated a new field of combinatorial set theory. For both theorems, induction seems to be the natural method, but the arguments we are going to discuss are quite different and truly inspired.

In 1928 Emanuel Sperner asked and answered the following question: Suppose we are given the set $N = \{1, 2, \dots, n\}$. Call a family \mathcal{F} of subsets of N an *antichain* if no set of \mathcal{F} contains another set of the family \mathcal{F} . What is the size of a largest antichain? Clearly, the family \mathcal{F}_k of all k -sets satisfies the antichain property with $|\mathcal{F}_k| = \binom{n}{k}$. Looking at the maximum of the binomial coefficients (see page 14) we conclude that there is an antichain of size $\binom{n}{\lfloor n/2 \rfloor} = \max_k \binom{n}{k}$. Sperner's theorem now asserts that there are no larger ones.

Theorem 1. *The size of a largest antichain of an n -set is $\binom{n}{\lfloor n/2 \rfloor}$.*

■ **Proof.** Of the many proofs the following one, due to David Lubell, is probably the shortest and most elegant. Let \mathcal{F} be an arbitrary antichain. Then we have to show $|\mathcal{F}| \leq \binom{n}{\lfloor n/2 \rfloor}$. The key to the proof is that we consider *chains* of subsets $\emptyset = C_0 \subseteq C_1 \subseteq C_2 \subseteq \dots \subseteq C_n = N$, where $|C_i| = i$ for $i = 0, \dots, n$. How many chains are there? Clearly, we obtain a chain by adding one by one the elements of N , so there are just as many chains as there are permutations of N , namely $n!$. Next, for a set $A \in \mathcal{F}$ we ask how many of these chains contain A . Again this is easy. To get from \emptyset to A we have to add the elements of A one by one, and then to pass from A to N we have to add the remaining elements. Thus if A contains k elements, then by considering all these pairs of chains linked together we see that there are precisely $k!(n-k)!$ such chains. Note that no chain can pass through two different sets A and B of \mathcal{F} , since \mathcal{F} is an antichain.

To complete the proof, let m_k be the number of k -sets in \mathcal{F} . Thus $|\mathcal{F}| = \sum_{k=0}^n m_k$. Then it follows from our discussion that the number of chains passing through some member of \mathcal{F} is

$$\sum_{k=0}^n m_k k! (n-k)!,$$

and this expression cannot exceed the number $n!$ of *all* chains. Hence



Emanuel Sperner

we conclude

$$\sum_{k=0}^n m_k \frac{k!(n-k)!}{n!} \leq 1, \quad \text{or} \quad \sum_{k=0}^n \frac{m_k}{\binom{n}{k}} \leq 1.$$

Replacing the denominators by the largest binomial coefficient, we therefore obtain

$$\frac{1}{\binom{n}{\lfloor n/2 \rfloor}} \sum_{k=0}^n m_k \leq 1, \quad \text{that is,} \quad |\mathcal{F}| = \sum_{k=0}^n m_k \leq \binom{n}{\lfloor n/2 \rfloor},$$

Check that the family of all $\frac{n}{2}$ -sets for even n respectively the two families of all $\frac{n-1}{2}$ -sets and of all $\frac{n+1}{2}$ -sets, when n is odd, are indeed the *only* antichains that achieve the maximum size!

and the proof is complete. \square

Our second result is of an entirely different nature. Again we consider the set $N = \{1, \dots, n\}$. Call a family \mathcal{F} of subsets an *intersecting family* if any two sets in \mathcal{F} have at least one element in common. It is almost immediate that the size of a largest intersecting family is 2^{n-1} . If $A \in \mathcal{F}$, then the complement $A^c = N \setminus A$ has empty intersection with A and accordingly cannot be in \mathcal{F} . Hence we conclude that an intersecting family contains at most half the number 2^n of all subsets, that is, $|\mathcal{F}| \leq 2^{n-1}$. On the other hand, if we consider the family of all sets containing a fixed element, say the family \mathcal{F}_1 of all sets containing 1, then clearly $|\mathcal{F}_1| = 2^{n-1}$, and the problem is settled.

But now let us ask the following question: How large can an intersecting family \mathcal{F} be if all sets in \mathcal{F} have the same size, say k ? Let us call such families *intersecting k -families*. To avoid trivialities, we assume $n \geq 2k$ since otherwise any two k -sets intersect, and there is nothing to prove. Taking up the above idea, we certainly obtain such a family \mathcal{F}_1 by considering all k -sets containing a fixed element, say 1. Clearly, we obtain all sets in \mathcal{F}_1 by adding to 1 all $(k-1)$ -subsets of $\{2, 3, \dots, n\}$, hence $|\mathcal{F}_1| = \binom{n-1}{k-1}$. Can we do better? No — and this is the theorem of Erdős–Ko–Rado.

Theorem 2. *The largest size of an intersecting k -family in an n -set is $\binom{n-1}{k-1}$ when $n \geq 2k$.*

Paul Erdős, Chao Ko and Richard Rado found this result in 1938, but it was not published until 23 years later. Since then multitudes of proofs and variants have been given, but the following argument due to Gyula Katona is particularly elegant.

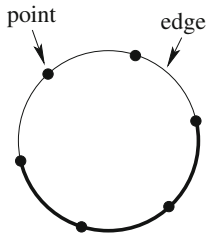

A circle C for $n = 6$. The bold edges depict an arc of length 3.

■ **Proof.** The key to the proof is the following simple lemma, which at first sight seems to be totally unrelated to our problem. Consider a circle C divided by n points into n edges. Let an arc of length k consist of $k+1$ consecutive points and the k edges between them.

Lemma. *Let $n \geq 2k$, and suppose we are given t distinct arcs A_1, \dots, A_t of length k , such that any two arcs have an edge in common. Then $t \leq k$.*

To prove the lemma, note first that any point of C is the endpoint of at most one arc. Indeed, if A_i, A_j had a common endpoint v , then they would have

to start in different direction (since they are distinct). But then they cannot have an edge in common as $n \geq 2k$. Let us fix A_1 . Since any A_i ($i \geq 2$) has an edge in common with A_1 , one of the endpoints of A_i is an inner point of A_1 . Since these endpoints must be distinct as we have just seen, and since A_1 contains $k - 1$ inner points, we conclude that there can be at most $k - 1$ further arcs, and thus at most k arcs altogether. \square

Now we proceed with the proof of the Erdős–Ko–Rado theorem. Let \mathcal{F} be an intersecting k -family. Consider a circle C with n points and n edges as above. We take any cyclic permutation $\pi = (a_1, a_2, \dots, a_n)$ and write the numbers a_i clockwise next to the edges of C . Let us count the number of sets $A \in \mathcal{F}$ which appear as k consecutive numbers on C . Since \mathcal{F} is an intersecting family we see by our lemma that we get at most k such sets. Since this holds for any cyclic permutation, and since there are $(n - 1)!$ cyclic permutations, we produce in this way at most

$$k(n - 1)!$$

sets of \mathcal{F} which appear as consecutive elements of some cyclic permutation. How often do we count a fixed set $A \in \mathcal{F}$? Easy enough: A appears in π if the k elements of A appear consecutively in some order. Hence we have $k!$ possibilities to write A consecutively, and $(n - k)!$ ways to order the remaining elements. So we conclude that a fixed set A appears in precisely $k!(n - k)!$ cyclic permutations, and hence that

$$|\mathcal{F}| \leq \frac{k(n - 1)!}{k!(n - k)!} = \frac{(n - 1)!}{(k - 1)!(n - 1 - (k - 1))!} = \binom{n - 1}{k - 1}. \quad \square$$

Again we may ask whether the families containing a fixed element are the only intersecting k -families of maximal size. This is certainly not true for $n = 2k$. For example, for $n = 4$ and $k = 2$ the family $\{1, 2\}, \{1, 3\}, \{2, 3\}$ also has size $\binom{3}{1} = 3$. More generally, for $n = 2k$ we get the largest intersecting k -families, of size $\frac{1}{2} \binom{n}{k} = \binom{n-1}{k-1}$, by arbitrarily including one out of every pair of sets formed by a k -set A and its complement $N \setminus A$. But for $n > 2k$ the special families containing a fixed element are indeed the only ones. The reader is invited to try his hand at the proof.

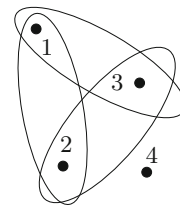

An intersecting family for $n = 4, k = 2$

Finally, we turn to the third result which is arguably the most important basic theorem in finite set theory, the “marriage theorem” of Philip Hall proved in 1935. It opened the door to what is today called matching theory, with a wide variety of applications, some of which we shall see as we go along.

Consider a finite set X and a collection A_1, \dots, A_n of subsets of X (which need not be distinct). Let us call a sequence x_1, \dots, x_n a *system of distinct representatives* of $\{A_1, \dots, A_n\}$ if the x_i are distinct elements of X , and if $x_i \in A_i$ for all i . Of course, such a system, abbreviated SDR, need not exist, for example when one of the sets A_i is empty. The content of the theorem of Hall is the precise condition under which an SDR exists.



“A mass wedding”

Before giving the result let us state the human interpretation which gave it the folklore name *marriage theorem*: Consider a set $\{1, \dots, n\}$ of girls and a set X of boys. Whenever $x \in A_i$, then girl i and boy x are inclined to get married, thus A_i is just the set of possible matches of girl i . An SDR represents then a mass-wedding where every girl marries a boy she likes. Back to sets, here is the statement of the result.

Theorem 3. *Let A_1, \dots, A_n be a collection of subsets of a finite set X . Then there exists a system of distinct representatives if and only if the union of any m sets A_i contains at least m elements, for $1 \leq m \leq n$.*

The condition is clearly necessary: If m sets A_i contain between them fewer than m elements, then these m sets can certainly not be represented by distinct elements. The surprising fact (resulting in the universal applicability) is that this obvious condition is also sufficient. Hall’s original proof was rather complicated, and subsequently many different proofs were given, of which the following one (due to Easterfield and rediscovered by Halmos and Vaughan) may be the most natural.

■ **Proof.** We use induction on n . For $n = 1$ there is nothing to prove. Let $n > 1$, and suppose $\{A_1, \dots, A_n\}$ satisfies the condition of the theorem which we abbreviate by (H). Call a collection of ℓ sets A_i with $1 \leq \ell < n$ a *critical family* if its union has cardinality ℓ . Now we distinguish two cases.

Case 1: There is no critical family.

Choose any element $x \in A_n$. Delete x from X and consider the collection A'_1, \dots, A'_{n-1} with $A'_i = A_i \setminus \{x\}$. Since there is no critical family, we find that the union of any m sets A'_i contains at least m elements. Hence by induction on n there exists an SDR x_1, \dots, x_{n-1} of $\{A'_1, \dots, A'_{n-1}\}$, and together with $x_n = x$, this gives an SDR for the original collection.

Case 2: There exists a critical family.

After renumbering the sets we may assume that $\{A_1, \dots, A_\ell\}$ is a critical family. Then $\bigcup_{i=1}^{\ell} A_i = \tilde{X}$ with $|\tilde{X}| = \ell$. Since $\ell < n$, we infer the existence of an SDR for A_1, \dots, A_ℓ by induction, that is, there is a numbering x_1, \dots, x_ℓ of \tilde{X} such that $x_i \in A_i$ for all $i \leq \ell$.

Consider now the remaining collection $A_{\ell+1}, \dots, A_n$, and take any m of these sets. Since the union of A_1, \dots, A_ℓ and these m sets contains at least $\ell + m$ elements by condition (H), we infer that the m sets contain at least m elements outside \tilde{X} . In other words, condition (H) is satisfied for the family

$$A_{\ell+1} \setminus \tilde{X}, \dots, A_n \setminus \tilde{X}.$$

Induction now gives an SDR for $A_{\ell+1}, \dots, A_n$ that avoids \tilde{X} . Combining it with x_1, \dots, x_ℓ we obtain an SDR for all sets A_i . This completes the proof. \square

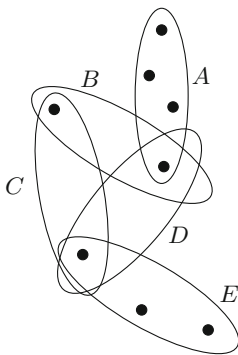

$\{B, C, D\}$ is a critical family

As we mentioned, Hall's theorem was the beginning of the now vast field of matching theory [6]. Of the many variants and ramifications let us state one particularly appealing result which the reader is invited to prove for himself:

Suppose the sets A_1, \dots, A_n all have size $k \geq 1$ and suppose further that no element is contained in more than k sets. Then there exist k SDR's such that for any i the k representatives of A_i are distinct and thus together form the set A_i .

A beautiful result which should open new horizons on marriage possibilities.

References

- [1] T. E. EASTERFIELD: *A combinatorial algorithm*, J. London Math. Soc. **21** (1946), 219-226.
- [2] P. ERDŐS, C. KO & R. RADO: *Intersection theorems for systems of finite sets*, Quart. J. Math. (Oxford), Ser. (2) **12** (1961), 313-320.
- [3] P. HALL: *On representatives of subsets*, J. London Math. Soc. **10** (1935), 26-30.
- [4] P. R. HALMOS & H. E. VAUGHAN: *The marriage problem*, Amer. J. Math. **72** (1950), 214-215.
- [5] G. KATONA: *A simple proof of the Erdős-Ko-Rado theorem*, J. Combinatorial Theory, Ser. B **13** (1972), 183-184.
- [6] L. LOVÁSZ & M. D. PLUMMER: *Matching Theory*, Akadémiai Kiadó, Budapest 1986.
- [7] D. LUBELL: *A short proof of Sperner's theorem*, J. Combinatorial Theory **1** (1966), 299.
- [8] E. SPERNER: *Ein Satz über Untermengen einer endlichen Menge*, Math. Zeitschrift **27** (1928), 544-548.



How often does one have to shuffle a deck of cards until it is random?

The analysis of random processes is a familiar duty in life (“How long does it take to get to the airport during rush-hour?”) as well as in mathematics. Of course, getting meaningful answers to such problems heavily depends on formulating meaningful questions. For the card shuffling problem, this means that we have

- to specify the size of the deck ($n = 52$ cards, say),
- to say how we shuffle (we’ll analyze top-in-at-random shuffles first, and then the more realistic and effective riffle shuffles), and finally
- to explain what we mean by “is random” or “is close to random.”

So our goal in this chapter is an analysis of the riffle shuffle, due to Edgar N. Gilbert and Claude Shannon (1955, unpublished) and Jim Reeds (1981, unpublished), following the statistician David Aldous and the former magician turned mathematician Persi Diaconis according to [1]. We will not reach the final precise result that 7 riffle shuffles *are* sufficient to get a deck of $n = 52$ cards very close to random, while 6 riffle shuffles do not suffice — but we will obtain an upper bound of 12, and we will see some extremely beautiful ideas on the way: the concepts of stopping rules and of “strong uniform time,” the lemma that strong uniform time bounds the variation distance, Reeds’ inversion lemma, and thus the interpretation of shuffling as “reversed sorting.” In the end, everything will be reduced to two very classical combinatorial problems, namely the coupon collector and the birthday paradox. So let’s start with these!

The birthday paradox

Take n random people — the participants of a class or seminar, say. What is the probability that they all have different birthdays? With the usual simplifying assumptions (365 days a year, no seasonal effects, no twins present) the probability is

$$p(n) = \prod_{i=1}^{n-1} \left(1 - \frac{i}{365}\right),$$



Persi Diaconis’ business card as a magician. In a later interview he said: “If you say that you are a professor at Stanford people treat you respectfully. If you say that you invent magic tricks, they don’t want to introduce you to their daughter.”

which is smaller than $\frac{1}{2}$ for $n = 23$ (this is the “birthday paradox”!), less than 9 percent for $n = 42$, and exactly 0 for $n > 365$ (the “pigeon-hole principle,” see Chapter 28). The formula is easy to see — if we take the persons in some fixed order: If the first i persons have distinct birthdays, then the probability that the $(i + 1)$ -st person doesn’t spoil the series is $1 - \frac{i}{365}$, since there are $365 - i$ birthdays left.

Similarly, if n balls are placed independently and randomly into K boxes, then the probability that no box gets more than one ball is

$$p(n, K) = \prod_{i=1}^{n-1} \left(1 - \frac{i}{K}\right).$$

The coupon collector

Children buy photos of pop stars (or soccer stars) for their albums, but they buy them in little nontransparent envelopes, so they don’t know which photo they will get. If there are n different photos, what is the expected number of pictures a kid has to buy until he or she gets every motif at least once?

Equivalently, if you randomly take balls from a bowl that contains n distinguishable balls, and if you put your ball back each time, and then again mix well, how often do you have to draw on average until you have drawn each ball at least once?

If you already have drawn k distinct balls, then the probability not to get a new one in the next drawing is $\frac{k}{n}$. So the probability to need exactly s drawings for the next new ball is $\binom{k}{n}^{s-1} \left(1 - \frac{k}{n}\right)$. And thus the expected number of drawings for the next new ball is

$$\sum_{s \geq 1} \binom{k}{n}^{s-1} \left(1 - \frac{k}{n}\right)^s = \frac{1}{1 - \frac{k}{n}},$$

as we get from the series in the margin. So the expected number of drawings until we have drawn *each* of the n different balls at least once is

$$\sum_{k=0}^{n-1} \frac{1}{1 - \frac{k}{n}} = \frac{n}{n} + \frac{n}{n-1} + \cdots + \frac{n}{2} + \frac{n}{1} = nH_n \approx n \log n,$$

with the bounds on the size of harmonic numbers that we had obtained on page 13. So the answer to the coupon collector’s problem is that we have to expect that roughly $n \log n$ drawings are necessary.

The estimate that we need in the following is for the probability that you need significantly more than $n \log n$ trials. If V_n denotes the number of drawings needed (this is the random variable whose expected value is $E[V_n] \approx n \log n$), then for $n \geq 1$ and $c \geq 0$, the probability that we need more than $m := \lceil n \log n + cn \rceil$ drawings is

$$\text{Prob}[V_n > m] \leq e^{-c}.$$

$$\begin{aligned} \sum_{s \geq 1} x^{s-1} (1-x)s &= \\ &= \sum_{s \geq 1} x^{s-1} s - \sum_{s \geq 1} x^s s \\ &= \sum_{s \geq 0} x^s (s+1) - \sum_{s \geq 0} x^s s \\ &= \sum_{s \geq 0} x^s = \frac{1}{1-x}, \end{aligned}$$

where at the end we sum a geometric series (see page 48).

Indeed, if A_i denotes the event that the ball i is not drawn in the first m drawings, then

$$\begin{aligned} \text{Prob}[V_n > m] &= \text{Prob}\left[\bigcup_i A_i\right] \leq \sum_i \text{Prob}[A_i] \\ &= n\left(1 - \frac{1}{n}\right)^m < ne^{-m/n} \leq e^{-c}. \end{aligned}$$

A little calculus shows that $(1 - \frac{1}{n})^n$ is an increasing function in n , which converges to $1/e$. So $(1 - \frac{1}{n})^n < \frac{1}{e}$ holds for all $n \geq 1$.

Now let's grab a deck of n cards. We number them 1 up to n in the order in which they come — so the card numbered “1” is at the top of the deck, while “ n ” is at the bottom. Let us denote from now on by \mathfrak{S}_n the set of all permutations of $1, \dots, n$. *Shuffling* the deck amounts to the application of certain *random permutations* to the order of the cards. Ideally, this might mean that we apply an arbitrary permutation $\pi \in \mathfrak{S}_n$ to our starting order $(1, 2, \dots, n)$, each of them with the same probability $\frac{1}{n!}$. Thus, after doing this just once, we would have our deck of cards in order $\pi = (\pi(1), \pi(2), \dots, \pi(n))$, and this would be a perfect random order. But that's not what happens in real life. Rather, when shuffling only “certain” permutations occur, perhaps not all of them with the same probability, and this is repeated a “certain” number of times. After that, we expect or hope the deck to be at least “close to random.”



Top-in-at-random shuffles

These are performed as follows: you take the top card from the deck, and insert it into the deck at one of the n distinct possible places, each of them with probability $\frac{1}{n}$. Thus one of the permutations

$$\tau_i = (2, 3, \dots, i, 1, i+1, \dots, n)$$

i
↓

is applied, $1 \leq i \leq n$. After one such shuffle the deck doesn't look random, and indeed we expect to need lots of such shuffles until we reach that goal.

A typical run of top-in-at-random shuffles may look as follows (for $n = 5$):

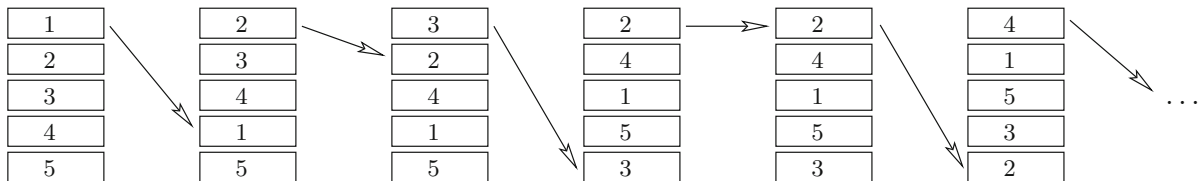

“Top-in-at-random”

How should we measure “being close to random”? Probabilists have cooked up the “variation distance” as a rather unforgiving measure of randomness: We look at the probability distribution on the $n!$ different orderings of our deck, or equivalently, on the $n!$ different permutations $\sigma \in \mathfrak{S}_n$ that yield the orderings.

Two examples are our starting distribution E , which is given by

$$\begin{aligned} E(\text{id}) &= 1, \\ E(\pi) &= 0 \quad \text{otherwise,} \end{aligned}$$

and the uniform distribution U given by

$$U(\pi) = \frac{1}{n!} \quad \text{for all } \pi \in \mathfrak{S}_n.$$

The *variation distance* between two probability distributions Q_1 and Q_2 is now defined as

$$\|Q_1 - Q_2\| := \frac{1}{2} \sum_{\pi \in \mathfrak{S}_n} |Q_1(\pi) - Q_2(\pi)|.$$

By setting $S := \{\pi \in \mathfrak{S}_n : Q_1(\pi) > Q_2(\pi)\}$ and using $\sum_{\pi} Q_1(\pi) = \sum_{\pi} Q_2(\pi) = 1$ we can rewrite this as

$$\|Q_1 - Q_2\| = \max_{S \subseteq \mathfrak{S}_n} |Q_1(S) - Q_2(S)|,$$

with $Q_i(S) := \sum_{\pi \in S} Q_i(\pi)$. Clearly we have $0 \leq \|Q_1 - Q_2\| \leq 1$. In the following, “being close to random” will be interpreted as “having small variation distance from the uniform distribution.” Here the distance between the starting distribution and the uniform distribution is very close to 1:

$$\|E - U\| = 1 - \frac{1}{n!}.$$

After one top-in-at-random shuffle, this will not be much better:

$$\|\text{Top} - U\| = 1 - \frac{1}{(n-1)!}.$$

For card players, the question is not “exactly how close to uniform is the deck after a million riffle shuffles?”, but “is 7 shuffles enough?”

(Aldous & Diaconis [1])

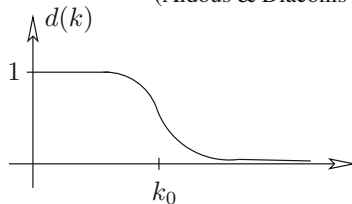

The probability distribution on \mathfrak{S}_n that we obtain by applying the top-in-at-random shuffle k times will be denoted by Top^{*k} . So how does $\|\text{Top}^{*k} - U\|$ behave if k gets larger, that is, if we repeat the shuffling? And similarly for other types of shuffling? General theory (in particular, Markov chains on finite groups; see e. g. Behrends [3]) implies that for large k the variation distance $d(k) := \|\text{Top}^{*k} - U\|$ goes to zero exponentially fast, but it does not yield the “cut-off” phenomenon that one observes in practice: After a certain number k_0 of shuffles “suddenly” $d(k)$ goes to zero rather fast. Our margin displays a schematic sketch of the situation.

Strong uniform stopping rules

The amazing idea of strong uniform stopping rules by Aldous and Diaconis captures the essential features. Imagine that the casino manager closely watches the shuffling process, analyzes the specific permutations that are applied to the deck in each step, and after a number of steps that depends on the permutations that he has seen calls “STOP!”. So he has a *stopping rule* that ends the shuffling process. It depends only on the (random) shuffles that have already been applied. The stopping rule is *strong uniform* if the following condition holds for all $k \geq 0$:

If the process is stopped after exactly k steps, **then** the resulting permutations of the deck have uniform distribution (exactly!).

Let T be the number of steps that are performed until the stopping rule tells the manager to cry “STOP!”; so this is a random variable. Similarly, the ordering of the deck after k shuffles is given by a random variable X_k (with values in \mathfrak{S}_n). With this, the stopping rule is strong uniform if for all feasible values of k ,

$$\text{Prob}[X_k = \pi \mid T = k] = \frac{1}{n!} \quad \text{for all } \pi \in \mathfrak{S}_n.$$

Three aspects make this interesting, useful, and remarkable:

1. Strong uniform stopping rules exist: For many examples they are quite simple.
2. Moreover, these can be analyzed: Trying to determine $\text{Prob}[T > k]$ leads often to simple combinatorial problems.
3. This yields effective upper bounds on the variation distances such as $d(k) = \|\text{Top}^{*k} - U\|$.

For example, for the top-in-at-random shuffles a strong uniform stopping rule is

“STOP after the original bottom card (labelled n) is first inserted back into the deck.”

Indeed, if we trace the card n during these shuffles,

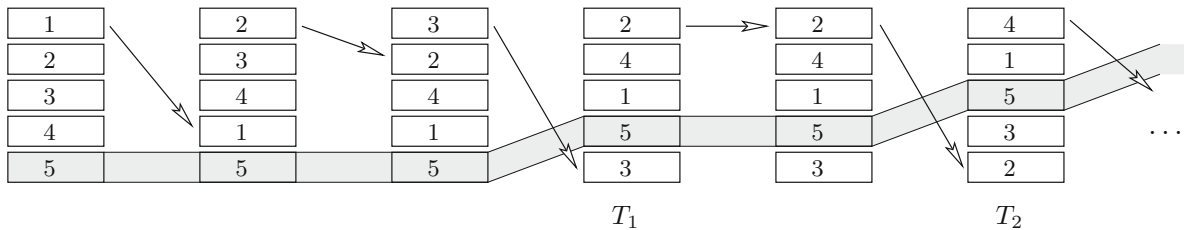

we see that during the whole process the ordering of the cards below this card is completely uniform. So, after the card n rises to the top and then is inserted at random, the deck is uniformly distributed; we just don't know when precisely this happens (but the manager does).

Now let T_i be the random variable which counts the number of shuffles that are performed until for the first time i cards lie below card n . So we have to determine the distribution of

$$T = T_1 + (T_2 - T_1) + \dots + (T_{n-1} - T_{n-2}) + (T - T_{n-1}).$$

But each summand in this corresponds to a coupon collector's problem: $T_i - T_{i-1}$ is the time until the top card is inserted at one of the i possible places below the card n . So it is also the time that the coupon collector takes from the $(n - i)$ -th coupon to the $(n - i + 1)$ -st coupon. Let V_i be the number of pictures bought until he has i different pictures. Then

$$V_n = V_1 + (V_2 - V_1) + \dots + (V_{n-1} - V_{n-2}) + (V_n - V_{n-1}),$$

Conditional probabilities

The conditional probability

$$\text{Prob}[A \mid B]$$

denotes the probability of the event A under the condition that B happens. This is just the probability that both events happen, divided by the probability that B is true, that is,

$$\text{Prob}[A \mid B] = \frac{\text{Prob}[A \wedge B]}{\text{Prob}[B]}.$$

and we have seen that $\text{Prob}[T_i - T_{i-1} = j] = \text{Prob}[V_{n-i+1} - V_{n-i} = j]$ for all i and j . Hence the coupon collector and the top-in-at-random shuffler perform equivalent sequences of independent random processes, just in the opposite order (for the coupon collector, it's hard at the end). Thus we know that the strong uniform stopping rule for the top-in-at-random shuffles takes more than $k = \lceil n \log n + cn \rceil$ steps with low probability:

$$\text{Prob}[T > k] \leq e^{-c}.$$

And this in turn means that after $k = \lceil n \log n + cn \rceil$ top-in-at-random shuffles, our deck is “close to random,” with

$$d(k) = \|\text{Top}^{*k} - \text{U}\| \leq e^{-c},$$

due to the following simple but crucial lemma.

Lemma. *Let $Q : \mathfrak{S}_n \rightarrow \mathbb{R}$ be any probability distribution that defines a shuffling process Q^{*k} with a strong uniform stopping rule whose stopping time is T . Then for all $k \geq 0$,*

$$\|Q^{*k} - \text{U}\| \leq \text{Prob}[T > k].$$

■ **Proof.** If X is a random variable with values in \mathfrak{S}_n , with probability distribution Q , then we write $Q(S)$ for the probability that X takes a value in $S \subseteq \mathfrak{S}_n$. Thus $Q(S) = \text{Prob}[X \in S]$, and in the case of the uniform distribution $Q = \text{U}$ we get

$$\text{U}(S) = \text{Prob}[X \in S] = \frac{|S|}{n!}.$$

For every subset $S \subseteq \mathfrak{S}_n$, we get the probability that after k steps our deck is ordered according to a permutation in S as

$$\begin{aligned} Q^{*k}(S) &= \text{Prob}[X_k \in S] \\ &= \sum_{j \leq k} \text{Prob}[X_k \in S \wedge T = j] + \text{Prob}[X_k \in S \wedge T > k] \\ &= \sum_{j \leq k} \text{U}(S) \text{Prob}[T = j] + \text{Prob}[X_k \in S | T > k] \cdot \text{Prob}[T > k] \\ &= \text{U}(S) (1 - \text{Prob}[T > k]) + \text{Prob}[X_k \in S | T > k] \cdot \text{Prob}[T > k] \\ &= \text{U}(S) + (\text{Prob}[X_k \in S | T > k] - \text{U}(S)) \cdot \text{Prob}[T > k]. \end{aligned}$$

This yields

$$|Q^{*k}(S) - \text{U}(S)| \leq \text{Prob}[T > k]$$

since

$$\text{Prob}[X_k \in S | T > k] - \text{U}(S)$$

is a difference of two probabilities, so it has absolute value at most 1. \square

This is the point where we have completed our analysis of the top-in-at-random shuffle: We have proved the following upper bound for the number of shuffles needed to get “close to random.”

Theorem 1. *Let $c \geq 0$ and $k := \lceil n \log n + cn \rceil$. Then after performing k top-in-at-random shuffles on a deck of n cards, the variation distance from the uniform distribution satisfies*

$$d(k) := \|\text{Top}^{*k} - \mathbf{U}\| \leq e^{-c}.$$

One can also verify that the variation distance $d(k)$ stays large if we do significantly fewer than $n \log n$ top-in-at-random shuffles. The reason is that a smaller number of shuffles will not suffice to destroy the relative ordering on the lowest few cards in the deck.

Of course, top-in-at-random shuffles are extremely inefficient — with the bounds of our theorem, we need more than $n \log n \approx 205$ top-in-at random shuffles until a deck of $n = 52$ cards is mixed up well. Thus we now switch our attention to a much more interesting and realistic model of shuffling.

Riffle shuffles

This is what dealers do at the casino: They take the deck, split it into two parts, and these are then interleaved, for example by dropping cards from the bottoms of the two half-decks in some irregular pattern.

Again a riffle shuffle performs a certain permutation on the cards in the deck, which we initially assume to be labelled from 1 to n , where 1 is the top card. The riffle shuffles correspond exactly to the permutations $\pi \in \mathfrak{S}_n$ such that the sequence

$$(\pi(1), \pi(2), \dots, \pi(n))$$

consists of two interlaced increasing sequences (only for the identity permutation it is one increasing sequence), and that there are exactly $2^n - n$ distinct riffle shuffles on a deck of n cards.

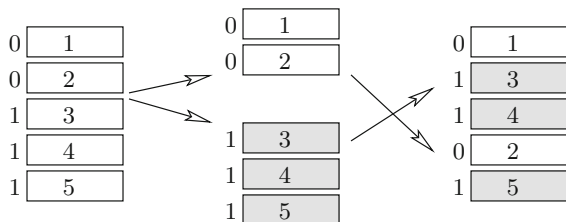

“A riffle shuffle”

In fact, if the pack is split such that the top t cards are taken into the right hand ($0 \leq t \leq n$) and the other $n - t$ cards into the left hand, then there are $\binom{n}{t}$ ways to interleave the two hands, all of which generate distinct permutations — except that for each t there is one possibility to obtain the identity permutation.

Now it’s not clear which probability distribution one should put on the riffle shuffles — there is no unique answer since amateurs and professional dealers would shuffle differently. However, the following model, developed first by Edgar N. Gilbert and Claude Shannon in 1955 (at the legendary

Bell Labs “Mathematics of Communication” department at the time), has several virtues:

- it is elegant, simple, and seems natural,
- it models quite well the way an amateur would perform riffle shuffles,
- and we have a chance to analyze it.

Here are three descriptions — all of them describe the same probability distribution Rif on \mathfrak{S}_n :

1. $\text{Rif} : \mathfrak{S}_n \rightarrow \mathbb{R}$ is defined by

$$\text{Rif}(\pi) := \begin{cases} \frac{n+1}{2^n} & \text{if } \pi = \text{id}, \\ \frac{1}{2^n} & \text{if } \pi \text{ consists of two increasing sequences,} \\ 0 & \text{otherwise.} \end{cases}$$

2. Cut off t cards from the deck with probability $\frac{1}{2^n} \binom{n}{t}$, take them into your right hand, and take the rest of the deck into your left hand. Now when you have r cards in the right hand and ℓ in the left, “drop” the bottom card from your right hand with probability $\frac{r}{r+\ell}$, and from your left hand with probability $\frac{\ell}{r+\ell}$. Repeat!
3. An *inverse shuffle* would take a subset of the cards in the deck, remove them from the deck, and place them on top of the remaining cards of the deck — while maintaining the relative order in both parts of the deck. Such a move is determined by the subset of the cards: Take all subsets with equal probability.

The inverse riffle shuffles correspond to the permutations $\pi = (\pi(1), \dots, \pi(n))$ that are increasing except for at most one “descent.” (Only the identity permutation has no descent.)

Equivalently, assign a label “0” or “1” to each card, randomly and independently with probabilities $\frac{1}{2}$, and move the cards labelled “0” to the top.

It is easy so see that these descriptions yield the same probability distributions. For (1) \iff (3) just observe that we get the identity permutation whenever all the 0-cards are on top of all the cards that are assigned a 1.

This defines the model. So how can we analyze it? How many riffle shuffles are needed to get close to random? We won’t get the precise best-possible answer, but quite a good one, by combining three components:

- (1) We analyze inverse riffle shuffles instead,
- (2) we describe a strong uniform stopping rule for these,
- (3) and show that the key to its analysis is given by the birthday paradox!

Theorem 2. *After performing k riffle shuffles on a deck of n cards, the variation distance from a uniform distribution satisfies*

$$\|\text{Rif}^{*k} - \text{U}\| \leq 1 - \prod_{i=1}^{n-1} \left(1 - \frac{i}{2^k}\right).$$

■ **Proof.** (1) We may indeed analyze inverse riffle shuffles and try to see how fast they get us from the starting distribution to (close to) uniform. These inverse shuffles correspond to the probability distribution that is given by $\overline{\text{Rif}}(\pi) := \text{Rif}(\pi^{-1})$.

Now the fact that every permutation has its unique inverse, and the fact that $U(\pi) = U(\pi^{-1})$, yield

$$\|\text{Rif}^{*k} - U\| = \|\overline{\text{Rif}}^{*k} - U\|.$$

(This is Reeds' inversion lemma!)

(2) In every inverse riffle shuffle, each card gets associated a digit 0 or 1:

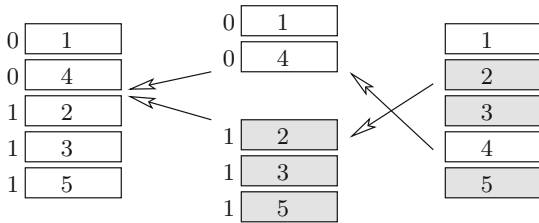

If we remember these digits — say we just write them onto the cards — then after k inverse riffle shuffles, each card has gotten an ordered string of k digits. Our stopping rule is:

“STOP as soon as all cards have distinct strings.”

When this happens, the cards in the deck are *sorted* according to the binary numbers $b_k b_{k-1} \dots b_2 b_1$, where b_i is the bit that the card has picked up in the i -th inverse riffle shuffle. Since these bits are perfectly random and independent, this stopping rule is strong uniform!

In the following example, for $n = 5$ cards, we need $T = 3$ inverse shuffles until we stop:

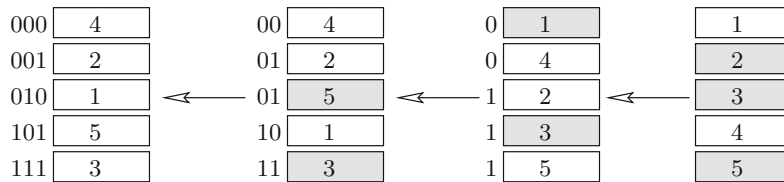

(3) The time T taken by this stopping rule is distributed according to the birthday paradox, for $K = 2^k$: We put two cards into the same box if they have the same label $b_k b_{k-1} \dots b_2 b_1 \in \{0, 1\}^k$. So there are $K = 2^k$ boxes, and the probability that some box gets more than one card is

$$\text{Prob}[T > k] = 1 - \prod_{i=1}^{n-1} \left(1 - \frac{i}{2^k}\right),$$

and as we have seen this bounds the variation distance $\|\text{Rif}^{*k} - U\| = \|\overline{\text{Rif}}^{*k} - U\|$. □

k	$d(k)$
1	1.000
2	1.000
3	1.000
4	1.000
5	0.952
6	0.614
7	0.334
8	0.167
9	0.085
10	0.043

The variation distance after k riffle shuffles, according to [2]

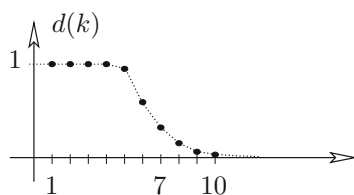

So how often do we have to shuffle? For large n we will need roughly $k = 2 \log_2(n)$ shuffles. Indeed, setting $k := 2 \log_2(cn)$ for some $c \geq 1$ we find (with a bit of calculus) that $P[T > k] \approx 1 - e^{-\frac{1}{2c^2}} \approx \frac{1}{2c^2}$.

Explicitly, for $n = 52$ cards the upper bound of Theorem 2 reads $d(10) \leq 0.73$, $d(12) \leq 0.28$, $d(14) \leq 0.08$ — so $k = 12$ should be “random enough” for all practical purposes. But we don’t do 12 shuffles “in practice” — and they are not really necessary, as a more detailed analysis shows (with the results given in the margin). The analysis of riffle shuffles is part of a lively ongoing discussion about the right measure of what is “random enough.” Diaconis [4] is a guide to recent developments.

Indeed, does it matter? Yes, it does: Even after three good riffle shuffles a sorted deck of 52 cards looks quite random ... but it isn’t. Martin Gardner [5, Chapter 7] describes a number of striking card tricks that are based on the hidden order in such a deck!

References

- [1] D. ALDOUS & P. DIACONIS: *Shuffling cards and stopping times*, Amer. Math. Monthly **93** (1986), 333-348.
- [2] D. BAYER & P. DIACONIS: *Trailing the dovetail shuffle to its lair*, Annals Applied Probability **2** (1992), 294-313.
- [3] E. BEHREND: *Introduction to Markov Chains*, Vieweg, Braunschweig/Wiesbaden 2000.
- [4] P. DIACONIS: *Mathematical developments from the analysis of riffle shuffling*, in: “Groups, Combinatorics and Geometry. Durham 2001” (A. A. Ivanov, M. W. Liebeck and J. Saxl, eds.), World Scientific, Singapore 2003, pp. 73-97.
- [5] M. GARDNER: *Mathematical Magic Show*, Knopf, New York/Allen & Unwin, London 1977.
- [6] E. N. GILBERT: *Theory of Shuffling*, Technical Memorandum, Bell Laboratories, Murray Hill NJ, 1955.



“Random enough?”



The essence of mathematics is proving theorems — and so, that is what mathematicians do: They prove theorems. But to tell the truth, what they really want to prove, once in their lifetime, is a *Lemma*, like the one by Fatou in analysis, the Lemma of Gauss in number theory, or the Burnside–Frobenius Lemma in combinatorics.

Now what makes a mathematical statement a true Lemma? First, it should be applicable to a wide variety of instances, even seemingly unrelated problems. Secondly, the statement should, once you have seen it, be completely obvious. The reaction of the reader might well be one of faint envy: Why haven't I noticed this before? And thirdly, on an esthetic level, the Lemma — including its proof — should be beautiful!

In this chapter we look at one such marvelous piece of mathematical reasoning, a counting lemma that first appeared in a paper by Bernt Lindström in 1972. Largely overlooked at the time, the result became an instant classic in 1985, when Ira Gessel and Gerard Viennot rediscovered it and demonstrated in a wonderful paper how the lemma could be successfully applied to a diversity of difficult combinatorial enumeration problems.

The starting point is the usual permutation representation of the determinant of a matrix. Let $M = (m_{ij})$ be a real $n \times n$ matrix. Then

$$\det M = \sum_{\sigma} \text{sign } \sigma m_{1\sigma(1)} m_{2\sigma(2)} \cdots m_{n\sigma(n)}, \quad (1)$$

where σ runs through all permutations of $\{1, 2, \dots, n\}$, and the sign of σ is 1 or -1 , depending on whether σ is the product of an even or an odd number of transpositions.

Now we pass to graphs, more precisely to *weighted directed bipartite* graphs. Let the vertices A_1, \dots, A_n stand for the rows of M , and B_1, \dots, B_n for the columns. For each pair of i and j draw an arrow from A_i to B_j and give it the weight m_{ij} , as in the figure.

In terms of this graph, the formula (1) has the following interpretation:

- The left-hand side is the determinant of the *path matrix* M , whose (i, j) -entry is the *weight* of the (unique) directed path from A_i to B_j .
- The right-hand side is the weighted (signed) sum over all *vertex-disjoint path systems* from $\mathcal{A} = \{A_1, \dots, A_n\}$ to $\mathcal{B} = \{B_1, \dots, B_n\}$. Such a system \mathcal{P}_σ is given by paths

$$A_1 \rightarrow B_{\sigma(1)}, \dots, A_n \rightarrow B_{\sigma(n)},$$

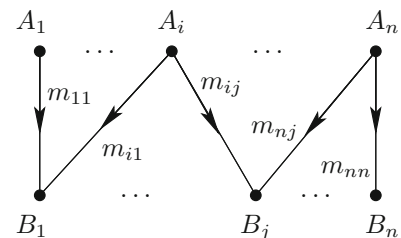

and the *weight* of the path system \mathcal{P}_σ is the product of the weights of the individual paths:

$$w(\mathcal{P}_\sigma) = w(A_1 \rightarrow B_{\sigma(1)}) \cdots w(A_n \rightarrow B_{\sigma(n)}).$$

In this interpretation formula (1) reads

$$\det M = \sum_{\sigma} \text{sign } \sigma w(\mathcal{P}_\sigma).$$

And what is the result of Gessel and Viennot? It is the natural generalization of (1) from bipartite to arbitrary graphs. It is precisely this step which makes the Lemma so widely applicable — and what's more, the proof is stupendously simple and elegant.

Let us first collect the necessary concepts. We are given a finite acyclic directed graph $G = (V, E)$, where *acyclic* means that there are no directed cycles in G . In particular, there are only finitely many directed paths between any two vertices A and B , where we include all trivial paths $A \rightarrow A$ of length 0. Every edge e carries a weight $w(e)$. If P is a directed path from A to B , written shortly $P : A \rightarrow B$, then we define the *weight* of P as

$$w(P) := \prod_{e \in P} w(e),$$

which is defined to be $w(P) = 1$ if P is a path of length 0.

Now let $\mathcal{A} = \{A_1, \dots, A_n\}$ and $\mathcal{B} = \{B_1, \dots, B_n\}$ be two sets of n vertices, where \mathcal{A} and \mathcal{B} need not be disjoint. To \mathcal{A} and \mathcal{B} we associate the *path matrix* $M = (m_{ij})$ with

$$m_{ij} := \sum_{P: A_i \rightarrow B_j} w(P).$$

A *path system* \mathcal{P} from \mathcal{A} to \mathcal{B} consists of a permutation σ together with n paths $P_i : A_i \rightarrow B_{\sigma(i)}$, for $i = 1, \dots, n$; we write $\text{sign } \mathcal{P} = \text{sign } \sigma$. The *weight* of \mathcal{P} is the product of the path weights

$$w(\mathcal{P}) = \prod_{i=1}^n w(P_i), \quad (2)$$

which is the product of the weights of all the edges of the path system.

Finally, we say that the path system $\mathcal{P} = (P_1, \dots, P_n)$ is *vertex-disjoint* if the paths of \mathcal{P} are pairwise vertex-disjoint.

Lemma. *Let $G = (V, E)$ be a finite weighted acyclic directed graph, $\mathcal{A} = \{A_1, \dots, A_n\}$ and $\mathcal{B} = \{B_1, \dots, B_n\}$ two n -sets of vertices, and M the path matrix from \mathcal{A} to \mathcal{B} . Then*

$$\det M = \sum_{\substack{\mathcal{P} \text{ vertex-disjoint} \\ \text{path system}}} \text{sign } \mathcal{P} w(\mathcal{P}). \quad (3)$$

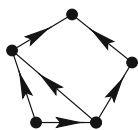

An acyclic directed graph

■ **Proof.** A typical summand of $\det(M)$ is $\text{sign } \sigma m_{1\sigma(1)} \cdots m_{n\sigma(n)}$, which can be written as

$$\text{sign } \sigma \left(\sum_{P_1: A_1 \rightarrow B_{\sigma(1)}} w(P_1) \right) \cdots \left(\sum_{P_n: A_n \rightarrow B_{\sigma(n)}} w(P_n) \right).$$

Summing over σ we immediately find from (2) that

$$\det M = \sum_{\mathcal{P}} \text{sign } \mathcal{P} w(\mathcal{P}),$$

where \mathcal{P} runs through *all* path systems from \mathcal{A} to \mathcal{B} (vertex-disjoint or not). Hence to arrive at (3), all we have to show is

$$\sum_{\mathcal{P} \in N} \text{sign } \mathcal{P} w(\mathcal{P}) = 0, \tag{4}$$

where N is the set of all path systems that are *not* vertex-disjoint. And this is accomplished by an argument of singular beauty. Namely, we exhibit an involution $\pi : N \rightarrow N$ (without fixed points) such that for \mathcal{P} and $\pi\mathcal{P}$

$$w(\pi\mathcal{P}) = w(\mathcal{P}) \quad \text{and} \quad \text{sign } \pi\mathcal{P} = -\text{sign } \mathcal{P}.$$

Clearly, this will imply (4) and thus the formula (3) of the Lemma.

The involution π is defined in the most natural way. Let $\mathcal{P} \in N$ with paths $P_i : A_i \rightarrow B_{\sigma(i)}$. By definition, some pair of paths will intersect:

- Let i_0 be the minimal index such that P_{i_0} shares some vertex with another path.
- Let X be the first such common vertex on the path P_{i_0} .
- Let j_0 be the minimal index ($j_0 > i_0$) such that P_{j_0} has the vertex X in common with P_{i_0} .

Now we construct the new system $\pi\mathcal{P} = (P'_1, \dots, P'_n)$ as follows:

- Set $P'_k = P_k$ for all $k \neq i_0, j_0$.
- The new path P'_{i_0} goes from A_{i_0} to X along P_{i_0} , and then continues to $B_{\sigma(j_0)}$ along P_{j_0} . Similarly, P'_{j_0} goes from A_{j_0} to X along P_{j_0} and continues to $B_{\sigma(i_0)}$ along P_{i_0} .

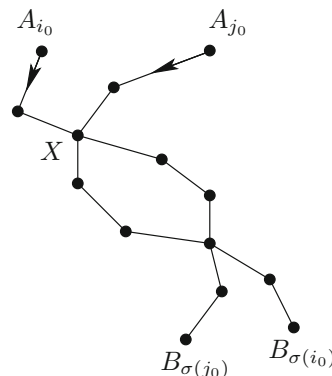

Clearly $\pi(\pi\mathcal{P}) = \mathcal{P}$, since the index i_0 , the vertex X , and the index j_0 are the same as before. In other words, applying π twice we switch back to the old paths P_i . Next, since $\pi\mathcal{P}$ and \mathcal{P} use precisely the same edges, we certainly have $w(\pi\mathcal{P}) = w(\mathcal{P})$. And finally, since the new permutation σ' is obtained by multiplying σ with the transposition (i_0, j_0) , we find that $\text{sign } \pi\mathcal{P} = -\text{sign } \mathcal{P}$, and that's it. \square

The Gessel–Viennot Lemma can be used to derive all basic properties of determinants, just by looking at appropriate graphs. Let us consider one particularly striking example, the formula of Binet–Cauchy, which gives a very useful generalization of the product rule for determinants.

Theorem. If P is an $r \times s$ matrix and Q an $s \times r$ matrix, $r \leq s$, then

$$\det(PQ) = \sum_{\mathcal{Z}} (\det P_{\mathcal{Z}})(\det Q_{\mathcal{Z}}),$$

where $P_{\mathcal{Z}}$ is the $r \times r$ submatrix of P with column-set \mathcal{Z} , and $Q_{\mathcal{Z}}$ the $r \times r$ submatrix of Q with the corresponding rows \mathcal{Z} .

■ **Proof.** Let the bipartite graph on \mathcal{A} and \mathcal{B} correspond to P as before, and similarly the bipartite graph on \mathcal{B} and \mathcal{C} to Q . Consider now the concatenated graph as indicated in the figure on the left, and observe that the (i, j) -entry m_{ij} of the path matrix M from \mathcal{A} to \mathcal{C} is precisely $m_{ij} = \sum_k p_{ik}q_{kj}$, thus $M = PQ$.

Since the vertex-disjoint path systems from \mathcal{A} to \mathcal{C} in the concatenated graph correspond to pairs of systems from \mathcal{A} to \mathcal{Z} resp. from \mathcal{Z} to \mathcal{C} , the result follows immediately from the Lemma, by noting that $\text{sign}(\sigma\tau) = (\text{sign } \sigma)(\text{sign } \tau)$. □

The Lemma of Gessel–Viennot is also the source of a great number of results that relate determinants to enumerative properties. The recipe is always the same: Interpret the matrix M as a path matrix, and try to compute the right-hand side of (3). As an illustration we will consider the original problem studied by Gessel and Viennot, which led them to their Lemma:

Suppose that $a_1 < a_2 < \dots < a_n$ and $b_1 < b_2 < \dots < b_n$ are two sets of natural numbers. We wish to compute the determinant of the matrix $M = (m_{ij})$, where m_{ij} is the binomial coefficient $\binom{a_i}{b_j}$.

In other words, Gessel and Viennot were looking at the determinants of arbitrary square matrices of Pascal’s triangle, such as the matrix

$$\det \begin{pmatrix} \binom{3}{1} & \binom{3}{3} & \binom{3}{4} \\ \binom{4}{1} & \binom{4}{3} & \binom{4}{4} \\ \binom{6}{1} & \binom{6}{3} & \binom{6}{4} \end{pmatrix} = \det \begin{pmatrix} 3 & 1 & 0 \\ 4 & 4 & 1 \\ 6 & 20 & 15 \end{pmatrix}$$

given by the bold entries of Pascal’s triangle, as displayed in the margin.

As a preliminary step to the solution of the problem we recall a well-known result which connects binomial coefficients to lattice paths. Consider an $a \times b$ -lattice as in the margin. Then the number of paths from the lower left-hand corner to the upper right-hand corner, where the only steps that are allowed for the paths are up (North) and to the right (East), is $\binom{a+b}{a}$.

The proof of this is easy: each path consists of an arbitrary sequence of b “east” and a “north” steps, and thus it can be encoded by a sequence of the form NENEEN, consisting of $a+b$ letters, a N’s and b E’s. The number of such strings is the number of ways to choose a positions of letters N from a total of $a+b$ positions, which is $\binom{a+b}{a} = \binom{a+b}{b}$.

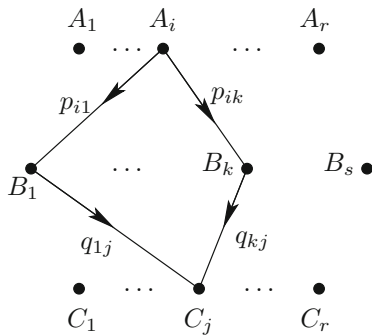

1							
1	1						
1	2	1					
1	3	3	1				
1	4	6	4	1			
1	5	10	10	5	1		
1	6	15	20	15	6	1	
1	7	21	35	35	21	7	1

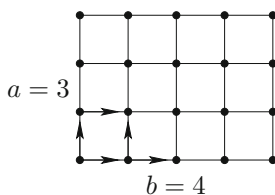

Now look at the figure to the right, where A_i is placed at the point $(0, -a_i)$ and B_j at $(b_j, -b_j)$.

The number of paths from A_i to B_j in this grid that use only steps to the north and east is, by what we just proved, $\binom{b_j + (a_i - b_j)}{b_j} = \binom{a_i}{b_j}$. In other words, the matrix of binomials M is precisely the path matrix from \mathcal{A} to \mathcal{B} in the directed lattice graph for which all edges have weight 1, and all edges are directed to go north or east. Hence to compute $\det M$ we may apply the Gessel–Viennot Lemma. A moment's thought shows that every vertex-disjoint path system \mathcal{P} from \mathcal{A} to \mathcal{B} must consist of paths $P_i : A_i \rightarrow B_i$ for all i . Thus the only possible permutation is the identity, which has sign = 1, and we obtain the beautiful result

$$\det \begin{pmatrix} \binom{a_1}{b_1} \\ \vdots \\ \binom{a_i}{b_j} \\ \vdots \\ \binom{a_n}{b_n} \end{pmatrix} = \# \text{ vertex-disjoint path systems from } \mathcal{A} \text{ to } \mathcal{B}.$$

In particular, this implies the far from obvious fact that $\det M$ is always nonnegative, since the right-hand side of the equality *counts* something. More precisely, one gets from the Gessel–Viennot Lemma that $\det M = 0$ if and only if $a_i < b_i$ for some i .

In our previous small example,

$$\det \begin{pmatrix} \binom{3}{1} & \binom{3}{3} & \binom{3}{4} \\ \binom{4}{1} & \binom{4}{3} & \binom{4}{4} \\ \binom{6}{1} & \binom{6}{3} & \binom{6}{4} \end{pmatrix} = \# \text{ vertex-disjoint path systems in}$$

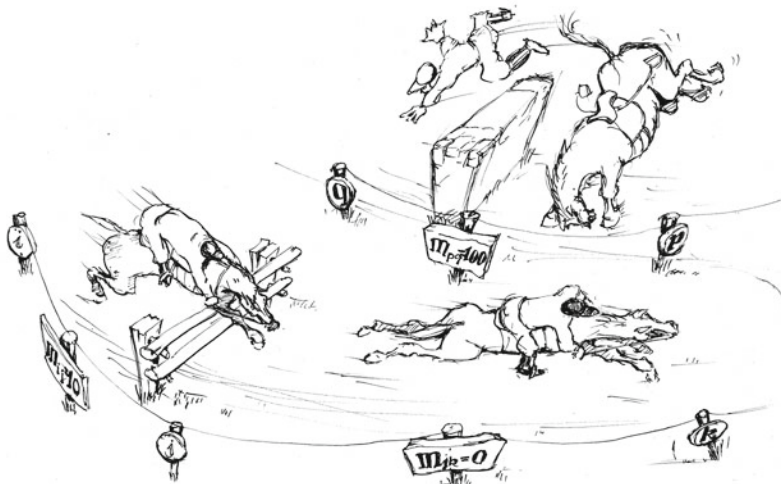
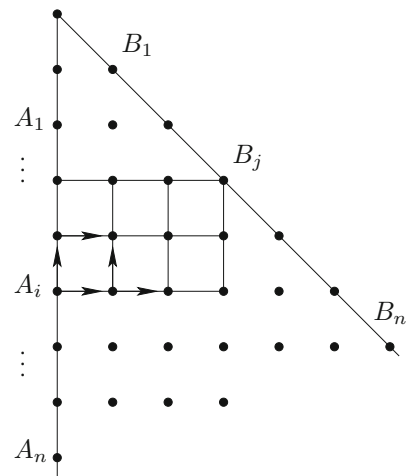
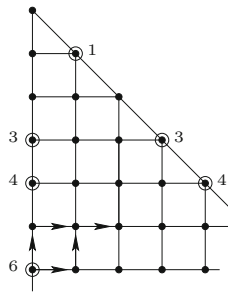

“Lattice paths”

References

- [1] I. M. GESSEL & G. VIENNOT: *Binomial determinants, paths, and hook length formulae*, Advances in Math. **58** (1985), 300-321.
- [2] B. LINDSTRÖM: *On the vector representation of induced matroids*, Bulletin London Math. Soc. **5** (1973), 85-90.

Cayley's formula for the number of trees

Chapter 33



One of the most beautiful formulas in enumerative combinatorics concerns the number of labeled trees. Consider the set $N = \{1, 2, \dots, n\}$. How many different trees can we form on this vertex set? Let us denote this number by T_n . Enumeration “by hand” yields $T_1 = 1$, $T_2 = 1$, $T_3 = 3$, $T_4 = 16$, with the trees shown in the following table:

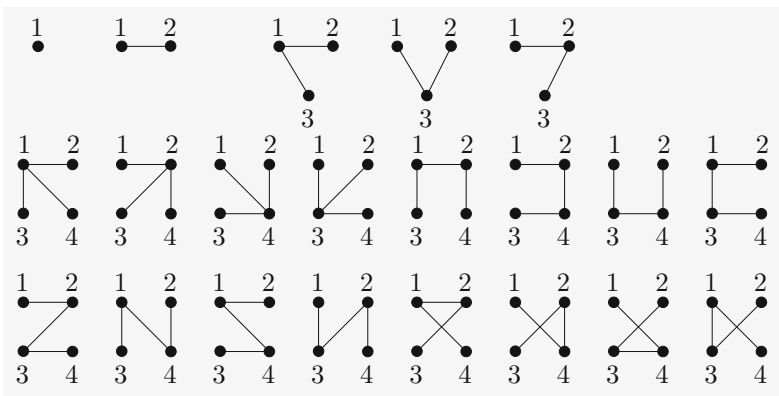

Arthur Cayley

Note that we consider *labeled* trees, that is, although there is only one tree of order 3 in the sense of graph isomorphism, there are 3 different labeled trees obtained by marking the inner vertex 1, 2 or 3. For $n = 5$ there are three nonisomorphic trees:

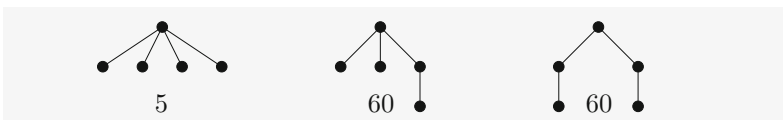

For the first tree there are clearly 5 different labelings, and for the second and third there are $\frac{5!}{2} = 60$ labelings, so we obtain $T_5 = 125$. This should be enough to conjecture $T_n = n^{n-2}$, and that is precisely Cayley's result.

Theorem. *There are n^{n-2} different labeled trees on n vertices.*

This beautiful formula yields to equally beautiful proofs, drawing on a variety of combinatorial and algebraic techniques. We will outline three of them before presenting the proof which is to date the most beautiful of them all.

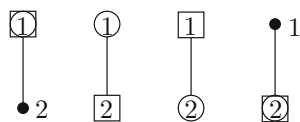

The four trees of \mathcal{T}_2

■ **First proof (Bijection).** The classical and most direct method is to find a bijection from the set of all trees on n vertices onto another set whose cardinality is known to be n^{n-2} . Naturally, the set of all ordered sequences (a_1, \dots, a_{n-2}) with $1 \leq a_i \leq n$ comes into mind. Thus we want to uniquely encode every tree T by a sequence (a_1, \dots, a_{n-2}) . Such a code was found by Prüfer and is contained in most books on graph theory.

Here we want to discuss another bijection proof, due to Joyal, which is less known but of equal elegance and simplicity. For this, we consider not just trees t on $N = \{1, \dots, n\}$ but trees together with two distinguished vertices, the *left end* \circ and the *right end* \square , which may coincide. Let $\mathcal{T}_n = \{(t; \circ, \square)\}$ be this new set; then, clearly, $|\mathcal{T}_n| = n^2 T_n$.

Our goal is thus to prove $|\mathcal{T}_n| = n^n$. Now there is a set whose size is known to be n^n , namely the set N^N of all mappings from N into N . Thus our formula is proved if we can find a bijection from N^N onto \mathcal{T}_n .

Let $f : N \rightarrow N$ be any map. We represent f as a directed graph \vec{G}_f by drawing arrows from i to $f(i)$.

For example, the map

$$f = \begin{pmatrix} 1 & 2 & 3 & 4 & 5 & 6 & 7 & 8 & 9 & 10 \\ 7 & 5 & 5 & 9 & 1 & 2 & 5 & 8 & 4 & 7 \end{pmatrix}$$

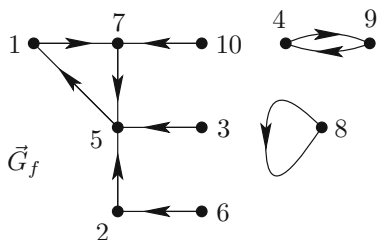

is represented by the directed graph in the margin.

Look at a component of \vec{G}_f . Since there is precisely one edge emanating from each vertex, the component contains equally many vertices and edges, and hence precisely one directed cycle. Let $M \subseteq N$ be the union of the vertex sets of these cycles. A moment's thought shows that M is the *unique* maximal subset of N such that the restriction of f onto M acts as a bijection on M . Write $f|_M = \begin{pmatrix} a & b & \dots & z \\ f(a) & f(b) & \dots & f(z) \end{pmatrix}$ such that the numbers a, b, \dots, z in the first row appear in natural order. This gives us an ordering $f(a), f(b), \dots, f(z)$ of M according to the second row. Now $f(a)$ is our left end and $f(z)$ is our right end.

The tree t corresponding to the map f is now constructed as follows: Draw $f(a), \dots, f(z)$ in this order as a *path* from $f(a)$ to $f(z)$, and fill in the remaining vertices as in \vec{G}_f (deleting the arrows).

In our example above we obtain $M = \{1, 4, 5, 7, 8, 9\}$

$$f|_M = \begin{pmatrix} 1 & 4 & 5 & 7 & 8 & 9 \\ 7 & 9 & 1 & 5 & 8 & 4 \end{pmatrix}$$

and thus the tree t depicted in the margin.

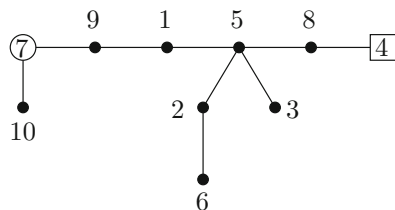

It is immediate how to reverse this correspondence: Given a tree t , we look at the unique path P from the left end to the right end. This gives us the set M and the mapping $f|_M$. The remaining correspondences $i \rightarrow f(i)$ are then filled in according to the unique paths from i to P . □

■ **Second proof (Linear Algebra).** We can think of T_n as the number of spanning trees in the complete graph K_n . Now let us look at an arbitrary connected simple graph G on $V = \{1, 2, \dots, n\}$, denoting by $t(G)$ the number of spanning trees; thus $T_n = t(K_n)$. The following celebrated result is Kirchhoff's *matrix-tree theorem* (see [1]). Consider the incidence matrix $B = (b_{ie})$ of G , whose rows are labeled by V , the columns by E , where we write $b_{ie} = 1$ or 0 depending on whether $i \in e$ or $i \notin e$. Note that $|E| \geq n - 1$ since G is connected. In every column we replace one of the two 1's by -1 in an arbitrary manner (this amounts to an orientation of G), and call the new matrix C . $M = CC^T$ is then a symmetric $n \times n$ matrix with the degrees d_1, \dots, d_n in the main diagonal.

Proposition. We have $t(G) = \det M_{ii}$ for all $i = 1, \dots, n$, where M_{ii} results from M by deleting the i -th row and the i -th column.

■ **Proof.** The key to the proof is the Binet–Cauchy theorem proved in the previous chapter: When P is an $r \times s$ matrix and Q an $s \times r$ matrix, $r \leq s$, then $\det(PQ)$ equals the sum of the products of determinants of corresponding $r \times r$ submatrices, where “corresponding” means that we take the same indices for the r columns of P and the r rows of Q .

For M_{ii} this means that

$$\det M_{ii} = \sum_N \det N \cdot \det N^T = \sum_N (\det N)^2,$$

where N runs through all $(n-1) \times (n-1)$ submatrices of $C \setminus \{\text{row } i\}$. The $n-1$ columns of N correspond to a subgraph of G with $n-1$ edges on n vertices, and it remains to show that

$$\det N = \begin{cases} \pm 1 & \text{if these edges span a tree} \\ 0 & \text{otherwise.} \end{cases}$$

Suppose the $n-1$ edges do not span a tree. Then there exists a component which does not contain i . Since the corresponding rows of this component add to 0, we infer that they are linearly dependent, and hence $\det N = 0$.

Assume now that the columns of N span a tree. Then there is a vertex $j_1 \neq i$ of degree 1; let e_1 be the incident edge. Deleting j_1, e_1 we obtain a tree with $n-2$ edges. Again there is a vertex $j_2 \neq i$ of degree 1 with incident edge e_2 . Continue in this way until j_1, j_2, \dots, j_{n-1} and e_1, e_2, \dots, e_{n-1} with $j_i \in e_i$ are determined. Now permute the rows and columns to bring j_k into the k -th row and e_k into the k -th column. Since by construction $j_k \notin e_\ell$ for $k < \ell$, we see that the new matrix N' is lower triangular with all elements on the main diagonal equal to ± 1 . Thus $\det N = \pm \det N' = \pm 1$, and we are done.

For the special case $G = K_n$ we clearly obtain

$$M_{ii} = \begin{pmatrix} n-1 & -1 & \dots & -1 \\ -1 & n-1 & & -1 \\ \vdots & & \ddots & \vdots \\ -1 & -1 & \dots & n-1 \end{pmatrix}$$

and an easy computation shows $\det M_{ii} = n^{n-2}$. \square



“A nonstandard method of counting trees: Put a cat into each tree, walk your dog, and count how often he barks.”

■ **Third proof (Recursion).** Another classical method in enumerative combinatorics is to establish a recurrence relation and to solve it by induction. The following idea is essentially due to Riordan and Rényi. To find the proper recursion, we consider a more general problem (which already appears in Cayley's paper). Let A be an arbitrary k -set of the vertices. By $T_{n,k}$ we denote the number of (labeled) forests on $\{1, \dots, n\}$ consisting of k trees where the vertices of A appear in different trees. Clearly, the set A does not matter, only the size k . Note that $T_{n,1} = T_n$.

For example, $T_{4,2} = 8$ for $A = \{1, 2\}$

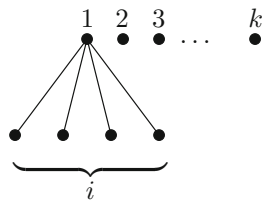
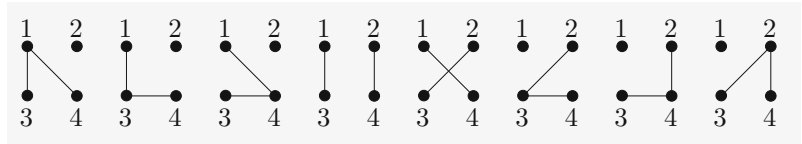

Consider such a forest F with $A = \{1, 2, \dots, k\}$, and suppose 1 is adjacent to i vertices, as indicated in the margin. Deleting 1, the i neighbors together with $2, \dots, k$ yield one vertex each in the components of a forest that consists of $k - 1 + i$ trees. As we can (re)construct F by first fixing i , then choosing the i neighbors of 1 and then the forest $F \setminus 1$, this yields

$$T_{n,k} = \sum_{i=0}^{n-k} \binom{n-k}{i} T_{n-1,k-1+i} \tag{1}$$

for all $n \geq k \geq 1$, where we set $T_{0,0} = 1, T_{n,0} = 0$ for $n > 0$. Note that $T_{0,0} = 1$ is necessary to ensure $T_{n,n} = 1$.

Proposition. We have

$$T_{n,k} = k n^{n-k-1} \tag{2}$$

and thus, in particular,

$$T_{n,1} = T_n = n^{n-2}.$$

■ **Proof.** By (1), and using induction, we find

$$\begin{aligned} T_{n,k} &= \sum_{i=0}^{n-k} \binom{n-k}{i} (k-1+i)(n-1)^{n-1-k-i} \quad (i \rightarrow n-k-i) \\ &= \sum_{i=0}^{n-k} \binom{n-k}{i} (n-1-i)(n-1)^{i-1} \\ &= \sum_{i=0}^{n-k} \binom{n-k}{i} (n-1)^i - \sum_{i=1}^{n-k} \binom{n-k}{i} i(n-1)^{i-1} \\ &= n^{n-k} - (n-k) \sum_{i=1}^{n-k} \binom{n-1-k}{i-1} (n-1)^{i-1} \\ &= n^{n-k} - (n-k) \sum_{i=0}^{n-1-k} \binom{n-1-k}{i} (n-1)^i \\ &= n^{n-k} - (n-k)n^{n-1-k} = k n^{n-1-k}. \quad \square \end{aligned}$$

■ **Fourth proof (Double Counting).** The following marvelous proof due to Arnon Avron and Nachum Dershowitz, which builds on an idea of Jim Pitman, gives Cayley's formula and its generalization (2) without induction or bijection — it is just clever counting in two ways.

We consider labeled forests with vertex set $\{1, \dots, n\}$. A *rooted forest* is a forest together with a choice of a root in each component tree. Let $\mathcal{F}_{n,k}$ be the set of all rooted forests that consist of k rooted trees. Thus $\mathcal{F}_{n,1}$ is the set of all rooted trees. Let us set $F_{n,k} := |\mathcal{F}_{n,k}|$, and note that $F_{n,k} = \binom{n}{k} T_{n,k}$, with $T_{n,k}$ as in the third proof, since we may choose the k roots in $\binom{n}{k}$ possible ways.

Here is the crucial idea: We count in two ways the number of rooted forests on n vertices that consist of k trees and have one distinguished non-root vertex. This will yield the equality

$$(n - k) F_{n,k} = kn F_{n,k+1}. \tag{3}$$

The left side is clear: In every forest $F \in \mathcal{F}_{n,k}$, we may choose any one of the $n - k$ non-root vertices as the distinguished vertex.

For the expression on the right side, consider a forest $F' \in \mathcal{F}_{n,k+1}$. Choose one of the n vertices in F' , say v , and attach to it any one of the k trees that do *not* contain v . The root of the chosen tree becomes the distinguished vertex. (This is illustrated in the figure.)

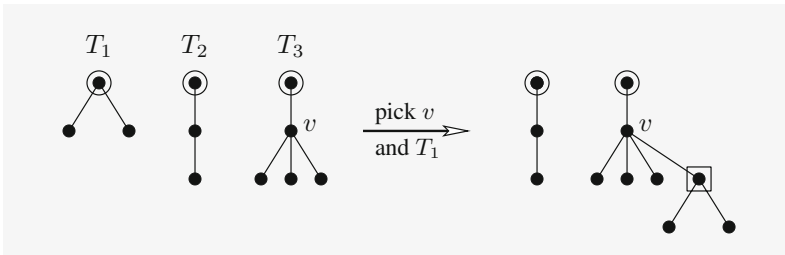

Illustration of the right side of (3).

As there are n choices for v and k choices for the tree that does not contain v , we get $knF_{n,k+1}$ choices altogether. All rooted forests in $\mathcal{F}_{n,k}$ with a distinguished non-root vertex arise uniquely in this process.

Iterating (3) $n - 1$ times, we obtain

$$\begin{aligned} F_{n,1} &= \frac{1}{n-1} n F_{n,2} = \frac{1}{n-1} \frac{2}{n-2} n^2 F_{n,3} = \dots \\ &= \frac{1 \cdot 2 \cdot \dots \cdot (k-1)}{(n-1)(n-2) \cdot \dots \cdot (n-k+1)} n^{k-1} F_{n,k} = \dots \\ &= \frac{1 \cdot 2 \cdot \dots \cdot (n-1)}{(n-1)(n-2) \cdot \dots \cdot 1} n^{n-1} F_{n,n} = n^{n-1} F_{n,n}. \end{aligned}$$

Since there is only one forest in $\mathcal{F}_{n,n}$ (each root being its own tree), we have $F_{n,n} = 1$ and conclude that $F_{n,1} = n^{n-1}$. \square

We get even more out of this proof, namely that

$$F_{n,k} = \binom{n-1}{k-1} n^{n-k} = \binom{n}{k} k n^{n-k-1}.$$

With $F_{n,k} = \binom{n}{k} T_{n,k}$ we have reproved the formula $T_{n,k} = k n^{n-k-1}$ without recourse to induction.

Let us end with a historical note. Cayley's paper from 1889 was anticipated by Carl W. Borchardt (1860), and this fact was acknowledged by Cayley himself. An equivalent result appeared even earlier in a paper of James J. Sylvester (1857), see [3, Chapter 3]. The novelty in Cayley's paper was the use of graph theory terms, and the theorem has been associated with his name ever since.

References

- [1] M. AIGNER: *Combinatorial Theory*, Springer-Verlag, Berlin Heidelberg New York 1979; Reprint 1997.
- [2] A. AVRON & N. DERSHOWITZ: *Cayley's formula: A page from The Book*, Amer. Math. Monthly **123** (2016), 699-700.
- [3] N. L. BIGGS, E. K. LLOYD & R. J. WILSON: *Graph Theory 1736-1936*, Clarendon Press, Oxford 1976.
- [4] A. CAYLEY: *A theorem on trees*, Quart. J. Pure Appl. Math. **23** (1889), 376-378; Collected Mathematical Papers Vol. 13, Cambridge University Press 1897, 26-28.
- [5] A. JOYAL: *Une théorie combinatoire des séries formelles*, Advances in Math. **42** (1981), 1-82.
- [6] J. PITMAN: *Coalescent random forests*, J. Combinatorial Theory, Ser. A **85** (1999), 165-193.
- [7] H. PRÜFER: *Neuer Beweis eines Satzes über Permutationen*, Archiv der Math. u. Physik (3) **27** (1918), 142-144.
- [8] A. RÉNYI: *Some remarks on the theory of trees*. MTA Mat. Kut. Inst. Kozl. (Publ. math. Inst. Hungar. Acad. Sci.) **4** (1959), 73-85; Selected Papers Vol. 2, Akadémiai Kiadó, Budapest 1976, 363-374.
- [9] J. RIORDAN: *Forests of labeled trees*, J. Combinatorial Theory **5** (1968), 90-103.



Consider the infinite product $(1 + x)(1 + x^2)(1 + x^3)(1 + x^4) \dots$ and expand it in the usual way into a series $\sum_{n \geq 0} a_n x^n$ by grouping together those products that yield the same power x^n . By inspection we find for the first terms

$$\prod_{k \geq 1} (1 + x^k) = 1 + x + x^2 + 2x^3 + 2x^4 + 3x^5 + 4x^6 + 5x^7 + \dots \quad (1)$$

So we have e. g. $a_6 = 4$, $a_7 = 5$, and we (rightfully) suspect that a_n goes to infinity with $n \rightarrow \infty$.

Looking at the equally simple product $(1 - x)(1 - x^2)(1 - x^3)(1 - x^4) \dots$ something unexpected happens. Expanding this product we obtain

$$\prod_{k \geq 1} (1 - x^k) = 1 - x - x^2 + x^5 + x^7 - x^{12} - x^{15} + x^{22} + x^{26} - \dots \quad (2)$$

It seems that all coefficients are equal to 1, -1 or 0. But is this true? And if so, what is the pattern?

Infinite sums and products and their convergence have played a central role in analysis since the invention of the calculus, and contributions to the subject have been made by some of the greatest names in the field, from Leonhard Euler to Srinivasa Ramanujan.

In explaining identities such as (1) and (2), however, we disregard convergence questions — we simply manipulate the coefficients. In the language of the trade we deal with “formal” power series and products. In this framework we are going to show how combinatorial arguments lead to elegant proofs of seemingly difficult identities.

Our basic notion is that of a *partition* of a natural number. We call any sum

$$\lambda : n = \lambda_1 + \lambda_2 + \dots + \lambda_t \quad \text{with} \quad \lambda_1 \geq \lambda_2 \geq \dots \geq \lambda_t \geq 1$$

a *partition* of n . $P(n)$ shall be the set of all partitions of n , with $p(n) := |P(n)|$, where we set $p(0) = 1$.

What have partitions got to do with our problem? Well, consider the following product of infinitely many series:

$$(1 + x + x^2 + x^3 + \dots)(1 + x^2 + x^4 + x^6 + \dots)(1 + x^3 + x^6 + x^9 + \dots) \dots \quad (3)$$

where the k -th factor is $(1 + x^k + x^{2k} + x^{3k} + \dots)$. What is the coefficient of x^n when we expand this product into a series $\sum_{n \geq 0} a_n x^n$? A moment's

- 5 = 5
- 5 = 4 + 1
- 5 = 3 + 2
- 5 = 3 + 1 + 1
- 5 = 2 + 2 + 1
- 5 = 2 + 1 + 1 + 1
- 5 = 1 + 1 + 1 + 1 + 1.

The partitions counted by $p(5) = 7$

thought should convince you that this is just the number of ways to write n as a sum

$$\begin{aligned} n &= n_1 \cdot 1 + n_2 \cdot 2 + n_3 \cdot 3 + \dots \\ &= \underbrace{1 + \dots + 1}_{n_1} + \underbrace{2 + \dots + 2}_{n_2} + \underbrace{3 + \dots + 3}_{n_3} + \dots \end{aligned}$$

So the coefficient is nothing else but the number $p(n)$ of partitions of n . Since the geometric series $1 + x^k + x^{2k} + \dots$ equals $\frac{1}{1-x^k}$, we have proved our first identity:

$$\prod_{k \geq 1} \frac{1}{1-x^k} = \sum_{n \geq 0} p(n) x^n. \tag{4}$$

What's more, we see from our analysis that the factor $\frac{1}{1-x^k}$ accounts for the contribution of k to a partition of n . Thus, if we leave out $\frac{1}{1-x^k}$ from the product on the left side of (4), then k does not appear in any partition on the right side. As an example we immediately obtain

- 6 = 5 + 1
- 6 = 3 + 3
- 6 = 3 + 1 + 1 + 1
- 6 = 1 + 1 + 1 + 1 + 1 + 1

Partitions of 6 into odd parts: $p_o(6) = 4$

$$\prod_{i \geq 1} \frac{1}{1-x^{2i-1}} = \sum_{n \geq 0} p_o(n) x^n, \tag{5}$$

where $p_o(n)$ is the number of partitions of n all of whose summands are *odd*, and the analogous statement holds when all summands are *even*.

By now it should be clear what the n -th coefficient in the infinite product $\prod_{k \geq 1} (1 + x^k)$ will be. Since we take from any factor in (3) either 1 or x^k , this means that we consider only those partitions where any summand k appears at most once. In other words, our original product (1) is expanded into

$$\prod_{k \geq 1} (1 + x^k) = \sum_{n \geq 0} p_d(n) x^n, \tag{6}$$

- 7 = 7
- 7 = 5 + 1 + 1
- 7 = 3 + 3 + 1
- 7 = 3 + 1 + 1 + 1 + 1
- 7 = 1 + 1 + 1 + 1 + 1 + 1 + 1

The partitions of 7 into odd resp. distinct parts: $p_o(7) = p_d(7) = 5$.

where $p_d(n)$ is the number of partitions of n into *distinct* summands. Now the method of formal series displays its full power. Since $1 - x^2 = (1 - x)(1 + x)$ we may write

$$\prod_{k \geq 1} (1 + x^k) = \prod_{k \geq 1} \frac{1 - x^{2k}}{1 - x^k} = \prod_{k \geq 1} \frac{1}{1 - x^{2k-1}}$$

since all factors $1 - x^{2i}$ with even exponent cancel out. So, the infinite products in (5) and (6) are the same, and hence also the series, and we obtain the beautiful result

$$p_o(n) = p_d(n) \quad \text{for all } n \geq 0. \tag{7}$$

Such a striking equality demands a simple proof by bijection — at least that is the point of view of any combinatorialist.

Problem. Let $P_o(n)$ and $P_d(n)$ be the partitions of n into odd and into distinct summands, respectively: Find a bijection from $P_o(n)$ onto $P_d(n)$!

Several bijections are known, but the following one due to J. W. L. Glaisher (1907) is perhaps the neatest. Let λ be a partition of n into odd parts. We collect equal summands and have

$$\begin{aligned} n &= \underbrace{\lambda_1 + \dots + \lambda_1}_{n_1} + \underbrace{\lambda_2 + \dots + \lambda_2}_{n_2} + \dots + \underbrace{\lambda_t + \dots + \lambda_t}_{n_t} \\ &= n_1 \cdot \lambda_1 + n_2 \cdot \lambda_2 + \dots + n_t \cdot \lambda_t. \end{aligned}$$

Now we write $n_1 = 2^{m_1} + 2^{m_2} + \dots + 2^{m_r}$ in its binary representation and similarly for the other n_i . The new partition λ' of n is then

$$\lambda' : n = 2^{m_1} \lambda_1 + 2^{m_2} \lambda_1 + \dots + 2^{m_r} \lambda_1 + 2^{k_1} \lambda_2 + \dots .$$

We have to check that λ' is in $P_d(n)$, and that $\phi : \lambda \mapsto \lambda'$ is indeed a bijection. Both claims are easy to verify: If $2^a \lambda_i = 2^b \lambda_j$ then $2^a = 2^b$ since λ_i and λ_j are odd, and so $\lambda_i = \lambda_j$. Hence λ' is in $P_d(n)$. Conversely, when $n = \mu_1 + \mu_2 + \dots + \mu_s$ is a partition into distinct summands, then we reverse the bijection by collecting all μ_i with the same highest power of 2, and write down the odd parts with the proper multiplicity. The margin displays an example.

Manipulating formal products has thus led to the equality $p_o(n) = p_d(n)$ for partitions which we then verified via a bijection. Now we turn this around, give a bijection proof for partitions and deduce an identity. This time our goal is to identify the pattern in the expansion (2).

Look at

$$1 - x - x^2 + x^5 + x^7 - x^{12} - x^{15} + x^{22} + x^{26} - x^{35} - x^{40} + \dots .$$

The exponents (apart from 0) seem to come in pairs, and taking the exponents of the first power in each pair gives the sequence

$$1 \quad 5 \quad 12 \quad 22 \quad 35 \quad 51 \quad 70 \quad \dots$$

well-known to Euler. These are the *pentagonal numbers* $f(j)$, whose name is suggested by the figure in the margin.

We easily compute $f(j) = \frac{3j^2-j}{2}$ and $\bar{f}(j) = \frac{3j^2+j}{2}$ for the other number of each pair. In summary, we conjecture, as Euler has done, that the following formula should hold.

For example,

$$\lambda : 25 = 5+5+5+3+3+1+1+1+1$$

is mapped by ϕ to

$$\begin{aligned} \lambda' : 25 &= (2+1)5 + (2)3 + (4)1 \\ &= 10 + 5 + 6 + 4 \\ &= 10 + 6 + 5 + 4. \end{aligned}$$

We write

$$\begin{aligned} \lambda' : 30 &= 12 + 6 + 5 + 4 + 3 \\ \text{as } 30 &= 4(3+1) + 2(3) + 1(5+3) \\ &= (1)5 + (4+2+1)3 + (4)1 \end{aligned}$$

and obtain as $\phi^{-1}(\lambda')$ the partition

$$\lambda : 30 = 5 + 3 + 3 + 3 + 3 + 3 + 3 + 3 + 1 + 1 + 1 + 1$$

into odd summands.

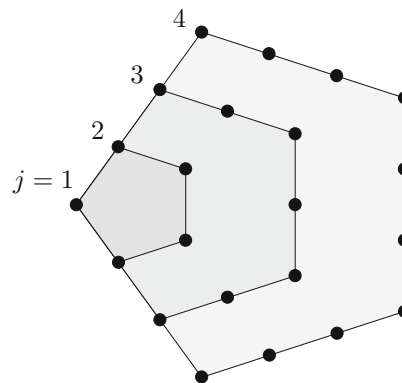

Pentagonal numbers

Theorem.

$$\prod_{k \geq 1} (1 - x^k) = 1 + \sum_{j \geq 1} (-1)^j \left(x^{\frac{3j^2-j}{2}} + x^{\frac{3j^2+j}{2}} \right). \quad (8)$$

Euler proved this remarkable theorem by calculations with formal series, but we give a bijection proof from *The Book*. First of all, we notice by (4) that the product $\prod_{k \geq 1} (1 - x^k)$ is precisely the inverse of our partition series $\sum_{n \geq 0} p(n)x^n$. Hence setting $\prod_{k \geq 1} (1 - x^k) =: \sum_{n \geq 0} c(n)x^n$, we find

$$\left(\sum_{n \geq 0} c(n)x^n \right) \cdot \left(\sum_{n \geq 0} p(n)x^n \right) = 1.$$

Comparing coefficients this means that $c(n)$ is the *unique* sequence with $c(0) = 1$ and

$$\sum_{k=0}^n c(k)p(n-k) = 0 \quad \text{for all } n \geq 1. \quad (9)$$

Writing the right-hand of (8) as $\sum_{j=-\infty}^{\infty} (-1)^j x^{\frac{3j^2+j}{2}}$, we have to show that

$$c(k) = \begin{cases} 1 & \text{for } k = \frac{3j^2+j}{2}, \text{ when } j \in \mathbb{Z} \text{ is even,} \\ -1 & \text{for } k = \frac{3j^2+j}{2}, \text{ when } j \in \mathbb{Z} \text{ is odd,} \\ 0 & \text{otherwise} \end{cases}$$

gives this unique sequence. Setting $b(j) = \frac{3j^2+j}{2}$ for $j \in \mathbb{Z}$ and substituting these values into (9), our conjecture takes on the simple form

$$\sum_{j \text{ even}} p(n - b(j)) = \sum_{j \text{ odd}} p(n - b(j)) \quad \text{for all } n,$$

where of course we only consider j with $b(j) \leq n$. So the stage is set: We have to find a bijection

$$\phi : \bigcup_{j \text{ even}} P(n - b(j)) \longrightarrow \bigcup_{j \text{ odd}} P(n - b(j)).$$

Again several bijections have been suggested, but the following construction by David Bressoud and Doron Zeilberger is astonishingly simple. We just give the definition of ϕ (which is, in fact, an involution), and invite the reader to verify the easy details.

For $\lambda : \lambda_1 + \cdots + \lambda_t \in P(n - b(j))$ set

As an example consider $n = 15$, $j = 2$, so $b(2) = 7$. The partition $3 + 2 + 2 + 1$ in $P(15 - b(2)) = P(8)$ is mapped to $9 + 2 + 1 + 1$, which is in $P(15 - b(1)) = P(13)$.

$$\phi(\lambda) := \begin{cases} (t + 3j - 1) + (\lambda_1 - 1) + \cdots + (\lambda_t - 1) & \text{if } t + 3j \geq \lambda_1, \\ (\lambda_2 + 1) + \cdots + (\lambda_t + 1) + \underbrace{1 + \cdots + 1}_{\lambda_1 - t - 3j - 1} & \text{if } t + 3j < \lambda_1, \end{cases}$$

where we leave out possible 0's. One finds that in the first case $\phi(\lambda)$ is in $P(n - b(j - 1))$, and in the second case in $P(n - b(j + 1))$.

This was beautiful, and we can get even more out of it. We already know that

$$\prod_{k \geq 1} (1 + x^k) = \sum_{n \geq 0} p_d(n) x^n.$$

As experienced formal series manipulators we notice that the introduction of the new variable y yields

$$\prod_{k \geq 1} (1 + yx^k) = \sum_{n, m \geq 0} p_{d,m}(n) x^n y^m,$$

where $p_{d,m}(n)$ counts the partitions of n into precisely m distinct summands. With $y = -1$ this yields

$$\prod_{k \geq 1} (1 - x^k) = \sum_{n \geq 0} (E_d(n) - O_d(n)) x^n, \tag{10}$$

where $E_d(n)$ is the number of partitions of n into an *even* number of distinct parts, and $O_d(n)$ is the number of partitions into an *odd* number. And here is the punchline. Comparing (10) to Euler’s expansion in (8) we infer the beautiful result

$$E_d(n) - O_d(n) = \begin{cases} 1 & \text{for } n = \frac{3j^2 \pm j}{2} \text{ when } j \geq 0 \text{ is even,} \\ -1 & \text{for } n = \frac{3j^2 \pm j}{2} \text{ when } j \geq 1 \text{ is odd,} \\ 0 & \text{otherwise.} \end{cases}$$

An example for $n = 10$:

- 10 = 9 + 1
- 10 = 8 + 2
- 10 = 7 + 3
- 10 = 6 + 4
- 10 = 4 + 3 + 2 + 1
- and
- 10 = 10
- 10 = 7 + 2 + 1
- 10 = 6 + 3 + 1
- 10 = 5 + 4 + 1
- 10 = 5 + 3 + 2,
- so $E_d(10) = O_d(10) = 5$.

This is, of course, just the beginning of a longer and still ongoing story. The theory of infinite products is replete with unexpected identities, and with their bijective counterparts. The most famous examples are the so-called Rogers–Ramanujan identities, named after Leonard Rogers and Srinivasa Ramanujan, in which the number 5 plays a mysterious role:

$$\prod_{k \geq 1} \frac{1}{(1 - x^{5k-4})(1 - x^{5k-1})} = \sum_{n \geq 0} \frac{x^{n^2}}{(1 - x)(1 - x^2) \cdots (1 - x^n)},$$

$$\prod_{k \geq 1} \frac{1}{(1 - x^{5k-3})(1 - x^{5k-2})} = \sum_{n \geq 0} \frac{x^{n^2+n}}{(1 - x)(1 - x^2) \cdots (1 - x^n)}.$$

The reader is invited to translate them into the following partition identities first noted by Percy MacMahon:

- Let $f(n)$ be the number of partitions of n all of whose summands are of the form $5k + 1$ or $5k + 4$, and $g(n)$ the number of partitions whose summands differ by at least 2. Then $f(n) = g(n)$.
- Let $r(n)$ be the number of partitions of n all of whose summands are of the form $5k + 2$ or $5k + 3$, and $s(n)$ the number of partitions whose parts differ by at least 2 and which do not contain 1. Then $r(n) = s(n)$.

All known formal series proofs of the Rogers–Ramanujan identities are quite involved, and for a long time bijection proofs of $f(n) = g(n)$ and of $r(n) = s(n)$ seemed elusive. Such proofs were eventually given 1981 by Adriano Garsia and Stephen Milne. Their bijections are, however, very complicated — Book proofs are not yet in sight.



Srinivasa Ramanujan

References

- [1] G. E. ANDREWS: *The Theory of Partitions*, Encyclopedia of Mathematics and its Applications, Vol. 2, Addison-Wesley, Reading MA 1976.
- [2] D. BRESSOUD & D. ZEILBERGER: *Bijection Euler's partitions-recurrence*, Amer. Math. Monthly **92** (1985), 54-55.
- [3] A. GARSIA & S. MILNE: *A Rogers–Ramanujan bijection*, J. Combinatorial Theory, Ser. A **31** (1981), 289-339.
- [4] S. RAMANUJAN: *Proof of certain identities in combinatory analysis*, Proc. Cambridge Phil. Soc. **19** (1919), 214-216.
- [5] L. J. ROGERS: *Second memoir on the expansion of certain infinite products*, Proc. London Math. Soc. **25** (1894), 318-343.



“How small can a set in the plane be in which you can turn a needle of length 1 completely around?”

This beautiful question was posed by the Japanese mathematician Sōichi Kakeya in 1917. It gained immediate prominence and, together with its higher-dimensional analogs, helped initiate a whole new field, today called *geometric measure theory*. To be precise, by “turning around” Kakeya had a continuous motion in mind that returns the needle to the original position with its ends reversed, like a Samurai whirling his pole. Any such motion takes place in a compact subset of the plane.

Obviously, a disk of diameter 1 is such a *Kakeya needle set* (of area $\frac{\pi}{4} \approx 0.785$), as is the equilateral triangle of height 1 that has area $\frac{1}{\sqrt{3}} \approx 0.577$. For *convex* regions Julius Pal showed that this is the minimum, but in general we can do better: The three-pointed *deltoid* in the margin is also a Kakeya needle set, as seen by moving the inner point around the small circle. The area of the deltoid is $\frac{\pi}{8} \approx 0.393$, and Kakeya seems to have thought that this is the minimum for connected sets.

So it was a big surprise when a few years after the question was posed Abram Samoilovitch Besicovitch produced needle sets of arbitrarily small area. His examples were rather complicated with many holes and large diameter, but in a remarkable paper Frederick Cunningham Jr. showed that one can even find simply connected needle sets of arbitrarily small area inside the circle of diameter 2.

As a matter of fact, Besicovitch was initially interested in a closely related problem, which he then applied to solve the needle problem. Call a compact set $K \subseteq \mathbb{R}^n$ a *Kakeya set* (or, more aptly, a *Besicovitch set*) if it contains a unit line segment in every direction. Besicovitch proved the spectacular result that for every dimension there are Kakeya sets of measure 0. But how can this be? Our intuition tells us that these sets need to be somehow spread out, since they contain segments in every direction! (In contrast, one can show that all Kakeya needle sets, which not only contain a needle in every direction, but in which the needle can turn, have positive measure.)

Now these were the years when the notion of (topological) dimension came into being at the hands of Lebesgue, Menger, Hausdorff and others, which precisely captured this “spreading out” by various covering conditions; here we use the Hausdorff dimension $\text{hd}(K)$. We don’t need the details of the

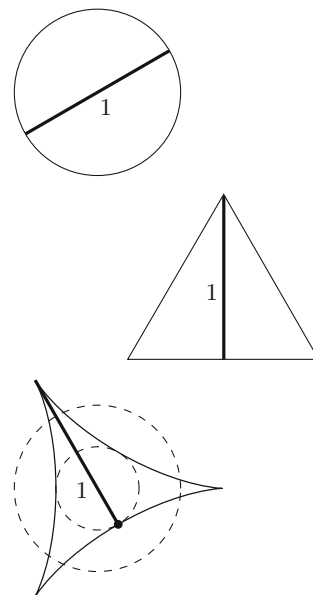

definition: Let us just note that the Euclidean space \mathbb{R}^n has Hausdorff dimension n , and that hd is a monotone function, so every $K \subseteq \mathbb{R}^n$ satisfies $\text{hd}(K) \leq n$.

The Kakeya conjecture. *Every Kakeya set in \mathbb{R}^n has Hausdorff dimension n .*

The conjecture is true for $n = 1$ and 2 , but it is open for all $n \geq 3$, and it appears to get more difficult as the dimension increases. Today it is considered to be one of the major open problems in geometric measure theory.

In an inspiring paper from 1999 Thomas Wolff gave the problem a completely new twist by suggesting to look at *finite* fields F . Consider the vector space F^n . Let us call $K \subseteq F^n$ a (*finite*) *Kakeya set* if K contains a line in every direction, meaning that to every nonzero vector $v \in F^n$ there exists some $w \in F^n$ such that the line $L = \{w + tv : t \in F\}$ is in K . Wolff posed the following finite version of the Euclidean Kakeya problem:

The finite Kakeya problem. *Is there a constant $c = c(n)$, only depending on n but not on $|F|$, such that every Kakeya set $K \subseteq F^n$ satisfies*

$$|K| \geq c|F|^n?$$

Clearly, this is true for $n = 1$, the only Kakeya set being all of F , and it is not hard to prove for $n = 2$, but for higher dimensions progress was again slow, until Zeev Dvir provided in his 2008 dissertation a beautiful and stunningly simple proof: All we need are two results about polynomials in n variables!

Let us fix some notation. $F[x_1, \dots, x_n]$ denotes the ring of polynomials $p(x_1, \dots, x_n)$ over the finite field F . A monomial $x_1^{s_1} \cdots x_n^{s_n}$ is sometimes written shortly as x^s , where $\sum_{i=1}^n s_i$ is the degree of x^s . The *degree* $\deg p$ of $p(x) = \sum a_s x^s$ is the maximum degree of the monomials x^s with nonzero coefficient a_s . The *zero polynomial* has all $a_s = 0$ and is said to have degree -1 . The polynomial $p(x)$ *vanishes* on $E \subseteq F^n$ if $p(a) = 0$ holds for all $a \in E$.

The two ingredients of the proof generalize the following well-known facts about polynomials in one variable:

- (1) Every polynomial of degree $d \geq 0$ in one variable has at most d roots.
- (2) For every set $E \subseteq F$ of size $|E| \leq d$ there is a nonzero polynomial $p(x)$ of degree at most d that vanishes on E .

In the following $q = |F|$ shall denote the size of F .

Just take $p_E(x) := \prod_{a \in E} (x - a)$.

In particular, a nonzero polynomial can vanish on all of F .

Lemma 1. Every nonzero polynomial $p(x) \in F[x_1, \dots, x_n]$ of degree d has at most dq^{n-1} roots in F^n .

■ **Proof.** We use induction on n , with fact (1) above as the starting case $n = 1$. Let us split $p(x)$ into summands according to the powers of x_n ,

$$p(x) = g_0 + g_1x_n + g_2x_n^2 + \dots + g_\ell x_n^\ell,$$

where $g_i \in F[x_1, \dots, x_{n-1}]$ for $0 \leq i \leq \ell \leq d$, and g_ℓ is nonzero. We write every $v \in F^n$ in the form $v = (a, b)$ with $a \in F^{n-1}$, $b \in F$, and estimate the number of roots $p(a, b) = 0$.

Case 1. Roots (a, b) with $g_\ell(a) = 0$.

Since $g_\ell \neq 0$ and $\deg g_\ell \leq d - \ell$, by induction the polynomial g_ℓ has at most $(d - \ell)q^{n-2}$ roots in F^{n-1} , and for each a there are at most q different choices for b , which gives at most $(d - \ell)q^{n-1}$ such roots for $p(x)$ in F^n .

Case 2. Roots (a, b) with $g_\ell(a) \neq 0$.

Here $p(a, x_n) \in F[x_n]$ is not the zero polynomial in the single variable x_n , it has degree ℓ , and hence for each a by (1) there are at most ℓ elements b with $p(a, b) = 0$. Since the number of a 's is at most q^{n-1} we get at most ℓq^{n-1} roots for $p(x)$ in this way.

Summing the two cases gives at most

$$(d - \ell)q^{n-1} + \ell q^{n-1} = dq^{n-1}$$

roots for $p(x)$, as asserted. □

Lemma 2. For every set $E \subseteq F^n$ of size $|E| < \binom{n+d}{d}$ there is a nonzero polynomial $p(x) \in F[x_1, \dots, x_n]$ of degree at most d that vanishes on E .

■ **Proof.** Consider the vector space V_d of all polynomials in $F[x_1, \dots, x_n]$ of degree at most d . A basis for V_d is provided by the monomials $x_1^{s_1} \dots x_n^{s_n}$ with $\sum s_i \leq d$:

$$1, x_1, \dots, x_n, x_1^2, x_1x_2, \dots, x_1^3, \dots, x_n^d.$$

The following pleasing argument shows that the number of monomials $x_1^{s_1} \dots x_n^{s_n}$ of degree at most d equals the binomial coefficient $\binom{n+d}{d}$. What we want to count is the number of n -tuples (s_1, \dots, s_n) of nonnegative integers with $s_1 + \dots + s_n \leq d$. To do this, we map every n -tuple (s_1, \dots, s_n) to the increasing sequence

$$s_1 + 1 < s_1 + s_2 + 2 < \dots < s_1 + \dots + s_n + n,$$

which determines an n -subset of $\{1, 2, \dots, d + n\}$. The map is bijective, so the number of monomials is $\binom{d+n}{n} = \binom{n+d}{d}$.

Next look at the vector space F^E of all functions $f : E \rightarrow F$; it has dimension $|E|$, which by assumption is less than $\binom{n+d}{d} = \dim V_d$. The evaluation map $p(x) \mapsto (p(a))_{a \in E}$ from V_d to F^E is a linear map of vector spaces. We conclude that it has a nonzero kernel, containing as desired a nonzero polynomial that vanishes on E . □

For $n = 2$ and $d = 3$ we get a basis of size $\binom{2+3}{3} = 10$: $\{1, x_1, x_2, x_1^2, x_1x_2, x_2^2, x_1^3, x_1^2x_2, x_1x_2^2, x_2^3\}$

Now we have all things needed to give Dvir's elegant solution of the finite Kakeya problem.

Theorem. *Let $K \subseteq F^n$ be a Kakeya set. Then*

$$|K| \geq \binom{|F| + n - 1}{n} \geq \frac{|F|^n}{n!}.$$

■ **Proof.** The second inequality is clear from the definition of binomial coefficients. For the first, set again $q = |F|$ and suppose for a contradiction that

$$|K| < \binom{q + n - 1}{n} = \binom{n + q - 1}{q - 1}.$$

By Lemma 2 there exists a nonzero polynomial $p(x) \in F[x_1, \dots, x_n]$ of degree $d \leq q - 1$ that vanishes on K . Let us write

$$p(x) = p_0(x) + p_1(x) + \dots + p_d(x), \quad (1)$$

where $p_i(x)$ is the sum of the monomials of degree i ; in particular, $p_d(x)$ is nonzero. Since $p(x)$ vanishes on the nonempty set K , we have $d > 0$. Take any $v \in F^n \setminus \{0\}$. By the Kakeya property for this v there exists a $w \in F^n$ such that

$$p(w + tv) = 0 \quad \text{for all } t \in F.$$

Here comes the trick: Consider $p(w + tv)$ as a polynomial in the single variable t . It has degree at most $d \leq q - 1$ but vanishes on all q points of F , whence $p(w + tv)$ is the zero polynomial in t . Looking at (1) above we see that the coefficient of t^d in $p(w + tv)$ is precisely $p_d(v)$, which must therefore be 0. But $v \in F^n \setminus \{0\}$ was arbitrary and $p_d(0) = 0$ since $d > 0$, and we conclude that $p_d(x)$ vanishes on all of F^n . Since

$$dq^{n-1} \leq (q-1)q^{n-1} < q^n,$$

Lemma 1, however, tells us that $p_d(x)$ must then be the zero polynomial — contradiction and end of the proof. \square

As often happens in mathematics, once a breakthrough is achieved improvements follow quickly. So it was in this case. The lower bound $\frac{1}{n!}$ for the constant $c(n)$ has been improved to $\frac{1}{2^n}$, and this is within a factor of 2 from the best possible bound. That is, there exist Kakeya sets of size roughly $\frac{1}{2^{n-1}}|F|^n$.

For recent developments the blog by Terence Tao at terrytao.wordpress.com/tag/kakeya-conjecture/ is an up-to-date source.

References

- [1] A. S. BESICOVITCH: *On Kakeya's problem and a similar one*, Math. Zeitschrift **27** (1928), 312-320.
- [2] F. CUNNINGHAM, JR.: *The Kakeya problem for simply connected and for star-shaped sets*, Amer. Math. Monthly **78** (1971), 114-129.
- [3] Z. DVIR: *On the size of Kakeya sets in finite fields*, J. Amer. Math. Soc. **22** (2009), 1093-1097.
- [4] J. PAL: *Über ein elementares Variationsproblem*, Det Kgl. Danske Videnskabernes Selskab. Matematisk-fysiske Meddelelser **2** (1920), 1-35.
- [5] T. TAO: *From rotating needles to stability of waves: emerging connections between combinatorics, analysis, and PDE*, Notices Amer. Math. Soc. **48** (2001), 294-303.
- [6] T. WOLFF: *Recent work connected with the Kakeya problem*, in: "Prospects in Mathematics (Princeton, NJ 1996)" (H. Rossi, ed.), Amer. Math. Soc., Providence RI 1999, pp. 129-162.
- [7] T. WOLFF: *On some variants of the Kakeya problem*, Pacific J. Math. **190** (1999), 111-154.



"Whirling a pole the Kakeya way"



Some of the oldest combinatorial objects, whose study apparently goes back to ancient times, are the *Latin squares*. To obtain a Latin square, one has to fill the n^2 cells of an $n \times n$ square array with the numbers $1, 2, \dots, n$ so that that every number appears exactly once in every row and in every column. In other words, the rows and columns each represent permutations of the set $\{1, \dots, n\}$. Let us call n the *order* of the Latin square.

Here is the problem we want to discuss. Suppose someone started filling the cells with the numbers $\{1, 2, \dots, n\}$. At some point he stops and asks us to fill in the remaining cells so that we get a Latin square. When is this possible? In order to have a chance at all we must, of course, assume that at the start of our task any element appears at most once in every row and in every column. Let us give this situation a name. We speak of a *partial Latin square* of order n if some cells of an $n \times n$ array are filled with numbers from the set $\{1, \dots, n\}$ such that every number appears at most once in every row and column. So the problem is:

When can a partial Latin square be completed to a Latin square of the same order?

Let us look at a few examples. Suppose the first $n - 1$ rows are filled and the last row is empty. Then we can easily fill in the last row. Just note that every element appears $n - 1$ times in the partial Latin square and hence is missing from exactly one column. Hence by writing each element below the column where it is missing we have completed the square correctly.

Going to the other end, suppose only the first row is filled. Then it is again easy to complete the square by cyclically rotating the elements one step in each of the following rows.

So, while in our first example the completion is forced, we have lots of possibilities in the second example. In general, the fewer cells are pre-filled, the more freedom we should have in completing the square.

However, the margin displays an example of a partial square with only n cells filled which clearly cannot be completed, since there is no way to fill the upper right-hand corner without violating the row or column condition.

1	2	3	4
2	1	4	3
4	3	1	2
3	4	2	1

A Latin square of order 4

1	4	2	5	3
4	2	5	3	1
2	5	3	1	4
5	3	1	4	2
3	1	4	2	5

A cyclic Latin square

1	2	...	$n-1$	
				n

A partial Latin square that cannot be completed

If fewer than n cells are filled in an $n \times n$ array, can one then always complete it to obtain a Latin square?

1	3	2
2	1	3
3	2	1

R : 1 1 1 2 2 2 3 3 3

C : 1 2 3 1 2 3 1 2 3

E : 1 3 2 2 1 3 3 2 1

If we permute the lines of the above example cyclically,

$R \rightarrow C \rightarrow E \rightarrow R$, then we obtain the following line array and Latin square:

1	2	3
3	1	2
2	3	1

R : 1 3 2 2 1 3 3 2 1

C : 1 1 1 2 2 2 3 3 3

E : 1 2 3 1 2 3 1 2 3

This question was raised by Trevor Evans in 1960, and the assertion that a completion is always possible quickly became known as the Evans conjecture. Of course, one would try induction, and this is what finally led to success. But Bohdan Smetaniuk's proof from 1981, which answered the question, is a beautiful example of just how subtle an induction proof may be needed in order to do such a job. And, what's more, the proof is constructive, it allows us to complete the Latin square explicitly from any initial partial configuration.

Before proceeding to the proof let us take a closer look at Latin squares in general. We can alternatively view a Latin square as a $3 \times n^2$ array, called the *line array* of the Latin square. The figure to the left shows a Latin square of order 3 and its associated line array, where R , C and E stand for rows, columns and elements.

The condition on the Latin square is equivalent to saying that in any two lines of the line array all n^2 ordered pairs appear (and therefore each pair appears exactly once). Clearly, we may permute the symbols in each line arbitrarily (corresponding to permutations of rows, columns or elements) and still obtain a Latin square. But the condition on the $3 \times n^2$ array tells us more: There is no special role for the elements. We may also permute the lines of the array (as a whole) and still preserve the conditions on the line array and hence obtain a Latin square.

Latin squares that are connected by any such permutation are called *conjugates*. Here is the observation which will make the proof transparent: A partial Latin square obviously corresponds to a partial line array (every pair appears at most once in any two lines), and any conjugate of a partial Latin square is again a partial Latin square. In particular, a partial Latin square can be completed if and only if any conjugate can be completed (just complete the conjugate and then reverse the permutation of the three lines).

We will need two results, due to Herbert J. Ryser and to Charles C. Lindner, that were known prior to Smetaniuk's theorem. If a partial Latin square is of the form that the first r rows are completely filled and the remaining cells are empty, then we speak of an $r \times n$ *Latin rectangle*.

Lemma 1. *Any $r \times n$ Latin rectangle, $r < n$, can be extended to an $(r + 1) \times n$ Latin rectangle and hence can be completed to a Latin square.*

■ **Proof.** We apply Hall's theorem (see Chapter 30). Let A_j be the set of numbers that do *not* appear in column j . An admissible $(r + 1)$ -st row corresponds then precisely to a system of distinct representatives for the collection A_1, \dots, A_n . To prove the lemma we therefore have to verify Hall's condition (H). Every set A_j has size $n - r$, and every element is in precisely $n - r$ sets A_j (since it appears r times in the rectangle). Any m of the sets A_j contain together $m(n - r)$ elements and therefore at least m different ones, which is just condition (H). □

Lemma 2. *Let P be a partial Latin square of order n with at most $n - 1$ cells filled and at most $\frac{n}{2}$ distinct elements, then P can be completed to a Latin square of order n .*

■ **Proof.** We first transform the problem into a more convenient form. By the conjugacy principle discussed above, we may replace the condition “at most $\frac{n}{2}$ distinct elements” by the condition that the entries appear in at most $\frac{n}{2}$ rows, and we may further assume that these rows are the top rows. So let the rows with filled cells be the rows $1, 2, \dots, r$, with f_i filled cells in row i , where $r \leq \frac{n}{2}$ and $\sum_{i=1}^r f_i \leq n - 1$. By permuting the rows, we may assume that $f_1 \geq f_2 \geq \dots \geq f_r$. Now we complete the rows $1, \dots, r$ step by step until we reach an $r \times n$ rectangle which can then be extended to a Latin square by Lemma 1.

Suppose we have already filled rows $1, 2, \dots, \ell - 1$. In row ℓ there are f_ℓ filled cells which we may assume to be at the end. The current situation is depicted in the figure, where the shaded part indicates the filled cells.

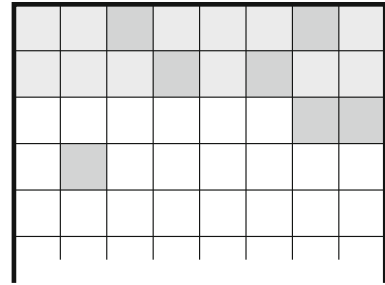

A situation for $n = 8$, with $\ell = 3$, $f_1 = f_2 = f_3 = 2$, $f_4 = 1$. The dark squares represent the pre-filled cells, the lighter ones show the cells that have been filled in the completion process.

The completion of row ℓ is performed by another application of Hall’s theorem, but this time it is quite subtle. Let X be the set of elements that do *not* appear in row ℓ , thus $|X| = n - f_\ell$, and for $j = 1, \dots, n - f_\ell$ let A_j denote the set of those elements in X which do *not* appear in column j (neither above nor below row ℓ). Hence in order to complete row ℓ we must verify condition (H) for the collection A_1, \dots, A_{n-f_ℓ} .

First we claim

$$n - f_\ell - \ell + 1 > \ell - 1 + f_{\ell+1} + \dots + f_r. \tag{1}$$

The case $\ell = 1$ is clear. Otherwise $\sum_{i=1}^r f_i < n$, $f_1 \geq \dots \geq f_r$ and $1 < \ell \leq r$ together imply

$$n > \sum_{i=1}^r f_i \geq (\ell - 1)f_{\ell-1} + f_\ell + \dots + f_r.$$

Now either $f_{\ell-1} \geq 2$ (in which case (1) holds) or $f_{\ell-1} = 1$. In the latter case, (1) reduces to $n > 2(\ell - 1) + r - \ell + 1 = r + \ell - 1$, which is true because of $\ell \leq r \leq \frac{n}{2}$.

Let us now take m sets A_j , $1 \leq m \leq n - f_\ell$, and let B be their union. We must show $|B| \geq m$. Consider the number c of cells in the m columns corresponding to the A_j ’s which contain elements of X . There are at most $(\ell - 1)m$ such cells above row ℓ and at most $f_{\ell+1} + \dots + f_r$ below row ℓ , and thus

$$c \leq (\ell - 1)m + f_{\ell+1} + \dots + f_r.$$

On the other hand, each element $x \in X \setminus B$ appears in each of the m columns, hence $c \geq m(|X| - |B|)$, and therefore (with $|X| = n - f_\ell$)

$$|B| \geq |X| - \frac{1}{m}c \geq n - f_\ell - (\ell - 1) - \frac{1}{m}(f_{\ell+1} + \dots + f_r).$$

It follows that $|B| \geq m$ if

$$n - f_\ell - (\ell - 1) - \frac{1}{m}(f_{\ell+1} + \dots + f_r) > m - 1,$$

that is, if

$$m(n - f_\ell - \ell + 2 - m) > f_{\ell+1} + \dots + f_r. \tag{2}$$

Inequality (2) is true for $m = 1$ and for $m = n - f_\ell - \ell + 1$ by (1), and hence for all values m between 1 and $n - f_\ell - \ell + 1$, since the left-hand side is a quadratic function in m with leading coefficient -1 . The remaining case is $m > n - f_\ell - \ell + 1$. Since any element x of X is contained in at most $\ell - 1 + f_{\ell+1} + \dots + f_r$ rows, it can also appear in at most that many columns. Invoking (1) once more, we find that x is in one of the sets A_j , so in this case $B = X$, $|B| = n - f_\ell \geq m$, and the proof is complete. \square

Let us finally prove Smetaniuk’s theorem.

Theorem. Any partial Latin square of order n with at most $n - 1$ filled cells can be completed to a Latin square of the same order.

s_1		2				7		
s_2			5		4			
s_3				5				
s_4		4						



•								
2	7							
		•						
				•				
	4	5			•			
			5			•		
4								•

2	3	4	1	6	5			
5	6	1	4	2	3			
1	2	3	6	5	4			
6	4	5	2	3	1			
3	1	6	5	4	2			
4	5	2	3	1	6			

■ **Proof.** We use induction on n , the cases $n \leq 2$ being trivial. Thus we now study a partial Latin square of order $n \geq 3$ with at most $n - 1$ filled cells. With the notation used above these cells lie in $r \leq n - 1$ different rows numbered s_1, \dots, s_r , which contain $f_1, \dots, f_r > 0$ filled cells, with $\sum_{i=1}^r f_i \leq n - 1$. By Lemma 2 we may assume that there are more than $\frac{n}{2}$ different elements; thus there is an element that appears only once: after renumbering and permutation of rows (if necessary) we may assume that the element n occurs only once, and this is in row s_1 .

In the next step we want to permute the rows and columns of the partial Latin square such that after the permutations all the filled cells lie below the diagonal — except for the cell filled with n , which will end up on the diagonal. (The diagonal consists of the cells (k, k) with $1 \leq k \leq n$.) We achieve this as follows: First we permute row s_1 into the position f_1 . By permutation of columns we move all the filled cells to the left, so that n occurs as the last element in its row, on the diagonal. Next we move row s_2 into position $1 + f_1 + f_2$, and again the filled cells as far to the left as possible. In general, for $1 < i \leq r$ we move the row s_i into position $1 + f_1 + f_2 + \dots + f_i$ and the filled cells as far left as possible. This clearly gives the desired set-up. The drawing to the left shows an example, with $n = 7$: the rows $s_1 = 2, s_2 = 3, s_3 = 5$ and $s_4 = 7$ with $f_1 = f_2 = 2$ and $f_3 = f_4 = 1$ are moved into the rows numbered 2, 5, 6 and 7, and the columns are permuted “to the left” so that in the end all entries except for the single 7 come to lie below the diagonal, which is marked by •s.

In order to be able to apply induction we now remove the entry n from the diagonal and ignore the first row and the last column (which do not contain any filled cells): thus we are looking at a partial Latin square of order $n - 1$ with at most $n - 2$ filled cells, which by induction can be completed to a Latin square of order $n - 1$. The margin shows one (of many) completions of the partial Latin square that arises in our example. In the figure, the original entries are printed bold. They are already final, as are all the elements in shaded cells; some of the other entries will be changed in the following, in order to complete the Latin square of order n .

In the next step we want to move the diagonal elements of the square to the last column and put entries n onto the diagonal in their place. However, in general we cannot do this, since the diagonal elements need not

be distinct. Thus we proceed more carefully and perform successively, for $k = 2, 3, \dots, n - 1$ (in this order), the following operation:

Put the value n into the cell (k, n) . This yields a correct partial Latin square. Now exchange the value x_k in the diagonal cell (k, k) with the value n in the cell (k, n) in the last column.

If the value x_k did not already occur in the last column, then our job for the current k is completed. After this, the current elements in the k -th column will not be changed any more.

In our example this works without problems for $k = 2, 3$ and 4 , and the corresponding diagonal elements $3, 1$ and 6 move to the last column. The following three figures show the corresponding operations.

2	3	4	1	6	5	7
5	6	1	4	2	3	
1	2	3	6	5	4	
6	4	5	2	3	1	
3	1	6	5	4	2	
4	5	2	3	1	6	

2	7	4	1	6	5	3
5	6	1	4	2	3	7
1	2	3	6	5	4	
6	4	5	2	3	1	
3	1	6	5	4	2	
4	5	2	3	1	6	

2	7	4	1	6	5	3
5	6	7	4	2	3	1
1	2	3	6	5	4	7
6	4	5	2	3	1	
3	1	6	5	4	2	
4	5	2	3	1	6	

Now we have to treat the case in which there is already an element x_k in the last column. In this case we proceed as follows:

If there is already an element x_k in a cell (j, n) with $2 \leq j < k$, then we exchange in row j the element x_k in the n -th column with the element x'_k in the k -th column. If the element x'_k also occurs in a cell (j', n) , then we also exchange the elements in the j' -th row that occur in the n -th and in the k -th columns, and so on.

If we proceed like this there will never be two equal entries in a row. Our exchange process ensures that there also will never be two equal elements in a column. So we only have to verify that the exchange process between the k -th and the n -th column does not lead to an infinite loop. This can be seen from the following bipartite graph G_k : Its vertices correspond to the cells (i, k) and (j, n) with $2 \leq i, j \leq k$ whose elements might be exchanged. There is an edge between (i, k) and (j, n) if these two cells lie in the same row (that is, for $i = j$), or if the cells before the exchange process contain the same element (which implies $i \neq j$). In our sketch the edges for $i = j$ are dotted, the others are not. All vertices in G_k have degree 1 or 2. The cell (k, n) corresponds to a vertex of degree 1; this vertex is the beginning of a path which leads to column k on a horizontal edge, then possibly on a sloped edge back to column n , then horizontally back to column k and so on. It ends in column k at a value that does not occur in column n . Thus the exchange operations will end at some point with a step where we move a new element into the last column. Then the work on column k is completed, and the elements in the cells (i, k) for $i \geq 2$ are fixed for good.

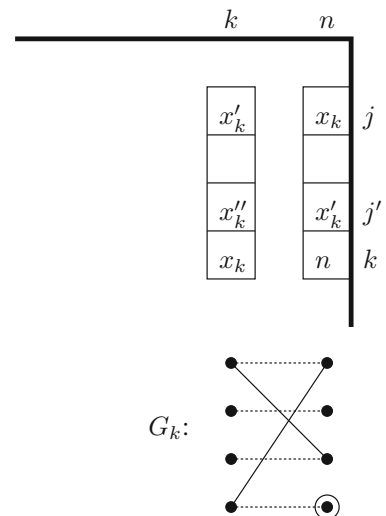

In our example the “exchange case” happens for $k = 5$: the element $x_5 = 3$ does already occur in the last column, so that entry has to be moved back to column $k = 5$. But the exchange element $x'_5 = 6$ is not new either, it is exchanged by $x''_5 = 5$, and this one is new.

2	7	4	1	6	5	3
5	6	7	4	2	3	1
1	2	3	7	5	4	6
6	4	5	2	3	1	7
3	1	6	5	4	2	
4	5	2	3	1	6	

2	7	4	1	3	5	6
5	6	7	4	2	3	1
1	2	3	7	6	4	5
6	4	5	2	7	1	3
3	1	6	5	4	2	
4	5	2	3	1	6	

Finally, the exchange for $k = 6 = n - 1$ poses no problem, and after that the completion of the Latin square is unique:

2	7	4	1	3	5	6
5	6	7	4	2	3	1
1	2	3	7	6	4	5
6	4	5	2	7	1	3
3	1	6	5	4	2	7
4	5	2	3	1	6	

2	7	4	1	3	5	6
5	6	7	4	2	3	1
1	2	3	7	6	4	5
6	4	5	2	7	1	3
3	1	6	5	4	7	2
4	5	2	3	1	6	

7	3	1	6	4	2	4
2	7	4	1	3	5	6
5	6	7	4	2	3	1
1	2	3	7	6	4	5
6	4	5	2	7	1	3
3	1	6	5	4	7	2
4	5	2	3	1	6	7

... and the same occurs in general: We put an element n into the cell (n, n) , and after that the first row can be completed by the missing elements of the respective columns (see Lemma 1), and this completes the proof. In order to get explicitly a completion of the original partial Latin square of order n , we only have to reverse the element, row and column permutations of the first two steps of the proof. \square

References

- [1] T. EVANS: *Embedding incomplete Latin squares*, Amer. Math. Monthly **67** (1960), 958-961.
- [2] C. C. LINDNER: *On completing Latin rectangles*, Canadian Math. Bulletin **13** (1970), 65-68.
- [3] H. J. RYSER: *A combinatorial theorem with an application to Latin rectangles*, Proc. Amer. Math. Soc. **2** (1951), 550-552.
- [4] B. SMETANIUK: *A new construction on Latin squares I: A proof of the Evans conjecture*, Ars Combinatoria **11** (1981), 155-172.

Graph Theory

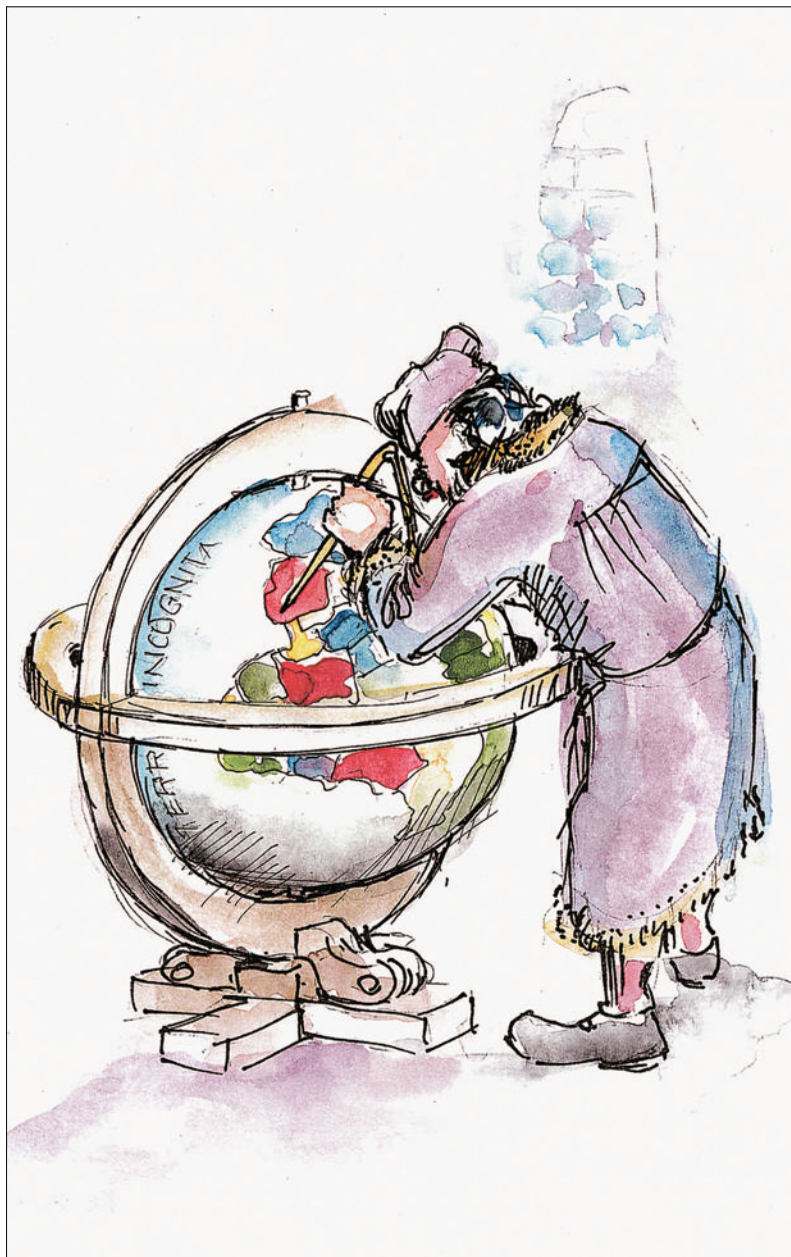

- 37**
Permanents and the power of entropy 261
- 38**
The Dinitz problem 271
- 39**
Five-coloring plane graphs 277
- 40**
How to guard a museum 281
- 41**
Turán's graph theorem 285
- 42**
Communicating without errors 291
- 43**
The chromatic number of Kneser graphs 301
- 44**
Of friends and politicians 307
- 45**
Probability makes counting (sometimes) easy 311

"The four-colorist geographer"

Permanents and the power of entropy

Chapter 37



In Chapter 24 we discussed Van der Waerden's conjecture, which established a *lower* bound for the permanent of a doubly stochastic matrix. There is also a wonderful theorem that gives an *upper* bound for integral matrices with prescribed row sums.

Consider an $n \times n$ matrix $M = (m_{ij})$ with 0/1-entries. To M we associate a simple bipartite graph $G_M = (U \cup V, E)$, whose vertices are given by $U = \{u_1, \dots, u_n\}$ and $V = \{v_1, \dots, v_n\}$, and where

$$u_i v_j \in E \quad :\iff \quad m_{ij} = 1.$$

Conversely, every bipartite graph G on $n + n$ nodes gives rise to a square 0/1-matrix M of size $n \times n$ with $G = G_M$. Now look at the permanent

$$\text{per } M := \sum_{\sigma} m_{1\sigma(1)} \cdots m_{n\sigma(n)}.$$

Every term $m_{1\sigma(1)} m_{2\sigma(2)} \cdots m_{n\sigma(n)}$ equals 0 or 1, and it is equal to 1 if and only if the set of edges $\{u_1 v_{\sigma(1)}, \dots, u_n v_{\sigma(n)}\}$ is a *perfect matching* of G_M , that is, a set of edges that covers each vertex exactly once. Hence the number $m(G_M)$ of perfect matchings in G_M is just the permanent, that is, $\text{per } M = m(G_M)$.

The correspondence $G \longleftrightarrow M_G$ stimulated a lot of the early research on permanents. One of the first difficult problems was a conjecture posed by Henryk Minc in 1967: Suppose the 0/1-matrix M has row sums d_1, \dots, d_n (or equivalently the vertices u_1, \dots, u_n have degrees d_1, \dots, d_n), then

$$\text{per } M \leq \prod_{i=1}^n (d_i!)^{1/d_i}.$$

Observe that we can have equality, as seen from the example in the margin.

Minc's conjecture was proved by Lev M. Brégman in 1973. A few years later Alexander Schrijver gave a short and sweet proof, with a randomized version appearing in the book of Alon and Spencer. But in our view the proof straight from the BOOK is due to Jaikumar Radhakrishnan. It is not much different, but it uses just the right tool — *entropy* from information theory. Before we come to this, let us state Brégman's theorem again.

The all 1's matrix J_n corresponds to the complete bipartite graph $K_{n,n}$, with $\text{per}(J_n) = m(K_{n,n}) = n!$.

If k divides n , the block diagonal matrix

$$M = \begin{pmatrix} J_k & & \\ & \ddots & \\ & & J_k \end{pmatrix}$$

with $\frac{n}{k}$ blocks has $d_1 = \dots = d_n = k$ and $\text{per } M = (k!)^{n/k}$.

Theorem 1. Let $M = (m_{ij})$ be an $n \times n$ matrix with entries in $\{0, 1\}$, and let d_1, \dots, d_n be the row sums of M , that is, $d_i = \sum_{j=1}^n m_{ij}$. Then

$$\text{per } M \leq \prod_{i=1}^n (d_i!)^{1/d_i}.$$

A Mathematical Theory of Communication

By C. E. SHANNON

INTRODUCTION

THE recent development of various methods of modulation such as PCM and PPM which exchange bandwidth for signal-to-noise ratio has intensified the interest in a general theory of communication. A basis for such a theory is contained in the important papers of Nyquist¹ and Hartley² on this subject. In the present paper we will extend the theory to include a number of new factors, in particular the effect of noise in the channel, and the savings possible due to the statistical structure of the original message and due to the nature of the final destination of the information.

The fundamental problem of communication is that of reproducing at one point either exactly or approximately a message selected at another point. Frequently the messages have meaning; that is they refer to or are correlated according to some system with certain physical or conceptual entities. These semantic aspects of communication are irrelevant to the engineering problem. The significant aspect is that the actual message is one selected from a set of possible messages. The system must be designed to operate for each possible selection, not just the one which will actually be chosen since this is unknown at the time of design.

If the number of messages in the set is finite then this number or any monotonic function of this number can be regarded as a measure of the information produced when one message is chosen from the set, all choices being equally likely. As was pointed out by Hartley the most natural

It is said that Shannon, following the advice of John von Neumann, used the name “entropy” because nobody knew exactly what this meant anyway . . .

$H(X_{p,1-p})$

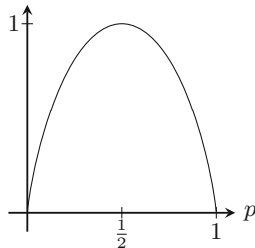

It does not happen often that a single paper gives birth to a whole field. Claude Shannon’s *A Mathematical Theory of Communication* from 1948 was such a singular achievement: It laid the foundations of information theory and coding, and thereby initiated one of the great mathematical success stories of the twentieth century.

Suppose X is a random variable taking values in $\{a_1, \dots, a_n\}$ with probabilities $\text{Prob}(X = a_i) = p_i$. It helps to think of X as an experiment with possible outcomes a_i , like throwing a die with outcomes $1, 2, \dots, 6$. How much information do we receive (on the average) from performing the experiment? Shannon’s ingenious idea was the “equation”

information after = uncertainty before.

For example, when a coin is rigged and heads comes up most of the time, then there is little information to be gained from throwing it, certainly less than when the coin is fair, in which case the uncertainty (and information) is largest.

By postulating certain natural conditions that an uncertainty measure for X should satisfy, Shannon arrived at his famous definition of *entropy*, which he denoted by $H(X)$:

$$H(X) = H(X_{p_1, \dots, p_n}) := - \sum_{i=1}^n p_i \log_2 p_i.$$

For example, if X is a throw of a biased coin with $\text{Prob}(X = \text{heads}) = p$, then the Shannon formula yields the function $H(X_{p,1-p}) = -p \log_2 p - (1-p) \log_2 (1-p)$ graphed in the margin.

In the following we always use the binary logarithm $\log_2 p$ with the convention $p \log_2 p = 0$ for $p = 0$. The *support* of the random variable X is $\text{supp } X := \{a : \text{Prob}(X = a) > 0\}$.

Later in his paper Shannon gave an alternative interpretation of $H(X)$ as the expected length of an optimal question strategy for the outcome of X . The appendix to this chapter contains a sketch of this approach.

Suppose X and Y are two random variables with value ranges $\{a_1, \dots, a_m\}$ and $\{b_1, \dots, b_n\}$. A key ingredient for Radhakrishnan’s proof is the concept of *conditional entropy of Y under knowledge of X* . To shorten the writing, let us set $p(a_i) := \text{Prob}(X = a_i)$, $p(b_j) := \text{Prob}(Y = b_j)$, and similarly $p(a_i, b_j) := \text{Prob}(X = a_i \wedge Y = b_j)$ for the joint distribution

of the pair (X, Y) , which may be viewed as a single random variable, and $p(b_j | a_i) := \text{Prob}(Y = b_j | X = a_i)$ for the conditional probabilities. Let

$$H(Y | a_i) := - \sum_{j=1}^n p(b_j | a_i) \log_2 p(b_j | a_i)$$

be the entropy (uncertainty) of Y if we know that the outcome of X is a_i . Now we take the expected value of this quantity over all possible outcomes of X and thus arrive at

$$H(Y | X) := \sum_{i=1}^m p(a_i) H(Y | a_i)$$

as the conditional entropy of Y under knowledge of X .

All we need for the proof of Brégman's theorem are three facts about entropy, whose (easy) proofs are given in the appendix; the rest is clever and beautiful probabilistic reasoning. Here are the facts:

- (A) $H(X) \leq \log_2(|\text{supp } X|)$, with equality if and only if X is uniformly distributed on the support of X , that is, $\text{Prob}(X = a) = \frac{1}{n}$ for $a \in \text{supp } X$, where $n = |\text{supp } X|$.
- (B) $H(X, Y) = H(X) + H(Y | X)$, and more generally $H(X_1, \dots, X_n) = H(X_1) + H(X_2 | X_1) + \dots + H(X_n | X_1, \dots, X_{n-1})$.
- (C) If $\text{supp } X$ is partitioned into the d sets E_1, \dots, E_d , where $E_j := \{a \in \text{supp } X : |\text{supp}(Y | a)| = j\}$, then

$$H(Y | X) \leq \sum_{j=1}^d \text{Prob}(X \in E_j) \log_2 j.$$

■ **Proof of Theorem 1.** Let $G = (U \cup V, E)$ be the bipartite graph associated with M , where d_i is the degree of the vertex u_i , and denote by \mathfrak{S} the set of perfect matchings of G . As per $M = m(G) = |\mathfrak{S}|$, we will prove the upper bound of the theorem for the number of perfect matchings of G . We may assume $\mathfrak{S} \neq \emptyset$ because otherwise there is nothing to show. We view each $\sigma \in \mathfrak{S}$ as the corresponding permutation $\sigma(1)\sigma(2) \dots \sigma(n)$ of the indices. Hence the vertex $u_i \in U$ is matched to $v_{\sigma(i)} \in V$ under σ .

The first idea is to pick $\sigma \in \mathfrak{S}$ uniformly at random and to consider the vector of random variables $X = (X_1, \dots, X_n) = (\sigma(1), \dots, \sigma(n))$.

By (A),

$$H(\sigma(1), \dots, \sigma(n)) = \log_2(|\mathfrak{S}|);$$

hence it suffices to show that

$$H(\sigma(1), \dots, \sigma(n)) \leq \log_2 \left(\prod_{i=1}^n (d_i!)^{1/d_i} \right) = \sum_{i=1}^n \frac{1}{d_i} \log_2(d_i!). \quad (1)$$

In particular, $H(Y | X) = 0$ if and only if the outcome of Y is determined once the result of X is known.

Next we use **(B)** to get

$$H(\sigma(1), \dots, \sigma(n)) = \sum_{i=1}^n H(\sigma(i) | \sigma(1), \dots, \sigma(i-1)). \quad (2)$$

Let's find out what the conditional entropy $H(\sigma(i) | \sigma(1), \dots, \sigma(i-1))$ means. It measures the uncertainty about the matching mate of u_i after the mates of u_1, \dots, u_{i-1} have been revealed. In particular, the support of the random variable $\sigma(i)$ under knowledge of $(\sigma(1), \dots, \sigma(i-1))$ is contained in the set of indices of the neighbors of u_i that have *not* already been matched to one of u_1, \dots, u_{i-1} .

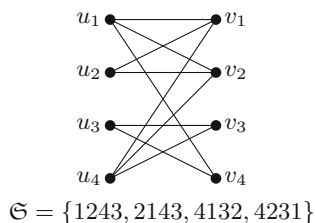

For example, let us check the formula in **(B)** for the graph in the margin, which has $|\mathfrak{S}| = 4$. Since all permutations in \mathfrak{S} are equally likely, we have $H(\sigma(1), \dots, \sigma(4)) = \log_2 4 = 2$. Now, $H(\sigma(1)) = -\frac{1}{4} \log_2 \frac{1}{4} - \frac{1}{4} \log_2 \frac{1}{4} - \frac{1}{2} \log_2 \frac{1}{2} = \frac{3}{2}$. Let us compute the conditional entropy $H(\sigma(2) | \sigma(1))$: For $\sigma(1) = 1$ we get $H(\sigma(2) | 1) = 0$ since $\sigma(2) = 2$ is then determined; similarly $H(\sigma(2) | 2) = 0$, but for $\sigma(1) = 4$ we have $H(\sigma(2) | 4) = 1$, since there are two equally likely outcomes $\sigma(2) = 1, \sigma(2) = 2$. For the expected value we thus compute $H(\sigma(2) | \sigma(1)) = \frac{1}{2} \cdot 1 = \frac{1}{2}$. The next conditional entropies $H(\sigma(3) | \sigma(1), \sigma(2))$ and $H(\sigma(4) | \sigma(1), \sigma(2), \sigma(3))$ are both 0, since the values are determined. So summing up we again get $H(\sigma(1)) + H(\sigma(2) | \sigma(1)) + H(\sigma(3) | \sigma(1), \sigma(2)) + H(\sigma(4) | \sigma(1), \sigma(2), \sigma(3)) = \frac{3}{2} + \frac{1}{2} + 0 + 0 = 2$, in accordance with **(B)**.

Radhakrishnan's wonderful idea was to examine the vertices u_1, \dots, u_n in a *random order* τ , where all τ are equally likely with probability $\frac{1}{n!}$, and then to take the average over the entropies. In other words, we reveal the matching mates in the order $\sigma(\tau(1)), \sigma(\tau(2)), \dots, \sigma(\tau(n))$. Let us look at a fixed τ . If $k_i = \tau^{-1}(i)$, that is, if in the ordering τ the vertex u_i appears in k_i th place, then equation (2) becomes

$$H(\sigma(1), \dots, \sigma(n)) = \sum_{i=1}^n H(\sigma(i) | \sigma(\tau(1)), \dots, \sigma(\tau(k_i - 1))).$$

As this holds for all τ , taking the average we get

$$H(\sigma(1), \dots, \sigma(n)) = \frac{1}{n!} \sum_{\tau} \left(\sum_{i=1}^n H(\sigma(i) | \sigma(\tau(1)), \dots, \sigma(\tau(k_i - 1))) \right).$$

Let us fix τ and look at a summand

$$H(\sigma(i) | \sigma(\tau(1)), \dots, \sigma(\tau(k_i - 1))). \quad (3)$$

To upper bound (3) we use fact **(C)** from above, applied to the random variables $X = (\sigma(\tau(1)), \dots, \sigma(\tau(k_i - 1)))$ and $Y = \sigma(i)$. For each σ let $N_i(\sigma, \tau)$ be the set of indices of the neighbors of u_i that are *not* among $\{\sigma(\tau(1)), \dots, \sigma(\tau(k_i - 1))\}$. Since u_i has d_i neighbors and σ is a perfect matching we have $1 \leq |N_i(\sigma, \tau)| \leq d_i$ for all σ . Now partition $\text{supp } X$ into the sets $E_{i,j}^{(\tau)}$, where $(\sigma(\tau(1)), \dots, \sigma(\tau(k_i - 1)))$ lies in $E_{i,j}^{(\tau)}$ if and

only if $|N_i(\sigma, \tau)| = j$, for $1 \leq j \leq d_i$. Considering $|N_i(\sigma, \tau)|$ as a random variable on \mathfrak{S} , we thus have

$$\text{Prob}(X \in E_{i,j}^{(\tau)}) = \text{Prob}(|N_i(\sigma, \tau)| = j),$$

and fact (C) tells us that for fixed τ

$$H(\sigma(i) | \sigma(\tau(1)), \dots, \sigma(\tau(k_i - 1))) \leq \sum_{j=1}^{d_i} \text{Prob}(|N_i(\sigma, \tau)| = j) \log_2 j.$$

Hence we get altogether

$$H(\sigma(1), \dots, \sigma(n)) \leq \frac{1}{n!} \sum_{i=1}^n \sum_{j=1}^{d_i} \log_2 j \sum_{\tau} \text{Prob}(|N_i(\sigma, \tau)| = j). \quad (4)$$

This seems to get more complicated as we go along — but wait! Looking at (1) it suffices to show that the innermost sum in (4) equals $n! \frac{1}{d_i}$ for all j , because then the right-hand side simplifies to $\sum_{i=1}^n \frac{1}{d_i} \log_2(d_i!)$.

And this assertion about the inner sum is easy! Fix σ , and let $\ell_1, \dots, \ell_{d_i}$ be the indices of the neighbors of u_i , $D_\sigma = \{\sigma^{-1}(\ell_1), \dots, \sigma^{-1}(\ell_{d_i})\}$ is the set of indices of the U -vertices that are matched onto the neighbors of u_i , including of course i itself, and they appear according to the ordering of D_σ under τ . If i comes first in D_σ , then no neighbors had been taken so far, whence $|N_i(\sigma, \tau)| = d_i$. If i is second, then one neighbor is gone, thus $|N_i(\sigma, \tau)| = d_i - 1$, and so on.

Now the power of averaging comes into play. With τ running through all $n!$ permutations, all possible orderings of the list D_σ occur with equal frequency, which means that i appears in all d_i places of D_σ with the same frequency $\frac{n!}{d_i}$. But this, in turn, implies that $|N_i(\sigma, \tau)| = j$ occurs with frequency $\frac{n!}{d_i}$ for all j , and this holds for all σ , whence

$$\sum_{\tau} \text{Prob}(|N_i(\sigma, \tau)| = j) = \frac{n!}{d_i},$$

for all j , and we are done. □

We cannot end this chapter without deriving a stunning asymptotic formula for the number $L(n)$ of Latin squares of order n . (See Chapter 36 for the definition of Latin squares.) The small examples

$$L(1) = 1, L(2) = 2, L(3) = 12, L(4) = 576, L(5) = 161280$$

suggest that $L(n)$ grows exceedingly fast. So, all we can hope for are good bounds — and these are miraculously supplied by Brégman’s Theorem and by the permanent theorem discussed in Chapter 24.

Take an empty $n \times n$ square and fill it row by row with the numbers $1, \dots, n$, so that the resulting configuration is a Latin square. There are $n!$ ways to fill the first row, since we may take every permutation. Suppose the first

$n = 1:$

1

 $n = 2:$

1	2
2	1

2	1
1	2

$n = 3:$

1	2	3
2	3	1
3	1	2

There are $3!2! = 12$ fillings of the first row and the first column; the rest is then determined.

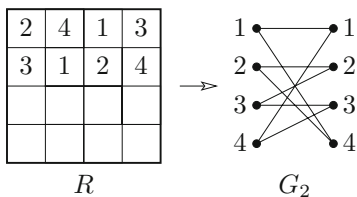

$n - k$ rows are properly filled to give an $(n - k) \times n$ Latin rectangle R . In how many ways can we fill the next row? Consider the following bipartite graph $G_k = (U \cup V, E)$, where U is the set of elements and V the set of column positions, with

$$ij \in E \iff i \text{ does not appear in the } j\text{th column of } R.$$

So, exactly the numbers that are joined to j can be used in column j of the $(n - k + 1)$ st row. In other words, a proper filling of the next row corresponds to a perfect matching of G_k . Now, every element $i \in U$ appears $n - k$ times in R , hence it is available in k columns for the next row. Thus i has degree k in G_k and similarly $d(j) = k$ for $j \in V$. (We used this argument already in the proof of Lemma 1 in Chapter 36.)

Let M_k be the 0/1-matrix corresponding to G_k , thus

$$\text{per } M_k = \text{the number of proper fillings of row } n - k + 1.$$

Every row and column in M_k sums to k ; let us denote the set of 0/1-matrices with this property by $\mathcal{M}(n, k)$. The permanent $\text{per } M_k$ depends, of course, on the setup of R , but if we have general lower and upper bounds for matrices in $\mathcal{M}(n, k)$, then by taking the product over all k , we obtain lower/upper bounds for $L(n)$.

By Brégman's Theorem with $d_1 = d_2 = \dots = d_n = k$ we get right away

$$\text{per } M \leq k!^{\frac{n}{k}} \quad \text{for all } M \in \mathcal{M}(n, k).$$

Now to the lower bound: If M is in $\mathcal{M}(n, k)$, then $\frac{1}{k}M$ is doubly stochastic, which implies by the permanent theorem in Chapter 24 that

$$\text{per } M = k^n \text{per} \left(\frac{1}{k}M \right) \geq k^n \frac{n!}{n^n}.$$

In summary, we have proved the following remarkable bounds.

Theorem 2. *The number $L(n)$ of Latin squares of order n is bounded by*

$$\frac{n!^{2n}}{n^{n^2}} \leq L(n) \leq \prod_{k=1}^n k!^{n/k}.$$

Using the approximations for $n!$ from page 13

$$\left(\frac{n}{e}\right)^n < n! < en\left(\frac{n}{e}\right)^n, \tag{5}$$

we can easily derive from this the following astonishingly simple asymptotic formula.

Corollary. *In the limit, the number $L(n)$ of Latin squares of order n satisfies*

$$\lim_{n \rightarrow \infty} \frac{L(n)^{1/n^2}}{n} = \frac{1}{e^2}.$$

Note that $\text{per } \lambda M = \lambda^n \text{per } M$ for an $n \times n$ matrix M .

The case $k = n$ corresponds to the $n!$ fillings of the first row.

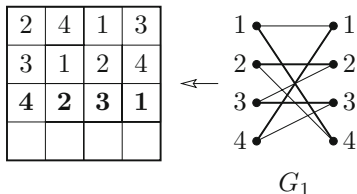

$$M_2 = \begin{pmatrix} 1 & 0 & 0 & 1 \\ 0 & 1 & 0 & 1 \\ 0 & 1 & 1 & 0 \\ 1 & 0 & 1 & 0 \end{pmatrix},$$

$$\text{per } M_2 = 2.$$

■ **Proof.** For the lower bound we get

$$L(n) \geq \frac{n!^{2n}}{n^{n^2}} > \frac{\left(\frac{n}{e}\right)^{2n^2}}{n^{n^2}} = \left(\frac{n}{e^2}\right)^{n^2},$$

so

$$\frac{L(n)^{1/n^2}}{n} > \frac{1}{e^2} \quad \text{and thus} \quad \lim_{n \rightarrow \infty} \frac{L(n)^{1/n^2}}{n} \geq \frac{1}{e^2}.$$

The upper bound needs a little more work. We will show that for any $\varepsilon > 0$

$$\frac{L(n)^{1/n^2}}{n} < \frac{1}{e^2}(1 + \varepsilon)$$

holds when n is large enough. For convenience we set $\mathcal{L}(n) = L(n)^{1/n^2}$.

Using (5) for k in place of n , we have

$$\begin{aligned} \log \mathcal{L}(n) &\leq \frac{1}{n} \log \prod_{k=1}^n (k!)^{\frac{1}{k}} = \frac{1}{n} \sum_{k=1}^n \frac{1}{k} \log k! \\ &< \frac{1}{n} \sum_{k=1}^n \frac{1}{k} \log \left(ek \left(\frac{k}{e}\right)^k \right) \\ &= \frac{1}{n} \sum_{k=1}^n \frac{1}{k} (1 + \log k + k \log k - k) \\ &= \frac{1}{n} \left[\sum_{k=1}^n \frac{1}{k} + \sum_{k=1}^n \frac{\log k}{k} + \sum_{k=1}^n \log k - n \right]. \end{aligned} \quad (6)$$

Now, look at page 13. The first sum is the harmonic number H_n , where $H_n < \log n + 1$. The third sum was also treated there, with

$$\sum_{k=1}^n \log k \leq (n+1) \log(n+1) - n \leq (n+2) \log n - n,$$

where the second inequality is derived in the margin, for $n \geq 6$. For the second sum in (6) the same integration method that we had used for the third one yields, using that $\frac{\log x}{x}$ is positive for $x > 1$ and monotonically decreasing for $x > e$, that

$$\sum_{k=4}^n \frac{\log k}{k} < \int_1^n \frac{\log x}{x} dx = \left[\frac{1}{2} (\log x)^2 \right]_1^n = \frac{1}{2} (\log n)^2.$$

Thus the second sum in (6) is smaller than $2 + \frac{1}{2} (\log n)^2$.

Putting everything together, we get

$$\log \mathcal{L}(n) < \frac{3 \log n}{n} + \frac{3}{n} + \frac{(\log n)^2}{2n} + \log n - 2.$$

The first three terms go to 0 as n gets large, and we conclude that for every $\delta > 0$

$$\log \mathcal{L}(n) \leq \delta + \log n - 2$$

will hold if n is large enough. Thus we get $L(n)^{1/n^2} \leq \frac{n}{e^2} e^\delta$ for all large enough n , and this is what we wanted to prove. \square

The inequality $(n+1)^{n+1} \leq n^{n+2}$ holds for $n \geq 6$: It may be rewritten as

$$\left(1 + \frac{1}{n}\right)^n \left(1 + \frac{1}{n}\right) \leq n,$$

where $(1 + \frac{1}{n})^n < e$ and $1 + \frac{1}{n} \leq 2$; thus the left side is less than $2e < 6 \leq n$.

Appendix: More about entropy

What was Shannon's alternative approach to entropy?

As before, let X be a random variable with value set $\{a_1, \dots, a_n\}$ and $p_i = \text{Prob}(X = a_i)$. We employ a certain strategy \mathcal{S} of yes/no questions until we know the value of X for sure. If our strategy leads us to ask ℓ_i questions in the case of the outcome $X = a_i$, then $\bar{L}(\mathcal{S}) := \sum_{i=1}^n p_i \ell_i$ is the expected number of questions. Of course, a good strategy will want to ask few questions for very likely outcomes a_i (when p_i is large), so as to minimize the average number.

As an example, suppose that the probabilities for throwing a loaded die are $p_1 = \frac{1}{3}$, $p_2 = p_3 = \frac{1}{8}$, $p_4 = \frac{1}{6}$, and $p_5 = p_6 = \frac{1}{8}$. A strategy might be the following. First question: "Is the outcome ≤ 3 ?" If yes, which happens with probability $\frac{7}{12}$, ask the second question: "Is it 1?" If yes again, we are done, otherwise we need one more question to decide whether the throw shows 2 or 3. Proceeding in analogous fashion if the first answer was no, we get $\ell_1 = 2$, $\ell_2 = \ell_3 = 3$, $\ell_4 = 2$, $\ell_5 = \ell_6 = 3$, thus

$$\bar{L}(\mathcal{S}) = 2\left(\frac{1}{3} + \frac{1}{6}\right) + 3\left(\frac{1}{8} + \frac{1}{8} + \frac{1}{8} + \frac{1}{8}\right) = \frac{5}{2}.$$

Shannon now proved that the entropy $H(X) = -\sum_{i=1}^n p_i \log_2 p_i$ is a lower bound for the expected number of questions $\bar{L}(\mathcal{S}) = \sum_{i=1}^n p_i \ell_i$ for every conceivable strategy \mathcal{S} . Let us check this! First we have that $\sum_{i=1}^n 2^{-\ell_i} = 1$ (why?), and the inequality $\log_2 x \leq x - 1$ for $x > 0$ together with $\sum_{i=1}^n p_i = 1$ yields

$$\sum_{i=1}^n p_i \log_2 \frac{2^{-\ell_i}}{p_i} \leq \sum_{i=1}^n p_i \left(\frac{2^{-\ell_i}}{p_i} - 1 \right) = \sum_{i=1}^n 2^{-\ell_i} - \sum_{i=1}^n p_i = 0.$$

But this means that $-\sum_{i=1}^n p_i \ell_i \leq \sum_{i=1}^n p_i \log_2 p_i$, or $\bar{L}(\mathcal{S}) \geq H(X)$.

The actual minimum $\bar{L}(X)$ can e. g. be computed by Huffman's algorithm, a classic in computer science.

Conversely, it is easy to find a strategy \mathcal{S}_0 with $\bar{L}(\mathcal{S}_0) < H(X) + 1$, hence

$$H(X) \leq \bar{L}(X) = \min_{\mathcal{S}} \bar{L}(\mathcal{S}) < H(X) + 1.$$

Looking at n -fold repetitions X^n of the experiment X , Shannon went on to show that the expected number of questions per experiment $\frac{1}{n} \bar{L}(X^n)$ used by optimal strategies for X^n converges to $H(X)$ for $n \rightarrow \infty$. (Shannon called this the "Fundamental theorem for a noiseless channel.")

Now to the three facts that we used in the proof of Theorem 1.

(A) $H(X) \leq \log_2(|\text{supp } X|)$.

Remember $0 \cdot \log_2 0 = 0$.

■ **Proof.** Assume without loss of generality that $p_i > 0$ for all i . Consider the general form of the AM-GM inequality $a_1^{p_1} \cdots a_n^{p_n} \leq p_1 a_1 + \cdots + p_n a_n$ on page 144. Set $a_i = \frac{1}{p_i}$ and take the logarithm to obtain

$$\sum_{i=1}^n p_i \log_2 \frac{1}{p_i} \leq \log_2 \left(\sum_{i=1}^n p_i \frac{1}{p_i} \right) = \log_2 n.$$

Equality holds if and only if $p_1 = \dots = p_n = \frac{1}{n}$, that is, if we have uniform distribution. \square

(B) $H(X, Y) = H(X) + H(Y | X)$.

■ **Proof.** We use the same notation as before and compute

$$\begin{aligned} H(X, Y) &= - \sum_{i,j} p(a_i, b_j) \log_2 p(a_i, b_j) \\ &= - \sum_{i,j} p(a_i, b_j) \log_2 (p(a_i)p(b_j | a_i)) \\ &= - \sum_{i,j} p(a_i, b_j) \log_2 p(a_i) - \sum_{i,j} p(a_i)p(b_j | a_i) \log_2 p(b_j | a_i) \\ &= - \sum_{i=1}^m p(a_i) \log_2 p(a_i) + H(Y | X) = H(X) + H(Y | X). \end{aligned}$$

The general formula follows by induction. \square

(C) $H(Y | X) \leq \sum_{j=1}^d \text{Prob}(X \in E_j) \log_2 j$.

■ **Proof.** We have $H(Y | X) = \sum_{i=1}^m p(a_i)H(Y | a_i)$. Partitioning the set $\{a_1, \dots, a_m\}$ into the subsets E_j given by the assumption and using (A) we get

$$\begin{aligned} H(Y | X) &= \sum_{j=1}^d \sum_{a \in E_j} p(a)H(Y | a) \\ &\leq \sum_{j=1}^d \sum_{a \in E_j} p(a) \log_2 j = \sum_{j=1}^d \text{Prob}(X \in E_j) \log_2 j. \quad \square \end{aligned}$$

References

[1] N. ALON & J. SPENCER: *The Probabilistic Method*, Third edition, Wiley-Interscience 2008.

[2] L. BRÉGMAN: *Some properties of nonnegative matrices and their permanents*, Soviet Math. Doklady **14** (1973), 945-949.

[3] A. KHINCHIN: *Mathematical Foundations of Information Theory*, Dover Publications 1957.

[4] B. D. MCKAY & I. M. WANLESS: *On the number of Latin squares*, Annals of Combinatorics **9** (2005), 335-344.

[5] J. RADHAKRISHNAN: *An entropy proof of Bregman's theorem*, J. Combinatorial Theory, Ser. A **77** (1997), 161-164.

[6] A. SCHRIJVER: *A short proof of Minc's conjecture*, J. Combinatorial Theory, Ser. A **25** (1978), 80-83.

- [7] H. MINC: *Permanents*, Encyclopedia of Mathematics and its Applications, Vol. 6, Addison-Wesley, Reading MA 1978; reissued by Cambridge University Press 1984.
- [8] C. SHANNON: *A Mathematical Theory of Communication*, Bell System Technical Journal **27** (1948), 379-423, 623-656.

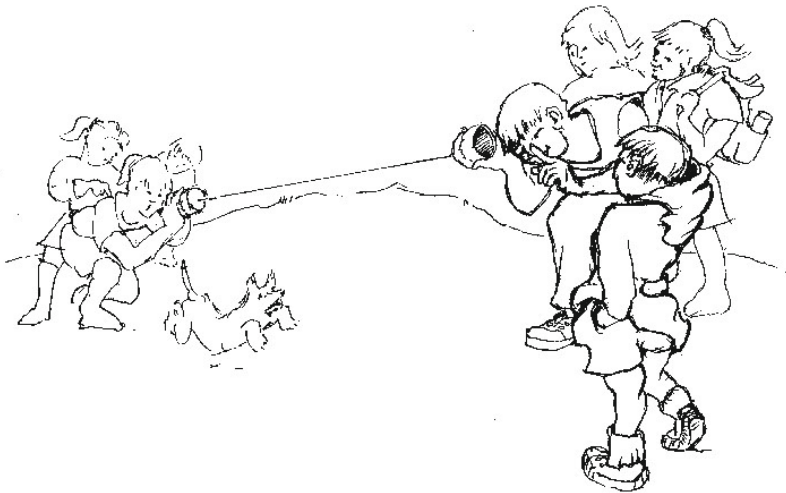

“Do you get any news?”

“Sure! — $\sum_i p_i \log_2 p_i$ of them!”



The four-color problem was a main driving force for the development of graph theory as we know it today, and coloring is still a topic that many graph theorists like best. Here is a simple-sounding coloring problem, raised by Jeff Dinitz in 1978, which defied all attacks until its astonishingly simple solution by Fred Galvin fifteen years later.

Consider n^2 cells arranged in an $n \times n$ square, and let (i, j) denote the cell in row i and column j . Suppose that for every cell (i, j) we are given a set $C(i, j)$ of n colors.

Is it then always possible to color the whole array by picking for each cell (i, j) a color from its set $C(i, j)$ such that the colors in each row and each column are distinct?

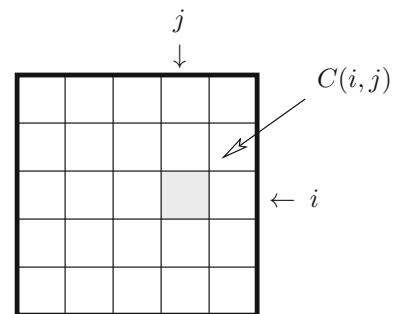

As a start consider the case when all color sets $C(i, j)$ are the same, say $\{1, 2, \dots, n\}$. Then the Dinitz problem reduces to the following task: Fill the $n \times n$ square with the numbers $1, 2, \dots, n$ in such a way that the numbers in any row and column are distinct. In other words, any such coloring corresponds to a Latin square, as discussed in the previous chapter. So, in this case, the answer to our question is “yes.”

Since this is so easy, why should it be so much harder in the general case when the set $C := \bigcup_{i,j} C(i, j)$ contains even more than n colors? The difficulty derives from the fact that not every color of C is available at each cell. For example, whereas in the Latin square case we can clearly choose an arbitrary permutation of the colors for the first row, this is not so anymore in the general problem. Already the case $n = 2$ illustrates this difficulty.

Suppose we are given the color sets that are indicated in the figure. If we choose the colors 1 and 2 for the first row, then we are in trouble since we would then have to pick color 3 for both cells in the second row.

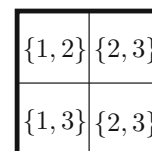

Before we tackle the Dinitz problem, let us rephrase the situation in the language of graph theory. As usual we only consider graphs $G = (V, E)$ without loops and multiple edges. Let $\chi(G)$ denote the *chromatic number* of the graph, that is, the smallest number of colors that one can assign to the vertices such that adjacent vertices receive different colors.

In other words, a coloring calls for a partition of V into classes (colored with the same color) such that there are no edges within a class. Calling a set $A \subseteq V$ *independent* if there are no edges within A , we infer that the chromatic number is the smallest number of independent sets which partition the vertex set V .

In 1976 Vizing, and three years later Erdős, Rubin, and Taylor, studied the following coloring variant which leads us straight to the Dinitz problem. Suppose in the graph $G = (V, E)$ we are given a set $C(v)$ of colors for each vertex v . A *list coloring* is a coloring $c : V \rightarrow \bigcup_{v \in V} C(v)$ where $c(v) \in C(v)$ for each $v \in V$. The definition of the *list chromatic number* $\chi_\ell(G)$ should now be clear: It is the smallest number k such for *any* list of color sets $C(v)$ with $|C(v)| = k$ for all $v \in V$ there always exists a list coloring. Of course, we have $\chi_\ell(G) \leq |V|$ (we never run out of colors). Since ordinary coloring is just the special case of list coloring when all sets $C(v)$ are equal, we obtain for any graph G

$$\chi(G) \leq \chi_\ell(G).$$

To get back to the Dinitz problem, consider the graph S_n which has as vertex set the n^2 cells of our $n \times n$ array with two cells adjacent if and only if they are in the same row or column.

Since any n cells in a row are pairwise adjacent we need at least n colors. Furthermore, any coloring with n colors corresponds to a Latin square, with the cells occupied by the same number forming a color class. Since Latin squares, as we have seen, exist, we infer $\chi(S_n) = n$, and the Dinitz problem can now be succinctly stated as

$$\chi_\ell(S_n) = n?$$

One might think that perhaps $\chi(G) = \chi_\ell(G)$ holds for any graph G , but this is a long shot from the truth. Consider the graph $G = K_{2,4}$. The chromatic number is 2 since we may use one color for the two left vertices and the second color for the vertices on the right. But now suppose that we are given the color sets indicated in the figure.

To color the left vertices we have the four possibilities $1|3$, $1|4$, $2|3$ and $2|4$, but any one of these pairs appears as a color set on the right-hand side, so a list coloring is not possible. Hence $\chi_\ell(G) \geq 3$, and the reader may find it fun to prove $\chi_\ell(G) = 3$ (there is no need to try out all possibilities!). Generalizing this example, it is not hard to find graphs G where $\chi(G) = 2$, but $\chi_\ell(G)$ is arbitrarily large! So the list coloring problem is not as easy as it looks at first glance.

Back to the Dinitz problem. A significant step towards the solution was made by Jeanette Janssen in 1992 when she proved $\chi_\ell(S_n) \leq n + 1$, and the *coup de grâce* was delivered by Fred Galvin by ingeniously combining two results, both of which had long been known. We are going to discuss these two results and show then how they imply $\chi_\ell(S_n) = n$.

First we fix some notation. Suppose v is a vertex of the graph G , then we denote as before by $d(v)$ the *degree* of v . In our square graph S_n every vertex has degree $2n - 2$, accounting for the $n - 1$ other vertices in the same row and in the same column. For a subset $A \subseteq V$ we denote by G_A the subgraph which has A as vertex set and which contains all edges of G between vertices of A . We call G_A the subgraph induced by A , and say that H is an *induced subgraph* of G if $H = G_A$ for some A .

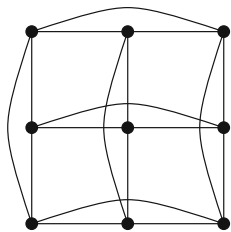

The graph S_3

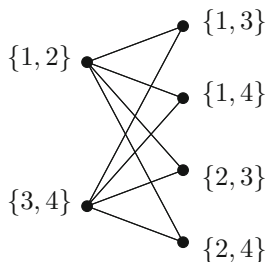

To state our first result we need *directed graphs* $\vec{G} = (V, E)$, that is, graphs where every edge e has an orientation. The notation $e = (u, v)$ means that there is an arc e , also denoted by $u \rightarrow v$, whose initial vertex is u and whose terminal vertex is v . It then makes sense to speak of the *outdegree* $d^+(v)$ resp. the *indegree* $d^-(v)$, where $d^+(v)$ counts the number of edges with v as initial vertex, and similarly for $d^-(v)$; furthermore, $d^+(v) + d^-(v) = d(v)$. When we write G , we mean the graph \vec{G} without the orientations.

The following concept originated in the analysis of games and will play a crucial role in our discussion.

Definition 1. Let $\vec{G} = (V, E)$ be a directed graph. A *kernel* $K \subseteq V$ is a subset of the vertices such that

- (i) K is independent in G , and
- (ii) for every $u \notin K$ there exists a vertex $v \in K$ with an edge $u \rightarrow v$.

Let us look at the example in the figure. The set $\{b, c, f\}$ constitutes a kernel, but the subgraph induced by $\{a, c, e\}$ does not have a kernel since the three edges cycle through the vertices.

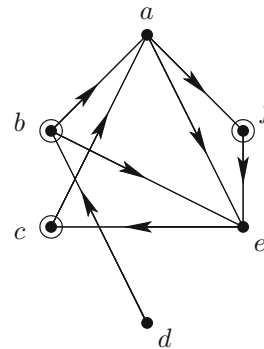

With all these preparations we are ready to state the first result.

Lemma 1. Let $\vec{G} = (V, E)$ be a directed graph, and suppose that for each vertex $v \in V$ we have a color set $C(v)$ that is larger than the outdegree, $|C(v)| \geq d^+(v) + 1$. If every induced subgraph of \vec{G} possesses a kernel, then there exists a list coloring of G with a color from $C(v)$ for each v .

■ **Proof.** We proceed by induction on $|V|$. For $|V| = 1$ there is nothing to prove. Choose a color $c \in C = \bigcup_{v \in V} C(v)$ and set

$$A(c) := \{v \in V : c \in C(v)\}.$$

By hypothesis, the induced subgraph $G_{A(c)}$ possesses a kernel $K(c)$. Now we color all $v \in K(c)$ with the color c (this is possible since $K(c)$ is independent), and delete $K(c)$ from G and c from C . Let G' be the induced subgraph of G on $V \setminus K(c)$ with $C'(v) = C(v) \setminus c$ as the new list of color sets. Notice that for each $v \in A(c) \setminus K(c)$, the outdegree $d^+(v)$ is decreased by at least 1 (due to condition (ii) of a kernel). So $d^+(v) + 1 \leq |C'(v)|$ still holds in \vec{G}' . The same condition also holds for the vertices outside $A(c)$, since in this case the color sets $C(v)$ remain unchanged. The new graph G' contains fewer vertices than G , and we are done by induction. \square

The method of attack for the Dinitz problem is now obvious: We have to find an orientation of the graph S_n with outdegrees $d^+(v) \leq n - 1$ for all v and which ensures the existence of a kernel for all induced subgraphs. This is accomplished by our second result.

Again we need a few preparations. Recall (from Chapter 11) that a *bipartite graph* $G = (X \cup Y, E)$ is a graph with the following property: The vertex set V is split into two parts X and Y such that every edge has one endvertex in X and the other in Y . In other words, the bipartite graphs are precisely those which can be colored with two colors (one for X and one for Y).

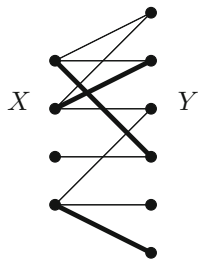

A bipartite graph with a matching

Now we come to an important concept, “stable matchings,” with a down-to-earth interpretation. A *matching* M in a bipartite graph $G = (X \cup Y, E)$ is a set of edges such that no two edges in M have a common endvertex. In the displayed graph the edges drawn in bold lines constitute a matching.

Consider X to be a set of men and Y a set of women and interpret $uv \in E$ to mean that u and v might marry. A matching is then a mass-wedding with no person committing bigamy. For our purposes we need a more refined (and more realistic?) version of a matching, suggested by David Gale and Lloyd S. Shapley. Clearly, in real life every person has preferences, and this is what we add to the set-up. In $G = (X \cup Y, E)$ we assume that for every $v \in X \cup Y$ there is a ranking of the set $N(v)$ of vertices adjacent to v , $N(v) = \{z_1 > z_2 > \dots > z_{d(v)}\}$. Thus z_1 is the top choice for v , followed by z_2 , and so on.

Definition 2. A matching M of $G = (X \cup Y, E)$ is called *stable* if the following condition holds: Whenever $uv \in E \setminus M$, $u \in X$, $v \in Y$, then either $uy \in M$ with $y > v$ in $N(u)$ or $xv \in M$ with $x > u$ in $N(v)$, or both.

In our real life interpretation a set of marriages is stable if it never happens that u and v are not married but u prefers v to his partner (if he has one at all) and v prefers u to her mate (if she has one at all), which would clearly be an unstable situation.

Before proving our second result let us take a look at the following example:

The bold edges constitute a stable matching. In each priority list, the choice leading to a stable matching is printed bold.

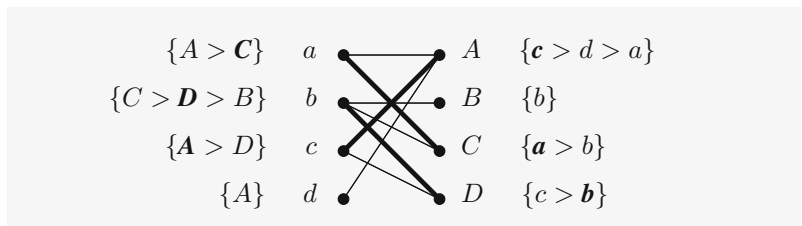

Notice that in this example there is a unique largest matching M with four edges, $M = \{aC, bB, cD, dA\}$, but M is not stable (consider cA).

Lemma 2. A stable matching always exists.

■ **Proof.** Consider the following algorithm. In the first stage all men $u \in X$ propose to their top choice. If a girl receives more than one proposal she picks the one she likes best and keeps him on a string, and if she receives just one proposal she keeps that one on a string. The remaining men are rejected and form the reservoir R . In the second stage all men in R propose to their next choice. The women compare the proposals (together with the one on the string, if there is one), pick their favorite and put him on the string. The rest is rejected and forms the new set R . Now the men in R propose to their next choice, and so on. A man who has proposed to his last choice and is again rejected drops out from further consideration (as well as from the reservoir). Clearly, after some time the reservoir R is empty, and at this point the algorithm stops.

Claim. *When the algorithm stops, then the men on the strings together with the corresponding girls form a stable matching.*

Notice first that the men on the string of a particular girl move there in increasing preference (of the girl) since at each stage the girl compares the new proposals with the present mate and then picks the new favorite. Hence if $uv \in E$ but $uv \notin M$, then either u never proposed to v in which case he found a better mate before he even got around to v , implying $uy \in M$ with $y > v$ in $N(u)$, or u proposed to v but was rejected, implying $xv \in M$ with $x > u$ in $N(v)$. But this is exactly the condition of a stable matching. \square

Putting Lemmas 1 and 2 together, we now get Galvin’s solution of the Dinitz problem.

Theorem. *We have $\chi_\ell(S_n) = n$ for all n .*

■ Proof. As before we denote the vertices of S_n by (i, j) , $1 \leq i, j \leq n$. Thus (i, j) and (r, s) are adjacent if and only if $i = r$ or $j = s$. Take any Latin square L with letters from $\{1, 2, \dots, n\}$ and denote by $L(i, j)$ the entry in cell (i, j) . Next make S_n into a directed graph \vec{S}_n by orienting the horizontal edges $(i, j) \rightarrow (i, j')$ if $L(i, j) < L(i, j')$ and the vertical edges $(i, j) \rightarrow (i', j)$ if $L(i, j) > L(i', j)$. Thus, horizontally we orient from the smaller to the larger element, and vertically the other way around. (In the margin we have an example for $n = 3$.)

Notice that we obtain $d^+(i, j) = n - 1$ for all (i, j) . In fact, if $L(i, j) = k$, then $n - k$ cells in row i contain an entry larger than k , and $k - 1$ cells in column j have an entry smaller than k .

By Lemma 1 it remains to show that every induced subgraph of \vec{S}_n possesses a kernel. Consider a subset $A \subseteq V$, and let X be the set of rows of L , and Y the set of its columns. Associate to A the bipartite graph $G = (X \cup Y, A)$, where every $(i, j) \in A$ is represented by the edge ij with $i \in X, j \in Y$. In the example in the margin the cells of A are shaded.

The orientation on S_n naturally induces a ranking on the neighborhoods in $G = (X \cup Y, A)$ by setting $j' > j$ in $N(i)$ if $(i, j) \rightarrow (i, j')$ in \vec{S}_n respectively $i' > i$ in $N(j)$ if $(i, j) \rightarrow (i', j)$. By Lemma 2, $G = (X \cup Y, A)$ possesses a stable matching M . This M , viewed as a subset of A , is our desired kernel! To see why, note first that M is independent in A since as edges in $G = (X \cup Y, A)$ they do not share an endvertex i or j . Secondly, if $(i, j) \in A \setminus M$, then by the definition of a stable matching there either exists $(i, j') \in M$ with $j' > j$ or $(i', j) \in M$ with $i' > i$, which for \vec{S}_n means $(i, j) \rightarrow (i, j') \in M$ or $(i, j) \rightarrow (i', j) \in M$, and the proof is complete. \square

To end the story let us go a little beyond. The reader may have noticed that the graph S_n arises from a bipartite graph by a simple construction. Take the complete bipartite graph, denoted by $K_{n,n}$, with $|X| = |Y| = n$, and all edges between X and Y . If we consider the edges of $K_{n,n}$ as vertices

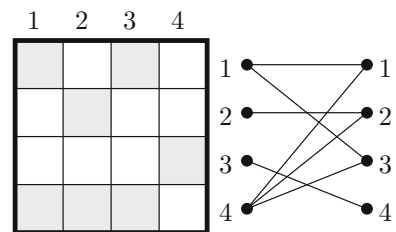
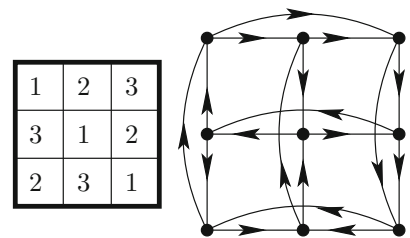

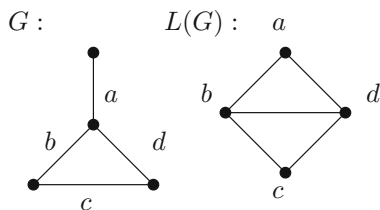

Construction of a line graph

of a new graph, joining two such vertices if and only if as edges in $K_{n,n}$ they have a common endvertex, then we clearly obtain the square graph S_n . Let us say that S_n is the *line graph* of $K_{n,n}$. Now this same construction can be performed on any graph G with the resulting graph called the *line graph* $L(G)$ of G .

In general, call H a *line graph* if $H = L(G)$ for some graph G . Of course, not every graph is a line graph, an example being the graph $K_{2,4}$ that we considered earlier, and for this graph we have seen $\chi(K_{2,4}) < \chi_\ell(K_{2,4})$. But what if H is a line graph? By adapting the proof of our theorem it can easily be shown that $\chi(H) = \chi_\ell(H)$ holds whenever H is the line graph of a *bipartite* graph, and the method may well go some way in verifying the supreme conjecture in this field:

Does $\chi(H) = \chi_\ell(H)$ hold for every line graph H ?

Very little is known about this conjecture, and things look hard — but after all, so did the Dinitz problem twenty years ago.

References

- [1] P. ERDŐS, A. L. RUBIN & H. TAYLOR: *Choosability in graphs*, Proc. West Coast Conference on Combinatorics, Graph Theory and Computing, Congressus Numerantium **26** (1979), 125-157.
- [2] D. GALE & L. S. SHAPLEY: *College admissions and the stability of marriage*, Amer. Math. Monthly **69** (1962), 9-15.
- [3] F. GALVIN: *The list chromatic index of a bipartite multigraph*, J. Combinatorial Theory, Ser. B **63** (1995), 153-158.
- [4] J. C. M. JANSSEN: *The Dinitz problem solved for rectangles*, Bulletin Amer. Math. Soc. **29** (1993), 243-249.
- [5] V. G. VIZING: *Coloring the vertices of a graph in prescribed colours (in Russian)*, Metody Diskret. Analiz. **101** (1976), 3-10.



Plane graphs and their colorings have been the subject of intensive research since the beginnings of graph theory because of their connection to the four-color problem. As stated originally the four-color problem asked whether it is always possible to color the regions of a plane map with four colors such that regions which share a common boundary (and not just a point) receive different colors. The figure on the right shows that coloring the regions of a map is really the same task as coloring the vertices of a plane graph. As in Chapter 13 (page 89) place a vertex in the interior of each region (including the outer region) and connect two such vertices belonging to neighboring regions by an edge through the common boundary.

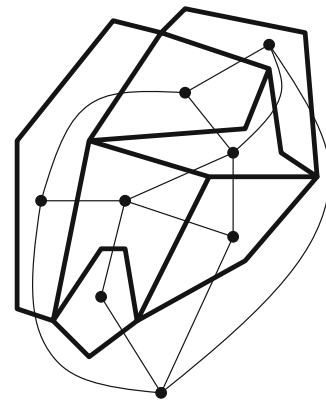

The dual graph of a map

The resulting graph G , the *dual graph* of the map M , is then a plane graph, and coloring the vertices of G in the usual sense is the same as coloring the regions of M . So we may as well concentrate on vertex-coloring plane graphs and will do so from now on. Note that we may assume that G has no loops or multiple edges, since these are irrelevant for coloring.

In the long and arduous history of attacks to prove the four-color theorem many attempts came close, but what finally succeeded in the Appel–Haken proof of 1976 and also in the more recent proof of Robertson, Sanders, Seymour and Thomas 1997 was a combination of very old ideas (dating back to the 19th century) and the very new calculating powers of modern-day computers. Twenty-five years after the original proof, the situation is still basically the same, there is even a computer-generated computer-checkable proof due to Gonthier, but no proof from The Book is in sight.

So let us be more modest and ask whether there is a neat proof that every plane graph can be 5-colored. A proof of this five-color theorem had already been given by Heawood at the turn of the century. The basic tool for his proof (and indeed also for the four-color theorem) was Euler’s formula (see Chapter 13). Clearly, when coloring a graph G we may assume that G is connected since we may color the connected pieces separately. A plane graph divides the plane into a set R of regions (including the exterior region). Euler’s formula states that for plane connected graphs $G = (V, E)$ we always have

$$|V| - |E| + |R| = 2.$$

As a warm-up, let us see how Euler’s formula may be applied to prove that every plane graph G is 6-colorable. We proceed by induction on the number n of vertices. For small values of n (in particular, for $n \leq 6$) this is obvious.

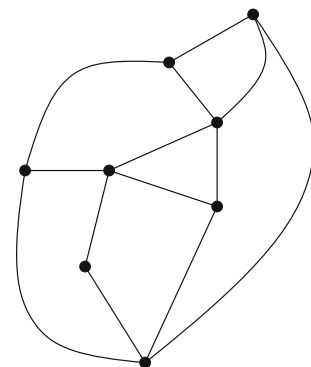

This plane graph has 8 vertices, 13 edges and 7 regions.

From part (A) of the proposition on page 91 we know that G has a vertex v of degree at most 5. Delete v and all edges incident with v . The resulting graph $G' = G \setminus v$ is a plane graph on $n - 1$ vertices. By induction, it can be 6-colored. Since v has at most 5 neighbors in G , at most 5 colors are used for these neighbors in the coloring of G' . So we can extend any 6-coloring of G' to a 6-coloring of G by assigning a color to v which is not used for any of its neighbors in the coloring of G' . Thus G is indeed 6-colorable.

Now let us look at the list chromatic number of plane graphs, which we have discussed in the chapter on the Dinitz problem. Clearly, our 6-coloring method works for lists of colors as well (again we never run out of colors), so $\chi_\ell(G) \leq 6$ holds for any plane graph G . Erdős, Rubin and Taylor conjectured in 1979 that every plane graph has list chromatic number at most 5, and further that there are plane graphs G with $\chi_\ell(G) > 4$. They were right on both counts. Margit Voigt was the first to construct an example of a plane graph G with $\chi_\ell(G) = 5$ (her example had 238 vertices) and around the same time Carsten Thomassen gave a truly stunning proof of the 5-list coloring conjecture. His proof is a telling example of what you can do when you find the right induction hypothesis. It does not use Euler's formula at all!

Theorem. *All planar graphs G can be 5-list colored:*

$$\chi_\ell(G) \leq 5.$$

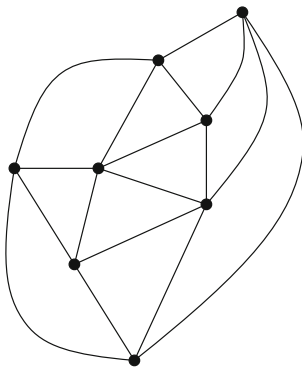

A near-triangulated plane graph

■ **Proof.** First note that adding edges can only increase the chromatic number. In other words, when H is a subgraph of G , then $\chi_\ell(H) \leq \chi_\ell(G)$ certainly holds. Hence we may assume that G is connected and that all the bounded faces of an embedding have triangles as boundaries. Let us call such a graph *near-triangulated*. The validity of the theorem for near-triangulated graphs will establish the statement for all plane graphs.

The trick of the proof is to show the following stronger statement (which allows us to use induction):

Let $G = (V, E)$ be a near-triangulated graph, and let B be the cycle bounding the outer region. We make the following assumptions on the color sets $C(v)$, $v \in V$:

- (1) *Two adjacent vertices x, y of B are already colored with (different) colors α and β .*
- (2) *$|C(v)| \geq 3$ for all other vertices v of B .*
- (3) *$|C(v)| \geq 5$ for all vertices v in the interior.*

Then the coloring of x, y can be extended to a proper coloring of G by choosing colors from the lists. In particular, $\chi_\ell(G) \leq 5$.

For $|V| = 3$ this is obvious, since for the only uncolored vertex v we have $|C(v)| \geq 3$, so there is a color available. Now we proceed by induction.

Case 1: Suppose B has a chord, that is, an edge not in B that joins two vertices $u, v \in B$. The subgraph G_1 which is bounded by $B_1 \cup \{uv\}$ and contains x, y, u and v is near-triangulated and therefore has a 5-list coloring by induction. Suppose in this coloring the vertices u and v receive the colors γ and δ . Now we look at the bottom part G_2 bounded by B_2 and uv . Regarding u, v as pre-colored, we see that the induction hypotheses are also satisfied for G_2 . Hence G_2 can be 5-list colored with the available colors, and thus the same is true for G .

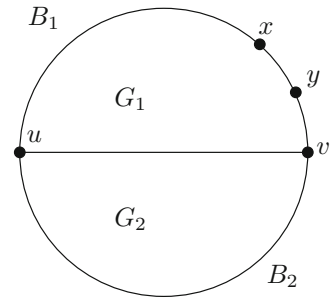

Case 2: Suppose B has no chord. Let v_0 be the vertex on the other side of the α -colored vertex x on B , and let x, v_1, \dots, v_t, w be the neighbors of v_0 . Since G is near-triangulated we have the situation shown in the figure.

Construct the near-triangulated graph $G' = G \setminus v_0$ by deleting from G the vertex v_0 and all edges emanating from v_0 . This G' has as outer boundary $B' = (B \setminus v_0) \cup \{v_1, \dots, v_t\}$. Since $|C(v_0)| \geq 3$ by assumption (2) there exist two colors γ, δ in $C(v_0)$ different from α . Now we replace every color set $C(v_i)$ by $C(v_i) \setminus \{\gamma, \delta\}$, keeping the original color sets for all other vertices in G' . Then G' clearly satisfies all assumptions and is thus 5-list colorable by induction. Choosing γ or δ for v_0 , different from the color of w , we can extend the list coloring of G' to all of G . \square

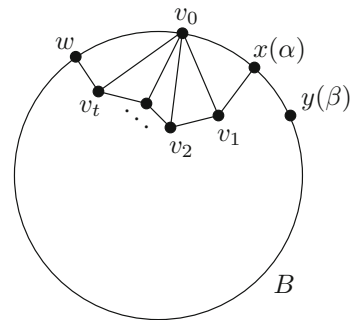

So, the 5-list color theorem is proved, but the story is not quite over. A stronger conjecture claimed that the list-chromatic number of a plane graph G is at most 1 more than the ordinary chromatic number:

Is $\chi_\ell(G) \leq \chi(G) + 1$ for every plane graph G ?

Since $\chi(G) \leq 4$ by the four-color theorem, we have three cases:

- Case I: $\chi(G) = 2 \implies \chi_\ell(G) \leq 3$
- Case II: $\chi(G) = 3 \implies \chi_\ell(G) \leq 4$
- Case III: $\chi(G) = 4 \implies \chi_\ell(G) \leq 5$.

Thomassen's result settles Case III, and Case I was proved by an ingenious (and much more sophisticated) argument by Alon and Tarsi. Furthermore, there are plane graphs G with $\chi(G) = 2$ and $\chi_\ell(G) = 3$, for example the graph $K_{2,4}$ that we considered in the chapter on the Dinitz problem.

But what about Case II? Here the conjecture fails: This was first shown by Margit Voigt for a graph that was earlier constructed by Shai Gutner. His graph on 130 vertices can be obtained as follows. First we look at the "double octahedron" (see the figure), which is clearly 3-colorable. Let $\alpha \in \{5, 6, 7, 8\}$ and $\beta \in \{9, 10, 11, 12\}$, and consider the lists that are given in the figure. You are invited to check that with these lists a coloring is not possible. Now take 16 copies of this graph, and identify all top vertices and all bottom vertices. This yields a graph on $16 \cdot 8 + 2 = 130$ vertices which

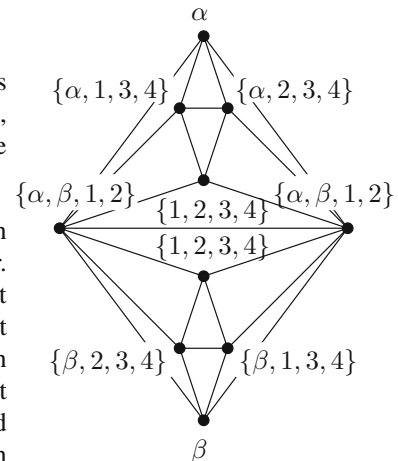

is still plane and 3-colorable. We assign $\{5, 6, 7, 8\}$ to the top vertex and $\{9, 10, 11, 12\}$ to the bottom vertex, with the inner lists corresponding to the 16 pairs (α, β) , $\alpha \in \{5, 6, 7, 8\}$, $\beta \in \{9, 10, 11, 12\}$. For every choice of α and β we thus obtain a subgraph as in the figure, and so a list coloring of the big graph is not possible.

By modifying another one of Gutner's examples, Voigt and Wirth came up with an even smaller plane graph with 75 vertices and $\chi = 3$, $\chi_\ell = 5$, which in addition uses only the minimal number of 5 colors in the combined lists. The current record is 63 vertices — achieved in 1996 by a young Iranian Math Olympiad participant, Maryam Mirzakhani, who in 2014 became the first woman ever to receive a Fields Medal.

To close let us remark that Victor Campos and Frédéric Havet have recently extended Thomassen's theorem by showing that every graph that can be drawn in the plane with at most two crossings is still 5-list colorable.

References

- [1] N. ALON & M. TARSI: *Colorings and orientations of graphs*, *Combinatorica* **12** (1992), 125-134.
- [2] V. CAMPOS & F. HAVET: *5-choosability of graphs with 2 crossings*, Preprint, May 2011, 18 pages, <http://arxiv.org/abs/1105.2723>.
- [5] P. ERDŐS, A. L. RUBIN & H. TAYLOR: *Choosability in graphs*, *Proc. West Coast Conference on Combinatorics, Graph Theory and Computing, Congressus Numerantium* **26** (1979), 125-157.
- [4] G. GONTHIER: *Formal proof — the Four-Color Theorem*, *Notices of the AMS* (11) **55** (2008), 1382-1393.
- [5] S. GUTNER: *The complexity of planar graph choosability*, *Discrete Math.* **159** (1996), 119-130.
- [6] M. MIRZAKHANI: *A small non-4-choosable planar graph*, *Bulletin Inst. Combinatorics Applications*, **17** (1996), 15-18.
- [7] N. ROBERTSON, D. P. SANDERS, P. SEYMOUR & R. THOMAS: *The four-colour theorem*, *J. Combinatorial Theory, Ser. B* **70** (1997), 2-44.
- [8] C. THOMASSEN: *Every planar graph is 5-choosable*, *J. Combinatorial Theory, Ser. B* **62** (1994), 180-181.
- [9] M. VOIGT: *List colorings of planar graphs*, *Discrete Math.* **120** (1993), 215-219.
- [10] M. VOIGT & B. WIRTH: *On 3-colorable non-4-choosable planar graphs*, *J. Graph Theory* **24** (1997), 233-235.

How to guard a museum

Chapter 40



Here is an appealing problem which was raised by Victor Klee in 1973. Suppose the manager of a museum wants to make sure that at all times every point of the museum is watched by a guard. The guards are stationed at fixed posts, but they are able to turn around. How many guards are needed?

We picture the walls of the museum as a polygon consisting of n sides. Of course, if the polygon is *convex*, then one guard is enough. In fact, the guard may be stationed at any point of the museum. But, in general, the walls of the museum may have the shape of any closed polygon.

Consider a comb-shaped museum with $n = 3m$ walls, as depicted on the right. It is easy to see that this requires at least $m = \frac{n}{3}$ guards. In fact, there are n walls. Now notice that the point 1 can only be observed by a guard stationed in the shaded triangle containing 1, and similarly for the other points 2, 3, ..., m . Since all these triangles are disjoint we conclude that at least m guards are needed. But m guards are also enough, since they can be placed at the top lines of the triangles. By cutting off one or two walls at the end, we conclude that for any n there is an n -walled museum which requires $\lfloor \frac{n}{3} \rfloor$ guards.

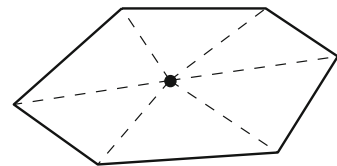

A convex exhibition hall

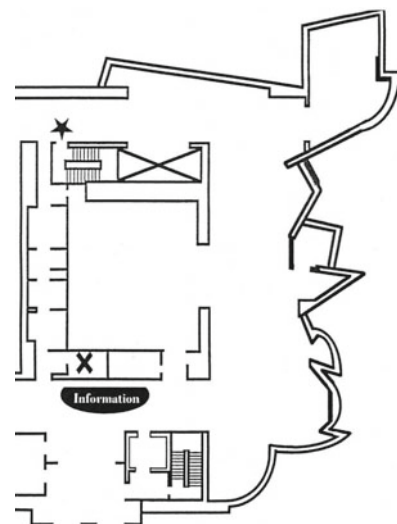
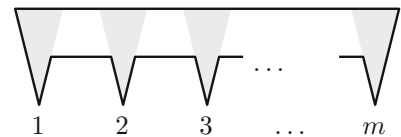

A real life art gallery...

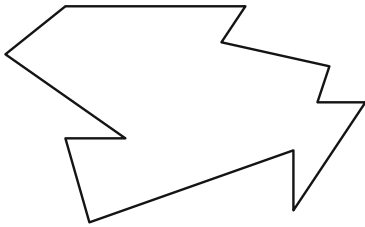
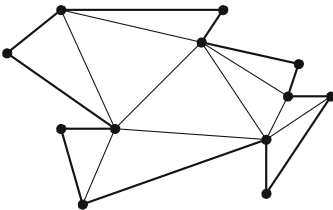
A museum with $n = 12$ walls

A triangulation of the museum

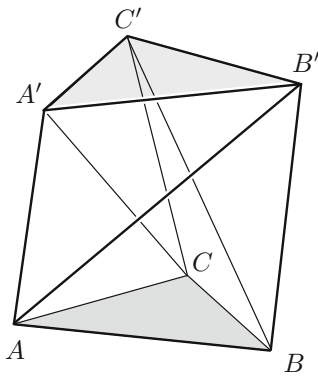
Schönhardt's polyhedron: The interior dihedral angles at the edges AB' , BC' and CA' are greater than 180° .

The following result states that this is the worst case.

Theorem. For any museum with n walls, $\lfloor \frac{n}{3} \rfloor$ guards suffice.

This “art gallery theorem” was first proved by Vašek Chvátal by a clever argument, but here is a proof due to Steve Fisk that is truly beautiful.

■ **Proof.** First of all, let us draw $n - 3$ noncrossing diagonals between corners of the walls until the interior is triangulated. For example, we can draw 9 diagonals in the museum depicted in the margin to produce a triangulation. It does not matter which triangulation we choose, any one will do. Now think of the new figure as a plane graph with the corners as vertices and the walls and diagonals as edges.

Claim. This graph is 3-colorable.

For $n = 3$ there is nothing to prove. Now for $n > 3$ pick any two vertices u and v which are connected by a diagonal. This diagonal will split the graph into two smaller triangulated graphs both containing the edge uv . By induction we may color each part with 3 colors where we may choose color 1 for u and color 2 for v in each coloring. Pasting the colorings together yields a 3-coloring of the whole graph.

The rest is easy. Since there are n vertices, at least one of the color classes, say the vertices colored 1, contains at most $\lfloor \frac{n}{3} \rfloor$ vertices, and this is where we place the guards. Since every triangle contains a vertex of color 1 we infer that every triangle is guarded, and hence so is the whole museum. \square

The astute reader may have noticed a subtle point in our reasoning. Does a triangulation always exist? Probably everybody's first reaction is: Obviously, yes! Well, it does exist, but this is not completely obvious, and, in fact, the natural generalization to three dimensions (partitioning into tetrahedra) is false! This may be seen from Schönhardt's polyhedron, depicted on the left. It is obtained from a triangular prism by rotating the top triangle, so that each of the quadrilateral faces breaks into two triangles with a nonconvex edge. Try to triangulate this polyhedron! You will notice that any tetrahedron that contains the bottom triangle must contain one of the three top vertices: but the resulting tetrahedron will not be contained in Schönhardt's polyhedron. So there is no triangulation without an additional vertex.

To prove that a triangulation exists in the case of a planar nonconvex polygon, we proceed by induction on the number n of vertices. For $n = 3$ the polygon is a triangle, and there is nothing to prove. Let $n \geq 4$. To use induction, all we have to produce is *one* diagonal which will split the polygon P into two smaller parts, such that a triangulation of the polygon can be pasted together from triangulations of the parts.

Call a vertex *A convex* if the interior angle at the vertex is less than 180° . Since the sum of the interior angles of P is $(n - 2)180^\circ$, there must be a

convex vertex A . In fact, there must be at least three of them: In essence this is an application of the pigeonhole principle! Or you may consider the convex hull of the polygon, and note that all its vertices are convex also for the original polygon.

Now look at the two neighboring vertices B and C of A . If the segment BC lies entirely in P , then this is our diagonal. If not, the triangle ABC contains other vertices. Slide BC towards A until it hits the last vertex Z in ABC . Now AZ is within P , and we have a diagonal.

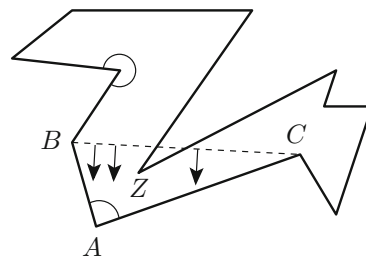

There are many variants to the art gallery theorem. For example, we may only want to guard the walls (which is, after all, where the paintings hang), or the guards are all stationed at vertices. A particularly nice (unsolved) variant goes as follows:

Suppose each guard may patrol one wall of the museum, so he walks along his wall and sees anything that can be seen from any point along this wall.

How many “wall guards” do we then need to keep control?

Godfried Toussaint constructed the example of a museum displayed here which shows that $\lfloor \frac{n}{4} \rfloor$ guards may be necessary.

This polygon has 28 sides (and, in general, $4m$ sides), and the reader is invited to check that m wall-guards are needed. It is conjectured that, except for some small values of n , this number is also sufficient, but a proof, let alone a Book Proof, is still missing.

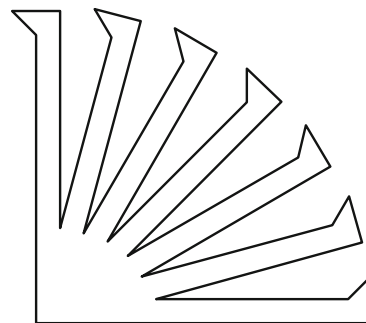

References

- [1] V. CHVÁTAL: *A combinatorial theorem in plane geometry*, J. Combinatorial Theory, Ser. B **18** (1975), 39-41.
- [2] S. FISK: *A short proof of Chvátal's watchman theorem*, J. Combinatorial Theory, Ser. B **24** (1978), 374.
- [3] J. O'ROURKE: *Art Gallery Theorems and Algorithms*, Oxford University Press 1987.
- [4] E. SCHÖNHARDT: *Über die Zerlegung von Dreieckspolyedern in Tetraeder*, Math. Annalen **98** (1928), 309-312.

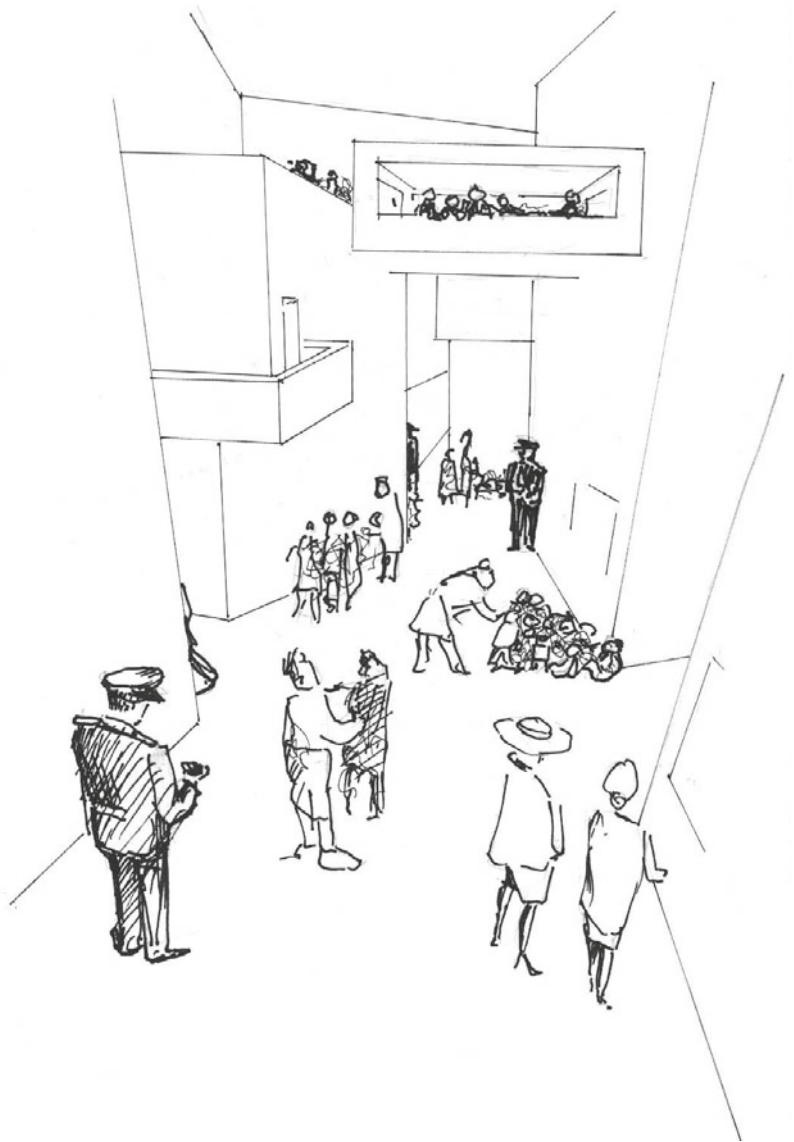

"Museum guards"
(A 3-dimensional art-gallery problem)



One of the fundamental results in graph theory is the theorem of Turán from 1941, which initiated extremal graph theory. Turán's theorem was rediscovered many times with various different proofs. We will discuss five of them and let the reader decide which one belongs in The Book.

Let us fix some notation. We consider simple graphs G on the vertex set $V = \{v_1, \dots, v_n\}$ and edge set E . If v_i and v_j are neighbors, then we write $v_i v_j \in E$. A p -clique in G is a complete subgraph of G on p vertices, denoted by K_p . Paul Turán posed the following question:

Suppose G is a simple graph that does not contain a p -clique. What is the largest number of edges that G can have?

We readily obtain examples of such graphs by dividing V into $p-1$ pairwise disjoint subsets $V = V_1 \cup \dots \cup V_{p-1}$, $|V_i| = n_i$, $n = n_1 + \dots + n_{p-1}$, joining two vertices if and only if they lie in distinct sets V_i, V_j . We denote the resulting graph by $K_{n_1, \dots, n_{p-1}}$; it has $\sum_{i < j} n_i n_j$ edges. We obtain a maximal number of edges among such graphs with given n if we divide the numbers n_i as evenly as possible, that is, if $|n_i - n_j| \leq 1$ for all i, j . Indeed, suppose $n_1 \geq n_2 + 2$. By shifting one vertex from V_1 to V_2 , we obtain $K_{n_1-1, n_2+1, \dots, n_{p-1}}$ which contains $(n_1 - 1)(n_2 + 1) - n_1 n_2 = n_1 - n_2 - 1 \geq 1$ more edges than $K_{n_1, n_2, \dots, n_{p-1}}$. Let us call the graphs $K_{n_1, \dots, n_{p-1}}$ with $|n_i - n_j| \leq 1$ the *Turán graphs*. In particular, if $p-1$ divides n , then we may choose $n_i = \frac{n}{p-1}$ for all i , obtaining

$$\binom{p-1}{2} \left(\frac{n}{p-1} \right)^2 = \left(1 - \frac{1}{p-1} \right) \frac{n^2}{2}$$

edges. Turán's theorem now states that this number is an upper bound for the edge-number of *any* graph on n vertices without a p -clique.

Theorem. *If a graph $G = (V, E)$ on n vertices has no p -clique, $p \geq 2$, then*

$$|E| \leq \left(1 - \frac{1}{p-1} \right) \frac{n^2}{2}. \quad (1)$$

For $p = 2$ this is trivial. In the first interesting case $p = 3$ the theorem states that a triangle-free graph on n vertices contains at most $\frac{n^2}{4}$ edges. Proofs of this special case were known prior to Turán's result. Two elegant proofs using inequalities are contained in Chapter 20.



Paul Turán

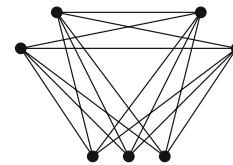

The graph $K_{2,2,3}$

Let us turn to the general case. The first two proofs use induction and are due to Turán and to Erdős, respectively.

■ **First proof.** We use induction on n . One easily computes that (1) is true for $n < p$. Let G be a graph on $V = \{v_1, \dots, v_n\}$ without p -cliques with a maximal number of edges, where $n \geq p$. G certainly contains $(p-1)$ -cliques, since otherwise we could add edges. Let A be a $(p-1)$ -clique, and set $B := V \setminus A$.

A contains $\binom{p-1}{2}$ edges, and we now estimate the edge-number e_B in B and the edge-number $e_{A,B}$ between A and B . By induction, we have $e_B \leq \frac{1}{2}(1 - \frac{1}{p-1})(n-p+1)^2$. Since G has no p -clique, every $v_j \in B$ is adjacent to at most $p-2$ vertices in A , and we obtain $e_{A,B} \leq (p-2)(n-p+1)$. Altogether, this yields

$$|E| \leq \binom{p-1}{2} + \frac{1}{2}\left(1 - \frac{1}{p-1}\right)(n-p+1)^2 + (p-2)(n-p+1),$$

which is precisely $(1 - \frac{1}{p-1})\frac{n^2}{2}$. \square

■ **Second proof.** This proof makes use of the structure of the Turán graphs. Let $v_m \in V$ be a vertex of maximal degree $d_m = \max_{1 \leq j \leq n} d_j$. Denote by S the set of neighbors of v_m , $|S| = d_m$, and set $T := V \setminus S$. As G contains no p -clique, and v_m is adjacent to all vertices of S , we note that S contains no $(p-1)$ -clique.

We now construct the following graph H on V (see the figure). H corresponds to G on S and contains all edges between S and T , but no edges within T . In other words, T is an independent set in H , and we conclude that H has again no p -cliques. Let d'_j be the degree of v_j in H . If $v_j \in S$, then we certainly have $d'_j \geq d_j$ by the construction of H , and for $v_j \in T$, we see $d'_j = |S| = d_m \geq d_j$ by the choice of v_m . We infer $|E(H)| \geq |E|$, and find that among all graphs with a maximal number of edges, there must be one of the form of H . By induction, the graph induced by S has at most as many edges as a suitable graph $K_{n_1, \dots, n_{p-2}}$ on S . So $|E| \leq |E(H)| \leq E(K_{n_1, \dots, n_{p-1}})$ with $n_{p-1} = |T|$, which implies (1). \square

The next two proofs are of a totally different nature, using a maximizing argument and ideas from probability theory. They are due to Motzkin and Straus and to Alon and Spencer, respectively.

■ **Third proof.** Consider a *probability distribution* $\mathbf{w} = (w_1, \dots, w_n)$ on the vertices, that is, an assignment of values $w_i \geq 0$ to the vertices with $\sum_{i=1}^n w_i = 1$. Our goal is to maximize the function

$$f(\mathbf{w}) = \sum_{v_i v_j \in E} w_i w_j.$$

Suppose \mathbf{w} is any distribution, and let v_i and v_j be a pair of nonadjacent vertices with positive weights w_i, w_j . Let s_i be the sum of the weights of

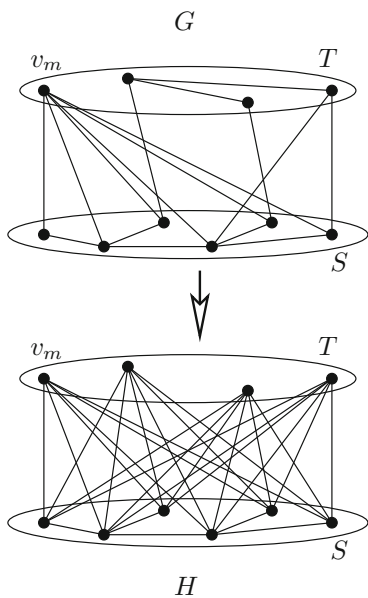
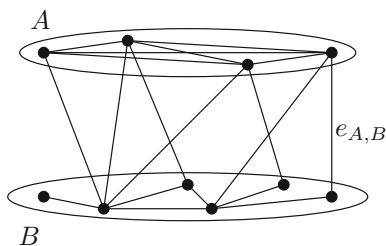

all vertices adjacent to v_i , and define s_j similarly for v_j , where we may assume that $s_i \geq s_j$. Now we move the weight from v_j to v_i , that is, the new weight of v_i is $w_i + w_j$, while the weight of v_j drops to 0. For the new new distribution \mathbf{w}' we find

$$f(\mathbf{w}') = f(\mathbf{w}) + w_j s_i - w_j s_j \geq f(\mathbf{w}).$$

We repeat this (reducing the number of vertices with a positive weight by one in each step) until there are no nonadjacent vertices of positive weight anymore. Thus we conclude that there is an optimal distribution whose nonzero weights are concentrated on a clique, say on a k -clique. Now if, say, $w_1 > w_2 > 0$, then choose ε with $0 < \varepsilon < w_1 - w_2$ and change w_1 to $w_1 - \varepsilon$ and w_2 to $w_2 + \varepsilon$. The new distribution \mathbf{w}' satisfies $f(\mathbf{w}') = f(\mathbf{w}) + \varepsilon(w_1 - w_2) - \varepsilon^2 > f(\mathbf{w})$, and we infer that the maximal value of $f(\mathbf{w})$ is attained for $w_i = \frac{1}{k}$ on a k -clique and $w_i = 0$ otherwise. Since a k -clique contains $\frac{k(k-1)}{2}$ edges, we obtain

$$f(\mathbf{w}) = \frac{k(k-1)}{2} \frac{1}{k^2} = \frac{1}{2} \left(1 - \frac{1}{k}\right).$$

Since this expression is increasing in k , the best we can do is to set $k = p-1$ (since G has no p -cliques). So we conclude

$$f(\mathbf{w}) \leq \frac{1}{2} \left(1 - \frac{1}{p-1}\right)$$

for any distribution \mathbf{w} . In particular, this inequality holds for the uniform distribution given by $w_i = \frac{1}{n}$ for all i . Thus we find

$$\frac{|E|}{n^2} = f\left(w_i = \frac{1}{n}\right) \leq \frac{1}{2} \left(1 - \frac{1}{p-1}\right),$$

which is precisely (1). \square

■ Fourth proof. This time we use some concepts from probability theory. Let G be an arbitrary graph on the vertex set $V = \{v_1, \dots, v_n\}$. Denote the degree of v_i by d_i , and write $\omega(G)$ for the number of vertices in a largest clique, called the *clique number* of G .

Claim. We have $\omega(G) \geq \sum_{i=1}^n \frac{1}{n - d_i}$.

We choose a random permutation $\pi = v_1 v_2 \dots v_n$ of the vertex set V , where each permutation is supposed to appear with the same probability $\frac{1}{n!}$, and then consider the following set C_π . We put v_i into C_π if and only if v_i is adjacent to all v_j ($j < i$) preceding v_i . By definition, C_π is a clique in G . Let $X = |C_\pi|$ be the corresponding random variable. We have $X = \sum_{i=1}^n X_i$, where X_i is the indicator random variable of the vertex v_i , that is, $X_i = 1$ or $X_i = 0$ depending on whether $v_i \in C_\pi$ or $v_i \notin C_\pi$. Note that v_i belongs to C_π with respect to the permutation $v_1 v_2 \dots v_n$ if and only if v_i appears *before* all $n - 1 - d_i$ vertices which are not adjacent to v_i , or in other words, if v_i is the *first* among v_i and its $n - 1 - d_i$ non-neighbors. The probability that this happens is $\frac{1}{n - d_i}$, hence $EX_i = \frac{1}{n - d_i}$.



“Moving weights”

Thus by linearity of expectation (see page 116) we obtain

$$E(|C_\pi|) = EX = \sum_{i=1}^n EX_i = \sum_{i=1}^n \frac{1}{n-d_i}.$$

Consequently, there must be a clique of at least that size, and this was our claim. To deduce Turán's theorem from the claim we use the Cauchy–Schwarz inequality from Chapter 20,

$$\left(\sum_{i=1}^n a_i b_i\right)^2 \leq \left(\sum_{i=1}^n a_i^2\right) \left(\sum_{i=1}^n b_i^2\right).$$

Set $a_i = \sqrt{n-d_i}$, $b_i = \frac{1}{\sqrt{n-d_i}}$, then $a_i b_i = 1$, and so

$$n^2 \leq \left(\sum_{i=1}^n (n-d_i)\right) \left(\sum_{i=1}^n \frac{1}{n-d_i}\right) \leq \omega(G) \sum_{i=1}^n (n-d_i). \quad (2)$$

At this point we apply the hypothesis $\omega(G) \leq p-1$ of Turán's theorem. Using also $\sum_{i=1}^n d_i = 2|E|$ from the chapter on double counting, inequality (2) leads to

$$n^2 \leq (p-1)(n^2 - 2|E|),$$

and this is equivalent to Turán's inequality. \square

Now we are ready for the last proof, which may be the most beautiful of them all. Its origin is not clear; we got it from Stephan Brandt, who heard it in Oberwolfach. It may be “folklore” graph theory. It yields in one stroke that the Turán graph is in fact the unique example with a maximal number of edges. It may be noted that both proofs 1 and 2 also imply this stronger result.

■ **Fifth proof.** Let G be a graph on n vertices without a p -clique and with a maximal number of edges.

Claim. G does not contain three vertices u, v, w such that $vw \in E$, but $uv \notin E$, $uw \notin E$.

Suppose otherwise, and consider the following cases.

Case 1: $d(u) < d(v)$ or $d(u) < d(w)$.

We may suppose that $d(u) < d(v)$. Then we duplicate v , that is, we create a new vertex v' which has exactly the same neighbors as v (but vv' is not an edge), delete u , and keep the rest unchanged.

The new graph G' has again no p -clique, and for the number of edges we find

$$|E(G')| = |E(G)| + d(v) - d(u) > |E(G)|,$$

a contradiction.

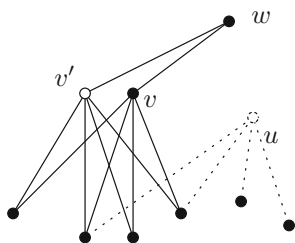
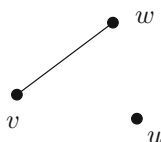

Case 2: $d(u) \geq d(v)$ and $d(u) \geq d(w)$.

Duplicate u twice and delete v and w (as illustrated in the margin). Again, the new graph G' has no p -clique, and we compute (the -1 results from the edge vw):

$$|E(G')| = |E(G)| + 2d(u) - (d(v) + d(w) - 1) > |E(G)|.$$

So we have a contradiction once more.

A moment's thought shows that the claim we have proved is equivalent to the statement that

$$u \sim v \iff uv \notin E(G)$$

defines an equivalence relation. Thus G is a complete multipartite graph, $G = K_{n_1, \dots, n_{p-1}}$, and we are finished. \square

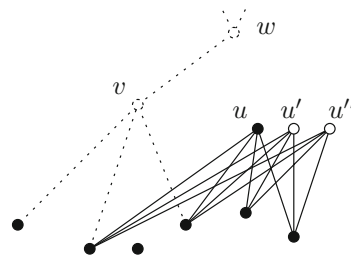

References

- [1] M. AIGNER: *Turán's graph theorem*, Amer. Math. Monthly **102** (1995), 808-816.
- [2] N. ALON & J. SPENCER: *The Probabilistic Method*, Third edition, Wiley-Interscience 2008.
- [3] P. ERDŐS: *On the graph theorem of Turán (in Hungarian)*, Math. Fiz. Lapok **21** (1970), 249-251.
- [4] T. S. MOTZKIN & E. G. STRAUS: *Maxima for graphs and a new proof of a theorem of Turán*, Canad. J. Math. **17** (1965), 533-540.
- [5] P. TURÁN: *On an extremal problem in graph theory*, Math. Fiz. Lapok **48** (1941), 436-452.



“Larger weights to move”



In 1956, Claude Shannon, the founder of information theory, posed the following very interesting question:

Suppose we want to transmit messages across a channel (where some symbols may be distorted) to a receiver. What is the maximum rate of transmission such that the receiver may recover the original message without errors?

Let us see what Shannon meant by “channel” and “rate of transmission.” We are given a set V of symbols, and a message is just a string of symbols from V . We model the channel as a graph $G = (V, E)$, where V is the set of symbols, and E the set of edges between unreliable pairs of symbols, that is, symbols which may be confused during transmission. For example, communicating over a phone in everyday language, we connect the symbols B and P by an edge since the receiver may not be able to distinguish them. Let us call G the *confusion graph*.

The 5-cycle C_5 will play a prominent role in our discussion. In this example, 1 and 2 may be confused, but not 1 and 3, etc. Ideally we would like to use all 5 symbols for transmission, but since we want to communicate error-free we can — if we only send single symbols — use only one letter from each pair that might be confused. Thus for the 5-cycle we can use only two different letters (any two that are not connected by an edge). In the language of information theory, this means that for the 5-cycle we achieve an information rate of $\log_2 2 = 1$ (instead of the maximal $\log_2 5 \approx 2.32$). It is clear that in this model, for an arbitrary graph $G = (V, E)$, the best we can do is to transmit symbols from a largest independent set. Thus the information rate, when sending single symbols, is $\log_2 \alpha(G)$, where $\alpha(G)$ is the *independence number* of G .

Let us see whether we can increase the information rate by using larger strings in place of single symbols. Suppose we want to transmit strings of length 2. The strings u_1u_2 and v_1v_2 can only be confused if one of the following three cases holds:

- $u_1 = v_1$ and u_2 can be confused with v_2 ,
- $u_2 = v_2$ and u_1 can be confused with v_1 , or
- $u_1 \neq v_1$ can be confused and $u_2 \neq v_2$ can be confused.

In graph-theoretic terms this amounts to considering the *product* $G_1 \times G_2$ of two graphs $G_1 = (V_1, E_1)$ and $G_2 = (V_2, E_2)$. $G_1 \times G_2$ has the vertex



Claude Shannon

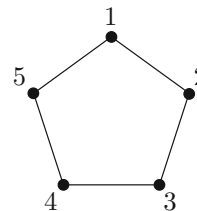

set $V_1 \times V_2 = \{(u_1, u_2) : u_1 \in V_1, u_2 \in V_2\}$, with $(u_1, u_2) \neq (v_1, v_2)$ connected by an edge if and only if $u_i = v_i$ or $u_i v_i \in E_i$ for $i = 1, 2$. The confusion graph for strings of length 2 is thus $G^2 = G \times G$, the product of the confusion graph G for single symbols with itself. The information rate of strings of length 2 *per symbol* is then given by

$$\frac{\log_2 \alpha(G^2)}{2} = \log_2 \sqrt{\alpha(G^2)}.$$

Now, of course, we may use strings of any length n . The n -th confusion graph $G^n = G \times G \times \cdots \times G$ has vertex set $V^n = \{(u_1, \dots, u_n) : u_i \in V\}$ with $(u_1, \dots, u_n) \neq (v_1, \dots, v_n)$ being connected by an edge if $u_i = v_i$ or $u_i v_i \in E$ for all i . The rate of information per symbol determined by strings of length n is

$$\frac{\log_2 \alpha(G^n)}{n} = \log_2 \sqrt[n]{\alpha(G^n)}.$$

What can we say about $\alpha(G^n)$? Here is a first observation. Let $U \subseteq V$ be a largest independent set in G , $|U| = \alpha$. The α^n vertices in G^n of the form (u_1, \dots, u_n) , $u_i \in U$ for all i , clearly form an independent set in G^n . Hence

$$\alpha(G^n) \geq \alpha(G)^n$$

and therefore

$$\sqrt[n]{\alpha(G^n)} \geq \alpha(G),$$

meaning that we never decrease the information rate by using longer strings instead of single symbols. This, by the way, is a basic idea of coding theory: By encoding symbols into longer strings we can make error-free communication more efficient.

Disregarding the logarithm we thus arrive at Shannon's fundamental definition: The *zero-error capacity* of a graph G is given by

$$\Theta(G) := \sup_{n \geq 1} \sqrt[n]{\alpha(G^n)},$$

and Shannon's problem was to compute $\Theta(G)$, and in particular $\Theta(C_5)$.

Let us look at C_5 . So far we know $\alpha(C_5) = 2 \leq \Theta(C_5)$. Looking at the 5-cycle as depicted earlier, or at the product $C_5 \times C_5$ as drawn on the left, we see that the set $\{(1, 1), (2, 3), (3, 5), (4, 2), (5, 4)\}$ is independent in C_5^2 . Thus we have $\alpha(C_5^2) \geq 5$. Since an independent set can contain only two vertices from any two consecutive rows we see that $\alpha(C_5^2) = 5$. Hence, by using strings of length 2 we have increased the lower bound for the capacity to $\Theta(C_5) \geq \sqrt{5}$.

So far we have no upper bounds for the capacity. To obtain such bounds we again follow Shannon's original ideas. First we need the dual definition of an independent set. We recall that a subset $C \subseteq V$ is a *clique* if any two vertices of C are joined by an edge. Thus the vertices form trivial

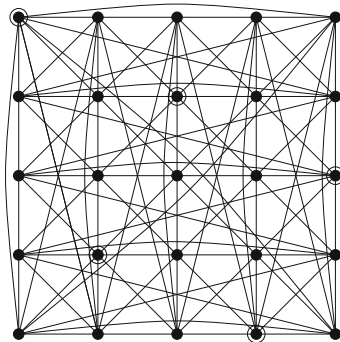

The graph $C_5 \times C_5$

cliques of size 1, the edges are the cliques of size 2, the triangles are cliques of size 3, and so on. Let \mathcal{C} be the set of cliques in G . Consider an arbitrary probability distribution $\mathbf{x} = (x_v : v \in V)$ on the set of vertices, that is, $x_v \geq 0$ and $\sum_{v \in V} x_v = 1$. To every distribution \mathbf{x} we associate the “maximal value of a clique”

$$\lambda(\mathbf{x}) = \max_{C \in \mathcal{C}} \sum_{v \in C} x_v,$$

and finally we set

$$\lambda(G) = \min_{\mathbf{x}} \lambda(\mathbf{x}) = \min_{\mathbf{x}} \max_{C \in \mathcal{C}} \sum_{v \in C} x_v.$$

To be precise we should use inf instead of min, but the minimum exists because $\lambda(\mathbf{x})$ is continuous on the compact set of all distributions.

Consider now an independent set $U \subseteq V$ of maximal size $\alpha(G) = \alpha$. Associated to U we define the distribution $\mathbf{x}_U = (x_v : v \in V)$ by setting $x_v = \frac{1}{\alpha}$ if $v \in U$ and $x_v = 0$ otherwise. Since any clique contains at most one vertex from U , we infer $\lambda(\mathbf{x}_U) = \frac{1}{\alpha}$, and thus by the definition of $\lambda(G)$

$$\lambda(G) \leq \frac{1}{\alpha(G)} \quad \text{or} \quad \alpha(G) \leq \lambda(G)^{-1}.$$

What Shannon observed is that $\lambda(G)^{-1}$ is, in fact, an upper bound for all $\sqrt[n]{\alpha(G^n)}$, and hence also for $\Theta(G)$. In order to prove this it suffices to show that for graphs G, H

$$\lambda(G \times H) = \lambda(G)\lambda(H) \tag{1}$$

holds, since this will imply $\lambda(G^n) = \lambda(G)^n$ and hence

$$\begin{aligned} \alpha(G^n) &\leq \lambda(G^n)^{-1} = \lambda(G)^{-n} \\ \sqrt[n]{\alpha(G^n)} &\leq \lambda(G)^{-1}. \end{aligned}$$

To prove (1) we make use of the duality theorem of linear programming (see [1]) and get

$$\lambda(G) = \min_{\mathbf{x}} \max_{C \in \mathcal{C}} \sum_{v \in C} x_v = \max_{\mathbf{y}} \min_{v \in V} \sum_{C \ni v} y_C, \tag{2}$$

where the right-hand side runs through all probability distributions $\mathbf{y} = (y_C : C \in \mathcal{C})$ on \mathcal{C} .

Consider $G \times H$, and let \mathbf{x} and \mathbf{x}' be distributions which achieve the minima, $\lambda(\mathbf{x}) = \lambda(G)$, $\lambda(\mathbf{x}') = \lambda(H)$. In the vertex set of $G \times H$ we assign the value $z_{(u,v)} = x_u x'_v$ to the vertex (u, v) . Since $\sum_{(u,v)} z_{(u,v)} = \sum_u x_u \sum_v x'_v = 1$, we obtain a distribution. Next we observe that the maximal cliques in $G \times H$ are of the form $C \times D = \{(u, v) : u \in C, v \in D\}$ where C and D are cliques in G and H , respectively. Hence we obtain

$$\begin{aligned} \lambda(G \times H) \leq \lambda(\mathbf{z}) &= \max_{C \times D} \sum_{(u,v) \in C \times D} z_{(u,v)} \\ &= \max_{C \times D} \sum_{u \in C} x_u \sum_{v \in D} x'_v = \lambda(G)\lambda(H) \end{aligned}$$

by the definition of $\lambda(G \times H)$. In the same way the converse inequality $\lambda(G \times H) \geq \lambda(G)\lambda(H)$ is shown by using the dual expression for $\lambda(G)$ in (2). In summary we can state:

$$\Theta(G) \leq \lambda(G)^{-1},$$

for any graph G .

Let us apply our findings to the 5-cycle and, more generally, to the m -cycle C_m . By using the uniform distribution $(\frac{1}{m}, \dots, \frac{1}{m})$ on the vertices, we obtain $\lambda(C_m) \leq \frac{2}{m}$, since any clique contains at most two vertices. Similarly, choosing $\frac{1}{m}$ for the edges and 0 for the vertices, we have $\lambda(C_m) \geq \frac{2}{m}$ by the dual expression in (2). We conclude that $\lambda(C_m) = \frac{2}{m}$ and therefore

$$\Theta(C_m) \leq \frac{m}{2}$$

for all m . Now, if m is even, then clearly $\alpha(C_m) = \frac{m}{2}$ and thus also $\Theta(C_m) = \frac{m}{2}$. For odd m , however, we have $\alpha(C_m) = \frac{m-1}{2}$. For $m = 3$, C_3 is a clique, and so is every product C_3^n , implying $\alpha(C_3) = \Theta(C_3) = 1$. So, the first interesting case is the 5-cycle, where we know up to now

$$\sqrt{5} \leq \Theta(C_5) \leq \frac{5}{2}. \quad (3)$$

Using his linear programming approach (and some other ideas) Shannon was able to compute the capacity of many graphs and, in particular, of all graphs with five or fewer vertices — with the single exception of C_5 , where he could not go beyond the bounds in (3). This is where things stood for more than 20 years until László Lovász showed by an astonishingly simple argument that indeed $\Theta(C_5) = \sqrt{5}$. A seemingly very difficult combinatorial problem was provided with an unexpected and elegant solution.

Lovász' main new idea was to represent the vertices v of the graph by real vectors of length 1 such that any two vectors which belong to non-adjacent vertices in G are orthogonal. Let us call such a set of vectors an *orthonormal representation* of G . Clearly, such a representation always exists: just take the unit vectors $(1, 0, \dots, 0)^T$, $(0, 1, 0, \dots, 0)^T$, \dots , $(0, 0, \dots, 1)^T$ of dimension $m = |V|$.

For the graph C_5 we may obtain an orthonormal representation in \mathbb{R}^3 by considering an “umbrella” with five ribs v_1, \dots, v_5 of unit length. Now open the umbrella (with tip at the origin) to the point where the angles between alternate ribs are 90° .

Lovász then went on to show that the height h of the umbrella, that is, the distance between $\mathbf{0}$ and S , provides the bound

$$\Theta(C_5) \leq \frac{1}{h^2}. \quad (4)$$

A simple calculation yields $h^2 = \frac{1}{\sqrt{5}}$; see the box on the next page. From this $\Theta(C_5) \leq \sqrt{5}$ follows, and therefore $\Theta(C_5) = \sqrt{5}$.

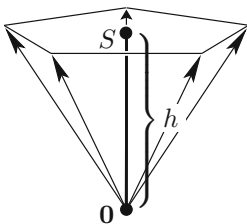

The Lovász umbrella

Let us see how Lovász proceeded to prove the inequality (4). (His results were, in fact, much more general.) Consider the usual inner product

$$\langle \mathbf{x}, \mathbf{y} \rangle = x_1 y_1 + \cdots + x_s y_s$$

of two vectors $\mathbf{x} = (x_1, \dots, x_s)$, $\mathbf{y} = (y_1, \dots, y_s)$ in \mathbb{R}^s . Then $|\mathbf{x}|^2 = \langle \mathbf{x}, \mathbf{x} \rangle = x_1^2 + \cdots + x_s^2$ is the square of the length $|\mathbf{x}|$ of \mathbf{x} , and the angle γ between \mathbf{x} and \mathbf{y} is given by

$$\cos \gamma = \frac{\langle \mathbf{x}, \mathbf{y} \rangle}{|\mathbf{x}| |\mathbf{y}|}.$$

Thus $\langle \mathbf{x}, \mathbf{y} \rangle = 0$ if and only if \mathbf{x} and \mathbf{y} are orthogonal.

Pentagons and the golden section

Tradition has it that a rectangle was considered aesthetically pleasing if, after cutting off a square of length a , the remaining rectangle had the same shape as the original one. The side lengths a, b of such a rectangle must satisfy $\frac{b}{a} = \frac{a}{b-a}$. Setting $\tau := \frac{b}{a}$ for the ratio, we obtain $\tau = \frac{1}{\tau-1}$ or $\tau^2 - \tau - 1 = 0$. Solving the quadratic equation yields the *golden section* $\tau = \frac{1+\sqrt{5}}{2} \approx 1.6180$.

Consider now a regular pentagon of side length a , and let d be the length of its diagonals. It was already known to Euclid (Book XIII,8) that $\frac{d}{a} = \tau$, and that the intersection point of two diagonals divides the diagonals in the golden section.

Here is Euclid's Book Proof. Since the total angle sum of the pentagon is 3π , the angle at any vertex equals $\frac{3\pi}{5}$. It follows that $\sphericalangle ABE = \frac{\pi}{5}$, since ABE is an isosceles triangle. This, in turn, implies $\sphericalangle AMB = \frac{3\pi}{5}$, and we conclude that the triangles ABC and AMB are similar. The quadrilateral $CMED$ is a rhombus since opposing sides are parallel (look at the angles), and so $|MC| = a$ and thus $|AM| = d - a$. By the similarity of ABC and AMB we conclude

$$\frac{d}{a} = \frac{|AC|}{|AB|} = \frac{|AB|}{|AM|} = \frac{a}{d-a} = \frac{|MC|}{|MA|} = \tau.$$

There is more to come. For the distance s of a vertex to the center of the pentagon S , the reader is invited to prove the relation $s^2 = \frac{d^2}{\tau+2}$ (note that BS cuts the diagonal AC at a right angle and halves it).

To finish our excursion into geometry, consider now the umbrella with the regular pentagon on top. Since alternate ribs (of length 1) form a right angle, the theorem of Pythagoras gives us $d = \sqrt{2}$, and hence $s^2 = \frac{2}{\tau+2} = \frac{4}{\sqrt{5}+5}$. So, with Pythagoras again, we find for the height $h = |OS|$ our promised result

$$h^2 = 1 - s^2 = \frac{1 + \sqrt{5}}{\sqrt{5} + 5} = \frac{1}{\sqrt{5}}.$$

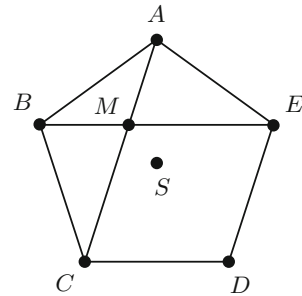
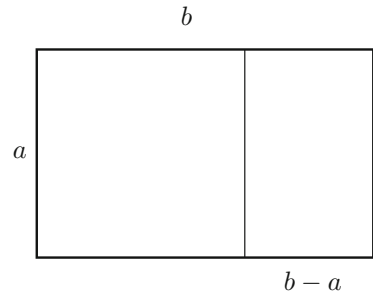

Now we head for an upper bound for the Shannon capacity of any graph G that has an especially “nice” orthonormal representation. For this let $T = \{\mathbf{v}^{(1)}, \dots, \mathbf{v}^{(m)}\}$ be an orthonormal representation of G in \mathbb{R}^s , where $\mathbf{v}^{(i)}$ corresponds to the vertex v_i . We assume in addition that all the vectors $\mathbf{v}^{(i)}$ have the *same* angle ($\neq 90^\circ$) with the vector $\mathbf{u} := \frac{1}{m}(\mathbf{v}^{(1)} + \dots + \mathbf{v}^{(m)})$, or equivalently that the inner product

$$\langle \mathbf{v}^{(i)}, \mathbf{u} \rangle = \sigma_T$$

has the same value $\sigma_T \neq 0$ for all i . Let us call this value σ_T the *constant* of the representation T . For the Lovász umbrella that represents C_5 the condition $\langle \mathbf{v}^{(i)}, \mathbf{u} \rangle = \sigma_T$ certainly holds, for $\mathbf{u} = \overline{OS}$.

Now we proceed in the following three steps.

(A) Consider a probability distribution $\mathbf{x} = (x_1, \dots, x_m)$ on V and set

$$\mu(\mathbf{x}) := |x_1 \mathbf{v}^{(1)} + \dots + x_m \mathbf{v}^{(m)}|^2,$$

and

$$\mu_T(G) := \inf_{\mathbf{x}} \mu(\mathbf{x}).$$

Let U be a largest independent set in G with $|U| = \alpha$, and define $\mathbf{x}_U = (x_1, \dots, x_m)$ with $x_i = \frac{1}{\alpha}$ if $v_i \in U$ and $x_i = 0$ otherwise. Since all vectors $\mathbf{v}^{(i)}$ have unit length and $\langle \mathbf{v}^{(i)}, \mathbf{v}^{(j)} \rangle = 0$ for any two nonadjacent vertices, we infer

$$\mu_T(G) \leq \mu(\mathbf{x}_U) = \left| \sum_{i=1}^m x_i \mathbf{v}^{(i)} \right|^2 = \sum_{i=1}^m x_i^2 = \alpha \frac{1}{\alpha^2} = \frac{1}{\alpha}.$$

Thus we have $\mu_T(G) \leq \alpha^{-1}$, and therefore

$$\alpha(G) \leq \frac{1}{\mu_T(G)}.$$

(B) Next we compute $\mu_T(G)$. We need the Cauchy–Schwarz inequality

$$\langle \mathbf{a}, \mathbf{b} \rangle^2 \leq |\mathbf{a}|^2 |\mathbf{b}|^2$$

for vectors $\mathbf{a}, \mathbf{b} \in \mathbb{R}^s$. Applied to $\mathbf{a} = x_1 \mathbf{v}^{(1)} + \dots + x_m \mathbf{v}^{(m)}$ and $\mathbf{b} = \mathbf{u}$, the inequality yields

$$\langle x_1 \mathbf{v}^{(1)} + \dots + x_m \mathbf{v}^{(m)}, \mathbf{u} \rangle^2 \leq \mu(\mathbf{x}) |\mathbf{u}|^2. \quad (5)$$

By our assumption that $\langle \mathbf{v}^{(i)}, \mathbf{u} \rangle = \sigma_T$ for all i , we have

$$\langle x_1 \mathbf{v}^{(1)} + \dots + x_m \mathbf{v}^{(m)}, \mathbf{u} \rangle = (x_1 + \dots + x_m) \sigma_T = \sigma_T$$

for *any* distribution \mathbf{x} . Thus, in particular, this has to hold for the uniform distribution $(\frac{1}{m}, \dots, \frac{1}{m})$, which implies $|\mathbf{u}|^2 = \sigma_T$. Hence (5) reduces to

$$\sigma_T^2 \leq \mu(\mathbf{x}) \sigma_T \quad \text{or} \quad \mu_T(G) \geq \sigma_T.$$

On the other hand, for $\mathbf{x} = (\frac{1}{m}, \dots, \frac{1}{m})$ we obtain

$$\mu_T(G) \leq \mu(\mathbf{x}) = |\frac{1}{m}(\mathbf{v}^{(1)} + \dots + \mathbf{v}^{(m)})|^2 = |\mathbf{u}|^2 = \sigma_T,$$

and so we have proved

$$\mu_T(G) = \sigma_T. \tag{6}$$

In summary, we have established the inequality

$$\alpha(G) \leq \frac{1}{\sigma_T} \tag{7}$$

for any orthonormal representation T with constant σ_T .

(C) To extend this inequality to $\Theta(G)$, we proceed as before. Consider again the product $G \times H$ of two graphs. Let G and H have orthonormal representations R and S in \mathbb{R}^r and \mathbb{R}^s , respectively, with constants σ_R and σ_S . Let $\mathbf{v} = (v_1, \dots, v_r)$ be a vector in R and $\mathbf{w} = (w_1, \dots, w_s)$ be a vector in S . To the vertex in $G \times H$ corresponding to the pair (\mathbf{v}, \mathbf{w}) we associate the vector

$$\mathbf{vw}^T := (v_1w_1, \dots, v_1w_s, v_2w_1, \dots, v_2w_s, \dots, v_rw_1, \dots, v_rw_s) \in \mathbb{R}^{rs}.$$

It is immediately checked that $R \times S := \{\mathbf{vw}^T : \mathbf{v} \in R, \mathbf{w} \in S\}$ is an orthonormal representation of $G \times H$ with constant $\sigma_R\sigma_S$. Hence by (6) we obtain

$$\mu_{R \times S}(G \times H) = \mu_R(G)\mu_S(H).$$

For $G^n = G \times \dots \times G$ and the representation T with constant σ_T this means

$$\mu_{T^n}(G^n) = \mu_T(G)^n = \sigma_T^n$$

and by (7) we obtain

$$\alpha(G^n) \leq \sigma_T^{-n}, \quad \sqrt[n]{\alpha(G^n)} \leq \sigma_T^{-1}.$$

Taking all things together we have thus completed Lovász' argument:

Theorem. Whenever $T = \{\mathbf{v}^{(1)}, \dots, \mathbf{v}^{(m)}\}$ is an orthonormal representation of G with constant σ_T , then

$$\Theta(G) \leq \frac{1}{\sigma_T}. \tag{8}$$

Looking at the Lovász umbrella, we have $\mathbf{u} = (0, 0, h = \frac{1}{\sqrt{5}})^T$ and hence $\sigma = \langle \mathbf{v}^{(i)}, \mathbf{u} \rangle = h^2 = \frac{1}{5}$, which yields $\Theta(C_5) \leq \sqrt{5}$. Thus Shannon's problem is solved.



“Umbrellas with five ribs”

$$A = \begin{pmatrix} 0 & 1 & 0 & 0 & 1 \\ 1 & 0 & 1 & 0 & 0 \\ 0 & 1 & 0 & 1 & 0 \\ 0 & 0 & 1 & 0 & 1 \\ 1 & 0 & 0 & 1 & 0 \end{pmatrix}$$

The adjacency matrix for the 5-cycle C_5

Let us carry our discussion a little further. We see from (8) that the larger σ_T is for a representation of G , the better a bound for $\Theta(G)$ we will get. Here is a method that gives us an orthonormal representation for *any* graph G . To $G = (V, E)$ we associate the *adjacency matrix* $A = (a_{ij})$, which is defined as follows: Let $V = \{v_1, \dots, v_m\}$, then we set

$$a_{ij} := \begin{cases} 1 & \text{if } v_i v_j \in E \\ 0 & \text{otherwise.} \end{cases}$$

A is a real symmetric $m \times m$ matrix with 0's in the main diagonal.

Now we need two facts from linear algebra. First, as a symmetric matrix, A has m real eigenvalues $\lambda_1 \geq \lambda_2 \geq \dots \geq \lambda_m$ (some of which may be equal), and the sum of the eigenvalues equals the sum of the diagonal entries of A , that is, 0. Hence the smallest eigenvalue must be negative (except in the trivial case when G has no edges). Let $p = |\lambda_m| = -\lambda_m$ be the absolute value of the smallest eigenvalue, and consider the matrix

$$M := I + \frac{1}{p} A,$$

where I denotes the $m \times m$ identity matrix. This M has the eigenvalues $1 + \frac{\lambda_1}{p} \geq 1 + \frac{\lambda_2}{p} \geq \dots \geq 1 + \frac{\lambda_m}{p} = 0$. Now we quote the second result (the principal axis theorem of linear algebra): If $M = (m_{ij})$ is a real symmetric matrix with all eigenvalues ≥ 0 , then there are vectors $\mathbf{v}^{(1)}, \dots, \mathbf{v}^{(m)} \in \mathbb{R}^s$ for $s = \text{rank}(M)$, such that

$$m_{ij} = \langle \mathbf{v}^{(i)}, \mathbf{v}^{(j)} \rangle \quad (1 \leq i, j \leq m).$$

In particular, for $M = I + \frac{1}{p}A$ we obtain

$$\langle \mathbf{v}^{(i)}, \mathbf{v}^{(i)} \rangle = m_{ii} = 1 \quad \text{for all } i$$

and

$$\langle \mathbf{v}^{(i)}, \mathbf{v}^{(j)} \rangle = \frac{1}{p} a_{ij} \quad \text{for } i \neq j.$$

Since $a_{ij} = 0$ whenever $v_i v_j \notin E$, we see that the vectors $\mathbf{v}^{(1)}, \dots, \mathbf{v}^{(m)}$ form indeed an orthonormal representation of G .

Let us, finally, apply this construction to the m -cycles C_m for odd $m \geq 5$. Here one easily computes $p = |\lambda_{\min}| = 2 \cos \frac{\pi}{m}$ (see the box). Every row of the adjacency matrix contains two 1's, implying that every row of the matrix M sums to $1 + \frac{2}{p}$. For the representation $\{\mathbf{v}^{(1)}, \dots, \mathbf{v}^{(m)}\}$ this means

$$\langle \mathbf{v}^{(i)}, \mathbf{v}^{(1)} + \dots + \mathbf{v}^{(m)} \rangle = 1 + \frac{2}{p} = 1 + \frac{1}{\cos \frac{\pi}{m}}$$

and hence

$$\langle \mathbf{v}^{(i)}, \mathbf{u} \rangle = \frac{1}{m} (1 + (\cos \frac{\pi}{m})^{-1}) = \sigma$$

for all i . We can therefore apply our main result (8) and conclude

$$\Theta(C_m) \leq \frac{m}{1 + (\cos \frac{\pi}{m})^{-1}} \quad (\text{for } m \geq 5 \text{ odd}). \quad (9)$$

Notice that because of $\cos \frac{\pi}{m} < 1$ the bound (9) is better than the bound $\Theta(C_m) \leq \frac{m}{2}$ we found before. Note further $\cos \frac{\pi}{5} = \frac{\tau}{2}$, where $\tau = \frac{\sqrt{5}+1}{2}$ is the golden section. Hence for $m = 5$ we again obtain

$$\Theta(C_5) \leq \frac{5}{1 + \frac{4}{\sqrt{5}+1}} = \frac{5(\sqrt{5} + 1)}{5 + \sqrt{5}} = \sqrt{5}.$$

The orthonormal representation given by this construction is, of course, precisely the ‘‘Lovász umbrella.’’

And what about C_7, C_9 , and the other odd cycles? By considering $\alpha(C_m^2)$, $\alpha(C_m^3)$ and other small powers the lower bound $\frac{m-1}{2} \leq \Theta(C_m)$ can certainly be increased, but for no odd $m \geq 7$ do the best known lower bounds agree with the upper bound given in (8). So, twenty years after Lovász’ marvelous proof of $\Theta(C_5) = \sqrt{5}$, these problems remain open and are considered very difficult — but after all we had this situation before.

For example, for $m = 7$ all we know is

$$\sqrt[6]{350} \leq \Theta(C_7) \leq \frac{7}{1 + (\cos \frac{\pi}{7})^{-1}},$$

which is $3.2271 \leq \Theta(C_7) \leq 3.3177$.

The eigenvalues of C_m

Look at the adjacency matrix A of the cycle C_m . To find the eigenvalues (and eigenvectors) we use the m -th roots of unity. These are given by $1, \zeta, \zeta^2, \dots, \zeta^{m-1}$ for $\zeta = e^{\frac{2\pi i}{m}}$ — see the box on page 37. Let $\lambda = \zeta^k$ be any of these roots, then we claim that $(1, \lambda, \lambda^2, \dots, \lambda^{m-1})^T$ is an eigenvector of A to the eigenvalue $\lambda + \lambda^{-1}$. In fact, by the set-up of A we find

$$A \begin{pmatrix} 1 \\ \lambda \\ \lambda^2 \\ \vdots \\ \lambda^{m-1} \end{pmatrix} = \begin{pmatrix} \lambda + \lambda^{m-1} \\ \lambda^2 + 1 \\ \lambda^3 + \lambda \\ \vdots \\ 1 + \lambda^{m-2} \end{pmatrix} = (\lambda + \lambda^{-1}) \begin{pmatrix} 1 \\ \lambda \\ \lambda^2 \\ \vdots \\ \lambda^{m-1} \end{pmatrix}.$$

Since the vectors $(1, \lambda, \dots, \lambda^{m-1})$ are independent (they form a so-called Vandermonde matrix) we conclude that for odd m

$$\begin{aligned} \zeta^k + \zeta^{-k} &= [\cos(2k\pi/m) + i \sin(2k\pi/m)] \\ &\quad + [\cos(2k\pi/m) - i \sin(2k\pi/m)] \\ &= 2 \cos(2k\pi/m) \quad (0 \leq k \leq \frac{m-1}{2}) \end{aligned}$$

are all the eigenvalues of A . Now the cosine is a decreasing function, and so

$$2 \cos \left(\frac{(m-1)\pi}{m} \right) = -2 \cos \frac{\pi}{m}$$

is the smallest eigenvalue of A .

References

- [1] V. CHVÁTAL: *Linear Programming*, Freeman, New York 1983.
- [2] W. HAEMERS: *Eigenvalue methods*, in: “Packing and Covering in Combinatorics” (A. Schrijver, ed.), Math. Centre Tracts **106** (1979), 15-38.
- [3] L. LOVÁSZ: *On the Shannon capacity of a graph*, IEEE Trans. Information Theory **25** (1979), 1-7.
- [4] C. E. SHANNON: *The zero-error capacity of a noisy channel*, IRE Trans. Information Theory **3** (1956), 3-15.

The chromatic number of Kneser graphs

Chapter 43



In 1955 the number theorist Martin Kneser posed a seemingly innocuous problem that became one of the great challenges in graph theory until a brilliant and totally unexpected solution, using the “Borsuk–Ulam theorem” from topology, was found by László Lovász twenty-three years later.

It happens often in mathematics that once a proof for a long-standing problem is found, a shorter one quickly follows, and so it was in this case. Within weeks Imre Bárány showed how to combine the Borsuk–Ulam theorem with another known result to elegantly settle Kneser’s conjecture. Then in 2002 Joshua Greene, an undergraduate student, simplified Bárány’s argument even further, and it is his version of the proof that we present here.

But let us start at the beginning. Consider the following graph $K(n, k)$, now called *Kneser graph*, for integers $n \geq k \geq 1$. The vertex-set $V(n, k)$ is the family of k -subsets of $\{1, \dots, n\}$, thus $|V(n, k)| = \binom{n}{k}$. Two such k -sets A and B are adjacent if they are disjoint, $A \cap B = \emptyset$.

If $n < 2k$, then any two k -sets intersect, resulting in the uninteresting case where $K(n, k)$ has no edges. So we assume from now on that $n \geq 2k$.

Kneser graphs provide an interesting link between graph theory and finite sets. Consider, e.g., the *independence number* $\alpha(K(n, k))$, that is, we ask how large a family of pairwise intersecting k -sets can be. The answer is given by the Erdős–Ko–Rado theorem of Chapter 30: $\alpha(K(n, k)) = \binom{n-1}{k-1}$.

We can similarly study other interesting parameters of this graph family, and Kneser picked out the most challenging one: the *chromatic number* $\chi(K(n, k))$. We recall from previous chapters that a (vertex) coloring of a graph G is a mapping $c : V \rightarrow \{1, \dots, m\}$ such that adjacent vertices are colored differently. The chromatic number $\chi(G)$ is then the minimum number of colors that is sufficient for a coloring of V . In other words, we want to present the vertex set V as a disjoint union of as few *color classes* as possible, $V = V_1 \dot{\cup} \dots \dot{\cup} V_{\chi}$, such that each set V_i is edgeless.

For the graphs $K(n, k)$ this asks for a partition $V(n, k) = V_1 \dot{\cup} \dots \dot{\cup} V_{\chi}$, where every V_i is an *intersecting* family of k -sets. Since we assume that $n \geq 2k$, we write from now on $n = 2k + d$, $k \geq 1$, $d \geq 0$.

Here is a simple coloring of $K(n, k)$ that uses $d + 2$ colors: For $i = 1, 2, \dots, d + 1$, let V_i consist of all k -sets that have i as smallest element. The remaining k -sets are contained in the set $\{d + 2, d + 3, \dots, 2k + d\}$, which has only $2k - 1$ elements. Hence they all intersect, and we can use color $d + 2$ for all of them.

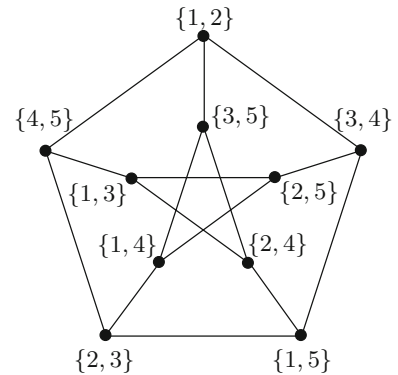

The Kneser graph $K(5, 2)$ is the famous *Petersen graph*.

This implies that

$$\chi(K(n, k)) \geq \frac{|V|}{\alpha} = \frac{\binom{n}{k}}{\binom{n-1}{k-1}} = \frac{n}{k}.$$

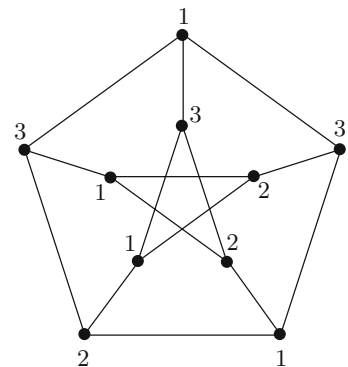

The 3-coloring of the Petersen graph.

So we have $\chi(K(2k + d, k)) \leq d + 2$, and Kneser's challenge was to show that this is the right number.

Kneser's conjecture. We have

$$\chi(K(2k + d, k)) = d + 2.$$

For $d = 0$, $K(2k, k)$ consists of disjoint edges, one for every pair of complementary k -sets. Hence $\chi(K(2k, k)) = 2$, in accordance with the conjecture.

Probably anybody's first crack at the proof would be to try induction on k and d . Indeed, the starting cases $k = 1$ and $d = 0, 1$ are easy, but the induction step from k to $k + 1$ (or d to $d + 1$) does not seem to work. So let us instead reformulate the conjecture as an existence problem:

If the family of k -sets of $\{1, 2, \dots, 2k + d\}$ is partitioned into $d + 1$ classes, $V(n, k) = V_1 \dot{\cup} \dots \dot{\cup} V_{d+1}$, then for some i , V_i contains a pair A, B of disjoint k -sets.

Lovász' brilliant insight was that at the (topological) heart of the problem lies a famous theorem about the d -dimensional unit sphere S^d in \mathbb{R}^{d+1} , $S^d = \{x \in \mathbb{R}^{d+1} : |x| = 1\}$.

The Borsuk–Ulam theorem

For every continuous map $f : S^d \rightarrow \mathbb{R}^d$ from d -sphere to d -space, there are antipodal points $x^, -x^*$ that are mapped to the same point $f(x^*) = f(-x^*)$.*

This result is one of the cornerstones of topology; it first appeared in Borsuk's famous 1933 paper. We sketch a proof in the appendix; for the full proof we refer to Section 2.2 in Matoušek's wonderful book "Using the Borsuk–Ulam theorem", whose very title demonstrates the power and range of the result. Indeed, there are many equivalent formulations, which underline the central position of the theorem. We will employ a version that can be traced back to a book by Lyusternik–Shnirel'man from 1930, which even predates Borsuk.

Theorem. *If the d -sphere S^d is covered by $d + 1$ sets,*

$$S^d = U_1 \cup \dots \cup U_d \cup U_{d+1},$$

such that each of the first d sets U_1, \dots, U_d is either open or closed, then one of the $d + 1$ sets contains a pair of antipodal points $x^, -x^*$.*

The case when all $d + 1$ sets are closed is due to Lyusternik and Shnirel'man. The case when all $d + 1$ sets are open is equally common, and also called the Lyusternik–Shnirel'man theorem. Greene's insight was that the theorem is also true if each of the $d + 1$ sets is *either open or closed*. As you will see, we don't even need that: No such assumption is needed for U_{d+1} . For the proof of Kneser's conjecture, we only need the case when U_1, \dots, U_d are open.

■ Proof of the Lyusternik–Shnirel’man theorem using Borsuk–Ulam.

Let a covering $S^d = U_1 \cup \dots \cup U_d \cup U_{d+1}$ be given as specified, and assume that there are no antipodal points in any of the sets U_i . We define a map $f : S^d \rightarrow \mathbb{R}^d$ by

$$f(x) := (\delta(x, U_1), \delta(x, U_2), \dots, \delta(x, U_d)).$$

Here $\delta(x, U_i)$ denotes the distance of x from U_i . Since this is a continuous function in x , the map f is continuous. Thus the Borsuk–Ulam theorem tells us that there are antipodal points $x^*, -x^*$ with $f(x^*) = f(-x^*)$. Since U_{d+1} does not contain antipodes, we get that at least one of x^* and $-x^*$ must be contained in one of the sets U_i , say in U_k ($k \leq d$). After exchanging x^* with $-x^*$ if necessary, we may assume that $x^* \in U_k$. In particular this yields $\delta(x^*, U_k) = 0$, and from $f(x^*) = f(-x^*)$ we get that $\delta(-x^*, U_k) = 0$ as well.

If U_k is closed, then $\delta(-x^*, U_k) = 0$ implies that $-x^* \in U_k$, and we arrive at the contradiction that U_k contains a pair of antipodal points.

If U_k is open, then $\delta(-x^*, U_k) = 0$ implies that $-x^*$ lies in $\overline{U_k}$, the closure of U_k . The set $\overline{U_k}$, in turn, is contained in $S^d \setminus (-U_k)$, since this is a closed subset of S^d that contains U_k . But this means that $-x^*$ lies in $S^d \setminus (-U_k)$, so it cannot lie in $-U_k$, and x^* cannot lie in U_k , a contradiction. \square

The closure of U_k is the smallest closed set that contains U_k (that is, the intersection of all closed sets containing U_k).

As the second ingredient for his proof, Imre Bárány used another existence result about the sphere S^d .

Gale’s Theorem. *There is an arrangement of $2k + d$ points on S^d such that every open hemisphere contains at least k of these points.*

David Gale discovered his theorem in 1956 in the context of polytopes with many faces. He presented a complicated induction proof, but today, with hindsight, we can quite easily exhibit such a set and verify its properties.

Armed with these results it is just a short step to settle Kneser’s problem, but as Greene showed we can do even better: We don’t even need Gale’s result. It suffices to take any arrangement of $2k + d$ points on S^{d+1} in *general position*, meaning that no $d + 2$ of the points lie on a hyperplane through the center of the sphere. Clearly, for $d \geq 0$ this can be done.

■ Proof of the Kneser conjecture. For our ground set let us take $2k + d$ points in general position on the sphere S^{d+1} . Suppose the set $V(n, k)$ of all k -subsets of this set is partitioned into $d + 1$ classes, $V(n, k) = V_1 \dot{\cup} \dots \dot{\cup} V_{d+1}$. We have to find a pair of disjoint k -sets A and B that belong to the same class V_i .

For $i = 1, \dots, d + 1$ we set

$$O_i = \{x \in S^{d+1} : \text{the open hemisphere } H_x \text{ with pole } x \text{ contains a } k\text{-set from } V_i\}.$$

Clearly, each O_i is an open set. Together, the open sets O_i and the closed set $C = S^{d+1} \setminus (O_1 \cup \dots \cup O_{d+1})$ cover S^{d+1} . Invoking Lyusternik–Shnirel’man we know that one of these sets contains antipodal points x^*

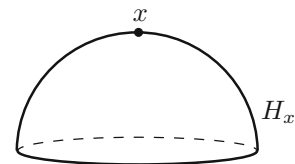

An open hemisphere in S^2

and $-x^*$. This set cannot be C ! Indeed, if $x^*, -x^*$ are in C , then by the definition of the O_i 's, the hemispheres H_{x^*} and H_{-x^*} would contain fewer than k points. This means that at least $d + 2$ points would be on the equator $\overline{H}_{x^*} \cap \overline{H}_{-x^*}$ with respect to the north pole x^* , that is, on a hyperplane through the origin. But this cannot be since the points are in general position. Hence some O_i contains a pair $x^*, -x^*$, so there exist k -sets A and B both in class V_i , with $A \subseteq H_{x^*}$ and $B \subseteq H_{-x^*}$.

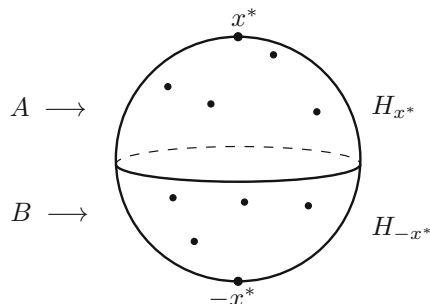

But since we are talking about *open* hemispheres, H_{x^*} and H_{-x^*} are disjoint, hence A and B are disjoint, and this is the whole proof. \square

The reader may wonder whether sophisticated results such as the theorem of Borsuk–Ulam are really necessary to prove a statement about finite sets. Indeed, a beautiful combinatorial argument has later been found by Jiří Matoušek — but on closer inspection it has a distinct, albeit discrete, topological flavor.

Appendix: A proof sketch for the Borsuk–Ulam theorem

For any *generic* map (also known as *general position* map) from a compact d -dimensional space to a d -dimensional space, any point in the image has only a finite number of pre-images. For a generic map from a $(d + 1)$ -dimensional space to a d -dimensional space, we expect every point in the image to have a 1-dimensional pre-image, that is, a collection of curves. Both in the case of smooth maps, and in the setting of piecewise-linear maps, one quite easily proves one can deform any map to a nearby generic map.

For the Borsuk–Ulam theorem, the idea is to show that every generic map $S^d \rightarrow \mathbb{R}^d$ identifies an odd (in particular, finite and nonzero) number of antipodal pairs. If f did not identify any antipodal pair, then it would be arbitrarily close to a generic map \tilde{f} without any such identification.

Now consider the projection $\pi : S^d \rightarrow \mathbb{R}^d$ that just deletes the last coordinate; this map identifies the “north pole” e_{d+1} of the d -sphere with the “south pole” $-e_{d+1}$. For any given map $f : S^d \rightarrow \mathbb{R}^d$ we construct a continuous deformation from π to f , that is, we interpolate between these two

maps (linearly, for example), to obtain a continuous map

$$F : S^d \times [0, 1] \longrightarrow \mathbb{R}^d,$$

with $F(x, 0) = \pi(x)$ and $F(x, 1) = f(x)$ for all $x \in S^d$. (Such a map is known as a *homotopy*.)

Now we perturb F carefully into a generic map $\tilde{F} : S^d \times [0, 1] \rightarrow \mathbb{R}^d$, which again we may assume to be smooth, or piecewise-linear on a fine triangulation of $S^d \times [0, 1]$. If this perturbation is “small enough” and performed carefully, then the perturbed version of the projection $\tilde{\pi}(x) := \tilde{F}(x, 0)$ should still identify the two antipodal points $\pm e_{d+1}$ and no others. If \tilde{F} is sufficiently generic, then the points in $S^d \times [0, 1]$ given by

$$M := \{(x, t) \in S^d \times [0, 1] : \tilde{F}(-x, t) = \tilde{F}(x, t)\}$$

according to the implicit function theorem (smooth or piecewise-linear version) form a collection of paths and of closed curves. Clearly this collection is *symmetric*, that is, $(-x, t) \in M$ if and only if $(x, t) \in M$.

The paths in M can have endpoints only at the boundary of $S^d \times [0, 1]$, that is, at $t = 0$ and at $t = 1$. The only ends at $t = 0$, however, are at $(\pm e_{d+1}, 0)$, and the two paths that start at these two points are symmetric copies of each other, so they are disjoint, and they can end only at $t = 1$. This proves that there are solutions for $\tilde{F}(-x, t) = \tilde{F}(x, t)$ at $t = 1$, and hence for $f(-x) = f(x)$. \square

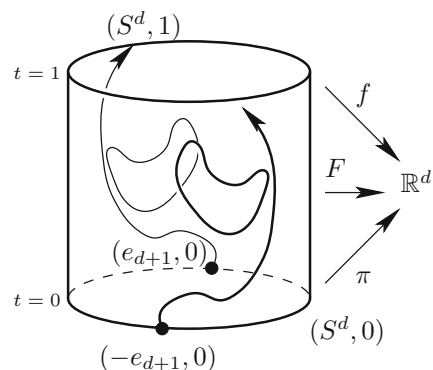
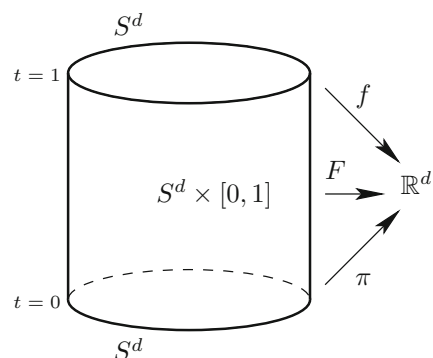

References

- [1] I. BÁRÁNY: *A short proof of Kneser’s conjecture*, J. Combinatorial Theory, Ser. B **25** (1978), 325-326.
- [2] K. BORSUK: *Drei Sätze über die n-dimensionale Sphäre*, Fundamenta Math. **20** (1933), 177-190.
- [3] D. GALE: *Neighboring vertices on a convex polyhedron*, in: “Linear Inequalities and Related Systems” (H. W. Kuhn, A. W. Tucker, eds.), Princeton University Press, Princeton 1956, 255-263.
- [4] J. E. GREENE: *A new short proof of Kneser’s conjecture*, American Math. Monthly **109** (2002), 918-920.
- [5] M. KNESER: *Aufgabe 360*, Jahresbericht der Deutschen Mathematiker-Vereinigung **58** (1955), 27.
- [6] L. LOVÁSZ: *Kneser’s conjecture, chromatic number, and homotopy*, J. Combinatorial Theory, Ser. B **25** (1978), 319-324.
- [7] L. LYUSTERNIK & S. SHNIREL’MAN: *Topological Methods in Variational Problems (in Russian)*, Issledowatelskiĭ Institute Matematiki i Mekhaniki pri O. M. G. U., Moscow, 1930.
- [8] J. MATOUŠEK: *Using the Borsuk–Ulam Theorem. Lectures on Topological Methods in Combinatorics and Geometry*, Universitext, Springer-Verlag, Berlin 2003.
- [9] J. MATOUŠEK: *A combinatorial proof of Kneser’s conjecture*, Combinatorica **24** (2004), 163-170.



It is not known who first raised the following problem or who gave it its human touch. Here it is:

Suppose in a group of people we have the situation that any pair of persons have precisely one common friend. Then there is always a person (the “politician”) who is everybody’s friend.

In the mathematical jargon this is called the *friendship theorem*.

Before tackling the proof let us rephrase the problem in graph-theoretic terms. We interpret the people as the set of vertices V and join two vertices by an edge if the corresponding people are friends. We tacitly assume that friendship is always two-ways, that is, if u is a friend of v , then v is also a friend of u , and further that nobody is his or her own friend. Thus the theorem takes on the following form:

Theorem. *Suppose that G is a finite graph in which any two vertices have precisely one common neighbor. Then there is a vertex which is adjacent to all other vertices.*

Note that there are finite graphs with this property; see the figure, where u is the politician. However, these “windmill graphs” also turn out to be the only graphs with the desired property. Indeed, it is not hard to verify that in the presence of a politician only the windmill graphs are possible.

Surprisingly, the friendship theorem does not hold for infinite graphs! Indeed, for an inductive construction of a counterexample one may start for example with a 5-cycle, and repeatedly add common neighbors for all pairs of vertices in the graph that don’t have one, yet. This leads to a (countably) infinite friendship graph without a politician.

Several proofs of the friendship theorem exist, but the first proof, given by Paul Erdős, Alfred Rényi and Vera Sós, is still the most accomplished.

■ **Proof.** Suppose the assertion is false, and G is a counterexample, that is, no vertex of G is adjacent to all other vertices. To derive a contradiction we proceed in two steps. The first part is combinatorics, and the second part is linear algebra.

(1) We claim that G is a regular graph, that is, $d(u) = d(v)$ for any $u, v \in V$. Note first that the condition of the theorem implies that there are no cycles of length 4 in G . Let us call this the C_4 -condition.



“A politician’s smile”

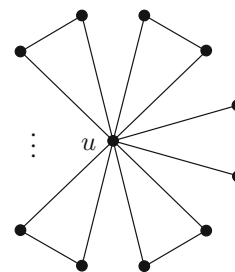

A windmill graph

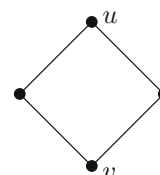

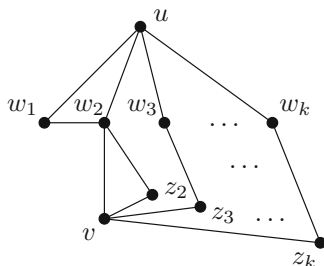

We first prove that any two *nonadjacent* vertices u and v have equal degree $d(u) = d(v)$. Suppose $d(u) = k$, where w_1, \dots, w_k are the neighbors of u . Exactly one of the w_i , say w_2 , is adjacent to v , and w_2 adjacent to exactly one of the other w_i 's, say w_1 , so that we have the situation of the figure to the left. The vertex v has with w_1 the common neighbor w_2 , and with w_i ($i \geq 2$) a common neighbor z_i ($i \geq 2$). By the C_4 -condition, all these z_i must be distinct. We conclude $d(v) \geq k = d(u)$, and thus $d(u) = d(v) = k$ by symmetry.

To finish the proof of **(1)**, observe that any vertex different from w_2 is not adjacent to either u or v , and hence has degree k , by what we already proved. But since w_2 also has a non-neighbor, it has degree k as well, and thus G is k -regular.

Summing over the degrees of the k neighbors of u we get k^2 . Since every vertex (except u) has exactly one common neighbor with u , we have counted every vertex once, except for u , which was counted k times. So the total number of vertices of G is

$$n = k^2 - k + 1. \quad (1)$$

(2) The rest of the proof is a beautiful application of some standard results of linear algebra. Note first that k must be greater than 2, since for $k \leq 2$ only $G = K_1$ and $G = K_3$ are possible by (1), both of which are trivial windmill graphs. Consider the adjacency matrix $A = (a_{ij})$, as defined on page 298. By part **(1)**, any row has exactly k 1's, and by the condition of the theorem, for any two rows there is exactly one column where they both have a 1. Note further that the main diagonal consists of 0's. Hence we have

$$A^2 = \begin{pmatrix} k & 1 & \dots & 1 \\ 1 & k & & 1 \\ \vdots & & \ddots & \vdots \\ 1 & \dots & 1 & k \end{pmatrix} = (k-1)I + J,$$

where I is the identity matrix, and J the matrix of all 1's. It is immediately checked that J has the eigenvalues n (of multiplicity 1) and 0 (of multiplicity $n-1$). It follows that A^2 has the eigenvalues $k-1+n = k^2$ (of multiplicity 1) and $k-1$ (of multiplicity $n-1$).

Since A is symmetric and hence diagonalizable, we conclude that A has the eigenvalues k (of multiplicity 1) and $\pm\sqrt{k-1}$. Suppose r of the eigenvalues are equal to $\sqrt{k-1}$ and s of them are equal to $-\sqrt{k-1}$, with $r+s = n-1$. Now we are almost home. Since the sum of the eigenvalues of A equals the trace (which is 0), we find

$$k + r\sqrt{k-1} - s\sqrt{k-1} = 0,$$

and, in particular, $r \neq s$, and

$$\sqrt{k-1} = \frac{k}{s-r}.$$

Now if the square root \sqrt{m} of a natural number m is rational, then it is an integer! An elegant proof for this was presented by Dedekind in 1858: Let n_0 be the smallest natural number with $n_0\sqrt{m} \in \mathbb{N}$. If $\sqrt{m} \notin \mathbb{N}$, then there exists $\ell \in \mathbb{N}$ with $0 < \sqrt{m} - \ell < 1$. Setting $n_1 := n_0(\sqrt{m} - \ell)$, we find $n_1 \in \mathbb{N}$ and $n_1\sqrt{m} = n_0(\sqrt{m} - \ell)\sqrt{m} = n_0m - \ell(n_0\sqrt{m}) \in \mathbb{N}$. With $n_1 < n_0$ this yields a contradiction to the choice of n_0 .

Returning to our equation, let us set $h = \sqrt{k-1} \in \mathbb{N}$, then

$$h(s-r) = k = h^2 + 1.$$

Since h divides $h^2 + 1$ and h^2 , we find that h must be equal to 1, and thus $k = 2$, which we have already excluded. So we have arrived at a contradiction, and the proof is complete. \square

However, the story is not quite over. Let us rephrase our theorem in the following way: Suppose G is a graph with the property that between any two vertices there is exactly one path of length 2. Clearly, this is an equivalent formulation of the friendship condition. Our theorem then says that the only such graphs are the windmill graphs. But what if we consider paths of length more than 2? A conjecture of Anton Kotzig asserts that the analogous situation is impossible.

Kotzig's Conjecture. *Let $\ell > 2$. Then there are no finite graphs with the property that between any two vertices there is precisely one path of length ℓ .*

Kotzig himself verified his conjecture for $\ell \leq 8$. In [3] his conjecture is proved up to $\ell = 20$, and Alexandr Kostochka has told us that it is now verified for all $\ell \leq 33$. A general proof, however, seems to be out of reach...

References

- [1] P. ERDŐS, A. RÉNYI & V. SÓS: *On a problem of graph theory*, *Studia Sci. Math.* **1** (1966), 215-235.
- [2] A. KOTZIG: *Regularly k -path connected graphs*, *Congressus Numerantium* **40** (1983), 137-141.
- [3] A. KOSTOCHKA: *The nonexistence of certain generalized friendship graphs*, in: "Combinatorics" (Eger, 1987), *Colloq. Math. Soc. János Bolyai* **52**, North-Holland, Amsterdam 1988, 341-356.

Probability makes counting (sometimes) easy

Chapter 45



Just as we started this book with the first papers of Paul Erdős in number theory, we close it by discussing what will possibly be considered his most lasting legacy — the introduction, together with Alfred Rényi, of the *probabilistic method*. Stated in the simplest way it says:

If, in a given set of objects, the probability that an object does not have a certain property is less than 1, then there must exist an object with this property.

Thus we have an *existence* result. It may be (and often is) very difficult to find this object, but we know that it exists. We present here three examples (of increasing sophistication) of this probabilistic method due to Erdős, and end with a particularly elegant, quite recent application.

As a warm-up, consider a family \mathcal{F} of subsets A_i , all of size $d \geq 2$, of a finite ground-set X . We say that \mathcal{F} is *2-colorable* if there exists a coloring of X with two colors such that in every set A_i both colors appear. It is immediate that not every family can be colored in this way. As an example, take *all* subsets of size d of a $(2d - 1)$ -set X . Then no matter how we 2-color X , there must be d elements which are colored alike. On the other hand, it is equally clear that every subfamily of a 2-colorable family of d -sets is itself 2-colorable. Hence we are interested in the *smallest* number $m = m(d)$ for which a family with m sets exists which is not 2-colorable. Phrased differently, $m(d)$ is the largest number which guarantees that *every* family with less than $m(d)$ sets is 2-colorable.

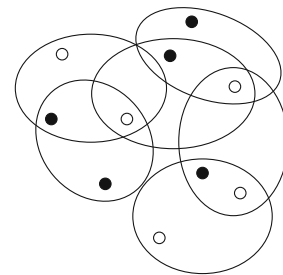

A 2-colored family of 3-sets

Theorem 1. *Every family of at most 2^{d-1} d -sets is 2-colorable, that is, $m(d) > 2^{d-1}$.*

■ **Proof.** Suppose \mathcal{F} is a family of d -sets with at most 2^{d-1} sets. Color X randomly with two colors, all colorings being equally likely. For each set $A \in \mathcal{F}$ let E_A be the event that all elements of A are colored alike. Since there are precisely two such colorings, we have

$$\text{Prob}(E_A) = \left(\frac{1}{2}\right)^{d-1},$$

and hence with $m = |\mathcal{F}| \leq 2^{d-1}$ (note that the events E_A are not disjoint)

$$\text{Prob}\left(\bigcup_{A \in \mathcal{F}} E_A\right) < \sum_{A \in \mathcal{F}} \text{Prob}(E_A) = m \left(\frac{1}{2}\right)^{d-1} \leq 1.$$

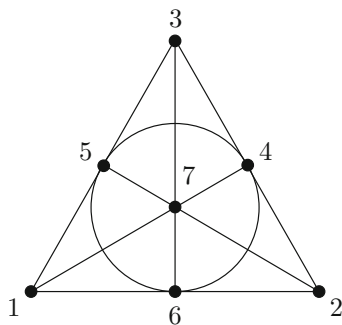

We conclude that there exists some 2-coloring of X without a unicolored d -set from \mathcal{F} , and this is just our condition of 2-colorability. \square

An upper bound for $m(d)$, roughly equal to $d^2 2^d$, was also established by Erdős, again using the probabilistic method, this time taking random sets and a fixed coloring. Using a very clever argument, Jaikumar Radhakrishnan and Aravind Srinivasan have established the best lower bound to date, which is approximately equal to $\sqrt{\frac{d}{\log d}} 2^d$. As for exact values, only the first two $m(2) = 3$, $m(3) = 7$ are known. Of course, $m(2) = 3$ is realized by the graph K_3 , while the Fano configuration yields $m(3) \leq 7$. Here \mathcal{F} consists of the seven 3-sets of the figure (including the circle set $\{4, 5, 6\}$). The reader may find it fun to show that \mathcal{F} cannot be 2-colored. To prove that all families of six 3-sets are 2-colorable, and hence $m(3) = 7$, requires a little more care.

Our next example is the classic in the field — Ramsey numbers. Consider the complete graph K_N on N vertices. We say that K_N has property (m, n) if, no matter how we color the edges of K_N red and blue, there is always a complete subgraph on m vertices with all edges colored red or a complete subgraph on n vertices with all edges colored blue. It is clear that if K_N has property (m, n) , then so does every K_s with $s \geq N$. So, as in the first example, we ask for the *smallest* number N (if it exists) with this property — and this is the *Ramsey number* $R(m, n)$.

As a start, we certainly have $R(m, 2) = m$ because either all of the edges of K_m are red or there is a blue edge, resulting in a blue K_2 . By symmetry, we have $R(2, n) = n$. Now, suppose $R(m-1, n)$ and $R(m, n-1)$ exist. We then prove that $R(m, n)$ exists and that

$$R(m, n) \leq R(m-1, n) + R(m, n-1). \quad (1)$$

Suppose $N = R(m-1, n) + R(m, n-1)$, and consider an arbitrary red-blue coloring of K_N . For a vertex v , let A be the set of vertices joined to v by a red edge, and B the vertices joined by a blue edge.

Since $|A| + |B| = N - 1$, we find that either $|A| \geq R(m-1, n)$ or $|B| \geq R(m, n-1)$. Suppose $|A| \geq R(m-1, n)$, the other case being analogous. Then by the definition of $R(m-1, n)$, there either exists in A a subset A_R of size $m-1$ all of whose edges are colored red which together with v yields a red K_m , or there is a subset A_B of size n with all edges colored blue. We infer that K_N satisfies the (m, n) -property and Claim (1) follows.

Combining (1) with the starting values $R(m, 2) = m$ and $R(2, n) = n$, we obtain from the familiar recursion for binomial coefficients

$$R(m, n) \leq \binom{m+n-2}{m-1}, \quad (2)$$

and, in particular,

$$R(k, k) \leq \binom{2k-2}{k-1} = \binom{2k-3}{k-1} + \binom{2k-3}{k-2} \leq 2^{2k-3}.$$

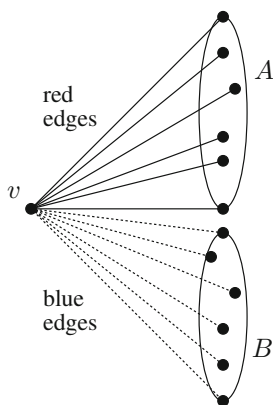

Now what we are really interested in is a lower bound for $R(k, k)$. This amounts to proving for an as-large-as-possible $N < R(k, k)$ that there *exists* a coloring of the edges such that no red or blue K_k results. And this is where the probabilistic method comes into play.

Theorem 2. *For all $k \geq 2$, the following lower bound holds for the Ramsey numbers:*

$$R(k, k) \geq 2^{\frac{k}{2}}.$$

■ **Proof.** We have $R(2, 2) = 2$. From (2) we know $R(3, 3) \leq 6$, and the pentagon colored as in the figure shows $R(3, 3) = 6$.

Now let us assume $k \geq 4$. Suppose $N < 2^{\frac{k}{2}}$, and consider all red-blue colorings, where we color each edge independently red or blue with probability $\frac{1}{2}$. Thus all colorings are equally likely with probability $2^{-\binom{N}{2}}$. Let A be a set of vertices of size k . The probability of the event A_R that the edges in A are all colored red is then $2^{-\binom{k}{2}}$. Hence it follows that the probability p_R for *some* k -set to be colored all red is bounded by

$$p_R = \text{Prob}\left(\bigcup_{|A|=k} A_R\right) \leq \sum_{|A|=k} \text{Prob}(A_R) = \binom{N}{k} 2^{-\binom{k}{2}}.$$

Now with $N < 2^{\frac{k}{2}}$ and $k \geq 4$, using $\binom{N}{k} \leq \frac{N^k}{2^{k-1}}$ for $k \geq 2$ (see page 14), we have

$$\binom{N}{k} 2^{-\binom{k}{2}} \leq \frac{N^k}{2^{k-1}} 2^{-\binom{k}{2}} < 2^{\frac{k^2}{2} - \binom{k}{2} - k + 1} = 2^{-\frac{k}{2} + 1} \leq \frac{1}{2}.$$

Hence $p_R < \frac{1}{2}$, and by symmetry $p_B < \frac{1}{2}$ for the probability of some k vertices with all edges between them colored blue. We conclude that $p_R + p_B < 1$ for $N < 2^{\frac{k}{2}}$, so there *must* be a coloring with no red or blue K_k , which means that K_N does not have property (k, k) . \square

Of course, there is quite a gap between the lower and the upper bound for $R(k, k)$. Still, as simple as this Book Proof is, no lower bound with a better exponent has been found for general k in the more than sixty years since Erdős' result. In fact, no one has been able to prove a lower bound of the form $R(k, k) > 2^{(\frac{1}{2} + \varepsilon)k}$ nor an upper bound of the form $R(k, k) < 2^{(2 - \varepsilon)k}$ for a fixed $\varepsilon > 0$. The most spectacular advance in recent years is due to David Conlon, who proved an upper bound of the form $\frac{4^k}{k^{\omega(k)}}$, where $\omega(k)$ tends to infinity (albeit very slowly) with k .

Our third result is another beautiful illustration of the probabilistic method. Consider a graph G on n vertices and its chromatic number $\chi(G)$. If $\chi(G)$ is high, that is, if we need many colors, then we might suspect that G contains a large complete subgraph. However, this is far from the truth. Already in the fourties Blanche Descartes constructed graphs with arbitrarily high chromatic number and no triangles, that is, with every cycle having length at least 4, and so did several others (see the box on the next page).

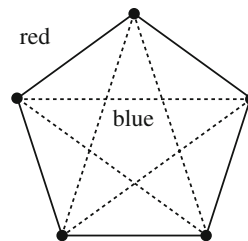

However, in these examples there were many cycles of length 4. Can we do even better? Can we stipulate that there are no cycles of small length and still have arbitrarily high chromatic number? Yes we can! To make matters precise, let us call the length of a shortest cycle in G the *girth* $\gamma(G)$ of G ; then we have the following theorem, first proved by Paul Erdős.

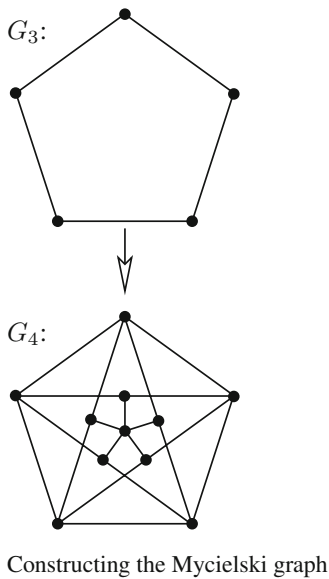

Triangle-free graphs with high chromatic number

Here is a sequence of triangle-free graphs G_3, G_4, \dots with

$$\chi(G_n) = n.$$

Start with $G_3 = C_5$, the 5-cycle; thus $\chi(G_3) = 3$. Suppose we have already constructed G_n on the vertex set V . The new graph G_{n+1} has the vertex set $V \cup V' \cup \{z\}$, where the vertices $v' \in V'$ correspond bijectively to $v \in V$, and z is a single other vertex. The edges of G_{n+1} fall into 3 classes: First, we take all edges of G_n ; secondly every vertex v' is joined to precisely the neighbors of v in G_n ; thirdly z is joined to all $v' \in V'$. Hence from $G_3 = C_5$ we obtain as G_4 the so-called *Mycielski graph*.

Clearly, G_{n+1} is again triangle-free. To prove $\chi(G_{n+1}) = n + 1$ we use induction on n . Take any n -coloring of G_n and consider a color class C . There must exist a vertex $v \in C$ which is adjacent to at least one vertex of every other color class; otherwise we could distribute the vertices of C onto the $n - 1$ other color classes, resulting in $\chi(G_n) \leq n - 1$. But now it is clear that v' (the vertex in V' corresponding to v) must receive the same color as v in this n -coloring. So, all n colors appear in V' , and we need a new color for z .

Theorem 3. For every $k \geq 2$, there exists a graph G with chromatic number $\chi(G) > k$ and girth $\gamma(G) > k$.

The strategy is similar to that of the previous proofs: We consider a certain probability space on graphs and go on to show that the probability for $\chi(G) \leq k$ is smaller than $\frac{1}{2}$, and similarly the probability for $\gamma(G) \leq k$ is smaller than $\frac{1}{2}$. Consequently, there must exist a graph with the desired properties.

■ **Proof.** Let $V = \{v_1, v_2, \dots, v_n\}$ be the vertex set, and p a fixed number between 0 and 1, to be carefully chosen later. Our probability space $\mathcal{G}(n, p)$ consists of all graphs on V where the individual edges appear with probability p , independently of each other. In other words, we are talking about a Bernoulli experiment where we throw in each edge with probability p . As an example, the probability $\text{Prob}(K_n)$ for the complete graph is $\text{Prob}(K_n) = p^{\binom{n}{2}}$. In general, we have $\text{Prob}(H) = p^m (1 - p)^{\binom{n}{2} - m}$ if the graph H on V has precisely m edges.

Let us first look at the chromatic number $\chi(G)$. By $\alpha = \alpha(G)$ we denote the *independence number*, that is, the size of a largest independent set in G . Since in a coloring with $\chi = \chi(G)$ colors all color classes are independent (and hence of size $\leq \alpha$), we infer $\chi\alpha \geq n$. Therefore if α is small as compared to n , then χ must be large, which is what we want.

Suppose $2 \leq r \leq n$. The probability that a fixed r -set in V is independent is $(1-p)^{\binom{r}{2}}$, and we conclude by the same argument as in Theorem 2

$$\begin{aligned} \text{Prob}(\alpha \geq r) &\leq \binom{n}{r} (1-p)^{\binom{r}{2}} \\ &\leq n^r (1-p)^{\binom{r}{2}} = (n(1-p)^{\frac{r-1}{2}})^r \leq (ne^{-p(r-1)/2})^r, \end{aligned}$$

since $1-p \leq e^{-p}$ for all p .

Given any fixed $k > 0$ we now choose $p := n^{-\frac{k}{k+1}}$, and proceed to show that for n large enough,

$$\text{Prob}\left(\alpha \geq \frac{n}{2k}\right) < \frac{1}{2}. \quad (3)$$

Indeed, since $n^{\frac{1}{k+1}}$ grows faster than $\log n$, we have $n^{\frac{1}{k+1}} \geq 6k \log n$ for large enough n , and thus $p \geq 6k \frac{\log n}{n}$. For $r := \lceil \frac{n}{2k} \rceil$ this gives $pr \geq 3 \log n$, and thus

$$ne^{-p(r-1)/2} = ne^{-\frac{pr}{2}} e^{\frac{p}{2}} \leq ne^{-\frac{3}{2} \log n} e^{\frac{1}{2}} = n^{-\frac{1}{2}} e^{\frac{1}{2}} = \left(\frac{e}{n}\right)^{\frac{1}{2}},$$

which converges to 0 as n goes to infinity. Hence (3) holds for all $n \geq n_1$.

Now we look at the second parameter, $\gamma(G)$. For the given k we want to show that there are not too many cycles of length $\leq k$. Let i be between 3 and k , and $A \subseteq V$ a fixed i -set. The number of possible i -cycles on A is clearly the number of cyclic permutations of A divided by 2 (since we may traverse the cycle in either direction), and thus equal to $\frac{(i-1)!}{2}$. The total number of possible i -cycles is therefore $\binom{n}{i} \frac{(i-1)!}{2}$, and every such cycle C appears with probability p^i . Let X be the random variable which counts the number of cycles of length $\leq k$. In order to estimate X we use two simple but beautiful tools. The first is linearity of expectation, and the second is Markov's inequality for nonnegative random variables, which says

$$\text{Prob}(X \geq a) \leq \frac{EX}{a},$$

where EX is the expected value of X . See the appendix to Chapter 17 for both tools.

Let X_C be the indicator random variable of the cycle C of, say, length i . That is, we set $X_C = 1$ or 0 depending on whether C appears in the graph or not; hence $EX_C = p^i$. Since X counts the number of all cycles of length $\leq k$ we have $X = \sum X_C$, and hence by linearity

$$EX = \sum_{i=3}^k \binom{n}{i} \frac{(i-1)!}{2} p^i \leq \frac{1}{2} \sum_{i=3}^k n^i p^i \leq \frac{1}{2} (k-2) n^k p^k,$$

where the last inequality holds because of $np = n^{\frac{1}{k+1}} \geq 1$. Applying now Markov's inequality with $a = \frac{n}{2}$, we obtain

$$\text{Prob}(X \geq \frac{n}{2}) \leq \frac{EX}{n/2} \leq (k-2) \frac{(np)^k}{n} = (k-2)n^{-\frac{1}{k+1}}.$$

Since the right-hand side goes to 0 with n going to infinity, we infer that $p(X \geq \frac{n}{2}) < \frac{1}{2}$ for $n \geq n_2$.

Now we are almost home. Our analysis tells us that for $n \geq \max(n_1, n_2)$ there exists a graph H on n vertices with $\alpha(H) < \frac{n}{2k}$ and fewer than $\frac{n}{2}$ cycles of length $\leq k$. Delete one vertex from each of these cycles, and let G be the resulting graph. Then $\gamma(G) > k$ holds at any rate. Since G contains more than $\frac{n}{2}$ vertices and satisfies $\alpha(G) \leq \alpha(H) < \frac{n}{2k}$, we find

$$\chi(G) \geq \frac{n/2}{\alpha(G)} \geq \frac{n}{2\alpha(H)} > \frac{n}{n/k} = k,$$

and the proof is finished. \square

Explicit constructions of graphs with high girth and chromatic number (of huge size) are known. (In contrast, one does not know how to construct red/blue colorings with no large monochromatic cliques, whose existence is given by Theorem 2.) What remains striking about the Erdős proof is that it proves the existence of relatively small graphs with high chromatic number and girth.

To end our excursion into the probabilistic world let us discuss an important result in geometric graph theory (which again goes back to Paul Erdős) — with a stunning Book Proof.

Consider a simple graph $G = G(V, E)$ with n vertices and m edges. We want to embed G into the plane just as we did for planar graphs. Now, we know from Chapter 13 — as a consequence of Euler's formula — that a simple planar graph G with $n \geq 3$ vertices has at most $3n - 6$ edges. Hence if m is greater than $3n - 6$, there must be crossings of edges. The *crossing number* $\text{cr}(G)$ is then naturally defined: It is the smallest number of crossings among all drawings of G , where crossings of more than two edges in one point are not allowed. Thus $\text{cr}(G) = 0$ if and only if G is planar.

In such a minimal drawing the following three situations are ruled out:

- No edge can cross itself.
- Edges with a common endvertex cannot cross.
- No two edges cross twice.

This is because in either of these cases, we can construct a different drawing of the same graph with fewer crossings, using the operations that are indicated in our figure. So, from now on we assume that any drawing observes these rules.

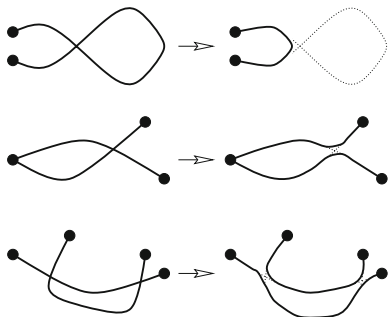

Suppose that G is drawn in the plane with $\text{cr}(G)$ crossings. We can immediately derive a lower bound on the number of crossings. Consider the following graph H : The vertices of H are those of G together with all crossing points, and the edges are all pieces of the original edges as we go along from crossing point to crossing point.

The new graph H is now plane and simple (this follows from our three assumptions!). The number of vertices in H is $n + \text{cr}(G)$ and the number of edges is $m + 2\text{cr}(G)$, since every new vertex has degree 4. Invoking the bound on the number of edges for plane graphs we thus find

$$m + 2\text{cr}(G) \leq 3(n + \text{cr}(G)) - 6,$$

that is,

$$\text{cr}(G) \geq m - 3n + 6. \quad (4)$$

As an example, for the complete graph K_6 we compute

$$\text{cr}(K_6) \geq 15 - 18 + 6 = 3$$

and, in fact, there is an drawing with just 3 crossings.

The bound (4) is good enough when m is linear in n , but when m is larger compared to n , then the picture changes, and this is our theorem.

Theorem 4. *Let G be a simple graph with n vertices and m edges, where $m \geq 4n$. Then*

$$\text{cr}(G) \geq \frac{1}{64} \frac{m^3}{n^2}.$$

The history of this result, called the *crossing lemma*, is quite interesting. It was conjectured by Erdős and Guy in 1973 (with $\frac{1}{64}$ replaced by some constant c). The first proofs were given by Leighton in 1982 (with $\frac{1}{100}$ instead of $\frac{1}{64}$) and independently by Ajtai, Chvátal, Newborn and Szemerédi. The crossing lemma was hardly known (in fact, many people thought of it as a conjecture long after the original proofs), until László Székely demonstrated its usefulness in a beautiful paper, applying it to a variety of hitherto hard geometric extremal problems. The proof which we now present arose from e-mail conversations between Bernard Chazelle, Micha Sharir and Emo Welzl, and it belongs without doubt in *The Book*.

■ **Proof.** Consider a minimal drawing of G , and let p be a number between 0 and 1 (to be chosen later). Now we generate a subgraph of G , by selecting the vertices of G to lie in the subgraph with probability p , independently from each other. The induced subgraph that we obtain that way will be called G_p .

Let n_p , m_p , X_p be the random variables counting the number of vertices, of edges, and of crossings in G_p . Since $\text{cr}(G) - m + 3n \geq 0$ holds by (4) for any graph, we certainly have

$$E(X_p - m_p + 3n_p) \geq 0.$$

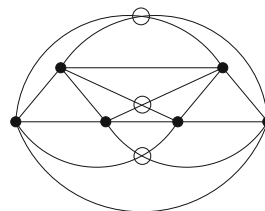
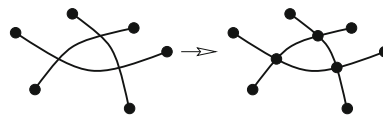

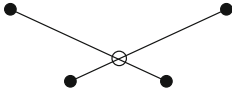

Now we proceed to compute the individual expectations $E(n_p)$, $E(m_p)$ and $E(X_p)$. Clearly, $E(n_p) = pn$ and $E(m_p) = p^2m$, since an edge appears in G_p if and only if both its endvertices do. And finally, $E(X_p) = p^4\text{cr}(G)$, since a crossing is present in G_p if and only if all four (distinct!) vertices involved are there.

By linearity of expectation we thus find

$$0 \leq E(X_p) - E(m_p) + 3E(n_p) = p^4\text{cr}(G) - p^2m + 3pn,$$

which is

$$\text{cr}(G) \geq \frac{p^2m - 3pn}{p^4} = \frac{pm - 3n}{p^3}. \quad (5)$$

Here comes the punch line: Set $p := \frac{4n}{m}$ (which is at most 1 by our assumption), then $pm = 4n$, and (5) becomes

$$\text{cr}(G) \geq \frac{n}{p^3} = \frac{1}{64} \frac{m^3}{n^2},$$

and this is it. □

Paul Erdős would have loved to see this proof.

References

- [1] M. AJTAI, V. CHVÁTAL, M. NEWBORN & E. SZEMERÉDI: *Crossing-free subgraphs*, Annals of Discrete Math. **12** (1982), 9-12.
- [2] N. ALON & J. SPENCER: *The Probabilistic Method*, Third edition, Wiley-Interscience 2008.
- [3] D. CONLON: *A new upper bound for diagonal Ramsey numbers*, Annals Math. **170** (2009), 941–960.
- [4] P. ERDŐS: *Some remarks on the theory of graphs*, Bulletin Amer. Math. Soc. **53** (1947), 292-294.
- [5] P. ERDŐS: *Graph theory and probability*, Canadian J. Math. **11** (1959), 34-38.
- [6] P. ERDŐS: *On a combinatorial problem I*, Nordisk Math. Tidskrift **11** (1963), 5-10.
- [7] P. ERDŐS & R. K. GUY: *Crossing number problems*, Amer. Math. Monthly **80** (1973), 52-58.
- [8] P. ERDŐS & A. RÉNYI: *On the evolution of random graphs*, Magyar Tud. Akad. Mat. Kut. Int. Közl. **5** (1960), 17-61.
- [9] T. LEIGHTON: *Complexity Issues in VLSI*, MIT Press, Cambridge MA 1983.
- [10] J. RADHAKRISHNAN & A. SRINIVASAN: *Improved bounds and algorithms for hypergraph 2-coloring*, Random Struct. Algorithms **16** (2000), 4–32.
- [11] L. A. SZÉKELY: *Crossing numbers and hard Erdős problems in discrete geometry*, Combinatorics, Probability, and Computing **6** (1997), 353-358.



About the Illustrations

We are happy to have the possibility and privilege to illustrate this volume with wonderful original drawings by Karl Heinrich Hofmann (Darmstadt). Thank you!

The regular polyhedra on p. 90 and the fold-out map of a flexible sphere on p. 98 are by WAF Ruppert. Jürgen Richter-Gebert provided illustrations for p. 92; Ronald Wotzlaw wrote the graphics for p. 158. Jan Schneider, Marie-Sophie Litz and Miriam Schlöter created the images for Chap. 15.

Page 281 features the Weisman Art Museum in Minneapolis designed by Frank Gehry. The photo of its west façade is by Chris Faust. The floorplan is of the Dolly Fiterman Riverview Gallery behind the west façade.

The portraits of Bertrand, Cantor, Erdős, Euler, Fermat, Herglotz, Hilbert, Littlewood, Pólya, Schur, Sylvester, and Van der Waerden are all from the photo archives of the Mathematisches Forschungsinstitut Oberwolfach, with permission. (Many thanks to Annette Disch and Ivonne Vetter!)

The Gauss portrait is a lithograph by Siegfried Detlev Bendixen published in *Astronomische Nachrichten* 1828, as provided by Wikipedia. The picture of Hermite is from the first volume of his collected works.

The Eisenstein portrait is reproduced with friendly permission by Prof. Karin Reich from a collection of portrait cards owned by the Mathematische Gesellschaft Hamburg.

The portrait stamps of Buffon, Chebyshev, Euler, and Ramanujan are from Jeff Miller's mathematical stamps website <http://jeff560.tripod.com> with his generous permission.

The photo of Claude Shannon was provided by the MIT Museum and is here reproduced with their permission.

The portrait of Cayley is taken from the "Photoalbum für Weierstraß" (edited by Reinhard Bölling, Vieweg 1994), with permission from the Kunstbibliothek, Staatliche Museen zu Berlin, Preussischer Kulturbesitz.

The Cauchy portrait is reproduced with permission from the Collections de l'École Polytechnique, Paris. The picture of Fermat is reproduced from Stefan Hildebrandt and Anthony Tromba: *The Parsimonious Universe. Shape and Form in the Natural World*, Springer-Verlag, New York 1996.

The portrait of Ernst Witt is from volume 426 (1992) of the *Journal für die Reine und Angewandte Mathematik*, with permission by Walter de Gruyter Publishers. It was taken around 1941.

The photo of Karol Borsuk was taken in 1967 by Isaac Namioka, and is reproduced with his kind permission.

We thank Dr. Peter Sperner (Braunschweig) for the portrait of his father, and Vera Sós for the photo of Paul Turán.

Thanks to Noga Alon for the portrait of A. Nilli!

Index

- acyclic directed graph, 230
- addition theorems, 184
- adjacency matrix, 298
- adjacent vertices, 80
- alternating diagram, 100
- antichain, 213
- arithmetic mean, 143
- arithmetic-geometric mean inequality, 43, 143, 172
- art gallery theorem, 282
- average degree, 90
- average number of divisors, 198

- Bernoulli numbers, 60, 186
- Bertrand's postulate, 9
- Besicovitch set, 247
- bijection, 127, 241
- Binet–Cauchy formula, 231, 237
- binomial coefficient, 15
- bipartite graph, 81, 273
- birthday paradox, 219
- Bolyai–Gerwien Theorem, 67
- Borromean rings, 99
- Borsuk's conjecture, 117
- Borsuk–Ulam theorem, 302
- Brégman's theorem, 261
- Bricard's condition, 71
- Brouwer's fixed point theorem, 203
- Brunnian links, 100
- Buffon's needle problem, 189

- Calkin–Wilf tree, 129
- Cantor–Bernstein theorem, 134
- capacity of a graph, 292
- capacity of a polynomial, 171
- cardinal number, 127
- cardinality, 127, 139
- Cauchy's arm lemma, 96
- Cauchy's minimum principle, 151
- Cauchy's rigidity theorem, 95

- Cauchy–Schwarz inequality, 143
- Cayley's formula, 235
- center, 35
- centralizer, 35
- centrally symmetric, 75
- chain, 213
- channel, 291
- Chebyshev polynomials, 168
- Chebyshev's theorem, 164
- chromatic number, 271, 301
- circles, linked, 100
- class formula, 36
- clique, 81, 285, 292
- clique number, 287
- combinatorially equivalent, 75
- comparison of coefficients, 59
- complete bipartite graph, 81
- complete graph, 80
- complex polynomial, 163
- components of a graph, 81
- conditional entropy, 262
- cone lemma, 70
- confusion graph, 291
- congruent, 75
- connected, 81
- connected components, 81
- continuum, 133
- continuum hypothesis, 136
- convex function, 173
- convex polytope, 73
- convex vertex, 282
- cosine polynomial, 167
- countable, 127
- coupon collector's problem, 220
- critical family, 216
- crossing lemma, 317
- crossing number, 316
- crossing relation, 103
- cube, 74

- cycle, 81
- C_4 -condition, 307
- C_4 -free graph, 200

- degree, 90
- dense, 138
- derivative in x_n , 170
- determinants, 229
- diagram of a knot, 105
- dihedral angle, 71
- dimension, 133
- dimension of a graph, 196
- Dinitz problem, 271
- directed graph, 273
- division ring, 35
- double counting, 198
- doubly stochastic matrix, 169
- dual graph, 89, 277

- edge of a graph, 80
- edge of a polyhedron, 74
- elementary polygon, 93
- entropy, 261, 262
- equal size, 127
- equicomplementability, 68
- equicomplementable polyhedra, 67
- equidecomposability, 68
- equidecomposable polyhedra, 67
- equivalent links, 105
- Erdős–Ko–Rado theorem, 214
- Euler’s criterion, 28
- Euler’s function, 32
- Euler’s polyhedron formula, 89
- Euler’s series, 55
- even function, 186
- expectation, 116

- face, 74, 89
- facet, 74
- Farkas Lemma, 176
- Fermat number, 3
- finite field, 35
- finite fields, 32
- finite Kakeya problem, 248
- finite set system, 213
- forest, 81
- formal power series, 241
- four-color theorem, 277

- Fox n -labeling, 103
- friendship theorem, 307
- fundamental theorem of algebra, 151

- Gale’s theorem, 303
- Gauss lemma, 29
- Gauss sum, 31
- general position, 303
- geometric mean, 143
- Gessel–Viennot lemma, 229
- girth, 314
- golden section, 295
- graph, 80
- graph coloring, 277
- graph of a polytope, 74
- Gregory–Leibniz series, 61
- Gurvits’ Proposition, 171

- H-stable, 171
- Hadamard determinant problem, 42
- Hadamard matrix, 43
- Hadamard’s inequality, 43
- harmonic mean, 143
- harmonic number, 12
- Heine–Borel theorem, 40
- Herglotz trick, 183
- Hilbert’s third problem, 67
- homogeneous, 170
- hyper-binary representation, 130

- incidence matrix, 79, 198
- incident, 80
- indegree, 273
- independence number, 291, 301, 315
- independent set, 81, 271
- induced subgraph, 81, 272
- inequalities, 143
- infinite products, 241
- initial ordinal number, 140
- intersecting family, 214, 301
- involution, 22
- irrational numbers, 47
- isomorphic graphs, 81

- Jacobi determinants, 57

- Kakeya conjecture, 248
- Kakeya needle set, 247
- kernel, 273

- Kneser graph, 301
Kneser's conjecture, 302
knot, 105
knot theory, 99
knots and links, 99
- labeled tree, 235
Lagrange's theorem, 4
Latin rectangle, 254
Latin square, 253, 271
Latin squares, 265
lattice, 93
lattice basis, 94
lattice paths, 229
lattice points, 30
law of quadratic reciprocity, 28
Legendre symbol, 27
Legendre's theorem, 10
lexicographically smallest solution, 70
line graph, 276
linear extension, 210
linearity of expectation, 116, 190
link, 105
linked circles, 100
list chromatic number, 272
list coloring, 272, 278
Littlewood–Offord problem, 179
log-convex function, 173
loop, 80
Lovász umbrella, 294
Lovász' theorem, 297
Lyusternik–Shnirel'man theorem, 302
- Markov's inequality, 116
marriage theorem, 216
matching, 274
matrix of rank 1, 119
matrix-tree theorem, 237
mean square average, 44
Mersenne number, 4
Minc's conjecture, 261
Minkowski symmetrization, 113
mirror image, 75
monomial, 248
monotone subsequences, 196
Monsky's Theorem, 157
multiple edges, 80
museum guards, 281
- Mycielski graph, 314
- near-triangulated plane graph, 278
nearly-orthogonal vectors, 118
needles, 189
neighbors, 80
Newman's function, 131
non-Archimedean real valuation, 156
non-Archimedean valuation, 160
- obtuse angle, 111
odd function, 184
order of a group element, 4
ordered abelian group, 160
ordered set, 139
ordinal number, 139
orthonormal representation, 294
orthogonal matrix, 39
outdegree, 273
- p -adic value, 156
partial Latin square, 253
partition, 241
partition identities, 241
path, 81
path matrix, 229
pearl lemma, 69
Pell's equation, 15
pentagonal numbers, 243
perfect matching, 261
periodic function, 184
permanent, 169, 261
Petersen graph, 301
Pick's theorem, 93
pigeon-hole principle, 195
planar graph, 89
plane graph, 89, 278
point configuration, 83
polygon, 73
polyhedron, 67, 73
polynomial with real roots, 146, 166
polytope, 111
prime field, 20
prime number, 3, 9
prime number theorem, 12
probabilistic method, 311
probability distribution, 286
probability space, 116

- product of graphs, 291
- projective plane, 201

- quadratic nonresidue, 27
- quadratic reciprocity, 28
- quadratic residue, 27

- rainbow triangle, 157
- Ramsey number, 312
- random variable, 116, 262
- rate of transmission, 291
- red-blue segment, 159
- Reidemeister moves, 99, 105
- Riemann zeta function, 62
- riffle shuffles, 225
- Rogers–Ramanujan identities, 245
- rooted forest, 239
- roots of unity, 37

- scalar product, 118
- Schönhardt’s polyhedron, 282
- segment, 68
- Shannon capacity, 292
- shuffling cards, 219
- simple graph, 80
- simplex, 74
- size of a set, 127
- slope problem, 83
- spectral theorem, 39
- speed of convergence, 59
- Sperner’s lemma, 203
- Sperner’s theorem, 213
- spherical dome, 101
- squares, 20
- stable matching, 274
- star, 79
- Stern’s diatomic series, 128
- Stirling’s formula, 13
- stopping rules, 222

- subgraph, 81
- sums of two squares, 19
- support of a random variable, 262
- Sylvester’s theorem, 15
- Sylvester–Gallai theorem, 77, 92
- system of distinct representatives, 215

- tangential rectangle, 146
- tangential triangle, 146
- top-in-at-random shuffles, 221
- touching simplices, 107
- tree, 81
- triangle-free graph, 314
- trivial knot, 105
- trivial link, 105
- Turán graph, 285
- two square theorem, 19
- 2-colorable set system, 311

- umbrella, 294
- unimodal, 14
- unit d -cube, 74

- valuation ring, 160
- valuations, 155, 160
- Van der Waerden’s conjecture, 169
- vertex, 74, 80
- vertex degree, 90, 199, 272
- vertex-disjoint path system, 229
- volume, 98

- weighted directed graph, 229
- well-ordering theorem, 139
- windmill graph, 307
- winged shape, 23
- winged square, 23

- zero-error capacity, 292
- Zorn’s lemma, 161