

Rethinking the financial network

Andrew G Haldane¹

On 16 November 2002, the first official case of Severe Acute Respiratory Syndrome (SARS) was recorded in Guangdong Province, China. Panic ensued. Uncertainty about its causes and contagious consequences brought many neighbouring economies across Asia to a standstill. Hotel occupancy rates in Hong Kong fell from over 80% to less than 15%, while among Beijing's 5-star hotels occupancy rates fell below 2%.

Media and modern communications fed this frenzy and transmitted it across borders. In North America, parents kept their children from school in Toronto, longshoremen refused to unload a ship in Tacoma due to concerns about its crew and there was a boycott of large numbers of Chinese restaurants across the United States. Dr David Baltimore, Nobel prize winner in medicine, commented: "People clearly have reacted to it with a level of fear that is incommensurate with the size of the problem".

The macroeconomic impact of the SARS outbreak will never be known with any certainty. But it is estimated to stand at anything up to \$100 billion in 2003 prices. Across Asia, growth rates were reduced by SARS by between 1 and 4 percentage points. Yet in the final reckoning, morbidity and mortality rates were, by epidemiological standards, modest. Only around 8000 people were infected and fewer than 1000 died.

On 15 September 2008, Lehman Brothers filed for Chapter 11 bankruptcy in a New York courtroom in the United States. Panic ensued. Uncertainty about its causes and contagious consequences brought many financial markets and institutions to a standstill. The market for Credit Default Swaps (CDS) froze, as Lehman was believed to be counterparty to around \$5 trillion of CDS contracts.

1 I would like to thank Ian Bond, Sebastiano Daros, Kemal Ercevik, David Gregory, Sujit Kapadia, Salina Ladha, Iman van Leyveld, Sarah Parkinson, Filipa Sa, Nick Vause, Lewis Webber, Matthew Willison and Peter Zimmerman for comments and contributions. I would also like to thank Maureen Snow and Joanne Spencer for assistance. Finally, I would like to thank Lord Robert May for conversations on the topic

Media and modern communications fed this frenzy and transmitted it across markets. Banks hoarded liquidity for fear of lending to infected banks, causing gridlock in term money markets, spreads on lower-rated companies' bonds spiked and there was an effective boycott of the remaining large US investment banks. Professor Paul Krugman, Nobel prize winner in economics, commented: "Letting Lehman fail basically brought the entire world capital market down."

The macroeconomic impact of Lehman Brothers' failure will never be known with any certainty. IMF forecasts of global growth for 2009 were revised down by over 5 percentage points following Lehman's failure. Yet in the final reckoning, the direct losses from Lehman's failure seem likely to be relatively modest. Net payouts on Lehman's CDS contracts amounted to only around \$5 billion.

These similarities are striking. An external event strikes. Fear grips the system which, in consequence, seizes. The resulting collateral damage is wide and deep. Yet the triggering event is, with hindsight, found to have been rather modest. The flap of a butterfly's wing in New York or Guangdong generates a hurricane for the world economy. The dynamics appear chaotic, mathematically and metaphorically.

These similarities are no coincidence. Both events were manifestations of the behaviour under stress of a complex, adaptive network. Complex because these networks were a cat's-cradle of interconnections, financial and non-financial. Adaptive because behaviour in these networks was driven by interactions between optimising, but confused, agents. Seizures in the electricity grid, degradation of eco- systems, the spread of epidemics and the disintegration of the financial system – each is essentially a different branch of the same network family tree.

This paper considers the financial system as a complex adaptive system. It applies some of the lessons from other network disciplines – such as ecology, epidemiology, biology and engineering – to the financial sphere. Peering through the network lens, it provides a rather different account of the structural vulnerabilities that built-up in the financial system over the past decade and suggests ways of improving its robustness in the period ahead.

Part 1 provides the diagnosis. Using network theory and evidence, it explains the emergence of two characteristics of the financial network over the past decade – complexity and homogeneity. Together, these resulted in a financial network:

- Which was at the same time both robust and fragile – a property exhibited by other complex adaptive networks, such as tropical rainforests;
- Whose feedback effects under stress (hoarding of liabilities and fire-sales of assets) added to these fragilities – as has been found to be the case in the spread of certain diseases;

- Whose dimensionality and hence complexity amplified materially Knightian uncertainties in the pricing of assets – causing seizures in certain financial markets;
- Where financial innovation, in the form of structured products, increased further network dimensionality, complexity and uncertainty; and
- Whose diversity was gradually eroded by institutions' business and risk management strategies, making the whole system less resistant to disturbance – mirroring the fortunes of marine eco-systems whose diversity has been steadily eroded and whose susceptibility to collapse has thereby increased.

This evolution in the topology of the network meant that sharp discontinuities in the financial system were an accident waiting to happen. The present crisis is the materialisation of that accident.

Given that diagnosis, Part 2 of the paper provides some tentative policy prescriptions. The experience of other network disciplines suggests a rather different approach to managing the financial network than has been the case in the past, if future systemic dislocations are to be averted. Three areas in particular are discussed:

- *Data and Communications*: to allow a better understanding of network dynamics following a shock and thereby inform public communications. For example, learning from epidemiological experience in dealing with SARS, or from macroeconomic experience after the Great Depression, putting in place a system to map the global financial network and communicate to the public about its dynamics;
- *Regulation*: to ensure appropriate control of the damaging network consequences of the failure of large, interconnected institutions. For example learning from experience in epidemiology by seeking actively to vaccinate the “super-spreaders” to avert financial contagion; and
- *Restructuring*: to ensure the financial network is structured so as to reduce the chances of future systemic collapse. For example, learning from experience with engineering networks through more widespread implementation of central counterparties and intra-system netting arrangements, which reduce the financial network's dimensionality and complexity.

Networks and finance are not complete strangers. There has been growing interest among network theorists in applying their techniques to financial phenomena over the past few years. For example, network techniques have already been ap-

plied extensively to the dynamics of payment systems and inter-bank networks.² But the financial crisis of the past two years provides both a greater body of evidence, and a stronger incentive, to apply the lessons from other network disciplines to the pressing problems facing financial policymakers today.

Part 1: Topology of the Financial Network

In many important respects, the current financial crisis is cut from familiar cloth. Its genesis was the over-extension of credit, over-inflation of asset prices and over-exuberance of participants. From the South Sea bubble to the sub-prime crisis, this roll-call of excesses is familiar. Gerald Corrigan, ex-President of the New York Fed, said ahead of the crisis:

“In recent years the pace of change and innovation in financial markets and institutions here and around the world has increased enormously as have the speed, volume and value of financial transactions. The period has also seen a greatly heightened degree of aggressive competition in the financial sector. All of this is taking place in the context of a legal and a regulatory framework which is increasingly outdated and ill-equipped to meet the challenges of the day. This has led to...concern that the fragility of the system has increased, in part because the degree of operational, liquidity and credit interdependency has risen sharply”.³

Corrigan was speaking in January 1987. The crisis foretold was the October 1987 stock market crash. Plus ça change.

Yet in some more fundamental respects this time’s crisis feels different – larger probably, more discontinuous, complex and interconnected certainly. There are already numerous accounts of why that might be. Here, I argue that these knife-edge dynamics can essentially be explained by two structural features of the financial network. These have developed over many years but at particular pace over the past decade. They are *complexity* on the one hand, and *homogeneity* on the other.

In essence, the financial network has over time become progressively more complex and less diverse. Why? And what have been the consequences?

In the 1987 film *Wall Street*, the financial sector mantra was “greed is good”. The stock market crash of the same year put paid to that doctrine, at least temporarily. By the early part of this century, both the circumstances and the individuals had changed. So too had the mantra. It had become the rather gentler “diversification is desirable”. Risk-taking became less Gordon Gekko and more Merton Miller.

2 Federal Reserve Bank of New York (2007); May, Levin and Sugihara (2008); Allen and Gale (2000).

3 Corrigan (1987).

Diversification came care of two complementary business strategies. The first was “originate and distribute”. Risk became a commodity. As such it could be bundled, sliced, diced and then re-bundled for onward sale. Credit became, in the jargon, structured. Securitisation was one vehicle for achieving this. Derivatives, such as CDS, were another. As these marketable instruments passed between participants, the network chain lengthened.

In principle, these instruments delivered a Pareto-improving reallocation of risk. Risk would flow to those best able to bear it. They had deep pockets which they sought to line with higher yield. For the system as a whole, this sounded like the land of milk and honey. For a risk shared was a risk halved – perhaps more than halved, given the magic of diversification. The network chain, meanwhile, just kept on growing.

The second strategy was diversification of business lines. Firms migrated activity to where returns looked largest. As each new day dawned – leveraged loans yesterday, CDOs today, proprietary trading tomorrow – the whole sector was drawn to the new source of sunlight. Through competitive forces, finance engaged in a frantic game of follow-the-leader, played for real money.

From an individual firm perspective, these strategies indeed looked like sensible attempts to purge risk through diversification: more eggs were being placed in the basket. Viewed across the system as a whole, however, it is clear now that these strategies generated the opposite result: the greater the number of eggs, the greater the fragility of the basket – and the greater the probability of bad eggs.

Securitisation increased the dimensionality, and thus complexity, of the financial network. Nodes grew in size and interconnections between them multiplied. The financial cat’s-cradle became dense and opaque. As a result, the precise source and location of underlying claims became anyone’s guess. Follow-the-leader became blind-man’s buff. In short, diversification strategies by individual firms generated heightened uncertainty across the system as a whole.

Meanwhile, a strategy of changing the way they had looked in the past led to many firms looking the same as each other in the present. Banks’ balance sheets, like Tolstoy’s happy families, grew all alike. So too did their risk management strategies. Financial firms looked alike and responded alike. In short, diversification strategies by individual firms generated a lack of diversity across the system as a whole.

So what emerged during this century was a financial system exhibiting both greater complexity and less diversity. Up until 2007, many participants in financial markets would have viewed that network evolution as the inevitable by-

product of technical progress in finance. Until then, complexity plus homogeneity equalled stability.

But in just about every non-financial discipline – from ecologists to engineers, from geneticists to geologists – this evolution would have set alarm bells ringing. Based on their experience, complexity plus homogeneity did not spell stability; it spelt fragility. In understanding why, it is useful to explore some of the wider lessons from those disciplines, taking in turn the effects of complexity and diversity on stability.

Complexity and Stability

Tropical rainforests are a complex adaptive system. In the immediate post-war period, these eco-systems were often used as a case-study when demonstrating why complex systems tended to exhibit greater stability.⁴ In Elton's (1958) words, this was because there are "always enough enemies and parasites available to turn on any species that starts being unusually numerous". Complexity strengthened self-regulatory forces in systems, so improving robustness. This was the prevailing ecological wisdom up until the early 1970s.

That conventional wisdom has since been turned on its head. From the 1970s onwards, orthodoxy was altered by a combination of enriched mathematical models and practical experience.⁵ Counter-examples emerged, with some simple eco-systems – savannas and grasslands – found to exhibit high robustness and some complex eco-systems proving vulnerable to attack. Perhaps tellingly, large-scale clearance of tropical rainforests highlighted their inherent fragility. Not for nothing did rainforests become known as a "non-renewable" resource from the early 1970s.

Finance appears to be following in ecologists' footsteps, albeit with a generational lag. Until recently, mathematical models of finance pointed to the stabilising effects of financial network completeness.⁶ Connectivity meant risk dispersion. Real-world experience appeared to confirm that logic. Between 1997 and 2007, buffeted by oil prices shocks, wars and dotcom mania, the financial system stood tall; it appeared self-regulating and self-repairing. Echoes of 1950s ecology were loud and long.

The past 18 months have revealed a system which has shown itself to be neither self-regulating nor self-repairing. Like the rainforests, when faced with a big shock, the financial system has at times risked becoming non-renewable. Many

4 For example, Voute (1946) and Elton (1958).

5 For example, May (1974).

6 For example, Allen and Gale (op.cit).

of the reasons for this have a parallel in other disciplines. In particular, in making sense of recent financial network dynamics, four mechanisms appear to have been important: connectivity; feedback; uncertainty; and innovation.

(a) Connectivity and Stability

Over the past 30 years, a great deal has been established about the links between network connectivity and robustness. These lessons span a range of disciplines including physics, biology, engineering and epidemiology. There are perhaps three key robustness results from this literature which are relevant to the financial system.

Perhaps the key one concerns the “robust-yet-fragile” property of connected networks.⁷ The intuition behind this result is beguilingly simple, but its implications profound. In a nutshell, interconnected networks exhibit a knife-edge, or tipping point, property. Within a certain range, connections serve as a shock-absorber. The system acts as a mutual insurance device with disturbances dispersed and dissipated. Connectivity engenders robustness. Risk-sharing – diversification – prevails.

But beyond a certain range, the system can flip the wrong side of the knife-edge. Interconnections serve as shock-amplifiers, not dampeners, as losses cascade. The system acts not as a mutual insurance device but as a mutual incendiary device.

Risk-spreading – fragility – prevails. The extent of the systemic dislocation is often disproportionate to the size of the initial shock. Even a modest piece of news might be sufficient to take the system beyond its tipping point. This same basic logic has latterly been applied to financial systems, using mathematical models and simulated data.⁸

These knife-edge dynamics match closely the behaviour of the financial system in the recent past. A lengthy period of seeming robustness (the Golden Decade from 1997 to 2007) was punctuated by an acute period of financial fragility (the period since). The shock causing this tipping point to be reached – the sub-prime crisis – was by global financial standards rather modest. The robust-yet-fragile property of networks helps make sense of these non-linear financial dynamics. Though they looked and felt like chaos, these dynamics were in fact manifestations of a new network order.

The second key robustness result concerns the “long-tailed distribution” of connected networks. The *degree* of a node measures the number of links to other

7 For example, May and Anderson (1991), Albert et al (2004), Kinney et al (2005), Watts (2002).

8 For example, at the Bank of England by Nier et al (2008) and Gai and Kapadia (2008); and by Battiston et al (2009) and Gallegati et al (2008).

nodes. So the *degree distribution* could be thought of as a histogram of the number of links for each node. For a network whose links are randomly configured, this degree distribution would be symmetric and bell-shaped; it would have a fat middle and thin tails.

But many real-world networks do not exhibit these properties, including the internet, biological food webs and epidemiology networks.⁹ Instead these networks have been found to have a thin middle and long, fat tails. There is a larger than expected number of nodes with both a smaller and a larger number of links than average. Some financial networks, such as payment systems, have also been found to exhibit long tails.¹⁰

Long tails have been shown to have important implications for network robustness. In particular, long-tailed distributions have been shown to be more robust to random disturbances, but more susceptible to targeted attacks.¹¹ Why? Because a targeted attack on a hub risks bringing the heart of the system to a standstill, whereas random attacks are most likely to fall on the periphery.

This result carries important policy implications. Long periods of apparent robustness, where peripheral nodes are subject to random shocks, should offer little comfort or assurance of network health. It is only when the hub – a large or connected financial institution – is subject to stress that network dynamics will be properly unearthed. When large financial institutions came under stress during this crisis, these adverse system-wide network dynamics revealed themselves.

The third result is the well-known “small world” property of connected networks.¹²

The origin of this was a chain letter experiment by Stanley Milgram in 1967. This showed that the average path length (number of links) between any two individuals was around six – hence “six degrees of separation”. Although networks tend to exhibit local clustering or neighbourhoods, certain key nodes can introduce short-cuts connecting otherwise detached local communities.

This small world property has again been found across a range of physical networks, including the World Wide Web and forest fires.¹³ Its implications for network robustness are subtle. In general, however, it will tend to increase the likelihood of local disturbances having global effects – so-called “long hops”. That could occur between different institutions or between different nation states. Either way, a small world is more likely to turn a local problem into a global one.

9 May (2006).

10 Pröpper et al (2008).

11 May and Anderson (1991), Porterie et al (2008)

12 Watts and Strogatz (1998).

13 On the former see Albert et al (2000); on the latter see Porterie et al (2008).

So what evidence do we have on these three characteristics in real financial networks? Charts 1-3 look at the evolution in the international financial network. In particular, they look at cross-border stocks of external assets and liabilities in 18 countries at three dates: 1985, 1995 and 2005. These data can be used to gauge the scale and evolution of interconnectivity within the global financial network.

In Charts 1-3, the nodes are scaled in proportion to total external financial stocks, while the thickness of the links between nodes is proportional to bilateral external financial stocks relative to GDP.¹⁴ Table 1, meanwhile, provides some summary statistics for the international financial network, in particular measures of the skew and fat-tailedness in the degree distribution and its average path length.

Three key points emerge. First, it is clear that the scale and interconnectivity of the international financial network has increased significantly over the past two decades. Nodes have ballooned, increasing roughly 14-fold. And links have become both fatter and more frequent, increasing roughly 6-fold. The network has become markedly more dense and complex. And what is true between countries is also likely to have been true between institutions within countries.

Second, the international financial network exhibits a long-tail. Measures of skew and kurtosis suggest significant asymmetry in the network's degree distribution. Global finance appears to comprise a relatively small number of financial hubs with multiple spokes.

Third, the average path length of the international financial network has also shrunk over the past twenty years. Between the largest nation states, there are fewer than 1.4 degrees of separation. Were the network extended beyond the 18 countries in the sample, the evolution of this "small world" property would be clearer still.

So based on evidence from a sampled international financial network, the past twenty years have resulted in a financial system with high and rising degrees of interconnection, a long-tailed degree distribution and small world properties. That is an unholy trinity. From a stability perspective, it translates into a robust-yet-fragile system, susceptible to a loss of confidence in the key financial hubs and with rapid international transmission of disturbances. That is not the worst description of financial events over the past decade – and in particular over the past 18 months.

14 Specifically, nodes are scaled by $(\text{Total External Assets} + \text{Total External Liabilities})$ for each node, and links between nodes i and j by $(\text{Total External Assets}_{ij} + \text{Total External Liabilities}_{ij}) / (\text{GDP}_i + \text{GDP}_j)$. The data are developed and analysed in Kubulec and Sa (2008).

(b) Feedback and Stability

In epidemiology, the impact of a disease depends crucially on such structural parameters as the mortality rate once infected and the transmission rate across agents.¹⁵ The first is largely fixed and biological. But the second is likely to be variable and sociological. In other words, agents' responses to infection, or indeed the fear of infection, are often crucial in determining its rate of transmission.

In practice, these behavioural responses typically take one of two forms: "hide" or "flight". For example, the response to the SARS epidemic in the 21st century was a "hide" response, with people self-quarantining by staying at home and with flight, in this case literally, prohibited. But the response to yellow fever in North America in the 19th century was "flight", with half the population of Memphis fleeing in 1878.¹⁶

Either response is rational from an individual perspective. Both responses have the aim of removing that individual from circulation with other, potentially infectious, agents. But the implications of these responses for infection rates across the system are potentially very different. Hide responses tend to contain infection locally, thus protecting the system globally. This was the SARS experience. Flight, by contrast, tends to propagate infection globally. This was the yellow fever experience, as incidence of the disease followed the railroad line out of Memphis.¹⁷

During this financial crisis, faced with fears about infection, similar sets of behavioural responses by financial institutions have occurred. Only the names are different. The "hiding" has taken the form of hoarding, typically of liquidity. And the "flight" from infected cities has taken the form of flight from infected assets, as institutions have sold toxic assets. Unlike in an epidemiological context, however, both behavioural responses have aggravated stresses in the financial system. How so?

Banks entered the crisis with a large portfolio of risky assets. As risk materialised, banks rationally sought to protect themselves from infection from other banks by hoarding liquidity rather than on-lending it. The result has been enduring stress in money markets. Banks' mutual interdependence in inter-bank networks meant that individually-rational actions generated a collectively worse funding position for all.

15 May (2006), Newman (2002).

16 Epstein et al (2008) provide a range of examples.

17 Wheelis (2006) provides an excellent example of the role of human (in this particular case literal) flight in transmitting the Plague to Europe in the 14th Century. Transmission of the Plague was reputedly the result of Genoese traders fleeing the Crimean city of Caffa after the Mongol army had catapulted infected corpses over the city walls

That, in turn, contributed to the second behavioural response. Unable easily to fund their asset portfolio, some financial firms instead opted for flight through sales of assets. These acted like the railroad out of Memphis, placing downward pressure on asset prices and thereby spreading the infection to other institutions. Others' immunity to infection was simultaneously being lowered by widespread marking of assets to market. In escaping the plague, asset flight served to propagate it.

These behavioural dynamics – panic hoarding of liabilities, distress sales of assets – have been defining features of this crisis. Placing these responses in a network framework clarifies the individual rationalities, but collective externalities, that drove these actions. These rational responses by banks to fear of infection added to the fragility of an already robust-yet-fragile financial network.

(c) Uncertainty and Stability

A related, but separate, behavioural response to fear of infection is felt in the pricing of financial instruments. Networks generate chains of claims. At times of stress, these chains can amplify uncertainties about true counterparty exposures. Who is really at the end of the chain – Warren Buffett or Bernard Madoff? Through their impact on counterparty uncertainty, networks have important consequences for dynamics and pricing in financial markets.

To illustrate, consider the case of pricing in the CDS market – an inherently complex, high dimension market. In particular, consider Bank A seeking insurance from Bank B against the failure of Entity C. Bank A faces counterparty risk on Bank B. If that were the end of the story, network uncertainty would not much matter. Bank A could monitor Bank B's creditworthiness, if necessary directly, and price the insurance accordingly.

But what if Bank B itself has n counterparties? And what if each of these n counterparties itself has n counterparties? Knowing your ultimate counterparty's risk then becomes like solving a high-dimension Sudoku puzzle. Links in the chain, like cells in the puzzle, are unknown – and determining your true risk position is thereby problematic.

For Bank A, not knowing the links in the chain means that judging the default prospects of Bank B becomes a lottery. Indeed, in some ways it is worse than a lottery, whose odds are at least known. In this example, Bank A faces uncertainty in the Knightian sense, as distinct from risk, about the true network structure. Counterparty risk is not just unknown; it is almost unknowable. And the higher the dimensionality of the network, the greater that uncertainty.

It is possible to formalise this intuition with some simple numerical examples.¹⁸

Consider two states of the world, pre-crisis and crisis. And consider the impact of network complexity on CDS pricing. Once we introduce Knightian uncertainty, asset prices are no longer determinate; they are defined by a range rather than a point. So the range of equilibrium CDS spreads can be taken as a metric of the uncertainty, and hence distortion, arising from different network structures.

Chart 4 plots a pre-crisis world where it is assumed that counterparty default probabilities, and the uncertainty around them, are low. Subject to those assumptions, it illustrates how the range of CDS spreads is affected by Bank B's number of counterparties. Larger numbers of counterparties are marginally beneficial. There is a "law of large numbers" benefit. Broadly-speaking, however, network dimensionality has no material bearing on CDS pricing.

Chart 5 simulates a crisis world in which the default probability of Bank B has risen and so too the uncertainty around that probability. The difference is striking. Pricing uncertainty now increases with the dimensionality of the web. Extra counterparties add to, rather than subtract from, pricing distortions. There is a "law of large numbers" cost. That uncertainty cost, or Knightian distortion, is roughly proportional the dimension of the network.

It is difficult not to draw comparisons with Lehman's experience. Lehman had large CDS counterparty exposures relative to its balance sheet and hundreds of counterparties. AIG was similarly situated. It is little wonder participants took fright as both institutions came under stress, fearful not so much of direct counterparty risk, but of indirect counterparty risks emanating from elsewhere in the network. The network chain was so complex that spotting the weakest link became impossible.

This added yet a further layer of fragility to the financial system.

(d) Innovation and Stability

A fourth dimension to complexity in network chains derives from the effects of financial innovation. Over the past decade, this often took a particular form – structured credit – with risk decomposed and then reconstituted like the meat in an increasingly exotic sausage. The result was a complex interlocking set of claims. With each restructuring of ingredients, the web branched and the dimensionality of the network multiplied.

Chart 6 shows some of the interlocking networks of structured products that emerged. I will not attempt to describe this chart; it would take too long and, even

¹⁸ The following is based on work in progress at the Bank on asset pricing under network Knightian uncertainty, by Sebastiano Daros and Kemal Ercevik.

if I had the time, I doubt I would have the ability. These were the self-same constraints – time, complexity – which faced investors in these products. Due diligence was the casualty. End-investors in these instruments were no more likely to know the name of the companies in their portfolios than the name of the cow or pig in their exotic hot dog.

To illustrate, consider an investor conducting due diligence on a set of financial claims: RMBS, ABS CDOs and CDO². How many pages of documentation would a diligent investor need to read to understand these products? Table 2 provides the answer. For simpler products, this is just about feasible – for example, around 200 pages, on average, for an RMBS investor. But an investor in a CDO² would need to read in excess of 1 billion pages to understand fully the ingredients.

With a PhD in mathematics under one arm and a Diploma in speed-reading under the other, this task would have tried the patience of even the most diligent investor. With no time to read the small-print, the instruments were instead devoured whole. Food poisoning and a lengthy loss of appetite have been the predictable consequences. Though it had aimed to dampen institutional risk, innovation in financial instruments served to amplify further network fragility.

Diversity and Stability

A final dimension to network robustness concerns the effects of diversity. The oceans provide a rich and lengthy test-bed of the links between diversity and robustness.

Over the past millennium, studies of coastal eco-systems reveal some dramatic patterns.¹⁹ For around 800 years, between the years 1000-1800AD, fish stocks and species numbers were seemingly stable and robust. Since then, almost 40% of fish species across the world's major coastal eco-systems have "collapsed", defined here as a fall in population of greater than 90%. That is systemic by any metric.

There appear to be many environmental reasons for this collapse, some natural, others man-made. But the distribution of this collapse across eco-systems is revealing. For species-rich – that is, diverse – eco-systems the rate of collapse has been as low as 10%; for species-poor eco-systems, as high as 60%. Diverse coastal eco-systems have proved to be markedly more robust, measured over century spans.

Results for large marine eco-systems suggest a similar picture. Over the period 1950-2003, the incidence of collapsed fisheries declines exponentially with

¹⁹ The results here are based on Worm et al (2006).

species- diversity.²⁰ Diversity also appears to increase the resilience of fisheries – that is, their capacity to recover – in the event of collapse. These results re-appear throughout marine eco-systems, “in coral reefs in Jamaica and on rocky shores in Panama”.²¹

And they do not appear to be unique to marine eco-systems. For example, similar effects of diversity have been found in studies of the resilience of crops to pathogen outbreaks; in the robustness of savannas and grassland to drought; and in morbidity and mortality rates among humans facing disease and infection.²² Diversity of the gene pool, it seems, improves durability.

The financial system has mirrored the fortunes of the fisheries, for many of the same reasons. Since the start of 2007, 23 of the largest European and US banks have seen their market capitalisation fall by 90% or more – the fisheries equivalent of collapse. But what took marine eco-systems two hundred years to achieve has been delivered by financial engineers in two. In explaining the collapse in fish and finance, lack of diversity seems to be a common denominator.

Within the financial sector, diversity appears to have been reduced for two separate, but related, reasons: the pursuit of return; and the management of risk. The pursuit of yield resulted in a return on equity race among all types of financial firm. As they collectively migrated to high-yield activities, business strategies came to be replicated across the financial sector. Imitation became the sincerest form of flattery.

So savings cooperatives transformed themselves into private commercial banks. Commercial banks ventured into investment banking. Investment banks developed in-house hedge funds through large proprietary trading desks. Funds of hedge funds competed with traditional investment funds. And investment funds – pension, money market mutual, insurance – imported the risk the others were shedding.

Cumulative returns earned by, on the face of it, very different financial models illustrate this story (Chart 7). Looking across global banks, large complex financial institutions (LCFIs), insurance companies and hedge funds, cumulative returns have exhibited a remarkably similar pattern, both in the run-up to crisis and in the subsequent run-down. Rolling averages of pairwise correlations across sectors averaged in excess of 0.9 throughout the period 2004-2007. At the height of the credit boom, financial imitation appears to have turned into near-cloning. Flattery gave way to fat-cattery.

20 Worm et al (op.cit.).

21 Levin and Lubchenco (2008).

22 For example, Tilman (1999) and Clay (2004).

What was true across financial sectors was also true within them. For example, hedge fund strategies rejoice in such oblique names as “convertible arbitrage” and “dedicated short bias”. The average pairwise correlation between these different funds’ strategies was roughly zero at the turn of the century. By 2008, it had risen to around 0.35. Far from daring to be different, hedge funds seem increasingly to have hunted as a pack.

Management of the risks resulting from these strategies amplified this homogeneity. Basel II provided a prescriptive rule-book ensuring a level playing field. Ratings were hard-wired into regulation. Risk models blossomed, with Value-at-Risk (VaR) and stress-testing providing seductively precise outputs. Like blossom, these models looked and acted alike – and may yet prove similarly ephemeral. The level playing field resulted in everyone playing the same game at the same time, often with the same ball.

Through these channels, financial sector balance sheets became homogenised. Finance became a monoculture. In consequence, the financial system became, like plants, animals and oceans before it, less disease-resistant. When environmental factors changed for the worse, the homogeneity of the financial eco-system increased materially its probability of collapse.

So where does this leave us? With a financial system exhibiting, for individually quite rational reasons, increasing complexity and homogeneity. A network which, in consequence, was robust-yet-fragile. A network predisposed to tipping points and discontinuities, even for small shocks. A network which, like Tolstoy’s unhappy families, could be unhappy in quite different ways. A network mostly self-repairing, but occasionally self-destructing. A network which, like the little girl with the curl, when the going was good was very, very good – but when it turned bad was horrid.

Part 2: Improving Network Stability

This is a gloomy prognosis: a financial system teetering between triumph and disaster. Unlike Kipling, policymakers in practice are unlikely to treat those two imposters just the same. Recent events have rather illustrated that. Public interventions in the financial system during this crisis – through liquidity injections, capital injections or public sector guarantees – already total in excess of £5 trillion in 2009.²³

23 For example, Bank of England *Financial Stability Report*, October 2008.

So what could be done to protect the financial network from future such dynamics? And are there lessons from other network disciplines which might help inform these efforts? Let me highlight three areas where improvements in the robustness of the financial network seem feasible: mapping; regulating; and restructuring.

(a) Mapping the Network

The SARS episode may be remembered by historians as an overblown economic reaction to a small health risk – that was Nobel Laureate Dr David Baltimore’s prognosis. But there is an alternative reading of the runes, one which offers some lessons, and not a little hope, for financial policymakers.

In 2000, the World Health Organisation (WHO) established the Global Outbreak Alert and Response Network (GOARN). This brings together over 120 international institutions and networks to share resources to better identify and manage outbreaks. In the case of SARS, the speed and scale of response was striking.

On 12 March 2003, less than two weeks after the Hong Kong outbreak, the WHO issued a global health alert. On 15 March, a “general travel advisory” was issued. By 17 March, a network of scientists from 11 laboratories in 9 countries was established to devise diagnostic tests, analyse samples and share results in real time. This allowed national agencies to promulgate information quickly and widely, with governments in Thailand, Malaysia, China, Singapore and Canada each imposing some combination of travel bans, quarantining and public health notices.²⁴

These measures appear to have contributed both to the rapid subsidence of SARS-related fears and uncertainties among the general public and to containing the spread of the disease. Since April 2004, there have been no reported cases of SARS. The global information infrastructure of GOARN is widely acknowledged as having helped nip the SARS crisis in the bud.

There are important lessons here for the financial system. At present, risk measurement in financial systems is atomistic. Risks are evaluated node by node. In a network, this approach gives little sense of risks to the nodes, much less to the overall system. It risks leaving policymakers navigating in dense fog when assessing the dynamics of the financial system following failure. The market repercussions of Lehman’s failure were in part the result of such restricted visibility.

What more might be done to prevent a repeat? Part of the answer lies in improved *data*, part in improved *analysis* of that data, and part in improved *communication* of the results. On data, in some real-world physical networks, data is collected on virtually all nodes and links. For example, in modelling the US

²⁴ For example, Smith (2006) and McKercher and Chon (2004).

electricity grid, data are collected on all major power stations (nodes) and power lines (links).²⁵ As these total 14,000 and 20,000 respectively, this is a large-dimension network.

Data from physical networks such as the power grid are relatively easy to collect. For many other large-dimension networks, sampling techniques are typically required. These typically take one of three forms: node sampling; link sampling; and “snowball” sampling.²⁶ There are lessons for the financial system from all three.

To date, sampling of nodes has been the dominant means of assessing risk within the financial system, typically for a sub-set of the nodes such as banks. Where non-bank financial intermediaries are an important part of the network, sampling of nodes has shown itself deficient. For example, little was known about the activities of off balance sheet vehicles – SIVs and conduits – ahead of crisis. More fundamentally, this approach provides little information on the links between nodes. These are central to understanding network dynamics. Imagine assessing the robustness of the electricity grid with data on power stations but not on the power lines connecting them.

Sampling of links has historically been little deployed when analysing the financial system. Some data exist on the degree of linkage between financial firms – for example, from regulatory returns on large exposures. This has been used to construct rough approximations of inter-bank networks.²⁷ These data are typically partial and lack timeliness, but the recent BCBS consultation on Large Exposures seeks to address this. They are weak foundations for understanding the financial network.

That takes us to snowballing – that is, constructing a picture of the network by working outwards from the links to one of the nodes. As a way of understanding the financial web, there are attractions to this approach. It is agnostic about which are the key nodes and important links. Network boundaries are uncovered by following the money, rather than by using institutional labels or national or regulatory boundaries.

Applied in practice, this approach might have helped identify some of the key nodal sources of risk ahead of financial crisis. In early 2007, it is doubtful whether many of the world’s largest financial institutions were more than two or three degrees of separation from AIG. And in 1998, it is unlikely that many of the world’s largest banks were more than one or two degrees of separation from

25 For example, Kinney et al (2005).

26 Lee, Kim and Jeong (2006).

27 Propper et al (2008).

LTCM. Rolling the snowball might have identified these financial black holes before they swallowed too many planets.

There have been a number of recent policy proposals in this general area. For example, the de Larosiere Report (2009) calls for a European and, ultimately, global initiative to create an international register of claims between financial institutions. A similar initiative following the LDC debt crisis resulted in the Bank for International Settlements (BIS) developing international banking statistics. These are now an essential source of international financial network data. There is a need for similar ambition now in fashioning international flow of funds and balance sheet data.

Even with these data, policymakers and practitioners need to invest in new means of *analysis*. Node-by-node diagnostics, such as VaR, have shown themselves during this crisis to offer a poor guide to institutional robustness. Fortunately, network theorists have identified some of the key summary statistics determining system robustness.²⁸

This includes degree distributions and average path lengths. In time, network diagnostics such as these may displace atomised metrics such as VaR in the armoury of financial policymakers.

To these static diagnostics could be added dynamic summary statistics of network resilience, such as simulated responses to nodal failure or stress. Stress-testing to date has focussed on institutional, idiosyncratic risk. It needs instead to focus on system-wide, systematic risk.²⁹ Advances in computing power mean that technology is no longer a constraint. In studies of the electricity grid, simulations of hundreds of thousands of observations are common. Finance can piggy-back on these efforts.

After data and analysis comes, crucially, *communication*. Network information is a classic public good. Not only is it in no-one's individual interest to collect it; nor is it remotely within anyone's compass. Aggregate data are a job for the authorities. And having been collected, these results need then to be disseminated. This is important both ex-ante as a means of better pricing and managing risk, and ex-post as a means of containing that risk.

In a world of 24/7 media, public communications during crisis become crucial. That was the lesson from SARS – and may yet be the enduring lesson from Lehman.

From mid-September to mid-October 2008, the financial crisis did not just dominate the news; it *was* the news. Only a hermit could have failed to have their

28 Newman (2002).

29 Haldane (2009).

perceptions shaped by this tale of woe. As woe became the popular narrative, depressed expectations may have become self-fulfilling.

In their recent book, *Animal Spirits*, George Akerlof and Robert Shiller emphasise the role of popular psychology – “stories” – in shaping people’s perceptions and actions. Depression is a psychological state as well as an economic one. Perhaps the best explanation we have about events following the Lehman crisis is that these two states merged. Adroit communications by the authorities, like counselling, might help head- off future bouts of clinical depression in the financial system.

This is undoubtedly an ambitious agenda. But experience after the Great Depression suggests grounds for optimism. That crisis brought about a revolution in thinking about macroeconomic theory and macroeconomic policy. In many respects, it marked the birth of modern macroeconomic models – in the form of IS/LM analysis – and modern macroeconomic policy – in the form of activist monetary and fiscal policy.

Though less heralded, it also resulted in a revolution in macroeconomic data. Despite attempts in the 1920s and 1930s, it was from the 1940s onwards that national accounts data emerged for the main developed economies. This was largely a response to the evolution in macroeconomic thinking and policy-making following the Great Depression. Crisis experience led theory which in turn led data. That is the evolutionary path finance now needs to be on.

(b) Regulating the Network

The first diagnosed case of Human Immuno-Deficiency Virus (HIV) in the United States came in June 1981. The first diagnosed case of HIV in Australia came in November 1982. In the early 1980s, rates of HIV and AIDS incidence in the US and Australia were roughly similar on a per capita basis. But from the mid-1980s onwards, things changed. By 1994, rates of incidence in the US were six times those in Australia. By 2003, the per capita prevalence of HIV in the US was ten times that in Australia.³⁰ What explains these differences?

The short answer appears to be government policy. In the US, the policy stance since the early 1980s has been largely theological. The preventative response has taken the form of moralising about sexual abstinence and monogamy. Since the mid-1990s, the US government has invested in the less contentious areas of HIV/AIDS treatment. But as recently as 2007, the US administration remained opposed to the provision of condoms or needle and syringe programmes to prevent the spread of HIV/AIDS.

30 Bowtell (2005, 2007).

Australian policy since the early 1980s has, by contrast, been grounded in biology rather than theology. It has been systematic, with policy evidence-based and preventative. Education and prophylactic measures have been widely available. But there have been targeted initiatives for high-risk groups – for example, sex workers and drug users – through subsidised needle and syringe exchanges and free condoms. The results of this programme are clear in the statistics.

There are perhaps two clear lessons from this experience. First, the importance of targeting high-risk, high-infection individuals – the “super-spreaders”. This principle has an impeccable epidemiological pedigree.³¹ For randomly distributed networks, targeted treatment has no value. But for networks exhibiting long tails – which is most of them, certainly including finance – targeted vaccination programmes offer a much more effective means of curtailing epidemics.

Not for nothing is epidemiology the origin of the 80/20 principle.³² For a number of diseases, including SARS and measles, the distribution of infection rates suggest 20% of the population is responsible for 80% of the spread. Similar patterns have been found in the transmission of HIV/AIDS, foot and mouth and computer viruses on the internet. In each of these cases, the right response has been shown to be targeted vaccination of the super-spreaders.

The second lesson concerns the importance of a system-wide approach to the management of network problems. The Australian HIV/AIDS programme was system-wide, tackling both the causes and consequences of the disease and its spread. Fisheries management provides a second revealing case study. Concerns about the collapse of fisheries came to a head during the 1970s and 1980s, leading to the imposition of fishing quotas for various species. The effect of quotas was, at best, mixed.

Recently, there has been a growing recognition of what went wrong. In setting quotas, no account was taken of interactions between species and the surrounding eco-system. During this century, fisheries management has pursued a different strategy – Ecosystem-Based Fishery Management (EBFM).³³ EBFM takes as its starting point the management of the eco-system. It develops system-level standards and single-species targets are calibrated to ecosystem-wide objectives. The EBFM approach is already being implemented in Alaska, California and the Antarctic.

Existing regulatory rules for financial institutions have echoes of fisheries management in the 1970s. Risk quotas are calibrated and applied node by node,

31 May and Anderson (1991).

32 May and Anderson (op.cit.), May (2005).

33 For example, Pikitch et al (2004).

species by species. This approach takes no account of individual nodes' system-wide importance – for example, arising from their connectivity to other nodes in the network or their scale of operations.

Charts 8 and 9 illustrate the problem. They plot the relationship between global banks' capital ratios and their size, where size is used here as a rough proxy for connectivity and scale. Chart 8 shows there is essentially no relationship between banks' systemic importance and their Basel capital ratios. There has been no targeted vaccination of the super-spreaders of financial contagion. Chart 9 uses leverage ratios rather than risk-weighted Basel capital ratios. It suggests that, if anything, the super-spreaders may historically have had *lower* capital buffers.

One potential explanation of these findings is that large banks have benefited from the diversification benefits – those words again – of Basel II. Another is that financial markets have allowed these banks lower capital buffers because of the implicit promise of government support. Chart 10 offers support for the latter hypothesis. It suggests a positive relationship between bank size and pre-crisis expectations of official sector support.³⁴ Size matters. Historically, the safety net was perceived to be fur-lined for those above a certain size.

This evidence is discouraging from a systemic risk perspective. It suggests incentives to generate and propagate risks may have been strongest among those posing greatest systemic threat. Basel vaccinated the naturally immune at the expense of the contagious: the celibate were inoculated, the promiscuous intoxicated. Latterly, this defect has begun to be addressed. Several countries – including the UK – have announced plans to introduce tighter regulatory requirements for systemic institutions.

There is further to go internationally. Work is needed to give systemic regulation practical effect. A number of calibration devices have been proposed.³⁵ With richer data on network topology, calibrated simulation models could help gauge financial institutions' marginal contribution to systemic risk. This is standard practice in management of the electricity grid and eco-systems. Finance needs to catch up.

34 Proxied by Fitch ratings agency's support ratings for institutions.

35 Including measures of banks' Conditional VaR or CoVaR (NYU Stern School of Business (2009), and Brunnermeier et al (2009)). These are statistical measures of an institution's VaR *conditional* on other institutions in the network simultaneously facing stress.

(c) *Restructuring the Network*

In Herbert Simon's *The Architecture of Complexity*, he tells the parable of two watchmakers, Hora and Tempus.³⁶ Both produce watches composed of 1000 parts. Both watches are, in this sense, equally complex. They are also of equal quality and sell at the same price. But Hora's business prospers, while Tempus's founders. Why?

The answer lies in the *structure* of complex systems. Hora's watches are designed as ten sub-assemblies each comprising ten elements, which are combined into ten larger sub-assemblies, ten of which then constitute a whole watch. Tempus, by contrast, assembles his watches part by part. The result is that, whenever Tempus is interrupted – in Simon's parable by a telephone call ordering more watches – his work is lost and he must start again. Hora suffers the same fate much less frequently, due to the sub-assembly structure of his watches.

The differences in the robustness of these equally complex structures are dramatic. If the probability of interruption is 0.01, Hora will complete 9 watches for every 10 attempts. By contrast, Tempus completes 44 watches for every million attempts. The probability of horological collapse is lowered from 0.999956 to 0.1.

The secret of the structure of Hora's complex watches is that they are "hierarchical", with separate and separable sub-structures. Simon discusses how a number of other networks, both social and physical, exhibit this hierarchical structure. This is no evolutionary accident. For many networks, hierarchy emerges naturally. It is the product of a process of Darwinian selection in which it is only the hierarchical structures that survive to maturity. Hora's business thrives, Tempus's dies.

In other networks, hierarchy is the result not of natural evolution but human intervention. For example, the optimal distribution of trees has been shown to comprise contiguous patches separated by firebreaks.³⁷ The firebreaks created by man generate hierarchy in this system. The same man-made firebreaks are present in epidemiological networks, such as the imposition of travel bans following the SARS outbreak in Asia or the prohibition of animal movement during the foot and mouth epidemic in the UK.³⁸

All of this has relevance to the future structure and design of the financial network. What is second nature to the watch-maker needs to become second nature to the watchdog. Four topical examples can be used to illustrate the importance of these structural issues for financial network design.

36 Simon (1962).

37 Carlson and Doyle (1999).

38 Kelling et al (2003).

First, the past decade has seen an explosion in the dimensionality, and thus complexity, of the financial web. Among others things, that has exacerbated the system's robust-yet-fragile characteristics and uncertainty about counterparty pricing within the network. Both have been much in evidence recently. Yet there are structural means of addressing these combined problems at a stroke.

The stroke is infrastructure. Central counterparties (CCPs) are intended to deal with precisely these problems. They interpose themselves between every trade. In this way, a high-dimension web is instantly compressed to a sequence of bilateral relationships with the central counterparty – a simple hub-and-spokes. The lengthy network chain is condensed to a single link. Provided that link is secure – the hub's resilience is beyond question – counterparty uncertainty is effectively eliminated.

Table 3 simulates the benefits of introducing a CCP in reducing counterparty uncertainty. As in the earlier example, Knightian uncertainty is measured by the size of the range of CDS spreads. In all cases, moving to a central counterparty ($n = 1$) results in a material reduction in uncertainty around spreads. These benefits are predicated on the CCP "super-spreader" itself being impregnable to attack.

There have been various initiatives to introduce central counterparties for the clearing of certain financial instruments, including CDS products, over the recent past.³⁹ This is welcome. But the debate needs not to end there. A much broad range of over-the-counter financial instruments, both cash and derivatives, could potentially benefit from the introduction of a central counterparty.

Central counterparties are of course not new. Clearing houses date from the early 19th century. But, latterly, the question often most asked of central counterparties has been "Why"? Experience during the crisis means we now know why. From a network resilience perspective, it is important that in future the central counterparty question becomes not "Why?" but "Why not?"

Second, financial innovation has created strings of gross claims between financial entities which far exceed their capital bases. Lehman had gross CDS exposures around eight times its balance sheet. These gross intra-system claims have grown rapidly over the past decade, fuelled by off balance sheet activity. CDS growth has outpaced Moore's Law – the more than doubling of microchip capacity every two or so years. In the CDS market, what were 1000-piece watches in 2000 would by 2007 have become more than 64,000 piece.

Intra-system claims on this scale increase network fragility. When one node collapses, the ripple across the system risks developing into a tsunami – as Lehman's experience attests. Herbert Simon recognised just this problem. Hierarchical net-

39 President's Working Group (2008).

works are, in his words, decomposable with intra-system interactions constrained. The financial system has recently evolved in the opposite direction, with intra-system interactions growing and decomposability of the system thereby reduced.

Policy initiatives may be able to help. For example, infrastructure could be developed to “net off” gross claims within the financial system. Attempts have already been made to do this in the CDS market, by tearing-up redundant claims among participants. This has reduced outstanding CDS claims by as much as 30%. The same netting principle could potentially be applied to a wider range of contracts and counterparties, to improve the decomposability and hence robustness of the system.⁴⁰

Third, financial innovation in the form of structured credit also had the consequence of creating a network structure which was non-hierarchical. Financial engineers created products in which elements of a loan portfolio were reassigned to a higher- order sub-assembly. In this way, an automatic dependence was created among almost every sub-structure. By contract design, the overall financial system became impossible to decompose into separable sub-structures.

Such a structure is in fact worse even than Tempus’s complex production line. Structured credit was equivalent to taking one part randomly from each of 1000 watches and reassembling the pieces. No watchmaker in their right mind would expect the resulting timepiece to keep time for too long. Such was the CDO story.

However sensible structuring of credit may have seemed for individual firms, it is difficult to conceive of a network which could have been less structurally robust.

Darwinian evolution is currently in the process of naturally deselecting CDOs. But there is a strong public policy case for the authorities intervening more aggressively when next financial innovation spawns species with undesirable physiological features.

Finally, the business strategies of financial firms have over the past decade created a network structure which is much less easily decomposable. Under the old financial order, mutuals were a sub-structure, as were commercial banks, investment banks and investment funds. In some cases that was by choice. In other cases it was the result of regulatory design: for the larger part of the past century, the Glass-Steagall Act in the US prohibited inter-breeding between commercial and investment banking.

Deregulation swept away banking segregation and, with it, decomposability of the financial network. The upshot was a predictable lack of network robustness. That is one reason why measures to restrict inter-breeding between commercial and investment banking have been proposed in the UK, US and Europe. It may

40 For example, as proposed in King (2008).

be the wrong or too narrow an answer. But it asks the right question: can network structure be altered to improve network robustness? Answering that question is a mighty task for the current generation of policymakers. Using network resilience as a metric for success would help ensure it was a productive one.

Conclusion

Through history, there are many examples of human flight on an enormous scale to avoid the effects of pestilence and plague. From yellow fever and cholera in the 19th century to polio and influenza in the 20th. In these cases, human flight fed contagion and contagion fed human catastrophe. The 21st century offered a different model. During the SARS epidemic, human flight was prohibited and contagion contained.

In the present financial crisis the flight is of capital, not humans. Yet the scale and contagious consequences may be no less damaging. This financial epidemic may endure in the memories long after SARS has been forgotten. But in halting the spread of future financial epidemics, it is important that the lessons from SARS and from other non-financial networks are not forgotten.

References

- Akerlof, G, and Shiller, R (2009), *Animal Spirits: How Human Psychology Drives the Economy, and Why It Matters for Global Capitalism*, Princeton University Press.
- Albert, R, Albert, I and Nakarado, G.L (2004), 'Structural vulnerability of the North American power grid', *arXiv:condmat/040107v1*.
- Albert, R, Jeong H and Barabasi, A-L (2000), 'Attack and error tolerance of complex network', *Nature*, Vol. 406: 379-382.
- Allen, F and Gale, D (2000), 'Financial Contagion', *Journal of Political Economy* 108(1) 1-33.
- Battiston, S, Gatti, D. D, Gallegati, M, Greenwald, B.C.N. and Stiglitz, J.E. (2009), 'Liasons Dangereuses: Increasing Connectivity, Risk Sharing, and Systemic Risk'. *Working Paper*.
- Bowtell, W (2005), 'Australia's response to HIV/AIDS 1982-2005', *Lowy Institute for International Policy*.
- Bowtell, W (2007), 'HIV/AIDS: The looming Asia Pacific Pandemic', *Lowy Institute for International Policy*.
- Brunnermeier, M, Crockett, A, Goodhart, C, Persaud, A.D and Shin, H. (2009), 'The fundamental principles of financial regulation', *Geneva Reports on the World Economy* 11.

- Carlson, J.M and Doyle, J (1999), 'Highly optimized tolerance: A mechanism for power laws in designed systems', *Phys. Rev. E* 60: 1412-1427.
- Clay, J (2004), 'World Agriculture and the Environment: A commodity-by-commodity guide to impacts and practices', *Washington (DC): Island Press*.
- Corrigan, E.G (1987), 'Financial Market Structure: A Longer View', *Federal Reserve Bank of New York*.
- de Larosière, J (2009), 'Report', *The high-level group on financial supervision in the EU*, available at ec.europa.eu/internal_market/finances/docs/de_larosiere_report_en.pdf.
- Elton, C.S (1958), 'The Ecology of Invasions by Animals and Plants', Methuen.
- Epstein, J.M, Parker, J, Cummings, D, and Hammond, R (2008), 'Coupled contagion dynamics of fear and disease: Mathematical and computational explorations', *PLoS ONE*, Vol. 3, Issue 12: 1-11.
- Federal Reserve Bank of New York (2007), 'New Directions for Understanding Systemic Risk', *FRBNY Economic Policy Review*, Vol. 13, No. 2.
- Gai, P and Kapadia, S (2008), 'Contagion in Financial Networks', *mimeo*, Bank of England.
- Gallegati, M, Greenwald, B, Richiardi, M and Stiglitz, J (2008), 'The Asymmetric Effect of Diffusion Processes: Risk Sharing and Contagion', *Global Economy Journal*, Vol 8, Issue 3.
- Galvani, A.P and May, R.M (2005), 'Dimensions of superspreading', *Nature*, Vol. 438: 293-296.
- Haldane, A (2009), 'Why Banks Failed the Stress Test', available at <http://www.bankofengland.co.uk/publications/speeches/2009/speech374.pdf>.
- Kelling, M.J, Woolhouse, M.E.J, May, R.M and Grenfell, B.T (2003), 'Modelling vaccination strategies against food-and-mouth disease', *Nature*, Vol. 421: 136-142.
- King, M (2008), Speech to the CBI dinner, Nottingham, Tuesday 20 January 2009, available at <http://www.bankofengland.co.uk/publications/speeches/2009/speech372.pdf>.
- Kinney, R, Crucitti, P, Albert, R and Latora, V (2005), 'Modeling Cascading Failures in the North American Power Grid', *The European Physics Journal*, B 46 (2005) 101.
- Kubelec, C and Sa, F (2009), 'The Geographical Composition of National External Balance Sheets: 1980-2005', Bank of England Working Paper (forthcoming).
- Lee, S.H, Kim, P-J and Jeong, H (2006), 'Statistical properties of sampled networks', *Physical Review*, Vol.73.
- Levin, S and Lubchenco, J (2008), 'Resilience, Robustness, and Marine Ecosystem-based Management', *Bioscience* Vol. 58: 27-32.
- Lloyd-Smith J.O, Schreiber S.J, Kopp, P.E and Getz, W.M (2005), 'Superspreading and the impact of individual variation on disease emergence'. *Nature* 438, 355-9.
- May, R.M (1974), 'Stability and Complexity in Model Ecosystems', *Princeton University Press*.
- May, R.M (2006), 'Network structure and the biology of populations', *Trends in Ecology and Evolution* Vol. 27, No. 7.
- May, R.B and Anderson, R.M (1991), 'Infectious Diseases of Humans', *Oxford University Press*.
- May, R, Levin, S.A and Sugihara, G (2008), 'Complex systems: Ecology for bankers', *Nature* Vol. 451: 893-895.
- McKercher, B and Chon, K (2004), 'The over-reaction to SARS and the collapse of Asian tourism', *Annals of Tourism Research* 31(3): 716-719.
- Milgram, S (1967), 'Small-world problem', *Psychology Today* 1(1): 61-67.
- Newman, M (2003), 'The structure and function of complex systems', *arXiv:cond-mat/0303516v1*.
- Newman, M (2008), 'The physics of networks', *Physics Today*: 33-38.
- Nier, E, Yang, J, Yorulmazer, T and Alentorn, A (2008), 'Network Models and Financial Stability', *Bank of England Working Paper No.346*.
- NYU Stern School of Business (2008), *Repairing the US Financial Architecture: An Independent View*.

- Pikitch, E.K, Santora, C , Babcock, E.A, Bakun, A, Bonfil, R, Conover, D.O, Dayton, P, Doukakis, P, Fluharty, D, Heneman, B, Houde, E.D, Link, J, Livingston, P.A, Mangel, M McAllister, M.K, Pope, J and Sainsbury, K.J (2004), 'Ecosystem-Based Fishery Management', *Science Magazine*, Vol. 305: 346-347.
- Porterie, B, Kaiss, A, Clerc, J-P and Zekri, L and Zekri, N (2008), 'Universal scaling of forest fire propagation', *eprint arXiv:0805.3365*.
- President's Working Group (2008), *Initiatives to strengthen OTC derivatives oversight and infrastructure*, available at <http://www.ustreas.gov/press/releases/hp1272.htm>.
- Pröpper, M, van Lelyveld, I and Heijmans, R (2008), 'Towards a network description of interbank payment flows', *DNB Working Paper No. 177*.
- Simon, H (1962), 'The architecture of complexity', *Proceedings of the American Philosophical Society*, Vol. 106, No. 6: 467-482.
- Smith, R.D (2006), 'Responding to global infectious disease outbreaks: Lessons from SARS on the role of risk perception, communication and management', *Journal of Social Science and Medicine*, 63, 3113-3123.
- Tilman, D (1999), 'The ecological consequences of changes in biodiversity: A search for general principles', *Ecological Society of America*, Vol. 80, No. 5: 1455-1474.
- Voute, A.D (1946), 'Regulation of the density of the insect populations in virgin forests and cultivated woods', *Archives Neerlandaises de Zoologie*, 7, 435-470.
- Watts, D (2002), 'A simple model of global cascades on random networks', *Proceedings of the National Academy of Sciences* 9: 5766-5771.
- Watts, D.J and Strogatz, S.H (1998), 'Collective dynamics of 'small-world' networks', *Nature* 393 (6684): 409-10.
- Wheelis, M (2002), 'Biological warfare at the 1346 Siege of Caffa', *Emerging Infectious Diseases*, Vol. 8, No.9.
- Worm, B, Barbier, E.B, Beaumont, N, Emmett Duffy, Folke C, Halpern, B.S, Jackson, J.B.C, Lotze, H.K, Micheli, F, Palumbi, S.R, Sala, E, Selkoe, K.A and Stachowicz, J.J (2006), 'Impacts of biodiversity loss on ocean ecosystem services', *Science*, Vol. 314: 787-790.

TABLES:

Table 1: Summary Statistics on the Global Financial Network

	1985	1995	2005
Skewness	7.4	8.0	3.1
Kurtosis	71.3	80.6	14.3
Average path length	1.55	1.44	1.37

Table 2: Climbing the Complexity Tree

Typical contract details(a)

[1]	Pages in CDO ² prospectus	300
[2]	Pages in ABS CDO prospectus	300
[3]	Pages in RMBS prospectus	200
[4]	Number of ABS CDO tranches in CDO ²	125
[5]	Number of RMBS in a typical CDO	150
[6]	Number of mortgages in typical RMBS	5,000

Metrics of complexity(a)

[1] + [3]*[5]*[2]*[4]	Pages to read for a CDO ² investor	1,125,000,300
[2] + [3]*[5]	Pages to read for an ABS CDO investor	30,300
[4]*[5]*[6]	Max. number of mortgages in a CDO ² (b)	93,750,000
[5]*[6]	Max. number of mortgages in an ABS CDO(c)	750,000

Sources: Bloomberg, deal documents and Bank calculations

(a) CDO² is used as short-hand for CDO of ABS CDO.

(b) Assuming there is no overlap in the composition of the RMBS pools that back the CDO or the CDO pools that back the CDO².

(c) Assuming there is no overlap in the composition of the RMBS pools that back the CDO.

Table 3: Range of CDS Premia (bp) and Central Counterparties

	Probability of counterparties defaulting	Number of counterparties			
		1	2	10	50
Low uncertainty around counterparties' inter-linkages	1%	0	2	0	
	5%	0	0	10	2
	10%	0	0		
	30%	0	18	2	6
			42	44	43
High uncertainty around counterparties' inter-linkages	1%	0	3	9	18
	5%	0	14	39	60
	10%	0	27	68	87
	30%	0	63	127	136
Probability of reference entity defaulting = 10%; Loss given default rate = 50%;					

CHARTS:

Chart 1: Global Financial Network: 1985

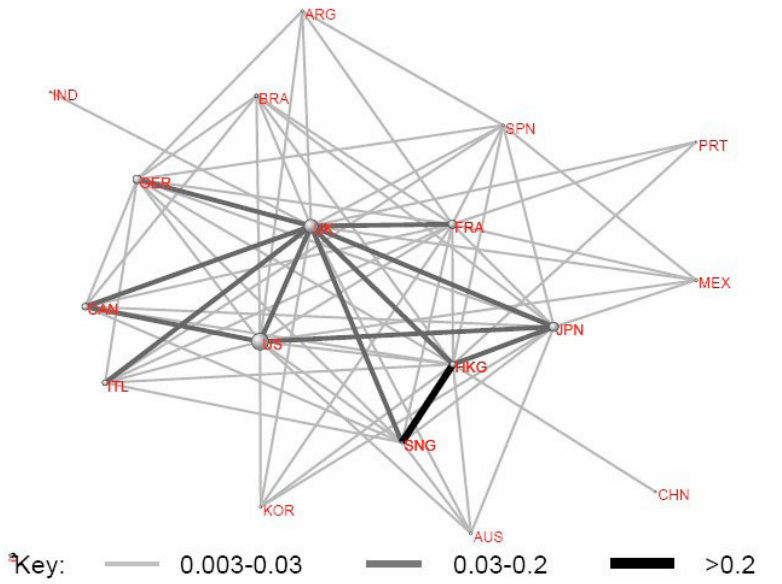

Chart 2: Global Financial Network: 1995

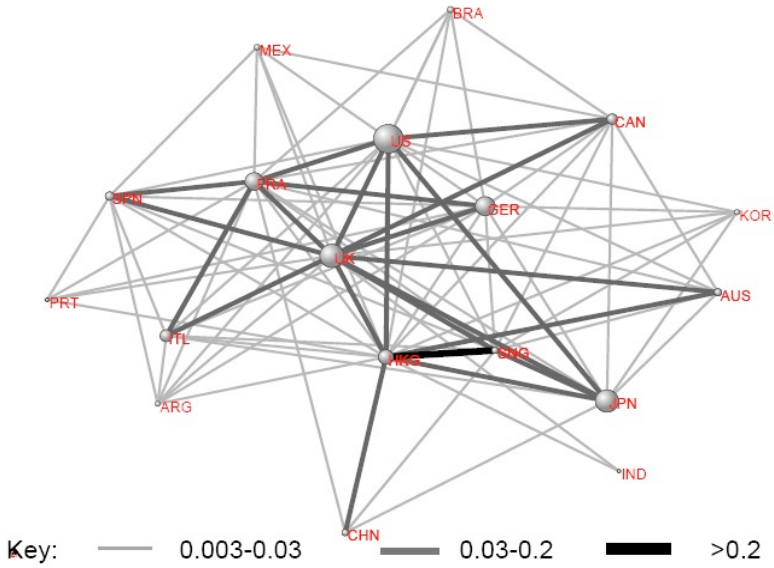

Chart 3: Global Financial Network: 2005

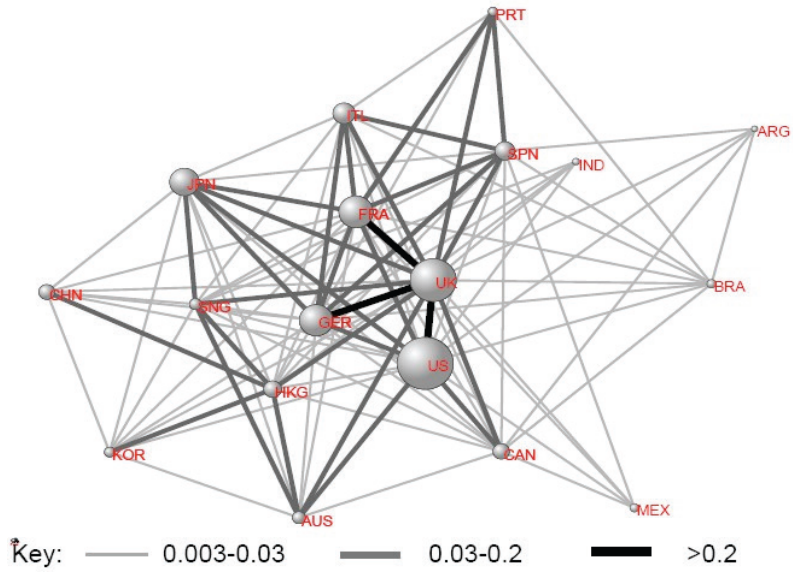

Chart 4: CDS Premia and Network Uncertainty – Pre-crisis

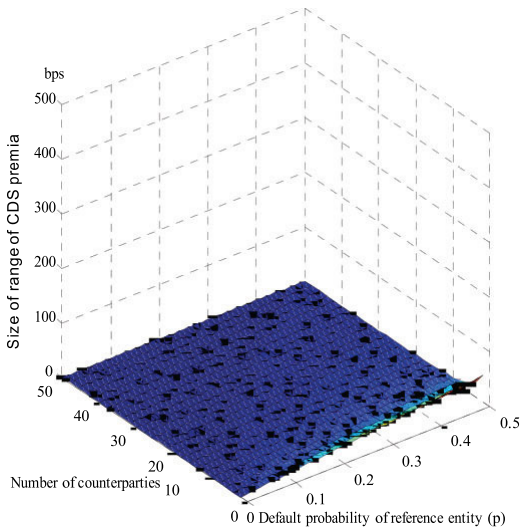

Chart 5: CDS Premia and Network Uncertainty – Post-crisis

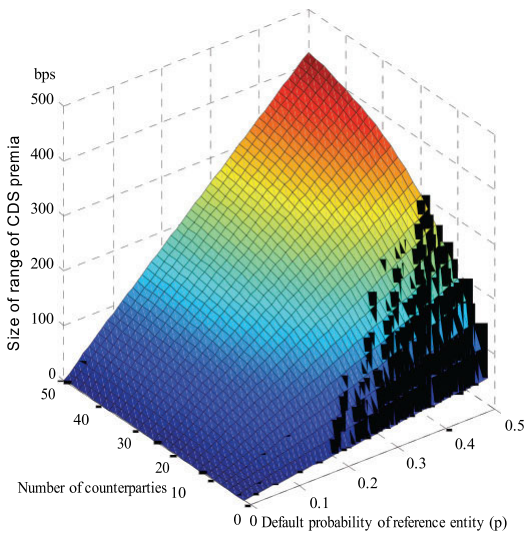

Chart 6: Financial Contract Design

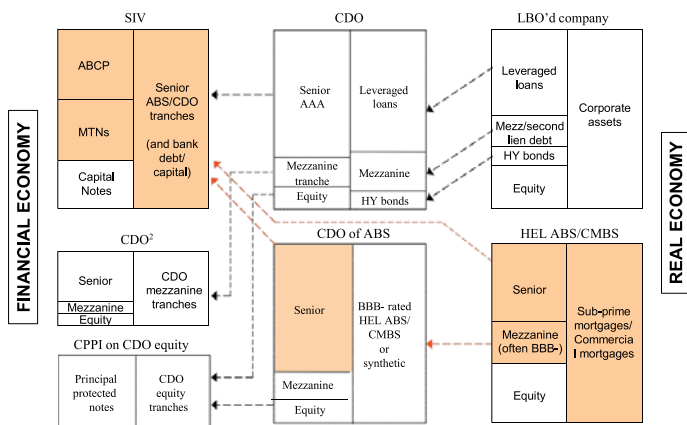
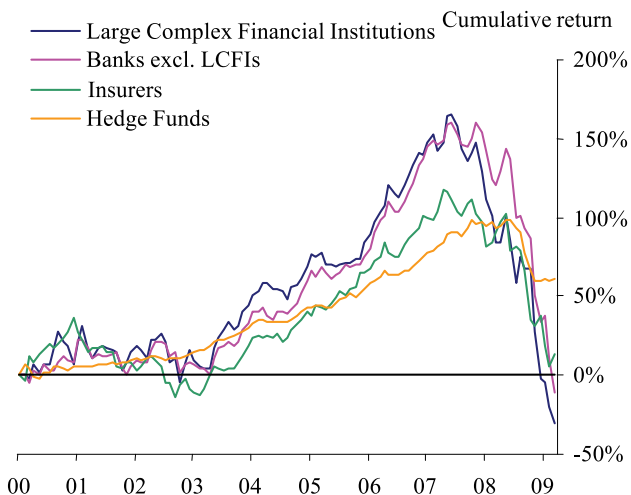

Chart 7: Weighted-average Cumulative Total Returns



Source: Bloomberg, CreditSuisse/Tremont and Bank calculations.

(a) Sample based on banks and insurers in S&P 500, FTSE All Share and DJ EuroSTOXX indices as at March 2009. Excludes firms for which returns not quoted over entire sample period.

Chart 8: Global Banks' Size and Capital Ratios ^(a)

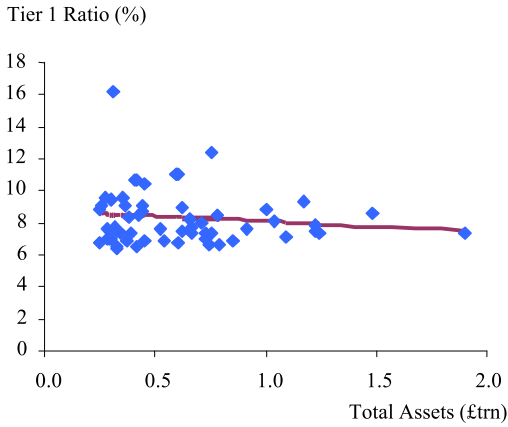

Source: Bankscope

(a) As at end 2007 due to data availability

Chart 9: Global Banks' Size and Leverage ratios ^(a)

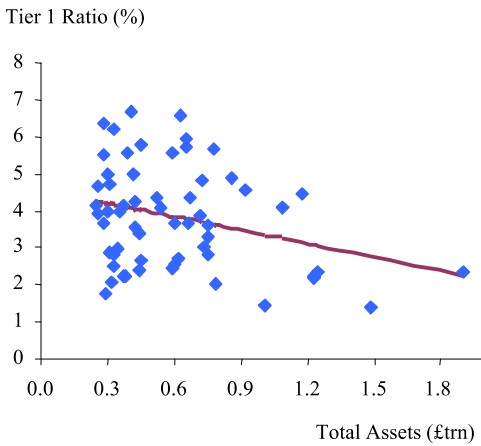

Source: Bankscope

(a) As at end 2007 due to data availability

Chart 10: Global Banks' Size and Government support ^(a)

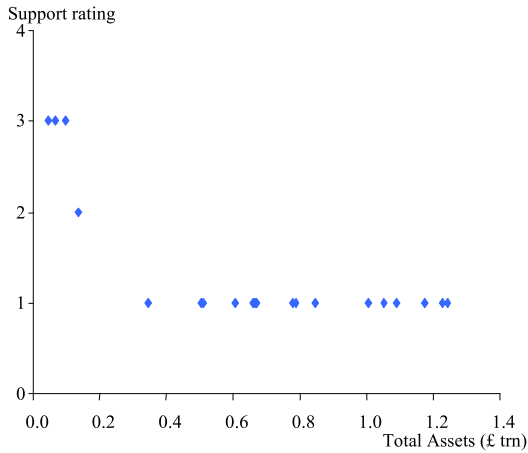

Source: Bankscope and Fitch

(a) As at end 2006. Government support proxied by Fitch's 'support rating'. A higher number is a lower level of support.