

# Compass Applications Using Giant Magnetoresistance Sensors (GMR)

Michael J. Haji-Sheikh

Electrical Engineering Department  
Northern Illinois University, DeKalb Illinois, USA  
mhsheikh@niu.edu

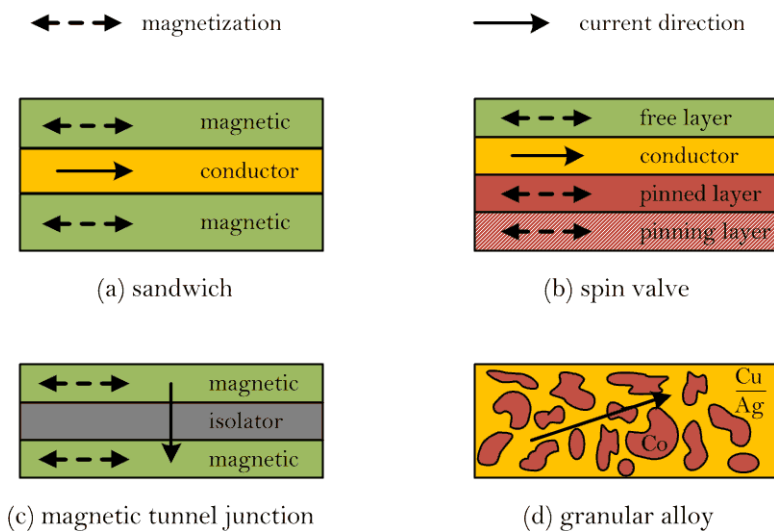
**Abstract.** The use of giant magnetoresistors, or GMR, for compass magnetometers is a recent trend in Earth field sensing. Thin film compass devices are often used in applications in global positioning systems (GPS) to aid in navigation. A GPS system can only tell a user about the direction of travel as long as the user is in motion. A compass indicates static orientation of the user which, with the addition of gyroscopic information along with GPS data can give precise location and orientation to users. Modern digital devices often incorporate compass devices with location applications to better aid consumers in locating services.

## 1 Introduction

Thin-film magnetoresistive compass magnetometers have been in existence since the 1980's. Prior to the thin-film devices, magnetometers were large and relatively bulky. Early magnetometers were often used to detect the presence of submarines and surface ships for military applications. Large iron objects, such as a ship or a submarine, will distort the Earth's magnetic field thereby making magnetometry a valuable method of remote sensing. These systems, flux-gate and proton magnetometers, were sensitive enough to help change our perceptions on the natural world [1,2]. In the late 1940's, geologists used Naval ships to map the ocean floor using magnetometers. Starting in the 1950's, magnetometry made the jump into orbit - the United States and the Soviet Union both launched magnetometers into space. These space based devices taught us about how the Earth's magnetosphere is configured. The earliest forms of these solid state devices were used in military applications during the cold war. These devices were made from an anisotropic magnetoresistor (AMR) material called permalloy. Permalloy, generally made from eighty percent nickel and twenty percent iron, was originally used as a transformer core material in the 1930's due to the permalloy's high permeability. These thin film devices have been combined with global positioning to make systems that accurately locate hikers in the back areas. Recently, due to the demands of the smart-phone industry, novel magnetometers using giant magnetoresistive (GMR) materials have been introduced into the market.

The work by S. Tumanski [3] published in 2001 discusses in detail using anisotropic magnetoresistive barber-pole magnetometers to sense the Earth's magnetic field. In it, Tumanski details both how an anisotropic magnetoresistor operates and how to sample and amplify the signal produced. A critical step in designing a magnetometer is to realize that the magnetometer is a vector sensor. A vector sensor must give an output that can look at the magnetic environment in three dimensions. By knowing all three dimensions we eliminate the need for a consistent level surface. This is important since hand held devices are rarely held level. The electronic compass must be able to translate this information into a usable form. This three axis compass needs to be connected to the relative direction of the observer's device, whether the device is a cell phone, an automobile or a global positioning system. Another important piece of information needed to understand the difficulty of the application is that the Earth's magnetic field is non-uniform globally. To take advantage of the sensors, users must include magnetic zone information in their software. Users would also like to be able to tilt their phones and still get directional information. Most suppliers of magnetometers for compass applications also supply algorithms for their customers to use in their devices. The algorithms use "flattening equations" which relate yaw, pitch and roll sensors (rotations around the three different axis) into a two dimensional direction vector which are connected to the compass rose.

The layout of the sensors has to take advantage of the odd-function behavior of certain configurations of thin-film sensors to be able to discern the orientation of the user to any degree of accuracy. The description of the odd-function is that the sensor has a different behavior in the right-half plane than in the left-half plane. Figure 1 [4] shows the basic types of GMR structures. Standard multilayer GMR sensors, such as a copper-cobalt multi-layer, are even function devices with transfer functions which have left-half plane and right-half plane behaviors that are identical (except for a small hysteresis). Devices made with AMR films can be configured as an odd-function device by geometry, where GMR type films use the interaction of layers of magnetic and non-magnetic thin films. The types of GMR films that have an odd-function response are the spin-valve (SV) and the magnetic tunnel junctions (MTJ). These sensing films rely on their directionality i.e. the odd function behavior on the pinned layer. The concept of the magnetic tunnel junction is quite interesting. The MTJ is constructed with two magnetic layers separated by a very thin non-conductor. When the two magnetization vectors of the magnetic layers are aligned in the anti-ferromagnetic orientation, the current through the alumina is at a minima and when they are aligned in a ferromagnetic orientation the current is at a maxima. A common non-conductor used in this type of design is thin film deposited alumina. To create the odd-function response, one of the films must have its orientation pinned to a reference orientation. If this orientation ever becomes unpinned, the sensor will lose its sense of direction.


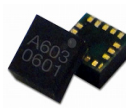
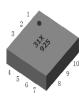
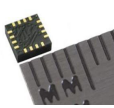
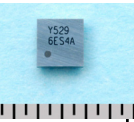
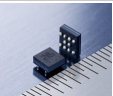
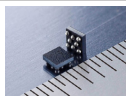





**Fig. 1.** Basic GMR structures from C. Reig , M.-D. Cubells-Beltrán and D. R. Muñoz [4]

This loss of sense of direction is not exclusive to GMR sensors since AMR sensors have a similar issue. A survey of high sensitivity magnetometers by Robbes [5] compares the superconducting quantum interference devices or SQUID with GMR and anisotropic magnetoresistance devices or AMR. The author's conclusion is that the GMR devices are promising as a highly sensitive magnetometer. Marchesi [6] summarizes the different technologies used in compass applications, though the goal of his work is to develop a planer fluxgate magnetometer.

Commercial entities have introduced new and innovative thin film magnetometers for compass applications. The market for compass devices now includes magnetic tunnel junctions (MTJs) and spin-valve devices along with pole piece devices. Companies that are supplying magnetometers for Hall compass applications are Aichi Steel, Honeywell, Philips, AK, MEMSIC, Yamaha, Freescale and others. A quick survey of commercially available compass devices is shown in Table 1. These compass devices are specifically designed to minimize the space required to fit inside of cellular devices. Most of the devices are surface mounts. The performance standard for these devices is the Honeywell HMC series which is based on the barber-pole permalloy devices. All the other devices are measured against this sensor. The most comprehensive of these devices are packaged with analog to digital conversion circuits. The chip manufacturers also supply algorithmic information to aid in the use of these devices since this information, as stated earlier, relates a three dimensional vector onto a two dimensional plain.

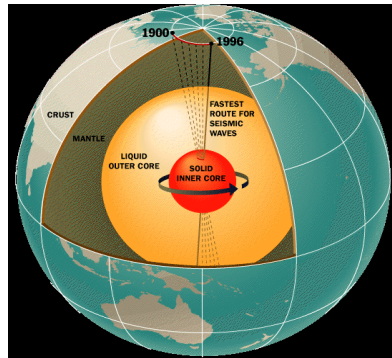
**Table 1.** Commercially available thin film AMR and GMR compass products

					
<b>GMI</b>	<b>GMI</b>	<b>AMR</b>		<b>GMR</b>	
<i>Aichi Steel</i>	<i>Aichi Steel</i>	<i>MEMSIC</i>	<i>Honeywell</i>	<i>Yamaha</i>	
AM306	AM603	MMC314XMS	HMC5883L	YAS529	
					
<b>TMR</b>	<b>TMR</b>	<b>TMR</b>			<b>AMR</b>
<i>Yamaha</i>	<i>Yamaha</i>	<i>Freescale</i>	<i>Multidimension#</i>	<i>Baolabs</i>	<i>SENSITEC</i>
YAS530	YAS532	Mag3110	MMC3031 (target)	BLBC3-D / BLB3-B	AFF756

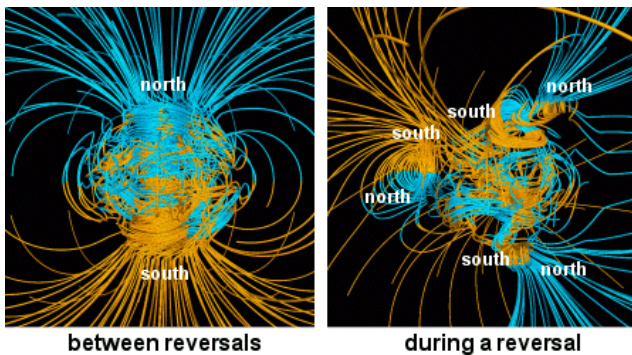
# photo not available.

## 2 The Earth's Magnetic Field

Any discussion of compass applications requires an understanding of the Earth's magnetic field. The Earth's magnetic structure has a definite effect on how much sensitivity required in a compass device and how to interpret the information. The Earth's composition simply is a large ball of liquid rock and metal with a very hot solid iron core and a thin cool skin. Significant research on the structure and shape of the Earth's magnetic environment performed by Glatzmaier and Roberts [7,8,9] has been performed in the last twenty years. Song [10] describes the structure of the Earth and the differential rotation of the core and mantle with respect to each other. Figure 2 [11] shows a cross-section of the Earth describing the differential rotation. This rotation was analyzed by seismic studies and determined to be as much as  $1.1^\circ$  per year of eastward rotation about the rotational axis. The Earth has gone through periods of time in which the magnetic poles reverse their direction. It is notable also that the core spins at a slightly faster rate than the rest of the planet which causes shear forces in the surrounding molten iron layer. The research shown in Figure 3 [11] was driven by the measurable variances in the location and direction of the local north and south poles and the magnetic reversals measured in the rocks of the Atlantic seabed. According to Glatzmaier and Roberts, this interaction between the central iron core and the molten iron core drives these field reversals. This interaction also drives the local variations in magnetic field. Their model treats the Earth's core like a dynamo i.e. an electric motor. In their model, the outer molten core acts like a stator and the core acts like the rotor. In a geologic time frame, the instability of the system results in a pole reversal every 100,000 years but only is a minor problem for compass applications in



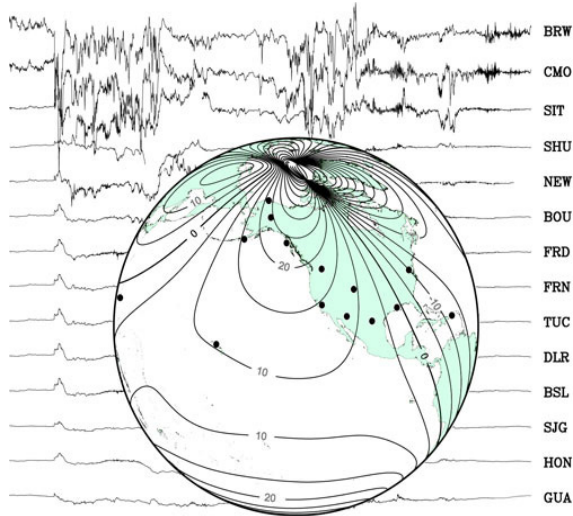
**Fig. 2.** Cross-section of the Earth [11] showing the direction of the solid cores rotation and the precession of the rotational axis of the core from 1900 to 1996



**Fig. 3.** Magnetic field models [11] representing a period like we are presently in and how it would look like during a reversal. This image represents 9000 years of simulation; a) represents the initial magnetic state, b) represents the midpoint. The images are from results of modeling from Glatzmaier and Roberts [9].

the short term. This has one notable exception; there are regions in the planet where compasses do not behave as expected.

The map of the Earth's present field conditions shows the difficulty in developing a compass device. The Earth's magnetic field does not always allow compasses to point north worldwide. This makes developing an application, which can take advantage of the high sensitivity of the magnetometer device, difficult at best. To improve the understanding of compass magnetometry, the United States Geological Survey (USGS) has an education page and field declination map available [12] that is only useful for the continental United States. Figure 4 [13] shows the lines of declination from the USGS. There has been, for centuries, an acknowledgment that a compass has to have augmented information for accuracy. Prior to the electronic age, the compass information was augmented by using the stars and clocks were used by mariners to navigate. After the advent of global positioning, navigation can be performed by the use of hand held GPS units. Many digital compasses use built in zone maps to correct for these magnetic variations.



**Fig. 4.** Magnetic field map of the northern hemisphere as viewed from the Pacific ocean from the USGS [12]. It is obvious from this image that the Earth's magnetic field is not a simple north south reference.

### 3 Compass Concepts

Compass devices have been produced in two different modes. The first is the 2-D compass which relies on a consistent z-axis orientation and the other type is the 3-D magnetic sensor, which does not depend on a consistent z-axis. For the 3-D device, it is important to project the three dimensional magnetic field vector  $\vec{B}$  onto a two dimensional plane to be able to ascertain user orientation. The components of the field can be broken into the three Cartesian directions as shown in Figure 5. By convention, the magnetic field normal to the Earth's surface is designated as the z - direction. A compass, (spinning magnet type) is generally set flat on a surface and the with the z direction normal to the plane of orientation. On a boat or an aircraft the compass is usually gimbal mounted to keep the compass level. This makes the measurement a pure two dimensional problem and can be handled by a two dimensional axis rotation matrix. The problem can then be solved by finding the angle in which the y direction is maximized and the x direction is zero. At that point the y direction is south and a reference direction is set. It then becomes relatively simple to orient the user to a compass rose. The angle is then found using trigonometry.

A common way to orient and calibrate an electronic compass requires that the compass is placed in a mode in which the user either drives his automobile in a circle or waves the compass in a figure eight by hand. It is possible to make a calculation without the rotation but there will be an error due to the small variations in the voltage offset and sensitivities involved in the manufacture of these sensors. To solve this 2-D angle, we designate that there are two vectors,  $X$  and  $Y$ , which designate the bridge voltage signal value. The magnitude of this signal is

$$V_{mag} = \sqrt{X^2 + Y^2} \quad (1)$$

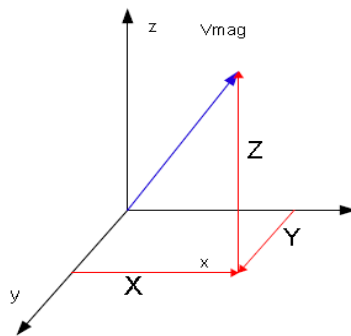
The result is then used to determine magnetic north

$$Y_{north} = -V_{mag} \quad (2)$$

and the value of  $X=0$ , since most compass devices are vector sensors and have an odd-function transfer curve which gives a positive output in the right-half plane and a negative output in the left-half plane. The Y sensor will have a positive output on the top-half and a negative output on the bottom half of the plane. This gives a very simple vector rotation problem where the angle is

$$\cos(\theta) = \frac{Y}{V_{mag}} \quad (3)$$

This analysis completely leaves out errors due to local field variations and actual sensor voltage-offsets. Unfortunately this only works for limited cases and most real sensors have variations in sensitivity and offsets. Most of the newer applications need three axis ( $x$ ,  $y$ , and  $z$ ) of information since they are mostly in hand held devices. It is easy to see the difficulty in figuring out the directions by running a simple thought experiment. If we orient our two dimensional sensor at a forty-five degree angle, we should have an equal amount of signal in both sensors. If we rotate the sensor on the  $x$  axis the magnitude of the  $X$  component will stay constant while the  $Y$  component will vary. This rotation will cause a significant directional error. To compensate for the error, most designs include a  $z$ -axis sensor. The  $z$ -axis sensor allows the magnetic sensor to accurately determine the direction of the magnetic field vector, so as to correct for this tilt. There is a single point in which the method breaks down. If all of the signal is in the  $z$ -axis sensor, then there is no projected component in either the  $x$  or  $y$  direction and the compass is indeterminate.



**Fig. 5.** Simple 3-d representation of a magnetic field. The projection of this vector onto the the relative position of a three axis magnetometer is what is necessary to determine position.

The rotation of the reference plane requires the sensor manufacturer to supply a set of flattening equations to allow for easy implementation, by the customer, of the sensor. The flattening equations are based on the concept of roll, pitch and yaw. These equations are well known and can be found in numerous sources. The following equations [14] are matrices for rotation:  $\alpha$  around the x-axis,  $\beta$  around the y-axis, and  $\gamma$  around the z-axis.

$$R_x(\alpha) = \begin{bmatrix} 1 & 0 & 0 \\ 0 & \cos \alpha & -\sin \alpha \\ 0 & \sin \alpha & \cos \alpha \end{bmatrix} \quad (4)$$

$$R_y(\beta) = \begin{bmatrix} \cos \beta & 0 & \sin \beta \\ 0 & 1 & 0 \\ -\sin \beta & 0 & \cos \beta \end{bmatrix} \quad (5)$$

$$R_z(\gamma) = \begin{bmatrix} \cos \gamma & -\sin \gamma & 0 \\ \sin \gamma & \cos \gamma & 0 \\ 0 & 0 & 1 \end{bmatrix} \quad (6)$$

The general rotation matrix is  $R=R_xR_yR_z$  and by identifying the values of the rotational angles, the relationship of the compass plane can be referenced to the Earth's surface. As mentioned earlier, these values are described as roll, pitch, and yaw and are compared to a local axis reference. Even though the Earth is spherical, the observer sees the surface of the Earth as a flat plane. This is why we can use the Cartesian or orthogonal coordinate system. The transformation of the vectors onto a new coordinate system can be done by using the following relationship

$$V_{mag}' = RV_{mag} \quad (7)$$

The final result of this type of transformation is represented by Hong Wan [15] in the following equations

$$X' = X \cos \beta + Y \sin^2 \beta - Z \cos \beta \sin \beta, \quad (8)$$

$$Y' = Y \cos \gamma + Z \sin \gamma \quad (9)$$

where the heading is

$$\alpha = \tan^{-1}(Y'/X') \quad (10)$$

Several cell phone manufacturers, such as Apple [16], have combined the results from similar equations with the results of the their accelerometers into fairly accurate global orientation methods. It is very important for a magnetometer to have a reasonably high signal to noise ratio for these methods to be used.

Another problem, when using a compass device, is that there are significant points in orientation on the Earth's surface in which there is no directional information. If the



z sensor device is directly aimed in the z-direction, there will be no x and y axis information since there is no projection of the vector onto the x and y direction. This means also that near this point the signal is relatively small. The low value of this signal can create heading errors.

### 4 GMR Sensor Behavior

The use of GMR sensors requires a brief discussion of the general behavior of GMR material and how this affects compass behavior. Giant magnetoresistive sensors have generated a significant amount of interest as compass devices. This interest is due to the high magnetoresistive ratio i.e  $\Delta R/R_0$ . From Figure 6 [17] it is easy to see that a comparison of the key GMR technologies with the AMR devices show that the difference in sensitivity is greater than an order of magnitude. This difference requires additional handling to try to match the sensitivity. When GMR sensors were first invented, the most common type of sensor was the multilayer device. This GMR sensor usually consists of a structure similar to the one in Figure 1a, which is a layer of magnetoresistive material followed by a non-magnetic spacer then another magnetoresistor. To increase the  $\Delta R/R_0$ , the pattern is repeated. This type of magnetoresistor is not very useful for a compass since it behaves as an even function. The most common type of GMR sensor used for a compass device is the spin valve. Figure 1b shows a typical spin valve structure which has a pinned layer and a pinning layer to set the magnetic behavior to a reference direction. Figure 7 shows a typical spin-valve response from NVE Corporation [18]. A major characteristic of these type of magnetoresistors is the odd-function response and the hysteresis behavior of these spin valves. The odd-function response allows for a directional component from the output of the sensor. This directionality is key to the compass. The hysteresis behavior is driven by instabilities and generally is not something that can be changed.

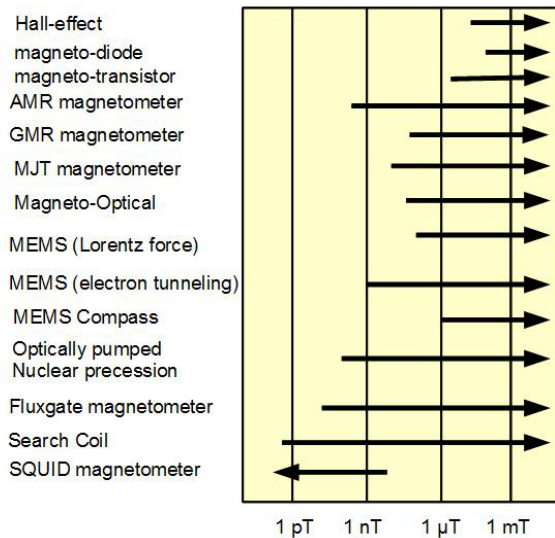
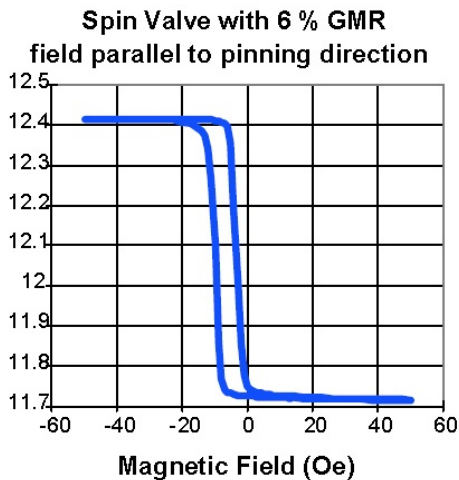


Fig. 6. Sensitivity range of different magnetic devices used for magnetometry from Lenz [17]

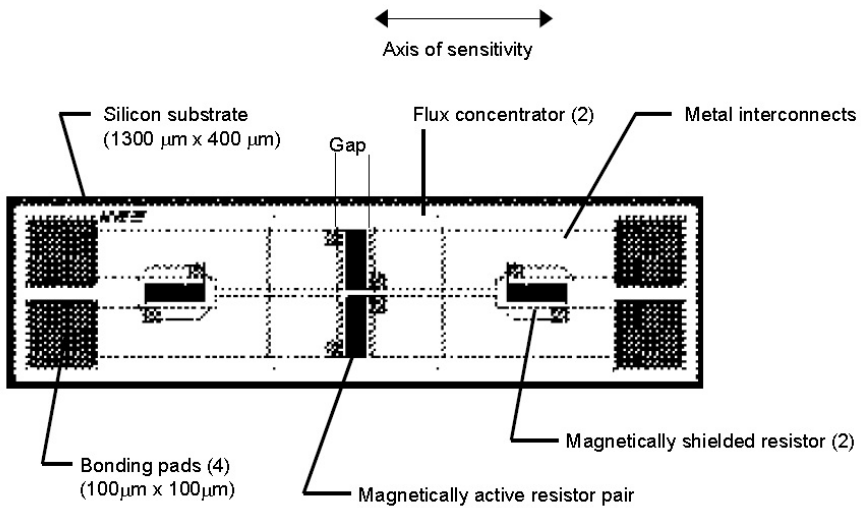
This hysteresis behavior requires that the compass designer put in some provisions to limit exposure of the sensor to large external magnetic fields. These provisions are often maximum field exposure values which limit the field exposure to less than 10 Gauss or 1 milli-Tesla. A common method to make a GMR sensor sensitive enough to be used as a compass device is the addition of pole pieces. This addition is needed to increase the directional bias due to the problem that the GMR sensor is sensitive to more than one field direction. Historically, anisotropic magnetoresistors, AMR, are used for thin film compasses due to their behavior which is directly coupled to current direction. In the barber-pole configuration, this device is naturally odd-functioned and a low cross-sensitivity. These AMR sensors have a naturally high sensitivity to low fields, but have a low dynamic range. The low dynamic range forces the user to make the magnetic environment of the sensor magnetically quiet.



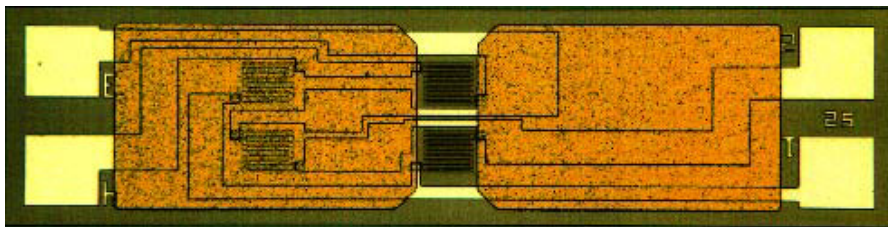
**Fig. 7.** Measured resistance vs. applied field for an antiferromagnetically pinned spin valve with the field applied parallel to the magnetization of the pinned layer with GMR = 6 % from Smith and Schneider[18]

To compete with this sensitivity, the soft magnetic pole pieces are also needed to intensify the field. These pole pieces require a significant amount of design, usually performed using some form of finite element analysis. The GMR compass unfortunately, has another disadvantage compared to the AMR compass. For the GMR sensor, unlike the AMR sensor, there is no equivalent structure to the barber-pole sensor. Figure 8 shows a typical schematic of a resistive bridge using GMR elements [19]. Figure 9 shows shows an actual sensor with two of these elements are used as reference devices while two are used to detect the field [19]. This cuts the effective signal in half as compared to the AMR device which can use all four elements. The advantage that the GMR devices have is that they are relatively small for the equivalent impedance. A typical AMR sensor has a sheet resistance of  $6 \Omega/\square$  to  $11 \Omega/\square$  where a typical spin-valve has a resistance of  $16 \Omega/\square$ . The dynamic range of a GMR sensor is

also greater than that of an AMR sensor. The best AMR sensors have a 3%  $\Delta R/R_0$  and a 6%  $\Delta R/R_0$  for the GMR spin-valve. Even with the addition of the pole pieces, these sensors can occupy less area than the equivalent AMR sensor. This size difference is due to the non-active elements being under the pole-pieces. As shown in Figure 6, the sensitivities of the GMR devices, even with the pole pieces, are going to be lower than the equivalent AMR sensor. Compass devices, for hand-held applications such as cell phones, only require between one to five degrees of accuracy. This range of directional accuracy is achievable using GMR compass devices. The specific GMR device that approaches the behavior of the AMR device better than the spin valve is the magnetic tunnel junction or MTJ.



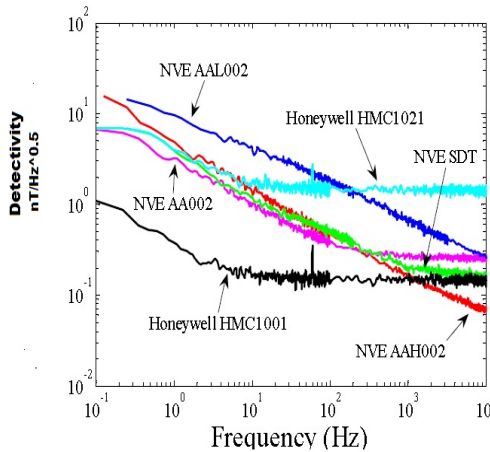
**Fig. 8.** Schematic representation of a typical GMR sensor [19]. The pole pieces also block the field from the two reference resistors,  $R_4$  and  $R_3$ .



**Fig. 9.** GMR sensor from NVE [19] with integrated pole pieces. Note that the inactive sensors are shielded from the external field by the soft-magnetic pole pieces.

Magnetic tunnel junction devices, unlike spin-valve devices, modify the resistance through the thickness of the devices. The current, in essence, is perpendicular to the sense plane. Magnetic tunnel junctions have the same issues as the spin-valve devices

and require pole pieces to form a directionally sensitive sensor. Figure 10 shows a comparison of detectivity versus frequency of several commercial sensors [20]. The MTJ and spin-valves have issues with  $1/f$  noise on top of the hysteresis issues. Generally, a compass device is measuring a very low DC field which may or may not have noise depending on the last state of the sensor. Another condition which may impact the behavior of the compass will be the impact of environmental noise i.e. the effect of AC fields generated by AC electrical equipment.



**Fig. 10.** MTJ sensor with flux concentrators from A. Jander et. al. [20]. Magnetic field detection in the low frequency range is shown.

Since background AC magnetic fields are ubiquitous, we will need to consider the effect of  $1/f$  noise on the compass device. It turns out that the  $1/f$  noise in GMR sensors is greater than the noise in AMR sensors by several orders of magnitude [21]. The source of magnetic noise in permalloy (AMR) is most likely lattice noise [22]. The  $1/f$  noise in GMR is also dependent on the voltage bias of the sensor. Wan et. al. [21] also noted that the  $1/f$  noise at low frequencies can change by a factor of 100 with a voltage bias change of a factor of 40 [23]. For MTJ sensors, the additional noise generated by tunneling electrons also affects the signal to noise ratio. The effect of the free layer thickness directly affects the  $1/f$  noise and the sensitivity [24] of the MTJ devices.

As the free layer is reduced in thickness, the  $1/f$  noise reduces but the MR ratio is also reduced. An additional design consideration for the use of GMR sensors as a compass device is the effect of temperature on the both the conductivity and on the sensitivity. Smits [25] shows that the conductivity of the MTJ, over temperature, is linear in the range of interest (233K-353K). Another parameter that can be used, is the current density and how it changes the sensor behavior. Russek [26] demonstrates the effect of current density on a spin valve as shown in Figure 11. This current bias effect can also be used to design the sensitivity of these compass.

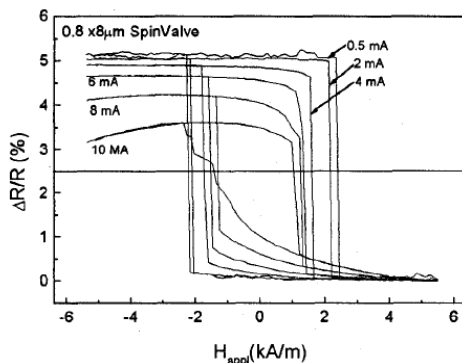


Fig. 11. Russek [26] et. al. plot of resistance change as the bias current is changed

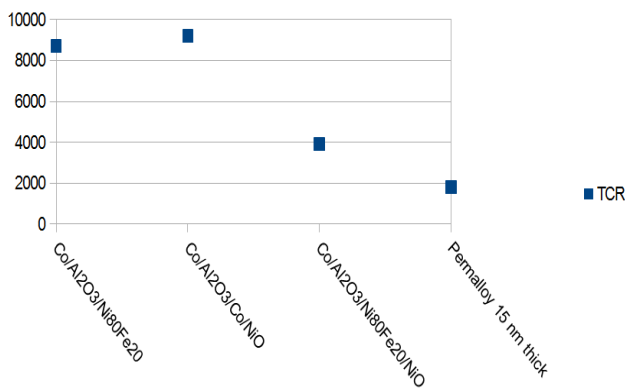


Fig. 12. Conductance versus temperature for three different MTJ devices and 15 nm permalloy. These films are Co/Al<sub>2</sub>O<sub>3</sub>/Co/NiO , Co/Al<sub>2</sub>O<sub>3</sub>/Ni<sub>80</sub>Fe<sub>20</sub>/NiO, Co/Al<sub>2</sub>O<sub>3</sub>/Ni<sub>80</sub>Fe<sub>20</sub>) and 80 Ni 20 Fe permalloy [25].

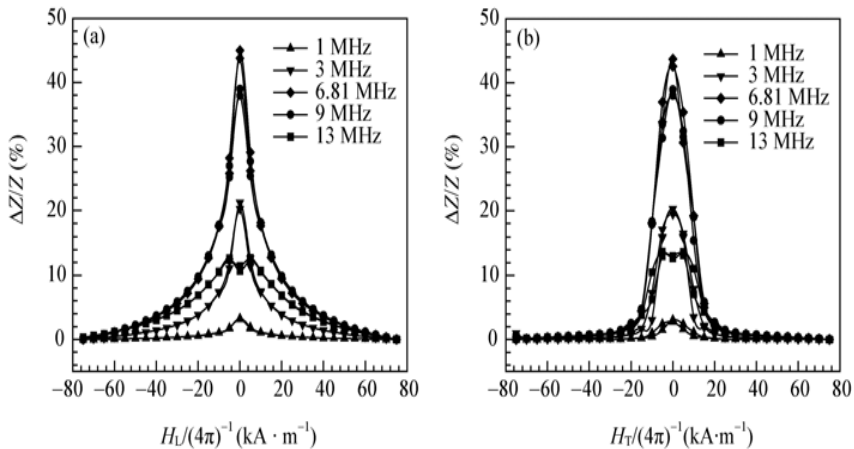
The importance, for a compass device, of the error sources is that the total signal necessary to find one degree of rotation is very small. If we take a simple Wheatstone bridge of approximately 1 kΩ with a 6% GMR over a 1mT range as shown in Figure 7 and use a pole piece construction as shown in Figure 8. This will increase the sensitivity by a factor of 2 to give us a sensitivity of 1.2%/ 10<sup>-4</sup>T so we can calculate the bridge output with the following equation

$$V_{out} = V_s * \left( \frac{R_1}{(R_1 + R_4)} - \frac{R_3}{(R_3 + R_2)} \right) \tag{11}$$

where V<sub>out</sub> is the output of the bridge and V<sub>s</sub> is the supply voltage. With a supply voltage of 5V, the bridge output would be around 30 mV/10<sup>-4</sup>T. If we then assume that the Earth's magnetic field in the area of Chicago, USA is around 16 mT then,

small angular changes will give very small changes in the field. To measure a one degree change, (the difference from zero degrees to one degree) the field changes by  $2.4 \times 10^{-6} \text{T}$ . This means that the voltage difference is  $16 \mu\text{V}$  and the minimum requirement to guarantee a one degree angle change (due to Nyquist sampling rules) is  $8 \mu\text{V}$ . The minimum noise level then must be less than the  $8 \mu\text{V}$ . If the device is exposed to a field level that saturates the sensor, it is likely that the sensor may not continue to respond at the same level in which the sensor was calibrated. Hysteresis is, by its nature, an effect that is repeatable though difficult to deal with. For most compass schemes, it is important to reset the sensor back to its original state. In AMR sensors, the hysteresis is reset by means of set-reset field straps. This is the method that both help to set a reference direction and zero out any bridge offset. Another significant problem in compass measurement is the effect of temperature. This problem is clearly shown in Figure 12 [26] and in Chien-Tu Chao et. al [27]. This graph shows the variation of ambient temperature on the conductivity of MTJ sensors. This material changes in base resistivity, in sensitivity and hysteresis loop size. This temperature behavior requires, to improve repeatability and signal accuracy, a temperature sensor to either directly put into a feedback scheme or as a reference in for a digital circuit.

The third type of GMR that is used for compass devices is giant magneto-impedance or GMI. The GMI effect is an offshoot of the MI or magneto-impedance. Magneto-impedance relies on the frequency skin-effect which is modified by the magnetic field. It was initially documented in the 1990's [28] and detailed in multiple experiments over time. Initial structures tested were made from ribbons of amorphous materials [29].



**Fig. 13.** Frequency behavior of GMI sensor between 1 MHz to 13 Mhz. This response is an even-function and not as suitable for compass application [29].

This sensitivity to the applied field, for the GMI, is frequency based, as shown in Figure 13 [29]. These ribbons originally were rather large and not suitable for compass devices but have benefited from miniturization methods used in the electronics industry. Morikawa et al. [30] developed a thin-film GMI sensor for Toyota research using thin films with a layered structure. The structures are Co-Si-B/Cu/CoSi-B, vCo-Si-B/Ag/Co-Si-B, and Fe-CoSi-B/Cu/Fe-Co-Si-B. Figure 14 [30] shows the sensor schematic used to test GMI by Morikawa et al [30]. Figure 15 [31] the results of testing the GMI thin-film sensor constructed by Maylin *et al.* showing the effect of frequency on the sensitivity. This device still produces an even function type of transfer function. An even function is a mathematical function that has a result that is the same in the left-half of the plane as it does in the right half of the plane. The behavior follows

$$Z = R \frac{\alpha}{[2\delta_0]} (\sqrt{\mu_R} - j \sqrt{\mu_L}) \quad (12)$$

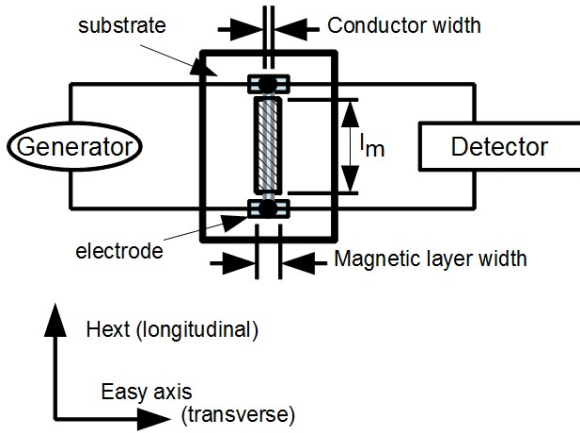
$$\delta_0 = \sqrt{2 \frac{\rho}{\omega}} \quad (13)$$

$$\mu_R = |\mu_t| + \mu_t'' \quad (14)$$

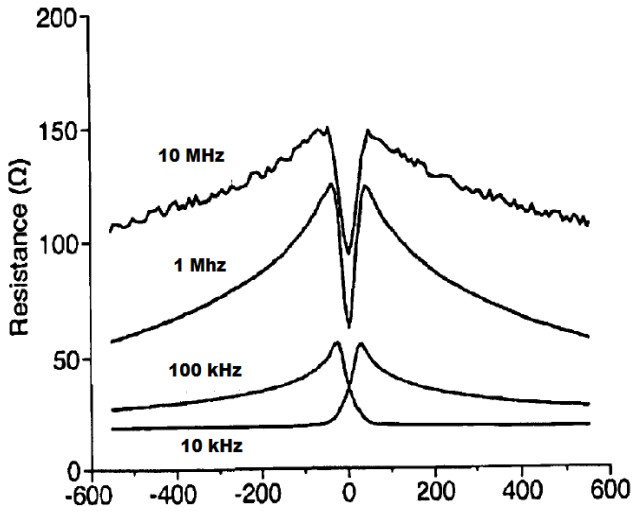
$$\mu_L = |\mu_t| - \mu_t'' \quad (15)$$

where  $\alpha$  is the wire radius,  $R$  is the resistance,  $\rho$  is the resistivity,  $\omega$  is the angular frequency, and  $\mu_t$  is the circumferential permeability of the wire. The permeability  $\mu_t$  is complex, and  $\mu_r$  significantly modifies the impedance at frequencies above 100 MHz. Unfortunately these sensors, to work properly, have very low starting impedance which increases their power consumption. It also makes the pattern sizes quite small. Additional work on GMI devices have shown that a DC bias can create an asymmetrical response, as shown in Figure 16, which gives the odd-function response necessary to produce a compass [32]. To achieve an odd-function result, the top and bottom layers can have anisotropy angles of between 15° and 45°. Figure 17 [33] compares the GMI output to a single AMR barber-pole resistor. The function described still has an issue with the output of of the sensor pair having the same value at different fields.

This problem would only be an issue when the sensor is exposed to fields not normal in nature such as hard magnets and electric motors. To make a functional compass, the device made from these elements would need to be reduced in size so that all three axis could be measured.

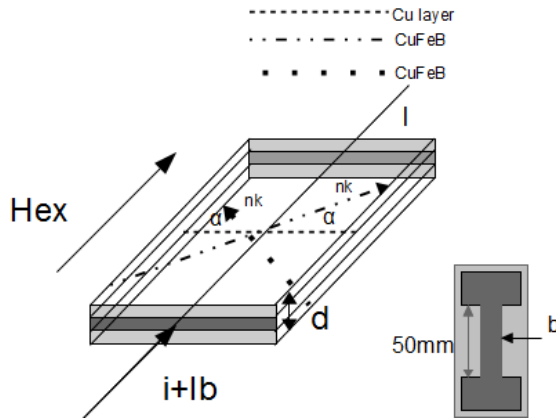


**Fig. 14.** Morikawa et al. [30] thin film GMI sensor. (a) Is the top view and (b) is the cross-sectional view.

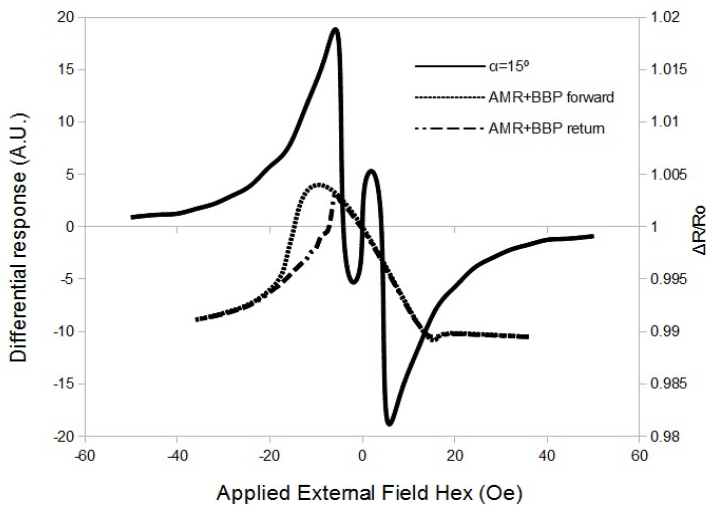


**Fig. 15.** Maylin et al. [31] thin film GMI sensor impedance results at 0.01, 0.1, 1, and 10 MHz. The output is an even function which is not ideal for a compass. This is because a vector pointing left has the same magnitude as a vector pointing right.





**Fig. 16.** Schematic of an experiment run by Delooze et. al. [32] (a) Film layer structure and principle quantities and directions. (b) In-plane view of the test structure.



**Fig. 17.** Data taken from Delooze et. al. [32] and the Author. This device is a combination of a GMI devices using opposite DC current directions on two sensors compared with a typical barber-pole AMR sensing element. The excitation frequency used for the GMI is 90 MHz,  $b = 40\ \mu\text{m}$  and  $I = 25\ \text{mA}$ .

## 5 Commercial GMR Compasses

Table 2 shows a comparison of some selected commercially available GMR compass devices. Table 2 is constructed from the available data sheets from these selected manufacturers. Also included in this table is a comparison of two equivalent AMR devices. All of the devices shown have A/D converters to allow for compensation

algorithms. The table shows four basic types of compass devices. These are, as have been discussed, AMR, Spin-valve, MTJ and GMI based sensors. Some of the issues, such as hysteresis, that were discussed in earlier sections show up in the commercial sensors.

The AMR sensors were included to act as a reference for the GMR sensors. It should be noted that the MEMSIC device in this table has a sensor licensed by Honeywell to MEMSIC. With this licensing, any variations in performance are probably due to the application specific integrated circuit or ASIC that was mated to the sensor. All five devices in this comparison have custom complimentary metal oxide semiconductor (CMOS) application specific integrated circuit (ASIC) devices to perform the analog to digital conversion and communication to an output device. Common output devices for these include automotive mirrors, cell phones and hand held GPS devices. Manufacturers over the years who have used such devices are Magna Donnelly, Garmin, Motorola, and Apple. The GMI sensor, from Aichi Steel, in this table, solves the dimensional issue and the vector issue by using fluxgate magnetometry methods. The size of the package, for the compass devices, is being driven by the needs of the digital phone market. The chief marketing handle for these communication devices is the size of the phone itself. Thin phones are important to the consumer base.

The thickness of the package, due to the z-axis sensor, is the biggest issue. In some devices, the z-axis device is a separate chip, mounted on its side. In other devices, the z-axis sensor is in the plane of the xy sensors but with z-axis pole-pieces. All the devices shown in Table 2 are between eight hundred microns to one millimeter in thickness, which seems to be a manufacturing limit. As expected, the largest devices are the AMR devices. These devices have the lowest impedance to device area. This then requires that the AMR sensor needs to grow quite large to achieve a reasonable resistance. The smallest devices are the MTJ sensors. The MTJ sensors have the highest impedance and therefore require less physical space on the chip.

An important consideration for the compass device is the input-output configuration. This means analog to digital conversion bits, current consumption, interface type and interrupts. The interface type that is used in these commercial devices is I<sup>2</sup>C which is a two wire communication protocol developed by Philips Electronics. It can be used with either seven or ten bit words and is a very common interface type. This basic circuit type is readily available at numerous foundries internationally. The continuous current consumption also gives insight on how much time the device remains "on".

The Yamaha device has the highest current draw is either "on" a significant amount of time and or has a significantly lower resistance in the sensor. The Aichi Steel and the Freescale devices have interrupt lines to add additional handshaking. The lowest supply voltage is 1.7 volts and the highest voltage is 5.25 volts with the majority able to operate at or around 3 volts. The analog to digital converters, ADC, range from 10 bits to 15 bits. The ADC also can control the accuracy of the commercial sensors depending on the volts/bit. The sense range of these devices is one to twelve Gauss of external applied field.

The basic performance of these selected commercial devices over temperature and initial offset versus temperature induced offset is important. These parameters are listed in Table 2 and can be compensated for using a temperature sensor.

**Table 2.** Selected AMR and GMR devices and their specifications from their data sheets. All these devices have signal processing. At this time, some of these devices are only prototypes.

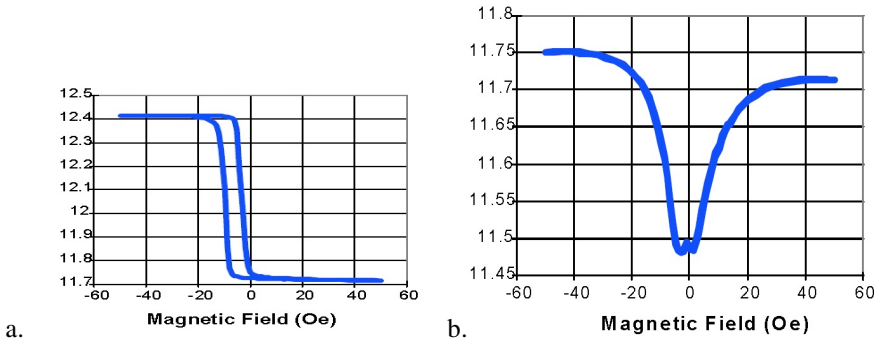
General	Technology	GMI	AMR		GMR	MTJ
	Company	Aichi Steel	MEMSIC	Honeywell	Yamaha	Freescale
	Product	AMI306	MMC314XMR	HMC5883L	YAS529	Mag3110
PKG	PKG	LGA 10	LGA 10	LGA 16	WLCSF 10	DFN 10
	Size (mm)	2 * 2 * 1	3 * 3 * 1	3 * 3 * 0.9	2 * 2 * 1	2 * 2 * 0.85
I/O	Voltage (V)	1.7 ~ 3.6	2.7 ~ 5.25	2.16 ~ 3.6	2.5 ~ 3.6	1.95 ~ 3.6
	Current_continuous working (mA)	>1	~2	~2	4	>1
	Current_samples per second (mA)	0.15 @ 20sps	0.55 @ 50sps	0.10 @ 7.5sps	4	0.14 @ 10sps
	Interface	IIC	IIC	IIC	IIC	IIC
	Interrupt	Y	/	/	/	Y
Maximum Ratings	Storage temp	-40 ~ 125	-55 ~ 125	-40 ~ 125	-50 ~ 125	-40 ~ 125
	Operating temp	-20 ~ 85	-40 ~ 85	-30 ~ 85	-40 ~ 95	-40 ~ 85
	Max exposed field		10000G		2000G	1000G
Performance	Range (+-Gauss)	12	4	1-8	3	10
	ADC (output bits)	12	12	12	10	15
	Sensitivity/Resolution (mGauss)	6	2	2	6 for XY / 12 for Z	1
	Offset (+-Gauss)		0.2			0.01
	Accuracy (deg)	1	2	2	5	
	Linearity (%FS)	0.5	1	0.1		1
	Hysteresis (%FS)		0.1	0.0025		1
	Repeatability (%FS)		0.1			
	Sensitivity TC	+ -7% @0-60degC	0.11%/degC	+ -5%		0.1%/degC
	Offset TC	+ -3mG/degC @0-60degC	+ -0.4mG/degC			+ -0.1mG/degC
	Bandwidth (Hz)		40	75	40	40
	Noise (RMS)		0.6mG@25Hz			0.5mG
	Features	Onchip temp sensor	Y	Y		Y
Single-chip-integration		/	/	/	Y	
Offset removal		Y	Y	Y	Y?	
Self test		/	/	Y	/	Y
Others					3 AD for external	Oversampling configuration

If the application needs a wide temperature range of operation, these values must be accounted for. If the user combines other types of sensor information with the compass values it is still possible to compensate for this offset. Most hand held devices, such as cell phones, also have global positioning devices, gyroscopes, and accelerometers. The maximum external field that the GMR and MTJ sensors can be exposed to is also quite important since both sensors depend on a pinned layer. The maximum field for the MTJ and the spin-valve GMR devices are 1000 G to 2000 G. This seems high, but it is the level that a hard magnet in a circuit assembly line can produce. Often production assembly lines use magnets to activate proximity sensors. These sensors are used indicate the position of assembly tooling and can expose these types of devices to high fields. These compass devices are also sensitive to solder temperature and epoxy curing temperatures due to the thermodynamics of thin film diffusion. The maximum storage temperatures for these devices is 125°C. This generally means that

the epoxy curing temperature should be 100°C or less. The wire bonding temperatures should also be limited to this range.

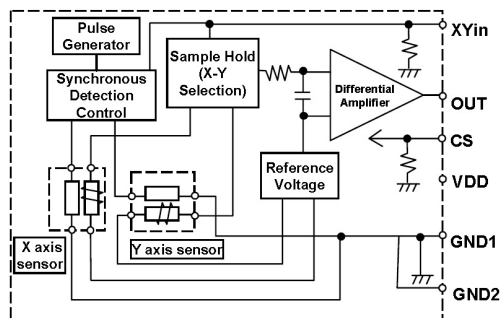
## 6 Discussion

GMR compass devices have expanded the market for electronic compasses due to their acceptable sensitivities and large dynamic ranges. These devices have significant issues, noise, hysteresis, and sensitivities. The initial issue is the cross-sensitivity of the typical GMR sensor and it bears restating how much this effects everything to do with this class of sensor. These sensors require magnetic pole pieces to enhance the directionality or the accuracy becomes poor. Figure 18 [18] shows a demonstration of the cross-axis behavior using pinned spin-valve devices. Hill [33] compared multi-layered GMR sensors versus spin-valve sensors for vector applications. The analysis in Hill [33] demonstrated that the more traditional multi-layered GMR devices are better vector devices. Unfortunately, multi-layered devices have sensitivity issues.



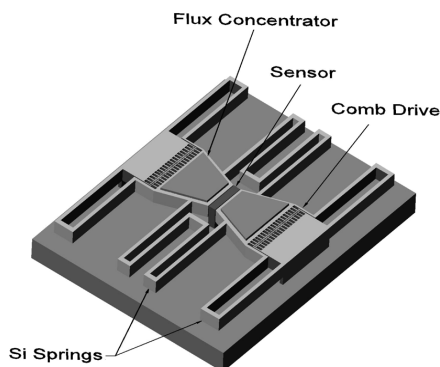
**Fig. 18.** Typical behavior demonstrating of cross-axis sensitivity issues as related to an anti-ferromagnetic coupled spin-valve [18]. a) Field parallel to the pinning direction (NVE 6% device). b) Field perpendicular to the pinning direction (NVE 2.4% device).

The spin-valve device in this study had poor cross-axis sensitivity. This is not the complete picture, a spin-valve device does have cross-axis behavior in one direction and none in the other direction. This cross-axis behavior probably does not really effect the actual compass device since the pole-pieces do most of the selectivity. To contrast this with the AMR sensor, the cross-axis sensitivity of the standard AMR sensor is completely dependent on magnetization direction (which can be controlled as in the set reset scheme sold by Honeywell). In an AMR compass device the magnetization can be controlled by the set-reset coil. The introduction of commercial GMR sensors has proven that these type of devices are viable. The goal of increasing the sensitivity of GMR sensors has driven researchers to try variations of other sensing methods to create novel sensors. The methods used by Aichi Steel may in the end be the most sensitive and effective magnetometer, this is due to the incorporation of the fluxgate technique as shown in Figure 19 [34].



**Fig. 19.** Schematic of Aichi Steel's flux-gate GMI sensor [34]. This is for a 2-axis system.

The idea of adding magnetic structures to micro-electronic machines [35, 36] has expanded the possibilities for compassing. Figure 20 is a schematic of a proposed MEMS concentrator structure. The flux concentrator i.e. pole-pieces are placed on “springs” and “comb drives” to modulate the magnetic field. The magnetic sensor is placed on a spring structure [37] in-between the pole pieces. These type of compass devices may be accurate but have additional manufacturing issues, such as etch chemistry compatibility, which need to be answered. The additional complication of repeatability and calibration will still need to be answered. A new direction for compass devices is the use of nanotechnology to create a new category of vector sensor [38, 39].



**Fig. 20.** Edelman's [37] concept for a MEMS flux concentrator to reduce  $1/f$  noise

Colossal magnetoresistors have issues still with operational temperature range which will in the short run impede implementation. These include nanowires made from variations on permalloy to colossal magnetoresistive materials.

## 7 Conclusions

Giant magnetoresistors are capable of being effective compass devices. Certain repeatability errors will have to be managed for the GMR devices to supplant AMR devices for high accuracy applications. As with all new technologies, it is now a race to come up with a method that can be accurate and manufactured in an inexpensive and reliable manner. The cost for implementation will always drive whether or not a new technology will be adopted. Compass devices are part of our history of exploration and discovery. From ancient times, where the compass made navigation across the Mediterranean possible, to modern times as an aid to personal navigation to and through the local shopping mall. We continue to find more ways to make compasses and new applications to use these devices.

## References

- [1] Morley, L.W.: Early Work Leading to the Explanation of the Geomagnetic Imprinting of the ocean Floor. *EOS* 67(36), 665–666 (1986)
- [2] Gubbins, D., Herrero-Bervera, E.: *Encyclopedia of Geomagnetism and Paleomagnetism*, August 17. Springer (2007)
- [3] Tumanski, S.: *Thin Film Magneto-resistive Sensors (Series in Sensors)*, 1st edn. Taylor & Francis (June 8, 2001)
- [4] Reig, C., Cubells-Beltrán, M.-D., Ramírez Muñoz, D.: Magnetic Field Sensors Based on Giant Magnetoresistance (GMR) Technology: Applications in Electrical Current Sensing. *Sensors* 9, 7919–7942 (2009)
- [5] Robbes, D.: Highly Sensitive Magnetometers—A Review. *Sensors and Actuators A* 129, 86–93 (2006)
- [6] Marchesi, M.: Fluxgate Magnetic Sensor System for Electronic Compass, Dissertation, Università Degli Studi di Pavia
- [7] Glatzmaier, G.A., Roberts, P.H.: A Three-dimensional Convective Dynamo Solution with Rotating and Finitely Conducting Inner Core and Mantle. *Phys. Earth Planet. Inter.* 91, 63–75 (1995)
- [8] Glatzmaier, G.A., Roberts, P.H.: A Three-dimensional Convective Dynamo Solution with Rotating and Finitely Conducting Inner Core and Mantle. *Phys. Earth Planet. Inter.* 91, 63–75 (1995)
- [9] Glatzmaier, G.A., Roberts, P.H.: An Anelastic Evolutionary Geodynamo Simulation Driven by Compositional and Thermal Convection. *Physica D* 97, 81–94 (1996)
- [10] Song, Richards: Seismological Evidence for Differential Rotation of the Earth's Inner Core. *Nature* 382, 221–224 (1996)
- [11] [http://www.nasa.gov/vision/earth/lookingatearth/29dec\\_magneticfield.html](http://www.nasa.gov/vision/earth/lookingatearth/29dec_magneticfield.html)
- [12] <http://education.usgs.gov/lessons/compass.html>
- [13] <http://geomag.usgs.gov/>
- [14] <http://mathworld.wolfram.com/RotationMatrix.html>
- [15] Wan, H.: System for Using a 2-axis Magnetic Sensor for a 3-axis Compass Solution, United States Patent 6,836,971 B1

- [16] Mayer, R., Piemonte, P., Huang, R., Patel, P.: Magnetometer Accuracy and Use, United States Patent 7891103 B2
- [17] Lenz, J., Edelstein, S.: Magnetic Sensors and their Applications. *IEEE Sensors Journal* 6, 631–649 (2006)
- [18] Smith, C.H., Schneider, R.W.: Low-Field Magnetic Sensing with GMR Sensors. Nonvolatile Electronics, Inc., <http://www.nve.com/docs/doc430dcd6b2a5c4.pdf>
- [19] NVE Magnetic Sensors Catalog
- [20] Jander, A., Smith, C., Schneider, R.: Magnetoresistive Sensors for Nondestructive Evaluation. Presented at the 10th SPIE International Symposium, Nondestructive Evaluation for Health Monitoring and Diagnostics, Conference 5770
- [21] Wan, H., Bohlinger, M.M., Jenson, M., Hurst, A.: Comparison of Flicker Noise in Single Layer, AMR and GMR Sandwich Magnetic Film Devices. *IEEE Transactions on Magnetics* 33(5) (September 1997)
- [22] Briaire, J.: 1/f Noise in Permalloy. Technische Universiteit Eindhoven (2000)
- [23] Nor, A.F.M., Hill, E.W.: Noise Power Spectral Density in Single-Strip NiFeCo–Cu GMR Sensors. In: *InterMag Europe 2002*, April 28- May 2 (2002)
- [24] Wisniowski, P., Almeida, J.M., Freitas, P.P.: 1/f Magnetic Noise Dependence on Free Layer Thickness in Hysteresis Free MgO Magnetic Tunnel Junctions. *IEEE Transactions on Magnetics* 44(11) (November 2008)
- [25] Smits, A.A.: Tunnel Junctions Noise and Barrier Characterization. Eindhoven University of Technology (2001)
- [26] Russek, S.E., Oti, J.O., Kim, Y.K., Cross, R.W.: Field Angle and Current Density Effects in Submicrometer Spin Valves for Digital Applications. *IEEE Transactions on Magnetics* 33(5) (September 1997)
- [27] Chao, C.-T., Chen, C.-C., Kuo, C.-Y., Wu, C.-S., Horng, L., Isogami, S., Tsunoda, M., Takahashi, M., Wu, J.-C.: Temperature Dependence of Electrical Transport and Magnetization Reversal in Magnetic Tunnel Junction. *IEEE Transactions on Magnetics* 46(6) (June 2010)
- [28] Panina, L.V., Mohri, K.: Magneto - impedance effect in amorphous wires. *Applied Physics Letters* 65, 1189 (1994)
- [29] Le, A.-T., Tung, M.T., Phan, M.-H.: A Study of Giant Magnetoimpedance Effect and Magnetic Response in Micro-patterned F/Ag/F Magnetic Ribbon Structures (F=Co-rich Amorphous Ribbon). *Journal of Superconductivity and Novel Magnetism* 25(4), 1133–1138 (2012), doi:10.1007/s10948-011-1379-y
- [30] Morikawa, T., Nishibe, Y., Yamadera, H., Nonomura, Y., Takeuchi, M., Taga, Y.: Giant Magneto-Impedance Effect in Layered Thin Films. *IEEE Transactions on Magnetics* 33(5) (September 1997)
- [31] Maylin, M.G., Gore, J.G., Square, P.T., Atkinson, D.: Elongate GMI integrating magnetic sensor, US Patent 6747449 (June 8, 2004)
- [32] Honkura, Y., Yamamoto, M., Mori, M., Koutani, Y.: Magnet with electromagnetic coil/impedance/sensor element, US Patent 7224161 (May 29, 2007)
- [33] Delooze, P., Panina, L.V., Mapps, D.J., Ueno, K., Sano, H.: Sub-Nano Tesla Resolution Differential Magnetic Field Sensor Utilizing Asymmetrical Magnetoimpedance in Multilayer Films. *IEEE Transactions on Magnetics* 40(4) (July 2004)
- [34] Hill, E.W.: A Comparison of GMR Multilayer and Spin-Valve Sensors for Vector Field Sensing. *IEEE Transactions on Magnetics* 36(5) (September 2000)

- [35] [http://www.aichi-mi.com/3\\_products/catalog%20e.pdf](http://www.aichi-mi.com/3_products/catalog%20e.pdf)
- [36] Choi, S.: A Micromachined Magnetic Field Sensor for Low Power Electronic Compass Application. Dissertation, Georgia Institute of Technology (May 2007)
- [37] Lenz, J., Edelstein, S.: Magnetic Sensors and Their Applications. *IEEE Sensors Journal* 6, 631–649 (2006)
- [38] Edelstein, A.S., Fischer, G.A.: Minimizing  $1/f$  Noise in Magnetic Sensors Using a Micro-electromechanical System Flux Concentrator. *J. Appl. Phys.* 91, 7795–7797 (2002)
- [39] Ziolo, R.F., Palacios, J.T., Zhang, X.: Magnetic Nanocompass Compass Compositions and Processes for Making and Using, U. S. Patent 5,889,091 (March 30, 1999)
- [40] Peczalski, A.: Nanowire Magnetic Sensor, U. S. Patent 7,926,193 B2 (April 19, 2011)