

Modeling of Walking through Pathways and a Stairway by Cellular Automata Based on the Guideline for Evacuation

Shigeyuki Koyama, Nobuhiko Shinozaki, and Shin Morishita

Yokohama National University
Graduate School of Environment and Information Sciences
79-7 Tokiwadai, Hodogaya-ku, Yokohama 240-8501 Japan
mshin@ynu.ac.jp

Abstract. Walking through a pathway, a T-junction, and a stairway was modeled by Cellular Automata, introducing local neighbor and transition rules based on the Public Guideline for Evacuation. Setting two types of "personal space" for each pedestrian in one direction and 45° inclined direction, a person moves to the next cell at some probability in 24 directions by interpolation of these two patterns. The moving probability was evaluated just for the crowd flow through a straight pathway so that the relationship between density and flow rate might agree with that proposed by the Guideline. It is shown that these flow models can be applied to inclined 24 direction pathways. As the combination of straight pathways, the crowd flow through T-junction was simulated, which showed good agreement with the estimated results according to the Guideline. The flow in a stairway was also simulated in the present paper.

Keywords: Evacuation, Modeling, Guideline, Inclined pathway, Stairway.

1 Introduction

An Evacuation simulation is very important to evaluate the duration time required to rush away from a room to outside of buildings. Especially in Japan, we encountered the earthquake disaster followed by tsunami on March 11, 2011. More than 15,800 died and 26,000 were injured. 3,000 people were not discovered yet. In addition we were damaged by a big earthquake occurred in Kansai district (west part of Japan) on January 17, 1995. At that time, more than 6,400 people were died and 43,000 were injured. Even without these kinds of natural disaster, we always encounter various risks in case of fire of houses or buildings. In such cases, quick escape may be most important to survive.

There have been numerous studies on evacuation simulation as an application of Cellular Automata (CA) or Multi-Agent Simulation [1]-[6]. Yuichiro Naka simulated the passenger flow in the concourse of stations on macroscopic and also microscopic point of view by introducing several local neighbor rules in the early 1970s [1]. Dirk Helbing, et al. presented a model of pedestrian behavior to study the mechanisms of

panic and jamming by uncoordinated motion in crowds [3]. One of the authors proposed several local neighbor rules for evacuation simulation by Cellular Automata [4]. Nishinari, et al. presented the floor field model for pedestrian dynamics introducing wall potentials and simulated evacuation flow from a room with several exits [6].

Though Cellular Automata model may be a strong tool for pedestrian flow simulations, the local neighbor rules or state transition rules introduced in the simulation might include subjectivity of the program engineer who completed the simulation. As a guarantee of the accuracy of simulation results, some of the previous authors demonstrated experiments where many voluntary subjects walked along several paths and the required time and position in a space were recorded.

In the present paper, the local neighbor and transition rules for a pedestrian to step forward were determined as simple as possible, in the way that a person may choose the next cell to proceed by just physical interaction among the other persons surrounding him/her. Peculiar characteristics of a person were excluded and all the people were adapted by the same rules. All the people may evacuate from the buildings through halls or stairs in good order without any personal troubles. The flow of crowds were adapted to the density-flow rate diagram and density-velocity diagram provided by the government by adjusting the probability introduced to settle the velocity of a person [7]-[9]. Several typical examples of flow patterns; through the inclined straight pathway, through a T-junction of pathways and through stairway were presented.

2 Cellular Automata Model

2.1 Cell Division

The floor plan was divided into cells of 30 x 30 cm, and at most one person was permitted to stay on one cell. The unit length of "30 cm" is very important in Japan, because typical width of doors or pathways is designed by multiple of 30 cm. Two persons were not permitted to stand on the adjacent cells to each other, because the cross sectional area of a body was estimated 60 x 30 cm. Then the maximum density in this model was about 5.5 persons/m². The typical state variable of each cell was "pedestrian, "vacant" or "obstacle" (such as wall, pillar or furniture), and a little more precise state variable were added.

2.2 Direction Vector

A person on a cell had the direction vector which indicated the direction of movement. A pedestrian on a cell could move in the eight directions including forward, backward, right, left and every 45 degree directions. When the direction of a pedestrian was not coincide to the eight directions mentioned above, the pedestrian should choose one of the eight directions according to the probability calculated by the following equations

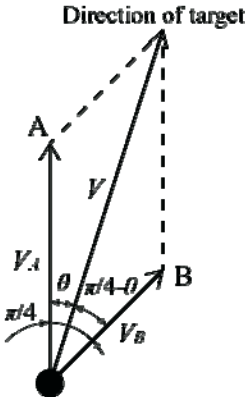

Fig. 1. Direction vector

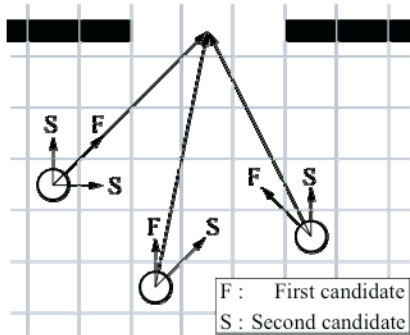

Fig. 2. Cells to proceed

$$prob(A) = a / (a + b)$$

$$prob(B) = b / (a + b)$$

$$a = \sqrt{2}|V|\cos(\pi/4 + \theta), \quad b = \sqrt{2}|V|\cos(\pi/4 - \theta)$$

where, $prob(A)$ and $prob(B)$ was the probability to select direction A and B. The direction vector V_A and V_B are shown in Fig. 1. The vector V was divided into two vectors coinciding to two directions from prescribed eight directions. The length of the vector V_A and V_B might be determined by direction of the original vector V . As shown in Fig. 2, each pedestrian had the cells to proceed by the first and second priority.

2.3 Walking Velocity

When a pedestrian walks along a free space without any constraint, the velocity is estimated as up to 1.3 m/s, the value of which has been supported by several documents edited by the Japanese government. As a person was set to proceed one cell in each time step, then the time step was estimated as $0.3/1.3 = 0.23$ s in physical meaning. The process of walking, a person moved to the next cell or not, was governed by probability. When the walking velocity was less than 1.3 m/s, the probability of movement was calculated as $v/1.3$. Furthermore, when the direction vector was inclined to 45 degree, the probability was decreased as $1/\sqrt{2}$, to keep the free velocity as 1.3 m/s.

As described in section 2.2, a person should select one of the eight directions to proceed in each time step. According to the fact that an average stride of adult men was 75-80 cm, and 2 or 3 time steps in this simulation corresponded to the time for one walking step of pedestrians, it was possible for a pedestrian to proceed $8 \times 3 = 24$ directions in one actual walking step at maximum as shown in Fig. 3. In this case, the velocity of a person in eight directions; forward, backward, right, left, and every 45

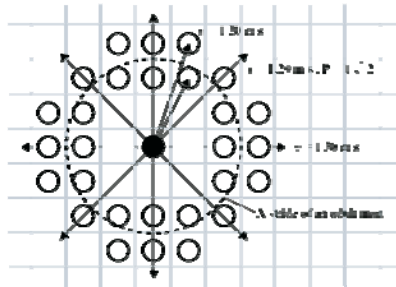

Fig. 3. Walking directions and speed of a pedestrian

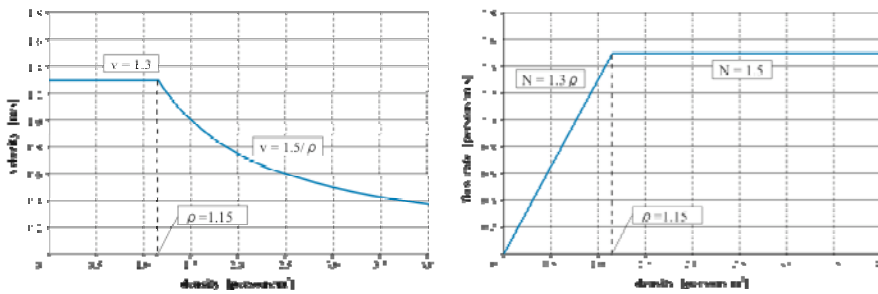

Fig. 4. Density-velocity diagram and density-flow rate diagram

degree directions was 1.3 m/s, while that was 1.2 m/s in other directions, which was considered as almost the same velocity.

2.4 Crowd Flow

Typical Idea of Modeling

In the crowd flow, the velocity of pedestrians may decrease as the density of crowds increased. According to the previous papers, the following tendency were observed.

- The transition of crowd flow state from free walking state may appear when the density exceeds 1 person/m².
- The relation among the parameters flow rate (f), velocity (v), and density (ρ) may be described as $f = \rho \times v$, when the density of crowd is up to 4 persons/m².
- Under the condition above, the flow rate becomes almost 1.5 person/m s.
- The flow rate at narrow passages like exits may be around 1.5 person/m s.

In the present paper, the crowd flow was simulated under the condition of density from 1.0 to 4.0 persons/m², which follows that $\rho \times v = 1.5$ persons/m s. The typical relation among density, velocity and flow rate is shown in Fig. 4.

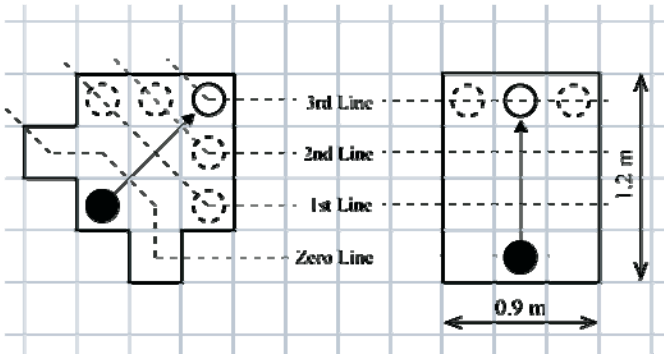

Fig. 5. Personal space

Definition of Personal Space

It has been pointed out that there may exist a "personal space" around a person, where one feels constrained or embarrassed when other persons come into the space caused by over-crowding. It may be a kind of domain or territory as wild animals. It has been reported that the walking space necessary for comfortable movement may be 70 cm width and 100-200 cm forward, or in other cases, one person in a crowd may be 1 m apart from other persons on both sides, and 1.5 m forward. In reference to these previous works, we set the personal space as shown in Fig. 5. In this paper, these two identical patterns of personal space were used to find the moving space.

Local Neighbor Rules for Movement

In this paper, the local neighbor rules were applied as simple as possible, so that the simulated crowd flow might satisfy the typical velocity-density diagram and flow rate diagram provided in the guideline. When there was no person inside of the personal space, the pedestrian continued to walk straight forward at the free walking speed of 1.3 m/s. In case that more than one person existed in the personal space, the movement of the pedestrian was expressed by "transfer probability" considering the location and the number of other persons in the space so that the simulated crowd flow might adjust the density-velocity diagram and flow rate diagram provided in the government rule as shown in Fig. 4. The transfer probability was calculated as follows according to the state of the personal space.

$$\text{transfer probability} = (1.0 - P_{\text{stop}} \times C_{\text{dens}}) \times C_{\text{dir}}$$

where P_{stop} is "stop probability", C_{dens} is "density coefficient" determined by the location of other persons in the personal space, and C_{dir} is "direction coefficient". P_{stop} was determined as

- 0.0 : no person in the personal space
- 1.0 : at least one person exists in the 1st line in Fig. 5
- 0.4 : at least one person exists in the 2nd line in Fig. 5
- 0.2 : at least one person exists in the 3rd line in Fig. 5

The density coefficient was determined as

- 1.0 : 0 - 2 persons in the personal space
- 0.6 : 3 persons in the personal space
- 0.3 : 4 persons in the personal space
- 0.0 : more than 5 persons in the personal space

The direction coefficient is set to 1.0 to the forward cell, and $1/\sqrt{2}$ to aslant cell.

The order of calculation for a pedestrian to decide the space to proceed at next time step was at random, and the movement for all pedestrians in simulation space was conducted all at once. Transfer probability to the cells where other person existed and the adjacent cells was zero. The probability to move was increased due to C_{dens} as the density increased, because the simulated crowd flow should adjust the flow-rate density diagram in high density region.

2.5 Movement through a Stairway

According to previous works, the velocity of pedestrians through a stairway corresponds to the number of steps per unit time on horizontal movement. Moreover, the velocity at a standard stairway on a projected horizontal plain may be as half as that through a horizontal passage according to the report edited by the Building Center of Japan. Based on the document on Evacuation Safety Performance Evaluation Manual, the velocity was set 0.45 times at up-stairway and 0.6 times at down-stairway as that at horizontal passages.

On the other hand, the velocity of passengers would decrease as the density of crowd is increased. The flow coefficient at a stairway is 1.3 persons/m s in the guideline of Japanese Ministry of Land, Infrastructure, Transport and Tourism, and 80 persons/m min (=1.33 persons/m s). In the present paper, the velocity of a person is evaluated by multiplying the transfer probability by "stair coefficient". The stair coefficient is determined as

- 0.6 : down flow, less than 2 persons in the personal space
- 0.8 : down flow, more than 3 persons in the personal space
- 0.4 : up flow, less than 2 persons in the personal space
- 0.9 : up flow, more than 3 persons in the personal space

3 Simulation Results and Discussions

3.1 One Directional Flow

Simulations were conducted for crowd flow on four types of inclined pathways as shown in Fig. 6; (a) orthogonal (0°), (b) $1/3$ inclination ($\tan^{-1}(1/3) = 18.4^\circ$), (c) $1/2$ inclination ($\tan^{-1}(1/2) = 26.6^\circ$), and (d) $1/1$ inclination ($\tan^{-1}(1/1) = 45^\circ$). These simulations were conducted to show that the crowd flow in each direction was adjusted to the density-flow rate diagram in the evacuation guideline and to show the results

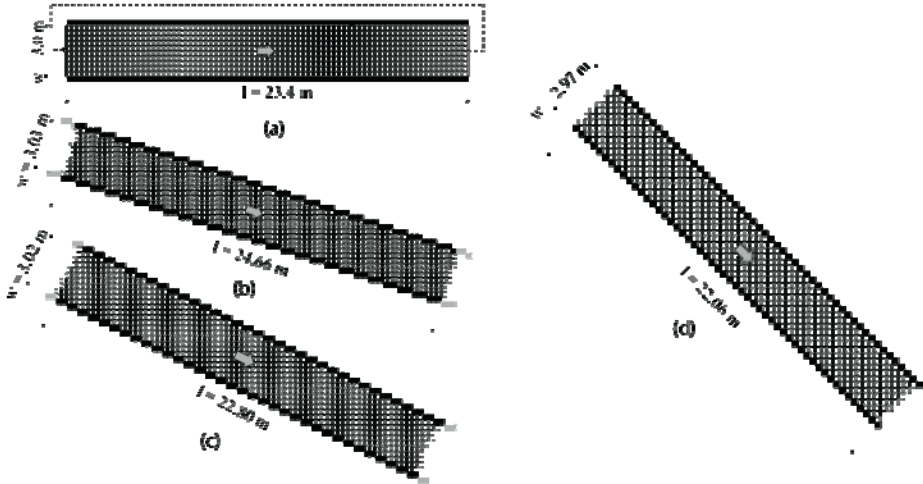

Fig. 6. Inclined pathways

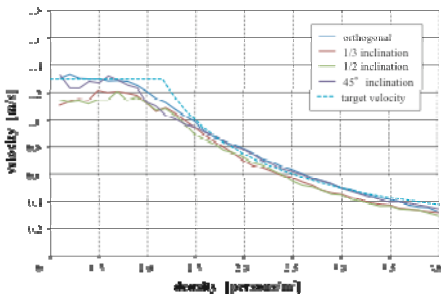

Fig. 7. Density-velocity diagram

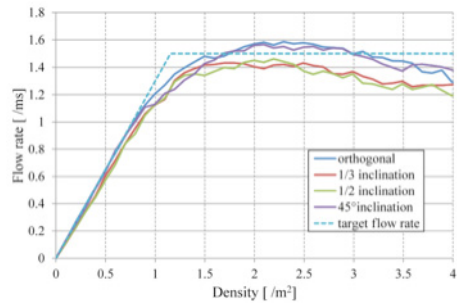

Fig. 8. Density-flow rate diagram

could be applied in two dimensional simulation. For each case study, pedestrians came into the pathway from the density of 0.1 to 4.0 persons/m² at initial state, and started the simulation at free walking speed of 1.3 m/s in one direction. Simulations were carried out ten times and averaged flow rate was estimated. Free walking state and also the crowd flow state were simulated corresponding to the flow density. The flow rate was estimated at each flow density as an average in 60 s. Periodical boundary condition for pedestrians was introduced in this simulation, where the pedestrians walking out from the exit was introduced from the inlet to get constant flow density on the pathway.

The results are shown in Figs. 7 and 8. The relation between the flow density and velocity is shown in Fig. 7, and flow density and flow rate in Fig. 8. As shown in Fig. 7, the free walking state was simulated under the density from 0.1 to 1.1 persons/m², and the velocities were almost 1.2 - 1.3 m/s in each case. The velocity of pedestrians began to decrease when the flow density exceeded about 1.1 persons/m²

in each case. The flow rate, as shown in Fig. 8, increased as the density was increased by 1.1 persons/m². After the flow rates were saturated around 1.5 persons/m s, it began to decrease from the density of 2.0 persons/m².

3.2 Flow around a T-Junction

Flow simulation was conducted around a T-junction, as shown in Fig. 9, where pedestrians coming into the gates A and B, joined at T-junction C, and flew out from the exit D. The pedestrians were placed on the pathway at a certain density randomly, and they walked in one direction at the free speed of 1.3 m/s. Two different cases of density, 0.3 and 0.7 persons/m², were set in the simulation.

The simulation result is shown in Table 1. When the flow density was 0.3 persons/m², the pedestrian flow remained as free walking state, because the total flow density at the junction was estimated about 0.6 persons/m², which was less than the transient density from free walking to crowd flow, 1.15 persons/m².

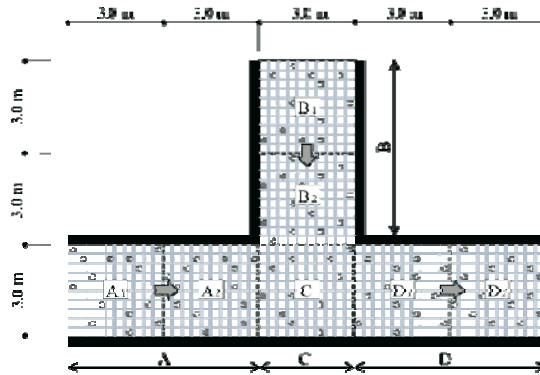

Fig. 9. Simulated area around T-junction

Table 1. Simulation results for T-junction flow

Inlet flow		Interval	A1 in	A1 out	A2 out	B1 in	B1 out	B2 out	C out	D1 out	D2 out
Low	Density [/m ²]	0~60s	0.32	0.32	0.40	0.30	0.30	0.36	0.69	0.69	0.68
		60~120s	0.31	0.30	0.38	0.30	0.30	0.36	0.66	0.68	0.61
	Flow rate [/m ² s]	0~60s	0.41	0.42	0.40	0.38	0.39	0.40	0.81	0.79	0.77
		60~120s	0.41	0.39	0.39	0.39	0.39	0.38	0.79	0.81	0.78
	Velocity [m/s]	0~60s	1.28	1.29	0.99	1.28	1.31	1.12	1.18	1.16	1.12
		60~120s	1.33	1.30	1.03	1.30	1.29	1.06	1.20	1.19	1.27
Inlet flow		Interval	A1 in	A1 out	A2 out	B1 in	B1 out	B2 out	C out	D1 out	D2 out
High	Density [/m ²]	0~60s	0.70	0.69	1.54	0.68	0.75	2.06	2.09	2.09	1.72
		60~120s	0.74	0.78	3.05	0.73	0.83	2.96	2.83	2.83	2.21
	Flow rate [/m ² s]	0~60s	0.90	0.89	0.88	0.86	0.90	0.87	1.65	1.61	1.58
		60~120s	0.92	0.86	0.78	0.92	0.84	0.74	1.54	1.49	1.49
	Velocity [m/s]	0~60s	1.28	1.29	0.57	1.27	1.21	0.42	0.79	0.77	0.92
		60~120s	1.24	1.10	0.26	1.25	1.02	0.25	0.54	0.53	0.68

On the contrary, when the initial density was set to 0.7 persons/m², the total density exceeded the transient density. As shown in Table 1, the density at C and D was increased as time passed, and the density at A was affected to be increased even though the point A was located at the upper stream of pedestrian flow. The velocity of pedestrians decreased corresponding to the elevation of flow density.

When the initial density was high, and the density exceeded 2.0, the flow rate at C and D was estimated around 1.5, which means that the flow rate in crowd flow maintained around 1.5 persons/m s as was appointed for target flow rate.

3.3 Flow through a Stairway

As shown in Fig. 10, flow simulation was also conducted for a stairway in one direction of a three-story building. People were placed at random at the density from 0.1 to 4.0 persons/m² to demonstrate the free walking as well as crowd flow state, and went down the stairs at 0.78 m/s and climbed up at 0.585 m/s as the free walking speed. After they walked out from the exit, they flew into the inlet so that steady-state flow may be realized. No entry was permitted from the second floor. The simulation was performed and averaged in 60 seconds, to measure the flow rate at each occupancy density.

The results of density-flow rate diagram are shown in Figs. 11 and 12, in case of walking down and climbing up. The simulation results showed good agreement with the theoretical prediction, which means that the proposed CA algorithm of pedestrian flow can be applied to the flow through a stairway.

4 Conclusions

In the present paper, the local neighbor and transition rules for a pedestrian to step forward were determined as simple as possible, so that the relationship between density and flow rate might agree with that proposed by the Guideline and Notification. The proposed algorithm was applied to one directional flow of orthogonal and inclined

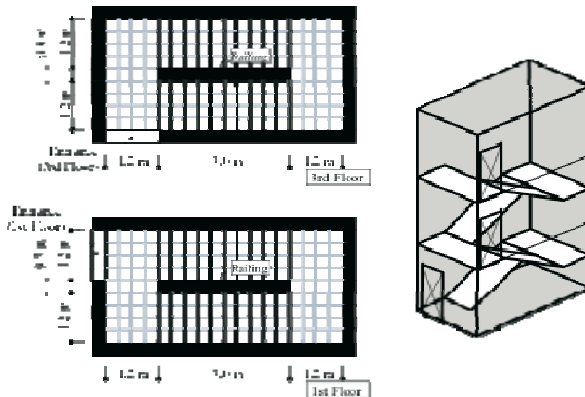

Fig. 10. Simulation model for a stairway

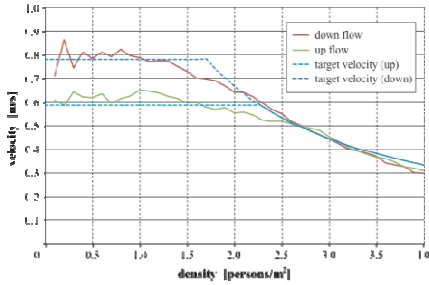

Fig. 11. Density-velocity diagram for a stairway

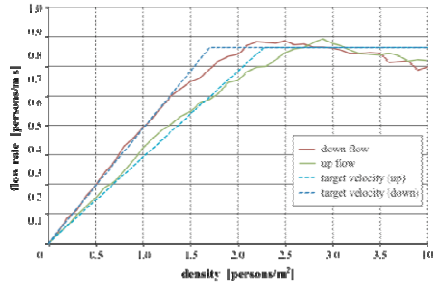

Fig. 12. Density-flow rate diagram for a stairway

pathways, T-junction pathway and a stairway. The results show good agreement with predicted values based on the Guideline, and furthermore, the time history of pedestrians flow revealed the precise mechanism of jamming around junction of pathways.

References

1. Naka, Y.: Study on Complicated Passenger Flow in a Railway Station, Railway Technical Research Report, No.1079 (1978)
2. Kato, K., Uehara, T., Nakamura, K., Yoshioka, M.: Analysis of Pedestrian Movement in Bi-directional Flow. Bulletin of Architectural Institute of Japan (289), 119–129 (1980)
3. Helbing, D., Farkas, I., Vicsek, T.: Simulating dynamical features of escape panic. Nature 407, 487–490 (2000)
4. Morishita, S., Nakatsuka, N.: Simulation of Emergency Evacuation by Cellular Automata. In: Proceedings of 6th International Conference on Complex Systems, pp. 92–97 (2002)
5. Narimatsu, K., Shiraiishi, T., Morishita, S.: Acquisition of Local Neighbor Rules in the Simulation of Pedestrian Flow by Cellular Automata. In: Sloot, P.M.A., Chopard, B., Hoekstra, A.G. (eds.) ACRI 2004. LNCS, vol. 3305, pp. 211–219. Springer, Heidelberg (2004)
6. Nishinari, K., Kirchner, A., Namazi, A., Schadschneider, A.: Extended Floor Field CA Model for Evacuation Dynamics. IEICE Transaction of Information & Systems E87-D(3), 726–732 (2004)
7. Building Center of Japan, Comprehensive Fire Safety Design for Buildings, vol. 3 (Evacuation Safety Method) (1989)
8. Building Center of Japan, Introduction to Building Fire Safety Engineering (2002)
9. Ministry of Construction Notification, No. 1441 & 1442 (2000)