

ICME-13 Monographs

Hans-Georg Weigand · William McCallum  
Marta Menghini · Michael Neubrand  
Gert Schubring *Editors*

# The Legacy of Felix Klein



**ICME 13**  
Hamburg 2016



Springer Open

# ICME-13 Monographs

## **Series editor**

Gabriele Kaiser, Faculty of Education, Didactics of Mathematics, Universität Hamburg, Hamburg, Hamburg, Germany

Each volume in the series presents state-of-the art research on a particular topic in mathematics education and reflects the international debate as broadly as possible, while also incorporating insights into lesser-known areas of the discussion. Each volume is based on the discussions and presentations during the ICME-13 conference and includes the best papers from one of the ICME-13 Topical Study Groups, Discussion Groups or presentations from the thematic afternoon.

More information about this series at <http://www.springer.com/series/15585>

Hans-Georg Weigand · William McCallum  
Marta Menghini · Michael Neubrand  
Gert Schubring  
Editors

# The Legacy of Felix Klein

*Editors*

Hans-Georg Weigand  
Universität Würzburg  
Würzburg, Bayern, Germany

Michael Neubrand  
University of Oldenburg  
Oldenburg, Germany

William McCallum  
University of Arizona  
Tucson, AZ, USA

Gert Schubring  
Universität Bielefeld  
Bielefeld, Germany

Marta Menghini  
Department of Mathematics  
Sapienza University of Rome  
Rome, Italy

and  
Universidade Federal do Rio de Janeiro  
Rio de Janeiro, Brazil



ISSN 2520-8322

ISSN 2520-8330 (electronic)

ICME-13 Monographs

ISBN 978-3-319-99385-0

ISBN 978-3-319-99386-7 (eBook)

<https://doi.org/10.1007/978-3-319-99386-7>

Library of Congress Control Number: 2018952593

© The Editor(s) (if applicable) and The Author(s) 2019. This book is an open access publication.

**Open Access** This book is licensed under the terms of the Creative Commons Attribution 4.0 International License (<http://creativecommons.org/licenses/by/4.0/>), which permits use, sharing, adaptation, distribution and reproduction in any medium or format, as long as you give appropriate credit to the original author(s) and the source, provide a link to the Creative Commons license and indicate if changes were made.

The images or other third party material in this book are included in the book's Creative Commons license, unless indicated otherwise in a credit line to the material. If material is not included in the book's Creative Commons license and your intended use is not permitted by statutory regulation or exceeds the permitted use, you will need to obtain permission directly from the copyright holder.

The use of general descriptive names, registered names, trademarks, service marks, etc. in this publication does not imply, even in the absence of a specific statement, that such names are exempt from the relevant protective laws and regulations and therefore free for general use.

The publisher, the authors and the editors are safe to assume that the advice and information in this book are believed to be true and accurate at the date of publication. Neither the publisher nor the authors or the editors give a warranty, express or implied, with respect to the material contained herein or for any errors or omissions that may have been made. The publisher remains neutral with regard to jurisdictional claims in published maps and institutional affiliations.

This Springer imprint is published by the registered company Springer Nature Switzerland AG  
The registered company address is: Gewerbestrasse 11, 6330 Cham, Switzerland

# Contents

## Part I Introduction

- 1 **Felix Klein—Mathematician, Academic Organizer,  
Educational Reformer** . . . . . 5  
Renate Tobies
- 2 **What Is or What Might Be the Legacy of Felix Klein?** . . . . . 23  
Hans-Georg Weigand

## Part II Functional Thinking

- 3 **Functional Thinking: The History of a Didactical Principle** . . . . . 35  
Katja Krüger
- 4 **Teachers’ Meanings for Function and Function Notation  
in South Korea and the United States** . . . . . 55  
Patrick W. Thompson and Fabio Milner
- 5 **Is the Real Number Line Something to Be Built,  
or Occupied?** . . . . . 67  
Hyman Bass
- 6 **Coherence and Fidelity of the Function Concept  
in School Mathematics** . . . . . 79  
William McCallum

## Part III Intuitive Thinking and Visualization

- 7 **Aspects of “Anschauung” in the Work of Felix Klein** . . . . . 93  
Martin Mattheis
- 8 **Introducing History of Mathematics Education Through  
Its Actors: Peter Treutlein’s Intuitive Geometry** . . . . . 107  
Ysette Weiss

<b>9</b>	<b>The Road of the German Book <i>Praktische Analysis</i> into Japanese Secondary School Mathematics Textbooks (1943–1944): An Influence of the Felix Klein Movement on the Far East . . . . .</b>	<b>117</b>
	Masami Isoda	
<b>10</b>	<b>Felix Klein’s Mathematical Heritage Seen Through 3D Models . . . . .</b>	<b>131</b>
	Stefan Halverscheid and Oliver Labs	
<b>11</b>	<b>The Modernity of the <i>Meraner Lehrplan</i> for Teaching Geometry Today in Grades 10–11: Exploiting the Power of Dynamic Geometry Systems . . . . .</b>	<b>153</b>
	Maria Flavia Mammana	
<b>Part IV Elementary Mathematics from a Higher Standpoint—Conception, Realization, and Impact on Teacher Education</b>		
<b>12</b>	<b>Klein’s Conception of ‘Elementary Mathematics from a Higher Standpoint’ . . . . .</b>	<b>169</b>
	Gert Schubring	
<b>13</b>	<b>Precision Mathematics and Approximation Mathematics: The Conceptual and Educational Role of Their Comparison . . . . .</b>	<b>181</b>
	Marta Menghini	
<b>14</b>	<b>Examples of Klein’s Practice <i>Elementary Mathematics from a Higher Standpoint: Volume I</i> . . . . .</b>	<b>203</b>
	Henrike Allmendinger	
<b>15</b>	<b>A Double Discontinuity and a Triple Approach: Felix Klein’s Perspective on Mathematics Teacher Education . . . . .</b>	<b>215</b>
	Jeremy Kilpatrick	

# Part I

## Introduction

**Hans-Georg Weigand, William McCallum, Marta Menghini,  
Michael Neubrand and Gert Schubring**

Throughout his professional life, Felix Klein emphasised the importance of reflecting upon mathematics teaching and learning from both a mathematical and a psychological or educational point of view, and he strongly promoted the modernisation of mathematics in the classroom. Already in his inaugural speech of 1872, the *Erlanger Antrittsrede* (not to be mistaken with the *Erlanger Programm* which is a scientific classification of different geometries) for his first position as a full professor at the University of Erlangen—at the age of 23—he voiced his view on mathematics education:

We want the future teacher to stand *above* his subject, that he have a conception of the present state of knowledge in his field, and that he generally be capable of following its further development. (Rowe 1985, p. 128)

Felix Klein developed ideas on university lectures for student teachers, which he later consolidated at the beginning of the last century in the three books *Elementary Mathematics from a higher standpoint*.<sup>1</sup> In *part IV* of this book, the three volumes are analysed in more detail: Klein's view of *elementary*; his mathematical, historical and didactical perspective; and his ability to relate mathematical problems to problems of school mathematics. In the introduction of the first volume, Felix Klein also faced a central problem in the preparation of mathematics teachers and expressed it in the quite frequently quoted *double discontinuity*:

The young university student finds himself, at the outset, confronted with problems, which do not remember, in any particular, the things with which he had been concerned at school. Naturally he forgets all these things quickly and thoroughly. When, after finishing his course of study, he becomes a teacher, he suddenly finds himself expected to teach the traditional elementary mathematics according to school practice; and, since he will be

---

<sup>1</sup>The previous English translation of the first two volumes by Earle Raymond Hedrick and Charles Albert Noble, published in 1931 and 1939, had translated “höheren” erroneously by “advanced”; see the comment by Schubring in: Klein 2016, p. v–vi, and the regular lecture of Jeremy Kilpatrick (2008) at ICME 11 in Mexico.



scarcely able, unaided, to discern any connection between this task and his university mathematics, he will soon fall in with the time honoured way of teaching, and his university studies remain only a more or less pleasant memory which has no influence upon his teaching. (Klein 2016 [1908], Introduction, Volume 1, p. 1)

At the 13th International Congress on Mathematical Education (ICME-13) 2016 in Hamburg, the “Thematic Afternoon” with the *The Legacy of Felix Klein* as one major theme, provided an overview of Felix Klein’s ideas. It highlighted some developments in university teaching and school mathematics related to Felix Klein’s thoughts stemming from the last century. Moreover, it discussed the meaning, the importance and the legacy of Klein’s ideas nowadays and in the future in an international, global context.

Three *strands* were offered on this “Thematic Afternoon”, each concentrating on one important aspect of Felix Klein’s work: *Functional Thinking, Intuitive Thinking and Visualisation*, and *Elementary Mathematics from a Higher Standpoint—Conception, Realisation, and Impact on Teacher Education*. This book provides extended versions of the talks, workshops and presentations held at this “Thematic Afternoon” at ICME 13.

Felix Klein was a sensitised scientist who recognised problems, thought in a visionary manner, and acted effectively. In *part I*, we give an account of some biographical notes about Felix Klein and an introduction to his comprehensive programme. He had gained international recognition through his significant achievements in the fields of geometry, algebra, and the theory of functions. Based in this, he was able to create a centre for mathematical and scientific research in Göttingen. Besides his scientific mathematics research, Klein distinguished himself through establishing the field of mathematics education by having such high regards for the history of mathematics as a keystone of higher education. He was far ahead of his time in supporting all avenues of mathematics, its applications, and mathematical pedagogy. He never pursued the unilateral interests of his subject but rather kept an eye on the latest developments in science and technology (see the article by Renate Tobies in this book).

Klein investigated functions from many points of view, from functions defined by power series and Fourier series, to functions defined (intuitively) by their graphs, to functions defined abstractly as mappings from one set to another. *Part II* examines the development of the *concept of function* and its role in mathematics education from Klein’s time—especially referring to the “Meraner Lehrplan” (1905)—to today. It includes students’ and teachers’ thinking about the concept of function, the communication (problems) and the obstacles this concept faces in the classroom. Klein made an important distinction between functions arising out of applications of mathematics and functions as abstractions in their own right. This distinction reverberates in mathematics education even today.

Alongside the concept of function or functional thinking, the idea of *intuition and visualisation* is surely another central aspect to Klein’s mathematical thinking. The articles in *part III* highlight Felix Klein’s ideas. The contributions look for the origins of visualisation in Felix Klein’s work. They show the influences of Felix Klein’s ideas, both in the national and in the international context. They then go on

to confront these ideas with the recent possibilities of modern technological tools and dynamic geometry systems.

*Part IV* presents the newly translated versions of the three books on “Elementary Mathematics from a Higher Standpoint”. At ICME-13, the third volume *Precision and Approximation Mathematics* appeared in English for the first time. Referring to these three famous volumes, this chapter presents a mathematical, historical and didactical perspective on Klein’s thinking.

The whole book intends to show that many ideas of Felix Klein can be reinterpreted in the context of the current situation, and give some hints and advice for dealing today with current problems in teacher education and teaching mathematics in secondary schools. In this spirit, old ideas stay young, but it needs competent, committed and assertive people to bring these ideas to life.

## References

- Kilpatrick, J. (2008). A higher standpoint. In *ICMI proceedings: Regular lectures* (pp. 26–43). [https://www.mathunion.org/fileadmin/ICMI/files/About\\_ICMI/Publications\\_about\\_ICMI/ICME\\_11/Kilpatrick.pdf](https://www.mathunion.org/fileadmin/ICMI/files/About_ICMI/Publications_about_ICMI/ICME_11/Kilpatrick.pdf). Accessed 6 Oct 2018.
- Klein, F. (1908). *Elementarmathematik vom höheren Standpunkte aus: Arithmetik, algebra, analysis* (Vol. 1). Leipzig, Germany: Teubner.
- Klein, F. (2016). *Elementary Mathematics from a Higher Standpoint. Vol. I. Arithmetic, algebra, analysis* (Translated 2016 by Gert Schubring). Berlin & Heidelberg: Springer.
- Rowe, D. (1985). Felix Klein’s “Erlanger Antrittsrede”. *Historia Mathematica*, 12, 123–141.

# Chapter 1

## Felix Klein—Mathematician, Academic Organizer, Educational Reformer



Renate Tobies

**Abstract** Having been a full professor at the University of Erlangen, the Technical University in Munich, and the University of Leipzig, Klein joined the University of Göttingen in 1886. He had gained international recognition with his significant achievements in the fields of geometry, algebra, and the theory of functions. On this basis, he was able to create a center for mathematical and scientific research in Göttingen. This brief biographical note will demonstrate that Felix Klein was far ahead of his time in supporting all avenues of mathematics, its applications, and instruction. It will be showed that the establishment of new lectures, professorships, institutes, and curricula went hand in hand with the creation of new examination requirements for prospective secondary school teachers. Felix Klein’s reform of mathematical instruction included all educational institutions from kindergarten onward. He became the first president of the International Commission on Mathematical Instruction in 1908 at the Fourth International Congress of Mathematicians in Rome.

**Keywords** Felix Klein · Biographical note

Max Born (1882–1970), who received the Nobel Prize in Physics for his contributions to quantum mechanics, once reminisced as follows about Felix Klein (1849–1925) in Göttingen: “Klein commanded not only mathematics as a whole but also all of the natural sciences. Through his powerful personality, which was complemented by his handsome appearance, he became a leading figure in the faculty and at the entire university. [...] Over the years, Klein became more and more of a Zeus, enthroned above the other Olympians. He was known among us as ‘the Great Felix’, and he controlled our destinies” (Born and Born 1969, p. 16).

How did Klein develop into this Zeus-like figure? By the time Max Born was completing his studies in Göttingen during the first decade of the twentieth century, Klein had already reaped the fruits of his mathematical accomplishments and achieved an international reputation. In 1904, while attending the Third International Congress of Mathematicians in Heidelberg, he expressed what might be called his guiding

---

R. Tobies (✉)  
University of Jena, Jena, Germany  
e-mail: renate.tobies@uni-jena.de

words: “In order for science to flourish, it is necessary for all of its components to be developed freely” (Klein 1905, p. 396). With this motto in mind, he aspired to promote all aspects of mathematics equally, including its practical applications and instruction. He was also an admirer and supporter of newly formulated approaches to mathematics and the natural sciences, including actuarial science, aerodynamics, the theory of relativity, modern algebra, and the didactics of mathematics.

Of course, Klein’s wide-reaching program expanded gradually into its mature form. Yet even as a young scholar, he was characterized by the breadth of his interests, the tendency to systematize and unify things, his desire to create an overview of the whole, and his concern for pedagogy. The present contribution will concentrate on three aspects: the centers of activity that defined Klein’s life; the characteristic features of his work; and the way in which he integrated educational reform with his broader ideas about reorganization in order to transform the University of Göttingen into an internationally renowned center for mathematical and natural-scientific research.

## 1.1 Felix Klein’s Upbringing, Education, and Academic Career

Felix Klein was born on April 25, 1849 in Düsseldorf, which was then the seat of government for the Rhine Province of the Prussian kingdom. He was the second of four children born to Peter Caspar Klein (1809–1889), a senior civil servant and chief treasurer of the Rhine Province, and his wife Sophie Elise Klein (née Kayser; 1819–1890), who came from a family of fabric manufacturers.

After being tutored at home by his mother, he spent two and half years at a private elementary school before transferring, in the fall of 1857, to the Humanistisches Gymnasium in Düsseldorf, which continues to exist today. In August of 1865, just sixteen years old, he completed his *Abitur*, for which he was examined in nine subjects: German, mathematics, Latin, Greek, Hebrew, French, Protestant theology, natural history, as well as the combined subject of history and geography. He decided to pursue further studies in mathematics and the natural sciences, a fact that is already noted on his *Abitur* diploma. His interest in the natural sciences was aroused less by the curriculum of his humanities-based *Gymnasium* than it was by his earlier experiences in elementary school and by his extra-curricular activities.

On October 5, 1865, Klein applied to the nearby University of Bonn, which had been founded through the sponsorship of the Prussian king in 1818. There were not many students enrolled at the time, so it did not take long for Julius Plücker (1801–1868), a professor of physics and mathematics, to recognize Klein’s talent. Plücker chose Klein, who was just in his second semester, to be his assistant for his course on experimental physics. However, because Plücker’s own research at the time was devoted to his concept of “line geometry” (*Liniengeometrie*), he involved his assistant in this work as well. By the time Plücker died—on May 22, 1868—Klein

had thus been educated on two fronts. Regarding his achievements in physics, it is documented that he received an award for his work on theoretical physics during the celebration of the university's fiftieth anniversary (see Tobies 1999). Firm evidence for his mathematical abilities is the faith that Plücker's family placed in him as a young man; they entrusted him with the task of preparing the second volume of Plücker's *Liniengeometrie* (Klein 1869). By way of this work, Klein independently developed a topic for his doctoral dissertation, about which he sought advice from Alfred Clebsch (1833–1872) and Rudolf Lipschitz (1832–1903). Under Lipschitz's supervision, Klein defended his dissertation in Bonn on December 12, 1868, and he received the highest grade for his work. In January of 1869, he moved to Göttingen to continue his studies with Clebsch and participate in the latter's school of algebraic geometry. During the winter semester of 1869/70, Klein studied in Berlin, after which he travelled with the Norwegian mathematician Sophus Lie (1842–1899) to Paris, where they published two short papers together in the *Comptes Rendus hebdomadaires des séances de l'Académie de sciences de Paris* and prepared additional publications. In July of 1870, his time in Paris was brought to an end by the outbreak of the Franco-Prussian War.

Declared unsuitable for military service, Klein applied to serve as a paramedic. After a few weeks on the front, he contracted typhus and returned to his parents' home in Düsseldorf. In January of 1871, he completed his *Habilitation* with Clebsch in Göttingen, where he remained for three semesters as a lecturer (*Privatdozent*). His work during this time yielded significant results on the relation between linear and metric geometry and in the areas of non-Euclidian geometry, equation theory, the classification of third-order surfaces, and the systematization of geometrical research, which would form the basis of his "Erlangen Program". As a *Privatdozent*, too, he supervised his first doctoral student. Recommended by Clebsch, and at the age of just twenty-three, Klein was soon hired as a full professor by the small University of Erlangen in Bavaria.

A unique feature at the University of Erlangen was that every newly appointed professor had to produce an inaugural work of scholarship outlining his research program. Klein's work, which he completed in October of 1872, bore the title *Vergleichende Betrachtungen über neuere geometrische Forschungen* (Klein 1872) and later appeared in English as "A Comparative Review of Recent Researches in Geometry." The key novelty of this much-discussed "Erlangen Program," lay in Klein's insight that geometries could be classified by means of their associated transformation groups, each of which determines a characteristic collection of invariants. This fundamental idea is still cited and used by mathematicians today (see, for example, Ji and Papadopoulos 2015). Klein also had to deliver an inaugural lecture for his new position. This took place on December 7, 1872 before a university audience of largely non-mathematicians. In his lecture, he spoke about his ideas concerning teaching activity, which, in addition to lectures, also included practica, seminars, and working with models. Because mathematical education in Germany at the time was primarily intended for future teachers at secondary schools, he was sure to underscore the following point: "If we create better teachers, then education will improve

on its own and its traditional form will be filled with new and vital content!” (Jacobs 1977, pp. 15–16).

During his short time in Erlangen (1872–1875), Felix Klein supervised six doctoral dissertations and managed a number of affairs brought about by early death of Alfred Clebsch, who passed away in November of 1872. For instance, Klein arranged for one of his students, Ferdinand Lindemann (1852–1939), to edit Clebsch’s lectures on geometry. Clebsch’s death also resulted in a vacancy on the editorial board of the journal *Mathematische Annalen*, which he had founded in 1868 with Carl Neumann (1832–1925); this was filled in 1873 by two of Clebsch’s students, Felix Klein and Paul Gordan (1837–1912). One year later, Klein secured an associate professorship for Gordan so that they could work together in Erlangen. While in Erlangen, too, Klein met his wife Anna Hegel (1851–1927), the eldest daughter of the historian Karl Hegel (1813–1901) and granddaughter of the great philosopher Georg Wilhelm Friedrich Hegel (1770–1831). From this marriage, which was consecrated on August 17, 1875, one son and three daughters would be born.

On April 1, 1875, Klein accepted a more challenging position at the Polytechnical School in Munich (as of 1877, a Technical College or *Technische Hochschule*), which, after its reorganization in 1868, began to educate teachers as well as engineers. His appointment there was as a professor of analytic geometry, differential and integral equations, and analytical mechanics. In order to manage the growing number of students at the college, the creation of an additional professorship had been authorized, and Klein ensured that this position was offered to another of Clebsch’s former students, Alexander Brill (1842–1935). At Klein’s initiative, they founded a new Institute of Mathematics, created a workshop for producing mathematical models, and reorganized their teaching duties so that time remained for their own research. It was here that, as Klein himself believed, he developed his own mathematical individuality—as well as that of many students. To earn doctoral degrees, however, Klein’s talented students had to submit their dissertations to the *University of Munich* (see Hashagen 2003); the *Technical College* in Munich did not receive the right to grant doctorates until 1901. This and other reasons led Klein to seek a position elsewhere.

This transition was made possible by Adolph Mayer (1839–1908), a professor of mathematics at Leipzig with whom Klein had been editing the journal *Mathematische Annalen* since 1876 (see Tobies and Rowe 1990). In October of 1880, Klein was appointed a professor of geometry at the University of Leipzig (Saxony). While there, he founded a new institution, the so-called *Mathematisches Seminar* (1881), and began to give lectures on geometric (Riemannian) function theory. Noting that the French mathematician Henri Poincaré (1854–1912) had started to work in the same field, Klein began a fruitful correspondence with him (see Rowe 1992; Gray 2012). This resulted in the development of a theorem for the uniformization of algebraic curves by means of automorphic functions, something that Klein regarded among his most important findings and that would further occupy him and other mathematicians later on. After this intensive period of research (1881–82) Klein felt somewhat exploited and began to reorient his work. He turned to writing textbooks.

In 1884, the desirable opportunity arose for Klein to return to the small university town of Göttingen; Moritz Abraham Stern (1807–1894) had resigned from his professorship there. Encouraged by the physicist Eduard Riecke (1845–1915), with whom Klein had already had a good working relationship as a lecturer (*Privatdozent*), the majority of the Philosophical Faculty (which was then still a single unit) voted in Klein's favor. He was offered the position in the summer semester of 1886, despite official opposition from the other professors of mathematics at Göttingen, Hermann Amandus Schwarz (1843–1921) and Ernst Schering (1833–1897) (see Tobies 1991, 2002). Before Klein left Leipzig, he had managed to ensure that he would be replaced there by Sophus Lie. This move intensified the aversions and differences that already existed between Klein and a number of other German mathematicians, who disapproved of granting the position to a foreigner.

While in Göttingen, Klein gradually developed the Zeus-like status mentioned by Max Born. It was not until 1892, when he rejected an invitation from the *University of Munich* and when Hermann Amandus Schwarz took a new position in Berlin, that Klein became increasingly free to make his own decisions and began to hold some sway at the Prussian Ministry of Culture in Berlin. With the support of the influential civil servant Friedrich Althoff (1839–1908), Klein was finally able to initiate and realize a sweeping reorganization and renovation of the University of Göttingen's institutions, personnel, curricula, and research programs. He justified many of these changes by referring to his experiences during visits to the United States in 1893 and 1896 (see Parshall and Rowe 1994; Siegmund-Schultze 1997). By this time, Klein's influence had spread even further throughout Germany and beyond.

## 1.2 The Characteristics of Klein's Methods

Klein's growing influence can only be understood by examining the way in which he worked, which David Hilbert (1862–1943) once described as selfless and always in the interest of the matter at hand.

- (1) The young Felix Klein internalized, from his upbringing and early education, a strong work ethic, which he maintained throughout his life. Stemming from a family of Westphalian tradesmen and farmers, his father had risen high through the ranks of the Prussian civil service and had impressed upon his children such virtues as unwavering discipline and thriftiness. That such lessons continued to be imparted throughout Klein's time at secondary school is evident from his following recollection: "We learned to work and keep on working" (Klein 1923). The essay that Klein wrote for his *Abitur* contains the following sentence, with a reference to Psalm 90:10: "Indeed, if a life has become valuable, it has done so, as the Psalmist says, on account of labor and toil" [Gymnasium Düsseldorf]. This creed increasingly defined his daily approach to work.

Whereas, in his younger years, Klein was known to meet up with colleagues and hike in the mountains, and although he continued take walks with colleagues

and with his family into old age, over time he refrained, on account of his health, more and more from participating in pleasantries unrelated to his work. He devoted every possible minute to pursuing his research and to helping his (male and female) doctoral students and post-doctoral researchers, from Germany and abroad, advance their own work. To this end, he met with each of them on a regular basis. The number of projects and positions that he took on reduced his free time to such an extent that his supportive wife was able to remark that they could hardly ever spend their wedding anniversary or birthdays together because priority was always given to his duties at the university. This tendency to overwork took its toll. After a long stay in a sanatorium, Klein retired early at the age of sixty-three. Even in retirement, however, he remained highly active. He gave lectures on the history of mathematics, made contributions to the theory of relativity, and continued to exert influence over hiring decisions, the formation of new committees, and book projects, among them his own collected works (Klein 1921–1923). Collaborators and colleagues would visit him at home where, though confined to a wheelchair, he refused to waste any time.

- (2) Klein was aware that he could not work without *cooperation*, and this pertained to both his scientific and organizational undertakings. On October 1, 1876, for instance, he wrote the following words to Adolph Mayer: “It is a truly unfortunate scenario: When, as on this vacation, I only have myself to consult, then I am unable to complete anything of value. [...] I need scholarly exchange, and I have been yearning for the beginning of the semester for some time now” (quoted from Tobies and Rowe 1990, p. 76). Already accustomed, while studying under Plücker, to developing new ideas through discussion, he had carried on this practice while working with his second teacher, Clebsch. Clebsch’s ability to find connections between distinct areas of mathematics that had hitherto been examined in isolation became a point of departure for Klein’s own research methods.

During his time studying in Berlin, Klein cooperated with the Austrian mathematician Otto Stolz (1842–1905) to develop the idea of combining non-Euclidian geometry with the projective metric devised by the British mathematician Arthur Cayley (1821–1895). With Ludwig Kiepert (1846–1934), a student of Karl Weierstraß (1815–1897), Klein made his first attempt to delve into the theory of elliptic functions. His most fruitful collaboration, however, was with the aforementioned Sophus Lie. They supported one another, published together, and maintained an intensive mathematical correspondence. Klein, moreover, went out his way to promote Lie’s career (see Rowe 1989; Stubhaug 2002). Even though they came to disagree over certain matters later in life, Klein took these differences in stride and, in 1897, even endorsed Lie’s candidacy to receive the inaugural Lobatschewski Prize (see Klein, GMA 1923).

Beginning in 1874, Klein also enjoyed a strong collaborative relationship with Paul Gordan, who had likewise studied under Clebsch. Both Lie and Gordan found it difficult to formulate their own texts, and so Klein was often asked to help them by editing their writing and systematizing their ideas. By recording their thoughts, he



immersed himself in them and expanded his own knowledge. Through his discussions with Gordan, and on the basis of the latter's knowledge of algebra, Klein entered into a wide-ranging field of research. Working together with students and colleagues at home and abroad, he combined the methods of projective geometry, invariant theory, equation theory, differential equations, elliptic functions, minimal surfaces, and number theory, thus categorizing various types of modular equations.

Klein applied this cooperative approach wherever and whenever he worked, vacations and research trips included. Even if not every mathematician from within Klein's sphere in Leipzig and Göttingen was willing to collaborate with him, everyone who sought his advice benefited from it. Here there is not enough space to list all of these beneficiaries. Prominent examples include Robert Fricke (1861–1930) and Arnold Sommerfeld (1868–1951), who edited books based on Klein's lectures and took his ideas in their own creative directions. Another mathematician worthy of mention is David Hilbert, who profited in Königsberg from the tutelage of Klein's student Adolf Hurwitz (1859–1919) and earned his doctoral degree under the supervision of Klein's student Lindemann, who was mentioned above. Klein personally supported Hilbert beginning with the latter's first research stay in Leipzig (1885/86); he recommended Hilbert to travel to Paris, maintained a correspondence with him (see Frei 1985), and secured a professorship for him in Göttingen (1895). There they conducted several research seminars together, and Hilbert, despite many enticing invitations to leave, remained Klein's colleague at that university.

Klein's skill at cooperating was also reflected in his activities as an editor: for the aforementioned *Mathematische Annalen*; for the *Encyklopädie der mathematischen Wissenschaften mit Einschluss ihrer Anwendungen* (B. G. Teubner, 1898–1935), which appeared in an expanded (and partially incomplete) French edition (see Tobies 1994; Gispert 1999); for the project *Kultur der Gegenwart* (see Tobies 2008); and for the *Abhandlungen über den mathematischen Unterricht in Deutschland, veranlasst durch die Internationale Mathematische Unterrichtskommission* (5 vols., B. G. Teubner, 1909–1916). Klein was able to connect a great number of people who collaborated on these projects.

Ever since Klein's years at the Technical College in Munich (1875–80), engineers and business leaders also numbered among his collaborative partners. While a number of engineers and technical scientists in the 1890s were initiating an anti-mathematics movement (Hensel et al. 1989), Klein was able to keep things in balance. In 1895, he joined the Association of German Engineers (*Verein deutscher Ingenieure*) as a mathematician; and, regarding mathematical instruction, he instituted a more applications-oriented curriculum that included actuarial mathematics and teacher training in applied mathematics. In order to finance the construction of new facilities in Göttingen, Klein followed the American model and sought funding from industry. His solution, which was novel in Germany at the time, was the Göttingen Association for the Promotion of Applied Physics and Mathematics (*Göttinger Vereinigung zur Förderung der angewandten Physik und Mathematik*). Initially founded exclusively for applied physics in 1898 and extended to include mathematics in 1900, this organization brought together Göttingen's professors of mathematics, physics, astronomy, and chemistry with approximately fifty financially

powerful representatives of German industry. In this way, Klein convinced industrial leaders that one of their goals should be to improve the application-oriented education of future teachers. The Ministry of Culture supported this initiative by introducing a new set of examinations—developed by Klein—that, for the first time, included the field of applied mathematics (1898). This, in turn, provided the impetus for establishing new institutes and professorships for applied mathematics, technical mechanics, applied electricity research, physical chemistry, and geophysics (see Tobies 1991, 2002, 2012, ch. 2.3). With these developments in mind, Klein began to shift the focus of his teaching more and more toward applications and questions of pedagogy. In his seminars, he no longer only cooperated with Hilbert and others on teaching “pure” mathematics but rather also with newly hired professors and lecturers to teach applied fields as well mathematical didactics (see [Protocols]).

- (3) From the beginning, Klein’s approach was distinguished by its *internationality*. He profited early on from the international networks of his teachers Plücker and Clebsch, and he came away with the general impression “that we restrict ourselves to a level that is far too narrow if we neglect to foster and revitalize our international connections” (a letter to M. Noether dated April 26, 1896; quoted from Tobies and Rowe 1990, p. 36). Klein lived by these words even when the officials at the Prussian Ministry of Culture did not yet value such things: “We have no need for French or English mathematics,” or so the ministry responded in 1870 when, at his father’s prompting, he sought a recommendation for his first trip abroad (see Klein 1923).

Proficient in French since his school days and an eager learner of English, Klein developed his own broad network of academic contacts beginning with his first research trips to France (1870), Great Britain (1873), and Italy (1874). This served his research approach well, which was to become familiar with and integrate as many areas of mathematics as possible, and it also benefited the *Mathematische Annalen*, for which he sought the best international contributions in order to surpass in prestige the competing *Journal für die reine und angewandte Mathematik* (Crelle’s *Journal*), which was edited by mathematicians based in Berlin. His international network also helped to the extent that many of his contacts sent students and young scientists to attend his courses. Even while Klein was in Erlangen, Scandinavian students (Bäcklund, Holst) came to study with him at the recommendation of Lie; while in Munich, he was visited by several Italian colleagues, and after his second trip to Italy (1878), young Italian mathematicians (Gregorio Ricci-Curbastro, Luigi Bianchi) came to study under him (see [Protocols], vol. 1; Coen 2012). Gaston Darboux (1842–1917), with whom Klein had corresponded even before his first trip to Paris and with whom he had collaborated on the review journal *Bulletin des sciences mathématiques et astronomiques*, sent young French mathematicians to work with him both in Leipzig and in Göttingen. Darboux was the first person to commission a translation of one of Klein’s works into a foreign language—*Sur la géométrie dite non euclidienne* (1871)—and they would go on to work together for many years,

work that included their participation on prize committees, teaching committees, and bibliographies (Tobies 2016).

During Klein's first semester in Leipzig (1880/81), the following international students (among others) came to work with him: Georges Brunel (1856–1900), recommended by Darboux; the Englishman Arthur Bucheim (1859–1888), who had been educated at Oxford by Henry John Stephen Smith (1826–1883); Guiseppe Veronese (1854–1917), at the instigation of Luigi Cremona (1830–1903); and Irving W. Stringham (1849–1917), who had already earned a doctoral degree under James Joseph Sylvester (1814–1897) at Johns Hopkins University in Baltimore. Under Klein's direction, they produced findings that were published in the *Mathematische Annalen* (Veronese in 1881 and 1882, Brunel in 1882) or in the *American Journal of Mathematics* (Stringham in 1881). To Daniel Coit Gilman, the president of Johns Hopkins, Stringham wrote enthusiastic letters about Klein's critical abilities and about the international nature of his seminars. When Stringham's former teacher Sylvester left his position in Baltimore, Klein was invited in 1883 to be his successor. Klein declined the offer for financial reasons, which was itself a sign of his international reputation. Ever since his time in Leipzig, Klein also made conscious efforts to enhance his relations with Russian and other Eastern European mathematicians. Wishing to foster exchange, he would always request his students from these areas to provide him with an overview of the institutions there, their staff, and their research trends.

In Göttingen, and thus back under the purview of the Prussian Ministry of Culture, Klein had to decline an invitation in 1889 to work as a visiting professor at Clark University in Worcester, Massachusetts (USA) because the Ministry did not approve ([UBG] Ms. F. Klein I, B 4). After securing his position, however, he ultimately travelled in 1893 with the official endorsement of the Ministry to Chicago for the World's Fair, which included an educational exhibit and which was being held in conjunction with a mathematics conference. While there, Klein gave twelve presentations on the latest findings in mathematics. He spoke about the work of Clebsch and Sophus Lie, algebraic functions, the theory of functions and geometry, pure and applied mathematics and their relation, the transcendence of the numbers  $e$  and  $\pi$ , ideal numbers, the solution of higher algebraic equations, hyperelliptic and Abelian functions, non-Euclidean geometry, and the study of mathematics at Göttingen (Klein 1894). In his talks, Klein gave particular weight to his own recent findings and to those of his students and collaborators, thus waging a successful publicity campaign for studying at the University of Göttingen (see Parshall and Rowe 1994). With these lectures, which were later translated into French at the instigation of Charles Hermite (1822–1901), Klein did much to increase his international profile.

During the 1890s, Hermite occasioned additional translations of Klein's work (on geometric number theory, the hypergeometric function, etc.), most of which appeared in the *Nouvelles annales de mathématiques, journal des candidats aux écoles polytechnique et normale*, which was then edited by Charles-Ange Laisant (1841–1920). Hermite gushed that Klein was “like a new Joshua in the Promised Land” (*comme un nouveau Josué dans la terre promise*) and nominated him, in 1897, to become a corresponding member of the Académie des Sciences in Paris (Tobies 2016). By

this time, Klein was already a member of numerous other academies in Germany, Italy, Great Britain, Russia, and the United States. When, in 1899, Laisant and the Swiss mathematician Henri Fehr (1870–1954) founded the journal *L'Enseignement mathématique*, Klein was made a member of its Comité de Patronage, which consisted of twenty mathematicians from sixteen countries. As the first international journal devoted to mathematical education, it published several reports concerning educational reforms, including essays by Klein (in French translation). Fehr reviewed Klein's books for the journal, among them his *Elementarmathematik vom höheren Standpunkte aus* ("Elementary Mathematics from an Advanced Standpoint," as the work would be known in English).

*L'Enseignement mathématique* became the official organ of the International Commission on the Teaching of Mathematics, which was founded in 1908 at the Fourth International Congress of Mathematicians in Rome. Klein's election to the board of this commission, which took place despite his absence from the conference, was a testament to his international reputation (see Coray et al. 2003). As president of this commission (from 1908 to 1920), Klein initiated regular conferences and publications devoted to the development of mathematical education not only in Germany but in all of the countries involved.

- (4) Felix Klein followed a principle of *universality*. When asked to characterize his efforts, he himself spoke about his universal program. As a young researcher, he wanted to familiarize himself with all branches of mathematics and to contribute to each of them in his own work, an approach that gave rise to his principles of transference (*Übertragungsprinzipien*) and his "mixture" of mathematical methods. Inspired by Clebsch, he also attempted from quite early on to bring together people with different areas of mathematical expertise in an effort to overcome disciplinary divides (see Tobies and Volkert 1998). This end was likewise served by his large-scale undertaking of the *Encyclopädie der mathematischen Wissenschaften*, for which he recruited international experts to provide an overview of all of mathematics and its applications (Tobies 1994). Klein's participation in the preparations for the *International Catalogue of Scientific Literature* (1902–21), which was directed by the Royal Society of London, can also be interpreted in this way.

Klein's universal program not only involved supporting and advancing new and marginal disciplines. He applied his universal approach to teaching as well. He promoted talented scholars regardless of their nationality, religion, or gender. Although a university professor, he was deeply interested in improving and fostering mathematical and scientific education from kindergarten onward. In this regard, Klein operated according to one of the guiding pedagogical mottos of the nineteenth century: "Teach everything to everyone."

### 1.3 Educational Reform and Its Institutional and International Scope

From early on, Klein felt that the mathematical education being offered at secondary institutions, which neglected applied mathematics and was based primarily on synthetic geometry, was in need of reform. Even while still a doctoral student, he argued that new geometric methods ought to be introduced into the curriculum to complement Euclidian geometry. In this matter, he found an ally in Gaston Darboux, as is documented in their correspondence from the 1870s (Richter 2015).

In 1890, the teachers of mathematics and the natural sciences at secondary schools founded an Association for the Promotion of Mathematical and Natural-Scientific Education (*Verein zur Förderung des mathematischen und naturwissenschaftlichen Unterrichts*) in order to be on equal footing with their colleagues in the philological and historical disciplines. When public discussions began to be held about designing new curricula, Klein felt that the time was ripe for reform. He developed a course of study for educating teaching candidates at the university level; he began to teach, as of 1892, continuing education courses for teachers who were already working; and he soon developed contacts with the association named above (Tobies 2000). For the year 1895, Klein invited the association to hold its annual conference in Göttingen. Here he was sure to showcase the university's modern facilities, and he celebrated the event by presenting the attendees with a book concerned with question of elementary geometry (Klein 1895), a work which was soon translated into French (1896), Italian (1896), and English (1897).

The Prussian Ministry of Culture honored Klein with decorations and titles. Althoff turned to Klein as an advisor in matters of hiring and other affairs. In Göttingen, two additional professors were hired to join Klein and Hilbert: Hermann Minkowski (1864–1909) in 1901, who was succeeded in 1909 by the number theorist Edmund Landau (1877–1938); and Carl Runge (1856–1927) in 1904, who was appointed as the first professor of applied mathematics at a German university. Under Klein's guidance, further expansions were made in the fields of technical mechanics, applied electricity theory, and geophysics.

In 1899, and with the backing of the Ministry of Culture, Klein supported an initiative that would allow Prussian technical colleges to grant doctoral degrees. By preparing a series of commissioned reports and by participating in a school conference in Berlin in 1900 (see Schubring 1989), Klein contributed to an imperial decree (issued that same year) which mandated that the diplomas (*Abitur*) granted by the three existing types of secondary schools for boys (the so-called *Humanistisches Gymnasium*, *Realgymnasium*, and *Oberrealschule*) would henceforth be regarded as equal. Until then, the graduates of *Oberrealschulen* had been at a disadvantage. At the same time, a process was begun to modernize mathematical and scientific education at all sorts of schools. The principle aims were to accord a central position of the notion of the function, to teach of analytic geometry, and to incorporate elements of differential and integral calculus, application-oriented instruction, and genetic methods. Having served three terms (1897, 1903, 1908) as the chairman

of the German Mathematical Society (*Deutsche Mathematiker-Vereinigung*), which was founded in 1890, Klein also took advantage of this venue to enhance discussions about pedagogical issues.

In the wake of the school conference in Berlin, Klein also came to be regarded as an expert by biologists, who requested his assistance in reintroducing the subjects of botany and zoology as components of higher education (the latter had been banned in Prussia since 1879 on account of the Darwinian theory of evolution). In response, Klein convened a meeting of Göttingen professors on the philosophical faculty in order to weigh the demands of the biologists without disadvantaging any other fields. This led to the creation of an additional organization within the framework of the Society of German Natural Scientists and Physicians (*Gesellschaft deutscher Naturforscher und Ärzte*), which, at its annual meeting in 1904, formed a twelve-member education committee in order to develop reformed curricula for all types of schools. Klein deployed his friend August Gutzmer (1860–1924) as the director of this committee, while Klein himself acted on behalf of the German mathematical society and spoke to audiences of philologists and historians in order to win their support for the proposed reforms to the mathematical and scientific curricula.

Plans for the reform were presented and discussed at conferences in Merano (1905), Stuttgart (1906), and Dresden (1907), and they were ultimately published. In order to implement them, a board was formed in 1908 in Cologne—the German Commission for Mathematical and Natural-Scientific Education (*Deutscher Ausschuss für mathematisch-naturwissenschaftlichen Unterricht*)—and Klein was asked to lead its division concerned with teacher education. In the same year, Klein was not only made the president, as mentioned above, of the International Commission on the Teaching of Mathematics; on February 17, 1908, he was also named a member of the upper chamber (House of Lords) of the Prussian House of Representatives (Tobies 1989). The invitation to join the House of Lords was an expression of Klein's status at the University of Göttingen, for his mandate as a member was to represent the university. Klein, who was nonpartisan, succeeded Göttingen's previous representative, the professor of ecclesiastical law Richard Wilhelm Dove (1833–1907), in this lifelong position (which, for Klein, ended in 1918 with the end of the German Empire). Here he took advantage of the alliances formed by the Göttingen Association for the Promotion of Applied Physics and Mathematics between science, industry, and the government to abet the implementation of educational reforms. In the speeches that he delivered in House of Representatives, he advocated for improving educational standards at all types of schools, including primary schools, schools for girls, and trade schools.

Klein was a firm believer in the equal abilities of men and women, and he accordingly believed that they should have access to the same educational opportunities. As early as 1893, he arranged for the first women to study under his supervision, even though women were officially not allowed to enroll in Prussian universities until 1908. By 1895, the Englishwoman Grace Chisholm (1868–1944) and the American Mary F. Winston (1869–1959) had submitted their dissertations to him. Numerous additional students—both men and women, from Germany and abroad—would come

to study under him (Tobies 1991/1992, 2019); in all, he supervised more than fifty dissertations.

The fact that Klein took a parliamentary position—and that he was the first German mathematician to do so—is best understood from an international perspective. In this matter, his role models were colleagues from Italy and France. According to Hilbert, Darboux influenced Klein's interest in educational reform in a particular way. Since 1888, Darboux had been a member of the French High Council for Public Education (*Conseil supérieur de l'instruction publique*), and in 1908 he was made the vice president of the Council's standing committee for advising the government in educational affairs (Richter 2015, p. 20). Darboux directed the French branch of the International Commission on the Teaching of Mathematics while the German subcommittee was being led by Klein.

As originally planned, the aforementioned *Encyklopädie der mathematischen Wissenschaften mit Einschluss ihrer Anwendungen*, which appeared in six comprehensive volumes, was intended to contain a seventh volume devoted to the history, philosophy, and didactics of mathematics. After initial plans were discussed in May of 1896, publications in *L'Enseignement mathématique* and further studies commissioned by the International Commission on the Teaching of Mathematics promoted the preparation of the volume. As late as April of 1914, Klein arranged for Heinrich Emil Timerding (1873–1945), the intended editor of the work, to attend the Congrès de philosophie mathématique in Paris. The First World War, however, prevented the project from being completed (Tobies 1994, pp. 56–69), just as it had stalled so many international collaborations (see Siegmund-Schultze 2011).

On March 15, 1915, the Académie des Sciences in Paris annulled Klein's membership because he had signed the so-called “Manifesto of the Ninety-Three,” a nationalistic proclamation in support of German military action. In a detailed study, Tollmien (1993) has demonstrated that Klein, like a number of other German scientists, had not been fully aware of what he was signing, that he regretted doing so, and that—unwilling to repay like with like—he discouraged German academies from expelling French scientists. As a member of the Prussian House of Lords, Klein issued a memorandum in March of 1916 that called for a thorough investigation of conditions abroad after war's end. To the international boycott of German scientists after the war, Klein responded with the motto “Keep quiet and work.” In his memoirs, he looked back fondly on his strong contacts with foreign scientists, and he lamented the period of nationalistic antagonism (Klein 1923).

When, in 1920, the Emergency Association of German Science (the German Research Foundation today) was formed as an organization for funding research, Klein was elected as the first chairperson of the committee (*Fachausschuss*) for mathematics, astronomy, and geodesy. While an anti-technical mood was setting in after the defeat in the First World War, and while the number of lessons in mathematics and the natural sciences at secondary schools were being reduced, Klein supported a nationwide union, the *Mathematischer Reichsverband* (1921), to counter such trends. When, in the same year, Richard von Mises (1883–1953) founded the *Zeitschrift für angewandte Mathematik und Mechanik*, which is still in circulation today, Klein applauded this achievement and saw in it the realization of one of his own goals,

which he had attempted to achieve in 1900 by coordinating the specializations of German mathematical journals.

Klein's vision was to accommodate all branches of mathematics and to secure a firm place for mathematics within the "culture of the present," that is, to make it a necessary component of other sciences, technology, and general education. He had been pursuing this vision with greater and greater vigor and detail ever since he had delivered his Erlangen inaugural lecture in 1872. To realize it, he endeavored to cater his arguments to the interests of his audiences, which included industrialists and government officials, and to underscore the importance of international connections to developments in Germany (see Siegmund-Schultze 1997). In light of Klein's integrative approach to mathematics, its applications, and its instruction, it might be appropriate to end with the following remark about him by Richard von Mises: "We see that the value and dignity of the works that he accomplished are in perfect harmony with the significance of the man behind them" (1924, p. 86).

*Translated by Valentine A. Pakis*

## Bibliography

- Born, M., & Born, H. (1969). In A. Hermann (Ed.), *Der Luxus des Gewissens: Erlebnisse und Einsichten im Atomzeitalter*. Munich: Nymphenburger Verlag.
- Coen, S. (Ed.). (2012). *Mathematicians in Bologna 1861–1960*. Basel: Birkhäuser.
- Coray, D., Furinghetti, F., Gispert, H., Hodgson, B. R., & Schubring, G. (Eds.). (2003). One hundred years of L'Enseignement Mathématique. In *Proceedings of the EM-ICMI Symposium*, October 20–22, 2000. Genève: L'Enseignement mathématique.
- Frei, G. (Ed.). (1985). *Der Briefwechsel David Hilbert – Felix Klein (1886–1918)*. Göttingen: Vandenhoeck & Ruprecht.
- Fricke, R., & Klein, F. (1897/1912). *Vorlesungen über die Theorie der automorphen Funktionen* (2 vols.). Leipzig: B.G. Teubner.
- Gispert, H. (1999). Les débuts de l'histoire des mathématiques sur les scènes internationales et le cas de l'entreprise encyclopédique de Felix Klein et Jules Molk. *Historia Mathematica*, 26, 344–360.
- Gray, J. (2012). *Henri Poincaré: A scientific biography*. Princeton: Princeton University Press.
- [Gymnasium Düsseldorf] Felix Klein's diploma from August 2, 1865; written examinations in German.
- Hashagen, U. (2003). *Walther von Dyck (1856–1934) Mathematik, Technik und Wissenschaftsorganisation an der TH München*. Stuttgart: Steiner.
- Hensel, S., Ihmig, K. N., & Otte, M. (1989). *Mathematik und Technik im 19. Jahrhundert*. Göttingen: Vandenhoeck & Ruprecht.
- Jacobs, K. (Ed.). (1977). Felix Klein. *Handschriftlicher Nachlass*. Erlangen: Mathematisches Institut der Universität.
- Ji, L., & Papadopoulos, A. (Eds.). (2015). *Sophus Lie and Felix Klein: The Erlangen program and its impact in mathematics and physics*. IRMA Lectures in Mathematics and Theoretical Physics (Vol. 23). Zurich: European Mathematical Society.
- Klein, F. (Ed.). (1869). *Julius Plücker: Neue Geometrie des Raumes gegründet auf die Betrachtung der geraden Linie als Raumelement, Zweite Abtheilung*. Leipzig: B.G. Teubner.
- Klein, F. (1872). *Vergleichende Betrachtungen über neuere geometrische Forschungen: Programm zum Eintritt in die philosophische Facultät und den Senat der k. Friedrich-Alexanders-Universität zu Erlangen*. Erlangen: Andreas Deichert. English translation (1893): A comparative review of



- recent researches in geometry (M. W. Haskell, Trans.). *Bulletin of the New York Mathematical Society*, 2, 215–249.
- Klein, F. (1894). *The Evanston colloquium: Lectures on mathematics*. Delivered from August 28 to September 9, 1893, before members of the Congress of Mathematics held in connection with the World's Fair in Chicago at Northwestern University, Evanston, IL, reported by Alexander Ziwet. New York: Macmillan & Co. Republished by the American Mathematical Society, New York, 1911.
- Klein, F. (1895). *Vorträge über ausgewählte Fragen der Elementargeometrie, ausgearbeitet von F. Tägert: Eine Festschrift zu der Pfingsten 1895 in Göttingen stattfindenden dritten Versammlung des Vereins zur Förderung des Mathematischen und Naturwissenschaftlichen Unterrichts*. Leipzig: B. G. Teubner. *Leçons sur certaines questions de géométrie élémentaire: possibilité des constructions géométriques; les polygones réguliers; transcendance des nombres  $e$  et  $\pi$* . (Démonstration élémentaire) Rédaction française autorisée par l'auteur par J. Griess. Paris: Nony et Cie. Italian translation (1896); English translation (1897): *Famous problems of elementary geometry* (W. W. Beman & D. E. Smith, Trans). Boston: Ginn.
- Klein, F. (1905). Über die Aufgabe der angewandten Mathematik, besonders über die pädagogische Seite. In A. Krazer (Ed.), *Verhandlungen des III. Internationalen Mathematiker-Kongresses in Heidelberg* (pp. 396–398). August 8–13, 1904. Leipzig: B.G. Teubner.
- Klein, F. (Ed.). (1912). *Die mathematischen Wissenschaften* (Die Kultur der Gegenwart 3/1). Leipzig: B.G. Teubner.
- Klein, F. (1921–1923). *Gesammelte mathematische Abhandlungen [=GMA]* (3 vols.). Berlin: Springer.
- Klein, F. (1923). Göttinger Professoren (Lebensbilder von eigener Hand): Felix Klein. *Mitteilungen des Universitätsbundes Göttingen*, 5, 11–36.
- Klein, F., & Fricke, R. (1890/1892). *Vorlesungen über die Theorie der elliptischen Modulfunctionen* (2 vols.). Leipzig: B.G. Teubner.
- Klein, F., & Sommerfeld, A. (1897–1910). *Über die Theorie des Kreisels* (4 vols). Leipzig: B. G. Teubner. English Translation (2008–2014): *The theory of the top* (4 vols.). Basel: Birkhäuser.
- Parshall, K. H. (2006). *James Joseph Sylvester: Jewish mathematician in a Victorian World*. Baltimore: The John Hopkins University Press.
- Parshall, K. H., & Rowe, D. E. (1994). *The emergence of the American Mathematical Research Community (1876–1900): J. J. Sylvester, Felix Klein, and E. H. Moore*. Series in the History of Mathematics (Vol. 8). Providence: American Mathematical Society.
- [Protocols] Felix Klein's protocols from his mathematics seminars. Bibliothek des Mathematischen Instituts der Universität Göttingen (online: <http://www.uni-math.gwdg.de/aufzeichnungen/kleinscans/klein/>).
- Richter, T. (2015). *Analyse der Briefe des französischen Mathematikers Gaston Darboux (1842–1917) an den deutschen Mathematiker Felix Klein (1849–1925)*. Wissenschaftliche Hausarbeit zur Ersten Staatsprüfung für das Lehramt an Gymnasien im Fach Mathematik. Friedrich-Schiller-Universität Jena.
- Rowe, D. E. (1986). 'Jewish Mathematics' at Göttingen in the era of Felix Klein. *Isis*, 77, 422–449.
- Rowe, D. E. (1989). The early geometrical works of Sophus Lie and Felix Klein. In D. E. Rowe & J. McCleary (Eds.), *The history of modern mathematics* (Vol. 1, pp. 209–273). Boston: Academic Press.
- Rowe, D. E. (1992). Klein, Mittag-Leffler, and the Klein-Poincaré Correspondence of 1881–1882. In: S. Demidov et al. (Eds.), *Amphora: Festschrift für Hans Wussing* (pp. 597–618). Basel: Birkhäuser.
- Schubring, G. (1989). Pure and applied mathematics in divergent institutional settings in Germany: The role and impact of Felix Klein. In D. E. Rowe & J. McCleary (Eds.), *The history of modern mathematics* (Vol. 2, pp. 171–220). Boston: Academic Press.
- Schubring, G. (2016). Die Entwicklung der Mathematikdidaktik in Deutschland. *Mathematische Semesterberichte*, 63, 3–18.

- Siegmund-Schultze, R. (1997). Felix Kleins Beziehungen zu den Vereinigten Staaten, die Anfänge deutscher auswärtiger Wissenschaftspolitik und die Reform um 1900. *Sudhoffs Archiv*, 81, 21–38.
- Siegmund-Schultze, R. (2011). Opposition to the Boycott of German mathematics in the Early 1920s: Letters by Edmund Landau (1877–1938) and Edwin Bidwell Wilson (1879–1964). *Revue d'Histoire des Mathématiques*, 17, 135–161.
- Stubhaug, A. (2002). *The mathematician Sophus Lie* (R. H. Daly, Trans.). Berlin: Springer.
- Tobies, R., with the assistance of König, F. (1981). *Felix Klein. Biographien hervorragender Naturwissenschaftler, Techniker und Mediziner* (Vol. 50). Leipzig: B.G. Teubner.
- Tobies, R. (1989). Felix Klein als Mitglied des preußischen Herrenhauses: Wissenschaftlicher Mathematikunterricht für alle Schüler – auch für Mädchen und Frauen. *Der Mathematikunterricht*, 35, 4–12.
- Tobies, R. (1991). Wissenschaftliche Schwerpunktbildung: Der Ausbau Göttingens zum Zentrum der Mathematik und Naturwissenschaften. In B. V. Brocke (Ed.), *Wissenschaftsgeschichte und Wissenschaftspolitik im Industriezeitalter: Das "System Althoff" in historischer Perspektive* (pp. 87–108). Hildesheim: Lax.
- Tobies, R. (1991/1992). Zum Beginn des mathematischen Frauenstudiums in Preußen. *NTM-Schriftenreihe für Geschichte der Naturwissenschaften, Technik und Medizin*, 28, 7–28.
- Tobies, R. (1994). Mathematik als Bestandteil der Kultur: Zur Geschichte des Unternehmens. *Encyklopädie der mathematischen Wissenschaften mit Einschluss ihrer Anwendungen. Mitteilungen der Österreichischen Gesellschaft für Wissenschaftsgeschichte*, 14, 1–90.
- Tobies, R. (1999). Der Blick Felix Kleins auf die Naturwissenschaften: Aus der Habilitationsakte. *NTM-Internationale Zeitschrift für Geschichte und Ethik der Naturwissenschaften, Technik und Medizin*, 7, 83–92.
- Tobies, R. (2000). Felix Klein und der Verein zur Förderung des mathematischen und naturwissenschaftlichen Unterrichts. *Der Mathematikunterricht*, 46, 22–40.
- Tobies, R. (2002). The development of Göttingen into the Prussian Centre of Mathematics and the exact sciences. In N. Rupke (Ed.), *Göttingen and the development of the natural sciences* (pp. 116–142). Göttingen: Wallstein.
- Tobies, R. (2006). Die Mathematik und ihre Anwendungen 'allseitig' entwickeln: Felix Klein zum 150. Geburtstag. In M. Toepell (Ed.), *Mathematik im Wandel* (pp. 9–26). Hildesheim: Franzbecker.
- Tobies, R. (2008). Mathematik, Naturwissenschaften und Technik als Bestandteile der Kultur der Gegenwart. *Berichte zur Wissenschaftsgeschichte*, 31, 29–43.
- Tobies, R. (2012). Iris Runge: A life at the crossroads of mathematics, science, and industry. With a Foreword by Helmut Neunzert (V. A. Pakis, Trans.) (=Science networks. Historical studies, Vol. 43). Basel: Birkhäuser.
- Tobies, R. (2016). Felix Klein und französische Mathematiker. In T. Krohn & S. Schöneburg (Eds.), *Mathematik von einst für jetzt* (pp. 103–132). Hildesheim: Franzbecker.
- Tobies, R. (2019). Internationality: Women in Felix Klein's courses at the University of Göttingen. In E. Kaufholz & N. Oswald (Eds.), *Against all odds. The first women in mathematics at European Universities—A comparative approach*. Berlin: Springer (forthcoming).
- Tobies, R., & Rowe, D. E. (Eds.). (1990). *Korrespondenz Felix Klein – Adolph Mayer: Auswahl aus den Jahren 1871 bis 1907*. Teubner-Archiv zur Mathematik (Vol. 14). Leipzig: B.G. Teubner.
- Tobies, R., & Volkert, K. (1998). *Mathematik auf den Versammlungen der Gesellschaft deutscher Naturforscher und Aerzte, 1843–1890* (=Schriftenreihe zur Geschichte der Versammlungen deutscher Naturforscher und Aerzte, Vol. 7). Stuttgart: Wissenschaftliche Verlagsgesellschaft.
- Tollmien, C. (1993). Der 'Krieg der Geister' in der Provinz: Das Beispiel der Universität Göttingen 1914–1919. *Göttinger Jahrbuch*, 41, 137–209.
- [UBG] Niedersächsische Staats- und Universitätsbibliothek Göttingen, Handschriftenabteilung, Cod. Ms. F. Klein.
- von Mises, R. (1924). Felix Klein: Zu seinem 75. Geburtstag am 25. April 1924. *Zeitschrift für angewandte Mathematik und Mechanik*, 4, 86–92.

**Open Access** This chapter is licensed under the terms of the Creative Commons Attribution 4.0 International License (<http://creativecommons.org/licenses/by/4.0/>), which permits use, sharing, adaptation, distribution and reproduction in any medium or format, as long as you give appropriate credit to the original author(s) and the source, provide a link to the Creative Commons license and indicate if changes were made.

The images or other third party material in this chapter are included in the chapter's Creative Commons license, unless indicated otherwise in a credit line to the material. If material is not included in the chapter's Creative Commons license and your intended use is not permitted by statutory regulation or exceeds the permitted use, you will need to obtain permission directly from the copyright holder.



# Chapter 2

## What Is or What Might Be the Legacy of Felix Klein?



Hans-Georg Weigand

**Abstract** Felix Klein was an outstanding mathematician with an international reputation. He promoted many aspects of mathematics, e.g. practical applications and the relation between mathematics and natural sciences but also the theory of relativity, modern algebra, and didactics of mathematics. In this article about the *The Legacy of Felix Klein* we firstly refer to his ideas in university teaching of mathematics teacher students and the three books “Elementary Mathematics from a higher (advanced) standpoint” from the beginning of the last century. Secondly we refer to his interests in school mathematics and his influence to the “Merano Resolution” (1905) where he pleaded for basing mathematics education on the concept of function, an increased emphasis on analytic geometry and an introduction of calculus in secondary schools. And thirdly we especially discuss the meaning and the importance of Klein’s ideas nowadays and in the future in an international, worldwide context.

**Keywords** Felix Klein · History · Legacy · University teaching

### 2.1 Felix Klein as a Sensitised Mathematician

When we talk about the legacy of Felix Klein, we are interested in the significance of Felix Klein’s work for mathematics and especially mathematics education, for our current theory and practice, and above all for tomorrow’s ideas concerning the teaching and learning of mathematics. We are interested in Felix Klein as a mathematician, as a mathematics teacher; but most of all, we are interested in his ideas on teaching and learning mathematics, the problems he saw at university and at secondary school level, and the solutions that he suggested for these problems. We are interested in these solutions because we recognize that we are nowadays confronted with similar or even the same problems as 100 years ago (Klein 1909–1916). Talking about Felix Klein’s legacy means hoping to find answers to some of the problems we

---

H.-G. Weigand (✉)

University of Wuerzburg, Wuerzburg, Germany  
e-mail: weigand@mathematik.uni-wuerzburg.de

© The Author(s) 2019

H.-G. Weigand et al. (eds.), *The Legacy of Felix Klein*, ICME-13 Monographs,  
[https://doi.org/10.1007/978-3-319-99386-7\\_2](https://doi.org/10.1007/978-3-319-99386-7_2)

are struggling with today. Talking about the Felix Klein's legacy today means giving answers to—at least—three basic questions:

- Which situations and which problems at the end of the 19th and the beginning of the 20th century can be seen in analogy to present situations?
- How did Felix Klein react to these problems and which solutions did he suggest?
- What do we know nowadays about the effect of the answers and solutions provided by Felix Klein 100 years ago?

Analogies between the situation 100 years ago and today can immediately be seen if we think about the current discussions concerning the goals and contents of teacher education at university level and especially the problems of students with the transition from high school to college or university and the transition back to high school. The problems with these transitions are expressed in Felix Klein's most famous statement, the “double discontinuity” from the introduction to the “Elementary mathematics from a higher standpoint, Volume I” (1908):

The young university student finds himself, at the outset, confronted with problems, which do not remember, in any particular, the things with which he had been concerned at school. Naturally he forgets all these things quickly and thoroughly. When, after finishing his course of study, he becomes a teacher, he suddenly finds himself expected to teach the traditional elementary mathematics according to school practice; and, since he will be scarcely able, unaided, to discern any connection between this task and his university mathematics, he will soon fall in with the time honoured way of teaching, and his university studies remain only a more or less pleasant memory which has no influence upon his teaching. (Klein 2016 [1908], Introduction, Volume 1, p. 1)

When we hear the lamentations of today's university professors about the decreasing abilities of freshmen, and when we note the negative views of young teachers about the effects of their mathematics studies, you can surely be in doubt whether there has been any change, or indeed any change at all in the last 100 years.

However, we also know that answers to problems in education—not limited to mathematics education—can only be offered taking full recognition of the current political, social and scientific situation. Answers are not and will never be general statements, they always have to be newly evaluated in an ongoing process of discussion between different social groups. What is or what might be the impact of Felix Klein's ideas on these current discussion processes?

Felix Klein's life shows that it always needs a sensitised person to analyse the environment and to think in a visionary manner. Felix Klein is an example of just such a person who recognized problems, thought about solutions, suggested changes, was driven by external requests and changed his mind based on personal experiences. In the following we try to highlight some characteristics of Felix Klein we see as the background of his way of thinking and the basis of the legacy of Felix Klein.

## 2.2 Felix Klein Recognized Problems and Described Them in Detail

In 1872—at the age of 23—Felix Klein became professor at the University of Erlangen. In his inaugural address, the *Erlanger Antrittsrede* (see Rowe 1985)—which was not published during his lifetime and must not be confused with the “Erlangen programme”—he considered the dichotomy, the division, between humanistic and scientific education. He therefore felt there was a lack of widespread knowledge of mathematics in society. For Felix Klein mathematics had been a formal educational tool for training the mind and he claimed mathematics lessons at school were not “developing a proper feeling for mathematical operations or promoting a lively, intuitive grasp of geometry.” (ibid., p. 139). Further, he voiced his view on mathematics education:

We want the future teacher to stand *above* his subject, that he have a conception of the present state of knowledge in his field, and that he generally be capable of following its further development. (ibid., p. 128)

Felix Klein recognized problems concerning the acceptance of mathematics in society and deficits of school mathematics, but—at this age or state of his thinking—he did not have a detailed plan or strategy to solve these problems. But it was the beginning of a long standing lifelong involvement in mathematics education at the university and at secondary school level.

## 2.3 Felix Klein Thought About Solutions for Problems

Felix Klein wanted to improve secondary mathematics by improving the preparation of teachers.

It is here that we, as university teachers of mathematics, have a wide, and hopefully rewarding, field for our activity. At stake is the task, precisely in the sense just mentioned, of raising the standards of mathematical education for later teaching candidates to a level that has not been seen for many years. If we educate better teachers, then mathematics instruction will improve by itself, as the old consigned form will be filled with a new, revitalized content! In recent years the situation has already improved in many respects, as the number of younger teachers. (Rowe 1985, p. 139)

“Better education” means—for Felix Klein—going beyond the contents of school level, but moreover, teachers should be aware of the present state of mathematics science.

We want the future teacher to stand *above* his subject, that he has a conception of the present state of knowledge in his field, and that he generally be capable of following its further development. (ibid.)

Also nowadays, we—of course—support Felix Klein in his opinion on teachers standing above their subject, and we also agree and support him for wanting teacher

students to do “an independent research study” and asked for “mathematical exercises and seminars for student participants” (ibid.). In the meanwhile, bachelor or master thesis and seminars are compulsory for teacher students which means this is a possibility to integrate them into research studies, either in mathematics, mathematics education, pedagogy or psychology. But it was and still is an open question how this education influenced and influences mathematics teaching and learning at school. Moreover, the more general question can be asked of how the connection between school and university mathematics can be established.

## 2.4 Felix Klein Suggested Changes not Only in General, but also in a Specific Way

Criticizing mathematics teacher education, mathematics in school or the way mathematics is taught at school was and is quite popular. The present state of an education system is always a compromise and will never fulfil the widespread and sometimes contradictory interests of professors, teachers, students, parents, heads of schools, policymakers and economic people. But criticizing is only a first step; moreover, it is important to provide suggestions for changes or alternative ways of teaching. Felix Klein not only criticized education circumstances and thought about alternatives in a general way, he suggested changes in specific ways and presented very particular moves to new approaches.

In the following we give two examples for Klein’s ideas about changes in teacher education:

- In his *Antrittsrede* (inaugural address) 1880 at the university of Leipzig “Über die Beziehungen der neueren Mathematik zu den Anwendungen” (Concerning the connection between the newer mathematics and the applications—published first in 1895a), Felix Klein wanted to respond to the fragmentation of the science of mathematics by introducing *general* elementary as well as *specialization* lessons and—what was completely new at this time—a with his university colleagues concerted study plan for students.
- Nowadays, we have the suggested subdivision in the form of bachelor and master studies. But although these ideas might point in a direction of Felix Klein’s ideas, it cannot be assumed that he also had supported the reduction and bureaucratic regimentation of the bachelor studies especially.
- Teacher education at university should be restructured by introducing new lectures, seminars and student exercises especially. Felix Klein supported exercises at university because he saw the necessity of educating students to work individually and independently and he created working and reading rooms for students at the university. These suggestions are well-accepted nowadays and hit the spirit of the *Reform Pädagogik* at the beginning of the last century. Moreover, he emphasized the importance of individual *scientific homework for students*, nowadays called bachelor or master thesis (Klein 1895b).

## 2.5 Felix Klein Asked for Change Not Only on the Organizational Level, but He also Suggested Changes in the Way Mathematics Should Be Taught at University

The present discussion about the adequate way of teaching and learning mathematics at the university asks on the one side for the contents, the changes, and refreshment of the current contents, on the other side it asks for new methods of learning and teaching. While there is a common agreement on the importance of the traditional lectures “calculus” and “linear algebra”, there are open questions about the necessity of “bridging-the-gap-lectures” and additional tutoring classes for freshmen or basic lectures in set theory, number theory, logics or computational mathematics. Concerning new teaching methods there are a lot of suggestions like integrating digital technologies, fostering self-reliance of students and introducing new concepts like the “inverted classroom”, “learning by teaching”, “research-based learning”, “e-learning” or “blended learning” in university teaching.

For Felix Klein, the abstract character of mathematics was a big problem in teaching mathematics: “It is the great abstractness we have to combat”<sup>1</sup> (1895a, p. 538). He asked for more visualization or—in German—“Anschauung” in university lectures, but also in the whole learning process. “Anschauung” was of great importance not only for research but also for teaching. He saw “Anschauung” as a basis for a strict logical formal way of thinking. In this context, he had a wide view on “Anschauung”<sup>2</sup>:

- Working with graphs in the frame of functional thinking was part of “Anschauung”.
- Felix Klein created collections of *geometrical models* at the universities of Erlangen, Munich, Leipzig and he completed the already existing collection in Göttingen (see also the article of Halverscheid and Labs in this book). He always emphasized the interrelationship between the representation of mathematical objects as models and in their symbolic form.
- Felix Klein always saw the connectivity between pure and applied mathematics. He pleaded for an education in applied mathematics and he even recommended a few semesters of study at a technical university for teacher students.<sup>3</sup>
- Moreover, Felix Klein saw the value of “new technologies” for universities, but also for high school teaching. In the first volume of “Elementary Mathematics from a higher Standpoint” (2016a [1908]) he recommended the calculation machine (Figs. 2.1 and 2.2), a tool which went into mass production towards the end of the 19th century and was widely used in industry and natural sciences: “Above all, every teacher of mathematics should be familiar with it.” (2016a, p. 24). At these times, however, it was too expensive and too unwieldy to be actually used in class rooms. But he also expressed his wish or vision “that the calculating machine, in

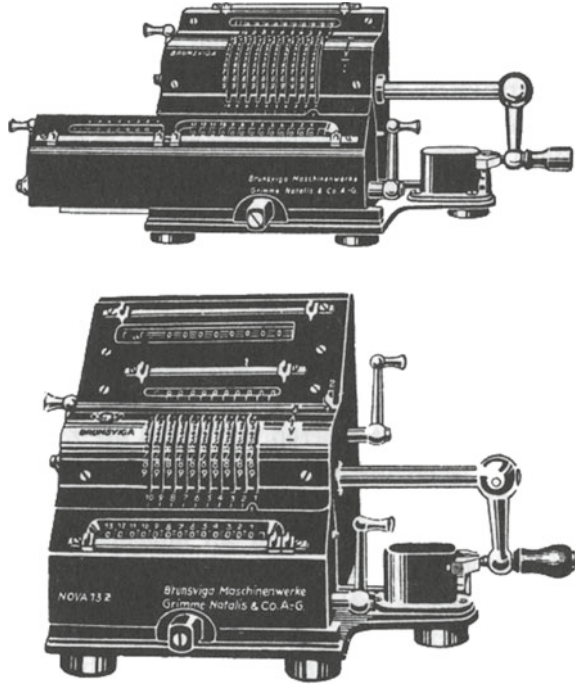
<sup>1</sup>“Es ist ihre (*die der Mathematik, author*) große Abstraktheit, die wir bekämpfen müssen”.

<sup>2</sup>For some information and more details, see the chapter “Intuitive Thinking and Visualisation” in this book.

<sup>3</sup>For an overview of the role of pure and applied mathematics in Germany, see Schubring (1989).



**Fig. 2.1** Pictures in Klein (1908)



**Fig. 2.2** A calculating machine from the beginning of the 20th century



view of its great importance, may become known in wider circles than is now the case.” (ibid.).

The mechanical calculating machine is an example of a tool that enhances human skills by performing mechanical calculations quickly. But it is also a visualizer for

arithmetic calculation methods during multiplication, division or square root extraction.

## **2.6 Felix Klein Was—Like Many of Us—(also) Driven by External Requests, but When He Was Involved in an Activity, He Was Extensively Committed**

Until 1900, Felix Klein criticized mathematics instruction at secondary school level, he gave some constructive proposals for changes, but he did not have or give an overarching strategy for new approaches.<sup>4</sup> In 1900, he was asked by the Prussian ministry to compile an expert report for changes in high school mathematics. Now he thought more deeply about mathematics classrooms and he suggested analytic geometry, descriptive geometry and calculus as new subjects for high school mathematics. With this external request, Felix Klein began his commitment to high school mathematics, leading to the Merano reform in 1905 and finally to the international involvement of Felix Klein as the first president of ICMI in 1908.

It is characteristic of a competent, committed and assertive person who is convinced of the correct goals which are recognised as important that he or she thinks globally about achieving these goals. Felix Klein wanted not only to change the curriculum in schools and teaching education at the university level, he also asked for a special in-service teacher training. At this point, he could build on his experience because he had previously organized courses for teachers during their holidays (see Tobies 2000). And—like always—Felix Klein saw the interrelationship of his activities: On the one hand, teacher training is professional development for the teacher, but on the other hand, he saw these courses as a possibility to give university teachers feedback on the effect of their teaching education.

Nowadays, “scaling up”, or the transfer of research results to schools and classrooms, is an important aspect in educational research (e.g. Wylie 2008). To make this transfer constructive, a close cooperation of teachers, teacher educators, professors from universities, administration people and policy makers is necessary. Felix Klein’s commitment in mathematics education at high school (Gymnasium) level is an example of the effect of the cooperation of different institutions in the education process.

---

<sup>4</sup>In 1898, Felix Klein presented his ideas about future structural changes of the high school system (Klein 1900) in public for the first time. See also Mattheis (2000).

## 2.7 Felix Klein Permanently Critically Considered and Reconsidered His Own Ideas

In his 1923 published memoirs (“Lebenserinnerungen”), Felix Klein mentioned that he already presented a “detailed programme” of his “planned teaching activities” in his inaugural address at Erlangen (Erlanger Antrittsrede). If you read the text of the Antrittsrede and especially the “summary of the Antrittsrede in fifteen points” (Rowe 1985, p. 125), you only recognize fragments of this programme.

Compared to his ideas in his inaugural address in 1872, Felix Klein later on—based on his experience at the Technical University Munich<sup>5</sup>—emphasised much more the meaning of applications in mathematics education, and he also changed his mind concerning teaching of mathematics at school and university. David E. Rowe summarizes these changes of mind:

The ‘Erlanger Antrittsrede’ of 1872, presented herein, gives a clear expression of Klein’s views on mathematics education at the very beginning of his career. While previous writers, including Klein himself, have stressed the continuity between the Antrittsrede and his later views on mathematics education, the following commentary presents an analysis of the text together with external evidence supporting exactly the opposite conclusion. (1985, p. 123)

Originally, Felix Klein saw the teaching of mathematics at the university not in relation to special lectures; later on he emphasized the importance of lectures like “Elementary mathematics from a higher standpoint”. Initially, he was very cautious about new contents or subjects at secondary school, later on—especially in the *Meraner Lehrplan*—he emphasized the meaning of calculus as “the coronation of functional thinking”.

These changes of mind should be seen very positively. It shows Felix Klein as a person, who continuously reflected his own ideas.

## 2.8 Final Remark

The “Legacy of Felix Klein” can only be understood and evaluated if you value the competent, committed and assertive person who reflected throughout his professional life and with his background as a mathematics scientist upon mathematics teaching and learning. We are convinced that Felix Klein is, in his attitude, belief and strength, an example for all people nowadays who are interested in improving mathematics education at university and high school. Many of Felix Klein’s ideas can be reinterpreted in the context of the current situation, and give some hints and advice for dealing with problems in teacher education and teaching mathematics in secondary schools today.

---

<sup>5</sup>Technische Hochschule München.

## References

- Klein, F. (1895a). Über die Beziehungen der neueren Mathematik zu den Anwendungen (25 Oktober 1880). *Zeitschrift für mathematischen und naturwissenschaftlichen Unterricht*, 26, 535–540. Newly edited in: Beckert, H., & Purkert, W. (Eds.). (1987). *Leipziger mathematische Antrittsvorlesungen. Auswahl aus den Jahren 1869–1922. Teubner-Archiv zur Mathematik* (Bd. 8, pp. 40–45). Leipzig: B. G. Teubner.
- Klein, F. (1895b). *Über den mathematischen Unterricht an der Göttinger Universität im besonderen Hinblick auf die Bedürfnisse der Lehramtskandidaten*. Leipzig: B. G. Teubner.
- Klein, F. (1900). Universität und Technische Hochschule. In F. Klein & E. Riecke (Eds.), *Über angewandte Mathematik und Physik in ihrer Bedeutung für den Unterricht an den höheren Schulen* (pp. 229–242). Leipzig: B. G. Teubner.
- Klein, F. (Ed.). (1909–1916). *Abhandlungen über den mathematischen Unterricht in Deutschland, veranlasst durch die Internationale Mathematische Unterrichtskommission* (5 vols.). Leipzig, Berlin: B.G. Teubner.
- Klein, F. (1923). Göttinger Professoren (Lebensbilder von eigener Hand): Felix Klein. *Mitteilungen des Universitätsbundes Göttingen*, 5, 11–36.
- Klein, F. (2016). *Elementary mathematics from a higher standpoint. Volume I: Arithmetic, algebra, analysis* (G. Schubring, Trans.). Berlin, Heidelberg: Springer.
- Mattheis, M. (2000). Felix Kleins Gedanken zur Reform des mathematischen Unterrichtswesens vor 1900. *Der Mathematikunterricht*, 46(3), 41–61.
- Rowe, D. (1985). Felix Klein's "Erlanger Antrittsrede". *Historia Mathematica*, 12, 123–141.
- Schubring, G. (1989). Pure and applied mathematics in divergent institutional settings in Germany: The role and impact of Felix Klein. In: D. E. Rowe & J. McCleary (Eds.), *The history of modern mathematics. Volume II: Institutions and applications*. Boston: Harcourt Brace Jovanovich.
- Tobies, R. (2000). Felix Klein und der Verein zur Förderung des mathematischen und naturwissenschaftlichen Unterrichts. *Der Mathematikunterricht*, 46(3), 22–40.
- Wylie, E. C. (Ed.). (2008). *Tight but loose: Scaling up teacher professional development in diverse contexts*. Princeton: ETS.

**Open Access** This chapter is licensed under the terms of the Creative Commons Attribution 4.0 International License (<http://creativecommons.org/licenses/by/4.0/>), which permits use, sharing, adaptation, distribution and reproduction in any medium or format, as long as you give appropriate credit to the original author(s) and the source, provide a link to the Creative Commons license and indicate if changes were made.

The images or other third party material in this chapter are included in the chapter's Creative Commons license, unless indicated otherwise in a credit line to the material. If material is not included in the chapter's Creative Commons license and your intended use is not permitted by statutory regulation or exceeds the permitted use, you will need to obtain permission directly from the copyright holder.



## Part II

# Functional Thinking

### William McCallum

Part II examines the function concept in school mathematics as it has evolved from Klein's time.

Katja Krüger describes the goals of the Prussian reform movement at the beginning of the twentieth century in the *Meraner Lehrplan*, particularly their call for functional thinking as a foundational principle. Krüger describes the impact of this movement on German mathematics education, using examples from textbooks and writings for teachers, which shows a focus on a dynamic conception of function. She also describes the work of mathematics teachers influenced by Klein and the wider group of educators and mathematicians of which he is a member.

Patrick W. Thompson and Fabio Milner describe the results of a comparative study of secondary teachers from South Korea and the USA. They examine the meanings that teachers attached to functions and function notation by looking at results from the instrument *Mathematical Meanings for Teaching secondary mathematics* developed by the first author and collaborators. They find significant differences between the mathematical meanings of South Korean and US teachers and conclude with the observation that in the US Klein's double discontinuity is in fact a continuity of flawed meanings that prospective teachers carry throughout their university careers and bring back to the school classroom.

Hyman Bass studies an important component of the function concept in school mathematics, the notion of a continuous number line that provides the domain for most functions students encounter. There is evidence that many students in the US lack a robust understanding of this continuum. Bass compares the construction narrative of the number line, common in US curricula, with the occupation narrative proposed by V. Davydov, in which numbers are discovered rather than built. The article describes activities from Davydov's work and concludes with a description of some advantages of the approach.

Finally, William McCallum examines the image of the function concept in school mathematics, using internet image search. Searches in different languages produce collections with a greater or lesser degree of mathematical coherence and mathematical fidelity. The results vary along multiple dimensions: the presence of

visible connections between ways of presenting functions; the density of meaningful annotation; the degree to which components are semantic rather than pictorial; and the extent to which extraneous features of an image violate mathematics properties. This also reveals a tension between the dynamic and static conceptions of function. These variations suggest directions of growth in professional discernment for in communities of educators.

# Chapter 3

## Functional Thinking: The History of a Didactical Principle



Katja Krüger

**Abstract** Establishing the habit of functional thinking in higher maths education was one of the major goals of the Prussian reform movement at the beginning of the 20th century. It had a great impact on the German school system. Using examples taken from contemporary schoolbooks and publications, this paper illustrates that functional thinking did not mean teaching the concept of function as we understand it today. Rather, it focusses on a specific kinematic mental capability that can be described by investigating change, variability, and movement.

**Keywords** Functional thinking · *Meraner Lehrplan* · Principle of movement  
Mathematical mental representations · Fundamental ideas

The Prussian *Meraner Lehrplan* (Meran curriculum) first called for education in functional thinking as a requirement of teaching mathematics in high schools in 1905. Henceforth it became a widely accepted motto of the reform movement in Germany and elsewhere (Hamley 1934). What then did Felix Klein and his contemporaries mean by this concept?

Firstly, this paper outlines the objectives of the *Meraner Lehrplan*. Secondly, it illustrates how functional thinking focussed on a specific habit of thinking with examples from contemporary representative textbooks and mathematical journals for teachers. Furthermore, functional thinking emerged in the *Meraner Lehrplan* as a guiding category for teaching mathematics in order to concentrate, unify and structure different areas of mathematics taught in schools. It marks an important stage in the development of so-called fundamental ideas (*fundamentale Ideen*), a didactical category that is now widely used in German-speaking countries. This paper pays particular attention to the practical work of mathematics teachers—contemporaries of Felix Klein—highlighting their efforts in developing subject-related teaching methods. This paper will demonstrate that education in functional thinking was connected with the idea of using mental representations of mathematical concepts (*Grundvorstellungen*, according to vom

---

K. Krüger (✉)  
University of Paderborn, Warburgerstr. 100, 33098 Paderborn, Germany  
e-mail: kakruege@math.uni-paderborn.de

© The Author(s) 2019  
H.-G. Weigand et al. (eds.), *The Legacy of Felix Klein*, ICME-13 Monographs,  
[https://doi.org/10.1007/978-3-319-99386-7\\_3](https://doi.org/10.1007/978-3-319-99386-7_3)

Hofe and Blum 2016). The focus lies on the conceptual interpretation that gives it meaning (Greefrath et al. 2016).

### 3.1 The Demand for Functional Thinking in the *Meraner Lehrplan*, 1905

The motto “education in functional thinking” is connected to an extensive reform movement of high school mathematics at the beginning of the 20th century. In the history of mathematical teaching, this reform became known as the *Kleinsche* or *Meraner Reform*. Felix Klein is recognized as the leader of this reform movement. He succeeded in combining reform proposals of the late 19th century (see Krüger 2000; Hamley 1934, p. 49 ff.; Schubring 2007) and initiated the establishment of a teaching committee at the annual general assembly of the Society of German Researchers and Physicians (*Gesellschaft Deutscher Naturforscher und Ärzte*) in 1904. The committee was instructed to reform the curricula for the whole complex of mathematical and scientific education. A prime objective was to close the gap between school and university mathematics education. As one means of doing this, the reformers introduced the function concept as the central theme in school mathematics. In addition, they included elements of analytical geometry and differential and integral calculus in secondary mathematical education. Furthermore, the committee put greater emphasis on applications in school mathematics and the so-called principle of movement (*Prinzip der Bewegung*), referring to the *Neuere Geometrie* (for elements of projective geometry as the “new geometry”, see Krüger 2000, Chaps. 3.2 and 5.3).

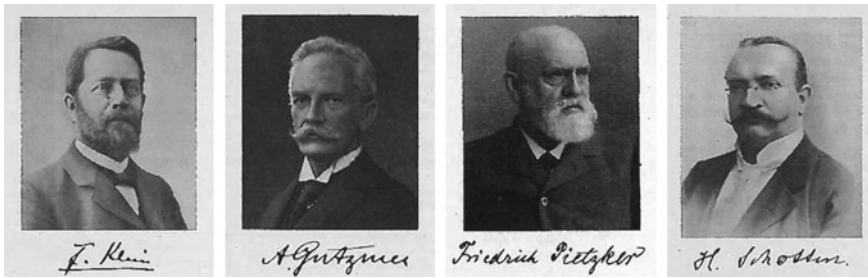
The reformers’ resolutions were condensed in a curriculum that was presented one year later in the next general assembly in Meran. Therefore, the so-called *Meraner Lehrplan* was not an official national curriculum but a proposal for mathematics education in high schools from Grade 5 to Grade 13, in the classical *humanistisches Gymnasium*.<sup>1</sup> Besides Felix Klein, the university mathematician Prof. August Gutzmer and representatives of high schools such as Dr. Friedrich Pietzker and Dr. Heinrich Schotten took a great role in this reform of mathematics education (Gutzmer 1908, p. 88). Both teachers were well known in these times as they were editors of relevant mathematical journals for teachers and board members of the *Verein zur Förderung des Unterrichts in Mathematik und Naturwissenschaften* (Association for the Promotion of Teaching of Mathematics and Sciences, founded in 1891; shortened to *Förderverein*) (Fig. 3.1).

Using the motto “education in functional thinking,” the *Meraner Lehrplan* not only refers to the subject-related modernisation of teaching mathematics, but also incorporated educational principles that were central in public debates at that time (Hamley 1934, p. 53; Krüger 2000, p. 168 f.; Schimmack 1911, p. 210; Schubring 2007). The efforts for alignment are already conveyed in the introduction of the *Meraner Lehrplan*:

---

<sup>1</sup>An orientation toward classical humanities was a characteristic of this type of high school.





**Fig. 3.1** Meran reformers: members of the teaching commission (Lorey 1938, pp. 18, 20, 26, 41)

It is necessary (as it is for all other subjects) to bring the course of teaching more closely in line with the natural process of mental development than has formerly been, to take preliminary mental representations everywhere into account, to establish organic connections between new insights and previous knowledge, and finally to bring the coherence of mathematical knowledge in itself as well as its relation to other educational subjects [*Bildungsstoff*] to mind gradually. With full recognition of the formal educational value [*Bildungswert*] of mathematics, it will furthermore be necessary to relinquish all unilateral and practically meaningless specialized knowledge, but rather to develop as far as possible the faculty for contemplating natural phenomena from a mathematical point of view. Two special tasks arise from here: the development of the ability of space perception and education in the habit of functional thinking. (Gutzmer 1908, p. 104; own translation, for original see Appendix 1)

In this preface, a psychological principle is described, as the students' mental development should be taken into account with regard to teaching mathematics. Special emphasis is placed on the role of previous knowledge and mental representations of mathematical concepts. With regard to functions and differential calculus, this psychological principle will be concretised in Sects. 3.2.1 and 3.3. In German-speaking countries, this idea of mental mathematical representations was developed later into the didactic category of *Grundvorstellungen* (see vom Hofe and Blum 2016) in the tradition of *Stoffdidaktik* (subject matter didactics).

The demand for developing “as far as possible the faculty for contemplating natural phenomena from a mathematical point of view” (Gutzmer 1908, p. 104) can be attributed to earlier reform attempts.<sup>2</sup> This “utilitarian principle” was associated with the plea for better introduction of applications in mathematical education that was recommended by the *Förderverein* at its inception. Students should thereby learn to contemplate “the mathematical in phenomena from their environment” instead of applying mathematics to artificial contexts (*Braunschweiger Beschlüsse* 1891; see Lorey 1938, p. 243). Functions and differential and integral calculus had proven themselves to explore motion and change as well as methods of analytical geometry.

The preface to the *Meraner Lehrplan* emphasised the didactical principle in mathematics teaching of requiring greater coherence of mathematical knowledge per se

<sup>2</sup>It took about 100 years to establish Heinrich Hertz's idea of mathematical modelling in schools' curricula. Hertz described the process of modelling as the basis of mathematization in natural sciences (Ortlieb et al. 2009, Chap. 1.2).

as well as greater coherence in relation to other educational subjects (*Bildungsstoff*). The recognized mathematical educationalist Walther Lietzmann later characterised it as a concentration principle (*Konzentrationsprinzip*), as this demand leads to the concentration of the whole of school mathematics to one “unified basic idea,” the concept of function “in the guise of algebra or arithmetic.”

They saw an essential demand in concentrating all of the subjects of the curriculum to one thought. The various mathematical branches that needed to be covered at school were supposed to be reconciled to one unified basic idea...

The *Meraner Lehrplan* chose the function concept as a binder. This concept had caught on in the guise of algebra or arithmetic and was not foreign to schools.... But the systematic enforcement of whole school mathematics on the basis of this idea was missing. (Lietzmann 1926, p. 231; own translation, for original see Appendix 2)

When characterising the “concentration principle,” Lietzmann does not speak of functional thinking but of the function concept as a “binder” (*Bindemittel*) that unifies different branches of school mathematics such as geometry, arithmetic, and algebra. In his main work, *Methodik des mathematischen Unterrichts*, Lietzmann describes the idea of concentrating and unifying the subject matter of school mathematics as an important didactical achievement of the Meran reform movement. He was a close confidant of Felix Klein and popularised the function concept through numerous textbooks and writings on mathematics teaching. Revised editions of his renowned *Methodik* have been published in Germany until as late as 1985. This may explain why the idea of concentrating and unifying the subject matter in mathematics education has remained influential until the present day.

From the present point of view, functional thinking as a “unifying principle” or “concentration principle” can be described as a prototype of a fundamental idea (*Fundamentale Idee*; Krüger 2000, Chap. 9.4). Vohns (2016) describes fundamental ideas as a guiding category of mathematical teaching. Up to the present, no other fundamental idea (such as symmetry, approximation, measure, and algorithm) has caused so many discussions about its importance for educational issues.

The demand for “education in the habit of functional thinking” has been attributed as a “special task” and a consequence of the aforementioned didactic, utilitarian, and psychological principle. “Functional thinking” in the *Meraner Lehrplan* does not mean a habit of thinking with respect to the function concept in arithmetic teaching only, rather it applies to mathematical education overall. Therefore, formal mental training remained the main objective of higher mathematics education. However, the adjective “functional” indicates a shift: In contrast to the traditional goal of mathematics instruction of “formation of logical thinking” with a focus on classical Euclidean geometry, functional thinking implied material aspects such as the selection and organisation of subject matter. Under the new programmatic principle, “education in the habit of functional thinking,” isolated mathematical topics and methods of problem solving that were based on special techniques were excluded from the curriculum. Some subjects, such as “unilateral and insignificant special knowledge” in the fields of teaching equations and trigonometry (see quote from Gutzmer [1908] in Sect. 1) were considered as expandable by the Meran reformers. The remaining and

newly added topics were organised to align with the principle of “education in the habit of functional thinking.” But what did the Meran reformers around Felix Klein mean by this principle?

## 3.2 Education in the Habit of Functional Thinking in Arithmetic, Algebra, and Geometry

During his lecture “*Die Meraner Vorschläge in der Praxis des mathematischen Unterrichts*” at the general meeting of the *Förderverein* in 1909, Schotten characterised the principle of functional thinking as follows:

Considering functional thinking first, it has not always been understood as it was meant to be. It is about making students aware of the variability of quantities in arithmetic or geometric contexts and of their shared dependence and mutual relationship, and getting them accustomed to observing the “vitality” of quantities and to engaging in contemplating the “variable”. (Schotten 1909, p. 97; own translation, for original see Appendix 3)

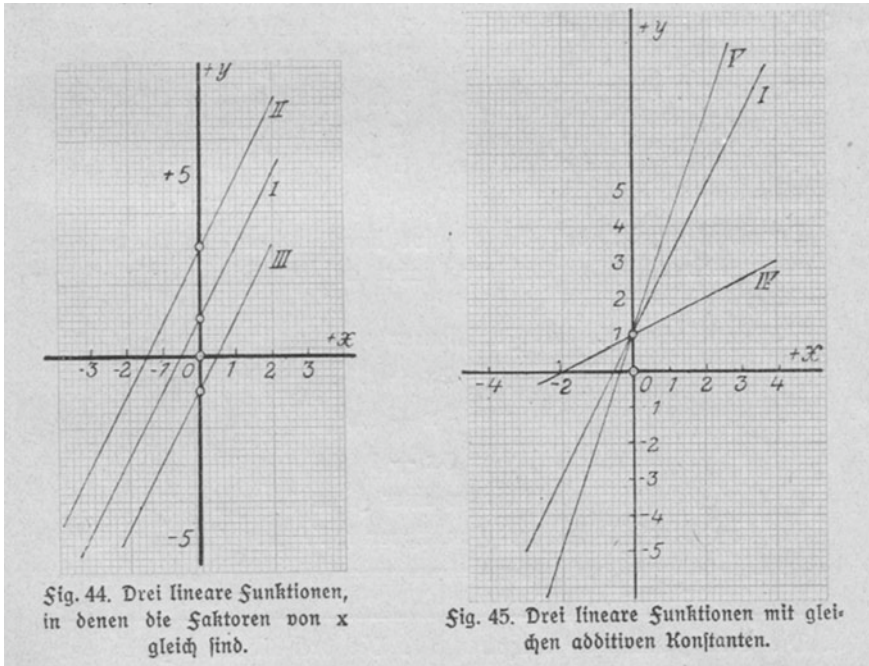
Education in functional thinking soon became a motto of the reform movement at that time, as it was referred to as a coherent and universally agreed-upon principle. This consensus was pointed out by the Austrian philosopher and professor of pedagogy Alois Höfler in his book *Didaktik des mathematischen Unterrichts*:

As one of the two content-related aims of the Meran proposals, “functional thinking,” gained universal and unreserved approval, the general thesis does not need to be proven, but proposals for its didactical effective realisation are required. (Höfler 1909, p. 19; own translation, for original see Appendix 4)

In fact, one can find many didactic and methodical instructions on how to realise functional thinking in mathematical education in the form of exercises or teaching materials. In the following, this comprehension of functional thinking is presented by giving extracts of curricula from that time and representative textbook exercises from the main areas of secondary mathematics education at that time: arithmetic (including algebra) and geometry. Therefore, textbooks that have been specially designed in the “spirit of the Meran reform movement” (Schimmack 1911, Chap. C.4; Hamley 1934, pp. 86–89) are used to exemplify what the reformers around Felix Klein meant by using functional thinking as a means of unifying these areas of school mathematics.

### 3.2.1 Functional Dependencies in Arithmetic and Algebra Teaching

Education in the habit of functional thinking began to be prepared in Grade 7 (*Quarta*). By evaluating and interpreting algebraic expressions such as terms and exploring functional aspects of formulas, students would practice functional thinking.



**Fig. 3.2** Graphs of linear functions: How does the position of the line in the coordinate system change when “Factor 2” or “Summand 1” are varied? (Malsch et al. 1929, p. 89)

The following exercises are taken from textbooks of teachers who actively supported the Meran reform (Schwab and Lesser 1912, Chap. IA, Behrendsen and Götting 1911, III. Sects. § 5, §10, §18, §22).

- Which value does the term  $s = a + b$  have for  $a = 6, b = 3, \dots$  ?
- Which values do  $n = a + b \cdot c$  and  $m = (a + b) \cdot c$  have for  $a = 2, b = 3, c = 4, \dots$ ?

This approach is comparable with recent teaching methods when introducing algebra at schools. The above mentioned *Grundvorstellungen* of variables (*Einsetzungsaspekt* and *Veränderlichenaspekt*) refer to the first steps towards teaching the variable and the function concept (Malle 1993, p. 46 ff.).

From Grade 9 (*Obertertia*) up to Grade 11 (*Obersekunda*), students were to be familiarised with different types of functions (e.g., linear, quadratic, trigonometric, exponential, logarithmic) and different representations such as equations, graphs, and tables. Graphical representations were considered very important, as they were already introduced in Grade 8 (*Untertertia*). Students should for example explore the effects of parameter variations (Fig. 3.2): How do variations of a parameter in a function equation affect the location and shape of the graph? In this way, functions and their graphical representations became a central issue in high school curricula,

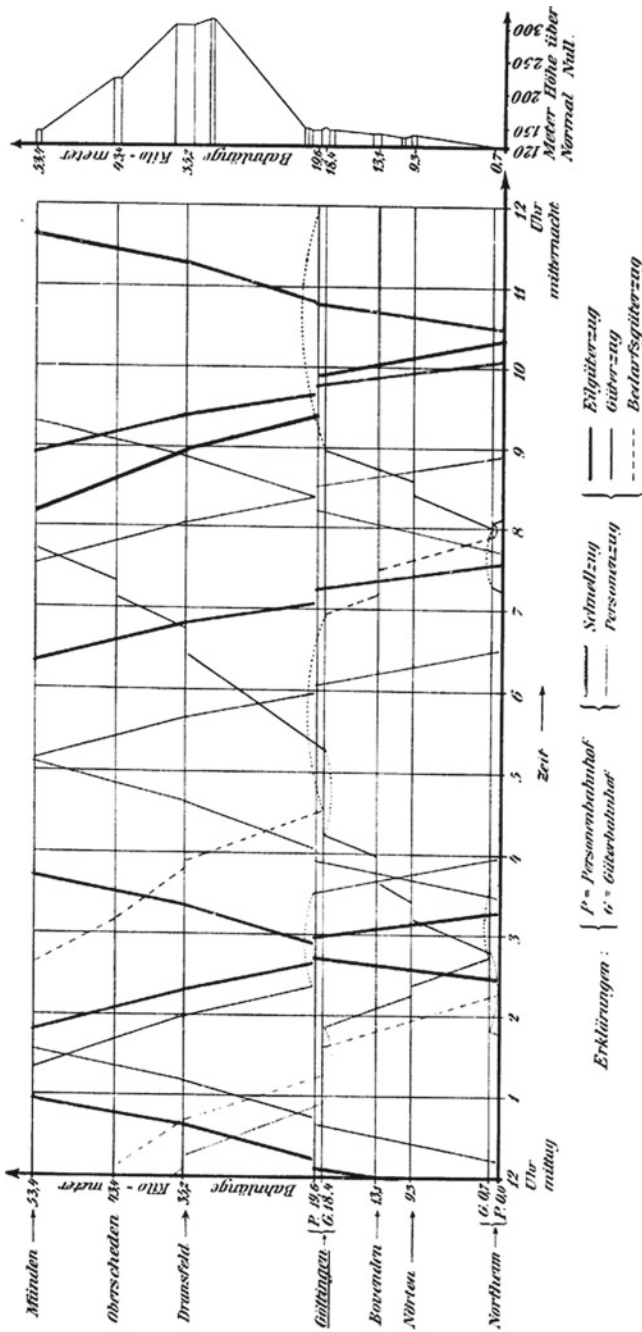


Fig. 3. Graphischer Eisenbahnfahrplan für die Strecke Northheim—Göttingen—Dransfeld—Münden; Winter 1906/07.  
 (Der Übersichtlichkeit wegen sind alle Züge, die nicht durchgehend auf dieser ganzen Strecke verkehren, fortgelassen; ebenso die  
 Minutenzahlen, welche Ankunfts- und Abfahrtszeiten genau angeben.)

Fig. 3.3 Graphical train schedule of the route Northheim—Münden in winter 1906/7 (Klein and Schimmack 1907, p. 35)

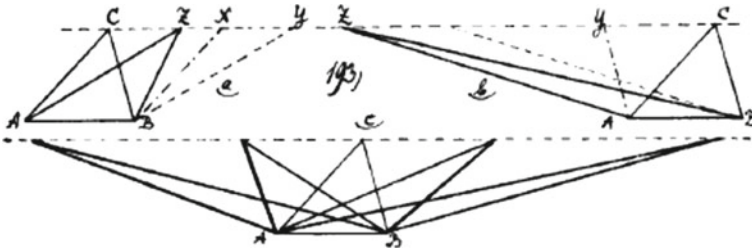


Fig. 3.4 Triangle transformations from Treutlein (1911, Appendix)

which has remained so even to the present day. The effects of parameter variations may now be easily investigated with digital tools (Vollrath and Weigand 2007, p. 153).

In addition, graphical representations were used to solve equations and illustrate empirical functional dependencies or time functions. Distance-time graphs were used to represent motion. Figure 3.3 shows a variety of such distance-time functions in a graphical train schedule. Each graph represents a train ride. Students could learn to read these graphs to determine in which direction the train goes, which trains are faster, and what the relationship between the slope of the graph and the velocity of the train is.

From today's point of view, it is conspicuous that the *Meraner Lehrplan* does not demand a formal definition of the function concept as a one-to-one correspondence of the elements of a domain and a co-domain. Instead, the curriculum refers to mutual or functional dependencies and thereby to prior conceptions of functions established during the history of mathematics. Felix Klein reflected on this pedagogical decision later in his famous book *Elementarmathematik vom höheren Standpunkt*:

We desire merely, that the general concept of function, according to the one or other of Euler's understandings should permeate as a ferment the entire mathematical teaching in the secondary schools. It should not, of course, be introduced by means of abstract definitions, but should be transmitted to the student as a living possession, by means of elementary examples, such as one finds in large number in Euler. (Klein 1933, p. 221)

These conceptions of functions were considered more adaptable to the main application contexts (predominantly mechanics) as they were connected to the exploration of "variation behaviour" (*Änderungsverhalten* according to Vollrath und Weigand 2007, p. 140). A coherent view of different types of functions was not developed until Grades 11 and 12 (*Prima*). Functions were then regarded as "a whole" and mutual dependencies and motion could be explored by methods of calculus (see Sect. 3.3).

### 3.2.2 *The Principle of Movement and Functional Thinking in Geometry*

In the geometry part of the *Meraner Lehrplan* one can also find instructions on how to familiarise students with functional thinking.

This habit of functional thinking should be cultivated also in geometry by perpetually exploring the changes that result from variation of length, position, or form of geometric figures such as quadrilaterals or circles. At the same time, the consideration of the occurring relationships, which can be arranged in rows by various aspects, offers an exquisite technique to the education to logical thinking. This technique is to be made advantage of as well as the consideration of transitional cases and the examination of limits. (Gutzmer 1908, p. 113; own translation, for original see Appendix 5)

By introducing the concept of moving geometric objects (*Prinzip der Bewegung*), the Meran reformers turned against the traditional Euclidean method of teaching geometry that had dominated mathematical education during the 19th century. The Euclidean method was criticised at that time, as it was considered to be inappropriate for the students' mental development. It was described as "stiff" and "lifeless" on two accounts. Firstly, it followed a stiff pattern of definition, theorem, and proof. Secondly, the Euclidian method was seen as a stiff mathematical proof technique making use of congruencies. The intent of focussing constantly on functional thinking was to invigorate geometry teaching.

At the beginning, the focus was on mobilising whole figures or parts of figures in order to make underlying measures and location relations emerge: How do changes in size and position of single parts affect the characteristics of a whole figure? Moveable figures should be increasingly represented in the mind when exploring functional dependencies. Considering previous Euclidean methods, activities involving *Flächenverwandlungen* (transformation of geometric figures where the area remains invariant) were very popular. The following invariants are fundamental for teaching the subject of areas: If base and height of parallelograms and triangles are both of equal length, the areas are also equal. In his book *Der geometrische Anschauungsunterricht*, Treutlein (1911) emphasises *Gestaltveränderungen* (changes of geometric shape), for which he provided various exercises that included sequences of illustrations. In addition, a draft of a student's workbook based on Treutlein's proposal for geometry teaching was published as an appendix. The following geometric constructions show different triangles that are built by holding the base and varying one point of the triangle along a parallel to the basis. In Fig. 3.4 one can find dashed lines illustrating that the area of a triangle is based on the one for a parallelogram. These sketches make clear that Treutlein used the movement of geometrical forms by showing them merging into each other or originating from each other. By considering geometric figures in a functional way and studying their varying structures, one could explore whether features remain invariant or change systematically.

In the years that followed, many teaching materials that realised the demand for movement by mechanical techniques or animated illustrations were developed. Other teachers came up with mathematical films, flicker books (*geometrische Kinohefte*;

see Fig. 3.5), and mechanical models with joint mechanisms (Krüger 2000, Chap. 7.5, Kitz). Thereby the students reinforce their functional imagination. From a contemporary point of view, access to the subject matter was provided through all of Bruner's (1974, p. 16 ff.) modes of representation: enactive, iconic, and symbolic. Nowadays, the exploration of moveable figures may be facilitated by digital tools such as dynamic geometry systems.

The *Meraner Lehrplan* proposed that transitional cases should be explored, for example, when introducing triangles. Both equilateral and right-angle triangles as a transitional case to the family of triangles are presented in Fig. 3.4. Other examples are variations in shape of quadrilaterals such as squares and rectangles as limit cases to rhombuses and parallelograms. By exploring these *Gestaltverwandlungen*, the notion of limit should be prepared in a geometrically vivid way. Taking into account these geometric proposals for education in functional thinking, the habit of mind can be characterised as kinematic and flexible.

### 3.3 Functional Thinking and Mental Representations in Differential Calculus

The new subject matter about differential and integral calculus was not supposed to act as additional theme on top of the curriculum. Rather, an "organic" structure of school mathematics would be realised by underlining calculus as a culmination of higher mathematical education. Thinking in variations and functional dependencies should be practiced and made more flexible in order to prepare for learning calculus. Education in the habit of functional thinking can therefore be considered as an attempt to establish a propaedeutic of calculus in high schools.

The Förderverein's vote about this issue ended in a draw. Friedrich Pietzker, who was the association's chairman, claimed that calculus was only described as an optional subject within the *Meraner Lehrplan*.

Coherent consideration of the functions that have hitherto occurred with respect to trends in decrease or increase (possibly bringing in the notions of *Differenzialquotient* and integral), using numerous examples from geometry and physics, especially mechanics. (Gutzmer 1908, p. 111; own translation, for original see Appendix 6)

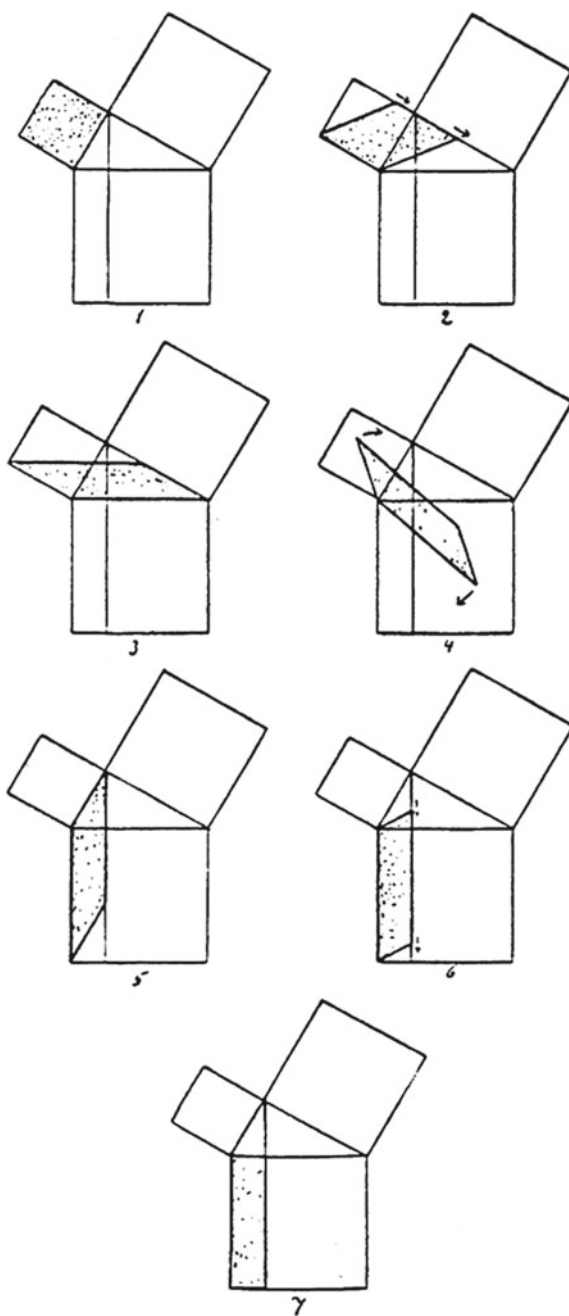
Pietzker doubts regarding infinitesimal calculus were not without cause.

An integration of infinitesimal calculus into school mathematics will result in teaching students another formal technique without enabling them to have a use for it. Instead of providing them further mental education, an external skill will be achieved that will be soon forgotten by all those who are not concerned with those precise sciences at a later time. (Pietzker 1904, p. 129; own translation, for original see Appendix 7)

Even a century later, procedure-orientated teaching of calculus in German high schools is being criticised (see Blum and Schmidt 2000).



**Fig. 3.5** Geometric flicker book visualising moving figures (Detlefs 1913, p. 39)



The journal *Zeitschrift für den mathematisch-naturwissenschaftlichen Unterricht* published a column about the Meran reform movement, showcasing both supporters and opponents of the movement:

As is well known, infinite calculus contains many formulas that need to become second nature to students if mathematics education is to fulfil its purpose. As a result, there is the risk of students' believing that the substance lies within these formulas and that knowing and applying them suffices to a mathematical qualification (Weinmeister 1907, p. 13; own translation, for original see Appendix 8).

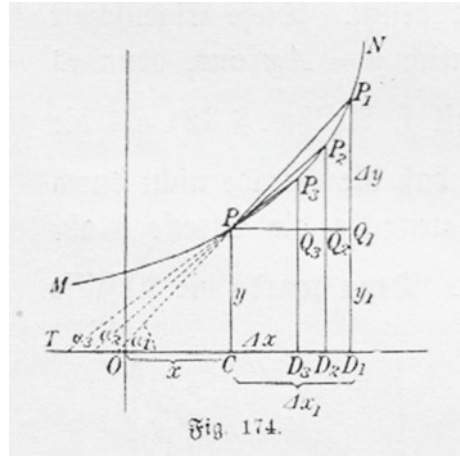
It took another 20 years until differential and integral calculus became a compulsory topic within *Richerts' Richtlinien* (1925), the new curriculum for high schools (*Gymnasien*) in Prussia. The Meran reformers took the chance to broaden their ideas about advanced teacher training. Summer schools (*Ferienkurse*) at different universities (e.g., Göttingen, Berlin, and Frankfurt a. M.; see Tobies 2000, p. 23 ff.) were offered so that high school teachers could become familiar with functional thinking and teaching infinitesimal calculus. Subject-related teaching methods were developed and set down in textbooks based on the *Meraner Lehrplan*. Felix Klein found support in Otto Behrendsen and Eduard Götting, two experienced teachers in Göttingen. Both were familiar with secondary mathematics education and were able to realise the reformers' proposals. Together they developed a course in school mathematics that provided ideas about functional thinking across several grades. This course functioned as a model for the Meran curriculum (Götting 1919).

The familiarisation with functional thinking in geometry and arithmetic teaching was supposed to help close the gap between mathematics education on the university and high school levels and help make the transition from school to university less arduous. This didactical approach is realised in Behrendsen and Götting's well known textbooks *Lehrbuch der Mathematik nach modernen Grundsätzen* (1911, 1912).

If students who have followed our course of instruction come to differential calculus, it will be taken for granted and as a natural consequence of the representation of functions that have been dealt with for many years up to this stage. It would be almost unnatural to follow certain dubious apostles' demand for stopping at this point. Nevertheless, differential and integral calculus are based on purely empirical geometric and related real mental representations that are clear of speculations. (Behrendsen and Götting 1912, preface; own translation, for original see Appendix 9)

By taking a closer look at the following textbook extracts, the authors' conception of teaching differential calculus in a "purely empirical" way can be illustrated. Practical experience had shown that it was difficult for students to understand the notions of limit and *Differenzialquotient*  $dy/dx$  (derivative of a function). The term *Differenzial* was found to be particularly challenging as it was characterised as an "infinitely small quantity" (ibid.). It took Behrendsen and Götting some time until these complex concepts were considered sufficiently developed from an educational point of view. Their introduction in differential calculus starts with a question that arises from generalising known characteristics of the slope of a linear function: Can the slope of any graph of a function be described by the ratio  $\Delta y/\Delta x$ ? Figure 3.6 leads to functional considerations how the slope of single small arcs varies:

**Fig. 3.6** Exploring slope of secants (Behrendsen and Götting 1912, p. 232)



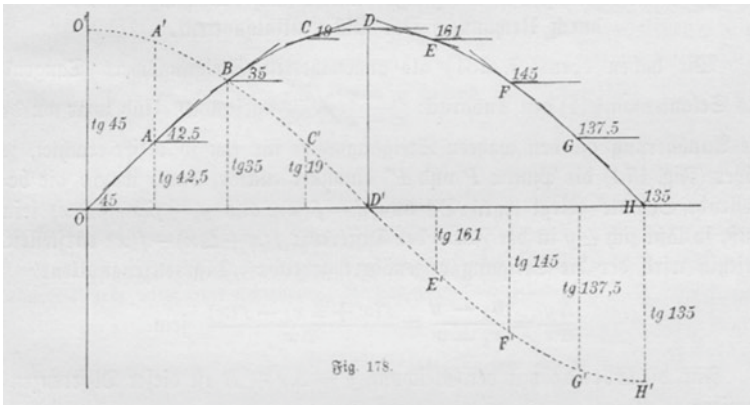
We simply notice that on the arc  $PP_1$  the slope of smaller sections of this arc changes, in fact increases. When we move point  $P_1$  closer to  $P$  up to  $P_2$ , meaning we decrease  $\Delta x_1$ , the chord  $PP_2$  coincide with the arc in more detail. But this will be even more the case with  $PP_3$ , so that the quotient  $\frac{P_3Q_3}{PQ_3}$  can be considered as the  $PP_3$  arc's slope quotient with greater approximation as  $\frac{P_2Q_2}{PQ_2}$  and  $\frac{P_1Q_1}{PQ_1}$ . (Behrendsen and Götting 1912, p. 232; own translation, for original see Appendix 10)

Hereby they obtain the slope of not only a single small arc but also the slope in a certain point of a function graph. This method visualises the moving secants, with a tangent as a mentally represented limit.

It is easy to realise that accuracy increases when the points  $P$  and  $P_3$  come closer to each other, meaning the secant  $P_3T$  approximates the characteristics of a tangent. The actual slope in a certain point of the curve is given by the direction of the tangent in the same point.... (ibid., p. 233; own translation, for original see Appendix 11)

It is remarkable that neither the tangent nor the slope of a function (by using tangents) are formally defined until this point. Instead, the authors use the mental geometrical representation of a tangent as a limit case and the idea of approximation instead. Behrendsen and Götting then provided a new function, the *Steigungsfunktion* (function of slopes). Therefore, they use a graphical method to obtain this function of slopes by sketching the curves' tangents and their slopes and thereby represent the *Steigungsfunktion* in a graphical manner (see Fig. 3.7).

After providing a geometric-graphical approach to the approximation of a function's slope, the *Differenzenquotient* (increment ratio) was used to find the "true" slope of a tangent by analytical means. Finally, the *Differenzialquotient* (derivative) was introduced as the limit of increment ratios. Thereby, an additional meaning with regard to its application in mechanics was obtained: velocity (*Grundvorstellung* of local rate of change) or, more explicitly, the instantaneous velocity or speed of a process (see Greefrath et al. 2016, p. 108).



**Fig. 3.7** *Graphisches Differenzieren* according to Behrendsen and Götting (1912, p. 235)

These textbook extracts document that the concept of a derivative was introduced using a geometric mental representation as a tangent slope (*Grundvorstellung* of tangent slope; *ibid.*, p. 109). By determining a function's slope with the help of the limit of the secant's slopes, Behrendsen and Götting provided an approach to the concept of derivative. This was popular in German high school mathematics for the following decades; however, it was also criticised (see Danckwerts and Vogel 2006, p. 45).

By familiarising students with functional thinking in the context of moving figures and shapes, the concept of limit was used in an informal manner in school mathematics but not established by a formal definition. This qualitative approach uses functional imaginations of limit processes as the basis for concept formation: How does the incremental ratio or slope change when the secant shifts?

The “coherent consideration of functions that have hitherto occurred with respect to trends in decrease or increase” was then established as a possibility for practicing functional thinking (Gutzmer 1908, p. 111). Graphical representations were still used to explore slopes of function graphs with the help of the *Differenzialquotient* (derivative).

When discussing bandy lines, determinations of maxima and minima, etc., one gets along with simple considerations of geometric sketches. The maximum, for example, is characterized by the fact that the tangent is first increasing and then decreasing afterwards. The graphical representation of the first *Differenzialquotienten* as a curve itself therefore is a decreasing function merging from positive to negative at the point in question. Regarding this consideration, long calculations can be avoided and functional thinking can be trained in an excellent way. (Behrendsen and Schimmack 1908, p. 21; own translation, for original Appendix 12)

Many school teachers developed concepts and materials for teaching calculus that aligned with functional thinking in the 20 years following the publication of the *Meraner Lehrplan*. Soon, the demand for more rigor in secondary mathematical education arose in terms of how to combine the need for scientific rigor and the

respect for students' mental capacity. In 1925, differential and integral calculus were finally introduced in the national Prussian curriculum.

By introducing infinitesimal methods, students gain knowledge about the most important tool of mathematics. It is a task of mathematical education on the one hand to steer a middle course between entitled scientific rigor and the regard to practical needs and on the other hand to use the tool of geometric visualizations extensively. (from annotations on methods for mathematics education in the 1925 Prussian directives; quoted from Lietzmann 1926, p. 263; own translation, for original see Appendix 13)

### 3.4 Conclusion

Functional thinking in the sense of the Meran reformers meant more than providing knowledge about elementary functions and techniques of calculus. "Education in the habit of functional thinking" has to be considered a certain ability to perceive and analyse the variability of quantities and their functional dependencies. It was regarded as a didactical principle for teaching mathematics in high schools that refers to the modernisation of subject matter and focusses on the concentration and unification of different branches of school mathematics. Therefore, it may be indicated as a precursor of the didactic category of *fundamentale Ideen*. Moreover, the attempt to build school curricula on psychological principles leads to the use of mental representations of mathematical concepts (*Grundvorstellungen*) emerging together with the demand for functional imagination. This idea became widely accepted and extended in German-speaking countries at the end of the 20th century. *Grundvorstellungen* of numerous basic mathematical concepts were elaborated at that time (such as variable, function, number, fraction, probability, derivative, and integral). The development of the subject-related didactic categories of *fundamentale Ideen* and *Grundvorstellungen* was stimulated by the challenging task of teaching calculus in high schools.

In addition to Felix Klein's Göttingen colleagues, Behrendsen, Götting, Lietzmann, and Schimmack, dedicated mathematics teachers such as Oskar Lesser, Georg Wolff, Peter Treutlein, and many more played important roles in modernising school mathematics based on Felix Klein's reform agenda. Without their creative application of these concepts into school curricula, the *Meraner Lehrplan* may not have had such an influence on high school mathematics. When highlighting Klein's unquestionable merits in initiating and organising the Meran reform movement, the efforts of these practitioners in mathematical education should not be understated.

## Appendix

- 1 Einmal gilt es (wie in allen anderen Fächern), den Lehrgang mehr als bisher dem natürlichen Gange der geistigen Entwicklung anzupassen, überall an den vorhan-

denen Vorstellungskreis anzuknüpfen, die neuen Kenntnisse mit dem vorhandenen Wissen in organische Verbindung zu setzen, endlich den Zusammenhang des Wissens in sich und mit dem übrigen Bildungsstoff der Schule von Stufe zu Stufe mehr und mehr zu einem bewußten zu machen. Ferner wird es sich darum handeln, unter voller Anerkennung des formalen Bildungswertes der Mathematik doch auf alle einseitigen und praktisch bedeutungslosen Spezialkenntnisse zu verzichten, dagegen die Fähigkeit zur mathematischen Betrachtung der uns umgebenden Erscheinungswelt zu möglicher Entwicklung zu bringen. Von hier aus entspringen zwei Sonderaufgaben: die Stärkung des räumlichen Anschauungsvermögens und die Erziehung zur Gewohnheit des funktionalen Denkens.

- 2 Sie erkannten es als eine wesentliche Forderung an, den gesamten Lehrstoff um einen großen Gedanken zu konzentrieren. Das Vielerlei der mathematischen Gebiete, die auf der Schule zu Wort kommen, mußte unter eine einheitliche Grundidee gebracht werden ...

Die Meraner Vorschläge wählten als Bindemittel den Funktionsbegriff. Dieser Begriff, der ebenso im geometrischen wie im arithmetischen Gewande die gesamte Mathematik durchsetzt, war selbstverständlich der Schule vorher nicht fremd. ... Was aber fehlte, war die systematische Durchdringung des gesamten Schulstoffs mit diesem Gedanken.

- 3 Was zunächst das funktionale Denken betrifft, so ist es nicht überall so aufgefaßt worden, wie es aufgefaßt werden sollte. Es handelt sich darum, die Variabilität der Größen –, seien es arithmetische oder geometrische –, ihre gemeinsame Abhängigkeit und ihren wechselseitigen Zusammenhang den Schülern zu Bewußtsein zu bringen: und sie daran zu gewöhnen, gerade auf diese 'Lebendigkeit' der Größen zu achten und ihr ihr Denken auf die Betrachtung des 'Veränderlichen' einzustellen.
- 4 Von den beiden inhaltlichen Zielpunkten der Meraner Vorschläge ... hat der zweite, das 'funktionale Denken', so allgemeine und rückhaltlose Zustimmung gefunden, daß nicht mehr Beweise für die allgemeine These nötig, sondern nur noch Ratschläge für ihre didaktisch wirksame Durchführung erwünscht sind.
- 5 Diese Gewohnheit des funktionalen Denkens soll auch in der Geometrie durch fortwährende Betrachtung der Änderungen gepflegt werden, die die ganze Sachlage durch Größen- oder Lageänderung im einzelnen erleidet, z. B. bei Gestaltänderung der Vierecke, Änderung in der gegenseitigen Lage zweier Kreise usw. Zugleich aber bietet die Betrachtung der hierbei auftretenden Beziehungen, die man nach mannigfachen Gesichtspunkten in Reihen ordnen kann, ein vorzügliches Mittel zur Schulung des logischen Denkens, das möglichst auszunützen ist, ebenso die Betrachtung der Übergangsfälle und die Herausarbeitung der Grenzfälle.
- 6 Zusammenhängende Betrachtung der bisher aufgetretenen Funktionen in ihrem Gesamtverlauf nach Steigen und Fallen (unter eventueller Heranziehung der Begriffe des Differentialquotienten und des Integrals), mit Benutzung zahlreicher Beispiele aus Geometrie und Physik, insbesondere der Mechanik.

- 7 ... eine Aufnahme der Systematik der Infinitesimal-Rechnung in den Unterricht [wird] im allgemeinen nur darauf hinauslaufen, den Schülern eine formelle Technik mehr beizubringen, ohne dass sie dadurch befähigt werden, nun mit dieser Technik gegebenenfalls viel anzufangen, statt der Erhöhung der geistigen Durchbildung, die man ihnen dadurch verschaffen möchte, wird eine gewisse äusserliche Fertigkeit erzielt werden, die bei allen, die nachher keine Veranlassung zur Beschäftigung mit den exakten Wissenschaften haben, bald genug vergessen werden wird.
- 8 Bekanntlich enthält die Unendlichkeitsrechnung sehr viel Formeln, die dem Schüler in Fleisch und Blut übergehen müssen, soll der Unterricht seinen Zweck erfüllen. Da liegt denn die Gefahr nahe, dass der Schüler glaubt, das Wesen des Unterrichts liege in diesen Formeln, und es genüge deren Kenntnis und ihre Anwendung zu seiner mathematischen Ausbildung.
- 9 Wenn der Schüler, der unserem Lehrgange gefolgt ist, an die Differentialrechnung gelangt, so pflegt ihm dieselbe als etwas so Selbstverständliches und als eine so notwendige Konsequenz der seit Jahren gepflegten Funktionsdarstellungen zu erscheinen, daß es geradezu unnatürlich wäre, wollte man den Warnungsrufen gewisser Bedenklichkeitsapostel wirklich Folgschaft leisten und hier halt machen. Allerdings ist die Differential- und Integralrechnung in einer rein empirischen, von allen Spekulationen freien Weise auf geometrische und ähnliche reale Vorstellungen gestützt gegeben worden.
- 10 Wir bemerken ohne weiteres, daß auf dem Kurvenbogen  $PP_1$  die Steigung einzelner kleinerer Teilbogen desselben wechselt und zwar in unserer Figur zunimmt. Rücken wir den Punkt  $P_1$  näher an  $P$  heran bis  $P_2$ , d.h. machen wir ...  $\Delta x_1$  kleiner, so fällt schon die Sehne  $PP_2$  genauer mit dem Bogen zusammen als vorher; noch mehr wird dies bei  $PP_3$  der Fall sein, so daß der Quotient  $\frac{P_2Q_2}{PQ_2}$  mit größerer Annäherung als Steigung des Bogens  $PP_3$  angesehen werden kann als  $\frac{P_2Q_2}{PQ_2}$  und  $\frac{P_1Q_1}{PQ_1}$ .
- 11 Es ist leicht einzusehen, daß die Genauigkeit zunimmt, wenn die Punkte  $P$  und  $P_3$  einander näher kommen, d.h. wenn die Sekante  $P_3T$  also immer mehr sich dem Charakter einer Tangente nähert. Die wirkliche Steigung in einem bestimmten Punkte der Kurve wird somit durch die Richtung der Tangente an dieselbe in diesem Punkt gegeben, ...
- 12 Bei der Diskussion krummer Linien, Bestimmung von Extremwerten usw. kommt man mit einfachen Überlegungen an geometrischen Skizzen aus. Das Maximum ist beispielsweise dadurch gekennzeichnet, daß die Tangente vorher ansteigt, nachher fällt; die graphische Darstellung des ersten Differentialquotienten selbst als Kurve ist daher an der betreffenden Stelle, eine abnehmende, vom Positiven zum Negativen übergehende Funktion. Bei dieser Behandlungsweise wird alles lange Rechnen vermieden und das funktionale Denken vortrefflich geschult.
- 13 Durch die Einführung infinitesimaler Methoden erhalten die Schüler Kenntnis von dem wichtigsten Werkzeug der Mathematik. Hier hat der Unterricht einen Mittelweg zu suchen zwischen berechtigten Anforderungen an wissenschaftliche Strenge und der Rücksicht auf die praktischen Bedürfnisse, und

er wird das Hilfsmittel geometrischer Veranschaulichung ausgiebig benutzen müssen.

## References

- Behrendsen, O., & Götting, E. (1911). *Lehrbuch der Mathematik nach modernen Grundsätzen* (2nd ed.). Unterstufe. Leipzig and Berlin: Teubner.
- Behrendsen, O., & Götting, E. (1912). *Lehrbuch der Mathematik nach modernen Grundsätzen*. Oberstufe. Leipzig und Berlin: Teubner.
- Behrendsen, O., & Schimmack, R. (1908). Über die Gestaltung des mathematischen Unterrichts im Sinne der neueren Reformideen. Vortrag beim Göttinger Ferienkurs. *Zeitschrift für den mathematisch-naturwissenschaftlichen Unterricht*, 39, 513–527.
- Blum, W., & Schmidt, G. (2000). Perspektiven für den Analysisunterricht. *Der Mathematikunterricht*, 46(4–5), 5–17.
- Bruner, J. (1974). *Entwurf einer Unterrichtstheorie*. Berlin: Pädagogischer Verlag Schwann.
- Danckwerts, R., & Vogel, D. (2006). *Analysis verständlich unterrichten*. Heidelberg: Spektrum Akademischer Verlag.
- Detlefs, H. (1913). Zum Beweise des pythagoreischen Lehrsatzes. *Unterrichtsblätter*, 19, 39.
- Götting, E. (1919). Die Entwicklung des mathematischen Unterrichts im Sinne der Reformbewegung am Gymnasium in Göttingen. *Zeitschrift für den mathematisch-naturwissenschaftlichen Unterricht*, 50, 42–47.
- Greerfrath, G., Oldenburg, R., Siller, H.-S., Ulm, V., & Weigand, H.-G. (2016). Aspects and “Grundvorstellungen” of the concepts of derivative and integral. Subject matter-related didactical perspectives on concept formation. *Journal for Didactics of Mathematics*, 37(Suppl. 1), 99–129.
- Gutzmer, A. (1908). Bericht betreffend den Unterricht in der Mathematik an den neunklassigen höheren Lehranstalten. In A. Gutzmer (Ed.), *Die Tätigkeit der Unterrichtskommission der Gesellschaft Deutscher Naturforscher und Ärzte* (pp. 104–114). Gesamtbericht. Leipzig und Berlin: Teubner.
- Hamley, H. R. (1934). *Relational and functional thinking in mathematics*. National Council of Teachers of Mathematics, Yearbook 9.
- Höfler, A. (1909). Didaktik des Mathematischen Unterrichts. *Didaktische Handbücher für den realistischen Unterricht an höheren Schulen*. Leipzig und Berlin: Teubner.
- Klein, F. (1933). *Elementary mathematics from a higher standpoint. Volume I: Arithmetic, algebra and analysis*. New translation 2016. Berlin: Springer.
- Klein, F., & Schimmack, R. (1907). *Von der Organisation des mathematischen Unterrichts. Vorträge über den mathematischen Unterricht an den höheren Schulen* (Vol. 1). Leipzig: Teubner.
- Krüger, K. (2000). *Erziehung zum funktionalen Denken—Zur Begriffsgeschichte eines didaktischen Prinzips*. Berlin: Logos-Verlag.
- Lietzmann, W. (1926). *Methodik des mathematischen Unterrichts. I. Teil: Organisation, Allgemeine Methode und Technik des Unterrichts* (2nd ed.). Leipzig: Quelle & Meyer.
- Lorey, W. (1938). *Der Deutsche Verein zur Förderung des mathematischen und naturwissenschaftlichen Unterrichts*. Frankfurt: Otto Salle.
- Malle, G. (1993). *Probleme der elementaren Algebra*. Braunschweig: Vieweg.
- Malsch, F., Maey, E., & Schwerdt, H. (1929). *Zahl und Raum. Lehr- und Übungsbuch der Mathematik*. Leipzig: Quelle & Meyer.
- Ortlieb, C. P., Dresky, C., Gasser, I., & Günzel, S. (2009). *Mathematische Modellierung. Eine Einführung in zwölf Fallstudien*. Wiesbaden: Springer.
- Pietzker, F. (1904). Diskussion über die Bildungsaufgabe der Mathematik. *Unterrichtsblätter*, 10, 129–133.



- Richert, H. (Ed.). (1925). Richtlinien für die Lehrpläne der höheren Schulen Preußens. Reprinted in 1980 *Mathematikunterricht*, 26(6), 81–93.
- Schimmack, R. (1911). Die Entwicklung der mathematischen Unterrichtsreform in Deutschland. *IMUK-Abhandlungen* (Vol. III.1). Leipzig und Berlin: Teubner.
- Schotten, H. (1909). Die Meraner Vorschläge in der Praxis des mathematischen Unterrichts. Bericht und anschließende Diskussion. *Unterrichtsblätter*, 15, 97–98.
- Schubring, G. (2007). Der Aufbruch zum “funktionalen Denken”: Geschichte des Mathematikunterrichts im Kaiserreich. *NTM International Journal of History & Ethics of Natural Sciences, Technology & Medicine*, 15, 1–17.
- Schwab, K., & Lesser, O. (1912). *Lehr- und Übungsbuch für den Unterricht in der Arithmetik und Algebra* (4. Auflage). 1. Teil: Unterstufe. Leipzig: G. Freytag.
- Tobies, R. (2000). Felix Klein und der Verein zur Förderung des mathematisch und naturwissenschaftlichen Unterrichts. *Der Mathematikunterricht*, 46(3), 22–40.
- Treutlein, P. (1911). *Der geometrische Anschauungsunterricht*. Reprinted 1985. Paderborn: Schöningh.
- Vohns, A. (2016). Fundamental ideas as a guiding category in mathematics education—Early understandings, developments in German speaking countries and relations to subject matter didactics. *Journal for Didactics of Mathematics*, 37(Suppl. 1), 225–254.
- Vollrath, H. J., & Weigand, H. G. (2007). *Algebra in der Sekundarstufe* (3rd ed.). Heidelberg: Springer Spektrum.
- Vom Hofe, R., & Blum, W. (2016). “Grundvorstellungen” as a category of subject matter didactics. *Journal for Didactics of Mathematics*, 37(Suppl. 1), 225–254.
- Weinmeister, P. (1907). Unendlichkeitsrechnung in der Schule. *Zeitschrift für den mathematisch-naturwissenschaftlichen Unterricht*, 38, 1–15.

**Open Access** This chapter is licensed under the terms of the Creative Commons Attribution 4.0 International License (<http://creativecommons.org/licenses/by/4.0/>), which permits use, sharing, adaptation, distribution and reproduction in any medium or format, as long as you give appropriate credit to the original author(s) and the source, provide a link to the Creative Commons license and indicate if changes were made.

The images or other third party material in this chapter are included in the chapter’s Creative Commons license, unless indicated otherwise in a credit line to the material. If material is not included in the chapter’s Creative Commons license and your intended use is not permitted by statutory regulation or exceeds the permitted use, you will need to obtain permission directly from the copyright holder.



# Chapter 4

## Teachers' Meanings for Function and Function Notation in South Korea and the United States



Patrick W. Thompson and Fabio Milner

**Abstract** Teachers' thinking about the concept of function is well researched. However, most research focused on their understanding of function definitions and properties. This paper addresses a more nuanced examination of teachers' meanings and ways of thinking that are affiliated with what might come to mind as teachers deal with functions in day-to-day interactions with students, such as "What does  $f$  mean in  $f(x)$ ?" We report results from using the Mathematical Meanings for Teaching secondary mathematics (MMTsm) instrument (Thompson in Handbook of international research in mathematics education. Taylor & Francis, New York, pp. 435–461, 2016) with 366 South Korean middle and high school teachers and 253 U.S. high school mathematics teachers. South Korean middle and high school teachers consistently performed at a higher level than U.S. high school teachers, including U.S. teachers who taught calculus.

**Keywords** Function · Mathematical meanings for teaching  
International comparison · Double discontinuity · Cultural regeneration  
Felix Klein

---

Research reported in this article was supported by NSF Grant No. MSP-1050595. Any recommendations or conclusions stated here are the authors' and do not necessarily reflect official positions of the NSF.

A more complete description of this study's theoretical foundation and presentation of results can be seen at <http://pat-thompson.net/Presentations/2016ICME-Funcs>.

---

P. W. Thompson (✉) · F. Milner  
Arizona State University, Tempe, USA  
e-mail: pat@pat-thompson.net

F. Milner  
e-mail: fabio.milner@asu.edu

© The Author(s) 2019  
H.-G. Weigand et al. (eds.), *The Legacy of Felix Klein*, ICME-13 Monographs,  
[https://doi.org/10.1007/978-3-319-99386-7\\_4](https://doi.org/10.1007/978-3-319-99386-7_4)

## 4.1 Introduction

The concept of function played a central role in Felix Klein's vision of secondary school mathematics. His *Elementary Mathematics from an Advanced Standpoint* (1932) developed a concept of function that mathematized a sketched graph, "restructuring school in the direction of giving more emphasis to geometrical aspects of meaning (intuition, *Anschauung*)" (Biehler 2005, p. 63). Biehler also noted that Klein (1932) wrote his "*Elementary Mathematics from an Advanced Standpoint*" book with the understanding that teachers already had a firm knowledge of the secondary mathematics curriculum. Klein's intention was to connect ideas in this curriculum to their brethren in higher mathematics. He pointed to a "double discontinuity" in the preparation of high school mathematics teachers: the discontinuity that high school students experience when they first meet higher mathematics in college, and then the discontinuity they experience when going from studying higher mathematics to teaching school mathematics (Buchholtz and Kaiser 2013; Kaiser et al. 2017; Kilpatrick 2008). We will return to the issue of double discontinuity in our concluding section.

## 4.2 A Focus on Meanings Instead of on Knowledge

We focus on teachers' mathematical meanings for teaching for a number of reasons. First, the word "knowledge" in "teachers' mathematical knowledge" is used largely as a primitive (undefined) term in researching teachers' mathematical knowledge for teaching. Second, "knowledge" is used most commonly as justified true belief, with an emphasis on "true". From this perspective, one cannot "know" something that is incorrect. We believe, as argued in Thompson (2013), that teachers operate mostly with ideas formulated for themselves in terms that could not be called true or justified from an expert perspective. We therefore cast aside concern with whether teachers "know" a concept and focus instead on meanings and ways of thinking teachers bring to mind in their moments of acting—interacting with students, planning instruction, or implementing their plan.

To this end, we designed an instrument called *Mathematical Meanings for Teaching secondary mathematics* (MMTsm; Thompson 2016). The MMTsm is a 46-item instrument containing items addressing teachers' meanings for function (definition and properties, notation, and modelling), variation and covariation, proportionality, rate of change, frames of reference, and structure sense. In this paper, we focus on teachers' meanings for functions.

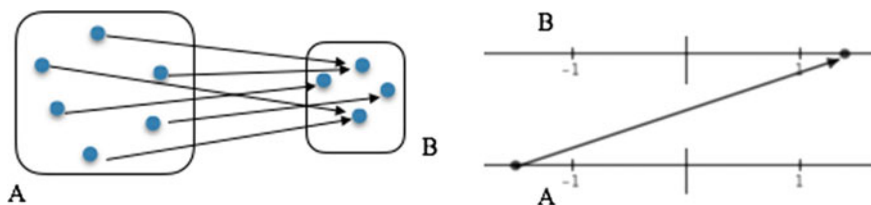


Fig. 4.1 Two images of functions as mappings—static (left) and dynamic (right)

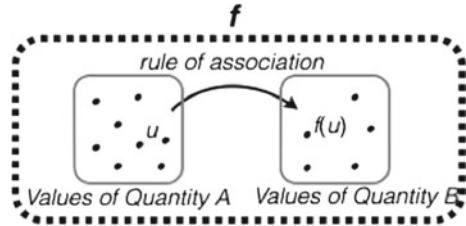
### 4.3 Our Perspective on Productive Meanings for Function

We take it as axiomatic that students profit when their teachers hold rich, coherent meanings and ways of thinking regarding ideas they teach. Also, different types of coherence are more or less appropriate to help different levels of students in learning those ideas. Figure 4.1 illustrates two teachers' images of *function as mapping*. Both images capture essential features of the common definition of function: every element of the domain is paired with a unique element of the range. The left image illustrates a teacher's strong focus on the idea of function as mapping elements of the domain to unique elements of the range. It also expresses the teacher's inattention to the nature of the domain and an inattention to how one might think about the independent variable's values varying. The right image illustrates a teacher who aims for students to think that a function's domain is a continuum of values. This teacher's image entails the action of "moving through" the continuum, so that *every* value of the continuum is mapped to one and only one value in the range. (Unfortunately, a static diagram cannot capture the dynamism of the teacher's image.) The left image could be productive for a teacher of higher-level mathematics, where domains can have arbitrary elements and structures. The right image could be productive for a high school teacher who hopes that students be able to envision functions as mapping continuous intervals to intervals.

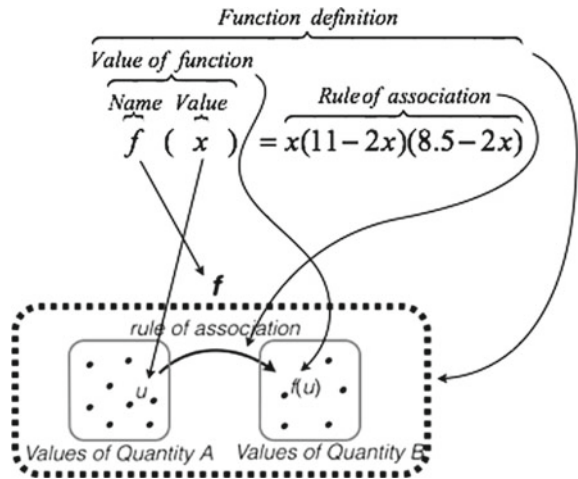
Any design of items that probe teachers' meanings for a concept must be grounded in a scheme of meanings that the designers take as a target understanding of the concept. For our purposes, we emphasize two aspects: (1) That a function is a named relation between two sets of elements such that the relation constitutes a rule of association between them, and (2) that one understands all the features of the relation being packed into the notation  $f(u)$ , so that " $f(u)$ " means "The value in  $f$ 's range that is associated with the value  $u$  in  $f$ 's domain." Figure 4.2 illustrates a common way that this way of understanding function is depicted in textbooks.

U.S. students commonly experience function notation with the attitude that " $f(x)$ " is an unnecessarily complicated way to say " $y$ ". This is understandable when we consider the density of meanings that are packed into function notation in relation to the concept of function. Figure 4.3 illustrates a coherent way in which one can understand a function  $f$  defined using function notation as denoting the same scheme of meanings as in Fig. 4.2.

**Fig. 4.2** Image of a function as a relation between values of A and B according to a rule of association



**Fig. 4.3** Connections between function concept and components of function notation



In the sequel, we discuss several items in the MMTsm, and results from 619 teachers from U.S. or South Korea, that probe ways they thought about function and function notation. We discuss this with the assumption that the meanings teachers have regarding functions and function notation influence the ways students understand these ideas.

### 4.4 Method

The study included 366 South Korean mathematics teachers (264 high school, 102 middle school) and 253 U.S. high school mathematics teachers. South Korean (SK) teachers constituted a geographic national sample; US teachers were from one state in the Southwest and one state from the Midwest. Teachers sat for the MMTsm in groups of varying size in summer 2013 and summer 2014. SK teachers taught a mean of 3.99 years (s.d. = 1.97); US teachers taught a mean of 4.35 years (s.d. = 4.22). SK teachers congregated for their required recertification examination; US teachers participated voluntarily in government-funded summer professional development programs. Teachers sat for the MMTsm in groups of sizes ranging from 40 to 150.

Here are two function definitions.

$$w(t) = \sin(t - 1) \text{ if } t \geq 1$$

$$q(s) = \sqrt{s^2 - s^3} \text{ if } 0 \leq s < 1$$

Here is a third function  $c$ , defined in two parts, whose definition refers to  $w$  and  $q$ . Place the correct letter in each blank so that the function  $c$  is properly defined.

$$c(v) = \begin{cases} q(\_) \text{ if } 0 \leq \_ < 1 \\ w(\_) \text{ if } \_ \geq 1 \end{cases}$$

**Fig. 4.4** MMTsm item addressing teachers' meanings for function notation. © 2016 Arizona Board of Regents. Used with permission

Items on the MMTsm were validated and refined over a three year period as described in Thompson (2016). Scoring rubrics assigned levels to teachers' responses according to the criterion *productivity of conveyed meaning for student learning*. For example, we deemed a meaning for variable that might convey to students that a variable stands for one number at a time as less productive for students' learning than a meaning that conveyed that a variable stands for the value of a quantity whose value varies.

## 4.5 Results

The MMTsm includes 18 items on functions (6 on definitions and properties, 8 on function notation, and 4 on functions as models). We present results from three items, one in each category, that exemplify the overall results. The items reported here were also reported in Musgrave and Thompson (2014) with data collected during item development.

### Item 1: Function Notation

The function notation item display in Fig. 4.4 was designed to see the extent to which teachers thought of the left-hand side as a name for the rule on the right-hand side. A similar item, given prior to the MMTsm to calculus students, showed that many students thought that they should use the same letter as appeared in the original definition in any re-use of the function with function notation. They thought that the letter within parentheses was part of the function name.

We considered teachers who placed  $t$  and  $s$  in the blanks as having thought of " $w(t)$ " and " $q(s)$ " as names and not in terms of a scheme of meanings as depicted in Fig. 4.3.

Results for this function notation item are given in Table 4.1.

**Table 4.1** Results from function notation item. Cell entries are *count (% of row total)*

	$v$ through-out	Mix of $s$ , $t$ , and $v$	$s$ , $t$	Other	I don't know	No answer	Total
Korea HS	203 (76.9%)	1 (0.4%)	14 (5.3%)	39 (14.8%)	2 (0.8%)	5 (1.9%)	264 (100.0%)
Korea MS	65 (63.7%)	0 (0.0%)	6 (5.9%)	19 (18.6%)	1 (1.0%)	11 (10.8%)	102 (100.0%)
US < calc	53 (29.6%)	7 (3.9%)	74 (41.3%)	20 (11.2%)	13 (7.3%)	12 (6.7%)	179 (100.0%)
US $\geq$ calc	32 (43.2%)	5 (6.8%)	25 (33.8%)	7 (9.5%)	3 (4.1%)	2 (2.7%)	74 (100.0%)

Calculus is a standard part of the high school curriculum in South Korea but not in the United States. We therefore disaggregated US teachers into teachers who never taught calculus and teachers who taught calculus at least once.

In many respects, the entries in Table 4.1 speak for themselves. SK high school teachers were the most sensitive to the role that  $s$  and  $t$  played in the definitions of  $w$  and  $q$  (77%) and the least likely to think of  $s$  and  $t$  as part of a function name (5%). US high school teachers who never taught calculus were the least sensitive to the role of  $s$  and  $t$  (30%) and the most likely to think that  $s$  and  $t$  were part of a function name (41%). It struck us that South Korean middle school teachers were 50% more likely to understand the role of  $s$  and  $t$  in their respective function definitions than were US high school teachers who taught calculus as a subject at least once.

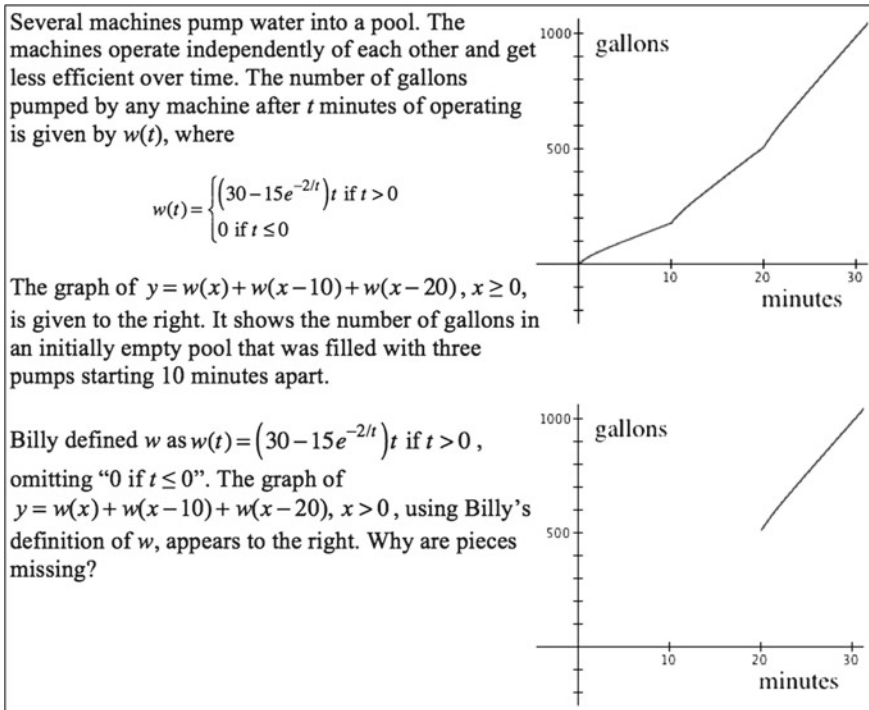
## Item 2: Function Definition

Part of a holistic meaning of function is that its definition is relative to a domain of values. The item in Fig. 4.5 was designed to address this issue.

Highest level responses explained that  $w$  is defined only for input values greater than 0, and therefore the graph of  $y = w(x) + w(x - 10) + w(x - 20)$ ,  $x > 0$ , exists only for values of  $x$  greater than 20.

The first two columns of Table 4.2 contain valid answers. The distinction is that responses in the first column explained why  $y$  was undefined for values of  $x$  less than or equal to 20 whereas responses in the second column gave an example or were given without explanation. The third column contains two different types of responses. The first type (“time cannot be negative”) explained that the value of the input to  $w$  is time, and there is no such thing as negative time. The second type (“ $w(t) < 0$ ”) explained that there actually is a graph, but it is below the horizontal axis, off the viewing pane shown on the page. The fourth column contains responses that explained the missing segments in Billy’s graph in terms of pumps’ behaviour, such as they malfunctioned and did not start until 20 min had elapsed (Fig. 4.6).

Sixty-three percent (63%) of SK high school teachers related the function definition to the domain of  $w$  by noting that the value of  $x$  in  $y = w(x) + w(x - 10) + w(x - 20)$  had to be greater than 20 for  $y$  to be defined, whereas 44% of SK middle school



**Fig. 4.5** MMTsm item addressing the extent to which teachers' meanings for function definition entails attention to a domain of definition. © 2016 Arizona Board of Regents. Used with permission

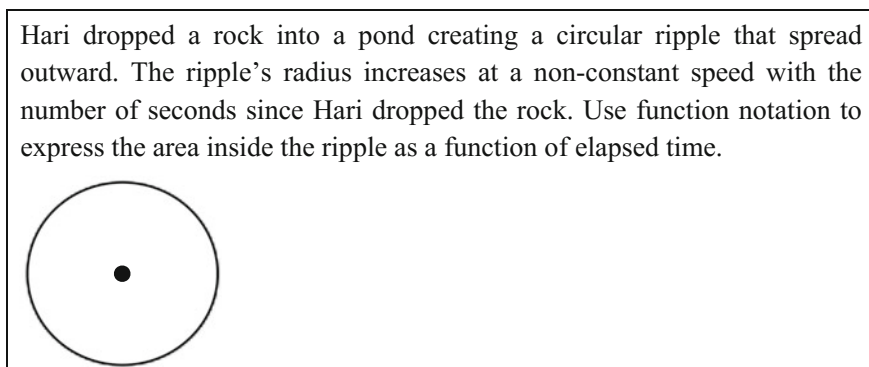
teachers, 11% of US precalculus teachers, and 12% of US calculus teachers said this. While we were not surprised by US precalculus teachers' non-normative responses,

**Table 4.2** Results from MMTsm item on function domain as part of function definition

	y undefined for $x \leq 20$ because ...	$x > 20$ example or no explanation	Time cannot be negative or $w(t) < 0$	Behaviour of pumps	Other, or could not interpret	I don't know	No answer	Total <sup>a</sup>
Korea HS	141 (53.4%)	23 (9.7%)	22 (8.4%)	6 (2.3%)	63 (23.9%)	4 (1.5%)	5 (1.9%)	264 (100.0%)
Korea MS	35 (34.3%)	10 (9.8%)	16 (15.7%)	10 (9.8%)	26 (25.5%)	0 (0.0%)	5 (4.9%)	102 (100.0%)
US < calc	9 (9.2%)	2 (2.0%)	5 (5.1%)	25 (25.5%)	46 (46.9%)	10 (10.2%)	1 (1.0%)	98 (100.0%)
US ≥ calc	5 (8.3%)	2 (3.3%)	5 (8.8%)	12 (20.0%)	33 (55.0%)	3 (5.0%)	0 (0.0%)	60 (100.0%)

<sup>a</sup>US totals exclude data from 95 teachers who responded to a different version of Item 2





**Fig. 4.6** MMTsm item for function as model (using function notation representationally)

we were quite surprised that US calculus teachers responded at essentially the same levels as precalculus teachers.

One might think that Item 2 is heavily reliant on teachers' meanings for function notation since it involves function notation in the definition of  $w$  and its use in defining  $y$ . However, the Kendall's tau statistic for these items is 0.07, so performance on the two seems unrelated.

### **Item 3: Function as Model (Using Function Notation Representationally)**

An important aspect of using functions to model situations is to use function notation representationally. For example, one could define the function  $d$  as the distance from Earth to Mars at each number of years since 00 CE. Then  $d(1999.7) - d(1998.2)$  would represent the net change in distance from Earth to Mars from 1998.2 years CE to 1999.7 years CE. We can do this meaningfully even without a rule of association for  $d$  that would allow us to compute these distances.

We anticipated that many teachers would use function notation on the left side of a function definition because this is customary when defining a function using function notation. We judged teachers to use function notation representationally when they used function notation on the right side of the function definition, defining the circle's radius as a function of time within the formula for area of a circle. A response using function notation on both sides of the function definition was scored at the highest level.

We scored responses according to whether they used function notation on both sides, right side only, or left side only. We were forced to include two additional categories of responses: Level 0 (could not interpret) and inconsistent use of variables (using different letters on either side of the definition).

Table 4.3 gives examples of responses in four categories. The first "both sides" example is quite impressive. This teacher used the Fundamental Theorem of Calculus to define the length of the radius as an integral of its velocity. The second example was the most common for "both sides" responses. The "right side only" example is straightforward. As we explained, we judged teachers to use function notation

**Table 4.3** Examples of responses to Item 3 in selected categories

Category	Example
FN (function notation) both sides:	$\begin{aligned} & \text{이제 물속의 속도가 : } v(t) \\ & \text{반경 : } r(t) = \int_0^t v(t') dt' \\ & \therefore \text{물속의 } S(t) = \pi \{ r(t) \}^2 = \pi \left\{ \int_0^t v(t') dt' \right\}^2 \\ & A(t) = \pi [r(t)]^2 \end{aligned}$
FN right side only:	$\begin{aligned} A &= \pi r^2 \\ A &= \pi (r(t)) \end{aligned}$
FN left side only:	$f(t) = \pi r$
Inconsistent use of variables:	$f(A) = \pi r^2$

**Table 4.4** Results for MMTsm item on function as model (using function notation representationally)

	FN both sides	FN right side only	FN left side only	Inconsistent use of variables	Level 0	I don't know	No answer	Total <sup>a</sup>
Korea HS	86 (32.6%)	77 (29.2%)	20 (7.6%)	10 (3.8%)	50 (18.9%)	9 (3.4%)	12 (4.6%)	264 (100.0%)
Korea MS	24 (23.5%)	15 (14.7%)	16 (15.7%)	5 (4.9%)	27 (26.5%)	5 (4.9%)	10 (9.8%)	102 (100.0%)
US < calc	20 (12.0%)	11 (6.6%)	58 (34.7%)	24 (14.4%)	32 (19.2%)	12 (7.2%)	10 (6.0%)	167 (100.0%)
US ≥ calc	19 (25.7%)	6 (8.1%)	27 (36.5%)	7 (9.5%)	8 (10.8%)	6 (8.1%)	1 (1.4%)	74 (100.0%)

<sup>a</sup>US totals do not include 12 teachers who responded to a version of the MMTsm that did not include this item

representationally when they used it on the right side, to represent the circle's radius as a function of time.

The example for “left side only” typifies responses in this category. Teachers responding with function notation on left side only wrote a formula on the right side. The example of “inconsistent variables” has a large intersection with “left side only” responses in that they used function notation only on the left side, but used different letters in the function's argument and in the defining formula.

Table 4.4 presents results for Item 3. We categorized teachers' responses according to the scheme presented in Table 4.3.

The first two columns in Table 4.4 represent teachers who have richer and more accurate meanings for function notation and the use of functions as models than

teachers included in the other columns. As in the previous examples, teachers from SK's high schools are 83% more likely than their U.S. counterparts (understood as those who taught calculus at least once) to have answered with function notation on the right-hand side or both sides (61.8% compared with 33.8%), the latter being more comparable to SK's middle school teachers.

The disparity becomes much larger when comparing SK's middle school teachers with those from U.S. high schools who had not taught calculus. SK's teachers' likelihood of having answered with function notation on the right-hand side or both sides is essentially double that of U.S. teachers in the comparison group. On the positive side for U.S. teachers who had taught calculus, when looking at the first column of Table 4.4, we see that they are only 21.1% less likely than SK's high school teachers to give such answers. This may be partly a consequence of the fact that high school calculus classes (just like those in college) include a fairly large number of modelling problems.

However, the larger disparity in response rates with function notation on the left-hand side only (34.7% for US teachers with calculus compared with 7.6% for SK's high school teachers) possibly reflects a rather weak meaning of function notation in the case of US teachers. The majority of teachers and calculus students interviewed prior to item development had the schema shown in line three of Table 4.3. "Using function notation", to them, meant writing " $f(x)$ " instead of  $y$ . They also felt that function notation by itself was meaningless, that a statement with function notation required an explicit rule of association on the definition's right side. Such an explicit representation is impossible in Item 3 because we only know that the rate of change of the radius of the circular ripples with respect to time is not constant—that the radius *is not* a linear function of time. But we do not know what function it is.

Also, when we compare all teachers from SK who participated in the study with all those from the U.S., we see the percentage in the first column (FN on both sides) being almost twice for SK (30.0%) compared with the US (16.2%). Even more extreme is the comparison for column three (FN left side only), where the percentage for the US (35.3%) is 3.6 times as large as for the SK teachers collectively (9.8%).

The statistics for these three sample items, because they are representative of the 18 items in the MMTsm on functions, indicate unequivocally that high school teachers in SK have more productive meanings for function definitions and properties, function notation, and for functions as models than their US counterparts. Future research will be required to investigate ways that these differences play out in teachers' instruction and students' learning.

## 4.6 Discussion

Results from TIMSS and other studies (Judson and Nishimori 2005; Tarr et al. 2000) indicate that U.S. students use calculators more frequently than their foreign counterparts. Possibly, by analogy, U.S. teachers may rely more on calculator use than their counterparts in South Korea and thus become more focused on how to input data on

the calculator than on the correct notation to write intended formulas on paper. Also, given the gender bias in TIMSS Advanced (end of high school) in favour of boys, we should check for gender differences in the MMTsm study.

We suspect, however, that deeper, cultural differences might be at play. Our experience is that the meanings and ways of thinking exhibited by a preponderance of US teachers are common among US school students, too. If teachers' meanings shape students' meanings by way of intersubjective operations of negotiation of meaning, then many of these teachers' students will pass through university with those meanings largely untouched only to become future high school mathematics teachers. This is the process Lortie (1975) described as a way that schools regenerate themselves. The evidence for the "Lortie hypothesis" is that US teachers we tested were school students before they were teachers, and their study of university mathematics evidently left the meanings they developed as school students (as shaped by their teachers) largely untouched. To study this hypothesis requires evolutionary and sociological research methods that, at this moment, do not exist in mathematics education.

We hasten to note that what we described above is not Klein's double discontinuity. Rather, for a majority of US teachers in our sample, it seems there was a *continuity* of mathematical meanings that teachers carried from school to university and back to school. They seem to have maintained these meanings despite their experiences in higher mathematics courses.

The problem we face in the US is to enrich future teachers' school mathematical meanings so that they are truly foundational, instead of irrelevant, for higher mathematics. Thompson (2013) outlines a number of long-term strategies that address this problem. One effort that is central to all of them is that university mathematics programs must take into account the mathematical meanings that students (not just future teachers) bring to their university studies. Again, this will require a long-term effort. Culturally embedded meanings and ways of thinking are difficult to dislodge among university instructors as well as high school instructors.

## References

- Biehler, R. (2005). Reconstruction of meaning as a didactical task—The concept of function as an example. In J. Kilpatrick, C. Hoyles, O. Skovsmose, & P. Valero (Eds.), *Meaning in mathematics education* (pp. 61–81). New York: Springer.
- Buchholtz, N., & Kaiser, G. (2013). Improving mathematics teacher education in Germany: Empirical results from a longitudinal evaluation of innovative programs. *International Journal of Science and Mathematics Education, 11*, 949–977. <https://doi.org/10.1007/s10763-013-9427-7>.
- Judson, T. W., & Nishimori, T. (2005). Concepts and skills in high school calculus: An examination of a special case in Japan and the United States. *Journal for Research in Mathematics Education, 36*, 24–43.
- Kaiser, G., Blömeke, S., König, J., Busse, A., Döhrmann, M., & Hoth, J. (2017). Professional competencies of (prospective) mathematics teachers—Cognitive versus situated approaches. *Educational Studies in Mathematics, 94*(2), 161–182. <https://doi.org/10.1007/s10649-016-9713-8>.

- Kilpatrick, J. (2008). A higher standpoint. In ICMI (Ed.), *Proceedings of the 11th International Congress on Mathematical Education* (pp. 26–43). Monterrey, Mexico: ICME. Retrieved from [http://www.mathunion.org/fileadmin/ICMI/files/About\\_ICMI/Publications\\_about\\_ICMI/ICME\\_11/Kilpatrick.pdf](http://www.mathunion.org/fileadmin/ICMI/files/About_ICMI/Publications_about_ICMI/ICME_11/Kilpatrick.pdf).
- Klein, F., Hedrick, E. R., & Noble, C. A. (1932). *Elementary mathematics from an advanced standpoint: Arithmetic, algebra, analysis*. New York: Macmillan.
- Lortie, D. C. (1975). *Schoolteacher*. Chicago: University of Chicago Press.
- Musgrave, S., & Thompson, P. W. (2014). Function notation as idiom. In P. Liljedahl & C. C. Nicol (Eds.), *Proceedings of the 38th Meeting of the International Group for the Psychology of Mathematics Education* (Vol. 4, pp. 281–288). Vancouver, BC: PME. Retrieved from <http://bit.ly/1p08TCG>.
- Tarr, J. E., Mittag, K. C., & Uekawa, K. (2000). A comparison of calculator use in eighth-grade mathematics classrooms in the United States, Japan, and Portugal: Results from the third international mathematics and science study. *School Science & Mathematics, 100*, 139–150. <https://doi.org/10.1111/j.1949-8594.2000.tb17249.x>.
- Thompson, P. W. (2013). In the absence of meaning. In K. Leatham (Ed.), *Vital directions for research in mathematics education* (pp. 57–93). New York: Springer.
- Thompson, P. W. (2016). Researching mathematical meanings for teaching. In L. D. English & D. Kirshner (Eds.), *Handbook of international research in mathematics education* (pp. 435–461). New York: Taylor & Francis.

**Open Access** This chapter is licensed under the terms of the Creative Commons Attribution 4.0 International License (<http://creativecommons.org/licenses/by/4.0/>), which permits use, sharing, adaptation, distribution and reproduction in any medium or format, as long as you give appropriate credit to the original author(s) and the source, provide a link to the Creative Commons license and indicate if changes were made.

The images or other third party material in this chapter are included in the chapter's Creative Commons license, unless indicated otherwise in a credit line to the material. If material is not included in the chapter's Creative Commons license and your intended use is not permitted by statutory regulation or exceeds the permitted use, you will need to obtain permission directly from the copyright holder.



# Chapter 5

## Is the Real Number Line Something to Be Built, or Occupied?



Hyman Bass

**Abstract** Klein emphasized geometry and intuition, and made the concept of function central to mathematics education. In fact, number and operations form the backbone of the school mathematics curriculum. A high school graduate should comfortably and capably meet an expression like, “Let  $y = f(x)$  be a function of a real variable  $x$ ,” implying that the student has a robust sense of the real number continuum, the home of  $x$ . This understanding is a central objective of the school mathematics curriculum, taken as a whole. Yet there are reasons to doubt whether typical (U.S.) high school graduates fully achieve this understanding. Why? And what can be done about this? I argue that there are obstacles already at the very foundations of number in the first grades. The *construction narrative* of the number line, characteristic of the prevailing curriculum, starts with cardinal counting and whole numbers and then *builds* the real number line through successive enlargements of the number systems studied. An alternative, based on ideas advanced by V. Davydov, the *occupation narrative*, begins with *pre-numerical* ideas of quantity and measurement, from which the *geometric* (number) line, as the environment of linear measure, can be made present from the beginning, and wherein new numbers progressively take up residence. I will compare these two approaches, including their cognitive premises, and suggest some advantages of the occupation narrative.

**Keywords** Quantity · Unit · Measurement · Number · Counting  
Real number line · Early childhood mathematics

---

This paper is adapted from a presentation at the workshop, *Math Matters in Education* (Texas A & M University, March, 2015) in honor of Roger Howe.

---

H. Bass (✉)  
University of Michigan, Ann Arbor, USA  
e-mail: [hybass@umich.edu](mailto:hybass@umich.edu)

© The Author(s) 2019  
H.-G. Weigand et al. (eds.), *The Legacy of Felix Klein*, ICME-13 Monographs,  
[https://doi.org/10.1007/978-3-319-99386-7\\_5](https://doi.org/10.1007/978-3-319-99386-7_5)

## 5.1 Introduction

Klein's mathematical work emphasized geometry and intuition.

As regards my own higher lectures, I have pursued a certain plan in selecting the subjects for different years, my general aim being to gain, in the course of time, a complete view of the whole field of modern mathematics, with particular regard to the intuitional or (in the highest sense of the term) geometrical standpoint.

—Klein (2000, p. 96)

His work in school mathematics education gave center stage to the concept of function (Klein 2000, p. 4).

We, who are called the reformers, would put the function concept at the very center of instruction, because, of all the concepts of the mathematics of the past two centuries, this one plays the leading role wherever mathematical thought is used. We would introduce it into instruction as early as possible with constant use of graphical method, the representation of functional relations in the  $x$   $y$  system, which is used today as a matter of course in every practical application of mathematics.

The learners that Klein had in mind were presumed to have a well-founded understanding (both formal and intuitive) of the real number line, of the “ $x$ ” in  $f(x)$ , of Euclidean geometry in *dimension one*. This paper addresses the fact that this essential foundational understanding may be less secure with some current curricular treatments.

The device beyond praise that visualises magnitudes, and at the same time the natural numbers articulating them, is the number line, where initially only the natural numbers are individualised and named. In the didactics of secondary instruction the number line has been accepted, though it is often still imperfectly and inexpertly exploited.

—Freudenthal (1983, p. 101)

My purpose here is to contrast the development of the number line common to most current curricula with an alternative proposed by V. Davydov, one that, I would argue, is closer in spirit to Klein's sensibility.

... the students' creation of a detailed and thorough conception of a real number, underlying which is the concept of quantity, is currently the end purpose of this entire instructional subject, from grade 1 to 10 ... the teacher, relying on the knowledge previously acquired by the children, introduces number as a ... representation of a general relationship of quantities, where one of the quantities is taken as a measure and is computing the other.

—Davydov (1990, pp. 167, 169)

## 5.2 The Construction Narrative of the Real Number Line

For intuitively meaningful parts of mathematics, there is a significant difference between the logical and the psychological points of entry, the latter being typically located somewhere midlevel in the logical hierarchy. The logical foundations are no

less intuitively abstract than are the more sophisticated structures that expand beyond our initial intuitions.

In the case of the real number line,  $\mathbb{R}$ , its twentieth century, set theory based, construction starts with the whole numbers, and continues (Peano Axioms) with successive enlargements, to integers,  $\mathbb{Z}$ , rational numbers,  $\mathbb{Q}$ , and finally reaching  $\mathbb{R}$ , by a process of geometric completion (filling invisible holes). This is what I call the *construction narrative* of the number line. In many school curricula the real number line is constructed by some rough approximation of this construction narrative: First, counting (whole) numbers; then, in some order, negative integers and positive fractions; merging into rational numbers; and finally real numbers, either constructed using some form of limits, or, commonly, just noting the existence of some irrational numbers, like  $\sqrt{2}$ , and vaguely leaving the real numbers underspecified as “the rationals plus the irrationals.”

The starting point of the construction narrative seem natural enough since humans (and other species) are biologically endowed with some primordial sense of small cardinal counting:

It is now widely acknowledged that the typical human brain is endowed by evolution with a mechanism for representing and discriminating numbers ... when I talk about numbers I do not mean just our familiar symbols – counting words and ‘Arabic’ numerals, I include any representation of the number of items in a collection, more formally the cardinality of the set, including unnamed mental representations. Evidence comes from a variety of sources.

—Brian Butterworth (2015)

A more spiritual, but less scientific evocation of this is Kronecker’s dictum, “*God made the integers, all else is the work of man.*”

The construction narrative begins with whole numbers and counting and progressively introduces new number systems. In all but one case (from rational to real numbers), the new system is created to enable solutions to equations formulated, but not solvable, in the previous system. In each extension it is tacitly presumed, but not generally proved, that the arithmetic operations extend and that Basic Rules of Arithmetic (commutativity, associativity, distributivity, etc.) continue to hold.



<b>The Construction Narrative of the Real Number Line</b> <b>Cognitive Premise:</b> Children’s early discernment of small cardinals and large differences		
Number Systems	Models	Conceptual frame
<b>Whole numbers</b>	(Finite) sets; disjoint union as sum; the “Number Queue”	Cardinal/Ordinal
<b>Fractions <math>n/d</math> (<math>\geq 0</math>)</b>	Part-whole images <u>Solve:</u> $a \cdot x = b$	Use $1/d$ as unit. Need common $d$ for addition
<b>Integers*</b>	Negatives; subtraction <u>Solve:</u> $a + x = b$	Reflection through 0 Take away; compare.
<b>Rational numbers</b>	Formal synthesis of fractions $\geq 0$ and negative numbers	Mirror reflection of fractions $\geq 0$
<b>Irrational numbers</b>	Miscellaneous natural examples: $\sqrt{2}, \pi, e$ Only $\sqrt{2}$ is proved	Incommensurability with 1
<b>Real numbers</b>	“Everything else.” Infinite decimals. <b><u>A significant conceptual gap</u></b>	<u>All</u> points on the (continuous) number line
<b>Complex numbers</b>	“The complex plane” <u>Solve:</u> $x^2 + 1 = 0$	

(\*) The curricular order of “Integers” and “Fractions ( $\geq 0$ )” is sometimes reversed.

### 5.3 Difficulties with the Construction Narrative

#### 5.3.1 *The Whole Number/Fraction Divide*

Whole numbers are conceived as cardinals of (discrete) sets, while fractions are conceived as relative measures of two (continuous) quantities, and so they seem, at first sight, to be different a species of numbers. The whole number 7 is treated as a noun, whereas, when thinking of  $3/4$ , it is hard to resist adding the word “of.” A fraction is conceptually an *operator* on quantities, not a conceptually free-standing mathematical object, since, unlike cardinal, the unit of measure is unspecified and not implicit. This difference makes it difficult to arrange for these two number populations and their interactions to harmoniously cohabit the same (real) number universe. Of course cardinal is appropriately viewed as a special (discrete) regime of measurement, but this perspective is not initially needed, and so not made explicit.

<b>Whole numbers</b> —>	<b>Fractions</b>
A whole number is, conceptually, a mathematical object. “7”	A fraction is, conceptually, a mathematical operator. “3/4 of . . .”
A whole number is <u>the (discrete) measure</u> (cardinal) of a set	A fraction is <u>the relative measure</u> of two quantities
Addition/subtraction corresponds to composition/decomposition (set union)	Addition/subtraction corresponds to composition/decomposition of quantities
Multiplication corresponds to repeated addition (or whole number rescaling), or to Cartesian arrays	Multiplication corresponds to composition of operators, or to rectangular area (in which case the product is a different species of quantity.)
Whole numbers are denoted with base-10 positional notation	Fractions are denoted with the fraction bar notation
Computational algorithms are anchored in this notation	Computational algorithms are anchored in this notation
Whole numbers are born in the cardinal/ordinal world	Fractions are born in the worlds of (possibly continuous) measure. (The cardinal world is one of these, though it is not typically seen this way.)

### 5.3.2 *The Continuum Gap*

The passages from rational numbers to irrationals, and then to real numbers is fragmentary and pretty much clouded in mystery in the school curriculum. The student may know little more than, “some numbers are irrational.” To build the real numbers with analytic rigor might exceed the resources of many school curricula, with the result that students are left with a weakly developed concept image of real numbers. How would a high school student explain the meaning of  $\sqrt{2} + \pi$ , or  $\sqrt{2} \cdot \pi$ ? Or  $2^\pi$  (“the product of  $\pi$  copies of 2?”) Our base-10 algorithms act first on the right most digits, and so could not be applied to infinite decimal expansions.

## 5.4 The Occupation Narrative of the Real Number Line

I contrast the construction narrative with what I call the *occupation narrative* of the real number line. Its cognitive premise is that, in addition to our early sense of counting, we come also with some primordial sense of continuous, pre-numerical measurement of quantity. This is an idea advanced and developed notably by Davydov (1975), and it is supported by current research:

Children’s understanding of measurement has its roots in the preschool years. Preschool children know that continuous attributes such as mass, length, and weight exist, although they cannot quantify or measure them accurately. Even 3-year-olds know that if they have some clay and then are given more clay, they have more than they did before. Preschoolers cannot reliably make judgments about which of two amounts of clay is more; they use

perceptual cues such as which is longer. At age 4-5 years, however, most children can learn to overcome perceptual cues and make progress in reasoning about and measuring quantities. Measurement is defined as assigning a number to a continuous quantity.

—Clements and Stephan (2001, pp. 2–3)

In this perspective the line is, intuitively, the natural environment for linear measurement, of quantities of length, measured by intervals on the line. Intuitively, the line is like a stretch of string—inelastic, so that length is not distorted—but flexible—so that, for example, it can measure your hat size as well as your height. Eventually it is allowed to have infinite extent in both directions.

It is in this sense that the (continuous) geometric line is made intuitively present from the early grades, and, as new kinds of numbers are introduced, they quickly take up residence on the line. In contrast with the construction narrative, wherein more and more points are installed to *build* the line, all points are present from the start in the occupation narrative, and more of them acquire numerical names across the curriculum. The numbers are like the “addresses” assigned to the geometric points. One could think of this as “coordinatizing the geometric line,” or “Cartesian coordinates in dimension one.”

The geometric line is coordinatized with numbers by choice of an ordered pair of points, that we typically call 0 and 1. Then we take the interval  $[0, 1]$  as the unit of linear measure. Note that the line has an intrinsic “linear structure,” arising from “betweenness:” Given three points, one will lie between the other two. This does not yet specify which one is largest. There are two possible “linear orders” on the geometric line. In choosing the ordered pair  $(0, 1)$  we specify not only the unit of measure  $[0, 1]$ , but also the order (orientation) of the line, by declaring that 1 is greater than 0, so 0 to 1 is the positive direction on the line. Our general convention is to depict the line horizontally, and to take (left  $\rightarrow$  right) as the positive direction.

A whole number  $N$  is then placed on the line by concatenating, to the right,  $N$  copies of the unit, starting at 0, and placing  $N$  at the final right endpoint. Note that this placement is essentially measure theoretic, not based exclusively on cardinal. Children are sometimes confused by counting hash marks, where the copies of the unit meet, instead of counting intervals. Fractions are similarly placed on the line using a subunit  $[0, 1/d]$ , where  $d$  is the denominator of the fraction.

This in fact foreshadows the general geometric concept of number on the (coordinatized) number line: A point  $a$  on the number line represents the number which is the measure of the *oriented interval* from 0 to  $a$ . (This will be negative if 0 lies between  $a$  and 1.) In fact, one may reasonably think of the oriented interval  $[0, a]$  as a one-dimensional vector. From this point of view, adding  $a$  to a general number  $x$  can be geometrically viewed as translation of the line by the vector  $[0, a]$ : a given distance in a given direction.

### **Davydov’s Approach**

Young children have a primordial sense of

- quantity, an attribute of physical objects (not only cardinalities): length, area, volume, weight, ... without numerical associations.

- And of addition (composing and decomposing quantities of the same species)
- They can make rough comparisons of size (“Which is more?”), which Davydov has them express symbolically, as “ $B > T$ .” And then infer that “ $B = T + C$ ” for the “quantity difference” Venenciano and Dougherty (2014) describe this as “Concurrent representation used to model change from a statement of inequality to a statement of equality”

Using two unequal areas of paper, the papers can be stacked such that the area of the larger piece that is not covered by the smaller piece can be cut off. The piece that is removed is defined as the difference. Similarly, beginning with the unequal areas of paper, by taping the precise amount of area to the smaller area to create a combined area equal to the larger area, defines the difference.

Given quantity  $B >$  quantity  $T$ : If  $B - C = T$  then  $B = T + C$ , i.e. “ $B = T$  by  $C$ .” The last statement is read, “Quantity  $B$  is equal to quantity  $T$  increased by the difference, quantity  $C$ .”

- Davydov develops in children such algebraic relations, involving “pre-numerical” quantities, and hence involving no numerical calculation.
- This practice also functions as a pre-cursor of algebraic thinking.
- And it imparts the correct sense of the meaning of the “ $=$ ” sign, meaning that the (eventually numerical) value of the two sides is the same. This meaning is sometimes distorted when equations are used primarily in the context of numerical computation: Students come to think that, “the right side is the computation of the left side.”
- Davydov develops these ideas in first grade, prior to the introduction of whole numbers, in a measurement context. Whole numbers appear only late in the first term of first grade.

## 5.5 Quantity, Unit, Measure, Number

A quantity has no intrinsically attached number. Rather, given two quantities,  $A$  and  $U$ , then, taking  $U$  as a “unit,” the number we attach to  $A$  is, “How much (or many) of  $U$  is needed to constitute  $A$ ?” Thus a number is a ratio of two quantities.

To understand a numerical quantity, it is necessary to specify, or know, the unit. And, for a given species of quantity, different units may be chosen: (feet, inches, meters—for length), (quarts, pints, liters—for liquid volume), etc. To numerically simplify a sum of two numerical quantities they must be of the same species and expressed with the same unit. (“Can’t add apples and oranges.”) That is why, in place value algorithms for addition, we vertically align the digits with the same place value position, i.e. with the same base-10 units. That is why, in adding fractions, we seek common denominators (“unit fractions”).

In principle, numerical quantities manifest the full continuum of (positive) real numbers. Whole numbers arise, in every measure regime, when a quantity is composed exactly of a set of copies of the unit. This is how to comprehend whole numbers in the general measure context, not simply cardinal counting. (In the cardinal world,

the default unit is the one element set, and each set is composed of a set of copies of this unit.)

Of course cardinal can be viewed as a (discrete) measurement context. However, since it is natural to choose the one-element set as unit, there is no a priori need to even introduce the concept of unit. Thus, in the cardinal introduction of whole number, the very concepts of unit, and of measure relative to a unit, do not immediately rise to conscious consideration. Later, when introducing multiplication, and place value, other sets are taken to function as units, but again this typically is not explicitly linked conceptually to the domain of continuous measure. This is related to the “whole number/fraction divide” discussed above.

This notion of number as a ratio of quantities may seem somewhat sophisticated, and not appropriate for very young children. Davydov argues the contrary, as demonstrated by the following activity design, to solve what he calls the “**fundamental problem of measure:**” *Given a quantity A, reproduce A in a different place and time.*

Here is how he enacts this with children: See Moxhay (2008).

1. A strip of tape, A, is on a table. In the next room is a roll of tape.
2. Task: Cut off a piece of that roll of tape exactly the length of A. But you are not allowed to move A.



3. Different approaches:

1. Make a guess, from a remembered image. This is very inexact.
2. If given a spool of string and scissors, cut off a piece of string the length of A. This is exact, but needs a customized mediating equivalent quantity, the string segment.
3. Suppose you are given a stick of wood, longer than A. Mark it at the length of A, and use this to measure off the tape.
4. Suppose you have a stick of wood shorter than A. Then you can count off lengths of the stick to *measure* A. In this case, the child actually constructs the idea of measurement, and engages the concept of unit.



5. Of course the short stick of wood will not, in general, measure  $A$  exactly. A number of iterates of the stick will measure a part of  $A$  with a remainder shorter than the stick. But then, since the stick is longer than that remainder, the remainder can be captured as in step 3.

This activity design, which leads the learner to the concepts of measure and of unit, creates what Harel (2003) calls *intellectual necessity*, and exemplifies a *didactical situation*, in the sense of Brousseau (1997). If we imagine this experiment with cardinal instead of linear measure, several conceptual and cognitive steps would be missing, and the first approach would suffice.

## 5.6 Who Was Vasily Davydov?



Vasily Davydov (1930–1988) was a Vygotskian psychologist and educator in the Soviet Union. With colleagues, in the 1960s, he developed a curriculum starting with quantity (of real objects) and measure. Adaptations of the Davydov early grades curriculum have been implemented in the U.S., with some claims of success. See, for example: Schmittau (2005), and Moxhay (2008). Many of these ideas are present in the NCTM and Common Core Standards, in the context of measurement, but not integrated with the development of number.

In Bass (1998) I speculated about the possibility of an early introduction of the continuous number line in the school curriculum, without then being aware of Davydov's work.

## 5.7 Conclusion: What Is Achieved by the Occupation Narrative of the Number Line?

- As mentioned earlier, Davydov’s early introduction of pre-numerical quantities provides an introduction to algebraic notation and relations, and to a robust sense of the meaning of the “=” sign.
- The whole number/fraction divide is bridged: The part-whole introduction of fractions is inherently a measurement approach, the *whole* being the unit of measure. Though cardinal counting is also a measurement context, that point of view is not emphasized, since there is a natural default choice of unit (the 1-element set), and so the very concept of unit, and its possible variability, need not at first enter conscious reflection or discussion. Here it is proposed that one emphasize the appearance of whole numbers in every measurement context. In fact, placement of whole numbers on the number line already requires appeal to (continuous) linear measure.
- The main point is that the geometric line, anchored in the context of linear measure, is present almost from the beginning. The progressive enlargements of the number world simply supplies numerical names to more and more of the (already present) points on the line.
- While a few irrational numbers can be identified and located on the number line, it can be pointed out that many (even “most”) numbers are irrational, and that even though we have not named them, they are there, as points on the geometric number line, leaving no “holes” (the line is connected).
- The number line makes it possible, from the beginning, to geometrically interpret the operations of adding, or multiplying by, a real number. (See Ji Yeong and Dougherty (2015) for a measurement treatment of multiplication.)

## References

- Bass, H. (1998). Algebra with integrity and reality. *Keynote Address at the NRC Symposium on the Nature and Role of Algebra in the K-14 Curriculum*. Proceedings published by the NRC.
- Brousseau, G. (1997). Foundations and methods of didactique. In N. Balacheff, M. Cooper, R. Sutherland, & V. Warfield (Eds. and Trans.). *Theory of didactical situations in mathematics: Didactique des mathématiques, 1970–1990* (pp. 21–75). Dordrecht, The Netherlands: Kluwer.
- Butterworth, B. (2015). Low numeracy: From brain to education. Plenary address at ICMI Study 23, Macau, China, June 2015.
- Chislenko, E., & Tschinkel, Y. (2007). The Felix Klein protocols. *Notices of the AMS*, 54, 960–970.
- Clements, D. H., & Stephan, M. (2001). Measurement in PreK-2 mathematics. In D. H. Clements, J. Sarama, & A.-M. DiBiase (Eds.), *Engaging young children in mathematics*. Reston: NCTM.
- Davydov, V. V. (1975). Logical and psychological problems of elementary mathematics as an academic subject. In L. P. Steffe (Ed.), *Children’s capacity for learning mathematics* (pp. 55–107). Chicago, IL: University of Chicago.
- Davydov, V. V. (1990). *Types of generalization in instruction: Logical and psychological problems in the structuring of school curricula*. Reston, VA: National Council of Teachers of Mathematics (Original published in 1972).

- Freudenthal, H. (1983). *Didactical phenomenology of mathematical structures*. Dordrecht: Reidel.
- Harel, G. (2003). The DNR system as a conceptual framework for curriculum development and instruction. In R. Lesh, J. Kaput, E. Hamilton, & J. Zawojewski (Eds.), *Foundations for the future*. Mahwah: Lawrence Erlbaum Associates.
- Howe, R. (2011). The greatest calamity in the history of science. In J. C. e Silva (Ed.), *ICMI Newsletter* (Vol. 18).
- ICMI Study 13. (2006). In F. Leung, K.-D. Fraf, & F. Lopez-Real (Eds.), *Mathematics education in different cultural traditions—A comparative study of East Asia and the West*. Berlin: Springer.
- Ji Yeong, I., & Dougherty, B. (2015). Linking multiplication models to conceptual understanding in measurement approach. In *11th Hawaii International Conference of Education*, Honolulu, HI. [https://www.researchgate.net/publication/270279409\\_Linking\\_Multiplication\\_Models\\_to\\_Conceptual\\_Understanding\\_in\\_Measurement\\_Approach](https://www.researchgate.net/publication/270279409_Linking_Multiplication_Models_to_Conceptual_Understanding_in_Measurement_Approach).
- Klein, F. (2000). *The Evanston colloquium*. AMS Chelsea: Providence.
- Moxhay, P. (2008). *Assessing the scientific concept of number in primary school children*. Paper presented at ISCAR 2008, San Diego. [lchc.ucsd.edu/MCA/Mail/xmcamail.2009\\_05.dir/pdfxxr6FcSxae.pdf](http://lchc.ucsd.edu/MCA/Mail/xmcamail.2009_05.dir/pdfxxr6FcSxae.pdf).
- National Research Council. (2009). In C. T. Cross, T. A. Woods, & H. Schweingruber (Eds.), *Mathematics learning in early childhood: Paths toward excellence and equity*. Committee on Early Childhood Mathematics, Center for Education, Division of Behavioral and Social Sciences and Education. Washington, DC: The National Academies Press.
- Schmittau, J. (2005). The development of algebraic thinking: A Vygotskian perspective. *ZDB*, 37. [lchc.ucsd.edu/mca/Mail/xmcamail.2014-11.dir/pdfv7AHOJXcb2.pdf](http://lchc.ucsd.edu/mca/Mail/xmcamail.2014-11.dir/pdfv7AHOJXcb2.pdf).
- Venenciano, L. & Dougherty, B. (2014). Addressing priorities for elementary school mathematics. *For the Learning of Mathematics*, 34. <http://flm-journal.org/Articles/739D3FD8C95A0A3770B35494FA3327.pdf>.

**Open Access** This chapter is licensed under the terms of the Creative Commons Attribution 4.0 International License (<http://creativecommons.org/licenses/by/4.0/>), which permits use, sharing, adaptation, distribution and reproduction in any medium or format, as long as you give appropriate credit to the original author(s) and the source, provide a link to the Creative Commons license and indicate if changes were made.

The images or other third party material in this chapter are included in the chapter's Creative Commons license, unless indicated otherwise in a credit line to the material. If material is not included in the chapter's Creative Commons license and your intended use is not permitted by statutory regulation or exceeds the permitted use, you will need to obtain permission directly from the copyright holder.





# Chapter 6

## Coherence and Fidelity of the Function Concept in School Mathematics



William McCallum

**Abstract** We define notions of mathematical coherence and mathematical fidelity and apply them to a study of the function concept in school mathematics, as represented by the results of image searches on the word “function” in various languages. The coherence and fidelity of the search results vary with the language. We study this variation from a mathematical viewpoint and distill dimensions which characterize that variation, and which can provide insights into the characteristics of professional communities of school educators and into principles for selection and evaluation of curriculum resources.

**Keywords** Klein · Function · Mathematical coherence · Mathematical fidelity

### 6.1 Introduction

We, who use to be called the reformers, would put the function concept at the very center of teaching, because, of all the concepts of the mathematics of the past two centuries, this one plays the leading role wherever mathematical thought is used. We would introduce it into teaching as early as possible with constant use of the graphical method, the representation of functional relations in the  $xy$  system, which is used today as a matter of course in every practical application of mathematics.

—Klein, 1908 (Klein et al. 2016)

Klein’s vision of the “function concept at the center of instruction” was part of a broader school reform movement at the beginning of the 20th century, as recounted by Krüger (2018) in this volume. Today many aspects of that vision have been realized in mathematics education. The function concept is firmly embedded in the school curriculum, with an explicit definition of the concept usually occurring in later grades. In earlier grades the influence of the function concept on curriculum varies. In many curricula, for example the reform curricula of the 90s in the US, functional thinking in early grades can be seen in the use of patterns and tables, even if the concept

---

W. McCallum (✉)

Department of Mathematics, The University of Arizona, Tucson, AZ 85721, USA  
e-mail: wmc@math.arizona.edu

© The Author(s) 2019

H.-G. Weigand et al. (eds.), *The Legacy of Felix Klein*, ICME-13 Monographs,  
[https://doi.org/10.1007/978-3-319-99386-7\\_6](https://doi.org/10.1007/978-3-319-99386-7_6)

79

was not explicitly defined. Recent standards in the US have partially reversed this trend, with a greater emphasis on arithmetic and the properties of operations in the early grades (National Governors Association Center for Best Practices & Council of Chief State School Officers 2010).

In this paper it is our purpose to analyze the function concept as it appears in school mathematics from a mathematical point of view. We intend this to be a work of mathematical analysis, not a work of educational research. It is not our purpose, nor our expertise, to investigate the relationship between the function concept on the one hand and students, teachers, and classrooms on the other hand. We focus on two aspects of the function concept in school mathematics: mathematical coherence and mathematical fidelity. By mathematical coherence we mean the strength and consistency of mathematical connections, the tendency of a curriculum, or of a collection of curriculum materials, to form a mathematically logical and consistent whole. By mathematical fidelity we mean the extent to which a curriculum, or a collection of curriculum materials, faithfully presents the underlying mathematical concept as it is situated in the discipline of mathematics. Note that mathematical fidelity is not the same as mathematical formality; a mathematical concept can be presented in a way that is appropriate for the age of the students, while still being presented with fidelity. We hope that the mode of mathematical analysis presented here may be useful to the producers of curriculum and other resources for students, teachers, and classrooms.

We illustrate the concepts of mathematical coherence and mathematical fidelity with an analysis of the results of internet image searches on the word “function” in various languages. One reason for doing this is simply that it is a convenient way of producing raw material with which to illustrate the mode of analysis. However, there is some reason to believe that the collection of images so obtained is telling us something about how the function concept is presented in schools. It is common to think of the internet as a network somewhat similar to the network of neurons in the brain (see, for example, Woodford 2017). Furthermore, searching on the word “function” in various languages leads to results that are largely related to school mathematics. The algorithms behind search engines are designed to give prominence to results that are highly interconnected with other sites on the internet; thus they might be seen as giving results that are prominent in the community using the network. Putting these observations together suggests that structural features of the results of an image search bear some relation to structural features of school mathematics in the language of the search. We do not, however, investigate that relationship, nor is such an investigation necessary for our purpose.

The paper is organized as follows. We start with a brief survey of various school mathematics definitions of the function concept, on order to ground the analysis that takes place in later sections. We then present the results of image searches in various languages, and discuss the mathematical coherence and mathematical fidelity of the results. We conclude with some thoughts on a possible connection between the analysis and the idea of concept image in mathematics education, and on implications of the analysis for the selection and evaluation of curriculum materials.

A note on terminology: We follow Zimba (2017) in using the word “presentation” rather than “representation.” The concept of representation in mathematics education

research is complex. It is linked to thoughts and processes which are not recoverable from mere contemplation of presentations. A presentation is an artifact—a written definition, an image, a physical model—that is the result of someone saying “here is a function.” Our goal in this paper to observe presentations with a mathematical eye, attempting to excavate their mathematical structure and meaning.

## 6.2 The Definition of Function in School Mathematics

We present seven definitions from various sources: three from widely used US high school textbooks, three from highly ranked internet search results on “definition of function,” and one provided by one of the lead authors of the US Common Core State Standards in Mathematics. In choosing these definitions, we have tried to illustrate a range, and have avoided choosing definitions that were badly flawed or wrong. We have also limited the choice to definitions that were intended for school students, not university students. Since the search was conducted in English, it naturally reflects a bias to sources from English speaking countries. Later in this article we look at image searches in other languages.

1. “In mathematics, relations like these—where each possible value of one variable is associated with exactly one value of another variable—are called functions. . . .” (Core-Plus Mathematics 2015).
2. “A relationship between inputs and outputs is a function if there is no more than one output for each input.” (Core Connections Algebra 2013).
3. “A function is a rule that assigns to each value of one quantity a single value of a second quantity.” (EngageNY/Eureka Math, Grade 8, Module 5 2017).
4. “A variable quantity regarded in relation to one or more other variables in terms of which it may be expressed or on which its value depends.” (Top ranked result from a Google search performed on 11 December 2017).
5. “A mathematical correspondence that assigns exactly one element of one set to each element of the same or another set.” (Merriam-Webster 2017).
6. “[A] function is a relation in which each element of the domain is paired with exactly one element of the range.” (iCoachMath.com 2017).
7. “A function is any sort of process, or calculation, or lookup table, or rule, that links input quantities and output quantities in a repeatable way.” (Jason Zimba 2017).

Compare these definitions with two definitions that bracket the period from the beginning of Klein’s “past two centuries” to the current day:

Those quantities that depend on others in this way, namely, those that undergo a change when others change, are called functions of these quantities. This definition applies rather widely and includes all ways in which one quantity can be determined by others. (Euler, 1755, Euler and Blanton 2000)

A function from a set  $A$  to a set  $B$  is a relation  $R \subset A \times B$  with the property that if  $(a, b) \in R$  and  $(a, b') \in R$  then  $b = b'$ . (Standard modern definition)

The first of these definitions, which we call the dynamic definition, conceives of a function as a dynamic object, a coordination of two varying quantities. In the second definition, which we call the static definition, there is no movement, only logic. An important difference between the two is that in the dynamic definition the condition on outputs—that no input produces more than one output—goes without saying; how could it be otherwise in a situation where one quantity changes in response to changes in another quantity? Whereas in the static definition, situated as it is in the wider context of relations on sets and subject to the demands of precision needed for formal mathematical proofs, it is necessary to state the condition explicitly. (See the chapter by Thompson and Milner in this volume for a comparison of dynamic and static definitions as they relate to teachers' mathematical meanings, Thompson and Milner 2018.)

The definitions in (1)–(7) feel the pull of both these bracketing definitions. On the one hand, the dynamic definition is the most natural one for a school context. Many early examples of functions that students encounter are functions of time representing moving objects. The definition (4) is close to the dynamic definition. On the other hand, with the possible exception of (7), the remaining definitions pay homage to the static definition by presenting the logical condition on outputs in some form (in (7) this is captured naturally and implicitly by the idea of a lookup table and by the word “repeatable”). One is compelled to wonder how this looks to the student, whose initial experience with functions rarely involves situations where the issue of having more than one output for a given input arises naturally, except in artificial examples constructed for the exact purpose of emphasizing that point. It might make sense to wait until the issue arises naturally, such when we consider implicit functions defined by equations in two variables, or when we consider scatter plots of statistical data. At that point, the idea of an input-output process might automatically suggest that only one output can be chosen.

### 6.3 Probing the Image of Function in the Internet Brain

We now move from definitions to images. We conducted searches using Google Image Search in various languages on the word “function” or on its translation into another language. Figures 6.1, 6.2, 6.3, 6.4 and 6.5 show the results for English, French, German, Japanese, and Spanish respectively.

Our purpose in conducting searches in different languages is not to attempt any international comparisons. There are many reasons why such comparisons are likely to be invalid. Some languages are spoken in many countries around the world, others are concentrated in a small number of countries. It would not be surprising if searches in a concentrated language showed less variation. Also, the proportion of search results that pertain to school mathematics could vary widely from country to country, depending on the extent to which school teachers in the country rely on the internet for materials.

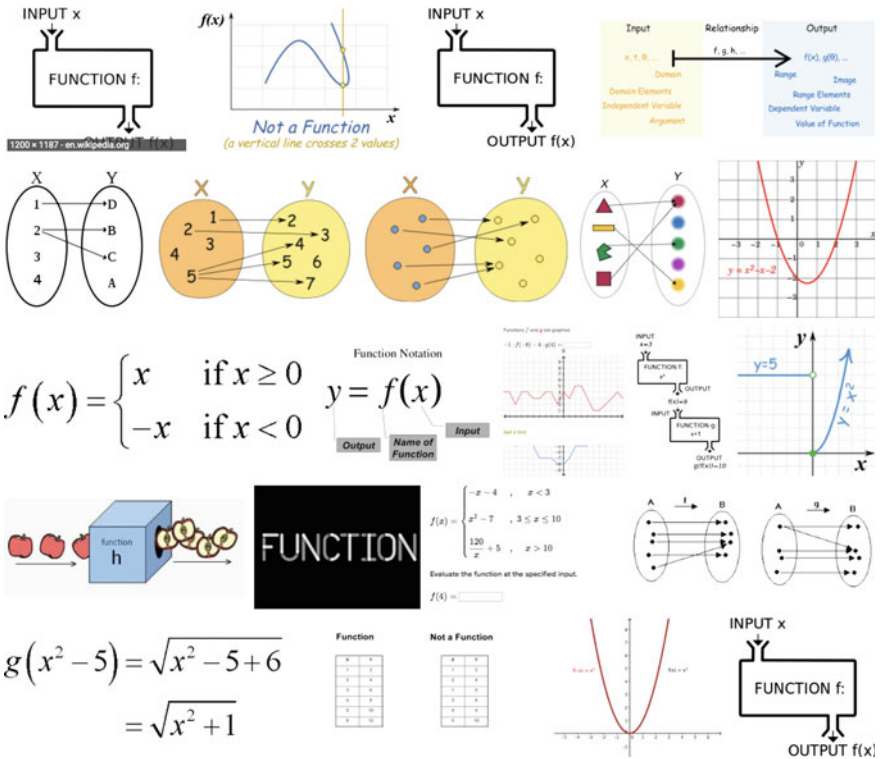


Fig. 6.1 Image search on “function”, 11 December 2017

Nonetheless, different languages partition the internet into distinct networks, and therefore the comparison of different language searches using the same search engine is a source of variation that can reveal structure in the underlying network. This helps determine whether the search results are merely random noise, or whether they are revealing a discernible artifact of school mathematics amenable to analysis.

In Fig. 6.1 we see a profusion of ways in which the function is presented. There are graphs, tables, and algebraic expressions. There are input-output machines. There are arrow diagrams with two sets representing domain and codomain and arrows between them showing the function. What does this collection of images tell us about the concept of function in school mathematics in English speaking countries?

For one thing, it reveals the attractive force of the static definition noted in the previous section. We see a graphical example in the top row (thus a highly ranked search); examples using arrow diagrams in the second row; and an example comparing two tables in the bottom row, one of which is a function and one not. None of these are natural examples of relations, such as equivalence or congruence, but rather examples of relations that almost satisfy the condition to be a function—every input has a unique output—but that fail this condition with one or two inputs. Note,

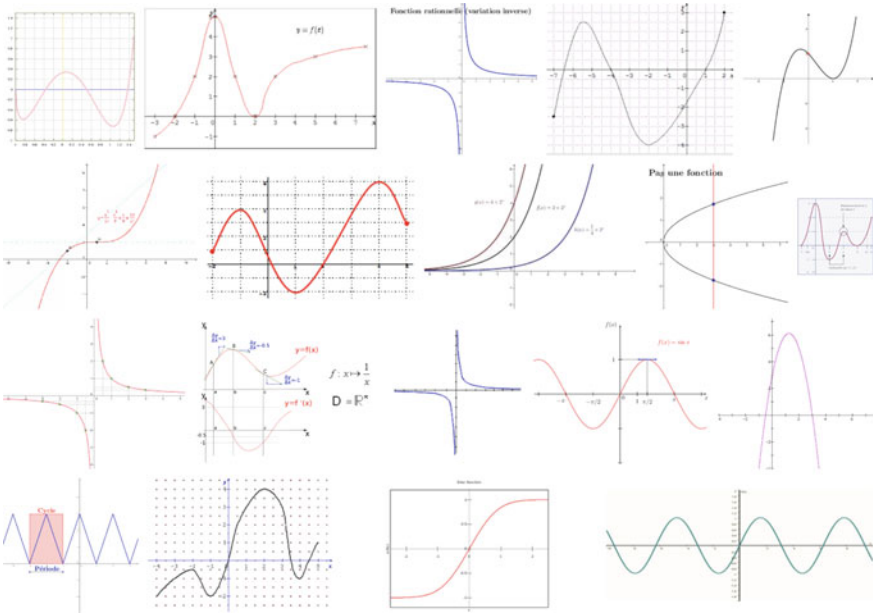


Fig. 6.2 French image search at google.fr, 11 December 2017

for example, the two arrows emanating from the number 2 in the second row, or that the  $x$ -value 1 unnaturally occurs twice in the table on the right in the bottom row. One would think that the world was full of impostors pretending to be functions and that it is the role of education to train students in ceaseless vigilance against them.

The Spanish language search yields results similar to English. (Note that both Spanish and English are much more widely spoken languages than the other three.) The searches in French, German, and Japanese produce a narrower range of results, focused mainly on graphs. Thus there are discernible differences in structure between the searches on different networks. In the next two sections we analyze these differences through the lenses of mathematical coherence and mathematical fidelity.

### 6.3.1 Mathematical Coherence

We have defined mathematical coherence to be the strength of mathematical connections. There are five major ways in which functions are presented in Fig. 6.1: table, graph, expression or equation, input-output process, and arrow diagram. Each of these is useful for presenting a different aspect of the function concept. We assess the strength of connections by observing the extent to which one mode of presentation contains signposts to another.

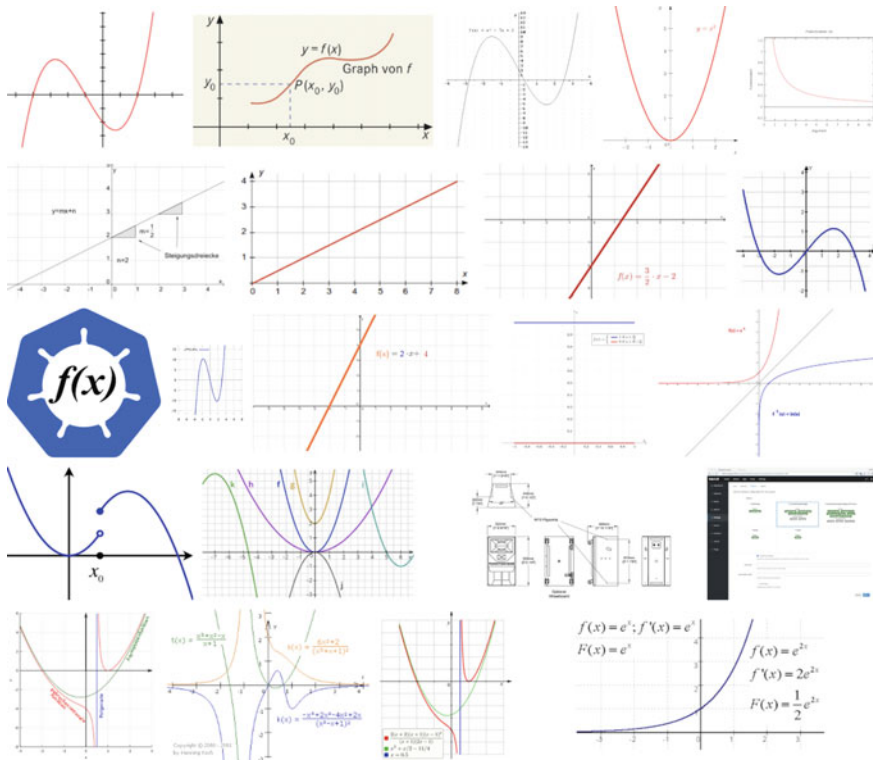


Fig. 6.3 German image search at google.de, 11 December 2007

Take for example the connection between a graph and an input-output machine. The input-output nature of a graph is not clearly visible, in that the process of reading outputs from inputs involves seeing hidden lines from the axes. Thus a possible sign that the graphical presentations are well connected mathematically to the input-output diagrams is the presence on the graph of auxiliary vertical and horizontal lines to a particular point on the graph. One sees such lines in the bottom left image in Fig. 6.4 or the second image in the top row in Fig. 6.3. One might also consider the presence or absence of grids on graphs as an indicator of the strength of this connection. There are marked differences on these indicators between the various searches.

Another possible connection to look for is between tables and input-output processes. A naked table depends on a convention that the column on the left is the input and the column on the right is the output, a convention that may or may not be strong in the mind of the student. However, some of the table images, for example the one on the bottom right in Fig. 6.4, are presented in spreadsheet form, which indicates an approach to tables that explicitly builds the input-output process into the production of the table.

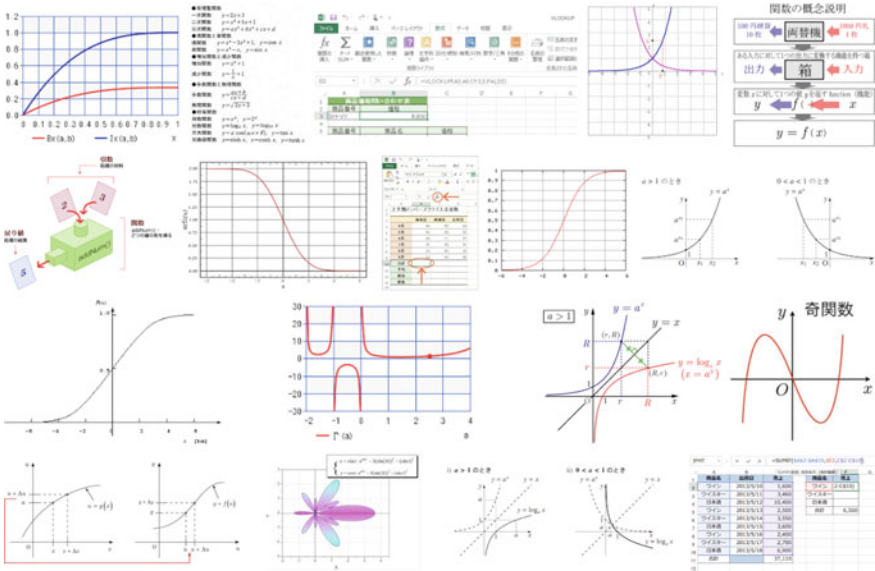


Fig. 6.4 Japanese image search at google.co.jp, 11 December 2007

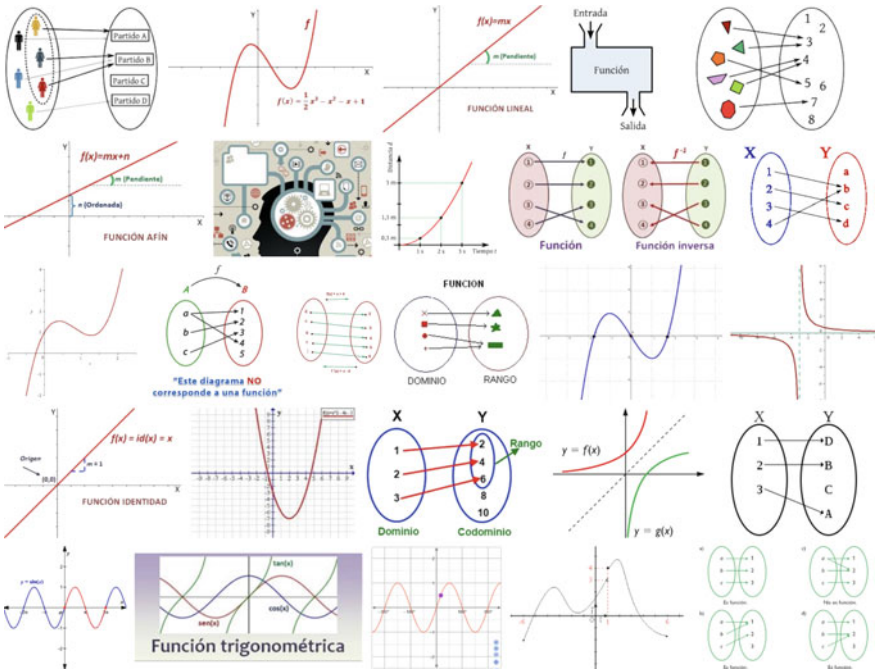


Fig. 6.5 Spanish image search at google.es, 11 December 2007



There are other important connections between ways of presenting functions that cannot reasonably be expected to be fully revealed in a search on images alone. For example, the connection between graphs and expressions or equations depends on written texts. However, there are some indications of the strength of that connection here. Consider, for example, the graph on the right of the third row in Fig. 6.1. Although the scale on the axes is not given, the graph of  $y = x^2$  suggests that a grid square represents a unit in this graph. But then the graph labeled  $y = 5$  is in fact the graph of  $y = 6$ . It is not particularly striking that among the millions of graphs on the internet there is one with a mistake, but it is worth noting that a mistaken graph receives a rank of 15 among those millions. The rank is determined by the density of connections to the image. The internet brain in this case seems to be treating the equation as merely a label for the graph, rather than a related way of describing it. Contrast this image with the image second from the left in the bottom row of Fig. 6.3. The graphs are color coded with the equations and the scale is indicated on the axes. The high rank given to this graph by the German internet brain suggests a greater appreciation of the connection.

### 6.3.2 *Mathematical Fidelity*

Mathematical fidelity refers to the extent to which a presentation is faithful to the concept as it is situated in the discipline of mathematics. The static definition is the canonically accepted one in the discipline, and the presence of arrow diagrams, with their representation of the two sets  $A$  and  $B$  and arrows linking elements of those sets, might at first sight be seen as an indicator of fidelity to the static definition.

However, fidelity is not the same thing as formality. A question that must be considered is the meaning and function of arrow diagrams in school mathematics. In practice, in their later lives using mathematics, students rarely if ever encounter such diagrams. Even in school mathematics, they only encounter them in the environment of tasks designed specifically to see if students understand the logical condition in the static definition. But, as we have seen, that condition goes without saying in the dynamic definition, which is more suited to the real functions most students encounter in their learning pathways during and after school. Understanding the static definition seems to be an isolated learning goal with little relation to other areas of school mathematics, and it is, furthermore, a goal which is not usually pursued to any great depth in modern curricula. Arrow diagrams of the sort seen here seem to be a non-functional stub in the web of school mathematical knowledge. It is worth noting that a different type of arrow diagram that uses two parallel number lines, which does not appear in our searches, is potentially much richer. See for example Gilbey (2017).

Although the connection between the arrow diagrams and the static definition is obvious to an advanced observer, it is worth wondering what it conveys to the novice. From an advanced point of view it is clear that they are intended to indicate an association between inputs and outputs. But arrows are also used to indicate movement, so the diagrams could be construed as suggesting that the inputs are somehow moved to the outputs. This could be problematic when compared with other ways of presenting functions. In a graph, for example, the inputs and outputs remain firmly fixed on the axes.

The input-output machines in our search results vary in their degree of fidelity to the function concept. Look particularly at the apple slicing machine on the left of the fourth row in Fig. 6.1. This would seem to violate the fundamental property that every input should have a unique output. Of course, it is not surprising that flawed images of functions exist on the internet, but it is striking that they receive such a high ranking, indicating that many of the neurons in the English internet brain have found this image valuable. Compare the apple-slicing machine with the image on the left of row 2 in Fig. 6.4, which carefully labels the inputs, the machine, and the outputs, indicating that the output is the result of adding the inputs.

Finally, consider the variation in the graphs across the different image searches. From a mathematical point of view the graph is possibly the richest way of presenting a function, as Klein suggested in the quotation at the beginning of this article. On the one hand it is faithful to the static definition, in that it shows a subset of the Cartesian product of the domain and codomain. On the other hand it can capture the dynamic quality of Euler's definition and the school definitions if it is used to visualize the coordination of two varying quantities by means of an imagined or digital moving image where a point moves along the graph linked to inputs and outputs on the axes. If equipped with a grid and a scale on the axes it captures the numerical information in a table. The degree of fidelity is captured by the extent to which the graph presents all these features, and one sees considerable variation in that extent as one looks at the different graphical images. Some are annotated in a way that is dense with meaning, others appear to mere pictorial images.

## 6.4 Concluding Thoughts

The collections of images from the internet brain considered in this paper bring to mind the idea of concept image in the sense of Tall and Vinner (1981):

We shall use the term *concept image* to describe the total cognitive structure that is associated with the concept, which includes all the mental pictures and associated properties and processes. It is built up over the years through experiences of all kinds, changing as the individual meets new stimuli and matures.

It would be interesting to know to what extent the digital images considered here reflect the concept images in the minds of individual students and teachers, or in the collective consciousness of the community of K–12 mathematics educators, if such a thing exists. Is it possible to investigate the coherence and fidelity of the entire collection of “mental pictures and associated properties and processes” related to the function concept in a particular community of practice in school mathematics?

Whether or not the idea of concept image can be extended that far, the exploratory analysis presented here shows significant variation between different networked communities along the dimensions of mathematical coherence and mathematical fidelity. At a more fine-grained level, for the function concept, we see variation in

- the extent to which a way of presenting functions makes visible connections to a different way
- the density of meaningful annotation in a presentation
- the degree to which components of a presentation are semantic rather than pictorial
- the extent to which extraneous features of the presentation violate mathematical properties.

The variation in these dimensions suggest that they are viable candidates for parameters of change in professional communities. Paying attention to them could lead to improved judgement and evaluation of curricular materials, to better curation of large resource collections, and to the creation of sub-communities with concept images that are more coherent and faithful than the larger communities to which they belong.

## References

- Core-Plus Mathematics Project. (2015). *Core-plus mathematics, Course 1, Student Materials*. New York: McGraw Hill Education.
- Dietiker, L., Hoey, B., Kysh, J., & Sallee, T. (2013). *Core connections algebra*. Sacramento: CPM Educational Program.
- Euler, L., & Blanton, J. D. (Trans.). (2000). *Foundations of differential calculus*. New York: Springer.
- Gilbey, J. (2017). *Percolation, patience and the chain rule*. Retrieved from <https://undergroundmathematics.org/blog/chain-rule>.
- iCoachMath.com. (2017). *Function*. Retrieved from <http://www.icoachmath.com>.
- Klein, F., Menghini, M., & Schubring, G. (2016). *Elementary mathematics from a higher standpoint*. Berlin: Springer.
- Krüger, K. (2018). Functional thinking—about the history of a didactical principle. *The legacy of Felix Klein*. Berlin: Springer.
- Merriam-Webster. (2017). *Function*. Retrieved from [www.merriam-webster.com](http://www.merriam-webster.com).
- National Governors Association Center for Best Practices & Council of Chief State School Officers. (2010). *Common core state standards for mathematics*. Retrieved from <http://www.corestandards.org>.
- New York State Education Department. (2017). *EngageNY grade 8 mathematics module 5, Topic A, Lesson 1*. Retrieved from <https://www.engageny.org>.
- Tall, D., & Vinner, S. (1981). Concept image and concept definition in mathematics with particular reference to limits and continuity. *Educational Studies in Mathematics*, 12(2), 151–169.

- Thompson, P., & Milner, F. (2018). Teachers' meanings for function and function notation in South Korea and the United States. *The legacy of Felix Klein*. Berlin: Springer.
- Woodford, C. (2017). *The internet and the brain*. Retrieved from [www.explainthatstuff.com](http://www.explainthatstuff.com).
- Zimba, J. (2017). *Reviewing and deepening function concepts*. Unpublished notes.

**Open Access** This chapter is licensed under the terms of the Creative Commons Attribution 4.0 International License (<http://creativecommons.org/licenses/by/4.0/>), which permits use, sharing, adaptation, distribution and reproduction in any medium or format, as long as you give appropriate credit to the original author(s) and the source, provide a link to the Creative Commons license and indicate if changes were made.

The images or other third party material in this chapter are included in the chapter's Creative Commons license, unless indicated otherwise in a credit line to the material. If material is not included in the chapter's Creative Commons license and your intended use is not permitted by statutory regulation or exceeds the permitted use, you will need to obtain permission directly from the copyright holder.



# Part III

## Intuitive Thinking and Visualization

**Michael Neubrand**

### **Introduction**

Besides the concept of functional thinking, the idea of *Anschauung* is surely the other central aspect in the Legacy of Felix Klein for mathematics education. *Anschauung*—a term quite hard to translate—embraces many facets. It originates from Felix Klein's basic thinking: The mathematics teacher should make things "*anschaulich erfassbar*", i.e. intuitively comprehensible. Drawings, pictures, models, experiments, dynamic representations of any kind, etc., are among the various possibilities for intuitive thinking and visualization. In this Strand, five authors display the ideas of Felix Klein. The contributions start from the roots in Felix Klein's work and the influences of these ideas, both in the national, and in the international context. Then, they move as far as to confront Felix Klein's ideas to the recent possibilities of modern technological tools and dynamic geometry systems.

*Martin Mattheis* (Germany) reveals in his conceptual contribution the deeper intentions of Felix Klein behind his central term "*Anschauung*". He sticks to different aspects, like sensate, idealizing, and abstract intuition and illustrates how Felix Klein dealt with intuition in the fields of numbers, functions, geometry, and spatial intuition.

However, Felix Klein was not alone in distributing ideas of intuition and visualization for the teaching of mathematics. *Ysette Weiss* (Germany) shows how Peter Treutlein, a German contemporary of Klein, used models in his teaching. Thoroughly esteemed by Felix Klein, Treutlein employed activities like paper folding or the construction of models to develop space intuition and to teach modern approaches to geometry.

Felix Klein had notable influence also in the international context. *Masami Isoda* (Japan) shows that the road how Felix Klein's ideas came into the Japanese teaching was through the so-called *Praktische Analysis*. Even older roots which were also seen by Felix Klein play a role. Thinking in graphs and considering mechanical devices to foster geometric and functional intuition find their way in the Japanese mathematics textbooks.

Modern technology, however, brings new life into the area of intuition, and we should assume that Felix Klein would appreciate these new possibilities. *Stefan Halverscheid* and *Oliver Labs* (Germany) exhibit a lot of opportunities how technology can stimulate the interplay between abstraction and visualization. Their examples connect mathematical considerations about the surfaces of cubic and quartic polynomial functions (over the complex numbers) with the real production of models via 3-D-printers. Thus, the famous historical Göttingen collection of mathematical models becomes now vivid by the modern technology tools.

*Maria Flavia Mammata* (Italy), finally, shows how Felix Klein's Meran Curriculum of 1905 can still be applied to the teaching of geometry in Grades 10–11 today. The intuitive approach to geometry is now facilitated using modern information technology. She presents activities with dynamic geometry software to intuitively set out geometric concepts between plane figures and spatial geometry.

# Chapter 7

## Aspects of “Anschauung” in the Work of Felix Klein



Martin Mattheis

**Abstract** Aimed at modernizing the teaching of mathematics at German secondary schools around 1900, The “Kleinian Reform Movement” was characterized by Felix Klein’s two key demands: “strengthening spatial intuition” and “training the habit of functional reasoning”. This paper presents a number of examples demonstrating the importance of the concept of intuition (*Anschauung*) for Klein and explains the role he assigned to intuition in mathematics instruction at school and university.

**Keywords** Anschauung · Intuition · Space intuition · Kleinian reform movement Meran curriculum proposal

### 7.1 Core Demands for Modernizing the Teaching of Mathematics at Secondary Schools

For Felix Klein, the insistence that intuition (*Anschauung*)<sup>1</sup>—or more precisely “space intuition” (*Raumanschauung*)—should be given a greater role in mathematics and mathematics teaching was one of the core demands in the process of modernizing mathematical teaching not only at universities and engineering colleges but also at secondary schools. Felix Klein played a key role in drawing up the Meran Curriculum Proposal of the 1905 Breslau Teaching Commission of the Gesellschaft Deutscher Naturforscher und Ärzte (GDNÄ), which essentially formulated two key demands regarding mathematics teaching at secondary schools: “Strengthening the capacity to think in three dimensions and training the habit of functional reasoning.”

---

<sup>1</sup>In translating Felix Klein’s ideas into English, I largely use the term “intuition” to convey the concept of “Anschauung”. The term “intuition” originates in the Latin for “consideration/looking at” and is employed here not in the sense of a sudden insight without any conscious reasoning but follows its use in the philosophical tradition as a discovering of truth through contemplation, i.e. rational intuition.

---

M. Mattheis (✉)

Institut für Mathematik, Johannes Gutenberg-Universität Mainz, Mainz, Germany  
e-mail: mattheis@mathematik.uni-mainz.de

A further aspect will be to dispense with all one-sided and practically insignificant specialized knowledge while fully recognizing the formal educational value of mathematics and to facilitate an optimal development of the ability to view the world of phenomena surrounding us from a mathematical angle. This entails two special objectives: enhancing the capacity to think in three dimensions and training the habit of functional reasoning. – This does not affect the objective of training logics, which has always been assigned to mathematics teaching. In fact, it can even be said that this objective is enhanced by giving more attention to the above-mentioned orientation of mathematics teaching. (Breslau Teaching Commission 1905, p. 154, translated by Martin Mattheis)

The Curriculum Proposal of the Teaching Commission initiated at the GDNÄ Assembly in Breslau in 1904 followed a lengthy and fundamental dispute over the principal goals of mathematics instruction at secondary schools and the value of mathematics for achieving a general education. The general educational character of mathematics lay for many, beyond the circle of neo-humanist minded classical philologists, above all in a formal development of the intellect.

Particularly from the second half of the 19th century on, the development and consolidation of educational institutions aimed at preparing young people for life and work in the modern world, the “realistische Bildungsanstalten”, was accompanied by a heated debate over whether the leaving qualifications conferred by the three different types of secondary school (*Gymnasium*, *Realgymnasium* and *Oberrealschule*) prepared their graduates equally for admission to higher education and to professional fields in the public services. In this context, especially in the period before 1900, debate also centered on the issue of what general knowledge mathematics teaching should look like. This is why efforts to modernize the mathematics syllabus in secondary schools, which many mathematicians thought necessary, were always potentially or actually confronted by the accusation of reducing the subject’s general knowledge character to a narrow specialism. Since this would have led to the status of the respective institutions being lowered from providers of general education to technical or vocational institutions, the attempt was often made to argue that, in addition to the goals proper of the desired change, the modernization would retain or even enhance the formal education value of mathematics teaching. The different objectives of the ever-increasing number of reform advocates ultimately culminated in the two bold and simple demands that calculus and analytical geometry should be introduced in secondary school curricula.

After the *3rd Prussian School Conference on Secondary School Teaching*, in June 1900, had come out in favor of giving equal status to the qualifications conferred by all three types of secondary school, this controversy was resolved, as far as Prussia was concerned, on the 26th November 1900 by decree of the Prussian King, who took a keen interest in secondary school education. In his role as state ruler, Wilhelm II declared the equivalence of degrees conferred by *Gymnasium*, *Realgymnasium* and *Oberrealschule*. In the years after 1900, the other constituent states in the confederation followed the Prussian example with respect to the equivalence of leaving qualifications conferred by the three types of secondary school (Mattheis 2000a, pp. 18–20).



Felix Klein, who had initially dealt primarily with mathematics in higher education and had—on this question and through his efforts to turn the University of Göttingen into a center of mathematics—been in close contact with the Prussian Ministry of Cultural Affairs, was requested at relatively short notice prior to the 3rd Prussian School Conference to produce two expert assessments of issues raised by mathematics teaching in secondary schools (printed in Schubring 2000). Having compiled his assessments, Felix Klein was the only university mathematician, among the total of 34 participants, to attend the Schools Conference held in Berlin from the 6th to the 8th June 1900.

In his reports for the Schools Conference, Klein explained what he thought a reform of mathematics teaching in secondary schools should look like. His demands centered on graduates from all three types of secondary school being qualified to study at both a university and a college of engineering (*Technische Hochschule*). Having failed in his initial attempt, by way of negotiations with the Ministry of Cultural Affairs, to have the modifications he desired implemented directly into the new curriculum to take effect from 1901, he followed other channels: rallying support for his ideas among teachers working in schools, the experimental schools established by the Ministry, and associations such as the *Gesellschaft Deutscher Naturforscher und Ärzte*. These ideas centered above all on the concept of functional reasoning (*funktionales Denken*),<sup>2</sup> i.e. that the concept of function should run through school mathematics right from the start, and on the need to strengthen spatial intuition (*räumliche Anschauung*), i.e. the capacity to think in three dimensions. Both ideas were then prominently included as a core demand in the Meran Curriculum Proposal in 1905 (Schubring 2007, pp. 5–8).

## 7.2 Intuition in Mathematics Teaching in Higher Education

In his inaugural lecture on assuming his first professorship in Erlangen, the 1872 Antrittsrede, Felix Klein was already emphasizing the importance of applications and intuition for mathematics and the teaching of mathematics at universities. To him, applying mathematics went significantly beyond “the predictive calculations of the astronomer, [...] the precision of geodetic measurements, [...] [or] the accomplishments of the engineering art”. In the second half of the 19th century, the formal educational value (*formaler Bildungswert*) of mathematics had come to be seen as an essential to an advanced education in Germany, and Klein believed this value lay in the “application of mathematical conceptions” above all in the fields of physics and the natural sciences, but also in medicine (Rowe 1985, p. 137).

Klein characterized a mathematician’s work as such as “drawing further conclusions from precisely formulated foundations”. To the mathematician, it was irrelevant whether the foundations were derived from hypotheses or from observed facts, i.e. from intuition (Rowe 1985, p. 137). However, in contrast to the actual work math-

---

<sup>2</sup>On *functional reasoning*, see the corresponding chapter in this volume.

ematician, this issue was, he said, relevant in applications such as mathematical physics where “applying abstract mathematical thinking to a sensate (better said: intuitive) domain” could be done in the same manner as in geometry (Rowe 1985, p. 138). For both fields, Klein insisted that, having actually drawn mathematical conclusions, the results gained should be referred “back to the vivid realm of sensate intuition” unless intuition and mathematical investigation happened to go hand in hand (Rowe 1985, p. 138).

Viewing mathematics from the opposite perspective, Felix Klein highlighted the considerable role played by the “intuition-oriented disciplines” in the progress made by mathematics in recent centuries: The questions raised by astronomy, mathematical physics and geometry had led to considerable advances in mathematics through the 18th and 19th century (Rowe 1985, p. 138).

However, when assessing Klein’s very broad definition of mathematics in 1872 and his remarks on its applications, one should always bear in mind that Klein was seeking with his Erlangen Antrittsrede, above all to raise funding for the changes he envisaged in mathematics instruction at Erlangen when assuming his professorship. This overriding goal is reflected in his chain of reasoning: “If we educate better teachers, then mathematics instruction will improve by itself”. This underpinned Klein’s demand for improved teacher training to include mathematics seminars and, importantly, “exercises in drawing and in building models” (Rowe 1985, p. 139).

The argument that mathematics had a formal educational value was also intended to support this project. To humanist-oriented academics, i.e. to many among the audience at his Erlanger Antrittsrede, the formal educational value of mathematics was crucial to the characterization of mathematics instruction as a general educational task not only at the *Gymnasium* but also at all other secondary schools and in higher education (Rowe 1985, p. 124pp; Mattheis 2000b, p. 42).

On assuming a professorship in geometry in Leipzig in 1880, Felix Klein once again delivered a programmatic *Antrittsrede*, although this inaugural lecture was not published until 1895. In the Leipzig Antrittsrede he presented a set of mathematical models, compiled in collaboration with Alexander von Brill at the Technische Hochschule in Munich, in order to reaffirm the importance of intuition in geometry. In particular, he criticized the way sensate objects such as fourth order curves or third order surfaces, although developed out of mathematical propositions, were not being brought into any relationship with the intuitive geometric objects on which they were originally based (Klein 1895, p. 538).

He contrasted this observation with the approach he had chosen, together with Brill, of using drawings and models—both for teaching purposes and for his own research. Taking on the possible counter-argument that more intuition would reduce mathematical abstraction, making mathematics more accessible and lowering standards, Klein stressed that the desired “visualization” should only be viewed as a “complementary intervention” and that such an argument failed to see that modeling can bring forth new ideas for abstract research (Klein 1895, pp. 539–540). Thus, Felix Klein did not regard the application of mathematical models in mathematics in higher education merely as a means of visualizing and clarifying familiar contents;

rather, models were, to him, also objects for stimulated ideas in the pursuit of new research findings (cf. Rowe 2013).

Here again, when assessing Klein’s Leipzig Antrittsrede, one should not forget that, on assuming the professorship in Leipzig, he was not only presenting his notions of mathematics teaching in higher education but very directly making a case for the additional funding required for the changes he envisaged—such as compiling a collection of models.

On November 2, 1895, in the same year as the first publication of his Leipzig Antrittsrede from 1880, Felix Klein delivered a lecture at the public session of the Königliche Gesellschaft der Wissenschaften zu Göttingen under the title “On the Arithmetization of Mathematics” (*Über Arithmetisierung der Mathematik*). Here, Klein examines the role of intuition (*Anschauung*) in mathematics. He begins by pointing out that in the work of Gauß we still find the incautious use of spatial intuition (*Raumanschauung*) as proof of the universal validity of propositions that were not at all universally valid. Klein argued that this had led to demands for exclusively arithmetical reasoning in mathematics. But this was unfortunate, so Klein, for his part, now sought to demonstrate “that mathematics is certainly not exhausted in logical deduction but that, alongside the latter, intuition completely retains its specific importance” (Klein 1896, p. 144, translated by Martin Mattheis).

Especially in the case of geometry, Klein called for results gained through arithmetical approaches to be reconnected with spatial intuition. He argued that imprecise spatial intuition should first be idealized in the axioms in order to proceed with a mathematical approach. This, Klein emphasized, gave rise to new concepts and insights. Such an approach should, he said, also be pursued in mechanics and mathematical physics (Klein 1896, p. 146). Here, the crux of his argument is that he wants to see logical deduction and intuition given equal status alongside each other, demanding that the role of intuition as both a source of ideas for reaching logical conclusions and as a form of application through deduction, be understood as acquired mathematical knowledge (Klein 1896, p. 149).

However, in addition to this view of intuition as something closely bound up with logical deduction, Klein also stressed the importance of what he called naïve intuition (*naïve Anschauung*):

Incidentally, naïve intuition, which is in large part an inherited talent, emerges unconsciously from the in-depth study of this or that field of science. The word ‘Anschauung’ has not perhaps been suitably chosen. I would like to include here the motoric sensation with which an engineer assesses the distribution of forces in something he is designing, and even that vague feeling possessed by the experienced number cruncher about the convergence of infinite processes with which he is confronted. I am saying that, in its fields of application, mathematical intuition understood in this way rushes ahead of logical thinking and in each moment has a wider scope than the latter. (Klein 1896, p. 147, translated by Martin Mattheis)

Thus, Felix Klein subsumes under the general term of “Anschauung” a certain degree of intuition gained through experience.

### 7.3 Intuition in Felix Klein's Lectures

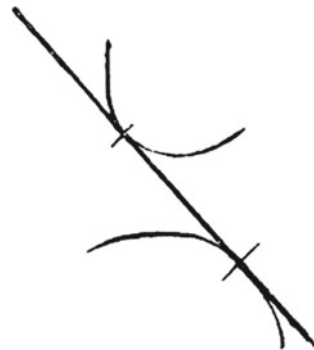
Having looked at Felix Klein's programmatic statements in his Antrittsreden and papers, we will now consider some concrete examples taken from lecture courses during Klein's period at the University of Göttingen. Already in the 1898/90 winter semester lectures on non-Euclidian geometry, published in handwriting in 1892, Klein described his view of the interplay between axioms and spatial intuition. He explicitly criticized the notion that intuition merely played a role in setting up the axioms, insisting instead that, especially in geometric considerations, mathematicians should always draw on intuition. Above all he thought the role of axioms was to counter the inexactness of intuition and create exactness (Klein 1892, p. 354).

Rather, in true geometric thinking, spatial intuition accompanies us at every step we take. [...] I assign the axioms the role that they represent postulations with the aid of which we transcend the inaccuracy of intuition or the limitations of intuition in order to achieve unlimited accuracy. (Klein 1892, p. 354, translated by Martin Mattheis)

A few pages on, taking the case of a common tangent of two curves, Klein then discussed the issue of the extent to which proofs can be obtained from intuition in pure mathematics. In the case of the two curves in Fig. 7.1, one may assume, based on intuition, that they share a common tangent. From Klein's viewpoint, however, the drawing merely represents a "sensualization" (*Versinnlichung*) of the true curves. He explicitly stated that without knowing which "mathematically precise law" the two curves followed, one could not make any statement as to whether a common tangent actually exists (Klein 1892, p. 359).

With our notion of the essence of intuition, an intuitive treatment of figurative representations will tend to yield a certain general guide on which mathematical laws apply and how their general proof may be structured. However, true proof will only be obtained if the given figures are replaced with figures generated by laws based on the axioms and these are then taken to carry through the general train of thought in an explicit case. Dealing with sensate objects gives the mathematician an impetus and an idea of the problems to be tackled, but it does not pre-empt the mathematical process itself. (Klein 1892, pp. 359–360, translated by Martin Mattheis)

**Fig. 7.1** In the case of a common tangent (Klein 1892, p. 359)



So Felix Klein regarded intuition as a useful heuristic aid for mathematicians seeking to reach mathematical conclusions but, in his view, it was by no means a substitute for correct proof.

### 7.3.1 *Sensate, Idealizing and Abstract Intuition*

The concept of intuition (*Anschauung*) is found in Felix Klein’s work in different contexts of meaning. First, there is “sensate intuition” (*sinnliche Anschauung*), for which, in his 1895 presentation, he also used the term “naive intuition” (*naive Anschauung*) (Klein 1896, p. 147). Sensate intuition comprises everything that surrounds us in real space and that we can touch and measure. In his lecture course on “Elementary Mathematics from a Higher Standpoint”, he additionally presented a further interpretation of spatial intuition in the form of “idealizing spatial intuition” (*idealisierende Raumschauung*), which addresses the abstract notion of geometrical objects, i.e. the mathematical idea freed from the error-prone inexactness of the real objects (Klein 1908, p. 88).

This is the proper place to say a word about the nature of space intuition. It is variously ascribed to two different sources of knowledge. One the sensibly immediate, the empirical intuition of space, which we can control by means of measurement. The other is quite different, and consists in a subjective idealizing intuition, one might say, perhaps, our inherent idea of space, which goes beyond the inexactness of sense observation. (Klein 1908, p. 88 or Klein 2016a, p. 37)

Such a distinction between the sensately immediate intuition and the idealizing inner intuition goes back to the respective concepts developed by Kant (Allmendinger 2014, pp. 52–53).

In relation to the development of infinitesimal calculus, Felix Klein introduced a further term to the circle of concepts that differentiate “intuition”. In the context, he places alongside “sensate intuition” the notion of “abstract intuition” to refer to what was in fact anything but an intuitive process of abstraction.

It is precisely in the discovery and in the development of the infinitesimal calculus that this inductive process, built up without compelling logical steps, played such a great role; and the *most effective heuristic aid was very often sense intuition*. And I mean here the *immediate* sense intuition, with all its inexactness, for which a curve is a stroke of definite width, *not the abstract* intuition, which postulates a completed passage to the limit, yielding a one-dimensional line. (Klein 1908, pp. 455–456 or Klein 2016a, p. 226)

Klein exemplified this line of thought, using the integral being defined as the limit of a sum of rectangles. From the perspective of sensate intuition, he thought it was reasonable to define the surface area “as the sum of a large number of quite narrow rectangles”, since the width of the rectangles is obviously limited by the degree of drawing accuracy. He gave further examples of the significance of the respective use of sensate intuition in the emergence of infinitesimal calculus, including Kepler’s measuring of barrels and spheres, the “method of exhaustion” applied by

Archimedes, Cavalieri's principle or the differential quotient of a function (Klein 1908, pp. 456–460 or Klein 2016a, pp. 226–227). Ultimately however, when speaking of *abstract* intuition, he meant the same as what he had already assigned the concept of *idealizing* intuition to.

After considering the various examples of intuition in the development of infinitesimal calculus, Klein then stressed that there were undoubtedly mathematical personalities who either found such a way of looking at things useful and or did not, and that the respective approach continued to play an important role in the period after 1900 in the development of new mathematical ideas in mathematical physics, mechanics and differential geometry (Klein 1908, p. 460 or Klein 2016a, p. 229).

*The force of conviction* inherent in such naïve guiding reflections is, of course, different for different individuals. Some – and I include myself here – find them very satisfying. Others, again, who are gifted only on the purely logical side, find them thoroughly meaningless and are unable to see how anyone can consider them as a basis for mathematical thought. (Klein 1908, p. 460 or Klein 2016a, p. 229)

Referring to David Hilbert's paper "On the Foundations of Logics and Arithmetic" delivered at the International Congress of Mathematicians in Heidelberg in 1904, Klein argued that even at the highest level of abstraction when one attempts to break loose from any form of intuition, e.g. in the theory of numbers considered in purely formal terms, a certain minimum amount of intuition still has to remain, even if it is only to recognize the symbols with which one is operating merely in accordance with axiomatic rules (Klein 1908, pp. 32–35 or Klein 2016a, p. 16).

### 7.3.2 *Intuition and the Function Concept*

Felix Klein's lectures "On the teaching of mathematics at secondary schools", delivered through the 1904/05 winter semester, were the first course in which Felix Klein dealt not only with mathematics but also, explicitly, with questions of post-primary education. He discussed not only higher secondary schooling for boys but also the role of mathematics in compulsory public schools (Volksschulen), girl's schools (*Mädchenschulen*), intermediate-level vocational schools (*mittlere Fachschulen*), universities and engineering colleges (*technische Hochschulen*). Indeed, he also outlined the historical development of mathematics teaching and examined the reforms that were proposed for higher-level math teaching. The course was divided into two parts: eight weeks of lectures on school education and, for the rest of the semester, an actual mathematics part dealing with "elementary mathematics from a higher standpoint" (Schimmack 1911, p. 40f.).

The first part, covering mathematics teaching, was later edited by Rudolf Schimmack for publication, appearing in 1907 under the title "Lectures on mathematical teaching at secondary schools" (*Vorträge über den mathematischen Unterricht an den höheren Schulen*), published by Teubner-Verlag. Schimmack was a close collaborator of Felix Klein's and the first person to gain a post-doctoral award in the

Didactics of Mathematics, receiving the *Habilitation* in 1911. Following the structure of the lecture course itself, the published work (Klein 1907) was subtitled Part 1: On the Organization of Mathematics Teaching (*Teil 1 Von der Organisation des mathematischen Unterrichts*). However, the content of Klein’s lectures on elementary mathematics from the 1904/05 winter semester did not come to publication.

In his introduction to the printed lectures, Felix Klein affirmed his full support for what he saw as the two primary demands of the Meran Curriculum Proposal (*Meraner Lehrplanvorschlag*): “strengthening the capacity to think in three dimensions (*räumliches Anschauungsvermögen*) and training the habit of functional reasoning”, since these aspects of mathematics “played the most important role in modern life” (Klein 1907, p. 6, translated by Martin Mattheis).

In the second chapter, Klein explored *inter alia* the question of the function concept and the relationship between functional reasoning and intuition. His emphasis here lay on the need to ensure that the function concept always be introduced in lessons as a “function concept in geometric form”, i.e. in today’s terms as a “function graph” (Fig. 7.2) (Klein 1907, p. 21, translated by Martin Mattheis).

In contrast to current practice, where many school students seem to have the idea that the function concept can be reduced to the representation of a graph, Felix Klein stressed the representational form of the function graph and the importance of this form in mathematics and beyond: “After all, Gentlemen, graphic representations are found not only throughout the seminal modern literature of the exact subjects but, one may say, in all areas of present-day life!”. (Klein 1907, p. 21, translated by Martin Mattheis) Klein was drawing attention here to a discrepancy in the 1901 Prussian curriculum for secondary schools, which did not even mention functions in course content requirements, yet demanded that they be grasped by students in the highest grade. The methodology guidelines stated that teachers should equip “the students with an in-depth understanding of the concept of function, with which they have

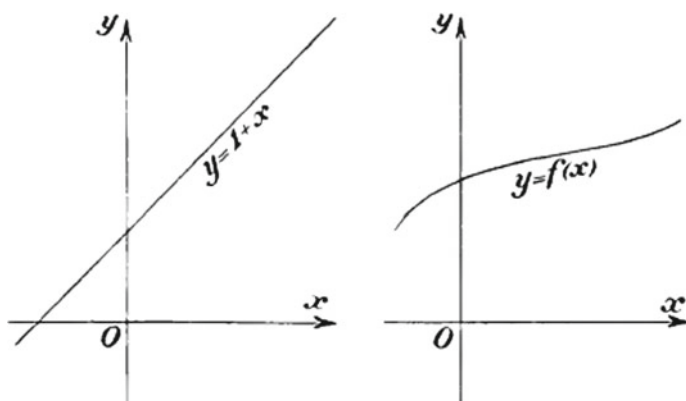


Fig. 7.2 The function concept in geometric form (Klein 1907, p. 21, reproduced with permission of Springer Nature Customer Service Center)

already been made familiar at earlier levels” (Klein 1907, pp. 21–22, translated by Martin Mattheis).

Klein again made the same connection between function concept and intuition (*Anschauung*) in the first part of his 1907/08 winter semester lecture course on “Elementary mathematics from a higher standpoint”. This material first appeared in a handwritten edition, published by Teubner Verlag. It was published in print in 1924 by Springer Verlag. The first volume enjoyed a second printing, with the whole series becoming something of a bestseller that is still in demand today. Indeed, a complete retranslation appeared in English in 2016.

With regard to the graphic representation of functions, Klein again stressed in Elementary Mathematics that such representation was important in any practical application of mathematics. Moreover, he also called for school students to be acquainted as early as possible with the function concept (Klein 1908, p. 10 or Klein 2016a, p. 4).

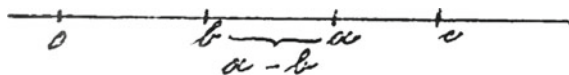
We, who used to be called the ‘reformers’, would put the function concept at the very center of teaching, because, of all the concepts of the mathematics of the past two centuries, this one plays the leading role wherever mathematical thought is used. We would introduce it into teaching as early as possible with constant use of the graphical method, the representation of functional relations in the x-y system, which is used today as a matter of course in every practical application of mathematics. (Klein 1908, p. 10 or Klein 2016a, p. 4)

With regard to removing some of the traditional subject matter from the curriculum to make way for this approach, Klein believed that it was important that “*Intense formation of space intuition*, above all, will always be a prime task” (Klein 1908, p. 11 or Klein 2016a, p. 4).

### 7.3.3 Proof Through Intuition

We noted above that Klein rejected in principle the idea of accepting proofs from intuition, as argued in his lectures on non-Euclidian geometry that were delivered in the 1889–90 winter semester (Klein 1892, p. 359). However, in his “Elementarmathematik vom höheren Standpunkte” (Elementary Mathematics from a Higher Standpoint) he derives just such proofs, showing that an algebraic question can be resolved intuitively purely by graphic geometric presentation (Fig. 7.3) (Allmendinger 2014, pp. 47–50).

1. Given  $a > b$  and  $c > a$ , where  $a, b, c$  are positive. Then  $a - b$  is a positive number and is smaller than  $c$ , that is,  $c - (a - b)$  must exist as a positive number. Let us represent the



**Fig. 7.3** Representation on the axis of abscissas (Klein 1908, p. 64, reproduced with permission of Springer Nature Customer Service Center)



numbers on the axis of abscissas and note that the segment between the points  $b$  and  $a$  has the length  $a - b$ .

A glance at the figure shows that, if we take away from  $c$  the segment  $a - b$  the result is the same as though we first took away the entire segment  $a$  and then restored the part  $b$ , i.e.,  $(1) c - (a - b) = c - a + b$ . (Klein 1908, pp. 64–65 or Klein 2016a, p. 28)

Here, Klein proves the parenthesis rule  $c - (a - b) = c - a + b$  exclusively through an intuitive approach by considering the number line, without any need for algebraic transformations.

## 7.4 Intuition and the Genetic Method

On the question of the didactical method to be followed by teachers of mathematics at secondary schools, Felix Klein argued—alongside his demand for the “cultivation of spatial intuition”—for the course material to be designed in line with the respective age group of students. In the Volume II of “Elementary Mathematics from a Higher Standpoint”, he writes that instruction in geometry at secondary level should follow the basic principle of moving from the concrete to the abstract.

Let us first ask, what requirements should be made today of a sound geometrical education. Everyone will surely admit for this that: 1. *The psychological aspects* must substantially prevail. Teaching cannot only depend on the subject matter, but it depends above all on the *subject* that you have to teach: one will present the same topic to a six-year-old boy differently than to a ten-year-old-boy – and this, in turn, differently to a mature man.

Applied in particular to geometry, this means that in schools you will always have to connect teaching at first with vivid concrete intuition and then only gradually bring logic elements to the fore; in general, the genetic method alone will provide a legitimate means slowly to develop a full understanding of concepts. (Klein 1909, pp. 435–436 or Klein 2016b, p. 238)

Felix Klein set out in detail the importance of the genetic teaching method in the first volume of “Elementary Mathematics from a Higher Standpoint”.

In order to give precise expression to my own view on this point, I should like to bring forward the *biogenetic fundamental law*, according to which the individual in his development goes through, in an abridged series, all the stages in the development of the species. [...] Now, I think that instruction in mathematics, as well as in everything else, should follow this law, at least in general. *Taking into account the native ability of youth, instruction should guide it slowly to higher things, and finally to abstract formulations; and in doing this it should follow the same road along which the human race has striven from its naïve original state to higher forms of knowledge.* (Klein 1908, pp. 588–589 or Klein 2016a, pp. 291–292)

The genetic method of teaching was regarded by Klein as essential not only for geometry, but also for every aspect of mathematics instruction. He illustrated this with inter alia the example of the notion of number. A child understands numbers as numbers of concrete objects, like nuts or apples, and not as axiomatically defined objects devoid of intuitive meaning with which one can operate according to formal rules. (Klein 1908, p. 9 or Klein 2016a, p. 4)

Corresponding demands to apply the principle of guiding school students learning mathematics from the intuitively concrete to the abstract can be found in Felix Klein's writings back in 1895 in his lecture "On the Arithmetization of Mathematics" (Klein 1896, p. 148). They also appear in his expertise on the Prussian Schools Conference of 1900 (Klein 1900, p. 70) and in his paper delivered at the assembly of the Gesellschaft Deutscher Naturforscher und Ärzte in Breslau in 1904 (Klein 1904, p. 135), which constituted the teaching commission that was to present the Meran Curriculum Proposal in the following year. Without explicitly referring to it by name, Klein outlined as early as 1895 the principle of the genetic method in saying that "learners will naturally pass through, on a small scale, the same developmental path that scholarship has passed through on a grand scale" (Klein 1896, p. 148, translated by Martin Mattheis). In his formulating his thoughts on the genetic method of teaching, Felix Klein clearly distinguished between a form of mathematics instruction suitable for secondary schools, which was to follow the basic principle of moving from the concrete to the abstract, and the deductive structure of teaching material—commonly used in higher education—aligned to the systematics of the discipline.

The *manner of teaching* as it is carried on in this field in Germany can perhaps best be designated by the words *intuitive* and *genetic*, i.e., the entire structure is gradually erected on the basis of familiar, concrete things, in marked contrast to the customary *logical* and *systematic* method in higher education. (Klein 1908, p. 14 or Klein 2016a, p. 9)

It does seem doubtful, however, whether Klein was describing here the teaching really being practiced at secondary schools in 1908. It is more likely that he was presenting the way school mathematics should, in his view, be taught.

## 7.5 Conclusion

The calls to "strengthening spatial intuition" and "training the habit of functional reasoning" were not only central to the Meran Curriculum Proposal, in which Felix Klein played such a leading role, but had already been fundamental to his overall idea of what mathematics teaching should look like in secondary schools and higher education. For Felix Klein, however, the concept of "intuition" (*Anschauung*) referred to more than the physically sensate intuition one needs to describe concrete three-dimensional objects. While "intuition" was, of course, an important means for learners to gain new mathematical insights, he also saw it as a tool in research. Moreover, Felix Klein extends the concept of "intuition" to mean a source of inspiration with which people contemplating mathematical questions arrive intuitively at ideas for their solution. Thus, in this wider sense, intuition plays an important role in all fields of mathematics and not only—as one might initially expect—in geometry.

## References

- Allmendinger, H. (2014). *Felix Kleins Elementarmathematik vom höheren Standpunkte aus: Eine Analyse aus historischer und mathematikdidaktischer Sicht (Siegener Beiträge zur Geschichte und Philosophie der Mathematik, Band 3)*. Siegen: universi – Universitätsverlag Siegen.
- Breslauer Unterrichtskommission. (1905). Bericht der Unterrichtskommission über ihre bisherige Tätigkeit: I. Bericht betreffend den Unterricht in der Mathematik an den neunklassigen höheren Lehranstalten. *Verhandlungen der Gesellschaft Deutscher Naturforscher und Ärzte, 77. Versammlung zu Meran 1905, Erster Teil*, 154–165.
- Klein, F. (1892). *Nicht-Euklidische Geometrie I. Vorlesung gehalten während des Wintersemesters 1889–90*. Göttingen: Autograph. Available at [http://gdz.sub.uni-goettingen.de/dms/load/img/?PID=PPN51697307XIILOG\\_0003&physid=PHYS\\_0003](http://gdz.sub.uni-goettingen.de/dms/load/img/?PID=PPN51697307XIILOG_0003&physid=PHYS_0003).
- Klein, F. (1895). Über die Beziehungen der neueren Mathematik zu den Anwendungen. Antrittsrede, gehalten am 25. Oktober 1880 bei Übernahme der damals an der Universität Leipzig neuerichteten Professur für Geometrie. *Zeitschrift für mathematischen und naturwissenschaftlichen Unterricht*, 26, 535–540. Available at <http://digital.slub-dresden.de/id404375774-18950260>.
- Klein, F. (1896). Über Arithmetisierung der Mathematik. *Zeitschrift für mathematischen und naturwissenschaftlichen Unterricht*, 27, 143–149. Available at <http://digital.slub-dresden.de/id404375774-18960270>.
- Klein, F. (1900). Gutachten vom 21. Mai 1900 zur Frage: Welche Fortschritte sind seit der Schulconferenz vom Jahre 1890 auf dem Gebiet des mathematischen und naturwissenschaftlichen Unterrichts an den höheren Schulen, insbesondere auch nach der angewandten und technischen Seite hin, zu verzeichnen und was kann dieser in Beziehung noch weiter geschehen? First published on pages 69–74 of Schubring, G. (2000). Felix Kleins Gutachten zur Schulkonferenz 1900: Initiativen für den Systemzusammenhang von Schule und Hochschule, von Curriculum und Studium. *Der Mathematikunterricht*, 46(3), 62–76.
- Klein, F. (1904). Bemerkungen zum mathematischen und physikalischen Unterricht. *Verhandlungen der Gesellschaft Deutscher Naturforscher und Ärzte, 76. Versammlung zu Breslau 1904, Erster Teil*, 130–144.
- Klein, F. (1907). *Vorträge über den mathematischen Unterricht an den höheren Schulen. Bearbeitet von Rudolf Schimmack*. Leipzig: Teubner.
- Klein, F. (1908). *Elementarmathematik vom höheren Standpunkte aus. Erster Band. Ausgearbeitet von E. Hellinger*. Leipzig: Teubner.
- Klein, F. (1909). *Elementarmathematik vom höheren Standpunkte aus. Zweiter Band. Ausgearbeitet von E. Hellinger*. Leipzig: Teubner.
- Klein, F. (2016a). *Elementary Mathematics from a Higher Standpoint: Vol. I. Arithmetic, algebra, analysis* (Translation of the 4th German edition, G. Schubring, Trans.). Berlin: Springer.
- Klein, F. (2016b). *Elementary Mathematics from a Higher Standpoint: Vol. II. Geometry* (Translation of the 4th German edition, G. Schubring, Trans.). Berlin: Springer.
- Mattheis, M. (2000a). Die Entwicklung des höheren Schulwesens in Preußen von 1871 bis 1900. *Der Mathematikunterricht*, 46(3), 5–21.
- Mattheis, M. (2000b). Felix Kleins Gedanken zur Reform des mathematischen Unterrichtswesens vor 1900. *Der Mathematikunterricht*, 46(3), 41–61.
- Rowe, D. E. (1985). Felix Klein’s “Erlanger Antrittsrede”. A transcription with English translation and commentary. *Historia Mathematica*, 12, 123–141. [https://doi.org/10.1016/0315-0860\(85\)90003-5](https://doi.org/10.1016/0315-0860(85)90003-5).
- Rowe, D. E. (2013). Mathematical models as artefacts for research: Felix Klein and the case of Kummer surfaces. *Mathematische Semesterberichte*, 60(1), 1–24. <https://doi.org/10.1007/s00591-013-0119-8>.
- Schimmack, R. (1911). *Die Entwicklung der mathematischen Unterrichtsreform in Deutschland (IMUK- Abhandlungen über den mathematischen Unterricht in Deutschland, Band III, 1)*. Leipzig/Berlin: Teubner.

- Schubring, G. (2000). Felix Kleins Gutachten zur Schulkonferenz 1900: Initiativen für den Systemzusammenhang von Schule und Hochschule, von Curriculum und Studium. *Der Mathematikunterricht*, 46(3), 62–76.
- Schubring, G. (2007). Der Aufbruch zum „funktionalen Denken“: Geschichte des Mathematikunterrichts im Kaiserreich. 100 Jahre Meraner Reform. *NTM International Journal of History & Ethics of Natural Sciences, Technology & Medicine*, 15(1), 1–17. (<https://doi.org/10.1007/s00048-006-0260-8>).

**Open Access** This chapter is licensed under the terms of the Creative Commons Attribution 4.0 International License (<http://creativecommons.org/licenses/by/4.0/>), which permits use, sharing, adaptation, distribution and reproduction in any medium or format, as long as you give appropriate credit to the original author(s) and the source, provide a link to the Creative Commons license and indicate if changes were made.

The images or other third party material in this chapter are included in the chapter's Creative Commons license, unless indicated otherwise in a credit line to the material. If material is not included in the chapter's Creative Commons license and your intended use is not permitted by statutory regulation or exceeds the permitted use, you will need to obtain permission directly from the copyright holder.



# Chapter 8

## Introducing History of Mathematics Education Through Its Actors: Peter Treutlein’s Intuitive Geometry



Ysette Weiss

**Abstract** This paper deals with the questions why and how to introduce into teacher education the history of teaching practices and educational reforms. In particular, we are interested in the developments of curricular school geometry during the 19th century and the reforms at the beginning of the last century in Germany. The life and work of Peter Treutlein—a contemporary of Felix Klein—and a conceptual reformist of geometry instruction, schoolbook author, committed teacher and school principal with educational experience of many years opens to us many opportunities to link present teaching practices in Geometry to its traditions, some of which we will discuss.

**Keywords** Felix Klein · Teacher education · History of mathematics education  
Reforms in geometry teaching · Peter Treutlein

### 8.1 Introduction

Are Felix Klein’s ideas and the European didactic and German speaking tradition of *Intuitive thinking and visualizations* still important for present and future theoretical considerations as well as the practice of the teaching and learning of mathematics? In the contribution, we study this question with respect to mathematics teacher education.

---

Y. Weiss (✉)  
Johannes Gutenberg-University Mainz, Mainz, Germany  
e-mail: weisspid@uni-mainz.de

© The Author(s) 2019  
H.-G. Weigand et al. (eds.), *The Legacy of Felix Klein*, ICME-13 Monographs,  
[https://doi.org/10.1007/978-3-319-99386-7\\_8](https://doi.org/10.1007/978-3-319-99386-7_8)

The translation of Felix Klein's *Elementary Mathematics from an Advanced Standpoint* (Volume II: Geometry)<sup>1</sup> by Hedrick and Noble from 1949 published by Dover (Klein 2004) and earlier by Macmillan (Klein 1939) finishes after the historical excursus to Euclid's Elements. The last chapter [i.e. the fourth so-called *Schlußkapitel* (Final Chapter)], of Klein's book (Klein 1925) is missing. The title of the missing chapter is "Observations of the Teaching of Geometry".<sup>2</sup>

Here, Felix Klein gives a short overview of the development of the teaching of geometry from the perspective of the goals of the Meraner Reform in England, France, Italy and Germany. Felix Klein's cultural-historical approach to development already appears in the structure of his overviews (Klein 2016, pp. 226–231):

- Importance of the Historical Background
- Contrasting Modern Requirements
- Criticism of the Traditional Teaching.

The last section of the fourth chapter, "Teaching practice in Germany", is dedicated to a critical reflection on the curricular development of geometry and to geometry instruction in Germany. Here, Felix Klein mainly discusses the work of Julius Henrici (1841–1910) and Peter Treutlein (1845–1912). His esteem for the work of Henrici and Treutlein (1883, 1896, 1897) becomes evident in the quote "Henrici-Treutlein is an extremely noteworthy book" (Klein 1925, p. 261) and in the subsequent description of recent developments in geometry. As early as 1911, Felix Klein wrote the introduction to Treutlein's (1911a) theoretical work on the reform of the traditional Euclidean curriculum in school geometry: "*Geometrical intuitive teaching (Anschauungsunterricht) as a first step in a two-stage geometrical instruction at our higher schools*".

In this introduction, Felix Klein wrote: "However, I am pleased to express that I mean to recognize everywhere the same principles that I follow in my own teaching. Such a coincidence finally is a matter of personal disposition." (Treutlein 1911a, p. III, translation by the author).

In 1925, after the publication of various textbooks by different authors implementing reforms of Euclidean school geometry, Felix Klein recommends Treutlein's conceptual work to teachers: "For this teaching, the following works will be of great use for many teachers: (a) The book, that arose from a mature pedagogical experience of P. Treutlein "*The geometrical intuitive teaching (Anschauungsunterricht) as a first step in a two-stage geometrical instruction at our higher schools*", Leipzig 1911" (Klein 1925, p. 292). The second textbook recommended by Felix Klein is Heinrich Emil Timerding's "The education of intuition (Anschauung)" (Timerding 1912).

Peter Treutlein was not only a conceptual reformist of geometry instruction and a schoolbook author, he was also a committed teacher and school principal with many

---

<sup>1</sup>The translated version of the second volume of Klein's book was published in 1939, later than the book on arithmetic, algebra, analysis, which was published as translation in 1932.

<sup>2</sup>In the meantime, Gert Schubring published a new translation (Klein 2016) of Felix Klein's *Elementary Mathematics from a Higher Standpoint* with a translation of the "Schlußkapitel" in Volume II.

years' educational experience, who implemented the realizations of his theoretical concepts in everyday school life, resulting in his three-volume textbook with Julius Henrici.

The study of the history of educational reforms and their theoretical foundation is particularly relevant today. German students have experienced several reforms during their school time, the theoretical foundation of which has not yet taken place. Keywords for these reforms are *output* and *competence orientation*, the introduction of educational standards and central tests, the abolition of the orientation classes and pre-school education, the reduction of upper secondary classes by one year, the digitalization of learning environments, the restructuring of secondary schools, and the overall present *inclusion*. In particular, regarding the tremendous speed with which these political reforms are pushed through, it is certainly worthwhile to engage in reform, which had been prepared for half a century; the *Meraner Reform* was discussed widely and implemented in small steps.

In this paper, we show how some activities related to the reform of geometrical instruction, and in particular, historical collections of mathematical models for use in schools could be used in current university training for mathematics teachers.

First, we take a look at some of the reasons why the history of mathematics and the history of mathematics education not only *can* but *should* be included in university teacher education. Hereby, we are particularly interested in the history of mathematics education at the end of the 19th century and at the beginning of the 20th century—a fascinating period of reforms of mathematical curricula as well as of the German school system.

The second question in our paper is how the history of the teaching of mathematics can be introduced in university education for future mathematics teachers and how the aforementioned school reforms could be meaningful for today's students. Here, we briefly glance at the history of mathematical models and instruments and their industrial production as teaching tools. In doing so, we will not concentrate on historical mathematical models for the visualization of higher mathematics and their use in teaching mathematics at university, but on mathematical models which illustrate and visualize school mathematics. This again leads us to Peter Treutlein and the school models that he invented.

In the last section, we outline how Peter Treutlein's collection of school models, his three-volume joint school textbook with Henrici (1881–1883) and Treutlein's conceptual theoretical work on reforms in geometry teaching can be used in the university education of mathematics teachers.

## 8.2 History of Mathematics in Mathematics Education

The topic of “the use of the history of mathematics in mathematics teaching” is gaining popularity in the international discourse of mathematics education. Possible reasons for this might be the introduction of topics from the history mathematics in the curricula in such countries as Denmark, Austria or Great Britain, or likewise

the new interest in concept development from a mathematical perspective and the historical genetic method in the style of Toeplitz (1949).

There are numerous publications on the variety of ways of using the history of mathematics in teaching mathematics as well as on the promotion of mathematical interests which range from theoretical material for classification (e.g. Jankvist 2009; Kronfellner 1998) to concrete descriptions of their realizations in teaching practices (e.g. Fauvel and van Maanen 2000; Katz and Michalowicz 2000; Jahnke 2006; Shell-Gellasch 2007; Glaubitz 2011). It is important to note whether the history of mathematics and mathematics education is used to inspire new perspectives on the teaching of mathematics and concept development or whether the history of a mathematical idea, an authority or an institution are the subject of investigation. The latter especially presumes methodology and knowledge of the history of mathematics.

A special challenge is presented by the use of original historical sources in order to teach a mathematical idea as well as its historical conceptual development. In this case, on top of the use of representations and mathematical languages that are different to those the students are used to, problems may also occur due to a foreign or ancient language or to different translations of the original source. On the other hand, working with artefacts bearing contemporary witness to a past period is particularly attractive. The mathematical exploration of historical sources is often easier if related to models, instruments, equipment or also mathematical toys, and even better if accompanied by appropriate texts and descriptions of the experiments. The mathematical concept development also benefits from the use of mathematical instruments and visualizing models. Vollrath illustrates how this can be done with a non-historical approach to historical drawing and measuring instruments in his book “Verborgene Ideen” (en.: hidden ideas) (Vollrath 2013).

There is no doubt that it is important for future mathematics teachers to know some of the history of their own discipline, that is, the history of mathematics, but also the history of their own profession, i.e. the history of mathematics education. Both topics are scientific disciplines with specialized knowledge and methodology. Do student teachers have the prerequisites and capabilities to look into the history of a mathematical concept in order to teach it later on with historical awareness?

To include the contents of the history of mathematics in their teaching, teachers are required to have developed a particular interest in this field and to therefore gladly accept the challenge of teaching mathematics in a way that also embraces perspectives of the humanities. Hardly any German university offers canonical lectures on the cultural history of mathematics or on selected topics on the history of mathematics. Therefore, an introduction to the history of *school* mathematics and its instruction should not require any substantiated knowledge of *history of mathematics* as an own scientific discipline.

The choice of topics related to the history of mathematical models and instruments and their collections allows for rich access to the history of mathematics and its education. The development and production of mathematical models was already used in the 19th and early 20th centuries for the training of student mathematics teachers. Nowadays this is an episode in the history of European science. The use of historical mathematical models and their digital images in the study, teaching and



development of mathematics allow us to relate historical, technical, educational and information technology aspects to each other.

One opportunity to link today's university teacher education to the last century could be to complete similar tasks, for example to design and produce a mathematical model. In the framework of a project at the Georg-August-University Göttingen to introduce the *Göttinger Sammlung historischer mathematischer Modelle* (Göttingen's collection of historical mathematical models) into teaching, students designed and produced their own mathematical models. In this project, the digitally available historical collection in Göttingen (*Göttinger Sammlung mathematischer Modelle und Instrumente* 2017) became the subject of several teaching activities in the study of mathematics as well as in mathematics education (see also Weiss-Pidstrygach 2015). Among the models of this collection are those produced by students a century ago. The collection of historical mathematical models in Göttingen is closely connected with the name and activities of Felix Klein (Rowe 2013). In 1880, when appointed Professor of Geometry at the University of Leipzig, Felix Klein suggested in his inauguration speech (Klein 1895, p. 538) acquiring a collection of mathematical models "to reduce the gap which already separates the theoretical mathematician from math's applications" and to improve teaching at the university. However, these models visualize higher mathematics and are quite demanding in terms of hidden mathematics. Understanding the background of most of the Brill and Schilling collection's models (Polo-Blanco 2007; Schilling 1903) is a very challenging mathematical task for students.

Another approach to link modern teaching with historical collections of models is the pedagogical perspective. There is a variety of literature with historical and pedagogical perspectives on the development of mathematical models, which can constitute the content framework for historical research (for instance Bartolini Bussi et al. 2010).

Contemporary student mathematics teachers can have varied experiences with mathematical models. Pedagogical reform is an important topic in educational studies. Fröbel, Pestalozzi, Kerschensteiner and Dewey (Führer 2000; Klafki 2000) explore sense perception and activity orientation in mathematics education and their approaches are part of the curriculum in educational science. Students are also familiar with modern mathematical hands-on exhibitions, as most schools have their own mathematical models and toys.

### 8.3 Treutlein's Models and Textbooks in the University Education of Mathematics Teachers

An extremely suitable introduction from a pedagogical perspective—but with a mathematician's eye—is given by Treutlein in his book *Intuitive Geometry as a First Level of Two-Level Geometry Courses at Our Secondary Schools* (Treutlein 1911a). The first chapter is dedicated to the history of intuitive geometry and forms a solid foun-

dition for the historical contextualization of his concept of a geometrical instruction starting with intuitive geometry. From the second chapter, he moves from the historical perspective to a mathematical and a pedagogical one. In this theoretically conceptual work, he also incorporates two of his other works: A collection of cataloged school models (Wiener 1912) and a school textbook of three volumes, which he composed between 1881 and 1883 with Julius Henrici—a school principal in Heidelberg.

The study of this work is made significantly easier through its digital availability. A historical excursus based on a few historical mathematical school models provides students with an opportunity to develop their own questions in a field particularly interesting to them and to discuss them afterwards.

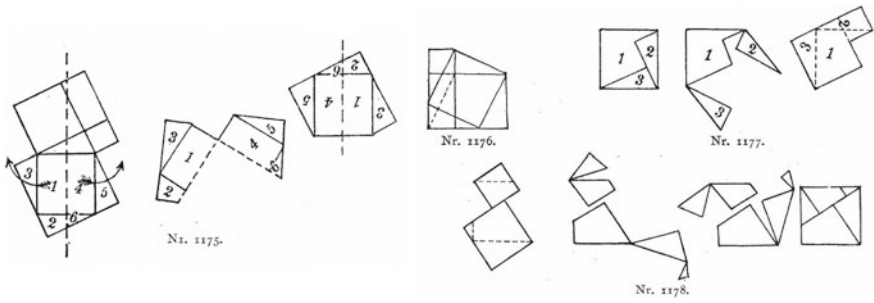
The study of Treutlein is highly relevant with regard to curricular and methodical reforms at the turn of the 19th century. His theoretical foundation, which includes examples in his *Intuitive Geometry Lesson*, forms the basis of the discussion of Treutlein's concept of a reform of geometry instruction. Treutlein suggests a division so that one should start with intuitive spatial geometry (*anschauliche Raumlehre*) with geometrical object lessons of two or three years, which are then followed by (academic) geometry lessons with the duration of five to six years. After a historical contextualization of intuitive geometry, Treutlein lists the requirements and theoretical principles for an intuitive spatial theory as well as the respective methods of instruction according to these principles. The last part of this work deals with practical exemplary lesson planning.

Treutlein's geometrical school models (Treutlein 1911b) put his concepts of reform into practice as they result from his education experience of more than forty years. The implementation and usage of his models are evident in some examples of the third paragraph (Treutlein 1911a, p. 109) as well as in his school geometry textbooks.

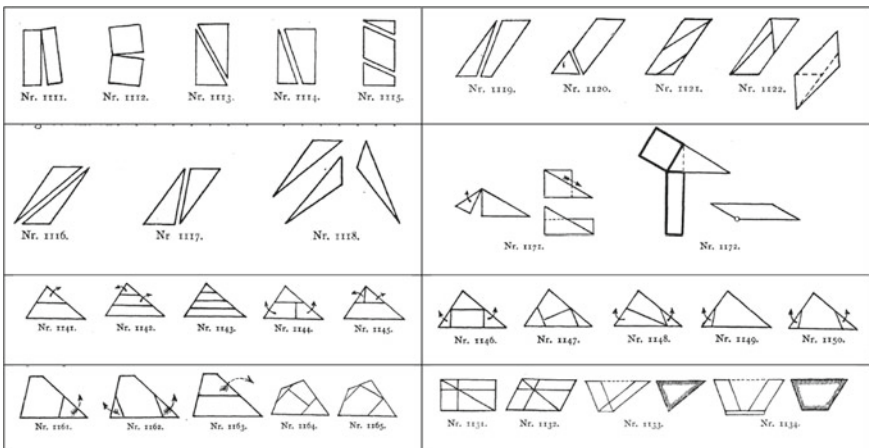
Treutlein's programme contains three essential 19th century thoughts:

- The idea of an intuitive geometry lesson as a preliminary step for subsequent formal deductive geometry instruction.
- The implementation of the most recent mathematical developments such as projective geometry and transformation geometry into mathematical instruction.
- The training of the spatial imagination and the fusion of both spatial and plain geometry.

The developments, implementations and generalizations of the Pythagorean Theorem (see Treutlein 1911a, pp. 183–184) can be used to compare assignments and exercises in modern textbooks with historical ones from Treutlein (see also Henrici and Treutlein 1897). Treutlein's book starts with a step-by-step development of the necessary technical terms through a comparison of areas which he constructs by means of gnomones, in the spirit of Euclid. For the conversion of surfaces, he uses self-constructed models while his arguments and demonstrations often derive from abstract geometry. The arithmetic examples often explain the algebraic terms (Figs. 8.1 and 8.2).



**Fig. 8.1** Examples of plain moveable models from Treutlein’s collection. The model 1175 is used as a solution sketch (see Treutlein 1911a, p. 183) and as an important example in the first volume of the tenth chapter “Comparison of areas” (see Henrici and Treutlein 1897, p. 88)



**Fig. 8.2** Samples from Treutleins catalogue (Wiener 1912, pp. 50–53)

Students can choose for themselves a model accompanied by the respective problem provided in Treutlein’s and Henrici’s geometry book in order to compare the development of concepts and demonstrations in modern schoolbooks and those written in Treutlein’s era. The students can also experience the differences between modern teaching methods and those of Treutlein’s time by planning a unit using one or more of Treutlein’s models. The comparison should clarify the difference between the student’s idea of a concept and the one Treutlein describes in his book.

Another possible way to link today’s teaching practice with that of a century ago comes from Treutlein’s criticism of the geometry classes of his time. He criticizes the following four features of geometry teaching practice (Treutlein 1911a, p. 71):

1. The well-known, much celebrated, and often infrequently hard-bred, strictly dogmatic teaching,
2. The sharp separation of general space geometry from plane geometry,

3. The retraction of the space considerations towards the very end of the usual course,
4. Beginning with more abstract doctrines, on straight lines and planes, before exploring the geometry of bodies.

One can similarly question the features of modern geometry teaching and whether these criticisms have been overcome.

A historical contextualization of Peter Treutlein's work and life gives Schönbeck (1994), a historical classification and reception of Treutlein's textbook in three volumes with Julius Henrici can be found for example in Gerhard Becker's paper (1994).

One of the most surprising discoveries in my studies of Treutlein's concept of intuitive geometry was the activity orientation of his exercises and tasks. He already uses paper folding, outdoor mathematics and construction of models to develop space intuition and to teach modern approaches to geometry like transformation geometry. A more detailed description of various possibilities how to relate Treutlein's models to present-day teacher university education the interested reader finds in Weiss-Pidstrygach (2015, 2016).

## References

- Bartolini Bussi, M. G., Taimina, D., & Isoda, M. (2010). Concrete models and dynamic instruments as early technology tools in classrooms at the dawn of ICMI: From Felix Klein to present applications in mathematics classrooms in different parts of the world. *ZDM—Mathematics Education*, 42(1), 19–31. <https://doi.org/10.1007/s11858-009-0220-6>.
- Becker, G. (1994). Das Unterrichtswerk "Lehrbuch der Elementargeometrie" von J. Henrici und P. Treutlein: Entstehungsbedingungen, Konzeption, Wirkung. In J. Schönbeck, H. Struve, & K. Volkert (Eds.), *Der Wandel im Lehren und Lernen von Mathematik und Naturwissenschaften. Band 1, Mathematik*. Weinheim: Deutscher Studienverlag.
- Fauvel, J., & van Maanen, J. (Eds.). (2000). *History in mathematics education: The ICMI study (new ICMI study series, 6)*. Dordrecht: Kluwer.
- Führer, L. (2000). Dreihundert Jahre Theorie des öffentlichen Mathematikunterrichts in Deutschland. *Beiträge zum Mathematikunterricht* (pp. 19–26). Franzbecker: Hildesheim.
- Georg-August-Universität Göttingen/Sammlungportal. (2017). *Sammlung mathematischer Modelle und Instrumente*. [http://sammlungen.uni-goettingen.de/sammlung/slg\\_1017/](http://sammlungen.uni-goettingen.de/sammlung/slg_1017/). Accessed March 21, 2018.
- Glaubitz, M. (2011). *Mathematikgeschichte lesen und verstehen – eine theoretische und empirische Vergleichsstudie*. Dissertation, Fakultät für Mathematik (Didaktik der Mathematik), Universität Duisburg-Essen.
- Henrici, J., & Treutlein, P. (1883). *Lehrbuch der Elementar-Geometrie: Lage und Größe der stereometrischen Gebilde. Abbildungen der Figuren einer Ebene auf eine zweite. (Kegelschnitte)* (1st ed.). Leipzig: B. G. Teubner.
- Henrici, J., & Treutlein, P. (1896). *Lehrbuch der Elementar-Geometrie: Abbildung in verändertem Maße. Berechnung der Größen der ebenen Geometrie* (2nd ed.). Leipzig: B. G. Teubner.
- Henrici, J., & Treutlein, P. (1897). *Lehrbuch der Elementar-Geometrie: Gleichheit der Gebilde in einer Ebene. Band 1. 2. Auflage*. Leipzig: B. G. Teubner.
- Jahnke, H. N. (2006). Students working on their own ideas: Bernoulli's lectures on the differential calculus in grade 11. In F. Furinghetti, H. N. Jahnke, & J. A. van Maanen (Eds.), *Studying origi-*

- nal sources in mathematics education*, Mathematisches Forschungsinstitut Oberwolfach Report 22/2006, 1313–1315.
- Jankvist, U. T. (2009). A categorization of the “whys” and “hows” of using history in mathematics education. *Educational Studies in Mathematics*, 71(3), 235–261. <https://doi.org/10.1007/s10649-008-9174-9>.
- Katz, V. J., & Michalowicz, K. D. (2005). *Historical modules for the teaching and learning of mathematics*. Washington, DC: Mathematical Association of America.
- Klafki, W. (2000). The significance of classical theories of Bildung for a contemporary concept of Allgemeinbildung. In I. Westbury, S. Hopmann, & K. Riquarts (Eds.), *Teaching as a reflective practice: The German Didaktik tradition*. Mahwah, NJ: Lawrence Erlbaum Associates.
- Klein, F. (1895). Über die Beziehungen der neueren Mathematik zu den Anwendungen. Antrittsrede, gehalten am 25. Oktober 1880 bei Übernahme der damals an der Universität Leipzig neuerrichteten Professur für Geometrie. *Zeitschrift für mathematischen und naturwissenschaftlichen Unterricht*, 26, 535–540. <http://digital.slub-dresden.de/id404375774-18950260>. Accessed March 21, 2018.
- Klein, F. (1925). *Elementarmathematik vom höheren Standpunkte aus: Geometrie*. Berlin: Springer.
- Klein, F. (1939). *Elementary mathematics from an advanced standpoint: Geometry*. Translated from the third German edition by E. R. Hedrick & C. A. Noble. New York: Macmillan.
- Klein, F. (2004). *Elementary mathematics from an advanced standpoint: Geometry*. Translated from the third German edition and with a preface by E. R. Hedrick & C. A. Noble, Reprint of the 1949 translation. Mineola, NY: Dover Publications.
- Klein, F. (2016). *Elementary mathematics from a higher standpoint: Vol. II. Geometry* (G. Schubring, Trans.). Berlin: Springer.
- Kronfellner, M. (1998). *Historische Aspekte im Mathematikunterricht: eine didaktische Analyse mit unterrichtspraktischen Beispielen*. Vienna: Hölder-Pichler-Tempsky.
- Polo-Blanco, I. (2007). *Theory and history of geometric models*. Dissertation, Rijks Universiteit Groningen, Groningen.
- Rowe, D. (2013). Mathematical models as artefacts for research: Felix Klein and the case of Kummer surfaces. *Mathematische Semesterberichte*, 60(1), 1–24.
- Schilling, M. (1903). *Catalog mathematischer Modelle für den höheren mathematischen Unterricht (6. Auflage)*. Halle/Saale: Verlagsbuchhandlung von Martin Schilling. <https://archive.org/details/catalogmathemati00schiuoft>. Accessed March 21, 2018.
- Schönbeck, J. (1994). Der Mathematikdidaktiker Peter Treutlein. In J. Schönbeck, H. Struve, & K. Volkert (Eds.), *Der Wandel im Lehren und Lernen von Mathematik und Naturwissenschaften. Band 1, Mathematik*. Weinheim: Deutscher Studienverlag.
- Shell-Gellasch, A. (Ed.). (2007). *Hands on history: A resource for teaching mathematics (No. 72)*. Washington, DC: Mathematical Association of America.
- Timerding, H. E. (1912). *Die Erziehung der Anschauung*. Leipzig: B. G. Teubner.
- Toeplitz, O. (1949). *Die Entwicklung der Infinitesimalrechnung – Eine Einleitung in die Infinitesimalrechnung nach der Genetischen Methode. Erster Band (Die Grundlehren der mathematischen Wissenschaften. 56)*. Berlin: Springer.
- Treutlein, P. (1911a). *Der Geometrische Anschauungsunterricht als Unterstufe eines zweistufigen geometrischen Unterrichts an unseren höheren Schulen*. Leipzig und Berlin: B. G. Teubner. <https://archive.org/details/dergeometrische00treugoog>. Accessed March 21, 2018.
- Treutlein, P. (1911b). Reihe 31-48 der Modellsammlung von P. Treutlein. In H. Wiener (Ed.), *Abhandlungen zur Sammlung mathematischer Modelle in zwanglosen Heften, Band 1, Heft 2*. Leipzig und Berlin: B. G. Teubner.
- Vollrath, H. J. (2013). *Verborgene Ideen: Historische mathematische Instrumente*. Wiesbaden: Springer Fachmedien.
- Weiss-Pidstrygach, Y. (2015). Historical mathematical models in teacher education—Workshop on the development of questions and critical questioning. In E. Barbin, U. Jankvist, & T. Hoff Kjeldsen (Eds.), *History and epistemology in mathematics education. Proceedings of the Seventh European Summer University* (pp. 129–140). Aarhus: Danish School of Education.

- Weiss-Pidstrygach, Y. (2016). Historische, pädagogische und geometrische Kontextualisierungen zu Treutleins Schulmodellsammlung – Projektarbeit in der Lehrerbildung. In T. Krohn & S. Schöneburg (Eds.), *Mathematik von einst für jetzt. Festschrift für Karin Richter* (pp. 233–246). Hildesheim: Franzbecker.
- Wiener, P. (1912). *Verzeichnis von H. Wieners und P. Treutleins Sammlungen mathematischer Modelle für Hochschulen, höhere Lehranstalten und technische Fachschulen. Zweite Ausgabe mit 6 Tafeln* (64pp). Leipzig und Berlin: B. G. Teubner.

**Open Access** This chapter is licensed under the terms of the Creative Commons Attribution 4.0 International License (<http://creativecommons.org/licenses/by/4.0/>), which permits use, sharing, adaptation, distribution and reproduction in any medium or format, as long as you give appropriate credit to the original author(s) and the source, provide a link to the Creative Commons license and indicate if changes were made.

The images or other third party material in this chapter are included in the chapter's Creative Commons license, unless indicated otherwise in a credit line to the material. If material is not included in the chapter's Creative Commons license and your intended use is not permitted by statutory regulation or exceeds the permitted use, you will need to obtain permission directly from the copyright holder.



# Chapter 9

## The Road of the German Book *Praktische Analysis* into Japanese Secondary School Mathematics Textbooks (1943–1944): An Influence of the Felix Klein Movement on the Far East



Masami Isoda

**Abstract** Japan caught up with the Klein movement at time it occurred and translated the movement into Japanese to be shared immediately. However, incidents such as the huge earthquake in 1923 caused stagnations. Fruitful classroom experiments were done over the years, and mathematics subjects up to calculus were integrated into the mathematics Clusters I and II secondary school textbooks in 1943–44. The textbooks included *praktische Analysis* in relation to mechanical instruments. This paper shows, compared to some impact from the US, the clear influence of the von Sanden's *Praktische Analysis* on Japan. It also explains how the mechanics and kinematics approaches, known since the era of van Schooten (*De Organica Conicarum Sectionum In Plano Descriptione, Tractatus. Geometris, Opticis; Præsertim verò Gnomonicis & Mechanicis Utilis. Cui subnexa est Appendix, de Cubicarum Æquationum resolutione. Elzevier, Lugdunum Batavorum, 1646*), served as missing link for integrating geometry and algebra into the concept of function in teaching in Japan during World War II.

**Keywords** Practical analysis · Mechanical instruments · Geometry · Algebra · Calculus · Felix Klein

---

M. Isoda (✉)  
Center for Research on International Cooperation  
in Educational Development, University of Tsukuba, Tsukuba, Japan  
e-mail: isoda@criced.tsukuba.ac.jp

© The Author(s) 2019  
H.-G. Weigand et al. (eds.), *The Legacy of Felix Klein*, ICME-13 Monographs,  
[https://doi.org/10.1007/978-3-319-99386-7\\_9](https://doi.org/10.1007/978-3-319-99386-7_9)

## 9.1 Background and Objective of This Paper

One of the major tasks of the history of mathematics education is to clarify the current position of mathematics education by examining the viewpoints of past reforms, which include the transition of issues, objectives, and materials. One of the difficulties is the interpretation of curricular reform in the context of earlier periods. In particular, based on the Japanese interpretation of the new math movement,<sup>1</sup> the secondary school curriculum was more oriented towards algebraic representation. Thus, current mathematics educators have never had a chance to study the mathematics that existed in the past. Historical mathematics before our times is, therefore, a kind of lost mathematics based on different conceptual frameworks, even though the technical terms look the same.

Reading and understanding historical textbooks gives the opportunity to relearn lost mathematics and recognize their viewpoint. The mathematics Clusters I and II textbooks from 1943 to 1944 (Grades 1 to 4, for 12- to 15-year-old students, Published from Secondary School Publisher)<sup>2</sup> for secondary school,<sup>3</sup> were a decisive achievement under the influence of the Klein movement<sup>4</sup> in the Far East, since starting with these books preliminary calculus became introduced into the mathematics curriculum of Japanese secondary schools. Even though published in the middle of World War II, the textbooks were very well organized and applied the principle of mathematization. Thus, they are usually referred to as the mirror to reflect the curriculum reform that was oriented towards mathematical activity. Indeed, after World

---

<sup>1</sup>Japanese New Math (Ministry of Education 1968) includes, as in other countries, the movement to introduce sets and structure. However, it also applied the principle of reorganizing mathematics as a spiral cycle of extension and integration to foster mathematical thinking using appropriate activities. It also added Freudenthal's (1968) mathematization idea, since in Japan similar ideas had existed already earlier (Nabeshima and Tokita 1957). The origin of this principle, i.e. the terminology of mathematization, can also be traced back to the guidebooks for the textbooks Clusters I and II.

<sup>2</sup>The books were published by the Secondary School Textbook Publisher on demand of the Ministry of Education. The authors were teachers and professors of the affiliate school of the Tokyo Higher Normal School which leads after graduation to Tokyo University of Literature and Science, and the Ministry.

<sup>3</sup>Until World War II, the Japanese school system was parallel, not linear, and has undergone a complicated process since 1872. In short, secondary schools, which used Clusters I and II textbooks, were preparatory schools for high schools, and high schools were preparatory schools for universities. The Clusters I and II textbooks were for exceptional and affluent students who were able to study at secondary schools. Compulsory education was limited to elementary and senior elementary school. Students normally went to senior elementary schools after the graduation from elementary schools, but exceptional students who had the availability to go to higher education went to secondary schools. Secondary and normal school teachers graduated from higher normal schools, high school teachers graduated from universities, and elementary school teachers from normal schools. Normal schools are a kind of vocational school after senior elementary school. Tokyo University of Science and Literature was the university for students who graduated from the Tokyo Higher Normal School which was the school for the graduated students of normal schools.

<sup>4</sup>Here, the Klein movement means the curriculum reform movement that took place up to World War II involving the integration using graphs of functions of different subjects such as arithmetic, algebra, and geometry into one mathematics culminating in calculus.





Fig. 9.1 Van Schooten (1646), excerpted from pp. 1–3, 26, 28, and 30, and Cluster II (1943), Vol. 3 (Grade 3 for 14 year olds), excerpted from pp. 2, 3, 4, and 27

War II, Japanese curriculum reforms developed appropriate mathematical activities (beginning in 1947), mathematical thinking (beginning in 1951), and mathematization (after the war and again in 2017). For current educators, however, it is difficult to understand these textbooks within the original meaning of the reform because it is based on lost mathematics. However, what is that lost mathematics in Clusters I and II? Several mathematics education research papers in Japan have examined this question. However, due to their brevity, the papers mainly focused on historical issues in the development of textbooks but did not provide an opportunity for current readers to learn about the lost mathematics itself.

In light of this situation, Masami Isoda and Maria Bartolini Bussi published (in Japanese) the *Encyclopedia of Curve: Properties, History, and Construction* (2009) in order to share the geometrical origin and algebraic transition of mathematics up to calculus (see Isoda 1996, 1998; Tall 2013). One finding in the book is the correspondence between the teaching sequences of Frans van Schooten’s textbook (1646) and the Cluster II textbook (1943) regarding the same mechanical instruments (see Fig. 9.1).

The textbooks in Fig. 9.1, published almost 300 years apart, cannot be directly connected. During those 300 years, historical processes were developed and revised for reorganizing mathematics in mathematics textbooks.<sup>5</sup> In the end, the same tasks and sequences may emerge that were earlier based on Euclid. Thus, the sequence in Fig. 9.1 can be understood as being based on Euclid. However, Clusters I and II did not

<sup>5</sup>The categories of mathematics textbooks used in schools after 1872 in Japan were developed in Europe under the influence of the French school system in the early 19th century (Schubring 2015). For the greater context see also: <http://math-info.criced.tsukuba.ac.jp/museum/TGSW2015/>.

include Euclidean-geometric proofs even though they enhanced the demonstration and proving by students. Before Clusters I and II, geometrical proof and construction was employed in secondary school. To introduce content up until calculus, however, Clusters I and II used intuitive explanation with practical experiments using various instruments rather than exact proof.<sup>6</sup>

Even though the influence of Klein involves long historical processes, one piece of evidence of the missing link connecting Japan and Europe is Hans von Sanden's *Praktische Analysis* (1914). This paper aims to illustrate the significance of this missing link in order to understand the historical development of the Clusters I and II mathematics textbooks. These books show the influence of the Klein movement on the integration of subjects up to calculus into the curricula of the Far East, especially in Japan, but not only there.<sup>7</sup>

## 9.2 The Influence of Klein on the Far East: The Case of Japan

During the Meiji period (1868–1912), leading Japanese mathematicians studied in Europe<sup>8</sup> in countries such as UK, France, and Germany. Many of them studied in Germany and the Klein movement in Europe was well known since its earliest stage.

The state of mathematics in schools at that time was summarized at the Fifth International Congress of Mathematicians in Cambridge in 1912, when the Japanese sub-commission of the International Commission of the Teaching of Mathematics published the *Report on the Teaching of Mathematics in Japan* (see Fujisawa 1912/2017). In the attached Divisional Report II, after the preface of Fujisawa, Noriyuki Nishikawa, Professor at Tokyo Higher Normal School, already mentioned for the middle school the movement “to give the pupils elementary concept of function is most important as a direct aim in teaching of algebra” (Nishikawa 1912, p. 13). At that time, graphs and functions were recognized as content that bridged subjects such as arithmetic, algebra, and geometry. However, the curricular reform of 1911 only mentioned that they should be treated in teaching and not as a means of integration of subjects. The curriculum at that time was influenced by the first generation of

---

<sup>6</sup>In Cluster II, Vol. 4 (Grade 4 for 15-year-olds, which is the last grade), there were tasks involving proofs; however, exact bases for proving were not given in the textbook. In this context, it was possible for students to use intuitive or algebraic explanations.

<sup>7</sup>Japanese was one of the teaching languages in many parts of the Far East. More than 10,000 Chinese students studied in Japan from 1896 to 1906. Some of them were related with the Xinhai Revolution. Sun Yat-sen, the founder of the Republic of China, also studied in Japan. After World War II, in the Republic of Korea, the first textbooks for secondary school mathematics were Korean adopted editions of Clusters I and II.

<sup>8</sup>Before WW II, the newest achievements in mathematics were usually published in German and French. German was a necessary language for Japanese mathematicians, as were French and English.

mathematicians who had studied in Europe, such as Dairoku Kikuchi,<sup>9</sup> who finally became the minister of education, and his colleague, Rikitaro Fujisawa.<sup>10</sup> Fujisawa insisted in the independence of every sub-discipline in mathematics to keep their theoretical differences. In his context, he could not share the reform conception of integrating the sub-disciplines.

It was against this conservative situation that under the order of the Japanese Ministry of Education, Gaisaburo Mori translated Otto Behrendsen and Eduard Götting's *Lehrbuch der Mathematik nach Modernen Grundsätzen* (1908, 1911) for secondary and high school teachers from German into Japanese in 1915–1916. To promote the reform movement throughout Japan, Motoji Kunieda and his colleagues at the Tokyo Higher Normal School established the Japan Society of Secondary School Mathematics<sup>11</sup> in 1919. The society shared the reform movement at every annual meeting as a national issue. Secondary school teachers presented their research on curriculum innovation at these meetings and it was published in the society's journal.

In 1921, Tsuruichi Hayashi, the first president of the society, translated Klein's 1904–1905 lectures for secondary school mathematics as the first book (1907) of the University of Göttingen lecture series. Kinosuke Ogura supervised the translation of *Leçons d'Algèbre Élémentaire* by Bourlet (1909) in 1919 and translated *Praktische Analysis* by von Sanden (1914) in 1928. Before these translations, a limited number of mathematicians, teachers and students had read the original books. The reform's intentions reached every secondary school teacher thanks to these Japanese editions. Hayashi recommended in his preface to Klein's book (1907) that secondary school teachers read both books by Behrendsen and Götting and by Bourlet. Both books treat functions and calculus in their later chapters, which follows the goals of both textbooks. The book by Bourlet was dedicated to algebra. The book by Behrendsen and Götting treated geometry, algebra (including coordinates, graphs, and simple construction), trigonometry, calculus with functions for Gymnasium, and projection.<sup>12</sup>

While the book by Behrendsen and Götting was written for secondary schools (Gymnasium), the book by von Sanden (1914) was written for undergraduate stu-

---

<sup>9</sup>Kikuchi was trained according to the tradition of Wasan, the Japanese mathematics of the Edo era. He received a top score in mathematics at Cambridge. Later, he became the president of the University of Tokyo and University of Kyoto and became the Minister of Education. Fujisawa studied in Germany before the Klein reform.

<sup>10</sup>Kikuchi and Fujisawa were founders of the mathematics department of the University of Tokyo and Fujisawa was an advisor of the next generations. The second generation of mathematicians related to this reform, such as Mori, Hayashi, and Kunieda, graduated mostly from the University of Tokyo and worked at other universities and schools. Hayashi had been a professor of the Tokyo Higher Normal School until the establishment of the mathematics department of the Tohoku Imperial University. Many of them had opportunities to study in Europe. Mathematicians in the University of Tokyo such as Teiji Takagi, a member of the first Fields' Award committee, also studied in Germany, but did not lead the reform himself, even though he was familiar with the reform. He merely referenced the existence of the movement in the preface to his secondary school textbooks.

<sup>11</sup>It was the predecessor of the Japan Society of Mathematical Education.

<sup>12</sup>Gymnasium in Germany corresponds to secondary and high schools in Japan before WW II. Clusters I and II for Japanese secondary schools corresponds to the first half of the German Gymnasium.

dents based on his experience at the University of Göttingen.<sup>13</sup> It treated integration of algebra and geometry for calculus with graphs of functions, construction with geometry, and plotting points as the sets of numerical solutions. This paper discusses how von Sanden's book influenced the integration of subjects up to calculus at secondary schools, comparing it with Hamley's (1934) *Relational and Functional Thinking in Mathematics*.

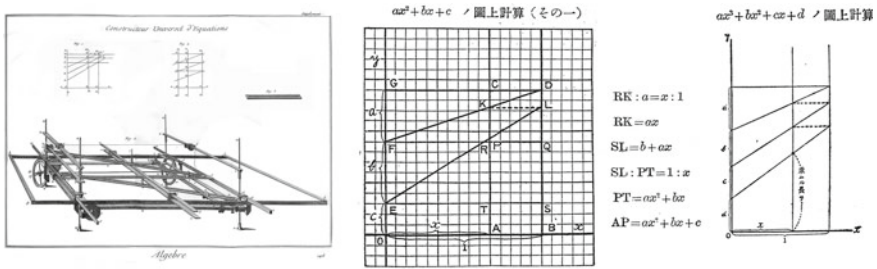
### 9.3 Integration of Algebra and Geometry with Mechanical Instruments

Minoru Kuroda, a teacher at the affiliated secondary school of the Tokyo Higher Normal School, was the first mathematics educator who studied abroad. He studied in Göttingen and returned to Japan in 1913. He contributed to the establishment of the Japan Society of Secondary Mathematical Education and to its proposal for curriculum reform in 1919. Because in 1923, while Kuroda and others planned the new curriculum, the metropolitan region of Tokyo was hit by a strong earthquake and destroyed by fire, the Ministry of Education was not able to enact the curricular reform. Even in this situation, several reform ideas from Kuroda's articles (1927) for the integration of disciplines, such as those shown in Fig. 9.2, had been kept from burning (see Isoda and Bartolini Bussi 2009). Because of this disaster, Japanese mathematicians spent several decades working on the experimental design of the integration of subjects up to calculus, including the relation between algebra and geometry using the graphs of functions. In the middle of World War II, they finally developed Clusters I and II (for 12- to 15-year-old secondary school students) following the principle of mathematization (1943–1944).

The influences of reform movements in Japan came not only from Germany but also from the UK and the US. Indeed, the Japanese respected John Perry, who began his professional career as a mathematician in Japan at the beginning of Meiji era. He became the president of the Physical Society of London in the early 20th century, and his works were also translated into Japanese. Perry also emphasized practical mathematics, even though he did not enhance the integration of the subjects including calculus using the function concept as Klein did. Experimental methods developed by Eliakin Hastings Moore in the US were also well known. Because the Japanese were able to practice their experimental research for several decades, reforms were

---

<sup>13</sup>The books were published after the publication of Felix Klein's world-famous book *Elementarmathematik vom Höheren Standpunkte aus* (1908–1928). The 1908 edition was photocopied as handwriting. It was well read by Japanese mathematicians such as Ogura who introduced it in Japanese in the Japanese journal *Tokyo Buturigakko Zasshi* (1909, Vol. 18). Later, both Ogura (1950) and Shokichi Iyanaga, President of ICMI (1975–1978), wrote about what they had learned. Iyanaga wrote about his impressions upon reading it as a high school student on the book for Ogura's 70th Anniversary Celebration (1956). Klein (1908) was translated into English (1924) and retranslated into Japanese (Toyama; 1959–1961) which did not include the Vol. 3 of Klein (2016).

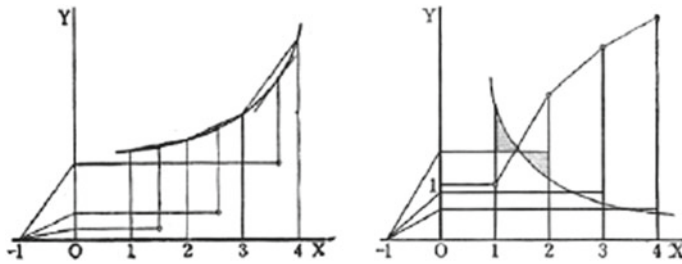


**Fig. 9.2** Mechanical instruments to draw the graph of polynomial functions, bridging geometry and algebra in Diderot’s *Encyclopedia*; cited in Vol. 19, of the *Supplements* (Diderot 1776): *Equation*, pp. 832–840 and in Vol. 33. *Planches* (Diderot 1777) *Algebrae*, p. 18, *Constructeur Universel Equations*, p. 14-E33-Nr. 33. The explanation on the right is from Kuroda (1927, p. 299) (Minoru Kuroda was the first mathematics educator who had the opportunity to study in Europe. This book was published posthumously in 1927 (he passed away in 1922) as a part of his collected publications. One third of the content was based on what he learned in Germany in 1910–1911 and in England and the US in 1912. The rest was his lectures at the open classes done by other teachers who promoted reform ideas and tentative plans for curricular reforms. His textbooks were mostly familiar textbooks that included the ideas of new movements within the limitation of the old curriculum. After he came back to Japan from abroad, he became a professor at the Tokyo Higher Normal School and wrote secondary school textbooks based on what he learned and what he experimented with at the affiliate secondary school of the Tokyo Higher Normal School.).

achieved by the third generations, and thus, they also knew the work of Hamley<sup>14</sup> (1934), which was also translated into Japanese by Aoki (1940).

Figure 9.2 shows an example for the integration of geometry and algebra for functions from Diderot (1776–1777) which is from Johann Andreas von Segner (1704–1777). He was born in Hungary, and in 1735 he became the first professor of mathematics at the newly founded University of Göttingen. This mechanism also appeared in von Sanden (1914). Kuroda (1927) explained the idea in the context of the reform movement proposed by Klein, which integrates geometry and algebra via graphs of functions.

<sup>14</sup>The Japanese translation of *Relational and Functional Thinking in Mathematics* was published in 1940 before Clusters I & II. The translator Seisiro Aoki was a scholar at the Tokyo Higher Normal School (University of Tsukuba). Before Cluster I and II, several developments of the curriculum had been done nationally since the establishment of the Japan Society of Secondary School Mathematics in 1919, and three curriculum plans were proposed in Tokyo, Osaka, and Hiroshima under that society (1940; see such as Mathematics Research Committee of the Affiliate School of the Tokyo Higher Normal School 1940 and Koga, S. 1940). Professors of the Tokyo Higher Normal Schools and teachers at the affiliated secondary school embedded their long-term experiments of lesson studies at their affiliated secondary school and others into the textbooks which synchronized with other countries such as Germany, England and USA.



**Fig. 9.3** Drawing the derivative and the primitive function from the given graph in Mathematics Cluster I (1944), Vol. 4 (Grade 4 for 15-year-olds), p. 9

## 9.4 Embedded German *Praktische Analysis* in the Japanese Textbook for Cluster I (1943)

The Japanese textbooks for Clusters I and II were the first textbooks in Japan that integrated arithmetic, algebra, and geometry via the concept of function and graphical representations including calculus. Figure 9.3 is a clear example that shows the ideas in von Sanden (1914) that adopted for the Japanese curriculum for 15-year-old students for realizing integration up to calculus.

Figure 9.3 can also be seen in von Sanden (1914, pp. 97 and 103).<sup>15</sup> According to the Japanese translators and editors, Ogura and Kondo (1928), Klein established the course for *praktische Analysis* at the University of Göttingen in 1904. Von Sanden became a lecturer at Göttingen and published the book based on his lecture courses. Ogura explained in the Japanese edition that *Praktische Analysis* was the best book in this area because of this origin. In addition to the English translation by Levy (1923), the Japanese edition was an adaptation by Ogura due to his addition of content and footnotes to make it more easily understood.<sup>16</sup> Thus, various efforts have been made to adapt the ideas of von Sanden from university mathematics into Japanese secondary school mathematics.

## 9.5 The Influence of Klein: Germany or Origins from UK and US?

Since the Japanese achievements were not only influenced by Germany but also the UK and the US, we can at first not be sure whether the origin of Fig. 9.3 can be

<sup>15</sup>Figure 2 was also included in Sanden (1914, pp. 45–48) but was not in Clusters I and II.

<sup>16</sup>Before translating von Sanden, Ogura had already published *Approximate Solution Using Diagrams and Graphs* (1923) in Japanese. This implicates that he did not completely translate from the English Edition. His translated books usually including many revisions and enlargements based on his own studies.

attributed to von Sanden or not. However, there is clear positive evidence that it originated in Germany when we compare it with the discussions of Hamley (1934):

Klein has said that “for a thorough and fruitful treatment of the function concept, the fundamentals of mechanics may be taken as a necessary material.” With this opinion we are in full agreement. It is not clear whether Klein restricts the term “mechanics” to *kinematics*, or whether he also includes *kinetics*, which involves the concept of mass. In our course, we have confined our attention almost exclusively to kinematics, not because of any unwillingness to include kinetics, but because the space-time concept provides us with all the functional material we need. (p. 112)

Klein emphasized mechanics as the foundation of the treatment of the function concept. However, Hamley explained the space-time concept as an alternative to kinematics. Mechanics here was basically represented by geometry. Klein propagated the integration of algebra and geometry for teaching calculus. Hamley introduced the space-time concept, which can be represented by numbers and algebra without geometry. Even though the space-time concept is normally used for functions in algebra, according to Hamley’s claim, Fig. 9.3 could not be explained because it does not depend only on space-time. This is how we can affirm that Klein and von Sanden’s view is shown in Fig. 9.3.

Of course, we also recognize that space-time situations appear in the introduction of calculus in Cluster I. However, in the case of Cluster I, differentiation and integration are solved using Fig. 9.3 before introducing the algebraic operations of differentiation and integration.<sup>17</sup> Before algebraic operations, the idea of the fundamental theorem of calculus is introduced, and space-time situations are solved by geometric operations as shown in Fig. 9.3. Additionally, in Cluster II, which is taught in parallel with Cluster I, before learning calculus, kinematics is applied as visualized in Fig. 9.1.

## 9.6 Conclusion

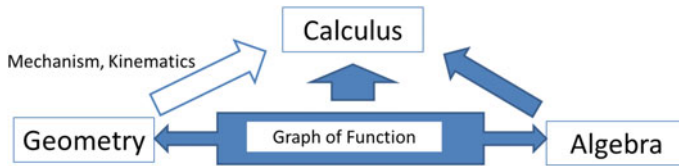
Due to the comparison between the books by von Sanden and Hamley, the integration of the sub-disciplines arithmetic, algebra, and geometry including calculus in Japanese school mathematics, which was originally proposed by Klein, is evidenced in Clusters I and II. We showed the book by von Sanden to be a missing link to the currently lost mathematics, which we never learn up to university in these days.

This point of discussion is summarized as shown in Fig. 9.4.

Figure 9.4 shows the basic framework for Clusters I and II. However, the era of the US occupation of Japan after WW II resulted geometry with construction was

---

<sup>17</sup>The treatment of graphs involving space-time also appeared in Hayashi’s (1921) translation of Klein (1907). The salient point is whether there is a reference to geometry or not. Cluster I and II show the efforts that have been made to adapt the ideas of von Sanden from university mathematics into Japanese secondary school mathematics based on geometry. Hamley focused on space-time and did not treat geometry as the basis of functions.



**Fig. 9.4** Mechanics and kinematics as a missing link for teaching the integration of the sub-disciplines including calculus

reintroduced but the functions up to calculus were following space-time framework.<sup>18</sup> There were two reasons. The first reason was the transforming of the school system from parallel to linear. The curriculum for secondary schools was divided into one part for new junior high and another for senior high schools, and student populations were redefined. Compulsory education ended with junior high schools, at 15 years old, with the curriculum reaching proofs in geometry and quadratic functions. Senior high schools were divided into schools depending on student achievement, from preparatory schools for the universities to various vocational schools. The second reason was the New Math. Algebraic mathematics including vectors and matrices were introduced, and construction and trigonometry in geometry became restricted. In this context, the direction from geometry to calculus in Fig. 9.4 by kinematics and mechanics becomes the missing link to understand Clusters I and II for our period.

Currently, technology such as dynamic geometry software enables anyone in the world to approach mechanisms and kinematics of Figs. 9.1, 9.2 and 9.3. For example, Isoda (2008) developed e-textbooks<sup>19</sup> for Fig. 9.1 and engaged in lesson study to demonstrate their significance in mathematics education (see Bartolini Bussi et al. 2010). The objectives of lesson study with e-textbooks are firstly to demonstrate the close relationship between elementary geometry and mechanisms and recognize that elementary geometry provides the intuition for reasoning about mechanisms, and secondly, to recognize the difference between the mathematical systems for the solutions for the loci of the mechanism in Fig. 9.1 using elementary geometry, analytic geometry and vectors, and so on. Analytic geometry usually uses the conclusions of geometric reasoning in order to algebraically prove the equation for the algebraic solution; however, this is the adaptation of the conclusion of elementary geometry.

<sup>18</sup>The General Headquarters of the Allied Forces governing Japan from 1945 to 1953 supervised and directed the Japanese curricular reform according to the principle of activity and appreciation especially for compulsory education (Makinae 2011), which is one of the bases for the current Japanese problem-solving approach. This approach is well known as a part of the recent lesson study movement aimed at developing children who learn mathematics by and for themselves.

<sup>19</sup>The lesson study video clips (Isoda 2008; Isoda & Yamamoto 2009; Isoda 2010) with Dr. Yuriko Yamamoto Buldin for graduate students of the Universidade Federal do Rio de Janeiro can be seen at: [http://math-info.criced.tsukuba.ac.jp/museum/dbook\\_site/dbookEng\\_with\\_DGraph\\_2010\\_0402/CDImageEnglish/Schooten-Monbsho-VTR/SchootenVTR/index.html](http://math-info.criced.tsukuba.ac.jp/museum/dbook_site/dbookEng_with_DGraph_2010_0402/CDImageEnglish/Schooten-Monbsho-VTR/SchootenVTR/index.html). A Japanese textbook with simulation can be seen at: [http://math-info.criced.tsukuba.ac.jp/museum/dbook\\_site/SchootenOnWeb1/Schooten1/index.html](http://math-info.criced.tsukuba.ac.jp/museum/dbook_site/SchootenOnWeb1/Schooten1/index.html). Van Schooten's e-textbook requires Adobe Flash Player; click the bottom to see the video (flv) and to use the simulation.



From the perspective of elementary geometry, the ways of reasoning of analytic geometry include tautology.<sup>20</sup> Mechanisms and kinematics provide intuition that is synchronized with elementary geometry which includes reasoning through the embedded figures of the theorem but is not always synchronized with reasoning using the form of algebra and calculus.

This paper concludes that the contents of the missing link between calculus and geometry was specified by kinematics and mechanics and that the link was one of the key ideas to be considered in the curricular integration of the subjects of arithmetic, algebra, and geometry for calculus and shows good evidence of what the Klein movement achieved in the Far East up until WW II. This paper also discussed how the Klein movement was introduced. However, it does not deeply describe how the Japanese worked on producing their own original adaptation through the decades until the production of the textbooks for Clusters I and II at the secondary level.

**Acknowledgements** This research was supported by JSPS (KAKENHI-Kiban A) 26245082 and MEXT (KAKENHI-Tyousenteki Hoga) 16K13568. The author deeply acknowledges Dr. Gert Schubring at the University of Bielefeld and Dr. Michael Neubrand at the University of Oldenburg, who gave him fruitful suggestions, and Dr. Aira Yap and Mr. Guillermo Bautista at the University of the Philippines, who technically supported his English writing.

## References

- Bartolini Bussi, M., Taimina, D., & Isoda, M. (2010). Concrete models and dynamic instruments as early technology tools in classrooms at the dawn of ICMI: From Felix Klein to present applications in mathematics classrooms in different parts of the world. *ZDM Mathematics Education*, 42(1), 19–31. <https://doi.org/10.1007/s11858-009-0220-6>.
- Behrendsen, O., & Götting, E. (1908). *Lehrbuch der Mathematik nach modernen Grundsätzen*. Leipzig: Teubner.
- Behrendsen, O., & Götting, E. (1911). *Lehrbuch der Mathematik nach modernen Grundsätzen* (2nd ed.). Leipzig: Teubner.
- Behrendsen, O., & Götting, E. (translated and edited by G. Mori) (1915–1916). *Lehrbuch der Mathematik nach modernen Grundsätzen* (Vols. 1 and 2). Tokyo: National Textbook Dealer (in Japanese. Japanese title: *Shinsyugi Suugaku*).
- Bourlet, C. (1909). *Leçons d'Algèbre Élémentaire* (6e éd). Paris: Librairie Armand Colin.
- Bourlet, C. (translated by M. Takebe, edited by K. Ogura) (1919). *Leçons d'Algèbre Élémentaire*. Tokyo: Sankaido (in Japanese. Japanese title: *Syotou Daisuugaku*).
- Diderot, D., et al. (1776–1777). *Supplément à l'Encyclopédie ou Dictionnaire raisonné des sciences, des arts et des métiers* (Vols. 19 and 33). Paris/Amsterdam: Panckoucke, Stoupe, Brune/M. M. Rey.
- Freudenthal, H. (1968). Why to teach mathematics so as to be useful. *Educational Studies in Mathematics*, 1(1), 3–8. <https://doi.org/10.1007/BF00426224>.
- Fujisawa, R. (1912, reprinted 2017). *Summary report on the teaching of mathematics in Japan, 1912*. Tokyo: [Japanese Sub-Commission of the International Commission on the Teaching of Mathematics], 1912.

---

<sup>20</sup><http://math-info.criced.tsukuba.ac.jp/software/up.Schooten-Descartes/Schooten-DescartesHTE M4rio.files/frame.htm>.

- Hamley, H. R. (1934). *Relational and functional thinking in mathematics*. New York: Columbia University.
- Hamley, H. R. (translated and commented by S. Aoki) (1940). *Relational and functional thinking in mathemese*. Tokyo: Monasu (in Japanese. Japanese title: *Kansuuteki Shikouno Shinri*).
- Isoda, M. (1996). The development of language about function: An application of van Hiele Levels. In L. Puig & A. Gutierrez (Eds.), *Proceedings of the 20th Conference of the International Group for the Psychology of Mathematics Education* (Vol. 2, pp. 105–112). Valencia: University of Valencia.
- Isoda, M. (1998). Developing the curriculum for curves using history and technology. In W. Yang, et al. (Eds.), *Proceedings of the Third Asian Technology Conference in Mathematics* (pp. 82–89). Tokyo: Springer.
- Isoda, M. (2008). Van Schooten (e-textbook) used for the lesson study workshop on the IV Colóquio de História e Tecnologia no Ensino da Matemática. retrieved August 25, 2018 from <http://mathinfo.criced.tsukuba.ac.jp/software/dbook/video/Schooten1646-Isoda2008/Schooten/index.html>.
- Isoda, M. (2010). Van Schooten and Japanese Textbook with movie (flv)(e-textbook embed Lesson Study Video on van Schooten, F. (1646). *De Organica Conicarum Sectionum In Plano Descriptione, Tractatus*. Elzavier) retrieved August 25, 2018 from [http://mathinfo.criced.tsukuba.ac.jp/museum/dbook\\_site/dbookEng\\_with\\_DGraph\\_2010402/CDImageEnglish/Schooten-Mombsho-VTR/SchootenVTR/index.html](http://mathinfo.criced.tsukuba.ac.jp/museum/dbook_site/dbookEng_with_DGraph_2010402/CDImageEnglish/Schooten-Mombsho-VTR/SchootenVTR/index.html).
- Isoda, M., & Bartolini Bussi, M. (2009). *Encyclopedia of curve: Properties, history and construction*. Tokyo: Kyoritsu (in Japanese. Japanese title: *Kyokusen no Giten: seishitsu, rekishi, sakuzuhou*).
- Isoda, M., & Yamamoto, Y. B. (2009). Challenges of Lesson Study in UFRJ on IV HTEM: Descartes' Dream with van Schooten, Using Historical Sources on e-textbook, Keynote lecture at V Colóquio de História e Tecnologia no Ensino da Matemática (V HTEM). Retrieved August 25, 2018 from <http://mathinfo.criced.tsukuba.ac.jp/software/up.Schooten-Descartes/Schooten-DescartesHTEM4rio.files/frame.htm>.
- Iyanaga, S. (1956). The road of Dr. Ogura. In Ogura's 70 years-old Celebration Committee (Ed.), *History of science and science education* (pp. 3–6). Tokyo: Dainihon.
- Klein, F. (1908). *Elementarmathematik vom höheren Standpunkte aus* (Handwriting ed.). Berlin: Springer.
- Klein, F. (1924). *Elementary mathematics from an advanced stand point: arithmetic, algebra, analysis*. New York: Dover.
- Klein, F. (2016). *Elementary mathematics from a higher standpoint* (Vols. 1, 2 translated by G. Schubring; Vol. 3 translated by M. Menghini & A. Baccaglioni-Frank). Berlin: Springer.
- Klein, F. (edited by Schimmack, R.) (1907). *Vorträge über den mathematischen Unterricht an den höheren Schulen*. Leipzig: Teubner.
- Klein, F. (edited by Schimmack, R., translated by M. Takebe & T. Hayashi, edited, commented and enlarged by T. Hayashi) (1921). *Vorträge über den mathematischen Unterricht an den höheren Schulen*. Tokyo: Dainihon (in Japanese. Japanese title: *Doitsuni Okeru Suugakukyōiku*, Mathematics Education in Germany: Lectures of Felix Z).
- Klein, F. (translated by Toyama, H.) (1959–1961). *Elementary mathematics from an advanced stand point: arithmetic, algebra, analysis*. v1–4. Tokyo: Syoko Syuppan/Tokyo Syoseki. (in Japanese. Japanese Title: Takai Tachibakaramita Syotou Suugaku).
- Kuroda, M. (1927). *New trends of mathematics education*. Tokyo: Baifukan (in Japanese).
- Makinae, N. (2011). The origin of the term “Appreciation” in mathematics education in postwar educational reform period: through the analysis of GHQ/SCAP records. *Journal of Japan Society of Mathematical Education: Mathematics Education*, 93(5), 2–11 (in Japanese).
- Mathematics Research Committee of the Affiliate School of the Tokyo Higher Normal School. (1940). A report of the mathematics curricula reform committee on the Japan society of secondary school mathematics. *Mathematics Education*, 28, 27–46. Tokyo: Affiliate School of the Tokyo Higher Normal School (written in Japanese).

- Ministry of Education (1968). *Course of study for elementary school mathematics*. Tokyo: Ministry of Education.
- Nabeshima, N., & Tokita, Y. (1957). *Secondary school mathematics education research*. Tokyo: Dainihon (in Japanese).
- Nishikawa, N. (1912). The teaching of mathematics in middle school. In Japanese Sub-Commission on the International Commission on the Teaching of Mathematics (Ed.), *Divisional reports of the teaching of mathematics of Japan: Being a series of reports prepared by the division of the Japanese Sub-commission of the international commission on the teaching of mathematics*. In *Report on the teaching of mathematics in Japan (prepared by Japanese Sub-Commission of the International Commission of the Teaching of Mathematics)* (pp. 1–39). Tokyo: Tokyo University of Literature and Science.
- Ogura, K. (1923). *Approximate solution using diagrams and graphs*. Tokyo: Sankaido (in Japanese). Japanese title: *Zu oyobi keisan zuhyou*.
- Ogura, K. (1950). *Reminiscence as a mathematician*. Tokyo: Kawaide.
- Secondary School Textbook Publisher. (1943). *Clusters I for secondary school mathematics grade 3*. Tokyo: Secondary School Textbook Publisher (in Japanese).
- Secondary School Textbook Publisher. (1944). *Clusters II for secondary school mathematics grade 4*. Tokyo: Secondary School Textbook Publisher (in Japanese).
- Schubring, G. (2015). *Hermeneutics of historical mathematics textbooks*. Retrieved from [http://math-info.criced.tsukuba.ac.jp/museum/TGSW2015/copy\\_of\\_ppt\\_Gert20151116.pdf](http://math-info.criced.tsukuba.ac.jp/museum/TGSW2015/copy_of_ppt_Gert20151116.pdf). Accessed February 5, 2018.
- Koga, S. (1940). A news of the mathematics curricula research committee for the 22nd annual meeting of the Japan society of secondary school mathematics. *School Mathematics*, 39, 61. Hiroshima: Affiliate School of the Hiroshima Higher Normal School (written in Japanese).
- Tall, D. (2013). *How human learn to think mathematically: Exploring the three worlds of mathematics*. New York: Cambridge University Press.
- van Schooten, F. (1646). *De Organica Conicarum Sectionum In Plano Descriptione, Tractatus Geometris, Opticis; Præsertim verò Gnomonicis & Mechanicis Utilis. Cui subnexa est Appendix, de Cubicarum Æquationum resolutione*. Lugdunum Batavorum: Elzevier.
- von Sanden, H. (1914). *Praktische analysis*. Leipzig: Teubner.
- von Sanden, H. (translated and edited by H. Levy) (1923). *Practical mathematical analysis*. London: Methuen.
- von Sanden, H. (translated, edited and enlarged by K. Ogura & T. Kondo) (1928). *Praktische Analysis*. Tokyo: Sankaido (in Japanese. Japanese Title: *Jituyou Kaisekigaku*).

**Open Access** This chapter is licensed under the terms of the Creative Commons Attribution 4.0 International License (<http://creativecommons.org/licenses/by/4.0/>), which permits use, sharing, adaptation, distribution and reproduction in any medium or format, as long as you give appropriate credit to the original author(s) and the source, provide a link to the Creative Commons license and indicate if changes were made.

The images or other third party material in this chapter are included in the chapter's Creative Commons license, unless indicated otherwise in a credit line to the material. If material is not included in the chapter's Creative Commons license and your intended use is not permitted by statutory regulation or exceeds the permitted use, you will need to obtain permission directly from the copyright holder.



# Chapter 10

## Felix Klein's Mathematical Heritage Seen Through 3D Models



Stefan Halverscheid and Oliver Labs

**Abstract** Felix Klein's vision for enhancing the teaching and learning of mathematics follows four main ideas: the interplay between abstraction and visualisation, discovering the nature of objects with the help of small changes, functional thinking, and the characterization of geometries. These ideas were particularly emphasised in Klein's concept of mathematical collections. Starting with hands-on examples from mathematics classrooms and from seminars in teacher education, Klein's visions are discussed in the context of technologies for visualisations and 3D models: the interplay between abstraction and visualisation, discovering the nature of objects with the help of small changes, functional thinking, and the characterization of geometries.

**Keywords** Felix Klein · Visualisation · Göttingen · Collection  
Mathematical models · Instruments · 3D models · Cubic and quartic surfaces  
3D printing

### 10.1 Introduction

#### 10.1.1 Klein's Vision for Visualisations

At the age of 23, Felix Klein (1849–1925) became a professor at Erlangen. On such occasions, professors used to give a speech. Klein's speech, which is known nowadays as the *Erlangen Programme*, was published with an appendix ("notes") containing a paragraph entitled "On the value of space perception". Even though the history of the reception of the speech and the written publication of the programme is complicated (Rowe 1983), and although its influence is contested (Hawkins 1984), this episode

---

S. Halverscheid (✉)  
Georg-August-Universität Göttingen, Göttingen, Germany  
e-mail: stefan.halverscheid@mathematik.uni-goettingen.de

O. Labs  
MO-Labs—Math Objects Dr. Oliver Labs, Ingelheim, Germany  
e-mail: oliver@MO-Labs.com

© The Author(s) 2019  
H.-G. Weigand et al. (eds.), *The Legacy of Felix Klein*, ICME-13 Monographs,  
[https://doi.org/10.1007/978-3-319-99386-7\\_10](https://doi.org/10.1007/978-3-319-99386-7_10)

reveals that at an early stage of his career, Felix Klein was already interested in the teaching and learning of mathematics and in methods of visualisation:

When in the text, we designated space-perception as something incidental, we meant this with regard to the purely mathematical contents of the ideas to be formulated. Space-perception has then only the value of illustration, which is to be estimated very highly from the pedagogical standpoint, it is true. A geometric model, for instance, is from this point of view very instructive and interesting. But the question of the value of space-perception in itself is quite another matter. I regard it as an independent question. There is a true geometry which is not, like the investigations discussed in the text, intended to be merely an illustrative form of more abstract investigations. (Klein 1893, p. 244)

Klein's point of view has undergone some changes over the years (Rowe 1985), but the idea of visualisation remains a guiding theme in Klein's work on teaching and learning—for example, in his “Elementary mathematics from a higher standpoint”, which was published much later, it is still quite present throughout the text. Klein was keen on using cutting-edge technology to visualise modern mathematics. The collections following his concept gather plaster models, diapositives, and newly constructed machines. According to Klein, “A model—whether it be executed and looked at, or only vividly presented—is not a means for this geometry, but the thing itself” (Klein 1893, p. 42).<sup>1</sup> In this text, we present implementations of some of today's modern technologies following Klein's main idea to offer objects of intense study.

### ***10.1.2 Four Threads of Klein's Vision for Teaching and Learning Mathematics***

Klein worked out the idea to *characterise geometries* using group theory very early in his career, together with Sophus Lie, as formulated in his Erlangen programme. Looking back, this is certainly one of the more important aspects in Klein's work, as it is still the way geometries are treated today, particularly non-Euclidean geometries. Hence, this is one of the four threads discussed here.

However, we start with another topic which is even more important for Klein's vision for teaching and learning mathematics, namely the interplay between abstraction and visualisation. For Klein, visualisations play a key role in experiences, both in geometry and other areas of mathematics. He says: “Applied in particular to geometry, this means that in schools you will always have to connect teaching at first with vivid concrete intuition and then only gradually bring logic elements to the fore.” (Klein 2016b, p. 238).

Three decades after his appointment as professor, Felix Klein developed an agenda to push mathematics in schools with the help of the teaching commission inaugurated by a society of German natural scientists and physicians. In a conference in Meran in 1905, an influential syllabus was suggested for secondary education. In the

---

<sup>1</sup>Author's translation.

appendix for the first volume of his *Elementary Mathematics from a Higher Standpoint*, Felix Klein writes: “The Meran curricula, in particular, are of high significance for the reform movement. They constitute already well-established norms according to which the progress of reform movements for all changes occurring in secondary education can be assessed. Their main demands are, as has already been explained in various sections, a psychologically correct method of teaching, the penetration of the entire syllabus with the concept of function, understood geometrically, and the emphasis on applications” (Klein 2016a, p. 294).

Interestingly, he links *functional thinking* with geometry. More generally, Klein wanted the “notion of a function according to Euler” to “penetrate (...) the entire mathematical teaching in the secondary schools” (Klein 2016a, p. 221). In particular, he very much wanted to implement calculus at school: “We desire that the concepts which are expressed by the symbols  $y = f(x)$ ,  $\frac{dy}{dx}$ ,  $\int y dx$  be made familiar to pupils, under these designations; not, indeed, as a new abstract discipline, but as an organic part of the total instruction; and that one advance slowly, beginning with the simplest examples. Thus one might begin, with pupils of the age of fourteen and fifteen, by treating fully the functions  $y = ax + b$  ( $a, b$  definite numbers) and  $y = x^2$ , drawing them on cross-section paper, and letting the concepts slope and area develop slowly. But one should hold to concrete examples” (Klein 2016a, p. 223).

A recurring topic in Klein's teaching and research is the use of small changes to discover the nature of objects. Indeed, he started to apply this as an ongoing theme in his very early years, e.g., in his work on cubic surfaces from 1873 in which one type of surface deforms into another by a tiny change in the coefficients. In his elementary mathematics lectures, this topic is still an important method in many places, e.g., when he discusses multiple roots which transform into several nearby simple roots under small changes. Again, these studies are accompanied by visualisations to stress the related geometric aspects.

We thus identify four main ideas that describe Felix Klein's concepts of visualisation:

- (1) interplay between abstraction and visualisation,
- (2) discovering the nature of objects with the help of small changes,
- (3) functional thinking, and
- (4) the characterization of geometries.

In the following section, these aspects are located within Klein's work. A particular emphasis is made on 3D models, which Klein pushed strongly in his mathematical collections. Examples from recent courses at schools and universities are used to illustrate how these ideas can be approached with today's technology.

## 10.2 Building on Klein's Key Ideas in Today's Classrooms and Seminars

### 10.2.1 *Interplay Between Abstraction and Visualisation*

#### 10.2.1.1 Abstraction and Visualisation at the Core of Mathematical Activities with Geometric Objects

Imagination and abstraction have haunted philosophers for a long time, a prominent example being Kant, who—in his *Critique of Pure Reason*—dismissed anything empirical as being part of geometry as a scientific discipline. Hawkins (1984) points out that Klein uses “geometry” in a rather liberal way. This is somehow ironic because Klein’s *Erlangen Programme* significantly influenced the way mathematicians nowadays agree what geometry actually means. In this very text, he works out the role of visualisation for geometry: “Its problem is to grasp the full reality of the figures of space, and to interpret—and this is the mathematical side of the question—the relations holding for them as evident results of the axioms of space perception” (Klein 1893, p. 244).

For Klein, any object, whether “observed or only vividly imagined”, is useful for working geometrically as long as it is an object of intense study. Later, in his lectures entitled *Elementary Mathematics from a Higher Standpoint*, he makes clear that the main role of objects of study is to enhance the interplay between abstraction and visualisation: “One possibility could be to renounce rigorous definitions and undertake to construct a geometry only based on the evidence of empirical space intuition; in his case one should not speak of lines and points, but always only of “stains” and stripes. The other possibility is to completely leave aside space intuition since it is misleading and to operate only with the abstract relations of pure analysis. Both possibilities seem to be equally unfruitful: In any case, I myself always advocated the need to maintain a connection between the two directions, once their differences are clear in one’s mind.

A wonderful stimulus seems to lay in such a connection. This is why I have always fought in favour of clarifying abstract relations also by reference to empirical models: this is the idea that gave rise to our collection of models in Göttingen.” (Klein 2016c, p. 221).

Following this line of thought, a suitable task design involving geometric models offers both opportunities for empirical experiences and the requirement to build up abstract concepts.

#### 10.2.1.2 The Interplay of Abstraction and Visualisation with 3D Printing from Grade 7

The celebrated opportunities of 3D printers surely involve a great deal of mathematics. However, while a CAD programme makes use of mathematics, it becomes

**Table 10.1** Part of an STL code for a triangle

Facet normal 0 1 0	Normal vector of the triangle
Outer loop	Start of the list vertices
Vertex 0 4 4	First corner of the triangle
Vertex 4 4 0	Second corner of the triangle
Vertex 0 4 0	Third corner of the triangle
Endloop	Ends the list of vertices

invisible. Shapes can be constructed without any need for abstraction, and the software creates files that 3D printers transform to create objects. Instead of disguising mathematics in such a way, we report an approach that works at the interface of computers to 3D printers. An example of this interface is the STL-code (STereoLithography code), which describes the tessellation of a surface—namely, the boundary of a solid.

This tessellation is done in triangles; the STL-code lists the corners of these triangles. For complicated shapes, the printer needs the normal vector pointing to the exterior of the solid. Table 10.1 represents the part of the code for the triangle  $\Delta f(0, 4, 4), (4, 4, 0), (0, 4, 0)$ , which has the normal vector  $(0, 1, 0)$ .

Curved surfaces need thousands of triangles to approximate the shape in a seemingly smooth way. The code has been introduced to various groups in lower grades with the trick of limiting ourselves to polytopes. Their boundary can be triangulated in finitely many triangles very accurately, which avoids all questions of approximation. It is important, however, to have some experience with 2D coordinates. The introduction of a third coordinate did not cause severe problems in our cases.

Variants of two tasks particularly enhanced the interplay between abstraction and visualisation. They have been tried in various groups of students from grade 7 on.

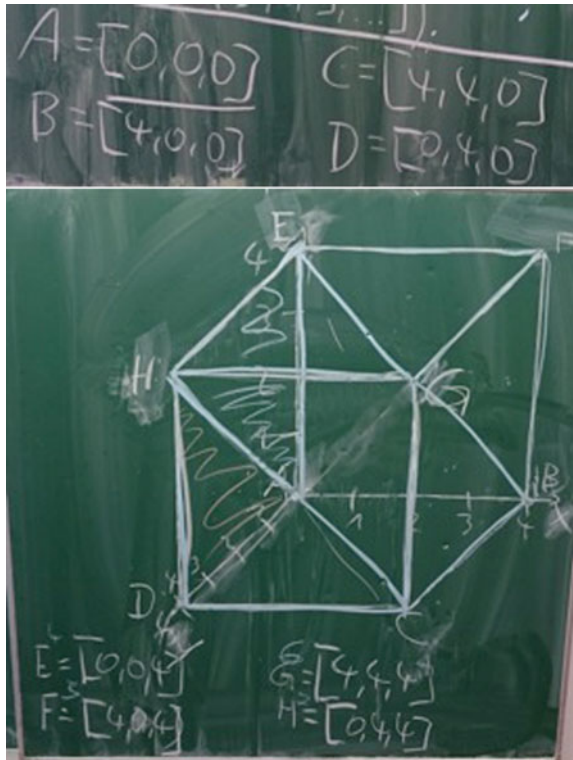
First task type from abstraction to visualisation: The following task provides an STL code of a polyhedron and asks to figure out its shape. The triangulation of a cube's surface often leads to first guesses which prove to be correct. For instance, if twelve triangles are used to triangulate the six squares, a first guess can be a dodecahedron. A rewarding discussion provides criteria as to when two triangles lie in the same plane (Emmermann et al. 2016) (Fig. 10.1).

Second task type from visualisation to abstraction: With a number of congruent regular tetrahedra, the experimental task is to determine whether these can be used for a tessellation of space without any holes (Fig. 10.2). A cognitive conflict causes trouble because eyesight cannot decide whether there is indeed a hole or whether some of the tetrahedra's movability is due to some artefacts in the production process of the tetrahedra. This problem can be answered by measuring activities with 7th graders or, more accurately, with the later help of the analytic geometry of angles.

In fact, determining whether packing of tetrahedra minimises the missing space is an open and hard problem.



**Fig. 10.1** Visualizing the triangulation of a cube by 7th graders. Photo by Halverscheid (2016)



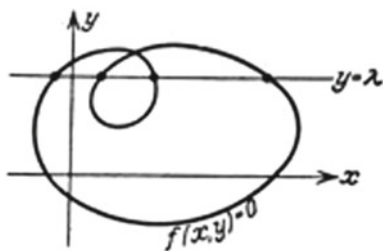
**Fig. 10.2** Activity on tetrahedral tilings. Photo by Halverscheid (2016)



### 10.2.2 *Discovering the Nature of Objects with the Help of Small Changes*

Applying small changes to a formula or an equation was one of the most natural things to do for Klein. Indeed, this was one of his main guiding themes in his early years as a mathematics researcher. As we will see, this point of view also became an important aspect of his teaching.

**Fig. 10.3** Varying a parameter. From the first page of the first section in the algebra chapter of Klein's book on elementary mathematics from a higher standpoint (Klein 2016a, p. 91)



### 10.2.2.1 Small Changes

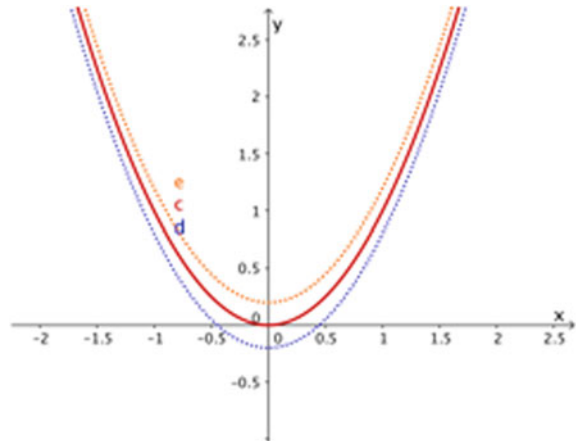
As a first example of Klein's teaching of mathematics with respect to small changes, let us look at the first section on algebra in his book on elementary mathematics (Fig. 10.3). Upon opening the book to this page, one immediately notices that there is a figure. As mentioned in the previous section, Klein always tries to explain abstract mathematics with the help of drawings.

However, another aspect catches the eye: the fact that he considers a function with a parameter lambda as his very first example. This clearly reflects his idea that one should always try to understand the true nature of mathematical objects. To give an example, let  $y = x^3 - x + 1$ . This is a function with one variable of degree three with one real root. Yet, this example does not reflect the nature of polynomial functions of degree three in an adequate way. Only by introducing parameters such as in  $y = x^3 + px + q$  can one realise that such functions may indeed have up to three roots and that a special case seems to be that of two roots with one of them doubled. This brings Klein to the study of discriminants in order to understand whole classes of mathematical objects globally.

The crucial points of these studies of classes of mathematical objects are the moments when essential things change; in the example of cubic functions above, this is the case when—suddenly—the function no longer has one real root but two and then even three. Klein realizes that one may thus reduce much of the study of the global picture to a local study in such special cases. To give an even simpler example, take  $y = x^2$ . When looking at small changes to this function, one realises that the single root indeed splits up into two different roots. Thus, to reflect the true nature of the single root, one should count it as a double root. Of course, algebraically, this can also be seen by the fact that the factor  $x$  appears twice in the definition of the function. Today's dynamic geometry systems now provide this as a standard technique for school teaching: a slider allows these small changes to be experienced interactively (Fig. 10.4).

Klein depends the understanding of concepts wherever appropriate. For functions in one variable, their roots are certainly one of the more important features. Thus, in the section on algebra in his elementary mathematics book, he spends quite some time on roots of functions with algebraic equations and—again—discusses this topic in a very visual and geometric way. From the well-known formula for roots of a polynomial of degree two in one variable  $x$  with the equation  $y = x^2 + px + q$ , it

**Fig. 10.4** A small change reflects the true nature of the single root—which should be indeed counted twice

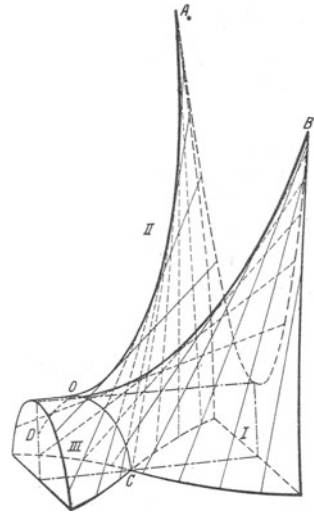


is immediate to see that it contains a single double root if and only if the so-called discriminant  $p^2 - 4q$  is zero. Thus, geometrically, all points on the parabola  $q = \frac{1}{4}p^2$  in the  $pq$  plane yield plane curves  $y = x^2 + px + q$  with a double root; all points above this curve (i.e., where  $q > \frac{1}{4}p^2$ ) correspond to functions with no real root, and all points below correspond to functions with two real roots.

Similarly, one can study the parameters  $p$  and  $q$  for which the cubic polynomial  $y = x^3 + px + q$  has a double root—these are all points on the discriminant plane curve with equation  $27q^2 = -4p^3$ , a curve with a cusp singularity at the origin. For studying the numbers of roots of a polynomial of degree four, with  $x^4 + ax^2 + bx + c$ , one has to work with three parameters— $a$ ,  $b$ , and  $c$ —so that the parameter space is three-dimensional. In this case, all points  $(a, b, c)$  yielding polynomial functions of degree four with a double root lie on a discriminant surface in three-space of degree 6 with a complicated equation. Because of its geometry, this discriminant surface is nowadays sometimes called a swallowtail surface. As in the case of the parabola, the position of a point  $(a, b, c)$  with respect to the discriminant determines exactly which number and kind of roots the corresponding function of degree four possesses. Because of this feature, this discriminant surface had already been produced as a mathematical model during Klein's time, and Klein shows a drawing of it in his elementary mathematics book. To give an example of this close geometric relation, consider our modern 3D-printed version, which even shows the non-surface part of this object—half of a parabola (see Figs. 10.5 and 10.6). Points  $(a, b, c)$  on this space curve correspond to functions  $x^4 + ax^2 + bx + c$  with two complex conjugate double roots. Klein was fascinated by these connections; he discussed such aspects frequently in both his research and his teaching. For example, in his introductory article to Dyck's catalogue from 1892 for a famous exhibition of mathematical and physical models (Dyck 1892), Klein discusses how discriminant objects describe in detail how small changes to coefficients of a function change its geometry.

Klein applies exactly the same ideas to many other cases. To discuss just the simplest spatial one here, take the double cone consisting of all points  $(x, y, z)$

**Fig. 10.5** The discriminant surface of a polynomial function of degree four (Klein 2016a, p. 105)

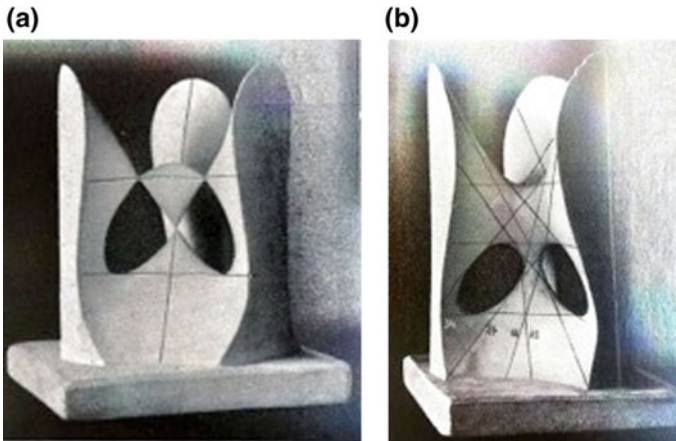


**Fig. 10.6** A 3D-printed mathematical sculpture by the second author showing this object



satisfying the equation  $x^2 + y^2 = z^2$ . Similar to the case of the parabola where the sign of epsilon in  $y = x^2 \pm \varepsilon$  decides about the geometry around the origin, the same happens with  $x^2 + y^2 = z^2 \pm \varepsilon$ . Indeed, the two conical parts of the double cone meet in a single point, but for  $\varepsilon > 0$ , the resulting hyperboloid consists of a single piece, whereas for  $\varepsilon < 0$ , the resulting hyperboloid is separated into two pieces.

In 1872, Klein already had the idea that such local small changes could be used to understand the global structure of large families. Indeed, when Klein presented his model of the Cayley/Klein cubic surface with four singularities during the meeting at Göttingen in 1872 where Clebsch presented his diagonal surface model, he thought that it should be possible to reach all essential different shapes of cubic surfaces [as classified by Schläfli 1863, see (Labs 2017)] by applying different kinds of small changes near each of the four singularities independently, as published by Klein in 1873. For example, when deforming all four singularities in such a way that they join



**Fig. 10.7** The Cayley/Klein cubic surface with four singularities (left image) was Klein’s starting point to reach all kinds of cubic surfaces with the help of small changes in 1872/73, such as a smooth one with 27 straight lines (right image, Clebsch’s diagonal cubic). Photos from Klein (2016c)

the adjacent parts (thus looking locally like a hyperboloid of one sheet), one obtains a smooth cubic surface with 27 real straight lines—one of the most classical kinds of mathematical models (Fig. 10.7).

As a final remark to this section, note that this idea to deform a curve or a surface locally without increasing its degree does not continue to work for surfaces of higher degrees, because starting from degree 8, it is not always possible to deform each singular point independently. For example, from the existence of a surface of degree 8 with 168 singular points [as constructed by S. Endraß (Labs 2005)], it does not follow that a surface of degree 8 with 167 singularities exists, as D. van Straten computed using computer algebra.

### 10.2.2.2 3D Scanner and Singularities of Surfaces in a Mathematics Seminar for Pre-service Teachers

In a meeting report of the Royal Academy of Sciences of Göttingen of August 3, 1872, it was stated: “Mr. Clebsch presented two models, [...] which refer to a special class of surfaces of the third order. [...] One of the two models represented the 27 lines of this surface, the other the surface itself, a plaster model on which the 27 lines were drawn.” This surface is an example of a so-called cubic surface, defined by all points  $(x, y, z)$  satisfying a polynomial equation of degree three (see Figs. 10.7 and 10.8, top left model).

One main feature of these cubic surfaces is that they are smooth if and only if they contain exactly 27 lines. Singularities appear if the surfaces are varied and the lines become identical. One idea for a current mathematics seminar was to study the small

**Fig. 10.8** Historical collection of models of surfaces of the third degree (cubic surfaces). Photo by Halverscheid (2015)



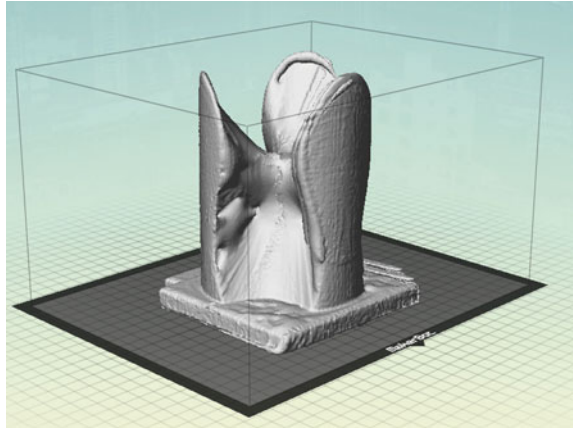
changes in the singularities. Each participant was given one of the singular models with the following task:

1. Produce a 3D scan of one of the models, which results in about 70,000 points describing the area in space.
2. Determine an approximate third-order equation describing the scanned area.
3. Reprint the surface and some variations.
4. Compare them with the original model (Figs. 10.9 and 10.10).

Comparing the reproductions with the original reveals the compromises made by the producers of the original models. These compromises arise because of the accurate visualisation of surfaces as a whole and of the “singularities”. The differences also show some particular difficulties of modeling exact formulae. The reproduction and the original can often be clearly distinguished in the vicinity of singularities.

The approach taken in these seminars mainly follows the intention to use mathematical models in mathematics education (Bartholdi et al. 2016). There are, of course, more refined techniques to create such models with singularities more accurately (see [www.Math-Sculpture.com](http://www.Math-Sculpture.com) by the second author).

**Fig. 10.9** 3D scan of one of the surfaces (step 1). Photo by Halverscheid (2015)



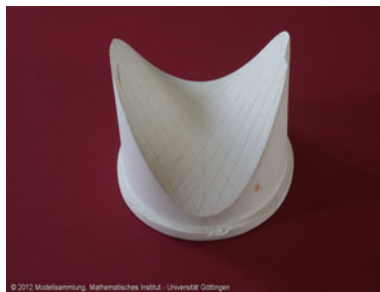
**Fig. 10.10** 3D printout of reproductions and variations of third-order surfaces (step 3). Photo by Halverscheid (2015)



### ***10.2.3 Linking Functional Thinking with Geometry***

As mentioned earlier, Klein stresses the link between functional thinking and geometry. The Meran syllabi defined “education for functional thinking” as an aim, and after World War I, functions indeed became much more prominent in secondary education in Germany. Krüger (2000) describes how “functional thinking” developed historically and how Klein used this term to strengthen mathematics in secondary education. Here, we will briefly mention some aspects appearing frequently in his elementary mathematics book which make clear that Klein had quite a broad understanding of the term “functional thinking”.

**Fig. 10.11** A hyperbolic paraboloid with its two families of straight lines. Retrieved from <http://modellsammlung.uni-goettingen.de/> on 30 May 2017, Georg-August-University Göttingen



**Fig. 10.12** A hyperbolic paraboloid with horizontal plane cuts. Retrieved from <http://modellsammlung.uni-goettingen.de/> on 30 May 2017, Georg-August-University Göttingen



### 10.2.3.1 General Functions in Klein's Elementary Mathematics Book

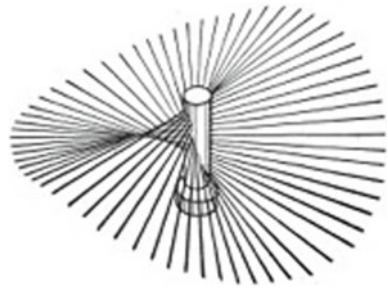
The first two examples in our section on small changes—the implicitly defined curve in Fig. 10.3 and the parabola with parameters in Fig. 10.4—are instances of Klein's view of functional thinking. As always, Klein stresses the fact that one should visualise a function—e.g., the parabola mentioned above—as a graph to obtain a geometric picture together with the abstract formulas. However, he proceeds much further by considering not only functions from  $\mathbb{R}$  to  $\mathbb{R}$  but also plane curves in polar coordinates, families of plane curves, and functions in two variables.

During Klein's time, many universities—including at Göttingen, of course—had a collection of three-dimensional mathematical sculptures illustrating important non-trivial examples for teaching purposes. One of the premier examples of those were certainly the so-called hyperbolic paraboloids, e.g., the figure given by the equation  $z = xy$ . From this equation, one immediately realises that the surface contains two families of straight lines, namely those for fixed values  $x = a$  with equations  $z = ay$  and those for fixed values of  $y = b$  with equations  $z = xb$ . Other models show different cuts of the surface, e.g., horizontal cuts yielding a family of hyperbolas. See Figs. 10.11 and 10.12 for two historical plaster sculptures from the collection of the Mathematics Department at the University of Göttingen.

Notice that the example of the hyperbolic paraboloid is particularly simple. In fact, in his elementary mathematics book, Klein also discusses more pathological cases such as the one given by  $z = \frac{2xy}{x^2+y^2}$ . The function is continuous everywhere, except at the origin  $(x, y) = (0, 0)$ , where it is not even defined. Klein discusses the



**Fig. 10.13** An image from Klein's book illustrating the impossibility of extending some rational function to a continuous one. Klein copied this image from B. St. Ball's book on the theory of screws from 1900



question of whether the function may be defined at this position in such a way that it becomes continuous everywhere. He accompanies his analytic explanations with an illustration (Fig. 10.13), which clearly shows that no unique  $z$ -value can be given for the origin because all points of the vertical  $z$ -axis need to be included into the surface to make it continuous.

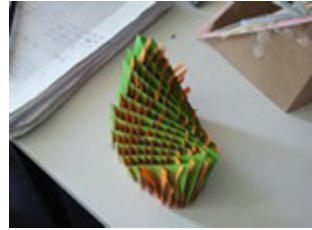
This example illustrates how, in his teaching, Klein tried to explain important aspects both analytically and visually to provide some geometric intuition for the mathematical phenomenon being discussed. He was not afraid of discussing pathological cases and thus often used more involved and more difficult examples in his university teaching to deepen the understanding of certain concepts, such as the example of continuous functions in the case above. Moreover, from the examples above, we see that for Klein, a function is not just a map from  $\mathbb{R}$  to  $\mathbb{R}$ ; rather, it should be seen in a much more general way. Such examples appear frequently in his elementary mathematics book, which shows Klein's belief that these ideas are very important for future school teachers and thus form an essential part of mathematical education.

### 10.2.3.2 General Functions in Today's Teaching

Providing a general concept of functions is easier in today's teaching than it was in Klein's time due to computer visualisations. However, as with around 1900, using hands-on models—built by the students themselves, if possible—is an even better approach in some cases. Here, we want to briefly mention three examples from a seminar for teacher students, for which each session was prepared by one of the students based on at least one mathematical model. The photos in Figs. 10.14, 10.15 and 10.16 shows an interactive hyperbolic paraboloid model constructed from sheets of paper, similarly to 19th century models; an interactive ellipse drawer; and a model illustrating the definition of Bezier curves.

For teaching a more general concept of functions, Bezier curves are a particularly illustrative example: First, these are functions from the interval  $[0; 1]$  to  $\mathbb{R}^2$ ; thus, the image is not a value but a point. Second, each of the points in the image is defined by an iterative construction process. In mathematics, students are used to defining

**Fig. 10.14** A hyperbolic paraboloid, constructed by students using sheets of paper. Photo by Labs (2011)



**Fig. 10.15** Drawing an ellipse in the seminar room. Photo by Labs (2011)



**Fig. 10.16** Students work on understanding the stepwise process of creating Bezier curves. Photo by Labs (2011)



functions by certain formulas. This can also be done in the case of Bezier curves, but in computer-aided design software, internally, it is in fact usually better to use the simple iterative process instead of quite complicated formulas.

### ***10.2.4 The Characterization of Geometries***

The history of an abstract foundation of geometry based just a few axioms goes back to antiquity. Yet, it took over 2000 years for the mathematical community to understand many of the essential problems involved, such as whether the Euclidean parallel axiom may be obtained as a consequence of the other axioms or not. This resulted in a new notion of “geometries” in the 19th century, particularly in different kinds of non-Euclidean geometries.

### 10.2.4.1 The Characterization of Geometries

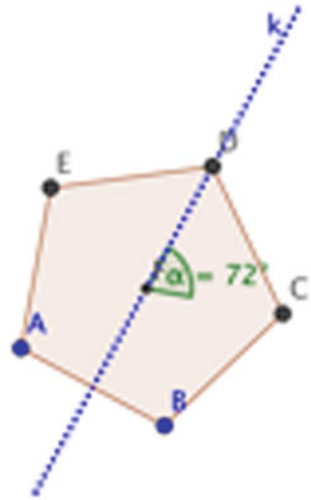
In modern terms, the first Euclidean axioms state that for any two different points, there is a unique, infinite straight line joining them, and that for any two points, there is a circle around one and through the other. The famous antique parallel axiom essentially asserts—in modern terms—that for any straight line and any point, there is a unique line parallel to the given line through the given point. Here, *parallel* means that the two lines have no point in common. In the Euclidean plane, this fact seemed to be unquestionable. Yet, why should this be restricted to the Euclidean plane and to straight lines that look straight? It is possible to find abstract mathematical objects—and even geometric objects in real three-space—that satisfy all Euclidean axioms except the parallel axiom. A quite simple one may be obtained by taking the great circles on a unit sphere as “lines” and pairs of opposite points as “points”. Then, for example, for any two “points” (in fact, a pair of opposite points on the sphere), there is a unique “line” (i.e., a great circle) through those two “points” (lying in the plane through the points and the origin). For the converse, there is a difference from ordinary Euclidean geometry: any two “lines” intersect in a unique “point” (because any two great circles meet at an opposite pair of points), so there are no non-intersecting “lines”, which means that there are no parallel lines. To obtain this kind of geometry in an abstract way, one may simply replace the parallel axiom by a new one asking that for any “line” and any “point”, there is nothing parallel to the “line” through the “point”. The geometry obtained in this way is nowadays called *projective geometry*. Similarly, one obtains a valid geometry by asking that each line has at least two parallels.

Together with Sophus Lie—with whom Klein spent some time in Paris for research in 1870—Klein developed the idea of characterising geometries via the set of transformations leaving certain properties invariant. These transformations form the *group* of the geometry at hand. For example, for the familiar Euclidean plane, these are the translations, rotations, reflections, and compositions of those maps. All of them leave lengths and angles—and thus all shapes—invariant. If one allows more transformations, such as scalings in the plane, then one obtains a new geometry. As scalings are part of this group, the geometry obtained is the so-called affine plane, where lengths and angles may change but parallel lines stay parallel. A projective transformation is even more general: one just forces that lines map to lines so that parallelism is not necessarily preserved by such a transformation. The geometry obtained in this way is the projective geometry mentioned above.

The groups of transformations mentioned so far contain infinitely many elements. However, these groups have interesting finite sub-groups. Nowadays, well-known examples include all transformations leaving certain geometric objects invariant. For example, a regular  $n$ -gon in the plane is left invariant by  $n$  rotations about its center and  $n$  reflections (Fig. 10.17). In space, a regular tetrahedron is left invariant by 24 transformations. To understand and describe all of these geometrically is an interesting exercise.

In the 19th century, mathematicians increasingly realised that groups appear over and over again. For example, the examples with large symmetry groups were of

**Fig. 10.17** The symmetries of regular polygons, rotations and reflections: the case of the pentagon



**Fig. 10.18** A smoothed version of a Kummer surface, created by the second author (photo retrieved from <http://www.math-sculpture.com/> on 5 June, 2017). Each of the 16 singularities has been deformed into a tunnel by a global small change of coefficients



particular interest for geometric objects defined by equations such as Kummer's famous quartic surfaces with 16 singularities. This is one of the reasons why K. Rohn produced the tetrahedral symmetric case as a plaster model in 1877; the modern object by the second author is a smoothed version of it (see Fig. 10.18).



**Fig. 10.19** Model 331, collection of mathematical models and instruments. Retrieved from <http://modellsammlung.uni-goettingen.de/> on 30 May 2017, Georg-August-University Göttingen

#### 10.2.4.2 A Spiral Curriculum on the Geometry of Tilings in a Mathematics Education Seminar

Our seminar concept meets the curricular challenge of using exhibits from past epochs for current curricula: pre-service teachers receive the subject-matter task of planning to one or only models from the third to the twelfth grade and to lead groups of different age levels. This is based on the idea of a spiral organisation of the curriculum; as Jerome Bruner put it, “any subject can be taught to act in some intellectually honest form to any child at any stage of development” (Bruner 1960, p. 33). It would now be a misunderstanding to conclude that the same lessons could be made for all grades. Rather, the intellectually honest form is concerned with the gradual transformation and adaptation of mathematical phenomena at different stages of abstraction.

For this seminar, both objects from the collection of mathematical models and instruments as well as exhibits from the wandering mathematics exhibition “Mathematics for touching” of the mathematics museum “Mathematicum” at Giessen were taken as a basis. All pre-service teachers in the seminar were given an object or group of objects along with the task of developing a theme and workshops for grades 3 through 12, and finally presenting them to small groups of 6 to 15 participants from primary through high school. During the practice, 27 pre-service teachers offered 58 workshops to a total of about 650 participants from schools.

The *collection of mathematical models and instruments* in the Mathematics Institute at Göttingen University is composed of models and machines, some of which are more than 200 years old. Felix Klein, who became responsible for the collection in about 1892, promoted elements of visualisation for teaching mathematics and had a vision to share mathematics with the wider public (Fig. 10.19).

**Fig. 10.20** Participating high school students produce tetrahedra. Photo by Halverscheid (2015)



In the collection are models of tessellations of the three-dimensional Euclidean space. The classification of planar and spatial lattices was intensively investigated in the nineteenth century. In 1835, Hessel worked out the 32 three-dimensional point groups; the works of Frankenheim in 1835 and Rodrigues in 1840 led to the classification of the 14 types of spatial lattices by Bravais in 1851. In 1891, Schoenflies—who wrote his habilitation at Göttingen University in 1884—and Fjedorow described these with the help of group theory. The eighteenth of Hilbert's problems asks whether these results can be generalised: “*Is there in  $n$ -dimensional Euclidean space also only a finite number of essentially different kinds of groups of motions with a fundamental region?*” Bieberbach solved his problem in arbitrary dimensions in 1910.

Schoenflies, who wrote an instructional book on crystallography in 1923, probably designed the models for the tessellations of the Euclidean space himself. One can obtain several reproductions of two of them with the help of 3D printing and can perform this puzzle for tessellations of the Euclidean space. These reproductions were made by the KLEIN-project, whose aim is to reproduce, vary, and use models of the collection for today's mathematics courses at schools and universities.

In relation to the level of abstraction, these questions are addressed already in the primary school. In the three-dimensional case, one can approach the questioning using the first examples—see the task from visualisation to abstraction above, which immediately illuminates that cubes have the property of filling the space, and cuboids also function in this way. The use of parallelepipeds requires more careful consideration. Schoenflies's complete solution of the problem characterises the geometry of grids and is still used today for the systematic description of solids in chemistry and physics. The pre-service teachers arranged different activities on two- to three-dimensional tessellations (Figs. 10.20 and 10.21).

**Fig. 10.21** 3D printouts of Schoenflies's models as duplicates, which enable students to carry out tilings. Photo by Halverscheid (2015)



### 10.3 Klein's Ideas on Visualisation and Today's Resources for the Mathematics Classroom as an Introduction to Research Activities

As the previous section showed, visualisation is prominent within many places in Klein's work and teaching. Content-wise, the four threads discussed are some of the major aspects involved. Regarding actual methods of teaching and learning, however, Klein pleads for activating students by letting them experience some kind of research, based on concrete examples. Indeed, at the beginning of the 1920s, Klein wrote about the beginnings of the collection of models around 1800: "As today, the purpose of the model was not to compensate for the weakness of the view, but to develop a vivid clear perception. This aim was best achieved by those who created models themselves" (Klein 1978, p. 78). Klein seems to express doubts here that the use of models in mathematics will automatically be successful. However, the use of manipulatives was characteristic for an *epoche* in pedagogy, which had an impact on teaching in primary schools instead of in secondary schools (Herbst et al. 2017).

He considered the deep process of creating a mathematical model as a part of teaching-learning processes to be particularly promising. In the quotation from Klein on the "weakness of intuition", one may see skepticism glittering with mere illustrative means consumed in a merely passive way. A mere consideration of the collection of objects, in this respect, would not be without problems and would have to be accompanied by activating formats. In the task orientation of the scientific and mathematical studies, the usage of historic models, computer-aided presentations, and 3D-printed models can be an opportunity for providing tasks with a product-oriented component.

In this way, Klein's quotes show him as a constructivist, with a striking feature of his work being the idea of enabling students to carry out suitable mathematical

operations (Wittmann 1981). At the same time, he considers the “genetic method” an important argument for the confrontation with or the construction of models because they allow an approach to mathematics using several methods: “In particular, applied to the geometry, this means: at school, one would have to provide a link to the vivid, hands-on visualisation and can just slowly move logical elements to the foreground”. He continues: “The genetic method alone will prove to be justified to allow the student slowly to grow up into these things”. As research objects, models address all levels of expertise. Klein seems to warn people not to underestimate methods to approach mathematics in different levels, when he asks, “Is it not just as worthy a task of mathematics to correctly draw as to correctly calculate?” (Klein 1895, p. 540). For him, tools for visualisation are an ongoing mathematical activity at all levels. The selection of the four major threads presented in this article illustrates this via examples from both Klein's own research and his teaching.

## References

- Bartholdi, L., Groth, T., Halverscheid, S., & Samuel, L. (2016). Mathematische Modelle zur Entwicklung und Vernetzung von Modulen in der Lehrerbildung. In C. Weber, et al. (Eds.), *Objekte wissenschaftlicher Sammlungen in der universitären Lehre* (pp. 63–70). Berlin: Humboldt-Universität zu Berlin. <https://edoc.hu-berlin.de/handle/18452/2078>, <https://doi.org/10.18452/1426>.
- Bruner, J. S. (1960). *The process of education*. Cambridge: Harvard University Press.
- Emmermann, L., Groth, T., & Halverscheid, S. (2016). Polytope mit dem 3-D-Drucker herstellen. Räumliches Denken und Operieren mit Koordinaten ab Klasse 7. In *PM: Praxis der Mathematik in der Schule* (Vol. 58, pp. 31–45). ISSN 1617-6960, 0032-7042.
- Hawkins, T. (1984). The erlanger programm of Felix Klein: Reflections on its place in the history of mathematics. *Historia Mathematica*, 11(4), 442–470. [https://doi.org/10.1016/0315-0860\(84\)90028-4](https://doi.org/10.1016/0315-0860(84)90028-4).
- Herbst, P., Fujita, T., Halverscheid, S., & Weiss, P. (2017). *The learning and teaching of geometry in secondary schools: A modeling perspective*. New York: Routledge. ISBN 9780415856911. <https://doi.org/10.4324/9781315267593>.
- Klein, F. (1978). *Vorlesungen über die Entwicklung der Mathematik im 19. Jahrhundert*. Berlin, Heidelberg, New York: Springer.
- Klein, F. (1893). A comparative view of recent researches in geometry (Dr. M. W. Haskell, Trans.). *Bulletin of the New York Mathematical Society*, 2(10), 215–249. <https://doi.org/10.1090/s0002-9904-1893-00147-x>. Available at <http://www.ams.org/journals/bull/1893-02-10/>.
- Klein, F. (1895). Über die Beziehungen der neueren Mathematik zu den Anwendungen. Antrittsrede Universität Leipzig am 25.10.1880. *Zeitschrift für den Mathematisch-naturwissenschaftlichen Unterricht*, 26, 540.
- Klein, F. (2016a). *Elementary mathematics from a higher standpoint: Vol. I. Arithmetic, algebra, analysis*. Berlin: Springer. <https://doi.org/10.1007/978-3-662-49442-4>.
- Klein, F. (2016b). *Elementary mathematics from a higher standpoint: Vol. II. Geometry*. Berlin: Springer. <https://doi.org/10.1007/978-3-662-49445-5>.
- Klein, F. (2016c). *Elementary mathematics from a higher standpoint: Vol. III. Precision mathematics and approximation mathematics*. Berlin: Springer. <https://doi.org/10.1007/978-3-662-49439-4>.
- Krüger, K. (2000). Erziehung zum funktionalen Denken Zur Begriffsgeschichte eines didaktischen Prinzips. *Journal für Mathematik-Didaktik*, 21(3–4), 326–327.



- Labs, O. (2005). *Hypersurfaces with many singularities*. Doctoral dissertation, University of Mainz, Mainz.
- Labs, O. (2017). Straight lines on models of curved surfaces. *Mathematical Intelligencer*, 39(2), 15–26. <https://doi.org/10.1007/s00283-017-9709-y>.
- Rowe, D. E. (1983). A forgotten chapter in the history of Felix Klein's: Erlanger programm. *Historia Mathematica*, 10(4), 448–454.
- Rowe, D. E. (1985). Felix Klein's "Erlanger Antrittsrede": A transcription with English translation and commentary. *Historia Mathematica*, 12(2), 123–141.
- von Dyck, W. (1892). *Katalog mathematischer und mathematisch-physikalischer Modelle, Apparate und Instrumente*. München: Hof- und Universitätsdruckerei von Dr. C. Wolf und Sohn.
- Wittmann, E. (1981). Beziehungen zwischen operativen "Programmen" in Mathematik. Psychologie und Mathematikdidaktik. *Journal für Mathematik-Didaktik*, 2(1), 83–95.

**Open Access** This chapter is licensed under the terms of the Creative Commons Attribution 4.0 International License (<http://creativecommons.org/licenses/by/4.0/>), which permits use, sharing, adaptation, distribution and reproduction in any medium or format, as long as you give appropriate credit to the original author(s) and the source, provide a link to the Creative Commons license and indicate if changes were made.

The images or other third party material in this chapter are included in the chapter's Creative Commons license, unless indicated otherwise in a credit line to the material. If material is not included in the chapter's Creative Commons license and your intended use is not permitted by statutory regulation or exceeds the permitted use, you will need to obtain permission directly from the copyright holder.



# Chapter 11

## The Modernity of the *Meraner Lehrplan* for Teaching Geometry Today in Grades 10–11: Exploiting the Power of Dynamic Geometry Systems



**Maria Flavia Mammana**

**Abstract** In 1905, at the meeting of the Deutschen Mathematiker-Vereinigung in Meran, the “Meraner Lehrplan,” a mathematics syllabus, was proposed. This document, which contains many of Felix Klein’s ideas on teaching geometry in school, proposed approaching geometry via intuitive geometry, which is the ability to see in space, in order to provide elements for both interpreting the real world and developing logical skills (see Treutlein in *Der geometrische anschauungsunterricht als unterstufe eines zweistufigen geometrischen unterrichtes an unseren höheren schulen*. Teubner, Leipzig/Berlin 1911). Klein’s ideas still hold today: An intuitive approach to geometry can be facilitated using information technology. Some activities related to a space geometry approach based on the analogy among figures and on the use of a dynamic geometry system will be presented in this chapter.

**Keywords** Teaching/learning geometry · Dynamic geometry system  
Quadrilaterals · Tetrahedra

### 11.1 Introduction

At the beginning of the 20th century, teaching and pedagogical experience suggested the opportunity to consider—at the school level—intuitive geometry as a preliminary to Euclidean geometry. Proposals for intuitive handling of geometry came from a variety of countries. Felix Klein was one of the major proponents of these ideas.

Klein’s ideas were well represented by the curriculum proposed in 1905 by a special commission at a meeting of scientists in Meran (part of Austria at that time) and then republished by Klein and Schimmak (1907). This document, the *Meraner Lehrplan*, proposed that geometrical teaching begins with the observation of objects of everyday life:

---

M. F. Mammana (✉)

Department of Mathematics and Computer Science, University of Catania, Catania, Italy  
e-mail: fmammana@dmi.unict.it

© The Author(s) 2019

H.-G. Weigand et al. (eds.), *The Legacy of Felix Klein*, ICME-13 Monographs,  
[https://doi.org/10.1007/978-3-319-99386-7\\_11](https://doi.org/10.1007/978-3-319-99386-7_11)

153

Preliminary geometry: Introduction to fundamental ideas of space as it may be observed, in such a way, however, that space appears chiefly as involving plane properties. Dimensions, surface lines, points, explained first in relation to immediate objects and illustrated from widely different bodies. Plane figures as part of the boundaries of bodies, then as independent forms in which the idea of direction, angle, parallelism, symmetry are to be brought out.... (Price 1911, p. 179)

It continues with the study of basic concepts of figures, lines, triangles, and parallelograms and then trapeziums and circles: “Properties of straight lines, angles and triangles; variation of figures in shape and size; ... simple properties of parallelogram deduced from the construction of figures. Extension of the parallelogram properties. The trapezium. Fundamental properties of the circle...” (Price 1911, p. 179). It then follows the theoretical study of the properties of figures, for students of 13–17 years, and the study of solid geometry, including exercises in drawing.

In textbooks that followed this proposal, intuitive geometry is seen as the ability to see into space and will provide items both to interpret the real world and to develop logical skills (Menghini 2010). Illustrating the work of various authors, Fujita et al. (2004) define intuitive geometry as “a skill to see geometrical figures and solids, creating and manipulating them in the mind to solve problems in geometry” (p. 2).

Klein’s ideas still hold today: An intuitive approach to geometry can be facilitated by the use of information technology. Some activities related to the space geometry approach that are based on both the analogy among figures and on the use of dynamic geometry software are presented here.

## 11.2 Teaching Space Geometry in School

Space geometry is part of school curricula but in classrooms it is often relegated to the end of the year and therefore covered superficially at best, if not left out completely. In fact, even though we live in a three-dimensional space, teaching/learning three-dimensional geometry presents difficulties in graphic representation and mental visualization: It is not easy to draw a three-dimensional figure on a plane and it is not easy to imagine the mutual positions of objects in space.

A new and catchy approach to three-dimensional geometry has been realized by means of *analogy*. Analogy is a “sort of similarity among distinct objects. Similar objects agree with each other in some aspect, analogous objects agree in clearly definable relations of their respective parts” (Polya 1957, p. 37). A problem can be solved using the solution of an analogous simpler problem: Use its method, result, or both. In our case, an analogy between quadrilaterals and tetrahedra can be found. In what follows, both results and method that were used to study some properties of quadrilaterals are then traced step by step in facing analogous properties of tetrahedra. The use of this analogy turns out to be very useful because it represents a bridge that creates a significant link between two and three dimensions (Mammana et al. 2012).

The use of dynamic geometry software (DGS) can also help: Cabri Géomètre (Geogebra can also be used) allows us to not only easily build plane and space geo-

metric figures but also to dynamically change them without modifying the properties used in building them. In particular, Cabri 3D, the three-dimensional version of Cabri Géomètre, can be a really useful instrument to overcome problems inherent in the visualization of three-dimensional figures.

The use of a DGS is not, of course, a panacea for all problems in teaching and learning geometry. Moreover, using DGS does not mean that you prove a geometrical problem, but only see that a property might be true. But I agree with Hofstadter's words, related to the use of Geometer's Sketchpad:

The beauty of Geometer's Sketchpad is that it allows you to discover instantly whether a conjecture is right or wrong—if it's wrong, it will be immediately obvious when you play around with a construction dynamically on the screen. If it's right, things will “stay in synch” right on the button no matter how you play with the figure. The degree of certainty and confidence that this gives is downright amazing. It's not a proof, of course, but in some sense, I would argue, this kind of direct contact with the phenomenon is even more convincing than a proof, because you really see it all happening right there before your eyes.... I just am not one who believes that certainty can come only from proofs. (Hofstadter 1997, p. 10)

### 11.3 The Content of the Activity

The content of the activity refers to a paper by Mammana et al. (2009). This paper shows the existence of a surprising analogy between quadrilaterals and tetrahedra, determining some properties that hold for both families of figures. In the following, only some definitions and properties that highlight the existing analogy between the quadrilaterals and tetrahedra are reported.

A quadrilateral  $Q$  is determined by four coplanar points, A, B, C, and D, called vertices, such that any three of them are non-collinear. The vertices determine six segments, AB, BC, CD, DA, AC, and BD, called edges. There are six edges: four sides and two diagonals. We call faces of  $Q$  the triangles determined by three vertices of  $Q$ . Then there are four faces: ABC, BCD, CDA, and DAB (Fig. 11.1). In a similar manner, a tetrahedron  $T$  is determined by four non-coplanar points, A, B, C, and D, called vertices. The vertices determine six segments, AB, BC, CD, DA, AC, and BD, called edges. We call faces of  $T$  the triangles determined by three vertices of  $T$ . There are four faces: ABC, BCD, CDA, and DAB (Fig. 11.1).

From now on we will assume that  $F$  is a quadrilateral or a tetrahedron of vertices A, B, C, and D.

Two edges of  $F$  are said to be opposite if they do not have common vertices. AB and CD, BC and DA, and AC and BD are then opposite edges. A vertex and a face of  $F$  are said to be opposite if the vertex does not belong to the face. For each vertex there is one and only one opposite face. For example, BCD is the opposite face to the vertex A.

A bimedial of  $F$  is the segment joining the midpoints of two opposite edges. Let  $M_1$ ,  $M_2$ ,  $M_3$ ,  $M_4$ ,  $M_5$ , and  $M_6$  be the midpoints of the edges AB, BC, CD, DA, AC, and BD, respectively. Then  $F$  has three bimedians:  $M_1M_3$ ,  $M_2M_4$ , and  $M_5M_6$ .

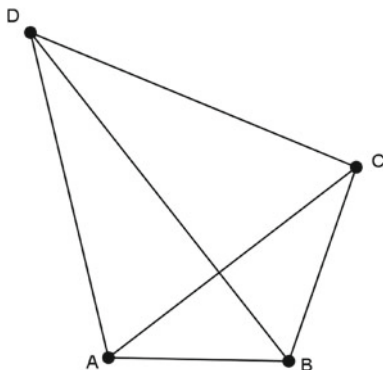


Fig. 11.1 Quadrilateral or tetrahedron

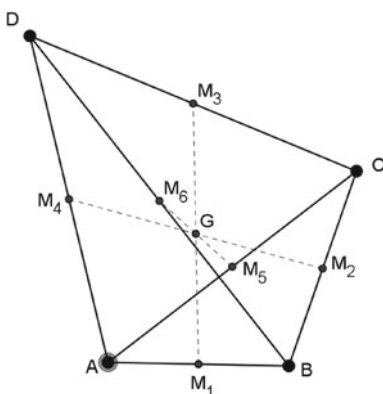


Fig. 11.2 Bimedians and centroid

**Theorem 1** *The three bimedians of a quadrilateral or of a tetrahedron all pass through one point which bisects each bimedian.*

The point G common to the three bimedians of  $F$  is called the centroid of  $F$  (Fig. 11.2).

A median of  $F$  is the segment joining a vertex with the centroid of the opposite face (being the centroid of the opposite face the centroid of the triangle opposite to the vertex). Let  $A'$ ,  $B'$ ,  $C'$ , and  $D'$  be the centroids of the faces opposite to the vertices A, B, C, and D, respectively. Then  $F$  has four medians:  $AA'$ ,  $BB'$ ,  $CC'$ , and  $DD'$ .

**Theorem 2** *The four medians of a quadrilateral or a tetrahedron  $F$  meet in its centroid, which divides each median in the ratio 1:3, the longer segment being on the side of the vertex of  $F$  (Commandino's theorem; see Fig. 11.3).*

A maltitude of a quadrilateral  $F$ , relative to an edge, is the line of the plane containing  $F$  that is perpendicular to the edge and passes through the midpoint of the opposite edge. Then  $F$  has six maltitudes.

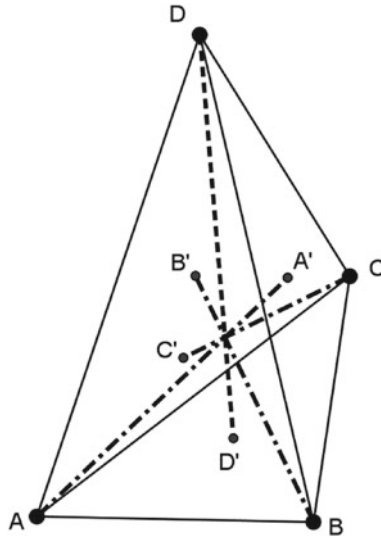


Fig. 11.3 Medians

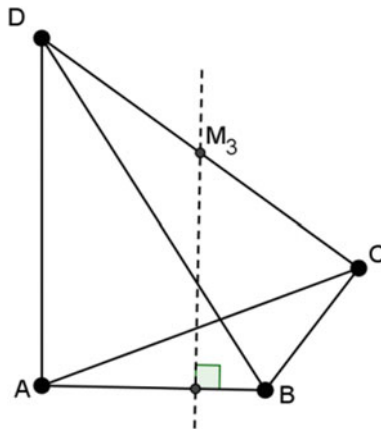


Fig. 11.4 Maltitude

The Monge plane of a tetrahedron  $F$ , relative to an edge, is the plane perpendicular to the edge passing through the midpoint of the opposite edge. Then  $F$  has six Monge planes.

**Theorem 3** *The maltitudes of a cyclic quadrilateral are concurrent. The Monge planes of a tetrahedron are concurrent (see Fig. 11.4).*

The analogy of the definitions and properties is summarized in the following table.

Quadrilaterals	Tetrahedra
<p><math>Q</math> is a convex quadrilateral with vertices A, B, C, D                      The points A, B, C, D are such that any three of them are non-collinear                      The vertices detect six segments AB, BC, CD, DA, AC, BD that are called edges. The edges of <math>Q</math> are the four sides and the two diagonals                      Two edges are said to be opposite if they do not have common vertices                      We call faces of <math>Q</math> the triangles determined by three vertices of <math>Q</math>                      A vertex and a face are said to be opposite if the vertex does not belong to the face. For each vertex there is one and only one opposite face</p>	<p><math>T</math> is a tetrahedron with vertices A, B, C, D                      The points A, B, C, D are non-coplanar                      The vertices detect six segments AB, BC, CD, DA, AC, BD that are called edges                      Two edges are said to be opposite if they do not have common vertices                      We call faces of <math>T</math> the triangles determined by three vertices of <math>T</math>                      A vertex and a face are said to be opposite if the vertex does not belong to the face. For each vertex there is one and only one opposite face</p>
<p>The segment joining the midpoints of two opposite edges of <math>Q</math> is called bimedial of <math>Q</math>  <math>Q</math> has three bimedians, two relative to a pair of opposite sides and one relative to the diagonals  <i>Theorem 1. The three bimedians of a quadrilateral all pass through one point which bisects each bimedian</i>                      The point G common to the three bimedians of <math>Q</math> is called centroid of <math>Q</math></p>	<p>The segment joining the midpoints of two opposite edges of <math>T</math> is called bimedian of <math>T</math>. <math>T</math> has three bimedians  <i>Theorem 1. The three bimedians of a tetrahedron all pass through one point which bisects each bimedian</i>                      The point G common to the three bimedians of <math>T</math> is called centroid of <math>T</math></p>
<p>The segment joining a vertex of <math>Q</math> with the centroid of the opposite face is called median of <math>Q</math>. <math>Q</math> has four medians  <i>Theorem 2. The four medians of a quadrilateral meet in its centroid, which divides each median in the ratio 1:3, the longer segment being on the side of the vertex of <math>Q</math></i></p>	<p>The segment joining a vertex of <math>T</math> with the centroid of the opposite face is called median of <math>T</math>. <math>T</math> has four medians  <i>Theorem 2. The four medians of a tetrahedron meet in its centroid, which divides each median in the ratio 1:3, the longer segment being on the side of the vertex of <math>T</math>. (Commandino's Theorem)</i></p>
<p>The line that is perpendicular to an edge of a quadrilateral <math>Q</math> and passes through the midpoint of the opposite edge is called maltitude of <math>Q</math>. <math>Q</math> has six maltitudes  <i>Theorem 7. The maltitudes of a cyclic quadrilateral are concurrent</i>                      The common point to the six maltitudes of a cyclic quadrilateral <math>Q</math> is called anticenter of <math>Q</math></p>	<p>The plane that is perpendicular to an edge of a tetrahedron <math>T</math> and passes through the midpoint of the opposite edge is called Monge plane of <math>T</math>. <math>T</math> has six Monge planes  <i>Theorem 7. The Monge planes of a tetrahedron are concurrent. (Monge Theorem)</i>                      The common point to the six Monge planes of a tetrahedron <math>T</math> is called Monge point of <math>T</math></p>

The statements and the proofs of the theorems are the same for both families of figures. The propositions presented are simple and easy to prove, so they can be easily used by teachers. The analogy between known plane figures, quadrilaterals, and figures that students do not usually study much, tetrahedra, allows the teacher to develop a stimulating activity in three-dimensional geometry. The analogy between quadrilaterals and tetrahedra offers an opportunity to develop geometry in two and three dimensions in parallel (Mammana et al. 2009).

## 11.4 Activities

The results contained in Mammana et al. (2009) have been successfully used in several activities that have been carried out in the first two years of high school, promoting an introduction of three-dimensional geometry and visualization (Mammana and Pennisi 2010; Mammana et al. 2012; Ferrara and Mammana 2013, 2014). The educational rationale of the activities was to have students experience 3D geometry in order to enhance their sense of self-efficacy, help them reach an accurate vision of the discipline, and experience positive emotional stimulation by fostering the students' positive attitude towards space geometry.

Usually, the activity starts by studying quadrilaterals, already familiar to the students, and then it continues by studying tetrahedra, using the numerous analogies with quadrilaterals. Thus, space geometry is less difficult because students are faced with 3D problems after having already become familiar with the solution of an analogous problem in the plane. The teaching/learning strategy that was used followed the scheme:

- Explore and verify using Cabri
- Conjecture
- Prove

This is done, for example, by observing and exploring a figure, perceiving the relations between objects, manipulating the figure, and experimentally verifying the hypothesis. Once the hypotheses are confirmed, a conjecture is formulated and finally proved.

During the whole activity, students usually work in pairs and on two computers: One computer is used to work on plane figures, the other to work on space figures. The whole activity is supported by worksheets that have been designed for this purpose: For each 2D worksheet there is a 3D worksheet. In this way there is an immediate correlation between the plane figures and space figures involved in the study. An example of a worksheet can be found in Mammana and Pennisi (2010).

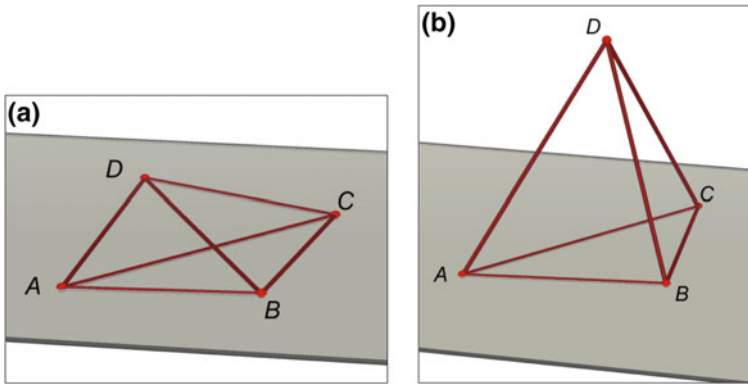
The passage from plane to space is done by means of a specific Cabri 3D tool, the “redefinition” tool. This is the key to the activity that, from a teaching point of view, makes the analogy work.

In Cabri 3D, given a quadrilateral with its diagonals (Fig. 11.5a), it is possible to use the redefinition tool to redefine a point, for example D out of the plane of ABC (Fig. 11.5b). In this way, the quadrilateral becomes a tetrahedron, the vertices of the quadrilateral become the vertices of the tetrahedron, and the edges of the quadrilateral become the edges of the tetrahedron.

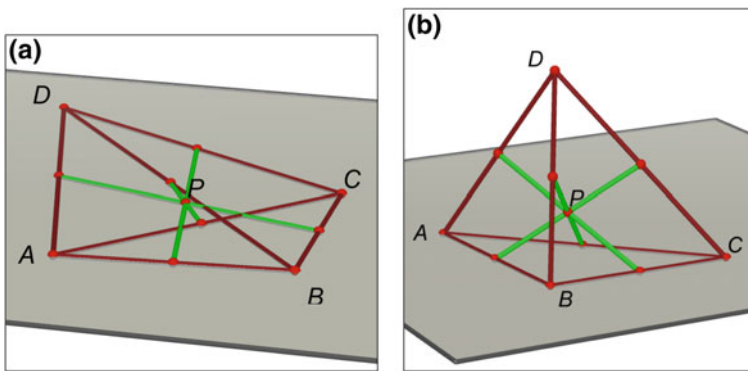
With the redefinition tool we can move from plane to space when investigating for bimedians (Fig. 11.6a, b) and medians (Fig. 11.7a, b). Once the tetrahedron is built it is possible to see it from all sides by activating the “glass ball” function. This action allows the students to change their point of view in order to see the figure from different perspectives.

The whole activity can be carried out in a mathematics laboratory:





**Fig. 11.5** a Quadrilateral. b Tetrahedron



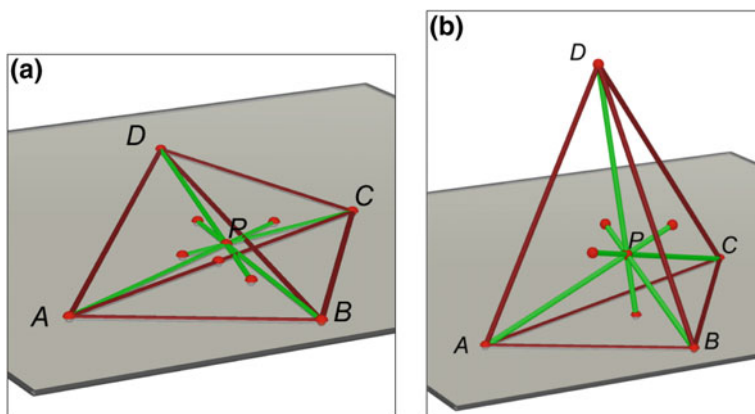
**Fig. 11.6** a Bimedians of a quadrilateral. b Bimedians of a tetrahedron

We can imagine the laboratory environment as a Renaissance workshop in which the apprentices learned by doing, seeing, imitating, and communicating with each other, in a word: practicing. In the laboratory activities, the construction of meanings is strictly bound, on one hand, to the use of tools, and on the other, to the interactions between people working together ... [and] to the communication and sharing of knowledge in the classroom, either working in small groups in a collaborative and cooperative way, or by using the methodological instrument of the mathematic discussion, conveniently lead by the teacher. (Anichini et al. 2004; own translation).

A math teaching laboratory, then, is intended as

a phenomenological space to teach and learn mathematics developed by means of specific technological tools and structured negotiation processes in which math knowledge is subjected to a new representative, operative, and social order to again become the object of investigation and be efficaciously taught and learnt. (Chiappini 2007; own translation)

The mathematics laboratory is not just the use of a computer (or two computers, since the students work in pairs). Rather, it is an activity for the classroom that has



**Fig. 11.7** **a** Medians of a quadrilateral. **b** Medians of a tetrahedron

been deeply thought through and structured by the teacher. The teacher, together with the students, the topic, and the structured activity are the main actors of the mathematics laboratory.

## 11.5 Conclusions

In an activity like the one that is proposed here, the following are crucial:

- The analogy between figures, an analogy that holds both in properties and in proofs, in the sense of the Meraner plan: “Geometry. Similarity, with special stress on similar situation.”
- The use of technology that helps in drawing the figure, in discovering properties (with the dragging mode or the redefinition tool), and in seeing the figure (with the glass ball), in the sense of the Meraner plan: “Ideas of space as it may be observed.”

Among teachers and students, spatial geometry has a general reputation for being difficult because it is difficult to *see*. Seeing in 3D geometry is, especially at a school level, very important. Euclidean geometry also allows us to interpret the space we live in: Seeing mathematics in everyday life is very crucial. We need to adjust our eye to what we have right in front of us. For example, as recently as June 2012, a 17-year-old student taking pictures during an excursion with her classmates near Syracuse in Sicily noted that there was a face in the rock she was taking a picture of (Fig. 11.8): “A simple click can bring out prodigious things that sometimes may escape the naked eye” (Ferrara and Mammana 2013).

So, I ask you, reader, what do you see in the famous Kandinsky painting *Squares with Concentric Circles* (Fig. 11.9)?



**Fig. 11.8** Face in the rock



**Fig. 11.9** Squares with concentric circles

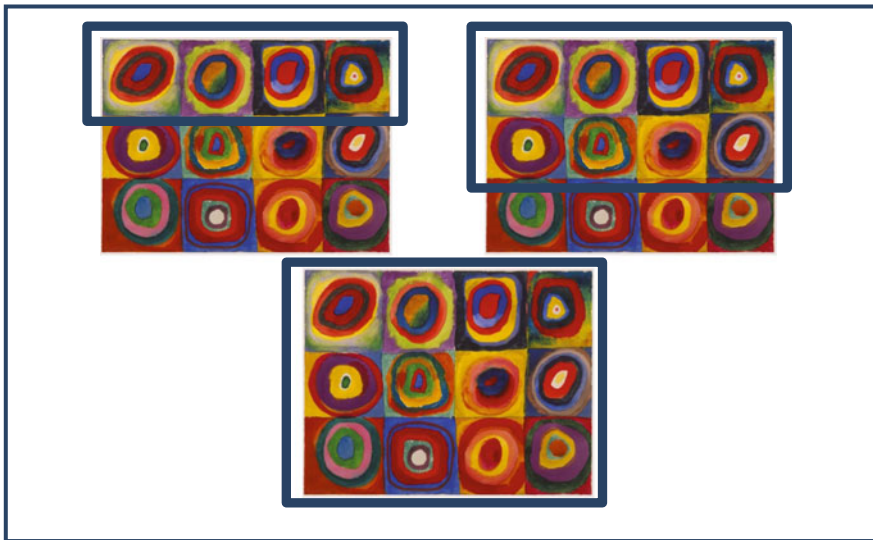
Maria Roberta, a seven-year-old second grader saw in the Kandinsky painting an axial symmetry (Fig. 11.10) and, even more, multiples of four (Fig. 11.11) and multiples of three (Fig. 11.12).

Maria Roberta, in her homework assignment on finding 3D geometrical objects in the kitchen, brought to school a salt container (a cylinder), sugar crystals (a sphere), a Toblerone box (a prism), and she carried everything in doll luggage (a parallelepiped).

The geometry activity presented here helps students approach 3D geometry: It involves manipulative activities (with digital technologies) in order to get an intuitive

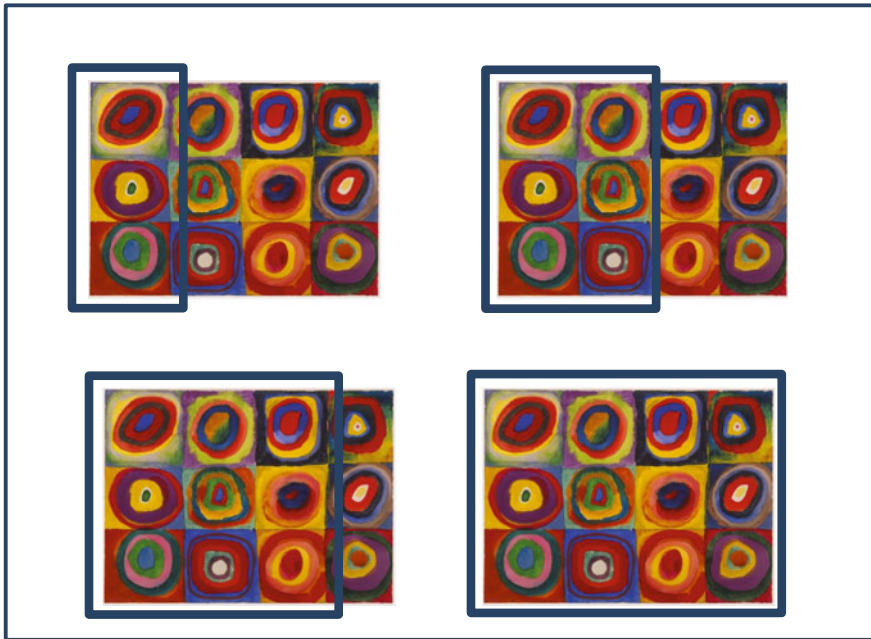


**Fig. 11.10** Axial symmetry



**Fig. 11.11** Multiples of four

knowledge of the properties that will be then formalized. The whole process relies on “similarity, with special stress on similar situation” (Klein and Schimmak 1907) and developing the attitudes of “seeing objects.” Training the eye to explore can be done not only in a dynamic geometry environment, but also at an early stage by



**Fig. 11.12** Multiples of three

observing carefully what surrounds us (see Maria Roberta’s activities that took her to see mathematics even in a painting!).

Let’s help our students to see!

## References

- Anichini, G., Arzarello, F., Ciarrapico, L., et al. (Eds.). (2004). *Matematica 2003. (Mathematics 2003)*. Lucca: Matteoni stampatore.
- Chiappini, G. (2007). Il laboratorio didattico di matematica: Riferimenti teorici per la sua costruzione. [The didactical laboratory of mathematics: Theoretical references about its construction]. *Innovazione educativa*, 8, 9–12.
- Ferrara, F., & Mammana, M. (2013). Close your eyes and see ... An approach to spatial geometry. In B. Ubuz, Ç. Haser, & M. A. Mariotti (Eds.), *Proceedings of the Eighteenth Congress of the European Society for Research in Mathematics Education* (pp. 625–634). Antalya (Turkey): Middle East Technical University.
- Ferrara, F., & Mammana, M. (2014). Seeing in space is difficult: An approach to 3D geometry through a DGE. In P. Liljedahl, C. Nicol, S. Oesterle, & D. Allan (Eds.), *Proceedings of the Joint Meeting of PME 38 and PME-NA 36* (Vol. 3, pp. 57–64). Vancouver, Canada: PME.
- Fujita, T., Jones, K., & Yamamoto, S. (2004). *The role of intuition in geometry education: Learning from the teaching practice in the early 20th century*. Paper presented to Topic Study Group 29

- (TSG29) at the 10th International Congress on Mathematical Education. Copenhagen, Denmark, July 4–11, 2004.
- Hofstadter, D. R. (1997). Discovery and dissection of a geometric gem. In J. King & D. Schattschneider (Eds.), *Geometry turned on! Dynamic software in learning, teaching, and research*. Washington (pp. 3–14). Washington, D.C.: The Mathematical Association of America.
- Klein, F., & Schimmak, R. (1907). Der Meraner Lehrplan für Mathematik. In F. Klein (Ed.), *Vorträge über den mathematischen Unterricht an den höheren Schulen. Bearbeitet von Rudolf Schimmack. Teil 1: Von der Organisation des mathematischen Unterrichts* (pp. 208–220). Leipzig: Teubner.
- Mammana, M., Micale, B., & Pennisi, M. (2009). Quadrilaterals and tetrahedra. *International Journal of Mathematical Education in Science and Technology*, 40(6), 817–828.
- Mammana, M., Micale, B., & Pennisi, M. (2012). Analogy and dynamic geometry system used to introduce three-dimensional geometry. *International Journal of Mathematical Education in Science and Technology*, 43(6), 818–830.
- Mammana, M., & Pennisi, M. (2010). Dragging quadrilaterals into tetrahedra. In W.-C. Yang, M. Majewski, T. de Alwis, & W. P. Hew (Eds.), *Proceedings of the 15th Asian Technology Conference in Mathematics* (pp. 373–384). Blacksburg, VA: Mathematics and Technology.
- Menghini, M. (2010). La geometria intuitiva nella scuola media italiana del '900. [Intuitive geometry in the Italian middle school at 1900]. *La Matematica nella Società e nella Cultura. Rivista dell'Unione Matematica Italiana*, I(III), 399–429.
- Polya, G. (1957). *How to solve it*. Princeton, NJ: Princeton University Press.
- Price, E. (1911). The “Meraner Lehrplan.” mathematical curriculum for gymnasia. *The Mathematical Gazette*, 6(95), 179–181.
- Treutlein, P. (1911). *Der geometrische anschauungsunterricht als unterstufe eines zweistufigen geometrischen unterrichtes an unseren höheren schulen*. Leipzig/Berlin: Teubner.

**Open Access** This chapter is licensed under the terms of the Creative Commons Attribution 4.0 International License (<http://creativecommons.org/licenses/by/4.0/>), which permits use, sharing, adaptation, distribution and reproduction in any medium or format, as long as you give appropriate credit to the original author(s) and the source, provide a link to the Creative Commons license and indicate if changes were made.

The images or other third party material in this chapter are included in the chapter's Creative Commons license, unless indicated otherwise in a credit line to the material. If material is not included in the chapter's Creative Commons license and your intended use is not permitted by statutory regulation or exceeds the permitted use, you will need to obtain permission directly from the copyright holder.



# Part IV

## Elementary Mathematics from a Higher Standpoint—Conception, Realization, and Impact on Teacher Education

Marta Menghini and Gert Schubring

Part IV is concerned with Klein's three volumes on *Elementary Mathematics from a Higher Standpoint* (*Elementarmathematik vom höheren Standpunkte aus*). These lecture notes from the early twentieth century were a seminal contribution to mathematics teacher education, presenting a methodological orientation, not just a content-oriented course. They became a model for many later approaches.

### *From Hand-written Notes to a Bestseller*

Klein's first volume originated from a two-semester lecture course, given in 1907-08-09. It was published as a *Nachschrift* of notes taken by experienced students and revised by the professor. In Klein's adaptation of this practice, a great number of lithographic copies could be distributed by the publisher Teubner in Commission: not typeset, but handwritten. Right at the beginning of volume I, one can find the famous quote about double discontinuity (see contribution by Kilpatrick). Volume II, on *Geometry*, was distributed in 1909 in the same manner. What became later volume III had originally, in 1901, been a separate lecture course on application of differential and integral calculus to geometry.

After the publication of the third, complete and revised edition of the *Elementarmathematik* from 1924 to 1928, now in regular book format, the German series became a bestseller, was often reprinted, and translated into many languages; the shortcomings, faults, and omissions of the hitherto dominant English translation of 1932 and 1939 are superseded now by the new and complete translation of all the three volumes, published in 2016. Indeed, all translations had so far excluded Volume III. The only complete translation has been the Chinese one, published in the People's Republic in 1989 and reprinted in the Republic of China in 1996.

### *Contributions to part IV*

Gert Schubring analyzes Klein's new establishment of the word *elementary*: not in its everyday meaning of "simple," but as the outcome of a process of "elementarization" of complex developments in mathematics. Klein does not propose to treat



the latest scientific results; rather, he allows proper choices according to criteria of the school system, yielding a certain “hysteresis” behind the recent, not yet elementarized state.

Through examples from Volume III, *Precision and Approximation Mathematics*, Marta Menghini shows how the relation between applied and pure mathematics was of utmost concern for Klein. Starting from an intuitive or practical approach, Klein develops abstract concepts working in rich “mathematical environments”; e.g., circular inversion is introduced in physics then creating point sets with particular properties.

Klein’s mathematical, historical and didactical perspective is illustrated by Henrike Allmendinger looking at the chapter on logarithmic and exponential functions from Klein’s Volume I, *Arithmetic, Algebra, and Analysis*. Klein discusses the customary approach to logarithms in school, presenting an alternative way led by the historical development.

Jeremy Kilpatrick shows how, in the three volumes, Klein was able to relate problems in the main branches of mathematics to problems of school mathematics, thus facing a central problem in the preparation of mathematics teachers: a double discontinuity in going from school to university and then back to school, to teach.

# Chapter 12

## Klein's Conception of 'Elementary Mathematics from a Higher Standpoint'



Gert Schubring

**Abstract** This chapter studies Klein's conception of elementarisation; it is first put into the context of other approaches for mathematics teacher education in Germany. Then, approaches in mathematics education and in history of education to conceive of the relation between academic knowledge and school disciplines are discussed. The wrong translation of Klein's German term "höher" in the long time prevailing American translation is commented on, in preparation for the analysis of the concept of "element" in the history of science. Klein's practice and his introduction of the term "hysteresis" to emphasise the independence of school mathematics are discussed. The last section reflects the consequences of the hysteresis notion for integrating recent scientific advances into school curricula.

**Keywords** Felix klein · Elementarisation · Elements · Apollonius · d'Alembert  
Hysteresis · Set theory

### 12.1 Introduction

My main issue here is the notion of elementarisation. There is a widespread misunderstanding to conceive of this term within connotations like "simple", merely a didactical category as the exact opposite to scientific and academic knowledge. For Klein, however, these are completely misleading connotations; rather, deep philosophical and epistemological meanings are revealed to be implied.

---

G. Schubring (✉)  
Universität Bielefeld, Bielefeld, Germany  
e-mail: gert.schubring@uni-bielefeld.de

G. Schubring  
Universidade Federal Do Rio de Janeiro, Rio de Janeiro, Brazil

© The Author(s) 2019  
H.-G. Weigand et al. (eds.), *The Legacy of Felix Klein*, ICME-13 Monographs,  
[https://doi.org/10.1007/978-3-319-99386-7\\_12](https://doi.org/10.1007/978-3-319-99386-7_12)

## 12.2 A Differing View of Elementary Mathematics

Actually, the term “elementary mathematics” was not new in Klein’s times; there existed a well-known publication for mathematics teachers and mathematics students—likewise in three volumes—that used this term and Klein expressed his profound disagreement with this work. It was the *Encyclopaedia of Elementary Mathematics*, published from 1903 with various re-editions, by Heinrich Weber and Josef Wellstein, both mathematics professors at the University of Straßburg.

As Klein pointed out, the Weber-Wellstein Encyclopaedia gave a systematic presentation of the various parts relevant to the school curriculum (Klein 2016a, b, third preface) whereas he was highlighting those issues that deserved methodological comments. More importantly, Klein criticised that ‘elementary’ meant for them “fundamental for higher mathematics” (see on Epstein’s 4th revised edition 1922: Klein 2016a, b, 300). And, that as a consequence, Weber-Wellstein did not address the relevance for teaching in schools:

Thus, we find in his book detailed and abstract discussions of the concept of number, limit concept, number theoretic issues, etc., while the elements of calculus remain disregarded, although the author supports their teaching in schools. (ibid., p. 300)

And Klein criticised that they did not reflect the pedagogical dimension of teaching, neglecting in particular Klein’s plea for intuitive approaches (p. 33):

I shall indicate at once certain differences between this work and the plan of my lecture course. In Weber-Wellstein, the entire structure of elementary mathematics is built up systematically and logically in the mature language accessible to the advanced student. No account is taken of how these things actually may come up in school teaching. The presentation in the schools, however, should be *psychological* – to use a ‘catch word’ – and not *systematic*. (ibid., p. 4)

Even worse, Weber-Wellstein did not follow Klein’s conception of elementarisation by reconstructing school mathematics via the function concept:

- Another difference between Weber-Wellstein and myself has to do with *delimiting the content of school mathematics*. Weber and Wellstein are disposed to be “*conservative*”, while I am “*progressive*”. [...] We, who use to be called the “*reformers*”, would put the *function concept* at the very centre of teaching, because, of all the concepts of the mathematics of the past two centuries, this one plays the leading role wherever mathematical thought is used.
- As opposed to these comparatively recent ideas, Weber-Wellstein adhere essentially to the traditional limitations of the subject matter. In this lecture course I shall of course be a protagonist of the new conception (ibid., pp. 4–5).

### 12.3 Differing Views of the Relation Between Academic Mathematics and School Mathematics

In fact, the basic epistemological issue implied by the concept of elementarisation is the relation between school mathematics and academic mathematics. This relation is far from being evident or easily resolvable. This is documented by two extreme recent positions in mathematics education and history of education about this relation. Both poles are represented by French researchers: Yves Chevallard and André Chervel.

Chevallard's conception of *transposition didactique* is well known: the conception of the didactic transposition proposes to examine how academic knowledge of mathematics ("savoir savant") becomes school mathematical knowledge. For this, the concept distinguishes three types of knowledge:

- "Objet de savoir"—subject of knowledge;
- "Objet d'enseigner"—subject to be taught: the academic knowledge becomes teachable knowledge by the efforts of mathematics educators (their community being called "noosphère");
- "Objet d'enseignement"—teaching subject (Chevallard 1985, 39).

As has been criticized by several researchers, the explanation offered by the transposition notion conceives of a unilateral process: it has as its starting point a pole designed as advanced, the academic or university knowledge and as its final point another pole inferior to it, made at school and involving the teacher in the classroom.

The other extreme is represented by the research area *history of school disciplines*. In fact, researchers of this area typically work on subjects such as literature, the humanities, the native language, history and geography, religion, and even philosophy. Thus, the focus of their approach is the socializing function of school and hence, in particular, of school disciplines. The school culture and school subjects are thus characterized by autonomies: it is believed that school disciplines enjoy autonomy with respect to the other disciplines (Chervel 1988, 73), while the example of mathematics shows that the set of all disciplines influence strongly the status, the level and the views of school mathematics (Schubring 2005). Moreover, Chervel emphasises the generative nature of the school, which results in creating, due to its character understood as relatively autonomous, school disciplines (see Vinao 2008).

### 12.4 Implications of the Term "Advanced"

Kilpatrick had emphasised in his lecture at ICME-11, 2008, in Mexico that the term "advanced" used by the American translators in the title is profoundly misleading and does not correspond to Klein's conceptions of elementarisation (Kilpatrick 2008). In fact, the term "advanced" corresponds best to Chevallard's conception of *transposition*.

The term “advanced” implies a fundamental misunderstanding of Klein’s notion of *elementary* and of *Elementarmathematik*. The term “advanced” means that elementary mathematics is somewhat delayed, being of another nature. It means exactly the contrary of what Klein was intending. By contrasting two poles, ‘elementary’ versus ‘advanced’, one would admit just that discontinuity between school mathematics and academic mathematics that Klein wanted to eliminate.

For Klein, there was no separation between elementary mathematics and academic mathematics. His conception for training teachers in higher education departed from a holistic vision of mathematics: mathematics, steadily developing and reforming itself within this process, leading to ever new restructured elements, and provides therefore new accesses to the elements. There is a widespread understanding of the term “elementary” as meaning it something ‘simple’ and not loaded with a conceptual dimension—perhaps even approaching ‘trivial’. Connected, in contrast, with the notion of element, ‘elementary’ means for Klein to unravel the fundamental conception. What is at stake, hence, is the concept of *elements*.

## 12.5 The Concept of Elements

Beyond mere factual information, with his lecture notes Klein led the students to gain a more comprehensive and methodological point of view on school mathematics. The three volumes thus enable us to understand Klein’s far-reaching conception of *elementarisation*, of the “elementary from a higher standpoint”, in its implementation for school mathematics: the elements are understood as the fundamental concepts of mathematics, as related to the whole of mathematics and according to its restructured architecture.

Clearly, Klein was not the first to reflect about the concept of elements. It is in particular in mathematics that one finds reflections about its meaning and its use. This strand of reasoning was brought about by the very title of Euclid’s paradigmatic geometry textbook. The analysis of a masterpiece of Hellenistic mathematics has also given rise to a revealing discussion of “elements” with regard to compendium, encyclopaedia and textbook: Fried and Unguru, in the introduction to their new edition of the *Conica* by Apollonius of Perga, discuss the division made by Apollonius himself in his presentation of his work to the mathematician Eudemos “regarding the contents of the **Conica**, namely, that the first four books ‘belong to a course in the elements,’ while the latter four ‘are fuller in treatment’” (Fried et al. 2001, p. 58). They understand Apollonius’ comments as implying that an “elementary treatment” did not mean for him rather trivial parts, which can be omitted, but instead essential conceptual expositions (ibid.). To approach Apollonius’s meaning of “elementary”, they refer to the analyses by historians of mathematics of the difference between the first four books of the *Conica* and the further books. They refer in particular to Heath who had published in 1896 an edition of Apollonius’ *Conica*:

According to Heath, the elementary nature of the first four books distinguishes them from the rest by the “fact that the former contain a connected and scientific exposition of the general theory of conic sections as the indispensable basis for further extensions of the subject in certain special directions, while the fifth book is an instance of such specialization...”. Heath also calls the first four books a “text-book or compendium of conic sections,” and the last four books “a series of monographs on special portions of the subject.” (ibid., pp. 58–59)<sup>1</sup>

And they largely agree with Gerald Toomer in his entry “Apollonius of Perga” in the *Dictionary of Scientific Biography*:

Toomer adopts the same kind of image when he writes, “[Apollonius’] aim was not to compile an encyclopedia of all possible theorems on conic sections, but to write a systematic textbook on the ‘elements’ and to add some more advanced theory which he happened to have elaborated.” (ibid., p. 59)

Fried and Unguru agree in particular with the distinction of “elements” from an encyclopedia but disagree with Heath’s assessment as a compendium. They insist on the *systematic* character of exposition and on the *connected and scientific exposition as indispensable basis* for refinements and extensions.

In Modern Times, probably the most profound reflection on the concept of elements has been undertaken in the wake of Enlightenment, among the first approaches to making science generally accessible.<sup>2</sup> It was Jean le Rond d’Alembert (1717–1783) who conceptualized what he called to “elementarise” the sciences. It was his seminal and extensive entry “éléments des sciences” in the *Encyclopédie*, the key work of the Enlightenment, where he gave this analysis of and reflection on how to elementarise a science, that is how to connect the elements with the whole of that science. This procedure is to be able to identify the elements of a science, or in other words, rebuild in a new coherent way all parts of a science that may have accumulated independently and not methodically:

“On appelle en général élémens d’un tout, les parties *primitives & originaires* dont on peut supposer que ce tout est formé”. (d’Alembert 1755, 491 e)<sup>3</sup>

In this sense, there is no qualitative difference between the elementary parts and the higher parts. The elements are considered as the “germs” of the higher parts:

“Ces propositions réunies en un corps, formeront, à proprement parler, les élémens de la science, puisque ces *éléments* seront comme un germe qu’il suffiroit de développer pour connoître les objets de la science fort en détail”. (d’Alembert 1755, 491 d)<sup>4</sup>

<sup>1</sup>Quotes from ibid, p. lxxvi and lxxvi–lxxvii.

<sup>2</sup>Alain Trouvé has studied contributions to the notion of element by philosophers, scientists and pedagogues, since Antiquity until the early 19th century (Trouvé 2008). Essentially, it is a documentation of positions taken, without a deeper analysis. Trouvé understood “élémenter” in the traditional sense, as “simplifying the contents of teaching”, a first form of what would later be called “transposition didactique” (ibid., p. 93).

<sup>3</sup>In general, one calls elements of a whole the primitive and original parts, of which one might suppose that this whole is formed.

<sup>4</sup>These propositions, united in one body, will properly constitute the elements of science, since these *elements* will be like a germ, which it would be sufficient to develop in order to know the objects of science in great detail.

An extensive part of the entry is dedicated to the reflection on elementary books—*livres élémentaires*, such as schoolbooks, which are essential, on the one hand, to disseminate the sciences and, on the other, to make progress in the sciences, that is, to obtain new truths. In his reflection on elementary books, d’Alembert emphasised another aspect of great importance regarding the relationship between the elementary and the higher: he underlined that the key issue for the composition of good elementary books consists in investigating the “metaphysics” of propositions—or in terms of today, the epistemology of science.

In the first phase of the French Revolution, the composition and publication of *livres élémentaires* constituted a key issue of the concerns for building a new society. The elaboration of *livres élémentaires* was conceived of as essential for instituting the new system of public education; practically the first measure for this task was to organise a *concours* for composing these textbooks (Schubring 1984, pp. 363 f.; Schubring 1988).<sup>5</sup> It is highly characteristic that in the later Napoleonic period the emphasis on *livres élémentaires* was replaced by a policy of creating *livres classiques*, focussing on the humanities (Schubring 1984, p. 371).

## 12.6 Klein’s Practice

In fact, Klein’s work can be understood exactly as providing an epistemological, or methodological access to mathematics as analysed and propagated by d’Alembert. It was not to provide factual knowledge—Klein presupposed it to have already been studied:

I shall by no means address myself to beginners, but I shall take for granted that you are all acquainted with the main features of the most important disciplines of mathematics. (Klein 2016a, b, p. 1 ff.)

Whereas he outlined as his goal:

And it is precisely in such summarising lecture courses as I am about to deliver to you that I see one of the most important tools. (ibid., p. 1)

Indeed, Klein explicitly exposed the epistemological aspect of his work: explaining the connections, in particular the connections between sub-disciplines, which normally are treated separately, and pointing out the links of particular mathematical issues and questions with a synthetic view of the whole of mathematics. Thus, future teachers would achieve to deepening of their understanding of the basic concepts of mathematics and appreciate the nature of mathematical concepts:

My task will always be to show you the *mutual connection between problems in the various disciplines*, these connections use not to be sufficiently considered in the specialised lecture

---

<sup>5</sup>Recently, Barbin has proposed a seemingly related notion: *élémentation*. It means, according to her, “the process by which a science is organized in view of its presentation or its teaching, and especially in the case of the writing of a textbook” (Barbin 2015, p. 41). This notion is rather near to transposition.

courses, and I want more especially to emphasize the relation of these problems to those of school mathematics. In this way, I hope to make it easier for you to acquire that ability which I look upon as the real goal of your academic study: the ability to draw (in ample measure) from the great body of knowledge taught to you here vivid stimuli for your teaching. (ibid., p. 2)

I should remark here that, given the methodological task of these lecture courses, Klein evidently did not aspire to elaborate any teaching unit or to propose a didactical sequence—as he always emphasised, this should be the exclusive task of the teacher, given his autonomy with regard to teaching methods. Klein was therefore always distant from what became later the dominant practice of so-called Subject didactics (*Stoff-Didaktik*) in Western Germany (see Schubring 2016).

There is a decisive difference between d'Alembert's and Klein's notion of elementarisation. Basically, d'Alembert's notion was not a historical one; he did not reflect the effect of scientific progress on the elements. But this was exactly Klein's notion. He emphasised:

The normal process of development [...] of a science is the following: higher and more complicated parts become gradually more elementary, due to the increase in the capacity to understand the concepts and to the simplification of their exposition ("law of historical shifting"). It constitutes the task of the school to verify, in view of the requirements of general education, whether the introduction of elementarised concepts into the syllabus is necessary or not. (Klein and Schimmack 1907, p. 90)

The historical evolution of mathematics entails therefore a process of restructuring of mathematics where new theories, which at first might have been somewhat isolated and poorly integrated, become well connected to other branches of mathematics and effect a new architecture of mathematics, based on re-conceived elements, and thus on a new set of elementarised concepts.

For Klein's conception of elementarisation there is a second concept, complementing the notion of "historical shifting": it is the notion of hysteresis. Hysteresis is a term from physics and since it is not so well known, here a definition within physics:

A retardation of the effect when the forces acting upon a body are changed (as if from viscosity or internal friction); *esp.*: a lagging in the values of resulting magnetization in a magnetic material (such as iron) due to a changing magnetizing force.

Klein continued in applying this term to the relation between scholarly mathematics and school mathematics:

In this connection I should like to say that it is not only excusable but even desirable that the schools should always lag behind the most recent advances of our science by a considerable space of time, certainly several decades; that, so to speak, a certain **hysteresis** should take place. But the hysteresis, which actually exists at the present time is in some respects unfortunately much greater. It embraces more than a century, in so far as the schools, for the most part, ignore the entire development since the time of Euler. (Klein 2016a, b, pp. 220–221; my emphasis, G.S.) (Fig. 12.1).

Klein's conception of elementarisation thus implied, regarding the curriculum, that new discoveries and developments in scholarly mathematics should have reached



Stellen wir endlich wieder unsere gewöhnliche Frage, was die Schule von allen diesen Dingen aufnehmen soll, was der Lehrer und was der Schüler wissen sollte.

Ich möchte da zuerst aussprechen, daß es nicht nur zu entschuldigen, sondern ganz in der Ordnung ist, wenn die Schule gegenüber den neuesten Fortschritten unserer Wissenschaft immer eine gewisse Spanne Zeit, sagen wir vielleicht 3 Decennien, zurückbleibt, wenn also, wie man vielleicht sagen kann, eine gewisse Hysteresis stattfindet. Die bestehende Hysteresis ist aber leider viel bedeutender, sie umfaßt mehr als ein Jahrhundert, indem die Schule meist die ganze Entwicklung von Euler an ignoriert; so bleibt für die Reformarbeit also noch ein genügend großes Feld. Und was wir an Reformen verlangen, das ist wirklich recht bescheiden, wenn Sie es mit dem heutigen Stande der Wissenschaft vergleichen: Wir wollen nur, daß der allge-

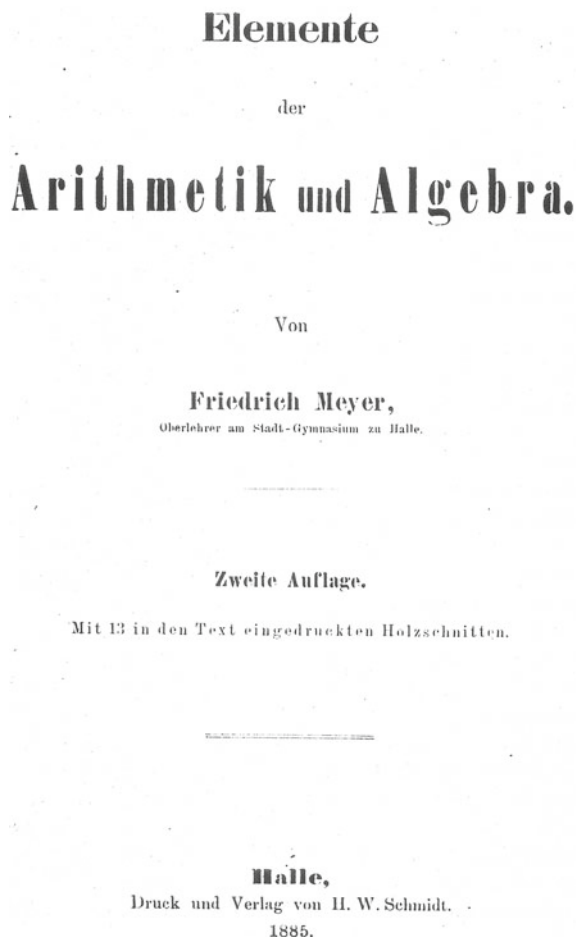
Fig. 12.1 Original handwriting of the lithographic second edition

a certain maturity, and integration with the remainder of mathematics—in other words, a restructuration of mathematics from newly conceived elements of science. The concept of hysteresis thus meant that new developments should enter *after* this process of renewed elementarisation. It is evident that Klein did apply the concept of hysteresis in particular to set theory (Fig. 12.2).

## 12.7 Modernism and the Challenge by Set Theory

Set theory was a case for Klein where this theoretical development was too fresh, and not yet accomplished and even further from having matured to the point of having induced an intra-disciplinary process of integration and restructuration. The concepts of set theory did not (yet) provide new elements for mathematics—hence Klein's polemic against Friedrich Meyer's schoolbook of 1885 who's intention had been, in fact, to use set theory as new elements for teaching arithmetic and algebra

**Fig. 12.2** Title page of Meyer's schoolbook



(see Klein 2016a, b, p. 289, note 181). Meyer, mathematics teacher at a Gymnasium in Halle and friend of Cantor, introduced there the notions of set theory—not yet fully developed then by Cantor—as foundations for the number concept. Klein had sharply criticised this schoolbook in his first edition, but softened his critique in subsequent editions. In Klein's times, mathematics had not achieved the level of architecture established by Bourbaki—and hence not of “modern math”.

Given that set theory has been almost identified with modernism in mathematics, I need to comment somewhat on the book by Herbert Mehrtens: *Modeme—Sprache—Mathematik* (1990), where he models Göttingen mathematics as bi-polar: Hilbert representing “modernism” and Klein representing “counter-modernism”. I was always critical of this book and Mehrtens' assessments, since he misrepresents both mathematicians: Hilbert was not that theoretician and formalist who freely created abstract theories whom Mehrtens compared with the artists of

that time as no longer bound by any claim to represent reality. And depicting Hilbert as “anti-intuitive” (1996, p. 521) deeply misunderstands Hilbert’s vision and practice of mathematics. Klein is, on the other hand, denounced by Mehrrens to be tied to reality and to intuition largely because German Nazi mathematicians later abused these notions.

Yet, one has to admit that Klein showed scepticism and reservation regarding set theory and axiomatics. On the one hand, he praised the progress in function theory brought about by Cantor’s new theories:

The investigations of George Cantor, the founder of this theory, had their beginning precisely in considerations concerning the existence of transcendental numbers. They permit one to view this matter in an entirely new light.

On the other hand, Klein warned against the abstractness of set theory. Thus, he showed misgivings when he spoke of the “modern” function concept launched by Cantor:

In connection with this, there has arisen, finally, a *still more far-reaching entirely modern generalisation of the function concept*. Up to this time, a function was thought of as always defined at every point in the continuum made up of all the real or complex values of  $x$ , or at least at every point in an entire interval or region. But since recently the concept of sets, created by Georg Cantor, has made its way more and more to the foreground, in which the continuum of all  $x$  is only an obvious example of a “set” of points. From this new standpoint functions are being considered, which are defined only for the points  $x$  of some *arbitrary set*, so that in general  $y$  is called a *function of  $x$  when to every element of a set  $x$  of things (numbers or points) there corresponds an element of a set  $y$* . (Klein 2016a, b, p. 220)

Clearly, this abstract function concept was not at all adapted for Klein’s curricular reform programme with a function concept as its kernel, which could interrelate analysis and geometry. His misgivings were even stronger concerning his doubts as to whether all this might have applications:

Let me point out at once a difference between this newest development and the older one. The concepts considered under headings 1. to 5. have arisen and have been developed with reference primarily to applications in nature. We need only think of the title of Fourier’s work! But the newer investigations mentioned in 6. and 7. are the result purely of the drive for mathematical research, which does not care for the needs of exploring the laws of nature, and the results have indeed found as yet no direct application. The optimist will think, of course, that the time for such application is bound to come. (ibid.)

Given Klein’s intense plea for applications, one should remark, furthermore, that he not only alerted, in the first volume in the context of the emergence of set theory, against pushing a formalist programme for the foundations of mathematics too far, but he also had taken up the issue again in volume III of his *Elementarmathematik*, advising against searching for the New only for the sake of doing it:

Provided that a deep epistemological need exists, which will be satisfied by the study of a new problem, then it is justified to study it; but if one does it only to do something new, then the extension is not desirable. (Klein 2016a, p. 157)

Klein did even not exempt Hilbert from his critical scepticism: he commented upon Hilbert's research on the foundations of arithmetic to establish the consistency of operating with numbers:

Obviously one can then operate with  $a, b, c, \dots$ , precisely as one ordinarily does with actual numbers. (Klein 2016a, b, p. 14)

commenting:

The tendency to crowd intuition completely off the field and to attain to really *pure* logical investigations seems to me not completely realisable. It seems to me that *one must retain a remainder, albeit a minimum, of intuition.* (ibid., p. 15)

Klein added, however, a cautious remark that he did not want to criticise Hilbert, albeit in a rather implicit manner:

I have felt obliged to go into detail here very carefully, in as much as misunderstandings occur so often at this point, because people simply overlook the existence of the second problem. This is by no means the case with Hilbert himself, and neither disagreements nor agreements based on such an assumption can hold. (ibid., p. 16)

The second problem, which Klein is emphasising here, was put by him as the epistemological aspect of the task of justification of arithmetic—and his intention was to say that it should not be overlooked when researching upon the logical aspect of justification of arithmetic.

## 12.8 Concluding Remarks

In fact, school mathematics will always be confronted with the tension between logical and epistemological aspects; there can be no definite solution. But Klein's concept of hysteresis offers a viable approach to realising an elementarisation that puts school mathematics into a productive relation with the progress of mathematics.

The attractiveness of Klein's lecture notes is due to his epistemological understanding of the elements, and to not falling into the trap of practicing elementarisation as a simplification but as the challenge to understanding the connectivity and coherence of the branches and specialities of mathematics.

## Bibliography

- Barbin, E. (2015). Descriptive geometry in France: History of *Élémentation* of a method (1795–1865). *International Journal for the History of Mathematics Education*, 10(2), 39–81.
- Chervel, A. (1988). L'Histoire des Disciplines Scolaires. Réflexions sur un domaine de recherche. *Histoire de l'éducation*, 38, 59–119.
- Chevallard, Y. (1985). *La Transposition Didactique*. Grenoble: La Pensée sauvage.
- d'Alembert, J. R. (1755). "élémens des sciences", *Encyclopédie ou Dictionnaire raisonné des Sciences des Arts et des Métiers*, tome V (pp. 491–497). Paris: Briasson.

- Fried, M., & Unguru, S. (2001). *Apollonius of Perga's Conica: Text, context, subtext*. Leiden: Brill.
- Kilpatrick, J. (2008). A higher standpoint. *Materials from ICME 11*, Regular lectures (pp. 26–43). <http://www.mathunion.org/icmi/publications/icme-proceedings/>.
- Klein, F. (2016a). *Elementary mathematics from a higher standpoint. Volume I: Arithmetic, algebra, analysis* (Translated by Gert Schubring). Heidelberg: Springer.
- Klein, F. (2016b). *Elementary mathematics from a higher standpoint. Volume III: Precision mathematics and approximation mathematics* (Translated by Marta Menghini in collaboration with Anna Baccaglini-Frank; Mathematical advisor for the English translation: Gert Schubring). Heidelberg: Springer.
- Klein, F., & Schimmack, R. (1907). *Vorträge über den mathematischen Unterricht an den höheren Schulen*. Leipzig: Teubner.
- Mehrtens, H. (1990). *Moderne – Sprache – Mathematik*. Frankfurt a.M: Suhrkamp.
- Meyer, F. (1885). *Elemente der Arithmetik und Algebra*. Halle: H. W. Schmidt.
- Schubring, G. (1984). Essais sur l'histoire de l'enseignement des mathématiques, particulièrement en France et en Prusse. *Recherches en Didactique des Mathématiques*, 5, 343–385.
- Schubring, G. (1988). Un savant des lumières - Un livre élémentaire pour la république. In C. Coutel, N. Picard, & G. Schubring (Eds.), *CONDORCET - Moyens d'apprendre à compter sûrement et avec facilité. Appareil critique - études, notes, commentaires, bibliographie* (pp. 157–175). Paris: ACL-éditions.
- Schubring, G. (2005). *Conflicts between generalization, rigor and intuition. Number concepts underlying the development of analysis in 17th–19th Century France and Germany*. New York: Springer.
- Schubring, G. (2016). Die Entwicklung der Mathematikdidaktik in Deutschland. *Mathematische Semesterberichte*, 63(1), 3–18.
- Trouvé, A. (2008). *La notion de savoir élémentaire à l'École. Doctrines et enjeux*. Paris: L'Harmattan.
- Viñao, A. (2008). A historia das disciplinas escolares, Tradução de Marina Fernandes Braga. *Revista Brasileira de Historia da Educação*, Curitiba (n. 18, pp. 173–215).
- Weber, H., & Wellstein, J. (1903–1907). *Encyklopädie der Elementar-Mathematik - ein Handbuch für Lehrer und Studierende*; in drei Bänden (4th edn). Revised by Paul Epstein. Leipzig: Teubner, 1922.

**Open Access** This chapter is licensed under the terms of the Creative Commons Attribution 4.0 International License (<http://creativecommons.org/licenses/by/4.0/>), which permits use, sharing, adaptation, distribution and reproduction in any medium or format, as long as you give appropriate credit to the original author(s) and the source, provide a link to the Creative Commons license and indicate if changes were made.

The images or other third party material in this chapter are included in the chapter's Creative Commons license, unless indicated otherwise in a credit line to the material. If material is not included in the chapter's Creative Commons license and your intended use is not permitted by statutory regulation or exceeds the permitted use, you will need to obtain permission directly from the copyright holder.



# Chapter 13

## Precision Mathematics and Approximation Mathematics: The Conceptual and Educational Role of Their Comparison



Marta Menghini

**Abstract** The relationship between applied and pure mathematics is of utmost concern for Klein. Examples from Volume III of his “Elementarmathematik” illustrate how, starting from an intuitive and sometimes practical approach, Klein develops abstract concepts working in rich “mathematical environments”. The examples concern the concept of empirical function and its comparison with an idealised curve, point sets obtained through circular inversion that lead to compare rational numbers and real numbers, and the “continuous” transformation of curves with the help of a point moving in space.

**Keywords** Precision mathematics and approximation mathematics  
Mathematical environments · Mathematics teacher training · Empirical functions  
Circular inversion · Transformation of curves · Felix Klein

### 13.1 The Lecture Course of Felix Klein

Felix Klein’s *Präzisions- und Approximationsmathematik* appeared in 1928 as volume III of the seminal series of lecture notes on elementary mathematics from a higher standpoint (*Elementarmathematik von einem höheren Standpunkte aus*; Klein 1928). The 1928 edition was in its turn a re-edition of a lecture course delivered by Klein in 1901 with the title *Anwendung der Differential- und Integralrechnung auf die Geometrie: eine Revision der Prinzipien*, published in 1902 in lithographic form (Klein 1902; a reprint of 1908, edited by Conrad Heinrich Müller, left the text essentially unchanged).

In this third volume Klein explores the relationship between *precision mathematics and approximation mathematics*. He crosses between various fields of mathematics—from functions in one and two variables to practical geometry to space

---

M. Menghini (✉)  
Sapienza University of Rome, Rome, Italy  
e-mail: marta.menghini@uniroma1.it

© The Author(s) 2019  
H.-G. Weigand et al. (eds.), *The Legacy of Felix Klein*, ICME-13 Monographs,  
[https://doi.org/10.1007/978-3-319-99386-7\\_13](https://doi.org/10.1007/978-3-319-99386-7_13)

curves and surfaces—always underlining the relationship between the exactness of the idealised concepts and the approximations to be considered in applications.

The point of view is not that of mathematics as a service subject, rather that of ... the heuristic value of the applied sciences as an aid to discovering new truths in mathematics. (Klein 1894, 6th Conference, p. 46)

Of course there is also “*a universal pedagogical principle to be observed in all mathematical instruction*”, namely that,

It is not only admissible, but absolutely necessary, to be less abstract at the start, to have constant regard to the applications, and to refer to the refinements only gradually as the student becomes able to understand them. (ibid., p. 50)

Therefore, the logical procedures that lead to theorems are confronted with the way in which concepts are formed starting from observations.

The final part of the book concerns gestalt relations of curves and surfaces, and shows how *Klein* masters the art of describing geometrical forms; Klein appeals to intuition leading the reader to think at continuous transformations of the geometric objects considered.

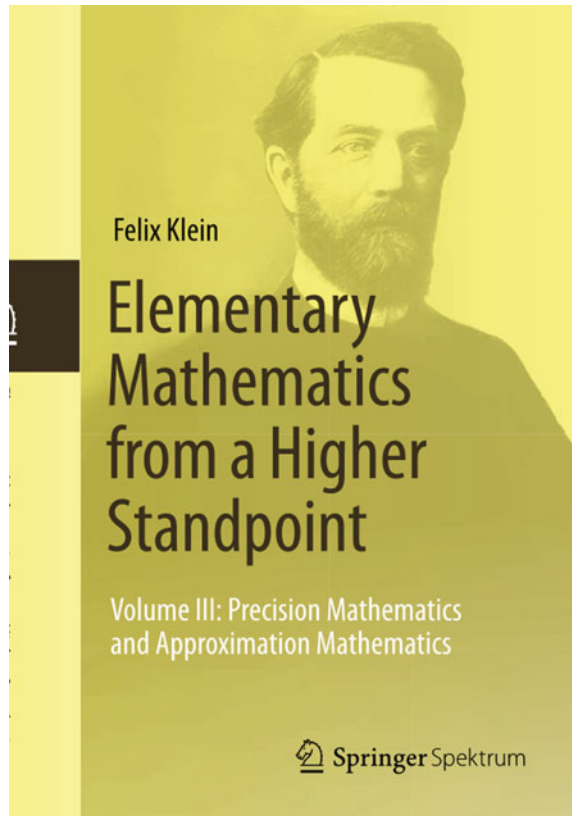
Volume III was translated for the first time in English in 2016 (Klein 2016; see Fig. 13.1). It is not clear why it was not translated jointly with the first two volumes in the 1930s. Maybe its value for the training of teachers, clearly recognised as concerns the two first volumes, had not yet been understood (see Kilpatrick, this volume; Menghini and Schubring 2016). Or, maybe, the decision was made because of the different role played by Klein in the 1928 edition of the third volume: Klein participated, together with Fritz Seyfarth, in the whole project of re-editing the three volumes on *Elementary mathematics from a higher standpoint*, but he died in 1925, after the first two volumes had appeared. The third volume was, therefore, edited only by Seyfarth; changes and insertions had been nevertheless discussed with Klein, as Seyfarth writes in his preface to the third edition (see Klein 2016, xiii). Probably for this same reason the third volume contains no particular indications of its importance for the training of the future mathematics teachers.

A translation after nearly a century, joined with a new edition of the two first volumes, must not be considered strange: this translation has an historical value, since Klein is one of the greatest mathematicians of history (books by Felix Klein are still in use today: Klein’s *Nicht-euklidische Geometrie* has been re-edited in 2006, the English version of the *Lectures on the Icosahedron* re-edited in 2007, and his *Development of mathematics in the nineteenth century* was translated in 1979); it also has a mathematical value—because of the interesting approaches and the links to applications. But, above all, it has a didactical value, concerning the training of mathematics teachers, for the reasons given at the beginning of this chapter, which we will try to explain more in depth through some examples.

The third volume focuses on precision and approximation mathematics, that is on the link between mathematics and its applications:

*Precision mathematics* includes all the propositions that can be logically deduced from the axioms of geometry or of analysis—obtained by abstraction from experience;

**Fig. 13.1** The 2016 edition of Precision Mathematics and Approximation Mathematics, translated from the third German edition (1928) by Marta Menghini with Anna Baccaglioni-Frank as collaborator and Gert Schubring as advisor



*Approximation mathematics* includes the results that can be obtained from experience with a certain degree of approximation.

Klein starts by considering those properties that applied mathematicians take for granted when studying certain phenomena from a mathematical point of view. These properties must be seen as supplementary conditions for the ideal objects of pure mathematics. In the meantime, these very properties prove to be the more intuitive ones. Therefore the comparison moves towards another field: it is a comparison between properties that can be considered only in the theoretical field of abstract mathematics and properties that can be grasped by intuition. This distinction still has repercussions in mathematics education today.



## 13.2 First Example: Empirical and Idealised Curve

Klein makes an important distinction between functions arising out of applications of mathematics and functions as abstractions in their own right. This topic had been introduced by Klein in his *American conferences* of 1984:

In imagining a line, we do not picture to ourselves “length without breadth”, but a strip of a certain width. Now such a strip has of course always a tangent (Fig. 13.2); i.e. we can always imagine a straight strip having a small portion (element) in common with the curved strip; similarly with respect to the osculating circle. The definitions in this case are regarded as holding only approximately, or as far as may be necessary. (Klein 1984, p. 98)

So we need to examine which restrictions we have to put to an idealised curve  $y = f(x)$  so as to obtain that it corresponds to the concept of an empirical curve.

We have the perception that the empirical curve,

- (a) is connected in its smallest parts, that is, it *takes on all values between the ordinates of two of its points*.
- (b) encloses a specific *area* between the  $x$ -axis and the ordinates of two of its points.
- (c) has everywhere a *slope* (and a *curvature*, ...).
- (d) has a finite number of maxima and minima.

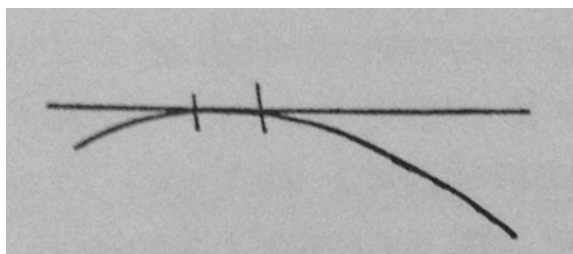
How can we translate these intuitive properties into mathematical properties of  $f(x)$  (Fig. 13.3)? The connectedness of point (a) can be expressed by saying that  $f(x)$  must be “continuous” (even if there is not a complete equivalence of the two meanings); point (b) is simply translated into the fact that  $f(x)$  is integrable; point (c) means that  $f(x)$  has a first (and second, ...) derivative at any point; finally point (d) is expressed by the property that  $f(x)$  *must split—in the given interval—into a finite number of monotonous parts*.

So, for instance, a function as  $y = \sin 1/x$  (Fig. 13.4) exists only in the ideal field: it belongs only to precision mathematics.

But the properties (theorems) that we can study mathematically on our idealised curve  $f(x)$ —once we have considered the restrictions suggested by our experience—can then apply also to our empirical curve. So we go back from abstraction to applications.

In 1913/14 the Italian geometer Guido Castelnuovo gave a series of lectures at the University of Roma entitled *Matematica di precisione e matematica delle*

**Fig. 13.2** Taken from Klein (1984, p. 98)



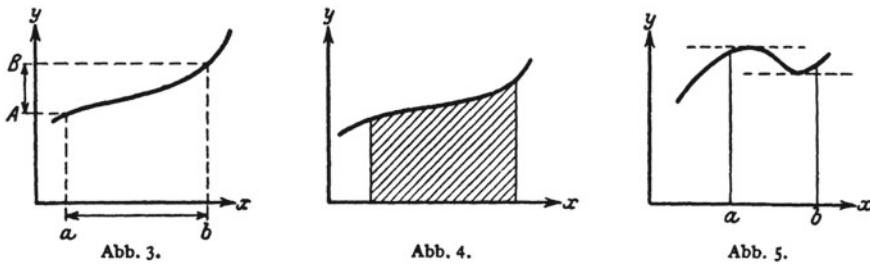


Fig. 13.3 Taken from Klein (1928, p. 22)

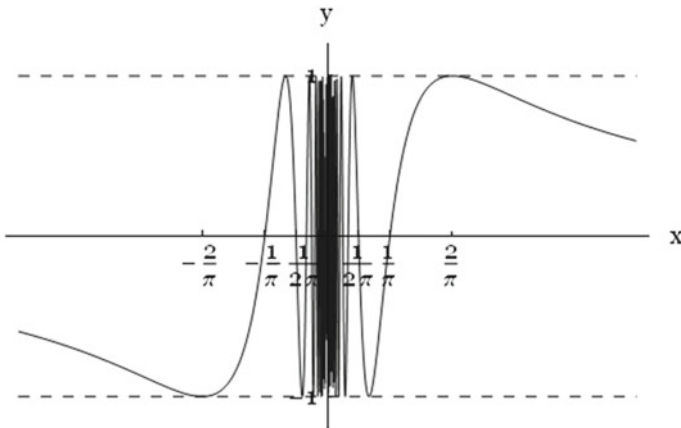


Fig. 13.4 The function  $y = \sin 1/x$

*approssimazioni*. The course was explicitly inspired by the course delivered by Felix Klein in 1902.

Castelnuovo states clearly at the beginning of his lecture course that the teaching and learning of mathematics would be more successful if it included, besides the logical procedures that lead to the theorems, also the way in which concepts are formed starting from observations, and how they can be verified in practice.

In 1911 the Liceo Moderno was established (Legge 21 July 1911, n. 860), which effectively started in 1913. In this school, the preparation towards university studies (not necessarily of a scientific nature) was achieved through the study of Latin, modern languages, and the sciences (Marchi and Menghini 2013). Mathematics is presented as an apt language for describing natural phenomena and a part of the programmes is concerned with approximation mathematics and its heuristic nature. Its mathematics programs were ascribed to Castelnuovo:

The renovation of the mathematics of the 17th century is linked to the blooming of the natural sciences. Within this context, the teacher will have to explain how the fundamental concepts of modern mathematics, particularly the concept of function, are implied by the observational sciences, and – being then rendered precise by mathematics – have in turn had

a positive influence on the development of the latter. (Castelnuovo 1912, p. 124, translated by the author)

Castelnuovo's course on precision and approximation mathematics is therefore very apt to train the teachers of his modern lyceé, which he hopes to become widespread. In particular, the comparison between empirical and idealised function describes very well the reciprocal aid of observational sciences and pure mathematics mentioned in the above quotation.

### 13.3 Second Example: Iterated Inversion with Respect to Three Touching Circles

One of the reasons for putting applications at the beginning of a teaching sequence is, as already said, *the heuristic value of applied sciences*. Even when starting from a practical approach Klein develops more abstract concepts working in rich “mathematical environments”, which form the core of a pertinent program for mathematics teacher education. In this case we are *not* necessarily interested in going back to applications: we take the idea from applications, and we work as mathematicians in the ideal field.

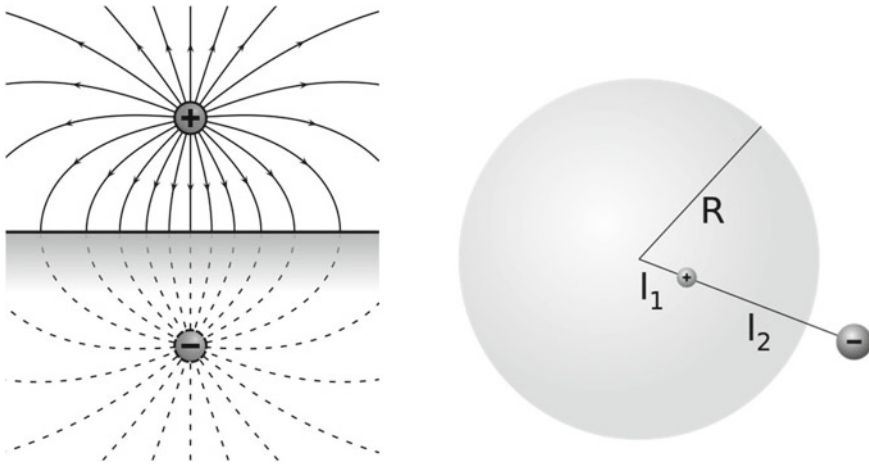
Let us start from an example taken from physics:

*The method of image charges* (also known as the method of images or method of mirror charges) is a technique to solve problems in electrostatics. The name comes from the fact that charged objects in the original problem are replaced with equivalent imaginary discrete point-charges, still satisfying the boundary conditions associated with the problem.

A simple case of the method of image charges is that of a point charge  $q$ , which we can consider located at the point  $(0, 0, a)$  above an infinite grounded (i.e.:  $V = 0$ ) conducting plate in the  $xy$ -plane. The problem can be simplified by replacing the plate of equipotential with a charge  $-q$ , located at  $(0, 0, -a)$ .

The method of images may also be applied to a sphere or to a cylinder. In fact, the case of image charges above a conducting plate in a plane can be considered as a particular case of images for a sphere. In this case a point-charge  $q$  lying inside the sphere at a distance  $l_1$  from the origin has as its image another point-charge lying outside the sphere at a distance of  $R^2/l_1$  from the origin. So, the relation between the two charges is given by *circular inversion*. The potential produced by the two charges is zero on the surface of the sphere (Fig. 13.5).

Klein states that already in 1850 *William Thomson* and *Bernhard Riemann*, when studying the equilibrium of charges on three *rotating cylinders* with parallel axes, observed that the “method of image charges” leads to the generation of a certain point set (see Thomson 1853; we could not find anything explicit on this topic in Riemann's legacy).



**Fig. 13.5** Image charges in the case of a plate (left) and of a sphere (right)

We leave now the field of applications and turn completely to the *ideal field* considering three disjoint circles (which correspond to the normal section of the three rotating cylinders).

We consider the point set obtained from the points of a given region (the one outside the 3 circles) by applying any combination of the inversions in the three given circles, that is applying to the region the whole group of “transformations” that arises from the three “generators”.

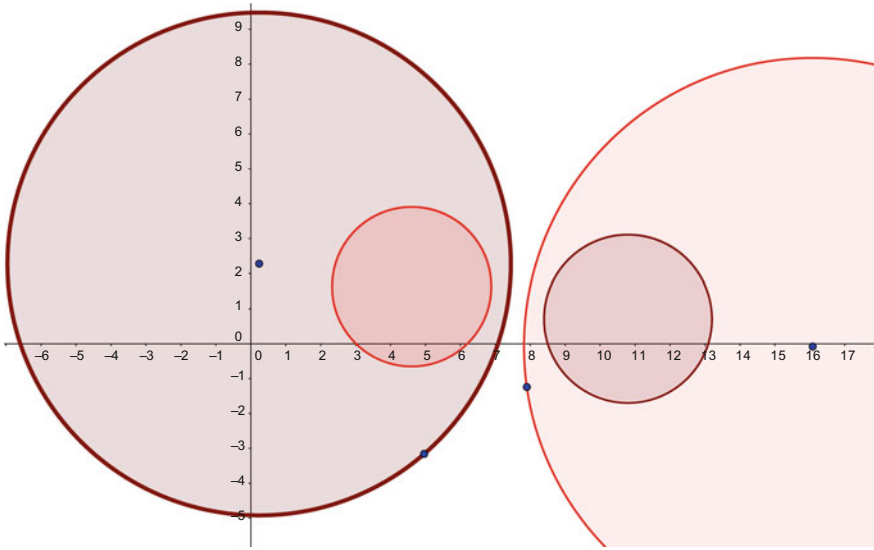
The text of Klein contains wonderful and clear drawings on this subject, but the use of a software like *Geogebra*, which has circular inversion in its menu, helps in following the probable development of the explanation that was delivered to Klein’s students during the lecture course. In the following the drawings are either taken from the text of Klein or made with Geogebra. In this second case the “historic overview” of the various constructions is didactically important. Here we can only show some *snapshots*.

So, let us start from two circles (Fig. 13.6). In the first step we apply circular inversion with respect to the left circle, that is we reflect in the left circle the whole region outside, including the right circle. All the points of the infinite region outside the left circle are transformed in the points internal to the circle, and the right circle is transformed in a smaller circle inside the left circle.

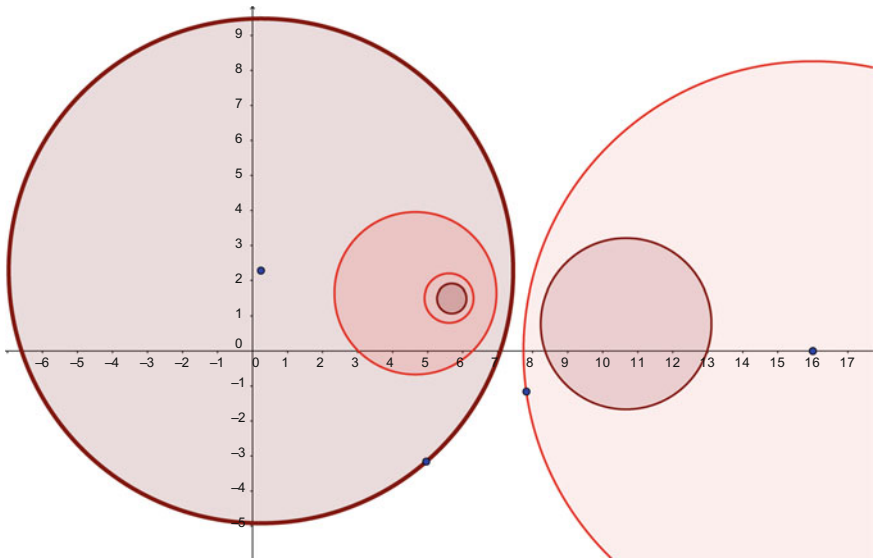
To simplify our language we will from now on *only speak of the reflection of the circles*, without mentioning all the points of the regions contained in or outside them. So, the next step is the reflection of the left circle into the right one.

Now we can proceed in any order, for instance reflecting again the right circle with its internal circle into the smaller circle at the left (Fig. 13.7).

It is easy to understand that we obtain a configuration made by chains of circles each inside the other (Fig. 13.8).



**Fig. 13.6** Each circle is reflected in a smaller circle inside the other one



**Fig. 13.7** Reflection of an internal circle in another internal circle

We then add the third circle, and continue to apply the circular inversion reflecting the whole configuration in the new circle, and also reflecting the new circle in the two former ones. We see that many chains of circles are appearing. In fact, an infinite number of chains (Fig. 13.9).

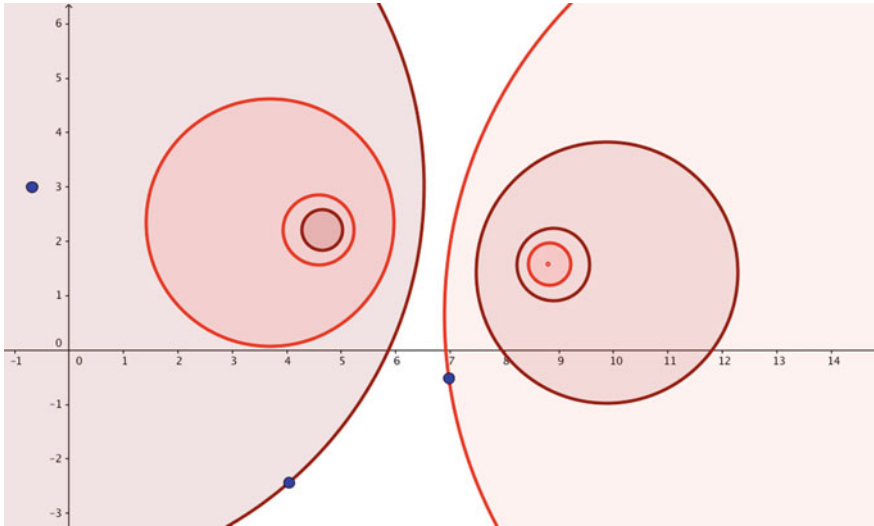


Fig. 13.8 Further reflections

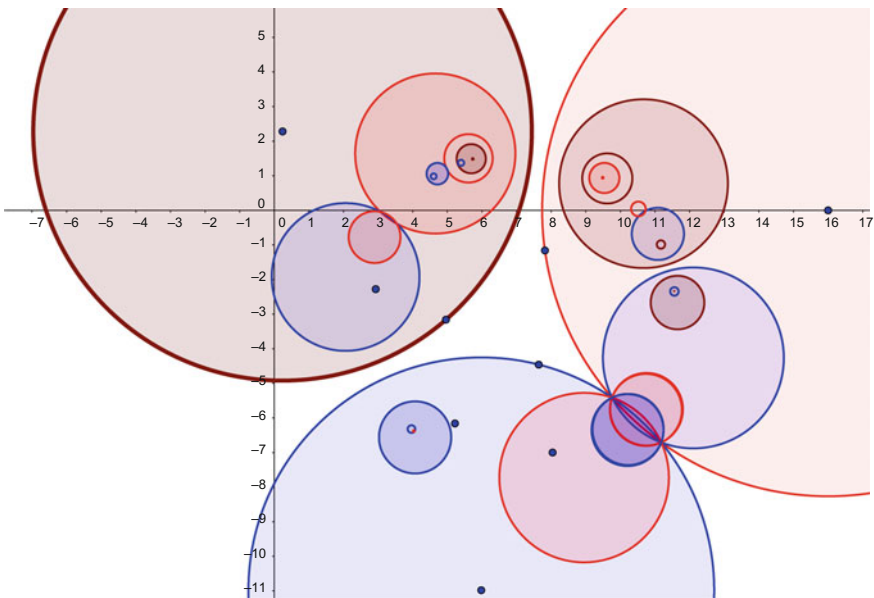
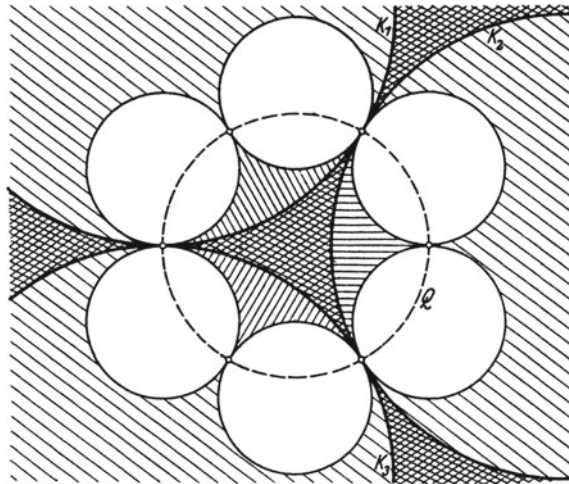


Fig. 13.9 Reflections in and of a third circle

And now we have the fundamental transition from an empirical construction to the idealised field. We use the *axiom of the nested intervals*: For every indefinitely decreasing sequence of closed intervals (segments, parts of curves, plane regions,

**Fig. 13.10** Taken from Klein (1928, p. 140)



parts of spaces), each of which contains all the following ones, there exists one and only one point common to all the intervals. This point is therefore univocally defined by the interval sequence.

The axiom of the nested intervals allows us to say that each chain (sequence) has a *limit point*.

Speaking again of the regions transformed, we can say that we obtain a net of regions that fill the plane except for an infinite set of limit points: What can we say about this limit point set? We find out that it is *nowhere dense*, but *nevertheless perfect* (it contains all of its accumulation points) and has the cardinality of the continuum (like the Cantor set).

Now we continue to *play* with circular inversion and consider three *touching* circles. And again we repeat the inversions. In the first step (Fig. 13.10) each circle contains the image of the two others. Each circle, as well as the external regions, contains curvilinear triangles.

The points of contact of the arising curvilinear triangles (and of the arising circles) accumulate on the orthogonal circle, that is the circle that is orthogonal to the three given ones (Figs. 13.10 and 13.11), as was also suggested by Fig. 13.9. *Proceeding with the construction, the orthogonal circle is filled more and more densely with the points of contact of two circles* (Fig. 13.12).

The next question is then: What can be said about the set of points of contact? *It is easy to understand that in the set of the points of contact each point is an accumulation point for the others, and that the set is everywhere dense on the periphery of the orthogonal circle.*

*“Until now I have spoken of these things in a somewhat indeterminate manner, because I did not refer to any quantitative relations but only to the figure as such.*

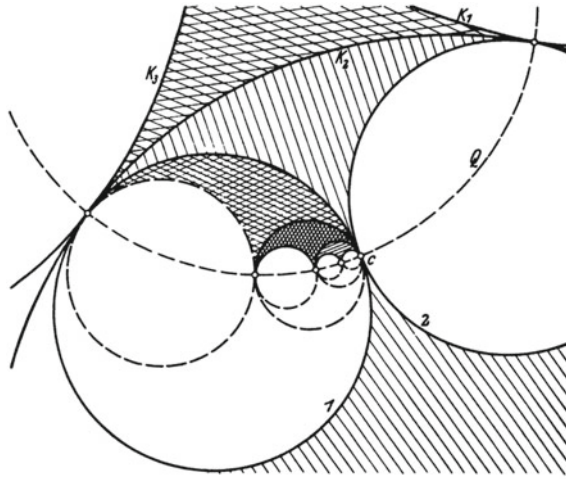


Abb. 81.

Fig. 13.11 Taken from Klein (1928, p. 141)

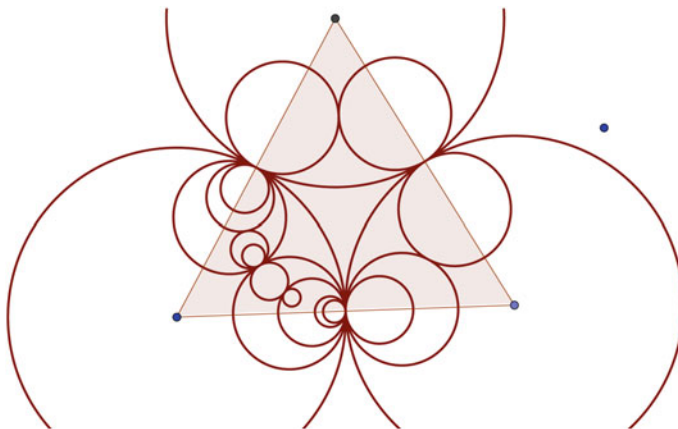
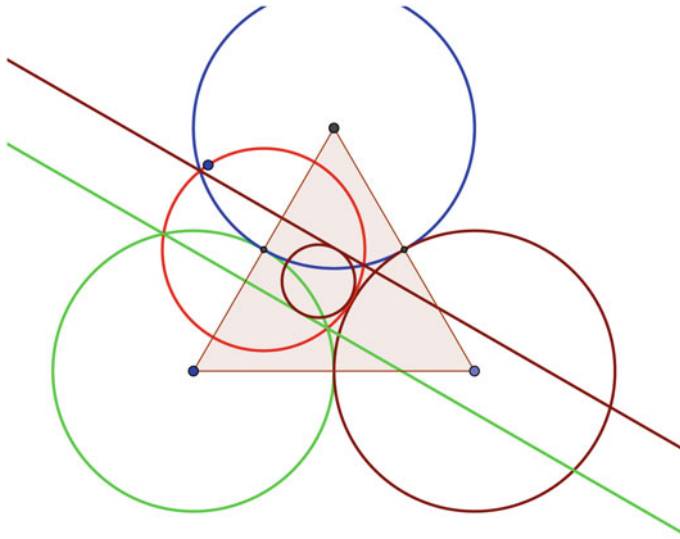


Fig. 13.12 Circles accumulate on the orthogonal circle

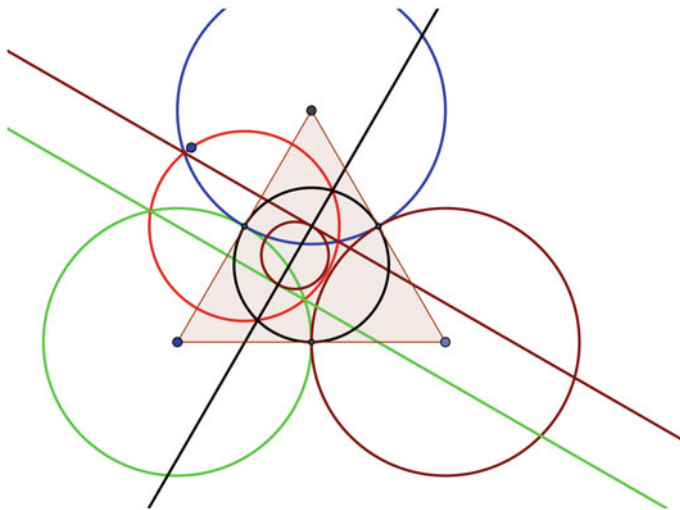
However, it is easy to give to the figure a form that allows an arithmetic interpretation of everything” (Klein 2016, p. 157).

Following the idea of Klein, let us consider a circle with its centre on the contact point of two of the three touching circles. If we reflect the two circles in it, these are transformed into lines, due to the rules of circular inversion. The third circle is instead transformed into a smaller circle (Fig. 13.13). Now we add the orthogonal circle, which is in its turn reflected into a line, perpendicular to the former two (Fig. 13.14), which divides the smaller circle in two parts.





**Fig. 13.13** Circle centred in the contact point of two circles



**Fig. 13.14** Reflections in the new circle

We thus obtain a curvilinear triangle delimited by two parallel straight lines and by a semi-circle touching these lines (Fig. 13.15).

Now we choose the line  $QQ$  (as called by Klein in Fig. 13.16) as  $x$ -axis, and the origin and the scale so that the points  $x = 0, x = 1$  fall at the two finite vertices. Then the whole figure is easy to construct, mirroring Fig. 13.15 unlimitedly on the right and on the left, and reflecting the sequence of infinitely many triangles such

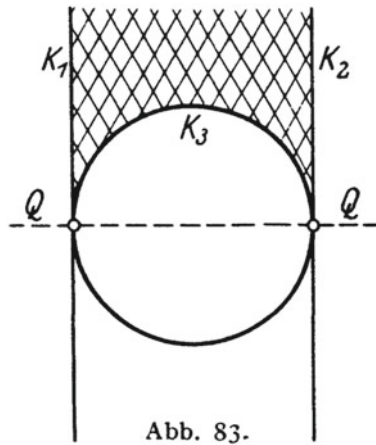
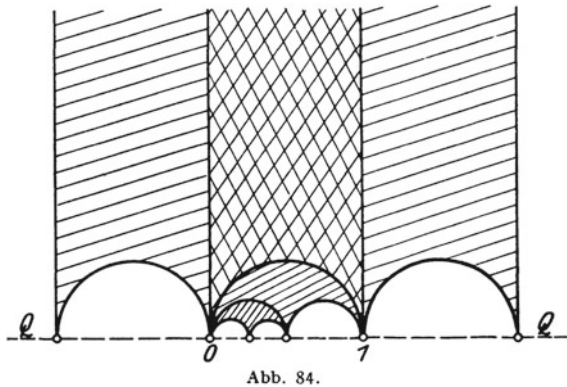


Fig. 13.15 Taken from Klein (1928, p. 143)

Fig. 13.16 Taken from Klein (1928, p. 144)



obtained in each of the occurring semi-circles. In this way all the points of contact can be found on the  $x$ -axis, and it is easy to calculate exactly arithmetically what had been explained in our first figure only with the help of our immediate geometric sense. Indeed, the formulas of the circular inversion indicate that a circle with rational centre and rational radius is transformed in another circle with rational centre and rational radius:

More precisely, the equation of circular inversion is given, in its simple vector form, by

$$OP \cdot OP' = r^2$$

where  $O$  is the centre of the circumference,  $r$  its radius,  $P$  and  $P'$  two corresponding points collinear with  $O$ . It is clear that a point on the circumference corresponds to itself. Moreover, the image of the centre is a point at infinity, and—since the

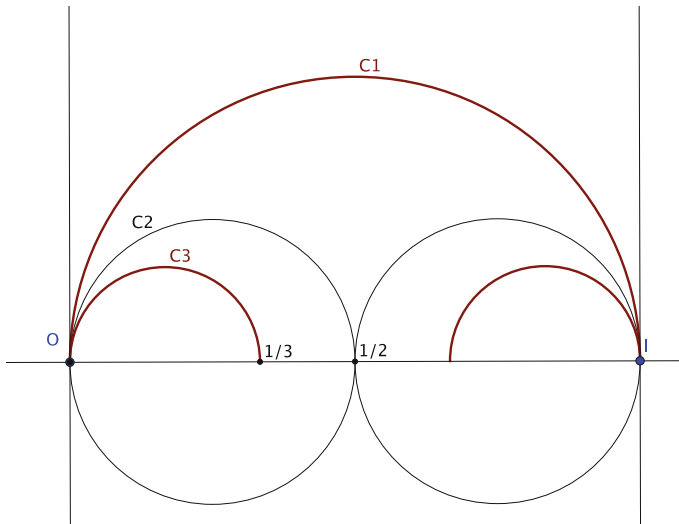


Fig. 13.17 Starting form a circle of diameter 1

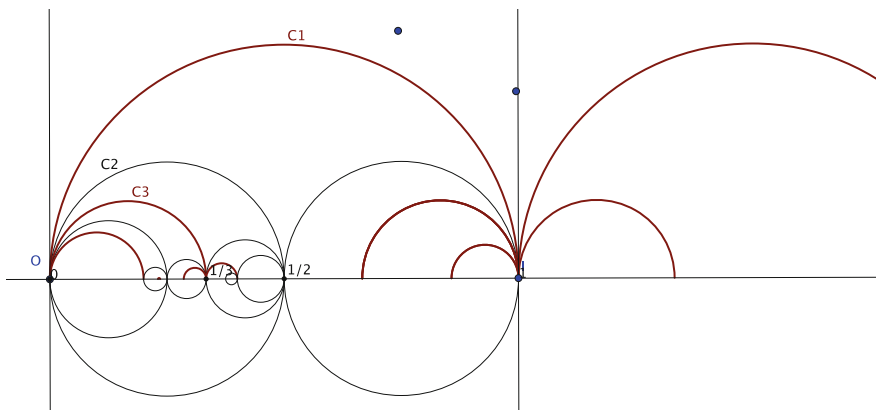


Fig. 13.18 Chain of consecutive inversions

correspondence is an involution—all points at infinity have the centre as their image point.

Let us consider the circle  $C_1$  whose diameter is the segment  $[0;1]$  on the number line. Its centre has abscissa  $\frac{1}{2}$ . The straight line  $x = 0$  (circle with infinite radius), perpendicular to the line  $QQ'$ , has as its correspondent with respect to  $C_1$  the circle  $C_2$ , which has as end points of its diameter 0 and  $\frac{1}{2}$ . In its turn, the image of  $C_1$  with respect to  $C_2$  is a circle  $C_3$ , whose diameter has as endpoints 0 and  $\frac{1}{3}$ , and so on (Figs. 13.17 and 13.18).

Therefore all the points of contact have rational abscissas  $x$  and every point with a rational  $x$  becomes a contact point. *So, there is not only an analogy between the set of the points of contact and the set of the rational points on the  $x$ -axis, but there exists an identity. In particular it turns out that the set of the points of contact is denumerable.* We have found a method of construction of the rational numbers on the real line, which provides a wonderful mental image of the relationship between rational numbers and real numbers on the number line.

### 13.4 Third Example: *Gestalt Relations of Curves*

The final part of Volume III concerns *gestalt relations* of curves in space and surfaces and shows Klein to be the master of the art of description of geometric forms. In part II, concerning—as above—the *free geometry of plane curves* (that is a geometry independent from a coordinate system), Klein discusses “the possibility to deduce properties of the idealised curve from the empirical shape” (Klein 2016, p. 189). Klein considers again the relation between an empirical and an idealised curve and poses the question:

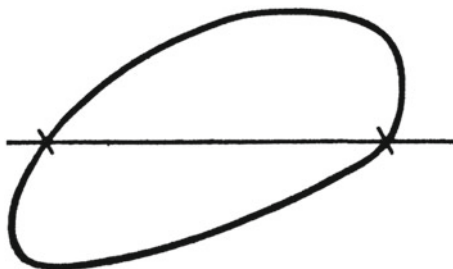
Can I now deduce from the gestalt relations of the empirical curve, which I see before my eyes, the corresponding properties of the idealised curve?

To answer this question, Klein’s conception is necessarily decisive, that the idealised curve is something that goes beyond sensorial intuition and exists only on the base of definitions. So we cannot appeal only to intuition. “Rather, we always need to reflect on whether, respectively why, things that we roughly see—so to speak—before our eyes in an empirical construction can be rigorously transferred to the idealised object *thanks to the given definitions.*”

As an example Klein considers the following figure (Fig. 13.19), namely a closed convex curve cut by a straight line:

In our mind, we substitute the straight line of the figure by an idealised straight line, and the drawn curve—at first—by a regular curve (a Jordan-curve). Intuition teaches us that the idealised straight line passes inside and outside the Jordan curve,

**Fig. 13.19** Taken from Klein (1928, p. 176)



**Abb. 103.**

giving rise to two intersection points. But, even admitting that the drawn curve is a continuous curve, we cannot deduce from the figure that any closed curve has two intersections with a straight line. It is, for instance, possible that in the neighbourhood of the point in which the empirical figure shows only one intersection, the idealised figure presents three or five of them. This is in fact not excluded, if we do not further limit with definitions the type of curve.

Now we pass to considering an algebraic curve and let us suggest general properties of the algebraic curves by looking at some of them, starting from simple representations, and passing from one curve to the other by *continuous* transformations. As Klein says, we perform *a proof by continuity*. What do we mean by continuous transformation of a curve? Let us follow Klein's interesting idea:

The general equation of a curve of the  $n$ -th degree  $C_n$  has  $\frac{n(n+3)}{2}$  constants. For instance, the general equation of a conic section has  $2(2+3)/2 = 5$  constants (in fact, six parameters which can be multiplied or divided by one of them):

$$ax^2 + by^2 + cxy + dx + ey + f = 0$$

We consider these as coordinates of a point in a higher dimensional space and call this point the "*representational point*" belonging to the curves  $C_n$ . If the  $C_n$  assumes all possible shapes, that is if the coefficients vary arbitrarily, the representational point varies in the *whole*  $\frac{n(n+3)}{2}$ -dimensional space.

It is very useful to choose for support such a space and to consider it alongside all the  $C_n$ . Indeed, Klein states, we do not know exactly what it means that a curve varies with continuity, but we can easily imagine a point moving continuously in the space.

To help furthermore imagination, let us take as a first example (which is not present in Klein) a conic section centred in the origin (with only three constants):

$$ax^2 + by^2 = c.$$

In this case the representational point  $P$  has coordinates  $a, b, c$  and varies in the 3D-space. We realise, with the help of Geogebra,<sup>1</sup> a simulation in which the point  $P$  moves in space while the conic section takes on the coefficients of the point  $P$  (Fig. 13.20a, b).

According to the values of  $a, b, c$  we get all kind of conic sections, but not the parabola as we do not have a term of the first degree.

We can also observe that we have the degenerate conics (a point or two lines) when the point  $P$  crosses the  $xy$  plane (that is, the constant  $c$  is  $= 0$ , as in Fig. 13.20c). During this transition a hyperbola becomes an ellipse or vice versa. This can be used in schools to show the way in which conic sections are transformed one into the other by continuity.

Klein himself considers a second example. It is a quartic. Klein is not worried about the number of constants: even if the representational space is of higher dimension

---

<sup>1</sup>I thank Anna Baccaglini-Frank for her collaboration in creating these files.

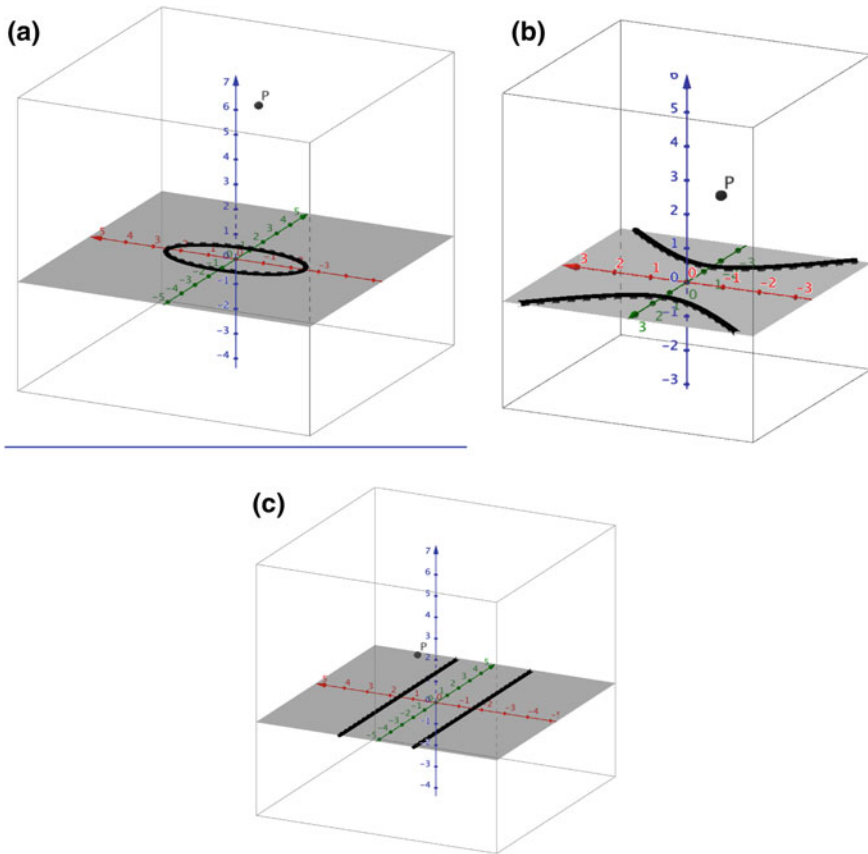


Fig. 13.20 a-c “Continuous” transformation of a conic section

Klein wants to stimulate our *intuition*: we have to imagine point  $P$  moving in the space, we have to understand how the quartic varies accordingly, understand that we find double points when  $P$  crosses certain surfaces, and that we have higher singularities (which can be avoided in our “walk in the space”) crossing certain curves on the surfaces.

Nevertheless we tried to simulate the situation with the help of Geogebra using, once again, only three coordinates. This does not change Klein’s example.

$$(ax^2 + by^2 - ab)(bx^2 + ay^2 - ab) = c$$

The starting point, corresponding to  $c = 0$ , is constituted by two ellipses (Fig. 13.21).

Moving  $P$  in space, the quartic takes on various forms (Fig. 13.22). For instance, when  $c$  becomes negative, the quartic becomes like the one of Fig. 13.23.

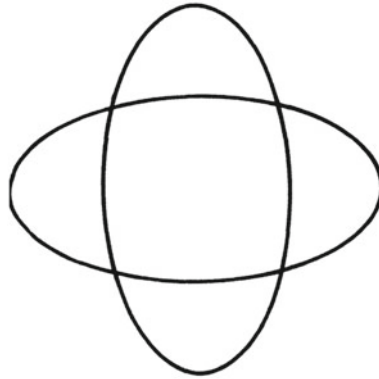
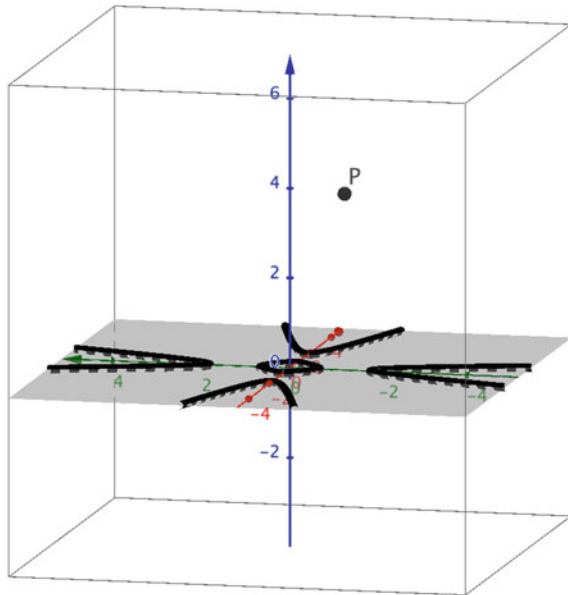


Abb. 116.

Fig. 13.21 Taken from Klein (1928, p. 191)

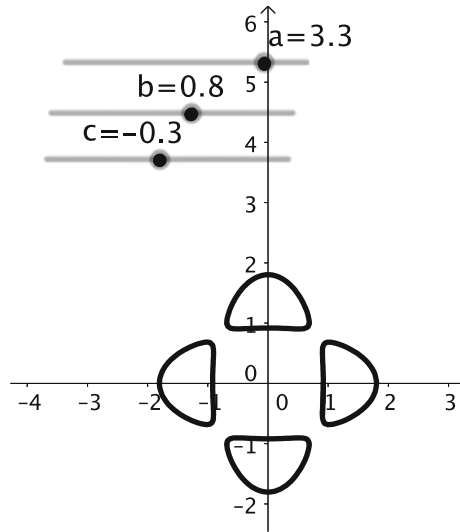
Fig. 13.22 One of the forms of the quartic



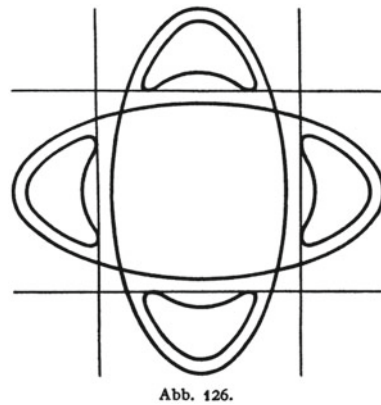
Klein observes how inflection points, double points or bitangents (namely tangents to two points of the curve) change when transforming the quartic, in particular Klein proves by continuity certain regularities concerning their number. For instance, the number of real inflection points (8 in Fig. 13.24) added to twice the number of isolated bitangents (4 in Fig. 13.25) is constant.

But from a didactic point of view, to look at the continuous transformation of such a quartic is sufficient.

**Fig. 13.23** The case of negative  $c$



**Fig. 13.24** Taken from Klein (1928, p. 202)

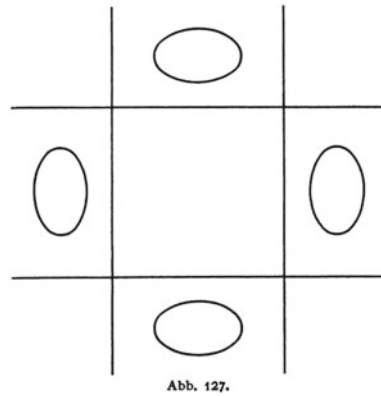


### 13.5 Conclusion

The history of mathematics education presents at different times and in different countries “utilitarian” periods in which applications of mathematics are considered an *end* of the curriculum, and even mathematical subject matter which cannot be linked to external use comes under attack (Niss 2008). On the other hand, applications can be regarded as a *means* to support learning, by providing interpretation and meaning. When considering the two aspects of applied mathematics, a means or an aim, we are not faced with a contradiction but, as Niss states, with a duality. Klein tries to support an even stronger conception of a continuous exchange between empirical observation and formalised objects.



**Fig. 13.25** Taken from Klein (1928, p. 202)



The third part of Klein’s work has the interesting title “*About the perception of idealised structures by means of drawings and models*”. In this last section Klein presents the *collection of models* in Göttingen with the related explanations. Klein continues to reason by continuity, appealing to intuition. He writes, at the beginning of this section, that a main theme within the topics treated in his lecture course has been the distinction between empirical space intuition, with its limited precision, and the idealised conceptions of precision geometry. As soon as one becomes aware of this difference, one can choose his way unilaterally in one or in the other direction. But both directions seem to be equally *unfruitful*.

Klein strongly advocates *the need to maintain a connection between the two directions, once their differences are clear in one’s mind*:

A wonderful stimulus seems to lay in such a connection. This is why I have always fought in favour of clarifying abstract relations also by reference to empirical models.

The examples shown above surely support this statement.

## References

- Castelnuovo, G. (1912). I programmi di matematica proposti per il liceo moderno. *Bollettino Mathe-sis*, IV(9), 120–128.
- Castelnuovo, G. (1913/14). *Matematica di Precisione e Matematica di Approssimazione*. Quaderno delle lezioni dell’A.A 1913/1914. [http://opere digitali.lincci.it/Castelnuovo/Lettere\\_E\\_Quaderni/quaderni/nC913\\_14A/mostracom.htm](http://opere digitali.lincci.it/Castelnuovo/Lettere_E_Quaderni/quaderni/nC913_14A/mostracom.htm).
- Klein, F. (1902). *Anwendung der Differential- und Integralrechnung auf die Geometrie: eine Revi-sion der Prinzipien: Vorlesung gehalten während des Sommersemesters 1901*. In C. Müller (Ed.), Leipzig: Teubner.
- Klein, F. (1928). Elementarmathematik vom höheren Standpunkte aus, 3: Präzisions- und Approx-imationsmathematik. In C. H. Müller (Ed.), *Series: Die Grundlehren der mathematischen Wis-senschaften*, 16 (3rd ed.), completed for the print and with additions by Fr. Seyfarth. Berlin: Springer (Reprint in 1968).

- Klein, F. (1984). *The Evanston colloquium: Lectures on mathematics delivered from August 28 to September 9, 1893 in Chicago at Northwestern University, Evanston*. New York: Macmillan.
- Klein, F. (2016). *Elementary mathematics from a higher standpoint 3: Precision mathematics and application mathematics*. Berlin, Heidelberg: Springer.
- Marchi, M. V., & Menghini, M. (2013). Italian debates about a modern curriculum in the first half of the 20th century. *The International Journal for the History of Mathematics Education*, 8, 23–47.
- Menghini M., & Schubring, G. (2016). Preface to the 2016 edition. In *Felix Klein: Elementary mathematics from a higher standpoint 3: Precision mathematics and application mathematics* (pp. v–x). Springer: Berlin, Heidelberg.
- Niss, M. (2008). Perspectives on the balance between application and modelling and ‘pure’ mathematics in the teaching and learning of mathematics. In M. Menghini, F. Furinghetti, L. Giacardi, & F. Arzarello (Eds.), *The first century of the international commission on mathematical instruction (1908–2008). Reflecting and shaping the world of mathematics education* (pp. 69–84). Rome: Istituto della Enciclopedia Italiana.
- Thomson, W. (1850). On the mutual attraction or repulsion between two electrified spherical conductors. *Philosophical Magazine, Series 4*(5), 287–297; 4(6), 114–115.

**Open Access** This chapter is licensed under the terms of the Creative Commons Attribution 4.0 International License (<http://creativecommons.org/licenses/by/4.0/>), which permits use, sharing, adaptation, distribution and reproduction in any medium or format, as long as you give appropriate credit to the original author(s) and the source, provide a link to the Creative Commons license and indicate if changes were made.

The images or other third party material in this chapter are included in the chapter’s Creative Commons license, unless indicated otherwise in a credit line to the material. If material is not included in the chapter’s Creative Commons license and your intended use is not permitted by statutory regulation or exceeds the permitted use, you will need to obtain permission directly from the copyright holder.



# Chapter 14

## Examples of Klein's Practice *Elementary Mathematics from a Higher Standpoint: Volume I*



Henrike Allmendinger

**Abstract** In the first volume of *Elementary Mathematics from a Higher Standpoint: Arithmetic, Algebra and Analysis*, Klein closely adheres to several principles which contribute a great deal to the understanding of Klein's higher standpoint—such as the principle of mathematical interconnectedness, the principle of intuition, the principle of application-orientation, and the genetic method of teaching. In addition, Klein conveys not only a mathematical but also a historical and a didactical perspective, all of which broaden this standpoint. This versatile approach to the mathematical content will be illustrated in this article by taking a closer look at the chapter on logarithmic and exponential functions.

**Keywords** Felix Klein · Elementary mathematics · Higher standpoint  
Logarithms · Perspectives

### 14.1 Introduction

The young university student finds himself, at the outset, confronted with problems, which do not remember, in any particular, the things with which he had been concerned at school. Naturally he forgets all these things quickly and thoroughly. When, after finishing his course of study, he becomes a teacher, he suddenly finds himself expected to teach the traditional elementary mathematics according to school practice; and, since he will be scarcely able, unaided, to discern any connection between this task and his university mathematics, he will soon fall in with the time-honoured way of teaching, and his university studies remain only a more or less pleasant memory which has no influence upon his teaching. (Klein 1908/2016, p. 1)

---

H. Allmendinger (✉)  
Applied University of Northern Switzerland, Canton, Switzerland  
e-mail: henrike.allmendinger@fhnw.ch

© The Author(s) 2019  
H.-G. Weigand et al. (eds.), *The Legacy of Felix Klein*, ICME-13 Monographs,  
[https://doi.org/10.1007/978-3-319-99386-7\\_14](https://doi.org/10.1007/978-3-319-99386-7_14)

Klein called this situation a *double discontinuity*<sup>1</sup> and met this problem by giving a series of lectures entitled *Elementarmathematik vom höheren Standpunkte aus (Elementary Mathematics from a Higher Standpoint)*.<sup>2</sup> In total, three manuscripts were published: one on arithmetic, algebra, and analysis; a second one on geometry; and a third one on precise and approximative mathematics.<sup>3</sup> The third volume, however, aims to show the connection between approximative mathematics and pure mathematics. Klein does not cover questions on mathematics education in the last volume.

In the first two volumes, Klein provides an overview of school mathematics to connect the different mathematical branches and to point out the connection to school mathematics (see Klein 1908/2016, p. 2). As described in Schubring (this book), Klein expected his students to have a basic knowledge of higher level mathematics, such as functions theory, number theory, and differential equations:

I shall by no means address myself to beginners, but I shall take for granted that you are all acquainted with the main features of the chief fields of mathematics. I shall often talk of problems of algebra, of number theory, of function theory, etc., without being able to go into details. You must, therefore, be moderately familiar with these fields, in order to follow me. (Klein 1908/2016, p. 1)

In teachers' education in Germany, there has been some intention to re-establish Felix Klein's ideas: In the COACTIV study, Krauss et al. (2008) stated that a large number of students lack profound knowledge in elementary mathematics and school mathematics when leaving university. In TEDS-M (Tatto et al. 2012) this was confirmed with representative samples. This led to the conclusion that

clearly, teachers' knowledge of the mathematical content covered in the school curriculum should be much deeper than that of their students. We conceptualised CK [content knowledge] as a deep understanding of the contents of the secondary school mathematics curriculum. It resembles the idea of "elementary mathematics from a higher viewpoint" (Krauss et al. 2008, p. 876)

In 2008, IMU and ICMI commissioned a project to revisit the intent of Felix Klein when he wrote *Elementary Mathematics from a Higher Standpoint*. The authors' aim was to write a book for secondary teachers that showed the connection between ongoing mathematical research and the senior secondary school curriculum ([www.kleinproject.org](http://www.kleinproject.org)).

However, in all discussions, the term *higher standpoint* was used intuitively and, without making it explicit or naming concrete characteristics, Klein's lectures were

<sup>1</sup>In Kilpatrick (this book) Klein's notion of the double discontinuity is described precisely.

<sup>2</sup>As Kilpatrick (2014) noted, the original English translation of the title using the word *advanced* as translation for *höher* is misleading, as the term *advanced* could be interpreted as "more developed," which Klein, who was aiming for a panoramic view, did not have in mind. Taking Kilpatrick's concerns into account, the new edition of Klein's lectures was released under that newly translated title.

<sup>3</sup>The latter has recently been translated into English by Marta Menghini and Gert Schubring (Klein 1902/2016). It is based on a lecture Klein held in 1901. In Klein's last years, he decided to republish it as a third part of the *Elementary Mathematics from a Higher Standpoint* series. For more information on that volume, see Meghini (this book).

assumed to have functioned as a role model. In my Ph.D. thesis (Allmendinger 2014), I attempted to help close this academic gap by analysing the lectures of Klein in an attempt to answer the guiding question: What is Klein's understanding of the term *higher standpoint*?

I decided to focus on the first volume of Klein's lecture notes, as the different approaches in all three volumes—described by Kilpatrick (this book)—make it difficult to compare them directly. In the first volume on arithmetic, algebra, and analysis, Klein includes pedagogical remarks throughout the whole lecture, while in the second volume on geometry Klein focuses in the first chapters on the mathematical aspects and then discusses pedagogical questions in a final chapter. Kilpatrick even concludes, that “the organization of the first volume allows Klein to make specific suggestions for instruction and references to textbooks and historical treatments of topics, whereas the comments in the second volume tend to be more general” (Kilpatrick 2014, p. 34).

For the analysis of the manuscript of the first volume, I used a phenomenological approach, as found in Seiffert (1970, p. 42). This approach analyses a source in its historical sense, as it concentrates on the source itself and does not focus on the historical background in the first place.

Additionally, I integrated didactic concepts and vocabulary to describe and specify Klein's procedure. I was able to show that today's movement towards improved mathematical university studies for teacher trainees bears some resemblance to and coherence with Klein's ideas.

As Klein directly comments on his intentions in his lecture notes, analysing these seems to be a possible procedure to locate the characteristics. But especially with regard to how Klein's concept is being adapted today, it is important to understand the circumstances that led Klein to construct this lecture and the conditions he faced. In Klein's days, there was no distinction between teacher trainees and mathematics students pursuing a scientific career. Therefore, the students in Klein's lectures had relatively broader background knowledge than today's teacher students. That is why I embedded my analysis in its historical context.<sup>4</sup>

In order to holistically describe Klein's understanding of the term *higher standpoint*, one must also take into account its counterpart—*elementary mathematics* (see Schubring in this book). As this term, like *higher standpoint*, has always been used quite intuitively, it is not possible to give a concrete definition.<sup>5</sup> For this article, I will use a preliminary definition: Everything is “elementary” that can be made accessible to an “averagely talented pupil” (Klein 1904, p. 9). Klein's lectures cover both subjects of the established school curriculum and subjects that Klein felt should be part of school curriculum, for example, calculus (see Meran Curriculum 1905).

The results of my analysis show that on the one hand Klein closely adheres to several principles, such as the principle of mathematical interconnectedness, the principle of intuition, the principle of application orientation, and the genetic method of

---

<sup>4</sup>A good overview of this historical context can be found in Schubring (2007).

<sup>5</sup>In the beginning of the 20th century some mathematicians aimed to give a definition of elementary mathematics (e.g., Weber 1903; Meyer and Mohrmann 1914), as discussed in Allmendinger (2014).

teaching. Those principles contributed greatly to the development of Klein's *Higher Standpoint*. In addition, Klein conveys a multitude of perspectives—mathematical, historical, and didactic—that widen this higher standpoint.

In the present chapter, I focus on presenting the different perspectives that characterise Klein's *Higher Standpoint*. I specify them generically by reference to the chapter in Klein's lecture notes on logarithmic and exponential functions (Klein 1908/2016, pp. 153–174) described by Kilpatrick (this book). This chapter is paradigmatic and outstanding at the same time, as all characteristics I found in Klein's lecture cumulate in this chapter. Therefore, it seems appropriate to outline Klein's intentions and his proceeding.

All three perspectives can clearly be noted in this chapter: Klein starts reviewing and reflecting the current teaching practice and making suggestions on how to improve the introduction of this theme in school. On the one hand, he regards the subject virtually from a didactic perspective. On the other hand, he gives an overview of its historical development and thus an insight in his historical perspective. Finally, Klein enhances the knowledge on logarithmic functions by adopting the standpoint of function theory.

## 14.2 Klein's Didactic Perspective

I start by taking a closer look at the didactic perspective: the standpoint of mathematical pedagogy. Klein had always shown great interest in questions of mathematical education [as noted, for example, in Schubring (2007) and Mattheis (2000)]. He was one of the main protagonists in the Meran reform, supporting and accelerating the integration of perception of space and the prominence to the notion of function, which culminates in the introduction of calculus. In my analysis, I was able to show that all the demands made in the Meran reform strongly influence Klein's lecture: Klein adheres closely to the "primacy of intuition" ("*Primat der Anschauung*"), and nearly all aspects of the notion of function that Krüger (2000) carved out in her Ph.D. thesis can be detected.

However, Klein's *Higher Standpoint* can be understood in the first place from the didactic perspective as a methodological one: Klein intends to prepare future teachers for their upcoming tasks and to provide them with the necessary overview and background. However, eventually he also criticises the common procedures in school and presents alternatives.

As in many other chapters, Klein starts his chapter on logarithmic and exponential functions by giving a short overview of the curriculum and teaching practice: "Let me recall briefly the familiar curriculum of the school, and the continuation of it to the point at which the so-called algebraic analysis begins" (Klein 1908/2016, p. 155).

By starting with powers of the form  $a = b^c$  with  $c$  a positive integer, Klein describes how one extends the notion for negative, fractional, and finally irrational values. The logarithm is then defined as that value  $c$ , which gives a solution to the named equation.

What matters is that he critically reflects on this procedure: To uniquely extend the values to fractional values, stipulations have to be made<sup>6</sup> that—in Klein's opinion—"appear to be quite arbitrary...and can be made clear only with the profounder resources of function theory" (Klein 1908/2016, p. 156).

If we now admit all real, including irrational, values of  $y$ , it is certainly not immediately clear why the principal values which we have been marking on the right now constitute a continuous curve and whether or not the set of negative values which we have marked on the left do similarly permit such a completion. (Klein 1908/2016, p. 156)

As we will see in the latter sections, he analyses the mathematical content from a historical and mathematical point of view in order to develop an alternative that avoids the emphasised problems.

Today, Klein's suggested approach of introducing the logarithmic function as the integral of  $1/x$  is often used as an example for a concept, which Freudenthal (1973) called *antididactical inversion*, which means that the smoothed end product of a historical learning process becomes the point of departure in education (e.g., Kirsch 1977). Nevertheless, Klein presents mathematical reorganisations of school mathematical contents in order to bypass obstacles that the students might face. He presents a mathematical analysis with an interest its impact on school practice.

Although Klein dedicates the implementation in the classroom to the "experienced school man" (Klein 1908/2016, p. 168), he has concrete ideas towards teaching methods, which he mentions in remarks throughout the whole lecture:

I am thinking, above all, of an impregnation with the genetic method of teaching, of a stronger emphasis upon space perception, as such, and, particularly, of giving prominence to the notion of function, under fusion of space perception and number perception! (Klein 1908/2016, p. 88)

### 14.3 Klein's Historical Perspective

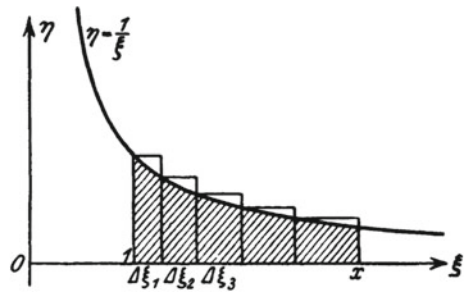
Klein has always shown a strong interest in historical development (e.g., Klein 1926). He is said to be one of the first representatives of a historical genetic method of teaching, as shown in Schubring (1978). Klein vindicates his approach with the help of the biogenetic fundamental law "according to which the individual in his development goes through, in an abridged series, all the stages in the development of the species" (Klein 1908/2016, p. 292).<sup>7</sup> The lectures in *Elementary Mathematics from a Higher Standpoint* can be seen as an example of Klein's understanding of this historical genetic method itself.

---

<sup>6</sup>For example, there are two values of  $x$  that solve the equation  $x = b^2$ . Generally, in the equation for every  $y = m/n$ , completely reduced, with an even value for  $n$  there are  $n$  different solutions. One decides to stipulate that that should be the so-called principal root.

<sup>7</sup>Nowadays this law is highly criticised, as it suggests that every individual has to go through the same learning process (see Wittmann 1981, p. 133).

**Fig. 14.1** Generalisation of Bürigi's approach (Klein 1908/2016, p. 167)



In Klein's opinion, following historical development is the "only scientific" way of teaching mathematics. That is why he aims to provide the future teachers with the necessary background to use this method in school. This requires profound knowledge of historical development, which Klein allocates by steadily integrating historic remarks and overviews:

An essential obstacle to the spreading of such a natural and truly scientific method of instruction is the lack of historical knowledge which so often makes itself felt. In order to combat this, I have made a point of introducing historical remarks into my presentation. (Klein 1908/2016, p. 292)

Klein therefore constantly adds historical remarks and digression, which are both rich in content and distinguished by a rather scarce depiction. They are sophisticated sections that demand intensive post-processing from the students. In the chapter on logarithmic and exponential functions, the reader will find one of the rarer parts of the lecture, where Klein extensively shows his understanding of a historical genetic approach: "In short, if we really wish to press forward to a full understanding of the theory of logarithms, it will be the best to follow the historical development in its broad outlines" (Klein 1908/2016, p. 157).

Klein shows a different approach to the definition of the logarithmic function by describing the historical development of the theory: The main idea Bürigi had when he was calculating his logarithmic tables, was to avoid the stipulation that was shown above by choosing a basis  $b$  close to 1. In this way, the calculation with integer valued  $y$ 's lead to a table, where the distance between neighbouring values of  $x$  was rather small.

Before finishing his historic overview, Klein shows how to set up a differential equation by generalising Bürigi's approach (see Fig. 14.1). His analysis and calculations lead to the definition of the natural logarithm as

$$\int \frac{1}{x} dx$$

This leads Klein to conclude:

I should like to outline briefly once more my plan for introducing the logarithm into the schools, in this simple and natural way. The first principle is that the proper source from which to bring in new functions is the quadrature of known curves. (Klein 1908/2016, p. 167)



In this way, the historic parts in Klein's lecture notes have a special meaning for mathematical education in general. They lead to new approaches to different subjects. But the historic remarks have a benefit for mathematics teachers' education as well. Nickel (2013) gave a classification on how and why the integration of the history of mathematics should be part of teachers' education. One can place Klein's historical perspective clearly in this suggested classification: Klein uses the history of mathematics as a tool of comfort and motivation by presenting fascinating anecdotes and as a tool to improve insightful contact with mathematics by reliving its historical development. It becomes obvious that Klein does not teach the history of mathematics as an autonomous learning subject.<sup>8</sup>

## 14.4 Klein's Mathematical Perspective

Last, Klein's understanding of a higher standpoint on elementary mathematics involves being capable of connecting school mathematics with the higher mathematics taught at university. This especially involves having background knowledge. Therefore higher mathematics becomes a tool to explain the contents of school mathematics.

In the chapter on logarithmic and exponential functions, the section on the standpoint of function theory is a typical example. Function theory is not part of school mathematics—neither in Klein's day nor today—but in Klein's opinion, the teacher has to have a basic knowledge of that subject to adequately understand the definition of the logarithm: "Let us, finally, see how the modern theory of functions disposes of the logarithm. We shall find that all the difficulties which we met in our earlier discussion will be fully cleared away" (Klein 1908/2016, p. 168).

Klein shows that the logarithm is defined by means of the integral

$$\omega = \int \frac{d\zeta}{\zeta}$$

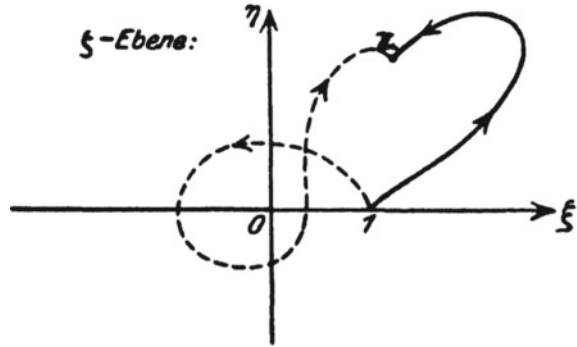
"where the path of integration is any curve in the  $\zeta$ -plane joining  $\zeta = 1$  to  $\zeta = z$ " (Klein 1908/2016, p. 168; see Fig. 14.2). He further states, that the integral has an infinite number of values. A definite value can be determined, if we "slit the plane along the negative real axis and agree that the path integration shall not cross this cut" (Klein 1908/2016, p. 168). Giving an insight into the means of function theory, Klein is able to show that "if  $n$  is even, the negative real values of  $b^{m/n}$  will constitute a set which is everywhere dense, but they belong to an entirely different one of our infinitely many functions, and cannot possibly combine to form a continuous analytic curve" (Klein 1908/2016, p. 170).

By this, he provides an answer to question of why the principal roots were chosen to build the logarithm function.

---

<sup>8</sup>The complete classification can be found in Nickel (2013).

**Fig. 14.2** Complex Logarithms (Klein 1908/2016, p. 170)



In this last part, one aspect of Klein’s understanding of the higher standpoint becomes evident. Klein does not expect his students to teach this prospectively to their pupils:

I hardly believe, however, that the average pupils, even in the Prima, can be carried so far.... I am sure all the more desirous that the teacher shall be in full possession of all the function-theoretic connections that come up here: For the teacher’s knowledge should be far greater than that which he presents to his pupils. He must be familiar with the cliffs and the whirlpools in order to guide his pupils safely past them. (Klein 1908/2016, p. 162)

Additionally, Klein uses higher mathematics and its vocabulary for a precise and significant representation of school mathematics. He occasionally has to discuss up-to-date research, as in his remarks on the *Logical Foundations of Operations with Integers* (Klein 1908/2016, pp. 10–16). School mathematics is also shown to be the origin of research: The search for algebraic solutions of equations is an interrogation that is easily accessible to pupils and is covered in school. However to understand that an equation of the fifth degree or higher is not algebraically soluble, one has to have profound knowledge of Galois’ theory.

All these examples give evidence of a mathematical perspective on the contents of math classes. Klein shows how university studies are connected to mathematical school contents in order to oppose the double discontinuity: He connects elementary mathematics with “higher” mathematics—literally discussing elementary mathematics from a higher standpoint. It can be assumed, that this mathematical perspective shows Klein’s higher standpoint in the narrow sense of the word.

Summarising, from a didactic perspective, Klein promotes a reflective attitude on the school curriculum and provides possible alternatives to the current teaching practice. Additionally, a historical perspective helps to place the object of investigation in an overall context and provide knowledge on the mathematical history of its development. Finally, from a mathematical perspective, the characteristics of Klein’s higher standpoint on elementary mathematics are a high degree of abstraction, formal technical language, and a foundation of school mathematics’ contents.

## 14.5 Higher Mathematics from an Elementary Standpoint?

In the chapter “Concerning the modern development and the general structure of mathematics” (Klein 1908/2016, pp. 81–88), described by Kilpatrick (this book), Klein introduces two different processes of growth in the history of mathematical development (calling them Plan A and Plan B), “which now change places, now run side by side independent of one another, now finally mingle” (Klein 1908/2016, p. 81). While in Plan A, each mathematical branch is developed separately using its own methods, Plan B aims at a “fusion of the perception of number and space” (Klein 1908/2016, p. 81)—mathematics is to be seen as a whole.

According to Klein, the education of mathematics in school and at university, should clearly be guided by Plan B: “Every movement for the reform of mathematical education must therefore for a stronger emphasis on the direction of B.... It is my aim that this lecture course shall serve this tendency” (Klein 1908/2016, p. 88).

In this chapter, Klein expresses his attitude towards mathematics education in general, as shown in the Meran reform, and legitimates the procedure in his *Elementary Mathematics from a Higher Standpoint* lectures (see Allmendinger and Spies 2013): The main principles, which are characteristic for the favoured Plan B and which Klein wants future teachers to implement in their school classes, are principles Klein attempts to pursue himself: the principle of interconnectedness, the principle of intuition, the principle of application orientation, and the genetic method of teaching.

By applying these principles, all “will all seem elementary and easily comprehensible” (Klein 1908/2016, p. 223). As a result, two different orientations can be identified in the lectures: Klein regards both elementary mathematics from a higher standpoint and higher mathematics from an elementary standpoint. This hypothesis can be underlined by Kirsch's aspects of simplification (see Kirsch 1977), as those show a striking resemblance to Klein's procedure in his lectures and his principles.

## 14.6 A Higher Standpoint: First Conclusions

As shown, Klein's *Elementary Mathematics from a Higher Standpoint* can be characterised by its underlying principles on the one hand and by a constant variation of different perspectives on the other hand. Both the principles and the perspectives aim for a connection between school and university mathematics, in order to overcome the double discontinuity: The mathematical, the historical, and the didactic perspectives help to restructure the higher standpoint on elementary mathematics. In particular, the didactic perspective shows an orientation that distinguishes Klein's lectures from other contemporary lectures on elementary mathematics. Moreover, the underlying principles show an additional orientation: Klein also demonstrates higher mathematics from an elementary standpoint.

Toeplitz (1932), however, questioned whether the establishment of lectures on elementary mathematics, which, for example, Klein had in mind, would be the right

way to prepare students for their future tasks. He criticised the selected contents: In Toeplitz's opinion, a teacher does not necessarily need to know the proof for the transcendence of  $e$ , to give just one example. He also had the opinion that Klein chose topics that required too much background knowledge for a lecture attempting to give an overview of the complete content of school mathematics' (see Toeplitz 1932, pp. 2f.). Toeplitz argues that a desirable higher standpoint cannot be taught in one single lecture, but has to be accomplished in every lecture of mathematical studies.

Nevertheless, the skills that accompany a higher standpoint in Toeplitz's understanding clearly resemble the ones Klein conveys in his *Elementary Mathematics from a Higher Standpoint*. Altogether, Klein's lectures can be understood as an archetype for current university studies, although adaptations have to be made depending on the given circumstances.

"It's not the task anymore to create new thoughts but to bring to light the right thoughts in the right way regarding the given circumstances" (Klein 1905, translated by the author).

## References

- Allmendinger, H. (2014). *Felix Kleins Elementarmathematik vom höheren Standpunkte aus. Eine Analyse aus historischer und mathematikdidaktischer Sicht* (SieB Vol. 4). Siegen: universi.
- Allmendinger, H., & Spies, S. (2013). Über die moderne Entwicklung und den Aufbau der Mathematik überhaupt. In M. Rathgeb, M. Helmerich, R. Krömer, K. Legnink, & G. Nickel (Eds.), *Mathematik im Prozess. Philosophische, Historische und Didaktische Perspektiven* (pp. 177–194). Wiesbaden: Springer Spektrum.
- Freudenthal, H. (1973). *Mathematik als pädagogische Aufgabe*. Stuttgart: Ernst Klett.
- Kilpatrick, J. (2014). *A higher standpoint. Materials from ICME 11*. [www.mathunion.org/icmi/publications/icme-proceedings/](http://www.mathunion.org/icmi/publications/icme-proceedings/). Regular lectures, 27–43.
- Kirsch, A. (1977). Aspekte des Vereinfachens im Mathematikunterricht. In *Didaktik der Mathematik*, 2, 87–101.
- Klein, F. (1904). Über eine zeitgemäße Umgestaltung des mathematischen Unterrichts an höheren Schulen. In F. Klein & E. Riecke (Eds.), *Neue Beiträge zur Frage des Mathematischen und Physikalischen Unterrichts an den höheren Schulen*. Leipzig und Berlin: B. G. Teubner.
- Klein, F. (1905). Bericht an die Breslauer Naturforscherversammlung über den Stand des mathematischen und physikalischen Unterrichts an den höheren Schulen. *Jahresbericht der Deutschen Mathematiker-Vereinigung*, 14, 33–47.
- Klein, F. (1926). *Vorlesungen über die Entwicklung der Mathematik im 19. Jahrhundert* (Vol. 1). Berlin: Julius Springer.
- Klein, F. (1908/2016). *Elementary mathematics from a higher standpoint, volume I: Arithmetics, algebra and analysis*. (G. Schubring, Trans.). Wiesbaden: Springer.
- Klein, F. (1902/2016). *Elementary mathematics from a higher standpoint, volume III: Precision Mathematics and Approximation Mathematics*. Translated by Marta Menghini and Gert Schubring. Wiesbaden: Springer.
- Krauss, S., Baumert, J., Brunner, M., & Blum, W. (2008). Secondary mathematics teachers' pedagogical content knowledge and content knowledge: Validation of the COACTIV constructs. *ZDM Mathematics Education*, 40, 873–892.

- Krüger, K. (2000). *Erziehung zum funktionalen Denken. Zur Begriffsgeschichte eines didaktischen Prinzips*. Berlin: Logos-Verlag.
- Mattheis, M. (2000). Felix Kleins Gedanken zur Reform des mathematischen Unterrichtswesen vor 1900. *Der Mathematikunterricht*, 46(3), 41–61.
- Meran Curriculum (1905). Bericht betreffend den Unterricht in der Mathematik an den neunklassigen höheren Lehranstalten. In A. Gutzmer (Ed.), *Die Tätigkeit der Unterrichtskommission der Gesellschaft Deutscher Naturforscher und Ärzte. Gesamtbericht* (pp. 104–114). Leipzig und Berlin: B. G. Teubner.
- Meyer, W. F., & Mohrmann, H. (1914). *Enzyklopädie der mathematischen Wissenschaften mit Einschluss ihrer Anwendungen*. Leipzig und Berlin: B. G. Teubner.
- Nickel, G. (2013). Vom Nutzen und Nachteil der Mathematikgeschichte für das Lehramtsstudium. In H. Allmendinger, Henrike, K. Lengnink, A. Vohns, & G. Wickel (Eds.), *Mathematik verständlich unterrichten—Perspektiven für Schule und Hochschule* (pp. 253–266). Wiesbaden: Springer Spektrum.
- Schubring, G. (1978). *Das genetische Prinzip in der Mathematikdidaktik*. Stuttgart: Klett-Cotta.
- Schubring, G. (2007). Der Aufbruch zum „funktionalen Denken“: Geschichte des Mathematikunterrichts im Kaiserreich. *N.T.M.*, 15, 1–17.
- Seiffert, H. (1970). *Einführung in die Wissenschaftstheorie. Band 2. Phänomenologie, Hermeneutik und historische Methode, Dialektik*. München: Beck.
- Tatto, M. T., Schwille, J., Senk, S. L., Ingvarson, L., Rowley, G., Peck, R., et al. (2012). *Policy, practice, and readiness to teach primary and secondary mathematics in 17 countries: Findings from the IEA Teacher Education and Development Study in Mathematics (TEDS-M)*. Amsterdam: IEA.
- Toeplitz, O. (1932). Das Problem der “Elementarmathematik vom höheren Standpunkt aus”. *Semesterberichte zur Pflege des Zusammenhangs von Universität und Schule aus den mathematischen Seminaren*, 1, 1–15.
- Weber, H. (1903). Über die Stellung der Elementarmathematik in der mathematischen Wissenschaft. In *Jahresbericht der Deutschen Mathematiker-Vereinigung*, 12, 398–401.
- Wittmann, E. (1981). *Grundfragen des Mathematikunterrichts*. Wiesbaden: Vieweg + Teubner.

**Open Access** This chapter is licensed under the terms of the Creative Commons Attribution 4.0 International License (<http://creativecommons.org/licenses/by/4.0/>), which permits use, sharing, adaptation, distribution and reproduction in any medium or format, as long as you give appropriate credit to the original author(s) and the source, provide a link to the Creative Commons license and indicate if changes were made.

The images or other third party material in this chapter are included in the chapter's Creative Commons license, unless indicated otherwise in a credit line to the material. If material is not included in the chapter's Creative Commons license and your intended use is not permitted by statutory regulation or exceeds the permitted use, you will need to obtain permission directly from the copyright holder.



# Chapter 15

## A Double Discontinuity and a Triple Approach: Felix Klein's Perspective on Mathematics Teacher Education



Jeremy Kilpatrick

**Abstract** Felix Klein was the first to identify a central problem in the preparation of mathematics teachers: a double discontinuity encountered in going from school to university and then back to school to teach. In his series of books for prospective teachers, Klein attempted to show how problems in the main branches of mathematics are connected and how they are related to the problems of school mathematics. He took three approaches: The first volume built on the unity of arithmetic, algebra, and analysis; the second volume attempted a comprehensive overview of geometry; and the third volume showed how mathematics arises from observation. Klein's courses for teachers were part of his efforts to improve secondary mathematics by improving teacher preparation. Despite the many setbacks he encountered, no mathematician has had a more profound influence on mathematics education as a field of scholarship and practice.

**Keywords** Klein · Higher standpoint · Mathematical knowledge for teaching Capstone · Genetic method

As an undergraduate mathematics major at the University of California, Berkeley, in the 1950s, I took a course entitled “Elementary Mathematics for Advanced Students” in which we used two books by Felix Klein with the title *Elementary Mathematics from an Advanced Standpoint*. The subtitles were *Arithmetic*, *Algebra*, *Analysis* and *Geometry*. We used Dover reprints (Fig. 15.1) of English translations that had first been published in 1932 and 1939, respectively, by Macmillan.

The course was what would be termed today a “capstone” course, meaning that it came near the end of our program and was designed to demonstrate our mastery of mathematics. Topics in the course included continued fractions and Pythagorean triples represented graphically, quaternions, plane algebraic (normal) curves,

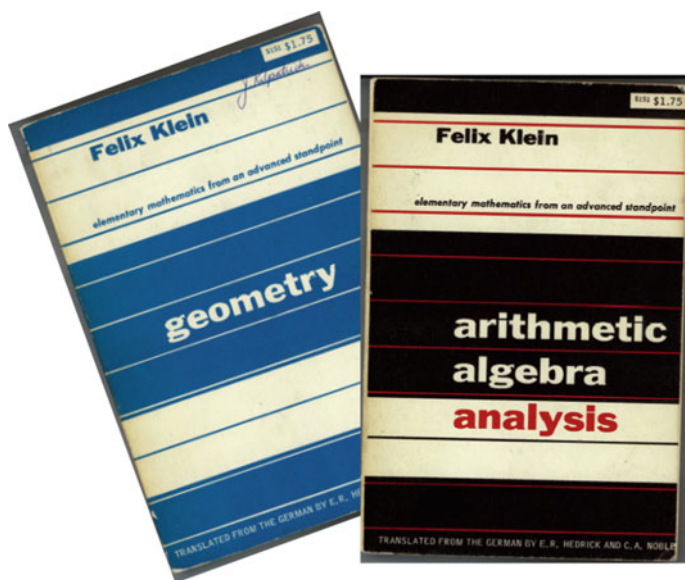
---

Portions of this chapter first appeared in Kilpatrick (2008).

---

J. Kilpatrick (✉)  
Regents Professor of Mathematics Education Emeritus, University of Georgia,  
105 Aderhold Hall, Athens, GA 30602-7124, USA  
e-mail: jkilpat@uga.edu

© The Author(s) 2019  
H.-G. Weigand et al. (eds.), *The Legacy of Felix Klein*, ICME-13 Monographs,  
[https://doi.org/10.1007/978-3-319-99386-7\\_15](https://doi.org/10.1007/978-3-319-99386-7_15)



**Fig. 15.1** Dover reprints of Klein (1924/1932, 1925/1939)

logarithm defined as area under a hyperbola, and geometric transformations. In the introduction to the volume on geometry, Klein points out that in presenting geometric topics, he first offers a general survey of the field, providing a frame into which students can insert items of mathematical knowledge that they have learned. Then he says, “Only afterward shall I emphasize that *interest in mathematical instruction* which was always my starting point [for the first volume]” (Klein 1925/1939, p. 1). He goes on to say that, as in the volume on arithmetic, algebra, and analysis, he will “draw attention . . . to the *historical development of the science*” (p. 2). He also notes that despite the separation of mathematical topics into two volumes, he definitely advocates

a tendency which I like best to designate by the phrase “*fusion of arithmetic and geometry*”—meaning by arithmetic, as is usual in the schools, the field which includes not merely the theory of integers, but also the whole of algebra and analysis. (p. 2)

In print for over a century, the volumes of Klein’s textbook have been used in countless courses for prospective and practicing teachers. The first two volumes were translated into English in 1924 and 1925, respectively, and into Spanish in 1927. Other translations followed. Not until 2016, however, was the third volume translated into English.

Klein’s three volumes provide excellent early examples of what today is termed *mathematical knowledge for teaching* (Ball and Bass 2000; Bass 2005). The organization of the first volume, with pedagogical issues and difficulties facing the teacher taken up after each topic rather than relegated to a final chapter, seems much superior

to that of the second. The organization of the first volume allows Klein to make specific suggestions for instruction and references to textbooks and historical treatments of topics, whereas the comments in the second volume tend to be more general. In the third volume, he makes no specific mention of pedagogy except briefly in the preface. Klein's courses for teachers were part of his reform efforts to improve secondary mathematics by improving the preparation of teachers. Despite the many setbacks he encountered, no mathematician has had a more profound influence on mathematics education as a field of scholarship and practice.

## 15.1 A Double Discontinuity

In the introduction to the first volume, Klein (1924/1932) noted the phenomenon of recent interest by university faculty in mathematics and natural sciences in the suitable training of prospective teachers. He noted that until recently, faculty had been exclusively concerned with their science "without giving a thought to the needs of the schools, without even caring to establish a connection with school mathematics" (p. 1). Considering the result of this practice, he noted that young university students found themselves, "at the outset, confronted with problems which did not suggest, in any particular, the things with which [they] had been concerned at school. Naturally [they] forgot these things quickly and thoroughly" (p. 1). Then when these students became teachers, they found themselves expected to teach traditional elementary mathematics "in the old pedantic way. . . . [They were] scarcely able, unaided, to discern any connection" (p. 1) between that task and their university mathematics. Therefore, beginning teachers "soon fell in with the time honored way of teaching . . . [Their] university studies remained only a more or less pleasant memory" (p. 1) that had no influence on their teaching.

He went on to say, "There is now a movement to abolish this double discontinuity, helpful neither to the school nor to the university" (Klein 1924/1932, p. 1). In Klein's view, the discontinuity meant that school mathematics and university mathematics typically seemed to have no connection. The courses enshrined in Klein's books assumed that prospective teachers were familiar with the main branches of mathematics, and he attempted to show how problems in those branches are connected and how they are related to the problems of school mathematics.

To eliminate the discontinuity, Klein (1924/1932) had two proposals: (a) update the school mathematics curriculum, and (b) "take into account, in university instruction, the needs of the school teacher" (p. 1). His goal was to show

*the mutual connection between problems in the various fields, a thing which is not brought out sufficiently in the usual lecture course, and more especially to emphasize the relations of these problems to those of school mathematics. In this way I hope to make it easier for you to acquire that ability which I look upon as the real goal of your academic study: the ability to draw (in ample measure) from the great body of knowledge there put before you a living stimulus for your teaching. (pp. 1–2)*



In this quotation, one hears echoes of Klein's early views of mathematics education expressed in his inaugural address (*Antrittsrede*) of 1872 when he became professor at Erlangen at the age of 23. The problem of the secondary school curriculum was, for Klein, neither insufficient time nor inadequate content:

What is required is more interest in mathematics, livelier instruction, and a more spirited treatment of the material! . . .

At stake [for university teachers of mathematics] is the task . . . of raising the standards of mathematical education for later teaching candidates to a level that has not been seen for many years. If we educate better teachers, then mathematics instruction will improve by itself, as the old consigned form will be filled with a new, revitalized content! . . .

[Therefore,] we, as university teachers, require not only that our students, on completion of their studies, know what must be taught in the schools. We want the future [teachers] to stand *above* [their] subject, that [they] have a conception of the present state of knowledge in [their] field, and that [they] generally be capable of following its further development. (Klein, in Rowe 1985, p. 139)

To address the school-to-university discontinuity, Klein proposed (a) taking the function concept as the focus of school instruction, and (b) making calculus the target of the secondary school curriculum. To address the university-to-school discontinuity, he proposed (a) offering university courses that would show connections between problems in various fields of mathematics (e.g., algebra and number theory), and (b) developing university courses in elementary mathematics from a higher standpoint. Finally, to address both discontinuities, Klein argued that instructors should make instruction livelier and more interesting, which meant that school mathematics should be more intuitive, less abstract, and less formal, and university mathematics should include more applied mathematics. Throughout his career, Klein saw school mathematics as demanding more dynamic teaching and consequently university mathematics as needing to help prospective teachers “stand above” their subject.

## 15.2 A Triple Approach

In each of the three volumes of his books for teachers, Klein took a different approach. In the first volume, to balance existing treatments of topics in school mathematics, Kline attempted to show the prospective teacher specific examples of how three seemingly unrelated branches of mathematics could be integrated. In the second volume, given that there were no unified treatments of geometry in the literature, he offered such a treatment, postponing attention to geometry teaching until the end of the volume. In the third volume, he had yet a different agenda: to show the contrast and emphasize the link between mathematics and its applications.

### 15.2.1 *Arithmetic, Algebra, Analysis*

To conclude the introduction to the first volume, Klein cited several recent discussions of mathematics instruction that supplemented the topics he would be treating. He pointed out, however, that some treatments of elementary mathematics build it up “systematically and logically in the mature language of the advanced student, [whereas] the presentation in the schools . . . should be psychological and not systematic. . . . A more abstract presentation will be possible only in the upper classes” (Klein 1924/1932, pp. 3–4). He also pointed out that he was adopting a “progressive” stance:

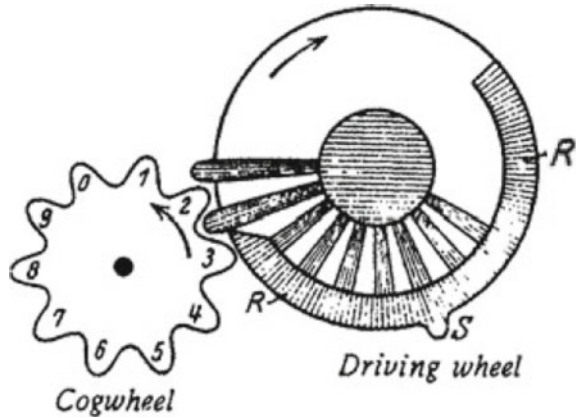
We, who are called the reformers, would put the function concept at the very center of instruction, because, of all the concepts of the mathematics of the past two centuries, this one plays the leading role wherever mathematical thought is used. We would introduce it into instruction as early as possible with constant use of the graphical method, the representation of functional relations in the  $x y$  system, which is used today as a matter of course in every practical application of mathematics. . . . Strong development of space perception, above all, will always be a prime consideration. In its upper reaches, however, instruction should press far enough into the elements of infinitesimal calculus for the natural scientist or insurance specialist to get at school the tools which will be indispensable [for him or her]. (p. 4)

Klein was anticipating the emphasis that he would put in the subsequent text on applications, geometric illustrations, space perception, and the historical development of the field.

The book is divided into three parts—arithmetic, algebra, analysis—together with supplementary sections on transcendental numbers and set theory. The main topics in the first part are the natural numbers; the extension to negative numbers, fractions, and irrationals; number theory; and complex numbers. An example of Klein’s emphasis on practical applications is his extended treatment of the mechanism for calculating machines (see Fig. 15.2, which shows how multiplication is performed). Later in the book, when discussing logarithmic tables, Klein (1924/1932) mentions that such a machine “makes logarithmic tables superfluous. At present, however, this machine is so expensive that only large offices can afford it. When it has become considerably cheaper, a new phase of numerical calculation will be inaugurated” (p. 174)—truly prophetic words.

Klein ends the discussion of arithmetic with a brief survey of the modern development of mathematics. Reviewing the first edition, John Wesley Young (1910) said, “It is a mere sketch, but it is a masterpiece” (p. 258). In the survey, Klein distinguishes two processes by which mathematics has grown, each of which leads to a different plan for instruction. In Plan A, the plan more commonly followed in school and in elementary textbooks, each branch of mathematics is developed separately for its own sake and with its own methods. The major branches—algebraic analysis and geometry—make occasional contact but are not unified. In Plan B, in contrast, “the controlling *thought is that of analytic geometry, which seeks a fusion of the perception of number with that of space*” (Klein 1924/1932, p. 77). Mathematics is to be seen as a connected whole, with pure and applied mathematics unified. Not surprisingly, Klein argues that Plan B is more likely than Plan A to engage those

**Fig. 15.2** Driving wheel and cogwheel in a calculating machine (Klein, 1933/2016a, p. 22)



pupils “not endowed with a specific abstract mathematical gift” (p. 78). Both plans have their place, and neither should be neglected. But secondary school instruction

has long been under the one-sided control of the Plan A. Any movement toward reform of mathematical teaching must, therefore, press for more emphasis upon direction B. [Klein is] thinking, above all, of an impregnation with the genetic method of teaching, of a stronger emphasis upon space perception, as such, and, particularly, of giving prominence to the notion of function, under fusion of space perception and number perception!”. (p. 85)

Klein then argues that his aim in this volume is to follow Plan B, thereby balancing existing books on elementary mathematics that almost invariably follow Plan A.

The main topics of the second part of the book, on algebra, concern the use of graphical and geometric methods in the theory of equations. Klein begins by citing textbooks on algebra and pointing out that the “one-sided” approach he will take is designed to emphasize material neglected elsewhere that can nevertheless illuminate instruction. His approach to solving real equations uses the duality of point and line coordinates, and he draws on the theory of functions of a complex variable to show how to represent, using conformal mapping, the solution of equations with a complex parameter.

The third part of the book, on analysis, concerns elementary transcendental functions and the calculus. It begins with a discussion of the logarithm, which provides a good illustration of Klein’s approach. He first considers how the logarithm is introduced in school—by performing the operation inverse to that of raising to a power—and draws attention to various difficulties and possible confusions that accompany such an approach, including the absence of any justification for using the number  $e$  as the base for what are, for the pupil, inexplicably called the “natural” logarithms. After discussing the historical development of the concept, emphasizing the pioneering work of Napier and Bürgi, Klein proposes an introduction that would define the logarithm of  $a$  as the area between the hyperbola  $xy = 1$ , the  $x$ -axis, the ordinate  $x = 1$ , and the ordinate  $x = a$ , first approximating the area as a sum of rectangles and then taking the integral. The section on the logarithm ends by considering

a complex-theoretic view of the function, which Klein argues that teachers should know even though it would not be an appropriate topic in school. In Young's (1910) review of the book, he points at Klein's treatment of the logarithm as the only one of his proposed reforms that would not be practical in the United States (and perhaps not even in Germany) since pupils need to use logarithms before they encounter hyperbolas, not to mention integrals.

The trigonometric functions and hyperbolic functions are also treated from the point of view of the theory of functions of a complex variable, and the part ends with an introduction to the infinitesimal calculus that relies heavily on Taylor's theorem and that includes historical and pedagogical considerations. The supplement at the end of the volume contains a proof of the transcendence of  $e$  and  $\pi$  and a brief, lucid introduction to set theory. As noted in Schubring (2016), the two appendices from Klein (1933/2016a) were inexplicably omitted from the first English translation.

### 15.2.2 Geometry

In the second volume, Klein (1909, 1925, 1925/1939) takes a different approach than in the first. Arguing that there are no unified textbook treatments of geometry, as there are for algebra and analysis, he proposes to give a comprehensive overview of geometry, leaving all discussion of instruction in geometry for a final chapter (unfortunately not included in the first English translation). Two supplements to the third edition that were prepared by Klein's colleague Fritz Seyfarth in consultation with Klein "concern literature of a scientific and pedagogic character which was not considered in the original text" (Klein 1925/1939, p. vi; the supplements were not translated into English either, but they do appear in Klein 1926/2016b).

The second volume, like the first, has three parts. The first concerns the simplest geometric forms; the second, geometric transformations; and the third, a systematic discussion of geometry and its foundations. Not surprisingly, Klein's innovative characterization of geometries as the invariants of their symmetry groups, from his famous Erlangen program (see, e.g., Bass 2005; Schubring n.d.), forms the basis of his discussion of the organization of geometry. In the discussion of foundations, Klein (1925/1939) emphasizes the importance of non-Euclidean geometry "as a very convenient means for making clear visually relations that are arithmetically complicated" (p. 184):

*Every teacher certainly should know something of non-euclidean geometry. . . . On the other hand, I should like to advise emphatically against bringing non-euclidean geometry into regular school instruction (i.e., beyond occasional suggestions, upon inquiry by interested pupils), as enthusiasts are always recommending. Let us be satisfied if the preceding advice is followed and if the pupils learn really to understand euclidean geometry. After all, it is in order for the teacher to know a little more than the average pupil. (p. 185)*

The third part ends with a discussion of Euclid's *Elements* in its historical context.

In the final chapter, Klein surveys efforts to reform the teaching of elementary geometry in England, France, Italy, and Germany. The supplement contains some

additional observations on questions of elementary geometry and updated material on reform in the four countries, particularly reports prepared for the surveys of teaching practices and curricula that had been initiated in 1908 during Klein's presidency of the *Commission internationale de l'enseignement mathématique* (CIEM, anglicized as the International Commission on the Teaching of Mathematics).

### 15.2.3 *Precision Mathematics and Approximation Mathematics*

The final volume in the series, Klein (1928/2016c), takes yet a third approach. As Marta Menghini and Gert Schubring point out in their introduction to the 2016 English translation, Klein maintained the view throughout his career that instruction needs to link mathematics to its applications. Because mathematics arises from observation and then transcends that observation to become abstract, learners need to see how the process works. Klein wanted the process to be intuitive:

The third volume focuses on those properties that applied mathematicians take for granted when studying certain phenomena from a mathematical point of view. These properties must be seen as supplementary conditions (and constraints) to be required for the ideal objects of pure mathematics. However, in the meantime, these very proper ties prove to be the more intuitive ones. Therefore the comparison moves towards another field: it is a comparison between properties that can be considered only in the theoretical field of abstract mathematics and properties that can be grasped by intuition. Here the problem proves to become pertinent for mathematics teaching. (Menghini and Schubring 2016, pp. vii–viii)

The third volume had been originally published in 1902 but was revised and put at the end of the series because, as Klein (1924/1932) noted in his introduction to the third edition of the first volume, it had been “designed to bridge the gap between the needs of applied mathematics and the more recent investigations of pure mathematics” (p. v.), a somewhat different purpose than that of the first two volumes, which were designed “to bring to the attention of secondary school teachers of mathematics and science the significance for their professional work of their academic studies, especially their studies in pure mathematics” (p. v). As Klein's colleague Seyfarth (1928/2016) pointed out in the introduction to the third edition:

The lecture notes, in their lithographic form, have for a long time been cited in mathematical literature with the title “applications of differential and integral calculus to geometry (a revision of the principles)”. The change of title is due to the personal request of Felix Klein, with whom I had—in the last two months before his death—a series of conversations about the work required for their publication. Klein believed that the new title [“precision mathematics and approximation mathematics”] would better meet the goals of the notes than the former. (p. xiii)

Klein's third volume for prospective teachers, like the previous two, attempts to help them get perspective on their forthcoming practice—to “stand above” its content. Discussing the mathematics a teacher needs to know, Klein (1924/1932) wrote: “The teacher's knowledge should be far greater than that which he presents

to his pupils. He must be familiar with the cliffs and the whirlpools in order to guide his pupils safely past them” (p. 162). The metaphor here is that of guide, someone who knows the mathematical terrain well and can conduct his or her pupils through it without them getting lost or injured. Klein went on to discuss how the novice teacher needs to be equipped to counteract common misperceptions of mathematical ideas:

If you lack orientation, if you are not well informed concerning the intuitive elements of mathematics as well as the vital relations with neighboring fields, if, above all, you do not know the historical development, your footing will be very insecure. You will then either withdraw to the ground of the most modern pure mathematics, and fail to be understood in the school, or you will succumb to the assault, give up what you learned at the university and even in your teaching allow yourself to be buried in the traditional routine. (p. 236)

Klein's goal in the third volume was to help the prospective teacher of mathematics maintain the link between the different scientific fields and understand how mathematics arises from observation.

### 15.3 Klein and Mathematics Teacher Education

Like many mathematicians, Felix Klein spent much of his time working on issues of mathematics education once he was no longer doing research in mathematics. Unlike most of them, however, he had pursued such issues throughout his career. As noted above, Klein's Erlangen inaugural address of 1872 dealt with mathematics education (Rowe 1983, 1985). In it, he deplored the lack of mathematical knowledge among educated people. He saw that lack as symptomatic of a growing division between humanistic and scientific education, a division in which mathematics is uniquely positioned: “Mathematics and those fields connected with it are hereby relegated to the natural sciences and rightly so considering the indispensability of mathematics for these. On the other hand, its conceptual content belongs to neither of the two categories” (Rowe 1985, p. 135). Observing that like all sciences, mathematics is undertaken for its own sake, Klein goes on to argue that “it also exists in order to serve the other sciences as well as for the formal educational value that its study provides” (p. 137).

In the inaugural address at Erlangen, Klein expressed a neohumanistic view of how mathematics ought to appear in school and university instruction, a view he was later to modify in light of his experience. After teaching at the technical institute in Munich from 1875 to 1880, for example, he adopted a more expansive outlook on the mutual roles of mathematics, science, and technology in modern education. When he became professor of geometry at Leipzig in 1880, he began to promote the teaching of applied mathematics in universities as well as in technical institutes. Klein's ultimate goal was to make mathematics a foundational discipline in tertiary education, and to achieve that goal, he initiated a reform of secondary mathematics education so that it would include the calculus. In Erlangen, however, he had said that livelier teaching rather than new subject matter was what the secondary schools needed: In autobiographical notes he made in 1913 (Rowe 1985, p. 125), he summarized what

he had said in that address: “*An den Gymnasien auszubauen: Interesse. Leben und Geist. Kein neuer Stoff* [To develop in the high schools: Interest. Life and spirit. No new material].” He then added a marginal remark reflecting his revised opinion that the secondary curriculum did need new material: “*Da bin ich nun anderen Sinnes geworden* [I have changed my mind about that].” After 40 years of teaching, Klein also reversed his view that prospective teachers should conduct an independent study on any topic whatsoever. In private notes made available to his colleague Wilhelm Lorey (quoted in Rowe 1985), he wrote:

I would now suggest that teaching candidates of average talent should confine themselves to such studies as will be of fundamental importance in the later exercise of their profession, while everything beyond this should be reserved for those with unusual talent or favorable circumstances. (p. 128)

A final comment in Klein’s (quoted in Rowe 1985) autobiographical notes suggests the toll his battles for reform had taken: “When one is young, one works much more hastily and unsteadily, one also believes the ideals will soon be attained” (p. 126).

Nonetheless, Klein was successful in reforming the secondary school curriculum as well as in creating university courses for teachers. His goal had long been to raise the level of mathematics instruction in both the technical institutes and the universities, and he came to realize that the key to achieving that goal would be to raise the level of secondary mathematics instruction to include the calculus, thereby raising the level of tertiary instruction (Schubring 1989). To push for reform in secondary and tertiary curricula, Klein forged an alliance among teachers, scientists, and engineers, and he also helped the international commission (CIEM) become an agent for curricular change. His courses for teachers were part of his reform efforts to improve secondary mathematics by improving the preparation of teachers.

## References

- Ball, D. L., & Bass, H. (2000). Interweaving content and pedagogy in teaching and learning to teach: Knowing and using mathematics. In J. Boaler (Ed.), *Multiple perspectives on mathematics teaching and learning* (pp. 83–104). Westport, CT: Ablex.
- Bass, H. (2005). Mathematics, mathematicians, and mathematics education. *Bulletin of the American Mathematical Society*, 42, 417–430.
- Kilpatrick, J. (2008). A higher standpoint. In *ICMI proceedings: Regular lectures* (pp. 26–43). <http://www.mathunion.org/icmi/publications/icme-proceedings/materials-from-icme-11-mexico/regular-lectures/>. Accessed 1 Mar 2017.
- Klein, F. (1908). *Elementarmathematik vom höheren Standpunkte aus: Arithmetik, algebra, analysis* [Elementary mathematics from a higher standpoint: Arithmetic, algebra, analysis] (Vol. 1). Leipzig, Germany: Teubner.
- Klein, F. (1909). *Elementarmathematik vom höheren Standpunkte aus: Geometrie* [Elementary mathematics from a higher standpoint: Geometry] (Vol. 2). Leipzig, Germany: Teubner.
- Klein, F. (1924). *Elementarmathematik vom höheren Standpunkte aus: Arithmetik, algebra, analysis* [Elementary mathematics from a higher standpoint: Arithmetic, algebra, analysis] (3rd ed., Vol. 1). Berlin, Germany: Springer.

- Klein, F. (1925). *Elementarmathematik vom höheren Standpunkte aus: Geometrie [Elementary mathematics from a higher standpoint: Geometry]* (3rd ed., Vol. 2). Berlin, Germany: Springer.
- Klein, F. (1926). *Elementarmathematik vom höheren Standpunkte aus: Geometrie [Elementary mathematics from a higher standpoint: Geometry]* (4th ed., Vol. 2). Berlin, Germany: Springer.
- Klein, F. (1928). *Elementarmathematik vom höheren Standpunkte aus: Präzisions- und Approximationsmathematik [Elementary mathematics from a higher standpoint: Precision mathematics and approximation mathematics]* (3rd ed., Vol. 3). Berlin, Germany: Springer.
- Klein, F. (1932). *Elementary mathematics from an advanced standpoint: Arithmetic, algebra, analysis* (3rd ed., Vol. 1, E. R. Hedrick & C. A. Noble, Trans.). New York, NY: Macmillan. (Original work published 1924).
- Klein, F. (1933). *Elementarmathematik vom höheren Standpunkte aus: Arithmetik, algebra, analysis [Elementary mathematics from a higher standpoint: Arithmetic, algebra, analysis]* (4th ed., Vol. 1). Berlin, Germany: Springer.
- Klein, F. (1939). *Elementary mathematics from an advanced standpoint: Geometry* (3rd ed., Vol. 2, E. R. Hedrick & C. A. Noble, Trans.). New York, NY: Macmillan. (Original work published 1925).
- Klein, F. (2016a). *Elementary mathematics from a higher standpoint: Arithmetic, algebra, analysis* (Vol. 1, G. Schubring, Trans.). Berlin, Germany: Springer. (Original work published 1933).
- Klein, F. (2016b). *Elementary mathematics from a higher standpoint: Geometry* (Vol. 2, G. Schubring, Trans.). Berlin, Germany: Springer. (Original work published 1926).
- Klein, F. (2016c). *Elementary mathematics from a higher standpoint: Precision mathematics and approximation mathematics* (Vol. 3, M. Menghini, Trans.). Berlin, Germany: Springer. (Original work published 1928).
- Menghini, M., & Schubring, G. (2016). Preface to the 2016 edition. In F. Klein (Ed.), *Elementary mathematics from a higher standpoint: Precision mathematics and approximation mathematics* (Vol. 3, pp. v–viii). Berlin, Germany: Springer.
- Rowe, D. E. (1983). A forgotten chapter in the history of Felix Klein's *Erlanger Programm*. *Historia Mathematica*, 10, 448–457.
- Rowe, D. E. (1985). Felix Klein's "Erlanger Antrittsrede": A transcription with English translation and commentary. *Historia Mathematica*, 12, 123–141.
- Schubring, G. (1989). Pure and applied mathematics in divergent institutional settings in Germany: The role and impact of Felix Klein. In D. E. Rowe & J. McCleary (Eds.), *The history of modern mathematics: Vol. 2. Institutions and applications* (pp. 171–220). San Diego, CA: Academic Press.
- Schubring, G. (2016). Preface to the 2016 edition. In F. Klein (Ed.), *Elementary mathematics from a higher standpoint: Arithmetic, algebra, analysis* (Vol. 1, pp. v–xii). Berlin, Germany: Springer.
- Schubring, G. (n.d.). *Felix Klein*. <http://www.icmihistory.unito.it/portrait/klein.php>. Accessed 1 Mar 2017.
- Seyfarth, F. (2016). Preface to the third edition. In F. Klein (Ed.), *Elementary mathematics from a higher standpoint: Precision mathematics and approximation mathematics* (Vol. 3, pp. xiii–xiv, M. Menghini, Trans.). Berlin, Germany: Springer. (Original work published 1928).
- Young, J. W. (1910). A synoptic course for teachers [Review of the book *Elementarmathematik vom höheren Standpunkte aus*, Vols. 1 & 2]. *Bulletin of the American Mathematical Society*, 16, 254–265.



**Open Access** This chapter is licensed under the terms of the Creative Commons Attribution 4.0 International License (<http://creativecommons.org/licenses/by/4.0/>), which permits use, sharing, adaptation, distribution and reproduction in any medium or format, as long as you give appropriate credit to the original author(s) and the source, provide a link to the Creative Commons license and indicate if changes were made.

The images or other third party material in this chapter are included in the chapter's Creative Commons license, unless indicated otherwise in a credit line to the material. If material is not included in the chapter's Creative Commons license and your intended use is not permitted by statutory regulation or exceeds the permitted use, you will need to obtain permission directly from the copyright holder.

