

Chapter 4

Thick-wall Domes

4.1 Introduction

In parallel with old Mediterranean civilizations, Eastern-European civilizations were formed. In the areas of Eastern Europe, where woods were growing abundantly, marshy soils and heavier conditions for settlement occurred, structures were generally built in wood, including prestigious structures. Unfortunately, there are few historical records on this subject. The first information is to be found in the texts by modern historians.

Vitruvius wrote in his work, “On the Building”, originating from the first years of the Christian Era, found in the library of the Monastery of St. Gall, Switzerland, in 1415, (I am quoting the translation from the 20th century in the work by Obmiński T. according to [1]): “In the nation of Colchis in Pont (over the Black Sea) due to the abundancy of woods, they lay trees on the right and left side (into a square) leaving so much space among them as the length of the tree will allow, on the top they lay transverse trees, surrounding with them the inside dwelling area. Afterwards, they lay alternately to the four sides beams that connect corners between themselves, in this way they lead the walls from wood upwards, vertically, with bottom layers up to the height of a tower, whilst the empty places, left by the roundness of trees, they fill with shingles and clay. Afterwards, they gradually narrow upwards the roofs brought out beyond the four corners and laid crosswise from beams. Thus, they raise, on the four sides towards the centre, a sort of monticules which they cover with branches and clay, and, in a barbarian way, they shape the vaulted roof of the tower” [2].

Shown in Fig. 4.1 is the St. George’s Orthodox Church in Drohobych, Ukraine. It was built on the turn of the 15th and 16th century. The walls and the roof of the temple was made from logs. This facility has been operating until this day in Ukraine. The domes of the Orthodox church’s roof called “globes” were covered using the shingle split from wood.



Fig. 4.1 Domes from logs of the Orthodox church in Drohobych, photograph by the author

The local civilizations worked out their systems of building wooden domes. The main load-bearing element of the original structures was the log made from the single trunk of a tree. Walls and even dome-like roof coverings of various facilities were built from logs.

4.2 Methods of Shaping Log Connections

The framework roofing, also called crown roofing, was shaped on the rectangular or polygonal projection. In the reference literature, there is no subject to justify the nomenclature that facilitates the description of the primary roofings from logs. The names used in this study: dome-like roof coverings, pyramidal coverings, cylindrical coverings, reflect the geometrical form of the facility. The definitions applied result from the attempts to name the basic types and the next development stages of the wooden spatial structures without intermediate supports. The records on this subject are scarce.

Figure 4.2 depicts five selected examples of crown walls, built from horizontally laid logs, hewn from tree trunks.

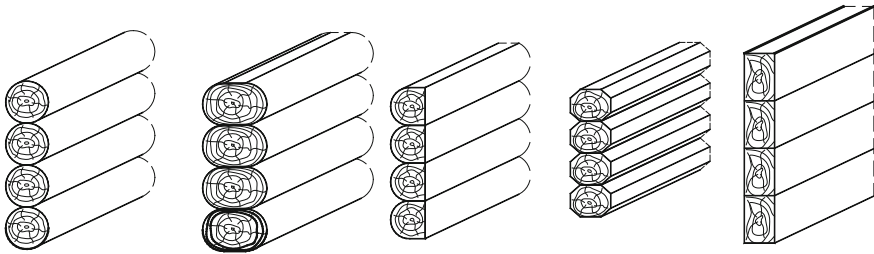

Fig. 4.2 Walls from beams (logs) laid horizontally according to [3]

Walls from beams laid horizontally were joined in the building's corners using various notch connections. Shown in Fig. 4.3, developed according to [3], are several examples of the most connections typical of log walls.

The impact on the spatial stiffness of crown structures will be exercised by nodes. Log daps in nodes were made at various angles. Owing to the skills of shaping notches and fasteners from wood, structures that transfer considerable strutting forces were obtained. In the work [3] (1914) by Obmiński T., examples of the connections of rectangular beams at angle are presented, jointly with the carpenter's designations shown in the left upper corner in Fig. 4.4a–c.

4.3 Dome-like Log Coverings

Originally, a pyramidal covering nearing a monastery vault was erected on the tetrahedron of building's walls made from logs (Fig. 4.5), which could be considered as a dome-like covering. The covering was stiffened with a spatial system of vertical (Fig. 4.5a) and horizontal (Fig. 4.5b) struttings. The cross strutting depicted in Fig. 4.5 stiffens the framework pyramid in horizontal plane and reduces the strutting transferred from the pyramid onto the building's walls. The vertical strutting also plays the role of a wind strutting.

High roofs in form of truncated or stepped pyramids were used in watch towers, bell towers, etc. They were erected in cemeteries, at temples and prestigious facilities, as well as located in fortifications as observation posts. The covering of towers constituted shingle, board planking or metal sheet. The majority of towers gave evidence of the rank of the settlement.

A separate group of framework structures used at a greater height and a higher projection of the structure covered constituted pyramidal "stepped" towers. The height of towers was increased by the stepped overbuilding of pyramids vertically, over straight sections of log walls (Fig. 4.6).

The increased height required a cross vertical strutting (Fig. 4.6) of several storeys. At the base of each pyramid with sloping walls the horizontal elements of

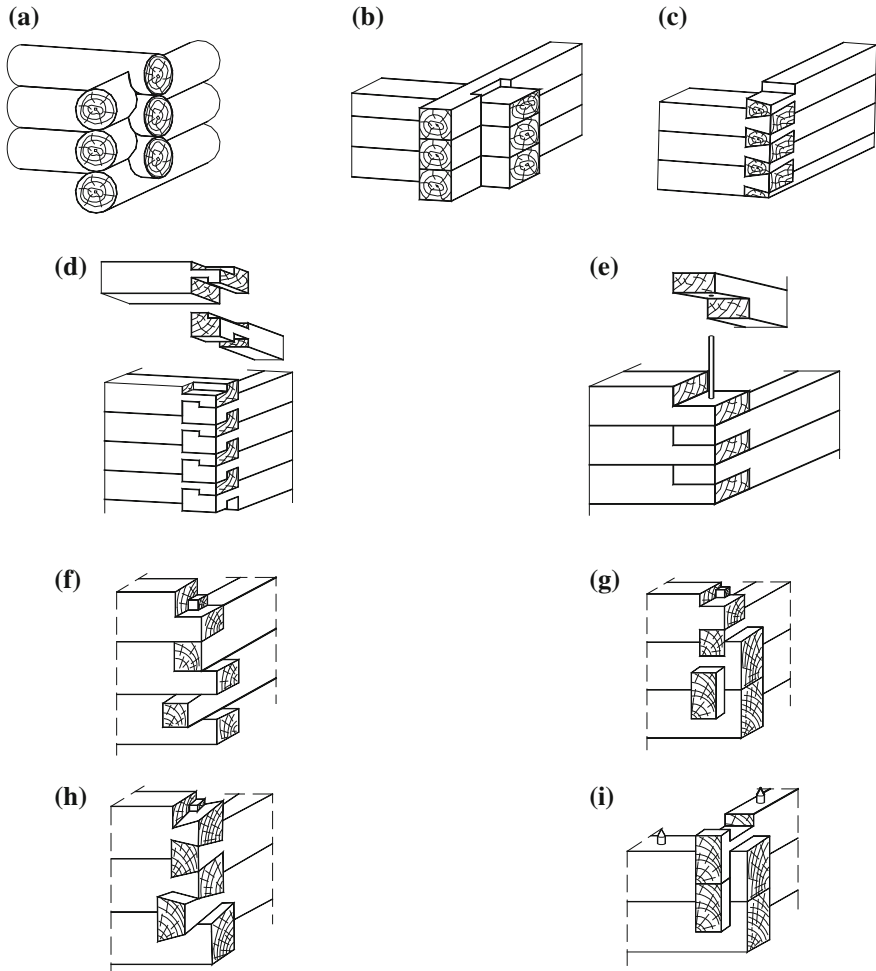

Fig. 4.3 Connections of perpendicular walls from beams laid horizontally [3], **a** saddle framework corner joint, **b** lap, **c** lock on “zincs”, **d** “lock” joint, **e** corner reinforced with a bar, **f** framework joint with tendons, **g** notches with undercuts and tendons, **h** slanting notches and studs, **i** connections of logs using notches and studs

the strutting were fabricated, taking over the thrust of wooden beams. Visible in Fig. 4.6 is the vertical strutting with horizontal tie members at each level of the roof bend.

Demonstrated in Fig. 4.7 are the unique vertical struttings and horizontal tie rods encountered until this day in Orthodox churches [5]. The vertical struttings of domes were fabricated as full membranes (Fig. 4.7a) or lighter wooden vertical trusses (Fig. 4.7b) whose bottom chord operated as a tie rod. The span of eminent roofings of principal houses and places of worship was determined by the length of

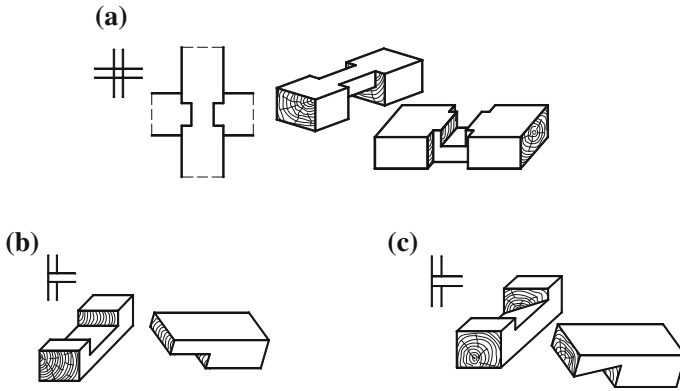

Fig. 4.4 Connections of beams at angle according to Obmiński in [3], **a** straight lap with auxiliary element, **b** straight lap, **c** slanting lap

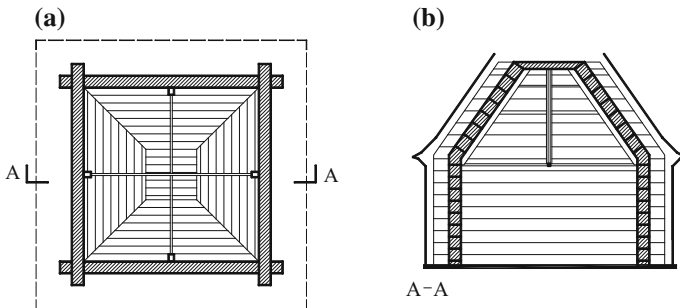

Fig. 4.5 Pyramidal (dome-like) framework structure on the square projection according to [4], **a** horizontal section with the projection of the vault, **b** vertical projection

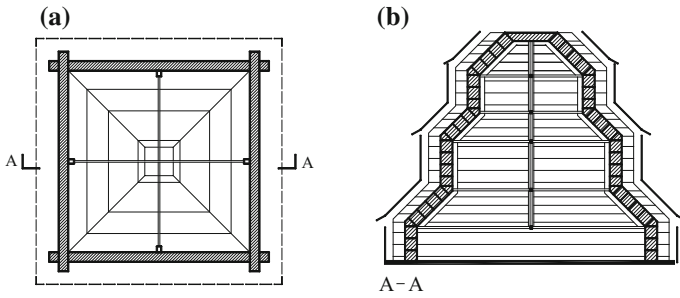

Fig. 4.6 Framework, stepped dome on the square projection according to [4], **a** horizontal section with the projection of the vault, **b** vertical projection

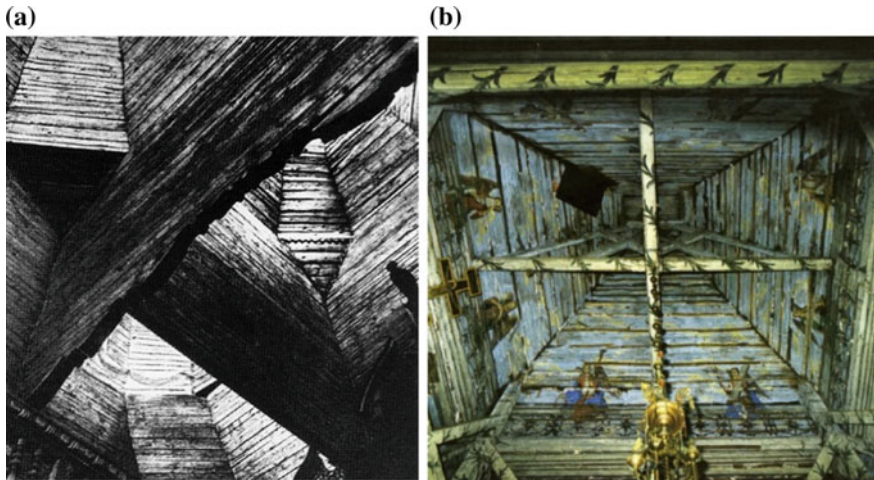

Fig. 4.7 Examples of struttings of a church tower according to [8], **a** with vertical full membranes, **b** with vertical truss membranes

logs acquired from the wood. The full membranes jointly with the increase in the dimensions of the covering base became heavier and heavier (Fig. 4.7a). They were replaced with lighter truss struttings (Fig. 4.7b). A rich collection of figures full of Orthodox church membranes in Ukraine is presented by Taras J. in his work [6] (2016), [7] (2006).

The dome-like roofings built on the plan of a hexagon and an octagon of the same length from logs in one latitudinal layer allowed to increase the surface covered. Figure 4.8 shows an example of a pyramidal facility on the plan of an octagon.

Due to the increased number of the sides of a pyramid, duplicated struttings contracting the opposite walls were used. They were used in the example in Fig. 4.8 in two levels: the bottom level at the base of the pyramid, and that in the middle of the height of the pyramid.

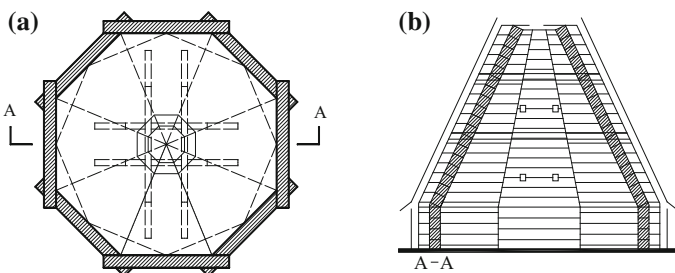

Fig. 4.8 Apparent pyramidal dome laid from horizontal logs on the polygonal projection according to [4], **a** horizontal section with the projection of the vault, **b** vertical section

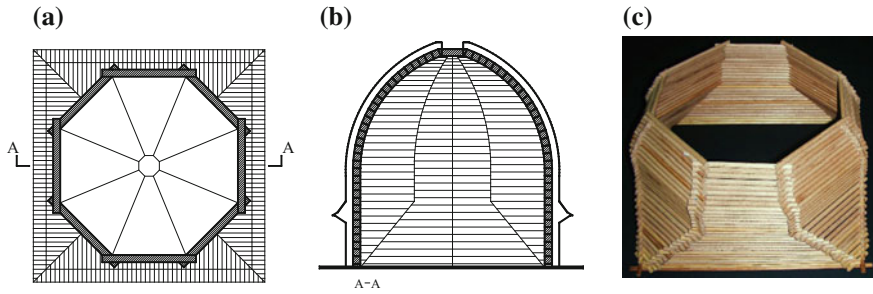

Fig. 4.9 Sectional-cylindrical framework dome on the octagonal projection according to [4], **a** horizontal section with the projection of the vault, **b** vertical section, **c** model of a dome from beech wood

An advanced, eminent dome-like structure having a square base, going over into an octagonal section is shown in Fig. 4.9. It differs from the pyramidal structure from Fig. 4.8 in this way that the sections of the octagonal covering in the plan are cylindrical vertically. Such a solution makes the structure more nearing the stone domes. An advantage of the solution is the resignation from cross struttings interfering with the inside space under the vault. The highest thrust at the dome's base takes over the square framework crown of a projection like in Fig. 4.9a. Shown in Fig. 4.9b is the section of a dome, and in Fig. 4.9c the sectional model of a cylindrical dome made from round bars of a 5.0 mm diameter that reconstruct the actual structure.

Shown on the model—Fig. 4.9c is the passage from the square projection of the log wall to the octagonal horizontal cylindrical vault from logs.

The building of log domes on the projection of polygons with the number of sides higher than eight made difficult the fabrication of connections from logs. The difficulties of the fabrication of notch connections in logs for segmentally cylindrical coverings on the octagonal projection were verified on the model drawn in Fig. 4.10.

The limit of the possibilities to increase the number of sides of the projection of dome-like sprung-arch vaults constituted the connections of logs on notches. The lock that connected the logs were already so complicated that they did not provide the load capacity of connections. Log domes on the octagonal projection were probably the last domes in the series of dome-like facilities. This is evidenced by Orthodox churches preserved still in the 20th century and described in the literature [8] by Brykowski [8] (1995), Kaniowska [9] (2005). Examples of the facilities built with the use of tower structures made according to the scheme as in Fig. 4.9 are placed in Figs. 4.11 and 4.12.

The structure of the Greek-Catholic Church in Krowica Sama, burnt down during the fire in 2002 in Poland [10], described by Rydzewski [11] is shown in Fig. 4.11.

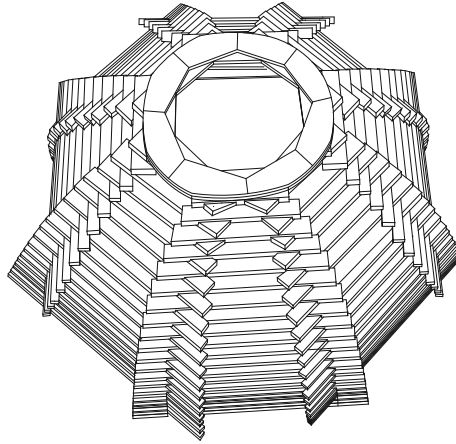

Fig. 4.10 Figure of a model of the dome-like covering from rectangular logs on the octagonal projection

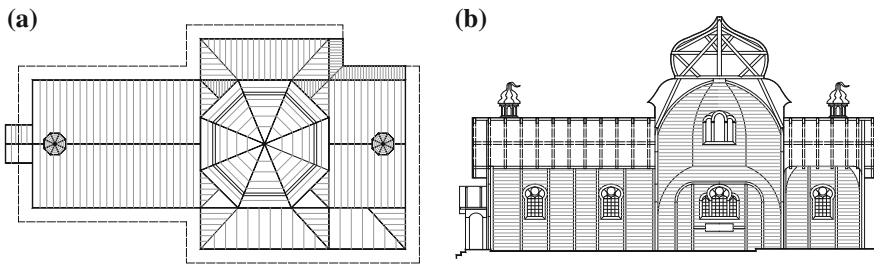

Fig. 4.11 St. Michael the Archangel Greek-Catholic Church in Krowica Sama, Poland, according to [11], **a** projection, **b** section

Shown in Fig. 4.12 is the renovated Transfiguration Orthodox Church in Krechov, Ukraine, built in 1648 to commemorate the visit paid by Bohdan Khmelnytsky to the Basilians' monastery. The view of another dome from logs on the octagonal projection is depicted in Fig. 4.13 according to [8] following the example of the Orthodox church in Korczmin, Lublin voivodship (Poland). The framework domes presented were based on the octagonal tambour resting on the stiff tetragon of log walls.

The building of dome-like coverings on the projections of polygons having the number of sides higher than eight is easier from logs without notches, joined using foreign fasteners. This was verified on the model shown in Fig. 4.14. The dome from rectangular logs, Fig. 4.14, was made on the plan of a dodecagon. The bending of the covering was obtained by arranging each latitudinal layer eccentrically in relation to the lower layer. Logs in each layer were laid in every second cut-out leaving empty every second span over the circumference of the line of latitude.



Fig. 4.12 Wooden dome of the Orthodox church in Krchov, Ukraine, photo by the author

Fig. 4.13 Dome of the Orthodox church in Korezmin [8], photo by Lang J. (1971)



The idea of building the pseudo-dome shown in Fig. 4.14 originates perhaps from Central Asia. Chmelnickij describes in [12] a similar covering on the tetragonal projection in the Turkmenistan architecture. Ceilings in form of apparent

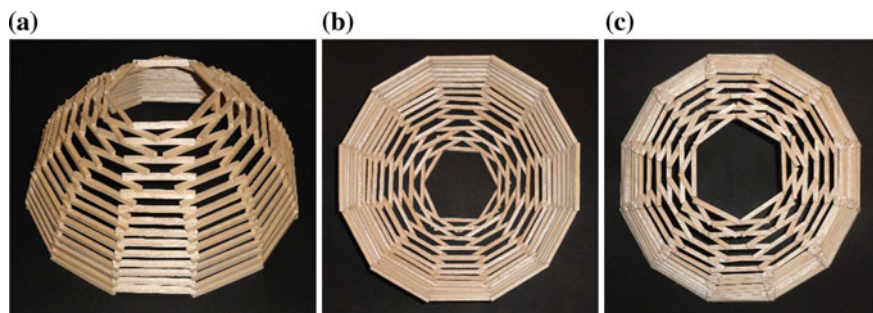

Fig. 4.14 Model of the dome from rectangular logs on the projection of a dodecagon, **a** side view, **b** side from the inside, **c** top view

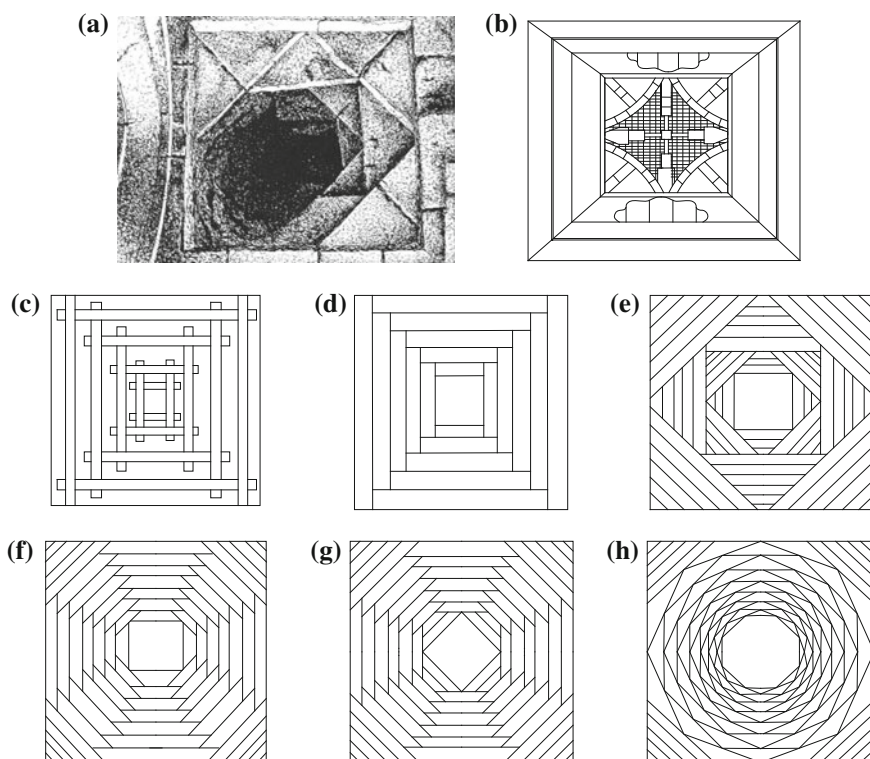

Fig. 4.15 Examples of apparent vaults from blocks: ceramic, stone and wooden, **a** 'rusan'—an apparent dome on the tetragonal projection [12], **b** form of the stone vault from the Mosque of Cristo de la Luz from 999, **c–h** wooden, lantern-type vaults according to [14]

vaults, arranged from large ceramic blocks are encountered in it, as shown in Fig. 4.15a. The covering was closed from the top with a flat stone or ceramic block. Such vaults in the Central Asian terminology bear the name of 'rusan'.

In the locality of P'yauyang, Korea, a form of a vault similar to a 'rusan', originating from the 6th–7th AC was discovered and designated with the name of a dome-like, lantern dome [13].

In Toledo, in the Mosque of Cristo de la Luz built on the turn of 999/1000, nine similar stone, lantern vaults on the projection of a square were built [14]. The sketch of one of them is shown in Fig. 4.15b. The remaining eight vaults were built according to the same scheme, introducing just the differences in the details of the finish particular.

Shown in Fig. 4.15c–h are six apparent vaults described in [14] arranged from wooden logs built in Bukovina, Poland, Moldova and Georgia in circa the 10th century AC. The figures present apparent views of those vaults built from logs without notches, on the tetragonal and polygonal projection. The lantern vault built on the octagonal projection is depicted in Fig. 4.15h.

4.4 Compilation of Dome-like Forms

In the examples specified shown are the transformations of dome-like coverings on the tetragonal up to the dodecagonal projection of a crown and lantern type (Fig. 4.15). Such domes built from logs were joined in the corners of the polygonal projection on notches: straight, inclined, with hidden dovetails and studs from wood.

In the thick-wall domes built from logs, joined with notches, the effects of slenderness of the dome R/g were negligibly small: where: R —radius of the dome, g —thickness of the dome shell. A spatial framework stiffening of dome-like coverings were full or truss membranes, shown in Figs. 4.5, 4.6, 4.7, 4.8 and 4.9. They were used as a protection against “a collapse” to the inside of heavy log walls. The dimensions of the struttings were limited by the length of stretched elements, e.g. of the lower chord of the stiffening (Fig. 4.7). The main obstacle in increasing the span of the construction constituted the stretched connections. **The introduction of the form of a sectional-cylindrical covering, made up of cut-outs of a cylinder on the octagonal projection relieved the inner space under the dome from struttings.**

Depicted in Fig. 4.16 is the compilation of the sections of vertical framework coverings from apparent vaults up to a cloister vault. The last link of the transformation of polygonal projections and stepped projections of pyramidal coverings was a thick-wall from logs, segmentally cylindrical on the octagonal projection demonstrated in Fig. 4.16e, due to the difficulties in fabricating notch connections. **The slenderness of the shells of such domes is measured by the ratio of the radius to the shell thickness R/g amounted to circa 12.**

The horizontal projections of lower thrust rings of the dome-like structures from logs are shown in Fig. 4.17. Each successive polygon made it possible to increase the surface covered. The transfer from the square projection to the circular

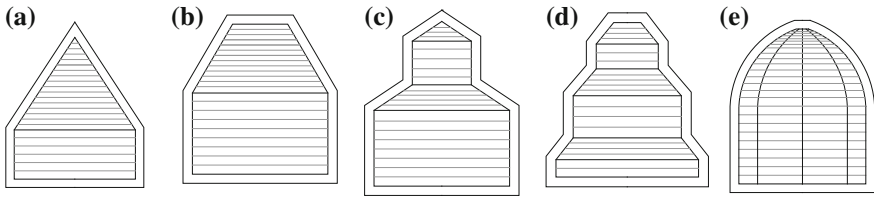

Fig. 4.16 Vertical sections of framework towers: **a** pyramid, **b** truncated pyramid, **c** stepped, **d** stepped duplicated, **e** sectional-cylindrical

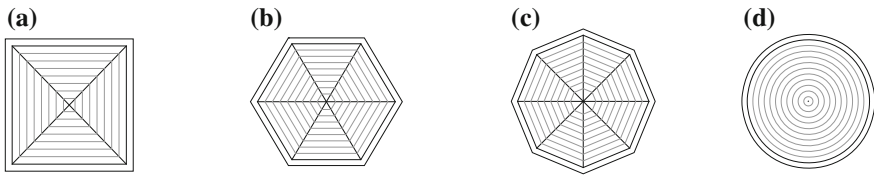

Fig. 4.17 Horizontal projections of dome-like vaults: **a** square, **b** hexagon, **c** octagon, **d** circle

projection was associated with the decrease in the length of logs from which the shell was built.

The decrease of the dimensions of logs, the elimination of notch connections as well as the application of foreign fasteners allowed to build domes of a higher span on a projection nearing a circle. The idea of the nameless author of shells from short quarterings introduced to the building trade wooden thick-wall domes on the plan of a circle, is discussed in Sect. 4.5.

4.5 Domes with a Massive Shell

The experiments on dome-like structures from logs, connected on notches, led to the formation of spherical thick-wall domes (Fig. 4.18). **The increase in the diameter of thick-wall domes became possible owing to the introduction of smaller structural elements in form of quarterings.** Simultaneously, in the place of notch connections, foreign fasteners were introduced, such as wooden studs and nails. **The introduction of foreign fasteners made possible a further development of dome systems.**

The width of quarterings, thus the thickness of the shell was determined from the thermo-insulation weathering conditions. The length of quarterings resulted from the radius of the dome. The easy treatment of wood under the building site conditions allowed to cut the quarterings to fit the shape of the dome. The tendency of the dimensional variations of quarterings in successive latitudinal layers is illustrated in Fig. 4.18a. The quarterings arranged layer-wise were cut to fit the shape of the sphere and connected with nails.

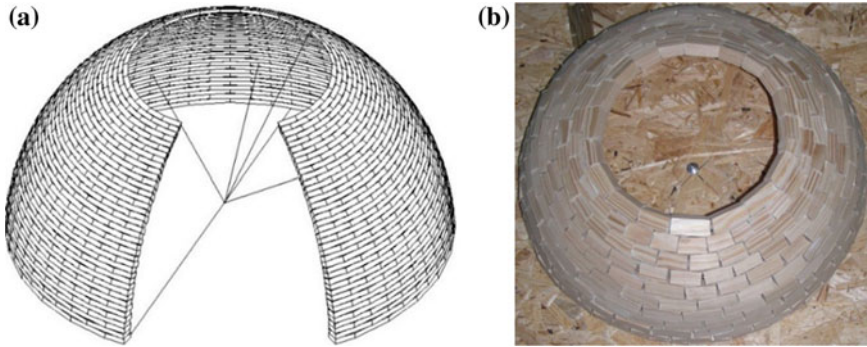

Fig. 4.18 Tendency in the variations of the dimensions of quarterings: **a** building principle of a thick-wall dome, **b** technological model of a thick-wall shell dome

The building of a dome from “identical” quarterings (Fig. 4.18b) does not fill the spherical surface tightly. Shown on the model (Fig. 4.18b) are fissures between thickset, not cut-to-size quarterings. The elimination of fissures consisted in the additional supplementing with wedges or cutting quarterings to fit the outside radius of the dome. The need to cut elements to fit the shape of the dome occurred with the low slenderness of quarterings, e.g. $\lambda = l/b \leq 5$ (l —length, b —width of a quartering). The fissures occurring at the inexact fit of quarterings were also filled with a binding material or closed in the meridional direction with a planking from boards and the covering discussed in Sect. 4.6.

The need to increase the span of domes and the difficulties in fitting the quarterings, requiring experienced carpenters, contributed to the search for a fabrication technology of thin-wall domes. **The further decreasing of the dimensions of quarterings eliminated the defects of the solutions and selected a next system of the economic structures of domes from solid wood as described in Sect. 4.6.**

The slenderness of the shells of thick-wall domes, measured with the ratio of the radius to the thickness of the shell R/g amounted to circa 20. The slenderness of the dome shell R/g became the limit of the span due to the load capacity of single-layer domes made from massive quarterings.

4.6 Examples of Domes with a Massive Shell

In his publication [15], Kashkarov K. P. (1937) presented the structure of two thick-wall domes: (1) the dome of the State Gosippodrom building in Moscow of a 20.05 m diameter, (2) the dome of a 60.0 m diameter. Figure 4.19 presents the building scheme of a thick-wall shell of the dome from quarterings following the example of the dome of the Gosippodrom Palace in Moscow built in 1934.

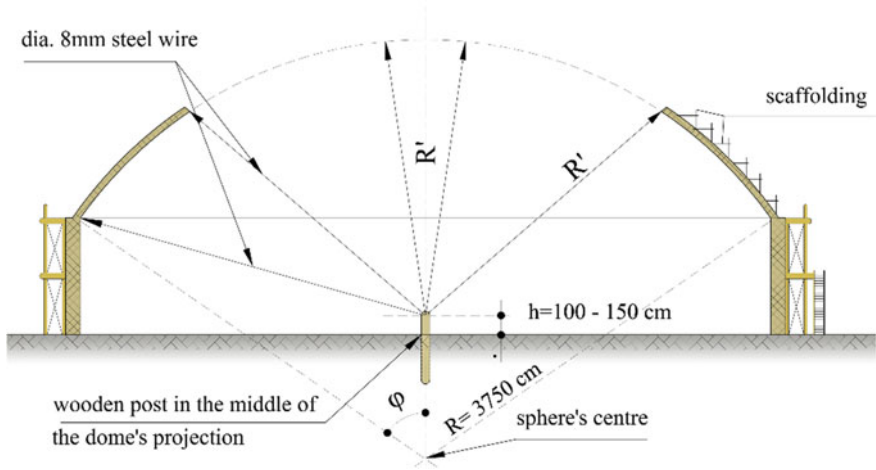

Fig. 4.19 Illustration of the building technology of a thick-wall shell of the dome [15]

Figure 4.20 shows carpenters working on a scaffolding and laying quarterings in form of a shell of the dome according to the scheme in Fig. 4.19. The latitudinal layers of the dome were built from planks laid flat, according to the traced radius of

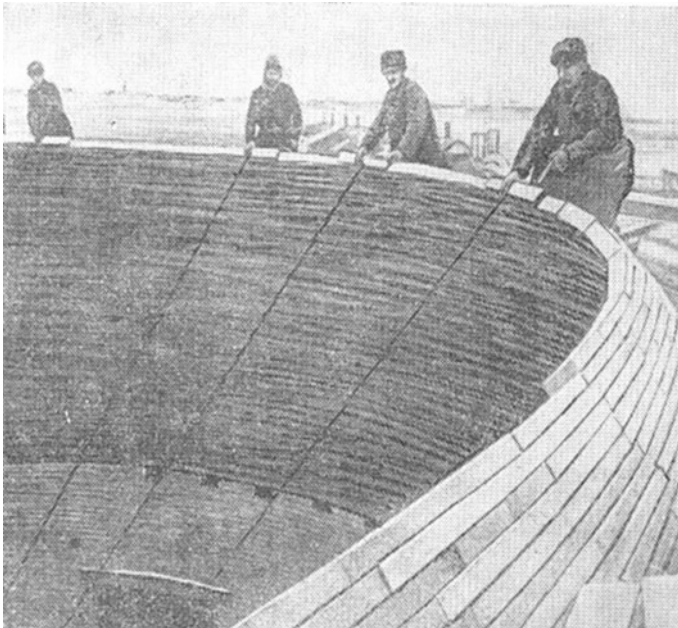

Fig. 4.20 Cutting to size of quarterings to be put into the shell of the dome of a 20.05 m diameter [16]

the layer R'. The length of the radius of the layer was measured off using a wire of a 8 mm diameter, anchored in a wooden post, in the middle of the projection of the dome.

The size of the radius was changed for each layer of the shell. The contact places of quarterings were covered with a next latitudinal layer and fastened with 100 mm long nails of a 4.0 mm diameter. The width of planks (layer thickness) was determined mainly for thermo-insulation reasons.

The length of quarterings was adopted depending on the radius of the canopy. The thickness of planks in one latitudinal layer was invariable, the thickness of the shell (width of planks) was maintained unchanged, only the thickness of plants at the height of the sphere was changed. The highest thickness of planks was used in the bottom rings of the dome, the least in the highest.

In 1934, according to the above-described principles, the dome of the Gosippodrom Palace in Moscow was built. On the basis of the papers [15, 16], the drawings and the data of the unique wooden dome of a 20.05 diameter and a 37.50 m diameter of the sphere were reconstructed. Shown in Figs. 4.21 and 4.22 is the section, projection and details of the already forgotten structure. The drawings of the constructed were used to produce its computer visualizations (Fig. 4.23).

The structure of the dome in Moscow demonstrated in Fig. 4.21 a, b is made up of outside arch centres—1, a thick-wall shell built from three ring-shaped layers of a different thickness—2a, 2b, 2c, as well as from planks 3 of the flat flanking between the outside arches—1. The ring-shaped layers 2a, 2b, 2c were split along the meridional section of the dome into three spheres and made from quarterings of a thickness decreasing from the thrust crown upwards.

In the first bottom zone the thickest quarterings 2a of a 65 × 40 mm section were used. In the central zone the quarterings 2b of a 65 × 30 mm section were used. In the upper zone, of the lower diameter of the meridian of latitude, the quarterings 2c were used, of the highest susceptibility and a 65 × 20 mm section were used. Each ring-shaped layer in the level of one line of latitude has a constant radius and covered the contact place of the quarterings of the previous layer, in the middle of the quartering's length. In order to facilitate the bending in the top zone of the dome being compressed, in the middle of the length of the planks 2c, cuts were made, but no more than to ½ of the plank's thickness.

The strengthening of the shell from quarterings constituted outside meridional elements, that is: twelve arch centres 1 having the nature of de l'Orme's arches and the meridional planking from planks 3, studded every 50.0 cm, when counted along the lower supporting ring, on the outside, as the dome was erected. The quarterings 2 were arranged step-wise along the outside ribs driving the geometric shape of the dome. The arch centre ribs 1 added on the outside constituted the strengthening of the shell. The distance of 5.25 m between the arch centres 1 was determined on the lower supporting ring. The latter was built on a flat plank lying on the wall. It was made up of four planks arranged vertically, which were bent into a ring having the diameter of the dome's projection. Shown in Fig. 4.22b, d is the construction of a rib 1 from arch centres over the meridional direction, allowing the building of a dome from quartering without an inside assembly scaffolding. The ribs driving the

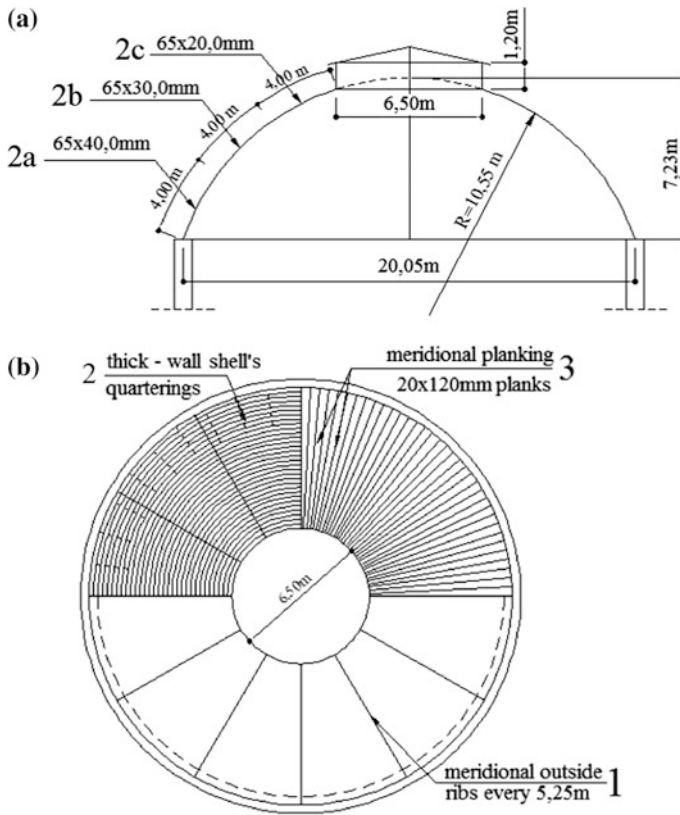

Fig. 4.21 Schematic diagram of a thick-wall dome with outside ribs [15, 16], **a** cross-section of the dome, **b** lay-out of outside ribs, quarterings and meridional planks

geometry of the dome 1 were made from two arch centres of a 50×200 mm section and strengthened on the outside with a flat nailed plank of a 40×100 mm section (Fig. 4.22 b). The connection of the ends of two vertical arch centres of one layer of the meridional rib 1 were fabricated in the middle of the length of an arch centre of the second layer. One half of the quarterings (between ribs 1 from arch centres) was strengthened on the outside with a meridional planking. Those were flat planks 3 (Fig. 4.23 b), laid on a shell from quartering between the outside ribs from arch centres, from the supporting ring to the central upper ring. The planks 3 of a 20×120 mm section were connected with the shell using 100 mm long nails of a 4.0 mm diameter. The coating from metal sheet on the dome's outside was laid on and fastened to the planks 3.

For the better explanation of the construction of the dome its computer visualizations were made, as shown in Fig. 4.23.

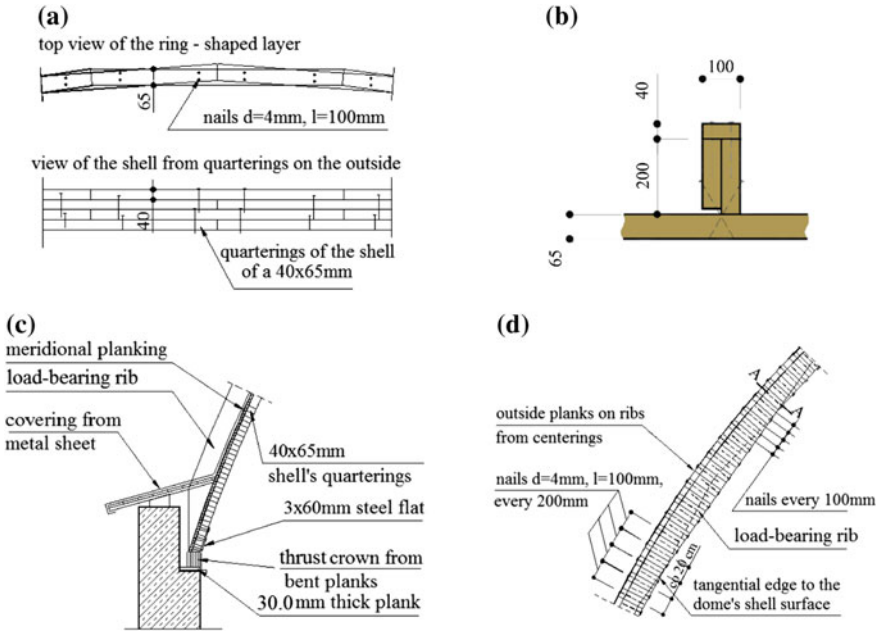

Fig. 4.22 Thick-wall dome with outside ribs [16], **a** arrangement of the shell's quarterings 2, **b** section of an outside rib 1, **c** supporting crown, **d** structure of an outside rib 1

The centring arches 1 increased the load capacity of the shell in the meridional direction. The shell quarterings of the ring-shaped layer assumed the circumferential forces in the dome. The outside centring arches 1 and the meridional planking 3 stabilized the shell from quarterings 2, reducing the dome's distortions due to the drying and swelling of wood. It is worth noticing that the solution shown on the visualization protects the dome against moistening, allows the drying of wood flooded with precipitation water, e.g. due to the wear of the covering from metal sheet.

Another impressive example of a thick-wall dome is the dome of the circular projection's diameter of $L = 60.0$ m, described by the engineer Kashkarov K. P in his paper [15] (1937). Inserted in Fig. 4.24a is the section, in Fig. 4.24b the projection, and in Fig. 4.24c–e the details of the construction, in Fig. 4.24f, g the description and the visualization of the structure developed on the basis of [14]. In the solution of the dome of a 60.0 m diameter all the building principles as discussed in the previous example of the dome of a 20.05 m diameter have been maintained. The difference consists in the introduction of ribs 1 driving the dome's geometry in an expanded form—shutterings, having bipolar coordinates (Fig. 4.24c), instead of the arch centre ribs of de l'Orme following the example of the dome shown in the visualization 4.23.

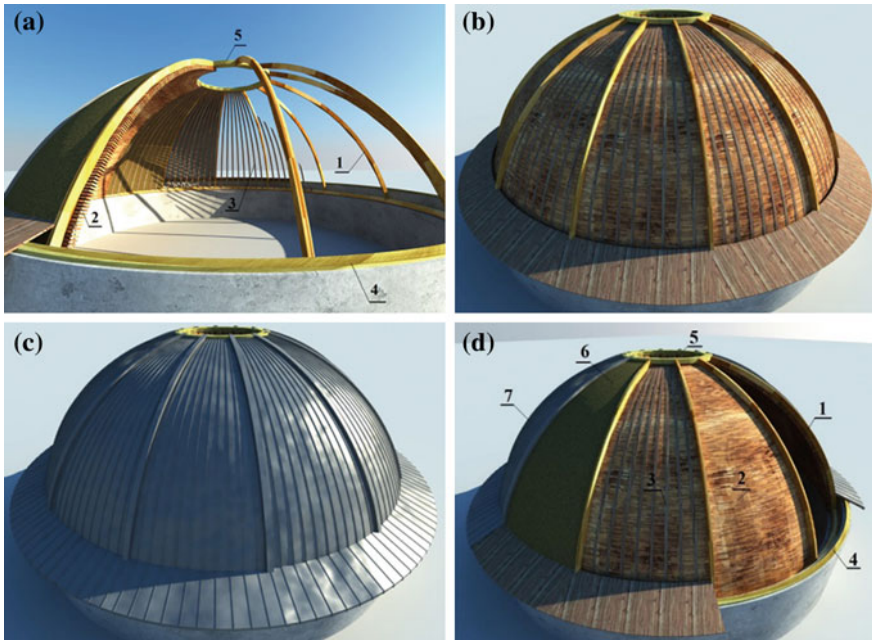

Fig. 4.23 Computer visualization of a thick-wall dome from quarterings with outside driving ribs from arch centres according to [16], **a** section with the view of the dome's inside, **b** shell from quarterings, load-bearing ribs and intermediate ribs, **c** covering from metal sheet, **d** view of dome's elements in successive layers: 1—outside arch centre ribs, driving on the outside the shape of the dome's sphere built from quarterings, 2—shell from quarterings, 3—meridional planking from planks arranged flat on the shell, 4—lower ring from bent planks, anchored to the supporting reinforced concrete ring, 5—upper ring from arch centres, 6—suggesting warming of the dome on the outside, 7—covering from metal sheet

In the dome of a 60.0 m diameter twenty main meridional ribs of bipolar coordinates were used, circa 30.60 m long, of the I-section and of the highest diameter of the section $h = 60.0$ cm, in the middle of its length. The main meridional ribs were disposed on the lower thrust ring in a spacing of 9.42 m. They were connected on the central upper ring every 94.3 cm.

The lower and upper chord of the rib 1 was adopted from 6 cm \times 6 cm quarterings, the web from a 5 mm thick plywood. The ribs 1 were designed from 3.60 m long segments and assembled during the construction on the outside of the shell 2, as it was erected. The assembly of the ribs 1 was conducted from the bottom ring up to the top ring of the dome.

Beside twenty main meridional ribs, sixty flat intermediate ribs were used, three ribs each between the main ribs, also in the meridional direction. The meridional board planking between the ribs strengthens on the outside the thick-wall shell from planks. The distance between the intermediate ribs, as measured over the lower thrust ring was adopted to be 2.35 m. The meridional planking 3 was built from

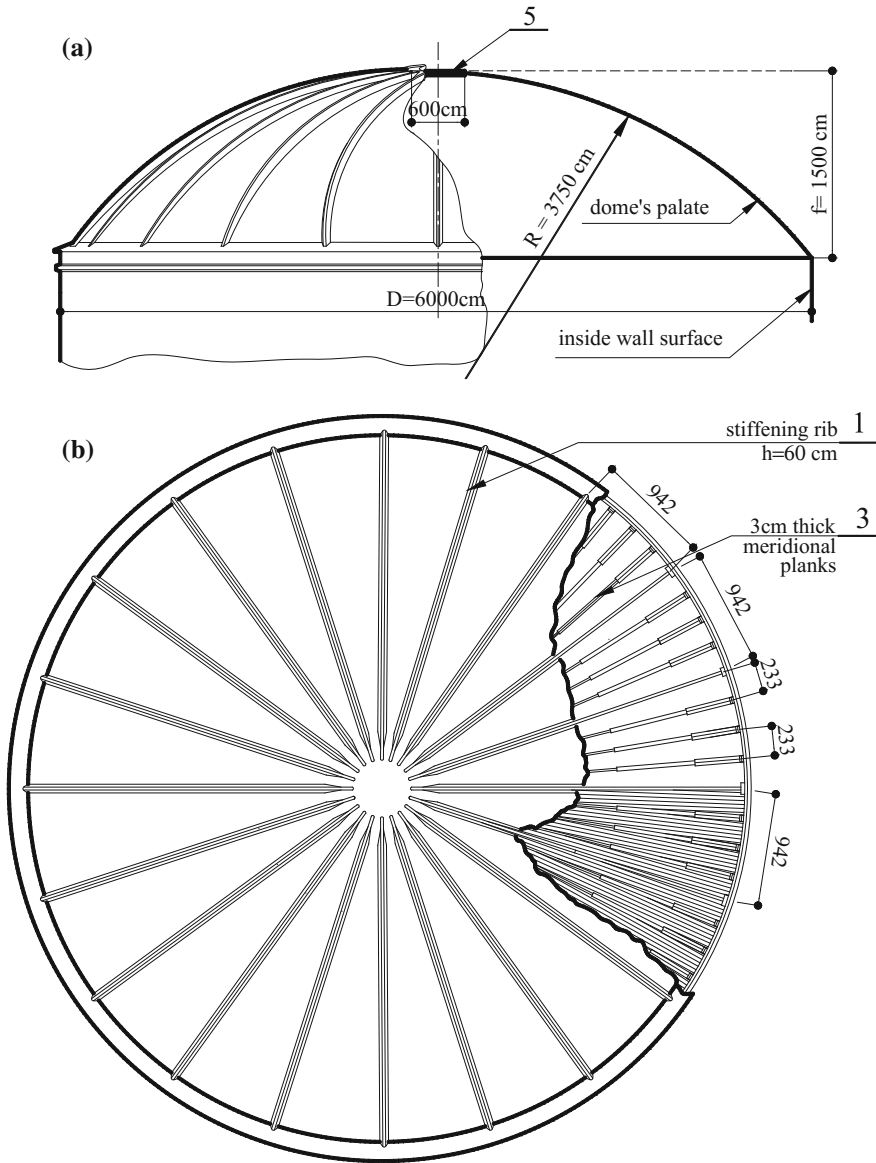

Fig. 4.24 Structure of a thick-wall dome of the projection's dimension $L = 60.0\text{ m}$ according to [14], **a** section of the dome, **b** projection of the dome, **c** view of the outside meridional rib, **d** scheme of the lay-out of the main ribs and the meridional outside planking on the thick-wall shell of the dome, **e** section of the shell and of the ribs, **f** reconstructed arrangement of the outside ribs, **g** view of the thick-wall shell, the meridional ribs and the meridional planking

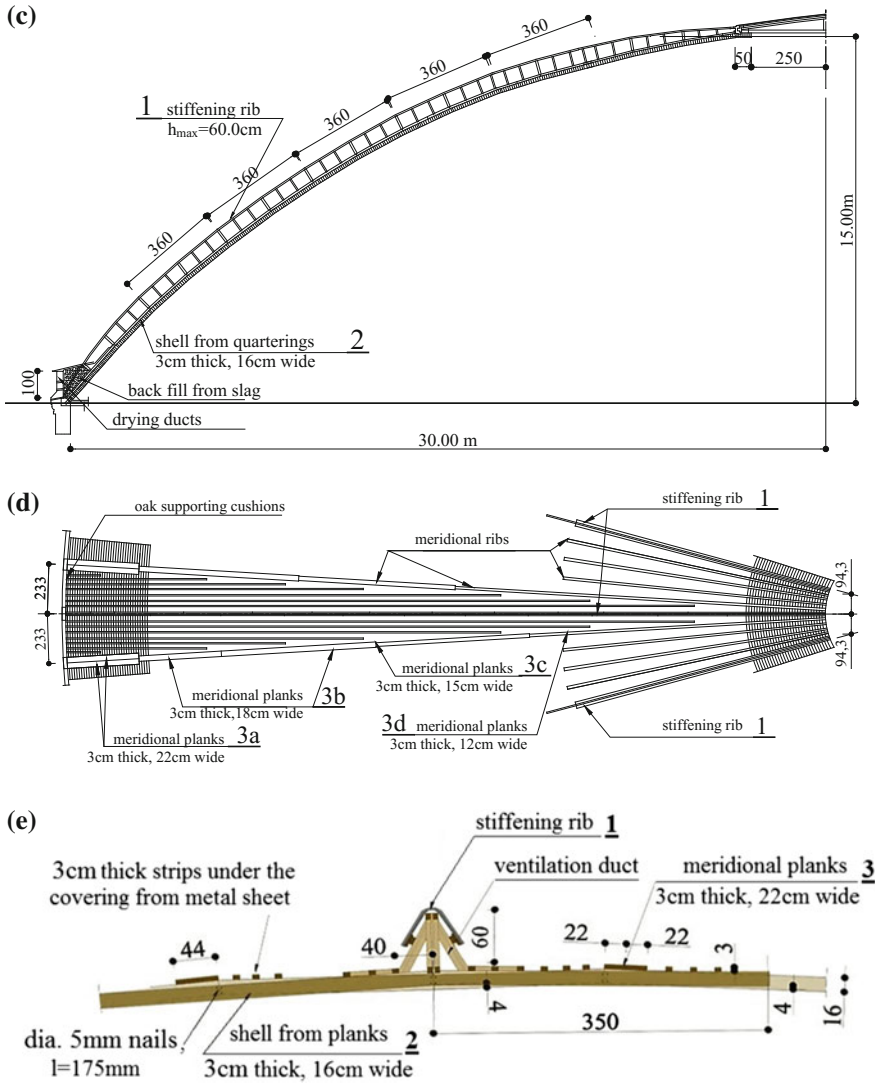

Fig. 4.24 (continued)

3.0 cm thick planks of a various width: the highest width 3×22.0 cm at the lower ring, in the central zone 3×18.0 cm, in the next one 3×15.0 cm, and at the top ring 3×12.0 cm.

The thick-wall shell 2 was arranged from 3.0 cm thick and 16.0 cm wide planks (Fig. 4.24c). The position of each arranged plank of the ring-shaped layer was controlled from the middle of the dome’s projection according to the scheme as in Fig. 4.19. The size of the radius was changed for each layer of the shell form

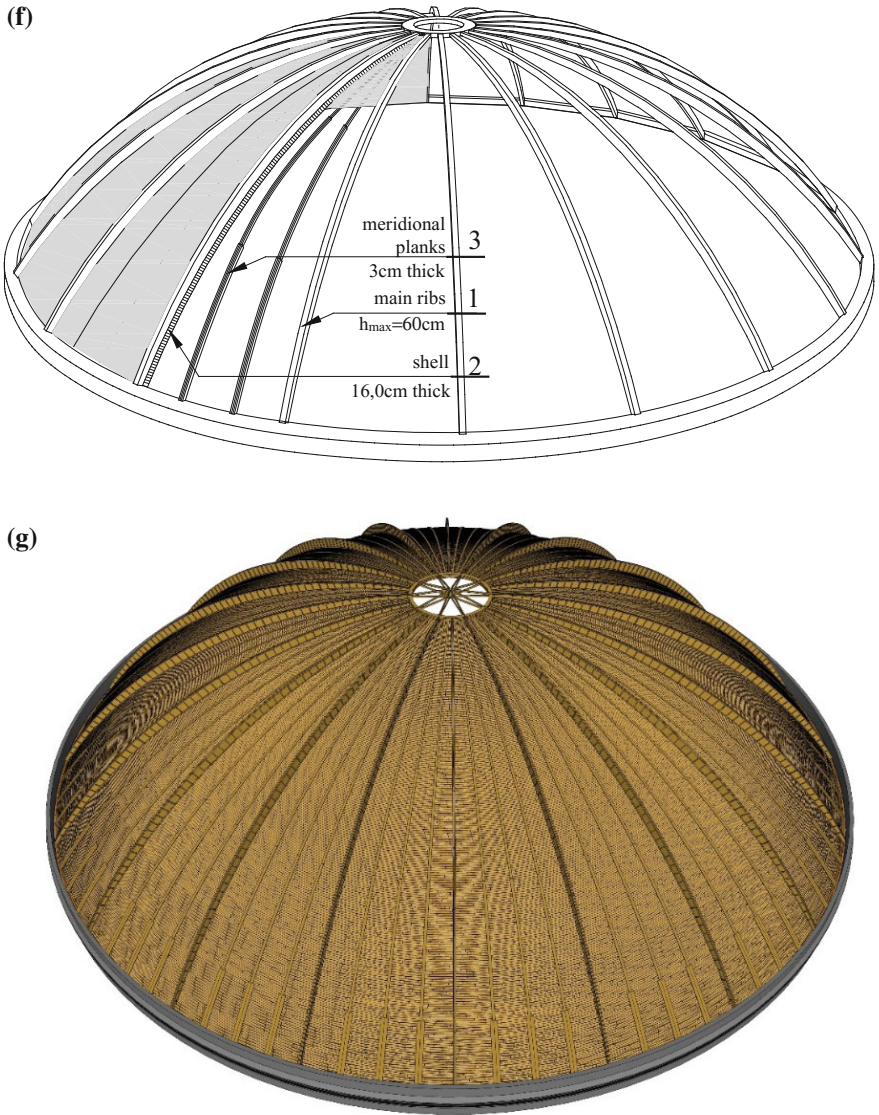

Fig. 4.24 (continued)

planks. The ventilation of the floor and of the ribs was made along the meridional ribs. The detail of the ventilation solution of the main meridional rib is shown in Fig. 4.24c, e. The natural exchange of air via ducts on both the sides of the rib 1 ensured the maintenance of a low moisture content and the drying of the construction impeding the development of biological corrosion.

4.7 Conclusions

The passage from wooden logs as elements to create thick-wall, crown-shaped dome-like coverings, as described in this chapter, to the small-dimensional quarterings joined with nails allowed to build domes on the plan of a circle. Their strengthening on the outside with de l'Orme's arch centre ribs made it possible to erect thick-wall shells of a diameter of the lower thrust ring of 20.05 m up to 60.0 m. The use of outside, stiffening meridional ribs as well as of the meridional planking relieved the inside utility space from the protruding elements of the construction.

The building of a shell with outside ribs did not require the use of a separate central scaffolding.

The thick-wall domes were an important experience on the way of the evolution of the construction of domes from solid wood.

The main advantages of the thick-wall dome are as follows:

1. possibility to build the dome without a central supporting scaffolding,
2. possibility to use low-grade wood for the construction of the shell, even planks of a worse quality,
3. good thermal insulation of the shell,
4. increase of the fire resistance of the facility owing to the minimum inside surface,
5. the slenderness of the shells of such domes between the driving ribs and the flat intermediate ribs, as measured using the ratio g/l_1 , was 8 up to 15. The slenderness of the shell jointly with plank susceptible ribs R/g was 123–197, where R —radius of the shell, g —thickness of the shell.

An enormous importance was attached to the ventilation of ribs and the covering of thick-wall domes. Ventilation ducts from planks were made along the outside arches, which fostered the drying of wood as well as influenced the elimination of the distortions of the shell due to the change in the moisture content of dome-creating elements. The continuous air replacement increase the durability of the facility and the maintenance of the moisture content below 18% impeded the growth of biological corrosion.

As shown in the chart—Fig. 4.25 according to [16], the moisture content of wood changes depending on the ambient temperature and the moisture content. For instance, the equivalent moisture content of wood is 15%, if the relative humidity of air totals 75%, and the temperature circa 20 °C. In his paper [18] (2003), Kozakiewicz P. emphasizes that the moisture content of wood is very essential in the protection against biological corrosion. The majority of technical, biological pests of wood has no capacity to infringe dried or very wet wood.

By convention, there is a distinction between the dry protective state in which the moisture content of wood does not exceed 18–20% and the wet protective state in which this moisture content is higher than 80%. It also results from the foregoing statement that the moisture content within the range of 20–80% contributes most to

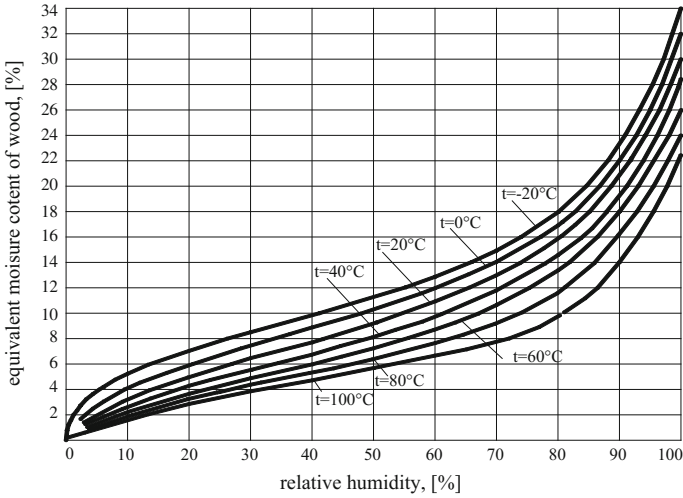

Fig. 4.25 Impact of the temperature on the equivalent moisture content of wood (RH) according to [16]

the destruction of wood. The shaping of a wooden construction, with the possibility to carry away the moisture content, increases the durability of the facility.

As shown in Fig. 4.26, the processes of shrinkage and expansion, dependent on the level of moisture content, influence the maintenance of the shape of the partition wall.

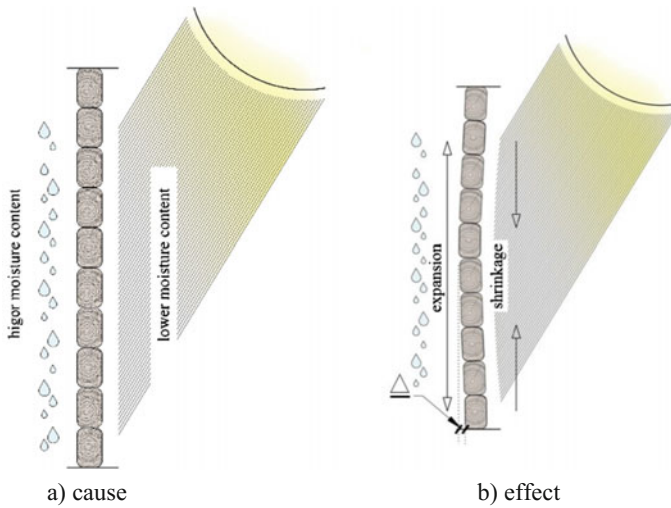

Fig. 4.26 Interference of the environment of a various moisture content with the partition wall from wood, Δ—horizontal distortion of the wall

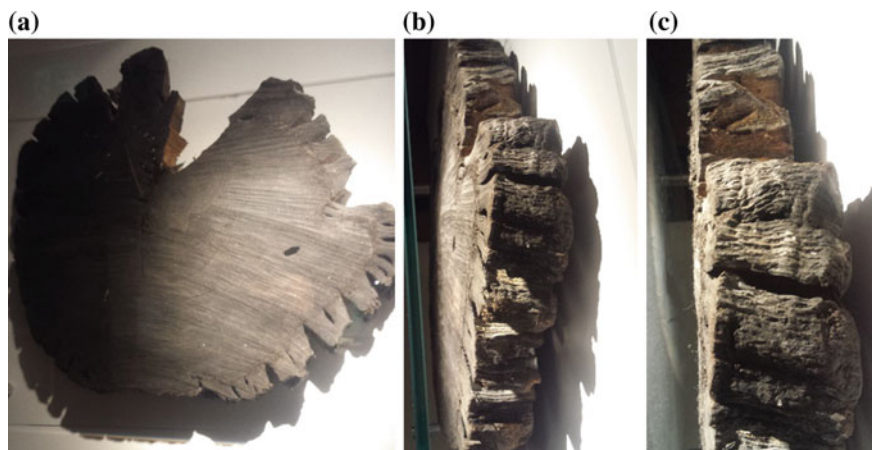

Fig. 4.27 View of the oak wood fragment retrieved from the Baltic Sea exposed in Internationales Maritime Museum in Hamburg, whose age has been estimated to be 8000 years, **a** view of the cross-section, **b**, **c** side view in close-up. Photograph by the author, 2017

A confirmation of this fact are the well-preserved wooden objects found in the Egyptian tombs as well as tree fragments retrieved from the sea.

A good illustration of the wood durability in a wet environment (wet protective state) are wood fragments retrieved from water. In the International Maritime Museum in Hamburg (*Internationales Maritimes Museum Hamburg, Hafen City*) a wood fragment from an oak wood log of a ca. 6.0 m length, retrieved from the Baltic Sea, from a depth of ca. 8.0 m are shown. The testing on the presence of the carbon isotope ^{14}C has demonstrated that the oak wood log is ca. 8000 years old. This is the oldest, preserved and described element from wood (Fig. 4.27).

References

1. Witruwiusz *O architekturze ksiąg dziesięć*, PWN, Warszawa 1956.
2. Widera B. *Dalsze losy radzieckiego konstrukttywizmu*, Wiadomości Konserwatorskie 14/2003, s. 5–10.
3. Obmiński T. *Budownictwo ogólne II Atlas* Wydanie i nakład Związku Studentów Inżynierii Politechniki Lwowskiej. Lwów 1925.
4. Obmiński T. *O cerkwiach drewnianych w Galicyi*. Sprawozdania komisji do badania historii sztuki w Polsce” t. IX, 1914, z. 3 i 4.
5. Brisch K., *Kuppeldach aus dem Aussichtsturm des Torre de las Damas (Damenturm)*, Foto: Bundesarchiv, Staatliche Museen zu Berlin.
6. Szczuko W. *Badania nośności zbrojonych belek drewnianych*. Zeszyty naukowe Nowosybirskiego Instytutu Inżynierjno-Budowlanego im. Kujbyszewa. Nr 624.072.2.011.6 1969 nr 2.
7. Taras J. *The Ukrainian Wooden Church Architecture. The illustrated dictionary*. National Academy of Sciences of Ukraine. The Ethnology Institute. Lviv 2006.

8. Brykowski R., *Drewniana architektura cerkiewna na koronnych ziemiach Rzeczypospolitej*. Towarzystwo Opieki nad Zbytkami Warszawa 1995.
9. www.greenhousedome.com.
10. Cyrankowski M., *Wpływ lakieru silikonowego na zwiększenie trwałości zabezpieczenia przeciwpożarowego drewna Fobosem M-2*. Annals of Warsaw Agricultural University SGGW, Forestry and Wood Technology No 55, Warsaw 2004.
11. Rydzewski P. *Cerkwie których nie ma - ziemia lubaczowska* www.roztocze.horyniec.grid.
12. Chmelnizkij S. *Zwischen Kuschanen Und Arabern. Die Architekturstilarten Mittelasiens im V.-VIII Jh. Ein Rückblick in die Kulturgeschichte der Sowjetunion*. Felgentreff & Goebel & Co KG, Berlin, November 1989.
13. Fontain J. von, Hempel R. *Propyläen Kunstgeschichte die Kunst des China, Korea, Japan*, Berlin 1968 Deskription 241.
14. Sourdel - Thomine J. von Spuler B. *Propyläen Kunstgeschichte die Kunst des Islam*, II. 102a, 102b, Berlin 1973.
15. Kaszkarow K., P. *Kopuły* Sprawocznik projektirowszczyka promyszlennych sooruzienij. Dieriewannyje konstrukciji. Kuzniecowa G. F. Głównaja redakcija stroitielnoj literatury. Moskwa-Leningrad 1937.
16. Karlsen G. G., Bolszakow W.W., Kagan M. E., Świencicki G., *Kurs dieriewiannych konstrukcij* cz. I i II, G. I. C. L. Moskwa, Leningrad 1943.
17. Jean-Denis Godet *Atlas drewna*, Multico, Oficyna Wydawnicza, Warszawa 2008.
18. Kozakiewicz P. *Fizyka drewna w teorii i w zadaniach* Wydawnictwo SGGW Warszawa 2003.