

IFIP AICT 481



Francisco J. Mata  
Ana Pont  
(Eds.)

# ICT for Promoting Human Development and Protecting the Environment

6th IFIP World Information Technology Forum,  
WITFOR 2016  
San José, Costa Rica, September 12–14, 2016  
Proceedings

 Springer



## Editor-in-Chief

*Kai Rannenber, Goethe University Frankfurt, Germany*

## Editorial Board

Foundation of Computer Science

*Jacques Sakarovitch, Télécom ParisTech, France*

Software: Theory and Practice

*Michael Goedicke, University of Duisburg-Essen, Germany*

Education

*Arthur Tatnall, Victoria University, Melbourne, Australia*

Information Technology Applications

*Erich J. Neuhold, University of Vienna, Austria*

Communication Systems

*Aiko Pras, University of Twente, Enschede, The Netherlands*

System Modeling and Optimization

*Fredi Tröltzsch, TU Berlin, Germany*

Information Systems

*Jan Pries-Heje, Roskilde University, Denmark*

ICT and Society

*Diane Whitehouse, The Castlegate Consultancy, Malton, UK*

Computer Systems Technology

*Ricardo Reis, Federal University of Rio Grande do Sul, Porto Alegre, Brazil*

Security and Privacy Protection in Information Processing Systems

*Stephen Furnell, Plymouth University, UK*

Artificial Intelligence

*Ulrich Furbach, University of Koblenz-Landau, Germany*

Human-Computer Interaction

*Jan Gulliksen, KTH Royal Institute of Technology, Stockholm, Sweden*

Entertainment Computing

*Matthias Rauterberg, Eindhoven University of Technology, The Netherlands*

## **IFIP – The International Federation for Information Processing**

IFIP was founded in 1960 under the auspices of UNESCO, following the first World Computer Congress held in Paris the previous year. A federation for societies working in information processing, IFIP's aim is two-fold: to support information processing in the countries of its members and to encourage technology transfer to developing nations. As its mission statement clearly states:

*IFIP is the global non-profit federation of societies of ICT professionals that aims at achieving a worldwide professional and socially responsible development and application of information and communication technologies.*

IFIP is a non-profit-making organization, run almost solely by 2500 volunteers. It operates through a number of technical committees and working groups, which organize events and publications. IFIP's events range from large international open conferences to working conferences and local seminars.

The flagship event is the IFIP World Computer Congress, at which both invited and contributed papers are presented. Contributed papers are rigorously refereed and the rejection rate is high.

As with the Congress, participation in the open conferences is open to all and papers may be invited or submitted. Again, submitted papers are stringently refereed.

The working conferences are structured differently. They are usually run by a working group and attendance is generally smaller and occasionally by invitation only. Their purpose is to create an atmosphere conducive to innovation and development. Refereeing is also rigorous and papers are subjected to extensive group discussion.

Publications arising from IFIP events vary. The papers presented at the IFIP World Computer Congress and at open conferences are published as conference proceedings, while the results of the working conferences are often published as collections of selected and edited papers.

IFIP distinguishes three types of institutional membership: Country Representative Members, Members at Large, and Associate Members. The type of organization that can apply for membership is a wide variety and includes national or international societies of individual computer scientists/ICT professionals, associations or federations of such societies, government institutions/government related organizations, national or international research institutes or consortia, universities, academies of sciences, companies, national or international associations or federations of companies.

More information about this series at <http://www.springer.com/series/6102>

Francisco J. Mata · Ana Pont (Eds.)

# ICT for Promoting Human Development and Protecting the Environment

6th IFIP World Information Technology Forum,  
WITFOR 2016

San José, Costa Rica, September 12–14, 2016  
Proceedings



*Editors*

Francisco J. Mata  
Universidad Nacional  
Heredia  
Costa Rica

Ana Pont  
Universitat Politècnica de València  
Valencia  
Spain

ISSN 1868-4238 ISSN 1868-422X (electronic)  
IFIP Advances in Information and Communication Technology  
ISBN 978-3-319-44446-8 ISBN 978-3-319-44447-5 (eBook)  
DOI 10.1007/978-3-319-44447-5

Library of Congress Control Number: 2016947782

© IFIP International Federation for Information Processing 2016

This work is subject to copyright. All rights are reserved by the Publisher, whether the whole or part of the material is concerned, specifically the rights of translation, reprinting, reuse of illustrations, recitation, broadcasting, reproduction on microfilms or in any other physical way, and transmission or information storage and retrieval, electronic adaptation, computer software, or by similar or dissimilar methodology now known or hereafter developed.

The use of general descriptive names, registered names, trademarks, service marks, etc. in this publication does not imply, even in the absence of a specific statement, that such names are exempt from the relevant protective laws and regulations and therefore free for general use.

The publisher, the authors and the editors are safe to assume that the advice and information in this book are believed to be true and accurate at the date of publication. Neither the publisher nor the authors or the editors give a warranty, express or implied, with respect to the material contained herein or for any errors or omissions that may have been made.

Printed on acid-free paper

This Springer imprint is published by Springer Nature  
The registered company is Springer International Publishing AG Switzerland

# Foreword

The International Federation for Information Processing (IFIP) is the global federation of societies of ICT professionals that aims at achieving a worldwide professional and socially responsible development and use of information and communication technologies. It was established in 1960 under the auspices of UNESCO as an international non-governmental organization (NGO), not-for-profit. Its members are societies, and volunteers come from all over the world to participate in its Technical Committees and Working Groups.

One of its strategic aims, among others, is to advance digital equity worldwide, by promoting accessibility of ICT, good practices, and appropriate access to knowledge and experiences. It also seeks to discover opportunities to use information and communication technologies to promote human development and protect the environment. This is done by organizing and contributing to activities aimed at achieving the UN Sustainable Development Goals (SDGs) and the plan of action of the ITU World Summit on the Information Society (WSIS).

Among the activities organized or promoted by IFIP to attain the above goals, one flagship event is the World Information Technology Forum (WITFOR), initiated by this organization in 2003. WITFOR intends to bring together members of the ICT community from governments, academia, industry, and associations, to discuss recent proposals aimed at reaching the sustainable development goals, promoted by the United Nations, to improve global conditions by: reducing poverty and hunger; achieving universal education; promoting gender equality; ensuring environmental sustainability; combating diseases and reducing mortality.

WITFOR investigates successful ICT strategies in developing countries and examines different initiatives and projects on effective, context-sensitive development and use of ICT applications. It is intended to:

- Help put ICT-enabled development initiatives on the agenda of different organizations, governmental bodies, and groups currently involved in ICT.
- Work with different groups to ensure that senior policy makers and political leaders are aware of the developmental potential of ICT and promote its diffusion and sustainable effective use.
- Assist international organizations and donor agencies to include issues of the spread of ICT and access to information into their loan and funding programs and be more proactive in using new technologies to reduce existing social tensions and conflicts.
- Encourage scholars, analysts, and researchers to put the issue of digital equity higher on their research agendas.
- Encourage industrialized nations, as individuals and groups, to listen to and learn from colleagues around the world about their unique concerns over access to ICT.
- Develop guidelines on these issues and advise governments to formulate and follow the best strategy for the use of ICT in order to achieve global ICT equity.

WITFOR has been organized by IFIP periodically since 2003 in cooperation with several stakeholders in different host countries. So far WITFOR has been held in Vilnius (Lithuania), in 2003; in Gaborone (Botswana), in 2005; in Addis Ababa (Ethiopia) in 2007; in Hanoi (Vietnam) in 2009; and in Delhi (India), in 2012. Among the topics addressed in these editions we find: preparing the ground for ICT (2003), building the infrastructure (2003, 2005, 2007, 2009), economic opportunity (2003, 2005, 2007, 2009), empowerment and participation (2003, 2005, 2007), health (2003, 2005, 2007, 2009, 2012), education (2003, 2005, 2007, 2009, 2012), environment (2003, 2005, 2007, 2009), social, ethical, and legal aspects (2003, 2005, 2007, 2009), agriculture (2005, 2007, 2009, 2012), and e-government (2009, 2012).

WITFOR 2016 was organized by IFIP in cooperation with the Costa Rican Ministry of Science, Technology and Telecommunications (MICITT) and the five Costa Rican public universities members of the National Council of Rectors (CONARE): Universidad de Costa Rica, Instituto Tecnológico de Costa Rica, Universidad Nacional, Universidad Estatal a Distancia, and Universidad Técnica Nacional. This is the first time that WITFOR was held in Latin America and we hope this conference will help to build bridges of understanding between different regions in the world, as well as to produce a fruitful exchange of experiences and opinions between academics, practitioners, and decision-makers, contributing in this way toward the creation of a more sustainable and equitable world.

We thank the financial support of IFIP and CONARE, and the collaboration of MICITT and the Costa Rican public universities. Without their contribution, it would not have been possible to organize WITFOR 2016.

July 2016

Gabriela Marín Raventós  
Ramon Puigjaner  
General Chairs

## Preface

We are very pleased to introduce the proceedings of the World Information Technology Forum 2016 (WITFOR 2016), held in San Jose, Costa Rica, during September 12–14, 2016.

WITFOR 2016 was the sixth edition of the World Information Technology Forum, and the first one organized as an academic conference. Previous editions were structured as discussion forums. Similar to previous events, WITFOR 2016 pursued the presentation and discussion of ICT-related strategies and projects to promote development worldwide. Therefore, this conference was aimed at the interface between development and technology.

A call for papers was issued under the general theme of “ICT for Promoting Human Development and Protecting the Environment.” Within this theme, four major topics were included encompassing the Sustainable Development Goals (SDGs) recently adopted by the United Nations: ICT and cross-cutting development issues, ICT and environmental problems, ICT and human development problems, and ICT and economic development problems.

In all, 45 papers were submitted by authors from 25 countries, representing all continents. After a thorough peer-reviewed process—in which each paper was reviewed by at least three members from a distinguished Technical Program Committee (TPC)—24 papers were accepted; 22 of them are included in these proceedings. We would like to thank the members of the TPC for their valuable effort and contribution during the review process. Their work was of great importance to guarantee the quality of the conference.

The papers selected for WITFOR 2016 can be classified into seven broad topics: environment and sustainability; education; health; digital equity; gender; economic development and infrastructure; and e-government and smart cities. The broad range of issues dealt in these papers, and the different points of views reflected in them, make these proceedings valuable for researchers, practitioners, and decision-makers interested in using ICT for promoting human development and protecting the environment. In addition, they demonstrate that WITFOR can evolve into an academic conference to help further the objectives of IFIP to foster international cooperation; to stimulate research, development, and applications; and to encourage education, dissemination, and exchange of information on all aspects of computing and communication.

WITFOR 2016 was complemented by keynote speakers, demonstrations, and panel sessions. In addition, the Second Conference on Science, Innovation, and Information and Communication Technology of the United Nations Economic Commission for Latin America and the Caribbean was co-located with WITFOR 2016. This allowed for an exchange of opinions and discussions among participants in both events.

We would like to acknowledge the general chairs, Gabriela Marín Raventós and Ramon Puigjaner, for their huge effort in organizing this event. The same would not have been possible without their hard and enthusiastic work. We also appreciate the

work of everyone involved in the organization of the conference. Last, but not least, we also thank the authors and participants of WITFOR 2016.

We hope that the collection of papers in these proceedings assist in furthering the understanding of ICT issues and applications related to development, and also facilitate a fruitful exchange of experiences between academics, practitioners, and decision-makers.

Francisco J. Mata  
Ana Pont  
Technical Program Chairs

# Conference Chairs

## General Chairs

Gabriela Marín Raventós      Universidad de Costa Rica, Costa Rica  
Ramon Puigjaner              IFIP, Spain

## Technical Program Chairs

Francisco J. Mata              Universidad Nacional, Costa Rica  
Ana Pont                        Universitat Politècnica de València, Spain

## Program Committee

Julio Abascal                    Euskal Herriko Unibertsitatea, Spain  
Jose Aguilar                    Universidad de los Andes, Venezuela  
Noura Aknin                    Université Abdelmalek Essaïdi, Morocco  
Benjamín Barán                Universidad Nacional de Asunción, Paraguay  
Elena Gabriela Barrantes      Universidad de Costa Rica, Costa Rica  
Pablo Boronat                  Universitat Jaume I, Spain  
Louiza Boualouche-  
Medjkoune                      Université Abderrahmane Mira de Béjaïa, Algeria  
Heilyn Camacho                Aalborg University, Denmark  
Sergio Camorlinga              University of Winnipeg, Canada  
Héctor Cancela                Universidad de la República, Uruguay  
Indira Carr                      University of Surrey, UK  
Ignacio Casas                  Pontificia Universidad Católica de Chile, Chile  
Bernard Cornu                 Centre National d'Education a Distance, France  
Roberto Cortés                Instituto Tecnológico de Costa Rica, Costa Rica  
Cecile Crutzen                Open Universiteit Nederland, The Netherlands  
Paul M. Cunningham          IIMC/IST-Africa, Ireland  
Valentina Dagiene              Vilnius University, Lithuania  
Kevin Daimi                    University of Detroit Mercy, USA  
Penny Duquenoy                Middlesex University, UK  
Amado Espinoza                Medisist, Mexico  
Simone Fischer-Hubner        Karlstad University, Sweden  
Inés Friss de Kereki            Universidad ORT, Uruguay  
José A. Gil Salinas              Universitat Politècnica de València, Spain  
Wayne Goddard                Clemson University, USA  
Víctor M. González            Instituto Tecnológico Autónomo de México, México  
Dorothy Gordon                Advance Information Technology Institute, Ghana  
Helena Grunfeld                Victoria University, Australia

Roger Harris	Roger Harris Associates, Hong Kong, SAR China
Richard Heeks	University of Manchester, UK
Magda Hercheui	University College London, UK
Asha Kanwar	Community of Learning, India
Kai Kimpa	University of Turku, Finland
Anton Knierzinger	Private Pädagogische Hochschule der Diözese Linz, Austria
Winfried Lamersdorf	Universität Hamburg, Germany
Louise Leenen	Council for Scientific and Industrial Research, South Africa
Ernst Leiss	University of Houston, USA
Erick Mata	Instituto Tecnológico de Costa Rica, Costa Rica
Ramiro Montealegre	University of Colorado, USA
Christina Mörtberg	Linnéuniversitetet, Sweden
Yuko Murayama	Iwate Prefectural University, Japan
Edward Mutafungwa	Aalto University, Finland
Vikas Nath	HotPopRobot.com, Canada
Erich Neuhold	Universität Wien, Austria
Paul Nleya	University of Botswana, Botswana
Norberto Patrignani	Politecnico di Torino & Università, Cattolica del Sacro Cuore, Italy
Sebastián Rovira	United Nations Economic Commission for Latin America and the Caribbean, Chile
Sindre Røsvik	Giske Kommune, Norway
Rodrigo Santos	Universidad Nacional del Sur, Argentina
Alain Senteni	Hamdan bin Mohammed Smart Universit, United Arab Emirates
Siraj Shaikh	Coventry University, UK
Leon Strous	Central Bank of the Netherlands, The Netherlands
Hiroshi Takeda	Jikei Institute, Japan
A Min Tjoa	Technische Universität Wien, Austria
Izak van Zyl	Cape Peninsula University of Technology, South Africa
Chris Westrup	University of Manchester, UK
Diane Whitehouse	The Castlegate Consultancy, UK

# Contents

## Environment and Sustainable Development

The Role of ICT to Achieve the UN Sustainable Development Goals (SDG) . . . .	3
<i>A. Min Tjoa and Simon Tjoa</i>	
Principles for Re-Designing Information Systems for Environmental Sustainability . . . . .	14
<i>Richard Baskerville, Jan Pries-Heje, and Jan Recker</i>	
Automated Plant Species Identification: Challenges and Opportunities . . . . .	26
<i>Erick Mata-Montero and Jose Carranza-Rojas</i>	
Environment Monitoring Using Commercial Off-the-Shelf (COTS) Technologies: A Case Study of the Odd-Even Rule for Pollution Control in Delhi . . . . .	37
<i>Vikas Nath and Artash Nath</i>	

## Education

Challenge to Promote Deep Understanding in ICT . . . . .	47
<i>Valentina Dagiene</i>	
Computer Animation as a Vehicle for Teaching Computational Thinking . . . .	53
<i>Leonel Morales Díaz and Laura S. Gaytán-Lugo</i>	
Transforming Low Socioeconomic Status Schools to Learning for Well-Being Schools . . . . .	60
<i>Heilyn Camacho</i>	
Transformative Applications of ICT in Education: The Case of Botswana Expansive School Transformation (Best) Project . . . . .	68
<i>Paul Thabano Tapela Nleya</i>	

## Health

Identification of Design Patterns for Serious Games in an Educational Videogame Designed to Create Awareness on Dengue and Malaria Fever . . .	85
<i>Eduardo Ramírez Elizondo</i>	
A Community Assets Infrastructure for the Secure Use of Mobile Computing Devices in the Rural Health Landscape . . . . .	96
<i>Kevin Kativu and Dalenca Pottas</i>	



**Digital Equity**

Progressing Toward Digital Equity . . . . . 109  
*Ramon Puigjaner*

Telecenters for the Future in Tea Estates of Sri Lanka . . . . . 121  
*Sirkku Männikkö-Barbutiu, Thomas Westin, Ranil Peiris,  
and Peter Mozelius*

Mobile Internet Tariff Models: Technical or Political Decisions?  
A Costa Rican Case Study . . . . . 132  
*Alexander Castro-Reyes and Gabriela Marín-Raventós*

guifi.net: A Bottom-up Initiative for Building Free  
Telecommunication Infrastructure . . . . . 144  
*Miguel Pérez, Pablo Boronat, José A. Gil, and Ana Pont*

**Gender**

Typifying Mechanisms for Gender Digital Equity in Latin America. . . . . 159  
*Gabriela Marín-Raventós and Marta Calderón-Campos*

Women in ICT: Opportunities for Their Inclusion in an International  
Labor Market . . . . . 171  
*Ana M. González, Beatriz Revelles, Elisabet Almeda,  
Núria Vergés Bosch, and José S. García*

**Economic Development and Infrastructure**

Can E-Commerce Provide a Solution to the Coffee Paradox? The Case  
of Costa Rica . . . . . 181  
*Francisco J. Mata, Ariella Quesada, and Gabriela Mata-Marín*

Innovation and Governance: The Role of Sharing Economy . . . . . 195  
*Elia Brugnoli, Alberto Polzonetti, and Matteo Sagratella*

e-Bridge 3.0: A Strategic Approach to Structural Health Monitoring  
of Bridges in Costa Rica . . . . . 205  
*Cesar Garita and Giannina Ortiz*

**E-Government and Smart Cities**

ICT and Citizen Efficacy: The Role of Civic Technology in Facilitating  
Government Accountability and Citizen Confidence . . . . . 213  
*Rebecca Rumbul*

Promoting Quality e-Government Solutions by Applying a Comprehensive Information Assurance Model: Use Cases for Digital Signature. . . . . 223  
*Ricardo Villalón-Fonseca, Alejandro Mora-Castro, Rodrigo Bartels-González, Miguel Carballo-Chavarría, and Gabriela Marín-Raventós*

Emergence and Ubiquity in the Smart Cities. . . . . 235  
*Jose Aguilar*

**Author Index** . . . . . 245

# **Environment and Sustainable Development**

# The Role of ICT to Achieve the UN Sustainable Development Goals (SDG)

A. Min Tjoa<sup>1</sup> and Simon Tjoa<sup>2</sup>(✉)

<sup>1</sup> Vienna University of Technology, Vienna, Austria  
amin@ifs.tuwien.ac.at

<sup>2</sup> St. Pölten University of Applied Sciences, St. Pölten, Austria  
simon.tjoa@fhstp.ac.at  
<http://www.tuwien.ac.at>, <http://www.fhstp.ac.at>

**Abstract.** This paper is aiming at illustrating the potential of ICT for achieving the Sustainable Development Goals which were declared by the United Nations in 2015 as binding for all nations of our planet addressing both developing and developed countries. ICT must play a significant role if the SDGs should be achieved as projected in 2030. The paper gives an overview of some of the existing efforts in this area and is written as an appeal to all professionals, scientists and IT-professional and their organization to take a holistic approach for all ICT-activities and projects to always include and monitor the effects of their work on the SDGs. The impacts of ICT on sustainability are twofold: On the one hand there might be negative effects on sustainability such as the generation of electronic waste, on the other hand ICT is definitely an enabler to more efficient resource usage, education and business operations which is critical success factor for achieving the SDGs.

**Keywords:** Sustainable development goals · Millennium development goals · WSIS · Code of ethics · Impact of IT-work on sustainability · Karlskrona manifesto

## 1 Introduction

On 25th to 27th of September 2015, the heads of state and high-representatives of United Nation's member nations agreed on the Sustainable Development Goals (SDGs) which supersede the Millennium Development Goals. The Millennium Development Goals (2000–2015) can be regarded as one of the most important and successful initiatives to eradicate poverty in modern history. The eight crystallized goals of the MDGs have been further translated into practical steps which have deliberated over one billion people from an extreme level of poverty and have achieved a better standard of life in many parts of the world. [19] Without any doubt one cannot neglect the eminent role of science, technology

and innovation as well as the dissemination of these new technologies in most of the practical steps leading to a society where no one should be left behind.

The aim of the SDGs is to set the objectives for driving forces all over the world to tackle the world's largest challenges such as fighting poverty, eliminating inequalities and achieving sustainable economic growth. The agenda comprises 17 SDGs which are further refined to 169 targets addressing economic, social and environmental aspects [20].

A key aspect of the agenda is that the defined goals address all countries. All countries of our planet are obliged to perform their level best to consider and enforce all their efforts to achieve within one generation a significant reduction of inequalities in their societies. This should be achieved in least developed countries, developing countries, middle income countries but also in the developed countries. Furthermore, this development should take into account a balancing of the economic, social and environmental factors towards a safe and sustainable planet [20].

No other domain in the recent past had such a strong influence on the development of countries and societies than information and communication technologies (ICTs), especially in driving today's innovation, efficiency and effectiveness across all sectors. ICT has been the fastest growing sector since a generation. The World Summit on Information Societies (WSIS) in 2003 and 2005 was devoted to the potential of ICTs towards the vision of "a people centered, inclusive and development-oriented information society" where everyone can have the potential to access and share information available (on the Web). Bridging the digital divide is essential for all people left behind to utilize potentially available information to create new businesses and (local) knowledge. We should be aware of the importance of local content in the local languages for taking advantage of information on the Web. The fundamental aim of the WSIS process was the improvement of peoples' life through a better use of ICTs.

The eleven action lines of WSIS are highly relevant for all the necessary efforts to achieve the SDGs.

This paper is aiming at sketching the enormous potential of ICT to accomplish the SDGs which cover the three dimensions of economic prosperity, social equity and environmental sustainability in 2030.

It is necessary for an organization like IFIP to make it explicit to all people working in the field of information processing to align their work to the SDGs which are global in the sense that they are binding for both the developed and the developing countries.

## 2 Role Models Within Computer Societies on Direct or Indirect Initiatives Toward SDGs

The International Federation for Information Processing (IFIP) [9] is an umbrella organization for information technology societies in more than 56 countries all over the world. The role of information technology on society has been discussed in different working groups of the Technical Committee 9 "ICT and Society" since 1976.

Already in 2005, an IFIP Working Group for “ICT and Sustainable Development” [10] was established to provide the platform for discussion and research on this eminent important topic for building a global society where nobody should be left behind which is also sustainable for future generations.

This IFIP Working Group covers the necessary promotion of research on the interactions amongst the social, environmental and economic impacts of ICT towards a sustainable society for generations to come. This includes the coordination of policy issues concerning synergies of a multi-stakeholder and people-centered driven information society and sustainable development targets.

The scope of this working group also covers the important aspect of early warning on (possible negative) impacts of ICT- applications and innovation to enable a strategic forecast of coming new technologies in the area.

In their Code of ethics ACM defines 24 imperatives which set ACM’s expectations of a member. Many of the mentioned principles such as “Contribute to society and human well-being”, “Be honest and trustworthy” or “Know and respect existing laws pertaining to professional work” reflect ethical behavior which in a very general manner build prerequisites for ICT to be a facilitator in reaching the SDGs.

In line with these principles, the Code of ethics of the ACM/IEEE-CS Joint Task Force on Software Engineering Ethics and Professional Practices defined the following eight principles for software engineers [1]:

1. *“PUBLIC - Software engineers shall act consistently with the public interest.*
2. *CLIENT AND EMPLOYER - Software engineers shall act in a manner that is in the best interests of their client and employer consistent with the public interest.*
3. *PRODUCT - Software engineers shall ensure that their products and related modifications meet the highest professional standards possible.*
4. *JUDGMENT - Software engineers shall maintain integrity and independence in their professional judgment.*
5. *MANAGEMENT - Software engineering managers and leaders shall subscribe to and promote an ethical approach to the management of software development and maintenance.*
6. *PROFESSION - Software engineers shall advance the integrity and reputation of the profession consistent with the public interest.*
7. *COLLEAGUES - Software engineers shall be fair to and supportive of their colleagues.*
8. *SELF - Software engineers shall participate in lifelong learning regarding the practice of their profession and shall promote an ethical approach to the practice of the profession”.*

All eight principles can be assigned to the sustainable development goals. As a “pars pro toto” -example we will illustrate the relevance of these code of ethics principles for software engineering professionalism by means of a (hypothetical) “Volkswagen-like” case on the basis of the eight principles described above (i.e. a case where software has been built to deliver manipulated environmental data to fulfill existing binding environmental standards). Since all the details of the

Volkswagen-case are not yet clarified and disclosed we do not refer to the “real” Volkswagen-case. However, we want to show that compliance to the ethical principles may even prevent enormous damages in “Volkswagen-like”-cases.

For the first principle (“Public”) ICT-workers should very much internalized the idea that the usage of their products must be compliant with the environmental, economic and social requirements of its deployment. In our case it could be imagined that already in the requirement analysis phase one could have detected a conflict of interest between the goals of the software to be built which could lead to manipulated results and the public interest of clean air which are defined by the binding environmental standards (both national and internationally for the target countries where the cars are sold).

Principle 2 (“Client and Employer”) is also breached due to the negative effects on car-buyers and ultimately also for the employer. For a car maker the penalties of such breaches can go into billions of US-dollars and it would be the task of every ICT-worker to warn the employer about the consequences of the misuse of software. Introducing a mandatory independent monitoring and/or auditing of SDGs for large projects with possible very damaging impacts could be an approach which should be considered in the future. This could also be important for all kinds of breaches which would cause reputational damage (e.g. child-labor).

The principle of “Judgement” is a prerequisite for an overall ethical-driven work of ICT-workers in their (team) work. For educational institutions and universities, the inclusion of SDGs into the curricula will be an important target of the near future. ICT-managers should handle SDG-requirements with equal importance to all other quality criteria within their software development process. The reputation of ICT-workers can be very much advanced by the potential of software to reduce negative impacts on sustainability. Lifelong learning is prime for keeping track with newest developments where ICT will function as one of the most important enabler for achieving the SDGs in 2030.

Recently through the initiative of a few prominent software engineering scientists in the area of requirement engineering the so-called Karlskrona Manifesto for Sustainable Design is formulated where inter-alia the following disposition of existing awareness within the software engineering community is stated [3].

The coherent and proper analysis of the initiators of the Karlskrona manifesto on the existing increasing consciousness within the software engineering community lead to the proposal of an initial set of principles and commitments [2]:

*“Sustainability is systemic.*

*Sustainability has multiple dimensions.*

*Sustainability is a concern independent of the purpose of the system.*

*Sustainability applies to both a system and its wider contexts.*

*Sustainability requires action on multiple levels.*

*System visibility is a necessary precondition and enabler for sustainability design.*

*Sustainability requires long-term thinking. (i.e. We should assess benefits and impacts on multiple timescales, and include longer-term indicators in assessment and decisions.)*

*It is possible to meet the needs of future generations without sacrificing the prosperity of the current generation. (i.e. Innovation in sustainability can play out as decoupling present and future needs. By moving away from the language of conflict and the trade-off mindset, we can identify and enact choices that benefit both present and future.” [2]*

A forerunner of the initiatives towards the role of ICT to combat global warming was the ICT-GLOW-initiative in 2010/2011 which leads to the establishment of the International Conference on ICT as Key Technology for the Fight against Global Warming in Toulouse, France in 2011. [11] A special track on “Cloud Computing for the Public Sector” completes this gathering of experts in the field. Already here the two aspects of the involvement of ICT for sustainability has been pointed out, i.e. on the one hand issues on the potential of ICT as enabler for the reduction of CO<sub>2</sub>-emissions and on the other hand, issues on the urgent need of systems which are designed and operated in an energy-aware way leading to a minimization of energy consumption [11].

“Sustainability design as introduced by Becker et al. in the context of software systems is the process of designing systems with sustainability as a primary concern, based on a commitment to these principles.” [2]

The above mentioned initiative in the field of requirement engineering clearly shows the holistic character of sustainability. However, one can state that this initiative is skewed to the environmental dimension of the SDGs which is still the main focus in the Northern hemisphere. The economic dimension of SDG for achieving economic prosperity and social equity is not in the center of the manifesto.

An approach which does not single out the aspect of eradication of the global imbalance was sketched in [17] where the challenges of this decade with respect to necessary adaptation of the ICT-work of scientists and professionals concerning social, economic and ethical challenges are briefly summarized.

Especially aspects of the elimination of economic poverty due to the use of mobile devices in the area of e-commerce and aspects of the use of crowd-sourcing for e-health applications were discussed.

In 2013, a very successful conference-series ICT for Sustainability (ICT4S) was started in Zurich with the support of the universities in Zurich with a predominant focus on environmental sustainability [8].

It can be stated that a lot of efforts are still needed for the holistic investigation of the use of ICT to achieve the SDGs. Therefore, in the next section we point out sectors of ICT which could significantly contribute to the success of SDG by 2030.

### 3 Possible Contribution of ICT to the SDGs

Hilti and Aebischer [7] categorize the effect of ICT as follows: Level 1 (“direct effects”) describe the negative effects of ICT which comprises the production and disposal. Level 2 (“enabling effects”) are those effects which arise from the application of ICT. Unlike to level 1, these effects can be either positive



(e.g. substitution effect, optimization effect) or negative (e.g. induction effect, obsolescence effect). Level 3 (“systemic effects”) refer to long-term impacts of ICT services on socio-economic systems. These impacts can also be positive (e.g. sustainable patterns of production and consumption) or negative (e.g. new emerging risks).

Further, the authors [7] outline how different domains in computer science, such as Environmental Informatics or Computational Sustainability, contribute to the achievement of sustainable ICT.

According to an Ericsson report [4] can accelerate the achievement of the SDG in five ways: (1) ICT spreads in a very fast way which can be best demonstrated by the uptake of mobile technologies reaching seven billion subscribers in 2015. (2) ICT can help to save costs in various sectors such as health, banking, or education. (3) ICT can help to point out the awareness of new technologies. Unlike in the past, information about new technologies can spread at enormous speed using social networks, mobile technologies or other electronic channels. (4) National and global information flows are enhancing and upgrading new applications. (5) Through the usage of ICT low cost online platforms can be established to educate workers in new technologies [4].

In its mapping, WSIS mapped its action lines to the sustainable development goals. For each mapping in the table a detailed rationale is given in the report. In the following we briefly outline the action lines as described by WSIS. [24] The action line C1 (“Role of Government and all Stakeholders in the Promotion of ICT for Development”) [23] highlights the importance of the buy-in from governments and stakeholders in order to establish the Information Society. C2 (“Information and communication infrastructure: an essential foundation for the Information Society”) [23] demands adequate infrastructure enabling affordable and ubiquitous access to ICT. C3 (“Access to information and knowledge”) [23] outlines that individuals and organizations should take advantage from access to information and knowledge using ICT. C4 (“Capacity building”) [23] states that every person should have the knowledge and skill set to profit from the Information Society. Further, actions how ICT can support education and lifelong learning activities are outlined. C5 (“Building confidence and security in the use of ICTs”) [23] highlights the central value of privacy, trust and security for the Information Society. C6 (“Enabling environment”) [23] points out actions to increase the confidence in the Information Society. C7 (“ICT applications: benefits in all aspects of life”) [23] highlight that ICT can improve the sustainable development in various areas such as e-government, e-business, e-learning, e-health, e-environment, e-agriculture, and e-science. Within the WSIS-SDG matrix C7 is refined into the individual applications. C8 (“Cultural diversity and identity, linguistic diversity and local content”) [23] stresses that cultural and linguistic diversity poses a critical success factor in the development of an Information Society. C9 (“Media”) [23] outlines the importance of media in all its forms in the development of an Information Society. C10 (“Ethical dimensions of the Information Society”) [23] emphasizes the relevance of ethics within the Information Society to avoid abusive usage of ICT. C11 (“International and regional cooperation”) [23] points out that international cooperation is indispensable in order to eliminate the digital divide.

	C1	C2	C3	C4	C5	C6	e-gov	e-bus	e-lea	e-hea	e-emp	e-env	e-agr	e-sci	C8	C9	C10	C11
SDG 1																		
SDG 2																		
SDG 3																		
SDG 4																		
SDG 5																		
SDG 6																		
SDG 7																		
SDG 8																		
SDG 9																		
SDG 10																		
SDG 11																		
SDG 12																		
SDG 13																		
SDG 14																		
SDG 15																		
SDG 16																		
SDG 17																		

Fig. 1. WSIS action lines - SDGs matrix [24]

In the following we highlight possible opportunities for a subset of the SDG. Due to space limitations we decided to tackle a few goals in more detail instead of providing an abstract view on every SDG (Fig. 1).

**SDG 4: Ensure Inclusive and Equitable Quality Education and Promote Lifelong Learning Opportunities for All.** ICT plays a major role in order to achieve quality education and lifelong learning possibilities as expressed within SDG 4. Platforms, such as Massive Open Online Courses (e.g. Coursera, Udacity, edX, iVersity, Khan Academy) which are available for free through the Internet highlight how (even specialized) knowledge can be made available to a wide public. Furthermore, online social networks and Web 2.0 platforms (such as YouTube) are widely used to spread knowledge via the internet in order to facilitate lifelong learning.

Another success story in providing information and education to everybody is the online encyclopedia Wikipedia which is a free-of-cost encyclopedia developed by using the knowledge of the community [21].

Open Access publications, such as Springer Open, are gaining popularity and support the accessibility of scientific contributions. Further, research social networks, such as Research Gate, establish the exchange between researchers and scholars all over the world. Open Source products (e.g. Linux, LibreOffice, Eclipse) and initiatives pose alternatives to expensive software suites and minimize thereby inequalities in education.

In order to design content on the internet in an inclusive way, the W3C started his Web Accessibility Initiative [25].

Initiatives setting common standards in education of digital competencies, such as the European e-Competency Framework (e-CF) [5] and the ICT profiles project [6] building upon, highlight which ICT competencies should be taught in order to address today's challenges. Although released 2014, the competency framework already addresses sustainable development.

**SDG 11: Make Cities and Human Settlements Inclusive, Safe, Resilient and Sustainable.** So called smart cities envision more effective usage of resource in urban areas supported by ICT. (Research) initiatives in the domain "intelligence transport system" will contribute to improvements in traffic planning. Self-driving vehicles which are currently one of the hottest innovations in car industry highlight how ICT could be an opportunity for aging society to keep mobile.

Smart metering systems and smart distribution systems can support the sustainable usage of electric power. Analogue to the usage of electric power smart distribution and management systems are currently under research to facilitate the efficient usage of water. ICT platforms enable participatory urban planning projects where citizen can express their opinions. eGovernment systems open up the possibility to complete administrative processes from anywhere.

Furthermore, ICT is key technology in assisting decision makers and responders during disasters. Thus, in the future ICT systems have to be created supporting the objectives of the Sendai framework. [18]

### 3.1 Joint Proposal of ICT Indicators for the Sustainable Development Goals Indicator Framework

This proposal has been prepared for the expert group meeting on an indicator-framework for the post-2015 development. It contains ICT indicators (e.g. individuals using internet or E-waste collection rate) and available datasets (e.g. datasets collected by ITU or UNU) which are required to calculate the impact on sustainability [15].

It should not be unmentioned that non-profit organizations have taken many initiatives in the efforts to instrument ICT as an enabler to achieve the SDGs. A prominent example is the SDG ICT Playbook of NETHOPE, representing more than 40 international non-profit organizations, which provides guidance on how ICT can support the achievement of the SDG. Therefore, SDG are linked to sector demands that could profit from the application of information technologies. These ICT solutions are further mapped to key underlying technologies, challenges and recommended methods addressing the challenges [14].

### 3.2 Towards a Compliant ICT-working Effort for SDGs

It is evident that the use of ICT has also facets which endanger the environment of our planet, e.g. the problem of electronic waste, cheap labor in the production process of IT-equipment etc.

More importantly however, as it has been pointed out above, ICT will play a most important role to achieve the SDGs. The ICT-scientific-community has

to be aware that this role of ICT as an enabler is a very noble one. Especially in the “pure” academic world unfortunately still there exists the tradition to depreciate the role of a discipline as an auxiliary science.

In the opinion of the authors it is high-time to (a) consider the impact of all our work as ICT-scientists and professionals with respect to its three dimensions of SDG in achieving economic prosperity for all, social equity and environmental sustainability.

IFIP has committed in its Milan Declaration in 2008 that the ICT profession should be founded on the essential elements of professionalism Competences (including knowledge), Integrity, Responsibility and Accountability and Public Obligation. In 2016 it should be mandatory that the notion of responsibility should be coined to all aspects of the SDG [13].

In the following we want to exemplarily point out just a few areas within the ICT-landscape where scientists and other professionals could contribute to the fulfillment of the SDGs or at least plays a role in mitigating economic, social and environmental disasters.

A few examples should illustrate the above role of ICT:

- In the field of Software Engineering it will be essential that both the compliance with Code of Ethics and severe sustainable monitoring of large software projects are considered as instruments to prevent environmental damaging software as described above in Volkswagen-like-cases. Taking the Karlskrona Manifesto as a compliance-guideline for Software Engineers would have prevented such a disaster.
- In the area of Sustainable Supply Chain Management one could use advance text mining and Bayesian Networks techniques to detect child labor in the supply chain. [16]
- Methods of crowd-sourcing could be used to early detect epidemics and agricultural plagues using big-data techniques.
- In education the MOOC-approach of disseminating knowledge for higher education also to the third world is an example for a successful impact of ICT. Here we can mention the LEJ Knowledge Hub of Pakistan as a role model where thousands of Courses are delivered by world authorities in Science, Engineering, Agriculture, Social Sciences, Economics and other fields are freely available at school, college and university levels. [12]
- In the area of Disaster Risk Reduction, ICT has achieved very successful which are originated in developing countries. Ushahidi’s success in many catastrophes as the earthquake in Haiti shows us that open source software can play a key role. [22]

It should be mentioned that IFIP has just established an “IFIP Domain Committee on IT in Disaster Risk Reduction” where an interdisciplinary bundling of IT-knowhow and other disciplines should enable significant disaster risk reduction.

## 4 Conclusion and Future Work

In this paper we emphasize the important role of ICT to achieve the Sustainable Development Goals, the so called SDGs (2016–2030) which follow the Millenium Development Goals- MDGs (2000–2015). In contrast to the MDGs the SDGs are binding for all countries developed and developing- and cover holistically the economic, social and environment dimension.

We are convinced that the conformance to the Code of Ethics which significantly include “sustainability” should be self-evident for every IT professional as in other disciplines the Hippocratic Oath is binding for medical doctors.

However, it will be an important requirement of the next future that for all ICT-projects and enterprises sustainability is included as a new dimension which is monitored by all internal audit functions of the involved organizational entities. For this reason, we are convinced that auditable standards and best practices on internal sustainability controls as well as performance indicators are required to ensure the conformance with these new objectives.

## References

1. ACM/IEEE-CS: Software engineering code of ethics and professional practice (2016). <http://www.acm.org/about/se-code>. Accessed June 2016
2. Becker, C., Betz, S., Chitchyan, R., Duboc, L., Easterbrook, S.M., Penzenstadler, B., Seyff, N., Venters, C.C.: Requirements: the key to sustainability. *IEEE Softw.* **33**(1), 56–65 (2016)
3. Becker, C., Chitchyan, R., Duboc, L., Easterbrook, S., Mahaux, M., Penzenstadler, B., Rodriguez-Navas, G., Salinesi, C., Seyff, N., Venters, C.C., Calero, C., Kocak, S.A., Betz, S.: The karlskrona manifesto for sustainability design (2015). <http://sustainabilitydesign.org/karlskrona-manifesto/>. Accessed June 2016
4. Ericsson, The Earth Institute, Colombia University: ICT & SDG - How Information and Communications Technologies ccan Achieve the Sustainable Development Goals. Report (2015). <https://www.ericsson.com/res/docs/2015/ict-and-sdg-interim-report.pdf>
5. European Committee for Standardization (CEN): European e-competence framework 3.0 (2014). [http://ecompetences.eu/wp-content/uploads/2014/02/European-e-Competence-Framework-3.0\\_CEN\\_CWA\\_16234-1\\_2014.pdf](http://ecompetences.eu/wp-content/uploads/2014/02/European-e-Competence-Framework-3.0_CEN_CWA_16234-1_2014.pdf)
6. European Committee for Standardization (CEN): ICT Profiles (2016). <http://www.ecompetences.eu/ict-professional-profiles/>
7. Hilty, L.M., Aebischer, B.: ICT for sustainability: an emerging research field. In: Hilty, L.M., Aebischer, B. (eds.) *ICT Innovations for Sustainability. Advances in Intelligent Systems and Computing*, vol. 310, pp. 3–36. Springer, Heidelberg (2015)
8. ICT4S: ICT4S 2013 - ICT for Sustainability - The Challenge of Making It Real (2013). <http://2013.ict4s.org/>
9. International Federation for Information Processing (IFIP): About IFIP (2016). [http://www.ifip.org/index.php?option=com\\_content&task=view&id=124&Itemid=439](http://www.ifip.org/index.php?option=com_content&task=view&id=124&Itemid=439). Accessed June 2016
10. International Federation for Information Processing (IFIP): TC 9- ICT and Society - Aims and Scopes (2016). [http://www.ifip.org/bulletin/bulltcs/tc9\\_aim.htm](http://www.ifip.org/bulletin/bulltcs/tc9_aim.htm). Accessed June 2016

11. Kranzlmüller, D., Toja, A.M. (eds.): ICT-GLOW 2011. LNCS, vol. 6868. Springer, Heidelberg (2011)
12. LEJ KnowledgeHub (2015). <http://lej4learning.com.pk/>
13. Milan Declaration: WCC 2008 Declaration on ICT Professionalism and Competences (2008). <http://ipthree.org/milan-declaration/>
14. NETHOPE: SDG ICT Playbook - From Innovation to Impact (2015)
15. Partnership on Measuring ICT for Development: Background note: Joint proposal of ICT indicators for the Sustainable (2015)
16. Thoeni, A.: Sustainability Risk Monitoring in Supply Chains Ranking Suppliers using Text Mining and Bayesian Networks with a Focus on Child Labor. Ph.D. thesis, Vienna University of Technology (2015)
17. Tjoa, A.M.: Next decade of social, economical and ethical challenges - perspectives of a networked world. In: 24th IEEE International Conference on Advanced Information Networking and Applications. IEEE Computer Society (2010)
18. UNISDR - The United Nations Office For Disaster Risk Reduction: ICTs and the Sendai Framework (2016). <https://www.unisdr.org/archive/47522>. Accessed June 2016
19. United Nations: The Millenium Development Goals Report, New York (2015)
20. United Nations: Transforming Our World: The 2030 Agenda For Sustainable Development, New York (2015)
21. Wikipedia: From wikipedia, the free encyclopedia, (06 2016). <https://en.wikipedia.org/wiki/Wikipedia>. Accessed June 2016
22. Wikipedia: Wikipedia - ushahidi (2016). <https://en.wikipedia.org/wiki/Ushahidi>
23. World Summit on the Information Society (WSIS): Plan of action, December 2003. Accessed June 2016
24. World Summit on the Information Society (WSIS): WSIS - SDG Matrix (2016). Accessed June 2016
25. World Wide Web Consortium (W3C): Designing for inclusion (2016). <https://www.w3.org/WAI/users/Overview.html>. Accessed June 2016

# Principles for Re-Designing Information Systems for Environmental Sustainability

Richard Baskerville<sup>1,2</sup>, Jan Pries-Heje<sup>3(✉)</sup>, and Jan Recker<sup>4</sup>

<sup>1</sup> Georgia State University, Atlanta, USA  
baskerville@acm.org

<sup>2</sup> Curtin University, Perth, WA, Australia

<sup>3</sup> Roskilde University, Roskilde, Denmark  
janph@ruc.dk

<sup>4</sup> Queensland University of Technology, Brisbane, Australia  
j.recker@qut.edu.au

**Abstract.** Many information systems claim to be “green”, meaning in support of environmental sustainability. But at closer look we find that these claims are often unsubstantiated; in other words, many green systems are not making any environment more sustainable. We identify three main root causes. First, the ‘environment’ is often ill-defined. Second, systems often overlook that ‘sustainability’ is a targeted function dependent on the goals of some stakeholders, which may include designers, users, organizations, policy makers, society or the planet as a whole. Third, we find that research on green information systems often overlooks conceptualizations such as ecology, environment or sustainability that originate in the sciences of the system, i.e., the basis on which information systems are built. To address these issues we present eight new design principles unique to the development of Green Information Systems that can act as prescriptive coherent design theory for developing information systems that improve environmental sustainability.

**Keywords:** Green information systems · Environmental sustainability · Systems design · Theory development · Design principles · Systems science

## 1 Introduction

In responding to increased social, cultural, and legislative pressures that expand the responsibility of firms to increase attention to environmental concerns, chief executives are increasingly turning to information systems (IS), as a solution to assist organizations in transforming to more sustainable entities [1]. Information systems have been argued to be the greatest force for productivity improvement in the last half century [2], and there is great hope that such systems can also help with the global environmental challenge [2, 3].

In response, IS scholars have started to explore the role that information systems provide might play [3–5], and have also taken steps to develop theories and artefacts that show how such systems, often labeled “Green IS”, could be built [6–8].

Our key contention in this paper is that many of the artefacts, theories and conceptions that bear the label “Green IS” do not live up to this name. In other words, we posit that Green IS are not actually and always green, meaning that much of the existing work on Green IS falls short of the proclaimed allure “to assist individuals and organizations to make better, that is, environmentally sustainable decisions, and to enable and effectuate environmentally sustainable work practices rather than environmentally unsustainable ones” [9, p. 2]. In this paper we will discuss three problems with the current conception of Green IS on which this contention is based. We provide a new conceptualization of Green IS and derive a set of six novel design principles that can guide the development of an information system for environmental sustainability. In doing so we take an important step to address the noted Green IS design challenge [2, 10]: How do we build information systems that allow organizational and/or individual actors to perform environmentally sustainable actions and decisions?

## 2 Related Work

### 2.1 Information Systems and Environmental Sustainability

The scholarly IS discipline has been challenged to provide an understanding how IS can contribute to environmentally responsible human activity [2, 3]. The key assumption is while information technology creates an environmental load due to the electricity required for its operation and the problem of disposing of obsolete hardware, IS can also be used to reduce environmental problems by allowing process and practices to change. This is because, in theory, IS can assist individuals and organizations to make better, *environmentally sustainable decisions*, and to enable *environmentally sustainable work practices*.

The studies to date fall in two categories: empirical and design. Empirical studies have, for instance, investigated factors that influence adoption of (*any type of*) Green IS [e.g., 11, 12]. Substantive-level studies have conceptualized requirements for *some type of* Green IS, such as energy systems, or examined specific systems for specific environmental challenges such as energy consumption, greenhouse gas emissions or specific organizational initiatives [e.g., 5, 13].

A second, smaller stream of Green IS research is concerned with the design of information systems for environmental sustainability. This stream has produced a number of instantiations and theories for Green IS design. Reported instantiations include open-source systems for energy data management [6], a greenhouse gas emission tracking system for logistics processes [7], or an index system for green supplier evaluation [8]. These efforts have contributed substantive-level design knowledge through the situated implementation of artefacts but they are not presented or developed in a way that the design knowledge becomes more abstract, complete and mature and where they could be termed design theory.

Regarding Green IS design theories, in 2014 two papers were presented at conferences that provide substantive-level design knowledge: they identify specific requirements for a specific type of Green IS design theory, namely an information system for sustainability reporting [14], and an information system to manage energy consumption



[15]. In 2016, Recker [9] proposed a first class-level design theory for green information systems, which postulates that any kind of Green IS must operate on the levels of belief formation, action formation and/or outcome measurement to faithfully belong to the class of systems for environmental sustainability. We will return to this theory below.

## 2.2 Systems and Their Environment

For design science, the concept of an environment is not necessarily related to natural environments. It refers quite specifically to the relationship between an artifact and its context. It is important to recognize this relationship in order to avoid too much obsession with the nature of the artifact itself. The context of the artifact, its environment, is the mold in which the artifact must fit sufficiently well to accomplish its goals.

The prospects for developing and applying an artifact to successfully achieve a goal depend on three key elements and their interrelationships. (1) The purpose or goal under which the activity was taken. (2) The characteristics of the artifact itself. (3) The nature of environment in which the artifact performs.

In Simon's sciences of the artificial view [16], there are two environments. The artifact itself has an inner environment that represents its substance and organization. The second environment is an outer environment constituting the surroundings in which the artifact must operate. Simon refers to the artifact itself as a meeting point or an interface between the inner and the outer environments.

Both the inner and the outer environments can be regarded as systems. For example, a computing artifact will comprise a system of hardware and software. The hardware and software constitute the inner system and the inner environment. If this computing artifact is deployed in an organization, the organization would constitute its outer environment. To the degree that we may consider an organization as a system, this outer environment is also the artifact's outer system. Simon [16] often refers to the "inner system" and the "outer environment".

Because both environments may also be thought of as systems, we must also be concerned with the complexity of the inner environment and the outer environment. A system's complexity is proportional to the amount of information required to describe the system or to resolve any uncertainty associated with the system [17]. We must be concerned about information at two levels. One level concerns the amount of information flowing across the artifact interface between the two environments. A second level concerns the amount of information necessary to properly specify the artifact's inner environment characteristics in order to match its outer environment across the interface. It also concerns the amount of information necessary to resolve the uncertainty about the artifact's inner environment behavior within the context of its outer environment. Complexity can emerge from the richness of the outer environment. The ability for the artifact to apprehend information about the outer environment across its interface can be seen as a major limiting factor in coping with outer environmental complexity.

Because of the high complexity, it can be impossible to obtain sufficient information to eliminate all uncertainty for many outer environments. Artifacts must often adapt or cope with variations in the outer environment. Such variations could be emergent change or unpredicted environmental conditions. Consequently the inner system may be

regarded as a system of organized phenomena capable of attaining the goals in some range of environments. The outer environment is expected to operate across this range. Consequently the outer environment delivers the conditions under which a properly designed inner system will adapt to that outer environment and attain the goals. In this way the conditions of the inner environment are largely determined by the conditions of the outer environment.

The substantive rationality of an inner environment in the way it adjusts to its outer environment constitutes its ability to discover appropriate adaptive inner environment conditions. Thus the limits of the inner environment to discover appropriate adaptive behavior constitute the limits of the inner environments procedural rationality. These are limiting properties of the inner environment appear at the interface and reveal the degree to which the inner environment matches the outer environment. In this way these limiting properties explain artifact defects by tracing them to the inner constraints on adaptivity.

### 2.3 Systems and Their Design

Information systems development (ISD) regards the design of processes and products. ISD typically unfolds in a series of stages such as analysis, design, coding and testing. The stages do not have to be carried out sequentially but can be done more or less in parallel. Often each stage operates with a defined notation and will often result in a prescribed artefact, such as a requirements specification or a computer program.

An ISD methodology is a prescribed and prepackaged way of carrying out the development. The package will typically include: (1) activities to be performed; (2) deliverables or artifacts resulting from the activities; and (3) principles for organizing the activities and attaching people to perform the activities. Many ISD methodologies claim to be of generic use. However, an ISD methodology can also be aimed at a specific type of design and development such as Green IS or sustainable systems.

A key question has been whether ISD methodologies were actually used in practice? This question was raised more than 20 years ago when Bødker and Bansler [18] could not find the prescribed use of structured analysis and design in practice. Following that a growing number of studies suggested that the relationship of methodologies to the practice of information systems development was altogether tenuous [19, 20]. At a point it seemed as if the concept of methodology had taken such a dominant role in our thinking about IS design and development that it had become a self-confirming hypothesis; such a thing had to exist. An alternative viewpoint was that IS design and development in reality was emergent and therefor 'amethodical', meaning that there was no predefined sequence, control, or rationality in practice [21].

## 3 Three Problems with the Current Conception of Green IS

There are four key assumptions about the design of Green IS that deserve careful distinction. These assumptions include *green*, *sustainability*, *ecology*, and *environment*.

The *green* concept entails the relationship between information systems and the natural environment. It implies a consideration of the relationship between people and nature. It spans issues dealing with the ways in which humankind is deteriorating or destroying the planet Earth. It entails an objective: creating information systems that reduce, or at least do not worsen pollution, biodiversity loss, global warming, the greenhouse effect, and other negative impacts that people create through modern social, economic, and political development [22].

The *sustainability* concept usually regards the capacity to meet the needs of the present without compromising the needs of the future [23]. Sustainability can regard the capacity of a design artifact to operate without triggering deterioration of its outer environment. Such a system-based conceptualization of sustainability provides a more general notion that encompasses both green and other forms of sustainability.

The *ecology* concept usually regards the interrelationships between organisms and their environment. However it can also be applied to systems which have a character that behaves in organic or organic-like ways. In an inner sense, sustainable ecological systems can be regarded as stable. In an outer sense, where the outer environment is itself unstable, sustainable ecological systems can be regarded as resilient [24].

The *environment* concept is also often used in its green sense, meaning the natural environment that is the surroundings or conditions in which a people, animals and plants lives or operate.

On basis of these four assumptions, we identify three problems in the current Green IS literature. **One problem** is the lack of clarity in distinguishing green as a goal or requirement from green as a characteristic of the artifact. For example, the artifact may be green in an egoist sense of “do no harm” to the environment around it. However, it may at the same time fail to be green in the utilitarian sense of helping to restore our polluted, overheated planet to a previous state that was more desirable: a less polluted, less warm planet.

A **second problem** is that references to the “environment” are often laden with assumptions, ill-defined and examined in isolation. From a systems perspective, the outer environment of an artifact goes no further than defining the necessary characteristics of its interface, and the functions required of the artifact. However, the environment can and must be seen from many perspectives; natural, economic, organizational, social, ecological, ethical and so on.

A **third problem** is that systems designers can easily overlook the alternative scope of sustainability requirements. Sustainability is not only relative to inner and outer artifact environments, but it is also a function targeted at the goals of some stakeholders. The sustainability requirements might be defined narrowly according to the goals of certain designers, users, organizations, policy-makers, society or the planet as a whole. Sustainability goals can also conflict. For example, designers, users and organizations may impose sustainability goals that address sustainability of the inner environment, like the organization’s stability and resilience. Further, the outer sustainability might restrict the available energy for the artifact, or limit its ability to transfer waste outputs; as a result there could be a loss of stability within the inner system.

## 4 A New Design Theory for Green IS

### 4.1 An Illustrative Empirical Case

In September 2015 the Volkswagen (VW) ‘Dieselgate’ [25] scandal broke loose. The US Environmental Protection Agency went public with the fact that they had found ‘defeat’ software embedded in diesel engines [26]. This piece of software was able to detect when a car was being tested, and then it could change the emission of Nitrogen Oxides NO<sub>x</sub> to the allowed level. In road-tests, however, the emission of NO<sub>x</sub> was up to 40 times higher [26].

The green perspective in this case is about NO<sub>x</sub>. According to GreenFacts [27] NO<sub>x</sub> can decrease lung function and increase the risk of respiratory symptoms such as acute bronchitis, cough and phlegm especially for children. Furthermore, one of the nitrogen oxides namely NO<sub>2</sub> is a trace gas in the atmosphere that absorb the terrestrial radiation leaving the surface of the Earth [28]. Thus high levels of NO<sub>x</sub> contribute to the ‘greenhouse effect’.

When the story broke it was a hot topic for weeks in newspapers all over the world. The International Federation of Information Processing – IFIP – brought a new perspective to the table focusing on the designers or developers. They said in a media release [25]:

*“ICT professionals must operate according to a Code of Ethics and should be willing to challenge or even report any order from management that risks the safety of that organization’s customers or staff. DieselGate is as much an indictment of the software industry as it is of the VW executives who issued the order for the software to be installed ...”*

And IFIP went on to state that they saw it as going against professional practice and they pointed to the Milan Declaration [29] for a definition of that practice.

It is easy to see that in this case there are several stakeholders with different perspectives on the question of a sustainable systems design. There is the EPA representing the common opinion that we must reduce the outlet of NO<sub>x</sub> from cars for health-reasons. There is society-at-large interested in avoiding global warming. There is IFIP that wants to foster a professional profession. There is the carmaker VW that wants to sell cars. And then there are the many users or buyers of the cars. Thus one thing to take into account is the multitude of *stakeholders*.

The last mentioned stakeholder was the user. The question here is how should they participate?

User participation can be defined as “participation in the system development process by potential users or their representatives” [30, p. 53]. Traditionally user participation has been found to be a major factor in systems’ success but there is no clear agreement on the benefits of user participation [31]. One explanation may be that user participation varies within each stage of the development process [32]. Thus the second issue is who is the user and how can we involve them?

If we now go back to the Dieselgate case we can find an announcement by VW from November 25 where they say they will “... install a small tubular part into some of its engines to help them come into line with European clean air standards” [33]. However, in US... the E.P.A. said it wants to make sure that VW’s fix will be effective before

ordering a recall. To do so, the agency wants to be able to test diesel cars in its own laboratory and during on-road testing ...” [33]. These two cites brings in a third dimension; the environment. Europe vs US at one level. Laboratory testing vs. Road testing at another level. Sustaining an economic versus ecological environment at a third level.

As soon as we talk about sustainability or Green IS we need to define; in relation to what environment? We could of course demand that one always took into account the 17 sustainable development goals by the United Nations <http://www.un.org/sustainabledevelopment/sustainable-development-goals/> but that would hardly be doable in practice just because of the large number of goals to take into account. Hueting and Reijnders [34, p. 252], for example, discuss goal conflicts and call it “scarcely conceivable for the whole spectrum ...”. And they continue saying that “Especially, simultaneously realising both ... production growth and conservation of the environment, is difficult”. Hence, goals may be conflicting, less relevant, and have different importance for different stakeholders. Thus the fourth thing to take into account is sustainability and the relevant environment.

## 4.2 What Must Green IS Do and How?

Assuming that stakeholders, users, environment and sustainability definitions are given, we can then examine how IS can be designed that can allow organizations and individuals to perform environmentally sustainable work practices and make environmentally sustainable decisions.

Recker [9] argued that IS that are labelled “Green IS” must provide function to support belief formation, action formation and/or outcome assessment as they relate to environmental sustainability. Belief formation captures how psychic states (beliefs, desires, opportunities, etc.) about the natural environment are formed. Action formation describes how psychic states about the natural environment translate to actions that impact the environment. Outcomes describe what the consequences of the actions are. Each of these functions can operate at an individual level, or at an organizational level or both. Recker [9] suggests that an answer to how Green IS can provide functionality lies in examining how information systems provide functional affordances [35], viz., action potentials to users.

Affordances describe the possibilities for goal-oriented action afforded to specified user groups by technical objects such as information systems [35]. They emerge from material properties existent in information systems but emerge at the interaction between user and artifact. Thus, affordances have to be perceived before they can be actualized, and perceiving an affordance does not necessarily mean that users actually realize the offered action possibility [36].

With these notions in mind, we can delineate how Green IS can be built that afford action potential to belief formation, action formation and/or outcome assessment as they relate to environmental sustainability.

### 4.3 How Should Green IS Be Designed?

In identifying principles that can guide the development of “true” IS for environmental sustainability on the basis of our arguments above, we took inspiration from the Action Design Research (ADR) methodology [37] that is prominent in design science research, a research paradigm attempting to develop and evaluate new technology to address practical problems or goals [38]. We deemed the ADR methodology relevant and applicable because it provides emphasis for development of generalised theory and its focus on the blend of design and action research is fundamental to our emphasis on understanding the empirical domains of stakeholders, users and environment in the development of a Green IS.

Our view of the design principles for Green IS is visualized in Fig. 1. Therein, the eight principles are broadly classified into three of the four core stages of the ADR methodology, (1) problem formulation, (2) building, intervention, and evaluation (viz., design), and (3) reflection and learning (viz., theorizing). We omitted the fourth ADR stage, formalization of learning, because this stage centred on generalization and the meta-level design. We explain each principle in turn.

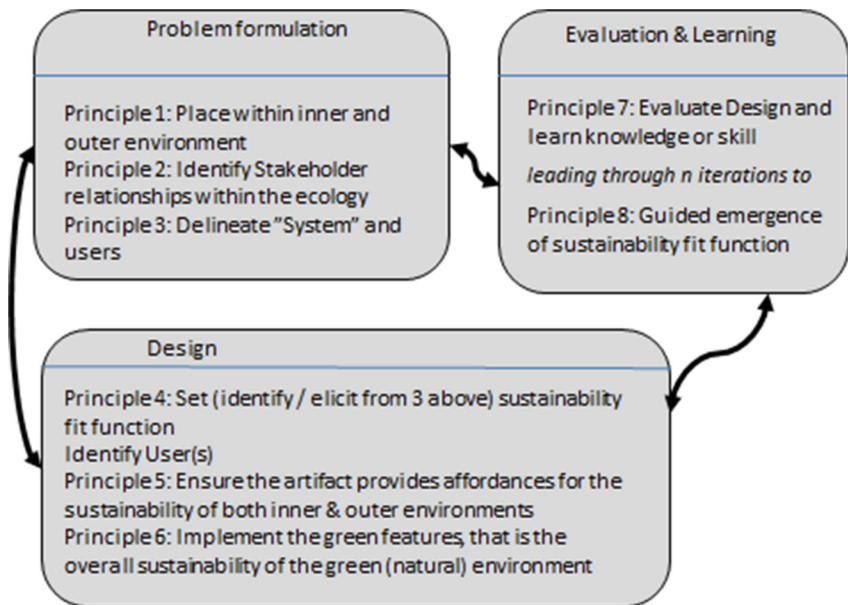


Fig. 1. Design principles for Green IS

**Principle 1:** Above we have argued that there is a generic requirement that designers make accommodations for the environment in which the designed artefact will operate. In Simon’s terms, this is the external interface design of the artefact, such that the environment and the artefact match according to the purpose at hand. For the purpose of our generic approach, it means matching the IS design to the constraints and affordances that are delivered intrinsically by the environment in which the IS stakeholders and users

will operate. In terms of design theory, this requirement embodies a specific capability of designers. That is, designers must be able to accommodate the environment.

**Principle 2:** To identify relevant affordances that must emerge from the relevant stakeholders' interaction with an artefact, it is important to understand their relationship with the ecology, in particular in terms of their goals and abilities.

**Principle 3:** Delineating the "System" and the "Users" is critical for distinguishing the artefact from its environment. The distinction may be as simple as defining the system as a software driven computing artefact. Such a distinction places the users in the artefact's outer environment, and pushes the social aspects of the ecology across the artefact's interface and out of the inner environment. Alternatively, the users can be regarded as part of the system. Such a distinction places the users within the artefact's inner environment and pulls the social aspects of the ecology across the artefact's interface and into the inner environment.

**Principle 4:** Once the interface has been delineated, designers can derive the sustainability fit functions for inner environmental sustainability and outer environmental sustainability based on definition of system, environments and user. These sustainability fit functions must incorporate environmental stability factors.

**Principle 5:** Based on the sustainability fit functions, designers can ensure that the artefact provides proper affordances for the sustainability of both inner & outer environments given the user. Where environments exhibit instability, the affordances must deliver qualities of resilience to both inner and outer environments. In addressing the outer environment, these sustainability affordances will include features that support sustainability of the green ecology.

**Principle 6:** Sustainability fit functions enable designs that can prioritize the green features. With green sustainability affordances based on the sustainability fit functions, the overall sustainability of the identified (natural) ecology can be given proper priority in the design.

**Principle 7:** Iteration of the appropriate design science evaluate-and-learn cycle supports refinement and improvement of satisfactory green IS designs. Evaluation covers the judgement or determination of the significance, worth, or quality of the design. Learning covers the acquisition of knowledge or skills throughout the iteration.

**Principle 8:** Green IS Designs occur in continuing iterations of problem formulation, design, and evaluation/learning that maintain the natural ecological sustainability fit functions as a centrepiece in the design-redesign process. Green IS design is a process of sustainability-guided emergence.

## 5 Conclusion

In this paper we contributed a design theory for Green IS that builds on a careful definition of the relevant concepts of stakeholders, system, environment and sustainability. We described our theory in terms of eight novel design principles. Importantly, the class of systems characterized by our design theory has explicit goals of affording environmentally sustainable practices and decisions to users. It allows designer to specify and implement systems that are true to the label “Green IS”. With this explicit focus and its requirements, systems in our theory differ from others that are also associated with being “green”. Notably, we prescribe that “Green IS” systems must adhere to the requirements set out in this paper.

We note several limitations. First, our research is on the level of theoretical rules and predictions. The development of an expository instantiation and an empirical evaluation of the design principles remains to be completed. Second, much like most other Green IS research we remained focus on the environmental dimension sustainability without regarding interaction effects to other dimensions (e.g., economic or social goals). Still, we believe our research provides a substantial and original contribution to design knowledge in green IS, which has been notably absent to date [2, 10]. Our theory allows both for prescriptiveness and guidance for action as well as for discrimination and identification of boundary conditions. Both is useful in progressing Green IS research because we provide assertions for testing and falsification as well as rules that can delineate the boundaries of the entire field.

## References

1. Gadatsch, A.: Comments on “Green IT: a matter of business and information systems engineering?”. *Bus. Inf. Syst. Eng.* **3**(6), 397 (2011)
2. Watson, R.T., Boudreau, M.-C., Chen, A.J.: Information systems and environmentally sustainable development: energy informatics and new directions for the IS community. *MIS Q.* **34**(1), 23–38 (2010)
3. Elliot, S.: Transdisciplinary perspectives on environmental sustainability: a resource base and framework for IT-enabled business transformation. *MIS Q.* **35**(1), 197–236 (2011)
4. Melville, N.P.: Information systems innovation for environmental sustainability. *MIS Q.* **34**(1), 1–21 (2010)
5. Seidel, S., Recker, J., vom Brocke, J.: Sensemaking and sustainable practicing: functional affordances of information systems in green transformations. *MIS Q.* **37**(4), 1275–1299 (2013)
6. Brewer, R.S., Johnson, P.M.: WattDepot: an open source software ecosystem for enterprise-scale energy data collection, storage, analysis, and visualization. In: 1st IEEE International Conference on Smart Grid Communications 2010, Gaithersburg, Maryland. IEEE, pp. 91–95 (2010)
7. Hilpert, H., Schumann, M., Kranz, J.: Leveraging Green IS in logistics: developing an artifact for greenhouse gas emission tracking. *Bus. Inf. Syst. Eng.* **5**(5), 315–325 (2013)
8. Shi, P., et al.: A decision support system to select suppliers for a sustainable supply chain based on a systematic DEA approach. *Inf. Technol. Manag.* **16**(1), 39–49 (2015)



9. Recker, J.: Toward a design theory for green information systems. In: 49th Hawaiian International Conference on Systems Sciences 2016, Kuauai, Hawaii. IEEE (2016)
10. Malhotra, A., Melville, N.P., Watson, R.T.: Spurring impactful research on information systems for environmental sustainability. *MIS Q.* **37**(4), 1265–1274 (2013)
11. Molla, A., Cooper, V., Pittayachawan, S.: The Green IT readiness (G-Readiness) of organizations: an exploratory analysis of a construct and instrument. *Commun. Assoc. Inf. Syst.* **29**(4), 67–96 (2011)
12. Chen, A.J., et al.: An institutional perspective on the adoption of Green IS & IT. *Australas. J. Inf. Syst.* **17**(1), 5–27 (2011)
13. Butler, T.: Compliance with institutional imperatives on environmental sustainability: building theory on the role of Green IS. *J. Strateg. Inf. Syst.* **20**(1), 6–26 (2011)
14. Hilpert, H., Kranz, J., Schumann, M.: An Information system design theory for green information systems for sustainability reporting - integrating theory with evidence from multiple case studies. In: 22th European Conference on Information Systems 2014, Tel Aviv, Israel. Association for Information Systems (2014)
15. Reuter, N., et al.: Identifying the role of information systems in achieving energy-related environmental sustainability using text mining. In: 22th European Conference on Information Systems 2014, Tel Aviv, Israel. Association for Information Systems (2014)
16. Simon, H.A.: *The Sciences of the Artificial*, 3rd edn. MIT Press, Cambridge (1996). p. 247
17. Klir, G.: *Facets of Systems Science*. IFSR International Series on Systems Science and Engineering, 2nd edn. Springer, New York (2001)
18. Bødker, K., Bansler, J.: A reappraisal of structured analysis: design in an organizational context. *ACM Trans. Inf. Syst. (TOIS)* **11**(2), 165–193 (1993)
19. Fitzgerald, B.: Systems development methodologies: the problem of tenses. *Inf. Technol. People* **13**(2), 13–22 (2000)
20. Wynekoop, J.L., Russo, N.: Studying system development methodologies: an examination of research methods. *Inf. Syst. J.* **7**(1), 47–65 (1997)
21. Truex, D., Baskerville, R., Travis, J.: Amethodical systems development: the deferred meaning of systems development methods. *Acc. Manag. Inf. Technol.* **10**, 53–79 (2000)
22. Chen, A.J.W., Boudreau, M.-C., Watson, R.T.: Information systems and ecological sustainability. *J. Syst. Inf. Technol.* **10**(3), 186–201 (2008)
23. Frova, G.: Five decades of development debate on sustainability. *Development* **54**(2), 271–281 (2011)
24. Holling, C.S.: Resilience and stability of ecological systems. *Annu. Rev. Ecol. Syst.* **4**(1), 1–23 (1973)
25. IFIP. IFIP IP3 Denounces Actions of Technologists Who Enabled VW DieselGate Scandal. IFIP News 2015, 8 October 2015. <http://www.ifipnews.org/ifip-ip3-denounces-actions-of-technologists-who-enabled-vw-dieseltgate-scandal/>
26. Holten, R: Volkswagen: the scandal explained (2015). <http://www.bbc.com/news/business-34324772>. (cited 2016 15 February)
27. GreenFacts. Air Pollution Nitrogen Dioxide (2016). <http://www.greenfacts.org/en/nitrogen-dioxide-no2/index.htm#1>. (cited 2016 15 February)
28. IPCC, Climate Change 2013: The Physical Science Basis. In: Stocker, T.F., Qin, D. (eds.) Intergovernmental Panel on Climate Change (2013)
29. IFIP, WCC 2008 Declaration on ICT Professionalism and Competences, T.I.P.P.I. IP3, a project of the International Federation for Information Processing (IFIP), Editor 2008, Milan, Italy (2008)
30. Barki, H., Hartwick, J.: Rethinking the concept of user involvement. *MIS Q.* **13**(1), 55–63 (1989)

31. Ives, B., Olson, M.H.: User involvement in MIS success: a review of research. *Manag. Sci.* **30**(5), 586–603 (1984)
32. Newman, M., Noble, F.: User involvement as an interaction process: a case study. *Inf. Syst. Res.* **1**(1), 89–113 (1990)
33. Russel, K., et al.: How Volkswagen Got Away With Diesel Deception in New York Times (2016)
34. Huetting, R., Reijnders, L.: Broad sustainability contra sustainability: the proper construction of sustainability indicators. *Ecol. Econ.* **50**(3), 249–260 (2004)
35. Markus, M.L., Silver, M.S.: A foundation for the study of IT effects: a new look at DeSanctis and Poole's Concepts of structural features and spirit. *J. Assoc. Inf. Syst.* **9**(10), 609–632 (2008)
36. Stoffregen, T.A.: Affordances as properties of the animal-environment system. *Ecol. Psychol.* **15**(2), 115–134 (2003)
37. Sein, M.K., et al.: Action design research. *MIS Q.* **35**(2), 37–56 (2011)
38. Gregor, S., Hevner, A.R.: Positioning and presenting design science research for maximum impact. *MIS Q.* **37**(2), 337–355 (2013)

# Automated Plant Species Identification: Challenges and Opportunities

Erick Mata-Montero<sup>(✉)</sup> and Jose Carranza-Rojas<sup>(✉)</sup>

Costa Rica Institute of Technology, Cartago, Costa Rica  
{emata,jcarranza}@itcr.ac.cr  
<http://www.tec.ac.cr>

**Abstract.** The number of species of macro organisms on the planet is estimated at about 10 million. This staggering diversity and the need to better understand it led inevitably to the development of classification schemes called biological taxonomies. Unfortunately, in addition to this enormous diversity, the traditional identification and classification workflows are both slow and error-prone; classification expertise is in the hands of a small number of expert taxonomists; and to make things worse, the number of taxonomists has steadily declined in recent years. Automated identification of organisms has therefore become not just a long time desire but a need to better understand, use, and save biodiversity. This paper presents a survey of recent efforts to use computer vision and machine learning techniques to identify organisms. It focuses on the use of leaf images to identify plant species. In addition, it presents the main technical and scientific challenges as well as the opportunities for herbaria and cybertaxonomists to take a quantum leap towards identifying biodiversity efficiently and empowering the general public by putting in their hands automated identification tools.

**Keywords:** Biodiversity informatics · Computer vision · Image processing · Machine learning · Leaf recognition · Plant identification · Citizen-Science · Species identification · Cybertaxonomy

## 1 Introduction

The word “biodiversity” is a synonym of “biological diversity”. The Convention on Biological Diversity (CBD) defines biodiversity as: “the variability among living organisms from all sources including, inter alia, terrestrial, marine and other aquatic ecosystems and the ecological complexes of which they are a part; this includes diversity within species, between species, and of ecosystems.”<sup>1</sup> Therefore, there are three levels of biodiversity: intra-specific (genetic), inter-specific,

---

<sup>1</sup> <https://www.cbd.int/convention/articles/default.shtml?a=cbd-02>.

and ecosystemic. Even though a full understanding of all three levels is indispensable to guide biodiversity conservation efforts, this paper focuses on inter-specific biodiversity and some associated taxonomic challenges.

The CBD Strategic Plan 2011–2020 has explicitly stated twenty ambitious targets known as the Aichi Targets<sup>2</sup>. Aichi Target 19 specifically proposes that “knowledge, the science base and technologies relating to biodiversity, its values, functioning, status and trends, and the consequences of its loss, are improved, widely shared and transferred, and applied”; but in fact biodiversity informatics will be fundamental to the achievement of all of the Aichi Targets.

It is estimated that about 10 million species of macro organisms inhabit the earth. This vast inter-specific biodiversity and the need to better understand it led to the development of classification schemes called biological taxonomies. Even since Aristotle’s times, when only approximately 500 species of animals had been identified, Aristotle himself established a classification method. In the XVIII century, Carl Linnaeus “father of modern taxonomy” formalized a system of naming organisms called binomial nomenclature which is used to this day.

Unfortunately, in addition to the enormous biodiversity of the earth, current identification and classification workflows are both slow and error-prone. Furthermore, classification expertise is in the hands of a small, decreasing number of expert taxonomists. This has been identified as a serious problem and is known as the “global taxonomic impediment”<sup>3</sup>. Automated identification of organisms has therefore become not just a dream among systematists for centuries [1] but a need to better understand, use, and save biodiversity.

Even though the number of plant species (about 400,000) is considerably smaller than the number of animal species, taxonomic work on them is still a monumental task. However, plant species identification is particularly important for biodiversity conservation. It is critical to conduct studies of biodiversity richness of a region, monitoring of populations of endangered plants and animals, climate change impact on forest coverage, bioliteracy, payment for environmental services, and weed control, among many other major challenges.

The rest of this paper is organized as follows: Sect. 2 summarizes progress made to automate the identification of taxa in systematics. It starts with a description of the traditional dichotomous keys approach, and then presents interactive keys, morphometric approaches, briefly describes DNA barcoding, and concludes with recent approaches based on machine learning and computer vision techniques. Section 3 summarizes the state of the art of leaf-based plant species identification using computer vision. Finally, Sect. 4 concludes with current challenges and opportunities.

## 2 Automated Taxon Identification in Systematics

Traditionally, systematists have not relied on quantitative data alone to identify taxa. They prefer the visual inspection of morphology, the (mostly) qualitative

<sup>2</sup> <https://www.cbd.int/sp/targets/>.

<sup>3</sup> <https://www.cbd.int/gti/>.

assessment of characters, and the comparison of these to reference specimens and/or images. While this process works, it is not quick, efficient or reliable [1]. The following subsections describe some attempts to automate or at least define algorithms that can be followed either manually (e.g., dichotomous keys and morphometrics) or translated into software that fully or partially automates the taxa identification process. In some cases, the resulting software guides a human user (e.g., interactive keys) who actually makes the decisions. In other cases, it fully automates the taxa identification process by extracting additional data from specimens (e.g., molecular and chemical data) or multimedia information such as digital images and sound.

## 2.1 Single-Access Keys

In biology, an *identification key* is a document or software that takes the form of a decision tree that offers a fixed sequence of identification steps. If each step has only two alternatives, the key is said to be *dichotomous*, otherwise it is *polytomous*. These keys are possibly the oldest attempt to designing algorithms for organismal identification long before computers were available. They aim at reducing the rate of errors, making explicit and objective the rules to be followed, and selecting optimal or semi-optimal sequences of questions.

This approach has several drawbacks even when those algorithms have been programmed. Among them are the difficulty to accommodate new species descriptions and the assumption that a user has all the information available to proceed from the top question (the *single-access key*) to the following levels. The latter means that when only partial information is available about the organism (e.g., only leaves or flowers of a plant), a user might not be able to go past the very first question.

## 2.2 Multiple-access Keys

These are decision trees that have multiple starting points that allow users to follow different paths, possibly because he/she has partial morphological information. In its computerized version, they are also called *interactive keys*. They start with a full domain of candidates (e.g., all plants from a country), and proceed to gradually discard candidates as the user proceeds answering questions in an arbitrary order. The final result could be a unitary set of candidates (full identification achieved), an empty set (a new species or an incomplete key), or a set with cardinality greater than 1 (some questions remain to be answered).

## 2.3 Morphometric Approaches

Morphometrics is the study of shape variation and its co-variation with other variables [2]. Three general approaches are usually distinguished: traditional morphometrics, landmark-based morphometrics and outline-based morphometrics. Traditional morphometrics is the application of multivariate statistical

analysis to sets of quantitative variables such as length, width, and height. Geometric morphometrics emphasizes methods that capture the geometry of the morphological structures of interest and preserve this information throughout the analyses. Outline-based morphometrics focuses on shape variation along the contour of an object. These three approaches are not necessarily mutually exclusive. [3] provides an excellent survey on this subject.

## 2.4 DNA Barcoding

DNA barcoding is a taxonomic method that uses a short genetic marker in an organism's DNA to identify it as belonging to a particular species [4]. The gene region that is being used as the standard barcode for almost all animal groups is a 648 base-pair region in the mitochondrial cytochrome c oxidase 1 gene ("CO1"). For plants, two gene regions in the chloroplast, *matK* and *rbcl*, have been approved as the barcode region. DNA barcoding has met with a strong reaction from scientists, especially systematists, who either express their enthusiastic support or vehement opposition [5,6]. The current trend appears to be that DNA barcoding should be used alongside traditional taxonomic tools and alternative forms of molecular systematics so that problem cases can be identified and errors detected.

## 2.5 Crowd Sourcing (Collective Intelligence)

Crowd sourcing approaches to species identification is neither a quantitative nor an automated method. However, it is included in this survey because it uses computer technology to gather georeferenced multimedia information (e.g., images) and a community of citizen scientists and biologists who jointly tackle the challenge of identifying an organism based on an image, collective knowledge, and interactive keys or other forms of computer-based tools. Besides, it is a low-cost high impact approach to empower and engage the general public in cibertaxonomy and biodiversity conservation. iNaturalist<sup>4</sup> and Pl@ntNET<sup>5</sup> [7] are two excellent examples of this approach. On the negative side, high levels of quality control are imperative because the community involved does not necessarily comprise domain experts.

## 2.6 Computer Vision and Machine Learning

In spite of enormous progress in the application of computer vision algorithms in other areas such as medical imaging, OCR, and biometrics [8], only recently have they been applied to identify taxa. Images of plant leaves and insect wings have been particularly attractive because they are flat and their morphology is used in most identification keys. Thus, in the last decade, research in computer vision has produced algorithms to help botanists and non-experts classify plants

<sup>4</sup> <http://www.inaturalist.org>.

<sup>5</sup> <http://www.plantnet-project.org/page:projet?langue=en>.

based on images of their leaves [9–13]. However only a few studies have resulted in efficient systems that are used by the general public, such as LeafSnap [14].

Computer vision and machine learning are two highly related artificial intelligence fields. In a *supervised learning* scenario, the general approach for organismal identification using computer vision comprises two general steps. First, digital images of identified species are fed to an algorithm that cleans them, segments them, and extracts relevant features. As a result, source images are typically transformed from the bitmap domain to a more tractable domain (e.g., histograms) and stored in a *training dataset*  $D$ . The second step consists of using the training dataset  $D$  to train an algorithm  $A$ . *Unsupervised learning* (e.g., cluster analysis) can also be used when a dataset of images is available but the associated species have not been identified.

Once algorithm  $A$  has been trained and tested, it is ready to try to identify species based on images of organisms. In the typical scenario, algorithm  $A$  has two inputs, namely, an image  $I$  of the unidentified organism and the dataset  $D$ . Algorithm  $A$  applies to image  $I$  the same filters used to create the dataset  $D$  and outputs a ranking of  $k$  *candidate species*. The larger the number  $k$  is, the better the chance of including the correct identification in the ranking is. However, most users would expect  $k$  to be a small value to be useful. Details on the use of computer vision and machine learning to identify plants based on images of leaves are presented in the following section.

### 3 Automated Leaf-Based Plant Species Identification

Several surveys regarding leaf-based identification of plants have been published in the past. [15] covers most classification methods such as  $k$  Nearest Neighbors (kNN), Probabilistic Neural Network (PNN), and Support Vector Machines (SVM), as well as their accuracy and precision. In [16], Metre and Ghorpade survey different texture-only techniques, provide a comparison schema for them, and pinpoint how important it is to create a centralized dataset of leaf images.

Most researchers agree on a general workflow to identify species based on images of their leaves [9–13]. The first step is data acquisition. Acquiring leaf images is a time consuming task. Because of the lack of standards and centralized repositories, researchers have typically generated isolated datasets for their projects. *Segmentation* of the leaf is then executed to explicitly separate leaf from non-leaf pixels. Afterwards, different techniques are used to extract features based on venation [17], curvature [14] and morphometrics [11]. Finally, machine learning techniques are used to generate the trained algorithm [9–13].

#### 3.1 Data Acquisition

Existing leaf recognition datasets use images of individual leaves on uniformly colored backgrounds for easier leaf segmentation. There are several datasets publicly available but, to our knowledge, there is not yet a centralized dataset which can grow as researchers and citizen scientists add more images and data. The following are examples of datasets from different projects:

- The Flavia Dataset [12] encompasses 32 species and a total of 3,621 fresh leaf images on white backgrounds. Leaves were collected in Nanking, China.
- Kumar et al. [14] created a dataset for 184 tree species from Northeastern USA that includes 23,916 images of fresh leaves with uniform backgrounds. It is used by the LeafSnap mobile app.
- Mata-Montero and Carranza-Rojas [18] from the Costa Rica Institute of Technology created a dataset that comprises 2,345 noisy and 1,468 clean leaf images from 67 Costa Rican tree species, all with uniform background.
- ImageCLEF is a leaf classification competition that has created its own dataset [7]. It currently includes 1,000 plant species from West Europe. It has more than 100,000 images of leaves, as well as flowers, fruits, stem and the whole plant pictures. It comprises both images with white background and images taken directly in the field with complex backgrounds and noise [7].

### 3.2 Leaf Segmentation

Leaf segmentation can act on images with uniform backgrounds, such as a white piece of paper, or complex backgrounds. The former is simpler although artifacts such as shadows and light gradients still generate some problems. Most researchers use uniform backgrounds to simplify this phase. In [14, 18] Expectation-Maximization (EM) is used to cluster pixels. This produces fairly good segmentation but shadows tend to generate false positives. Similarly, in [19] the authors study how a semi-controlled light environment affects clustering algorithms. They perform color clustering and then apply Grab-Cut to find the global optimal segmentation solution.

Very few studies have tackled the problem of segmenting leaves with complex backgrounds [20, 21]. This feature is highly desirable for at least two types of leaves: leaves of tall trees from which it is difficult to take a sample and then photograph it with a uniform background, and leaves of plants that have been mounted on herbarium sheets. In the former case, it would be ideal to zoom-in with the camera and take a picture of the leaf in its tree. In the latter, the background may not be as complex as a natural setting but overlapping of leaves and other plant elements in the herbarium sheet makes the automated extraction of leaves and their subsequent segmentation very challenging.

We are not aware of any research that aims at generating leaf image datasets from herbarium sheets. The benefit of doing this is twofold. First of all, herbaria all over the world have invested millions of dollars over long periods of time to collect samples of plants. Rather than going again to the field to take pictures or collect more samples, it would be considerably less expensive to use leaves of plants that have already been identified and conserved in herbaria. Secondly, it would help demonstrate the value of herbaria collections.

### 3.3 Feature Extraction and Identification

Segmentation of the input image  $I$  produces a segmented image  $I'$  to which feature extraction is applied. This subsection briefly surveys approaches that use curvature, texture, venation, leaf morphometrics, or combinations of them.



**Curvature.** In [14] Kumar et al. create what they call a Histogram of Curvature over Scale (HCoS), which consists on measuring the leaf area and arc length of the intersection of the leaf and disks of radius  $r$ , where  $1 \leq r \leq 25$  pixels, and the disks are centered at every leaf contours pixel of the leaf in  $I'$ . All calculations are then added into a unique histogram that describes the contour of the leaf. Using kNN and histogram intersection, a list of the  $k$  species whose leaves more closely match the leaf in  $I$  is presented to the user. Another method applied on both simple and complex leaves is the one described in [22]. Their method captures both global and local shape features and uses them separately during identification. This allows to discriminate leaves with similar shape but different margin patterns, and viceversa. Similarly to [14], several scales are explored by convolving the contour against a Gaussian filter with different values  $\sigma$ . This is particularly useful for serration of the margin.

**Texture.** Local Binary Patterns (LBP) descriptors are used in [23] to identify medicinal and house plants from Indonesia. Different LBP descriptors were extracted from different sample points and radius, and concatenated into histograms. Then a four layer PNN classifier was used. For complex background images the achieved precision was 77% and for uniform background images 86.67%. In [24] Speeded Up Robust Features (SURF) features were used to develop an Android application for leaf recognition. The reported precision was 95.94% on the Flavia dataset [12]. In [10] authors identify plants based only on a portion of the leaf, allowing botanists to identify damaged plants. The reported precision is 98.7% when using Artificial Neural Network (ANN) for classification on their own small dataset.

**Venation.** Very few studies have used venation extraction as the basis for taxa identification. Venation extraction is not trivial, since veins are often merged with other leaf features. Some authors have simplified the task by using special equipment or treatments that render images with more clearly identified veins [25,26]. However, this defeats the goal of having users get an automated identification for specimens that they have photographed with ordinary digital cameras.

In [25], vein pixels are extracted from laser scanned images in 3D. The laser scans a 3D point cloud in which veins are 3D-convex. A curvature threshold is then used to obtain potential vein pixels. Finally a squared linear fitting is applied to approximate the vein contour lines. In [17] researchers developed a tool to help botanists extract veins of leaves with minimum human interaction. They used a patch-based approach where a set of linear functions are learned from patches of images containing veins using Independent Component Analysis (ICA). Then these learned functions are used as a pattern map for vein detection.

**Leaf Morphometrics.** Leaves display very rich morphology. Traditional leaf measurements include aspect ratio, leaf area, rectangularity, circularity, convexity, and solidity, among others [11]. Additionally, color moments for gray scale

intensities such as mean, variance, kurtosis, skewness have also been used [11]. Traditional, landmark-based, and outline-based morphometrics have been used both separately and in combined form.

**Multimodal Approaches.** In [9], a multimodal system composed of 38 morphological features and a Principal Component Analysis (PCA) approach for texture were used. The PCA training phase took all the dataset pictures and put them in a matrix, where a small number of characteristic features called eigenpictures were generated. Then, each image was represented as a linear combination of these eigenpictures. Their reported precision on the Flavia dataset [12] for the morphological features was 91.9%, for the PCA algorithm 85.4%, and for both combined 89.2%.

In [13] a combination of shape, texture and color was used to recognize Indonesian medicinal plants. As a classifier they used PNN with a reported precision of 72.16% over 51 medicinal species, with a total of 2,448 images. The authors created a mobile app which runs on Android OS called Medleaf [13]. Their best precisions were achieved by using Local Binary Pattern Variance (LBPV) as a feature base and not morphological features.

In [18] texture extraction of the whole leaf using LBP was compared with the HCoS curvature method developed by [14]. In the experiments it was proved that texture is more resilient to noise on leaf images. Better accuracy was achieved by assigning a small importance factor to curvature (10%) and a larger one to texture (90%). This result also matches results of [23] with regard to the usefulness of LBP for identification based on images of damaged leaves.

**Deep Learning Approaches.** Deep learning has become a huge success in computer vision research [27]. In [28] a Convolutional Neural Networks (CNN) was applied to a dataset with 44 species. The CNN was not coded with layers for specific features (e.g., curvature or texture), but the authors could infer that a layer was related to shape/curvature and another one to patterns similar to texture/venation. With this interpretation, the authors conclude that shape/curvature is not as discriminating as texture/venation, which is consistent with [18].

## 4 Challenges and Opportunities

Biodiversity conservation presents several monumental challenges. At the political and management level, it requires information and a deep understanding of living nature. However, about 80% of the organisms on the planet do not even have a name. The scientific task of naming and classifying those organisms is gigantic, not only because of the large number of species to identify and describe, but also because it is tedious, slow, and error-prone. The global taxonomic impediment adds to the complexity of these challenges. Finally, access to this knowledge is limited by the scientific and non-digital nature of large amounts of literature.

Fortunately, computer vision and machine learning techniques that have been very effective in other realms are now being used to identify organisms, in particular plants, with high levels of accuracy (90% or more). This could have an important impact in concrete conservation actions such as control of trade of endangered species and the execution of rapid biodiversity inventories. The following paragraphs, summarize some opportunities we currently have to cope with the above mentioned challenges.

*Building a Global Dataset:* Global biodiversity informatics initiatives such as GBIF<sup>6</sup>, EOL<sup>7</sup>, and BHL<sup>8</sup>, have successfully built large global databases of biodiversity information that is freely available on the web. GBIF currently provides more than 600 million specimen-level records, EOL over a million species level descriptions, and BHL more than 50 million pages of literature. An analogous dataset of digital images of plant elements (e.g., leaves) does not exist. However, there are several opportunities that should be taken. First of all, digital cameras are now very inexpensive and powerful. Secondly, even though data sharing protocols and standards need to be in place, organizations such as TDWG<sup>9</sup> are devoted to precisely this endeavor. Finally, crowd sourcing offers now excellent opportunities to both, generate large repositories of information, and raise awareness of the general public through citizen science projects. iNaturalist and Pl@ntNET [7] have been very successful and deserve being emulated. The PlantCLEF dataset already demonstrates that this can be done at the European level.

*Work with Herbaria:* Herbaria hold treasures of information that should be critical to scale up the size and impact of a global dataset of digital images of elements of plants. Herbaria maintain large collections of plants that have been carefully mounted on sheets, could be digitized, and whose elements (e.g., leaves) could be extracted to feed a global dataset. Because herbaria sheets contain juxtaposed leaves, flowers, and other plant elements, research on detection and extraction of leaves needs to be further developed. In addition, more research is needed to deal with noisy images, complex backgrounds, damage detection and *digital image repair*, along with leaf identifications based on portions of the leaf (in case it is damaged). Landmark-based morphometrics research should help with the latter. Finally, as a very important herbaria financial sustainability side effect, herbaria around the world would have more arguments to demonstrate the value and impact of maintaining and investing in their collections. However, it is very critical for herbaria to supplement their collections with digital images through crowd sourcing and changes in their traditional workflows.

*Deep Learning:* Deep Learning, particularly using CNN, is a very hot topic in computer vision. The exciting results obtained in events such as ImageNet [27] have generated a lot of expectation. As more data and computational power are now available, this technique has become the most widely used, without

<sup>6</sup> <http://www.gbif.org>.

<sup>7</sup> <http://www.eol.org>.

<sup>8</sup> <http://www.bhl.org>.

<sup>9</sup> <http://www.tdwg.org>.

substantial algorithmic changes since its inception. Instead of following a gradual path that aims at using images of elements of an organism first (e.g., leaves or flowers of a plant), and then pictures of the whole organism, CNN tackles directly the challenge of identifying organisms by using pictures of the whole or parts of the organism. However, this approach has at least two important limitations. First, it tends to work better with very large sets of images [29]. Secondly, it lacks the explanatory power of other approaches such as landmark-based morphometrics. Nevertheless, as global data sets are developed, it is just a matter of time to overcome the former. Additionally, research work is already under way to overcome the latter [28].

## References

1. MacLeod, N.: *Automated Taxon Identification in Systematics: Theory, Approaches and Applications*. Systematics Association Special Volumes. Taylor & Francis, Boca Raton (2007)
2. Bookstein, F.L.: *Morphometric Tools for Landmark Data: Geometry and Biology*. Cambridge University Press, Cambridge (1997)
3. Adams, D.C., Rohlf, F.J., Slice, D.E.: Geometric morphometrics: ten years of progress following the revolution. *Ital. J. Zool.* **71**, 5–16 (2004)
4. Hebert, P.D.N., Cywinska, A., Ball, S.L., Dewaard, J.R.: Biological identifications through DNA barcodes. *Proc. Biol. Sci.* **270**, 313–321 (2003)
5. Ebach, M.C., Carvalho, M.R.D.: Anti-intellectualism in the DNA barcoding enterprise. *Zoologia (Curitiba)* **27**, 165–178 (2010)
6. Rubinoff, D., Cameron, S., Will, K.: A genomic perspective on the shortcomings of mitochondrial DNA for “barcoding” identification. *J. Hered.* **97**(6), 581–594 (2006)
7. Joly, A., et al.: LifeCLEF 2015: multimedia life species identification challenges. In: Mothe, J., Savoy, J., Kamps, J., Pinel-Sauvagnat, K., Jones, G., San Juan, E., Capellato, L., Ferro, N. (eds.) *CLEF 2015*. LNCS, vol. 9283, pp. 462–483. Springer, Heidelberg (2015). doi:[10.1007/978-3-319-24027-5\\_46](https://doi.org/10.1007/978-3-319-24027-5_46)
8. Andreopoulos, A., Tsotsos, J.K.: 50 years of object recognition: directions forward. *Comput. Vis. Image Underst.* **117**(8), 827–891 (2013)
9. Lagerwall, L.D., Viriri, S.: Plant classification using leaf recognition. In: *Proceedings of the 22nd Annual Symposium of the Pattern Recognition Association of South Africa*, pp. 91–95, November 2011
10. Rashad, M.Z., El-Desouky, B.S., Khawasik, M.Z.: Plants images classification based on textural features using combined classifier. *Int. J. Comput. Sci. Inf. Technol.* **3**(4), 93–100 (2011)
11. Bhardwaj, A., Kaur, M., Kumar, A.: Recognition of plants by leaf image using moment invariant and texture analysis. *Int. J. Innov. Appl. Stud.* **3**(1), 237–248 (2013)
12. Wu, S., Bao, F., Xu, E., Wang, Y.-X., Chang, Y.-F., Xiang, Q.-L.: A leaf recognition algorithm for plant classification using probabilistic neural network. In: *2007 IEEE International Symposium on Signal Processing and Information Technology*, pp. 11–16, December 2007
13. Herdiyeni, Y., Santoni, M.: Combination of morphological, local binary pattern variance and color moments features for indonesian medicinal plants identification. In: *2012 International Conference on Advanced Computer Science and Information Systems (ICACSIS)*, pp. 255–259, December 2012

14. Kumar, N., Belhumeur, P.N., Biswas, A., Jacobs, D.W., Kress, W.J., Lopez, I.C., Soares, J.V.B.: Leafsnap: a computer vision system for automatic plant species identification. In: Fitzgibbon, A., Lazebnik, S., Perona, P., Sato, Y., Schmid, C. (eds.) *Computer Vision – ECCV 2012*. LNCS, vol. 7573, pp. 502–516. Springer, Heidelberg (2012)
15. Kumar, P.M., Kamble, M., Pawar, S., Patil, P., Bonde, N.: Survey on techniques for plant leaf classification
16. Metre, V., Ghorpade, J.: An overview of the research on texture based plant leaf classification (2013). CoRR, vol. abs/1306.4345
17. Li, Y., Chi, Z., Feng, D.: Leaf vein extraction using independent component analysis. In: *IEEE International Conference on Systems, Man and Cybernetics, 2006, SMC 2006*, vol. 5, pp. 3890–3894, October 2006
18. Mata-Montero, E., Carranza-Rojas, J.: A texture and curvature bimodal leaf recognition model for identification of costa rican plant species. In: *2015 Latin American Computing Conference (CLEI)*, pp. 1–12, October 2015
19. Soares, J., Jacobs, D.: Efficient segmentation of leaves in semi-controlled conditions. *Mach. Vis. Appl.* **24**(8), 1623–1643 (2013)
20. Cerutti, G., Tougne, L., Mille, J., Vacavant, A., Coquin, D.: Understanding leaves in natural images - a model-based approach for tree species identification. *Comput. Vis. Image Underst.* **117**(10), 1482–1501 (2013)
21. Le, T.-L., Duong, N.-D., Nguyen, V.-T., Vu, H., Hoang, V.-N., Nguyen, T.T.-N.: Complex background leaf-based plant identification method based on interactive segmentation and kernel descriptor. In: *Proceedings of the 2nd International Workshop on Environmental Multimedia Retrieval, EMR 2015*, pp. 3–8. ACM, New York (2015)
22. Zhao, C., Chan, S.S., Cham, W.-K., Chu, L.: Plant identification using leaf shapes—a pattern counting approach. *Pattern Recogn.* **48**(10), 3203–3215 (2015)
23. Herdiyeni, Y., Kusmana, I.: Fusion of local binary patterns features for tropical medicinal plants identification. In: *2013 International Conference on Advanced Computer Science and Information Systems (ICACSIS)*, pp. 353–357, September 2013
24. Nguyen, Q., Le, T., Pham, N.: Leaf based plant identification system for android using surf features in combination with bag of words model and supervised learning. In: *International Conference on Advanced Technologies for Communications (ATC)*, October 2013
25. Sun, Z., Lu, S., Guo, X., Tian, Y.: Leaf vein and contour extraction from point cloud data. In: *2011 International Conference on Virtual Reality and Visualization (ICVRV)*, pp. 11–16, November 2011
26. Ghiassi, M., Lee, S., Nitin, M., Lu, H., Jiang, W.: Classification of *Camellia* (Theaceae) species using leaf architecture variations and pattern recognition techniques (2012)
27. Krizhevsky, A., Sutskever, I., Hinton, G.E.: Imagenet classification with deep convolutional neural networks. In: Bartlett, P., Pereira, F., Burges, C., Bottou, L., Weinberger, K. (eds.) *Advances in Neural Information Processing Systems 25*, pp. 1106–1114 (2012)
28. Lee, S.H., Chan, C.S., Wilkin, P., Remagnino, P.: Deep-plant: plant identification with convolutional neural networks (2015). CoRR, vol. abs/1506.08425
29. Simard, P.Y., Steinkraus, D., Platt, J.C.: Best practices for convolutional neural networks applied to visual document analysis. In: *Proceedings of the Seventh International Conference on Document Analysis and Recognition, ICDAR 2003*, vol. 2, p. 958. IEEE Computer Society, Washington, DC (2003)

# Environment Monitoring Using Commercial Off-the-Shelf (COTS) Technologies

## A Case Study of the Odd-Even Rule for Pollution Control in Delhi

Vikas Nath<sup>(✉)</sup> and Artash Nath

HotPopRobot.com, Toronto, Canada  
vikas.nath@gmail.com

**Abstract.** 195 countries gathered in Paris in 2015 to conclude the legally binding climate agreement to reduce their greenhouse gas emissions. Continuous environment monitoring is a prerequisite for designing policies which can reduce global climate emissions. Only a handful of countries have the capabilities to carry out advanced climate measurements. Commercial Off-the-Shelf (COTS) Technologies can lower the technological and financial barriers for developing countries to monitor climate emissions. The authors made use of environmental COTS technologies along with information and communication technologies (ICT) to assess the impact of pollution control initiatives rolled out by the Delhi government on experimental basis.

**Keywords:** Climate change · Commercial Off-the-Shelf (COTS) Technologies · Delhi · Environmental monitoring and policies · Information and Communication Technologies (ICT) Odd-Even rule · Particulate matter · Pollution · Sensors

## 1 Introduction

The historic climate agreement concluded in Paris in December 2015 commits all nations to reduce their greenhouse gas emissions. 195 countries adopted the legally binding global climate deal. Developed nations will provide US \$100 billion financing every year from 2020 to fight climate change while all countries will be required to submit to external monitoring of their progress in reducing climate emissions [1]. The global “stocktaking” will happen every five years, starting in 2023, where countries will be assessed for their performance in cutting emissions compared to their national plans. Significantly, developed and developing countries will monitor, verify and report their greenhouse gas emissions using the same global system. A “Capacity-Building Initiative for Transparency” has been set up to enable developing countries to meet the enhanced data and tracking progress requirements.

Continuous monitoring of emissions is the first step to meeting the goal of keeping increase in the global average temperature to well below 2 °C above pre-industrial levels. It yields scientific data and evidence to assess the effectiveness of existing climate action

plans and policies, and in designing newer ones. It compels countries to walk their talk on climate change; share their action plans on mitigating climate change, be transparent in their implementation mechanism, and compare outcomes and performances with other countries.

The climate deal opens up enormous opportunities to use Commercial Off-The-Shelf (COTS) products and technologies to set up robust mechanisms for monitoring greenhouse emissions and feed the results in policymaking process.

## **2 Commercial Off-the-Shelf (COTS) Technologies**

Commercial off-the-shelf products and technologies are standard manufactured rather than custom-made. These are readily available, open to sale to the general public and are less expensive than their custom made counterparts. They have high levels of dependability as they have been tested on a large scale. Support, documentation and compatible technologies are readily available. COTS products and technologies cut down the costs and complexities of creating prototypes and bringing new products into the market. Semiconductor based electronics such as integrated chips and micro-controllers are examples of COTS products that can be purchased cheaply, and are able to withstand temperatures ranging from  $-40$  centigrade to  $+85$  centigrade allowing their operations in industrial environment.

With the growing use of COTS products, designers are engineering them to be more rugged and be able to operate in extreme environments. For instance, the National Aeronautics and Space Administration (NASA) backed PhoneSat project converted an Android phone into a small satellite for low-cost earth observation bringing down the total hardware cost to \$3,500. It showcases how off-the-shelf; commercially available technology can be used for advanced applications.

## **3 Environmental COTS**

Our planet is being continuously monitored for environmental changes. These include measuring rise in sea-levels, change in ocean temperature, shrinking of polar ice caps, concentration of greenhouse gases in the upper atmosphere, changes in ozone levels and increasing rates of deforestation. Such monitoring is expensive and require technological and financial capabilities which are beyond most countries.

Only a handful of countries have the capabilities to deploy weather and meteorological satellites to undertake remote sensing and climate monitoring. Even for gathering ground-based data, developing countries lack the know-how and financial resources to set up multiple environmental monitoring stations. For instance, Delhi - the populous and sprawling capital of India has only 10 stations to monitor pollution data which gives an incomplete picture of the air quality index. Outside Delhi, the data is even scarce.

Access to environmental COTS such as sensors for measuring concentrations of carbon dioxide, nitrogen dioxide, methane, ozone and particulate matters in the atmosphere will improve and democratize environmental data collection. Anyone can purchase a set of sensors, hook them to a microcontroller or even a mobile phone, and upload readily available program to start gathering local environmental data and share

the data online. It will be possible to set up a mesh of sensors using COTS technologies such as WI-Fi, ZigBee, Bluetooth and Radio Frequency to aggregate and triangulate the data being gathered. Low cost of new COTS products such as drones and quad copters makes it possible to attach sensors on them and fly them over highways, coastal areas, lakes and forested areas to get detailed environmental data. Access to this 24/7 and on-demand data can trace the source and type of emissions, reduce their volume, check economic losses, and improve public health.

## **4 Pollution in Delhi**

The world is rapidly urbanizing. More than half of the world's population currently lives in cities, and by 2050 over two-thirds will do so. While cities generate 80 % of global GDP and are hive of employment, innovation, creativity, and commerce, they also emit almost 71–76 % of energy related carbon dioxide emissions, and account for 37–49 % of global greenhouse gas emissions [2].

Delhi is no different. With a population of over 20 million – the traffic volume is high, the traffic speed low and vehicles idle for a long time at traffic lights. Delhi air is heavily polluted from smoke, dust and exhaust of motor vehicles. As it is a landlocked city surrounded by industrial and agricultural zones, there is very little capacity in the atmosphere to clear itself of the pollutants. It is mainly dependent on rainfall to bring a sudden drop in particulate matter concentration.

Delhi pollution effects everyone – young and old, rich and poor, political class and common people. It is not uncommon for major newspapers and media channels to regularly carry briefings on pollution, the particulate matter count in the air, and its effect on the health of people. It does not help that India still follows Bharat Stage-III equivalent of Euro-III specifications which are 14 years behind the vehicular emission norms followed in Europe.

## **5 Odd-Even Experiment in Delhi: Using COTS for Measuring Pollution**

On 1 January 2016, the Delhi Government embarked on a two-week Odd-Even experiment to bring down pollution levels. It meant that on “even numbered dates”, cars with even numbered registration plates would run while on “odd numbered dates”, cars with odd numbered registration plates would run. Similar experiments have been tried out in other cities in the world, including in Mexico, Paris and most noticeably in Beijing where the odd-even formula was imposed ahead of the 2008 Olympics with convincing results. In Delhi, there were several exemptions from the rule, namely two wheelers, public vehicles, cars powered by compressed natural gas (CNG), and cars driven by women could be on the roads at any time.

As we are “makers” and love building things, we planned an experiment while the Odd-Even rule was in effect in Delhi. The objective of our experiment was threefold. First, measure the decrease in pollution levels while Odd-Even rule was in effect. Second, determine how pollution levels vary at different times of the day. Third, come up with findings to reduce the effect of pollution on our health.

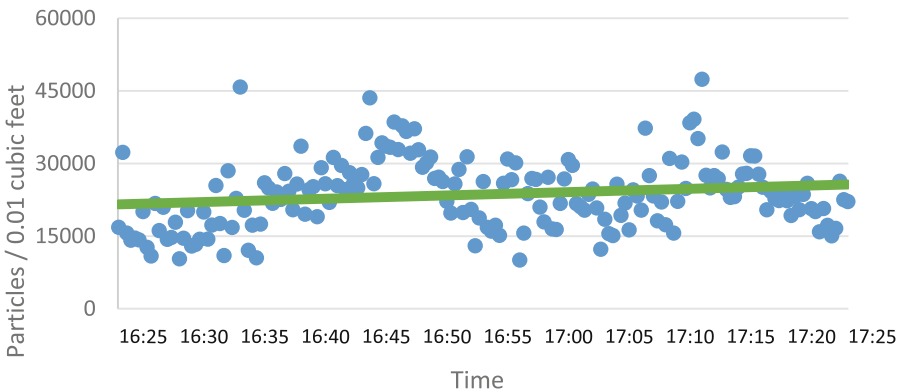


We built a “Pollution Sensor” using COTS, namely an Arduino - a low-cost, off-the-shelf micro controller, and an Optical Dust Sensor (Shinyei PPD42NS) which is mass produced for measuring pollutants in the air. The Sensor uses infrared scattering to measure particulate matter concentration in the range of 2.5 microns - particles of this size have the greatest effect on human health. We wrote a program to get raw data from the sensor and convert it into particular matter readings (particles per 0.01 cubic feet). The program was uploaded to Arduino. The Arduino instructed the Optical Dust Sensor to take readings every 20 s and send it to our laptop. Later we added another low-cost COTS – a temperature and moisture sensor to our “Pollution Sensor” to take more detailed measurements. The data was imported into Excel to make graphs and draw conclusions.

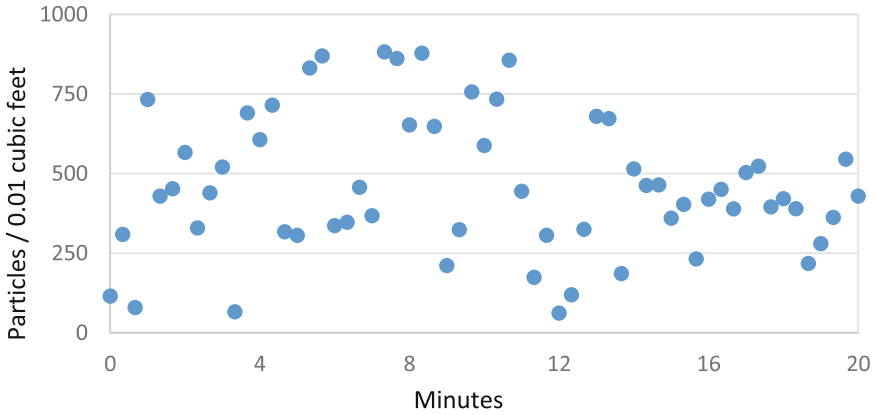
Our experiment ran from 29 December 2015 to 7 January 2016. We took our pollution sensor to different places in Delhi including Paschim Vihar, Punjabi Bagh, Janakpuri, Red Fort, Raj Ghat, Kasmeri Gate, Delhi Domestic Airport, Dhaula Kuan, Safdarjung Enclave and Narela. These venues were in West, East, North, South and Central parts of Delhi to get fair representation of pollution levels in the city. The sensor was also taken outside of Delhi to Panipat (Haryana state) and Mumbai (Maharashtra state) to get comparative data for analysis. We even took the sensor high up in the air (in Spice Jet and Indigo airlines) to get cleaner air data for calibration. Observations taken ranged from 30 min to 30 h continuously.

## 6 Observations from Our Experiment

The particulate matter concentration in Delhi ranged from a thousand particles per 0.01 cubic feet in quiet residential areas to 40,000 particles per 0.01 cubic feet in busy intersections (near Punjabi Bagh and Dhaula Kuan). Figure 1 shows the average count to be 25,000 particles per 0.01 cubic feet in the busy Chandni Chowk area and never went below the 10,000 mark. In comparison, Fig. 2 shows that the concentration was less than 1000 particles per 0.01 cubic feet in the airline cabin of Spice Jet airlines from Delhi to Mumbai at the cruising height.

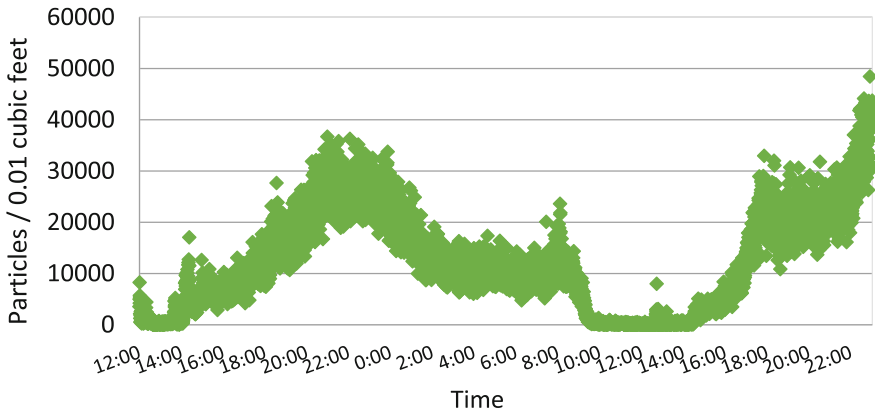


**Fig. 1.** One-hour pollution level count at Chandni Chowk, Delhi, India (5 January 2016)



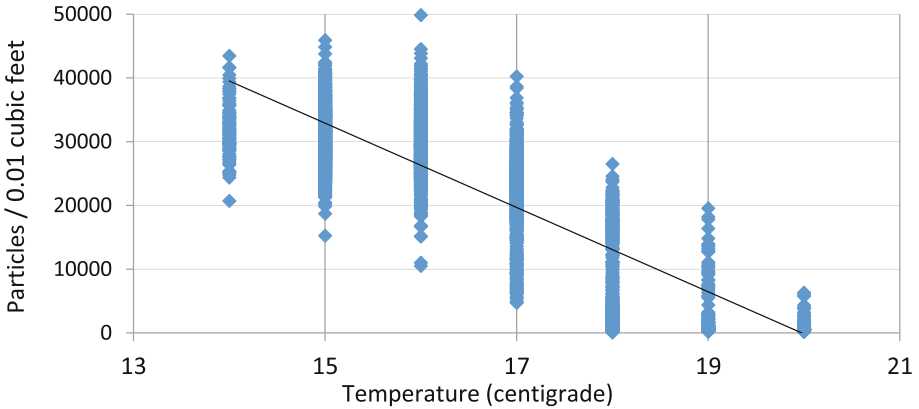
**Fig. 2.** Pollution count in spice jet airlines from Delhi to Mumbai, India (9 January 2016)

Figure 3 shows that particulate matter count was lowest during late morning and afternoon and climbed up rapidly in the evening. Particulate matter concentration was higher at the intersections and where traffic movement was slow. Even though Mumbai has lesser number of vehicles compared to Delhi, the pollution levels were higher (up to 45,000 particles per 0.01 cubic feet) at some of the intersections (on the way from Chakala to the domestic airport) because of slower moving traffic and greater number of diesel vehicles.

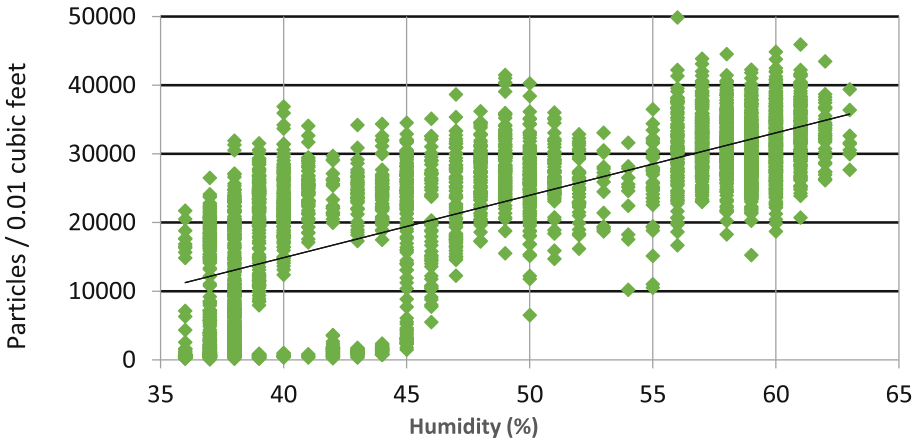


**Fig. 3.** Pollution levels peak during evenings and drop in the afternoon (36-h observation from 31 December 2015 – 1 January 2016)

We did not observe any significant difference in pollution levels when the Odd-Even rule was in effect. In part because variables such as temperature, moisture, sunlight and wind speed change rapidly and measuring their collective impact on pollution level was beyond the scope of the experiment. We found that the particulate matter concentration decreases when temperature increases and increases when the moisture level in the air



**Fig. 4.** Pollution levels decrease with temperature (26-h observation from 11 am, 6 Jan to 1 pm, 7 Jan 2016)



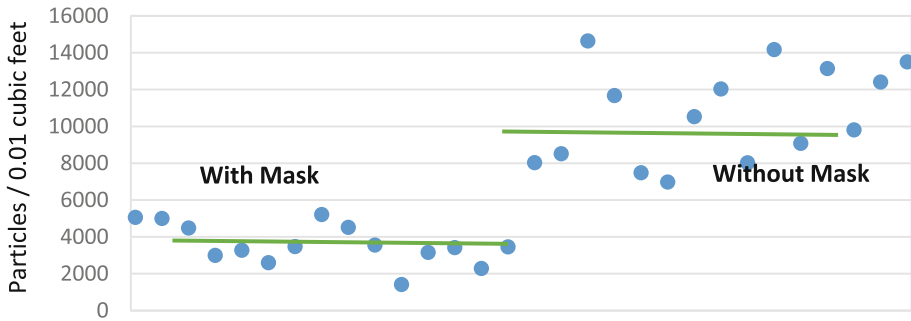
**Fig. 5.** Pollution levels increase with humidity (26-h observation from 11 am, 6 Jan to 1 pm, 7 Jan 2016)

rises as shown in Figs. 4 and 5 respectively. This explains why pollution count is low in late mornings when the sun is out and the moisture levels are lower.

Interestingly while our Sensor measured data in particles per 0.01 cubic feet the data collected by the Government through the System of Air Quality and Weather Forecasting and Research stations (SAFAR) collected data was in micrograms per cubic meter. Nevertheless, the trend in pollution levels (of 2.5 micron particles) aligned with each other in most instances.

## 7 Findings from Our Experiment

First, face masks are effective. Wear your face mask when the pollution count is likely to be high. Even the cheapest face mask in the Delhi costing Rs. 10 (USD 0.15) cuts down particulate matter concentration by more than half as shown in Fig. 6.



**Fig. 6.** The mask effect: face mask cuts pollution intake by half

Second, the best time to step outside the home is in late morning when the sun is out and temperature is higher and humidity is low. It is advisable to come back by evening. The worst time to go out is late in the evening when pollution levels starts to rise due to lower temperature and higher humidity.

Third, pollution count changes with local factors. The bursting of fire crackers at the midnight of 31 December 2015 to celebrate the New Year increased the pollution count significantly. The pollution count was found to be lower in areas where trees and bushes are planted. Local actions to curb pollution matters and everyone should do their part.

## 8 Suggestions

Odd-Even rule in Delhi brought awareness on the need to act to curb pollution. Health and lives of people are at stake. There should be follow-ups and piloting of other projects and strategies to make Delhi air cleaner.

Based on our experiment, we have three suggestions to bring down pollution levels in Delhi and elsewhere. First, there should be more COTS based pollution sensors fielded by NGOs and citizen scientists to gather detailed local data on emissions. This will allow us to identify the major sources of pollution and validate air quality data provided by the government. Second, growing hardy shrubs and bushes on road dividers and trees on the road sides can cut down exposure to particulate matters. Third, free the pavements from commercial encroachments and create cycling paths to promote walking and cycling as an emissions free mode of transport.

## **9 COTS and Environmental Sector Start-Ups**

As climate change affects everyone, it opens up huge markets for products, technologies and services which can reduce the impact of climate change and allow people to lead better quality of lives.

From farming to clean water, and from food supply chains to energy access, the start-up sector is growing - boosted by the interest and financing from angel investors and venture capitalists. Disposable pollution masks vending machines, wearables that repel pollutants, collar sensors that warn people when entering high pollution zones, and mobile air purifiers are COTS based products that are already in the market. Innovative products and services are also being developed through hackathons, in incubation zones, maker spaces, and in garages and basements of young entrepreneurs. The spread of environment maker fairs and the rise of sharing economies can only catalyze the adoption and scaling up of COTS for addressing climate change.

### **References**

1. United Nations (UN), Framework Convention on Climate Change, Conference of the Parties, Twenty-first session, Adoption of the Paris Agreement (2015)
2. Intergovernmental Panel on Climate Change (IPCC), Climate Change 2014: Synthesis Report, Contribution of Working Groups I, II and III to the Fifth Assessment Report of the Intergovernmental Panel on Climate Change (2014)

# **Education**

# Challenge to Promote Deep Understanding in ICT

Valentina Dagiene<sup>(✉)</sup>

Institute of Mathematics and Informatics, Vilnius University, 08663 Vilnius, Lithuania  
valentina.dagiene@mii.vu.lt

**Abstract.** The international Bebras challenge on informatics and computational thinking is well-known in over fifty countries as an informal school activity. Running the contest annually for more than ten years, we have noticed that the students (and their teachers) consider the activities as a very exciting learning experience in problem solving and increased understanding of what lies beyond ICT. The crucial point of the challenge is the tasks: they focus mainly on the informatics (computer science) concepts and help in understanding beyond technology, they are short, attractive, and answerable in a few minutes; some of them have multiple-choice answers or are open-ended, and others have interactive components (solving by dragging, clicking, sorting, etc.). The performance of the Bebras challenge in many countries during the last years has shown a high acceptance by school students at all levels. The challenge also involves a fairly high number of female participants.

**Keywords:** ICT and human development problems · ICT and gender · Digital literacy · Deep learning · Informatics education · Problem solving

## 1 Introduction

The status of informatics (computer science or computing) education as a deep understanding of information and communication technology (ICT) is unsatisfactory in many countries [1]. Although computers, applications and ICT in general are an increasingly natural part of the everyday work in schools, the focus is mainly oriented toward the basic digital literacy skills while the underlying principles are left uncovered.

Bringing informatics and ICT as a creative subject to schools through curriculum changes in the form of a formal track is essential, but it takes time especially when changes are reflected in a top-down way. Non-formal and informal ways are much faster and could involve a number of voluntary activities. We can enumerate an increased number of initiatives, e.g., CS Unplugged, code.org, Code academy, Hour of Code, aiming at making informatics and ICT creativity accessible to everyone.

The Bebras challenge on informatics and computational thinking is another similar activity [2]. The Bebras (*Beaver* in English) is an annual contest held in parallel in schools in many European countries and all over the world (e.g. Australia, Canada, France, Germany, Japan, Malaysia, Taiwan, USA). It provides motivated and game-like tasks in the format of multiple-choice questions, open-ended problems, and interactive tasks where students answer by doing actions, dragging and dropping objects, drawing

shapes, clicking on particular items, setting puzzles, writing answers in text boxes, etc. [3]. The name “Beaver” – in Lithuanian “Bebras” – was chosen in connection with the hard-working, intelligent, goal seeking and lively wild animal.

The Bebras challenge is developed for all primary, secondary and high school students. The contest is performed in schools on computers. Students should solve 18 to 24 tasks within 45 or 55 min. There are different task sets for the five defined age groups: Mini Beavers (grades 3–4), Benjamins (grades 5–6), Cadets (grades 7–8), Juniors (grades 9–10) and Seniors (grades 11–12). The participants are usually supervised by teachers who may integrate the contest in their teaching activities as well.

## 2 Some Statistics and the Methodology

The Bebras challenge is a medium to involve students of all grades in the task solving activities contest (the Bebras week in November). Actually, participation and discussions are more important aspects than competitiveness. Each Bebras task can both demonstrate an aspect of informatics knowledge and test the participant’s ability of understanding ICT fundamentals [4]. The challenge is designed to promote informatics fundamentals for both boys and girls and to attract equal attention for both genders. A quite large number of girls took part in the contest last year (Table 1). Note however that some countries did not provide any data about gender, and 16 % of Australian and 23 % of UK participants were of unknown gender.

**Table 1.** Distribution of number of participants by countries and gender in the 2015 contest

Country	Total	Girls %	Country	Total	Girls %
Australia	16 925	~39	Latvia	1 209	–
Austria	17 641	46	Lithuania	24 709	43
Azerbaijan	4 065	44	Macedonia	19 608	47
Belorussia	53 587	–	Netherlands	21 086	44
Belgium	1 762	32	Pakistan	7 369	–
Bulgaria	474	28	Poland	13 392	–
Canada	10 288	40	Russia	24 543	–
Czechia	52 596	45	Serbia	30 823	–
Estonia	4 020	–	Slovakia	66 842	46
Finland	5 598	45	Slovenia	24 158	–
France	344 976	49	South Africa	28 543	44
Germany	248 084	44	Spain	711	–
Hungary	13 438	45	Sweden	6 206	56
Iceland	475	51	Switzerland	13 475	48
Iran	2967	–	Taiwan	27 864	45
Ireland	3 141	–	Turkey	13 784	49
Italy	12 017	32	Ukraine	93 820	49
Israel	~2 000	–	United Kingdom	55 967	~35
Japan	3 538	57	USA	39 213	–



The methodology in this research is based on quantitative statistical data and an overview of evidence presented in previous research in this area. The design of the Bebras challenge provides multiple kinds of data collection. These are statistics automatically collected during the online contest, and observation participants during competition.

The paper deals with a short reflection on the historical origin of twelve years of Bebras challenge, and connects this analysis with current dynamics within and across activities.

A detailed model on the Bebras Challenge on Informatics and Computational Thinking is developed and presented in paper [5]. An implementation of the model and results drawn from the model to reflect on the outcomes are discussed as well.

Bebras tasks are created and discussed during annually organized international workshops. The tasks should represent the main informatics areas: information comprehension, algorithms and programming, use of computer systems, discrete structures and patterns, logical puzzles, ICT and society. Each task is assigned one of three difficulty levels: hard, medium, or easy [4]. In one of the case studies, we found that the Bebras tasks are well-developed in terms of the cognitive domain (Bloom's taxonomy): a majority of the tasks fall into higher categories in understanding, applying, analysing, and evaluating [6].

The real challenge for researchers and educators is to design suitable, attractive, and promotional tasks. The tasks should cover different areas of informatics, be suitable for the age group and possible to answer in a short time, and they should do justice to the image of informatics.

### **3 From an ICT User to a Creative Thinker Beyond Technology**

A deep understanding must be based on a continuously developing level and involve a well-developed and rich basis of knowledge that has a relative complexity. Can we cultivate this kind of thinking with younger students as well? The answer should be positive, yes, if we would like to have a digitally literate and creative society. To reach this goal, we need to provide children with interesting, well-developed tasks and allow the children to explore these tasks.

A deep understanding of informatics (computer science) means that the concepts of the subject are well represented and well connected. Thus, a deep understanding of informatics involves the ability to understand basic principles of computing by recalling a set of connected main concepts. The deep thinking also involves the construction of new informatics (as well as ICT) concepts and is almost always based on students' previous knowledge.

When the Bebras contest was established in 2004, it focused mainly on ICT and computer fluency. Later on, it shifted to solving problems beyond ICT and promoting various types of thinking - algorithmic, logical, operational, based on informatics fundamentals and computing principles [7]. Essentially, the idea was to encourage children to learn ICT deeper, and to support the development of algorithmic thinking as well as computational thinking.

The term computational thinking was popularised in 2006 with Jeanette Wing's paper [8] but actually originated with Seymour Papert in 1996 [9]. Computational thinking is seen as a problem-solving process that includes formulating problems, representing data through abstractions, automating solutions, identifying, analysing, and implementing possible solutions, generalizing and transferring knowledge [10]. Computational thinking is an increasingly important focus in the curricula in schools around the world.

Our aspiration is to wrap up serious scientific problems of informatics and the basic concepts of ICT into playful tasks and inventive questions, thus attracting students' attention. It is not an easy matter to prepare tasks in such a way. As a general guideline, we find it more important to understand and handle the fundamentals and main concepts of informatics than recalling various technical details related to computers and ICT.

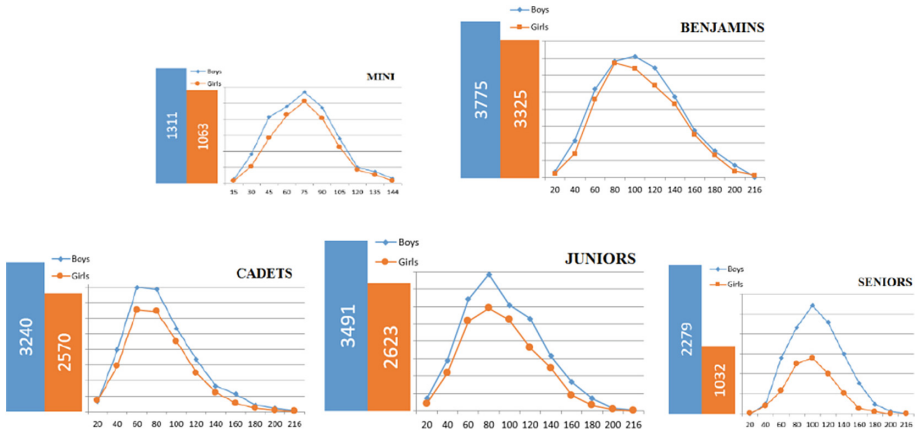
Understanding computing processes, controlling computations, calculations and estimations is more significant than being able to perform computations by ourselves. Information technology has to be understood at many levels, e.g., as a fundamental culture and not as a collection of buttons and instructions; as a development of ideas and not a finished work; as an explanation of the concepts, etc. We keep all these topics in mind while organizing the challenge and working on task preparation. The promoting idea of the Bebras challenge is not to test students' knowledge, but this contest can be used also for assessment of the students' achievements in computational thinking, especially over a longer time period [11].

## 4 How Girls Have Solved the Bebras Tasks

Several case studies originated from the results that girls aged 10–13, can manage equally well (or even better) as boys in the Bebras challenge [6, 12, 13]. Researchers from Lithuania, Finland, and Sweden have identified that, in the case of Benjamins, there is no great difference in the performance of boys and girls, and girls performed better than boys in several tasks, especially related to instructions and rules [13].

The pupils' performance in solving tasks increases with age. Furthermore, a case study from Germany shows that boys showed a significantly better performance compared to girls in upper grades [16]. A similar shifting between genders with increasing age has been noticed in the Lithuanian Bebras contests during many years. One of the main reasons for this shifting is the school-leaving programming exam, which is a prerequisite to enter the male dominated Computer Science related studies at our universities. More detailed investigations of this topic are needed. However, it appears extremely important to seek Bebras tasks that are attractive for girls of all ages [14, 15].

Last year 24709 students took part in the contest in Lithuania, out of which 2374 Mini Beavers, 7100 Benjamins, 5810 Cadets, 6114 Juniors, and 3311 Seniors. Figure 1 shows the total number of boys and girls in these age groups, together with the distributions of their total scores. The horizontal axis represents all the possible scores (between 0 and 144 for the Mini group, and between 0 and 216 for all others); the vertical axis represents the number of boys and girls who got the respective score.



**Fig. 1.** Distributions of the scores: how successful boys and girls were when solving tasks

From the charts, we can notice that the girls in all groups, except for Seniors, are doing very well with a minimal difference from the boys’ results. These results could be one of the influential factors disproving the misconception that informatics (computer science) is inherently a male study subject.

## 5 Future Works

The large and multifaceted data, collected during the international Bebras challenge, gives the possibilities to analyse many interesting aspects, related to, e.g., students’ understanding, difficulties and misconceptions in informatics based on different factors. We need to elaborate statistical models for measuring students’ achievements and impact on thinking.

It is noticed that the non-curriculum approach provides an opportunity for grassroots influence on the formal curricula. Nowadays, top-down state-led education systems in many countries over the world struggle to efficiently deliver informatics and better ICT education in schools. Using nonformal and informal approaches for informatics education, we could make significant influence to the school curricula. An important issue for that goal is to estimate how effectively the materials, designed for outreach, e.g. the Bebras challenge, can be adapted to informatics curricula, the setting where a certain level of assessment will almost inevitably be required.

Another problematic issue, which needs to be researched, concerns the view of informatics and ICT as a male-dominated discipline. A long-term research is necessary in order to determine whether the girls, who had a successful introduction to informatics at an early age, exhibit less of the gender inhibiting stereotypes in informatics later in life.

## References

1. Guerra, V., Kuhnt, B., Blochliger, I.: Informatics at school – Worldwide. Technical report, University at Zuerich (2012)
2. Bebras International Challenge on Informatics and Computational Thinking. <http://www.bebas.org/en/facts>
3. Dagiene, V.: Information technology contests – introduction to computer science in an attractive way. *Inf. Educ.* **5**(1), 37–46 (2006)
4. Dagiene, V., Futschek, G.: Bebras international contest on informatics and computer literacy: criteria for good tasks. In: Mittermeir, R.T., Sysło, M.M. (eds.) ISSEP 2008. LNCS, vol. 5090, pp. 19–30. Springer, Heidelberg (2008)
5. Dagiene, V., Stupuriene, G.: Bebras - a sustainable community building model for the concept based learning of informatics and computational thinking. *Inf. Edu.* **15**(1), 25–44 (2016)
6. Dagiene, V., Pėlikis, E., Stupurienė, G.: Introducing computational thinking through a contest on informatics: problem-solving and gender issues. *Informacijos Mokslai* vol. **73**, pp. 55–63 (2015). Vilniaus universiteto leidykla
7. Csernoch, M., Biro, P., Math, J., Abari, K.: Testing algorithmic skills in traditional and non-traditional programming environments. *Inf. Edu.* **14**(2), 175–197 (2015)
8. Wing, J.M.: Computational thinking. *Commun. ACM* **49**(3), 33–35 (2006)
9. Papert, S.: An exploration in the space of mathematics educations. *Int. J. Comput. Math. Learn.* **1**(1), 95–123 (1996)
10. ISTE and CSTA (International Society for Technology in Education and the Computer Science Teachers Association). Operational Definition of Computational Thinking for K-12 education (2011). <https://csta.acm.org/Curriculum/sub/CurrFiles/CompThinkingFlyer.pdf>
11. Barendsen, E., Mannila, L., Demo, B., Grgurina, N., Izu, C., Mirolo, C., Sentence, S., Settle, A., Stupurienė, G.: Concepts in K-9 computer science education. In: Proceedings of the 2015 ITiCSE on Working Group Reports, pp. 85–116. ACM, New York (2015)
12. Kalas, I., Tomcsányiova, M.: Students' attitude to programming in modern informatics. *Informática na Educação: Teoria & Prática*, vol. **12**(1), pp. 127–135 (2009). Porto Alegre
13. Dagiene, V., Mannila, L., Poranen, T., Rolandsson, L., Stupuriene, G.: Reasoning on children's cognitive skills in an informatics contest: findings and discoveries from Finland, Lithuania, and Sweden. In: Gülbahar, Y., Karataş, E. (eds.) ISSEP 2014. LNCS, vol. 8730, pp. 66–77. Springer, Heidelberg (2014)
14. Ilomaki, L.: The Effects of ICT on School: Teachers' and Students' Perspectives. Ph.D. thesis, University of Turku, Finland (2008)
15. Tomcsányiová, M., Kabátová, M.: Categorization of pictures in tasks of the Bebras contest. In: Diethelm, I., Mittermeir, R.T. (eds.) ISSEP 2013. LNCS, vol. 7780, pp. 184–195. Springer, Heidelberg (2013)
16. Hubwieser, P., Muhling, A.: Investigating the psychometric structure of Bebras contest: towards measuring computational thinking skills. In: International Conference on Learning and Teaching in Computing and Engineering (LaTiCE), Taipei, Los Alamitos, April 9–12, pp. 62–69. IEEE Press (2015)

# Computer Animation as a Vehicle for Teaching Computational Thinking

Leonel Morales Díaz<sup>1</sup>(✉) and Laura S. Gaytán-Lugo<sup>2</sup>

<sup>1</sup> Universidad Francisco Marroquín, 6ta Calle Final Zona 10, Guatemala 01010, Guatemala  
litomd@ufm.edu

<sup>2</sup> Universidad de Colima, Km. 9 Carretera Colima – Coquimatlán, 28300 Colima, Mexico

**Abstract.** Several platforms and programming languages exist nowadays designed and built to help educators introduce kids and youngsters into computational thinking. Some of them employ visual elements as the primary output of code in order to provide an immediate and engaging feedback for students. Computer animations, digital drawings and videogames are common products in these environments. With the rising popularity of animated films, children and teenagers may find more attractive to enroll in computer animation courses than in computer programming ones. Based in our own experience conducting computer animation workshops, we believe that this interest can be combined with the aforementioned introductory programming environments to introduce students to both computational thinking and computer animation as complementary subjects. In this paper we will present a general strategy to accomplish this based on what we call animation patterns.

**Keywords:** Computational thinking · Computer animation · Programming languages · Animation patterns

## 1 Introduction

Introductory programming languages often categorized as first programming environments, like Scratch [11], Alice [3] and others, can be used to produce moving images and animated stories that range in quality from the rudimentary to highly complex and elaborated. In fact, children, teenagers and adults enrolled in courses that use these environments end up creating animations even if the purpose of the course was to merely teach them how to program.

Producing digital animated films is a task that requires, among others, skills in graphic design and computer programming among others [15, 16]. Several concepts and techniques applied in computer animation are employed by users of first programming environments without realizing that fact. Duration of movements, coordination of several acting agents, change of scenes, interactions between characters, appearance modification, simultaneity, parallel programming, camera movements and several others appear naturally without fancy names in environments like Scratch, Alice, Kodu Game Lab [14], Stencyl [18], and Snap [20].

If attendants to computer programming courses that use those environments knew in advance that they would be creating animations and that the skills they learn would actually be of use in a prospective career in computer animation they would feel more motivated to enroll. Knowing only the information the course name provides it is difficult for them to infer that. The importance and effects of choosing a meaningful and attractive title has been studied in other contexts as presented in [12].

On the other hand, if the name of a course on computer programming is going to be changed to something like “computer animation” then the teacher has to be sure that they are actually teaching the subject. For that purpose, a switch in the emphasis has to be made from teaching programming structures to practicing animation patterns.

In the following sections we will discuss in more detail these three ideas: animation patterns instead of programming structures, utility of the approach to acquire skills that are valuable for the animation industry, and attractiveness of animation in contrast to that of “pure” computer programming to young audiences. The research paths that can be followed to develop these approaches will also be portrayed.

The viewpoints presented in this work are rooted in several years of experience conducting computer animation workshops using first programming environments, aimed precisely to introduce students to computational thinking at the same time. A special section describing these experiences is included.

Because computational thinking is regarded as a fundamental skill in the 21<sup>st</sup> century world [7], instructional approaches that make it more accessible to young audiences are important to explore and include in the research agenda especially in those countries and regions where the positive impact of technology is expected to be the greatest.

## 2 Animation Patterns vs. Programming Structures

Traditional introductory programming courses are based on syllabi that include explaining algorithms and several programming structures like decision, loops, variables and types, procedures, definition, etc., that are common to many programming languages [1]. Examples of use are presented with each structure hoping that students will understand the general idea behind each one. First programming environments can be used to teach programming in that way [13, 17] but also to teach computer animation [21].

If the emphasis is to be switched to computer animation then instead of structures the syllabus could be based on teaching and practicing animation patterns. Each pattern represents a technique to create an animated scene and actually provides an opportunity to employ programming structures, only within the context of animation. The approach does not guarantee that all programming structures will be covered, although there is no reason to think that it is not possible, most likely only a subset of them will be constantly used and practiced.

An important difference regards learning the syntax of a programming language. In the traditional approach the syntax plays an important role. It has to be learned at the same time that programming structures have to be understood burdening the attention of students [4, 19]. In introductory programming environments the syntax is much less demanding or even completely taken care of, like in block programming [17, 21].

## 2.1 Animation Patterns

An animation pattern involves specific movements and effects that are useful and significant in the context of a story told with computer-generated images. The pattern is abstract and requires programming to be implemented with particular characters or objects. The animation patterns thus provide the context to make the programming relevant and meaningful.

Patterns range from the most basic frame by frame and loop through images, to multi-character scenes with interactions among objects that decide in each step what their next movement will be. To use the patterns in a course they must be previously collected, classified according to difficulty or relatedness, and exemplified in an animation that students can build during a class. The goal is to develop in them the ability to use any pattern with any character or scene whenever is needed, which requires a flexibility of mind, a competence for abstraction, and of course programming skills. A suggestion for pattern classification follows:

- Basic patterns with a single character: movement, turns, flips, bouncing, resizing, sudden appearance, fading, color changing.
- Compound patterns: advancing and jumping, moving and turning, resizing and appearing-disappearing.
- Interactive patterns between two or more characters: conversation, coordinated movement, approaching, contact, dancing, contrasting movement, races, collisions.
- Patterns involving backgrounds: switching background, moving background behind still images, adding elements to background.
- Patterns that use randomness: random movement, random turns, random drawing, random movement over one axe, random resizing.
- Patterns of interaction with the user: responding to clicks, responding to keypresses, basic games.

## 2.2 Programming Structures Through Animation Patterns

As students practice with patterns they employ repeatedly the programming structures needed for the pattern. Advancing a pattern or innovating on it can lead the student to learn autonomously the new programming structures needed or ask the teacher for guidance. Teachers have to be well versed in how to use the different programming structures available in the environment being used, and also they have to be ready to use the questions students make to introduce those structures [8]. Not being properly prepared for such situations can be detrimental of the educational process [6].

## 3 Value of Computer Animation Skills

Although some first programming environments are well capable of generating high quality animations and video effects they are not the tool of choice for professionals in the industry. It is highly improbable that a person that masters Alice, Scratch or similar,



could be hired in an animation company only on that basis, or at least common job descriptions in the industry so suggest (confront for example [5]).

On the other hand animation concepts used in professional settings are not that different compared to those that can be learned using first programming environments. Finding if students that already master animations in first programming environments are more prepared to learn specialized animation software and tools would provide a strong argument not only for learning animation with first programming environments but also to hire young apprentices in animation companies provided they already do animations in those environments and will complete instruction inside the company. The proposed animation pattern set is subject to fine-tuning to align with industry requirements [21].

## 4 Attractiveness of Computer Animation

It is very easy to assume that computer animation would be more attractive for young learners than computer programming. It seems that the concept of computer animation is closer to them thanks to the film industry, video games and the pervasiveness of animation in web pages. Finding if in fact when presented with two options for a course, one framed as computer animation and the other as computer programming, students would prefer the first option is a research challenge by itself.



**Fig. 1.** Computer animation workshop for middle school students in Guatemala, using Alice.



Offering courses on computer animation may also have an effect on future enrollment in computer programming because a first contact between students and programming environments would already be made. Confirming or rejecting these hypothesis would require long term studies. Nevertheless, even if enrollment is not increased the value of computational thinking instruction is by itself a goal worth seeking especially in less developed regions because an important portion of current and future requirement of every job position is related to that skill [2].

On the other hand we have some experience accumulated after several years offering free computer animation workshops using Scratch or Alice for middle and high school students (Fig. 1) and sometimes also for teachers in which case the pedagogical approach is emphasized.

These workshops have been successful in providing an enjoyable first experience with computer programming through computer animation. In the case of Alice workshops, we have recently started paying special attention to how students engage with the language and found that they do in one of four possible ways – as described in previously published works [9, 10] and shortly described in the following subsections.

#### 4.1 Alice Styles of Use

The styles of use or styles of interaction with Alice are particular and distinct ways in which students engage with the platform after an introductory lesson. They become especially apparent when participants are invited to explore freely the environment and build the animation of their choice. The identified styles are four: instruction follower, scene designer, dialogue storyteller and action animator.

**Instruction Followers.** Students that prefer to follow instructions and copy the actions and choices of the instructor through all the workshop. They tend to use the same characters and to place them as similarly as possible as the instructor is doing on her screen. When they are told to explore and work freely they keep working on the same animation in order to make it a better copy of the model. Usually all students start the workshop following instructions but instruction followers persevere for most time. In fact they seem to enjoy achieving the perfect copy.

**Scene Designers.** Some students seem less interested in adding movement to their animation and prefer to use Alice as a kind of artist composition tool to create beautiful scenes. These are scene designers. They enjoy adding elements and decorations, changing colors, rearranging components and moving the point of view of the scene using camera movements.

**Dialogue Storytellers.** A popular style among girls although not limited to them. Dialogue storytellers enjoy placing characters in the scene and making them chat using the “say” and “think” commands. Their code usually includes long sequences of those instructions. They like to modify the dialogues and watch the resulting story.

**Action Animators.** Some students seem to have a special ability to understand the programming model in Alice and start using advanced commands to create complex

animations in which the story is not the central element but the intensity of the action. These are the action animators.

#### **4.2 A Reflection on Styles of Use and Computer Animation**

The study of the different styles of use is still a work in progress, although it allows a brief reflection: would such styles have become noticeable in a setting in which computer programming is emphasized instead of computer animation? If a computer animation course teaches computational thinking as well as a computer programming course but also adds the benefit of being friendlier with different mindsets of students then the computer animation approach seems to be more beneficial. Once again, this idea deserves a specific research effort.

### **5 Conclusions**

This paper has outlined the general idea of using first programming environments like Alice, Scratch, Kodu Game Lab and others, to teach computer animation instead of computer programming but at the same time introduce many concepts and practice structures that are usually part of a computer programming course. One of the points of the article is that computer animation leads to learn computational thinking at the same time.

Three ideas were discussed: animation patterns in computer animation courses replace programming structures as the component units of the syllabus, the expected value of skills and concepts learned with first animation environments for the computer animation industry, and how the attractive of computer animation courses could be greater than that of pure computer programming courses. Each of these ideas induces questions and opens paths of research.

The different styles of use in the particular case of Alice were briefly explained as a first result after some years offering free computer animation workshops with that environment. A computer animation perspective seems to be better suited to accommodate the spontaneous apparition of those styles leading to a more pleasant experience for a wider audience, but at the present time this remains a hypothesis pending validation.

There could be other approaches to teach computer animation that do not require first programming environments but the high availability and the increasing familiarity with them that schools and teachers have, makes them an option worth considering. Additionally the introduction and exposure to computational thinking that is possible with first programming environments seems to make them a better choice in regard of the requirements of modern world technology and labor market.

## References

1. Association for Computing Machinery, IEEE Computer Society: Joint task force on computing curricula. *Computer Science Curricula 2013: Curriculum Guidelines for Undergraduate Degree Programs in Computer Science*. ACM (2013)
2. Hu, C.: Computational thinking: what it might mean and what we might do about it. In: *Proceedings of the 16th Annual Joint Conference on Innovation and Technology in Computer Science Education (ITiCSE 2011)*, pp. 223–227. ACM, New York (2011)
3. Carnegie Mellon University, Alice.org (2015). <http://www.alice.org/>. Accessed 6 June 2016
4. Lahtinen, E., Ala-Mutka, K., Järvinen, H.M.: A study of the difficulties of novice programmers. *ACM. SIGCSE Bull.* **37**(3), 14–18 (2005). ACM
5. <https://www.prospects.ac.uk/job-profiles/ animator> Accessed 6 June 2016
6. Bayón, J.B.: Formación del profesorado con scratch: análisis de la escasa incidencia en el aula. *Opción* **31**(1), 164–182 (2015)
7. Wing, J.M.: Computational thinking. *Commun. ACM* **49**(3), 33–35 (2006)
8. Assiter, K., Wiseman, C.: Exploratory learning with Alice: experiences leading a computer science workshop for girl scouts. *J. Comput. Sci. Coll.* **31**(4), 21–27 (2016)
9. Morales Diaz, L., Gaytan-Lugo, L.S., Fleck, L.: Interaction styles in Alice: notes and observations from computer animation workshops. In: *Proceedings of the Latin American Conference on Human Computer Interaction*. ACM (2015)
10. Morales Diaz, L., Gaytan-Lugo, L.S., Fleck, L.: Profiling styles of use in Alice: identifying patterns of use by observing participants in workshops with Alice. In: *2015 IEEE Blocks and Beyond Workshop (Blocks and Beyond)*. IEEE (2015)
11. Lifelong Kindergarten Group at the MIT Media Lab, Scratch - Imagine, Program, Share (2015). <https://scratch.mit.edu/>. Accessed 6 June 2016
12. Hairston, M., Keene, M.: *Successful Writing*, 5th edn. Norton, New York (2003)
13. Resnick, M., Maloney, J., Monroy-Hernández, A., Rusk, N., Eastmond, E., Brennan, K., Millner, A., Rosenbaum, E., Silver, J., Silverman, B., Kafai, Y.: *Scratch: programming for all*. *Commun. ACM* **52**(11), 60–67 (2009)
14. Microsoft Research, Kodu Home. <http://www.kodugamelab.com/>. Accessed 6 June 2016
15. Hegg, R.: The art of programming in computer animation. *IEEE Spark* **4**, 2–3 (2014)
16. Parent, R.: *Computer Animation: Algorithms and Techniques*. Newnes, Morgan-Kaufmann, Boston (2012)
17. Flanagan, S.: Introduce programming in a fun, creative way. *Tech. Dir.* **74**(6), 18–20 (2015)
18. Stencyl, LLC, Stencyl: Make iPhone, iPad, Android & Flash Games without code. <http://stencyl.com/>. Accessed 6 June 2016
19. Jenkins, T.: On the difficulty of learning to program. In: *Proceedings of the 3rd Annual Conference of the LTSN Centre for Information and Computer Sciences*, vol. 4, pp. 53–58 (2002)
20. University of California at Berkeley, Snap! (2016). <http://snap.berkeley.edu/> Accessed 6 June 2016
21. Dann, W., Cooper, S.: Education: Alice 3: concrete to abstract. *Commun. ACM* **52**(8), 27–29 (2009)

# Transforming Low Socioeconomic Status Schools to Learning for Well-Being Schools

Heilyn Camacho<sup>(✉)</sup>

Aalborg University, Aalborg, Denmark  
hcamacho@hum.aau.dk

**Abstract.** This article presents the initial finding about the complexity of dealing with a transformation of a low socioeconomic school into a learning for well-being school. The article looks at the problem through the lens of complexity theory to discuss the different components, subsystems and the different kind of changes that need to take place for the transformation process. The article concludes with some suggestions for developing a framework that may help practitioners and researchers when approaching this kind of complex change.

**Keywords:** ICT and education · Complexity theory · Low socioeconomic status schools · School change · Learning for well-being

## 1 Introduction

Over the past 30 years, research community has developed a body of theoretical and empirical work regarding the influence of socioeconomic status (SES) in the students performance. It has showed that: (a) students from low socioeconomic families have lower academic achievements, (b) Low SES (LSES) environments affects students' growth and cognitive development, (c) LSES students have lower innate ability, less favourable attitudes towards school (often they lack of motivation to learn), less ambitious to further education and higher education (they see themselves remaining in the same situation and they do not have role models to follow) and (d) poverty negatively affects a student's physical and emotional health, which influences educational outcomes [1–3].

In the other hand, we have The Incheon Declaration 2015 [4], which encourages all countries to provide inclusive, equitable, quality education and life-long learning opportunities for all. It is a transformative vision for education for the next 15 years. Other visions similar to Incheon Declaration are the 21 st century skills program, UNESCO's four pillars for education and Learning for well-being framework. Yet far too many children and youth, especially those from poor and minority families, are relegated to lower quality education and lower quality futures.

Learning for well-being is defined learning “as broad and unconfined to the narrow borders of school-based education; its goals are equally broad, encompassing the physical, spiritual and emotional, as well as the cognitive.” [5, p. 55] According with the framework of Learning for well being, “learning is social endeavour, it has

important emotional and spiritual components, it is related to cultural context as well as individual ways of learning and it occurs not only in our brain but in every part of our body” [5, p. 58]. This definition is aligned with UNESCO’s four pillars of education: learning to know, learning to do, learning to live together and learning to be.

Having this view of learning and vision of inclusion, we may ask, is it at all possible to achieve learning for well-being in LSES schools? The CREO (believe and create in Spanish) project is an action research project aims to improve the education and life opportunities of students from LSES high schools. This research project deals with the questions about how LSES high schools can be transformed in learning for well-being high schools?

Through the cycle of planning, action, reflection and planning again, we aim to try out different initiatives to change the current situation of one high school in Costa Rica, with the end goal not only of improving the learning and life conditions for those students, but also to develop a framework to facilitate change in LSES high schools, that could be useful for other LSES schools in Costa Rica and outside of the country.

The scope of CREO project is very broad but in this article we focus on the analysis of the complexity to initiate an organizational change at one high school with the aim to implement new teaching approaches and the use of information and communication technologies (ICT) to move the school closer to a learning for well-being school.

The research question for this paper is what systemic approach in terms of multiple changes at different levels could potentially help researchers and practitioners to effectively handle the complex process of transforming a low socioeconomic school?

As this is a research in progress, in this paper we analysis the complexity of the phenomena and provide description of the first actions taken and the first inputs for the possible approach. For the analysis we use complex theory as lens to understand the phenomenon and discuss the challenging situation that a practitioner faces when trying to decide how to start the change process.

## 2 Complexity Theory

Schools have been identified as a complex adaptive systems and researches demand different approaches for schools reforms [6, 7]. For the discussion of the concept of complexity theory we draw extensively on [7], mainly because the limit space in this paper and his focus on school reform. Complexity theory conceptualizes the workings of non-linear systems composed of multiple interacting and diverse elements that influence each other. They are seen as systems that change constantly based on information feedback into the system. This systemic view seems compelling, because nothing stands alone; everything is interconnected and interdependent. Complex systems cannot be understood by analysing the individual components, it should be analysed as a whole, in the case of the schools, it is necessary to understand the relationships among students, teachers, families, communities and administrators to see what emerges from their collective interaction [7].

According to [7], complexity theory offers a holistic framework for understanding the systemic nature of education reform and who proposes the following questions when designing, implementing and assessing school reforms: “Are initial conditions

promising? Will people do things differently and in ways that align with a school's core values? Is power distributed appropriately? Do people have a say? Do students, teachers, parents, and administrators share core values? Are similar rituals, routines, and practices aligned with these values and enacted at multiple levels of the system? Are there logical reasons why the pieces would work in concert and be mutually supportive?" [7, p. 1794]. He identifies two implications of using complexity theory to understand school reforms: (a) Look at school reforms as evolving solutions, where the research should analysis the interaction at multiple levels of the system and avoid micromanage fragments of the system and (b) Educational reform policies should target at multiple levels of a system and work to effect them simultaneously.

### 3 Methodology

The methodology chosen for this project is action research. This is a huge field with different approaches based on participative and pragmatic values. We have decided to use Lewin's [8] nature of action research.

We understand Lewin's main work as explained in [9], where he presents Lewin's planned change approach composed by field theory, group dynamic, action research and three step change model. The fact that we approach the problem as a planned change, does not mean that we understand the research situation as static or linear, all the contrary, we are quite aware of the complexity and changeable elements of this research project, which is the way also as we understand Lewin's approach of working with real world problems.

Field theory focuses on constructing and understanding the situation as a whole, it establish the relationship between the life spaces (holistic view of the individuals and their situation) and the forces and elements that composes it [10]. Another very relevant aspect of the field theory related with this research project is the aspect of theory based method for analysis the real world problem. As [10, p. 490] have stated "Lewin's basic argument was that, if one does not understand the current situation, the forces that are maintaining the current quasi-stationary equilibrium, one cannot even begin to bring about change. Beyond that, field theory allows individuals and groups to explore, understand and learn about themselves and how they perceive the world and how those around them perceive it". Related with group dynamic helps us to understand the behaviour of the different groups involved in the project.

The basic process of action research involves repeated cycles of action and critical reflection upon the action. The implementation of these steps provides a clearer understanding of the situation. Interpreting the information from the first product cycles helps us to make decisions on how to conduct the following cycles and also produces new knowledge. According to [11], Lewin's original model of action research includes (1) analysis, (2) fact-finding, (3) conceptualization, (4) planning, (5) implementation of action, (6) evaluation.

We report data from a high school in the south of Costa Rica, which serves some of the most vulnerable (disadvantage) students in the age between 15 and 19, with a modality of three days of teaching per week, from 6:00 pm to 10:00 pm, only the 5 basic subjects. By vulnerable students we mean students that are premature transitioned

to adulthood either because they are, or about to become, parents or they have home situation that does not allow them to attend school in the formal systems (for example, they should work to support their homes) or students that have failed in the formal educational system and try to get one more opportunity in this modality. Those students come, usually, from the lower social economic level. To date, the school has a high dropout rate and very low score on state exams.

The high school was created with the aim to be supported by ICT in order to allow flexibility regarding schedule and also different pedagogical approaches that would appeal to the target group. However, so far, the Costa Rican Ministry of Education has not managed to incorporate technology in the modality and the high school is running almost as a normal high school in Costa Rica, but with less resource and less teaching hours for the students.

So far, in the first cycle, we have had collected the following data (from April – December 2015): (a) Six interviews with teachers (they are around 11). These interviews were focused to know the organizational culture of the school, perception of the teachers about the students and competences and use of ICT, (b) Interview with the school leader. The aim of this interview was to know the structure and process of the school and the relationship with the Ministry of Education, parents and community, (c) A questionnaire for students to get to know their access and use of technology, (d) Three workshops with the teachers. These workshop focused in understanding the challenges of the school and appropriation of the project and problems (first workshop), reporting back the result of the data collection and planning of future actions (second and third workshop), (e) One workshop with a group of 15 students. This workshop aimed to hear the students about the school problems, understand their background, motivations and challenges as students and (f) Ten interviews with parents. The focus was to get to know students home background, parents economical and educational status, parents perception and interaction with the school.

## 4 Data Analysis

Following the action research methodology, we analysed the data in order to conceptualize the problem and define an overall plan and the first actions to take. We looked at each dataset collected and drew the main issues/aspects of each one. This categorization and interpretation process was guided by the pre-defined aims of the data collection.

In the following paragraphs we present a summary of the fact-finding from the field and fact-finding from the literature (we present very brief description because space limitation), which were used to move to the conceptualization phase of action research. After that, we present the actions defined to approach the problem (planning phase).

### 4.1 Fact-Finding from the Field

In general, from the data we can say that: (a) there is a lacked room for creativity and exploration and very low use of technology in the classroom, this provokes that

teaching become one way passive process, where the students listen what the teachers say and take notes or follow the copies of some text book, therefore, students feel bored in the classes; (b) according with the teachers, their main challenges are to develop students desire to learn and to have a better future and deal with State regulation that limit their autonomy; (c) in the same line leadership main complain is the so many proceeds to follow and documentation to report back to the Ministry of Education; (d) for most of the students it is easy to state their goal for their future but their action are counter-productive to achieve the goal (not attending school, not doing homework, etc.); (e) students would like a more active high school (participation in the community activities, science exhibition, independence day fest, art festival, graduations, etc.) and a more enjoyable classroom; (f) there is not a culture of knowledge creation and sharing neither collaborative learning among the staff of the school, furthermore, there is a lack of common values and shared vision; (g) there is not resistance to change from the teachers neither from the leader, they are quite willing to participate in a change process, however, the time often shows up as a constraint to be more active and proactive in the process; (h) there is not interaction among the schools and the families (parents are not involved in the education of their children) not between the school and the community. Actually, the school has a bad reputation within the community. The school is seen as a kind of “last option” school. It is possible to conclude that the community sees the school as one of the worse schools in the town; and (i) finally, we identified a lack of competences regarding management and teachers low competences on active learning and use of ICT for teaching.

## 4.2 Fact-Finding from the Literature

Following Lewin’s approach about using theoretical frameworks to analyse the real world situation. The literature recommend LSES schools should be approached differently (small groups, active learning, play based learning, improving teaching quality and leadership competences, among others) [1–3]. In the same line, we have the factor of ICT usage for education, which is not only a tool for teaching but a basic skill nowadays.

[12] recommend that for drop out prevention, it is crucial to have a high quality instruction, a school that promotes a positive behaviour and environment. The staff should have the competences and the resources to design learning environments according with the reality of the students, school culture that promotes collaborative learning and connexions with the families.

School culture is fundamental for any reform. Organizational culture is a key factor for organizations and schools are not excluded. [13] has identified six traits that could influence organisational culture in schools (shared vision, traditions, collaboration, innovation, communication and share decision making). Any effort to reform schools should involve the field of organizational culture [14]. [7, p. 1791] has stated regarding organizational culture and school reforms “Schools are complex systems. If those in schools don’t share common values, the system will not work as well as it might otherwise.”



The other field from the theory is the organizational change, which involves the organizational culture [15], the capacity of an organization to share and create knowledge [16] and the capacity to become a learning organization [17].

Four more aspects to consider are: (a) the relevance of students centered approach to develop critical thinking, problems solving, reflective skills [18], (b) The fundamental role of the leadership in the schools and also in the change process [19], (c) the benefit of ICT in management activities [20], and (d) multiple strategies interventions for schools and the lack of experimental research addressing schools problems with a multiple levels and components approach [21].

With these two datasets we identified many misalignments between the current practice and how things should be, according with the theory. At this point, we could bring back the [7] questions to understand the systemic nature of the school (theory section). The main question is which node should we approach and how, as the schools does not have the capability to deal with many changes at the same time. We could see that a new pedagogical approach (problem or play based learning) would not be supported by the current organizational culture and organizational structure. The same would happen with the introduction of ICT (for teaching and/or management), as the staff does not have the competences to benefit from it. To run an organizational change – cultural change for example – the current leadership lacks of the necessary competences because his educational background.

We identify mainly three subsystems in the overall system and that each system should be approached with different theories: classroom system (pedagogy theory field), school system (organizational theory field) and community (human development theoretical field). Those three systems interact and influence each other. For the conceptualization phase, we see community as a context of the school (national and local), furthermore, we include into the system a new component – technology. The overall understanding is that technology may support and facilitate the transformational process and therefore technology would become one of the components, which would influence and be influenced by the other components. See Fig. 1.

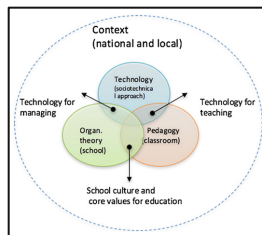


Fig. 1. Conceptualization of the overall system to plan actions

In the planning phase, we have defined three key actions to start the process of moving close to a learning for well-being school. These three actions are going to be implemented at the same time responding to the complexity theory:

- Develop leadership competences. One of the strongest nodes in the system is the head of the school. He has influence in the many of the nodes and it is also where

the three spheres converge. It is fundamental to develop leader skills to create a share vision, manage change, establish new share values and foster the IT usage – in classroom as well as for managing the school.

- Change the organizational culture of the school, by creating a collaborative and learning organization, furthermore by introducing new common values about students centered methodologies and IT usage and the principles of learning for well-being (the holistic approach of development). Following the complexity theory, it is expected that impacting this node, will have effect on the other aspects of the systems. This action is going to be implemented by creating an online community among the teachers, the leader and the researcher.
- Influence motivation of students by keeping the focus on the end goal. The project is in the process to develop an App which will allow students to establish a long term goal for finishing their high school and set up short term goals to see the progress. Teachers will have access to the App with the idea that they could encourage students to keep on. Later on, it is expected to have some kind of “virtual mentors” in the App, with the aim that former students, from the high school, who has graduated and continue with their higher education, give motivational messages. This action aims to approach the emotional and personal aspects of the students by providing a tool to keep focus on their overall goal. At the moment, March 2016, we are in the planning phase of the online community and the App.

## 5 Conclusion

The complexity of the transformation LSES demands different the theoretical framework to understand and approach the situation. To answer the research question of this paper, we present some preliminary recommendations for a systematic approach to transform LSES schools: (a) approach the phenomena with the complexity theory (do not see the problem as parts but a whole) and identify the key nodes to define which are the most relevant nodes to approach first, (b) identify the current organizational culture and organizational practice, (c) create partnership with external actors to overcome the challenges of knowing multiple theoretical approaches, (d) approach the transformation process as an organizational change, as a new practice – pedagogical and organizational – should be established, (e) develop leading change competences for the principal, (f) to make the process sustainable, create an organizational culture of knowledge sharing and creation, (g) define a suitable training program for professional development, according with the inputs from the study of the current situation.

## References

1. Bøg, M., Dietrichson, J., Filges, T., Jørgensen, A.-M.: Protocol for ‘academic interventions for children and students with low socioeconomic status: a systematic review’, p. 45. Det Nationale Forskningscenter for Velgærd (2014)

2. Curtis, D., Drummond, A., Halsey, J., Lawson, M.: Peer-mentoring of students in rural and low-socioeconomic status schools: increasing aspirations for higher education, p. 35. National Vocational Education and Training Research Program (2012)
3. World Education Forum. Incheon Declaration (2015)
4. Ilona, K.: Learning for well-being: a policy priority for children and youth in Europe. A process for change. Universal Education Foundation (2012)
5. Johansson, E.: Ecological systems and complexity theory: toward an alternative model of accountability in education. *Complicity Int. J. Complex. Educ.* **5**, 1–10 (2008)
6. McQuillan, P.J.: Understanding small school reform through the lens of complexity theory: It's "good to think with". *Teach. Coll. Rec.* **110**, 1772–1801 (2008)
7. Lewin, K.: *Resolving Social Conflicts/Field Theory in Social Science*. American Psychological Association, Washington, D.C (2008)
8. Burnes, B.: Kurt Lewin and the planned approach to change: a re-appraisal. *J. Manag. Stud.* **41**, 977–1002 (2004)
9. Burnes, B., Cooke, B.: Kurt Lewin's field theory: a review and re-evaluation. *Int. J. Manag. Rev.* **15**, 408–425 (2013)
10. Baskerville, R., Wood-Harper, T.: A critical perspective on action research as a method for information systems research. *J. Inf. Technol.* **11**, 235–246 (1996)
11. Alaimo, K., Olson, C.M., Frongillo, E.A., Briefel, R.R.: Food insufficiency, family income, and health in US preschool and school-aged children. *Am. J. Public Health* **91**, 781 (2001)
12. Mac Iver, M.A., Mac Iver, D.J.: How do we ensure that everyone graduates? an integrated prevention and tiered intervention model for schools and districts. *New Dir. Youth Dev.* **127**, 25–35 (2010). doi:[10.1002/yd.360](https://doi.org/10.1002/yd.360)
13. Goldring, L.: The power of school culture. *Leadersh.* **32**, 32–35 (2002)
14. Reigeluth, C.: *Chaos theory and the sciences of complexity: foundations for transforming education*. American Educational Research Association, San Diego (2004)
15. Schein, E.H.: *Organizational Culture and Leadership*, 4th edn. Jossey-Bass, San Francisco (2010)
16. Nonaka, I., Takeuchi, H.: *The Knowledge-Creating Company: How Japanese Companies Create the Dynamics of Innovation*. Oxford University Press, New York (1995)
17. Senge, P.M. *The Fifth Discipline: The Art and Practice of the Learning Organization*. New York (1990)
18. Kolmos, A., Kuru, S., Hansen, H., Eskil, T., Podesta, L., Fink, F., de Graaff, E., Wolff, J.U., Soylo, A.: *Problem Based Learning*. Report, p. 44. TREE - Teaching and Research in Engineering in Europe (2007)
19. Bartoletti, J., Connelly, G. *Leadership matters: what the research says about the importance of principal leadership*, p. 16. National Association of Elementary School Principals (2013)
20. Levy, M., Powell, P.: Information systems strategy for small and medium sized enterprises: an organisational perspective. *Strateg. Inf. Syst.* **9**, 63–84 (2000)
21. Freeman, J., Simonsen, B.: Examining the impact of policy and practice interventions on high school dropout and school completion rates: a systematic review of the literature. *Rev. Educ. Res.* **85**, 205–248 (2015)

# Transformative Applications of ICT in Education: The Case of Botswana Expansive School Transformation (Best) Project

Paul Thabano Tapela Nleya <sup>(✉)</sup>

University of Botswana, Gaborone, Botswana  
nleyapt@mopipi.ub.bw

**Abstract.** Best project was launched under auspices of World Information Technology Forum (WITFOR) Education Commission during 2005 to investigate transformative applications of ICT in education. Activity Theory, Development Work Research and Change Laboratory were underpinning frameworks used. Results at first school showed it was isolated from community and activities integrating school subjects with community human resources were designed. Findings at second school suggested that teachers failed to motivate most students due to social problems and categorization of students. Problem-Solving and development system was designed to overcome identified contradictions. Lastly, alternatives to exclusive school-subject interpretation of ICTs within test-oriented pedagogy curriculum practices at third school were replaced using mobile technologies. A lighter technological infrastructure was achieved. However, contradictions identified could not be overcome through one-time change, but required continuous internal development and learning in the school communities.

**Keywords:** Activity theory · Change laboratory · Developmental work research · Expansive · Transformation and ethnography

## 1 Introduction

The Government of Botswana hosted WITFOR during 2005 organized by the International Federation for Information Processing (IFIP) in Gaborone. The general theme of the forum was ICT for accelerated development and one of the sub-themes was Education. The work on this theme was based on IFIP's expert group declaration of July 2005, the Stellenbosch declaration: ICT in Education: make it work [1]. The declaration described the challenges of ICT use in education in the developing countries and gave a number of important recommendations. It highlighted the need to use ICT for integrating education to the real world. It also recommended bridging the gap between technologies as well as developing and understanding the use and the effects of ICT in education. The WITFOR Education Commission sought to pursue this trend by launching the Best project. The Botswana educational system is organized into three levels: primary, secondary with the junior and senior divisions (3 year junior and 2 year senior high), and post-secondary education of diverse types. Primary is organized into

standards and currently takes seven years. The study Change Laboratory (CL) studies focused on one junior and two senior secondary schools

### 1.1 Objectives of Study

The objectives of the Best Project were identified taking into account that more systematic understanding of educational change is needed in the area of ICT [2]. They proposed that education projects should aim to coordinate the introduction of computers with national policies and programs related to changes in curriculum, pedagogy, assessment, and teacher training, and respectively, start to think in terms of combinations of input factors that can work together to influence learning. In addition, capacity building should be at the heart of the renewal of effective and high quality work in ICTs and education. The objectives of the BeST Project were discerned into four categories:

- To enhance teachers' capabilities to perform as change agents in the era of ICTs. To carry out developmental interventions in collaboration with local practitioners and academic researchers and design required pedagogical transformation and reinvent school-community relations aimed at preparing students to be competitive in the global employment market through broadening their learning perspectives using ICTs.
- To facilitate school transformations related to creative use of ICTs. The research component to focus on the pedagogical use of ICT's in schools and the advancement of collaboration between schools and the surrounding community. To extend the infrastructure of intellectual capacities for school renewal and establish innovative learning and knowledge communities that stimulate, support and advance school and community experiments and local developmental actions. To go beyond borders through the construction of genuine interaction between schools, community development and academic research in order to make possible learning and systematic knowledge creation on the ICT's use in schools and communities.
- To build collaborative human capacity infrastructure between the University of Botswana and Helsinki University. To create sustainability through collaborative effort and bilateral research and development collaboration between The Centre of Activity Theory and Developmental Work Research in the Helsinki University (recently named The Centre for Research on Activity, Development and Learning (CRADLE) and the Department of Educational Technology in the University of Botswana.
- To establish virtual ICT based tools for collaborative research and development activities and learning based on horizontal collaboration between schools and research institutes. Also to provide an open-source-based and technology-mediated learning environment for the schools.

In reaching these objectives, the project is not designed to transfer models of using ICTs from developed countries, but utilizes their experiences as resources for reflecting innovatively on the current practices and future trajectories of the development of schools in Botswana [3]. An implementation plan was made where the CL method, and its use in the development of school activity and the pedagogical use of ICT's in schools

were introduced. An inter-organizational interest group, the Activity Theory Interest Group (ATIG) was involved in the negotiations to direct and guide the use of CL in schools. The Government of Botswana had previously selected ten schools to act as pilot schools of the Best project. In each school, a heterogeneous (across curriculum) group of teachers was formed to assist in the implementation of ICTs.

Excerpt 1 (Speaker from university): the best way is to go and build a net, you know, a small interest group around ourselves so at least at the end of the day we have multiplied, you know this cascading, so here the department is very committed because we are transforming it.

Excerpt 2 (Speaker from non-formal/community education): It could be nice if we have already conceptualized ourselves as one thing. I mean different individual parts of a system where we will be all contributing to the larger Botswana system posed at the university.

Inspired by the work done by WITFOR Education Commission, an international group of researchers was formed for supporting teachers' ICT competence in Southern African Developing Communities (SADC). The Academy of Finland granted a two-year research grant for a feasibility study (2007–2008). A substantial research plan was prepared in collaboration with researchers from Helsinki University and the University of Botswana through negotiations with representatives of the Ministries of Education, Communication Science, and Technology, as well as specialists in distant and non-formal learning sectors of education in Botswana. Based on this collaboration, the Academy of Finland further allotted a four-year funding (2009–2012) for the project.

In developing country contexts, there is a lack of research on the application of ICTs to teaching and learning in school-based settings and only few examples of investigations into how mobile technologies can be used in education [3]. Being school-based, the Best Project has significance of investigating the ways in which new forms of technology can enhance teachers' capabilities and improve knowledge and professionalism in Botswana and delineate own way to modern information society. Four interconnected developmental processes have been intertwined in the project: (1) the development of activity in ten pilot schools from which three schools were studied by using Change Laboratory method; (2) the development of a group of change agents at the University of Botswana and its capability to carry out developmental interventions in schools; (3) the development of boundary crossing collaboration and object-oriented interagency among participants (including officials responsible for school development, teacher training, and ICT implementation), and (4) the development of collaborative activities between Finnish investigators and those of SADC region.

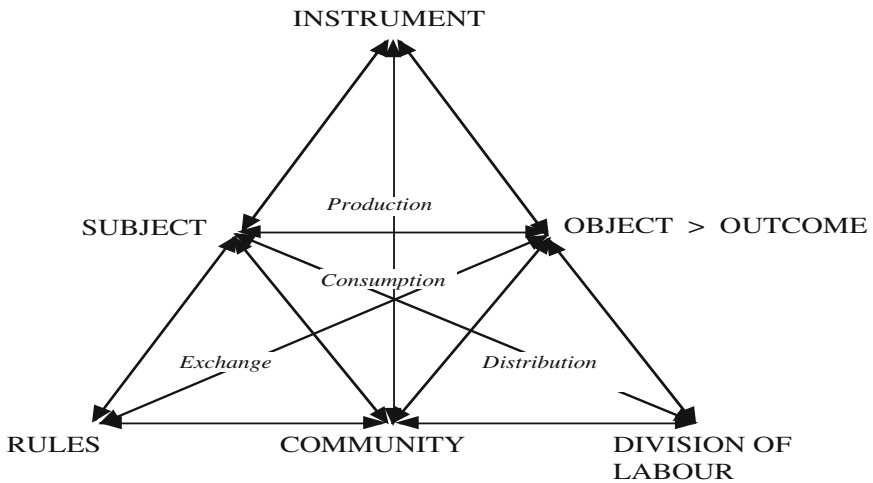
## 2 Theoretical Frameworks

The Best project is based on the expansive learning theory and Developmental Work Research, which have their foundations in Cultural-Historical Activity Theory. Activity Theory has an emphasis on semiotic and cultural mediation of human conduct, and human development [4–6]. The theory originates from psychology, but is nowadays a multidisciplinary paradigm that has gained popularity as an approach that takes into account the

cultural and organizational context and also directly focuses on day-to-day practical work, thus providing an alternative socio-ecological and unifying approach [7, 8].

Vygotsky is known for formulating the general genetic law of cultural development, which has strongly affected pedagogical-philosophical views of Activity Theory. According to this formulation [4] every function in the child’s cultural development appears twice: first, on the social level, and later, on the individual level; first between people (inter-psychological), and then inside the child (intra-psychological.” This formulation invites the notion of mediation, which offers the way that phenomena of human conduct and people’s activities are studied. Mediation has formed the basis of the method of double stimulation by which the mental functions are studied with the aid of two sets of stimuli. These two sets of stimuli fulfil different roles vis-à-vis the subject’s behaviour. One set of stimuli fulfils the function of the object on which the subject’s activity is directed. The second function serves as signs that facilitate the organization of this activity [4]. Vygotsky’s method implies an intervention, which operates with “the second stimuli”, the mediating means, by which people are solving an original task, the first stimulus. These theoretical ideas have formed the foundation which has been applied and used in significant ways in studying organisational learning, knowledge building and professional development. Currently, the framework has been used and considered valuable in studies which focus on technology-mediated and technology-enhanced activities in education.

Three features of a framework found relevant for the BeST project are outlined. Firstly, for a systemic analysis, it offers a unit of analysis, which corresponds to people’s activity. As such a unit, the model of activity system depicts the constituents of activity within a triangular form of activity (Fig. 1). The activity system serves as a dynamic, continuously changing and developing whole of elements of activity. The model represents relationships between subject (actors), object of work/outcome and instruments



**Fig. 1.** The model of activity system (Source: Engeström, 1987, pp. 73–82; reproduced with permission from Cambridge University Press) [9].

used in the activity, as well as social determinants of the activity, such as community, rules and division of labour. The forms of change of an activity system are related to inner contradictions between elements of the activity. The analysis of contradictions provides some basis of an expansive re-conceptualization of the activity. Secondly, the framework entails the cycle of expansive learning, relating to how to study change as a process of professional development and capacity building.

The expansive cycle consists of six steps that are conducted in collaboration between the practitioners of studied community or organization and academic interventionist-researchers. Each phase consists of finding answers to specific questions in the analysis and design process [9].

These steps can be used in the research design, where participants of the study can push the development further if they name the nature of the change with the help of the expansive cycle, recognize its inner contradictions and find ways of overcoming them. In each phase, a different challenge is faced. Thirdly, a central feature of the framework is multi-voicedness, which means horizontal and vertical dialogue as well as local experimentations for developing new practices in the context of societal and educational transformations. The dialogue in Botswana aimed at creating and conceptualising new understanding of school activity in the era of ICTs. The key participants and stakeholders shared experiences in organizing expansive learning. The BeST project concentrated on how to make capacity building with the teachers without losing the relationship between policy implementation represented by governance and educational technology skills offered by the University of Botswana (Fig. 2).

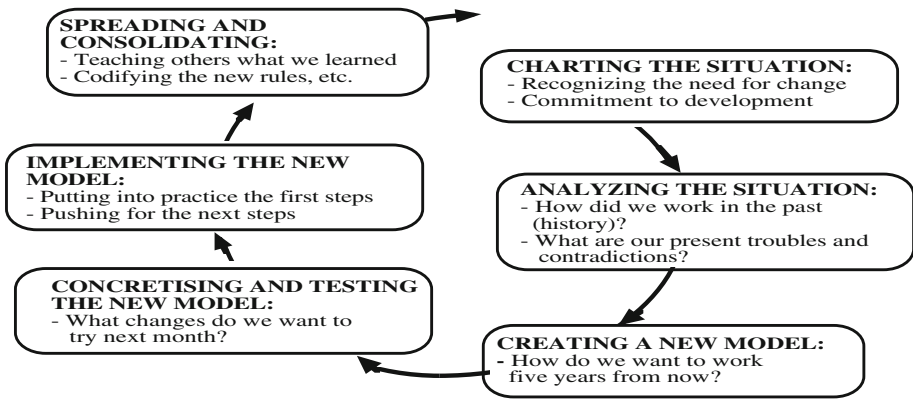


Fig. 2. The Steps of expansive cycle (Source: Adapted from Engeström et al., 1996, p. 11 [10].

### 3 Methodology

The research design is based on the CL intervention which is an ethnography method that enables a series of interventions to take shorter calculated periods. The CL consists of six to twelve well-prepared weekly sessions of two to three hours carried out in the



school. In addition, a varying number of follow-up sessions after a period of about two month’s experimentation with new solutions is recommended. CL is a novel research design for transforming work; a tool and method of crossing the boundary between academic research and practice of any field of activity. It focuses on the daily shop floor practice while still keeping the point of view analytical and systemic. The collaborative analysis and design of a new activity is aided by a set of tools that help participants of the project to share and jointly process their observations and ideas. Figure 3 visualises the CL design as wallboards that are divided horizontally into three columns, providing the research tools as well as vertically into rows representing the past, present, and future of the activity.

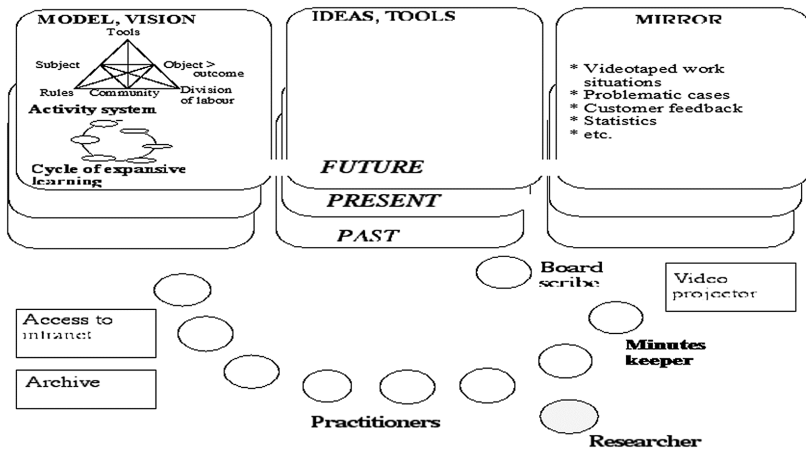
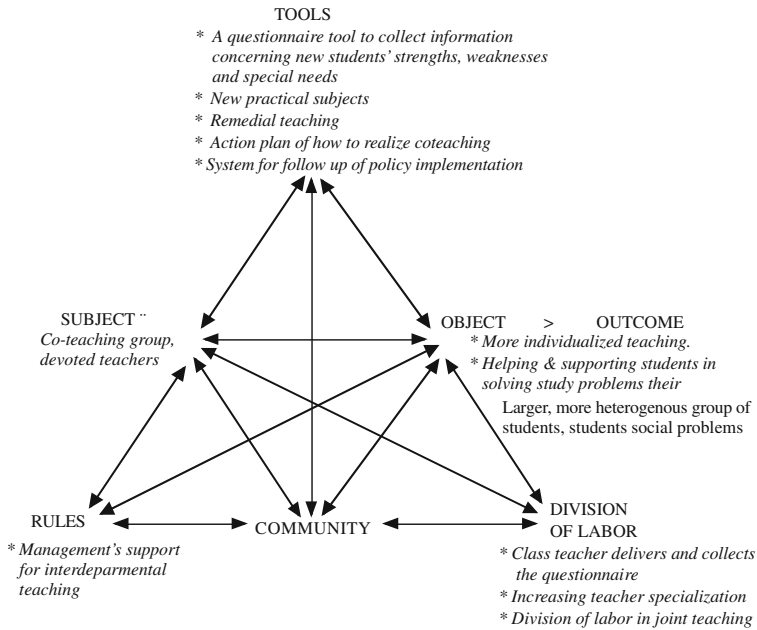


Fig. 3. Prototypic layout of change laboratory (Source: Engeström et al., 1996, p. 11 [10]).

The ‘Mirror’ board in the right column represents and examine concrete data concerning the activity. The mirror of the present activity includes cases that enable the analysis of changing work situations. The mirror of the past outlines data denoting historical changes in the activity. The mirror of the future represents follow-up data relating to participants’ experiments with the new concepts and tools, which they have created and with which they begin to build the future form of the activity. The ‘model/ vision’ board is used for modelling the historical forms of the activity with the help of the model of activity system. As participants progress between the mirror (based on ethnography), and the theoretical model of activity, they generate generalizations concerning transformations of the activity and its present form and contradictions. The ‘ideas’ and ‘tools’ board is reserved for representing the intermediate-level products of design of the activity discussed in the CL sessions.

The design of CL aims at creating a dynamic interplay between participants’ personal involvement, commitment and research-based intellectual distancing as well as a multi-voiced dialogue. Participants move between concrete observations concerning their own practices and the more abstract system of joint activity in which they participate. The CL is informed by the expansive cycle of development with its six main phases as

illustrated in Fig. 4, where the need for change is identified, and some analysis of the historical situation done to identify existing contradictions. Then developing a new model and testing the model regarding the changes required before implementation, to push for the anticipated changes and finally disseminating the new model.



**Fig. 4.** Ideas identified for new solutions in teachers' activity system model (Source: Virkkunen, J. and Newnham, D, 2013, P.165) [12]

### 3.1 Ethnography and Qualitative Research Strategy

Change Laboratory as an ethnography and developmental work research technique, usually adopts a case study research approach that is based on qualitative research strategy. Qualitative research is also appropriate in the realm of developmental research, due to the ecological, contextual, phenomenological, historical or dynamic perspectives of its processes. Case studies have features such as, featuring smaller numbers of units (at times one), data being mostly collected in naturally occurring environments, and either being quantitative, qualitative or both, the aim being to understand and theorize through the unfolding research literature. Case studies allow for questions regarding *why and how* to be answered with an understanding of the nature and complexity of the systemic phenomena. In all three schools, ethnography studies were mainly carried out by an employed international researcher. Both the Department of Educational Technology and Ministry of Education Department of Teacher Training and Development played an active role in making preparations for the school visits for CL activities. Activity Theory Interest Group members collaborated with the international group on trips to the schools where CL activities were taking place. Some government 'Kitsong

Centres' designed for ICT use by the respective communities within the three schools were also visited in the process to adopt an integrated approach.

Ethnography studies were realised in two-three week sessions using CL technique conducted by the trained practitioner at the schools. The data gathering included video-recording of some school activities, carrying out interviews and spontaneous discussion with teachers, principals, community institutions, students and parents. The interviews were videotaped and voice recorded and observations written down into field notes. The interviews were transcribed during the same day and analysed for missing data and noting issues that the recorded data revealed. This information partly guided further data collection. Usually interviewees would mention something that would catch the researcher's interest, and the researcher would follow up until the lead was exhausted. The value of ethnography using CL technique was obvious in the international project where the participants did not share unique contexts of history, geography, language use, organizational patterns, conventions, and others.

### 3.2 Data Collection

The Change Laboratory design requires some multiple kinds of data collection. These are above all ethnography investigations (i.e. interviewing key persons and video recorded CL sessions). To stay within the limits of funding frame of the BeST Project, only three schools from the selected ten pilot schools were covered using CL. These schools were selected to represent a variety of regional circumstances and diverse school-based resources and cultures.

Excerpt 3 (*Speaker from policy making*): *We looked at the five regions, and we said what are the critical challenges that we can pick from the schools and set up a national picture? But then we said that we cannot only look at the schools; we need to look at the ministry person there. These are driving forces, the people who are mandated with providing infrastructure or guidelines...*

Key persons from the selected ministry groups were interviewed and video-recorded. Also looking for examples of school-based applications of ICT, the headmasters, heads of the Computer Department, computer studies teachers, and librarians at the schools were also interviewed and video-recorded. The conducted CL sessions at the three schools and meetings held were video and voice recorded. These data were important for self-reflective purposes of the CLs in progress, and also later for scientific analyses, evaluative and documenting purposes of the project.

**Limitations.** Due to international partners' limits to stay in Botswana, the number of sessions had to be limited without much time to follow activities in the schools after the completed set of CL sessions and therefore to support the development and experimentation of new solutions. For the same reason the time between the sessions was tightened to more than one session per week. This schedule meant that teachers had difficulties finding time to be present in every session. However, the use of the CL technique, with its structured data collection procedures provided a strong base for the processes. The funding situation also limited the degree to which follow-up activities at the project venues could be made for purposes of monitoring and support.

## 4 Outcomes of CL Intervention and Lessons Learned

The BeST Project was a multiple-case study where each school-based case resulted in CL intervention where relationships between learning, change and development are complex. The framework of expansive development of an activity implies that learning and development were related to the production of transformative knowledge about the activity. A CL intervention seldom brings up a dramatic immediate change. It rather, leads to learning that produces new concepts and practical tools and the immediate change is in opening a development process that the new tools make possible, in other words, opening a Zone of Proximal Development of the change agents. The application of the new activity takes a longer time, and calls for management of developmental activity. The change therefore does not take place in a simple linear progress. Rather, in contact with other members and organizations, the ideas should be discussed in several phases of developing the new vision, new tools with experimentations, and new rules. It is within this context that the outcomes were anticipated.

The three conducted CLs varied amongst each other, due to the region and circumstances in the school, and also how the CL was conceptualized in each school. Although the CLs resulted in different outcomes, they do not challenge each other, but rather show complementary facets of a prism that is organizing our thinking about complexity of transformations, facets which are linked to the globalized education reforms and information ecologies [10]. All three CLs have taken the first steps of explorative enterprises toward a new school infrastructure, which supports and promotes professional collaboration and partnership, and constructs links from school to the outside world. This has paved the ground in order to implement creative and efficient use of ICTs in Botswana schools and trained the participants to be change agents in their educational environments. From the outcomes of the three CLs, it is critical to solicit funding to scale up the next step of the project's strategy for redesigning school activity in Botswana and the SADC region as was initially anticipated. In the light of the identified objectives for the project, the outcomes and lessons learned from the project were as follows:

- Enhancing teachers' capabilities to perform as change agents ICT era Teachers were active participants and ready for making their own designs through mirror data, analyzing, and sharing practices, including double binds, which have connections to their own work experiences at the schools.

**Lesson 1:** The need to facilitate CL environments in schools and develop teachers' activities to transform and enable boundary crossing from of old ways of working and thinking together.

- *Facilitating school transformations related to creative use of ICTs.* Extending the notion of learning technology was based on the perspective that the development of mobile technologies allows capitalizing on lighter technical infrastructures. Prevalence of mobile technologies in all spheres of life may play an important role in accelerating educational transformation.

**Lesson 2:** Rather than waiting for overall educational transformation to take place, it is essential to put efforts for creating local ecologies of technology-mediated learning and instruction, using available mobile technologies which will provide models and frameworks for going through the transformation as was done successfully at one school in the BeST project.

- *Building human collaborative capacity infrastructure between the University of Botswana and Helsinki University.* During 2010 and 2011, the University of Botswana and University of Helsinki proposed a Master's programme. Results of needs analysis survey conducted reported a dire need for a Masters' degree in educational technology. A collaborative Masters' degree programme was developed to the satisfaction of the collaborating partners. Several logistical problems regarding collaborative teaching and supervision of students that existed were also resolved before the programme was launched. The program has since been approved, but not launched due to financial situation in the institution. The Master's programme was also intended to include the SADC region.

**Lesson 3:** Establishment of collaborative Master's degree programme could provide capacity building in Activity Theoretical frameworks and the possible establishment of an Activity Theory Centre, and related virtual facilities in collaboration with Helsinki University to provide the required expertise.

- *Establishing virtual ICT based tools.* The CLs revealed the institutional tradition of organizing teaching and learning that brought about the constraints for creative use of ICTs at the pilot schools. In terms of such a contradiction, the training of a separate group of students for ICT literacy in the subject-based (computer studies) environment of testing worked against the use of teachers' increasing professional capability to improve quality of teaching (pedagogy) and learning of all students with novel ICT-based practices.

**Lesson 4:** The present project brings to light the contradictions existing between democratic policy vision in Botswana's education, and old centralized regime with a strong testing and examinations culture, originating partly from colonial history and guiding school activity.

**Lesson 5:** On the overall, it was evident that the application of new activity within schools takes a longer time, and calls for management of developmental activity.

## 5 Summary Findings, Conclusion and Recommendations

### 5.1 Mahupu School

The leading contradiction in the ethnographic data revealed that the school was rather isolated from the community. Teachers questioned parents for a lack of interest in the children's education, which they said was manifested by a lack of school function

attendance and alcohol abuse of the parents. Parents also felt they had little control over their children and little contribution to do with their school going as shown in the excerpt:

Excerpt 4 (Teacher): *It is something like she said, mind your own business. It is like parents are not very much supportive to the program for the school, so the parents live their own life there, teachers live their own life separated from the school, other people in other government departments also lived their own life and people do not come together and support one another. It is like there are some barriers in between; if the school asks for assistance from the community ... they come with a different mind to be against what the school is trying to do or to try to be on the side of the kids.*

The CL participants discussed the changes that had taken place in child rearing practices between home and school in the village and began to question the present situation. With the actions of designing school activity, CL had effect to infusing the school subjects and integrating human resources within the community. The teachers of this junior secondary school had positive attitudes toward using ICTs, but the role of new technology remained minimally touched in the presented BeST project plans.

## 5.2 Malefi Senior Secondary

Since the researcher-interventionists came from different cultures, the preliminary data collection was planned to be broad and exploratory [3]. The CL data revealed that teachers felt they were unable to motivate many of their students. Suggested causes for the lack of motivation were social problems such as alcohol abuse, drugs, and teenage pregnancies. There existed among students a growing number of orphan children that the teachers felt were not interested in school. They blamed children's social background and parents for their problems with the students [11]. The various ideas that the CL work groups produced in the seven sessions conducted are presented as elements in a model of a new form of a teachers' activity system (Fig. 4). The figure is an analysis of how teachers sought to achieve more individualized teaching as a way of resolving contradictions identified in the school. Teacher work groups prepared a plan of how and when they would experiment with the new solution they had prepared. The main inner contradiction in the activity was one between the more heterogeneous student population with more social problems than earlier and the teachers' tools that were predominantly based on mass teaching that did not allow enough attention to be paid to individual students' specific needs and interests. The main tool used by teachers to manage the increasingly heterogeneous group of students and the performance criteria had been the *Categorization* of students into single, double, and triple science syllabus track groups and to subsequently focus their efforts on the latter two groups [13].

Excerpt 5 (Participant): *The frustrations for the students: they hate being beaten; they seem not to like the way they have been categorized according to the sciences, that's what we picked from the audio. And they are also frustrated by the bad grades they get.*

The contradiction was aggravated by the demoralizing effect of the categorization on the single science students and because the variance of student's performance was increasingly due to social problems. Tabulawa [13], also observed in another school in Botswana, the apparent neglect of the cultivation of students' substantive study motivation based on their interest in the subject matter. Mirror data presented in the Change

Laboratory made the teachers more conscious of this problem and stimulated them to find solutions to it.

Excerpt 6 (Student): *Especially when you are doing single sciences they just think that they have to give priority to the triple sciences and maybe double sciences, and if you say that you are single sciences, they just say hey you aggg.*

Excerpt 7 (Teacher): *It is a bit of a problem because the computer lab there is only one, and there are something like 20 computers and there are 80 students doing computer studies Researcher: So other students who are not doing computer studies are not having, don't have access to computers? Teacher: Ya they do not have.*

Participants increasingly took responsibility for developing new solutions and all groups carried out at least one experiment and the joint developmental work continued further. Group members of CL sessions, fifteen months after the CL, reported continuing the experimentation with the new tools, and that they were planning to establish a new structure to ensure that experiments would be carried out accompanied with a progress report every fortnight on future and present challenges to be overcome.

The most radical of the new solutions developed was the dialogical study planning tool and process that would help the teachers deal with students' varying needs and interests including their social problems and a remarkable breaking away from the prevalent authoritarian and unidirectional teacher role. This experiment also demonstrates the ideas of re-mediation, collaborative teaching as well as the idea to add into the curriculum subjects, other than sciences, that would be relevant to the students' vocational interests, addressed directly the central contradiction in the activity system [11]. The researchers do not have follow-up data on what happened to its development after that, but clearly, the group that was developing it would have gained from an internal-to-the country support group of researchers after the first experiment. Tabulawa [14] has alleged that Botswana's Revised Policy on Education issued in 1994 is based on two contradictory concepts, one highlighting the objective of producing independent, innovative, and flexible personalities, and the other, a behaviorist model of a revision of the curriculum. This duality is seen in the development projects that the CL group formed. Dialogical study planning and collaborative teaching clearly correspond to the first line of the policy. The following two, policy implementation and development of Audio Visual (AV) teaching materials, are more in line with the latter although these teaching aids could later expand to become tools for students' inquiry.

The new system that the teachers created, can, on the one hand, be seen as an elaboration and implementation of the traditional top-down system of school development in Botswana<sup>1</sup> [15]. On the other hand, it can be seen as the development of a system of internal problem solving and development in the school, a step towards that is a prerequisite of overcoming the contradiction. However, the contradiction cannot be overcome

---

<sup>1</sup> According to Tabulawa (1998, pp. 250–252), the prevalent model of managing pedagogical change in schools has in Botswana been based on a top down, expert-centered, technical approach that ignores the teachers' views, experience, and voice and puts them in the role of a passive adopter and implementer of teaching strategies developed by experts without input from teachers.

through a one-time change, but calls for continuous internal development and learning in the school community.

### 5.3 Mater Spei College

The school was considered by the research team to be ahead in many aspects in ICT use compared to other schools because the local mining company was sponsoring the school with computers, smart board and educational software. Anchoring on teachers' practice, the project produced an object for negotiations and for an expansive cycle of developing a school activity in an ICT era. The essence was to search for alternatives to the exclusive school-subject interpretation of ICTs within test-oriented pedagogy and, thus, challenge long-established curriculum practices. The alternative policy in the context of purposeful efforts for managing the large-scale developmental cycle was found to be using mobile technology. The CL focused on using various *freeware net-based tools* in order to rely more on digitalization and mobile technology, Internet and social media such as *Facebook, Diigo, Google Maps, Google Calendar and Skype*.

*Excerpt 8 (Teacher): "I'm familiar with PowerPoint and Excel software." Teacher's expectations to CL are "to improve the use of ICT-learning, stuff in Internet that I have not used to make classes, not only websites, but some other tools."*

The use of mobile technologies not only enabled a lighter technological infrastructure, but also allowed teachers to show their competences in the creative use of ICTs. *The community of practice* at the school prospered for the rest of the study period and used an alternative approach enabling innovative use of more ubiquitous technologies where fixed laboratories were no longer a handicap. At the end of the project, participating teachers in the school were denominated as *digital ambassadors* by policymakers for showing respect for teachers' knowledge creation potential.

## 6 Conclusion and Recommendations

The CL process at the schools showed that focusing on the object as well as the historical changes in the activity can disclose the associated central developmental challenges and needs in the activity that the new technology could help to meet. Learning to master new technological tools, such as ICTs can open up a broad perspective of expansive development for the actors (*hybridization*). New models of teaching (*pedagogy*) are not easy to create, as they involve the questioning of current ones and making plans to changing them. The motivation for developing desired models arises from a possibility to overcome existing contradictions in the current activity. This aspect is often not taken into consideration when planning to integrate ICTs into school systems. The advantage of using the CL method is its systematic developmental procedures that guide practitioners' transformative agency to focus on the expansive development process that they undertake. Most of the time, ideas of ICT use are either beyond the realistic zone of possibilities of the expansive development of the activity, or below it and thereby providing only an alternative way of continuing the existing pedagogical approach.



The increasing collaboration between teachers and ICT professionals as well as the development of various kinds of hybrid roles of pedagogically oriented ICT specialists and ICT oriented teachers is a natural line of further development [16]. The unit of development in the pedagogical use of ICTs should thus not be considered to be a school or a network of schools, but a heterogeneous network of schools and agencies of pedagogical and technical development.

Given the lessons learned from the CL process described in this paper, it seems that a CL process within the school and the establishment of objects of joint pedagogical development in it could be a good first step for building such collaboration as was the case in the CL studies presented in this paper. While the results of a CL are initially local, their spreading, diffusion and possible utilization follow the logic of invention and innovation in an open development context. The CLs of the BeST Project worked on school-based conceptualizations and brought forth information about the micro-genesis of novel solutions and possibilities and obstacles that will be encountered during transformation processes. Small cycles may remain isolated events if they are not processed by the concentrated efforts to manage the diversity of sources in knowledge creation in the context of the overall expansive cycle of development. Several information sharing workshops for all the ten selected schools were therefore conducted to achieve this goal. However, the funding situation prohibited stakeholders to follow-up on CL processes at the respective venues as was desirable.

## 6.1 Recommendations

The need to follow-up on CL activity conducted under the auspices of the BeST pilot project to develop technology-enhanced teaching and learning practices at the selected schools so as to sustain the established communities of practice and build a strong base for an *epistemic knowledge-building approach*.

Integrate the BeST Project *knowledge-building approach* with Ministry of Education & Skills development innovation system and policy development strategy so as to generate seed funding locally to scale-up the project.

Establish a longitudinal research proposal based on BeST project principles to be submitted for funding to varied local as well as international research entities (UB-Office of Research & Development, Ministry of Education & Skills Development, Southern African-Nordic Centre (SANORD) WITFOR, Higher Education Institutions Institutional Cooperation Instrument (HEI ICI) 2016-2018 etc.).

Integrate developmental work research practices on technology-enhanced practices in schools within the ThutoNet education policy initiative which is a component of the national MALITLAMO ICT policy.

Forging another link with Helsinki Centre for Activity Theory in order to investigate sustained processes of knowledge advancement using novel research theories (i.e. Activity Theory) and instruments/tools (i.e. Change Laboratory and Developmental Work Research) required as benchmarks and leading to possible establishment of Activity Theory Centre at the University of Botswana as was initially envisaged.


The BeST project has therefore made a significant contribution which WITFOR should pursue further and assist in soliciting funding to support the scaling-up of the project to SADC as was initially envisaged.

## References

1. IFIP: The Stellenbosch declaration: “ICT in Education: make it work” (2005). <http://www.terry-freedman.org.uk/artman/uploads/thestellenboschdeclaration.pdf>. Accessed 10 Mar 16
2. Wagner, D.A., Day, B., James, T., Kozma, R.B., Miller, J., Unwin, T.: Monitoring and evaluation of ICT in education projects: a handbook for developing countries. infoDev, International Bank for Reconstruction and Development/The World Bank, Washington, D. C (2005)
3. Serpell, R.: Multiple perspectives and constraints on progressive social change: a commentary. *Mind Cult. Act.* **21**(3), 259–263 (2014). doi:10.1080/10749039.2014.897894
4. Leach, J., et al.: DEEP IMPACT: An Investigation of the Use of Information Communication and Technologies for Teacher Education in the Global South. DIFID, London (2005). <http://www.open.ac.uk/deep/Public/web/publications/pdfs/ReportFeb2006.pdf>
5. Vygotsky, L.S.: *Mind in Society. The Development of Higher Psychological Processes*. Harvard University Press., Cambridge (1978)
6. Luria, A.: *Cognitive Development. Its Cultural and Social Foundations*. Harvard University Press, Cambridge (1976)
7. Leont’ev, A.N.: The problem of activity in psychology. In: Wertsch, J.W. (ed.) *The Concept of Activity in Soviet Psychology*, Sharpe, Armonk (1981)
8. Cole, M.: *Culture in Mind*. Harvard University Press, Cambridge (1996)
9. Engeström, Y.: Learning by Expanding: An Activity-Theoretical Approach to Developmental Research, p. 11. *Oriente-Konsultit*, Helsinki (1987)
10. Engeström, Y.: Development as breaking away and opening up: a challenge to Vygotsky and Piaget. *Swiss J. Psychol.* **55**, 126–132 (1996)
11. Nardi, B.N., O’Day, V.L.: *Information Ecologies with Heart*. MIT Press, Cambridge (1999)
12. Virkkunen, J., Newnham, D.: *The Change Laboratory. A Tool for Collaborative Development of Work and Education*. SensePublishers, Rotterdam (2013)
13. Virkkunen, J., Newnham, D., Nleya, P., Engeström, R.: Breaking the vicious circle of categorizing students in school. *Learn. Cult. Soc. Inter.* **1**(3–4), 183–192 (2012)
14. Tabulawa, R.T.: Teachers’ perspectives on classroom practice in Botswana: implications for pedagogical change. *Int. J. Qual. Stud. Educ.* **11**(2), 249–268 (1998)
15. Tabulawa, R.T.: Educational reform in Botswana: reflections on policy contradictions and paradoxes. *Comp. Educ.* **45**(1), 87–107 (2009)
16. Barowy, W., Jouper, C.: The complex of school change: Personal and systemic codevelopment. *Mind Cult. Act.* **11**(1), 9–24 (2004)

**Health**

# Identification of Design Patterns for Serious Games in an Educational Videogame Designed to Create Awareness on Dengue and Malaria Fever

Eduardo Ramírez Elizondo 

Universidad Estatal a Distancia, San José, Costa Rica  
eramireze@uned.ac.cr

**Abstract.** An educational videogame may sound like the perfect solution to combine an educational process with a fun experience. Even though this holds true in some cases, most of the times educational games do not guarantee positive results in the cognitive development of the player. This is because they are designed to contain educational-related topics but do not focus on the real impact that is achieved on the player. In this paper, we identify different design patterns in the educational videogame “Pueblo Pitanga: Enemigos Silenciosos” and we share the results of applying these patterns and the impact the players. This videogame was designed to create awareness on Dengue and Malaria fever in young kids and teenagers. It was designed and developed by Green Lava Studios for the Pan American Health Organization (PAHO).

**Keywords:** Dengue · Malaria · Design patterns · Educational videogames · Serious games

## 1 Introduction: Creating Fun and Educational Experiences

Nowadays, videogames are part of everyday’s life activities in popular culture. They are available in personal computers, mobile devices and specific gaming consoles (e.g.: PlayStation 4, Nintendo 3DS, etc.). These products are getting more popular in current generations, as they have become a basic product of consumption [1]. Younger generations, like Generation X and Y, grew up with these technologies, making these technologies a natural and straightforward environment of virtual interaction for them. Videogames have an important role as entertainment resources for these generations. Through a videogame a player can get involved in decision making processes. This very important characteristic allows the player to learn from a good or bad decision, which enables the player to go through the natural process of learning, as a result of previous actions.

Educational games, also known as Serious Games, are known for being used for purposes outside simple entertainment, e.g.: advertising, military training, social studies, science learning, etc. Serious Games have the potential to adapt the decision making requirements in order to teach a specific topic to a player. For the aforementioned reasons, an educational videogame may appear as the perfect way to educate younger

generations. Even though this holds true in some cases, most of the times educational games do not guarantee positive results in the cognitive development of the player. This is because they are designed to contain educational-related topics but do not focus on achieving a real impact on the player. Moreover, there is a lack of assessment tools to analyze serious games and there is insufficient knowledge on their impact on players [2]. According to Huynh-Kim-Bang et al. [3], a way to achieve positive learning results from an education game is by using appropriate design patterns for educational games. The different design patterns that were considered in this paper are described in Sect. 2.

The **main objective of this paper** is to identify the design patterns that were applied in the educational videogame “**Pueblo Pitanga: Enemigos Silenciosos**” and to analyze if positive learning results were achieved in the players after playing the game. The videogame is an action/adventure platformer game. It was designed to create awareness, in young kids and teenagers, of vector-borne diseases like dengue fever, malaria, and diarrhea. Using a dynamic dialog system inspired by “The Secret of Monkey Island” by LucasArts, the game tells the story of a boy named Fabio. The developers used an approach similar to MDA (Mechanics, Dynamis, Aesthetics). MDA is a formal approach to understanding games that attempts to bridge the gap between game design and development, game criticism, and game research [4], (see example in Sect. 3.2.1).

**Plot of “Pueblo Pitanga: Enemigos Silenciosos”:** Fabio, the main character, finds out that his sister Luisa is in the hospital because of a mysterious illness. Now he must find out all about this disease. As Fabio starts his journey many other residents of Pueblo Pitanga also start getting sick; however, this time they are showing different symptoms to those that Luisa had. During the journey, Fabio and a group of friends will identify different diseases and will recognize the poor hygiene conditions in the town, all while learning how to solve these problems. In the end, the problems are solved thanks to the joint effort of all the neighbors, the government, private entities and schools. The main goal is to teach the players how to maintain a town free of pest breeding grounds. In order to do this, Fabio, with help of the town’s community, learns the process of eliminating mosquito hatcheries in a proper way.

**Outline of this Paper:** This paper is outlined as follows. Section 1 presents the introduction, Sect. 2 summarizes the work developed by Mitgutsch et al. [3], from which the design patterns for educational games that are applied in this paper were obtained. Section 3 identifies the specific design patterns that were applied in the game “Pueblo Pitanga: Enemigos Silenciosos” through concrete examples of the game. Section 4 presents results about the impact of the game in the learning process of the users and their cognitive development in the topic. Section 5 presents the conclusions of the paper.

## 2 Design Patterns

An educational system must be able to successfully implement a learning process in order to teach and transmit knowledge to the user. Serious Games need to include such a learning process during the gameplay time in order to successfully teach the specified

topic to the player. A way to implement this is by using the design patterns for educational games identified by the authors of the paper “Design Patterns in Serious Games: A Blue Print for Combining Fun and Learning” [3].

Design patterns allow a more effective design of an educational game. In the work of Mitgutsch et al., design patterns were identified using an empirical method to understand the difference in patterns used in videogames and serious games [3]. The authors identified and classified common methods to create fun and educational fun environments. They identified which elements were ludic (playful) and which conducted to the learning process.

The design patterns were arranged in six main categories and they were organized by the level of abstraction: **Context**, **Learning Agents** and **Fun Aspects**. In Table 1, the six categories are represented with letters A, B, C, D, E and F, each category is sub-classified in design patterns (each bullet point is a design pattern). These patterns should be applied during the game design.

**Table 1.** Pattern classification, as proposed in [3]. The patterns that were identified in the game analyzed in this paper are underlined.

<b>CONTEXT</b>	<b>LEARNING ASPECTS</b>
<b><u>A- When do you need to combine entertainment and learning?</u></b>	<b>B- How to make interaction instructive?</b>
<ul style="list-style-type: none"> <li>• Serious Games             <ul style="list-style-type: none"> <li>◦ <u>Game-based Learning Blend</u></li> </ul> </li> </ul>	<ul style="list-style-type: none"> <li>• <u>Instructive Gameplay</u> <ul style="list-style-type: none"> <li>◦ <u>Questions-Answers</u></li> <li>◦ Pavlovian Interaction</li> <li>◦ <u>In-Situ Interaction</u></li> <li>◦ Microworld Interaction</li> <li>◦ Social educative Interaction</li> <li>◦ Teachable Agents</li> <li>◦ Varied Serious Gameplay</li> </ul> </li> <li>• New Perspectives</li> <li>• Rapid Feedback</li> </ul>
<b>FUN ASPECTS</b>	<b>C- How to initiate the reflective process?</b>
<b><u>E- How to motivate users?</u></b>	<ul style="list-style-type: none"> <li>• <u>Time for Action / Time for Thought</u> <ul style="list-style-type: none"> <li>◦ Debriefing</li> <li>◦ <u>Reified Knowledge</u></li> </ul> </li> <li>• Advanced Indicators</li> </ul>
<ul style="list-style-type: none"> <li>• <u>Fun Reward</u> <ul style="list-style-type: none"> <li>◦ Serious Boss</li> <li>◦ Graduating Ceremony</li> <li>◦ <u>Object Collection</u></li> <li>◦ Local Competition</li> <li>◦ Protégé Effect</li> <li>◦ External Competence Validator</li> </ul> </li> <li>• Fun Context             <ul style="list-style-type: none"> <li>◦ Fantasy World</li> <li>◦ Comic relief</li> <li>◦ Serendipity</li> <li>◦ Narrative Structure</li> </ul> </li> </ul>	<b>D- How to convey information without disturbing game immersion?</b>
<b><u>F- How to help users advance in the game</u></b>	<ul style="list-style-type: none"> <li>• Hollywoodian Introduction</li> <li>• Museums</li> <li>• Informative Loading Screen</li> <li>• On the grapevine</li> </ul>
<ul style="list-style-type: none"> <li>• Smooth Learning Curve             <ul style="list-style-type: none"> <li>◦ Tutorials</li> </ul> </li> <li>• Pace and path choice</li> </ul>	

### 3 Pattern Identification

In order to identify the design patterns in the game “Pueblo Pitanga: Enemigos Silenciosos”, the description of the design patterns presented in [3] were thoroughly studied

and afterwards recognized in the videogame. It was possible to identify that the developers applied several design patterns in their videogame. The design patterns that were distinctly applied and recognized are listed below:

- **CONTEXT: A: Game-based Learning Blend**
- **LEARNING ASPECTS: B: Questions-Answers**
- **LEARNING ASPECTS: B: In-Situ Interaction**
- **LEARNING ASPECTS: C: Time for Action/Time for Thought**
- **LEARNING ASPECTS: C: Reified Knowledge**
- **FUN ASPECTS: E: Fun Reward/Object Collection.**

The identified patterns are underlined in Table 1. In this paper, each of the identified patterns is described with the help of an example taken from the videogame “Pueblo Pitanga: Enemigos Silenciosos”. Due to the fact that multiple design pattern were recognized in the game, including patterns related to *context*, *learning aspects* and *fun* aspects, it is expected that results of the impact in the users will be positive. The results of the evaluation of the impact in the players will be shown in Sect. 4.

### 3.1 Context

#### 3.1.1 Pattern A: When Do You Need to Combine Entertainment and Education?

**Pattern: Game-Based Learning Blend.** As it is described in [3], this approach is achieved by involving teams with different expertise: the game experts and the knowledge experts. In this case, Green Lava Studios was in charge of the entertainment and the medical doctors in PAHO were in charge of providing the knowledge related the different diseases. In this project, Green Lava had creative freedom to create a proposal. The doctors provided basic ideas about how the game had to be played. In the end, both parties proposed their different solutions and decided that a dynamic dialogue system was the best choice to blend the educational information and humor in a simple flowing conversation with the different characters. At this point, Green Lava took the decision of simulating the style of Monkey Island’s humorous dialogue system.

### 3.2 Learning Aspects

#### 3.2.1 Pattern B: How to Make Interaction Instructive?

**Pattern: Questions and Answers.** This approach is mainly used when the amount of information that will be included in the game is not yet defined or clear. The implementation of questions and answers during the gameplay provides flexibility, since content can be adapted easily in this way [3]. Since the dengue problem includes a wide amount of factors, it was decided to adapt the content using this pattern. This was implemented by inserting questions during the conversations with characters. In the game, three options are given to the player in order to answer the character’s question, see Fig. 1. If the player selects an incorrect answer, the progress to complete the level gets slower. Green Lava designed the dialogue system in a way to allow the player perceive the questions as a regular conversation, this falls under the MDA approach.



**Fig. 1.** Example illustration the pattern *Questions and Answers*. Please note that for every question there are three possible answers. The progress in the game depends on the answer.

**Pattern: In-Situ Interaction.** According to Mitgutsch and Alvarado [3], to make learners more aware of abstract concepts, it is useful to let them experience narrative and emotional contexts. Dengue and Malaria are problems that are related to bad hygiene of a community. These communities often face poverty and have a bad infrastructure. In order to make learners more aware of the abstract concept of this problem, the scenes were made with high details in terms of narrative and emotional context, for example: there is a neighborhood in the game where characters with good intentions want to collaborate to fight the mosquito spread, but they are not on a financial position to fix their own roofs (the player experiences the associated limitations). Later in the game, the city mayor helps fixing these roofs in order to keep the rest of the town safe (Fig. 2).

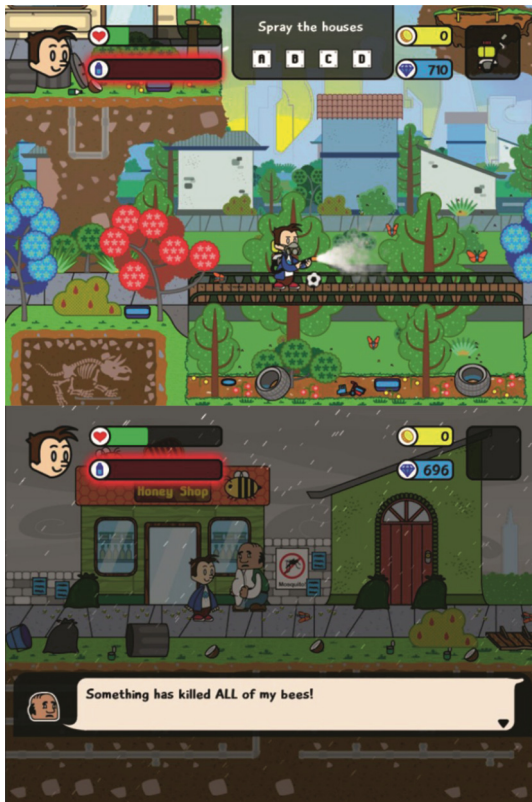


**Fig. 2.** Example illustration the pattern *In-Situ Interaction*. In this case the conditions of the neighborhood are experienced by the player.



### 3.2.2 Pattern C: How to Initiate the Reflective Process?

**Pattern: Time for Action/Time for Thought.** The method of this design pattern is to create intensive action phases and to conclude with a less intensive phase dedicated to thought and reflection [3]. The topic that was identified to use this method was the fumigation process during a mosquito breeding emergency. Even though fumigation is used for mosquito control, the community must be aware that this action is needed only in extreme cases. This is because fumigation has a negative impact in the environment and because mosquitoes can gain resistance to the venom. In the game, the player controls a fumigation machine in order to kill mosquitoes. After this action phase, the player discovers that a beekeeper has lost his small business because “something” killed all his bees. At this point, the purpose of the scenario is to make the player reflect on the fact that fumigation can affect other species, and that it is better to avoid fumigation when possible. A solution is fighting against the mosquito in an earlier phase of the mosquito breeding emergency (Fig. 3).



**Fig. 3.** Example illustration the pattern *Time for Action/Time for Thought*. The first illustration shows the action (fumigation) and the second illustration the consequence (bees been killed).

**Pattern: Reified Knowledge.** Sometimes, the educational topic is an abstract concept that is hard to be identified as “gained knowledge” by the players. To make the player aware of this “gained knowledge”, the “gained knowledge” should be represented as an object or game item [3]. An example of this kind of concepts, is the learning process of communicating a message to a community. In the game, the player must alert other neighbors about the presence of the mosquitoes, the threat they represent and the way in which they should fight them. After successfully completing this task, the player will receive “the communication medal”. In this way, the game shows the player that a new knowledge was acquired (Fig. 4).



**Fig. 4.** Example illustration the pattern *Reified Knowledge*. The first illustration when Fabio is receiving a “communication medal” after completing a task.



**Fig. 5.** Example illustration the pattern *Fun Reward – Object Collection*.

### 3.3 Fun Aspects

#### 3.3.1 Pattern E: How to Motivate Users?

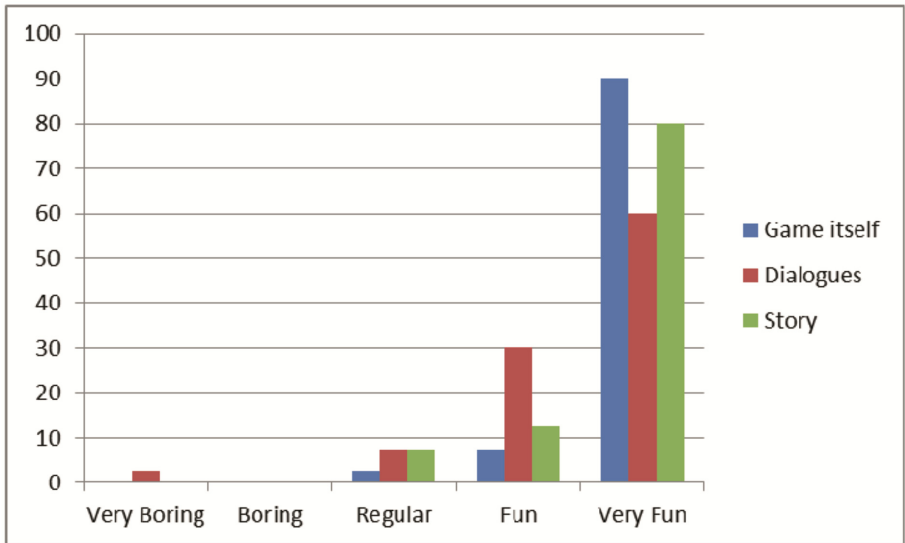
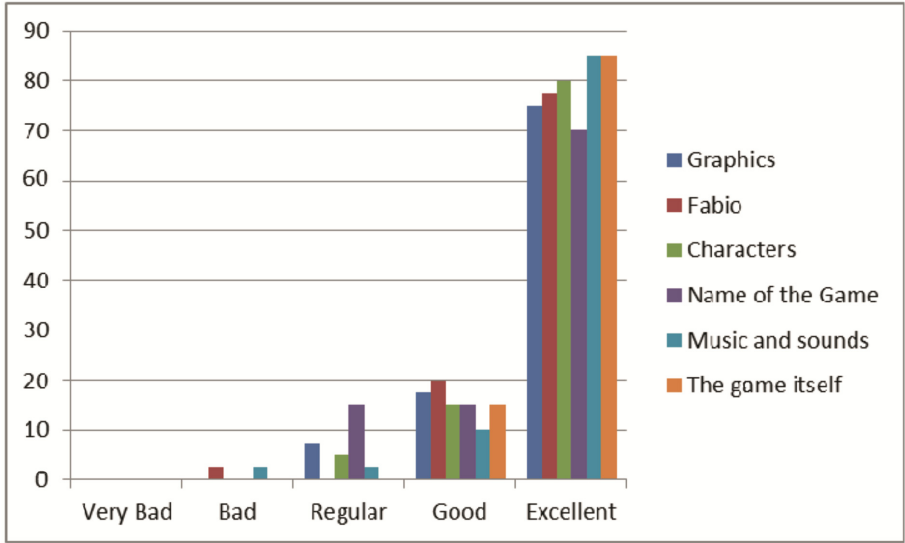
**Pattern: Fun Reward - Object Collection.** During the gameplay, diamonds are given to the player when they complete a task. The player can buy additional mini-games inside the game and complete achievements. These games are not related to the main topic of the game, they are designed for pure entertainment. This gives the player a different motivation to finish the game (Fig. 5).

## 4 Results and Analysis

In order to evaluate if the videogame provided more than just entertainment to the users, several testing sessions were made during and after the development of the game. As described in Sect. 3, it was identified that several patterns were implemented in the game “Pueblo Pitanga: Enemigos Silenciosos” in order to increase the chance of success during the learning process. The objective of this section is to show if a considerable difference in the knowledge of the students was observed before and after they played the game.

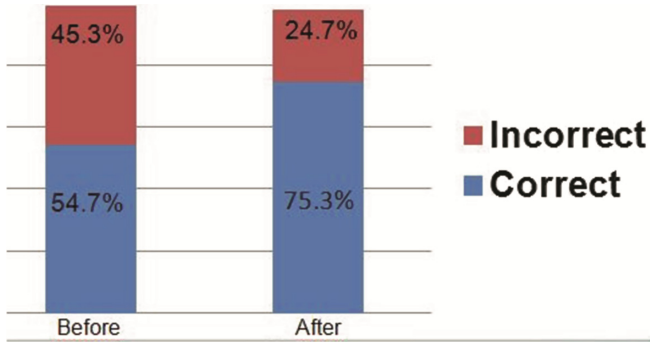
In this paper we have considered that a difference in correct answers of more than 10 % with respect to the first attempt is considered successful. This percentage of 10 % was selected by the design team. The tests were made with a focus group of 80 Costa Rican students from 9 to 16 years old. These tests consisted on a set of questions in a separate paper about the educational material. The same set of questions were asked before and after playing the game.

The game itself was evaluated as “excellent” by 90 % of the students (see Fig. 6). Also specific elements of the game, such as graphics, characters, music and sounds were evaluated as “excellent by more than 75 % of the students. Additionally, 90 % of the students considered the game itself “very fun”, therefore the goal of making a fun game was achieved. Regarding the learning experience (see Fig. 7), before playing the game, the correct answers from all the players gave a total of 54.7 %. Once the players finished the game, the total of correct answers increased to 75.3 %. An increase in correct answers was observed in 100 % of the students of the focus group. An improvement of 20.6 percent points was achieved. This indicates that the objective of the game was attained and that the application of the design pattern proved to create positive results. The game not only provided entertainment, but did comply with the requirements stated by the PAHO and the expectation of the designers.



**Fig. 6.** Results of the answers given by the students about the videogame

In future work it would be interesting to analyze if a correlation with age and background exists. The designers of the game agree that the application of the selected identified patterns were crucial for the success of the results.



**Fig. 7.** Results of the answers given by the students before and after playing the game

## 5 Conclusions

The main objective of this paper was to identify the design patterns that were applied in the educational videogame “Pueblo Pitanga: Enemigos Silenciosos” and to analyze if positive learning results were achieved in the players after playing the game. Design patterns are strong tools for the game design and development of an educational or serious game. They help the game experts and knowledge experts to simplify tasks in order to communicate and teach a specific topic in the game, always looking for a balance between fun and learning.

The patterns and results exemplified in this paper help to understand how to correctly implement game mechanics and educational topics with different techniques or methods. Depending on the topic of the serious games, the implementation of these patterns are always subject to the amount and quality of detail of the educational material that the knowledge expert intends to teach. The game experts are the ones in charge of finding a balance between education and entertainment using these design patterns. The game experts will need to identify the desired pattern in relation with the type of knowledge or data that the player must learn.

From the results it can be observed that there was a significant improvement in the answers of the students. An improvement of more than 20 percent points in good answers was obtained in the test after the students played the videogame “Pueblo Pitanga: Enemigos Silenciosos”. The designers of the game agree that the application of the selected identified patterns were crucial for the success of the results.

In future work it would be interesting to compare two versions of the same game, one in which the educational design patterns are applied and one in which they are removed. This would allow an even more precise quantification of the benefits of using the described design patterns.

**Acknowledgments.** The author would like to thank the Pan American Health Organization for their support during the execution of the project and the Universidad Estatal a Distancia for the support during the making of this paper.

## References

1. Lewis, C., Wardrip-Fruin, N., Whitehead, J.: Motivational game design patterns of ‘ville games. In: Proceedings of the International Conference on the Foundations of Digital Games (FDG 2012), pp. 172–179. ACM, New York (2012)
2. Mitgutsch, K., Alvarado, N.: Purposeful by design?: a serious game design assessment framework. In: Proceedings of the International Conference on the Foundations of Digital Games (FDG 2012), pp. 121–128. ACM, New York (2012)
3. Huynh-Kim-Bang, B., Wisdom, J., Labat, J.-M.: Design patterns in serious games: a blue print for combining fun and learning. In: Project SE-SG (2010). <http://seriousgames.lip6.fr/DesignPatterns/designPatternsForSeriousGames.pdf>
4. Robin, H., LeBlanc, M., Zubek, R.: MDA: a formal approach to game design and game research. In: Proceedings of the AAAI Workshop on Challenges in Game AI, vol. 4 (2004)

# A Community Assets Infrastructure for the Secure Use of Mobile Computing Devices in the Rural Health Landscape

Kevin Kativu<sup>(✉)</sup> and Dalenca Pottas

Nelson Mandela Metropolitan University, Port Elizabeth, South Africa  
{Kevin.Kativu, Dalenca.Pottas}@nmmu.ac.za

**Abstract.** The ubiquity of mobile computing devices in the workplace has created a vast landscape of opportunity in rural communities centered on the increased population access owing to the improved mobility. Healthcare workers are able to reach previously disconnected communities and homesteads to deliver health related services through the use of custom mobile computing devices or applications that facilitate the viewing, recording and updating of patient records. Notably, the presence of electronic patient information presents privacy and confidentiality challenges that if not addressed, may affect the delivery of health services thereby negatively impacting on the overall health outcomes of the communities. Deficit based solutions target the needs and challenges of the communities in developing solutions and have been widely used; however, little emphasis has been placed on utilizing the existing asset resources that contribute positively to the overall health outcomes in the development of solutions. This paper leverages off an asset model developed by Morgan and Ziglio to identify existing community assets in a rural community through the use of a survey issued to community health workers and the supporting IT staff. The results point to assets in the cohesive social structures centered on the trust bond between the patients and the providers. Moreover, mentoring support structures and periodic training activities keep the health worker skills up to date. Furthermore, a positive appreciation of health information sensitivity and the need for patient privacy and confidentiality provide for productive interactions between health workers and patients.

**Keywords:** Rural health · Health assets · Information security

## 1 Introduction

The proliferation of mobile hand-held devices such as smart phones and tablet computers has improved the mobility of the health workforce. This growth has been supported by the rapid deployment of wireless infrastructure communication networks which have greatly improved the capacity for service delivery [13]. As computers become cheaper and more powerful, the value is no longer measured on device capability but rather on the ability of organizations to develop processes and structures that leverage off this capability [5]. The

applications market for mobile devices has also grown rapidly and has attracted a large community of developers whose efforts have in turn contributed significantly to shift towards mobile computing devices. These devices are increasingly making appearances in both homes and the workplace as preferred productivity and media consumption devices. This phenomenon has been termed the consumerization of IT.

## 2 Background: Mobility in the Workplace

The growing need for mobility when conducting work related activities has given rise to the growth in consumer owned devices in the workplace. In a survey conducted by Accenture in 2011, 23 % of the employees sampled were already making routine use of personal technology tools at work with a further 29 % making use of these tools at least once a week [11, 14]. Additionally, in a survey conducted by Harris Interactive and ESET, more than 80 % of employed adults use some kind of personally owned mobile device for work-related functions [16].

In the broad sense, consumerization refers to the penetration of consumer market devices into business settings [7]. In the IT context, consumerization describes the dual application of computing devices for personal and work related activities. In effect, the consumerization of mobile computing devices describes the phenomenon of employees using their personally owned devices to perform work-related activities [14], a view supported by D'Arcy [6], who defines consumerization as the “migration of consumer technology, devices, platforms and applications into enterprise computing environments”. These devices are typically used to access the resources on the corporate network and offer the added flexibility of enabling employee productivity from anywhere without the limitations of time or access to a workstation [16]. This phenomenon has commonly been described as “Bring Your Own Device” (BYOD).

Consumerization however, extends beyond “BYOD”, as according to Gens, Levitas, and Segal [9], applications such as Facebook, Twitter and other social networking platforms are extending the accessibility of business processes. Serving to further support this notion, Morrow [16] describes the “D” in BYOD as referring to more than just the physical devices but also consumer oriented web and cloud based applications. For the purposes of this study, the consumerization of mobile computing devices is an overarching reference to BYOD (devices) and Bring Your Own Service (BYOS) and the use of mobile computing devices provided by an institution, Institution Provided Devices (IPDs).

It is commonplace for institutions to provide their employees with mobile computing devices that are subsequently used for both personal and work-related activities. The institution exercises more control on such devices and in many cases implements a Mobile Device Management system that enables them to manage the mobile devices operating within the organization. The major distinction point between IPDs and BYOD is the ownership of the devices. However, in terms of use and application, there is no distinction.

The rural healthcare landscape is unique due to the prevalence of various contextual constraints in the operational environment. Rural communities are typically resource



constrained and lack various assets such as communications infrastructure, skilled health workforce, electricity, and sanitation in addition to the financial economic constraints associated with inadequate employment opportunities.

In the rural healthcare context, mobile computing devices extend the productivity of a health worker by enabling mobility thereby allowing the wider provision of health services to remote and digitally disconnected communities. The benefits of mobility in the rural context are further supported by Braun, Catalani, Wimbush, and Israelski [3] who suggest mobile technology can potentially enhance the capacity of community health workers to innovate, improve accuracy and productivity while achieving higher levels of protocol adherence. Community health workers typically commute between patients whilst carrying mobile computing devices that have either been customized or host applications that facilitate the provision of health related services.

The health workers and the mobile computing devices can be classified as tangible community assets having a direct impact on the positive health outcomes in their respective communities. On the other hand, the knowledge and experience of the health worker coupled with the information they retrieve, generate and store on the devices can be classified as intangible assets. In this paper, we aim to map the information security related assets that may have a direct or indirect positive effect on the overall health outcomes of a community.

### **3 Health Information Security**

Healthcare organizations are information rich and have an implicit capacity to create or access the knowledge necessary for the successful delivery of their services [19]. Consequently, the need to ensure this information is protected and information systems are compliant with regulatory requirements is of paramount importance [1]. Patient health information is typically stored in the form of Electronic Health Records (EHRs) and the information stored within is private and confidential. The compromise of this information can have lasting negative effects on the patient and information custodian. Conforming to the security requirements however, is no easy feat, particularly in the rural context. The use of mobile computing devices adds to the complexity as data is no longer accessible from a single manageable location but through multiple terminals thereby increasing the vulnerability of the information. It is therefore important to establish existing information security assets in the environment to establish a foundation from which advanced security measures and implementations can be built upon on the road to compliance. Establishing information security assets from an asset-based perspective creates an opportunity for the identification of deployable security resources and opportunities to strengthen and fully utilize the resources for the general positive health outcomes of the community.

### **4 Defining IT Assets**

IT assets fall into two main categories, the tangible and intangible assets. Tangible assets take on a physical form and can be seen or handled. These are typically physical

resources that can contribute to the positive outcome of a community. Intangible assets have an implicit value to the community. Unfortunately, the nature of intangible assets means they are not always visible and consequently, organizations may fail to recognize them as assets and realize their full potential [19]. Intangible assets consist of resources such as information, knowledge, experience, goodwill and trust.

Assets contribute positively to the productivity and general well-being of a community. However, in developing IT systems, the focus has largely been placed on identifying needs and challenges of the communities and working towards solutions that can address the needs and challenges. This has been termed the deficit perspective. However, by definition, existing assets can play a major role in the development of community oriented solutions that leverage off the positive attributes of the existing assets to address some of the needs and challenges being faced.

The identification of assets requires a systematic methodology to identify those resources that contribute positively to the outcomes of a community. The methodology is discussed after introducing the theoretical lens applied to the study.

## 5 Theoretical Grounding

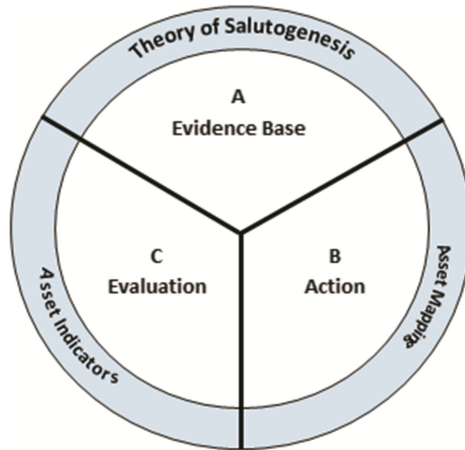
This section presents the theoretical lens that has been selected for use in this study. The significance of the salutogenic approach stems from the inherent lack of resources in rural settings, particularly in the African context. A salutogenic approach shifts the focus from the lack of resources (which is complex to address) to utilizing the existing resources that may or may not be readily identified as assets that can make a positive contribution to the community health outcomes.

### 5.1 Theory of Salutogenesis

Asset based perspectives encourage the shift in focus from identifying the pathogenic healthcare indicators to identifying the salutogenic indicators. According to Bauer, Davies, and Pelikan, [2], ongoing health development can be analyzed from salutogenic (health resources and positive health) or pathogenic (risk factors and disease) perspectives. Salutogenic perspectives emphasize the creation of health [15] and examines how resources in human life support development towards positive health (Bauer et al., 2006). Pathogenic perspectives focus on the prevention of disease by analyzing how risk factors of individuals and their environment lead to ill health [2]. All too often, health measurement instruments focus on measuring ill-health as opposed to a more holistic view on health [4]. Salutogenesis within the context of asset-based perspectives brings to focus the factors or traits, be it individual, group, or community based that contribute positively to the health outcomes of a community. The reality is that the salutogenic and pathogenic perspectives are simultaneous, co-dependent processes that interact and complement each other to achieve a common goal.

Figure 1 depicts the Asset Model developed by Morgan and Ziglio [15] which aims to redress the balance between evidence derived from the identification of problems to one which places a greater emphasis on the positive capability to jointly identify

problems and activate solutions. The resulting effects promote the self-esteem of individuals and communities leading to less dependency on professional services. Morgan and Ziglio [15] define a health asset as “any factor (or resource), which enhances the ability of individuals, groups, communities, populations, social systems and/or institutions to maintain and sustain health and well-being and to help to reduce health inequities”.



**Fig. 1.** The Asset Model [15]

From a rural health standpoint where fiscal and professional resources are scarce, asset-based perspectives are essential in redressing the challenges encountered in these settings. Bottom up approaches that incorporate the existing “asset infrastructure” in addressing the deficit derived challenges may result in more robust, self-propelling healthcare systems that have less of a reliance on the availability of professional skills and health information systems. On the other end of the scale are deficit-based perspectives, which are centered on identifying the community’s needs, deficiencies and problems. Deficit-based perspectives are the most commonly adopted views.

## 6 Methodology

There is limited literature surrounding salutogenic approaches to health information security in a rural context. Consequently, the study is exploratory in nature and employs qualitative methods of enquiry in order to obtain an in-depth view of the prevailing phenomena. A survey consisting of two qualitative questionnaires was developed. The first questionnaires were distributed to 25 rural healthcare workers who make use of

netbook computers in conducting their day-to-day activities. These workers represent 80 % of the total workforce with that designated role in the organization. The second questionnaire was issued to the 5 IT support staff that directly support the community health workers. The questionnaires were developed in three parts to address three different aspects, namely, day-to-day activities, training and awareness and device and information security. In order to obtain a clear contextual perspective, the dataset used in this study was limited only to the data collected from the questionnaires. To the authors' knowledge, no similar studies in this particular context have been conducted.

## **6.1 Methodology Bias**

The study was conducted in the rural Eastern-Cape province of South Africa. The community health workers and the IT support staff were all conveniently sampled from the same community and report to the same non-profit organization. Consequently, the feedback could be biased towards presenting the community or the organization in a positive light for fear of reprimand. The following measures were put in place to avert bias:

- Each participant was informed verbally and in writing that the feedback would be anonymous.
- Confidentiality forms were distributed to each participant reassuring that the information gathered would be used explicitly for the study.
- No participant personal details were recorded.
- Each participant was asked to complete the questionnaire individually and the questionnaires were collected in no particular order.

## **6.2 Data Analysis**

The development of a community asset infrastructure requires a salutogenic, systematic analysis of the operating environment in order to identify the resources that contribute positively towards the health outcomes of the community. Qualitative content analysis was used to analyze the dataset captured from the questionnaires. The pre-identified categories (day-to-day activities, training and awareness and device and information security) were used to logically organize the responses in the questionnaires. Coding was used to identify themes within the responses that represented assets within the context and those that could be deemed deficits.

The resulting output is a set of asset indicators that can be used as input in the development of community oriented healthcare solutions that contribute to the manifestation of positive community health outcomes.

## **7 Results**

This section presents the results from the study. The results are presented according to the three aspects used in structuring the questionnaires.

## 7.1 Day-to-Day Activities

Community health workers in the context are issued with Institution Provided Devices (IPDs) to carry out their activities. These devices enable the faster processing and delivery of health related services while building an electronic knowledgebase of the community's health indicators. The use of IPDs means the health workers do not have to commit any personal resources thereby removing the economic impact on the typically resource constrained workers themselves.

The presence of supervisors and team leaders in the field provides mentorship and may reassure the health workers in conducting their activities. Moreover, supervisors and team leaders may play a secondary role of surveillance which, as argued by Herath and Rao [12] may prove to be a deterrent of malicious or inappropriate activity by increasing the likelihood of getting caught. On a more positive note, the availability of mentors in the field to consult significantly reduces the likelihood for errors. The presence of a mentor also aids in the conformance to operational protocols and safe practices in the field. In this context, the supervisors and team leaders are said to be present at the distribution and collection of devices. They also ensure that recorded data is relatively error free. A final tally of the egress and ingress of devices is conducted by an IT staff member daily.

## 7.2 Training and Awareness

Refresher training keeps the community health worker abreast with the latest developments surrounding their line of work. These developments can include changes in operational practices and/or the introduction of new mechanisms to aid in their day-to-day activities. This periodic training provides a solid platform for the dissemination of critical information such as security reminders and security awareness. Von Solms and Von Solms [17] identify the lack of emphasis on the core importance of information security awareness amongst users as one of the "10 deadly sins of information security management. The frequent update/refresh of skills enables the health worker to consistently deliver an optimum level of care to his/her patients thereby improving the community health profile.

When asked whether they are aware of the sensitive nature of the health information stored and transmitted on the devices, the participants resoundingly responded positively indicating a high level of awareness regarding the confidentiality and privacy of the patient information. When conducting their duties, the health workers present the patients with physical documentation outlining the patients' rights and the confidentiality requirements on the health workers part. In addition to the documentation, the health workers explain in detail the confidentiality of any information the patient may divulge to the health worker and reassures the patient that this information will only be used to assist in the delivery of health related services. The impact of the confidentiality awareness can further be substantiated by the participants who mostly indicated that the patients are generally forthcoming with their health information during consultation.

### 7.3 Device and Information Security

The community health workers typically work in the communities of origin, therefore, an embedded social trust relationship exists between the workers and their clients. These trust relationships nurture the development of communities that are more cohesive and characterized by strong social bonds. Morgan and Ziglio [15] suggest that such cohesive social bonds and ties are more likely to maintain and sustain health. This is substantiated further by participant responses indicating that the patients they visit in their daily routines are generally trusting of the activities of the health workers. Trust requires the patient to take some risk in believing that the health worker will in no way cause him/her harm [10] and once obtained, trust breeds confidence in proceedings and allows the patients to be forthcoming regarding various health conditions they may be experiencing thereby improving the patients' overall health outlook.

The community health workers commute between patients while carrying (concealed) valuable devices such as netbooks and GPS mappers. However, only 2 of the 25 respondents cited security concerns when commuting with these devices. Interestingly, the view of the IT support staff was contradictory as they cited the potential for robbery while commuting with the devices as a major threat. However, taking into account the fact that the IT support staff do not work in the field and the specific communities themselves, the more accurate representation would be derived from the community health workers themselves who do the day-to-day commuting while carrying the devices.

### 7.4 Asset Mapping

Asset mapping supports health professionals to identify the strengths and gifts of the people who make up the community prior to intervening. The Glasgow Center for Population Health [8] describes asset mapping as documenting the tangible and intangible resources of a community. An asset-based perspective seeks to enhance these assets. Asset-based solutions leverage the existing knowledge and the positives from the community to build the foundation for self-propelling systems. The dataset was examined to identify the assets and deficits within the community as per the feedback of the participants. Factors that could be deemed as building health in the community were classified as assets and those that were deemed to be challenges were classified as deficits.

### 7.5 Asset Indicators

Asset indicators are the output of the asset mapping process. The set of indicators provide input into the development of community oriented solutions by leveraging off the identified indicators and developing solutions that are either built around or inclusive of the identified assets. The direct input from the community results in relevant applications that focus on furthering the health outcomes by utilizing the resources that have already been identified as enablers to the positive health outcomes (Table 1).

**Table 1.** Contextual asset indicators

Category	Assets
Day-to-day activities	Institution issued devices
	Assistive operating structures
Training and awareness	Refresher training
	Awareness of information sensitivity
	Understanding of the importance of confidentiality
Device and information security	Embedded community social bond
	Embedded community security
	Dedicated devices

## 8 Discussion

Healthcare practitioners are bound by the Hippocratic Oath, which requires that information seen or disclosed by a patient should remain confidential. However, from a security perspective, the system is only as secure as the weakest link, and evidence suggests that in many cases, the health worker is the weakest link [16, 17]. Inadequate training and security awareness can compromise an otherwise secure system. It is therefore paramount that the Hippocratic Oath be complemented by mechanisms that can facilitate the provision of confidentiality, integrity, availability and privacy. Deficit based perspectives aim to address the needs and challenges within a community, and while necessary, a more comprehensive solution would take both perspectives into account.

The scope of this paper was to identify the asset infrastructure in the community and thus does not discuss the prevailing deficiencies. It is important however to note that no single perspective can be applied in isolation. Asset indicators can provide a good foundation for the development of self-propelling systems that rely less on the already scarce professional services.

## 9 Conclusion

This paper presented the asset indicators identified in a rural health community. The evidence suggests that various mechanisms can be leveraged to ease the deployment of secure systems. No single perspective provides a fully functional and sustainable solution, however, the insight gained from using both perspectives facilitates the development of a more sustainable solution that enhances deficit derived solutions by leveraging off the existing asset infrastructure.

## 10 Limitations and Future Work

The study was conducted in a single rural community in the Eastern Cape province of South Africa and while the results may be generalizable to similar contexts, various

cultural differences cannot be accounted for. The participants surveyed only made use of netbooks, which represent a single class of mobile computing device. The feedback is therefore limited to the participants' experiences on these particular devices. Future studies exploring a wider scope of devices and broader sample of communities may aid in the identification of additional asset indicators or place a stronger emphasis on specific assets.

The output from this study will serve as input towards the development of a framework to be used as a guide in the development of security controls in resource constrained settings. The asset indicators identified in this study will provide a baseline from which assets can be identified and further developed in other similar contexts. The success of such an endeavor will reinforce the notion that when it comes to developing security controls, one "size does not fit all" and variables such as context, culture and digital exposure must be taken into consideration.

## References

1. Agbele, K., Nyongesa, H., Adesina, A.: ICT and information security perspectives in E-Health systems. *J. Mob. Commun.* **4**(1), 17–22 (2010)
2. Bauer, G., Davies, J.K., Pelikan, J.: The EUHPID Health Development Model for the classification of public health indicators. *Health Promot. Int.* **21**(2), 153–159 (2006)
3. Braun, R., Catalani, C., Wimbush, J., Israelski, D.: Community health workers and mobile technology: a systematic review of the literature. *PLoS ONE* **8**(6), 4–9 (2013)
4. Bringsén, Å., Andersson, H.I., Ejlertsson, G.: Development and quality analysis of the Salutogenic Health Indicator Scale (SHIS). *Scand. J. Public Health* **37**(1), 13–19 (2009)
5. Brynjolfsson, E., Hitt, L.M.: Beyond computation: information technology, organizational transformation and business performance. *J. Econ. Perspect.* **14**(4), 23–48 (2000)
6. D'Arcy, P.: CIO strategies for consumerization: the future of enterprise mobile computing (Whitepaper). Dell (2011)
7. Disterer, G., Kleiner, C.: BYOD Bring Your Own Device. *Procedia Technol.* **9**, 43–53 (2013)
8. Glasgow Center for Population Healthcph. Asset based approaches for health improvement: readdressing the balance, 1–24 October 2011
9. Gens, F., Levitas, D., Segal, R.: 2011 Consumerization of IT Study: Closing the "Consumerization Gap." A report by IDC, sponsored by Unysis (2011)
10. Gilson, L., Palmer, N., Schneider, H.: Trust and health worker performance: exploring a conceptual framework using South African evidence. *Soc. Sci. Med.* **61**(7), 1418–1429 (2005)
11. Harris, J., Ives, B., Junglas, I.: The genie is out of the bottle: managing the infiltration of consumer IT into the workforce (Whitepaper). Accenture Institute for High Performance (2011)
12. Herath, T., Rao, H.R.: Encouraging information security behaviors in organizations: role of penalties, pressures and perceived effectiveness. *Decis. Support Syst.* **47**(2), 154–165 (2009)
13. Jovanov, E., Raskovic, D., Price, J., Chapman, J., Moore, A., Krishnamurthy, A.: Patient monitoring using personal area networks of wireless intelligent sensors. *Biomed. Sci. Instrum.* **37**, 373–378 (2001)
14. Marshall, S.: IT consumerization: a case study of BYOD in a healthcare setting. *Technology Innovation Management Review*, pp. 14–18, March 2014
15. Morgan, A., Ziglio, E.: Revitalising the evidence base for public health: an assets model. *Promot. Educ.* **4**(2 Suppl), 17–22 (2007)



16. Morrow, B.: BYOD security challenges: control and protect your most sensitive data. *Netw. Secur.* **2012**(12), 5–8 (2012)
17. Von Solms, B., Von Solms, R.: The 10 deadly sins of information security management. *Comput. Secur.* **23**(5), 371–376 (2004)
18. Vroom, C., Von Solms, R.: Towards information security behavioural compliance. *Comput. Secur.* **23**(3), 191–198 (2004)
19. Wickramasinghe, N., Davison, G.: Making explicit the implicit knowledge assets in healthcare: the case of multidisciplinary teams in care and cure environments. *Health Care Manag. Sci.* **7**(3), 185–195 (2004)

# **Digital Equity**

# Progressing Toward Digital Equity

Ramon Puigjaner<sup>(✉)</sup>

IFIP Vice-President, Catalonia, Spain  
putxi@uib.cat

**Abstract.** In the computer domain, the objective to be reached in order to give opportunities equality to all persons is defined as Digital Equity. However, different international organizations are working to reach this goal. The analysis of the key points for reaching this objective and how international organizations (International Telecommunications Union, United Nations, International Federation for Information Processing) are working for this goal will be presented in the paper.

**Keywords:** Digital equity · Building the infrastructure · Education levels · ITU WSIS · UN SDG · IFIP

## 1 Introduction

ICT is a set of technologies that well used should allow the progress and the wellbeing of people everywhere in the world. However as there are important differences in the current situation of people, depending on its general level of use in each country, the use of ICT to reach the progress and the wellbeing cannot be the same in all countries. To evaluate this influence of the ICT we will use the concept of Digital Equity.

Digital equity [1] is the social-justice goal of ensuring that everyone in our society has equal access to technology tools, computers and the Internet. Even more, it is when all individuals have the knowledge and skills to access and use technology tools, computers and the Internet. A simple definition of digital equity can be a state in which both the digital divide and the participation gap are bridged.

Digital equity ensures that everyone has equal opportunities to use the tools and resources needed to fully participate as a citizen in today's digitally-powered world. Lacking these opportunities causes people to encounter educational, economic and social limitations that negatively impact their quality of life. The progress towards the Digital Equity, as it is established in the IFIP strategic action, should be achieved by:

- Promoting accessibility to ICT,
- Promoting good practices,
- Promoting and enhancing appropriate access to knowledge and experiences,
- Organizing and contributing to activities aimed at achieving the goals of the World Summit on the Information Society (ITU-WSIS) [2],
- Organizing and contributing to activities aimed at achieving the UN Sustainable Development Goals (SDGs) [3], as we will analyze in Sect. 4.

To analyze in depth the points suggested in the previous paragraphs, this paper will be organized as follows: in Sect. 2 the concept of Digital Equity will be detailed; Sect. 3 will be devoted to the relations of Digital Equity with the ITU-WSIS Action Lines; the relation of ITU-WSIS Action Lines with the UN Sustainable Development Goals will be the topic of Sect. 4. In Sect. 5 it is analyze the differences of Digital Equity in developed and developing countries and how IFIP [4] can contribute to reach these goals. Finally Sect. 6 gives some conclusions about the coming future.

## 2 Concept of Digital Equity

### 2.1 What Is Digital Equity?

As it has been stated in the previous section, Digital equity is the social-justice goal of ensuring that everyone in our society has equal access to technology tools, computers and the Internet. Even more, it is when all individuals have the knowledge and skills to access and use technology tools, computers and the Internet. Digital equity can be defined as the state in which both the digital divide and the participation gap are both bridged. Digital equity ensures that everyone has equal opportunities to use the tools and resources needed to fully participate as a citizen in today's digitally-powered world. Lacking these opportunities causes people to encounter educational, economic and social limitations that negatively impact their quality of life.

Technology is so commonplace in our lives that it may be hard to believe there are still many people with limited access to and knowledge of the resources that are available online today. Children still stand in lines at libraries for a brief stint on a computer and parents have difficulty completing online employment applications; a clear and important difference between the new digital generation and the previous ones. While cell phones may have helped to close the gap to some degree, there are still important activities that are not well-suited for small mobile devices.

### 2.2 The Five Dimensions of Digital Equity

These dimensions have been chosen as fundamental categories by educators and professionals working in the field. If you are just beginning to learn about this field then these categories should help you address your basic needs:

- Access to technology resources (hardware, software, wiring and connectivity): possibility to have access to the technological resources allowing us to access the information existing in the network.
- Access to high quality digital content; if the information available in the network is not of good quality, people will not be attracted to access it.
- Access to high quality, culturally relevant content; the available information should not only be of high quality but adapted to the context in which each community is leaving.
- Educators skilled in using these resources effectively for teaching and learning; it is obvious that for approaching the digital equity it is necessary to educate users but in

many environments there are not enough people with appropriate skills for learning end users in all the needed categories (e.g. basic user, advanced user, expert in installation and maintenance, hardware and software developer and builder, ICT research).

- Opportunities for learners and educators to create their own content; a way to increase the capacity of learners and educators is to offer them some tools to create contents accessible to the appropriate end users.

## 2.3 Digital Divide Impacts

It is difficult to have progress toward Digital Equity homogeneously in its five dimensions and, in consequence the risk to fall in Digital Divide exists, at least in someone of the five dimensions. How to avoid this inconvenient situation? What are the initial steps to progress toward Digital Equity?

- First it is necessary to allow that people can obtain the education allowing to conveniently using computers and networks in a large sense that is that users need to acquire a convenient knowledge for a correct use of computers and networks depending on the people desired education level: basic user, advanced user, expert in installation and maintenance, hardware and software developer and builder, ICT research, etc..
- And second people should be able to easily and deeply use both computers and networks for accessing and using all kind of information. Without infrastructure the other dimensions have no sense. But the investment in a new infrastructure has to be done only if the possibility of maintaining it is ensured; otherwise there is an important risk of wasting the funds of this investment.

In summary, the first steps to reach Digital Equity should be education and infrastructure. However the progress towards Digital Equity cannot be reached through individual efforts but by the coordinate effect of actions promoted by governments and governmental organizations. The global organizations to consider will be the International Telecommunication Union (ITU), the United Nations (UN) and the International Federation for Information Processing (IFIP).

## 3 Relation Between Digital Equity and the ITU-WSIS Action Lines

### 3.1 WSIS Action Lines

The Action Lines of the World Summit in Information Society (WSIS), proposed by the ITU are:

- AL1. The role of public governance authorities and all stakeholders in the promotion of ICTs for development
- AL2. Information and communication infrastructure

- AL3. Access to information and knowledge
- AL4. Capacity building
- AL5. Building confidence and security in the use of ICTs
- AL6. Enabling environment
- AL7. ICT Applications: benefits in all aspects of life
  - AL7.1 E-Government
  - AL7.2 E-Business
  - AL7.3 E-Learning
  - AL7.4 E-Health
  - AL7.5 E-Employment
  - AL7.6 E-Environment
  - AL7.7 E-Agriculture
  - AL7.8 E-Science
- AL8. Cultural diversity and identity, linguistic diversity and local content
- AL9. Media
- AL10. Ethical dimensions of the Information Society
- AL11. International and regional cooperation.

### 3.2 Relation Between WSIS and Digital Equity

The action lines proposed by the ITU have as global goal the implementation of the Digital Equity in order to avoid the Digital Divide. The description of these Action Lines can be found in [2]. Maybe the idea of Digital Equity with respect to the WSIS Action Lines is not explicitly expressed, but after reading the documentation contained in [2], the conclusion is that Digital Equity should be considered as a transversal goal, common to all action lines. The goal of each one of these Action Lines works, in some way, to complete one or several dimensions of Digital Equity. Some examples of this fact are presented in the coming sections.

**Example 1. Action Line 2: Information and Communication Infrastructure.** The vision of this action line, as it is defined in [2], is: Infrastructure is the cornerstone in achieving goals such as digital inclusion, enabling universal, sustainable, ubiquitous and affordable access to ICTs by all, taking into account relevant experiences from developing countries and countries with economies in transition.

Digital Equity should be supported by a convenient infrastructure. So the infrastructure suggested in this Action Line has to be able to allow all citizens the correct access and use of ICT, covering one of the five dimensions of the Digital Equity.

**Example 2: Action Line 3: Access to Information and Knowledge.** The vision of this action line, as it is defined in [2], is: For the post-2015, it is envisioned inclusive information and knowledge societies to facilitate access and use of information and exchange of knowledge among all people, including those coming from previously marginalized groups and regions in addition to persons with impairments with a significant portion of knowledge flows and innovations that advance human rights and the attainment of development goals.

To succeed with the Digital Equity the government has to create and offer information and knowledge to all citizens or to establish the appropriate mechanisms allowing the creation and offering of information and knowledge accessible for all citizens. Otherwise there is the risk of provoking the Digital Divide between the citizens of the same country or between the citizens of the country with the citizens of other countries.

**Example 3: Action Line 8: Cultural Diversity and Identity, Linguistic Diversity and Local Content.** The vision of this action line, as it is defined in [2], is: The vision on inclusive Knowledge Societies is that of a more culturally and linguistically diverse digital world, where around 40 % of all existing languages are present in cyberspace and where development takes into account local, national and regional contexts, builds on the knowledge generated by all communities, promotes innovation and creativity, and allows all human beings to practice their own culture and enjoy that of others free from fear. It is a world where marginalized groups, including indigenous peoples, and those coming from migrations, diasporas and from language minorities, enjoy increased recognition and equity; artists, cultural professionals and practitioners are empowered to create, produce, disseminate enjoy and preserve a broad range of cultural goods, services and activities; and where intangible expressions inherited from past generations are kept alive for future generations.

If the global goal is to attain the Digital Equity it is necessary to respect the cultural diversity and identity giving the convenient importance to the linguistic diversity and local content. Otherwise there will be people without interest in accessing the information existing in the network and avoiding the attainment of the Digital Equity.

## 4 ITU-WSIS Action Lines and the UN Sustainable Development Goals

### 4.1 UN Sustainable Development Goals (SDG)

The recently defined by the United Nations Sustainable Development Goals are:

- SDG1. End poverty in all its forms everywhere
- SDG2. End hunger, achieve food security and improved nutrition and promote sustainable agriculture
- SDG3. Ensure healthy lives and promote well-being for all at all ages
- SDG4. Ensure inclusive and equitable quality education and promote lifelong learning opportunities for all
- SDG5. Achieve gender equality and empower all women and girls
- SDG6. Ensure availability and sustainable management of water for all
- SDG7. Ensure access to affordable, reliable, sustainable and modern energy for all
- SDG8. Promote sustained, inclusive and sustainable economic growth, full and productive employment and decent work for all
- SDG9. Build resilient infrastructure, promote inclusive and sustainable industrialization and foster innovation

SDG10. Reduce inequality within and among countries

SDG11. Make cities and human settlements inclusive, safe, resilient and sustainable

SDG12. Ensure sustainable consumption and production patterns

SDG13. Take urgent action to combat climate change and its impacts

SDG14. Conserve and sustainably use the oceans, seas and marine resources for sustainable development

SDG15. Protect, restore and promote sustainable use of terrestrial ecosystems, sustainably manage forests, combat desertification, and halt and reverse land degradation and halt biodiversity loss

SDG16. Promote peaceful and inclusive societies for sustainable development, provide access to justice for all and build effective, accountable and inclusive institutions at all levels

SDG17. Strengthen the means of implementation and revitalize the global partnership for sustainable development

Each one of these goals is divided in [3] in a number of sub-goals (83) whose analysis allows a better understanding with respect to WSIS ALs and to the IFIP TCs.

#### 4.2 Relations Between the UN SDG and the WSIS Action Lines

WSIS has prepared a matrix indicating the effect of each one of the Action Lines on the different Sustainable Development Goals [5]. Table 1 presents these relations.

**Table 1.** Effect of each one of the Action Lines on the SDG

Sustainable Development Goal	WSIS Action Lines
1. End poverty in all its forms everywhere	AL1, AL2, AL3, AL4, AL5, AL7.2, AL7.4, AL7.7, AL7.8, AL10
2. End hunger, achieve food security and improved nutrition and promote sustainable agriculture	AL3, AL4, AL6, AL7.2, AL7.4, AL7.7, AL8, AL10
3. Ensure healthy lives and promote well-being for all at all ages	AL1, AL3, AL4, AL7.4, AL7.7, AL8, AL10
4. Ensure inclusive and equitable quality education and promote lifelong learning opportunities for all	AL3, AL4, AL5, AL6, AL7.3, AL7.5, AL7.7, AL8, AL10
5. Achieve gender equality and empower all women and girls	AL1, AL3, AL4, AL5, AL6, AL7.2, AL7.4, AL7.7, AL9, AL10
6. Ensure availability and sustainable management of water and sanitation for all	AL3, AL4, AL7.8, AL8
7. Ensure access to affordable, reliable, sustainable and modern energy for all	AL3, AL5, AL7.8
8. Promote sustained, inclusive and sustainable economic growth, full and productive employment and decent work for all	AL2, AL3, AL5, AL6, AL7.5, AL7.7, AL8, AL10

(Continued)



**Table 1.** (Continued)

Sustainable Development Goal	WSIS Action Lines
9. Build resilient infrastructure, promote inclusive and sustainable industrialization and foster innovation	AL2, AL3, AL5, AL6, AL7.1, AL7.2, AL7.6, AL7.7, AL9, AL10
10. Reduce inequality within and among countries	AL1, AL3, AL6, AL7.5, AL10
11. Make cities and human settlements inclusive, safe, resilient and sustainable	AL2, AL3, AL5, AL6, AL7.6, AL8, AL10
12. Ensure sustainable consumption and production patterns	AL3, AL4, AL7.5, AL7.7, AL8, AL9, AL10
13. Take urgent action to combat climate change and its impacts	AL3, AL4, AL7.6, AL7.7, AL7.8, AL10
14. Conserve and sustainably use the oceans, seas and marine resources for sustainable development	AL3, AL4, AL7.6, AL7.8
15. Protect, restore and promote sustainable use of terrestrial ecosystems, sustainably manage forests, combat desertification, and halt and reverse land degradation and halt biodiversity loss	AL3, AL7.6, AL7.8
16. Promote peaceful and inclusive societies for sustainable development, provide access to justice for all and build effective, accountable and inclusive institutions at all levels	AL1, AL3, AL4, AL5, AL6, AL7.1, AL9, AL10
17. Strengthen the means of implementation and revitalize the global partnership for sustainable development	AL1, AL3, AL4, AL5, AL6, AL7.1, AL7.2, AL7.4, AL7.5, AL7.7, AL7.8, AL9, AL10, AL11

If all WSIS Action Lines have some impact in the UN SDGs, the actions conducting to the Digital Equity will contribute at some level to approach the UN SDGs. So we can say that Digital Equity establishes the UN SDG in the specific domain of ICT that is WSIS Action Lines represent the application of SDG in the ICT domain. In some sense the dimensions of Digital Equity are included in one or several SDG and actions going toward Digital Equity contribute to the UN SDGs.

## 5 Digital Equity in Different Groups or Environments

Is Digital Equity in identical situation in all countries? Is Digital Equity in identical situation for the different genders?

It would be interesting to see the situation of Digital Equity with respect to different criteria like developed versus developing countries, like gender issue, etc. but let us concentrate in this article in the differences between developed and developing countries.

### 5.1 Situation of Digital Equity in Developed and Developing Countries

Digital Equity is neither yet reached in developed nor in developing countries. However the level of Digital Equity is quite different in developed and in developing countries. We can analyze these differences comparing the state of the five dimensions of Digital Equity in both types of countries.

- Access to technology resources (hardware, software, wiring and connectivity): possibility to have access to the technological resources allowing us to access the information existing in the network: Obviously the situation of the technological resources in developed countries is more comfortable than in developing ones, mainly because the extension of the network coverage and its capacity in developed countries are much more higher, faster and reliable than in developing ones. Also because the availability of devices in developed countries is greater, with higher novelty of models and at prices economically cheaper taking into account the economic level of the country. And finally the possibility for the end users of receiving the appropriate education is also higher; and this is true at all levels of education: basic user, advanced user, expert in installation and maintenance, hardware and software developer and builder, ICT research, etc.; it is easy to find the necessary education at reasonable prices for all type of education. Also in many countries there are strong differences in the access possibilities for the different genders.
- Access to high quality digital content; if the information available in the network is not of good quality, people will not be attracted to access it. Developed countries have an infrastructure allowing the access to all information existing in Internet by both the quality of the physical connection and the freedom for accessing all kind of information. Developing countries can have limitations by one or both of these aspects; in some cases the network has not enough capacity for accessing heavy information, and in other cases the access is limited by political reasons.
- Access to high quality, culturally relevant content; the available information should not only be of high quality but adapted to the context in which each community is living. Most of the web pages are written in English (or at least is the greatest minority) making difficult the access of people not fluent in reading this language. Also the topics contained in these pages are thought with Anglo-Saxon parameters making the access by people of other cultures of low interest. Consequence: not all pages are equally interesting for all people in the world, increasing the disadvantages of people of developing countries.
- Educators skilled in using these resources for effectively teaching and learning; it is obvious that for approaching the digital equity it is necessary to educate users but in many environments there are not enough people with appropriate skills for learning end users in all the needed categories. Education is a key point for reaching Digital Equity. However to deliver education it is necessary to have educators of all the needed profiles. The number and quality of the education centres dedicated to the educators are higher in developed than in developing countries.

- Opportunities for learners and educators to create their own content; a way to increase the capacity of learners and educators is to offer them some tool to create contents accessible to the appropriate end users. The hardware and software infrastructure is much more solid in developed than in developing countries.

## 5.2 Contribution of IFIP to Digital Equity

The International Federation for Information Processing is a society created in 1960 under the auspices of UNESCO grouping computer societies under the base of one member society per country. From the technical point of view IFIP is composed of a number of Technical Committees (TC) each one dedicated to a specific aspect of computer science, engineering and applications. Each TC is composed of a number of Working Groups (WG), each one devoted to a specific aspect of the TC domain. Currently there are 13 TCs and 120 WGs grouping thousands of computer professionals.

IFIP has decided that Digital Equity is one of its Strategic Activity Lines. In general we can consider that the work of all these bodies contribute to the Digital Equity. However there are some of them are more specifically oriented to tackle the Digital Divide and empowering Digital Equity.

From the previous introduction let us review the different TCs and analyze what is their involvement in some aspect of the Digital Equity. The IFIP TCs are:

- TC1 on Foundations of Computer Science, whose aims are: to support the development of theoretical computer science as a fundamental science; and to support the development and exploration of fundamental concepts, models, theories, systems, and and the understanding of laws, limits, and possibilities of information processing. Its influence on Digital Equity is generic but not directly implied.
- TC2 on Software, Theory and Practice, whose aim is to obtain a deeper understanding of programming concepts in order to improve the quality of software by studying all aspects of the software development process, both theoretical and practical. So, building good software products has a positive influence on Digital Equity mainly promoting good practices in the creation of software products.
- TC3 on Education whose aims are: to provide an international forum for educators to discuss research and practice in: teaching informatics; and educational uses of communication and information technologies (ICT); to establish models for informatics curricula, training programs, and teaching methodologies; to consider the relationship of informatics in other curriculum areas; to promote the ongoing education of ICT professionals and those in the workforce whose employment involves the use of information and communication technologies; to examine the impact of information and communication technologies on the whole educational environment: teaching and learning; administration and management of the educational enterprise; and local, national and regional policy-making and collaboration. As education is a key factor for reaching Digital Equity, we can see that the aims of this TC are fully in line with the dimensions of Digital Equity.
- TC5 on Information Technology Applications whose aim is to promote research and development of fundamental concepts, models, and theories to support

applications of ICT. So, it has a generic interest for Digital Equity; only the promotion of applications appropriate for developing countries can help to attain Digital Equity.

- TC6 on Communication Systems, whose aims are to promote the international exchange of information related to communication systems; to bridge gaps existing between users, telecommunication operators, service providers and computer and equipment manufacturers; and to establish working contacts with international bodies concerned with data communication, such as ITU, ETSI, ISO, IEEE, IETF, ITC and ATM Forum. The aims of this TC are fully in line with a dimension of the Digital Equity (creation of a convenient infrastructure). In particular in this TC there is a WG devoted to developing countries so dedicated to bridge the gap between developed and developing countries with respect to Digital Equity. This is the WG6.9 on Communications Systems for Developing Countries, whose aims are: to identify and study technical problems related to the access to, understanding of and application of network and telecommunications technology in developing countries or regions; to encourage cross-fertilization of concepts and techniques among developing countries, and between developing countries and developed countries; to promote activities oriented to the diffusion of the methods and techniques for accessing computer networks in developing countries or regions.
- TC7 on System Modelling and Optimization, whose aims are: to provide an international clearing house for computational (as well as related theoretical) aspects of optimization problems; to promote the development of necessary theory to meet the needs of complex optimization problems and cooperate with the International Mathematics Union; and to foster interdisciplinary activity on optimization problems spanning the areas such as Economics, Biomedicine, Meteorology, etc., in cooperation with associated international bodies. So, it has not a specific interest for Digital Equity.
- TC8 on Information Systems whose aim is to promote and encourage interactions among professionals from practice and research and advancement of investigation of concepts, methods, techniques, tools, and issues related to information systems in organizations. So, it has a generic interest for Digital Equity specially proposing good practices for the information systems.
- TC9 on ICT and Society whose aims are: to develop understanding of how ICT progress is associated with change in society; and to influence the shaping of socially responsible and ethical policies and professional practices.

The aims of this TC are fully in line with several dimensions of the Digital Equity. In particular it has a WG devoted to Developing countries dedicated to bridge the gap between developed and developing countries. It is the WG9.4 on Social Implications of Computers in Developing Countries, whose aims are: to collect, exchange and disseminate experiences of ICT implementation in developing countries; to develop a consciousness amongst professionals, policy makers and public on social implications of ICT in developing nations; to develop criteria, theory, methods, and guidelines for design and implementation of culturally adapted information systems; and to create a greater interest in professionals from industrialized countries to focus on issues of special relevance to developing countries.

- TC10 on Computer Systems Technology, whose aim is the promotion of the State-of-the-Art and the coordination of information exchange on concepts, methodologies, and tools in the stages in the life cycle of computer systems. So, it has a generic but not specific interest for Digital Equity.
- TC11 on Security and Privacy Protection in Information Processing Systems whose aim is to increase the trustworthiness and general confidence in information processing and to act as a forum for security and privacy protection experts and others professionally active in the field. Obviously the topics concerned by this TC are of high importance for reaching Digital Equity, ensuring the needed security and privacy protection to the information and to the end users.
- TC12 on Artificial Intelligence whose aims are: to foster the development and understanding of Artificial Intelligence and its applications worldwide; to promote interdisciplinary exchanges between Artificial Intelligence and other fields of information processing; and to contribute to the overall aims and objectives and further development of IFIP as the international body for Information Processing. The aims of this TC are not of specific interest for Digital Equity.
- TC13 on Human-Computer Interaction whose aims are: to encourage empirical research (using valid and reliable methodology, with studies of the methods themselves where necessary); to promote the use of knowledge and methods from the human sciences in both design and evaluation of computer systems; to promote better understanding of the relation between formal design methods and system usability and acceptability; to develop guidelines, models and methods by which designers may be able to provide better human-oriented computer systems; and to co-operate with other groups, inside and outside IFIP, so as to promote user-orientation and “humani-zation” in system design. Obviously the topics concerned by this TC are important for reaching Digital Equity, because a good interface to the searched information helps a lot to its usability by the end users.
- TC14 on Entertainment Computing whose aims are: to enhance algorithmic research on board and card games; to promote a new type of entertainment using information technologies; to encourage hardware technology research and development to facilitate implementing entertainment systems; and to encourage non-traditional human interface technologies for entertainment. Maybe the topics concerned by this TC are marginal for reaching Digital Equity, but it works on topics making the access to information more attractive to the end users.

So IFIP has convenient bodies to tackle the problems derived from and related to Digital Equity in general and specifically in developing countries. The recent creation of a Standing Committee in Digital Equity will increase and coordinate the action to promote the Digital Equity.

## 6 Conclusions

We have analyzed the concept of Digital Equity and the different aspect it includes. Also we have seen how several international organizations; the Action Lines of the World Summit in Information Society, the United Nations Sustainable Development

Goals and the Technical Committees of the International Federation for Information Processing have a strong overlapping with the goals proposed by Digital Equity. Maybe these international organizations have not an exact coincidence on their goals, but an important overlap between them has been clearly stated.

## References

1. International Society for Technology Education: Digital Equity Toolkit – Working Draft (2006)
2. World Summit in Information Society: WSIS Action lines. <http://www.itu.int/net/wsis/implementation/>
3. United Nations: Transforming our World – The 2030 Agenda for Sustainable Development goals. <https://sustainabledevelopment.un.org/topics>
4. International Federation for Information Processing: Structure of IFIP. [http://www.ifip.org/index.php?option=com\\_content&task=view&id=131&Itemid=448](http://www.ifip.org/index.php?option=com_content&task=view&id=131&Itemid=448)
5. World Summit in Information Society: WSIS-SDG Matrix Linking WSIS Action Lines with Sustainable Development Goals. [http://www.itu.int/net4/wsis/sdg/Content/wsis-sdg\\_matrix\\_document.pdf](http://www.itu.int/net4/wsis/sdg/Content/wsis-sdg_matrix_document.pdf)

# Telecenters for the Future in Tea Estates of Sri Lanka

Sirkku Männikkö-Barbutiu, Thomas Westin<sup>(✉)</sup>, Ranil Peiris, and Peter Mozelius

Department of Computer and Systems Sciences, Stockholm University, Stockholm, Sweden  
{sirkku, thomasw, ranil, mozelius}@dsv.su.se

**Abstract.** This paper reports on a study conducted at one of the Sri Lankan tea estate districts, exploring the present day status of telecenters to examine how they have succeeded in meeting the initial high expectations attached to them. During a field study, two major types of telecenters have been examined through observations, interviews and document analysis. Our findings suggest that the challenges of the initiation phase still prevail. The hopes are placed on the younger generation, as they are regarded as those who can benefit from the ICTs and thus contribute to the development of the remote communities of tea estates. In the concluding discussion, we advocate for the possibilities of co-designing new services that might help to transform the telecenters to meet the needs and requirements of the tea estate communities of today and tomorrow.

**Keywords:** Digital divide · Education · Telecenters · Tea estate areas · Accessibility · Sustainability · ICT literacy · Community development · Civic services

## 1 Introduction

This paper reports on a study conducted in one of the Sri Lankan tea estate areas, Nuwara Eliya, and discusses the present-day telecenter situation. During the field study, two major types of telecenter arrangements were identified: the government initiated Nenasala telecenters, and the e-kiosk type community centers run by the Thondaman Foundation connected to the Ceylon Workers' Congress. The purpose of this paper is to describe and analyse the major telecenter models that exist today, and discuss the potential and challenges of these to provide e-services to their communities.

### 1.1 About the Telecenter Movement

The telecenter movement has its origins in Scandinavia and the United States, where telecenters were established in the 1980s in an effort to provide access to Information and Communication Technology (ICT), particularly in rural areas where the access to the new technology was limited [1].

Telecenters have many names and many different forms depending on where and by whom they have been established. In general terms, telecenters can be defined as physical places which facilitate public access to ICTs, especially to the Internet, and thus

benefit educational, personal, social, and economic development [2]. Telecenters have varying models for administration and funding. They can be run and financed by NGOs, government, international organizations, development banks, foreign assistance agencies, private companies and individual entrepreneurs [3]. Despite the various names – telecenters, e-kiosks, and Internet cafés – the common denominator is the aim to bring ICTs to the inhabitants of a certain area. Another name for telecenters is community resource center and they have been established in many countries with the purpose of assisting to decrease the digital divide [4, 5]. In Sri Lanka, the Information and Communication Technology Agency (ICTA) introduced telecenters in 2004. Over the years, some 838 Nenasala telecenters have been established around the island in rural and semi-rural regions [6].

## 1.2 Context of the Study: Tea Estate Areas in Sri Lanka

Estate areas refer to the coffee and later tea and rubber plantations originally established by the British in the nineteenth century. Geographically they are concentrated in South-central Sri Lanka. Tea is an important part of the Sri Lankan economy and the estate areas developed their own particular socio-economic and cultural conditions with the migrated Indian Tamil population as the workforce. The plantation workers reside within the boundaries of the tea estate, earning their livelihood in the tea factories or on the steep slopes of the tea plantation plucking tealeaves. Estate areas have remained isolated and marginalized with limited possibilities for social mobility and development.

According to the year 2012 census, there are about 900,000 people living in the tea estate areas of Sri Lanka [7], which is 4.4 % of the total population. The majority of these, 84 %, live in the following six districts: Nuwara Eliya, Badulla, Rathnapura, Kegalle, Kandy and Matale. Nuwara Eliya is the largest district with 53 % of the total tea estate population. Access to education and societal services is limited [8] within the tea estates. Even though the literacy rates for the three population groups – urban, rural and estate populations – are almost even, there is a clear difference concerning computer literacy. The estate population reaches only to 8.8 %, which is considerably lower than the 36.8 %, the corresponding figure for the urban population [8]. In this study, computer literacy denotes basic computer skills, while digital literacy refers to more in-depth skills and competences in ICT use and awareness of potential opportunities with ICT services at the telecenters.

Despite the government efforts, the internal digital divide is still remarkable in Sri Lanka separating the urban areas where access to ICTs and the Internet is relatively good, from the rural areas and particularly tea estate areas, where the access to ICTs is poor [8]. Accessibility issues are related to both technical matters such as weak infrastructure, low bandwidth and lack of personal computers or smartphones, and also to lack of basic computer skills. Other important aspects are the lack of relevant content in vernacular languages as well as issues related to special needs for people with impairments [9]. Despite the investment of the Sri Lankan government in building infrastructure through telecenters [1], the telecenter network does not always reach those who would need it most: the underprivileged population of the tea estate areas.



By establishing telecenters, a particular kind of ICT infrastructure is being brought into a community. This infrastructure may have potential of empowering the members of the community through reducing isolation, bridging the digital divide, creating educational and economic opportunities [10–12]. In official (government) rhetoric [13] this potential is often presented as a matter-of-fact solution to the various issues facing isolated rural communities. This is the case also with the nationwide Nenasala project, introduced for strengthening democratic processes, enhancing socio-economic development and quality of life for those who are economically and socially marginalized in the society [1]. How this transformation and empowerment is actually taking place, if it does so, needs to be examined, as our understandings of the dynamics between communities and new technologies still are limited.

Now that more than ten years have passed since the founding of the first telecenters, it is time to revisit the Sri Lankan telecenter landscape to see how the centers are functioning today and, most importantly, how they have managed to meet the high expectations of transformation and empowerment of the rural population that were attached to them in the beginning. It is also of interest to explore the present day telecenter landscape as new actors have appeared. The dynamics between the communities and ICTs needs to be analyzed as this can inform us of the ways of improving the technologies for the good of the people.

### 1.3 Research Problem and Question

Telecenters were introduced in Sri Lanka with the hope of providing access to ICTs for the population and thus contributing to the improvement of people's lives. The problem is that the potential of telecenters to empower members of communities is often presented as a matter-of-fact in government rhetoric and independent studies of the impact of the centers are insufficient. This is why we wish to examine the present situation focusing on the following questions: What kind of telecenters are there today in tea estate areas of Sri Lanka and how are they used by the local population? The answer to this question is important as a baseline for further research on the relation between tea estate population and the ICTs and how the services could be developed.

The rest of the paper is structured as follows: Next section describes the research methodology applied in the study, followed by our findings in the form of an analysis of the tea estates and of the two main types of telecenters, which we found during our field visits. We also account for the attitudes and the actual use of present-day telecenters. In our discussion, we highlight the issue of the future role of telecenters and present the specific opportunities and challenges that we have identified in our study. We conclude by presenting our ideas for further research in the form of participatory co-design of future telecenters.

## 2 Method

In this study we have applied exploratory case study strategy [14] where the purpose is to learn about a particular, relatively unknown phenomenon – in this case – Sri Lankan

telecenters in their present day form in the specific geographical area of tea estates. We chose the Nuwara Eliya district because it has got the largest population among the tea estates. As we wanted to examine what kind of telecenters there are today and how they are used by the local population, we chose to combine various data collection methods. We carried out content analysis of existing ICT policy documents and government and private actors' websites related to telecenters to get an official and general picture of the situation, and the types of telecenters that are in function. We also visited the Nuwara Eliya district to learn about the actual conditions of telecenters. We interviewed telecenter managers and instructors. We conducted group discussions with the users and made observations at a number of telecenters. In total, the authors visited four tea estates and seven telecenters in these tea estates. We interviewed 10 telecenter instructors, the district coordinator of the Thondaman Foundation telecenters, four tea estate managers and groups of telecenter users. The seven telecenters were those who responded to our request to visit and interview them. This random sample covers the government initiated Nenasala telecenters and the e-kiosk type community centers run by Thondaman Foundation.

### 3 Findings: Present-Day Tea Estate Telecenters

At present, there can be found two major types of telecenters: those initiated by the Sri Lankan government called Nenasala and those initiated by the Thondaman Foundation called Prajashakthi. In this section, we give a short account of both types of telecenters that we visited during our field study.

#### 3.1 Nenasala Telecenters

Nenasala telecenters were introduced in 2004 by the Sri Lankan government as part of the eSriLanka project. The original purpose of the telecenters was threefold: (1) to contribute to the so-called diffusion effect which is about developing people's use of ICTs; (2) to bring in the technology companies for the provision of connectivity and technology; and (3) to stimulate other sectors in society to use ICTs for the development of their services to the communities (for example healthcare, education, agriculture, and retail) [1].

The government provided telecenters with a 'start package' of basic equipment and partial financial support during the first four years after which the telecenters should be self-sustained. The government would also subsidize connectivity over a period of four years [1, 13]. After this time the center would take over.

The goal of the Nenasala project was to establish multi-service community information centers. The centers were also envisioned to function as a hub of local, national and global information resources and thus be part of the efforts in poverty alleviation, social and economic development and peace building. Furthermore, the goal was to make these centers economically and technically sustainable in order to ensure long-term development.

Right from the beginning, there existed different kinds of models concerning ownership, location, and economic arrangements. Four types of Nenasala telecenters can be

distinguished; telecenters were established in conjunction to: Buddhist or Hindu temples (temple model); libraries (library model); non-government organizations (NGO model); or as a business in a form of Internet cafes (enterprise model). According to personal communication with an ICTA representative on May 29, 2015, the enterprise model never gained much popularity, as only one person would make profit on such an activity. The library model is gaining more popularity at present. Also, the ICTA representatives believe that this is the most viable model because libraries are already established services in a community and they provide a location and facilities where to develop ICT related activities and services. Libraries are run by the local councils and thus provide a sustainable solution even for telecenter activities. However, while the library model seems more sustainable, they are new and just starting. Only through time we can say how they are succeeding.

Nenasala telecenters have been a major investment for the Sri Lankan government with striving goals for the program. From year 2004 and onwards, the ambitious plan has been to install 1000 telecenters around the country (at present 838) [6]. However, it is difficult to find information about the number of telecenters that are actually in function today. In our efforts to contact telecenters, we found that several of them were closed down.

### 3.2 Prajashakthi e-Kiosks

Savumiamoorthy Thondaman formed the Ceylon Workers' Congress (CWC) as an Indian Estates Workers Trade Union in 1950. It became the largest trade union in the country. It has traditionally represented Tamil population (Sri Lankan Tamils of Indian origin) in the plantation sector of the economy and has a strong position among the tea estate workers. Thondaman has been the dominant trade union leader of the Indian Tamil workers for nearly four decades. The work of the Savumiamoorthy Thondaman Memorial Foundation is closely connected to the Millennium Development Goals fighting poverty and providing education and health care. The Foundation took the initiative to e-kiosk centers with the overall vision of achieving socio economic development through ICT and involvement of all stakeholders [15].

There are high hopes and expectations attached to ICTs. Computer literacy is seen as the key competence for the plantation youth in becoming active citizens in a new knowledge society. In his address on the occasion of the opening of an e-kiosk center, the former president Rajapaksa expressed his hopes of how the center would assist empowering the plantation community by providing access to knowledge through the use of ICT [16].

The e-kiosk title "Prajashakthi" translates to 'community empowerment', which is the central idea of the e-kiosk center project. The marginalized tea estate communities are to be empowered with the help of Internet and ICTs. With its political roots, the Foundation seeks to transform the communities into well-informed, self-sufficient parts of the Sri Lankan society.

The Prajashakthi telecenters aim at operating as a holistic model of service provider – a community center that brings different groups to the center – especially children, youth, women, people with impairments – for various activities that serve the purpose of

empowerment. Computer literacy is part of the services but it is combined with other aspects like English language learning, entrepreneurship and health information. Telecenters address the social and cultural needs of the society encouraging children and youth to express themselves through writing, song and dance thus reproducing the local culture but also finding novel ways for cultural utterances.

Microsoft Office and Internet browsing are central learning tasks. Through the community website [www.thondaman.org](http://www.thondaman.org), the children are given email and chat facilities. Sports and physical education also form an important part of activities in a community center of Prajashakthi type. The Foundation organizes common training seminars for the telecenter instructors and develops own educational content, which is shared by the centers. All the services offered by these centers are free of charge, which is not the case in Nenasala telecenters where the fees make a basic income for the managers and need to cover the expenses of the telecenter.

In summary, the two types of telecenters described here differ in several aspects. Nenasala telecenters are a state initiative whereas Prajashakthi telecenters have been founded through a private actor. The Nenasala telecenters were given a start package but are to be self-reliant subsequently. Prajashakthi telecenters are financially supported by both the Thondaman Foundation and the government. The approach of the Foundation is a wider social, cultural and economic engagement than that of the Nenasala telecenters, which only focus on ICT accessibility and training.

### 3.3 Attitudes Towards and Use of Telecenters

The tea estate managers describe the relation to the estate workers in a feudal manner. As one manager said: “We take care of them from the cradle to the grave”. Housing, medical services, schooling, shops are organized by the estate. The estate managers are well aware of the existing co-dependency between the estate population and the tea industry: if the tea estates wish to keep their employees, they need to provide good working and living conditions. The development of the tea industry goes hand in hand with the development of the workers.

The estate managers, which we interviewed, welcome ICT and education; they consider well-educated workers as good workers with potential to keep up with the new requirements related to the (technological) development of the tea industry. Some of the tea estates have even established estate owned telecenters where workers and their families are able to learn about the use of ICTs and also get language training in English language.

Although telecenters are thought of as open for the whole population, it is the children, youth and the younger generation that mainly use them. Gamage and Halpin [17] report that there is a general belief of telecenters being only for educated people. This belief has limited the use of the centers. In a sense, this is also what we found during our field study. ICTs are considered as something for the younger generation. In our discussions with some families, the parents told us that it is important for the young to learn about ICTs so that they can get hold of new opportunities and advance in their lives.

As to the parents themselves, telecenters are not considered as places of services or opportunities. This is also the attitude of the telecenter instructors: they focus on the younger generation and have designed their activities to meet the needs of the young by providing for example special software for drawing and educational games such as Typing Master on telecenter computers. We visited one Nenasala telecenter where they planned to start ICT lessons for (young) mothers, who would then spread the skills further to their children and other family members.

The community centers of Thondaman Foundation with their holistic approach to community development address even other groups with their activities. For example, they provide sewing classes for women and they support local entrepreneurship.

Instructors and users that we spoke with expressed their wish to learn even other skills – for example image processing. However, the software e.g. Adobe Photoshop is costly and cannot be purchased by the telecenters. The knowledge of open source alternatives seems to be limited among telecenter managers, which also hinders the development of services.

As English language is a second language for the population, language training is considered important and thus provided in telecenters. There is, however, lack of suitable, contextualized training programs for these Tamil speaking populations of tea estates. English language is even a key to a lot of information on the Internet and, consequently, poor English language skills form a barrier for the tea estate population to use the ICTs and the Internet [8].

Telecenters are also a place where the younger generation get together and socialize even in a more leisurely manner. Smaller children make drawings with the help of computers often several of them sitting together around a computer looking at and commenting each other's work. Young people play entertainment games such as Angry Birds with Android-based smartphones in case they have one and some also use Facebook and Twitter.

At present, no governmental e-services are provided through tea estate telecenters even though e-Sri Lanka project has been successfully implemented in many other parts of the island. It seems that both the telecenter managers and instructors are not aware of the potential opportunities of various e-services that might improve the local living conditions. For example, health care information about disease prevention could be very useful for the tea estate community. However, there does not seem to exist any kind of framework for such e-service. The telecenter staff also lacks the resources for further improvement as they are struggling to keep the basic services going. This was noted at telecenter manager interviews in May 2015.

When asked about the present use and the services provided, telecenter managers and instructors point out the limited resources and competences as an obstacle. If they had better, functioning equipment, and a better variety of software and knowledge of the software, they would be more attractive to the users. At a Nenasala library telecenter with about 100 active members, the manager said: "Our users would like to learn web design, but we don't have a good knowledge". In addition, there seems to be lack of collaboration between different actors in the educational sector that would help to consolidate the services and bring more users to the telecenters. As one of the Prajashakthi e-kiosk managers suggested: "We should have a (national) system to give a

certificate for our participants in collaboration with a university or another institution”. A certificate would give a needed recognition of the (training) courses taken at the telecenters, and it could be used when applying for jobs. Collaboration with well-recognized educational institutions in society, both for providing content as well as for validation of knowledge, would be important for the telecenters. The e-kiosk manager continued: “If we can get theory from a university, we can start teaching. Thondaman vocational training is registered, these centers are not registered”, suggesting that with a proper license, telecenters could become a competitive and attractive actor in the educational sector of the country.

Our findings suggest that the attitudes towards and the use of telecenters are constrained by the limited ICT resources and knowledge as well as limited awareness of the possibilities.

## 4 Discussion

Even though the idea of telecenters is being questioned as mobile phones are becoming the possession of everyone [18], research also shows that telecenters offer important complementary services providing access to technology and information, as well as playing a role in the development of ICT skills [19]. In Sri Lanka, the government envisions free Internet via Wi-fi for the next generation of Nenasalas, which we learnt at a meeting with ICTA in May 2015. This would certainly enhance the possibilities of providing new services through telecenters.

Future telecenters can play a central role as (1) a distribution node for education, (2) providing peripherals and (3) technical support services: (1) Basic computer training and use of simple services such as e-mail, is necessary for the 91.2 % of the estate sector [8] that still lack computer literacy to enable use of ICT services such as an “English for all” application [20]. For those who are digital literates, courses in more advanced skills could be provided in collaboration with the Sri Lankan universities, e.g. with Wikiversity [21]. These services could also be transferred to smartphones or USB sticks at the telecenters, to bring home where Internet connection may not work; (2) While smartphones provide many opportunities, the small format of the screen and touch based interface make them hard to use for all tasks. To write a longer document, to program a computer or to make more advanced graphics require peripherals. Instead of (or complimentary to) personal computers, telecenters could provide larger screens, printers, and keyboards etc. that visitors could connect to with their smartphones; and (3) When a computer or mobile phone breaks down either in software or hardware, it is necessary to have someone nearby who can help to fix the problem.

The Prajashakthi e-kiosks seem to benefit from the holistic approach to social reform and transformation that is part of the foundation of the CWC. The e-kiosks have several different activities of which ICT related ones are only a part. The instructors have continuous training and competitive salaries, which increases their motivation and dedication in their work in e-kiosks. The Nenasala telecenters have not included the possibilities of entrepreneurial activities for the estate inhabitants as part of their mission. The Prajashakthi e-kiosks recognize the importance of economic self-reliance and

advice the inhabitants within the tea estates in the process of establishing small-scale businesses.

The future of telecenters is closely dependent on the attitudes of the users and the telecenter staff. Awareness building, information and communication about the novel technical possibilities is crucial [22, 23]. For this reason, it would be very important for the (Nenasala) telecenters to network and exchange information, experiences, knowledge and resources between the managers and instructors. Continuous, active interaction with the local community is also vital for raising awareness. Here, the use of vernacular languages plays a part. Recognition of the local language (Tamil) is important for creating participation, ownership and empowerment among the community members. Increased awareness can subsequently lead to creation of relevant, contextualized educational content and creation of new services.

ICT developers and designers can play an important role in informing of the novel technical possibilities and contribute to the development of new services in a respectful collaboration with the community. The appropriation of ICTs can thus take place as self-organized activities of the community rather than an outside intervention. It is the community that must define the needs and requirements that the future services are based on.

In addition to the awareness and competence issues, telecenters seem to struggle with the same questions as reported before [17, 24]. Adequate infrastructure, stable Internet connectivity and power supply are the very base of any telecenter operations. If this base does not exist, it will be very hard to develop and provide new services. Sri Lankan government is now launching the Google Loon [13], which is to provide Internet connection to the island. Finding a suitable economic model for the telecenters [3] is also an issue that still is searching for a sustainable answer.

## 5 Conclusions and Future Research

The purpose of the study presented in this paper has been to examine the present situation of telecenters in the Sri Lankan tea estate areas; what types of telecenters exist and how the local population uses these. We have found two major actors in the telecenter field: the government initiated Nenasala telecenters and the Prajashakthi telecenters founded by the Thondaman Foundation. The conditions for these two types of telecenters differ in several respects: funding arrangements, management (salary, training, competence development), range of services, equipment, and infrastructure. These conditions frame their possibilities to carry out their mission purposefully, as well as their potential of being part of the future transformational processes. Our previous studies show that communication-intermediary tasks, networking between telecenters and stakeholders, and local knowledge and practices are important for gaining sustainable transformations. These are issues that telecenters need to address for their further development.

We believe that telecenters could continue to play a relevant role despite the widespread use of smartphones that have their limitations, too. A center that can support the whole community with stable Internet connection, relevant educational programs not only in ICT use but also in other areas as well in close collaboration with other



educational institutions, and that provides necessary technological support, would seem like a viable future model. However, to move beyond basic skills training of today, both the instructors and the users must become aware of potential ICT opportunities and services. Based upon this study, we believe that raising such awareness could be achieved through application of participatory action research design. In such a process, new services may be co-designed based upon the needs and requirements of the local population. These new services can play an important role in transformative processes leading to improvement of lives in the remote, disadvantaged communities of tea estates.

## References

1. Shadrach, B.: Nenasala the Sri Lankan Telecentre Experience. Information and Communication Technology Agency, Colombo (2012)
2. Reilly, K., Gómez, R.: Comparing approaches: telecentre evaluation experiences in Asia and Latin America. *Electron. J. Inf. Syst. Dev. Countries* **4**, 1–17 (2001)
3. Windsor, S.S., Royal, C.: Different telecentre models in ICT for development and their impact on organizational sustainability. *Int. J. Technol. Manag. Sustain. Dev.* **13**, 161–175 (2014)
4. Jensen, M., Esterhuysen, A.: The Community Telecentre Cookbook for Africa Recipes for Self-sustainability: How to Establish a Multi-purpose Community Telecentre in Africa. United Nations Educational Scientific and Cultural Organization, Paris (2001)
5. Islam, M.A., Tsuji, K.: Bridging digital divide in Bangladesh: study on community information centers (2011)
6. Nenasala Official Web Site: Nenasala. <http://www.nenasala.lk/>
7. Department of Census and Statistics Sri Lanka. <http://www.statistics.gov.lk/PopHouSat/CPH2011/index.php?fileName=Activities/TentativelistofPublications>
8. Peiris, R., Mozelius, P., Männikkö-Barbutiu, S., Westin, T.: Bridging the digital divide in Sri Lankan tea estate areas. In: IFIP 9.4 13th International Conference on Social Implications of Computers in Developing Countries, Negombo (2015)
9. Gomez, R.: Libraries, telecentres, cybercafes and public access to ICT: international comparisons (2011)
10. Mishra, G.: Telecentres as a medium for good governance in rural India. In: Handbook of Research on Democratic Strategies and Citizen-Centered E-Government Services, pp. 56–72. IGI Global (2014)
11. Malek, J.A., Ahmad, A.R., Awang, M.M.: Alfitri: Symbiotic relationship between telecentre and lifelong learning for rural community development: a Malaysian experience. *Turk. Online J. Educ. Technol.* **13**, 148–155 (2014)
12. Okello-Obura, C., Kacunguzi, D., Kidaaga, J.: Application of information and communications technologies in business operations and access to business information by small and medium enterprises in Western Uganda (2015). [http://reference.sabinet.co.za/webx/access/electronic\\_journals/mousaion/mousaion\\_v33\\_n1\\_a8.pdf](http://reference.sabinet.co.za/webx/access/electronic_journals/mousaion/mousaion_v33_n1_a8.pdf)
13. ICTA: Information and Communication Technology Agency II Information and Communication Technology Agency of Sri Lanka – ICTA. <http://www.icta.lk/index.php?lang=en>
14. Yin, R.K.: Case Study Research: Design and Methods. SAGE Publications, Thousand Oak (2003)
15. About Thondaman Foundation: Thondaman Foundation. <http://www.thondaman.org/aboutstmf.html>



16. Saumyamoorthi Thondaman Memorial Foundation: Prajashakthi. Saumyamoorthi Thondaman Memorial Foundation, Colombo (2007)
17. Gamage, P., Halpin, E.F.: E-Sri Lanka: bridging the digital divide (2007)
18. Central Bank of Sri Lanka: Annual Report 2014, Colombo, Sri Lanka (2014)
19. Sey, A., Coward, C., Bar, F., Sciadas, G., Koepke, L., Alampay, E., Best, M., Blake, T., Donner, J., Gordon, A.: Connecting people for development: why public access ICTs matter, vol. 241 (2013)
20. Google play: English for All. <https://play.google.com/store/apps/details?id=com.efi.learner.intermediate>
21. Wikiversity:FAQ – Wikiversity. [http://en.wikiversity.org/wiki/Wikiversity:FAQ#What\\_is\\_Wikiversity.3F](http://en.wikiversity.org/wiki/Wikiversity:FAQ#What_is_Wikiversity.3F)
22. Sulaiman V.R., Hall, A., Kalaivani, N.J., Dorai, K., Reddy, T.S.V.: Necessary, but not sufficient: critiquing the role of information and communication technology in putting knowledge into use (2012)
23. Islam, M.S., Hasan, M.N.: Multipurpose community telecentres in Bangladesh: problems and prospects (2009)
24. Jensen, M.: Nenasala Review on behalf of the World Bank Final Report. ICTA (2007)

# Mobile Internet Tariff Models: Technical or Political Decisions? A Costa Rican Case Study

Alexander Castro-Reyes<sup>1</sup> and Gabriela Marín-Raventós<sup>2</sup>(✉)

<sup>1</sup> Doctorate Program in Government and Public Policy, University of Costa Rica,  
San Pedro, Costa Rica

castro.alexander@gmail.com

<sup>2</sup> CITIC-ECCI, University of Costa Rica, San José, Costa Rica

gabriela.marin@ucr.ac.cr

**Abstract.** We focus on the discussion about the proposal of shifting to a post paid mobile Internet tariff model based on usage, and its impact on universal use and service access for the poor sectors of the country. This proposal aims to address the problem of cellular data network saturation, by charging per downloaded kilobyte instead of allowing unlimited use. We analyze the position of important actors using the *Advocacy Coalition Framework*. The study reveals the absence of public policies on IT connectivity and infrastructure in Costa Rica. Based on the results, we conclude that the proposed change does not solve the saturation problem, but rather imposes limitations on access and usage for low-income people, generating social exclusion and digital divide.

**Keywords:** E-readiness and ICT impact · Digital divide · ICT public policy

## 1 Introduction

By signing the Free Trade Agreement between the United States, Central America, and Dominican Republic in January 2004, Costa Rica begins a process of openness and organization of the telecommunications market, which had been a monopoly of the State until then. Our country embarks upon the adoption of laws and regulations that would shape the sector, among those the Telecommunications General Law and the Law on Strengthening and Modernization of the Public Entities in the Telecommunications Sector.

The first law mentioned above establishes mechanisms for regulating the sector, where as with the second, the Superintendency of Telecommunications (SUTEL) was created. This regulatory entity is responsible for promoting the efficiency, equity, quality, and coverage of the telecommunications services.<sup>1</sup>

Once the legislation required by the sector was approved, in 2011 the first two private mobile telephony carriers, Claro and Movistar, began operating [1]. They would compete with the state-owned telecommunications corporation called Costa

---

<sup>1</sup> SUTEL, <http://Sutel.go.cr/pagina/quienes-somos>.

Rican Electricity Institute (ICE), previously sole provider of mobile telephony services in the country.

As a result, the number of cellular line subscriptions increased rapidly. Only two months after, Claro and Movistar had begun operations, the number of active cellular lines was 4.153.067, while it reached 7.111.981 in 2013, an increase of 58 % compared to 2011. Opening of the cellular market resulted in high penetration of the service, with 151 subscriptions out of 100 inhabitants [2].<sup>2</sup> In 2014 the total number of subscriptions was 7.101.892, which rather shows that the upper limit of the market was been reached.

Furthermore, the perceptual participation of the operators in the market also changed. In 2011, ICE owned 90 % of all mobile telephony subscriptions, whereas Claro and Movistar reached 3 %, respectively. By 2014, the total participation of ICE declined to 61 %, while Claro rose to 16 % and Movistar 20 % [2, 3].

The trigger for these market changes was the supply of mobile cellular lines with unlimited access to Internet at higher speeds than those offered with fixed lines, along with facilities to access smartphones and the usage of datacards, both for prepaid and postpaid plans [3, 4].

Nevertheless, service operators soon showed saturation problems on their networks caused by a limited infrastructure and excessive growth in data traffic generated primarily by prepaid costumers who used their cellular phones as hotspot to connect small offices. Meanwhile, users pointed out of service problems regarding access, quality, speed, and coverage.<sup>3</sup>

In order to relieve the cellular network and discourage data consumption, in October 2012, SUTEL authorized operators to change the prepaid mobile Internet tariff of unlimited band to a rate based on downloaded kilobyte. They argued that the measure was taken to stop the “abusive use” of the cellular network [5]. However, it was until August 2013 that the operators decided to gradually accept the new tariff model, which, in the case of ICE for example, affected 3.8 million clients [6].

This measure generated discomfort in prepaid customers, mainly because the problems of access, quality of service and speed still persisted. Therefore, on March 28<sup>th</sup> 2014, the Defensoría de los Habitantes (Ombudsman’s Office) requested SUTEL a report on the planned measures to improve the quality and coverage of the data transmission service from the cellular network. Despite the pressure on this regard made by the Defensoría and by clients, on June 2014, SUTEL convened public audience to discuss, instead, a change in the postpaid mobile Internet tariff model to a rate per download, thus standardizing it to the one already existing for prepaid customers.<sup>4</sup>

The reason given by SUTEL was the saturation of the cellular network caused by excessive data traffic generated by 5 % of postpaid users. They also argued that the tariff

---

<sup>2</sup> De León [8] notes that there is a bias to misinterpret the number of connections with the degree of penetration of the cellular network and mobile Internet, as the trend in Latin America has been that users own more than one registered line, but they are not all active.

<sup>3</sup> The saturation of the data network was a recurring topic discussed by the SUTEL [5] as well as coverage problems [6].

<sup>4</sup> La Gaceta No. 105, June 3<sup>rd</sup>, 2014, p. 75.

model based on per kilobyte downloaded is applied internationally<sup>5</sup>, and that it should benefit consumers, because they would only pay for consumption and not for connection speed. This position was also supported by the previous Minister of Science, Technology and Telecommunications (MICITT) on June 10<sup>th</sup>, 2014 [7].

The rejection of this proposal was felt quickly in within Costa Rican Congress, the Ombudsman's Office, consumer organizations, business associations, and the academic sector. The opposition was due to the impact that this measure could have on the most vulnerable sectors of the country, where one important means of access to Internet is via cellular phone [8]. Meanwhile, Costa Rican Executive Power expressed its concern because the proposal could run counter to the country's efforts to universalize Internet access.

Some of the criticisms pointed out to the new tariff proposal were the lack of technical studies to back it, the use of outdated reports, the unresolved problems on the quality and the coverage of the service, the lack of information provided to the service's users, and the opinions expressed by SUTEL, viewed as in defense of the interests of the operators. This was highly criticized since SUTEL is supposed to be the public entity assigned by the Ministry of Science, Technology and Telecommunications (MICITT), to regulate the telecom market on behalf of Costa Rican citizens' welfare.

Due to public and social media pressures, and to legal actions that were brought by concerned actors, the audience requested by SUTEL was canceled and rescheduled for September 2015. It was canceled once more for similar reasons, and up to date, June 2016, its convocatory is currently being expected.

## 2 Defining the Problem

The proposal of changing the tariff model has generated concern in the country on account of the impact it would have on the most vulnerable social sectors, and on social exclusion and digital divide, this being the problem at hand.<sup>6</sup>

In Costa Rica, 20 % of the total population (1,170,634 people) lives in poverty, especially in rural areas; where, in addition, the supply of fixed Internet services as DSL/ADSL is limited or none-existent, based on estimations from the National Household Survey of INEC [11] and the State of the Nation Program [12]. Therefore, the proposal of changing the mobile Internet tariff model could generate social exclusion by raising the cost of access and usage of the service. It would affect the sectors with fewer resources, because they would be excluded from the intended benefits of Internet access as in the case of rural education since public programs use Internet post-paid services, which is discussed later. Another important issue is the intensity with which the service can be used. Providing access to users, but under conditions where they are unable to sustain the service due to monthly costs or have to restrict its use, is a way of creating uncovered digital divide.

---

<sup>5</sup> Limiting the consumption of data and establishing tariffs per kilobytes is an international trend currently in use [9].

<sup>6</sup> President of Costa Rica, Luis Guillermo Solís, said the proposal contradicts the country's vision of providing universal access to Internet [10].

The issue being discussed here is relevant for the former reasons, and furthermore, because the value of Internet access lies not only in the access to information and knowledge, but also in helping people enhance their skills and improve their standard of living by having access to services in digital form, such as healthcare programs and education.

The problem is two-sided. It is important to find an integral and inclusive solution, one that would benefit not only users, but also operators allowing them to make their service profitable. Profitability is required by companies to be sustainable and to invest in better infrastructure and better technologies like 4 and 5G, and LTE, which bring advantages to its users.

The role of cellular or mobile service providers is crucial, because without them, it is not possible to provide Internet service to remote areas where fixed DSL or ADSL connections are non-existent. Mobile Internet has become a resource that can bridge the digital divide, but only if the cost is within the reach of people, and if the service is of high quality, coverage, and speed.

### **3 Antecedents: What Has Happened in Other Countries?**

In 2009, the Organisation for Economic Co-operation and Development (OECD) [13] issued a report giving an account of the trend, at the international level, of the replacement of unlimited mobile Internet connections for models of charging per download. In that document, De León [14] points out that, because of the limited capacity of the radioelectric spectrum, in some OECD countries and in Latin America, the broadband service is sold by maximum transfer capacity and not by unlimited access.

The tariff structure change has resulted in a wide range of prices and service plans, in which the service provider charges per each additional Megabyte (MB), or drastically reduces transfer speed. Moreover, it is mentioned that the average monthly data consumption in the OECD countries is 4 GB per month, driven in part by the development of mobile applications that require larger amounts of traffic and high-speed networks (3G, 4G, WiMax, LTE). The study depicts that these applications have had a major impact in the mobile network data flow [14].

Meanwhile, in Latin America, mobile telephony operators have followed the international model of charging per download, instead of plans with unlimited capacity, offering a wide variety of tariffs, implementing fair use policies, or by charging the user the cost per every additional megabyte downloaded [14]. The adoption of this business model in the region responds to the rapid growth in mobile network data traffic, and the limited availability of radio spectrum frequencies due to saturation [15].

Hence, public policies in the region have been directed towards radio spectrum liberalization processes, and licensing to release the wireless network traffic. But beyond the spectrum availability, these policies leave out an important issue: the intensity with which customers can use the service [16]. According to De León [14] these *de facto* policies contrast with public policies undertaken by broadband leading countries, such as Australia, United States, and New Zealand. These nations, with greater vision, have directed their efforts to ensure universal access to the service and to improve the broadband infrastructure capacity. In order to do so, they have assigned significant public

financial resources to develop broadband infrastructure and to create a smart grid of data transport (networks) that would allow the passage of high amounts of traffic. They do so as to give a boost to their own economies, reinforcing activities such as e-health, e-commerce, education, access to telecommunication services, and rapid Internet access.

De León concludes that "...the common denominator in these countries has been the creation of national broadband plans and the involvement of the highest authorities of the government in the strategic definition of such plans, injecting large sums of money to support these plans with a simultaneous vision to protect and to use market competition schemes, as well as the pursuit of efficiency and effectiveness of the plans." [14, p. 104].

As proposed by [17], the cost of postpaid mobile Internet service can be analyzed through its *affordability*. This measure has been established by the average price for postpaid plan, as a percentage of monthly GDP per capita. In the postpaid plan, the optimal threshold is 5 % or less. It is a proxy of the proportion of income to be assigned to access the broadband service [17]. Based on 2014 statistics, Latin American countries with better affordability are Argentina, Chile, Costa Rica and Uruguay, with percentages below 2 %, relatively close to Japan, France, Italy, which are in the order of 0.6 % [18]. In contrast, countries in Central America (El Salvador, Guatemala, Honduras and Nicaragua) and South America (Bolivia, Ecuador, Paraguay, Peru) were above the desired 5 % threshold, which means that the service is not affordable for most population given its relative high price.

## 4 Theoretical Framework

To analyze the proposal of changing the postpaid mobile Internet tariff to a rate per download model, and its implications on universalization and access to the service, we have resorted to *Advocacy Coalition Framework (ACF)* of Sabatier and Jenkins [19, 20]. It aims to explain the change that occurs in public policies based on the role of ideas, beliefs, values, and ideology of the actors, who are actively involved in the discussion and political decision making. This framework has been used to analyze public policies in areas as public health, nuclear security, pollution air, water policy, climate change, oil and mineral, in the United States, Canada and Europe [20]. Also, it has been applied in Asia, Africa, Australia and South America, in metallurgical development policies, domestic violence, water policy, education, drugs and smoking control public policies [20].

Under this framework, the actors are grouped into a *policy subsystem*. This subsystem is understood as those governmental and non-governmental actors who interact around a particular policy issue, to dissuade decision makers and civil society about previously determined interests and beliefs [20, 21]. The subsystem is composed by a wide variety of actors including governmental agencies and actors at different levels, legislators, bureaucrats, private organizations, academic community, associations, and individuals, where the cohesive elements are the ideas and beliefs shared around a policy issue or subject. The subsystem is expressed by the position actors adopt or by their discourse [19, 20].

Such beliefs can be categorized into three levels: the *deep core*, the *policy core* and the *secondary aspects* [21]. The *deep core* refers to profound-rooted axioms shared by all actors, such as ideas about freedom, universal equity, and the type of government [22]. The *policy core* comprises the beliefs shared by the actors regarding a topic or issue of public policy. Finally, the *secondary aspects* refer to the technical and instrumental part of the implementation of a public policy. Secondary aspects are propitious to find room for negotiation, where quantitative technical information or qualitative arguments that are valid and solid enough can generate a shift in the policy debate, by indicating that the path taken thus far in policy making is not the best [23].

Our focus of analysis is the policy core, concentrating the discussion on a possible change for the postpaid Internet tariff model: from unlimited use to a rate per download. We are also interested on secondary aspects, which address how this model is intended to be applied, and how it would affect the sectors with lowest incomes. However, the analysis is based on the deep core.

In Costa Rica, the welfare state has its roots in the establishment of the Second Republic, in 1949. Since then, a universally recognized thought (*Deep Core*) is the State's obligation to *ensure the welfare of all its citizens, and particularly, to ensure welfare of the most unprotected population*. In consequence, the country has undertaken great efforts to improve the welfare for all its population, and especially for the most vulnerable sectors, by providing subsidized electricity, education, and health services throughout its territory.

With the emergence of Internet and its potential benefits, Costa Ricans started believing that the *universal access to Internet generates social welfare and promotes socioeconomic development of the country's population*. These beliefs were endorsed by ICE, public and leading provider of telecommunications services in the country. With market globalization, and the signing of the Free Trade Agreement, liberal groups with political power in the country promoted the idea that the *market is the best mechanism for allocating resources, in opposition to tariff structures controlled by the State*.

Thus, a questioning on how to organize the telecommunications sector in a context of trade openness and free market (*policy core beliefs*) arises, but also it would have to be possible to ensure digital equity and the welfare of the most vulnerable social sectors (*deep core belief*).

## 5 Methodology

Under ACF, it is important to recognize the beliefs, opinions, and positions of the actors involved in the discussion of the proposal of changing the tariff model and its impact on the most vulnerable sectors. To achieve this, we interviewed five key high-level actors that have participated actively in the discussion process of changing the tariff model. They belong to the academic, public, and private sectors and are recognized leaders in the information technology field. We selected them because their opinions represent their corresponding sectors.

The interviews were personal, consisting of eleven questions previously provided to respondents. The following aspects were addressed: (1) the reasons that motivated the proposal of changing the tariff model, (2) the potential effects on access and use of the

service, (3) the social sectors affected and/or benefited with the intended change, and (4) the proposal improvements suggested. The actors interviewed were:

- **Governmental Sector:** Minister of Science, Technology and Telecommunications (MICITT).
- **Private Sector:** Vice-President of the Chamber of Information and Communication Technologies (CAMTIC).
- **Academic Sector:** Director of the Informatics Center of the University of Costa Rica (UCR-CI), and Director of the Information Society Program of the University of Costa Rica (UCR-PROSIC).
- **Telephony Operators:** Board Member of Costa Rican Electricity Institute (ICE).

Subsequently, their responses and issue perceptions were analyzed and filtered in a frequency matrix by topic and assumed position.

## 6 Analysis

The interviews were recorded and transcribed. The idea was to determine the topics upon which the various actors focused on and that can eventually be considered in the national discussion of the changing tariff model. Table 1 shows what each interviewee

**Table 1.** Results of interviews by category and dimension

Dimension	Category	Referred to by				
		CAMTIC	PROSIC-UCR	CI-UCR	MICITT	ICE
Telecommunications infrastructure	Saturation of the mobile network	x	x	x	x	x
	Reduced Internet infrastructure both fixed and mobile	x	x	x	x	x
	Infrastructure's limited capacity	x	x	x		x
	Limited speed of the fixed network	x		x		
	Improve the infrastructure of the fixed network		x	x		
	Specific techno: Hotspot WLAN, Ethernet rings	x	x	x		
	Improve the use of the radio spectrum		x	x		
Local market conditions	Variety of proposal within each pre/postpaid model		x			x
	Different tariff models	x	x			x
	Service quality	x				
	Revenue per person (RPU)				x	
	Differentiated tariffs	x	x	x	x	x
	High consumption data	x	x	x	x	x
Social impacts	Impact on the least able	x	x	x		x
	Increased costs to the less fortunate	x	x	x		x
	Difficulty to access Internet services	x	x	x	x	x
	Increasing digital divide	x	x			x
	Unequal access		x	x		x
	Digital literacy	x				
	Tariff model is insufficient (not integral)		x			x
The role of the Government	Vacuum in telecommunications and infrastructure investment public policy	x	x	x		x
	Government's undefined position		x	x		x
Causes for the rejection	Proposed model based on weak technical reasons	x	x	x		x
	Proposed model based on weak financial reasons	x	x	x		x
	Proposed model based on weak consumption analysis	x	x	x		x



referred to. The “categories” were also ordered by dimensions, so as to help interpret the position of those interviewed.

After analyzing the data, five main topics addressed by the interviewees were identified: (1) the conditions of telecommunications infrastructure, (2) the local market conditions, (3) the social implications of the proposal, (4) the role of the government in the issue, and (5) the causes for rejection of the current proposal.

The most interesting discovery is that the responses posted by the Minister of MICITT are the least critical to the proposal, and they reflect no causes for its rejection (see Table 1). This position was also supported for his antecessor at MICITT. However, in both cases, their position was questioned by the Costa Rican Executive Power because the proposed change in tariff structure does not contribute to the national efforts to universalize Internet access.

In the following section we present the stated arguments in detail.

### **6.1 Telecommunications Infrastructure**

All respondents agreed on the idea that the main problem of the saturation of the mobile data network in Costa Rica is due to the lag in the infrastructure that the country has. In the case of fixed infrastructure, some constraints were identified, such as the connection speeds that are offered and the reduced supply of ADSL lines, mainly in rural areas.

They also highlight that these limitations push users to make an intensive use of cellular data network, which is comparatively faster to acquire. This phenomenon leads the saturation in the mobile network. Moreover, they also diagnose that this saturation generates problems of access and quality, such as denial of service access, data traffic retransmissions, and latency. For the Director of CI-UCR, this situation is more common when mass activities are performed in specific areas of cellular coverage, or at large events like the Football World Cup, and where users’ massive data traffic concentrates on a few antennas causing saturation in them and connections collapse. According to the Director of PROSIC-UCR, a similar situation occurs during traffic peak hours, where the use of geographic positioning applications, and data transmission in those hours, can cause problems of network congestion.

Under these conditions, the rate per download would go against users since much of the contracted plans (which define maximum service usage) would be consumed by congestion access problems and retransmissions. As a solution, the Vice-president of CAMTIC proposes to liberalize the service and to create cellular aggregation rings, while the Director of PROSIC and of the CI-UCR point out the need for cellular network planning and for an improvement on the use of the radio spectrum.

### **6.2 Local Market Conditions**

All interviewees agreed that the limited supply of differentiated mobile Internet service plans is due to the lack of real competition among service operators, for rates are set administratively by the SUTEL. Therefore, all mobile Internet plans in the market are in essence very similar; thus users choose the operator based on other criteria, such as coverage or relative quality of the service, as stated by the Director of CI-UCR.

The Minister of MICITT holds that part of the problem is due to the low incomes that the operators receive per user. He argues that the *revenue per user* is relatively low in Costa Rica. He stated that low income does not allow operators to become profitable and invest in infrastructure, making it necessary to find other forms of charging. Regarding this point, the Director of CI-UCR and the Board Member of ICE recognized that the income of the operators has lessened as costumers use the Internet to send text messages and make online calls, which constantly diminishes the use of traditional voice and text services. However, the Director of CI-UCR indicated that profitability is constrained also by high costs. He depicted that transportation problems and efficiencies mainly occur in 3G networks, while 4G networks are more efficient since all the voice, text and data traffic is encapsulated, representing a lower cost to operators.

Furthermore, they all recognized the need to find new payment forms that would allow service carriers to keep operating, but under different conditions: liberalizing the market and stimulating competition, but with formulas that do not exclude vulnerable social sectors from Internet service access.

### 6.3 Social Implications

A recurring concern in the discussion of the model is the impact that this proposal can have on the most vulnerable population and on government programs aimed to these sectors, such as education.

As stated by the Ministry of Public Education (MEP), this measure “would affect 1,574 public schools across the country, since they have access to the Internet via data-cards that MEP must pay monthly as part of postpaid plans, and which are the only tool to enter the web that these institutions can count on” [24]. MEP also remarked that the tariff per download would affect the online services that the institution offers to students and parents, such as information on school calendar, practices to get ready for the nationwide baccalaureate exams, and the program “The Professor in your House.” Many students make inquiries from the cellular phone, especially those in areas outside the Greater Metropolitan Area, and where there are not fixed telephony services [24]. About this particular, the Director of PROSIC-UCR considers important for operators to generate alternative tariff models addressed to the lower income citizens. The Vice-president of CAMTIC, the Director of CI-UCR, and the Board Member of ICE had similar positions. For them, the tariff models that are offered should ponder the target population to which the service is addressed, it being from rural or urban areas. They all recommend that tariff models should consider different thresholds rates.

### 6.4 The Role of the Government

The interviewees pointed out the absence of a clear public policy, with corresponding financial support, regarding infrastructure and telecommunications. Such absence is shown in the undefined position the Government has had in relation to the discussion of the proposed tariff model. Most of them accounted that, while in 2014 the Minister of MICITT expressed support for this proposal, the Executive Power affirmed that it set aside the country’s vision of universal access to the Internet. Furthermore, at this point

it is worth mentioning the opposition expressed in public media by the Minister of Education due to the impact this could have on the programs and services offered by the institution, especially in rural zones or poor urban areas. As the Vice-president of CAMTIC indicated, the Government's lack of definition on this issue is evidenced by not taking into consideration its effects on other plans or state programs.

The solutions suggested by interviewees stressed the need of a greater participation of the Government on this issue, by developing clear policies in infrastructure, digital literacy, and development of mobile applications to take advantage of these technologies, lowering the cost of smartphones, and liberalizing the telecommunications market.

## 6.5 Causes for the Rejection of the Current Proposal

The interviewees agreed on the perception that the rejection of the tariff change proposal is based on: the lack of technical support to justify the change, the price suggested per kilobyte, the limit threshold to start charging per kilobyte, and the arguments included on users with excessive consumption.

According to SUTEL, the "abusive" consumption by 5 % of postpaid users saturates the network, so it is necessary to charge per download in order to relieve network congestion, and they propose that the price per kilobyte downloaded be € 0.0076 once you exceed 500 MB consumption [25]. Four out of five interviewees consider the lack of updated and rigorous technical information one of the main weaknesses of the proposed plan. They remarked that the proposal does not present technical studies to identify the users with "abusive" consumption, or even does not define what is regarded as "abusive" consumption. Neither does it provide data about the calculation of the price per kilobyte, but it sets a consumption limit of 500 MB, considering it a suitable average. These arguments are classified as erroneous by the representative of CAMTIC and the Director of CI-UCR. They argued that even though there is a high consumption by some users, the proposal does not clearly identify who they are. They claimed that in the market there certainly exist users with high consumption needs; therefore, these costumers should not be pointed out as "abusive", but rather they have to be provided tariffs and plans that suit their consumption habits. The importance of defining and implementing fair use policies is also stressed by all.

Both the Director of CI-UCR and the Board Member of ICE state that there are users with different consumption necessities that require connectivity plans that would meet their needs. Hence, it is important to have competition in the sector that would provide a variety of connectivity plans: by consumer, by regions, or by time slots, lowering the service in slots where the network has less traffic, and thus, balancing it. It is clear that users have different consumption habits, so it is beneficial to offer differentiated plans or rates.

## 7 Conclusions

From the observations made by the interviewees, it can be concluded that the current proposal of changing the postpaid mobile Internet tariff model is counterproductive to people with fewer economical resources and from rural zones, as it establishes

restrictions on access to the service and on public education programs. It mainly affects users from rural areas. The proposal seeks, wrongly, to solve through price obstacles, problems regarding infrastructure, access, coverage, and quality. According to the interviewees, these problems need to be addressed differently, so they propose other solutions.

In order to do so, they pointed out the necessity to promote a framework for competition and liberalization of the sector that may lead to differentiation and heterogeneity through tariff customized models for consumption, speed, geographical area (rural/urban), and time slots, and the implementation of fair use policies. This requires studies of average consumption on prepaid and postpaid data to avoid speculation on consumption and price per kilobyte, as the current proposal is been perceived.

In terms of service, the proposal of shifting the payment model to use parameters is accepted as long as it brings service quality and coverage, as well as state subsidies for users with fewer resources and with reduced options of Internet access.

Most sectors claim that the infrastructure of the fixed network must be improved, especially in rural areas, by offering high-speed ADSL lines and the implementation of wireless access, to make a better use of the radio spectrum. Public policies that promote investments in network infrastructure, socioeconomic development and digital equity are critical. Some bet on promoting the liberalization of the sector and fostering free competence, and influencing on cost reduction of smartphones and mobile devices with cellular network access such as tablets. However, this must not be enough. It is also essential to pursue public policies that promote digital literacy and the development of citizen centric mobile applications, to empower vulnerable communities. Maybe the solution comes from incorporating successful experiences of other countries, but customized to our environment and need.

## References

1. PROSIC: Hacia la sociedad de la Información y el Conocimiento. Programa de la Sociedad de la Información y el Conocimiento. Universidad de Costa Rica (2012)
2. SUTEL: Estadísticas del Sector de Telecomunicaciones: Informe 2014. Superintendencia de Telecomunicaciones (2014)
3. SUTEL: Estadísticas del Sector de Telecomunicaciones: 2010–2012. Superintendencia de Telecomunicaciones (2013)
4. Mercedes, A.: Contratos de Internet móvil se dispararon a un millón en 2 años (2013). [http://www.nacion.com/nacional/Contratos-Internet-movil-dispararon-millon\\_0\\_1364263614.html](http://www.nacion.com/nacional/Contratos-Internet-movil-dispararon-millon_0_1364263614.html). (cited 5 Sept 2013)
5. Herrera, M.: SUTEL avala cobro de Internet por descarga (2012). [http://www.nacion.com/nacional/comunidades/SUTEL-avala-cobro-Internet-descarga\\_0\\_1299870057.html](http://www.nacion.com/nacional/comunidades/SUTEL-avala-cobro-Internet-descarga_0_1299870057.html). (cited 18 Oct 2012)
6. Agüero, M.: Internet móvil: talón de Aquiles de operadoras (2013). [http://www.nacion.com/nacional/comunidades/Internet-móvil-talon-Aquiles-operadoras\\_0\\_1347065638.html](http://www.nacion.com/nacional/comunidades/Internet-móvil-talon-Aquiles-operadoras_0_1347065638.html). (cited 11 Jun 2013)
7. Fallas, G.: Ministra de Ciencia y Tecnología respalda cobro por descarga para Internet móvil postpago (2014). <http://www.ameliarueda.com/nota/ministra-de-ciencia-y-tecnologia-respalda-cobro-por-descarga-para-internet->. (cited 10 Jun 2014)

8. Quesada, J.: Diputados consideran que cambio en cobro de Internet celular podría ser ilegal (2014). <http://www.teletica.com/Noticias/56069-Diputados-consideran-que-cambio-en-cobro-de-Internet-celular-podria-ser-ilegal.note.aspx>. (cited 9 Jun 2014)
9. Sancho, M.: Gobierno apoya propuesta de cobro por descarga de Internet (2014). <http://www.crhoy.com/gobierno-apoya-propuesta-de-cobro-por-descarga-de-internet-w917m0x/>. (cited 10 Jun 2014)
10. Fallas, G.: Cobro por descarga en internet móvil postpago conlleva un “mensaje contradictorio” (2014). <http://www.ameliarueda.com/nota/cobro-por-descarga-en-internet-movil-postpago-conlleva-un-mensaje-contradictorio>. (cited 13 Jun 2014)
11. INEC: Encuesta Nacional de Hogares Julio 2014: resultados generales. Instituto Nacional de Estadística y Censo (2014)
12. Programa Estado de la Nación en Desarrollo Humano Sostenible: Vigésimo primer Informe Estado de la Nación en Desarrollo Humano Sostenible (2015)
13. OCDE: Communications Outlook 2009. Information and Communications Technologies. Organización para la Cooperación y el Desarrollo Económico (2009)
14. De León, O.: Panorama de la banda ancha en América Latina. CEPAL (2010). <http://www.cepal.org/es/publicaciones/3833-panorama-de-la-banda-ancha-en-america-latina-2010>
15. Prensario Internacional: El Fin de la Banda Ancha Ilimitada (2011) <http://www.prensario.net/458-El-Fin-de-la-Banda-Ancha-Ilimitada.note.aspx>. (cited 24 Jun 2011)
16. Flores-Roux, E.: Banda ancha móvil: la urgencia de acelerar su despliegue en Banda Ancha. In: Jordan, V.; Galperín, H.; Peres, W. (eds.) CEPAL, pp. 136–148 (2013)
17. CEPAL: Estado de la Banda ancha en América Latina y el Caribe (2015). <http://www.cepal.org/es/publicaciones/38605-estado-de-la-banda-ancha-en-america-latina-y-el-caribe-2015>
18. CEPAL: La nueva revolución digital. De la Internet del consumo a la Internet de la producción (2015). <http://www.cepal.org/es/publicaciones/38604-la-nueva-revolucion-digital-la-internet-consumo-la-internet-la-produccion>
19. Sabatier, P.A., Jenkins-Smith, H.C.: Policy Change and Learning: An Advocacy Coalition Approach. Westview Press, Boulder (1993)
20. Sabatier, P.A., Jenkins-Smith, H.C.: The advocacy coalition framework: an assessment. In: Theories of the policy process, pp. 117–165. Westview Press, Boulder (1999). <http://www.ucdenver.edu/academics/colleges/SPA/FacultyStaff/Faculty/Documents/Weible%20and%20Sabatier%20ACF%20chapter%20in%20Fischer%20et%20al.%202006.pdf>. (2016)
21. Hann, A., Sabatier, P.: Belief systems and public policy. *Politics* **15**(1), 19–26 (1995)
22. Weible, C., Sabatier, P., Lubell, M.: A comparison of a collaborative and top-down approach to the use of science in policy: establishing marine protected areas in California. *Policy Stud. J.* **32**(2), 187–207 (2004)
23. Sabatier, P.A., Weible, C.M.: The advocacy coalition framework. In: Sabatier, P.A. (ed.) *Theories of the Policy Process*, pp. 189–220. Westview Press, Boulder (2007)
24. Avendaño, M.: Cobro de Internet móvil por descarga afectaría a 1.574 centros educativos públicos (2014). <http://www.ameliarueda.com/nota/cobro-de-internet-movil-por-descarga-afectaria-a-1.574-centros-educativos-p>. (cited 16 Jun 2014)
25. SUTEL: Convocatoria a audiencia pública, La Gaceta No. 192 (2015). [https://SUTEL.go.cr/sites/default/files/audiencias/gaceta\\_convocatoria\\_audiencia\\_publica\\_28\\_oct\\_0.pdf](https://SUTEL.go.cr/sites/default/files/audiencias/gaceta_convocatoria_audiencia_publica_28_oct_0.pdf)

# guifi.net: A Bottom-up Initiative for Building Free Telecommunication Infrastructure

Miguel Pérez<sup>1</sup>, Pablo Boronat<sup>1</sup>, José A. Gil<sup>2</sup>(✉), and Ana Pont<sup>2</sup>

<sup>1</sup> Universitat Jaume I, Castelló de la Plana, Spain  
{mperez, boronat}@uji.es

<sup>2</sup> Department of Computer Engineering, Universitat Politècnica de València, València, Spain  
{jagil, apont}@disca.upv.es

**Abstract.** Building telecommunication network infrastructures is a key issue both, in developing regions and isolated areas in order to facilitate people not only access to information and new technologies, but also to give them the opportunity of self-organize. Nevertheless, despite the huge importance of the network infrastructure for the development of people, building a neutral and open communication system is not a priority for governments, so community networks are a solid and real alternative.

In this document we present **guifi.net**, a bottom-up community network, born in Spain, having over 30,000 active nodes, totaling more than 55,000 km in network links, and showing a sustained growing rate.

**guifi.net** is an opportunity to build a distributed telecommunications infrastructure governed by the participants in an indiscriminate way.

But a network such as **guifi.net** is not only of interest in developing areas. In many countries, internet connections, despite being a basic service, are usually monopolized by a small number of private companies. An open and free network as **guifi.net** offers users the opportunity of being participants in the decisions regarding infrastructure and services.

**Keywords:** Telecommunication infrastructure · Community networks · Free access · Digital gap

## 1 Introduction

Nobody doubts nowadays about the huge opportunities that Information and Communications Technologies (ICT) bring both the developed and developing world. Nevertheless many of these opportunities are completely lost in the case of developing countries or poor societies due to the lack of appropriate communications infrastructure. For instance, without this infrastructure the access to e-learning and e-health programs are

---

This work was partly supported by Spanish Ministry under Grant DPI2014-57746-C3 (MERBOTS Project).

not possible for many citizens; young people are losing many economic chances in the new digital society; and, in general, the most disadvantaged and unconnected socio-economic groups are left behind and the digital divide is becoming wider.

Providing infrastructure communication for developing countries, rural areas or isolated communities should be a priority for governments. They should promote initiatives in this sense, motivating telecommunication companies to invest in developing infrastructure to facilitate every individual the use of ICT. But the ugly truth is the opposite. Building the infrastructure is not currently a key issue in practice. Even more, powerful telecommunications companies don't see a good business in providing infrastructure for many geographic areas (areas with low population density or underdeveloped) and then, they simply ignore the problem.

To deal with this lack of official interest the community initiative is making progress in many countries and, literally speaking gaining ground progressively. In this paper we present **guifi.net** [1, 2], a bottom-up community initiative, developed initially in Catalonia and extended currently to the rest of Spain, aimed at providing free connectivity to everyone no matter where they live and their economic status. **guifi.net** is also the history of David vs Goliath but in this work we just focus on presenting how it works and how it is expanding and covering a large part of our country. We also point some ideas to export the experience to other countries, especially those with poor or inexistent communications infrastructure with the aim of bridging the technological gap.

## 2 Motivation

Just over a decade, when WiFi wireless devices started to become popular [3], many bottom-up community networks were created by citizens [4, 5], usually enthusiastic of technology and communications. The participation and management in these networks are usually open to any individual, firm, company or public administration.

**guifi.net** [1] was another of these community networks that appeared at first in the county of Osona in Catalonia, where the councils of Vic and Gurb are located. In fact, the name of the network is a combination of Gurb and WiFi.

At the beginning there are usually two main non-exclusive reasons that can encourage individuals to create their own community network: (i) there are some people, activist and enthusiast of new technologies, that want to be independent of big telecommunication companies and, (ii) there are other people who suffer what is known as the digital divide (either for lack of telecommunications infrastructure supply, either for economic reasons).

Unlike other eminently urban communities, **guifi.net** was born in a rural area with little economic interest for private operators, as they had to make a investment to deploy infrastructure in a geographical area with low density of potential customers. That was the reason why a group of people began to organize themselves to build their own network infrastructure. Today, almost all wireless communities that were created years ago in Spain have disappeared or have joined **guifi.net**. In fact, **guifi.net** has grown and has become, as far as we know, the largest active community network in the world [6].

But why **guifi.net** had sustained growth and other networks were not? This is because since its beginning, the enthusiastic people of Osona, and especially Ramon Roca who lead the project, had the vision to prepare and organize the network growth. Everything was conceived taking into account that more people would and could be connected in a future and thus they will contribute expanding the network.

However, this is more complicated than it seems at first sight, because a high number of issues must be considered such as, a technical organization that allows steady growth with limited human intervention; the implementation of a website where all the necessary information is centralized (locations, links, network addresses, emails of the participants, maps, monitoring tools, etc.); the dissemination of the initiative, its operation and its organization through workshops and talks; the review of legal issues that may affect the network; holding meetings with politicians, administrations and companies to offer new perspectives and alternatives, etc. All these questions are not simple and they require a huge effort and an almost perfect organization.

Figure 1 shows **guifi.net** web homepage. This website provides information about the project, contains a guide for connecting new nodes, and also provides technical support, offers user’s chats, etc.



**Fig. 1.** The **guifi.net** website homepage.

Initiatives like **guifi.net** can also help to limit the use or waste of public money, which generally tends to flow towards a few hands. We could also limit the pressure of economic powers that control basic services for people. In short, community networks



can permit a more distributed, participatory, transparent and democratic management of any basic service. After all, what is most feared by regimes with no freedom? Two things: people having access to information and their ability to organize. But beware; all those nice words imply high costs, hard and continuous work, patience and to be bound to the understanding and cooperation.

### 3 What guifi.net Is?

It is said that guifi.net is a free, open and neutral network. This means that the network as a whole, does not belong to anyone (no predominance), everyone can connect (obviously saving technical problems) and it is independent of the content or services (simply an infrastructure that people use as they want). Next the main aspects that define what guifi.net is are explained.

#### 3.1 Network Funding

The network grows when someone adds new infrastructure, but this infrastructure has a cost. In the case of customers or end nodes they had to assume the associated cost, in a similar way that happens when you install a single television antenna. In the case of optical fiber deployment or installation of supernodes (nodes that allow connection to client nodes and participate in the routing task), there is a common infrastructure to be afford. For funding this infrastructure several methods can be used.

One of the funding methods, that makes it quickly growing is that the network is partially supported by the active involvement of many municipalities and some universities and schools that have installed guifi.net nodes to facilitate citizens and students the access to the services that they offer. These facilities, are usually carried out using public funds, and are also available for any private operator who wants to drive traffic and sell services on the free network.

Another form of funding is sponsorships. It is a kind of patronage or crowdfunding among users. When someone proposes a new location, a budget is proposed to install a node that provides new coverage or improves the network. People who are interested in the facility agree to cooperate economically. To this end, a web application has been developed to show the contribution commitments and the amount of funds available. Once, the donations cover the cost, the node installation is performed.

There are other types of financing. For example, people interested in a specific facility can advance the money for it to be done quickly, and later, if someone wants to participate in the network using that facility must pay a fraction of the cost, usually without trading margin and becoming co-owners of the facility proportionally to the payment done.

Finally and specially in the case of optical fiber infrastructure, the installation and maintenance costs can be distributed equally among private operators who do business on these services. In any case, the aim is to spread the costs of infrastructure facilities including those who can take advantage of them.

### 3.2 Network Technology

Worth mentioning that **guifi.net**, despite its name, it is not tied to any particular technology. The most appropriate technology for each case can be used. Currently, most of the network is based on WiFi technology in infrastructure mode (in which the nodes can be access point or client nodes), but there are areas that operate in mesh or ad hoc mode (where nodes act simultaneously as access point and client at the same time), or other areas where the infrastructure consists in fiber optic links. This latest technology is requiring a huge organizational challenge, both for economic management as for the deployment problems.

**guifi.net** is an open transport network, and users can deploy any kind of service in it (like Internet access, Web servers, VoIP, p2p file sharing, etc.). Among new users, there is often confusion between **guifi.net** connection and access to Internet. Although **guifi.net** is connected to the Internet as an operator (in the Internet Exchange Point of Barcelona), **guifi.net** does not offer direct internet access. This connection is used to allow the access from the Internet to the services of **guifi.net** and is marketed by private operators that base their business on this network. From the point of view of **guifi.net**, Internet access is another service on the network, which must be provided by the participants.

But the truth is that **guifi.net** facilitates this basic Internet access service in different ways. For example, private operators can offer it cheaper because they do not have to deploy or rent their own network. Many municipalities, usually small villages, offer free web browsing (via a web proxy) through **guifi.net** (as an example, only in the province of Castelló more than 50 villages offer this facility). Companies or neighboring communities can share the same access to the Internet thanks to the free network that facilitates their access. Also, a subscriber to an ADSL line at home can share it with other community members or use it from a second home.

The fact of having a self-managed network and at cost (no profit margins for the use of the network itself) can offer many other applications to individuals and companies, as for example: to manipulate remote automatic systems or to control systems or domotic installations.

### 3.3 Network Organization

The network expands when individuals, companies or entities connect to the network, and therefore, opening new regions. These new regions will be capable of carrying traffic from other points or nodes.

There are many interests that may collide with each other in the use of the network, occasionally disagreements or conflicts may arise. To resolve them and to ensure the basic principles of the network, when creating nodes or network regions, a license called Interconnection Agreement or XOLN (Xarxa Oberta, Lliure i Neutral which means: Open, Free and Neutral Network) must be accepted. With this agreement legal and ethical aspects are addressed; such as that network connection must not be discriminatory, what kind of traffic manipulation is allowed and which is not, what are the network legal responsibilities, or how potential conflicts will be resolved. The XOLN is inspired by free software licenses, but adapted to communications systems.

For conflict management, legal defense or representation of the network against others, a non-profit organization, guifi.net Foundation [7] has been created. For example, to amend the interconnection agreement, which is quite unusual; proposals are addressed to the Foundation. The Foundation filters them and proposes a reasoned writing, then amendments are discussed until a consensus and finally, if necessary, changes are incorporated in the XOLN.

To give an idea of the size of the network today, there are about 30,000 active nodes totaling a 55,000 km linear network. Figure 2 shows the expansion of the network since its beginning in 2004, while Fig. 3 shows the deployment of the network in the Iberian Peninsula.

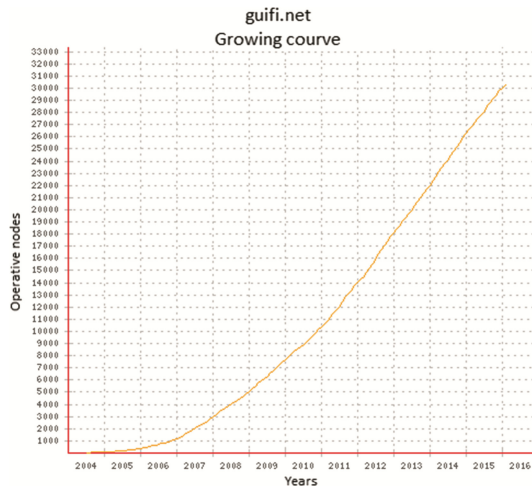


Fig. 2. guifi.net growth curve.

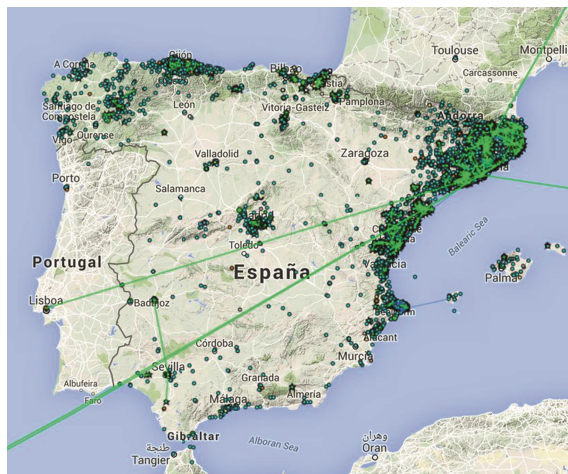
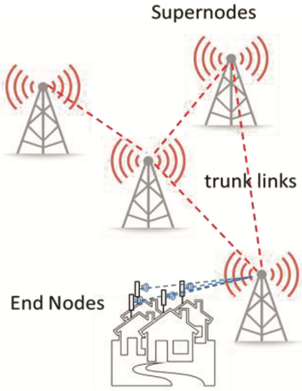


Fig. 3. guifi.net deployment in the Iberian Peninsula (January 2016)

## 4 How Does It Work?

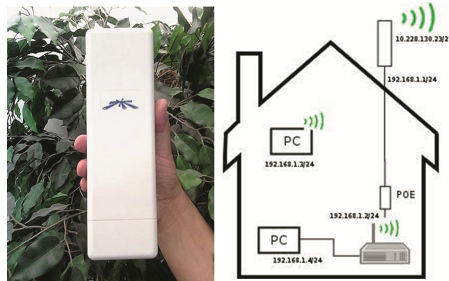
In **guifi.net** most of the network acts as a wireless WiFi network in infrastructure mode. Figure 4 illustrates the topology of this kind of infrastructure.



**Fig. 4.** **guifi.net** topology.

Let's see how this type of infrastructure network is organized. A node is a **guifi.net** installation (even if it is an island) located in a geographical place that can be found on the map of **guifi.net**. In infrastructure mode, there are two types of nodes:

- **Customer or end nodes.** These nodes are not suitable for connecting new nodes. They only provide network connectivity to end users. For example, a single family house or a neighborhood community can share a client node. This means that these nodes can have multiple users (or connected devices). Usually the node has two Internet Protocol addresses (IP). A public IP in the range 10.0.0.0/8, assigned automatically by the web application (currently we use IPv4 addresses) and, another private IP in the range 192.168.0.0/16. Private addresses are for single users, in a similar way that IP addresses are organized to perform an ADSL connection through an ISP. Privates IP are only for domestic or internal networks and are not part of



**Fig. 5.** Example of a customer or end node.

**guifi.net** or managed by **guifi.net**. The infrastructure cost of these end nodes may currently be around 100€. Figure 5 shows a photo of an integrated outdoor antenna-radio-router and a schematic example of the structure of an end node in a family house.

- **Multiradio nodes or supernodes.** These nodes usually have more than one radio or antenna. The photo of Fig. 6 shows the supernode at the roof of the School of Informatics in the Universitat Politècnica de València. Some radios are used for connecting client nodes and other radios for point-to-point links that interconnect supernodes (backbone links). Nodes also have almost one router involved in dynamic routing (usually through OSPF or BGP protocols [8]). The cost of these nodes is normally shared between users and the price of the hardware infrastructure may be around 600€. It must be considered that labor cost for the installation of this type of nodes often surpasses the cost of the material.



**Fig. 6.** Supernode at the Universitat Politècnica de València

**guifi.net** public IP's are coordinated directly from the website (<http://guifi.net>). For an antenna that provides coverage to customers usually it has up to 29 IP addresses (one network mask of 27 bits within the range 10.0.0.0/8). For point-to-point links, the web application assigns addresses in the range 172.16.0.0/12; these are networks that use two IP address (netmask of 30 bits).

Nodes are administered through the website. When a new node is registered its location should be included on the map. Each node has its own homepage providing all type of information about the node and permitting to contact the owner via email. This enables users to organize themselves to expand or upgrade the network.

In addition to the website, the support for users also includes different email lists organized by geographical areas and topics, a social network, forums and instant messaging channels. All these media can be found in the Support section of the website and are used by network users to contact each other and coordinate operations on the network.

## 5 How to Join guifi.net Community

Being part of the **guifi.net** network is not a complicated process, but minimal technical knowledge is required. As mentioned above, the vast majority of the network is operated in infrastructure mode. In this section we discuss how to join the network using this mode and assuming that there is already a nearby network infrastructure (the antennas currently used in **guifi.net** for client nodes are able to cover distances of 5 km or more provided there is line of sight path).

Basically, the requirement is to connect a WiFi antenna (usually in the U-NII 5 GHz band) with one of the supernodes that form the backbone of **guifi.net**. The router of the new node must have an IP in the range used by the supernode. **guifi.net** website is responsible for coordinating and distributing the IPs between nodes.

For connecting a new node three basic steps are needed. These three steps are described in detail in the website (<http://guifi.net/es/threesteps>):

1. **Adding a new node** on the **guifi.net** website. This is to locate on the map the geographical position in which the new node will be physically located.
2. **Adding a router** (with radio and WiFi antenna) to the node. In this step the model of the router to be installed is required. This information has to be uploaded in the corresponding entry that was created in the previous step associated to the new node.
3. **Defining the link**. That is, what supernode and which of their radios is to be bound to the new node. In this step is when the web application assigns the IP address for the new node.

After performing these three steps, the web application is then able to generate the configuration file for the router, including the Extended Service Set Identifier (ESSI), IP, gateway, and other technical parameters needed (at least for those devices commonly used in **guifi.net**). This process is known as “unsolclic” (meaning “just one click” which give us an idea about how easy the process is). After loading this configuration file on the router, it will be ready to connect to the supernode and access any service offered in **guifi.net**.

Before starting the three steps process, some details have to be taken into account. To add the node in the website (step 1), previously a user account should be created. As Fig. 7 shows, there are several tools that can help us to plan and define the new links. But, although in the **guifi.net** map the link we want to create can appear as feasible, we should ensure that there are still available IP addresses and that the signal strength is adequate. For the latter we must go up to the roof with the antenna to detect all possible WiFi signals (the ESSID’s belonging to our radios begin with **guifi.net-** followed by a location summary). However, if the process is too complicated, an installation technician can be called. There are professionals spread across all areas covered by **guifi.net** and they can be located by searching the **guifi.net** website.

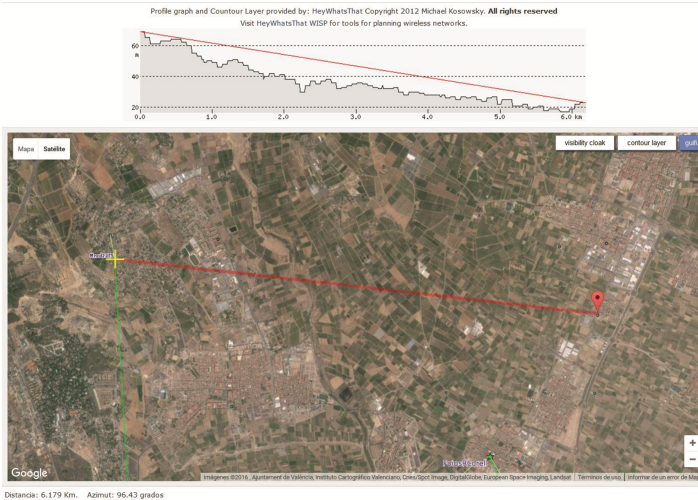


Fig. 7. Example of tools to plan new links.

## 6 How to Collaborate in the Guifi.net Project?

The best way to collaborate is extending the network by creating your own node, even if in your geographical area there are still no nodes. In the case of a new area it is important to contact with the city council, neighborhood association or cooperatives. If an initial installation is done and a service is provided, such as a web proxy, the word of mouth marketing will facilitate the expansion. In <http://social.guifi.net> there are always volunteers to help and answer questions.

There are also other ways of collaboration in the project. The **guifi.net** Foundation combines the efforts of several working groups that can provide support with technical issues, as well as legal aspects, promotion and dissemination of the network.

Although we have discussed the general interests of **guifi.net** in previous sections, we also want to emphasize its international vocation. The larger the network, the more transparent, the more equitable and the more sustainable it will be.

In fact, multinationals do their own thing and it would be of high interest to know if an open and joint infrastructure project like **guifi.net** could also operate as a new type of multinational.

Like in the free software movement where software can be used globally, the **guifi.net** platform, its management model and the lessons learned could be also used in many different countries instead of wasting energy by reinventing the wheel. In any case, contributions and improvements are always welcome.

To introduce the community network in other continents, countries and regions (which is already being done) is an activity that can also allow us to test new technologies. For example, in Spain, networks with ad hoc routing protocols in wireless networks have not grown too much, in part because the infrastructure operating mode is well known and there are trained installers.

The internationalization of **guifi.net** could mean some legal problems due to the existence of different legislations, but it should not be a major obstacle (except in countries with restricted freedom) considering the permeability of standards and markets.

One of the features that, in our opinion, should have a community like **guifi.net** is the capability to exercise surveillance over investments made with public money; both on investments in proprietary networks, closed to the general public, and on the money allocated for the promotion of private networks under the pretext of improving the market. Among the functions that **guifi.net** should play are, on one hand, to facilitate the organization of small operators who can take part in major projects, and on the other hand, being critical of granting investments of doubtful viability or excessive amounts.

Among others awards and prizes [4], the **guifi.net** project got the “European Broadband Awards 2015” awarded by the European Community for its model of economic management which is an honor and a pride for all its members.

## 7 Other Community Networks

As discussed in Sect. 1, after an initial boom in which appeared a high number of initiatives aimed at creating community networks, there are some few good examples of networks that survived their first years and look healthy in different parts of the world. These networks extend their infrastructure by connecting sections that are managed in a distributed manner. In IPv4 there was a global framework for the coordination of private address ranges so that if different networks are connected, there are not duplicate addresses. This organization was called *freenetworks.org*. Unfortunately it seems that this organization currently has no activity.

Other networks with the same philosophy as **guifi.net** can be found, among many others, in countries like Austria (Funkfeuer [9]), Germany (Freifunk [10]), Greece (AWMN [11]) and USA (Keratoconus [12]).

Usually there is a common misunderstanding between free or community networks and other networks that facilitate sharing Internet access as FON [13]. Community networks extend network infrastructure; on this infrastructure services can be provided or not. Instead of this, FON [14] is a company that enables people to share their Internet access (free or not) but no network infrastructure is created by the community. FON is rather a federation of domestic access points. Community networks stress on working on the extension of a network infrastructure in order to enable a certain degree of independence of telecommunications companies and its business model based on a proprietary and closed network. On this infrastructure community networks can grow other services such as **guifi.net** web proxies.

## 8 Conclusions

In this paper we have presented **guifi.net**, a bottom-up community network for building free access telecommunication infrastructure.

**guifi.net** is an actual alternative for providing open access to the Information and Communication Technologies to everybody, regardless of socioeconomic status,



geographical region of residence or country of birth, thus contributing to bridge the digital gap.

In our work we explain what **guifi.net** is, the main reasons that motivated its creation more than 10 years ago, how it works and how it is becoming a social phenomenon in Spain.

We have also provided information for joining the network and collaborating with the project, and finally, we hope that our work can contribute to spread **guifi.net** around the world and encourage more people to join it, thus expanding its area of action and promoting digital inclusion.

**Acknowledgments.** We would like to express our deepest gratitude to Ramon Roca for leading the guifi.net project. Without his valuable initiative, hard work, and dedication, this network would never have been possible. We would also like to thank all the members of this community, many of them completely anonymous, because they have made possible the growth and expansion of the network.

## References

1. Wikipedia. guifi.net. <https://es.wikipedia.org/wiki/guifi.net>
2. guifi.net Red de Telecomunicaciones del Procomún Abierta, Libre y Neutral. <https://guifi.net/es>
3. Gast, M.S.: 802.11 Wireless Networks: The Definitive Guide, 2nd edn. O'Reilly Media Inc., Sebastopol (2013). (tenth release)
4. Schuler, D.: New Community Networks. Addison-Wesley, New York (1996)
5. London, S.: Civic networks: building community on the net. In: Norgaard, R. (ed.) Composing Knowledge. Bedford/St. Martin's (2007)
6. Jiménez, J., et al.: Supporting cloud deployment in the guifi.net community network. In: Global Information Infrastructure Symposium - GIIS 2013, Trento, pp. 1–3 (2013)
7. Fundació guifi.net. <http://fundacio.guifi.net>
8. Black, U.N.: IP Routing Protocols - RIP, OSPF, BGP. PNNI & Cisco routing protocols. Prentice Hall, Upper Saddle River (2000)
9. Funkfeuer. <http://www.funkfeuer.at>
10. Freifunk. <https://freifunk.net/en/>
11. Athens Wireless Metropolitan Network (AWMN). <http://www.awmn.net>
12. The Global Keratoconus Freedom Group. <http://www.kcfreedom.net>
13. Wikipedia. FON. <https://es.wikipedia.org/wiki/FON>
14. FON. Global Wifi Network. <https://corp.fon.com>

# **Gender**

# Typifying Mechanisms for Gender Digital Equity in Latin America

Gabriela Marín-Raventós<sup>1(✉)</sup> and Marta Calderón-Campos<sup>2</sup>

<sup>1</sup> CITIC-ECCI, Universidad de Costa Rica, San Pedro, Costa Rica  
gabriela.marin@ucr.ac.cr

<sup>2</sup> ECCI, Universidad de Costa Rica, San Pedro, Costa Rica  
marta.calderon@ucr.ac.cr

**Abstract.** Gender digital equity in Latin America and the Caribbean is our goal. We analyze gender specific structural inequalities that constitute barriers for women's access to ICT: such as education, traditional cultural beliefs and practices, and economic inequality. We argue also that male-dominated ICT design and implementation (functionality, content, and human-computer interaction) can inhibit gender digital equity. We present a model to typify the existing mechanisms for reaching gender digital equity and propose a new mechanism: creating gender consciousness in ICT design and construction, and attracting women to the ICT field. The proposed model reflects the four mechanisms and depicts the possible means through which they can be implemented. Moreover, the model appoints actors capable of and responsible for such means. Recommendations for the ICT community regarding gender digital equity are also included.

**Keywords:** ICT and gender · Inequity · Digital divide · Digital equity

## 1 Introduction

Latin America and the Caribbean is a middle-income region, with the majority of its 42 countries and territories belonging to that category. It is a heterogeneous region, ranging from low income countries, such as Honduras, Nicaragua, Guatemala, Paraguay, Bolivia, and Dominican Republic to higher income, and regarded as more developed countries, such as Chile, Mexico, Argentina, and Brazil [1]. According to the Socio-Economic Database for Latin America and the Caribbean (SEDLAC), 34.3 % of the Latin American population is middle class, with income between \$10 a day and \$50 a day; 25.3 % is still under the poverty line of \$4 a day [1].

In last decades, many countries in Latin America and the Caribbean have made a big effort to close their gender gaps [2]: poverty has been reduced to lower levels, more girls are in school, child mortality has dropped, and diseases are being fought. However, gender issues remain and reduction in gender gaps does not mean that women's empowerment has been reached [2]. In particular gender digital divide is still prevalent in the Region.

Digital divide is “an inequality in the power to communicate and to process information digitally” [3]. In most existing published research about digital divide, the word gender refers to sex, that is, to biological women and men, since information about gender identity is not available [3]. In our research, we adopt this position.

In the next section we analyze general gender gaps in Latin America and the Caribbean. In Sect. 3, numbers and aspects of the Region’s digital divide are presented. Causes of gender digital divide are presented in Sect. 4, with the objective of trying to identify means for obtaining gender digital equity. Understanding ICTs and their potential for the empowerment of women is necessary in order to overcome the gender digital divide. Section 5 describes some different types of projects that have been implemented throughout the region to overcome gender digital divide. Our main contribution is in Sect. 6 where we present a model to typify the existing three mechanisms for reaching gender digital equity and propose a new mechanism: creating gender consciousness in ICT design and construction, and attracting women to the ICT field. Finally, Sect. 7 includes the conclusions and recommendations for the ICT community, which includes government, academia, non-profit organizations, and industry, as a guide for them to design and implement solutions for each of the four mechanism categories mentioned above, in order to contribute to reach gender digital equality and equity.

## 2 General Gender Gaps in the Region

Figure 1 shows that women are still underrepresented in the best-paid professions and receive significantly lower salaries than men. The average gender earning gap between men and women is 58 % in the region. Engineering, including computer-related professions, is the field in which female representation reaches the lowest percentage (17 %), and the second highest gender earning gap (76 %).

OCCUPATION (SORTED BY AVERAGE MONTHLY EARNINGS, HIGHEST TO LOWEST)	SHARE OF WOMEN	WOMEN (AVERAGE MONTHLY EARNINGS*)	MEN (AVERAGE MONTHLY EARNINGS*)	GENDER EARNINGS GAP
DIRECTORS AND CHIEF EXECUTIVES	● 28%	333	626	● 88%
ARCHITECTS, ENGINEERS AND RELATED PROFESSIONALS	● 18%	342	553	● 62%
LEGAL PROFESSIONALS	● 37%	351	431	● 23%
HEALTH PROFESSIONALS (EXCEPT NURSING)	● 43%	289	453	● 57%
COMPUTING PROFESSIONALS	● 17%	233	409	● 76%
SENIOR GOVERNMENT OFFICIALS	● 29%	289	404	● 40%
BUSINESS PROFESSIONALS	● 46%	272	427	● 57%
PRODUCTION AND OPERATIONS DEPARTMENT MANAGERS	● 32%	310	369	● 19%
OTHER DEPARTMENT MANAGERS	● 37%	302	378	● 25%
PHYSICISTS, CHEMISTS AND RELATED PROFESSIONALS	● 43%	229	351	● 53%
<b>AVERAGE</b>	● <b>33%</b>	<b>302</b>	<b>479</b>	● <b>58%</b>

Fig. 1. 10 TOP-Paying Occupations in Latin America, CIRCA 2007. (Source: [4])

The World Economic Forum introduced the Global Gender Gap Index (GGGI) in 2006 for capturing the magnitude of gender-based differences [2]. Three concepts are important for understanding the GGGI. The first is that it measures gaps rather than levels of attainment. The second is that it measures outcome variables instead of input variables. This means that variables such as rights, culture or customs, considered inputs, are not reflected in the GGGI. Output variables are related to basic rights, such as education and health. The third concept is that the index ranks countries by gender equity rather than by women’s empowerment. The GGGI considers four categories: Economic Participation and Opportunity, Educational Attainment, Health and Survival, and Political Empowerment.

According to the World Economic Forum, Latin America and the Caribbean have closed the gender gap by 70%. Since 2006, this region “has shown the most improvement on the overall GGGI and second-most improvement on both the Economic Participation and Opportunity and Political Empowerment sub-indexes” [2].

However, according to the Inter-American Development Bank [5], even with more education than men, women are still concentrated in lower-paid occupations. When comparing men with women of the same age and educational level, men earn 17 percent more than women. Changing household roles and stereotypes is essential to attaining gender equity in the labor market.

Women’s reality is still difficult. Too many women still die in childbirth. Employment, salary and decision making gaps still exist. More needs to be done in order to enhance access to education, job opportunities, and reproductive health services.

### 3 Digital Divide in Latin America and the Caribbean

The digital divide is rooted in the very issues that constrain Latin America’s overall economic development: income inequality, lack of infrastructure, and still-nascent technological knowledge base [6]. Note that income inequality is not necessarily related to

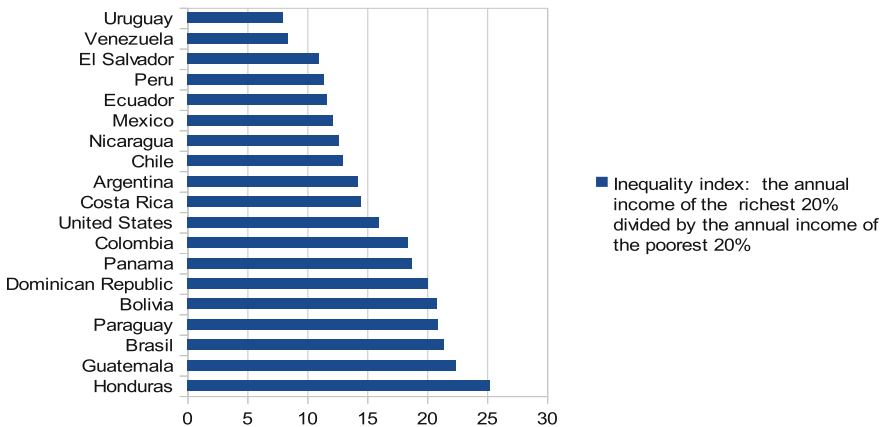


Fig. 2. Inequality in the Americas (Source: [7])

a country's wealth. Figure 2 depicts some statistics that highlight the heterogeneity in Latin America's income inequality. Uruguay ranks as the most equitable country in Latin America, with the wealthiest 20 percent receiving 8 times more than the poorest 20 percent. Venezuela comes in at number two. The United States takes eleventh place – behind Costa Rica and ahead of Colombia, and several spots below its southern neighbor Mexico. Brasil, Guatemala, and Honduras are regarded as the countries with highest inequality, and therefore, more susceptible to digital divide.

Information and communication technologies (ICT) face constraints in the region, such as a poor legal framework for the development of the ICT sector, heavy administrative burdens, almost non-existing government prioritization for ICT development, low Internet penetration, rates and pervasive brain drain which undermines the potential for faster growth of the economies' ICT sectors [8].

Despite the digital divide has been closing in Latin America and the Caribbean, improvement has been lower amongst women, youth, indigenous peoples, afro-descendants, and rural populations [9].

In order to close this gap, it is necessary to understand the problem of the digital divide. The most difficult barrier to overcome is not related to access (telecommunication infrastructure and dissemination of artifacts), but to use [10]. Opportunities created by technological innovations depend on the use made of them and how they affect the professional development and life of people. The Economic Commission for Latin America and the Caribbean (ECLAC) [11] points out that there is a lag in the ability to adopt and disseminate information technology and systems innovation in Latin America and the Caribbean. They point out that this panorama is even more discouraging given the fact that in recent years, the region's connectivity growth has been the world's fastest. Unequal access of different social sectors to this new technology is their concern. ECLAC warns that the risk of widening the domestic digital divide is greater within the region, than the threat of increasing the gap between the region and the developed world [11].

In particular we are interested in examining how to diminish digital divide existing amongst Latin American and the Caribbean women.

## 4 Gender Digital Divide

Gender digital divide is a reality in many developing countries. Hilbert found that women used Internet less than men, both in Latin America and Africa [3]. Other two differences between men and women, related to having or not a job and attending an educational institution, were found. In both cases, men reach higher employment and educational attainment percentages. However, when eliminating these two facts, that is, when considering only educated and working women and men, women become more active Internet users than men. Technophobic arguments, such as thinking that women have a negative attitude toward ICTs, are no longer valid [3, 12]. However, there are gender specific structural inequalities that constitute barriers for women's access to ICTs. According to [10], they are education, traditional cultural beliefs and practices, as well as economic inequality.

The gender digital divide can only be overcome reaching gender equality and gender equity. According to the International Fund for Agricultural Development, gender equality “means that women and men have equal opportunities, or life chances, to access and control socially valued goods and resources. This does not mean that the goal is that women and men become the same, but it does mean that we will work towards women’s and men’s equal life chances [13].” On the other hand, gender equity “means fairness of treatment for women and men, according to their respective needs. This may include equal treatment or treatment that is different but which is considered equivalent in terms of rights, benefits, obligations and opportunities [13].” We believe gender equality is the basis upon which gender equity can be sought.

## 5 Towards Gender Equity: Types of Projects

First, we should be aware that ICTs uses are not gender neutral, even when producers’ goal is to sell technology with the least variation in order to lower costs. For example, in a study of How Women and Men Use the Internet [14], Deborah Fallows identified several gender differences: (1) Men are more interested than women in technology and are more tech savvy. (2) Moreover, significantly more men than women: maintain and fix their own computers, are more likely to try new gadgets and applications and software, and are more confident in themselves as searchers and geeks, and pursue and consume information online more aggressively. (3) Women are more enthusiastic online communicators, use email in a more robust way, and are more concerned about general criminal use of the internet than men.

Understanding ICTs and their potential for the empowerment of women is necessary in order to overcome the gender digital divide. Empowering women will give them the capacity to cope with life requirements more efficiently and to transform life conditions. Initiatives for building these two capacities exist and have to be encouraged [10].

In order to build the capacity of coping with life requirements, it is necessary to provide women with the skills that will give them self confidence to use technology. Projects such as TIC-as (ICT-as), under the leadership of the cooperative Sulá Batsú [14], can help to achieve this goal, integrating more women in rural areas to ICTs. Women need to get basic knowledge for using word processors and spreadsheets and navigating in the web. They can also use technology in order to learn about other fields, such as agriculture, legislation, negotiation, marketing, and finance. This can help them to find a job, or a better job, or even, start their own business.

Attracting women to ICT studies is also important because it can help women transform life conditions. ICT is not gender neutral [15]. There are differences between men and women on hardware and software requirements, desired interaction modes, use contexts, and acquisition capacity. Therefore, increasing the participation of women in ICT design and development can help to promote gender digital equity, create awareness of the importance of including gender issues when designing and developing technology, destroy the public perception that ICT is a male domain, ensure a competitive workforce, and enhance the quality of women in general [16].

Initiatives such as *Meninas Digitais* (digital girls) in Brazil [17] and *Work Intel Network (WIN)* [18] aim primarily at students of high school and technological education, to motivate them to follow careers in ICT. The robotic program of the *Fundación Omar Dengo* in Costa Rica is designed to develop creativity and innovation skills in children creating and programming robots [19].

It is interesting to note that most initiatives to empower women and to reduce gender digital divide are women driven, and do not correspond to structured public policies.

## 6 Typifying Mechanisms for Reaching Gender Digital Equity

Mechanisms for reaching digital equity must attack several dimensions, since it is not only an economical issue. Several mechanisms have been proposed and implemented. We present a characterization of mechanisms based on the degree of ICT appropriation that women can reach.

The first category is **providing women with access to technology**. This seems simple, but the effect is not necessarily the expected. Women who have not received training on computers can feel frustrated. If the computer is at home and available for all the members of the family, there is no warranty that women will use it. Women could think that the computer is for her husband and kids, and that it is not worth using it [20]. Access can also be provided through public computer centers, but some women may not visit these places by themselves. If there is a charge for using a computer, women with low income can hardly afford it, and if they can, probably they will find other priorities to invest the money, foreexample, to enhance the quality of living of her children. Moreover, moving to a public computer center may not be possible for some women who have to take care of other members of the family. Access to mobile telephones plays an important role, not only because they are low cost devices, but because they are for personal use (not for family use), and can help overcome the impossibility of moving to a public computer center.

The second category is **allowing women to learn how to use standard software tools** (for example, word processing and spreadsheets). This can be a social activity, so that a group of women can learn together and support amongst themselves. However, these software tools may not be useful enough to make women enthusiastic TIC users. Additionally, as stated before, women may not be able to leave their house and move to the training center, because of distance, cost, or obligation of taking care of someone else.

The third category is empowering women through **enabling women to learn how to use ICTs to take control of their lives**. TICs can be tools for improving life conditions. Women must be empowered such that they can find out how technology can help them improve their own quality of life: for example, help them control domestic expenses, sell products they produce, increase their income, find employment opportunities, or learn about topics they need to know, such as health, child care and nutrition, among others [3]. Even more importantly, ICTs can help women increase their self esteem. ICTs can become channels to reunite women groups to fight for their own rights.



Evaluation methodologies are required in order to determine whether an ICT project really improves women's social conditions and promotes a positive change at personal, institutional, community, and social levels. For example, the Gender Evaluation Methodology (GEM), developed by the Association for Progressive Communications (APC), has been used in many initiatives since 2002 [21]. GEM, created with the participation of experts on ICT development in 25 countries from Latin America, Asia, Africa, and Central and East Europe, is useful for determining what role ICTs play in changes that empower women and how this changes shift gender relations between women and men. Methodologies like GEM provide policy makers and the ICT community with feedback that can help them improve the social effects of ICT projects [21].

Moreover, when men and women share the learning experience and work together, in an environment without discrimination in which both have the same participation opportunities, men can change their opinion about women's ability to use computers. This is very important because respect and power relations can become more favorable for women. In Latin America, more than 300 community telecenters have been installed [12]. At these places, people can learn about ICTs and how to use them to promote community development. People, from very different backgrounds, work at these telecenters. The Women's Networking Support Programme (WNSP), of the APC, is "a network of women throughout the world committed to using technology for women's empowerment" [22]. WNSP experiences in telecenters show that the diversity of technological solutions and innovation are promoted when men and women participate in an equitable environment [12].

Previous three categories to pursue gender digital equity have been studied and promoted in most countries. We want to highlight the importance of higher female representation in ICT related jobs as a means to enhance gender digital equity. It constitutes our fourth category of mechanisms: **creating gender consciousness in ICT design and construction, and attracting women to the ICT field**. Women have special gender needs that will hardly be considered if they do not participate in ICT's design and implementation. An interesting example of gender consciousness is that Hewlett-Packard (HP) discovered that quilters used HP ink-jet printers to transfer patterns onto cloth [23]. This is a female need that HP seriously considered and developed custom quilting software. This decision was taken due to the presence of a significant number of women at HP. Women in the ICT field should become aware of situations such like the shown in this example. Many women in the world are owners of small businesses which could take advantage of ICTs. Paying more attention to their needs could help ICT developers, or women themselves, find new business opportunities which would improve female living and working conditions.

Women on ICT jobs would be the voice of many unheard women and would help achieve gender digital equity. Attracting women to ICT college careers and empowering them to play a proactive role in the professional field is a challenge. Numbers show that the percentage of women studying ICT careers is very low and it is even decreasing not only in our Region [24]. Consciousness on this fact has been obtained but researchers and university department authorities had not succeeded in attracting more women.

Figure 3 evidence the actors, and the means they normally use, to implement the four mechanisms identified to enhance gender digital equity. Most proposals to diminish

gender digital divide concentrate on the first three mechanisms. However, we believe the fourth mechanism, creating gender consciousness in ICT design and construction, can facilitate the previous three, not only in Latin America and the Caribbean, but globally. Women can design and develop ICT technologies better suited for female needs, can develop more female friendly applications and e-learning tools to promote ICT use amongst the female community, and can help empower women.

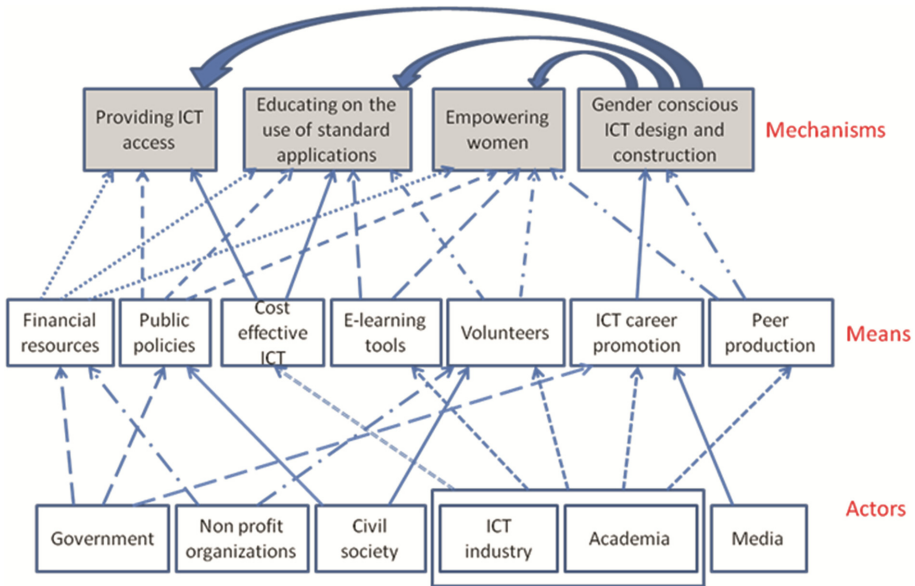


Fig. 3. Mechanisms for Reaching Gender Digital Equity

## 7 Recommendations and Conclusions

The ICT community, which includes government, academia, non-profit organizations, and industry, can contribute to design and implement solutions for each of the four mechanism categories mentioned above, in order to contribute to reach gender digital equality and equity.

For the first category, the ICT community should continue developing cost efficient devices, protocols and communication technologies, in order to warranty low cost access to women. Community access centers are a source to provide access, if schedules are designed to incorporate women’s needs, and daycare facilities for children and elderly are provided. Moreover, they must foster an environment in which women can interact with someone who can solve her doubts. Mobile technology may play an important role since they avoid the need to attend community centers. They are easy to use and low cost.

Government policies can provide incentives and financial sources to supply mobile technology access to women. They can impose conditions on companies that want to

operate in a country, such as obliging an operator to donate telephone connections to the lowest income population.

For the second category, it is important to be aware of the limitations women can face. Developing on-line training programs may be very convenient, because women would not have to leave home, and could choose when to connect and interact with the applications. E-learning is a challenging option requiring the participation of professionals from different backgrounds. Content creation is a major issue, because training applications should be easy to use and should offer options to solve doubts. Usability is a very important feature, since women value it more than men, and may not have too much time to experiment with the application [15].

For the third category, the ICT community should understand women's needs. These are not necessarily standard, since needs could depend on the natural and social environment. An important issue is promoting innovation and entrepreneurship among women. Introducing women to electronic commerce and social networks to sell their products is an example of how this could be achieved.

Another possibility is thinking about how to introduce women in the service sector, that, in general, offers better income conditions than the manufacturing sector. Telework may become helpful to overcome limitations women face when looking for a job. Women could receive necessary job training through on-line applications.

Creating online content that can help women improve their living conditions must be a cooperative activity result of the interaction of the ICT community and women. Examples of key areas of content are education, health, nutrition, and child and elder care. Language used has to be understandable and adapted to the natural and social environment.

Women should not be only content consumers. Introducing women to peer production in any of its two modalities, commons-based and corporate-based, could help them to introduce them in the creation of information (e.g., financial services, accounting) and culture (e.g., music) [25]. This would allow women to get an income and would help balance gender-power relations.

Giving women the possibility of participating in community decisions related to ICT projects makes sense when they have understood the opportunities technology offers. Government policies can enforce female participation in decision making, but cultural aspects could neutralize the possible effects of these policies. Teaching women how they can assume an active role in the Internet governance, through commons-based peer production, would help them to become more autonomous, because they could create services and information by and for themselves and could freely organize in non-hierarchical organizations [25].

The ICT community should also take advantage of international volunteer programs, in which experts in ICT volunteer as tutors in education programs. It would help to lower program costs. For example, from 2001 to 2013, Korea Internet Volunteers (KIT) has contributed with more than 900 volunteer teams, mostly formed by college professors and students, who have supported ICT education programs in 70 countries in Latin America, Africa and other continents [26]. Governments and non-profit organizations should promote local volunteer programs, in which active and retired ICT experts could participate. ICT enterprises could establish social programs in which both the company

and the employees contribute according to their capabilities. Companies could provide materials and ICT tools helpful to women, and employees could volunteer to work as instructors.

However, the ICT community should understand that introducing ICT in a community is not sufficient to achieve positive social changes. Reviewing existing evaluating methodologies and promoting its use is a pending task.

For the fourth category, creating gender consciousness in ICT design and construction, especially attracting women to the ICT field, is a pending task worldwide. Moreover, retaining them not only while they study, but also during their professional life, requires also our attention. Their presence in classrooms and working places can contribute to get higher levels of innovation and competitiveness.

Women conceptualize a profession mostly based on the opinion of others and the messages they receive from the society [24, 27]. On the other hand, men make their career decision based on their personal experiences with technology, starting from toys they have played with. Therefore, attracting young women to computer-based careers requires of several changes. Young girls should have the same opportunity as boys of playing with toys that let them solve problems and design solutions. Girls should receive support from their parents and professors when they decide to study a technological college career. The ICT community can develop promoting programs showing what ICT professionals do, highlighting the opportunities that ICT offer to improve people's lives and promoting professional development. Media can highlight the achievements of women in technological fields, which would help to change stereotypes that keep young girls away from ICT careers and would provide them with models to follow.

Universities can play a more proactive role in recruiting ICT students. Both female and male professors can visit primary and high schools to talk about possible professional development paths and to resolve the doubts students could have. Some changes on Computer Science curricula can also be beneficial. Changing the program of the career introductory course from a technological approach to an ICT potential impact approach can help women to be sure they made the right decision when choosing career. A mentoring system during the first college year, in which women are empowered and motivated to express their needs and opinions and their self esteem is increased, could help retain them in the ICT field. Promoting a non-discrimination study environment and working on teams in which at least a woman is always present might help male classmates understand that they get better technological solutions when both sexes cooperate.

The ICT community must become aware of the importance of designing technology considering gender differences. The field of gender human-computer interaction has contributed to understand that women and men use computers for different purposes and goals [15], due to differences in their personal interests and in the roles both sexes play within their families and communities. Physical differences (e.g., in weight, height, and strength) should also be considered, in order to avoid personal damage and fatigue. However, there are no general rules that can be applied when identifying special needs of men and women, because human beings are complex and their motivations and interests sometimes can seem contrary to what is expected. If the aforementioned mechanisms for empowering women and helping them empower themselves are effective,

more Latin American women could become business owners, new needs may emerge, and ICT women may think about them more seriously than men would. It is difficult to do research to prove the possible positive impacts of (1) gender conscious technology design, and (2) greater presence of women in the ICT field, on gender digital equity. Cause effect factors on long term societal phenomena are very hard to measure. We invite the international community to try to propose mechanisms to address this issue, and help us demonstrate the impact of our proposed mechanism.

Finally, to foster gender digital equity, women in ICT related jobs should not limit their activities to designing and building technology. They should also have the opportunity of participating in the definition of related policies, making sure that regulations and incentives necessary to motivate and facilitate the creation and use of applications favoring women, are created and implemented.

## References

1. Socio-Economic Database for Latin America and the Caribbean. Stats. <http://sedlac.econo.unlp.edu.ar/eng/statistics.php>
2. The Global Gender Gap Report. World Economic Forum, Switzerland (2015)
3. Hilbert, M.: Digital gender divide or technologically empowered women in developing countries? A typical case of lies, damned lies, and statistics. *Women's Stud. Int. Forum* **34**(6), 479–489 (2011)
4. Ñopo, H.: The paradox of girl's educational attainment. In: *America's Quarterly, Issue Gender Equality: Political Backrooms, Corporate Boardrooms and Classrooms*, pp. 101–104 (2012)
5. Ñopo, H.: *New Century, Old Disparities: Gender and Ethnic Gaps in Latin America and the Caribbean*. Inter-American Development Bank, Washington, D.C. (2012)
6. Marín, G.: Digital equity and gender issues in Latin America. In: *23rd IFIP World Computer Congress (WCC 2015)*. [http://www.wcc-2015.org/WORKSHOP\\_ON\\_DIGITAL\\_EQUITY\\_speakers.php](http://www.wcc-2015.org/WORKSHOP_ON_DIGITAL_EQUITY_speakers.php)
7. The Huffington Post: U.S. Income Inequality Worse than Many Latin American Countries. [http://www.huffingtonpost.com/2013/01/27/us-income-inequality-wors\\_n\\_2561123.html](http://www.huffingtonpost.com/2013/01/27/us-income-inequality-wors_n_2561123.html)
8. World Economic Forum: Singapore overtakes the United States in the World Economic Forum's Global Information Technology Report. <http://web.worldbank.org/archive/website00818/WEB/OTHER/SINGAP-2.HTM>
9. Inter-American Development Bank. Gender Equality in LAC and the IDB. <http://www.iadb.org/en/topics/gender-indigenous-peoples-and-african-descendants/gender-equality/gender,1926.html>
10. Huyer, S, Sikoska, T.: *Overcoming the Gender Digital Divide: Understanding ICTs and their Potential for Empowerment of Women*. In straw Research Paper Series No. 1, April 2003
11. Economic Commission for Latin America and the Caribbean: Digital Divide could Widen in Latin America, <http://www.cepal.org/en/pressreleases/digital-divide-could-widen-latin-america>
12. Sabanes, D.: *Mujeres y nuevas tecnologías de la información y la comunicación*. In: *Cuadernos Internacionales de Tecnología para el Desarrollo Humano 2*, Spain (2004)
13. International Fund for Agricultural Development. <http://www.ifad.org/gender/glossary.htm>
14. Fallows, D.: *How Women and Men Use the Internet*. Pew Research Center Washington (2006). <http://www.pewinternet.org/2005/12/28/how-women-and-men-use-the-internet/>

15. Sula Batsú: TIC-as La ciencia nos necesita. <http://sulabatsu.com/ticas/que-es-tic-as/>
16. Calderón, M., Marín, G.: Tablet use patterns and drivers of user satisfaction: a gender approach. In: Collazos, C., Liborio, A., Rusu, C. (eds.) CLIHC 2013. LNCS, vol. 8278, pp. 71–78. Springer, Heidelberg (2013)
17. Ashcraft, C., Eger, E., Friend, M.: Girls in IT: The Facts. National Center for Women and Information Technology (2012)
18. Program Meninas Digitais. <https://sbcmt.wordpress.com/meninasdigitais/>
19. Kass, K.: How Intel Empowers their Female Work Force, United States, Intel. <https://www.simply-communicate.com/case-studies/company-profile/how-intel-empowers-their-female-work-force>
20. Fundación Omar Dengo: Programa de robótica educativa infantil. <http://www.fod.ac.cr/robotica/index.php/red-de-robotica-educativa/10-proyectos/14-cursos-infantiles>
21. Gorano, C., Goñi, M.: TIC para el Cambio Social: Las Mujeres Protagonistas. Intendencia Municipal de Montevideo, Montevideo (2007)
22. Association for Progressive Communications: GEM Gender Evaluation Methodology for Internet and ICTS. <http://www.genderevaluation.net/>
23. Association for Progressive Communications: Glossary. <https://www.apc.org/en/glossary/term/253>
24. Speizer, I.: By Adding More Women to its Workforce, HP Sees Customer Need More Clearly, Workforce (2004). <http://www.workforce.com/articles/by-adding-more-women-to-its-workforce-hp-sees-customer-needs-more-clearly>
25. Calderón, M.E., Marín, G.: En quién o en qué confían las mujeres para tomar la decisión de estudiar computación. *Rev. Novatica* **231**, 13–21 (2015)
26. Benkler, Y.: *La Riqueza de las Redes*. Icaria Editorial, Barcelona (2015)
27. Red de Redes Telecentros LAC, Proyectos. <http://www.telecentros.org/proyectos.php?id=2>
28. Adya, M., Kaiser, K.M.: Factors influencing girls' choice of information technology careers. In: Trauth, E.M. (ed.) *Encyclopedia of Gender and Information Technology*, pp. 282–288. IGI Global, Hershey (2006)

# Women in ICT: Opportunities for Their Inclusion in an International Labor Market

Ana M. González<sup>1</sup>✉, Beatriz Revelles<sup>1</sup>, Elisabet Almeda<sup>2</sup>, Núria Vergés Bosch<sup>2</sup>, and José S. García<sup>3</sup>

<sup>1</sup> GENTIC, Open University of Catalonia, Barcelona, Spain  
{anagonzalezram,brevelles}@uoc.edu

<sup>2</sup> Copolis, University of Barcelona, Barcelona, Spain  
{elisabet.almeda,nuria.verges}@ub.edu

<sup>3</sup> Department of Sociology, University of La Laguna, San Cristóbal de La Laguna, Spain  
josamaga@ull.es

**Abstract.** ICT is a key sector for developing contemporary economies and it entails an opportunity for increasing the employment rates internationally. Women were traditionally underrepresented; therefore, we need to reinforce their role in the international labor market. Before the implementation of positive actions, we need to know what is the situation and experiences of women in ICT workplaces. Through the Spanish Labor Force Survey we analyze the evolution of women. Despite the economic crisis, data shows that women have as good job prospects as men in the ICT labor market. However, women present higher levels of qualifications than men in the same category which may be interpreted as a sign of gender discrimination. Significantly, women display more critical opinions regarding the average work week.

**Keywords:** Female talent · Incorporation of women in ICT · Labor conditions · Employment

## 1 Introduction

The low number of women in ICT was widely discussed in the literature [1–4] as a dysfunction of the education and the labor market. The lack of women in these areas evidences social injustice, particularly, in regards to the importance and great opportunities of the ICT sector for future employment [5, 6]. Apparently, women are less attracted compared to men, as shown by the low number of women in the ICT workforce. Male predominated professions tend to create unfriendly environments for the few women in the workplace. Literature attributes this as the primary cause of the exclusion of women from ICT sectors [1, 7, 8]. This work attempts to shed light on the situation of women in the Spanish labor market in relation to ICT employment. The role of women in the labor market, not specifically in ICT sector, has been traditionally linked to insecurity and poor conditions because women hold subordinate positions. In this work, we examine to what extent male and female employment shows similar characteristics, or



otherwise, in the ICT sector. The incorporation of women in the labor market has to do with maternity and second shift [9]. Labor conditions within the ICT sector affect women seriously, because they require total availability, long-hours and extra work, making difficult a work-life balance [10].

During the last decades, multinational corporations have implemented programs to mentor and attract women in their professional staff. However, positive actions have shown limited results [5]. The percentage of women in private organizations remains relatively low, around 20 %, and they occupy management and commercial positions rather than technological ones. It seems some positions are still male predominated. Therefore, we need to collect more information about how to tackle female barriers in the workplace and create more attractive environments for women in ICT sector. We need to send positive messages to women in STEM (science, technology, engineering and mathematics) in order to facilitate their incorporation into the ICT sector [11]. Role model programs are encouraging women in university but the low number of women is still a problem. Likewise, managers in the TIC sector show an increasing interest to including women, as such female talent has value for them [12]. We need to know more information about the perception of women towards the ICT employment. Female opinion about their labor conditions provides information about what problems are perceived as obstacles due to gender issues. The Labor Force Survey is an international survey that explores labor participation across 28 Member States of the European Union [13].

The paper comprises three sections. In the first section we introduced the article. In the second section we present the objectives and methodology. The third section explores the situation of women in the ICT sector and the main findings of our work. Finally, we summarize the main conclusions of this paper and make some recommendations for future implementation in education and business organizations.

## 2 Objectives and Methodology

The objective of this work aims to provide feasible data about the participation of women in the ICT workforce. This work analyzes working conditions of women in the ICT sector according to the Spanish Labor Force Survey. This survey is a large household sample survey providing quarterly results on labor participation of people aged 15 and over as well as on persons outside the labor force. European countries provide information about their national labor workforce in accordance with Council Regulation (ECC) No. 577/98 of 9 March 1998. From the application of this survey, the microdata contains information about several dimensions of labor conditions, unemployment situation, in a representative sample per regions, as well as sectors of activity. Spanish Labor Force Survey covers 60.000 households and 150.000 people.

Some methodological notes about the ICT sector are necessary for understanding the findings of this study. We use the classification of technological occupations (National Classification of Occupations CNO) by the National Institute of Statistics, as proposed by the ILO in 2011. Occupational categories cover professionals in information technology (code 27 of the National Classification of Occupations (CNO) 20) which comprise analysts and software designers and multimedia specialists in databases and



computer networks; technical positions in science and engineering (code 31); technicians and information technology and communications (code 38) that comprise operations and information technology user support, computer programmers and technicians in audiovisual recording, broadcasting and telecommunications.

### 3 Women in the ICT Labor Market

ICT employment is a relative small percentage of the total Spanish employment (4 %). This sector of activity only represents 1.4 % of the workers; however, the importance of the economic sector increases the relevance for the workforce. The representation of women in these groups of occupations is very limited 0.6 % in comparison with men, which is 2.1 % of the total population. Women represent around 24 % of the total employees in the ICT sector. A characteristic of this sector is the high rate of employment for both men and women professionals which supports the hypothesis of good expectations of employment for male and female workers. According to the Labor Force Survey in 2015, the unemployment rate (people in ICT sector who left the labor market last year) reaches 3.2 %, similar for men and women in the workforce. Employment and unemployment rates from 2008 to 2013 in the ICT sector show a steady situation, even if Spain was severely affected by the economic crisis, ICT employment displays a positive evolution. The economic crisis destroyed 3.5 million jobs, mostly in two activity sectors ‘building construction’ and ‘specialized construction activities’. Consequently, the ICT sector presents a healthy situation that positively affects male and female workforce.

Table 1 presents rates of employment of men and women and shows a gender gap in the ICT sector. The percentage of women is smaller than men in every age group as a result of low female presence generally. Additionally, the female workforce displays different percentages in occupation rates between age groups. Women between 46–64 years old have the lowest percentages (0.6 %) which reflects a historical underrepresentation of women in the ICT sector. The youngest women (25–30 years old) are 2.5 less represented than men in the same age group. This data suggests that there is as low integration of women in the ICT labor sector despite an increasing number of female graduates. These results indicate that the implementation of positive actions is necessary for the inclusion of women in ICT environments.

**Table 1.** Rates of employment in ICT sector by age groups

	Men	Women	Total
25–30	3.9 %	1.4 %	2.6 %
31–45	5.3 %	2.0 %	3.7 %
46–64	2.8 %	0.6 %	1.7 %
Total	3.6 %	1.1 %	2.4 %

Source: EPA 2015, INE second term

We have looked at employment security in the ICT labor market from a gender perspective. Table 2 displays gender differences in ICT employment. The results indicate

similar percentages of men and women with regard to temporary employment and part-time employment. In the case of temporary employment, women show a slight difference (13.8 % men; 15.8 % women) but the effect is very small and lacks statistical significance. Parttime rates are similar to men and women rates from other sectors. However, we explore reasons why men and women are part-time employees, displaying women argue family to a greater extent than men (33.5 % women; 4.5 % men).

**Table 2.** Gender differences regarding employment typology

	Men	Women	Total
< 35 h	5.2 %	4.7 %	5.1 %
Temporary jobs	13.8 %	15.8 %	14.3 %
Part-time	3.4 %	5.5 %	3.9 %

Source: EPA 2015, INE second term

Working long hours is identified as a factor which contributes to creating an unfriendly environment in the ICT sector [14–16]. The percentage of employees working overtime in the ICT sector is higher than in any other activity sector, although men and women work the same amount of extra hours, with being slightly higher (9.5 % men; 9.8 % women). This indicates that women undertake the same work as men and is disadvantage for professional mothers [1, 3, 4]. According to the Labor Force Survey 2015, women would like to work fewer hours than they actually do, even accept a pay cut. The Labor Force Survey asks questions about preferences for working hours and the willingness to accept a reduction in wages. Findings show that 9.8 % of women would accept a reduction in working hours compared to 4.6 % of their male counterparts. Moreover, 64.2 % of women would prefer to accept pay cuts, while 56.7 % of men would be willing to accept to work more hours than women in the ICT sector. The survey shows gender differences regarding the work attitudes and life styles of men and women. Results suggests that women suffer severely the long working hours in the ICT sector, since they accept lower wages instead of spending more free time outside work.

We identify that a work-life balance is as a handicap for the female workforce [3, 4, 9]. Despite the effectiveness of positive policies, women are negatively affected by social gender roles that continue distributed traditionally. In relation to family care, the Labor Force Survey includes some questions that allow us to know how men and women are living with children under 17 years old. As a result, we know how family matters in the distribution of male and female workforce in the Table 3. The data show that there is not a difference between men and women with children under 17 years old in the ICT sector (42.5 % men while 47.7 % women). These results suggest that women still have to compromise time for care, although we do not know the extent of coresponsibility at home nor the effect on external support for house-keeping. Table 3 displays a greater gender balance among ICT workers than among non-ICT/non-qualified workers (50.4 % men while 56.7 % women), but a greater gap than other qualified occupations (49.4 % men while 51.8 %).

**Table 3.** Men and women with children under 17 years old

	Men	Women	Total
ICT occupations	42.5 %	47.7 %	43.8 %
Other qualified occupations	49.4 %	51.8 %	50.5 %
Non-ICT/Nonqualified occupations	50.4 %	56.7 %	53.3 %
Total	49.6 %	55.3 %	52.2 %

Source: EPA 2015, INE second term

Previous studies suggest that women have to make greater efforts than men to achieve similar positions in professional careers because male dominated environments discourage women from pursuing higher milestones. In addition, they indicate that female work is undervalued because of gender stereotypes [2, 11–15]. We examine the academic credentials in the male and female workforce, checking whether women need to demonstrate greater merit than men to achieve the same position on the professional ladder. Some questions of the Labor Force Survey point to indirect ways to investigate over qualification. Data from Labor Force Survey 2105 suggest that women are more qualified than men in the ICT sector using two different indicators. Firstly, we compare over qualification by measuring more than one standard deviation from the average years of schooling by total population included in the occupation category. Through this indicator, women in the ICT sector display over qualification because they show an almost doubled ratio (19.4 %) to their male counterparts (10.7 %) in each sex group category. Secondly, we compare over qualification as a deviation of the average number of schooling years. According to this second indicator, data shows that 17.7 % of women (while 13.3 % of men) complete more years in school than the general population. There is gender statistical significance but the relationship between both variables (sex of workers and schooling years) is weak.

## 4 Conclusions

The results of this work confirm our primary findings of qualitative studies [17], concerning major obstacles faced by women in male predominated environments. The main problem suggested by responses from women interviewees in the Labor Force Survey is the time demanding environment of the ICT sector. The findings show women would accept lower wages to reduce their working schedule. Women are critical of the length of the work by week in the ICT sector. We can suggest that working hours are more stressful for women than men because of their impact on the work-life balance. The labor Force Survey shows similar percentages of male and female workers in the ICT sector with children living at home under 17-year-old, which suggests female double shift. The long-hours climate in the workplace probably clashes with care roles at home. It would be interesting to compare differences between countries regarding diverse culture and persistence of gender roles. A future line of research will provide more evidence about northern and southern countries regarding motherhood and professional orientation of women by countries.

This work also confirms the opportunity offered by the ICT sector for qualified women. Firstly, the employment rates should be an incentive for women who have higher percentages than men in unemployment rates (although it depends on wiping out gender bias in the workplace). The ICT sector was affected in a lesser extent by Spanish economic situation, maintaining employment rates and labor conditions compared to the rest of the economic activity. Unlike building, construction and banking sectors, ICT sector has shown steady rates of employment. Women employees also take advantage of the positive characteristics of the ICT sector.

Although the population employed in this sector accounts for 4 % of total employment, it expects a positive growth in the future which opens new avenues to qualified professionals [5]. This prospect should encourage young women to seek this educational qualifications and vocational training required by the ICT sector. The higher education and the labor market should adapt their structures in order to attract more young women into this traditionally male environment and encourage them to develop stimulating careers in this sector. Data suggests that encouraging women to enter technological vocations depends on employment policies to reverse the segregation in the labor market and create women friendlier workplaces [13]. Although employment conditions include a great number of work-life balance measures, the opinions of women in the Labor Force Survey suggest it is still a stressful context for women workers. This impediment is naïve because this is the most innovative sector, with total flexibility and creativity as fundamental pillars of working hours. The challenge of the ICT sector will be to implement effective measures to adapt its environment to meet the needs of women, relaxing daily work life in the institutions.

Over qualification points to the persistence of gender bias and discriminatory situations in the ICT labor market. It points to fighting against employers (headhunters and other human resources recruiters) and its prejudices related to gender and age. Our suggestion entails training courses for reinforcing abilities and competences in young people. Mentoring programs seem very positive for creating a culture of confidence in the companies and from bosses to young workers. Moreover, mentoring programs are more effective if there is a transfer from business experience to higher school curricula, in order to bridge the gap between learning and professional experience. Working jointly together, from private to public spaces, benefits global competitiveness.

The management of working hours in the workplace is a main factor that contributes to difference between men and women. Women prefer to work shorter hours which suggests that they suffer an increasing pressure on their careers. Care responsibility is a well-known cause of delaying careers for women in the labor market, but we suggest that we should consider other factors related to less stressful conceptions about life and health. The gender gap comes not only from personal choices but also from the dynamics of business world. In our view, companies should deal with a different concept of working-time to attract female and talent. Women accept fewer working-hours, even if they receive lower wages, while men feel this need to a lesser extent. These differences between men and women create asymmetries even where there are gender sensitive policies.

Diversity policy is considered an opportunity to create new perspectives and solutions in the ICT sector. Some international corporations implement diverse models of

management for attracting talent concerning the attraction of diverse people (according to their origin, sexual orientation, religion, culture, gender and other characteristics). However, the effectiveness of these policies depend on the cultural change rather than the simple incorporation of people. Diverse talent entails the decision of accepting a different kind of knowledge that inspires creativity and innovation. Classical structures in companies, concerning on-site orientation and rigid hours, could reach its limit. By contrast, the organization of culture tends to erase differences between male and female workers (or diversity of employees) because of a strong tendency to respect the aims of the corporation.

## References

1. Cockburn, C.: *Brothers: Male Dominance and Technological Change*. Pluto Press, London (1983)
2. Kvande, E.: In the belly of the beast: constructing feminities in engineering organizations. *Eur. J. Women's Stud.* **6**, 305–328 (1999)
3. Margolis, J., Fisher, A.: *Unlocking the Clubhouse Women in Computing*. The MIT Press, Cambridge (2002)
4. Castaño, C. (ed.): *La segunda brecha digital*. Ediciones Cátedra, Madrid (2008)
5. Directorate-General for Internal Policies: *Encouraging STEM Studies for the Labour Market*. IP/A/EMPL/2014-13 PE 542.199 (2015)
6. Gill, R.: Cool, creative and egalitarian? exploring gender in project based new media work in Europe. *Inf. Commun. Soc.* **5**(1), 70–89 (2002)
7. Rommes, E., Bos, M., Geerdink, J.O.: Design and use of gender specific and stereotypical toys. *Int. J. Gend. Sci. Technol.* **3**(1), 184–204 (2011)
8. Bystydziński, J.M., Bird, S.: *Removing Barriers: Women in Academic Science, Technology, Engineering, and Mathematics*. Indiana University Press, Bloomington (2006)
9. Hochschild, A., Machung, A.: *The Second Shift*. Avon Books, New York (1990)
10. De la Rica, S.: Segregación ocupacional y diferencias salariales por género en España 1995–2002. FEDEA (2007). <http://www.fedea.net/documentos/pubs/dt/2007/dt-2007-35.pdf>
11. Etzkowitz, H., Uzzi, B., Kemelgor, C.: *Athena Unbound: The Advancement of Women in Science and Technology*. Cambridge University Press, Cambridge (2000)
12. <http://ec.europa.eu/eurostat/web/microdata/european-union-labour-force-survey>
13. <http://www.niemanlab.org/2011/05/mit-management-professor-tom-malone-on-collective-intelligence-and-the-genetic-structure-of-groups/>
14. Faulkner, W.: Nuts and bolts and people: gender-troubled engineering identities. *Soc. Stud. Sci.* **37**(3), 331–353 (2007)
15. Faulkner, W.: Doing gender in engineering workplace cultures: II. Gender in/authenticity and the in/visibility paradox. *Eng. Stud.* **1**(3), 169–189 (2009)
16. Faulkner, W.: Can women engineers be ‘real engineers’ and ‘real women?’ gender in/authenticity in engineering. In: Ernst, W., Horwath, I. (eds.) *Gender in Science and Technology: Interdisciplinary Approaches*, pp. 187–203. Transcript Verlag, Bielefeld (2014)
17. Vergés, N., González, A.M., Almeda, E.: Doing and undoing genders and information and communication technologies. In: *Proceedings of the XV International Conference on Human Computer Interaction (Interacción 2014)*, vol. 80, p. 2. ACM, New York (2014). <http://dx.doi.org/10.1145/2662253.2662333>

# **Economic Development and Infrastructure**

# Can E-Commerce Provide a Solution to the Coffee Paradox?

## The Case of Costa Rica

Francisco J. Mata<sup>1</sup>(✉), Ariella Quesada<sup>1</sup>, and Gabriela Mata-Marín<sup>2</sup>

<sup>1</sup> Programa de Investigación y Extensión en Tecnología de Información y Desarrollo, Escuela de Informática, Universidad Nacional, Heredia, Costa Rica

{fmata, ariella.quesada.rosales}@una.cr

<sup>2</sup> Escuela de Planificación y Promoción Social, Universidad Nacional, Heredia, Costa Rica  
gabymata@gmail.com

**Abstract.** In spite of the boom in coffee consumption worldwide, farmers in coffee-producing countries are subject to increasingly lower prices. This situation is referred to as the “coffee paradox”, and affects the livelihood of millions of coffee farmers and their associated workers. ICT may provide a way to address this problem by eliminating intermediaries in the global value chain for coffee; therefore, we study the effect of e-commerce systems used in Costa Rica for trading coffee on prices received by local actors and discuss whether these systems provide a solution to the coffee paradox. Based on this discussion, we propose a new e-commerce system.

**Keywords:** ICT and sustainable economic development · E-commerce · Coffee · Costa Rica

## 1 Introduction

Coffee is the most widely traded tropical agricultural product in the world and approximately 70 countries in the world produce coffee [1]. It is estimated that 25 million farmers—mainly smallholders—produce 80 % of the coffee in the world, and that this agricultural product provides a livelihood to another 100 million people [2, 3]. Therefore, coffee prices are essential for improving living conditions, particularly in low-income producing countries. Deininger and Okidi [4] estimated that a 10 % increase in the price of exported coffee would reduce poverty by 6 percentage points in the case of Uganda.

Furthermore, global consumption of this product, estimated at 1.6 billion coffee cups every day, has doubled in the past 40 years [2]—making the global coffee market worth more than US \$70 billion in 2011 [5]. In spite of the increase in the global demand for coffee, this product has been performing as a primary commodity with declining prices due to increases in world production. This situation is referred to as the

coffee paradox—i.e., “the coexistence of a ‘coffee boom’ in consuming countries and of a ‘coffee crisis’ in producing countries” [6, p. xvi]. The structure of the global value chain (GVC) for coffee and the relative power of some of the actors involved in it—particularly intermediaries located in developed countries—are greatly responsible for this outcome.

Since e-commerce can restructure GVCs [7, 8], we analyze whether e-commerce can be used to address the coffee paradox by eliminating intermediaries. Our discussion focuses on Costa Rica, a country where we were able to obtain data and where e-commerce is actually used to trade coffee.

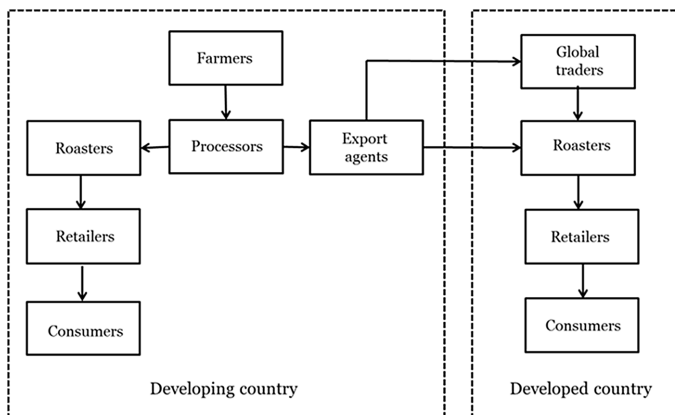
Although there is evidence that the e-commerce systems used in Costa Rica to trade coffee are capable of increasing earnings for local actors—due to eliminating intermediaries—, they also present limitations for effectively addressing the coffee paradox. Therefore, we argue that a new e-commerce system would be needed for this purpose.

This article is organized in five sections. Section 2 presents the major actors involved in the GVC for coffee, and explain their production and market functions, and their ability to appropriate rents. The e-commerce systems used to trade coffee in Costa Rica are presented in the Sect. 3. Section 4 analyzes these systems and discusses their ability to solve the coffee paradox. Conclusions and recommendations are provided in the last section.

## 2 Coffee Production, Processing and Distribution

### 2.1 Global Value Chain for Coffee

As Fig. 1 shows seven major actors can be identified in the global value chain (GVC) for coffee: farmers, processors, export agents, global traders, roasters, retailers, and consumers. This value chain can be divided into two components: one corresponding to actors located in developing countries and the other in developed countries.



**Fig. 1.** GVC for Coffee (Adapted from Fitter and Kaplinsky [9] and UNCTAD [10])



Coffee farmers grow coffee trees that produce coffee cherries. The two main species of coffee trees are Arabica (*Coffea arabica*), which is the most highly regarded in terms of taste—and hence the more valued—and Robusta (*Coffea canephora*), which is more resistant to diseases and pests, yet has a bitter taste and more caffeine content.

Coffee cherries are usually picked by hand by seasonal workers—in a labor-intensive process—to select only the ripe cherries. After the coffee cherries are harvested, they need to be processed to separate the beans from the skin and pulp of the cherries and reduce the humidity in the beans. This process produces “green coffee” and is done in curing plants or mills. Since small farmers—who are the majority worldwide—do not have such facilities, they sell their harvested cherries to coffee processing plants—owned by independent processors—or organize into cooperatives to share processing facilities, and obtain economies of scale.

Not all the coffee produced is exported; a part remains in the country for local consumption (see left-hand side of Fig. 1). Thirty percent of the coffee produced was consumed internally in coffee-producing countries for the 2012–2013 coffee crop; however, most coffee-producing countries have a small local market for coffee, with the exception of Brazil, Indonesia, Mexico and Ethiopia [1]. Locally-consumed coffee is roasted by local companies and later sold to consumers in the same country mainly through local supermarkets.

On the other hand, green-coffee beans have been traditionally the main object of export for coffee-producing countries. Green-coffee is sold through export agents to global traders or directly to roasters in consuming countries.

Roasters usually first blend different types of green-coffee beans. Roasting these beans is later performed to release their aroma. Most roasted coffee is ground by the roasters and packed in vacuum-sealed bags. However, some customers prefer to buy the whole beans once roasted and ground them before brewing.

Retailers, mainly supermarkets, sell roasted ground or whole coffee, instant or soluble coffee and decaffeinated coffee to customers. Restaurants, caterers and coffee shops are other possible coffee retailers.

## 2.2 Market Functions of the Intermediaries in the GVC for Coffee

As the GVC for coffee shows (see Fig. 1), there are five major intermediaries between farmers in developing countries and consumers in developed countries. In addition to the operational capacities required for coffee production, processing and distribution—already presented—, these actors also carry out market functions—that is, activities needed to facilitate the transactions in the GVC for coffee. Table 1 presents the market functions associated to each of these five intermediaries.

The previous functions reflect activities that small farmers are not capable to perform, due to lack of economies of scale, expertise, or contact networks. They are grouped in three main categories: matching buyers and sellers, facilitation of transactions, and institutional infrastructure, following the framework presented by Bakos [11].

Auctioning and negotiation are used as price discovery mechanisms for green coffee, whereas fixed pricing is used for roasted coffee. This is due to the larger volume traded in green coffee between companies, in comparison to the small quantity of roasted coffee bought by consumers.

**Table 1.** Market functions of the intermediaries in the GVC for coffee

Intermediary	Market functions <sup>a</sup>		
	Matching buyers and sellers	Facilitation of transactions	Institutional infrastructure
Processors <sup>b</sup>	Determination of green coffee offerings	Logistics (collecting coffee cherries from farmers and packaging green coffee for export) Settlement (paying to farmers based on crop prices) Trust (guaranteeing quality)	Regulatory (enforcing national export regulations)
Export agents <sup>b</sup>	Search (matching coffee produced with preferences of global traders and international roasters) Price discovery (determining price for green coffee with global traders and international roasters)	Logistics (shipping green coffee to traders and roasters) Settlement (collecting payments from exports and paying to processors) Trust (guaranteeing quality)	Legal (making and executing contracts according to regulations) Regulatory (enforcing national and international regulations for exporting green coffee)
Global traders	Search (matching coffee produced with preferences of international roasters) Price discovery (determining price of green coffee with international roasters)	Logistics (storing green coffee in international harbors and later shipping it to roasters) Trust (guaranteeing quality)	Regulatory (enforcing international regulations for trading green coffee)
International roasters	Determination of roasted coffee offerings	Trust (guaranteeing quality)	
Retailers	Price discovery (determining price of roasted coffee with consumers)	Logistics (distributing roasted coffee or coffee drinks to consumers)	

a. Based on the framework for market functions proposed by Bakos [11].

b. Activities of processors and export traders are regulated by law in Costa Rica.

Furthermore, guaranteeing the quality of coffee is an important market activity for several of the intermediaries in the GVC for coffee, as Table 1 shows. This is due to the fact that coffee is an experience good, rather than a search good. An experience good is one for which its quality and price can only be assessed after consumption, as opposed to a search good whose characteristics can be fully determined before purchase [12]. Quality considerations for coffee are further elaborated.

### 2.3 Coffee and Quality

To understand the impact of e-commerce on the GVC for coffee and its possible uses for addressing the coffee paradox, we need to distinguish between mainstream and specialty coffee. These two types of coffee are discussed below.

Mainstream coffee is intended for the general public and represents between 80–90 % of the total coffee market [13]. Mainstream coffee is considered an agricultural commodity, which is traded following the traditional GVC for coffee: coffee-producing countries export green coffee, which is later roasted and sold in developed countries (see Fig. 1). Essential in this GVC is the undifferentiated (commodity) nature of coffee for consumers. This allows international roasters to rely on different types of coffee beans to produce the blends associated to their own brands. Since taste differences are difficult to detect by most coffee drinkers, this practice makes it possible for these roasters to substitute beans based on prevailing economic conditions—obtaining higher profitable positions than other actors in the GVC for coffee [14].

On the other hand, specialty coffee can obtain 25 % or more in price premiums at the retail level, although this type of coffee only represents 10–15 % of total coffee traded [13]. The emergence of the specialty coffee market is an attempt to differentiate coffee and promote decommodification [6, 9, 14, 15]. This type of coffee is less related to traditional or common industrial blends (i.e., mainstream coffee), and more to high quality and/or limited availability on the supply side (gourmet or eco/sustainable coffee), or flavoring and ambience on the demand side [6, 13].

Decommodification in the specialty coffee market allows upgrading in the GVC for coffee. Upgrading is the process by which a firm improves its economic position in a GVC [16]. In this regard, four upgrading opportunities are possible for coffee: (i) process upgrading—aimed at increasing efficiency in the production process, for example through eco/sustainable certifications—, (ii) product upgrading—that is, producing more sophisticated products with higher value-added, such as organic coffee or coffee with geographical indication—, (iii) functional upgrading—which involves adopting new functions or abandoning old ones with the aim of increasing the skill content, for example when farmers sell directly green coffee to roasters in developed countries—, and (iv) intersectoral upgrading—that is, applying competences acquired in a certain value chain to a different sector or another chain, such as the case when roasters in coffee-producing countries use competences acquired in blending and roasting high quality coffee to sell roasted coffee directly in the international market [14]. Functional and intersectoral upgrading are epitomized in the e-commerce systems used in Costa Rica to trade coffee, as explained in Sect. 3.

### 2.4 Rent Appropriation

One of the main controversies in coffee, as well as in other tropical agricultural products, is the distribution of rents between developing and developed countries [2, 6, 9, 14, 15]. Each of the activities described in the GVC for coffee add value to the product purchased by the final consumers, and therefore is reflected in the final price. However, it is commonly observed that a hierarchy of value exists in GVCs, with less

wealth appropriated in nodes associated to the production of raw materials, usually located in poor or developing countries. Wealth increasingly grows as activities advance to manufacturing and distribution, commonly located in rich or developed countries [17].

Furthermore, under oligopolistic conditions some actors may be able to extract rents—i.e., a compensation beyond their value-added. These oligopolistic conditions are present in the GVC for coffee, since four multinational corporations control 45 % of the roasting segment [3]. These numbers contrast with the 25 million persons involved in coffee production—mainly smallholder farmers, who account for 80 % of the total coffee production [2].

The previous condition favors an asymmetrical distribution of income between developing and developed countries, in which on average 30 % of the retail price of coffee is shared by developing-country actors whereas 70 % by developed-country players [6, 15]. In particular, farmers in developing countries are able to receive just 7–10 % of the retail price of the coffee sold in developed countries [13].

Although most coffee for household consumption is purchased worldwide in supermarkets for a matter of convenience, it is not these retailers—but roasters—that enjoy a privileged position in the GVC for coffee. This situation differs from other agricultural products, for example fruit and vegetables, for which supermarkets establish quality standards and impose logistical requirements [6]. Therefore, the governance of the GVC for coffee—reflecting authority and power relationships among actors in the chain [17]—rests on international roasters, particularly those that are multinational.

### 3 E-Commerce Systems for Coffee in Costa Rica

The two e-commerce systems used to trade coffee in Costa Rica are presented in this section, according to the type of coffee they focus on: green or roasted.

#### 3.1 E-Commerce Systems for Green Coffee

As indicated before, the majority of exports of coffee from producing countries are in the form of green coffee. The need for roasters to know in advance the quality of this type of coffee before buying explains why pioneering digital exchanges for mainstream green coffee have failed (for an explanation of these exchanges see [10, 13, 18]), leaving only futures-markets systems to protect prices. The lack of success to establish internationally-agreed standards for green coffee favors international roasters to buy such coffee from known export agents and global traders to reduce quality risk, as presented in Fig. 1.

To solve the previous problem, the Cup of Excellence (CofE)<sup>1</sup> scores the quality of green coffee before it is traded through an auctioning system. This business-to-business (B2B) system is used by farmers to directly sell specialty green coffee to roasters in

---

<sup>1</sup> This is a program developed by the Alliance for Coffee Excellence, a US-based non-profit organization. See <http://www.allianceforcoffeexcellence.org> for more information.

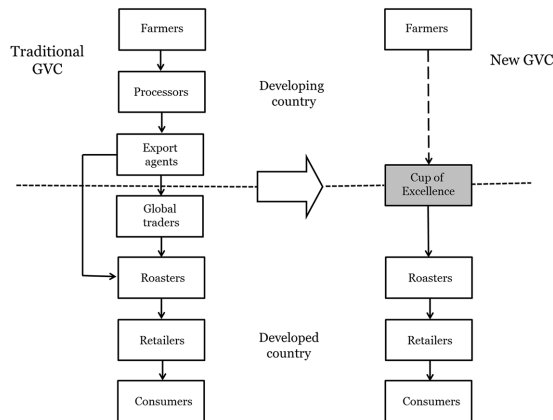
developed countries. The system is aimed at rewarding quality, considering the organoleptic characteristics of the coffee traded, and promotes national competitions for gourmet coffee in several countries, including Costa Rica. Organoleptic characteristics are associated to the human senses, and in the case of coffee they are related to acidity, aroma, body and flavor [6, 15]. Combinations of these attributes are considered in coffee cupping (see [13] for more information).

Farmers interested in participating in the CofE may submit a sample of green coffee. To produce this coffee, farmers process their own coffee cherries to obtain a small lot of green coffee—referred to as a micro-lot—not requiring a processor in this case, although they may use the facilities of an existing processor.

These micro-lots are scored before an Internet auction, based on several cupping rounds, first conducted by a national jury and later by an international jury. These contests serve as the basis for selecting samples to be auctioned on the Internet. Samples of the coffees selected can be requested by potential buyers for their independent cupping, before the auction. Providing samples is a way to reduce information asymmetry regarding quality [19]. Therefore, these ex-ante mechanisms (cupping contests and samples) solve the quality problems previously noted for trading green coffee through e-commerce in the mainstream market.

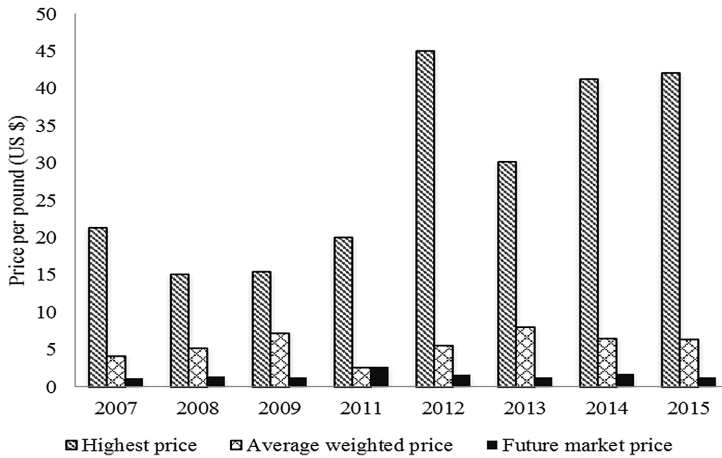
The CofE enables farmers to sell directly to roasters in developed countries. In this way traditional processors, export agents and global traders in the GVC for coffee are disintermediated (see Fig. 2). In doing so, however, the Asociación de Cafés Finos de Costa Rica—organizer of the Cup of Excellence in Costa Rica—acts as export agent for the coffees traded in the auction.<sup>2</sup>

Figure 3 presents the highest and weighted average prices obtained by the coffee auctioned in Costa Rica through the CofE since 2007 and compares them with the



**Fig. 2.** Traditional GVC for Coffee and its transformation by the CofE

<sup>2</sup> By law, green coffee in Costa Rica can only be exported by a registered export agent.



**Fig. 3.** Highest and average prices for coffees auctioned by the CofE in Costa Rica and comparison with ICE futures market prices (Data for CofE prices obtained from <https://www.allianceforcoffeexcellence.org/en/cup-of-excellence/auction-results/> and for ICE futures market prices from <https://www.theice.com/FuturesUSReportCenter.shtml>, both retrieved on 15 January 2016. The CofE was not organized in Costa Rica in 2010)

corresponding ICE Futures Market price. Overall, difference in prices between the highest bids obtained in these auctions and the futures market prices range from 660 % (2011) to 3,215 % (2015) and vary from -1 % (2011) to 552 % (2013) between the weighted average bids and this same benchmark price.

It is important to highlight that the amount of coffee traded through the CofE tends to be low in comparison with the amount of Costa Rican coffee exported. The lowest amount traded through this system was 62,199 lb in 2009 and the highest 95,266 lb in 2011. In 2015, 87,774 lb were traded,<sup>3</sup> which is less than 0.1 % of the total coffee exports for Costa Rica for the 2014–2015 crop.<sup>4</sup> This situation is due to the need to taste and score the coffee before auctioning it electronically, which limits the number of contestants, and the fact that only micro-lots of exceptional quality participate in the auction.

### 3.2 E-Commerce Systems for Roasted Coffee

Exports of roasted coffee by producing countries are very small, as previously mentioned. However, exports for this type of coffee are likely to increase since such exports

<sup>3</sup> Volume data for CofE obtained from <http://www.allianceforcoffeexcellence.org/en/cup-of-excellence/auction-results/> (retrieved on 15 January 2016).

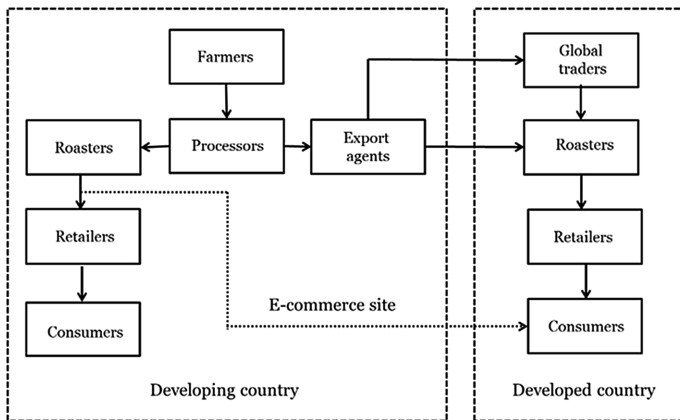
<sup>4</sup> Total coffee exports for Costa Rica for the 2014–2015 crop obtained from [http://www.icafe.cr/wp-content/uploads/informacion\\_mercado/informes\\_actividad/actual/Anexos%20Mundial.xlsx](http://www.icafe.cr/wp-content/uploads/informacion_mercado/informes_actividad/actual/Anexos%20Mundial.xlsx) (retrieved 24 January 2016).

carry a higher price than exports of green coffee, due to their increased added-value. Furthermore, higher margins can be obtained if roasted coffee is exported directly to customers [20].

For this reason, exporting roasted coffee through e-commerce is an important avenue for coffee-producing countries. This is evident in the case of Costa Rica, where 14 out of the 63 Costa Rican roasters<sup>5</sup>—that is 22 % of the local roasters in the country—sell coffee through their own business-to-consumer (B2C) e-commerce sites.<sup>6</sup> At first glance, it might be assumed that such systems are aimed to sell roasted coffee locally. However, the fact that the majority of these systems are in English confirm the fact that they are oriented to international customers.

Albeit many of the Costa Rican brands of roasted coffee traded by e-commerce are also sold through local supermarkets, their focus on geographical indication and/or eco/sustainable labeling and their emphasis on high-quality Arabica blends provides evidence that most of them correspond to specialty—rather than to mainstream—coffee. It should be noted that quality of roasted coffee is assessed by the consumers mainly through symbolic quality attributes—different from the previous e-commerce system relying on the organoleptic characteristics of the green coffee traded. Symbolic attributes are based on reputational characteristics, and in the case of coffee are reflected in brands, geographical indications, and eco/sustainable labels [6].

Figure 4 depicts the modification in the GVC due to this upgrading strategy, which changes the territoriality of the roasting function from developed countries to the coffee-producing countries. As shown in this figure, Costa Rican roasters can compete with roasters in the developed countries and also disintermediate retailers in these countries, by using this type of B2C systems.



**Fig. 4.** Traditional GVC for coffee and upgrading achieved by e-commerce sites developed by roasters in coffee-producing countries

<sup>5</sup> Similarly, to the case of export agents, local roasters need to be registered in Costa Rica.

<sup>6</sup> Information as of January 2016 obtained from Internet searches.

Table 2 shows examples of the differences in price obtained by Costa Rican roasters using e-commerce by depicting some of the brands sold simultaneously in Costa Rican supermarkets and in the roasters' e-commerce system. An increase in prices, although not as notorious as in the case of the CofE, can also be observed in this table.<sup>7</sup> It should be pointed out that roasted coffee –different from green coffee – is not subject to export regulations in Costa Rica. Therefore, Costa Rican roasters–similarly to international roasters–do not need to perform any legal or regulatory functions, when exporting roasted coffee (see Table 1).

**Table 2.** Prices of roasted coffee for selected brands in US\$

Roaster	Brand	Price <sup>a</sup>			
		EC site <sup>b</sup>	Supermarket <sup>c</sup>	Difference	
				Absolute	Relative
Café Rey (caferey.net)	Rey Premium (Dark Roast Ground 400 gr.)	11.86	6.66	5.20	78.08 %
	Tarrazú (Ground 500 gr.)	14.86	8.32	6.54	78.61 %
Grupo Britt (cafebritt.com)	Britt (Ligth/Dark Roast 340 gr.)	12.95	8.42	4.53	53.80 %
	Tarrazú Montecielo (Ground 340 gr.)	12.95	9.55	3.40	35.60 %
	Organic Coffee (Ground 340 gr.)	13.95	9.97	3.98	39.92 %
Triángulo de oro (triangulodeoro.com)	Triangulo de Oro Premium (Medium Roast Ground 340 gr.)	9.99	5.07	4.92	97.04 %

a. Prices as of 25 January 2016.

b. Do not include shipping and handling.

c. Prices in San José from a major supermarket chain.

#### 4 Analysis of the E-Commerce Systems Used in Costa Rica for Coffee

As presented in the previous section, the two types of e-commerce systems used in Costa Rica favor disintermediation in the case of specialty coffee, and allow increasing earnings for Costa Rican actors in the CGV for coffee. In the case of the CofE, the disintermediation is related to functional upgrading and focuses on the organoleptic characteristics of coffee. The ability of the CofE to provide market functions associated to processors, export agents, and international traders, such as settling payments to farmers, reducing search costs for international roasters to obtain high-quality coffee,

<sup>7</sup> It is important to note that earnings for the roasters may be higher than the price differences shown in Table 2, since the supermarket price includes a markup to cover operation expenses and obtain profits.



providing support for a new price discovery mechanism—direct auctioning by roasters for good quality-coffee is a better price discovery mechanism than the negotiation and future-markets contracts used for green coffee—, and delivering trusted—in terms of quality—third-party support for electronic transactions (see Table 1) favor cybermediation. Cybermediaries can be defined as new type of intermediaries providing functions for electronic markets offered by different intermediaries in traditional markets [8].

However, the extent of the benefits provided by the CofE is limited. Only a reduced number of farmers can participate in the competitions, due to need to cup and score the micro-lots. This limitation favors a search for scarcity from the roasters, which explains the very high prices paid for the coffee traded through this system, and also does not allow a “scalable development approach” [21].

Furthermore, a stakeholder analysis of the CofE has proved that roasters in developed countries are the real winners, since they are able to obtain even higher prices from selling the award-winning coffees than the respective farmers producing such coffees in the developing countries [6]. Therefore, this type of disintermediation does not change governance of the GVC—dominated by the international roasters, as previously explained.

On the other hand, through the e-commerce systems used by Costa Rican roasters to sell directly coffee to international customers, these roasters are able to bypass retailers in developed countries. This is done by conducting the market functions associated to international retailers in the GVC for coffee: price discovery based on fixed pricing and logistics associated to distributing roasted coffee to international consumers (see Table 1). Furthermore, the focus of these roasters in a niche (specialty coffee) favors them to substitute international roasters through reintermediation [8]. This is possible thanks to intersectoral upgrading using competences for speciality coffee, acquired in the local market. Costa Rican roasters have been developing specialty-coffee brands for the local market for more than thirty years. This trend began in 1983 when Grupo Britt introduced this type of coffee for the Costa Rican market [20]. Since then, other Costa Rican roasters have emulated this strategy.

Through this reintermediation and disintermediation, the Costa Rican roasters’ sites are also able to generate higher—but not as extraordinary as in the case of the CofE—prices by selling coffee internationally. Although e-commerce in this case affects territoriality in the GVC—due to the fact that the roasting function moves from developed to developing countries (see Fig. 4)—, this intersectoral upgrading strategy might not necessarily favor farmers—who are the most affected by the coffee paradox. In the end, local roasters may enjoy the similar privileged position as roasters in developed countries. Therefore, these systems do not either change the governance structure of the GVC for coffee.

## 5 Conclusions and Recommendations

Although the two types of e-commerce systems used in Costa Rica to export coffee internationally are able to generate higher earnings for local actors in the GVC for coffee, their effect in solving the coffee paradox is limited—as already discussed in the previous section. This situation can be explained by the fact that these systems are not able to

change the governance structure of this chain, which favors roasters. Farmers, on the other hand, are the actors that mostly bear the consequences of the coffee paradox.

This governance structure is a consequence of the structural conditions in the GVC for coffee that make customers closer to roasters, hardly establishing these customers a connection with farmers. In fact, currently there is no market that allows farmers and customers to relate in a direct manner since both operate in opposite sides of the GVC for coffee [22]. While farmers are the important component in the green-coffee market, roasters become the key component in the roasted-coffee market. Since customers act in the roasted-coffee market, farmers are invisible to them. Each of the two e-commerce systems presented deal with only one of such markets and none is able to connect farmers with customers.

Based on these conclusions, we hypothesize that if e-commerce were to be used to provide a direct connection between farmers in developing countries and consumers in developed countries, a better solution to the coffee paradox would be obtained.

Although at the beginning of the coffee activity in the 19th century, it was not possible to establish a connection between farmers in developing countries and consumers in developed countries, nowadays e-commerce is able to provide such association. However, for this connection to be meaningful farmers should be able to offer roasted—and not just green—coffee.

In this sense, there is evidence that some farmers in Costa Rica are vertically integrating—farmers participating in the CofE process their own coffee cherries and others are also roasting their own coffee beans, yet in small quantities. However, to effectively achieve this integration, farmers face challenges regarding their ability to perform the market functions associated to the intermediaries they are assimilating (see Table 1)—in addition to acquiring the required skills to carry the accompanying operational aspects. E-commerce might be able to assist farmers in this regard. The creation of electronic markets through e-commerce would help in matching buyers and sellers—due to IT's ability to lower search costs [11, 19, 23].

Furthermore, e-commerce could assist functions related to facilitating transactions—e.g., logistics and payments [8]. In addition, legal and regulatory requirements for exporting roasted coffee are less stringent than for green coffee, as previously explained.

Based on the previous, we are proposing a new e-commerce system aimed at creating an electronic market—through a cybermeridiary—for selling Costa Rican roasted coffee directly from farmers to international consumers. This new system would involve combining the functional and intersectoral upgrading processes provided by the two e-commerce systems used in Costa Rica.

Since Costa Rican farmers lack the skills and expertise, as well as the technological capacities and organizational skills to develop and operate such system, discussions for developing such a system are underway between the Universidad Nacional de Costa Rica—a public higher education having the technical expertise to develop such system—and the Asociación de Cafés Finos de Costa Rica—organizer of the Cup of Excellence in Costa Rica.

Due to the quality characteristics of coffee, a key requirement for the proposed system is creating a reputation of offering high-quality coffee for the system. This is necessary to avoid cupping and scoring the coffee offered, and open the possibility of

relying on non-organoleptic coffee attributes for marketing—similar to the case of the roasters’ e-commerce systems. In this way, the system would be able to rent this reputation to the producers. Renting a reputation from an e-commerce system is a viable mechanism to produce reputational spill-overs to sellers in electronic markets without having them to invest on creating their own reputation [19].

Creating this reputation for the envisioned system might be achieved by allowing only winners of the CofE to participate—a quality requirement easy to verify—in this electronic market. Yet different from the CofE, this new system should not be limited to trading exceptional—but rather good-quality—coffees. In this way, the system would avoid falling into the “scarcity trap” of the CofE, and hence allow a scalable development solution to the coffee paradox.

A system like the one proposed undoubtedly raises questions regarding the farmers’ capabilities to use it—i.e., access to ICT and knowledge to use these technologies—, and to whether such a system would create a benign intermediary. We are addressing such questions by implementing a prototype in collaboration with the Costa Rican farmers.

Although the proposed system would not solve the coffee paradox for all Costa Rican farmers, it would assist those already recognized for producing high-quality coffee to obtain higher earnings—in this way, contributing to mitigate the effects of the coffee paradox.

## References

1. ICO: Exports of all Forms of Coffee to Exporting Countries: Calendar years 2000 to 2013. International Coffee Organization, London (2014)
2. Fairtrade Foundation: Fairtrade and Coffee. Fairtrade Foundation, London (2012)
3. World Bank: World Development Report 2008: Agriculture for Development. The World Bank, Washington, D.C. (2007)
4. Deininger, K., Okidi, J.: Growth and poverty reduction in Uganda, 1999-2000: panel data evidence. *Dev. Policy Rev.* **21**, 481–509 (2003)
5. Geller, M., Dalal, M.: Analysis: Single-cup Coffee Sales Seen Growing. Reuters (2012). <http://www.reuters.com/article/2012/02/03/us-coffee-idUSTRE81203720120203>. Retrieved on 25 July 2014
6. Daviron, B., Ponte, S.: The Coffee Paradox: Global Markets, Commodity Trade and the Elusive Promise of Development. Zed Books, London (2005)
7. Chircu, A.M., Kauffman, R.: Reintermediation strategies in business-to-business electronic commerce. *Int. J. Electron. Commer.* **4**, 7–42 (2000)
8. Giaglis, G.M., Klein, S., O’Keefe, R.: The role of intermediaries in electronic marketplaces: developing a contingency model. *Inf. Syst. J.* **12**, 231–246 (2002)
9. Fitter, R., Kaplinsky, R.: Who gains from product rents as the coffee market becomes more differentiated?: a value-chain analysis. *IDS Bull.* **32**, 69–82 (2001)
10. UNCTAD: Electronic Commerce and Development Report 2003. United Nations Conference on Trade and Development, New York (2003)
11. Bakos, Y.: The emerging role of electronic marketplaces on the internet. *Commun. ACM* **41**, 35–42 (1998)
12. Nelson, P.: Information and consumer behavior. *J. Polit. Econ.* **78**, 311–329 (1970)
13. ITC: The Coffee Exporter’s Guide, 3rd edn. International Trade Centre, Geneva (2011)

14. Kaplinsky, R., Fitter, R.: Technology and globalisation: who gains when commodities are de-commodified? *Int. J. Technol. Globalisation* **1**, 5–28 (2004)
15. Fitter, R., Kaplinsky, R.: Can an Agricultural ‘Commodity’ be De-commodified, and if so Who is to Gain? *IDS Bulletin*. Institute of Development Studies, University of Sussex, Brighton (2001)
16. Gereffi, G., Humphrey, J., Sturgeon, T.: The Governance of Global Value Chains. *Rev. Int. Polit. Econ.* **12**, 78–104 (2005)
17. Gereffi, G., Korzeniewicz, M., Korzeniewicz R.P.: Introduction: Global Commodity Chains. In: Gereffi, G., Korzeniewicz, M. (eds.) *Commodity chains and global capitalism*. Praeger Publisher, Westport (1994)
18. UNCTAD: *Electronic Commerce and Development Report 2001*. United Nations Conference on Trade and Development, New York (2001)
19. Choi, S., Whinston, A., Stahl, D.: *The Economics of Electronic Commerce*. Macmillan Computer Publishing, Indianapolis (1997)
20. Brenes, E.R., Bolaños, I., Burciaga, R., Jimeno, M., Salas, F.: *Café Britt S.A.* *J. Bus. Res.* **38**, 23–33 (1997)
21. Wilson, B.R., Conley, J.F., Harris, T.M., Lafone, F.: New terrains of taste: spatial analysis of price premiums for single origin coffees in Central America. *Appl. Geogr.* **35**, 499–507 (2012)
22. Pelupessy, W.: La Crisis de Mercado en Cadenas Globales del Café. *Perspectivas Rurales* **5**, 57–71 (2001)
23. Bakos, Y.: The emerging landscape for retail e-commerce. *J. Econ. Perspect.* **15**, 69–89 (2001)

# Innovation and Governance: The Role of Sharing Economy

Elia Brugnoni<sup>1</sup>, Alberto Polzonetti<sup>1(✉)</sup>, and Matteo Sagratella<sup>2</sup>

<sup>1</sup> E-Lios Srl Spin off Unicam Camerino (MC), Camerino, Italy  
{elia.brugnoni, alberto.polzonetti}@e-lios.eu

<sup>2</sup> School of Law – Unicam Camerino (MC), Camerino, Italy  
matteo.sagratella@unicam.it

**Abstract.** The sharing economy originates from the development of new business models that help to record important data concerning economic development, by showing they can attract the attention of investors and the public at large. This paper tackles with the main issues related to technological development and to the ever increasing predominance of intangible or immaterial goods thus focusing on the so-called ‘sharing economy’. The players and the interests involved have been observed, together with the conflicts that institutions are called to anticipate and manage. Some principles that may offer some inspiration have been suggested too. Our objective was to show how the sharing economy may be considered as a remarkable economic resource for Italy in terms of both employment levels and tax revenue growth. In fact, it could be a great opportunity to establish new companies that, by implementing new business models, would have a positive effect on the industries that are currently suffering from the economic crisis and are relegated to grey areas or illegality. By evaluating the existing critical aspects of the Italian context in relation to industry regulations and governance, the paper aims at suggesting some pragmatic solutions to develop an ecosystem to facilitate the emergence of innovative companies that could boost employment. Mobility, tourist hospitality, work and training sectors have been taken into consideration.

**Keywords:** Sharing economy · Governance · Innovation · Sustainability · Testability · Open society

## 1 Introduction

The emergence of new technologies, which are ever more powerful but also cheaper to produce, originates from the exponential growth of transistors’ complexity, as the so-called ‘Moore’s law’ had foreseen 50 years ago by envisaging that the power of microprocessors would double approximately every two years, at the same cost. For example, if a Volkswagen Beetle, in 1971, had undergone the kind of technological improvement forecast by “Moore’s law”, today, ‘you would be able to go with that car 300.000 miles per hour. [1] Lately, such an impressive technological advancement has produced sensational effects, also thanks to strategic business choices. As a result, large companies producing microprocessors have been marketing on a large scale less powerful processors, but at increasingly lower prices. This kind of marketing policy allows higher

funding needed to develop top range products that are ever more powerful and competitive, but also likely to be replaced within a short time.

The huge offering of low-priced microprocessors and the need to use such an enormous computing power, formed the basis of the simultaneous development and spreading of the Internet and of its applications.

At the end of the 90's, the pastures of new business opportunities came to light and, new economic, social and political visions, or even some reformulations of the same, have also emerged, at times. However, the very first steps of the various approaches were made through software development.

The pressure exerted by the new peer-to-peer approach for the exchange of information led to the questioning of intellectual property models, as well as to many opportunities for new companies, services and professions, at the same time.

Up to then, the virtual web world set some limitations to such trends, but from then on the process of integration of the two realities has started.

However, a common theme for this multifaceted phenomenon is the technology's power to change society and people's lives within a scenario where resources are becoming increasingly scarce and the choices imposed on society more difficult.

In particular, the so-called 'sharing economy', or collaborative consumption economy, was initially so defined by Prof. Yochai Benkler, from Yale Law School, in 2004 [2].

Sometimes the opportunity to develop an economic and social context consistent with a certain moral vision of life has led to consider the sharing economy as an alternative to the capitalistic system<sup>1</sup>.

Many have already used very convenient and advantageous services such as Uber, Lyft, Airbnb, Upwork etc. that allow users and owners to get into contact.

That's the reason why some believe that rather than a sharing economy, the one that is taking shape could actually be an accessibility economy, where, also due to the enduring economical crisis, people try to get some extra income or through new, low-cost purchase opportunities.

## **2 Sharing Economy and Accessibility Economy - Is There Room for Both?**

The vision of sharing economy that 'purists' (i.e. those who see it as essentially local, horizontal and community based) have, appears to be in contrast with the actual working of companies operating at global level. Nevertheless, the continuous contamination between the two approaches is quite remarkable.

That is clearly shown by the evidence that many of these companies, which now appear to be almost monopolistic ones, up to a few years ago were small startups themselves, having a limited geographical scope and a small community of users. It seems that there is enough room for both approaches.

---

<sup>1</sup> The future of business: what are the alternatives to capitalism? Jules Peck, the Guardian, <http://bit.ly/IEWNdmb>.

The dynamic ‘creative destruction’ foreseen by Schumpeter seems to be confirmed, while new perspectives, expectations and problems are also emerging. To provide an example of the current state of the international debate, it may be interesting to consider the point of view of Robert D. Atkinson, President of the Information Technology and Innovation Foundation, based in Washington D.C. who, in spite of his progressive stand, is quite critical about the ambiguities existing both in the United States and, particularly, in Europe.

In this case, the basic assumption is that economic progress should be accompanied by the creative destruction originating from technological progress. The role that progressives should play is to be supportive of innovation (and not act as populists by slowing it down), and increase factors of production, by helping workers, adjusting to the changes that are taking place.

According to the Innovation Technology & Innovation Foundation’s founder, the progressive movement is or should be dealing with the continuous transformation of economy and its institutions. However, as Atkinson points out, the progressives show an ambiguous attitude about such transformation, since they are concerned about ‘balances within the social-democratic society’.

The fast technological innovations and connectivity increase have led to a multi-direction development of new companies and business activities that have often overflowed into more traditional sectors and, therefore, have been redefined. Given the above scenario, there is a need to tackle how the change is taking place, not only within the market but within society too. A conflict arise again, i.e. the conflict between the interests of those who, legitimately, intend to innovate by offering new value to consumers, and the interests of those who have been living, or have lived, thanks to a particular order that was sometimes justified by the intervention of political authorities.

### 3 Interests and Problems Generated by the Sharing Economy

Nowadays, we witness great transformations concerning the organization of various sectors, such as mobility, tourism, education, which are facilitated by a technological gearing.

**Mobility and Transport.** Within the mobility sector, there are small and large companies offering new services which can compete with those operating within a sector that hasn’t changed for decades. The introduction of mobile connectivity and the immediate availability of information provide the opportunity to fulfill an increasing transport demand and, at the same time, to use existing resources in a more efficient manner.

An interesting example is that of Bla Bla Car: The company manages to do that thanks to social communication tools, that enable it to reach a large number of users (both car owners and potential passengers), and by highlighting the opportunity to get to know new people while saving on travel costs. Technology has helped to tackle such a lack by offering a win-win solution where everybody wins, environment included.

In the last few years, car-sharing services have shown an enormous growth. In fact, it is anticipated that 12 million people will be using such services worldwide, by 2020. In Italy, 220,000 people used car-sharing services in 2014, the car fleet totaled about

3,000 cars in 11 cities, and in 2013 the sector's growth reached 70 %. Milan is the leading city of Italian car-sharing<sup>2</sup>, with 80 % of the market. The sector boasts a robust expansion trend and an ever increasing integration with public transport services.

In other cases, such as the Uber or Lyft ones, a service that was directly competing with traditional taxi services generated a harsh conflict with taxi drivers. The political authorities of many countries were rather embarrassed by such a clash. The embarrassment of political decision-makers became even greater if taxi licences were considered as they are very expensive and sometimes taxi drivers invest their lifetime savings to purchase them. How the public transport system is going to evolve is still unknown. Will taxis be able to improve their offer? Will the new companies, such as Uber, succeed in breaking the strict regulatory barriers that prevent their full development, or will they have to adjust to them? Will political authorities be able to manage the transition towards new mobility models?<sup>3</sup>

**Tourism.** Within the tourist hospitality sector, the opportunity to rent out rooms or apartments for short periods of time has provided a new source of income to many property owners. On its website Airbnb advertises that, so far, its platform has been helping 60 million guests to find a room in over 34,000 cities around the world. Such figures mean that, compared to 2013, the number of people using their services has increased by 6 times.

Although less noisily, professional hoteliers have started to stick up their nose about such a phenomenon that has begun to weaken their stance within the industry.

Moreover, they also feel that they're facing a kind of unfair competition because of the poor control that public authorities have exerted over the phenomenon in question, especially in relation to tax issues. In this case, perhaps the poor and fragmented regulatory efforts are the reason why such a market cannot fully develop since it is affected by a lack of clarity and generates uncertainty. Lombardy's regional authority, for example, has started to keep into consideration this increasingly growing trend through its new tourism law<sup>4</sup> that's been recently issued.

**Education and Training.** Within the higher education sector, the development of Massive Open Online Courses (MOOC) is changing the education approach completely. This trend is about free online courses that are offered through special platforms, such as Coursera or EdX, by some of the most prestigious universities in the world, which are accessible to those who wish to study using such a system. The new method offers

---

<sup>2</sup> From the report 'Nutrire la Mobilità nel Futuro' (Feeding Future's Mobility) presented by AlixPartners, at Forum Automotive di Milano, 2015.

<sup>3</sup> The Italian Competition & Market Authority, in a reply dated November 2, 2015 to a request made by the Ministry of Interior about the use of platforms, such as Uber, urged legislators to regulate the sector in order to ensure competition, as well as road and passenger safety by defining a 'third kind' of drivers, in addition to taxi drivers and car rental drivers <http://bit.ly/1P7BCYI>.

<sup>4</sup> 'Lombardia, giro di vite per le case su Airbnb: check in e tassa di soggiorno come in hotel' (Clamping down on Airbnb accommodation: check-in and city tax like in hotels) <http://bit.ly/1iFQbo8>.



the opportunity to carry out in-depth studies not only to university students but also to working students<sup>5</sup> or professionals.

In 2014, there were over 2,500 courses available, with over 400 universities involved around the world, and the leading Coursera and EdX platforms totaled about 14 million students. The courses, cover a wide range of topics and may also focus on particular ones by ensuring a rather high quality level. Universities all over the world have started to invest a great deal of resources on this sector as such courses help to promote the universities globally, by starting to establish a relationship with potential students who may decide to enroll for traditional courses too, at a later stage.

The sector shows a significant growth due to several reasons, such as the high costs of university education, especially in the United States, and the use of big data tools for the management of exam results that, being online, have become a new source of business for IT platforms. Academic knowledge may now be shared free of charge in almost every country originates from the remarkable demand for education at a global level. After all, the more information available, the stronger is the need for intellectual tools that may be used to make sense of such an increasing amount of data.

**Work and Employment.** On the other hand, as regards work and employment, the effects of the economic crisis are being tackled through online platforms that help people looking for a job and employers getting in touch. However, they are not just some basic notice boards, but are rather similar to proper employment centres. Instead of just offering temporary or permanent jobs, the new platforms also advertise offers and requests for spot jobs.

Nowadays, it seems that work is increasingly becoming a matter of coordinating skilled professionals. Within this field, conflicts arise between those who consider temporary or occasional jobs negatively because they don't provide proper worker protection, and those who see them as a great opportunity to create new businesses by using the technological gearing available, as well as to offer skills and knowledge to a wider audience of millions of potential employers.

## 4 The History of the Relationship Between Innovations and Institutions

The conflicts between different interested parties have always existed, but the growth of available wealth and the economic, social and political development are relatively new phenomena. That is probably why it may be worthy to recall some examples from the past to better understand common issues and differences.

Great Britain found its way towards an unprecedented development before the end of the 17th century. In fact, the Glorious Revolution of 1688 opened the Kingdom to those political, social and legal reforms that were going to pave the way for the Industrial Revolution that would take place a century later.

---

<sup>5</sup> Data provided by edSurge 2014 <http://bit.ly/1MNaKuY>.

As properly explained by Daron Acemoglu and James Robinson in their book ‘Why Nations Fail’ [5], such a transformation in Great Britain was driven by a new social class, the bourgeoisie that put forward new values and interests in contrast with the traditional aristocracy and great landowners. The clash between those classes concerned very practical matters, such as private property regulations or, for example, the protectionist regulations that halted the development triggered by the technical revolution. Therefore, such matters would work as a divide between the parties.

It is also important to consider how the country’s institutions (first of all, Parliament and Common Law Courts) were able to facilitate the economic transformation and to accompany the social metamorphosis brought about by the industrial revolution of the 19th century.

**Innovations, Institutions and Legitimacy.** The question to be asked is whether the new economic models envisaged for the forthcoming decades are also going to be accompanied by a new legitimacy of governments and institutions that are meant to regulate such an economic, social and political transition. So far, the picture described explains why the sharing economy is important not only to understand how new technologies are going to be used, but also to understand how society, politics and institutions are going to be influenced.

A sharing economy can bring technological innovations to sectors of the economy which haven’t been affected by productivity increase and that have actually been spared process and organizational innovations for decades.

**Convergence of Interests – Between Idealism and Pragmatism.** In contrast with past experiences, the main distinctive feature of this historical period is that a convergence of interests may often exist for individual players.

The end of a society that’s divided into classes, where each one features its own identity that is linked to its own production, professional or revenue generating activities, opens up a world where mobility reigns, not just in terms of employment, but also as regards the use of resources. However, it’s probably still impossible to see how the discourse concerning the sharing economy’s nature is going to evolve.

For some, the nature of sharing ought to open up to an exchange system that is legitimate for its own sake, i.e. one that is based on principles related to the equality of the parties involved. Such principles are considered intrinsically ethical and should not require any interventions from institutions or external government to validate them.

This is the hope of Internet enthusiasts who would like to bring about a network that would overcome the interests of more complex organizations, so to introduce a new alternative model to consumerism.

**The Network Effects and Phenomenon Governance – Exclusion Reduces Efficiency.** In a sharing economy, therefore, there is a growing network of players that are not easy to categorize, being simultaneously service consumers and suppliers.

Furthermore, another feature of this network is the role played by those operating as part of both sharing and traditional economy. Can democratic institutions evolve quickly enough to support the next steps of the transition and promote economic development? On the other hand, will other routes be found to achieve a direct legitimization of the

economic system? As a first comment, which could also be a starting point, it could be said that an effective governance of the network in question may stem from the awareness that none of the parties involved could be excluded without risking to reduce the importance of the network itself.

**The Obstacles to Innovation – the Role of Institutions.** Sometimes, political power sets some insuperable obstacles to technological innovation because it perceives the consequent modification of the status quo as a threat to its authority and stability, rather than a risk for those who have a direct interest in the lack of changes within a given economic sector. For example, in England, in 1589, when William Lee showed his revolutionary knitting machine to Queen Elizabeth I, he was told that the implementation of such a tool would have taken the work away from many citizens who would then become beggars [5].

## 5 How and Why Should Innovation Be Encouraged?

Innovation is an advantage if the benefits produced are extended to the whole society. This can only happen if an innovation incorporates the ability to be sustainable, if the costs of its implementation are carefully evaluated and its benefits are clearly evident.

The opening of institutions to new requests and interests is a very important aspect of innovation success. Actually, it's an essential requirement for it. In an era where the world's population amounts to 7 billion people, and raising, the usable resources needed to ensure a decent living in increasingly larger areas of the planet are becoming more and more scarce. This fact on its own has the potential to trigger conflicts. On the other hand, technological innovations also offer the solutions to drastically reduce the costs of such resources, thanks to the implementation of new usage methods and new organization models.

**Innovation Methods – Sustainability, Testability and Market Opening.** The principle of sustainability, with its many aspects, has now become deeply rooted in the innovations to be implemented. The sharing economy is going in the right direction as regards the efficient use of resources and the spreading of a greater sensitivity about environmental issues. Although more and more often innovations originate from the bottom, nevertheless, sometimes it's impossible to evaluate the possible effects that their introduction may have on the market and on society.

However, even though a product originates 'from the bottom', it's not always possible to transfer it to another market if the product in question is not fit to fulfill the existing demand. Therefore, new ideas or inventions are not always ready to do that 'jump'.

Sometimes, unfortunately, such opportunities may be hindered by bureaucratic constraints. In Europe, however, the recent moves made by the European Commission

towards a Digital Single Market<sup>6</sup> seem to be going in the right direction. More consistency amongst regulations concerning data protection, intellectual property and consumer rights would favour the development of small and medium-sized companies. That would also encourage the establishment of large digital organizations, similar to those that usually originate in the United States rather than in Europe.

Moreover, cities are the ideal place where new ideas may become actual innovations likely to produce contamination effects.

After all, the city itself does challenge the status quo, by attracting so many people who wish to change their social status. However, the fast pace imposed by technological changes and the remarkable exchange opportunities brought about by globalization, have transformed some industries significantly, whereas others have remained unchanged.

### **Why Innovate? A Question to Be Answered by Comparing Costs and Benefits.**

The remarkable growth opportunities offered by today's economy are associated with the creation of value. That is facilitated by the increasingly sophisticated use of intangible goods which are difficult to evaluate, such as algorithms, information, software, huge databanks, patents, copyright, the implementation of sizeable business models, organizational skills, corporate capital, knowledge, abilities and strategic networks [6].

It is reckoned that in the most developed countries the contribution of intangible goods<sup>7</sup> to the real economy, in terms of GDP, is the double of that provided by material goods. However, the problem with assessing the value of such goods makes it often difficult for institutions (either political or financial ones) to support apparently risky companies without a profit or an electoral return. In parallel, from a political point of view, there is some resistance in supporting those initiatives whose effects are uncertain. In particular, political and regulatory barriers have their own precise meaning if they are put into context, both historically and socially. They tend to ensure that some categories of citizens are not affected by competition or changes.

How can such an enduring protection be justified when circumstances change? How can any institutions that are supposedly open to their citizens' requests ignore the cost-benefit ratio deriving from protecting a given category or industry (so that it can remain the same), whereas the value generated by innovations could make more resources available for the benefit of a large number of citizens-consumers?

**The Existence of a Right to Innovation.** Replying to such questions, it is possible to perceive a right to innovation that the institutions ought to keep into consideration, learning from past experiences. Such a right naturally emerges from the free exchange taking place in the markets. Sometimes, its explosive power reveals itself in real life and may be quite ruthless. Some players are rewarded, whereas some risk to be pushed out

---

<sup>6</sup> European Commission's website on Digital Single Market <http://ec.europa.eu/priorities/digital-single-market/>.

<sup>7</sup> Disrupted Innovation: Financing innovative small firms in the UK', Sameen, Queded, Big Innovation Centre 2013.

of the market if they don't adjust their offer. Institutions are forced to face the dilemma: whether it's worthy to risk losing some of their political influence by reducing protections, compared to the support they may obtain by opening up to new opportunities that would benefit the rest of the community.

## 6 How Can the Right to Innovation Be Accomplished? Criticalities and Suggestions

Since the city is a place where innovation develops more easily, the regulatory aspects of economy have to be dealt with at some higher institutional levels. Therefore, the sharing economy in Italy involves a series of players operating at different levels.

The ways in which new platforms (i.e. access tools that are essential for the sharing economy), introduce themselves to the markets recall the general problems affecting the ecosystem of innovative startup companies.

In particular, there are several limitations concerning:

- The taxation of new companies;
- Bureaucratic constraints for companies;
- The ability of the university system to educate and train skilled ICT staff;
- Difficulties in obtaining loans from financial institutions.

The number of investments made through risk capital or venture capital is significantly lower compared to other European countries. Although Italy comes second, after the UK, in terms of percentage of innovative small and medium-sized companies, only 0.002 % of GDP is invested in venture capital, against a European average of 0.024 %<sup>8</sup>. Furthermore, there is no entrepreneurial culture that would lead operators to accept the risk of embarking in a startup company<sup>9</sup>.

However, there are young workers, trying to access, or access again, the employment market through startup companies. They are actually creating new entrepreneurial experiences that very often, unfortunately, don't last long<sup>10</sup>, due to the negative aspects described above<sup>11</sup>.

Nevertheless, these are valuable experiences as they help to come to terms with the real world and provide training opportunities based on actual economic conditions. Fragmented regulations and regional financing do not allow for a proper use of the

---

<sup>8</sup> Annual report by the European Venture Capital Association (EVCA).

<sup>9</sup> Moreover, young people have a kind of cultural resistance about joining startup companies and/or starting their own, as mentioned in the Standard Eurobarometer UE for 2013: although 50 % of European consider the possibility of starting their own business, only 5.8 % decides to take that route.

<sup>10</sup> Summary of the last OECD research on entrepreneurship - August 2015 <http://bit.ly/1GNqSw2>.

<sup>11</sup> For an analysis of entrepreneurs'/startupper's reasons, see the study by Pais e Sirigu. <http://bit.ly/1MeNUMw>.

already scarce financial resources<sup>12</sup>. There is no place where such innovation experiences could be put together so that they would attract the best available talents, as well as Italian and foreign investors, according to international best practices<sup>13</sup>.

Some ideas and suggestions to be developed in order to tackle the above limitations include the following:

- Simplification of bureaucratic, administrative and fiscal requirements and improvement of legal certainty;
- Regulatory simplification at both national and supranational levels, as regards the sharing economy to enhance transparency and trust;
- Establishing partnerships between public and private sectors - in particular with the research and university compound - and directing resources on some key topics concerning economic development;
- Facilitating the aggregation of small and medium-sized companies, also in view of open innovation processes and of the spreading of collaborative models;
- Ensuring that the education and university system, together with companies and public administrations, aims at providing the education and training needed within the business scenarios, as well as continuous training for freelance and employed professionals, in order to expand the entrepreneurial culture.

## References

1. Sneed, A.: Moore's Law Keeps Going, Defying Expectations, *Scientific American* (2015)
2. Benkler, Y.: Sharing Nicely: On Shareable Goods and the Emergence of Sharing as a Modality of Economic Production. *Yale Law J.* **114**, 273–358 (2004)
3. Atkinson, R.D., McTernan, M., Reed, A. (eds.): *Sharing in the Success of the Digital Economy: A Progressive Approach to Radical Innovation*. Pickering & Chatto Publishers, London (2015)
4. Eckhardt, G.M., Bardhi, F.: The sharing economy isn't about sharing at all. *Harvard Business Review* (2015)
5. Afzal, M., over Interest, D., Tanzi, V., Barreix, A., Villela, L.: (2015). Acemoglu, D., Robinson, J.A.: *Economic Origins of Dictatorship and Democracy*. Cambridge University Press, New York (2006). Acemoglu, D., Robinson, J.: *Why Nations Fail: The Origins of Power, Prosperity, and Poverty*. Crown Publishing Group, New York (2012). *Microfinance, Rights and Global Justice*, 29, 180
6. Onișor, L.F.: Marketing and business development between idea, scientific discovery and innovation. In: *International Conference on Marketing and Business Development Journal*, vol. 1(1), pp. 29–39. The Bucharest University of Economic Studies (2015)

---

<sup>12</sup> White Paper for Startup, by Digital Magics 2015.

<sup>13</sup> As an example, see Israel's legislative efforts to attract investors from abroad, aiming at attracting investments in the following industries: manufacturing, communications, IT, medical technology, biotechnology, nanotechnology, research. <http://bit.ly/1P7DIYE>.

# e-Bridge 3.0: A Strategic Approach to Structural Health Monitoring of Bridges in Costa Rica

Cesar Garita<sup>1(✉)</sup> and Giannina Ortiz<sup>2</sup>

<sup>1</sup> School of Computer Science, Costa Rica Institute of Technology, Cartago, Costa Rica  
cesar@itcr.ac.cr

<sup>2</sup> School of Construction Engineering, Costa Rica Institute of Technology,  
Cartago 159-7050, Costa Rica  
gortiz@itcr.ac.cr

**Abstract.** The general condition of road infrastructure is a major weakness of the Costa Rican economy. In particular, a significant percentage of national bridges show an average or critical condition regarding parts of their structure. On the other hand, road and bridge infrastructure is crucial for the national economy since it promotes activities such as tourism and commercial trade. In this context, proper planning and prioritization of infrastructure projects is of high importance for related government institutions. In order to support these strategic activities, it is necessary to gather and monitor up-to-date information originating from different distributed systems and tools. e-Bridge 3.0 is a recent on-going project at the Costa Rica Institute of Technology (TEC) aimed at the design of a bridge monitoring system to integrate strategic information about bridge structures. Modern business intelligence techniques will be applied to generate strategic performance indicators regarding for instance general reliability and remaining lifespan. This paper introduces the e-Bridge 3.0 project as an initiative towards the establishment of a national bridge monitoring system, which would have a significant impact on the effectiveness of national civil infrastructure management.

**Keywords:** ICT and infrastructure · Bridges · Structural Health Monitoring

## 1 Introduction

Bridges represent one of the most critical elements of road infrastructure. They are of paramount importance for the general quality of life of individuals and for economic activities such as tourism, goods transportation and businesses. In the particular case of Costa Rica, most bridge structures were built more than 30 years ago and investment on proper maintenance has been minimal. Currently, a national bridge inventory is being carried out by the e-Bridge program at the Costa Rica Institute of Technology (TEC) in conjunction with the National Road Council. Preliminary inspection results indicate that a significant percentage of bridges show a regular or critical condition regarding specific parts of their structure. The primary causes of this situation are varied in nature including scour, vehicle impact, earthquakes, corrosion, as well as lack of adequate monitoring and maintenance activities.

In this context, the e-Bridge 3.0 – Bridge Monitoring System project aims at the design and development of a system prototype to support the integration of information about national bridge structures regarding technical specifications, structural reliability, performance variables, as well as geographical and environmental aspects. One of the main novel aspects of e-Bridge 3.0 is the application of business intelligence models and tools to generate control panels of strategic key performance indicators of bridges in the country. Such monitoring system will be useful to support strategic maintenance, planning, and optimization of resource investments for related government institutions.

This paper presents the e-Bridge 3.0 project as an on-going multidisciplinary research and development initiative towards the establishment of a bridge monitoring system in Costa Rica. Such system would play a significant role improving the future infrastructure and socio-economic development of the country.

## 2 Background and Related Work

The e-Bridge 3.0 project represents the third stage of a route map established by a research group on bridge health monitoring at TEC. This research group was created in 2011 with the collaboration of several schools including: Construction Engineering, Computer Science, Electronics, Industrial Production Engineering and Forest Engineering. The project is also part of an e-Science Program and holds strong collaborations with related end-user organizations including Costa Rica Ministry of Transportation, National Road Council and local government units. The general aim of the research group is to generate ICT tools to analyze the condition and behavior of bridge structures in order to better support planning and maintenance activities. The application of these tools will contribute to strengthen one of the key pillars of national economic competitiveness. Previous stages of e-Bridge covered specific projects with focus on capacity building and information integration (see for instance [1–3]). Following the established road map, after this third stage, we plan to create a spin-off company specializing on Structural Health Monitoring (SHM) services with a Central American scope.

Regarding existing projects and initiatives related to bridge monitoring systems, several reports can be found that survey several available tools and platforms [4–6]. Some of the most comprehensive proprietary systems include BRIMOS and SHM Live. BRIMOS (Bridge Monitoring System) offers a method for damage detection in bridges and other civil structures based mostly on vibration monitoring [7]. BRIMOS supports different kinds of monitoring applications including hot-spot, permanent and cable monitoring. SHM Live is a web site that manages and displays data about structures monitored in real time anywhere in the world [8]. The system allows real-time configuration of event alarms and offers different data visualization options.

Furthermore, there are several systems specializing in SHM data management which are aimed at storing, retrieving and sharing large amounts of data gathered through monitoring activities [9, 10]. In [11], several examples of data mining operations are providing in order to reach a better understanding of SHM data. Key Performance Indicators (KPIs) associated to bridge SHM have been defined in the



context of the BRIMOS project, including integrity, operability, fatigue assessment, damage location and life-cycle curve [7].

Considering existing approaches, one of the main differentiating aspects considered for e-Bridge 3.0 is the incorporation of specialized business intelligence techniques and platforms that support data cubes, strategic key performance indicators and dashboards associated to bridge monitoring. Moreover, the system will apply a scientific workflow management approach for data integration from different systems following virtual enterprise / collaborative networks concepts and models (see [2, 12–14]), and it will be tailored to a specific bridge inspection methodology for the national context.

### 3 The e-Bridge 3.0 Project

This section describes the general and specific objectives of the project and outlines the ICT development methodology for the system prototype.

#### 3.1 Project Objectives and General Architecture

The general objective of the e-Bridge 3.0 project (2016–2017) is to design a prototype of a bridge health monitoring system including assessment methodologies, environmental risk analysis, diagnostic features and business intelligence techniques to support bridge performance analysis.

More specific objectives include the following points:

- Analyze the information management requirements for the design of the bridge monitoring system.
- Design proper instrumentation protocols for remote electronic bridge monitoring.
- Develop methodologies for the diagnostic of the structural condition of bridges.
- Develop methodologies to assess environmental vulnerability of bridges.
- Design and develop a prototype of a business intelligence system to support decision making in relation to structural health monitoring of bridges.

The main components of e-Bridge 3.0 architecture are based on the architecture defined for e-Bridge 2.0 (see [1] for details). In summary, these components include: a technical information system for bridge structures; sensors systems to measure actual bridge performance; a geoportal to analyze geographical aspects; and an information integration system using scientific workflow management [2]. In e-Bridge 3.0, the information integration system will be expanded to include business intelligence capabilities for the bridge monitoring system.

#### 3.2 General ICT Development Methodology

As mentioned earlier, the main output of the project will be a prototype for a bridge monitoring system based on business intelligence techniques. In general, the development of the software prototype will follow a cascade-like model including phases for requirement analysis, design, and development as described in the following paragraphs.

For the information management requirements analysis of this prototype, potential sponsors and end-users will be identified. Subsequently, user research techniques will be applied and use-case specifications will be delivered describing the main system processes and user interactions.

For the design of the business intelligence component, a thorough evaluation and selection of available technologies will be carried out based on carefully defined criteria according to the project characteristics. Strategic performance indicators will be integrated in a centralized database from different system components or information sources. Potential strategic indicators associated to bridge information may include for instance: reliability index, global technical assessment, remaining life time, environmental risks, socio-economic importance, and structural damage, among others.

The integration of these indicators from different components will be implemented with web services and scientific workflows. Once the indicators associated to related information sources are processed and stored in the database, the business intelligence prototype will allow strategic queries through data cubes and dashboards using tools such as Pentaho and available extensions. For the prototype development, free and open-source technologies will be preferred whenever possible.

Finally, the project follows a detailed action plan including dissemination activities such as academic publications and the organization of national workshops on SHM.

## 4 Preliminary Results

Using preliminary technical data from visual inspections of around 150 bridges carried by the e-Bridge team, an initial data cube (multi-dimensional data structure for rapid query analysis) has been designed and tested using Pentaho [15]. Current cube dimensions include bridges, regions, evaluations, and routes, so that queries regarding different variables can be solved. In this way, data cube analysis can provide answers to relevant questions such as:

- Average bridge length by type of structure and province.
- Amount of bridges per route.
- Amount of bridges per province.

These queries can be easily solved using built-in drag-and-drop functionalities of Pentaho based on fields associated to predefined data cube dimensions and measures.

The results of the queries can be displayed in a wide variety of graphical possibilities. For instance, Fig. 1 shows the graphical result for a query regarding the average length of bridges by province and type of structure. Namely, the horizontal axis represents provinces and for each province, bars of different colors indicate the average bridge length (vertical axis) per type of structure e.g. culvert, truss, continuous beam.

These charts will be integrated as strategic indicators dashboards to monitor and query different aspects of national bridges from a web-based application. The user-friendly execution of queries and the flexible visualization of the results have proven to be extremely valuable features for the construction engineers responsible for carrying out the bridge inspections and for generating the associated official reports.

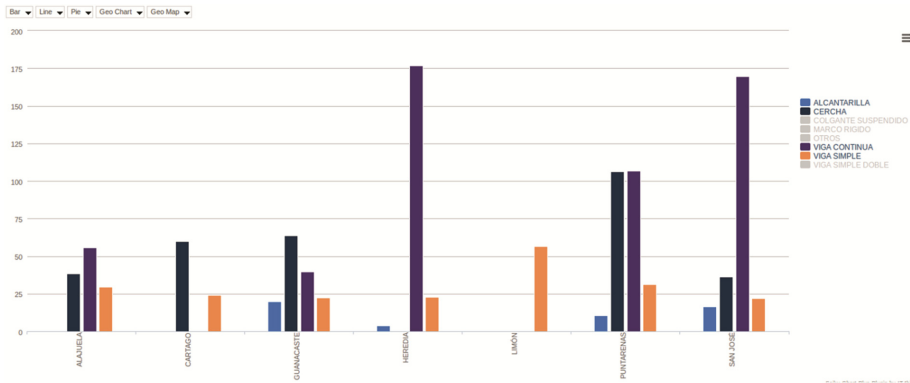


Fig. 1. Example of graphical visualization of query results.

## 5 Conclusions and Future Work

The on-going e-Bridge 3.0 project approach will allow a flexible execution of strategic queries about the real structural condition of bridges in Costa Rica through the application of business intelligence techniques such as key performance indicators panels associated to specific structural and environmental variables. These indicators and monitoring panels would have a positive impact on the efficiency of resource investment and planning of national public infrastructure. Preliminary results will be extended to include around 400 bridges and more data cubes and visualization features will be made available through a web interface in the near future. This information will be useful for a variety of audiences and organizations related to road maintenance activities including: municipalities, road contractor companies, government units, construction engineering researchers, and universities among others.

**Acknowledgements.** The authors wish to acknowledge the valuable contributions from all colleagues of the e-Bridge 3.0 project.

## References

1. Ortiz, G., Garita, C.: The e-bridge 2.0 approach for SHM of bridges in Costa Rica. Presented at the 10th International Workshop on Structural Health Monitoring - IWSHM 2015. University of Stanford, California (2015)
2. Garita, C., Ortiz, G.: Towards a workflow management approach for health monitoring of bridges. In: Camarinha-Matos, L.M., Afsarmanesh, H. (eds.) Collaborative Systems for Smart Networked Environments. IFIP AICT, vol. 434, pp. 489–497. Springer, Heidelberg (2014)
3. Obando, A., Garita, C.: Diseño General de una Red Inalámbrica para Monitoreo de Salud de Puentes. Presented at the XXXIV Convención IEEE de Estudiantes de Centroamérica y Panamá - CONESCAPAN XXXIV, San Salvador, El Salvador (2015)
4. Gastineau, A., Johnson, T., Schultz, A.: Bridge Health Monitoring and Inspections - A Survey of Methods. University of Minnesota MN/RC 2009-29 (2009)

5. Dong, Y., Song, R.: Bridges Structural Health Monitoring and Deterioration Detection - Synthesis of Knowledge and Technology. University of Alaska Fairbanks MN/RC 2009-29 (2010)
6. Garita, C.: Enfoques de Integración de Información para Sistemas de Monitoreo de Salud Estructural de Puentes. *Tecnología en Marcha*, vol. 29 (2016)
7. Wenzel, H., Furtner, P., Clifton, R.: The role of structural health monitoring in the life-cycle-management of bridges. Presented at the 8th International Cable Supported Bridge Operators Conference - ICSBOC 2013, Edinburgh, Scotland (2013)
8. Daniele Zonta, P.E., Pozzi, M., Molognoni, M., Zandonini, R.: Monitoring load redistribution in a cable-stayed bridge. Presented at the 5th European Conference on Structural Control - EACS, Genova, Italy (2012)
9. Koo, K.Y., Battista, N.D.: SHM data management system using MySQL database with MATLAB and web interfaces. Presented at the 5th International Conference on Structural Health Monitoring of Intelligent Infrastructure (SHMII-5), Cancún, México (2011)
10. Tas, N.C., Raileanu, C., Dejori, M., Neubauer, C.: Bridge sensor mart: a flexible and scalable data storage and analysis framework for structural health monitoring. Presented at the 5th International Conference on Bridge Maintenance, Safety and Management, Philadelphia, USA (2010)
11. Sonnleitner, E., Kosorus, H., Anderlik, S., Stumptner, R., Freudenthaler, B., Allmer, H., Kung, J.: Integration of data mining operations for structural health monitoring. Presented at the 8th International Workshop on Structural Health Monitoring, California, USA (2011)
12. Garita, C.: A case study of VO education in Costa Rica. In: Camarinha-Matos, L.M. (ed.) *Virtual Enterprises and Collaborative Networks*. IFIP, vol. 149, pp. 589–596. Springer, US (2004)
13. Garita, C., Afsarmanesh, H., Hertzberger, L.O.: A survey of distributed information management approaches for virtual enterprise infrastructures. In: Franke, U.J. (ed.) *Managing Virtual Web Organizations in the 21st Century: Issues and Challenges*, pp. 164–183. Idea Group Publishing (2002)
14. Afsarmanesh, H., Garita, C., Camarinha-Matos, L.M., Lima, C.: Workflow support for management of information in PRODNET II. In: 5th International Workshop on Intelligent Manufacturing Systems - IMS, Gramado, Brazil, pp. 49–54 (1998)
15. Hatle, S., Sayeed, A., Gupta, D., Neela, G., Winter, S.: Pentaho Data Integration Tool (2013)

# **E-Government and Smart Cities**

# ICT and Citizen Efficacy: The Role of Civic Technology in Facilitating Government Accountability and Citizen Confidence

Rebecca Rumbul<sup>(✉)</sup>

mySociety, London, UK  
Rebecca@mysociety.org

**Abstract.** This paper examines whether civic technology ICTs provide an effective method for enhancing the political efficacy of citizens and their perceived accountability of governments. Using a survey-based methodology, a quantitative analysis was conducted of the users of civic action sites in the UK, Kenya, South Africa and USA. The key question examined is whether the particularized or citizen-audit actions that these sites facilitate have a spill-over effect in altering the level to which citizens believe they are able to hold government to account. The results suggest that citizen efficacy and perceptions of government accountability are enhanced. Stark differences in user demographics between territories demonstrate a wide spectrum of civic technology usage, however, with common confidence in the efficacy of the ICT. The findings suggest that publication and user-facilitation of government information through the medium of civic technology in developed and developing countries increases feelings of external efficacy and government accountability.

**Keywords:** ICT · Civic technology · Digital democracy · Efficacy

## 1 Introduction

The proliferation of civic technologies, a form of non-profit ICT, around the globe has gained pace since the advent of early civic participatory websites in the early 2000's, with significant funding being allocated to the NGO sector for the development and implementation of such sites, and with improvements in connectivity and access to hardware occurring in many developing countries. Civic technology is defined as a non-profit technology that seeks to empower and engage citizens through the facilitation of information exchange between citizen and government, leading to greater governmental transparency and accountability. Often included under the umbrella of 'e-gov' studies, it stands apart from traditional concepts of e-government in its creation and maintenance by non-profit organisations. The purpose of such civic technologies is primarily to empower citizens through enabling some form of civic or political participation and in facilitating the flow of official information, whether that be on a specific policy subject, a specific citizen complaint, or information on parliamentary proceedings. This study examined whether civic technologies are having an impact upon those individuals that

use them, specifically, whether using civic technologies to access information instigates, or alters, the personal efficacy and belief of user-citizens in their ability to hold their governments to account. Research into the medium-long term impacts of civic technologies upon citizen attitudes is scarce, in part due to the small scale of organisations running these sites, in part due to their youth, and in part due to the transience of the user experience. One of the early architects of civic technologies, mySociety, is based in the UK and operates a suite of Open Source civic technology platforms that enable citizens to participate in civic activities, whether that is through parliamentary monitoring site TheyWorkForYou, through making Freedom of Information requests via WhatDoTheyKnow, or through reporting maintenance issues to local authorities via FixMyStreet. Escher [1] examining mySociety website users in the UK, noted that a significant volume of users were first-time users with individual and particularised interests. However, it has also been shown that, to a limited degree, such digital platforms correlate with increased community involvement in an offline capacity [2]. Cantijoch *et al.*'s research [2] demonstrates that, whilst individual interests drive initial online participation, the very act of online participation may alter the subsequent attitudes or actions of citizens. What is not currently clear is what attitudes towards the use of these civic technologies themselves, and towards government, are developed by citizens in the process of their action. Civic technologies enable participation, but to what end? Civic technologists themselves describe their aims variously as enabling transparency to facilitate the accountability of, or the exertion of power over, government institutions [3]. This study examined the attitudes of citizens using civic technologies in the UK, South Africa, Kenya and the USA. Quantitative data was collected via online surveys, as well as via online analytics programmes to address the question of whether use of civic technologies increases personal external efficacy, alters the confidence citizens hold in their respective governments, and whether specifically, that can be attributed to their ability to participate via civic technologies.

This research is both novel and significant in its approach. Civic technologies have been subject to a much lower volume of scrutiny in their role in citizen participation than social media platforms or dedicated petition sites, however, these websites have been recognised by governments and commentators as a potentially effective route to diversifying and broadening participation [4, 5]. This study sheds light on whether those assertions may be correct, and provides substantive evidence of attitudinal change in citizen's engagement with civic activities. This study also illuminates previously unexamined public attitudes towards civic technologies, delineating the confidence citizens have in the civic technologies they are using, and the confidence citizens have or develop in their governments through the use of civic technologies.

## 2 Efficacy, Confidence and Participation

Significant volumes of individuals now use the internet as one of their primary sources of news and political information [6–8], and many use it as their primary medium of personal administration, whether that takes the form of using online banking services, purchasing consumer goods, or arranging a family holiday. Internet users therefore have

a reasonable level of efficacy in navigating their online environment. Citizens in many countries do not, however, exhibit high levels of personal efficacy in their civic or political spheres [9–11]. Political efficacy has been described by several authors as possessing two distinct constructs, distinguishing between ‘internal’ and ‘external’ dimensions of the concept of efficacy [8, 12–14]. Whilst internal efficacy concerns the understanding of one’s own ability to understand and participate, external efficacy refers to the extent to which citizens believe governments and authoritative institutions will be responsive to citizen demands or participation [14, 15]. The literature suggests that citizen beliefs concerning government responsiveness directly affects the extent to which citizens will choose to participate [14, 16, 17].

The digital availability of political and governance-related information does not necessarily mean that individuals will alter their approaches to engaging with civic activity [8], however scholars have pointed to internet connectivity as a tool for enhanced democracy and participation [18]. The study of political efficacy has historically centred around traditional forms of political participation [15, 19], and in recent years, the equivalent actions conducted through digital means [20, 21]. Such activities include verbal or financial support of political campaigns, dissemination of partisan policy messages and participation in meetings and elections. Civic participation, however, encompasses a broader field of concern than that specific to party political ideals, providing space for individual participation and engagement in civic issues external to partisan boundaries. Individual citizens are able to raise issues, investigate them, and communicate them through digital means in a quicker and potentially more impactful fashion than in the pre-digital age. Whilst this form of political participation largely concerns organised issue-specific lobbying and campaigning, the digital ability to conduct such activities also enables citizens to pursue very individualised participatory agendas, often referred to as ‘particularised contacting’ [2, 22]. Some scholars have considered this as a diminished form of political participation, ranking it amongst routine administrative activities [23, 24] or failing to distinguish these activities from larger-scale contact concerning macro-political concerns [22], however these activities, conducted through civic technologies, have been shown to have specific impacts upon citizen behaviour in regard to both community-based civic activity [2, 25] and in engaging with government concerning micro-level individualised issues [17]. It is possible to posit, therefore, that this particularised form of civic engagement may impact the levels of confidence in government and its ability to account for its actions that citizens hold.

The concepts of confidence and trust in government have been examined by a number of scholars, many of whom have identified a trend in decreasing levels of trust and confidence in government [26, 27]. In consideration of such findings, several authors have emphasised the role that accountability and transparency hold in potentially reducing levels of mistrust [28–30]. Accountability and transparency scholars have identified the role that publication of official information plays in achieving what is perceived to be a more accountable government [31, 32]. The citizens ability to review information about or produced by governments and politicians is one aspect of increasing personal external efficacy [8, 33, 34]. In considering the emergence of digital



methods for accessing information, authors [4, 28] identified the potential of e-government in particular in facilitating an increase in transparency and accountability in government administration and service delivery, potentially resulting in increased efficiencies and better communication that would bolster citizen confidence in government overall. However, studies of the weaknesses or risks associated with e-government have identified links between citizen trust in government and propensity to use e-government systems [35], and the tendency of e-government initiatives to become bureaucratically rationalised rather than customer-focused [36, 37]. Civic technologies, unlike e-government, operate at the intersection of e-government and civil society. Run in the majority of cases by NGOs, civic technologies seek to expand the ability of the citizen to engage with governance mechanisms in a way rational to the user, whether in a form of particularised contacting in which the citizen interacts with an official individual, or in a citizen audit role in which the citizen is able to acquire and review official information on the activities of governments and politicians.

This study examines the external efficacy of participants through their particularised use of civic technologies, to determine whether levels of efficacy and confidence are altered through the use of such platforms. The study will examine any alteration in such levels of efficacy, analysing this alongside perceptions of government behaviours in relation to the existence of civic technologies.

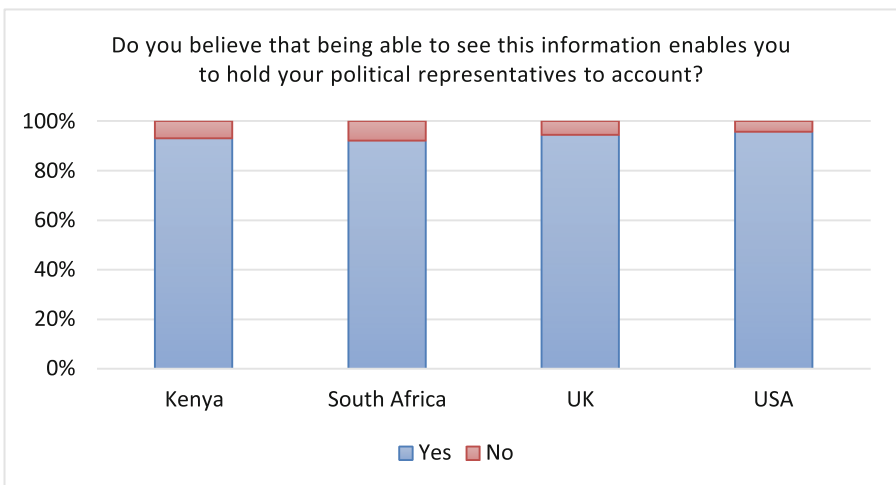
### 3 Data and Methods

This study examined five civic technology sites operating in the UK, USA, Kenya and South Africa. It draws on 4,371 survey responses of civic technology users, and focuses on examining basic demographic information and public attitudes data. The participating sites were FixMyStreet (UK), TheyWorkForYou (UK), GovTrack (USA), Mzalendo (Kenya), and People's Assembly (South Africa). Each of these civic technology platforms provides users with either the opportunity for particularized contacting (FixMyStreet) or citizen parliamentary audit (TheyWorkForYou, GovTrack, Mzalendo and People's Assembly). Site users were invited to take part in surveys, either following a transaction (if the site was a transactional one (such as FixMyStreet), or following a minimum period of time spent on the participating site (such as Govtrack). Sites with a high volume of users (UK & USA sites) invited a sample of visitors to take the survey, in the UK this was 1 in 2 site users, and this was 1 in 4 in the USA, whereas 100 % of users of lower-volume sites (South Africa and Kenya) were invited to take the survey to ensure a sufficient sample. The survey was conducted online, consisted of approximately 19 questions (certain additional questions were added at the request of the participating platforms) and no personally identifying information was requested. The first nine questions concerned personal information such as age, educational attainment, employment status and employment sector. The remaining questions concerned individual user attitudes to civic technology and government. These questions focused on how users perceived the benefit of the tool they were using above other methods of reporting or receiving information from government, their confidence in governance structures, and their perceptions of the effect of civic technologies upon government

behaviour. Questions did not directly ask about levels of confidence or trust, rather, they focused on the individuals assessment of government behavior, perceived ability to hold government to account, and expectation of government behaving in a different manner in the event that the information and functionality of civic technology sites did not exist. The data was collected between February 2015 and October 2015.

## 4 Findings

The data collected demonstrates a wide demographic spectrum of civic technology usage. Individuals of all ages are using civic technologies. In the USA and UK, the majority of users were found to be older, with 48 % of users of FixMyStreet in the UK over the age of 55, and another 22.6 % of users falling into the 46-55 category, meaning that over 70 % of users of FixMyStreet in the UK are over the age of 45. Similarly in the USA, 55 % of users of GovTrack register as over 55, with another 19 % in the 46–55 category, totalling 74 % of users over 45. These results contrast significantly with the results from Kenya and South Africa, where only 14 % and 34 % respectively are over the age of 45. These findings have significant implications for the development and implementation of ICTs as tools for good governance, as the demographic divides indicate that these tools may only be operationalized by distinct sections of the population of each country. The findings of this research demonstrate that the users of civic technology generally tend towards identifying as male. Whilst there is less of a gender imbalance in the USA, the UK demonstrates a fairly high user gender imbalance, with 64 % of users of FixMyStreet in the UK compared to 52 % in the USA (GovTrack) identifying as male. Previous studies [1, 2, 25] on mySociety’s UK deployments reinforce this finding, with their studies finding a male user dominance of 66 % and 64 %



**Fig. 1.** Survey results for the question “Do you believe that being able to see this information enables you to hold your political representatives to account?”

respectively. This gender imbalance is also evident in Kenya and South Africa, with Kenya evidencing 72 % of users identifying as male, and South Africa 68 %. Citizens using civic technologies in all studied areas tended to be well-educated, with between 40–60 % of citizens holding at least degree-level qualifications, however fewer were economically active, with less than 50 % of users across all sites in full-time employment.

The data shows that users of civic technologies hold a pre-existing interest in politics, with over 70 % of users confirming at least daily consumption of political news. This is perhaps unsurprising given the political and government content of such civic platforms. The number of users believing that such civic platforms enable them to hold governments and politicians to account was extremely high across all platforms surveyed, as shown in Fig. 1.

Over 94 % of individuals in the UK felt that being able to see the information displayed through civic technology site TheyWorkForYou enabled them, at least in part, to hold the British government to account. In the USA, this was 95 %, in Kenya 94 %, and in South Africa 91 %. The data also alluded to the level of mistrust felt by many citizens in government behavior. In Kenya, 83 % of users believed that their ability to scrutinize government information via the Mzalendo platform directly affected how politicians behaved, and over 92 % believed that politicians would behave differently if the information displayed on Mzalendo was not available digitally in the public domain. These figures were mirrored in all five cases, demonstrating similar levels of belief in both developed countries (UK and USA) and developing nations (Kenya and South Africa). These beliefs demonstrate a level of efficacy directly related to the user's ability to review political or governmental information online.

Significantly, a high volume of users across the four parliamentary monitoring platforms were unaware of other methods of accessing the information contained on those sites. Fully 48 % in Kenya, 55 % in South Africa, and 68 % in the UK were unaware of other methods of accessing parliamentary information. Similarly, 55 % of users of particularised contacting civic technology site FixMyStreet in the UK were unaware of any other method of reporting issues to their local authority. This is not surprising, as many official government and parliamentary websites are difficult to navigate, search or interact with, and many official organisations do not upload the volume or quality of information contained on the civic technology platforms. Whilst across the four countries studied access to official information is generally granted, it can also be a lengthy or cumbersome process to acquire, and the process itself is not widely understood.

## 5 Conclusion

This paper makes a novel contribution to the study of online participation through civic technology and e-democracy platforms. Substantively, it has provided a new insight into the question of how citizens use civic technologies, and how these platforms shape their attitudes and opinions concerning their respective governance structures. The comparative cases used demonstrate the differences and similarities in usage and attitudes in both developed (UK and USA) and developing (South Africa and Kenya) countries. Through combining questions concerning attitudes to government, and perceived effects

of civic technologies upon government behavior, the research has shown a clear indication of increased political efficacy amongst civic technology users.

The overarching question posed by this research concerned individual external efficacy in civic engagement. In particular, the research examined whether citizens using civic technologies developed increased personal efficacy as a result of using these digital tools. The findings of this research suggest that the use of civic technologies could contribute to increasing the external political efficacy of individual citizens. The majority of citizens using civic technologies in a citizen audit or particularized contacting role confirmed that the use of such platforms enabled them in their own way, at least in part, to hold their respective governments to account. This self-reported level of efficacy does not confirm that these individuals would actually use the information or experience acquired via civic technologies for further political or civic activities. However, taking into consideration the linked findings concerning the majority of individuals that knew of no other way to engage with government, the data does indicate that the very ability to engage with governance mechanisms rationally through digital means is sufficient in itself to increase individual external efficacy.

The significance of this finding is emphasized by the lower levels of trust exhibited by participants. The second question asked by this research concerned the individual citizen perception of government actions and behaviours, and examined whether citizens felt that availability of information online in any way affected the conduct of government officials. The majority of participants believed that their ability to engage with their respective governments through civic technologies affected how those governments behaved, and believed that those governments would behave differently if these methods of engagement were not available. This is an important finding in relation to the question of citizen efficacy. External efficacy concerns the extent to which citizens believe that government apparatus is responsive to their demands. Through using the ICTs in the study and as a result of the existence of those technologies, citizens felt that government behaviours would in some way be different to government conduct in the absence of those platforms.

Lastly, this study examined the demographic and attitudinal spectrum of civic technology users comparatively across both developed and developing nations. The comparative examination of such data is of practical importance given the increasing use of ICTs and civic technologies in improving citizen engagement in developing countries. It is quite possible that civic technologies and their users differ greatly between nations, however this has not been demonstrated in the literature. The data gathered for this research demonstrated the significant variability in demographic trends between countries, and highlighted clearly the dangers of generalisation in analysing demographic data across borders. Viewed as a whole, the data presents a very rounded and healthy picture of the users of civic technology. However broken down by country, the data evidences clear demographic divisions in the use of, and access to, civic technology. The most stark comparative results concerned the age profile of ICT users, with older individuals of 45 and over dominating civic technology usage in the UK and USA, whereas under-45's dominated usage in Kenya and South Africa. Female users were also under-represented in the study in all countries with the exception of the USA. These demographic findings demonstrate that the implementation of ICTs cannot be

standardized across borders. Whilst ICTs have been shown in this study and by previous authors to have positive citizen outcomes [2, 17, 25], in practice their development, implementation and usage will be nuanced and will need to accommodate local cultural differences in digital engagement. Given the demographic differences in civic technology usage examined in this research, the ability of ICTs to universally affect citizen external efficacy will be limited.

This study has presented a novel approach to examining external efficacy and government transparency through ICTs, however, further study of this growing sphere of activity is needed to fully uncover the true potential of civic technologies in improving citizen participation. Such digital solutions are increasingly being discussed by governments and NGOs as possible solutions to citizen engagement, however until more is known about the people that use these platforms, the way they engage, and how they feel about their engagement, their overall impact will remain limited.

## References

1. Escher, T.: TheyWorkForYou.com. Analysis of users and usage for UK Citizens Online Democracy. UK Citizens Online Democracy (2011)
2. Cantijoch, M., Galandini, S., Gibson, R.: It's not about me, it's about my community': a mixed-method study of civic websites and community efficacy. *New Media Soc.*, 1461444815616225 (2015)
3. Rumbul, R.: Who Benefits From Civic Technology? mySociety (2015). <https://www.mysociety.org/files/2015/10/demographics-report.pdf>
4. Bertot, J.C., Jaeger, P.T., Grimes, J.M.: Using ICTs to create a culture of transparency: e-government and social media as openness and anti-corruption tools for societies. *Gov. Inf. Q.* **27**(3), 264–271 (2010)
5. Olphert, W., Damodaran, L.: Citizen participation and engagement in the design of e-government services: the missing link in effective ICT design and delivery. *J. Assoc. Inf. Syst.* **8**(9), 491 (2007)
6. Graham, L., Metaxas, P.T.: Of course it's true; i saw it on the Internet!: critical thinking in the Internet era. *Commun. ACM* **46**(5), 70–75 (2003)
7. Johnson, T., Kaye, B.: Choosing is believing? How web gratifications and reliance affect internet credibility among politically interested users. *Atlantic J. Commun.* **18**(1), 1–21 (2010)
8. Kenski, K., Stroud, N.J.: Connections between Internet use and political efficacy, knowledge, and participation. *J. Broadcast. Electron. Media* **50**(2), 173–192 (2006)
9. Bromley, C., Curtice, J., Seyd, B.: Political engagement, trust and constitutional reform. *Br. Soc. Attitudes*, 199–226 (2001)
10. Forrest, A.L., Weseley, A.J.: To vote or not to vote? An exploration of the factors contributing to the political efficacy and intent to vote of high school students. *J. Soc. Stud. Res.* **31**(1), 3 (2007)
11. Francis, J.D., Busch, L.: What we now know about "i don't know's". *Public Opin. Q.* **39**(2), 207–218 (1975)
12. Balch, G.I.: Multiple indicators in survey research: the concept "sense of political efficacy". *Polit. Methodol.* **1**, 1–43 (1974)

13. Converse, P.E.: Change in the American electorate. In: Campbell, A., Converse, P.E. (eds.) *The Human Meaning of Social Change*, pp. 263–337. Russell Sage Foundation, New York (1972)
14. Niemi, R.G., Craig, S.C., Mattei, F.: Measuring internal political efficacy in the 1988 National Election Study. *Am. Polit. Sci. Rev.* **85**, 1407–1413 (1991)
15. Finkel, S.E.: Reciprocal effects of participation and political efficacy: a panel analysis. *Am. J. Polit. Sci.*, 891–913 (1985)
16. Abramson, P.R., Aldrich, J.H.: The decline of electoral participation in America. *Am. Polit. Sci. Rev.* **76**, 502–521 (1982)
17. Sjoberg, F.M., Mellon, J., Peixoto, T.: The effect of government responsiveness on future political participation. Available at SSRN 2570898 (2015)
18. Anderson, D.M.: Cautious optimism about online politics and citizenship. In: Anderson, D.M., Cornfield, M. (eds.) *The Civic Web: Online Politics and Democratic Values*, pp. 19–34. Rowman & Littlefield, Oxford (2003)
19. Craig, S.C., Maggionto, M.A.: Measuring political efficacy. *Polit. Methodol.*, 85–109 (1982)
20. Bennett, W.L., Wells, C., Rank, A.: Young citizens and civic learning: two paradigms of citizenship in the digital age. *Citizensh. Stud.* **13**(2), 105–120 (2009)
21. Dimitrova, D.V., Shehata, A., Strömbäck, J., Nord, L.W.: The effects of digital media on political knowledge and participation in election campaigns: evidence from panel data. *Commun. Res.*, 0093650211426004 (2011)
22. Teorell, J., Torcal, M., Montero, J.R.: Political participation: mapping the terrain. In: van Deth, J.W., Montero, J.R., Westholm, A. (eds.) *Citizenship and Involvement in European Democracies: A Comparative Analysis*, pp. 334–357. Routledge, London (2007)
23. Parry, G., Moyser, G., Day, N.: *Political Participation and Democracy in Britain*. Cambridge University Press, New York (1992)
24. Verba, S., Scholzman, K.L., Brady, H.E.: *Voice and equality: civic voluntarism in american politics*. Harvard University Press, Cambridge (1995)
25. Cantijoch, M., Galandini, S., Gibson, R.K.: Civic websites and community engagement: a mixed methods study of citizen empowerment initiatives. In: APSA 2014 Annual Meeting Paper (2014)
26. Levi, M., Stoker, L.: Political trust and trustworthiness. *Annu. Rev. Polit. Sci.* **3**, 475–507 (2000)
27. Nye Jr., J.S., Zelikow, P.D., King, D.C. (eds.): *Why People Don't Trust Government*. Harvard University Press, Cambridge (1997)
28. Norris, D.F., Fletcher, P.D., Holden, S.: Is your local government plugged in? Highlights of the 2000 electronic government survey. Prepared for the International City/County Management Association and Public Technology, Inc. (2001). [www.umbc.edu/mipar/final\\_draft/PDFs/e-gov.icma.final-4-25-01.pdf](http://www.umbc.edu/mipar/final_draft/PDFs/e-gov.icma.final-4-25-01.pdf)
29. Thomas, J.C., Streib, G.: The new face of government: citizen-initiated contacts in the era of e-government. *J. Public Adm. Res. Theor.* **13**(1), 83–102 (2003)
30. Tolbert, C.J., Mossberger, K.: The effects of e-government on trust and confidence in government. *Public Adm. Rev.* **66**(3), 354–369 (2006)
31. Pasquier, M., Villeneuve, J.P.: Organizational barriers to transparency a typology and analysis of organizational behaviour tending to prevent or restrict access to information. *Int. Rev. Admin. Sci.* **73**(1), 147–162 (2007)
32. Ball, C.: What is transparency? *Public Integrity* **11**(4), 293–308 (2009)
33. Usluel, Y.K.: Can ICT usage make a difference on student teachers' information literacy self-efficacy. *Libr. Inf. Sci. Res.* **29**(1), 92–102 (2007)

34. Bundy, A.: Australian and New Zealand information literacy framework. Principles, standards and practice, 2 (2004)
35. Bélanger, F., Carter, L.: Trust and risk in e-government adoption. *J. Strateg. Inf. Syst.* **17**(2), 165–176 (2008)
36. Colesca, S.E.: Increasing e-trust: a solution to minimize risk in e-government adoption. *J. Appl. Quant. Methods* **4**(1), 31–44 (2009)
37. Moon, M.J., Welch, E.W.: Same bed, different dreams? A comparative analysis of citizen and bureaucrat perspectives on e-government. *Rev. Public Pers. Adm.* **25**(3), 243–264 (2005)

# Promoting Quality e-Government Solutions by Applying a Comprehensive Information Assurance Model: Use Cases for Digital Signature

Ricardo Villalón-Fonseca<sup>1</sup>(✉), Alejandro Mora-Castro<sup>1</sup>,  
Rodrigo Bartels-González<sup>1</sup>, Miguel Carballo-Chavarría<sup>2</sup>,  
and Gabriela Marín-Raventós<sup>1</sup>

<sup>1</sup> CITIC - ECCI, University of Costa Rica, San José, Costa Rica  
ricardo.villalon@ucr.ac.cr

<sup>2</sup> Central Bank of Costa Rica, San José, Costa Rica

**Abstract.** Information and Communication Technologies, and specifically e-Government developments, occupy a relevant position in the national agenda of many countries worldwide. But development of such projects requires a careful planning, mostly when legal implications are bound to technological systems. This is the case when considering digital signature technology, as an essential element to support trust for e-government services. In this paper, we propose a comprehensive, systemic, and systematic, information assurance process to audit technological solutions for e-government services, and we show examples using digital signature from Costa Rica. Our approach supports applications developed with heterogeneous infrastructure and technologies. It also comprises the entire assurance process, including identification of threats and vulnerabilities, risk analysis, policy definition, and definition of security controls.

**Keywords:** e-Government · Digital signature · Information assurance · Private key infrastructure

## 1 Overview

Information and communication technologies (ICT) have been a priority development for many countries during last decades [1]. ICT enable benefits such as economic growth, sustainable development, government transparency, better life quality, and evolution of the information society [1]. Countries are developing national strategies for ICT that altogether are called e-Government, also known as e-gov, to deliver efficient and effective services to citizens [2].

In Costa Rica, a country of Central America, the Government started an e-gov plan, by 1998, to achieve the established economic, social, and educational goals [3]. In 2015, United Nations [1] recognized Costa Rica's efforts by awarding



the highest worldwide rise of 23 positions on the ICT Development Index (IDI), moving from global position 80 to 57. Although this is a good position for Costa Rica at the Americas, being the seventh of the region, there is still too much work to be done.

Sometimes there are doubts about the contribution of some ICT developments. For example, from our interviews with ICT government experts, we know that a poor or unrealistic design, or a lack of an appropriate project management, can generate issues such as deficient interoperability between different technologies, inappropriate infrastructure installed at the target context, insufficient system robustness, or security problems.

At the national level, some e-gov services require high quality implementations, because they are susceptible to legal implications. Failure to comply them can lead to lack of confidence from citizens, and ICT development may slow down, as a consequence. An example is digital signature, a mathematical scheme based on Private Key Infrastructure (PKI) [4], that is used to demonstrate the authenticity of a digital message or document. Digital signature is an essential component of an e-gov infrastructure, but it relies on technology for a correct implementation.

Costa Rica already has a framework to sign legally binding documents using digital signature, through law 8454 [5] created on 2005. To support this law, Costa Rican government emitted the directive 067-MICITT-H-MEIC [6], by April 2014, to encourage and massify digital signature usage around the country. This directive asks the government institutions to provide online services through digital signature, as an alternative to handwritten signature. The directive gives a time frame of three years for the upgrade, but there is no regulation for quality or security assurance of existing or newly created digital signature solutions.

Digital signature solutions can be created with several different development paradigms, heterogeneous technologies, or different infrastructure platforms. This raises the concern of creating a national standard, with technical guidelines to evaluate the quality and assurance of these applications, given the legal implications, and the lack of technical regulations. Without some basic regulation, there is a risk of eventual trust issues in e-gov systems, that could jeopardize the development of national ICT strategies.

In this paper, we present the results of a research developed at the University of Costa Rica (UCR), in collaboration with the Costa Rican Ministry for Science, Technology and Telecommunications (MICITT), and the Central Bank of Costa Rica (BCCR) to create technical guidelines for improving the information security level of software applications having digital signature components, at government or private institutions. We propose a new comprehensive, systemic, and systematic, approach to analyze relevant scenarios of digital signature usage, in order to audit software applications created with heterogeneous software and hardware components. The proposal enables the entire assurance process, including identification of threats and vulnerabilities, risk analysis, policy definition, and definition of security controls.

We start with a literature review of relevant digital signature approaches at other countries. Then, we present the digital signature use cases and the application architecture examples used in the paper. After that, we explain our methodology for auditing or evaluating applications, followed by the results of applying the systemic and systematic assurance process, to show the advantages of our approach. Finally, we present the conclusions and future work to contextualize the results in a national scenario.

## 2 Literature Review

We did a review of several international solutions related to improving information security of software applications with digital signature components. Even though there are many countries implementing PKI solutions, we focused on those countries developing information assurance regulations, and technical guides for software applications in contexts requiring digital signature. At the end of this section, we summarize the contributions of the reviewed research.

In Brazil, information assurance of digital signature software is defined by technical manuals [7, 8], which specify the certification requirements to be met. The requirements apply to software components for user authentication with digital certificates, as well as the creation and verification of digital signatures. Compliance with the security requirements is subject to a certification process [9], based on predefined tests [10, 11].

The approach in France is to develop two certifiable protection profiles, based on the Common Criteria framework [12]. Profiles are defined for signature creation applications [13], and signature verification modules [14]. They aim to protect critical resources, such as the electronic document, and all its intermediate representations, the digital certificate, the digital signature, and the signature attributes. Conformity with protection profiles can be certified [15].

Spain also uses Common Criteria protection profiles to assess and certify digital signature applications. There are four protection profiles [16–19], which define security requirements for digital signature creation and verification software that uses the National Electronic Identity Document (DNI-e) as the secure signature device. These profiles focus on the protection of different assets, such as the electronic document and its intermediate representations, signature attributes, signature verification data, signature policies, and authentication data to use the DNI-e. Concordance with protection profiles is certifiable [20].

In contrast, Belgium uses an open source approach to audit its digital signature applications. Belgian citizens obtain, at the age of twelve, an electronic identity card, known as eID, which contains digital certificates [21]. Federal Public Service for Information and Communication Technology (Fedict) is an organization that develops different ways to promote usage of eIDs. They selected an open source approach, and collaborate intensively with software developers to create digital signature applications. The source code of eID initiatives is available through guidelines, and can be accessed by interested parties, which can propose and make improvements [22].

In summary, we found operational solutions whose objectives are comparable to ours. We identified relevant information security aspects that must be protected as part of the information assurance process, such as handling of digital certificates, integrity of the data (signed and to be signed), and confidentiality of the credentials required to access the encryption devices. Therefore, the creation of a national regulation, and technical guidelines to evaluate the information assurance process of digital signature applications seems to be a must-have.

### 3 Digital Signature Scenarios

From the literature review, and additional considerations within the Costa Rican context [6], we selected the digital signature use cases to be analyzed. In this section, we briefly describe these scenarios, and we use one of them to explain how our methodology works.

#### 3.1 Selected Use Cases

We are interested on four digital signature use cases because of their relevance in the context of software applications. The scenarios are:

1. *Digital signature creation*: creation of a set of electronic data to be attached to an electronic document, in order to identify the signer unequivocally, and ensure the integrity of the signed document.
2. *Digital signature verification*: validation of the identity of the signer, the integrity of the signed document, and the validity of the digital certificate used to create the signature.
3. *User authentication with digital certificates*: process of demonstrating ownership of a private key, with the purpose of validating the user identity.
4. *Conversion from basic to advanced format*: addition of attributes to a signed document, in order to ensure long-term verifiability of the contained digital signatures.

Following, we describe the details for a simplified version of the digital signature creation process, and we use it in next sections, as an example, to apply our methodology. The remaining use cases are solved using the same methodology.

Digital signature creation typically starts when a user picks an electronic document to be signed, and his or her digital certificate for identification. The certificate is validated using a set of predefined criteria. Before signing, a hash function is applied to the document to generate a digest. Then, the digest is encrypted using the private key of the user, which produces the digital signature. Finally, the original document, the digital signature, and the digital certificate are put together to create a signed data object, also known as the signed document, as shown in Fig. 1.

Digital signature creation use case shown in Fig. 1 can be implemented in several different ways, by using heterogeneous technologies, software architectures,

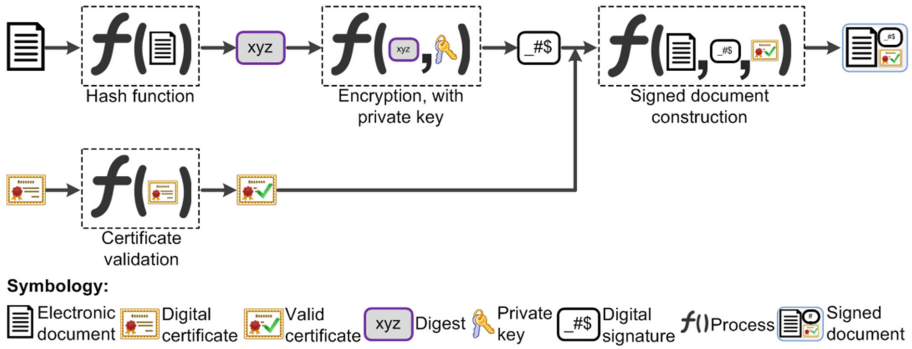


Fig. 1. Digital signature creation process.

or different infrastructures. In next section, we show two example implementations for this use case. Even though both implementations follow the same process, they may cast diferent risk analysis. This shows that, at a large scale, it could be hard to audit a large number of applications having very different implementations. We will use the example to show how to deal with this problem by using our methodology.

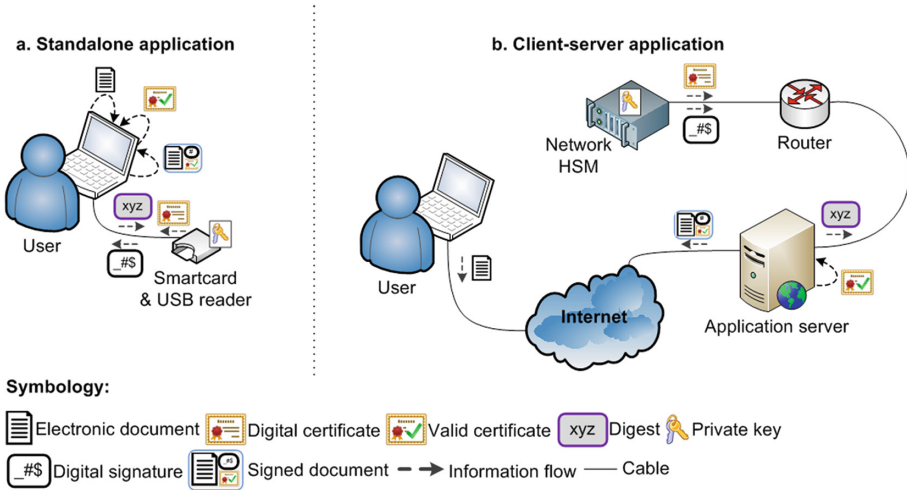
### 3.2 Application Architectures

There are multiple variables influencing the design of a software application to digitally sign a document. The development paradigm, the programming language, or even the infrastructure platform are examples of these variables. The relationship between the software application and its possible implementations is one-to-many. For example, consider two different architectures to implement a digital signature creation application, as shown in Fig. 2.

The standalone architecture, Fig. 2a, represents an all-in-one application, installed in the computer of the user, and all the required software components to create the digital signature are located in the same computer. In this example, the secure cryptographic device, which stores the private key of the user, is connected to the computer using a USB cable.

On the other side, the client-server architecture, in Fig. 2b, represents an application with distributed software components across different machines. Some actions take place on the user side, but other functions are executed on the application server, and they are remote from each other. In this case, the secure cryptographic device is also remotely accessed, by using a network communication.

Both architectures implement the same use case for digital signature. But they are exposed to different information security risks, because of the vulnerabilities or threats that can show up at the different components of each architecture, and because they also have different communication channels between components. For example, asking the cryptographic device to sign a digest requires a



**Fig. 2.** Standalone and client-server architectures implementing a digital signature creation process.

local communication for the standalone application, but it is a remote operation for the client-server application.

In the next section, we describe a methodology to deal with these differences in a systemic and systematic way. We propose an assurance solution for the entire system, using a systematic step-by-step process to deal with the different risk analysis inherent to each architecture.

## 4 Methodology: InfoSec-Tree Model with Extensions

We selected the InfoSec-Tree Model [23] as the main tool to establish our information assurance process. We extended the original model, and improved the systemic capabilities provided by its whole-parts structure. We propose new ideas to use the model in a wider context, as a tool for risk analysis. We also add new elements to support the systematic auditing of a large number of software applications, with similar security requirements, but having different software components, implementation techniques, and using different software development tools.

### 4.1 The Basic Model

The InfoSec-Tree Model is an information security model proposing a hierarchical whole-parts approach. In this model, a software application or technological system is decomposed into its parts, using a tree structure. The root node represents the entire system being assured. Child nodes are created by decomposing

the root node into its components, and each component can be divided into sub-components, and so on. The depth of the tree represents the required assurance granularity level for the system or its subcomponents. The only restriction of the hierarchical structure is to keep consistent the whole-parts relation between each node and its children.

The InfoSec-Tree Model proposes a security triad abstraction to specify security requirements inside each node of the tree, or between pairs of communicating nodes. Triads representing security requirements for information contained inside a node are called internal-triads. End-point triads represent security requirements of information being transmitted between two nodes. Triads have a structure like (*assurance moment, information state, security service*), to represent the time dimension of the event, the state of information, and the security requirement, respectively.

Information flow diagrams are another important component of the InfoSec-Tree Model. They represent communicating nodes, connected through endpoint-triads. Information flows describe scenarios of information transmitted between pairs of communicating nodes, and also provide the elements to define information security controls in this context.

There are some interesting facts about the InfoSec-Tree Model that permit us think on it as a solution:

- The whole-parts structure enables a systemic security analysis of a software application. The nodes can represent modules or components of the application, at any level. This feature facilitates a security analysis of several different software applications using a consistent methodology.
- The target system can be composed of hardware, software, or a mix of them, and it also can be of any size. This enables an homogeneous way to define an assurance process comprising a software application, and its technological infrastructure.
- The original model is designed to define security controls but, in our experience, the underlying structure can be extended, in a natural way, for risk analysis, threats and vulnerability identification, security policy definition, and other additional components of an information assurance process.

Following, we explain the main ideas for the proposed extensions to the InfoSec-Tree Model.

## 4.2 Adding Vulnerabilities, Threats and Risk Analysis

The original InfoSec-Tree Model proposes a solution to define information security controls for an entire computer system. But, after using the model for a while, we found that it can also be used to precisely set the location of identified vulnerabilities and threats in a system. Consequently, the tree structure is a good place to locate and identify security risks. Triads represent places where information is located, so we can use them to identify risks, and we can pinpoint their location accurately, by indicating the specific triads where vulnerabilities and threats occur.

### 4.3 Defining Control Objectives

The result of applying the original InfoSec-Tree Model is a set of specific security controls, located at different points, of a specific application. But we require a wider definition for the concept of security control, because we need to audit the security of a large number of applications, having different architectures and infrastructures. We need to establish a minimum but appropriate set of security requirements for many software applications having digital signature components. Then, we broaden the security control concept to control objective.

A control objective is a generic definition of a security control to specify a security countermeasure. It excludes specific implementation details such as used technologies, algorithms, implementation languages, or other specific technical details. Details are only included when they represent a relevant aspect to reach the goal indicated by a security requirement. This new definition provides an appropriate level of generality to define security controls at a large scale.

Additionally, control objectives enable usage of tools that generally apply, on industry, during an information assurance process. For example, in-depth or layered security [24] can be defined in a natural way at consecutive nodes of an infoSec-Tree. Other strategies, such as principle of least privilege or least common mechanism [24], can be also be applied. Therefore, we can establish generic but consistent security requirements, over a large number of different applications.

### 4.4 Analyzing Risks in Information Flows

While doing risk analysis for information flows, with the original InfoSec-Tree model, we obtained different risk assessments for the different application architectures. We identified systematic differences for applications having local (centralized) or remote (distributed) communicating components. For example, our standalone application has only local communications between components, for the digital signature creation use case. But the client-server application has some remote communications between nodes, like the communication between the server and the cryptographic device, and consequently risk assessment is different.

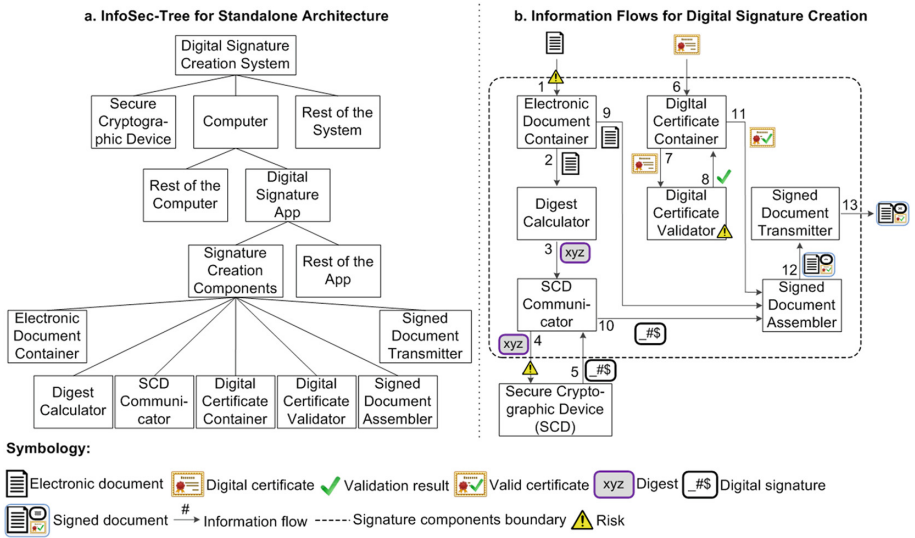
Then, we propose to differentiate risk analysis base on local or remote communications. We can have the same information flow diagram, but different risk analysis and security controls for different architectures. This way, we keep a systematic assurance process, based on how local or remote are the flows, but at the same time enabling analysis of different application implementations. Consequently, we can generate appropriate technical guidelines for an assurance process using a standardized methodology.

## 5 Results

In this section, we show the results of testing our methodology, for the digital signature creation use case, with a standalone architecture and a client-server

architecture. First, we describe the infosec-tree and information flow diagrams. After that, we explain how the systemic and systematic approach arises. Finally, we show the risk analysis process, and compare the results between our example architectures.

The infosec-tree for the standalone architecture from Fig. 2 is shown in Fig. 3a. The root node Digital Signature Creation System represents the entire system we want to assure. It comprises the end-user Computer, the Secure Cryptographic Device, and other components that we are not interested, represented as the Rest of the System. The Digital Signature Application is part of the Computer, and it is composed of the Signature Creation Components, and other elements (Rest of the App). The Signature Creation Components is composed of seven smaller elements that we are going to use when creating a digital signature.



**Fig. 3.** Infosec-tree and information flow diagram for the digital signature creation process.

The infosec-tree for the client-server architecture is not shown, but it has a corresponding tree structure, with a user-side and a server side, instead of having all components at the user-side. In that case, the Secure Cryptographic Device and the Digital Signature Application with its components are located at the server-side. The user-side contains the end-user Computer, a Web Browser, and other elements to appropriately communicate with the server.

Even though the two implementations have different architectures, and consequently different infosec-trees, they have the same information flow diagram, shown in Fig. 3b, for creation digital signature use case described in Fig. 1.

The flow starts when an electronic document is provided (1 in Fig. 3b), and is temporarily stored in an Electronic Document Container. There, the document



is sent (2) to a Digest Calculator, to produce a digest with a hash function. The digest is passed (3) to a Secure Cryptographic Device Communicator (SCDC), which transmits (4) the digest to a Secure Cryptographic Device (SCD). The SCD encrypts the digest with the private key of the user, and produces a digital signature that is sent back (5) to the SCDC. On the other hand, the application also receives (6) the digital certificate of the user, which is temporarily stored in a Digital Certificate Container, and validated (7, 8) by the Digital Certificate Validator. Then, the original document, the digital signature and the digital certificate are put together (9, 10, 11) using a Signed Document Assembler to generate the signed document. Finally, the Signed Document is sent (12) to its final destination (13) with a Signed Document Transmitter.

The infosec-tree enables a systemic assurance process, because the whole-parts structure naturally covers the entire system. From a security perspective, a systemic approach helps improve confidence levels in the system. Furthermore, the information flow diagram promotes a systematic assurance process, because we can iterate over all nodes of the diagram, and over all connections between nodes, doing an assurance process for each corresponding component or communication channel. Internal triads of the original InfoSec-Tree Model can be used to specify security aspects for a component, and they can be extended to include information about the associated vulnerabilities, threats, and risks, as described in our methodology. In the same way, end-point triads can be used to specify security aspects for the communication channels.

After iterating over the components and communicating links of the system, we obtain a detailed list with our security concerns, such as vulnerabilities, threats, and risks, that we can locate precisely, at the corresponding elements of the flow diagrams. Then, we can move on to consider security policies, and use them to define the appropriate security control objectives. As an example, in Fig. 3b, we show three identified risks, using warning symbols, for information flows 1 and 4, and at the Digital Certificate Validator node.

The risk for information flow 1 identifies eventual modifications (integrity) to the electronic document to be signed, when the document is going from its source to the Electronic Document Container. The risk for information flow 4 identifies eventual modifications (integrity) to the digest, while moving towards the cryptographic device for signing. The risk at the Digital Certificate Validator identifies eventual problems when validating the digital certificate, due to an incorrect implementation of the software component.

Now, we can compare how the security issues associated to the identified risks can impact the information security of the system. The application architecture is a relevant aspect at this point. For example, an attacker trying to intrude information in flows 1 or 4, with a standalone implementation, will have to intrude local communications between the CPU and a local device, such as the hard disk or a USB cryptographic device. In contrast, for the client-server architecture, the flows are network communications that can be intercepted with a man-in-the-middle attack, unless we encrypt the communication channels appropriately. The risk identified at the Digital Certificate Validator has a similar impact for both

architectures, because interactions to validate the certificate are very similar in both implementations. After assessing the impact associated with the risks, we can proceed to define the corresponding control objectives.

## 6 Conclusions and Future Work

We found, from the literature review, that our initiative to create a national regulation, with technical guides for e-gov solutions, is accepted and well supported in developed countries having important e-gov strategies. We tested our methodology with use cases in the context of digital signature applications. We determined risk scenarios for information security, in a simplified way that can be applied to groups of heterogeneous software applications but having similar goals. After identifying risks, we evaluate impact and define appropriate control objectives.

Our methodology is comprehensive and systemic, it can be applied in width and height, to all components of the systems, and up to the desired level of granularity or detail. But it is also systematic, by its organized way to analyze the security requirements. The systemic and systematic behaviours enable us to define well supported technical guidelines, with wide coverage and suitable confidence levels for large-scale scenarios.

In summary, we consider that our information assurance methodology is appropriate to develop technical guides supporting regulations at a national scale. This way we can improve the quality and security of ICT projects, such as developing ICT national strategies with e-government services.

For future work, we are working on a first draft of the technical guidelines for digital signature applications, and we expect to use the methodology in other information security contexts. Finally, we are proposing the creation of software tools that help to automate usage of the assurance model, so we can improve auditing processes, and also adapt better for new emerging architectures, and technological platforms.

## References

1. International Telecommunication Union: Measuring the Information Society Report. ITU, Geneva (2015)
2. United Nations: United Nations E-Government Survey 2014 - E-Government for the Future We Want. United Nations, New York (2014)
3. Alvarado, L., Garro, A.: Gobierno electrónico en Costa Rica. Tesis para optar por el grado de Licenciatura en Derecho. Facultad de Derecho, pp. 252–260. Universidad de Costa Rica (2009)
4. Buchmann, J., Karatsiolis, E., Wiesmaier, A.: Introduction to Public Key Infrastructures. Springer, New York (2013)
5. Gobierno de Costa Rica: Ley de Certificados. Firmas Digitales y Documentos Electrónicos. Diario Oficial La Gaceta. Imprenta Nacional, San José (2005)
6. Gobierno de Costa Rica: Masificación de la implementación y el uso de la firma digital en el sector público costarricense. Diario Oficial La Gaceta. Imprenta Nacional, San José (2014)

7. Instituto Nacional de Tecnologia da Informação: Manual de Condutas Técnicas 4 - Volume I: Requisitos, Materiais e Documentos Técnicos para Homologação de Softwares de Assinatura Digital no Âmbito da ICP-Brasil. 2.0, São Paulo (2007)
8. Instituto Nacional de Tecnologia da Informação: Manual de Condutas Técnicas 5 - Volume I: Requisitos, Materiais e Documentos Técnicos para Homologação de Softwares de Autenticação no Âmbito da ICP-Brasil. 2.0, São Paulo (2007)
9. Instituto Nacional de Tecnologia da Informação: Homologações. <http://www.iti.gov.br/servicos/homologacoes>
10. Instituto Nacional de Tecnologia da Informação: Manual de Condutas Técnicas 4 - Volume II: Procedimentos de Ensaio para Avaliação de Conformidade aos Requisitos Técnicos de Softwares de Assinatura Digital no Âmbito da ICP-Brasil. 2.0, São Paulo (2007)
11. Instituto Nacional de Tecnologia da Informação: Manual de Condutas Técnicas 5 - Volume I: Procedimentos de Ensaio para Avaliação de Conformidade aos Requisitos Técnicos de Softwares de Autenticação no Âmbito da ICP-Brasil. 2.0, São Paulo (2007)
12. Common Criteria: About the Common Criteria. <https://www.commoncriteria.portal.org/ccra/>
13. Agence Nationale de la Sécurité des Systèmes d'Information: Protection Profile Electronic Signature Creation Application, 1.7 (2011)
14. Agence Nationale de la Sécurité des Systèmes d'Information: Protection Profile Electronic Signature Verification Module, 1.7 (2011)
15. Agence Nationale de la Sécurité des Systèmes d'Information: Certification Critères Communs. <http://www.ssi.gouv.fr/administration/produits-certifies/cc/>
16. INTECO: PPSCVA-T1, EAL1. Perfil de Protección para la aplicación de creación y verificación de firma electrónica Tipo 1, con control exclusivo de los interfaces con el firmante y nivel de evaluación de los requisitos de seguridad EAL1. 2.0 (2009)
17. INTECO: PPSCVA-T1, EAL3. Perfil de Protección para la aplicación de creación y verificación de firma electrónica Tipo 1, con control exclusivo de los interfaces con el firmante y nivel de evaluación de los requisitos de seguridad EAL3. 2.0 (2009)
18. INTECO: PPSCVA-T2, EAL1. Perfil de Protección para la aplicación de creación y verificación de firma electrónica Tipo 2, con nivel de evaluación de los requisitos de seguridad EAL1. 2.0 (2009)
19. INTECO: PPSCVA-T2, EAL3. Perfil de Protección para la aplicación de creación y verificación de firma electrónica Tipo 2, con nivel de evaluación de los requisitos de seguridad EAL3. 2.0 (2009)
20. Certification Body: Functional Certification. [https://oc.ccn.cni.es/index.php?option=com\\_content&view=article&id=52&Itemid=55](https://oc.ccn.cni.es/index.php?option=com_content&view=article&id=52&Itemid=55)
21. Fedict: The eID. [http://eid.belgium.be/en/find\\_out\\_more\\_about\\_the\\_eid/the\\_electronic\\_identity\\_documents/the\\_eid](http://eid.belgium.be/en/find_out_more_about_the_eid/the_electronic_identity_documents/the_eid)
22. Fedict: The Approach. [http://eid.belgium.be/en/developing\\_eid\\_applications/the\\_approach](http://eid.belgium.be/en/developing_eid_applications/the_approach)
23. Villalón-Fonseca, R., Solano-Rojas, B., Marín-Raventós, G.: Infosec-Tree Model: an applied, in-depth, and structured information security model for computer and network systems. *J. Internet Technol. Secur. Trans. (JITST)* **3**, 300–310 (2014). Infonomics Society, Londres
24. Bishop, M.: *Computer Security: Art and Science*. Addison Wesley, Boston (2002)

# Emergence and Ubiquity in the Smart Cities

Jose Aguilar<sup>1,2</sup>(✉)

<sup>1</sup> CEMISID, Departamento de Computación, Facultad de Ingeniería,  
Universidad de Los Andes, Mérida 5101, Venezuela  
aguilar@ula.ve

<sup>2</sup> Laboratorio de Robótica y Sistemas Inteligentes, Escuela Politécnica Nacional, Quito, Ecuador

**Abstract.** This paper aims to add two concepts to the term of Smart City, ubiquity and emergence. The first term used recently in computer science to describe the impact of Information and Communication Technology (ICT) in all areas of society, being the basis of two new research areas that currently have great interest, called the Internet of Things and smart environments. The second term, widely used by some sciences (biology, theology, etc.) to describe the behavior and dynamics that occur in the real phenomena in their areas. In this paper, we analyze their contributions to help to design cities more autonomous, with more capacities of self-management and adaptation.

**Keywords:** Emergent systems · Ubiquitous systems · Smart cities

## 1 Introduction

The term “smart” is used to define devices such as smart phones, smart cars, smart homes, among others; with different uses and capabilities. The questions to ask are: What makes them smart? Why call them smart? And in the case of this work, What does a city to be “smart”?

In the last twenty years, one of the most innovative industries are aerospace and automotive, based on the introduction of various degrees of automation in its processes. Automation is based in ICT. In fact, some scientists prefer to extend ICTs with the notion of automation (ICAT). The automation are reaching environments common of the life of human beings, with a high level of spatio-temporal integration of technologies with their environments (house, school, etc.).

On the other hand, in the cities there are a lot of “hard technologies” (see [2] for details on that term): telephones, computers, vehicles, among other. There is a long list of technological objects of daily use, which are incorporated into our lives. Thus, a city could not stay out of the impact of ICAT, in particular to exploit the information and knowledge that it generates, which can help improve public services, urban planning processes, among others.

For this, it is necessary to analyse how to integrate and exploit the ICAT in the cities, to make it sustainable, to create innovation processes in them, to increase the social, political and economic self-control, etc.

Particularly, the cities should use the ICAT to be smart. They allow computerize, interconnect and automate all processes that occur in a city (energy management, management of traffic, etc.). For a city to become “smart” must perform a transformation process, implementing the ICAT in their core processes. ICAT enables monitor their activities, interconnect the different entities that compose them, transmit information flows, analyse systems that conform them, make smart decisions, etc.

But a first aspect to determine in a city are its essential processes. According to some authors, the main systems in which a city is based are [4, 7, 10, 17]: (i) the systems of infrastructure (health, education, etc.). (ii) the citizen systems: they define social networking in specific areas of activities in a city (security, civil protection, education, etc.); (iii) the production system: includes regulatory frameworks, administrative processes, business networks, etc. (iv) the transport system: includes the road network, public transport, etc., (v) the communication systems (telephony, Internet, etc.). (vi) the water system: covers the supply and sanitation cycle; and the (vi) the energy system: includes the generation and distribution infrastructure, and the waste treatment.

These have a huge impact on the dynamics and development of the city. A citizen in a city is continually immersed in these systems, and depend on them to survive [16]. In this context, a city must combine ICAT with their systems, integrating ubiquitously.

This ubiquitous integration of the ICAT in the different components of a city (vehicles, buildings, etc.), become specialized robots that can intelligently respond (for example, a building to the energy system of a city) [11, 15]. This will enable a more sophisticated management of resources, and an emergence of behaviour from the inter-relations of these systems, currently unimaginable.

In this context, we can envisage the main systems of a smart city composed by a set of robots (or agents), with autonomous capabilities to work together and to reach collective goals. For example, the vehicles coordinate with the smart semaphores and the public transport systems to optimize the traffic; or the buildings and homes work with the energy distribution system of the city to improve the consumption, etc.

Currently there are many initiatives worldwide to improve the capacities of the cities, to meet the demands of the future. Some have called them smart cities, cities of knowledge, among other names. We are interested especially in this work to analyze the term of smart city, in order to extend it with two other terms, indispensable for an autonomous city: emergence and ubiquity, a step beyond the traditional definition of smart city. In this paper, we explore them.

## 2 Smart Cities

A smart city uses the ICAT to ensure its energy, environmental, political, economic and social sustainability. In a smart city, the ICAT are integrated into its urban structure, to improve the quality of life or optimize the services provided to citizens.

A smart city incorporates knowledge in the activities of their critical systems. To do this, it requires socializing, researching and analyzing the data, information and knowledge, circulating in the city. The smart city uses them, and incorporates into their decision making processes. Specially, a smart city uses them to improve the functioning of

the city and to discover the solutions to its problems. But to succeed, it must study the systems on which it is based, and make them more efficient, more intelligent.

Thus, a smart city is transformed into a “system of systems”, using technology [17]. The transformation of a city in “smart” is a complex process. The first step is to develop a transformation plan, where priorities are established, solving several problems at once, since the challenges and threats to sustainability come from all angles and require a holistic strategy.

Many existing smart cities projects focus on specific management solutions and operating services, mainly oriented to energy efficiency. In addition, these solutions do not use ubiquitous computing, and even less semantic mining, which allows interoperability between applications, knowledge discovery, the emergence, etc.

Smart cities should incorporate many technological paradigms to achieve their goals, some of them are [11–15]: (i) the Internet of Things paradigm, (ii) the cloud computing paradigm, and (iii) the big data paradigm.

From the IT point of view, a city can be seen as a concentration of entities (individuals, families, neighborhoods, businesses, schools, public institutions, etc.), through which a lot of information and data flows. In particular, the cities [10, 12]:

- Produce a lot of information and data in different ways.
- Consume much of that information in their internal dynamics.
- Process this information, to be use.
- Store the information, to be used in the time required by the task required.
- Distribute, the information.

A smart city stores all its information. Information is omnipresent in the city, and consumes it in the right place, at the right time. That is, the city makes an intelligent information management, based on the paradigm of ubiquity of information.

### 3 More than Smart Cities

Currently there is not a clear definition of smart city, some entities as the IEEE [6] have defined some criteria, but are still very vague. Perhaps for this is that the main objectives of a smart city is to economize (recycle, reuse, etc.) all of their resources (water, energy, waste), but the projects around the smart cities have no clear and concrete proposals about these issues.

Many of the Smart Cities projects focus on concrete solutions of management and operation of services. These solutions do not often use ubiquitous computing, do not allow the emergence of services from the interactions of the entities of the city, and even less semantic information integration that allows the interoperability.

In this section we will introduce two new concepts, Ubiquitous and Emergence. They enable self-adaptation of cities, exploiting the resources available for any task, to make the most sustainable cities.

In the “Ubiquitous and Emergent Cities” the services are not invasive, and the emergence of services as processes of self-organization occur. “Ubiquitous and Emergent Cities” define a new form of interaction among the people with the technology,

according to the concept of “calm technology” [9], where the person is the center of the city, and the city is imbued with good practice in order to improve the quality of life of its citizens. It implies new human-machine interfaces with forms that allow sensing automatically extract the required information from users to generate responses from the systems.

“Ubiquitous and Emergent Cities” define a new techno-culture, where objects are located both in the urban space and domestic, with a unique identity, to be locatable and traceable, searchable and recyclable. Thus, the “Ubiquitous and Emergent Cities” see all their entities as objects of “internet of things” with:

- Mechanisms to locate them accurately.
- Mechanisms to mine them.
- Tools to handle virtually.
- Mechanisms that allow generate autonomous intelligent behavior.

### 3.1 Ubiquitous Cities

A Ubiquitous City uses the Intelligent environments paradigm to perceive, adapt and respond to people from a perspective in which the information is available anywhere and for whom the require [8, 13, 15]. To do this, the city is seen as a services center, where those services exploit the information available, to provide their capabilities at any time and place (open space and domestic, private and public, etc.).

A Ubiquitous City has a network of services available to citizens from a perspective of *prosumers*, i.e., citizens with the ability to produce and consume services. That implies certain qualities in the technology of the city, such as [8]:

- Ability to real time processing of large volumes of data.
- Ability to perform tasks of Business Intelligence and Advanced Analytics, permanently and dynamically.
- Based on non-invasive technologies, multi-user systems, multi-device systems, multi-modal systems and multi-platforms systems.
- Based on the paradigm of “context-aware computing”.

A ubiquitous city allows the access to all entities that compose it, controlling them remotely, monitoring vital variables (e.g. environmental), among other things, relying on automated systems to aid decision making, prevention systems, among others.

A ubiquitous city needs a middleware based on a service bus, the platform integrates services that enable ubiquity. This makes the ubiquitous-as-a-service city in a space of global integration, to catalyze innovation in the city. Thus, the government, citizens, entrepreneurs and researchers are *prosumers* of services in different areas: education, health, transport, energy, etc. All converge on the platform. *Prosumers* articulate emerging service environments based on their needs. That makes the ubiquitous city an open ecosystem of integrated management of e-services, which is interactive, intelligent, modular, multimodal, interoperable and adaptive, which allows any person to participate in this new paradigm of social integration. It composes services to govern, to organize business, etc.

Although many of these services already exist today in smart cities, they appear as specific solutions with high proactive participation of users in order to be used. This fragmentation and active participation of users, do not make possible the social “domestication” [5]. Ubiquitous city offers a service architecture across devices “tamed” by society (digital television, smart phones, etc.) to do their daily activities without the user’s knowledge. Ubiquitous cities enable the paradigm of e-inclusion.

In general, services in a ubiquitous city are varied, and are usually based on location (LBS, Location Based Services) such that the information and services provided to users are based on context. The most representative services of a Ubiquitous City are [8, 15]:

- U-Life: These services enable users to control the home equipment automatically. For example, management of climate comfort and energy efficiency at home. Other services in this area are the U-Emergency, U-Health, and U-education.
- U-Business: These services involve all areas of the economy, and include U-Banking, U-Payments, U-Work, and U-Logistics.
- U-government: are all the services for the management of local, regional and national governments. Examples are: U-Democracy, U-Defense, U-Police, and U-Criminal.
- Intelligent Transport Systems (ITS): these services play a vital role to ensure mobility in the city. Examples are U-logistics, smart cars and smart roads.
- Intelligent Buildings: they are services that enable optimal energy management, security, and the reaction to the context and its users. Examples are U-Office and U-Apartment.

A wide range of ICAT are necessary in a Ubiquitous City, which are integrated through its middleware. In addition to those already named (Cloud Computing, etc.), it requires other technologies [8]: Computer aware of the context, Augmented Reality, Geographic Information Systems, Global Positioning System (GPS), Broadband Convergence Network (BCN), High Speed Downlink Packet Access (HSDPA) Wireless Broadband (WiBro), Ubiquitous Sensor Network (USN), System-on-a-Chip (SoC), etc.

Some aspects must be considered, to achieve a ubiquitous city [13, 15]:

- It is necessary a computational platform to offer the ubiquity services in the city. Particularly, this services middleware must guarantee integration and interoperability of the services, and must provide security, privacy, among others. With respect to privacy, in [18] is summarized the key challenges and issues, and the emerging technology standards, in the context of privacy and security in smart cities. They establish that the privacy can be achieved: “(i) by imposing high security requirements onto the used technology to avoid third party abuses; and (ii) by decoupling technical smart city data streams from the personal one to avoid abuse of data by insiders”.
- The open data paradigm must be used to allow the utilization of the data in the different contexts.
- It is necessary a synergy between the different actors of the city (government, universities, etc.), to identify the real requirements, to integrate their strengths and to work together, to define the laws for a ubiquitous city, etc.
- It is necessary to promote an innovation ecosystem where emerge the *prosumers* users, in order to provide unimaginable services, to investigate about the new technologies, their impacts, etc.



### 3.2 Emergent Cities

An U-city should enable the integration of services dynamically. To do so requires ICAT capacities for self-configured according to the needs of citizens. That is, are cities that can self-optimize, self-evolve from its internal dynamics. These are the basis of emergent cities.

Something will be considered emerging, if we have indicators of the phenomenon on a macro level (observable) [1]. Emergence classic indicators are observable patterns at a higher level, with specific temporal and spatial characteristics. A system emerges in a given environment because it is detectable, and such detection is useful. Emergent systems are based on the logic of the Swarm, communities trying to collectively solve problems that require a lot of flexibility and improvisation. This leads to a Collective, or Social, or swarm, Intelligence in the city, which is reflected in their neighborhoods, in their institutions, and the achievements and goals that arise.

A kind of global wisdom, characteristic of distributed entities interacting, appears in emergent cities, associated with the “Wisdom of Crowds” Paradigm [1]:

- Diversity of Opinion.
- Independence of Opinions
- Aggregation of opinions.

These are the foundations of what some authors have called as *Swarmocracia*. Moreover, in an emergent city should be given the following characteristics, typical of all emergent system [1]:

- Feedback process.
- Shared memory space.
- Mechanisms and local decision rules.

All this makes the city look like a completely distributed system consisting of heterogeneous entities acting on it. In a city emerges entities, which obey laws of a higher order, which come from that social intelligence. Such entities are able to handle the unpredictability of a city, and consist necessarily of lower-level entities.

The intelligence of an emergent city is based on the combination of telecommunication networks (nerves), the integrated entities ubiquitously (the brains), and sensors and indicators (sensory organs), which operate in the city naturally. It is a web of transport systems, supply energy and water, buildings, household appliances, machinery production, or any management system connections of human activities.

The emergence is because the city produces behaviors in humans prefiguring. These behaviors feed back to the city, so they produce adjustments in it: stores on the boulevards, artists living in specific areas of the city, etc. The city expresses the repeated behavior of groups, collects information on the global behavior, etc.

An emergent city uses that in its dynamics [11]. For example, an emergent urban planning observes its streets, its operation, the people, etc., and learns from it. From that look, the urban planner tries to extract the identity of the neighborhood, to define the streets, houses, etc. It involves seeing the cities as a machine learning.

Particularly, in an emergent city the citizens must communicate horizontally. Horizontal communication defines forms of dialogue between equals, allowing the emergence of the collective intelligence [1]. A key element is the method to reach collective decisions and avoid conflicts, as part of a process of consultation and dialogue. This method must assume that all options are known by all individuals, and it is necessary to consider all views.

In general, three essential aspects that characterize an emerging city:

- The construction of the shared reality.
- The identity and urban self-reference.
- The ability to self-reproduce.

The self-organizing process of the city, can see in time, as the shops/companies are grouped in very different areas. From a single micro-behavior (close to similar stores), the model is capable of generating a macro-behavior (patterns of organization: location of shops/businesses). For example, it explains the formation of neighborhoods in a city as a unit. These neighborhoods arise from thousands of local interactions that occur in the city. The neighborhoods are patterns over time, emerging from tacit consensus [1]: the financial area is located in a given area, the pubs in other stores, the artisans in another, and so on. The patterns of these urban areas are characterized by their cultural dynamics that determine their activities, people who frequent them, social rules that govern them, urban forms that occur, among other things. The people live in these areas, follow the social norms that are proper to them, without any authority.

Like any emergent system, the city per se is an emergent pattern over time, the product of multiple generations, where the disturbances (changes of government, technological innovations, etc.) are molding it (in Florence, silk spinners have been grouped into the same areas for hundreds of years). Some of these patterns are maintained, because they are linked to physical structures (churches such as San Pedro have allowed the existence of a religious neighborhood around it, etc.), but others have arisen by the laws of emergence (e.g., the neighborhood of silk not have a physical structure as attractor) [1]. And this is not because of laziness, it is due to the cultural emergence that occurs on the scale of thousands of years.

## 4 Conclusions

The XXI century will be a century in which cities play a key role in the new global political model. The most successful cities will be those that offer more prosperity to its citizens, overcoming the challenges presented to them for their sustainability. The ICAT are fundamental to it, making them more intelligent, allowing [11]:

- A smart government.
- A digital context to integrate its citizens in the knowledge society.
- A digital social model.
- An electronic economy.

The cities each day will be more embedded in smart devices environments, tools of environmental intelligence and data analytics, among others, in a transparent manner that will individualize services to offer its citizens in the fields of health, culture, among others. These new services have the following characteristics [8, 12–15]:

- Ubiquity of the user and services.
- Citywide Sensorization
- Adaptation to the user context.
- Semantic technologies.
- Integrated Services

Ubiquitous city allows to see a city as a network of services, available at the appropriate time and place, through the most appropriate device for each situation. The emergent city allows local autonomy, and from there bring out the solutions required for the needs of cities. In that sense, the “Ubiquitous and Emergent Cities” develop an autonomous behavior based on the ICAT, as a result of processes of self-organization. All this allows a Collective Intelligence of a city, with [3]:

- Adaptive, autonomous and intelligent capacities.
- Capabilities to discover and exploit this knowledge.
- Capacity to integrate and automate social processes.
- Capacities to exploit the components deployed in the city.

But, the social intelligence emerges in a city, if there is:

- An empowerment of the intelligence.
- An intelligent instrumentation.
- The orchestration of efforts.

Particularly, an essential element of a ubiquitous and emergent city are spaces to build social consensus. These spaces are an essential element of life in the city. In these spaces are given dynamics of recognition of diversity, such that different views can be discussed and explored. It is not from the imposition but from the dialogue as a way of building social agreements, like a “ubiquitous and emergent city” defines its future. These consensuses make the development proposals emerge from the local level, which makes possible the emergence of a new citizen, responsible, constructive, among other qualities. Emergent systems provide concrete ways to do this.

In this context, it is important to define a Collective/Social Intelligence. This type of intelligence is based on the recognition of the diversity (social, political, etc.) of the citizens, in the respect to the others (including the earth), in the definition of common public benefits, etc. The social intelligence is reached when the communities are capable to agree, to build collective agreements, in order to achieve a good living. In this case, a “smart, ubiquitous and emergent” city, will simply follow these social patterns.

**Acknowledgements.** Dr Aguilar has been partially supported by the Prometeo Project of the Ministry of Higher Education, Science, Technology and Innovation of the Republic of Ecuador.

## References

1. Aguilar, J.: *Introducción a los Sistemas Emergentes*, Talleres Gráficos, Universidad de Los Andes, Mérida, Venezuela (2014)
2. Aguilar, J.: *Hacia una Tecnología Democrática para Mérida: bases para un nuevo Paradigma Universitario en la creación de una Facultad en Tecnologías Informáticas*. *Revista de la Academia de Mérida* **14**, 17–80 (2009)
3. Aguilar, J., Besembel, I., Cerrada, M., Hidrobo, F., Narciso, F.: *Una metodología para el Modelado de Sistemas de Ingeniería Orientado a Agentes*. *Revista Iberoamericana de Inteligencia Artificial* **12**, 39–60 (2008)
4. Batty, M., Axhausen, K., Fosca, G., Pozdnoukhov, A., Bazzani, A., Wachowicz, M., Ouzounis, G., Portugali, Y.: *Smart cities of the future*. *Eur. Phys. J. Spec. Top.* **214**, 481–518 (2012)
5. Clohessy, T., Acton, T., Morgan, L.: *Smart City-as-a-Service (SCaaS): a future roadmap for e-government smart city cloud computing initiatives*. In: *IEEE/ACM 7th International Conference on Utility and Cloud Computing*, Londres, UK, pp. 836–841 (2014)
6. IEEE smartcities (2013). <http://smartcities.ieee.org/>
7. Komninos, N.: *What makes cities intelligent?* In: Mark, D. (ed.) *Smart Cities: Governing, Modelling and Analysing the Transition*, pp. 77–87. Taylor and Francis (2013)
8. Lee, S., Han, J., Leem, Y., Yigitcanlar, T.: *Towards ubiquitous city: concept, planning, and experiences in the Republic of Korea*. In: Yigitcanlar, T., Velibeyoglu, K., Baum, S. (eds.) *Knowledge-Based Urban Development: Planning and Applications in the Information Hershey*. PA, IGI Global Era, pp. 148–169 (2008)
9. Lombardi, P., Giordano, S., Farouh, H., Yousef, W.: *Modelling the smart city performance*. *Innov. Eur. J. Soc. Sci. Res.* **25**, 137–149 (2012)
10. Taewoo, N., Pardo, T.: *Conceptualizing smart city with dimensions of technology, people, and institutions*. In: *12th Annual International Digital Government Research Conference: Digital Government Innovation in Challenging Times*, New York, NY, USA, pp. 282–291 (2011)
11. Bezerra, R., Nascimento, F., Martins, J.: *On computational infrastructure requirements to smart and autonomic cities framework*. In: *IEEE First International Smart Cities Conference (ISC2)*, Guadalajara, pp. 1–6 (2015)
12. Jaloudi, S.: *Open source software of smart city protocols current status and challenges*. In: *International Conference on Open Source Software Computing (OSSCOM)*, Amman, pp. 1–6 (2015)
13. Khan, Z., Pervez, Z., Ghafoor, A.: *Towards cloud based smart cities data security and privacy management*. In: *IEEE/ACM 7th International Conference on Utility and Cloud Computing (UCC)*, London, pp. 806–811 (2014)
14. Leon-Garcia, A., Tizghadam, A.: *Application platforms for smart cities*. In: *IEEE First International Smart Cities Conference (ISC2)*, Guadalajara, pp. 1–6 (2015)
15. Nandury, S., Begum, B.: *Smart WSN-based ubiquitous architecture for smart cities*. In: *International Conference on Advances in Computing, Communications and Informatics (ICACCI)*, Kochi, pp. 2366–2373 (2015)
16. Oliveira, A., Campolargo, M.: *From smart cities to human smart cities*. In: *48th Hawaii International Conference on System Sciences (HICSS)*, Kauai, HI, pp. 2336–2344 (2015)

17. Peltan, T.: Smart Cities as complexity management. In: Smart Cities Symposium Prague (SCSP), Prague, pp. 1–5 (2015)
18. Sen, M., Dutt, A., Agarwal, S., Nath, A.: Issues of privacy and security in the role of software in smart cities. In: International Conference on Communication Systems and Network Technologies (CSNT), Gwalior, pp. 518–523 (2013)

## Author Index

- Aguilar, Jose 235  
Almeda, Elisabet 171
- Bartels-González, Rodrigo 223  
Baskerville, Richard 14  
Boronat, Pablo 144  
Brugnoni, Elia 195
- Calderón-Campos, Marta 159  
Camacho, Heilyn 60  
Carballo-Chavarría, Miguel 223  
Carranza-Rojas, Jose 26  
Castro-Reyes, Alexander 132
- Dagiene, Valentina 47
- García, José S. 171  
Garita, Cesar 205  
Gaytán-Lugo, Laura S. 53  
Gil, José A. 144  
González, Ana M. 171
- Kativu, Kevin 96
- Männikkö-Barbutiu, Sirkku 121  
Marín-Raventós, Gabriela 132, 159, 223  
Mata, Francisco J. 181  
Mata-Marín, Gabriela 181  
Mata-Montero, Erick 26  
Mora-Castro, Alejandro 223
- Morales Díaz, Leonel 53  
Mozelius, Peter 121
- Nath, Artash 37  
Nath, Vikas 37  
Nleya, Paul Thabano Tapela 68
- Ortiz, Giannina 205
- Peiris, Ranil 121  
Pérez, Miguel 144  
Polzonetti, Alberto 195  
Pont, Ana 144  
Pottas, Dalenca 96  
Pries-Heje, Jan 14  
Puigjaner, Ramon 109
- Quesada, Ariella 181
- Ramírez Elizondo, Eduardo 85  
Recker, Jan 14  
Revelles, Beatriz 171  
Rumbul, Rebecca 213
- Sagratella, Matteo 195
- Tjoa, A. Min 3  
Tjoa, Simon 3
- Vergés Bosch, Núria 171  
Villalón-Fonseca, Ricardo 223
- Westin, Thomas 121