

# Chapter 8

## Giant Magnetoimpedance Sensors and Their Applications

Since GMI changes as a function of external dc magnetic field or applied dc/ac current, it is possible to design and produce GMI-based sensors that can measure either magnetic fields or dc/ac currents. GMI also changes sensitively with applied stress, and this provides a new opportunity to develop stress sensors. A brief description of these typical sensors is given in this chapter. It shows that the high sensitivity of GMI to applied magnetic field, current, and external stress is very useful for a wide range of industrial and engineering applications.

### 8.1 Types of Giant Magnetoimpedance-Based Sensors

#### 8.1.1 Magnetic Field Sensors

A primary magnetic sensor based on the GMI effect (the so-called GMI sensor) has been proposed and analysed by Atkinson et al. [1]. The circuit of a GMI sensor is displayed in Fig. 8.1. In the circuit, a single-wire sensing element that can be from 0.1 to 10 m long is connected to a bridge circuit via coaxial leads. Herein the source voltage and source resistance play an important role in the bridge balance. In order to use this circuit for a GMI sensor, the impedance changes as a function of external magnetic field at a fixed frequency are needed. This typical sensor operates in an open mode and can be used for measuring or tracking the presence of both homogeneous and inhomogeneous magnetic fields. A detailed investigation of how the processing parameters can be controlled, as well as the influences of these parameters on the performance of a designed GMI sensor, has been reported [2, 3]. Moreover, here the circuit of the GMI sensor is more complicated than the case of [1]. Different classes of novel GMI field sensors using Co-rich amorphous wires have been developed by Mori and his group in collaboration with Aichi Steel Co., Japan [4–7]. In particular, they have developed a reliable amorphous wire CMOS IC multivibrator GMI sensor using the analogue switches instead of the

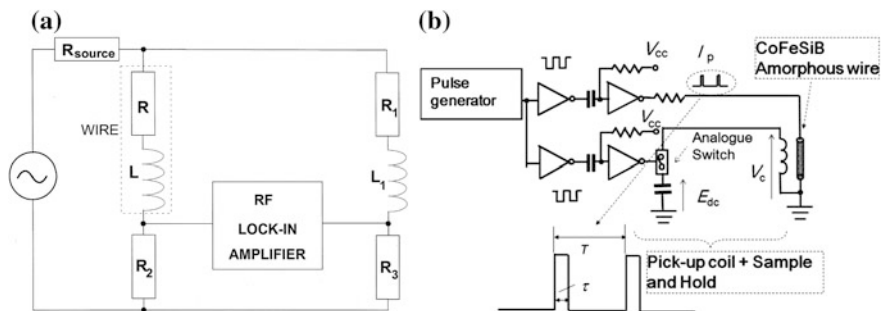

**Fig. 8.1** **a** Simple circuit of a primary GMI sensor using a Co-rich amorphous wire (reprinted with permission from Elsevier [1]); **b** complex circuit of a modern GMI sensor using a Co-rich amorphous wire with a field resolution of up to  $10^{-8}$  Oe and high thermal stability (reprinted with permission from Elsevier [2])

Schottky diodes for achieving high temperature stability [3] and many stable and highly sensitive GMI sensors [4–6].

For comparison, Table 8.1 summarises several magnetic induction sensor types, with their range and typical sensitivity. It is worth mentioning that the sensitivity of the GMI sensor is much higher than that of conventional magnetic sensors (e.g. Hall and GMR sensors). A pico-Tesla ( $10^{-8}$  Oe) resolution has been achieved for micro-GMI sensors making use of ultralow intrinsic magnetic noise in Co-rich amorphous wires with the pulse GMI effect. This type of sensor is useful especially for biomagnetic measurements without any magnetic shielding at room temperature. Therefore, the GMI sensor is superior to a superconducting quantum interference device (SQUID)-based sensor, which is highly sensitive but requires cryogenic liquids to operate. GMI sensors are also cost-effective, power-efficient, reliable, quick response, and portable [2–7].

### 8.1.2 Passive, Wireless Magnetic Field Sensors

By combining GMI sensors and the surface acoustic wave (SAW) transponder devices, Hauser et al. [8] designed a new wireless sensor for measuring magnetic fields. Figure 8.2 illustrates the diagram of a passive, wireless magnetic field sensor.

**Table 8.1** Magnetic induction sensor types, range, and typical sensitivity

Sensor type	Magnetic induction typical range (Oe)	Typical sensitivity (Oe)
Hall	$1-10^6$	10
Magnetoresistance	$1-10^6$	1
Magnetoimpedance	$10^{-6}-1$	$10^{-8}$
Flux gate	$10^{-6}-1$	$10^{-6}$
SQUID	$10^{-9}-10^{-6}$	$10^{-10}$

**Fig. 8.2** Passive, wireless magnetic field sensor (reprinted with the permission of IEEE [8])

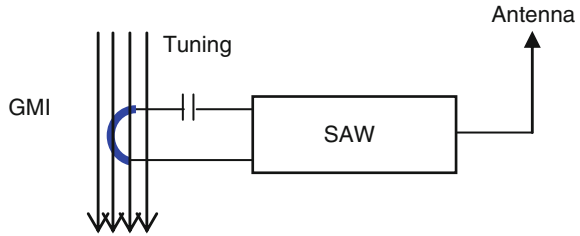

In this diagram, the GMI device is coupled with the second port of the SAW transponder, and the circuit is adjusted to the resonance of the transducer's capacitance. Tuning the resonance for one octave in frequency by applying a magnetic field to the GMI sensor can yield a sufficient effect for radio request readout. The main advantage of this sensor is that it can be used for applications where a magnetic field has to be measured without physical contact and where a wired power supply is not feasible for the sensor.

Recently, Al Rowais et al. [9] developed a wireless magnetic field sensor consisting of a three-layer thin-film GMI sensor and a SAW device on one substrate. However, it is unclear whether a sensor using a thin-film GMI sensor is more advantageous than one using a Co-based amorphous wire.

### 8.1.3 Current Sensors

Using a nearly zero magnetostrictive Co–Fe–Si–B amorphous wire, Valenzuela et al. [10] have successfully produced a current sensor based on the GMI effect. In this sensor, the dc current to be monitored flows through a solenoid, and the magnetic field produced by this solenoid on the wire leads to a controlled decrease of its impedance response. Consequently, the axial magnetic field dependence of impedance is used to measure the dc current accurately. The advantage of this sensor is its reduced dimensions, since the sensing element is a wire. In another work, Rheem et al. [11] developed a high-sensitivity current sensor based on the asymmetric GMI (AGMI) effect and using a field-annealed Co-based amorphous ribbon. Figure 8.3 shows the AGMI effect of the ribbon and a current sensor set-up utilising the AGMI effect of this ribbon. It has been shown that the sensor output voltage increases with applied current up to 1A with a good linearity. Due to the asymmetric characteristic of the GMI effect, this sensor can only measure dc currents. Obviously, the two GMI current sensors [10, 11] are suitable for dc current measurements but not for ac current measurements. This therefore warranted further development for a GMI current sensor that can be used to measure both dc and ac currents.

A new design of the contactless current GMI sensor has been reported [12]. A double-core structure was used in order to improve the temperature stability. The temperature coefficient of sensitivity and offset drift were reduced to one-half compared to a single-core sensor. It was also suggested that the design of this

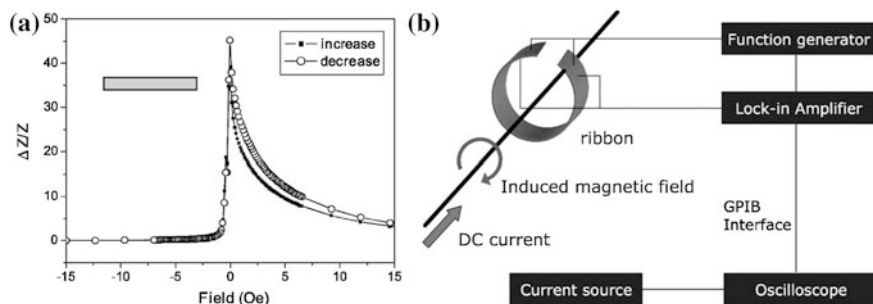

**Fig. 8.3** **a** Asymmetric GMI of a field-annealed Co-rich amorphous ribbon and **b** the current sensor set-up based on the GMI effect of the ribbon (reprinted with the permission of Elsevier [11])

current sensor enhanced its stability as compared to that using the AGMI effect [11]. This is because the asymmetry in GMI was achieved by surface crystallisation as well as internal stress, which are often temperature-dependent and unstable in time. Recently, a high dynamic range dc–ac current sensor utilising the GMI effect has been developed [13]. The sensor exhibited good sensitivity (0.24 V/A) and very good linearity, free from hysteresis, in a wide dynamic range of  $\pm 40$  A.

### 8.1.4 Stress Sensors

Based on the applied stress dependence of the GMI effect, Tejedor et al. [14] first proposed the development of stress sensors using amorphous ribbons. This showed that for a Co-based amorphous ribbon, the application of a tensile stress changes the effective anisotropy and influences the GMI effect. The maximum stress sensitivity of the effective anisotropy field ( $\sim 214$  MPa/Oe) is found at a given frequency of 1 MHz for the conventionally annealed ribbon. For the stress-annealed ribbon, the sensitivity is 167 MPa/Oe, and the impedance variation as a function of the applied stress is about 100 MPa/ $\Omega$ .

Recently, a magnetoelastic sensor based on the stress dependence of the GMI effect in a Co–Mn–Si–B amorphous microwire has been introduced by [15]. This showed that the stress dependence of the GMI effect induced variation on the ac voltage measured between the ends of the sample placed in the magnetic field under applied tensile stress (Fig. 8.4). For instance, when the sample was under a load of 3 g, the change of the voltage across the microwire was found to be about 3.5 V [15]. The high sensitivity of the GMI ratio in responding to quite small values of mechanical load makes this stress-sensitive GMI effect promising for practical applications. More recently, utilising Co–Fe–Si–B amorphous ribbons and a unique magnetic field bias, Bowles et al. [16] developed a low-cost and high proportional change stress sensor. This stress sensor, combined with a battery-free analogue tag, allows the data to be transmitted inductively to a remote transceiver without a

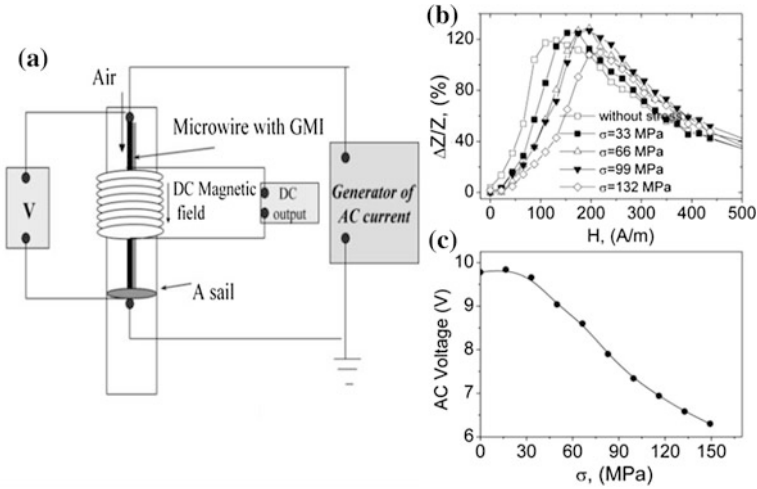
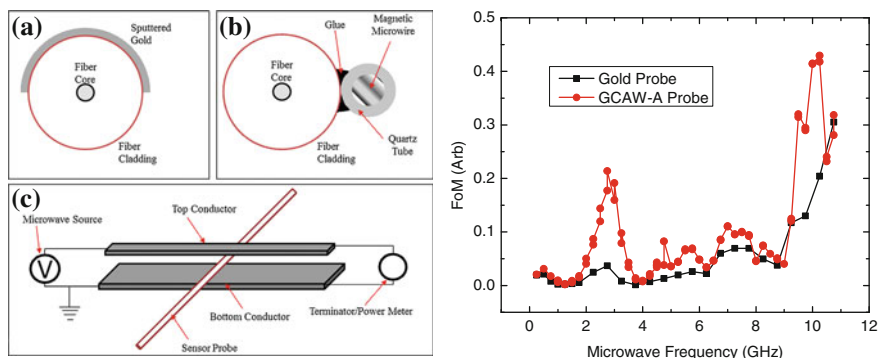

**Fig. 8.4** Schematic representation of the magnetoelastic sensor based on stress dependence of GMI effect (a),  $\Delta Z/Z(H)$  dependencies of Co–Mn–Si–B amorphous microwire measured at different applied stresses (b), and calibration curves of sensor (c) (reprinted with the permission of Elsevier [15])

hardwire connection. This showed that the stress-induced impedance sensor has several advantages over conventional stress sensors. For instance, a semiconductor strain gauge usually shows a change in resistance of only 15 % when strained to its maximum recommended stress level, while the amorphous alloy sensor has been demonstrated to show a large change in the inductance of 315 % when strained to its maximum working level [16]. Furthermore, a lower cost and power analogue electrical circuit is superior to the amorphous alloy sensor. Indeed, the discovery of the giant stress impedance (SI) effect in several amorphous wires [17] has provided the opportunity for developing these materials for novel stress-sensor applications.

### 8.1.5 RF and Energy Sensors

It has been shown that Co-rich amorphous microwires with vanishing magnetostriction exhibit both the GMI and the ferromagnetic resonance (FMR) effects [17]. While GMI is a large change in the ac impedance of a ferromagnetic conductor subject to an external magnetic field, FMR arises due to the precession of the magnetic moments of a ferromagnetic material when subjected to an external magnetic field, making the microwires attractive for electromagnetic energy absorption applications. Vazquez et al. [18–20] have attributed these two effects to the same origin in the microwires and established a correlation between them. As the microwires show excellent microwave absorption properties [19], they have recently been exploited for applications in metamaterials and structural health



**Fig. 8.5** *Left panel* Schematic of an FBG probe. Cross-sectional view of **a** the gold-based probe; **b** the microwire-based probe; **c** a sensor probe in the microstrip transmission line (TEM cell). The sensor was perpendicular to the length of the TEM cell conductors; *Right panel* FoM of the microwire-A microwire-based probe and the gold-based probe

monitoring [21, 22]. Very recently, Phan and co-workers have developed a new method of using a Co-rich glass-coated amorphous microwire as a microwave absorber for the fabrication of a fibre Bragg grating-based microwave energy sensor with improved sensitivity and less perturbation of the microwave field [23]. As compared to a similar approach that uses gold to absorb electromagnetic radiation, the microwire yields a device with greater sensitivity ( $\sim 10$  times at  $f = 3.25$  GHz) relative to the perturbation of the microwave field. The set-ups of the energy sensors using two different probes and their sensitivities achieved over a wide frequency range are displayed in Fig. 8.5.

To optimise the overall performance of the sensor, the relationship between the magnetic properties, GMI, and microwave absorption effects in the microwires has been thoroughly investigated by the same group [24]. The authors have demonstrated that the larger GMI and microwave absorption effects achieved in the microwires originate mainly from higher saturation magnetisation, given that the coercivity, the effective anisotropy field, and the thickness of the glass-coating layer are the same. This knowledge is essential in tailoring the magnetic and microwave properties of microwires for RF and energy sensing applications. Since this type of sensor is physically small and minimally perturbs the field being measured, it can be deployed as a distributed sensor.

### 8.1.6 Temperature Sensors

Based on the temperature dependences of GMI and inductance of amorphous microwires exhibiting low Curie temperatures, Zhukov and co-workers have proposed different types of temperature sensors [25, 26]. The basic set-up and working principle of a GMI-based temperature sensor are displayed in Fig. 8.6.

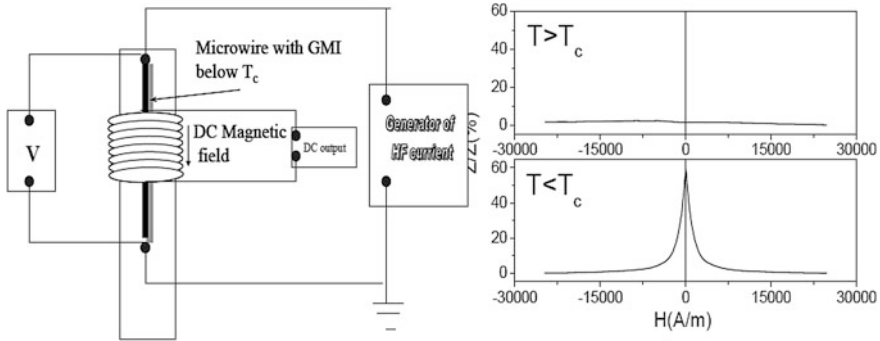

**Fig. 8.6** *Left panel* Basic set-up of a GMI-based temperature sensor. *Right panel* using the drastic variation in GMI in the vicinity of the Curie temperature (reprinted with the permission of Elsevier [25])

It can be seen in Fig. 8.6 (left panel) that the GMI-based temperature sensor operates by utilising the drastic variation in GMI signal in the ferromagnetic ( $T < T_C$ ) and paramagnetic ( $T > T_C$ ) regimes in the vicinity of the Curie temperature of the microwire. A similar mechanism is applied to the case of inductance-based temperature sensors. In both cases, it should be noted that the sensitivities and working ranges of the sensors depend strongly on variations in the magnetisation at the Curie temperature. These sensors may find useful applications in automatically switching temperature-on/off systems. On the other hand, since the temperature of the microwire varies sensitively with microwave field intensity [23, 24], it is possible to design a new class of microwave field sensor for temperature sensing. Further research is needed to fully exploit this possibility.

## 8.2 Applications of Giant Magnetoimpedance-Based Sensors

Many industrial and engineering applications of GMI have been proposed to date, including computer disk heads, rotary encoders, pin-hole detectors, displacement and detection sensors, direction sensors for navigation (electronic compass), current sensors, field sensors, stress sensors, biomedical sensors, environmental sensors, car traffic monitoring, anti-theft systems, and so forth. Here, we briefly describe some GMI-based sensing devices of practical importance.

### 8.2.1 Target Detection and Control of Industrial Processes

A magnetic field sensor based on the GMI effect (or a GMI sensor) in an amorphous wire can be used to detect the presence or passage of moving objects, simply by fixing a small permanent magnet on the vehicles/pieces [27], as displayed in Fig. 8.7.

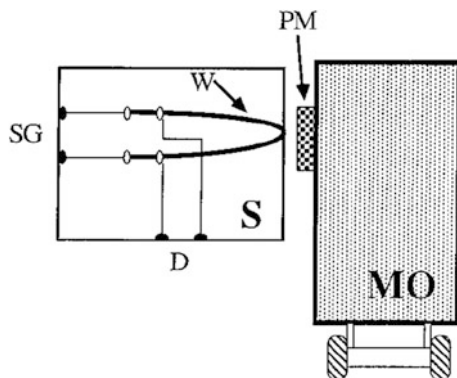
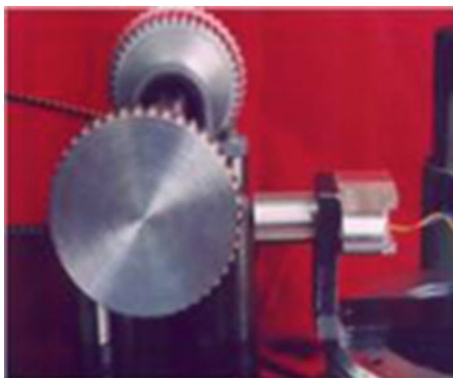

**Fig. 8.7** Layout of the sensor and the moving vehicle, showing the sensor (S), the wire (w), the moving vehicle (MO), the permanent magnet (PM), and the signal generator (SG) and detector circuit (D) contacts, respectively (reprinted with the permission of AIP [27])

The detection is observed as a decrease in the ac voltage on the wire's ends. Such a device has been used to monitor and control many industrial processes, and the advantages of using GMI sensors include simplification and low costs for devices fabrication. Indeed, the monitoring and control systems employing GMI sensors have been found to be much superior to those based on optical devices in the case of industrial processes involving (non-magnetic) dusty atmospheres. From this perspective, the passive and wireless magnetic field sensor is best suited for remote control of industrial processes [2].

Recently, a new type of magnetic sensing device based on the GMI effect, the so-called nano-GMI sensor, has been developed [28]. It has been used in anti-lock brake systems (ABS) and the electric injector speed measuring for automotive and truck industries (see Fig. 8.8).

**Fig. 8.8** Picture of an anti-lock brake system (ABS) using nano-GMI sensor (reprinted with the permission of [28])





### 8.2.2 Space Research and Aerospace Applications

The role of magnetic sensors is important in the field of space physics research. For instance, accurate measurement of the ambient magnetic field vector and its orientation in space can be achieved with the use of highly sensitive magnetic sensors such as GMI sensors. The space magnetic instruments utilising the GMI sensors can be used on board spacecraft to precisely measure magnetic fields in space. These magnetic sensors can also be used to eliminate the sources of stray magnetic fields generated by complex systems of mechanical, electrical, and electronic components on board the spacecraft.

Magnetic sensors have played an important role in aerospace applications [29]. Figure 8.9 shows a road map for space applications of AMR and GMR technologies. As compared to the AMR and GMR sensors, the higher sensitivity of the GMI sensor makes it more attractive for aerospace applications. For instance, in aircraft engines the precise determination of the gear-tooth position can be achieved with the use of high-sensitivity magnetic sensors such as GMI sensors [30]. This gear-tooth sensor detects the presence and absence of a gear tooth made of a ferrous material. It detects a fixed level of magnetic field when no magnetic material is present over it. When a tooth moves over the sensor, the ferrous material acts a flux concentrator, thus leading to a change of the magnetic flux that can be detected by the sensor. Consequently, the sensor can be used to control the speed of the gear as

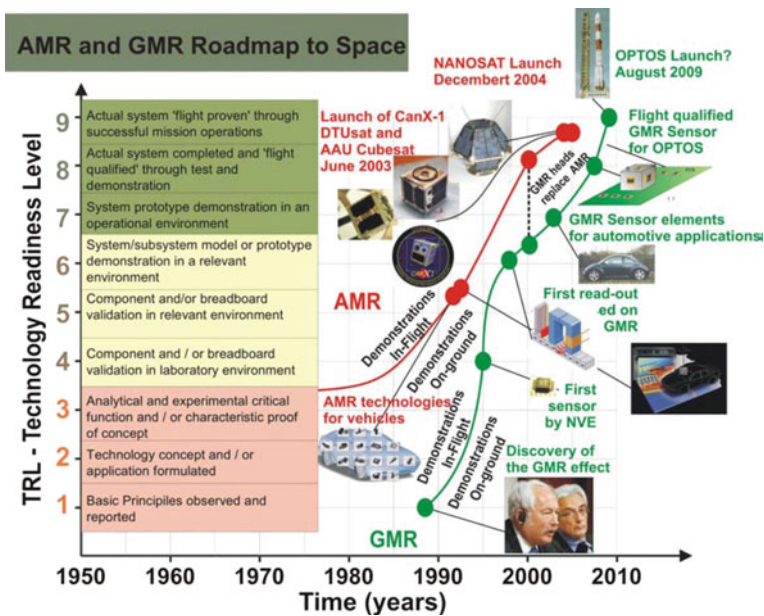

Fig. 8.9 Road map for space applications of AMR and GMR technologies (reprinted with the permission of Elsevier [29])

well as determining the gear-tooth position precisely. Furthermore, the development of non-contact switching systems utilising magnetic sensors has been successful in greatly improving the safety standards of flights. In this case, the GMI sensors can be ideal because of their ultrahigh sensitivity.

### 8.2.3 *Electronic Compasses*

Electronic compasses using flux gate (FG) sensors are used for a wide variety of engineering and electronic devices such as in cars, small boats, and for mobile phones. However, the disadvantages of electronic compasses using FG sensors include large size and high power consumption. Recently, the development of electronic compasses using GMI sensors has proved very successful [2–7]; when compared with the FG sensor, the GMI sensor is much reduced in its dimensions and has low power consumption (see Fig. 8.10).

### 8.2.4 *High-Density Information Storage*

Today, magnetic sensors play an important role in magnetic storage disks and tape drives [31]. In particular, the reading module comprises a special GMR or GMI sensor that is a multilayer structure consisting of magnetic and non-magnetic layers. The writing module operation induces local magnetic moments in bit areas of the hard disk magnetic layer. Bits with remanent magnetisation cause measurable change in the resistance of the GMR or GMI sensor of the reading module, which enables one to distinguish between two levels of digital signal. It should be emphasised that because the sensitivity of the GMI sensor is much higher than that of the GMR sensor, the GMI sensors will be the future option for magnetic storage disks and tape drives. Indeed,

**Fig. 8.10** Comparison of flux gate (FG) and magnetoimpedance (MI) electronic compasses. The size of the MI sensor is much smaller (reprinted with the permission of Elsevier [2])

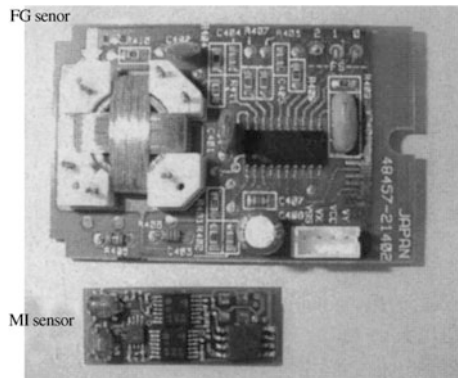

GMI chips with extremely high reproducibility have been successfully manufactured and used in electronic circuits of computer and mobile devices [2–7].

### 8.2.5 Traffic Control

Accidents and jams present serious problems in our transportation; this is partially due to the lack of automatic controlling and monitoring systems. Many systems such as ultrasonic sensors and video cameras have been used for monitoring traffic conditions. Uchiyawa et al. [32] proposed and developed a new car-sensing system using an amorphous wire GMI sensor built into a disk set on the road. A systematic illustration of this device is presented in Fig. 8.11. When a car passes over the disk, the GMI sensor detects stray fields from the car body. The speed and length of a car can be estimated by processing the signals from two GMI sensors. Using a microcomputer, the disk system can record the length, velocity, and time for 2000 cars. The advantages of this sensing technique are that it can be easily installed, it is insensitive to weather conditions, it does not obstruct the stress surface, and it is very reliable. The new sensing system is useful for automatic traffic measurements.

### 8.2.6 Magnetic Tracking Systems

Using GMI sensors and magnet markers, magnetic guidance systems have been designed and developed for use in the automated highway system (AHS). One example is a car that can drive itself automatically using this magnetic guidance system, as shown in Fig. 8.12 [2]. Research on the automatic control of a car has been carried out mainly in Japan. In this research, the magnetic markers are fixed into the road, and the GMI sensors are placed on the car to sense the position of these markers. By travelling from marker to marker, the car can automatically drive without the help of a driver (see Fig. 8.12). In similar principles, these magnetic

**Fig. 8.11** Car-sensing system using two MI sensors and a microcomputer built into the disk set on the road (reprinted with the permission of IEEE [32])

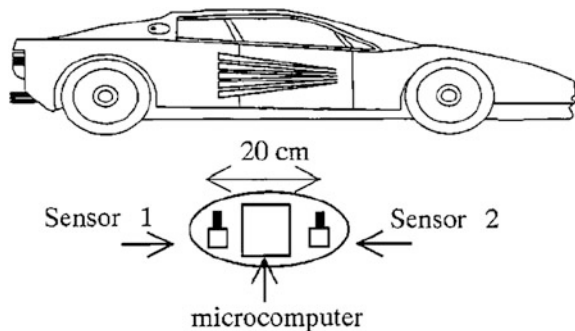



**Fig. 8.12** Automated highway system (AHS) experiment with a MI sensor: this car drives automatically without a driver (reprinted with the permission of Elsevier [2])

guidance systems can be used in many industrial processes involving the automatic control of transporting products.

### 8.2.7 Magnetic Rotary Encoders

Switch-type GMI sensors can be used in magnetic encoders because of their ultrahigh sensitivity. These sensors are superior for producing a simplified and less expensive product with increased management control over conventional magnetic sensors [29]. Recently, He and co-workers have developed a sensitive magnetic sensor using a Fe–Co–Si–B amorphous wire and a coil wrapped around it [33]. To show the sensitivity and the spatial resolution, the magnetic field of a Japanese 1000 yen bill was scanned using this newly developed sensor Fig. 8.13.



**Fig. 8.13** Scanning result of Japanese 1000 yen bill using the GMI field sensor (reprinted with the permission of MDPI [33])

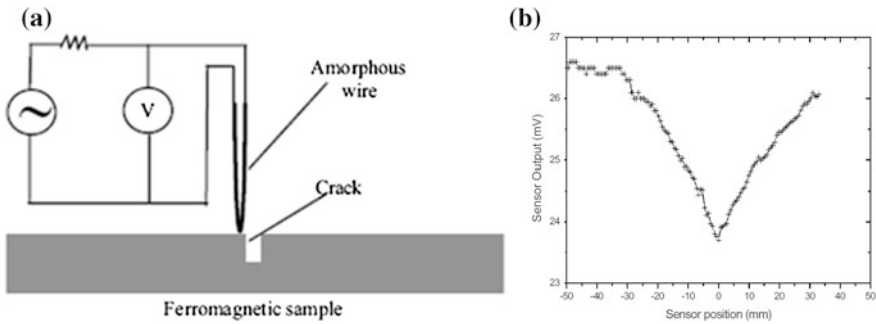

**Fig. 8.14** Left panel a circuit diagram of the amorphous wire as GMI sensor and a crack. Right panel GMI sensor output as a function of the position of the Co–Fe–Si–B amorphous wire sensor at a driving current frequency of 1 MHz (reprinted with the permission of AIP [34])

Figure 8.14 shows a circuit diagram of the amorphous wire GMI sensor used for crack detection (the left panel). It can be seen from the right panel of Fig. 8.14 that there is a large decrease in the output voltage of the GMI sensor circuit when the sensor is moved across the crack [34]. This indicates that the GMI sensor can be used for non-destructive crack detection.

### 8.2.8 Non-destructive Crack Detection

Magnetic methods of non-destructive evaluation have been widely used either to monitor the material state and properties or to find defects. For instance, the eddy current method and the residual magnetic field technique are often used to prevent catastrophic breakage of mechanical parts in machines. In this context, the GMI sensor can be used either to detect magnetic fields created by current passing through conductors or to detect localised magnetic fields [34, 35]. The lack of continuity resulting from a crack produces disturbance in the magnetic field in the material, and the magnitude of the disturbance is determined by the size and shape of the crack. In particular, the GMI property of the amorphous wire can be used to capture cracked regions in the materials.

### 8.2.9 Biological Detection

In biomedical applications, magnetic methods have proved useful for disease treatments and improving human health. For instance, magnetic trackers are used to determine the position of medical tools inside the body (e.g. endoscope, colonoscope, and biopsy needle) and to observe biomechanical motions. Magnetopneumography is a magnetic method that can detect ferromagnetic dust deposited in human lungs by

using its magnetic moment after dc magnetisation. In fact, the sources of magnetic induction in biological systems (e.g. body, human brain, and animals) are detected to be very small; the magnetic field range is  $10^{-10}$ – $10^{-5}$  Oe. In order to detect such small magnetic fields, the requirement for a detection device lies in its high sensitivity. A miniature GMI magnetic sensor should be the option, because it can detect magnetic fields as small as  $10^{-8}$  Oe.

A new type of magnetic sensing device utilising the miniature GMI sensor has been designed successfully for biological detection, such as fast identification and diminution of the direction threshold of pathogens or other targeted biomolecules (e.g. DNA, RNA, antibodies, and metabolites). This magnetic method has proved to be superior to the classical methods (electrical, electrochemical, and optical). That is, while the main disadvantages of the classical methods are high cost, time-consuming, and high detection threshold, the magnetic method provides several advantages such as rapid results, multianalyte detection, low cost, and reduced waste handling. The produced new magnetic sensing device (e.g. GMI-based biomagnetic sensor) comprises a magnetic wire or ribbon as a GMI sensing element [36–42]. A typical example is illustrated in Fig. 8.15 [37]. The principle of the GMI-based biosensor is briefly described as follows. The labelled target biomolecules are intercepted on the sensing element surface by fixed specific natural or artificial bioreceptors such as aaDNA, antibodies, proteins, and enzymes. Thereafter, the functionalised magnetic microparticles (e.g. streptavidin magnetic beads) are introduced to mark the structures formed on the sensing element surface. The magnetic microparticles with high affinity for target biomolecules (e.g. biotinylated biomolecules) are designed to be attached to each magnet biomolecule. Subsequently, upon the application of an external magnetic field, the magnetic microparticles bound to the sensing element's active surface will develop a dipole field that will be detected by the GMI sensor. Accordingly, the sensor impedance

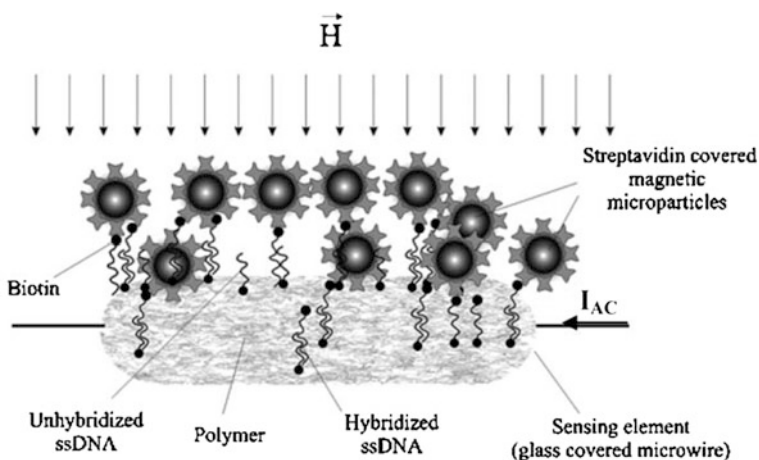
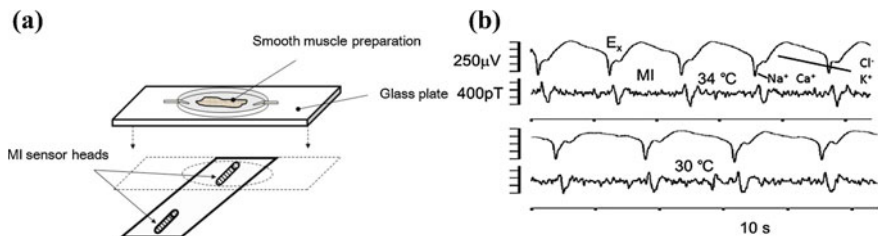

**Fig. 8.15** The principle of a GMI-based magnetic biosensor using the ssDNA hybridisation phenomenon (reprinted with the permission of Elsevier [37])

will be modified proportionally to the magnetic microparticle concentration. Consequently, the target biomolecules will be detected and quantitatively evaluated.

Recently, the research group led by Phan has successfully integrated the radio-frequency magnetoimpedance technology with superparamagnetic nanoparticles to develop a novel biosensing platform for quick, reliable, and sensitive detection of cancer cells and biomolecules [38–40]. Instead of developing a biosensor based on the conventional MI effect, which has limited sensitivity, the authors have demonstrated that by exploiting the MR and MX effects it is possible to improve the sensitivity of the biosensor by up to 50 and 100 %, respectively [38]. The MX-based approach shows the most sensitive detection of superparamagnetic nanoparticles at low concentrations, demonstrating a sensitivity level comparable to that of a SQUID-based biosensor. It is cryogen-free and operates at room temperature, providing a promising avenue to the development of low-cost highly sensitive biosensors. The biosensor has been successfully employed to detect and quantify various bioanalytes, such as Curcumin-type anticancer drugs, bovine serum albumen (BSA) proteins, and Lewis lung carcinoma (LLC) cancer cells that have taken up surface-functionalised iron oxide nanoparticles [39, 40]. Since the iron oxide nanoparticles are widely used as magnetic resonance imaging (MRI) contrast agents, the newly developed biosensing technique can also be used as a new, low-cost, fast, and easy predetection method before MRI.

Using the ultrasensitive wire-based GMI field sensors, the research group led by Mori has developed many novel biosensing devices for the detection of magnetic activity that enables non-contact and non-invasive evaluation of electrical activity in humans [41–44]. The biomagnetic field in the living cell tissue has been successfully detected using pT-MI sensor. Figure 8.16a illustrates the experimental set-up for detection of biomagnetic fields in a living tissue. The stomach musculature of a guinea pig was used, which produces pace-making electric activity with a rather regular cycle even after isolation. The results of simultaneously detected time series of the electric and magnetic oscillatory signals are displayed in Fig. 8.16b. These studies have demonstrated the high capacity of using the pT-MI sensors to detect cardiac magnetic activity in several healthy subjects, and suggest future applications of this biosensing technology in biomedicine.



**Fig. 8.16** **a** Experimental set-up for measuring the active magnetic field in smooth muscle preparations, which are dipped in a circulating wormed physiological saline solution. **b** Measured results of simultaneously detected time series of the electric and magnetic oscillatory signals for a guinea pig stomach preparation (reprinted with the permission of IEEE [3])

### ***8.2.10 Magnetic Anomaly Detection and Geomagnetic Measurements***

Our living system is governed in nature by the Earth's magnetic field, the magnitude of which may vary from  $10^{10}$  Oe to  $10^{-4}$  Oe when going from inside the Earth to the Earth's surface. Nevertheless, the magnitude of the Earth's surface magnetic field varies between  $10^{-4}$  and 1 Oe depending upon its geometry. The detection and orientation of the Earth's magnetic field have found wide applications in petroleum and minerals exploration or shielding used for degaussing of high-performance monitors [29]. However, because the Earth's magnetic field is very small, detecting it is a difficult task, and this requires a highly sensitive magnetic sensor. This requirement can be fulfilled by using a GMI sensor. A GMI-based sensing element (e.g. wire or microwire) as small as 1 mm used in the constructed GMI sensor can be used to detect magnetic anomalies and localised weak magnetic fields. Many devices utilising the GMI sensors have been used in anti-theft systems and in magnetic marking and labelling technology. The GMI sensor can be used to eliminate the error of measurements due to the effect of the Earth's magnetic field. It can also be used for the detection of stray magnetic fields created by engines and machines during their operating processes.

### ***8.2.11 Stress-Sensing Applications***

Altering the GMI response with mechanical stress paves the way towards the development of strain sensors. For example, engineers and manufacturers have been faced with the problem of the accurate measurement of torque. The new finding of the giant impedance-stress effect in amorphous wires or ribbons offers a new opportunity to develop strain sensors that can be used for accurate measurements of torque [17].

Stress-induced impedance sensors utilising amorphous alloys have proved useful for wireless, battery-free applications. A demonstration unit has recently been developed for vehicle tyre pressure monitoring (see Fig. 8.17). A quick response acceleration sensor has been constructed using the SI element of amorphous wires combined with a CMOS IC multivibrator [3]. This sensor has a very high sensitivity so its application to the sensing of road bridge seismovibration due to passing cars has been realised.

### ***8.2.12 Other Applications***

Many other applications of GMI can be found in [2–7, 26]. In these cases, such magnetic sensing devices utilising GMI-based sensors can be used to measure



**Fig. 8.17** Tyre pressure monitoring system incorporating an amorphous alloy wireless, battery-free sensor (reprinted with the permission of Elsevier [17])



variables, instead of measuring magnetic field or current. However, some of these devices usually use principles similar to those of magnetic field sensors [26]. Aside from this, it is emphasised that GMI has been successfully used as a research tool to investigate intrinsic and extrinsic magnetic properties of novel artificially grown soft magnetic materials [17, 45].

## References

1. Atkinson D, Squire PT, Maylin MG, Gore J (2000) An integrating magnetic sensor based on the giant magneto-impedance effect. *Sens Actuators A* 81:82–85
2. Honkura Y (2002) Development of amorphous wire type MI sensors for automobile use. *J Magn Mater* 249:375–377
3. Uchiyama T, Mohri K, Life Fellow, IEEE, Honkura Y, Panina LV (2012) Recent advances of pico-tesla resolution magneto-impedance sensor based on amorphous wire CMOS IC MI sensor. *IEEE Trans Magn* 48:3833
4. Kawajiri N, Nakabayashi M, Cai CM, Mohri K, Uchiyama T (1999) Highly stable MI micro sensor using C-MOS IC multivibrator with synchronous rectification. *IEEE Trans Magn* 35(5):3667–3669
5. Mohri K, Uchiyama T, Shen LP et al (2002) Amorphous wire and CMOS IC-based sensitive micromagnetic sensors utilizing magnetoimpedance (MI) and stress-impedance (SI) effects. *IEEE Trans Magn* 38(5):3063–3068
6. Mohri K, Humphrey FB, Panina LV et al (2009) Advances of amorphous wire magnetics over 27 years. *Phys Status Solidi A* 206(4):601–607
7. Mohri K, Uchiyama T, Panina LV, Yamamoto M, Bushida K (2015) Recent advances of amorphous wire CMOS IC magneto-impedance sensors: innovative high-performance micromagnetic sensor chip. *J Sens Article ID* 718069:8
8. Hauser H, Steindl R, Hausleitner C, Pohl A, Nicolics J (2000) Wirelessly interrogable magnetic field sensor utilizing giant magnetoimpedance effect and surface acoustic wave devices. *IEEE Instrum Measur* 49:648–652
9. Al Rowais H, Li B, Liang C, Green S, Gianchandani Y et al. (2011) Development of a passive and remote magnetic microsensor with thin-film giant magnetoimpedance element and surface acoustic wave transponder. *J Appl Phys* 109:07E524

10. Valensuela R, Freijo JJ, Salcedo A, Vazquez M, Hernando A (1997) A miniature dc current sensor based on magnetoimpedance. *J Appl Phys* 81:4301–4303
11. Rheem YW, Kim CG, Kim CO, Yoon SS (2003) Current sensor application of asymmetric giant magnetoimpedance in amorphous materials. *Sens Act A* 106:19–21
12. Malátek M, Ripka P, Kraus L (2005) Double-core GMI current sensor. *IEEE Trans Magn* 41:3703–3705
13. Asfour A, Yonnet JP, Zidi M (2012) A high dynamic range GMI current sensor. *J Sens Technol* 2(4):7p. Article ID:25485. doi:[10.4236/jst.2012.24023](https://doi.org/10.4236/jst.2012.24023)
14. Tejedor M, Hernando B, Sanchez ML, Prida VM, Vazquez M (2001) Magneto-impedance effect in amorphous ribbons for stress sensor application. *Sens Actuators A* 81:98–101
15. Cobeno AF, Zhukov A, Blanco JM, Larin V, Gonzalez J (2001) Magnetoelastic sensor based on GMI of amorphous microwire. *Sens Act A* 91:95–98
16. Bowles A, Gore J, Tomka G (2005) A new, low-cost, stress sensor for battery-free wireless sensor applications. *Proc SPIE Int Soc Opt Eng* 5765:1104–1111
17. Phan MH, Peng HX (2008) Giant magnetoimpedance materials: fundamentals and applications. *Prog Mater Sci* 53:323
18. Lofland SE, Garcia-Miquel H, Vazquez M, Bhagat SM (2002) *J Appl Phys* 92:2058
19. García-Miquel H, Esbrí MJ, Andrés JM, García JM, García-Beneytez JM, Vázquez M (2001) *IEEE Trans Magn* 37:561
20. Dominguez M, Garcia-Beneytez JM, Vazquez M, Lofland SE, Bhagat SM (2002) *J Magn Magn Mater* 249:117
21. Peng HX, Qin FX, Phan MH, Tang J, Panina LV, Ipatov M et al (2009) *J Non-Cryst Solids* 355:1380
22. Qin FX, Peng HX (2013) *Prog Mater Sci* 58:183
23. Colosimo P, Chen A, Devkota J, Srikanth H, Phan MH (2014) Sensing RF and microwave energy with fiber Bragg grating heating via soft ferromagnetic glass-coated microwires. *Sens Actuators, A* 210:25
24. Devkota J, Colosimo P, Chen A, Larin VS, Srikanth H, Phan MH (2014) Tailoring magnetic and microwave absorption properties of glass-coated soft ferromagnetic amorphous microwires for microwave energy sensing. *J Appl Phys* 115:17A525
25. Zhukov A, Zhukova V (2009) In magnetic properties and applications of ferromagnetic microwires with amorphous and nanocrystalline structure. Nova Science Publishers, Hauppauge, NY, pp 1–162
26. Zhukova V, Ipatov M, Zhukov A (2009) Thin magnetically soft wires for magnetic microsensors. *Sensors* 9:9216–9240
27. Valensuela R, Vazquez M, Hernando A (1996) A position sensor based on magnetoimpedance. *J Appl Phys* 79:6549–6591
28. <http://www.snpc.org.cn>
29. Díaz-Michelena Marina (2009) Small magnetic sensors for space applications. *Sensors* 9:2271–2288. doi:[10.3390/s90402271](https://doi.org/10.3390/s90402271)
30. Lenz JE (1990) A review of magnetic sensors. *Proc IEEE* 78:973–989
31. Maekawa S, Shinjo T (eds) (2002) Spin dependent transport in magnetic nanostructures. Gordon and Breach Science Publishers, New York (Advances in Condensed Matter Science. Vol. 3)
32. Uchiyawa T, Mohri K, Itho H, Nakashima K, Ohuchi J, Sudo Y (2000) Car traffic monitoring system using MI sensor built-in disk set on the road. *IEEE Trans Magn* 36:3670–3672
33. He Dongfeng, Shiwa Mitsuharu (2014) a magnetic sensor with amorphous wire. *Sensors* 14:10644–10649. doi:[10.3390/s140610644](https://doi.org/10.3390/s140610644)
34. Kim DJ, Park DA, Hong JH (2002) Nondestructive evaluation of reactor pressure vessel steels using the giant magnetoimpedance sensor. *J Appl Phys* 91:7421–7423
35. Goktepe M, Ege Y, Bayri N, Atalay S (2004) Torsional stress impedance effect in  $\text{Fe}_{71}\text{Cr}_7\text{Si}_9\text{B}_{13}$  amorphous wire. *Phys Status Solidi (c)* 1:3436–3439

36. Kurlyandskaya GV, Sanchez ML, Hernando B, Prida VM, Gorria P, Tejedor M (2003) Giant-magnetoimpedance-based sensitive element as a model for biosensors. *Appl Phys Lett* 82:3053–3055
37. Chiriac H, Tibu M, Moga AE, Herea DD (2005) Magnetic GMI sensor for detection of biomolecules. *J Magn Magn Mater* 293:671–673
38. Devkota J, Ruiz A, Wang C, Mohapatra S, Mukherjee P, Srikanth H, Phan MH (2013) Detection of low-concentration superparamagnetic nanoparticles using an integrated radio frequency magnetic biosensor. *J Appl Phys* 113:104701
39. Devkota J, Trang MT, Stojak K, Ha PT, Pham HN, Ngo TL, Phuc NX, Mukherjee P, Srikanth H, Phan MH (2014) Synthesis, inductive heating, and magnetoimpedance-based detection of multifunctional  $\text{Fe}_3\text{O}_4$  nanoconjugates. *Sens Actuators B* 190:715–722
40. Devkota J, Howell M, Mohapatra S, Mukherjee P, Srikanth H, Phan MH (2015) Magneto-reactance based detection of MnO nanoparticle-embedded Lewis lung carcinoma cancer cells. *J Appl Phys* 117:17D123
41. Uchiyama T, Nakayama S, Mohri K, Bushida K (2009) Biomagnetic field detection using very high sensitivity magneto-impedance sensors for medical applications. *Phys Status Solidi A* 206(4):639–643
42. Nakayama S, Atsuta S, Shinmi T, Uchiyama T (2011) Pulse-driven magnetoimpedance sensor detection of biomagnetic fields in musculatures with spontaneous electric activity. *Biosens Bioelectron* 27:34–39
43. Uchiyama T, Mohri K, Nakayama S (2011) Measurement of spontaneous oscillatory magnetic field of guinea-pig smooth muscle preparation using pico-tesla resolution amorphous wire magneto-impedance sensor. *IEEE Trans Magn* 47(10):3070–3073
44. Mohri K, Nakamura Y, Uchiyama T, Mohri Y, Mohri Yu, Inden Y (2010) Sensing of human micro-vibration transmitted along solid using pico-tesla magneto-impedance sensor (pT-MI sensor). *Piers Online* 6(2):161–164
45. Knobel M, Pirota KR (2002) Giant magnetoimpedance: concepts and recent progress. *J Magn Magn Mater* 242–245:33–40