

Food Engineering Series

*Series Editor: Gustavo V. Barbosa-Cánovas*

George Saravacos

Athanasios E. Kostaropoulos

# Handbook of Food Processing Equipment

*Second Edition*



Springer

# Food Engineering Series

## **Series Editor**

Gustavo V. Barbosa-Cánovas, Washington State University, USA

## **Advisory Board**

José Miguel Aguilera, Catholic University, Chile

Kezban Candoğan, Ankara University, Turkey

Richard W. Hartel, University of Wisconsin, USA

Albert Ibarz, University of Lleida, Spain

Jozef Kokini, Purdue University, USA

Michael McCarthy, University of California, USA

Keshavan Niranjana, University of Reading, United Kingdom

Micha Peleg, University of Massachusetts, USA

Shafiur Rahman, Sultan Qaboos University, Oman

M. Anandha Rao, Cornell University, USA

Yrjö Roos, University College Cork, Ireland

Jorge Welti-Chanes, Monterrey Institute of Technology, Mexico.

Springer's *Food Engineering Series* is essential to the Food Engineering profession, providing exceptional texts in areas that are necessary for the understanding and development of this constantly evolving discipline. The titles are primarily reference-oriented, targeted to a wide audience including food, mechanical, chemical, and electrical engineers, as well as food scientists and technologists working in the food industry, academia, regulatory industry, or in the design of food manufacturing plants or specialized equipment.

More information about this series at <http://www.springer.com/series/5996>

George Saravacos • Athanasios E. Kostaropoulos

# Handbook of Food Processing Equipment

Second Edition

 Springer

George Saravacos  
21100 Nauplion, Greece

Athanasios E. Kostaropoulos  
Athens, Greece

ISSN 1571-0297

Food Engineering Series

ISBN 978-3-319-25018-2

ISBN 978-3-319-25020-5 (eBook)

DOI 10.1007/978-3-319-25020-5

Library of Congress Control Number: 2015952650

Springer Cham Heidelberg New York Dordrecht London

© Springer International Publishing Switzerland 2016

This work is subject to copyright. All rights are reserved by the Publisher, whether the whole or part of the material is concerned, specifically the rights of translation, reprinting, reuse of illustrations, recitation, broadcasting, reproduction on microfilms or in any other physical way, and transmission or information storage and retrieval, electronic adaptation, computer software, or by similar or dissimilar methodology now known or hereafter developed.

The use of general descriptive names, registered names, trademarks, service marks, etc. in this publication does not imply, even in the absence of a specific statement, that such names are exempt from the relevant protective laws and regulations and therefore free for general use.

The publisher, the authors and the editors are safe to assume that the advice and information in this book are believed to be true and accurate at the date of publication. Neither the publisher nor the authors or the editors give a warranty, express or implied, with respect to the material contained herein or for any errors or omissions that may have been made.

Printed on acid-free paper

Springer International Publishing AG Switzerland is part of Springer Science+Business Media  
([www.springer.com](http://www.springer.com))

# Contents

<b>1</b>	<b>Design of Food Processes and Food Processing Plants . . . . .</b>	<b>1</b>
1.1	Introduction . . . . .	1
1.2	Overview of Chemical Process and Plant Design . . . . .	2
1.2.1	Process Flow Sheets . . . . .	3
1.2.2	Types of Process Designs . . . . .	3
1.2.3	Material and Energy Balances . . . . .	4
1.2.4	Design of Equipment . . . . .	5
1.2.5	Plant Layout and Buildings . . . . .	6
1.2.6	Economic Analysis in Process/Plant Design . . . . .	7
1.2.7	Manufacturing Cost and Profitability . . . . .	11
1.2.8	Computer-Aided Process/Plant Design . . . . .	14
1.3	Design of Food Processes . . . . .	15
1.3.1	Unit Operations in Food Processing . . . . .	19
1.3.2	Food Process Flow Sheets . . . . .	22
1.3.3	Material and Energy Balances . . . . .	23
1.3.4	Computer-Aided Food Process Design . . . . .	28
1.4	Food Plant Design . . . . .	28
1.4.1	Elements of Food Plant Design . . . . .	29
1.4.2	Good Manufacturing Practices . . . . .	36
1.4.3	Food Plant Economics . . . . .	38
	References . . . . .	47
<b>2</b>	<b>Design and Selection of Food Processing Equipment . . . . .</b>	<b>51</b>
2.1	Introduction . . . . .	51
2.2	Sizing and Costing of Equipment . . . . .	52
2.3	Materials of Construction . . . . .	54
2.3.1	Metals . . . . .	55
2.3.2	Plastics–Rubber . . . . .	59
2.3.3	Glass–Ceramics . . . . .	60
2.3.4	Wood . . . . .	60

2.4	Fabrication of Equipment . . . . .	61
2.4.1	Strength of Construction . . . . .	61
2.4.2	Fabrication and Installation of Equipment . . . . .	64
2.5	Hygienic Design of Food Processing Equipment . . . . .	66
2.5.1	Hygienic Standards and Regulations . . . . .	66
2.5.2	Cleaning of Food Equipment . . . . .	69
2.6	Selection of Food Processing Equipment . . . . .	72
2.6.1	Selection of Equipment . . . . .	72
2.6.2	Testing of Equipment . . . . .	78
2.6.3	Equipment Specifications . . . . .	79
2.7	Directories of Equipment . . . . .	82
2.7.1	Directories of Food Equipment . . . . .	82
2.7.2	Exhibitions of Food Equipment . . . . .	83
	References . . . . .	83
<b>3</b>	<b>Mechanical Transport and Storage Equipment . . . . .</b>	<b>87</b>
3.1	Introduction . . . . .	87
3.2	Mechanical Transport Equipment . . . . .	88
3.2.1	Fluid Food Transport Equipment . . . . .	88
3.2.2	Pneumatic and Hydraulic Transport Equipment . . . . .	108
3.2.3	Mechanical Conveyors . . . . .	112
3.3	Food Storage Equipment . . . . .	126
3.3.1	Introduction . . . . .	126
3.3.2	Storage of Solids . . . . .	126
3.3.3	Storage of Liquids . . . . .	138
	References . . . . .	146
<b>4</b>	<b>Mechanical Processing Equipment . . . . .</b>	<b>149</b>
4.1	Introduction . . . . .	149
4.2	Size Reduction . . . . .	149
4.2.1	Introduction . . . . .	149
4.2.2	Cutting . . . . .	153
4.2.3	Crushing and Grinding Equipment . . . . .	165
4.3	Size Enlargement . . . . .	186
4.3.1	Introduction . . . . .	186
4.3.2	Agglomeration Equipment . . . . .	189
4.3.3	Selection of Agglomeration Equipment . . . . .	207
4.4	Homogenization . . . . .	207
4.4.1	Introduction . . . . .	207
4.4.2	Homogenization Equipment . . . . .	208
4.5	Mixing and Forming Equipment . . . . .	214
4.5.1	Introduction . . . . .	214
4.5.2	Fluid Mixing Equipment . . . . .	214
4.5.3	Paste and Dough Mixing Equipment . . . . .	219

4.5.4	Extrusion and Forming Equipment . . . . .	220
4.5.5	Butter and Cheese Processing Equipment . . . . .	226
4.5.6	Solid Mixing and Encrusting Equipment . . . . .	227
	References . . . . .	230
<b>5</b>	<b>Mechanical Separation Equipment . . . . .</b>	<b>233</b>
5.1	Introduction . . . . .	233
5.2	Classification Operations . . . . .	235
5.2.1	Grading . . . . .	236
5.2.2	Sorting . . . . .	237
5.3	Solid/Solid Separations . . . . .	241
5.3.1	Screening . . . . .	241
5.3.2	Fluid Classification . . . . .	247
5.4	Solid/Liquid Separators . . . . .	251
5.4.1	Screens . . . . .	251
5.4.2	Sedimentation Equipment . . . . .	251
5.4.3	Industrial Filters . . . . .	252
5.4.4	Centrifuges . . . . .	258
5.4.5	Mechanical Expression . . . . .	263
5.5	Solid/Air Separators . . . . .	270
5.5.1	Cyclone Separators . . . . .	270
5.5.2	Bag Filters . . . . .	272
5.5.3	Air Filters . . . . .	274
5.5.4	Electrical Filters . . . . .	275
5.5.5	Wet Scrubbers . . . . .	276
5.6	Removal of Food-Related Parts . . . . .	276
5.6.1	General Aspects . . . . .	276
5.6.2	Removal of Undesired Own Parts . . . . .	277
5.6.3	Removal of Desired Parts . . . . .	287
5.6.4	Food Cleaning Operations . . . . .	287
	References . . . . .	290
<b>6</b>	<b>Heat Transfer Equipment . . . . .</b>	<b>293</b>
6.1	Introduction . . . . .	293
6.2	Heat Transfer Coefficients . . . . .	293
6.3	Empirical Correlations of ( <i>h</i> ) . . . . .	296
6.3.1	General Correlations . . . . .	296
6.3.2	Simplified Equations for Air and Water . . . . .	298
6.3.3	Heat Transfer Factor . . . . .	299
6.4	Heat Exchangers . . . . .	300
6.4.1	Overall Heat Transfer Coefficients . . . . .	300
6.4.2	Fouling of Heat Exchangers . . . . .	302
6.4.3	Residence Time Distribution . . . . .	303
6.4.4	Tubular Heat Exchangers . . . . .	304
6.4.5	Plate Heat Exchangers . . . . .	306



6.4.6	Agitated Kettles . . . . .	310
6.4.7	Scraped Surface Heat Exchangers . . . . .	312
6.4.8	Direct Heat Exchangers . . . . .	314
6.4.9	Baking and Roasting Ovens . . . . .	315
6.4.10	Fryers . . . . .	318
6.4.11	Radiation Heaters . . . . .	319
6.4.12	Heat Generation Processes . . . . .	321
6.4.13	Hygienic Considerations . . . . .	324
	References . . . . .	329
<b>7</b>	<b>Food Evaporation Equipment . . . . .</b>	<b>331</b>
7.1	Introduction . . . . .	331
7.2	Heat Transfer in Evaporation . . . . .	332
7.2.1	Physical Properties . . . . .	332
7.2.2	Heat Transfer Coefficients . . . . .	333
7.2.3	Fouling in Evaporators . . . . .	333
7.2.4	Heat Transfer in Film Evaporators . . . . .	334
7.2.5	Falling Film Evaporation of Fruit Juices . . . . .	338
7.3	Food Quality Considerations . . . . .	340
7.4	Food Evaporators . . . . .	340
7.4.1	Material and Energy Balances . . . . .	340
7.4.2	Long Residence-Time Evaporators . . . . .	341
7.4.3	Short Residence-Time Evaporators . . . . .	344
7.5	Energy-Saving Evaporation Systems . . . . .	348
7.5.1	Multiple-Effect Evaporators . . . . .	348
7.5.2	Vapor Recompression Evaporators . . . . .	351
7.5.3	Heat Pump Evaporators . . . . .	353
7.5.4	Combined Reverse Osmosis/Evaporation . . . . .	355
7.5.5	Water Desalination . . . . .	355
7.5.6	Waste-Heat Evaporators . . . . .	355
7.6	Evaporator Components . . . . .	356
7.6.1	Evaporator Bodies . . . . .	356
7.6.2	Vapor/Liquid Separators . . . . .	357
7.6.3	Condensers . . . . .	358
7.6.4	Vacuum Systems . . . . .	359
7.6.5	Evaporator Control . . . . .	360
7.6.6	Testing of Evaporators . . . . .	360
7.6.7	Hygienic Considerations . . . . .	361
	References . . . . .	364
<b>8</b>	<b>Food Dehydration Equipment . . . . .</b>	<b>367</b>
8.1	Introduction . . . . .	367
8.2	Principles of Drying . . . . .	368
8.2.1	Psychrometric Calculations . . . . .	368
8.2.2	Drying Rates . . . . .	370
8.2.3	Food Dehydration Technology . . . . .	374

8.3	Design and Selection of Food Dryers . . . . .	375
8.3.1	Heat and Mass Transfer . . . . .	376
8.3.2	Modeling and Simulation of Dryers . . . . .	379
8.3.3	Design of Industrial Dryers . . . . .	381
8.3.4	Selection of Industrial Dryers . . . . .	382
8.3.5	Commercial Food Drying Equipment . . . . .	383
8.3.6	Special Food Dryers . . . . .	405
8.3.7	Hygienic and Safety Considerations . . . . .	409
8.4	Energy and Cost Considerations of Drying . . . . .	410
8.4.1	Heat Sources for Drying . . . . .	410
8.4.2	Heat Recovery . . . . .	411
8.4.3	Energy-Efficient Dryers . . . . .	412
8.4.4	Cost Considerations . . . . .	413
	References . . . . .	415
<b>9</b>	<b>Refrigeration and Freezing Equipment . . . . .</b>	<b>421</b>
9.1	Introduction . . . . .	421
9.2	Refrigeration Equipment . . . . .	422
9.2.1	Refrigeration Cycles . . . . .	422
9.2.2	Compressors . . . . .	427
9.2.3	Evaporators . . . . .	433
9.2.4	Condensers . . . . .	443
9.2.5	Capacity Control . . . . .	445
9.3	Refrigerants . . . . .	446
9.3.1	Introduction . . . . .	446
9.3.2	Natural Refrigerants . . . . .	452
9.3.3	Fluorocarbon and Blend Refrigerants . . . . .	453
9.4	Lubricants . . . . .	455
9.4.1	Main Types of Lubricants . . . . .	455
9.4.2	Function of Lubrication . . . . .	456
9.4.3	Requirements for Good Lubrication . . . . .	456
9.4.4	Choice of Refrigerant Lubricants . . . . .	458
9.4.5	Additives . . . . .	459
9.5	Cooling of Foods . . . . .	459
9.5.1	Chilling . . . . .	459
9.5.2	Cooling Equipment . . . . .	462
9.6	Freezing of Food . . . . .	468
9.6.1	Freezing . . . . .	468
9.6.2	Freezing Equipment . . . . .	474
9.6.3	Thawing Equipment . . . . .	482
9.7	Cold Storage . . . . .	485
9.7.1	General Aspects . . . . .	485
9.7.2	Reduction of Weight Loss . . . . .	489
9.8	Ice Manufacturing . . . . .	493
	References . . . . .	499

<b>10</b>	<b>Thermal Processing Equipment</b> . . . . .	503
10.1	Introduction . . . . .	503
10.2	Kinetics of Thermal Inactivation . . . . .	504
10.2.1	Inactivation of Microorganisms and Enzymes . . . . .	504
10.2.2	Thermal Damage to Food Components . . . . .	507
10.3	Heat Transfer Considerations . . . . .	507
10.3.1	General Aspects . . . . .	507
10.3.2	Unsteady-State Heat Transfer . . . . .	508
10.4	Thermal Process Calculations . . . . .	511
10.4.1	In-container Sterilization . . . . .	511
10.4.2	Continuous Flow Thermal Processes . . . . .	514
10.5	Thermal Processing Equipment . . . . .	517
10.5.1	General Aspects . . . . .	517
10.5.2	In-container Sterilizers . . . . .	517
10.5.3	Continuous Flow (UHT) Sterilizers . . . . .	535
10.5.4	Thermal Pasteurizers . . . . .	539
10.5.5	Thermal Blanchers . . . . .	543
10.5.6	Hygienic Considerations . . . . .	544
	References . . . . .	546
<b>11</b>	<b>Mass Transfer Equipment</b> . . . . .	549
11.1	Introduction . . . . .	549
11.2	Distillation Equipment . . . . .	551
11.2.1	Vapor/Liquid Equilibria . . . . .	551
11.2.2	Determination of Equilibrium Stages . . . . .	557
11.2.3	Food Distillation Equipment . . . . .	564
11.3	Solvent Extraction/Leaching Equipment . . . . .	570
11.3.1	Liquid/Liquid and Liquid/Solid Equilibria . . . . .	570
11.3.2	Determination of Equilibrium Stages . . . . .	573
11.3.3	Mass Transfer Considerations . . . . .	574
11.3.4	Food Extraction and Leaching Equipment . . . . .	576
11.3.5	Curing . . . . .	579
11.4	Gas/Liquid Absorption Equipment . . . . .	585
11.4.1	Gas/Liquid Equilibria . . . . .	586
11.4.2	Determination of Equilibrium Stages . . . . .	587
11.4.3	Gas Absorption and Stripping Equipment . . . . .	590
11.5	Adsorption and Ion Exchange Equipment . . . . .	591
11.5.1	Adsorption Equilibria and Mass Transfer . . . . .	592
11.5.2	Adsorption Equipment . . . . .	593
11.5.3	Ion Exchange Equipment . . . . .	594
11.5.4	Food Applications . . . . .	595
11.6	Crystallization from Solution Equipment . . . . .	597
11.6.1	Solubility Considerations . . . . .	597
11.6.2	Nucleation and Mass Transfer . . . . .	598
11.6.3	Industrial Crystallizers . . . . .	599
	References . . . . .	602

<b>12</b>	<b>Equipment for Novel Food Processes</b> . . . . .	605
12.1	Introduction . . . . .	605
12.2	Membrane Separation Equipment . . . . .	606
12.2.1	Mass Transfer Considerations . . . . .	606
12.2.2	Membranes and Membrane Modules . . . . .	608
12.2.3	Membrane Separation Systems . . . . .	609
12.2.4	Reverse Osmosis and Nanofiltration . . . . .	611
12.2.5	Ultrafiltration . . . . .	613
12.2.6	Microfiltration . . . . .	616
12.2.7	Pervaporation . . . . .	618
12.2.8	Electrodialysis . . . . .	620
12.3	SCF Extraction . . . . .	621
12.3.1	Supercritical Fluids . . . . .	621
12.3.2	SCF Extraction Processes and Equipment . . . . .	622
12.3.3	SCF Extraction in Food Processing . . . . .	623
12.4	Crystallization from Melt . . . . .	624
12.4.1	Freeze Concentration . . . . .	624
12.4.2	Fat Fractionation . . . . .	626
12.5	Nonthermal Food Preservation . . . . .	627
12.5.1	Food Irradiation . . . . .	628
12.5.2	High-Pressure Processing . . . . .	634
12.5.3	Pulsed Electric Field Processing . . . . .	635
12.5.4	Nanotechnology . . . . .	636
12.6	Robotics . . . . .	637
	References . . . . .	641
<b>13</b>	<b>Food Packaging Equipment</b> . . . . .	645
13.1	Introduction . . . . .	645
13.1.1	General Aspects . . . . .	645
13.1.2	Packaging Characteristics . . . . .	647
13.1.3	Packages and Packaging Materials . . . . .	651
13.2	Preparation of Food Containers . . . . .	657
13.2.1	Unscrambling . . . . .	657
13.2.2	Fabrication and Forming of Packages . . . . .	658
13.3	Filling Equipment . . . . .	666
13.3.1	General Characteristics . . . . .	666
13.3.2	Dosing . . . . .	670
13.3.3	Product Transfer Systems . . . . .	672
13.3.4	Valves . . . . .	674
13.3.5	Weighing . . . . .	676
13.4	Closing Equipment . . . . .	679
13.4.1	Closing of Food Packages . . . . .	679
13.4.2	Glass Closures . . . . .	680
13.4.3	Closing of Metallic Containers . . . . .	681
13.4.4	Closing of Plastic Packages . . . . .	682
13.4.5	Closing of Cartons and Cardboard . . . . .	683

13.5	Aseptic Packaging . . . . .	683
13.6	Group Packaging . . . . .	688
13.6.1	Grouping of Packages . . . . .	688
13.6.2	Wrapping . . . . .	688
13.6.3	Palletizing . . . . .	691
13.7	Cleaning of Packaging Media . . . . .	693
	References . . . . .	694
<b>Appendix A: Notation and Conversion of Units . . . . .</b>		<b>697</b>
<b>Appendix B: Selected Thermophysical Properties . . . . .</b>		<b>703</b>
<b>Appendix C: Control of Food Processing Equipment . . . . .</b>		<b>709</b>
<b>Appendix D: Food Plant Utilities . . . . .</b>		<b>711</b>
<b>Appendix E: Manufacturers and Suppliers of Food Equipment . . . . .</b>		<b>717</b>
<b>Index . . . . .</b>		<b>757</b>

# Chapter 1

## Design of Food Processes and Food Processing Plants

### 1.1 Introduction

*Process design* refers to the design of food processes and manufacturing methods, including process flow sheets, design of processing and control equipment, and economic evaluation of the process. *Plant design* refers to the design of the whole processing plant, including the processing/control equipment, the utilities, the plant buildings, and the waste treatment units. The two terms are used interchangeably in the technical literature. Both process and plant design are basic parts of feasibility and implementation studies of an industrial project, such as a food processing plant.

The necessary phases for realizing an industrial project include the preliminary study, the feasibility study, and the implementation of the project. The feasibility study includes most of the technical and economic information obtained in process and plant design. The implementation phase involves detailed engineering, construction, supply of equipment, and plant erection and start-up.

The development of food process/plant design is based on the principles of food science and technology, chemical engineering, and on the practical experience of food engineers, chemical engineers, and food technologists. In plant design, the experience and developments in other technical fields, such as materials science, mechanical engineering, and management, should also be considered.

Since the literature on research and development and applications of food process/plant design is limited, it is necessary to review the basics of chemical process/plant design, which will be applied critically in the various chapters of this book.

The unique requirements of design of food processes, food plants, and food processing equipment are considered in more detail in this chapter. The numerous food processing operations are classified in an analogous manner with the established unit operations of chemical engineering. Food processes are represented by the familiar process block diagrams (PBDs) and the process flow diagrams

(PFDs), which are indispensable for material and energy balances, and preliminary sizing of process equipment.

Some important aspects of food plant design are discussed in the last part of this chapter, emphasizing the need for an integrated approach of hygienic design, food product quality and safety, and cost-effectiveness.

The general aspects of design and selection of food processing equipment are discussed in Chap. 2. Since the final goal of any food plant design is the satisfaction of the consumers, a few elements have been added to this chapter and Chap. 2, concerning the effectiveness of plant design toward this goal.

## 1.2 Overview of Chemical Process and Plant Design

Chemical process and plant design have been developed mainly in the chemical, petrochemical, and petroleum industries, where very large amounts of materials, usually gases and liquids, are processed continuously into a rather small number of products. The design, operation, and control of these large plants have been advanced in recent years by the use of computers and the availability of data banks of the physical properties of gases and liquids.

Modern process and plant design must reduce raw material costs, capital investment, plant energy consumption, inventory in the plant, and the amount of pollutants generated. The new plants need improved process flexibility, safety, and control technology. Process design should be based more on computer modeling, fundamental principles, and molecular simulations than on today's semiempirical approaches (Edgar 2000).

Process design includes the synthesis, analysis, evaluation, and optimization of process alternatives. Chemical process design is essential in the design of new plants, in the modification or expansion of an existing plant, in the production of a new product, and in the simulation and control of an operating plant. The importance of design is demonstrated by the fact that during the process design (about 2 % of the total project cost), decisions are made that will fix the major portion of the capital and operating expenses of the final plant (Biegler et al. 1997). Economics plays a very important role in any design of chemical processes and chemical plants.

The engineering part of a design project involves basically the development of the process flow sheet, the material and energy balances, and the sizing of the process equipment. In addition, the following essential components of the process plant should be considered: plant location, utilities, plant layout, buildings (architectural and civil engineering), plant operation and control, health and safety, waste disposal, personnel, and legal requirements (restrictions).

Continuous processes are generally preferred over batch processes in the large chemical, petrochemical, and petroleum industries, because they are less expensive in both equipment and operating costs. Batch processes may prove more economical for smaller plants and for food, pharmaceutical, and specialty products. Batch

processes are also preferred when little information is available, when process/products have relatively short life cycles, or when a variety of products are produced in small quantities.

Although considerable progress has been made on the application of modeling and computers to the design of chemical processes and plants, design continues to rely largely on the practical experience and the “art” of design engineers. In the design process, a balance of many technical, operational, and economic factors must be considered (Sandler and Luckiewicz 1987; Liu et al. 1988; Wells and Rose 1986).

### ***1.2.1 Process Flow Sheets***

Process flow sheets represent graphically the required process equipment and the flow of materials and utilities in an industrial plant. The simplest diagram of a process is the *process block diagram* (PBD), which is used mainly for material and energy balances. The most important representation is the *process flow sheet diagram* (PFD), which is used in the preliminary design of process equipment and processing plants. The *process control diagram* (PCD) shows the automatic control of the processing plant, and the *piping and instrumentation diagram* (PID) indicates the details of piping and process instrumentation of the plant. The PFD, PID, and PCD are used in the detailed process/plant design.

The analysis, selection, and optimization of the process flow sheets (PFDs) are essential in large-scale processing plants, where process economics is very important. Combinations of PFD and analytical tables of materials, energy, and labor requirements in each stage are useful, especially when performing an economic analysis of the process. Systematic synthesis models (Biegler et al. 1997) have recently replaced the intuitive flow sheet development. Numerical solutions and computer techniques are used to solve complex flow sheet problems.

In more complex plant designs, techniques of operations research are used. The Gantt and the PERT diagrams enable the time scheduling and realization of a process and indicate the task priorities in achieving a goal (Hausmann 1987; Loker et al. 1989).

### ***1.2.2 Types of Process Designs***

There are several types of process and plant design, ranging from simple estimations of low-accuracy to high-accuracy detailed designs. Simple and preliminary estimates are employed to obtain an approximate idea of the required equipment and investment, while a detailed design with drawings and specifications is used for the construction, operation, and control of the processing plant.



**Table 1.1** Types of chemical process design

Design/estimate	Accuracy, %	Design cost, % of investment
Ratio estimate	40	0.1
Factored estimate	25	0.2
Preliminary estimate	15	1.0
Definitive estimate	10	1.5
Detailed design	5	2.5

Data from Peters and Timmerhaus (1990)

Table 1.1 shows five types of process estimates and designs of increasing accuracy and design cost (Peters and Timmerhaus 1990; Sinnott 1996). The *ratio* or *order of magnitude estimate* is based on data from a similar previous process/plant. The *factored* or *study estimate* is based on known data of major equipment. The *preliminary* or *budget authorization estimate* is based on sufficient data to proceed with the design project. The *definitive* or *project control estimate* is based on almost complete data before preparing the drawings and specifications. The *detailed design* or *the contractor's estimate* is based on complete data, engineering drawings, and specifications for equipment and plant site. The accuracy of the estimation varies from 40 % (ratio method) to 5 % (detailed design).

The first three estimation methods of Table 1.1 are also known as *pre-design estimates*. The most common cost estimates are the preliminary and detailed designs with accuracies of 15 and 5 %, respectively. The cost of preparing the process design as a percentage of the total investment, shown in Table 1.1, is indicative and it depends on the investment, being substantially lower for large projects (Perry and Green 1984; Peters and Timmerhaus 1990). The time required for preparing the preliminary and detailed process designs varies with the complexity and size of the project, being typically about 8 and 12 months, respectively.

### 1.2.3 Material and Energy Balances

The design of process equipment and plant utilities is based primarily on material and energy (heat) balances, which are usually calculated on the PBD. Some approximations are necessary to reduce and simplify the time-consuming calculations, especially for large, complex processing plants, e.g., feed enters the various units at saturation temperature.

Two general methods of calculations are usually applied: the modular and the equation-oriented approach (Biegler et al. 1997). In the modular approach, three types of equations are solved separately: (1) the connectivity equations of the units of the flow sheet, (2) the transport rate and equilibrium equations for each unit, and (3) the equations for the physical, thermodynamic, equilibrium, and transport properties. In the equation-oriented mode, all of the process equations are combined (material/energy balances, thermodynamic and transport, equipment performance,

kinetics, and physical property) into a large, sparse equation set, which is solved simultaneously, usually applying a Newton-type equation solver.

The models for material/energy balances are simplified into linear equations by assuming ideal solutions and saturated liquid or vapor streams. The calculations of material and energy balances are usually made by hand or by PC computers, using simple Excel spreadsheets or data tables. For complex, nonideal processes, rigorous methods are employed, requiring special computer algorithms. The physical and transport properties of the materials are obtained from standard books or databases.

### 1.2.4 Design of Equipment

In preliminary estimations, the approximate size of the process equipment is needed for economic evaluation and subsequent detailed calculations for the processing plant. Material and energy balances, based on the process flow sheet, are used as a basis for the estimation of the various units. A fixed feed rate is assumed (kg/h or tons/h) and all of the materials and heat flows in each unit are calculated.

Transport rate equations and equilibrium relationships are used, including mechanical transfer (pumping), heat transfer, mass transfer, reaction rate, and phase equilibria (vapor/liquid, liquid/liquid, and fluid/solid).

The physical and engineering properties of the materials being processed are needed under the actual conditions of concentration, temperature, and pressure. Data of physical and transport properties are obtained from standard literature texts (Perry and Green 1984, 1997; Reid et al. 1987) or databases (DIPMIX 1997).

Transport properties and heat and mass transfer coefficients are difficult to predict theoretically, and experimental or empirical values, appropriate for the specific equipment and process conditions, are normally used. Computer programs are used in calculations of the various unit operations of the process plant. Such programs are part of the large computer packages used in process simulations, but simpler software for personal computers is available (CEP 2000).

In several cases, such as in handling of equipment or in relation among workers/operators/manufactured product and equipment involved, the factor “human being” has also to be considered. Here, knowledge of work study can be very helpful.

Empirical data and “rules of thumb” are used to facilitate the various design calculations, such as the design velocities ( $u$ ) in process pipes, e.g.,  $u$  (liquid) = 1.5 m/s and  $u$  (gas/vapor) = 30 m/s, water pressure in pipes (4–6 bars), and overall heat transfer coefficients (natural convection of air near walls, 10 W/m<sup>2</sup> K, and forced circulation of thin liquids in pipes, 2000 W/m<sup>2</sup> K).

The design of chemical process equipment is based on the principles of unit operations and process engineering. In analyzing the various industrial processes, simplified equations and shortcut methods are often used (Bhatia 1979–1983; Sandler and Luckiewicz 1987; Walas 1988).

Equipment design yields quantitative data on required equipment, such as dimensions of pipes, power of pumps, surface area of heat exchangers, surface

area of evaporator heaters, dimensions of distillation or extraction columns, and dimensions of dryers. In addition, the approximate quantities of the required plant utilities are calculated. In equipment sizing, a safety or overdesign factor of 15–20 % is normally used.

After the preliminary sizing of the process equipment, detailed specifications are set, which are necessary for purchasing the equipment from the suppliers. At this stage, a preliminary cost estimate of the equipment is made, using cost indices and other methods, outlined in Sect. 1.2.6 on economic analysis. Whenever possible, standard or “off-the-shelf” equipment should be used, which is generally less expensive and more reliable than nonstandard equipment. Standard equipment includes pumps, heat exchangers, valves, standard evaporators, distillation columns, and centrifuges.

When specialized or nonconventional equipment is needed, detailed specifications are required which will help the fabricator to construct the appropriate unit (e.g., filters, chemical reactors, special dryers, and distillation columns). Sometimes, special equipment is needed for a new process, for which there is no industrial experience. In such cases, a pilot plant installation may be required, which will supply the specifications for the desired industrial equipment. The scale-up ratio of capacities (industrial/pilot plant) is usually higher than 100:1.

The utilities or auxiliary facilities, which are necessary for the operation of the processing plants, include energy, water, steam, electricity, compressed air, refrigeration, and waste disposal. Energy in the form of heat or electricity is needed for the operation of the plant. Heat is produced primarily by combustion of fuels (oil, gas, and coal). Water is supplied from the municipality or from the surrounding plant area (drilled wells, rivers, or lakes) and is required for process, sanitary, and safety uses. High-pressure steam may be used for power generation, and the exhaust steam is utilized for process heating. Waste disposal involves the treatment of liquid, gas/vapor, and solid wastes (see Appendix D).

The selection of the materials of construction of process equipment is very important from the economic, operational, and maintenance points of view. Corrosion-resistant materials such as stainless steels may be required in handling and processing corrosive fluids. National and international construction codes are necessary for plant and worker protection and for standardization of the process equipment (see Chap. 2). Some of the codes related to chemical process equipment are ASME (pressure vessels), TEMA (heat exchangers), ANSI (piping and instrumentation), and DIN (materials and construction).

### ***1.2.5 Plant Layout and Buildings***

The layout of process and utility equipment is essential to ensure the safety, operability, and economic viability of any process plant and for planning future extensions. A balance of many technical, operational, and economic factors must be achieved. Plant layout follows the development of the PFD and the preliminary

sizing of the process equipment and is necessary before piping, structural, and electrical design. The layout of equipment should allow for a safe distance between the units, facilitating the operation, servicing, and cleaning of each unit.

Plant layout is shown in engineering drawings or, if plants are more complex, in 3D models, which are useful for construction engineers and for instruction of plant operators.

Plant buildings are needed mainly to house the process and utility equipment, the storage areas, the plant offices and labs, and the personnel common rooms (cafeterias, washrooms). In choosing the plant location, several factors should be considered, including raw materials, markets for the products, energy and water supplies, waste disposal, labor supply, legal restrictions, and living conditions. In some large petroleum and petrochemical plants, several large units and the required piping are installed outside the buildings (e.g., distillation columns, storage tanks).

In the installation of plant equipment, special attention should be paid to the foundations of the heavy units, considering also any vibrations of rotating/reciprocating equipment. In the construction of industrial buildings, the local and federal (national) regulations and codes should be followed, particularly those that are related to the health and safety of the workers and the consumers and the protection of the natural environment.

## ***1.2.6 Economic Analysis in Process/Plant Design***

### **1.2.6.1 Fixed Capital Investment**

Cost analysis is an important part of process and plant design. Fixed capital investment in process equipment, manufacturing costs, and general expenses should be considered in the early stages of design.

The fixed capital investment in process plants consists of a number of items, which depend on the type of plant and the manufactured products. Table 1.2 shows the important cost items and their percentages of the fixed capital investment for a typical chemical plant (Peters and Timmerhaus 1990). It should be noted that the cost of piping in chemical, petrochemical, and petroleum plants (mostly gas/liquid processing) is relatively high, compared to other processing industries, such as pharmaceuticals and foods (mostly solids processing).

The contingency item refers to unexpected approximate costs of the project. In addition, a working capital of about 20 % of the fixed capital may be needed for the initial operation of the plant.

The installed utilities, representing about 15 % of the fixed capital, include auxiliary buildings (5 %), steam (4 %), water supply (3 %), waste treatment (1 %), electrical (1 %), and compressed air (1 %) (Perry and Green 1984).

The fixed capital investment for a chemical plant can also be estimated by empirical rules or approximations, which yield results similar to those of Table 1.2. Thus, the fixed capital (FC) can be broken down into four basic components, related

**Table 1.2** Fixed capital investment for typical chemical plant

Item of fixed capital	% of fixed capital cost
Purchased equipment	23.0
Equipment installation	12.0
Piping, installed	14.0
Instrumentation and control	5.0
Electrical	3.0
Utilities, installed	15.0
Buildings and construction	12.0
Engineering	8.0
Contingency	8.0

Data from Peters and Timmerhaus (1990)

to the mechanical equipment (ME), electrical equipment (EE), plant buildings and site or civil engineering works (CE), and overhead (OV), according to the following fractional proportions (Sinnott 1996):

$$1.00FC = 0.37ME + 0.08EE + 0.29CE + 0.26OV \quad (1.1)$$

The fixed capital can also be estimated from the process equipment cost (EC) by the factorial method:

$$FC = f_L EC \quad (1.2)$$

where the factor  $f_L$ , or the Lang factor, is equal to 3.1 for solids processing, 4.7 for fluids processing, and 3.6 for mixed fluids/solids processing.

In food processing, the installation, piping, and instrumentation and control costs are smaller than in chemical processing. The base equipment is more expensive (stainless steel, hygienic requirements) than the chemical equipment. As a result, the empirical Lang factor ( $f_L$ ) in food processing plants varies in the range of 1.5–2.5 (Bartholomai 1987; Clark 1997b).

The fixed capital investment can be considered as consisting of two parts, the fixed manufacturing component (FM), which includes the cost of equipment and 25 % contingency, and the fixed nonmanufacturing component (FN). Typically,  $FN = 0.4 FM$ .

The working capital for a processing plant can be taken approximately as 20 % of the fixed capital.

### 1.2.6.2 Cost of Equipment

The most accurate cost estimation for process equipment is to obtain a price quotation from a reliable vendor (supplier of equipment). Specification sheets for each process unit should be prepared for the equipment supplier. The specifications should contain basic design data, materials of construction, and special information

that will help the supplier to provide the appropriate equipment. Standardized equipment should be preferred because of lower cost and faster delivery.

When approximate cost data are required for preliminary design, empirical methods and rules are used, which will yield fast results within the accepted accuracy (Chilton 1960). A popular method is to use the Guthrie charts of equipment cost versus capacity (Guthrie 1969; Peters and Timmerhaus 1990; Perry and Green 1984; Douglas 1988). Plotted on log–log scales, the Guthrie charts show straight lines. These charts are represented by the generalized cost–capacity equation:

$$C = C_o(Q/Q_o)^n \quad (1.3)$$

where  $C$  and  $C_o$  are the equipment costs (e.g., USD) at plant capacities  $Q$  and  $Q_o$  (e.g., kg/h), respectively.

The capacity factor ( $n$ ) varies with the type of equipment over the range 0.5–1.0 and is taken approximately as  $n = 2/3$ . The “2/3” factor has a theoretical basis, since the cost of spherical vessels is given by the relationship  $C = k V^{2/3}$ , where  $V$  is the vessel volume and  $k$  is a constant (Biegler et al. 1997).

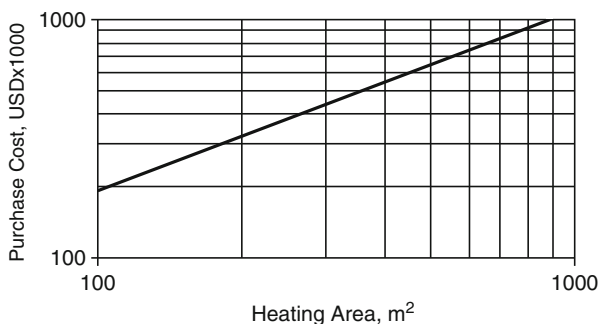
Figure 1.1 shows a log–log plot of the cost of long-tube vertical evaporators, estimated from the data of Peters and Timmerhaus (1990) for stainless steel 304 and converted to year 2000, using the M&S index. The capacity factor in this case is  $n = 0.53$ .

The plant capacity–cost relationship (Eq. 1.3) is normally applied to equipment and utilities of the main chemical processes. Better cost estimates can be obtained by modifying Eq. (1.3), taking into consideration the cost of all auxiliaries outside the main process, such as environmental installations and materials handling and storage (Haseltine 1986).

### 1.2.6.3 Engineering Cost Indices

The cost of process equipment and processing plants changes over the years, due to inflation and other economic factors, and there is a constant need for updating the

**Fig. 1.1** Guthrie chart for long-tube evaporators (stainless steel, 2000 prices). Data from Peters and Timmerhaus (1990)



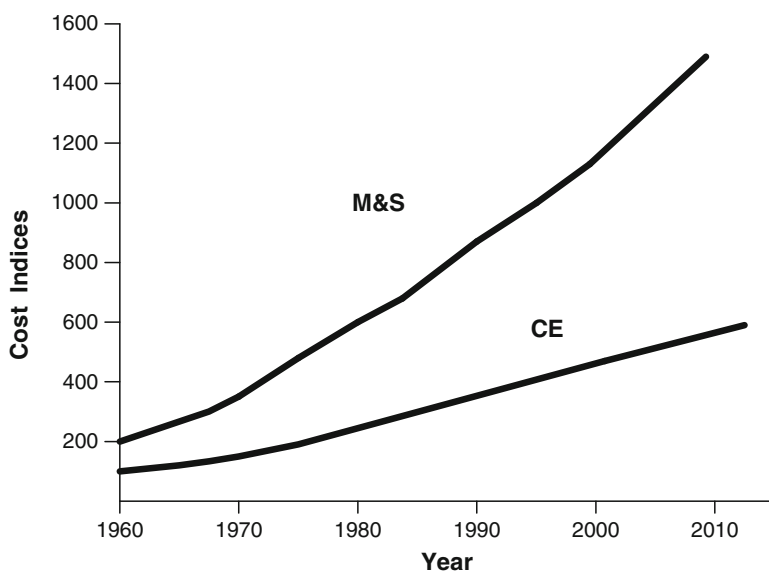
cost data. For this reason, cost indices or empirical rules are used, like the M&S index (Marshall and Swift, formerly Marshall and Stevens), published periodically in the journal *Chemical Engineering*.

The M&S equipment index is the weighted average of the cost of equipment for eight chemical process industries, including chemicals, petroleum, and paper. It takes into consideration the cost of machinery and major equipment, plus costs of installation, fixtures, tools, office furniture, and other minor equipment. The basis of the M&S index = 100 is the year 1926.

The CE (chemical engineering) plant cost index, also published in the journal *Chemical Engineering*, is the weighted average of chemical plant costs (66 items, including equipment, buildings, and engineering).

Figure 1.2 shows the continued increase of both indices during the last 35 years, with a sharp rise during the decade 1970–1980, due to rising energy costs, and a leveling off after 1990. Cost indices are approximate mean values with variations up to 10 % and recent annual inflation of about 4.5 %.

Although most of the engineering indices refer to the US industry, they are applied to chemical industries in other parts of the world, with little correction (Perry and Green 1984). Country-specific plant construction indices, based on the CE index, can be developed, using approximate models, the constants of which can be determined by fitting local cost data (CE 1997). These models take into account the following main items: local steel price, labor cost, inflation index, and crude oil index. In case of limited operation of equipment due to early replacement, their effective retail value should be also considered (see also p. 38).



**Fig. 1.2** Marshall and Swift (M&S) and chemical engineering (CE) cost indices. Data from the *Journal of Chemical Engineering*

## 1.2.7 Manufacturing Cost and Profitability

### 1.2.7.1 Manufacturing Cost

Although the main objective of process economics is the profit on the invested capital, some other criteria should also be considered in designing and building a chemical process plant. The plant should be operated and controlled safely for the workers, the products should be safe and without adverse health effects to the consumers, and the environment should not be damaged by plant wastes.

The economic analysis of chemical processes and chemical plants is covered in Perry and Green (1984), Douglas (1988), Peters and Timmerhaus (1990), and in specialized economics books. The elements of process economics, needed for preliminary design, are summarized here.

The manufacturing cost, usually calculated in USD/year, consists of two basic parts: (1) the direct or variable operating cost, which includes the cost of raw materials, labor, utilities, and overhead and the administrative costs, and (2) the indirect or fixed charges (USD/year), consisting of the depreciation of the fixed investment and the taxes/insurance. Depreciation is usually taken as 8 % of the fixed investment, i.e., the fixed capital will be recovered in 12 years. The product cost (USD/kg) is calculated by dividing the manufacturing cost by the annual production rate (kg/year) (Table 1.3).

### 1.2.7.2 Profitability

Process profitability can be estimated by the following simple economic calculations (Biegler et al. 1997):

**Table 1.3** Approximate cost indices for process equipment (M&S) and plants (CE)

Year	M&S index	CE index
1960	230	100
1965	240	105
1970	300	120
1975	440	180
1980	610	240
1985	800	305
1990	915	360
1995	1030	380
2000	1100	385
2005	1300	500
2010	1510	550
2012	–	600

Data from the *Journal of Chemical Engineering*



$$\text{gross profit} = \text{gross sales} - \text{manufacturing cost} \quad (1.4)$$

$$\text{gross profit before taxes} = \text{gross profit} - \text{sales etc. expenses} \quad (1.5)$$

$$\text{net annual cash flow} = \text{gross profit before taxes} - \text{taxes} \quad (1.6)$$

$$\text{return on investment} = \text{ACF}/\text{FI} \quad (1.7)$$

$$\text{payback time} = \text{FI}/(\text{ACF} + \text{AD}) \quad (1.8)$$

where FI is the fixed investment, ACF is the net annual cash flow, and AD is the annual depreciation.

The payback time (Eq. 1.8) is the time of plant operation, usually in years, at which the cumulative cash flow becomes equal to zero. In the first years of operation, the ACF is negative, due to the high operating cost, but it turns into a positive net cash flow, after the payback time. An alternative method of estimating the payback time is

$${}_1\Sigma^n \text{ACF}_n = 0 \quad (1.9)$$

The previous simplified economic analysis can be used in preliminary design and approximate cost estimations. However, it does not consider the “value of money,” i.e., the interest that could be earned from the fixed invested capital. In detailed design and in actual economic evaluations, the prevailing interest rate is taken into account in the form of “discounted” cash flows (Perry and Green 1984).

The annual discounted cash flow (ADCF) is related to the ACF:

$$\text{ADCF} = f_d \text{ACF} \quad (1.10)$$

where  $f_d = 1/(1+i)^n$  is the discounted factor,  $i$  is the fractional interest rate (yearly basis), and  $n$  is the number of years.

The cumulative (sum) of the ADCF after  $n$  years is defined as the net present value (NPV) and is calculated from the following summation:

$$\text{NPV} = {}_1\Sigma^n \text{ADCF}_n / (1+i)^n \quad (1.11)$$

The discounted cash flow rate of return (DCFRR) or return on investment (ROI) is the fractional interest rate ( $i$ ) for which NTV becomes equal to zero, after a chosen number of years ( $n$ ), and it is calculated as follows, using a graphical or a trial-and-error iteration technique:

$${}_1\Sigma^n \text{ADCF}_n / (1+i)^n = 0 \quad (1.12)$$

The DCFRR is also known as the profitability index, initial rate of return (IRR), or investor’s rate of return.

In economic planning, the cost of replacement of major process equipment, after a number of years, should be considered. This is accomplished by reserving the

replacement cost (RC) of the equipment, which is converted to the capitalized cost (CC), using the prevailing annual interest rate ( $i$ ), according to the following equation (Clark 1997b):

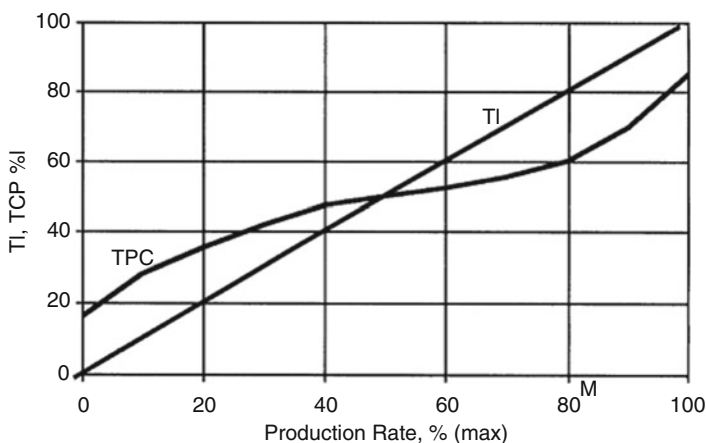
$$CC = RC(1 + i)^n / [(1 + i)^n - 1] \tag{1.13}$$

The capitalized cost, estimated from Eq. (1.13), assumes that the equipment has no salvage value after  $n$  years of operation.

### 1.2.7.3 Breakeven Point

The processing plant should be operated so that the total income is higher than the total product (operating) cost and a reasonable profit is realized. At low rates of production, the total income is lower than the total product cost, because the fixed costs (e.g., depreciation, maintenance) remain constant and a financial loss is obtained. The rate of production above which the operation is profitable is called the “breakeven point,” as shown in Fig. 1.3.

In some processing systems, like the one shown in Fig. 1.3, there is an optimum operating rate of production (point  $M$ ), where the net profit is maximized (Peters and Timmerhaus 1990). In the generalized diagram of Fig. 1.3, the “breakeven” point is at a production capacity of about 50 % of the maximum plant capacity, and the optimum operation is at about 80 % of maximum capacity. For a combination of reasons, the optimum operating capacity may not be the maximum production capacity.



**Fig. 1.3** Production rate-related “breakeven diagram of a processing plant.  $TI$  total income,  $TPC$  total product cost,  $M$  maximum profit

### 1.2.8 Computer-Aided Process/Plant Design

Although the design of chemical processes and chemical plants has been based until recently on practical experience and empirical rules, there has been a lot of activity on the applications of computer-aided techniques in this important area of chemical engineering. Computer-aided process engineering (CAPE) has been the favorite subject of university and industrial research and development projects, directed primarily to large-scale chemical and petrochemical processes, both in the USA and in other parts of the world. Process design, which is the major component of CAPE, is a major subject of the annual European Symposium on Computer-Aided Process Engineering (ESCAPE), the proceedings of which are published in the journal *Computers and Chemical Engineering*.

Most of the progress in CAPE has been in the modeling, simulation, and optimization of chemical processes, with emphasis on flow sheet development, separation processes, and energy utilization. The processing of gases and liquids has received particular attention, due largely to the availability of reliable prediction methods and databanks of the physical, thermodynamic, and transport properties of the materials being processed. Limited attention has been given to the processing of solids and semisolids, due to difficulties in modeling and to insufficient data on engineering properties.

In preliminary calculations for process design, general-purpose software is used, such as the Excel spreadsheets (Maroulis and Saravacos 2003). For process simulation, large systems, like ASPEN PLUS (Aspen Technology Inc.), (Aspen 2001), HYSIM/HYSYS (Hyprotech Ltd.), and PRO II (Simulation Sciences), are used (Sinnott 1996). The international CAPE system, developed by a consortium of universities and industries, can be applied to various process industries.

Several computer programs have been adapted for use in PCs, utilizing simplified software (e.g., Microsoft Windows). A list of such programs, convenient for preliminary design and costing of chemical process equipment and plants, is published annually in the CEP Software Directory (CEP 2000).

The computer-aided design (CAD) programs usually consist of an executive system; packages of physical, thermodynamic, and transport properties; and collections of design subroutines for various process units (Douglas 1988). CAD software is available for preparing process flow sheets, piping and instrumentation diagrams, and engineering drawings of chemical equipment and chemical plants. Two-dimensional (2D) drawings are normally used, but in special cases, three-dimensional (3D) drawings offer a better visualization of the instrumentation and the process or the whole plant (CE 1999).

## 1.3 Design of Food Processes

The identification of food engineering and its objectives within food science is described by Kostaropoulos (2012). Systematic process design is gradually adopted in the design of food processes, replacing the empirical approaches of the past. In addition to the principles and techniques of chemical process design, the design of food processes must be based on the principles and technology of food science and engineering.

Successful and efficient manufacturing technologies, developed in other industries, can be adapted, modified, and implemented in the food industry. Food quality and food safety must receive special consideration, while applying the engineering principles and techniques.

Food processing involves several physical unit operations and microbiological, biochemical, and chemical processes, which aim at preservation and improvement of food quality or conversion to safe and nutritional food products in large, economic scale. Food preservation and conversion technology has advanced considerably in recent years (Fellows 1990; Heldman and Hartel 1997).

Food engineering has evolved into an interdisciplinary area of applied science and engineering, based primarily on chemical engineering and food science. The traditional unit operations of chemical engineering have been adapted to food processing, taking into consideration the complexity of food materials and their sensitivity to processing conditions (Leniger and Beverloo 1975; Loncin and Merson 1979; Heldman and Lund 1992; Valentas et al. 1997).

The physical operations of food processing can be analyzed by applying the established concepts of unit operations and transport phenomena of chemical engineering (Gekas 1992; Fryer et al. 1997). In addition to the traditional engineering considerations of process cost, energy optimization, and process control, demands on food quality and safety should be satisfied. In this respect, application of the principles and advances of food science is essential.

The trend for improved product quality in all industries (product engineering) should be taken into consideration in all stages of process design. In the food industry, advances in the developing field of food materials science should be considered, with respect to the effect of food handling, processing, and storage on the structure and quality of food products (Aguilera 2000).

Process control and automation, adapted from other industries, must take into consideration the requirements of accurate control of safe thermal processing, time–temperature effects on product quality, and desired micro- and macrostructure of food products.

In the food industry, the trend for improved products (product engineering) should be taken into consideration in all stages of process design (Aguilera 2000). This involves all aspects, starting with the processing of “raw materials” or with the further processing of prefabricated products. Besides food manufacturing, an efficient design should also take into consideration aspects of supply, handling, and storage, and the successive kind of food trade (e.g. import-export,

wholesale, cash and carry types of delivery markets and marketing) up to the final consumption of food.

In *manufacturing*, the basic requirements are (1) manufacturing of high-added-value products; (2) constant output of manufactured products, as far as possible; and (3) permanently constant high quality of produced food.

In *trade*, the requirements are (1) constant supply of food to the consumers, (2) constant good quality of the retail products, (3) compliance with the specifications and standards, (4) possibility to extend the shelf life of the products, and (5) facility in handling, including transportation.

In *consumption*, the requirements are (1) increase of assortment of products, (2) satisfaction of an easy-to-use trend, (3) good quality, and (4) reasonable price.

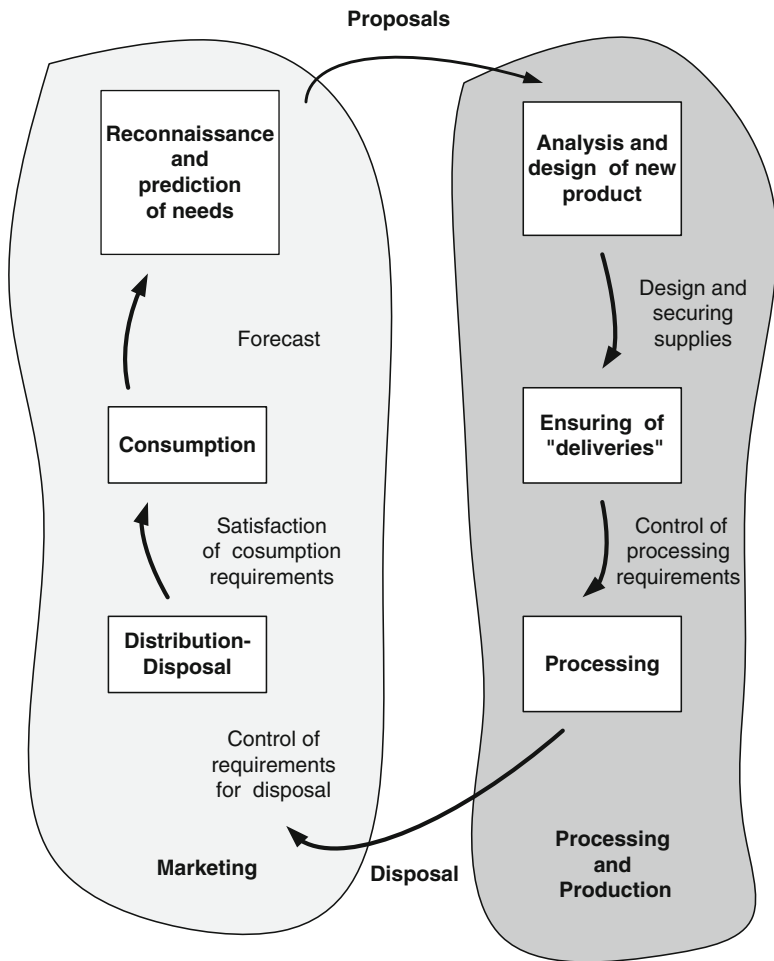
The *quality* requirements are (1) safety of food [e.g., no transfer of infection or contamination], (2) dietary suitability [e.g., adequate nutrition], (3) process suitability [e.g., the right initial raw food material for manufacturing certain foods], and (4) sensory characteristics, such as odor and optical properties, texture, acoustic properties (e.g., crispy products), and taste.

Basic elements for improvement of food quality are marketing and research. Figure 1.4 gives an overview of the improvement tasks of the “cycle”: food marketing–food development–food processing–consumption.

The procedure of introducing new products in the market is indicated in Fig. 1.5. It is important to foresee the right time that a product has to be renewed or replaced (e.g.,  $M'_1$  for product A and  $M'_2$  for product B). For estimating  $M'_1$  and  $M'_2$ , the tangents on the breaking points of the curves are drawn: Total sales of a product as function of time are drawn, and  $M_1$  and  $M_2$  are the points where the verticals from points  $M'_1$  and  $M'_2$  meet the  $x$ -axis (time). Furthermore, each new replacement should surpass the already achieved sales of the removed product. The term “new products” does not always refer to essentially new products. As “new” are also characterized products that are based on line extensions or formulations. This includes updating formulations and redesigning packaging (Rudolph 2004).

The introduction of “new” products is essential for the welfare of food factories. However, probably not all products indicated as “new food products” may be really new! There is some disagreement on what a food product may be called “new.” Often there is diversification concerning what the industry or the consumers face as new. Often for the industry, the “new” simply reflects only a new appearance such as new packaging or combination of packaging media, “season’s adjustments,” or extension of already existing products, while the consumers do not agree that new items are not the same as new products.

It is estimated that the number of “new products” of food introduced every year exceeds 8000 (Kontny 1989). As mentioned by Lord (2000), referring to information of the Marketing Intelligence Service Ltd., of about 11,000 new foods introduced in USA in 1996, only 7.2 % featured real innovations. A.C. Nielsen and Litton Matysiak and Wilkes, Inc., reported that only 8.9 % of “new products” in 1995 were actually new. Furthermore, according to a study concerning the 20 most new products introduced by US companies, in which certain restrictions were put



**Fig. 1.4** Relation of food processing–marketing

for the use of the term “new,” only 9 % of the called “new” products were indeed new (Lord 2000).

A successful investment in research contributes to the long life cycle of a new product in the market. However, only a small number of genuinely new developed products are tested in an actual market, and furthermore, only a smaller part out of them finally survives in the market. Large companies often prefer to cooperate or incorporate the smaller ones when the new invented products promise good market future (see also introduction of Appendix E). However, according to Dornblaser (1997a) cited by Lord (2000), the research profits of larger companies are significant (Fig. 1.6). Successful new products had spent more time on assessment creating clear product definitions (Giese 2003). Often, small companies are more flexible in presenting “new products.”

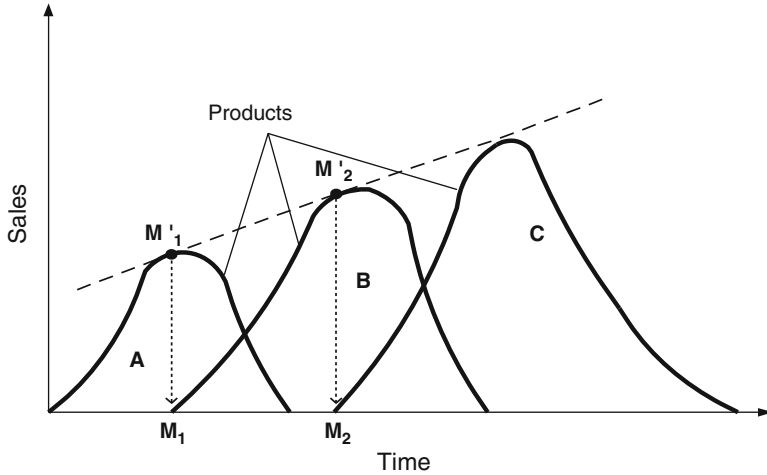


Fig. 1.5 Market replacement of a product

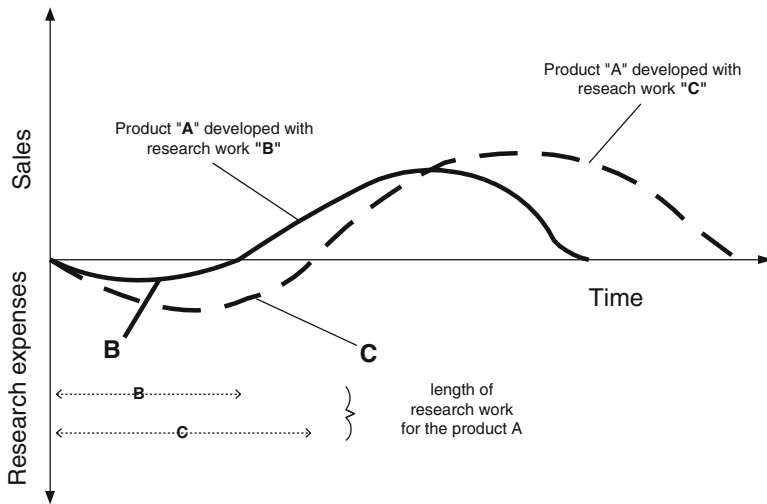


Fig. 1.6 Influence of research on the life cycle of a product

Food plant control should cover the whole spectrum from delivery of raw materials up to consumption. Two main categories of control in food manufacturing may be distinguished: (1) control related to the means of processing/manufacturing and (2) control of products.

1. In processing, control and automation adapted from other industries must take into consideration the requirements of accurate control of safe thermal processing, time-temperature effects on product quality, and the desired

micro- and macrostructure of food products. Control is extended to (a) equipment (condition, maintenance, etc.), (b) operational parameters (conditions of processing), (c) main installations (hydraulic and electric installation, buildings), and (d) auxiliary installations (energy, water supply, wastes, etc.).

2. Product control includes (a) incoming deliveries (raw materials, additives, packaging materials, etc.) and (b) control of products during and after processing (storage, handling, transport, retail). In some cases, it may be extended to controls that are related to environmental factors (quality of water, air, etc.). Main categories of product control are (a) microbiological and biological analyses (decay, infections, etc.), (b) chemical analyses (composition, residual substances, chemical reactions), and (c) technical analyses (packaging material, texture, sensory evaluation, etc.). Details on food quality and safety programs are cited in Sect. 1.4.

### ***1.3.1 Unit Operations in Food Processing***

The basic unit operations of chemical engineering, i.e., fluid flow, heat transfer, and mass transfer, have been applied to the food processing industry for many years. The theory on these operations was developed originally for gases and liquids (Newtonian fluids), which constitute the main materials of the chemical industry (Perry and Green 1984). However, food processing (or food manufacturing) deals mostly with non-Newtonian fluids and semisolid and solid food materials, and adaptation or extension of the theory is necessary. Some food processing operations, dealing with such complex materials, are still treated empirically, using rules, practices, and equipment developed through experience (Brennan et al. 1990). A comprehensive review of food process engineering operations is presented by Saravacos and Maroulis (2011).

Due to the diversity of food processes and food products, several specialized unit operations were developed in the food processing industry (Ibarz and Barbosa-Canovas 2002). More than 150 food processing operations were listed by Farkas (1977, 1980). The unit operations were classified into three broad groups, based on the purpose of food processing, i.e., separation (mechanical, physical, thermal, chemical), assembly (mechanical, physicochemical), and preservation (heat, cold, drying, chemical, irradiation). In addition, packaging operations must be considered.

The *separation processes* include mechanical separations (based on size/density and mechanical properties of the materials) and physical separations (based on mass transfer rates of components at interphases). The latter are often listed as mass transfer operations (King 1971). Since most foods are solids or semisolids, several solid/solid separations, developed through experience, are used in food processing operations. Thus, in the processing of fruits and vegetables, the following mechanical operations are applied: abrading, crushing, cutting, dividing, expressing (juice),



filtering, finishing, grinding, peeling, pitting, shelling, sieving, sizing, slicing, and stemming.

The *assembly* of food materials is accomplished mostly by mechanical operations. Examples of assembly operations include agglomeration, coating, forming, enrobing, mixing, extrusion, molding, pelleting, stuffing, emulsification, crystallization (from melt), baking, and foaming.

The *preservation operations* of food processing are based on the elimination of the spoilage cause (microbes, enzymes, pests, and chemicals). Preservation operations can be subdivided into three major categories: physical, chemical, and mechanical. The physical operations include heating (frying, boiling, pasteurization, sterilization, blanching, cooking), cooling (chilling, freezing), and drying (dehydration, desiccation, evaporation). Chemical preservation includes permitted chemical substances, such as vinegar and lactic acid. The mechanical operations include cleaning, washing, sorting, and high pressure. However, in some cases of food, mechanical operation is not clear. Extrusion, e.g., is a mechanical as well as thermal (physical) process.

For the purposes of this book, the unit operations of food processing are classified on the basis of the processing equipment, with typical examples shown in Table 1.4. It should be noted that the *unit operations* are defined as physical operations, while the *processes* involve some type of reaction (chemical, biochemical, or microbiological). In this sense, some of the processing operations, listed in Table 1.4, are actually processes, e.g., sterilization (heat transfer and microbiological reaction), blanching (biochemical and physicochemical reactions), and irradiation (energy absorption and microbiological reaction).

Food quality considerations are very important in the selection and operation of processes. Food materials can be considered as either living or nonliving plant (or animal) tissues. In food processing, fresh fruits and vegetables are considered to consist of living tissues. Dried plant foods and animal tissues are generally considered as nonliving tissues. The quality of living tissues is influenced by storage conditions of temperature, relative humidity, and gas atmosphere. In most food processing operations, the food materials consist mostly of nonliving tissues (Farkas 1980).

In fruit and vegetable processing, heat treatment operations, such as blanching, cooking, and sterilization, convert the living into nonliving tissues. Optimization of heat treatment operations is possible, since the rate of destruction of spoilage microorganisms and enzymes is faster than the rate of quality deterioration (undesirable changes in color, flavor, structure, and nutritive value).

A practical description of the unit operations, used in the processing of fruits and vegetables, was presented by Gould (1996). Fruit and vegetable processing is a large industry worldwide, consisting of a large number of small- to medium-sized processing plants and producing several diverse food products. These plants utilize several and often specialized unit operations, since the materials being processed are solids or semisolids, sensitive to mechanical and thermal processing. On the other hand, the dairy, edible oil, milling, and beer industries deal with large amounts of fewer products, utilizing a smaller number of standard unit operations.

**Table 1.4** Classification of unit operations of food processing

Group of operations	Typical food processing operations
Mechanical processing (Chaps. 4 and 5)	Peeling, cutting, slicing
	Size reduction
	Sorting, grading
	Mixing, emulsification
Assembly operations (Chap. 4)	Agglomeration
	Extrusion, forming
Mechanical separations (Chap. 5)	Screening
	Cleaning, washing
	Filtration
	Mechanical expression
	Centrifugation
Mechanical transport (Chap. 3)	Pumping of fluids
	Pneumatic conveying
	Hydraulic conveying
	Mechanical conveying
Heat transfer operations (Chaps. 6, 9, and 10)	Heating, blanching
	Cooking, frying
	Pasteurization
	Sterilization
	Evaporation
	Cooling, freezing, thawing
Mass transfer operations (Chaps. 8 and 11)	Drying
	Extraction, distillation
	Absorption, adsorption
	Crystallization from solution
	Ion exchange
Membrane separations (Chap. 12)	Ultrafiltration
	Reverse osmosis
Fermentation	Alcoholic fermentations
	Lactic fermentations
	Dairy fermentations
Nonthermal preservation (Chap. 12)	Irradiation
	High pressure
	Pulsed electric fields
Packaging (Chap. 13)	Filling, closing
	Metallic, plastic packages
	Aseptic packaging
	Modified atmosphere, vacuum

The scale-up methods, used successfully in chemical engineering, are difficult to apply, even to continuous food processing operations, due to the complex physical, chemical, and biological reactions in the food systems. Pilot plant data, under similar processing conditions, are necessary for scale-up to industrial operations of complex food processes, like extrusion cooking of starch-based foods (Valentas et al. 1991) or processing of new foods.

The pilot plant is useful in determining new food processes and in testing new processing equipment under industrial-like operating conditions. It is often used for the production of large samples of new food products, which are needed for storage and marketing tests.

The required unit operations of a food processing plant should be arranged in the proper sequence, i.e., a plant layout should be followed.

A number of empirical specifications and standard practices (good manufacturing practices, GMPs) are necessary for the hygienic and safe operation of food processing equipment and processing plants (Gould 1994; NZIFST 1999). The GMPs are discussed in the Sect. 1.4 and equipment design (Chap. 2).

### 1.3.2 Food Process Flow Sheets

In food process design, flow sheets similar to those of chemical process design are used, i.e., process block diagrams (PBDs), process flow diagrams (PFDs), process control diagrams (PCDs), and process instrumentation and piping diagrams (PIDs). In addition, Sankey diagrams (Seibel and Spicher 1991) may be used, which present material and energy balances in graphical form. Materials handling diagrams are also useful, since they describe interconnections of processing operations, even if they are located in different buildings or even sites.

The selection of an optimized process flow sheet in the chemical and petrochemical industries requires extensive computer calculations, due to the large number of possible process configurations. However, the realistic process configurations in a given food processing system are limited, because there is usually only one major operation or process in a given flow sheet, which defines more or less the other auxiliary operations.

CAD uses mainly 2D flow sheets for various process, equipment, and plant representations. In special cases, 3D diagrams are useful for a better visualization of complex processing equipment or processing plants (CE 1999), as in grain mills and edible oil processing, where materials transport and piping play a dominant role.

PBDs are normally used for a quick representation of the process and for preliminary calculations of material and energy balances. Each rectangular block represents individual unit operations or group of operations. The PFDs or process flow sheets show more details of the process or plant, using specific symbols for equipment, piping, and utilities. They are simple and any changes may be done easily. Both PBD and PFD flow sheets can show process details, like material flow

rates (kg/h), energy flows (kW), temperatures ( $^{\circ}\text{C}$ ), and pressures (bars). They can be combined with tables of data.

PCD show the position of the control units in the processing lines and their connection to the sensors. PIDs indicate the type and location of instrumentation and the type and connections of pipes. There are no generally accepted standards for process symbols in flow sheets. There are some universally applied symbols for chemical process equipment, listed in the chemical engineering literature, e.g., Walas (1988), Sinnott (1996), and DIN 28004.

In addition to the PBD and PFD, diagrams showing the exact position of the processing equipment in the food plant (ground plans) are also used. Front and side views of the processing line may also be required.

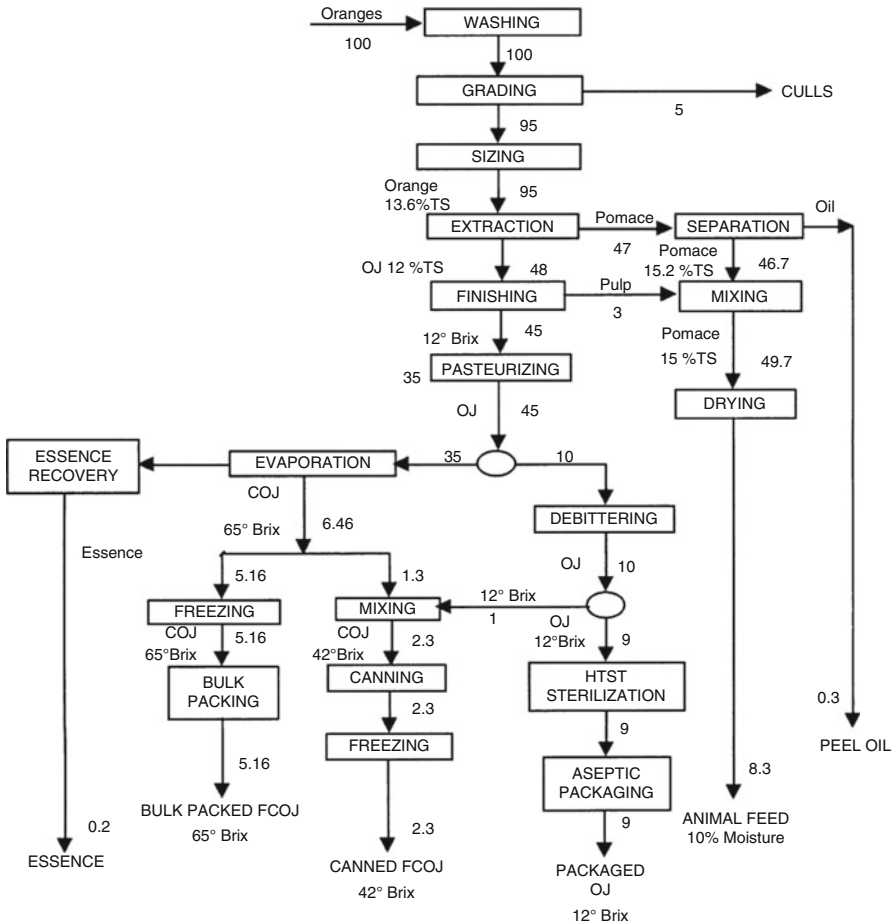
For illustrative purposes, one block diagram and one process flow sheet for the same food processing plant are shown in Figs. 1.7 and 1.8. The plant chosen is a multiproduct facility for orange processing (Nagy et al. 1993; Kimball 1999; Valentas et al. 1991), involving several unit operations and processes and a variety of processing equipment, which will be analyzed in detail in the examples of subsequent chapters of this book.

Figure 1.9 shows a 3D flow sheet for a tomato paste processing plant for better visualization of the plant and equipment. The same tomato paste plant is shown in the form of a process flow sheet (Fig. 1.10) and floor plan or layout of equipment (Fig. 1.11). It should be noted that some of the operations shown in the flow sheets of Figs. 1.7–1.11 might involve more than one piece of equipment. For example, the separation of oil from orange peels may include an oil press, a grinder, a mixer of pulp/water, and one or more centrifuges (Kimball 1999).

### 1.3.3 *Material and Energy Balances*

The principles and techniques of material and energy balances of chemical engineering are, in general, applicable to most food process calculations. However, food processes require special attention, due to the complexity of food materials and the importance of food quality. In material balances, accurate food composition data are difficult to obtain, due to variability even for the same food material. Variations are due to the variety, growing conditions, and age of the raw materials. If reliable experimental data are not available for the food material being processed, approximate values can be obtained from the literature, e.g., the USDA food composition data (Watt and Merrill 1963; Souci et al. 1981).

Simple material and energy balances can be performed on mechanical and heat preservation operations. Simultaneous heat and mass transfer operations, such as drying, blanching, baking, and steam injection, may need more detailed analysis and experimental verification of the assumptions on food composition and energy requirements (Farkas and Farkas 1997). Due to variability of raw food materials, material and energy balances may be required periodically, during the operation of the food processing plants.



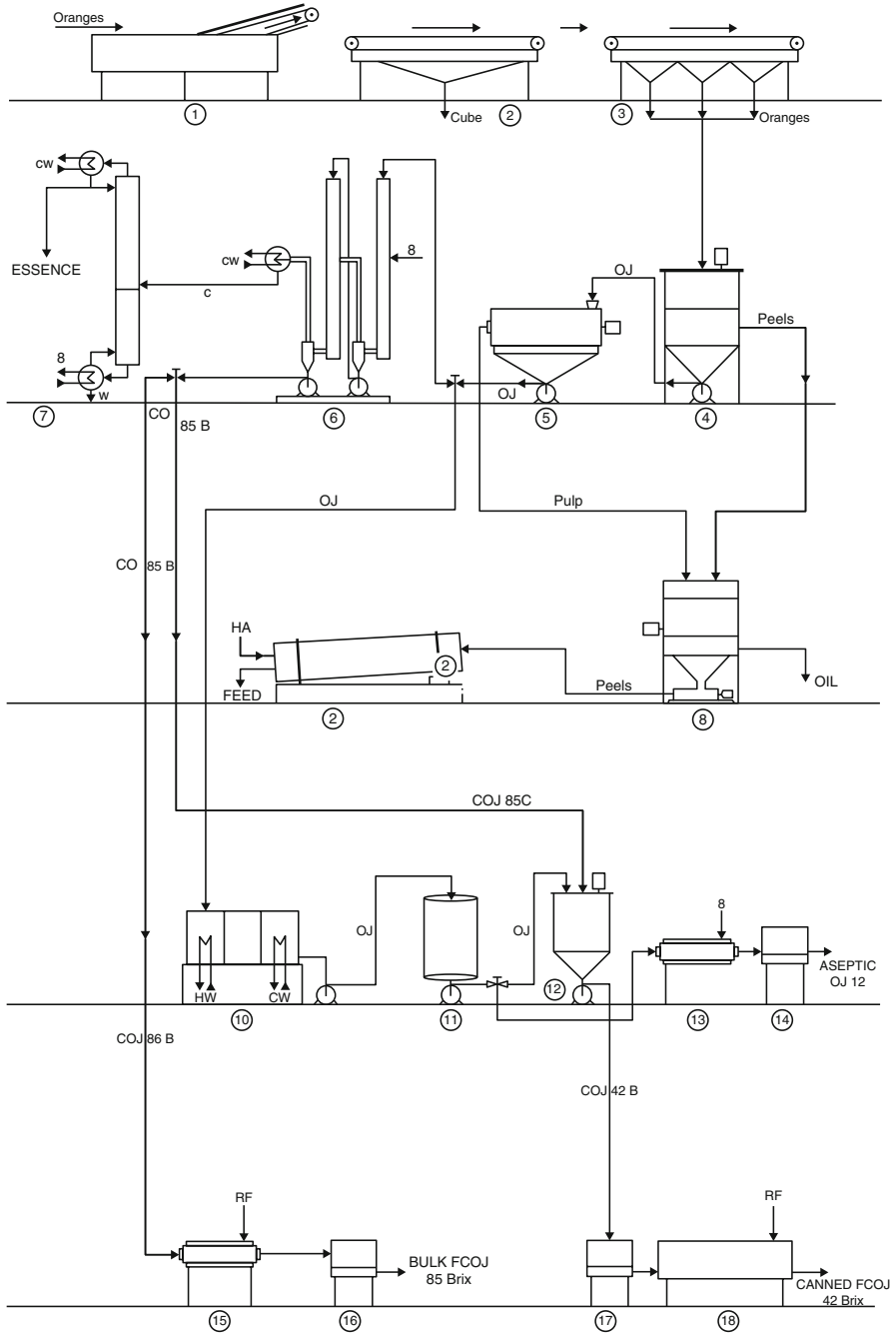
**Fig. 1.7** Simplified process block diagram for multiproduct orange processing plant. Basis of material balances: 100 parts of oranges; see Example 1.1. *OJ* orange juice, *COJ* concentrated orange juice, *FCOJ* frozen concentrated orange juice, *CULLS* damaged fruit, unfit for processing

Overall and component material balances are calculated at the boundaries of a food process, from the mass conservation equations in the system:

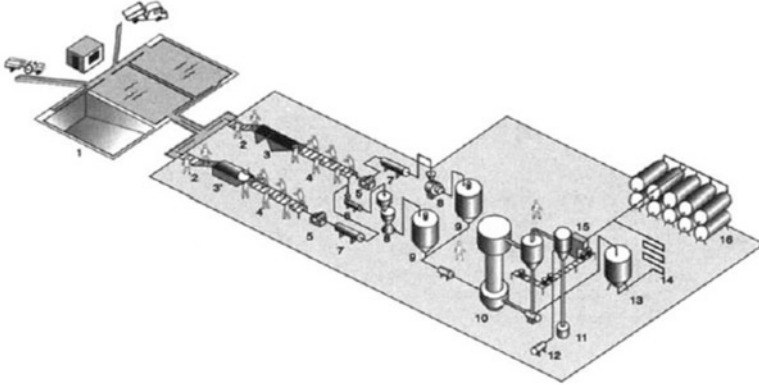
$$\text{total mass in} - \text{total mass out} = \text{total mass accumulated} \quad (1.14)$$

$$\text{total component in} - \text{total component out} = \text{total component accumulated} \quad (1.15)$$

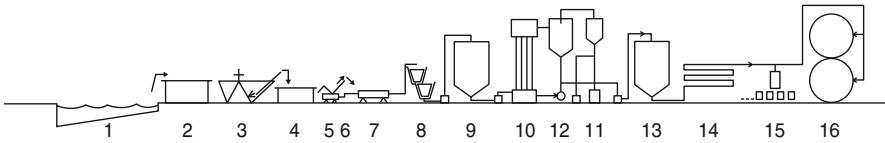
For continuous operations, the accumulated materials (total and component) are equal to zero.



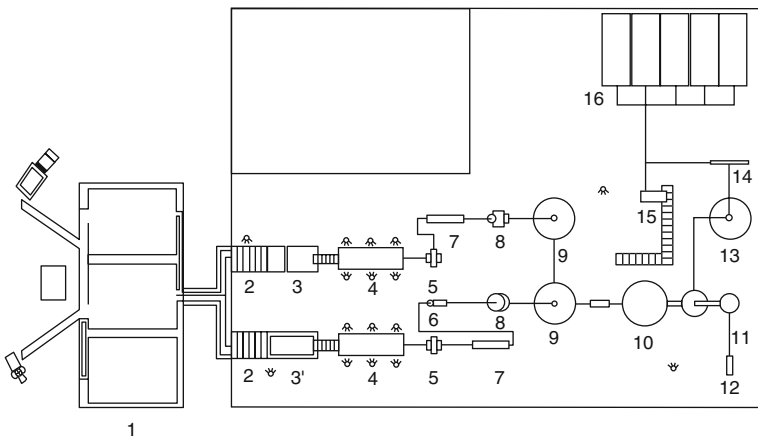
**Fig. 1.8** Simplified process flow diagram (PFD) for a multiproduct orange processing plant (see Fig. 1.4)



**Fig. 1.9** Simplified 3D PFD for a tomato paste processing plant (see Fig. 1.10)



**Fig. 1.10** Simplified process flow sheet of the tomato paste processing plant (Fig. 1.9): (1) Water basin, (2) preselection and loading, (3) washing, (4) sorting, (5) crushing, (7) heating, (8) straining of pulp, (9) preliminary storage, (10) evaporator, (11) barometric condenser, (12) vacuum pump, (13) concentrates tank, (14) sterilization, (15) aseptic packaging, (16) aseptic storage



**Fig. 1.11** Floor plan (layout of equipment) of a tomato paste plant (see Fig. 1.10)

The component material balance (Eq. 1.15) can be written for one or more food components, which are important in a given processing operation. Typical components, involved in food processing, are water (moisture), total solids (TS), soluble solids (SS), fat, oil, salt, and protein. The soluble solids are usually expressed as °Brix (% sucrose by weight), measured with refractometers, which are used widely in the laboratory and the processing plant. The concentration of components is expressed as mass or weight fraction  $x_i = \text{\%}(\text{weight})/100$ .

Volumetric flows, e.g., L/h or m<sup>3</sup>/h, should be converted to mass flows, e.g., kg/h or tons/h, using the density of the material (kg/L or kg/m<sup>3</sup>).

Energy balances are calculated at the boundaries of a food process, from the energy conservation equation (first law of thermodynamics) in the system:

$$\text{total energy in} - \text{total energy out} = \text{total energy accumulated} \quad (1.16)$$

For preliminary design calculations and equipment sizing, the main energy form considered is heat and only heat balances are calculated. The mechanical and electrical requirements for pumping, transportation, refrigeration, and operation of the various pieces of process and utility equipment are considered in the detailed process, equipment, and plant design.

Heat balances involve the enthalpy and specific heats of the various process and utility streams. Thus, the total heat of a stream ( $Q$ ) is equal to the sensible ( $Q_s$ ) and latent ( $Q_l$ ) heats:

$$Q = Q_s + Q_l = \sum m_i C_{pi} \Delta T + \sum m_j \Delta H_j \quad (1.17)$$

where components  $i$  participate in sensible heating or cooling by  $\Delta T$  degrees (°C or K) and components  $j$  are involved in evaporation (condensation) or freezing (fusion). The specific heat of water ( $C_p$ ) is normally taken as equal to 4.18 kJ/kg, while all food materials have lower values. The heat of evaporation or condensation of water depends on the pressure. Thus, at atmospheric pressure ( $P = 1$  bar,  $T = 100$  °C),  $\Delta H = 2257$  kJ/kg. The heat of freezing or fusion of water is taken as  $\Delta H_f = 333$  kJ/kg.

Thermophysical and thermodynamic data for foods are obtained from food engineering and food properties handbooks and databases (Rahman 2009; Rao and Rizvi 1995; Saravacos and Maroulis 2001). The importance of transport properties in food process and equipment design was discussed by Saravacos (2000). Typical physical properties are given in Appendix B.

The material and energy balances are essential in the design of food processes, processing equipment, process utilities, and waste treatment facilities, in process optimization and control, and in cost analysis of the process and the processing plant. The sizing, design, and selection of food processing equipment are discussed in Chap. 2.

Detailed material and heat calculations are given in Example 1.1.



### ***1.3.4 Computer-Aided Food Process Design***

Adoption of computer packages of CAD, used in chemical engineering, is difficult, due to the diversity of food processes and food products and the limited available data on the physical and engineering properties of food materials (Saravacos and Kostaropoulos 1995, 1996). There is a need for more reliable data, especially on the transport properties of foods, which are required in the design of food processes and processing equipment (Saravacos and Maroulis 2001).

In food process design, rough models, which realize their limitations, are more practical than sophisticated computer models and simulations based on uncertain assumptions and data. Computer modeling has been applied to various food processes (Saguy 1983; Teixeira and Shoemaker 1989; ICHIME 1992; Cadbury 1992). CAD is useful in food process modeling and product development (Datta 1998). A generalized CAD package, including mathematical and simulation operations (MATLAB and SIMULINK), has been proposed for design and optimization of food processes (Diefes et al. 1997). The use of computer spreadsheets in food technology is discussed by Singh (1996). Food process modeling, with special attention to food quality and food safety, is discussed by Irudayaraj (2001) and Tijskens et al. (2001).

Process simulators, developed for food processing operations, include the following: (1) belt dryer for food products (Kiranoudis et al. 1994), (2) pasta dryer (de Cindio et al. 1994), (3) aseptic thermal processing (Skjoldbrand and Ohlsson 1993), (4) food process simulator for training production operators (Skjoldbrand et al. 1994), and (5) milk heating simulator under fouling conditions (Georgiadis et al. 1997).

Computational fluid dynamics (CFD), applied to various engineering problems, can be used in the design and evaluation of fluid flow and heat and mass transfer problems of food processing and storage (James 1996).

Computer-integrated manufacturing (CIM) is intended to improve the business and process functions, including both operational and organizational activities (Parrish 1990; Swientek 1993; Downing 1996). CIM enables manufacturers to plan production resources efficiently, based on market forecasts (Edgar 2000; Mermelstein 2000). CIM software can help food companies to schedule personnel, equipment, and utilities and allocate optimal use of their manufacturing lines.

## **1.4 Food Plant Design**

The principles of chemical process and plant design, reviewed in Sect. 1.1, find applications in the design of new food processing plants. The same stages of process and plant design are used, i.e., the preliminary design, the detailed design, the construction of buildings and utilities, the installation of equipment, and the plant start-up (Dolezalek and Wamecke 1981; Wagner 1998).

Although CAD is applied widely in chemical processing, food applications are rather limited, due to the complexity and large variety of food products, processes, and equipment. Some old-fashioned processing methods are still used effectively, and innovations should be examined thoroughly before large industrial application. Mathematical modeling, simulations, and process control in food processing are as good as the underlying physical principles and the technical data available (Clark 1997a).

The selection of a competent and experienced plant designer is essential for the success of the project. The choice between a “turnkey” design of an outside firm and a joint designer-company team depends on the availability of qualified engineers within the company. Criteria of selection of a plant designer are given by Okun (1989) and Aggteleky (1987).

The motivation for plant design may be related to internal or external factors. Internal (company) motivations include problems related to plant site and location, condition of equipment and plant facilities (service life), storage inadequacy, and production statistics. External factors include marketing and economics, food and environmental legislature, competitiveness, know-how and patent acquisition, company acquisition or merging, international markets, and unexpected events.

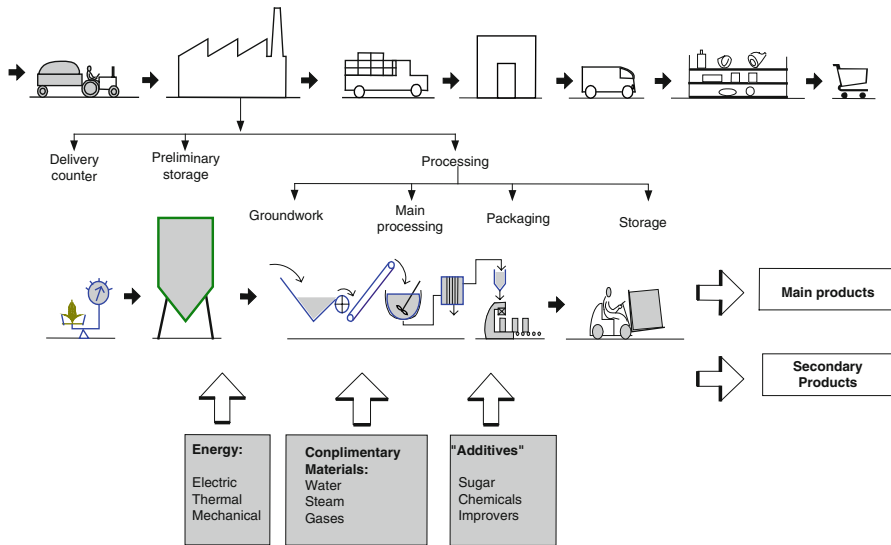
## ***1.4.1 Elements of Food Plant Design***

### **1.4.1.1 General Aspects**

Construction and renovation of food processing facilities is governed by many local, state, federal, and international agencies with overlapping regulations (Popham 1996). Product quality and shelf life are directly affected by the quality of the processing space. Production time can be minimized and sanitation and maintenance programs can be minimized with construction that satisfies regulatory and inspection programs. In addition to food safety (Hazard Analysis Critical Control Point, HACCP), environmental regulations should be considered.

Laws and regulations cover a wide range of constraints, which should be considered at the design stage of a food processing plant. In the USA, such regulations are contained in the FDA Act, the USDA Meat Inspection Act, the GMPs, the 3-A Standards, the Pasteurized Milk Ordinance, the Occupational Health and Safety Act (OHSA), the Environmental Protection Act (EPA), and so on.

The general organization of food processing plants is similar to the setup of other manufacturing companies. The basic departments of a food processing facility are (1) delivery, (2) temporary storage of raw materials, (3) storage of other materials used in food processing, (4) processing, (5) product storage including cold rooms, (6) utilities, (7) effluent treatment, (8) laboratory and R&D, (9) offices, and (10) employee facility rooms.



**Fig. 1.12** Processing operations of manufactured food

Process flow sheets, discussed in Sects. 1.1 and 1.2, are utilized in the design of equipment and utilities and in plant layout. Proper plant layout is essential for efficient operation, food safety, and effective plant and equipment maintenance (Schwecke 1989; Sinnott 1996). Figure 1.12 shows a food processing flow sheet.

The design of food plant utilities (steam, water, electricity, air, and waste treatment) is similar to the chemical process industries. A summary of typical utilities for food processing plants is given in Appendix D.

There are certain important features that distinguish food-related plant designs and investments from other industrial applications. Some characteristic features are the following:

1. The raw materials and final products of the food industry are sensitive biological materials, which impose certain limits on the processing operations, e.g., temperature and mechanical energy. Raw materials can be stored for a limited time, sometimes under controlled conditions.
2. In several processes, the quality of the final food product depends strongly on a single critical step, which should be performed under the gentlest possible conditions. There is a limit to storage time, after which food spoilage will take place.
3. In many plants, large quantities of sensitive raw materials must be processed in the shortest possible period. Therefore, in the case of seasonal crops, the equipment must be able to withstand sudden extreme processing conditions.
4. Hygienic factors play an important role not only in the food plant but also in the process–food product–operating personnel interaction.

5. The quality of a special product (individuality) should be maintained, even in mass production.
6. In many cases, such as fruits and vegetables, food processing is seasonal. In such operations, a significant part of the employees are unskilled labor.
7. Since most seasonal raw materials are perishable, relatively short-term cash flow must be provided for their purchase.

Plant design refers either to the construction of new processing/manufacturing plants or to the improvement or expansion of existing/operating plants. In the latter cases, a detailed evaluation of the existing operation is necessary, before any commitments are made. The adopted solutions should be introduced into the plant as smoothly as possible, without disturbing the existing operation.

Improvement of an existing plant is an ongoing continuous process, while process, equipment, and plant expansion is a periodic process. Both improvement and expansion may refer to construction of buildings, installation of equipment, or changes in personnel.

Reasons for investments related to the extension or improvement of food industries are (1) increase of capacity or productivity, (2) reduction of the cost of production, (3) environmental issues, and (4) external economic and political decisions.

Reasons for investment in new processing establishments of an already existing enterprise are, among others, (1) extension of activities, (2) meeting of an increased demand, and (3) benefits of new technologies.

Most investments (70–75 %) for food processing plants in the USA (Young 2000) and in Germany (BEV 2000) are related to plant renovation and expansion, and only 25–30 % involve construction of new plants. Renovations and expansions enable to respond to market alternations and requirements faster and with incremental capital investments, combined as well with less investment risk (Gregerson 2001).

Plant design can be divided into two general types: (1) long-term design, applied to new manufacturing lines of the same or new products; it may also be applied in a step-by-step renovation of a process or a whole plant; and (2) short-term design, which aims at meeting and solving urgent problems, such as replacing existing processes or equipment.

In all types of food plant design, the main goal is the achievement of the best possible results with respect to quality requirements, high productivity, and low cost. Some typical requirements of food processing operations and equipment are the following:

1. *Production rate.* In principle, processing should be as fast as possible, in order to reduce the danger of microbial spoilage and infection and prevent quality degradation, e.g., vitamin loss due to prolonged heat treatment. However, the production rate should keep step with the minimal requirements of the applied process, e.g., time–temperature requirement.

2. *Heat application.* In most cases, heat must be applied at the lowest possible level to prevent quality losses. However, in cold chains (refrigeration storage and transport systems), temperature should be kept at the highest possible level for saving energy.
3. *Standardization.* In general, standardization is applied to simplify processing and control operations. However, in several applications, standardization must not have negative effects on the quality and the “individuality” of the food products.
4. *Sanitation.* Hygienic (sanitary) conditions must cover the entire manufacturing spectrum, from raw material lines to final products, covering processes, equipment, buildings, and personnel.

### 1.4.1.2 New Food Plants

Continuous operation of food processing plants is desirable, since it is more cost effective, particularly in large plants, and the processes can be controlled more effectively. However, batch processing is still practiced in several food plants, due to the complexity of some processes and the diversity and low volume of the processed products. The output of a batch food processing plant can be maximized by judicious plant design, which optimizes the use of the available equipment (Cadbury 1992). Batch processing requires intermediate storage tanks for further processing of the materials (Sinnott 1996). Optimization of the process cycles should consider the entire plant operation. Time-utilization (Gantt) charts should include both processing and cleaning of the process equipment.

Plant layout is particularly important in food processing because of the uniqueness of processes and the strict requirements for food hygiene and product quality. One-story (ground-level) buildings are generally preferred, while multilevel installations are advantageous, when gravity flow of large-volume materials is important, as in grain milling plants.

In planning a new food plant, several factors should be considered, including the following basic requirements: location, product/process, food hygiene (sanitation), plant safety, and flexibility.

1. *Location.* The right choice of plant location is important for present and future processing operations. Plants processing large quantities of raw materials (e.g., sugar beets) into products to be shipped to distant markets must be located near the agricultural production. Plants using large quantities of imported raw materials (e.g., oilseeds) must be located near sea harbors. Plants processing products of short shelf life, like fresh milk, must be located near consumption centers (large cities). Other important factors, determining plant location, are land cost, transportation facilities, climate, water supply, legislation, taxation, and regional infrastructure.
2. *Product/process.* The physical state of the raw materials and products (liquids or solids) affects decisively plant design. Thus, gravity flow of the materials can be utilized in processing liquids and grains. In planning a dehydration plant,

low-humidity packaging and storage areas are needed, while high humidity is needed in packaging and cold storage of ready-to-eat vegetables and fruit salads.

3. *Food hygiene.* Hygiene (sanitation) is a fundamental requirement of all food plant operations: processing, packaging, storage, buildings, and personnel. Microbial and nonmicrobial contamination should be prevented by proper design and operation of all processing equipment and the entire plant. Most of the sources of contamination are related to the processing equipment, and the hygienic design of equipment is discussed in Chap. 2 (Jowitt 1980). Hygienic operation of the whole food plant is discussed in the Sect. 1.4.2.
4. *Plant safety.* Safety of personnel, products, and plant facilities (hazardous operations, HAZOPS) should be considered in any plant design. In respect to the use of food processing equipment, it should be also taken into consideration the recommendations set by organizations engaged in the publication of standards for the hygienic design and the hygienic design and satisfaction of such equipment (e.g., the EHEDG, the European Hygienic Equipment and Design Group). Furthermore, there are specific requirements, recommended by various organizations, for fire hazards, electric motors, dust explosions, and so on. Dust explosions are particularly important in processing and storage of food powders. Moisture-proof electric motors must be used in damp environments, such as canning. Explosion-proof electric motors should be used for dusty environments, such as grain mills and powder conveyors.

Steam boilers should be located in a separate boiler house to confine any explosion hazard. Plant layout and construction should prevent accidents by the personnel, e.g., special floor coatings and protective rails in silos.

The noise level in the processing areas should not cause health problems in the operators. Maximum noise levels, according to Directive 86/188 of the European Union, should not exceed 90 dB in 8-h work and 93 dB for 4-h work near the noisy equipment. In some processing areas, the noise level may be excessive, e.g., 90–110 dB in a bottling plant. In such cases, the operators must take protective measures such as wearing earmuffs.

Noise can be reduced by proper selection of equipment, better foundations and seating of equipment with moving parts, gentle conveying, and isolation of noisy equipment in special rooms.

5. *Food storage.* Storage facilities are influenced by the type of raw material, process, and product. For example, bulk storage and hydraulic transport are used in tomato and orange processing, while silo storage and pneumatic transport are practiced in grain processing. The “just-in-time” delivery policy may reduce significantly the logistic cost and storage space requirements. Surge tanks for temporary storage may be needed in some cases, for the smoother operation of several processing lines.
6. *Flexibility.* In some food plants, the processing operations must be modified according to the nature of the raw materials. Adjustment of equipment and operating lines should be made without disrupting the whole operation and losing valuable time. Plant design should account for periodic cleanup of processing equipment in order to maintain efficiency and hygienic conditions.

### 1.4.1.3 Plant Improvement

Improvement or adjustment of existing plants is a continuous task in food manufacturing plants. Even newly designed food plants may need improvement, since a perfect design, particularly in food processing, is an impossible task. The difficulties in plant design are manifested especially in seasonal processing, e.g., of fruits and vegetables. In some cases, the same processing facility may be used for processing of different food products, such as thermal processing of fruit/vegetable juices and milk.

Plant improvements may include the following:

1. *Production.* Food quality and plant productivity may be improved through new and better processing methods and equipment.
2. *Conveyance.* Increasing the speed of conveyance/transportation of raw material and products will reduce losses through spoilage and mechanical injury.
3. *Storage.* Better storage facilities and conditions will reduce quality losses and minimize logistic costs.
4. *Energy.* Reduction, e.g., of heat losses by insulation of equipment and control of electrical losses.
5. *Buildings.* Better use of building space and insulation of buildings.
6. *Environment.* Utilization of specific environmental conditions, e.g., low air temperature in potato storage. Elimination or reduction of environmental burden of water effluents, air pollutants, solid waste, thermal pollution, and noise.
7. *Management.* Greater effectiveness in all fields of the enterprise. Improvement of information flow through the various departments and feedback adjustments, using computer technology. Labor conditions could be improved, and the total number of personnel is reduced by judicious automation.

Plant improvement is based on a thorough analysis of the existing plant and in finding alternative solutions of the recognized problems. The consequences of proposed changes must be considered carefully, before any plant alterations are made. Most improvements require “individual” or “custom-made” solutions, in which the expertise and experience of the plant designer are of paramount importance.

### 1.4.1.4 Plant Expansion

Expansion of existing plants is necessary to meet increased demand of the company’s products or to expand the activities to related new fields. The difference between new plant construction and plant expansion lies in the fact that, in the latter case, the existing substructure of the enterprise is taken into consideration. In planning plant expansion, the following points should be considered:

1. Avoid causing problems to existing installations (e.g., energy and effluent networks), transport systems, or creating production “bottlenecks.” Typical

examples of the last problem are packaging machines and storage facilities, which are designed to be used also in the plant expansion.

2. Use existing installations and equipment for the purpose of reducing investment and operating cost of the expanded facility.
3. Purchase, if possible, the same type of equipment, if similar products are to be produced. In this manner, maintenance cost will be reduced.
4. Purchase new equipment whose combination with existing similar machines will increase plant flexibility. For example, new small compressors, combined with existing larger units, will meet the additional refrigeration load of expanded cold storage facilities.

#### 1.4.1.5 Mobile Food Plants

Mobile food plants may be used in special food processing operations, as in the introduction of a new process (pilot plant), or in seasonal food processing of small food operations (Kostaropoulos 2001). A mobile plant consists of a number of small processing units, usually mounted on a trailer truck, which can be transported to the site of food processing and connected to process utilities (steam, water, refrigeration).

Mobile factories are particularly attractive for processing relatively small quantities of similar raw materials, which are harvested at different seasons and locations, e.g., apricots (summer) and peaches (fall). Large food processing plants have to transport the raw materials, sometimes over long distances. A special type of mobile food plants is the fish-processing ship factories, which move to various fishing areas (Kostaropoulos 1977).

Mobile pilot plants may be used before the construction of the industrial plant for demonstration and for production of test samples of the food product. A preassembled aseptic processing system, installed on a 12-m van platform, was used for test production of fruit and vegetable juices and sauces (Rice 1987). Other mobile food plants, reported in the literature, are portable units for processing of milk, meat, pasta, or bread (Anonymous 1993) and mobile slaughter and meat processing units for pigs (Viere 1994).

#### 1.4.1.6 Advanced Food Plants

New food processing and manufacturing concepts, food structure engineering, process design and control, and hygienic aspects are the elements of advanced modern food plants (SIK 2001). Progress in food processing can be accelerated by adopting new technologies from other processing and manufacturing industries.

Automatic control of food processes can be achieved by combining modern analytical techniques (optical/color, microwave, X-rays), interfacing with computers. Future plants should be able to adjust their production by taking into consideration the consumers' sensory and texture evaluation of the food products.



Total automation of food processing plants, using robotics and computer technology, can prevent microbial contamination and improve hygienic operation and product safety.

## ***1.4.2 Good Manufacturing Practices***

### **1.4.2.1 GMPs**

The principles and practices of GMPs should be taken into serious consideration in food plant and equipment design (Popham 1996). GMPs are a combination of manufacturing and management practices aimed at ensuring that food products are consistently produced to meet specifications and customer expectations (NZIFST 1999). They are practical rules and recommendations, based on experience, which, when followed in the various food processing operations, will result in safe and high-quality food products (Gould 1994). In the USA, the following agencies have responsibilities regarding food processing plants and processing equipment: the FDA (Food and Drug Administration), USDA (US Department of Agriculture), EPA (Environmental Protection Agency), FTC (Federal Trade Commission), and CS (Customs Service).

Each country has rules and regulations, related to foods, which should be considered carefully, when building or operating a food plant. The European Union (EU) is developing a uniform food legislature for its 14 member countries (as of 2001).

GMPs cover a wide spectrum of manufacturing practices, but the main emphasis is on food plant hygiene (sanitation), while food quality receives the proper consideration (Troller 1993; Marriott 1997).

The Code of Federal Regulations in the USA (Part 110, Title 21) contains the practices that must be followed in food plants, processing foods for human consumption (Gould 1994). These regulations are enforced by the FDA. They are updated regularly and published in the *Federal Register* (Washington, DC). The rules cover the buildings, processing equipment, and personnel of the processing plant. They also cover processing, hygienic, and control operations, receiving, warehousing, shipping, and distribution of the food products.

In the design and layout of food plants, the following aspects related to GMPs should be taken into consideration: (1) single-floor versus multistory buildings, (2) land space for future expansion, (3) waste disposal, and (4) building details (drainage, doors, lighting, ventilation, plumbing). Regulations similar to the GMPs, related to the design of food plants processing meat and poultry, are administered by the USDA.

The hygienic design and specifications of food processing equipment are discussed in Chap. 2.

Both GMPs and USDA require adequate space for equipment installation and storage of materials, separation of operations that might contaminate food (cross-contamination), and adequate lighting and ventilation.

Process utilities (steam, water, and refrigeration) must be placed in separate rooms and the process fluids transported to the processing equipment through overhead piping. Special treatments are needed for plant floors (tiles, polymer resins, and sealed concrete). Epoxy paints are suitable for protection of plant walls and ceilings (Man 1994a, b; Shepard 1981).

Although the major hygienic hazard in food processing plants is microbial contamination, plant design should also provide for elimination of various pests from food areas, such as insects, rodents, and birds.

Plant design should consider cleaning of food processing equipment and buildings, with appropriate preparation room for cleaning solutions and CIP piping.

#### 1.4.2.2 Food Safety Programs and HACCP

Food quality programs are essential in the processing, storage, and distribution to control product consistency. The need for uniform standards in world trade has led to the adoption of international standards, like the series of ISO 9000, which detail the quality assessment procedures for industrial products in general. Food quality usually refers to the nutritional, sensory, compositional, and convenience attributes of food products. Sometimes, food quality includes food safety, which refers to the absence of microbial, chemical, or physical hazards.

Food safety programs are required for securing food safety and for complying with the regulations of government and international organizations. A food safety program consists of documents, records, systems, and practices, including HACCP. Most modern food safety programs are implemented by the HACCP system. The HACCP system was first introduced in 1989 by the US National Advisory Committee on Microbiological Criteria for Foods (Gould 1994). It is a system that identifies, evaluates, and controls hazards that are significant to the production of safe food. HACCP was first applied to meat, poultry, and dairy products, which are sensitive to microbial spoilage and hazards.

The HACCP system is based on the following seven principles (Codex Alimentarius 1997; NZIFST 1999):

1. Conduct a hazard analysis (biological, chemical, and physical).
2. Determine the critical control points (CCPs).
3. Establish critical limits for each CCP.
4. Establish a system to monitor each CCP.
5. Establish the corrective action to be taken when monitoring indicates that a particular CCP is not under control.
6. Establish procedures for verification to confirm that the HACCP system is working effectively.

7. Establish documentation concerning all procedures and records appropriate to these principles and their application.

Prerequisite tasks needed for successful application of the HACCP programs are assembly of the HACCP team, description of the food and its distribution, intended use and consumers of the food, development of the flow diagram which describes the process, and verification of the flow diagram (NACMCF 1997). Computer software is available for performing effective HACCP and food safety surveys (Mermelstein 2000; Mortimore and Wallace 2000, 2001).

Proper plant design is a prerequisite for an effective HACCP program (Kvenberg 1996). Consideration should be given to eliminating or substantially reducing the potential hazards. The following factors are important for effective design: (1) product flow through the processing system without cross-contamination, (2) prevention of contamination of foreign bodies, (3) restriction of employee traffic, and (4) positive air pressure in the processing areas.

### ***1.4.3 Food Plant Economics***

#### **1.4.3.1 Overview of Food Plant Economics**

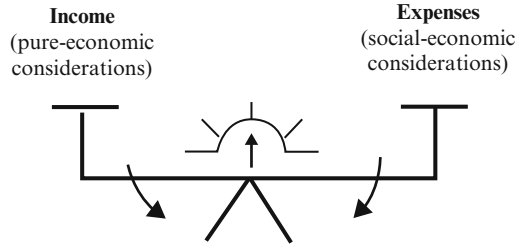
The basic aim of economic overview of plant design is to explore the economic implications of plant tasks undertaken. These tasks may be confined to a limited intervention on existing plant operations (e.g., energy savings through additional investment), or quite extended, as estimation of the profitability of a whole investment. Very often, economic analyses comprise comparisons between cash inflow (income) and outflow (expenses), as shown in Fig. 1.13. In plant design, this counteracting relation may be influenced by further opposing interactions, such as when pure economic or socioeconomic factors are involved.

Costs of food plants, e.g., the cost of heat exchangers as a function of the heating area (Sinnott 1996) or the cost of evaporators as a function of the heating area (Fig. 1.1) and the cost of energy (Bernecker 1984), may be linear or nonlinear. Many economic time-related functions are nonlinear, since market changes are unpredictable. Therefore, quite often, economic forecasting may be verified only in a range confined by optimistic or pessimistic prediction curves (Fig. 1.14).

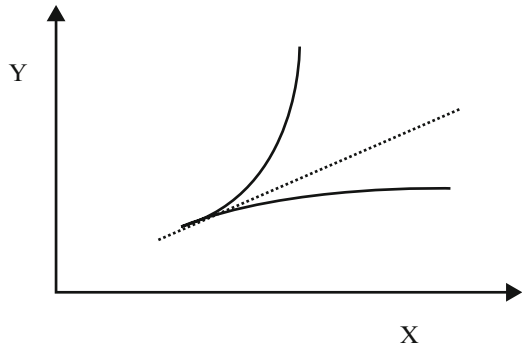
The relation of unit cost as a function of increased production rate is nonlinear. As a rule, the unit cost decreases when the production rate is increased (Kettner et al. 1984). However, the unit cost ( $y$ )–production rate ( $x$ ) curve tends to become asymptotic to the  $x$ -axis, due to the additional excessive expenses, required when production capacity reaches its limits.

No perfect prediction of future economic developments can be achieved by mere plant design. This is because, besides economic developments, after some time, changes due to technical progress may make the actual investment unprofitable. These changes may refer to products, processes, and equipment. Good plant design

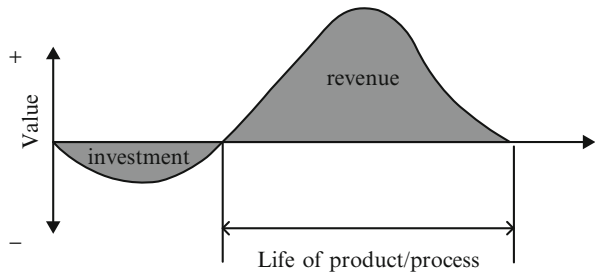
**Fig. 1.13** Economic comparisons



**Fig. 1.14** Economic forecasts



**Fig. 1.15** Economic value of an investment



strives to keep processing methods and whole plants in operation as long as possible. Furthermore, the basic aim is to achieve profitability with the less possible changes in the manufacturing process.

The revenue that will be achieved up to the time the actual investment “runs out” must be larger than the needed expenses (Fig. 1.15) (Kettner et al. 1984). The actual investment may refer to expenses for the development and introduction of a new product or a new or improved manufacturing process.

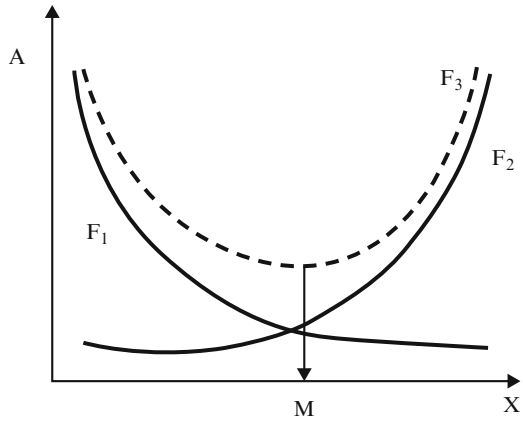
The “breakeven point” (BEP) of an investment indicates the time required for getting back, through sales and so on, the money that was spent for investments of starting the production of a product (fixed expenses) and the money that was subsequently spent up to the time that revenues equalize the total expenses (Fig. 1.3). As mentioned earlier, these two curves may be nonlinear. The BEP

curve may be used to estimate the optimal production rate (e.g., pieces per hour) with respect to the production expenses (Aggteleky 1987).

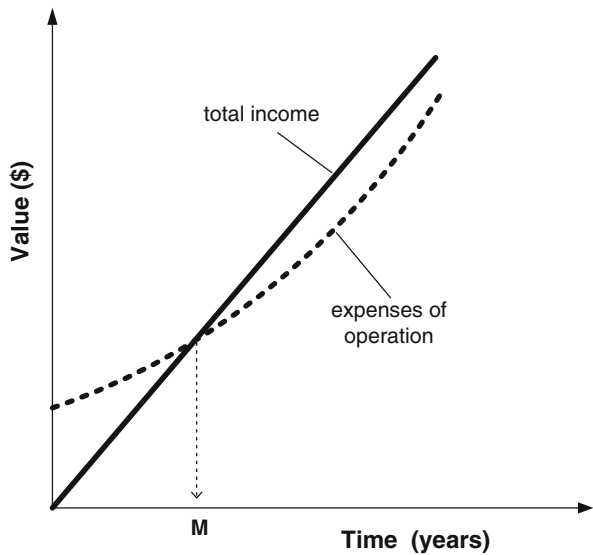
In economic comparisons, the optimum operating point is usually obtained by a graphical representation of the investment and operating curves (Fig. 1.16). As the production capacity ( $X$ ) is increased, the operating cost per unit product ( $F_1$ ) decreases and the investment cost ( $F_2$ ) increases. The summation of the two curves ( $F_3$ ) goes through a minimum ( $M$ ), which is the optimum point.

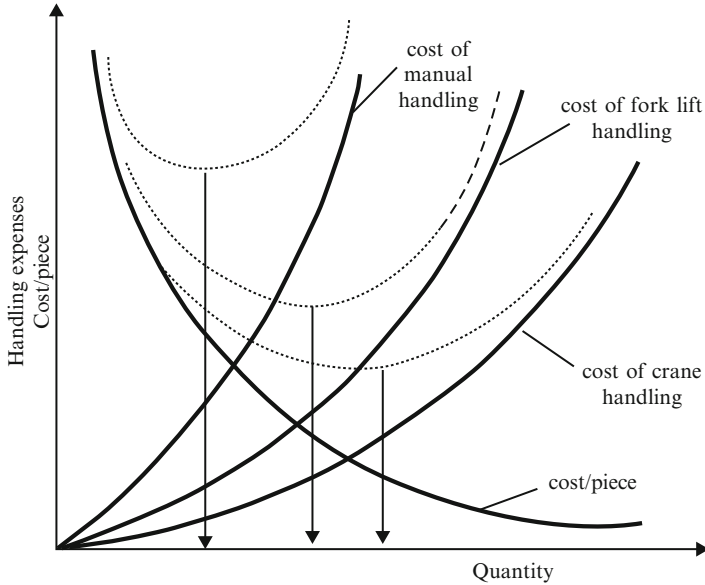
Figure 1.17 shows the critical “breakeven” point ( $M$ ) as an intersection of the curves for expenses of operation and total income. It indicates the time at which the total income surpasses the expense obligations.

**Fig. 1.16** Optimum operating conditions



**Fig. 1.17** “Breakeven” point of an investment





**Fig. 1.18** Cost of material handling methods

In food processing, the optimum operating condition is important in finding the optimal investment in energy-related problems, e.g., the optimum number of effects in a multiple-effect evaporator and the thickness of insulation in cold storage rooms. Other examples are the reduction of cost through automation (Aggteleky 1982), the extension of plant design (Kettner et al. 1984), and the money savings through maintenance of equipment.

The optimization method may also be applied to scheduling the various material handling, production, and other plant operations. Figure 1.18 shows the cost of material handling in relation to the method applied and to the quantity transported. Expenses are high when forklifts or cranes are used in handling small quantities or in manual handling of large quantities. As indicated in Fig. 1.18, there is an optimum for each case on material transport (Aggteleky 1982).

Plenty of free space in food processing plants is beneficial up to a certain point. It facilitates material handling, makes temporary storage possible, and simplifies maintenance. However, if certain limits are exceeded, the expense for additional space is unreasonably high, because the cost of buildings, piping, and energy increases and transport distances become too long. Again, the results of a cost–benefit analysis, as presented in Figs. 1.16 and 1.17, can show the optimum space requirements, in relation to the quantity handled and the method applied.

### 1.4.3.2 Economic Analysis of Food Plants

The economic evaluation of food processing plants is based on the principles of chemical process and plant design: the estimated capital cost includes processing equipment and facilities, buildings, installation, utilities, environmental control, engineering fees, and contingency.

However, there are some basic economic differences between chemical and food industries. One major difference is the fact that the raw materials and the processed products of the food industry cannot, in general, be stored for a very long time. This increases short-term financial obligations, such as payment of raw food materials. Therefore, additional capital is needed for storage of raw materials, processed products, and packaging materials (Clark 1997a, b). Economic analysis requires the estimation of DCFRR and payback period ROI (Eqs. 1.12 and 1.13). The ROI time in the food industry is usually taken as 5 years.

Preliminary plant cost estimation is based on the cost of major processing equipment (see Example 2.1). In the chemical industry, the cost of a plant is estimated as four to five times the cost of the major equipment. However, the cost of the major food processing equipment is relatively higher, because smaller units are used, the materials of construction are expensive (stainless steel, hygienic design), and there is less piping and instrumentation. As a result, the estimated plant cost in food processing is about 1.5–2.5 times the cost of the major equipment (Bartholomai 1987; Pyle 1997).

An empirical rule for total cost of large food plants is USD 1200/m<sup>2</sup> floor space (2000 prices), 65 % of which is for installed equipment and 35 % for buildings (Clark 1997b).

The major part of the operating cost of food processing plants (60–80 %) is for raw materials and labor (Maroulis and Saravacos 2008). The rest is for packaging materials, energy, and depreciation (about 10 % each).

Mathematical modeling and simulation are used to evaluate and optimize the operation of food processing plants. Thus, modeling and linear programming were applied to an apple juice concentrate plant in Argentina (Bandoni et al. 1988). The plant processed 164 tons/day of apples, producing 20.6 tons/day of apple juice concentrate 72° Brix, 1.2 tons/day of aroma essence, and 54.5 tons/day of pomace. Raw material represents 60–65 % of the total cost of apple juice concentrate. Availability of raw material and apple variety has an important effect on process economics.

In processing operations, in which certain equipment is planned to be utilized for a limited period, the salvage value of the replacement of such equipment may also be important. Usually, the amortization of common equipment does not exceed 7–10 years. Besides operational reasons for a limited time of utilization of equipment, replacement of certain equipment before its amortization period may be advisable, when this equipment is surpassed technologically, influencing the overall efficiency of the enterprise, but the equipment still has a salvage value, which is equal to its initial value minus its depreciation.

Some reasons for the depreciation of equipment are (1) relatively low productivity of existing equipment, (2) introduction of new processing methods making obsolete existing equipment, (3) introduction of new systems of automation and computer technology which cannot work with the old equipment, (4) difficulty in getting the right personnel, and (5) increased repairing cost in maintenance.

An economic analysis of a citrus processing plant in Italy was presented by Moresi (1984). The plant processed 20 tons/h of oranges and alternatively 10 tons/h of lemons, producing frozen citrus juice concentrates, peel oil, and dried pomace. The block flow sheet of the plant is similar to Fig. 1.7. The profitability of the citrus plant depends strongly on the cost of raw material (oranges and lemons), which accounts for about 70 % of the total product cost. In order to compete in the world market of citrus concentrate, the raw material may have to be subsidized by the local government or union, e.g., the European Union.

*Example 1.1* Calculate preliminary material and energy balances for the simplified PBD shown in Fig. 1.7 and the flow sheet of Fig. 1.8. These diagrams show a medium-sized multiproduct plant, which will process 20 tons/h (20,000 kg/h) of oranges, and it will operate continuously 24 h/day, 25 days/month for 4 months/year (i.e., 2400 h/year). The plant will produce aseptically packaged orange juice (OJ) 12° Brix, frozen concentrated orange juice (FCOJ) 42° Brix in metallic cans, FCOJ 65° Brix in bulk containers, dried animal feed of 10 % moisture, peel oil, and fruit essence. Other by-products from orange wastes, which could be produced in considerable quantities, include citrus molasses, pectin, and flavonoids.

Data on processing and properties of oranges were obtained from the literature on citrus products (Kimball 1999; Ting and Rouseff 1986; Nagy et al. 1993). A similar citrus processing plant with mixed feed of oranges and lemons was analyzed by Moresi (1984).

### Material Balances

The oranges fed to the processing plant are assumed to contain 13.6 % TS (total solids) and to yield 48 % OJ 12° Brix, 47 % pomace, and 5 % damaged fruit, unfit for processing (culls). Although the °Brix value refers to % sucrose in aqueous solutions, for preliminary calculations, it can be assumed to be equivalent to % soluble solids (% SS) or % total solids (% TS), by weight.

Material balances are written around each unit operation, according to the basic equations (overall, 1–15, and component, 1–16), assuming continuous operation (no accumulation of material). All balances are based on a feed of 100 parts of raw fruit, which includes 95 % sound fruit and 5 % culls.

*Juice extraction.* The solids concentration ( $X$ ) of the orange pomace from the juice extractor is calculated from component material balance,  $48(0.12) + 47X = 95(0.136)$  and  $X = 15.2$  % TS.

*Oil separation.* Oil separation by pressing, emulsification, and centrifugation is assumed to yield 0.3 % peel oil, reducing the amount of pomace to 46.7 %, without substantial change of the 15.2 % TS.



*Juice finisher.* The finisher is assumed to separate the extracted juice into juice of 12 % TS (or °Brix) and 3 % pulp of 12 % TS. Thus, the juice will be  $48 - 3 = 45$  %. The mixing of 3 % pulp and 46.7 % pomace will yield 49.7 % pomace with a concentration  $X$ , calculated from the balance equation,  $49.7X = 46.7(0.52) + 3(0.12)$  and  $X = 15$  %.

*Drying.* The orange pomace is dehydrated in a rotary air-dryer into dried pellets for animal feed. Assuming a moisture content of 10 % and no losses of solids, the animal feed will be  $49.7(0.15)/0.90 = 8.3$  %.

*Pasteurizing.* All 12° Brix OJ is pasteurized at 90 °C for 10 s to inactivate the pectic enzymes, which may damage the cloudy juice. There is no change of material balance in this operation. It should be noted that the OJ directed to the evaporator may not be pasteurized, if processed fast enough (no delay), since the first effect of the evaporator usually operates at relatively high temperature (e.g., 90 °C or higher).

*Splitting of orange juice.* The pasteurized 12° Brix OJ is split into two streams; one part (35 %) is used for production of COJ and the rest (10 %) for production of packaged single-strength and “cut-back” OJ. The split (35/10) is arbitrary, but in practice it is dictated by the demand of juice products. Different products could also be produced, e.g., chilled OJ.

The 10 % pasteurized OJ is debittered to remove traces of the bitter flavors (limonene and naringin). Debittering is accomplished by passing the OJ through an ion-exchange column, which is regenerated and reused several times. The debittered OJ is split into two parts, one (9 % of the total oranges) for aseptic packaging and the rest (1 %) for mixing with the 65° Brix COJ (cut-back juice). No significant change of OJ flows takes place in the debittering operation, since the bitter components removed (limonene and naringin) are present only in parts per million concentration.

*Evaporation.* A multiple-effect (in this example, three) evaporator of the long vertical tube type is used for the evaporation of the 35 % OJ into  $35(0.12)/0.65 = 6.46$  % COJ 65° Brix.

The amount of water evaporated from the 35 % OJ will be  $35 - 6.46 = 28.54$  %.

*Mixing (cut-back).* A quantity ( $X$ ) of 65 % COJ is mixed with 1 % of “cut-back” OJ to produce  $(1 + X)$  % COJ of 42° Brix, according to the equation  $(0.65)X + (0.12)1 = (0.42)(1 + X)$  and  $X = 1.3$  %. Therefore, the amount of the 42° Brix COJ will be  $1.3 + 1 = 2.3$  % and, of the 65 % COJ,  $6.46 - 1.30 = 5.16$  %.

*Essence recovery.* Since a triple-effect evaporator is used, the condensate of the first effect will be approximately  $28.54/3 = 9.5$  %, which is assumed to contain all of the volatiles of the orange juice, and it is used as the feed to the essence distillation column. For essence recovery 0.2 % on the raw oranges, the essence concentration in the column will be  $9.5/0.2 = 47.5$ -fold, and the overall concentration of the fruit essence will be  $47.5 \times 3 = 142.5$ -fold (based on the raw oranges).

*Final operations of juices.* The aseptic packaging of the OJ and the freezing-packaging operations of the concentrated juice do not change appreciably the compositions and amounts of the materials.

*Material balances for 20,000 kg/h of oranges:* 12° Brix OJ,  $20,000 \times 0.45 = 9000$  kg/h. Pomace 15 % TS,  $20,000 \times 0.497 = 9940$  kg/h. 12° Brix OJ for concentration,  $20,000 \times 35 = 7000$  kg/h.

Packaged 12° Brix OJ,  $20,000 \times 0.09 = 1800$  kg/h. Total 65° Brix COJ,  $20,000 \times 0.0646 = 1292$  kg/h.

Packed 65° Brix FCOJ,  $20,000 \times 0.0516 = 1032$  kg/h.

Canned 42° Brix FCOJ,  $20,000 \times 0.023 = 460$  kg/h.

Water evaporated in evaporator,  $20,000 \times 0.2854 = 5708$  kg/h.

Feed to essence recovery column  $5708/3 = 1900$  kg/h.

Concentrated (distilled) essence,

$$20,000 \times 0.002 = 40 \text{ kg/h.}$$

$$\text{Dried orange pomace, } 20,000 \times 0.083 = 1660 \text{ kg/h.}$$

$$\text{Peel oil, } 20,000 \times 0.003 = 60 \text{ kg/h.}$$

## Heat Balances

The material flows obtained from material balances are utilized in energy balance calculations. For preliminary calculations of equipment sizing and process economics, the heat balances are the most important, and they can be estimated on the PBD. Mechanical and electrical energy, refrigeration, and fuel calculations require more details of the processing equipment and typical numerical examples are given in subsequent chapters of this book.

Calculation of heat balances around each processing unit requires thermophysical data, particularly specific heats, enthalpies, and densities of the process streams. For this example, the specific heats ( $C_p$ ) of orange juices were obtained from Kimball (1999). They are very close to the  $C_p$  of aqueous sucrose solutions: 12° Brix (OJ), 3.86 kJ/kg K; 42° Brix (COJ), 3.06 kJ/kg K; and 65° Brix (COJ), 2.44 kJ/kg K.

The specific heat of the orange juices decreases slightly with decreasing temperature down to the freezing point. For preliminary analysis, the specific heats of unfrozen juices are considered constant. The effect of freezing can be taken into consideration by using the heat of fusion (or freezing) of water, which is  $\Delta H_f = 333$  kJ/kg. Empirical equations for the prediction of the thermophysical properties of orange juices are given by Kimball (1999).

*Steam requirements.* Steam is used for evaporation, pasteurization, and sterilization. Assume that saturated steam of 100 % quality at 110 °C (1.43 bar absolute pressure) is to heat the first effect of the evaporator. The heat of vaporization (or condensation) of water at 110 °C is  $\Delta H_v = 2230$  kJ/kg (Smith and Van Ness 1987). The theoretical steam economy (kg of evaporated water/kg steam) for the triple-effect evaporator is close to 3 (see Example 7.1). However, in practice, the steam economy ( $E$ ) would be lower, and for a triple-effect evaporator, assume

$E = 2.5$ . Thus, the steam requirement for evaporating 5708 kg/h of water will be  $5708/2.5 = 2283$  kg/h.

The condensate from the first effect of the evaporator (at 110 °C) is used to preheat the feed of orange juice to the evaporator.

Steam requirement for the essence recovery column: The feed enters the column as a saturated liquid and the rate of  $F = 1900$  kg/h. The distillate is  $D = 20,000 \times 0.0002 = 40$  kg/h and the residue  $B = F - D = 1900 - 40 = 1860$  kg/h (see Chap. 11). Assume a practical reflux ratio of  $R = 2$ , i.e.,  $L/D = 2$ . Therefore,  $L = 2D = 2 \times 40 = 80$  kg/h, and  $V = 80 + 40 = 120$  kg/h ( $L$ ,  $V$ , and  $D$  are the flow rates in the enriching section of the column). For the stripping section of the column,  $L' = F + L = 1900 + 80 = 1980$  kg/h, and  $V' = L' - B = 1980 - 1860 = 120$  kg/h. The steam (110 °C) required in the reboiler of the distillation column will be approximately equal to the flow rate of vapors in the stripping section, i.e.,  $S = V' = 120$  kg/h. The column is assumed to operate at atmospheric pressure with a practically constant boiling point of 100 °C.

Steam requirements for pasteurization and sterilization, using 1.43-bar steam (110 °C): Pasteurization of 9000 kg/h 12° Brix OJ by heating from room temperature (assume 20 °C) to 90 °C requires steam ( $X$ , kg/h), obtained from the equation,  $X = [(9000)(3.86)(90 - 20)]/2230 = 1090$  kg/h. For sterilization of 1800 kg/h 12° Brix OJ at 95 °C for 15 s, steam requirement  $[(1800)(3.86)(95 - 20)]/2230 = 202$  kg/h.

Total steam requirement is 3695 kg/h.

The air-dryer of the animal feed will use a fuel (e.g., gas) as a heat source, since steam is not economical for this product and flue (combustion) gases of high temperature can be tolerated for this product (see Example 8.1).

*Cooling water.* The major requirement for cooling water is to condense the water vapors of the last effect of the evaporator. Assume that the vapors in the last (vacuum) effect condense at 50 °C (see Example 7.1) and that cooling water at 20 °C is used. The heat of condensation of water at 50 °C is  $\Delta H_v = 2384$  kJ/kg, and the required water will be  $[(1900)(2384)]/[4.18(50 - 20)] = 36,121$  kg/h.

The essence column operates at atmospheric pressure, condensing the vapors ( $V = 120$  kg/h, mainly water) at 100 °C ( $\Delta H_v = 2257$  kJ/kg), without subcooling. Cooling water requirement:  $(120)(2257)/[4.18(100 - 20)] = 810$  kg/h.

Total cooling water requirement:  $36,121 + 810 = 36,931$  kg/h or about 40 m<sup>3</sup>/h.

The cooling requirements of the pasteurizer and sterilizer are neglected (heat regeneration).

### Summary of material and energy balances of Example 1.1

Raw material: 20,000 kg/h oranges (13.6 % TS)

Products: Packaged orange juice (OJ) 12° Brix, 1800 kg/h

Canned frozen concentrated (FCOJ) 42° Brix, 460 kg/h

Packed frozen concentrate (FCOJ) 65° Brix, 1032 kg/h

Dried orange peels (pomace) 10 % moisture, 1660 kg/h

Peel oil, 60 kg/h

Fruit essence 40 kg/h

Steam requirements: evaporation	283 kg/h
Essence recovery	120 kg/h
Pasteurization	1090 kg/h
Sterilization	202 kg/h
Total steam	3695 kg/h

Fuel requirement for drying: 485 kg/h LPG (Example 8.1)

Cooling water: condenser of evaporator	36,121 kg/h
Essence recovery column	810 kg/h
Total cooling water	36,931 kg/h

## References

- Aggteleky B (1982) *Fabrikplanung*, vol 2. Hanser, Munich
- Aggteleky B (1987) *Fabrikplanung*, vol 1. Hanser, Munich
- Aguilera JM (2000) Microstructure and food product engineering. *Food Technol* 54(11):56–65
- Anonymous (1993) Portable processing. *J Food Eng Int* 10:33
- Aspen (2001) The HACCP training resource pack. Aspen, Gaithersburg
- Bandoni JA, Rotstein E, Romagnoli JA (1988) Simulation modeling and optimal operation of an apple juice concentrate plant. *J Food Eng* 7:159–175
- Bartholomai A (1987) *Food factories—processes, equipment, costs*. VCH, Weinheim
- Bernecker G (1984) *Planung und bau verfahrenstechnischer anlagen*. VDI, Düsseldorf
- BEV (2000) *Struktur der Bruttoanlageinvestitionen 1998*. Bundes Verein der Ernährungs Industrie. [www.bve-online.de](http://www.bve-online.de)
- Bhatia MV (1979–1983) *Process equipment series*, vols. 1–5. Technomic, Lancaster
- Biegler LT, Grossmann IE, Westerberg AW (1997) *Systematic methods of chemical process design*. Prentice-Hall, Englewood Cliffs
- Brennan JG, Butters JR, Cowell NP, Lilly AEV (1990) *Food engineering operations*, 3rd edn. Applied Science, London
- Cadbury RG (1992) Maximizing the output of a batch food plant—the design engineer’s role. In *Food engineering in a computer climate*. ICHIME. Taylor and Francis, New York, pp 395–400
- CE (1997) Plant construction costs. *Chem Eng* 104(8):98–108
- CE (1999) CAD improves on the basics. *Chemical Engineering July*, pp 109–110
- CEP (2000) CEP software directory. *Chemical engineering progress*. AIChE, New York
- Chilton CH (1960) *Cost engineering in the process industries*. McGraw-Hill, New York
- Clark JP (1997a) Food plant design. *Food engineering in practice*. In: Jowitt R (ed) *Engineering and food at ICEF 7*, part 1. Sheffield Academic, Sheffield, pp A42–A48
- Clark JP (1997b) Cost and profitability estimation. In: *Handbook of food engineering practice*. CRC, New York, pp 539–557
- Codex Alimentarius (1997) Supplement to volume IB, Annex to CAC/RCP 1–1969, Rev. 3
- Datta ASK (1998) Computer-aided engineering in food process and product development. *Food Technol* 52(10):44–52
- de Cindio B, Brancato B, Pollini CM (1994) Process modeling of pasta drying. In: Bimbenet JJ, Dumoulin E (eds) *Automatic control of food and biological processes*. Elsevier, Amsterdam, pp 183–189

- Diefes HA, Okos MR, Morgan MT (1997) A steady state food process design and analysis program with generalized unit operation models. Paper presented at the annual IFT meeting, Orlando, FL, June 1997
- DIPMIX (1997) Database of transport properties and related thermodynamic data of binary mixtures. Engineering Research Station. Texas A&M University, College Station
- Dolezalek CM, Wamecke HJ (1981) Planung von fabrikanlagen. Springer, Berlin
- Douglas JM (1988) Conceptual design of chemical processes. McGraw-Hill, New York
- Downing DL (ed) (1996) A complete course in canning. Books I, II, and III, 13th edn. CTI, Timonium
- Edgar TF (2000) Process information: achieving a unified view. *Chem Eng Prog* 96(1):51–57
- Farkas DF (1977) Unit operations concepts optimize operations. *Chem Technol* 7:428–433
- Farkas DF (1980) Optimizing unit operations in food processing. In: Linko P, Malkki Y, Olkku J, Larinkari J (eds) Food process engineering, vol 1. Applied Science, London, pp 103–115
- Farkas BE, Farkas DF (1997) Material and energy balances. In: Valentas KJ, Rotstein E, Singh RP (eds) Handbook of food engineering practice. CRC, New York, pp 253–289
- Fellows PJ (1990) Food processing technology. Ellis Horwood, London
- Fryer PJ, Pyle DL, Rielly CD (1997) Chemical engineering for the food industry. Blackie Academic and Professional, London
- Gekas V (1992) Transport phenomena of foods and biological materials. CRC, New York
- Georgiadis M, Rotstein G, Macchietto S (1997) Modeling simulation and optimization of milk heat treatment processes under fouling and effect on plant's flexibility. In: *Frontiers in food engineering*, CoFE 97. AIChE, New York, pp 382–387
- Giese J (2003) Product development. Software aids formulation. *Food Technol* 57(10):78–79
- Gould WA (1994) GMPs/food plant sanitation. CTI, Timonium
- Gould WA (1996) Unit operations for the food industry. CTI, Timonium
- Gregerson J (Editor-in-Chief) (2001) 26th Plant construction survey: clean, lean, safe, secure. Magazine Issue 4.1.2001
- Guthrie KM (1969) Capital and operating costs for 54 chemical processes. *Chem Eng* 77 (6):140–156
- Haseltine DM (1986) Improve your capital cost estimating. *Chem Eng Prog* 92(6):26–32
- Hausmann KW (1987) Industrielle Lehre. Oldenburg, Munich
- Heldman DR, Hartel RW (1997) Principles of food processing. Chapman & Hall, New York
- Heldman DR, Lund DB (1992) Handbook of food engineering. Marcel Dekker, New York
- Ibarz A, Barbosa-Canovas GV (2002) Unit operations in food engineering. CRC, Boca Raton
- ICHEME (1992) Food engineering in a computer climate. Taylor and Francis, New York
- Irudayaraj J (ed) (2001) Food processing operations modeling. Marcel Dekker, New York
- James DA (1996) How to use CFD. Leatherhead Food RA, Leatherhead
- Jowitt R (1980) Hygienic design and operation of food plant. Ellis Horwood, London
- Kettner H, Schmidt J, Greim HR (1984) Leitfaden der systematischen Fabrikplanung. C. Hasner, Munich
- Kimball DA (1999) Citrus processing. Aspen, Gaithersburg
- King CJ (1971) Separation processes. McGraw-Hill, New York
- Kiranoudis CT, Maroulis ZB, Marinos-Kouris D (1994) An integrated computer-based dryer simulator. *Comput Chem Eng* 18:S265–S269
- Kontny V (1989) From peanut butter in Paducah to coffee in Kowloon, food plant strategies in global market. In: The fourth international conference on design and engineering new factor, renovations and expansions. Food Plants'89, Irvine, CA
- Kostaropoulos AE (1977) Mobile factories for food manufacturing. *Europa Industrie Revue* 3:36–37
- Kostaropoulos AE (2001) Mobile module factories. An additional way in food processing. Paper presented at the symposium food factory of the future. SIK–Swedish Institute of Food and Biotechnology, Gothenburg, Sweden, June 2001
- Kostaropoulos AE (2012) Food engineering within science of food. *Int J Food Stud* 1:109–113

- Kvenberg JE (1996) The influence of plant and equipment design on the development of HACCP programs. Paper presented at the annual IFT meeting, New Orleans, June 1996
- Leniger HA, Beverloo WA (1975) Food process engineering. D. Reidel, Dordrecht
- Liu YA, McGee HA Jr, Epperly WR (eds) (1988) Recent developments in chemical process and plant design. Wiley, New York
- Lokyer K, Muhleman A, Oakland J (1989) Production and operations management. Pitman, London
- Loncin M, Merson RL (1979) Food engineering. Academic, New York
- Lord JA (2000) New products failure and success. CRC, Boca Raton
- Man J (1994a) Killer floors. Prepared Foods 2:93
- Man J (1994b) How to improve your plant-floor flexibility. Prepared Foods 3:94–95, 98
- Maroulis ZB, Saravacos GD (2003) Food process design. Marcel Dekker, New York
- Maroulis ZB, Saravacos GD (2008) Food plant economics. CRC, New York
- Marriott NG (1997) Essentials of food sanitation. Chapman and Hall/Aspen, New York
- Mermelstein NH (2000) Software for food processing. Food Technol 54(1):56–59
- Moresi M (1984) Economic study of concentrated citrus juice production. In: McKenna B (ed) Engineering and food, vol 2. Elsevier Applied Science, London, pp 975–991
- Mortimore S, Wallace C (2000) HACCP: a practical approach. Kluwer Academic, Norwell
- Mortimore S, Wallace C (2001) The HACCP training resource pack. Aspen, Gaithersburg
- NACMCF (1997) Hazard analysis and critical control point-principles and applications guidelines. National Advisory Committee of Microbiological Criteria for Foods, Washington, DC
- Nagy S, Chen CS, Shaw PE (1993) Fruit juice processing technology. Agscience, Aurburndale
- NZIFST (1999) Food industry guide to good manufacturing practice, 2nd edn. New Zealand Institute of Food Science and Technology, Auckland
- Okun S (1989) Taking the guesswork out of contractor selection. In: Fourth international conference on design engineering of plants, renovations, and expansions, Irvine, CA
- Parrish D (1990) Flexible manufacturing. Butterworth-Heinemann, London
- Perry RH, Green DW (1984) Perry's chemical engineers' handbook, 6th edn. McGraw-Hill, New York
- Perry RH, Green DW (1997) Perry's chemical engineers' handbook, 7th edn. McGraw-Hill, New York
- Peters MS, Timmerhaus KD (1990) Plant design and economics for chemical engineers, 4th edn. McGraw-Hill, New York
- Popham KR (1996) Industrial plant design/construction constraints and opportunities. Paper presented at the annual IFT meeting, New Orleans, LA, June 1996
- Pyle DL (1997) Introduction to process design. In: Fryer PJ, Pyle DL, Rielly CD (eds) Chemical engineering for the food industry. Blackie Academic and Professional, London, pp 1–62
- Rahman MS (2009) Food properties handbook, 2nd edn. CRC, New York
- Rao MA, Rizvi SSH (eds) (1995) Engineering properties of foods, 2nd edn. Marcel Dekker, New York
- Reid RC, Prausnitz JM, Poling BE (1987) The physical properties of gases and liquids, 4th edn. McGraw-Hill, New York
- Rice J (1987) Mobile aseptic plant. Food Process June, pp 76–78
- Rudolph MJ (2004) Cross industry technology transfer. Food Technol 50(1):32–34
- Saguy I (ed) (1983) Computer-aided techniques in food technology. Marcel Dekker, New York
- Sandler HJ, Luckiewicz ET (1987) Practical process engineering. McGraw-Hill, New York
- Saravacos GD (2000) Transport properties in food engineering. Paper presented at the international conference on engineering and food (ICEF 8). Puebla, Mexico, April 2000
- Saravacos GD, Kostaropoulos AE (1995) Transport properties in processing of fruits and vegetables. Food Technol 49(9):99–105
- Saravacos GD, Kostaropoulos AE (1996) Engineering properties in food processing simulation. Comput Chem Eng 20:S461–S466
- Saravacos GD, Maroulis ZB (2001) Transport properties of foods. Marcel Dekker, New York

- Saravacos GD, Maroulis ZB (2011) Food process engineering operations. CRC, New York
- Schwecke W (1989) Thinking food safety in plant design. Food Plants'89. Fourth international conference on design and engineering. Plant Strategies Inc., Chester
- Seibel W, Spicher G (1991) Backwaren. In: Heiss R (ed) Lebensmitteltechnologie. Springer, Berlin, pp 167–180
- Shepard WL (1981) How to attack those nagging floor problems. Food Eng Int 4:26
- SIK (2001) Food factory of the future. International symposium. SIK, Gothenburg
- Singh RP (1996) Computer applications in food technology. Academic, New York
- Sinnott RK (1996) Chemical process design. In: Coulson JM, Richardson JF (eds) Chemical engineering, vol 6. Butterworth-Heinemann, London
- Skjoldbrand C, Ohlsson T (1993) A computer simulation program for evaluation of the continuous heat treatment of particulate food products. Part 1: design. J Food Eng 20:149–165
- Skjoldbrand C, Sundstrom B, Janestad H, Anderson CG (1994) Simulators of food processes. In: Bimbenet JJ, Dumoulin E, Trystram G (eds) Automatic control of food and biological processes. Elsevier, Amsterdam, pp 433–440
- Smith JM, Van Ness HC (1987) Introduction to chemical engineering thermodynamics, 4th edn. McGraw-Hill, New York
- Souci SW, Fachmann W, Kraut H (1981) Die Zusammensetzung der Lebensmittel. Wissenschaftlicher Verlag, Stuttgart
- Swientek B (1993) Robotics: get a grip in it. Prepared Foods 5:80–84
- Teixeira AA, Shoemaker CE (1989) Computerized food processing operations. Van Nostrand Reinhold, New York
- Tijksens LMM, Hertog M, Nicolai BM (eds) (2001) Food process modeling. CRC, New York
- Ting SV, Rouseff BL (1986) Citrus fruits and their products. Marcel Dekker, New York
- Troller JA (1993) Sanitation in food processing, 2nd edn. Academic, New York
- Valentas KJ, Levine L, Clark JP (1991) Food processing operations and scale-up. Marcel Dekker, New York
- Valentas KJ, Rotstein E, Singh RP (1997) Handbook of food engineering practice. CRC, New York
- Viere HP (1994) Mobile Schlachthanlage-Integrierte Schlacht- und Verarbeitungsbetrieb und Modulbauweise. Fleischwirtschaft 74(4):382–387
- Wagner W (1998) Planung in Anlagebau. Vogel Buchverlag, Würzburg
- Walas SM (1988) Chemical process equipment. Butterworths, London
- Watt BK, Merrill AL (1963) Composition of foods, raw, processed, prepared. Agriculture handbook no. 8. USDA, Washington, DC
- Wells GL, Rose LM (1986) The art of chemical process design. Elsevier Science, Amsterdam
- Young R (2000) Plant construction survey. Food Eng J, 20 May 2000

# Chapter 2

## Design and Selection of Food Processing Equipment

### 2.1 Introduction

The principles of mechanical design and construction of food processing equipment are similar to those for the equipment of the chemical and process industries. The basic engineering requirements of process equipment are the containment of the material, the strength of the components, the efficiency of the operation, and the transfer of energy during processing. The equipment should be resistant to corrosion and be cost effective, and its operation should not present occupational hazards to the operators. In addition, the food processing equipment must comply with strict standards and regulations, which are necessary for securing the quality and safety of the food products to the consumers.

Hygienic (sanitary) design of food processing equipment involves selection of appropriate materials of construction and design, fabrication, and operation of the equipment that will ensure the safety of the food products from microbial and other contaminations and preserve the food quality. The equipment should be easily cleaned and sanitized by continuous (CIP; see p. 65) or noncontinuous techniques and be adapted to integrated systems of process control and automation.

Plant and equipment maintenance in food processing are of paramount importance. Due to stricter regulations and more or less fluid products, mechanization and automation are more advanced in dairy technology than in other food processing plants (Tannine and Law 2001).

Equipment used in the processing of seasonal products, such as tomatoes, oranges, and sugar beets, requires special maintenance. All equipment, remaining idle for a substantial time, should be examined thoroughly and repaired, if needed, before starting the new processing period. Equipment failure during the busy processing period can result in significant losses of raw materials, due to spoilage. The quality of processed food products is affected significantly by the processing equipment (Kostaropoulos and Saravacos 1995).



## 2.2 Sizing and Costing of Equipment

The sizing of food processing equipment is based on material and energy balances around each process unit. The process block diagram (PBD) and data tables obtained in process design (Chap. 1) are essential. Shortcut (simplified) equations are normally used for preliminary sizing of process equipment. Food engineering properties and databanks, especially transport properties, are needed for the calculations (Rao and Rizvi 1995; Rahman 1995; Saravacos and Maroulis 2001). Sizing calculations yield preliminary data on the dimensions of the equipment and the requirements for utilities (steam, water, refrigeration, power).

An oversizing capacity of 10–20 % is normally used to account for production problems, e.g., breakdown of a critical unit, and to meet production peaks. Oversizing is also advisable, when operating or environmental conditions change substantially, e.g., higher capacity of an air-cooling unit to account for increased humidity of cold storage rooms or for higher temperature and humidity of ambient air.

Equipment sizing also depends on the manufacturing plans of the food company. Thus, if greater flexibility is desired, two smaller units are better than a larger one. Splitting the capacity of process and utility units may also be advantageous for a more steady and flexible operation and for a reduction of the maintenance cost of the whole processing plant.

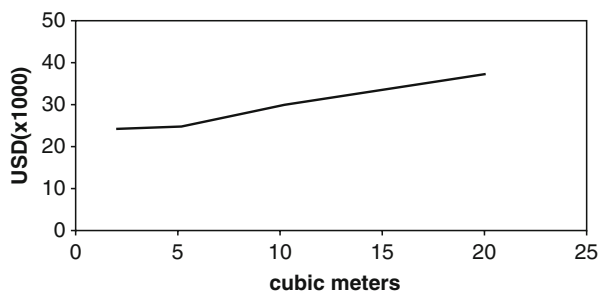
The cost of materials is the major component of the cost of the processing equipment. Typical costs of metallic materials, converted to year 2000 (M&S index), are carbon steel \$430/t, SS 304 \$2000/t, SS 316 \$3200/t, and aluminum \$1600/t (Sinnott 1996). The cost of construction also depends on the type of material used, i.e., raw, rolled, extruded, plate, and alloy, and the precision of workmanship in fabrication.

The price of standardized or “off-the-shelf” equipment is, in general, considerably lower than the price of custom-made equipment. Whenever possible, such equipment is preferred.

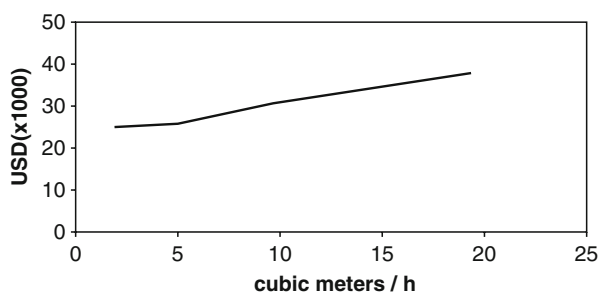
Cost indices and Guthrie charts of *Chemical Engineering* magazine (M&S, CE) can be used for general processing equipment (Table 1.3 and Fig. 1.2). Published cost data for various food processing plants and equipment are very limited, e.g., Bartholomai (1987). These data are useful in preliminary equipment and plant design and in economic evaluation of a proposed food processing plant. Of course, more realistic cost data on specific equipment can be obtained from price quotations of equipment suppliers.

Cost data were collected in Europe for certain food processing equipment for the period 1960–1990 (Kostaropoulos and Saravacos 1997). Typical diagrams of cost versus capacity for food tanks, plate heat exchangers, and centrifuges, used in the dairy, edible oil, and juice/beverage industries, are shown in Figs. 2.1, 2.2, 2.3, 2.4 and 2.5. The material of construction is food-grade stainless steel, and the cost in USD (US dollars) was converted to year 2000, using the M&S equipment cost index. The “2/3” rule (1.3) was applicable to most equipment, except for tanks of

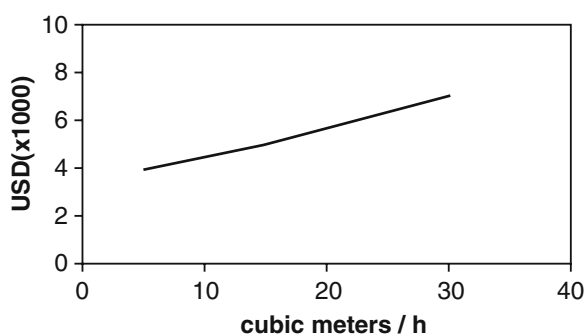
**Fig. 2.1** Cost of storage tanks for liquid foods (year 2000). Data from Kostaropoulos and Saravacos (1997)



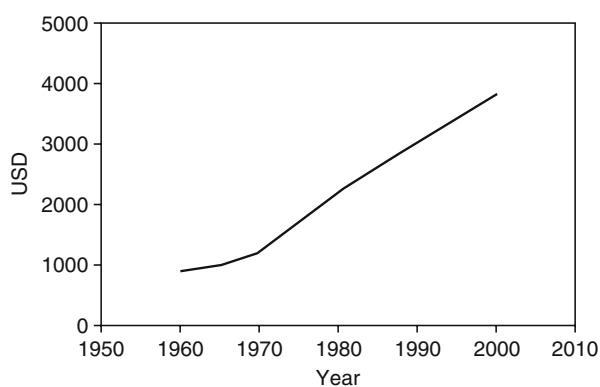
**Fig. 2.2** Cost of plate heat exchangers (year 2000). Data from Kostaropoulos and Saravacos (1997)



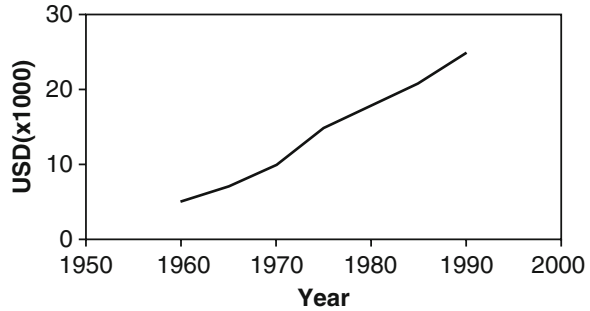
**Fig. 2.3** Cost of centrifugal pumps for liquid foods (year 2000). Data from Kostaropoulos and Saravacos (1997)



**Fig. 2.4** Cost of centrifugal pumps (5 m<sup>3</sup>/h) in the period 1960–2000. Data from Kostaropoulos and Saravacos (1997)



**Fig. 2.5** Cost of centrifugal separators ( $6 \text{ m}^3/\text{h}$ ) in the period 1960–1990. Data from Kostaropoulos and Saravacos (1997)



low capacities (below 200 L), where a higher capacity factor ( $n$ ) was found. The capacity factor for special mechanical equipment, like centrifuges and homogenizers, is nearly  $n = 1$ . There is an almost linear relationship between the weight and the power of the centrifugal pumps.

Nearly linear increases of the cost of centrifugal pumps and centrifuges during the period 1960–1990 were observed (Figs. 2.4 and 2.5), corresponding to average annual increases (inflation) of 6.5 and 7.5 %, respectively. These increases are significantly higher than the average annual increases of the M&S equipment index (4.5 %) over the same period (Fig. 1.2). The higher inflation rates of food processing equipment are due to the higher increases of prices of the alloying metals, i.e., Cr, Ni, and Mo, used in food-grade stainless steels (Hall et al. 1988).

### 2.3 Materials of Construction

The properties and cost of materials of construction are very important factors in the design, construction, operation, and maintenance of general processing equipment. Selection and application of these materials are based on the principles of metallurgy and materials science (Murray 1999; Cardarelli 2000).

The main materials being used for food processing equipment are metals, plastics, and glass–ceramics. Furthermore, wood and some natural fibers are used in some special applications. The materials used in the construction of food equipment must have the following properties: (1) mechanical strength, (2) easy to fabricate, (3) easy to repair, (4) resistance to corrosion, (5) hygienic properties, and (6) desirable thermal properties.

The mechanical strength is especially important in the construction of equipment used in processing of large quantities in a relatively short time, e.g., in seasonal processing. Furthermore, strength is usually more important in the first stages of processing, in which large amounts of raw material have to be processed. Mechanical strength is also important when material stress is involved, such as in loaded tanks and silos and in abrasion during cutting, milling, and pneumatic transport of grain. For protection against abrasion, hardening of the surface of the metal is

necessary. In fabrication and repair of food processing equipment, the hardness and welding ability of the materials are also important.

The resistance against corrosion is especially important in (1) wet processing (e.g., canning industry) and (2) processing of foods or food ingredients of relatively low pH, which may attack the equipment materials and when corrosive chemicals are used, e.g., caustic solutions for peeling,  $\text{SO}_2$  for preservation, and cleaning chemicals.

Factors that may enhance corrosion are (Perry and Green 1997) (1) increase of temperature, (2) pressure, (3) acidity (pH), (4) presence of impurities, (5) aeration, (6) relative velocity (material/product), and (7) temperature difference ( $\Delta T$ ) during heat transfer.

Corrosion of food processing equipment may be distinguished as: (1) uniform corrosion (e.g., oxidation due to humidity), (2) pitting (tiny holes on the surface of the metals, due to the attack of aqueous solutions containing chlorides), (3) stress corrosion (e.g., overloading of pumps and grinding machines), (4) intergranular corrosion (due to high temperature during welding), and (5) galvanic corrosion (due to the direct contact of dissimilar metals).

The materials that are used for food processing and preservation equipment may come directly in contact with the food or may be part of supporting elements of machines and structures without contacting food at all. Nevertheless, due to strict measures taken for protecting food from contamination, even materials not coming in direct contact with food should fulfill the hygienic conditions established by regulations for food protection. For materials of equipment that come directly in contact with food, the hygienic regulations are to a great extent the same as the regulations for food containers and packaging materials.

The hygienic (sanitary) materials do not exchange components with the food, i.e., they do not contaminate the food or absorb components of the processed product. They should have smooth or polished surfaces, not react with detergents, and they should be cleaned easily. Thermal properties are important when heat transfer to and from the processed products must take place (e.g., pasteurization of liquids in tubes, cooling down food in plate freezers). The main characteristics of materials employed in the construction of food processing equipment are given in Table 2.1.

### 2.3.1 Metals

Metals are the most important materials used in the construction of food processing equipment. They can be classified into two main categories: ferrous metals and their alloys and nonferrous metals. The nonferrous metals are either used in the construction of equipment and in equipment parts coming directly in contact with food or are included in alloys or in chemicals that are used for influencing the properties of other materials (e.g., paints, plastics).

**Table 2.1** Properties of construction materials

Product	Tensile strength (MPa)	Thermal conductivity (W/m K)	Acetic acid	Nitric acid	HCl	H <sub>2</sub> SO <sub>4</sub>	NaOH	H <sub>2</sub> O <sub>2</sub>
<i>Metals</i>								
C steel	350–490	35–46	–	–	–	–	++	–
304/316 SS	565	18.8	++	+++	–	+–	++	++
Cu	20–40		–	–	++	–	+–	–
Cu alloys	400–450	375.8						
Al	50–60	208.8	+++	+–	–	–	–	+++
Al alloys	150–470							
Monel	480–600		+	–	–	+–	++	++
<i>Plastics</i>								
Polyester	55–72	0.170	++	+	++ +	+++	–	++
PVC (soft)	20–60	0.160	+++	+++	++ +	+++	+++	+++
Polyethylene	6–37	0.334	+++	+++	++ +	++	+++	++
Rubber			–	–	++	+++	+++	++

Data from Loncin (1969), Schimpke (1959), and Perry and Green (1997)

+++ : very good resistance

++ : sufficient resistance, if used under normal conditions

+ : sufficient resistance for no permanent contact

– : insufficient resistance

Recently, there have been efforts to develop metals containing antimicrobial compounds in their structure. Such metals are a special stainless steel coated with the antimicrobial compound, AgION, and a special titanium dioxide that can be used in cutting devices (Curiel 2001).

### 2.3.1.1 Steel

The ferrous metals used for food processing equipment are carbon steel, low-alloy steel, cast iron, stainless steel, and cast stainless steel. Stainless steel is the main material used in direct contact with food.

Carbon steel and low-alloy steel are used only in special cases in direct contact with food, e.g., in the edible oil industry (mills, presses, and oil tanks at temperatures below 150 °C; Loncin 1961), in preliminary processes of the canning industry (e.g., cleaning of raw potatoes), and in sorting of fruits and vegetables in packing houses.

Carbon is the main component (0.03–1.7 %) that influences the strength of steel. Increasing the carbon content causes an increase of the alloy tensile strength (e.g., the steel strength is tripled when 0.9 % carbon is added), a reduction of strain (down 14-fold when more than 1.6 % carbon is added), an increase of hardness (up to 3.5-

fold), and a reduction of welding ability (Schimpke 1959). The addition of elements such as Cr, Ni, Mn, Mo, Ni, or Ti leads to alloyed metals, which have enhanced properties.

The composition of the various carbon and low-alloy steels is given by the standards of the American Iron and Steel Institute (AISI). For example, AISI 1020 contains 0.2 % carbon, 0.3–1.65 % Mn, 0.1–0.3 % Si,  $P < 0.04$  %, and  $S < 0.05$  % (Peters and Timmerhaus 1990).

Carbon steel contains less than 4 % Cr, whereas the Cr content of low-alloy steel lies between 4 and 7 % (Sandler and Luckiewicz 1987). Low-alloy steel also contains small amounts of Mo ( $< 0.5$  %) to increase the high-temperature strength. Both metals must have a low content ( $< 0.05$  %) of S and P (Loncin 1961). Both are sensitive to oxidation and are often protected through coatings (paints, plastics). Carbon steel is resistant to water-free mineral acids (e.g.,  $H_2SO_4$ ) and relatively resistant to lye solutions, but it is attacked by organic acids and dilute mineral acids and it is very sensitive to moisture (Loncin 1961). Its corrosion rates are about 0.13–0.5 mm/year. Low-alloy steel is a little more resistant than carbon steel against humidity (Perry and Green 1997). Cast iron is used mainly for supporting purposes and casings and cast parts of food equipment that do not come directly in contact with food. The tensile strength of carbon steel and low-alloy steel is 345–485 and 220 MPa, respectively. The thermal conductivity of both metals is 36–46 W/m K (Perry and Green 1997).

### 2.3.1.2 Stainless Steels

High-grade stainless steel is the most important type of steel used in direct contact with food in constructing food processing equipment. Stainless steels are characterized, in general, by chromium content higher than 12 % and by their passivity, i.e., the ability to form an impervious surface coating, which inhibits corrosion. Austenitic stainless steel, containing nickel ( $Ni > 3.5$  %), is mainly used, because this type is more corrosion resistant and more ductile. In most food equipment, two types of stainless steel are used: AISI 304 and AISI 316. The corresponding specification numbers in the British Standards for stainless steel (BS 1501) are 801B and 845B, respectively (Sinnott 1996). For the German Institute for Standardization (DIN), stainless steels have the specification DIN 17440 (X5CrNi18-8) (Grassuck et al. 1994). The carbon content of AISI 304 and AISI 316 is 0.08 %. Low carbon content improves welding, which may also be achieved by adding titanium (Ti) or niobium (Nb) (Ullmann 1973). The Cr and Ni content for both types is 18 and 8 %, respectively. Cr improves the hardness and abrasion resistance of the alloy. Ni increases the toughness and improves the properties at low temperatures. AISI 316 also contains 2–3 % Mo, which enhances the alloy properties at higher temperatures, important in welding (Perry and Green 1997), and increases the resistance to pitting due to chlorides. Besides these two types, variations 304L and 316L are also used. Both of them have further reduced carbon content (0.03 %), which enables welding of thicker stainless steel sheets (Sinnott 1996).

Both types of stainless steel are resistant to oxidation and acids. Their resistance against lye is similar to that of carbon steel. Therefore,  $\text{HNO}_3$  and  $\text{NaOH}$  solutions may be used to an advantage in cleaning processes (CIP). Both materials are not very resistant against halogens (Cl), which cause pitting especially at high temperatures and low pH values. AISI 316 is about 25 % more corrosion resistant than AISI 304. The tensile strength of both types of stainless steel is 565 MPa. Their thermal conductivity ( $\lambda$ ) is relatively low (18.8 W/m K). However, in heating or cooling fluids, the low  $\lambda$  of stainless steel does not influence heat transfer very much, since the thickness of the metal sheets in heat exchangers is small and the effect of other factors (viscosity and fluid velocity) is much more pronounced (Chap. 6).

### 2.3.1.3 Aluminum

Aluminum is the most widely used nonferrous metal for food processing equipment. It has the advantages of high strength-to-weight ratio, nonmagnetic properties, good thermal and electrical conductivity, and resistance to corrosive environments. Commercially pure (>99.5 % Al) wrought metal (DIN 1712, Sheet 3, American Aluminum Association, AA 1060) is used in tanks for storage and transportation of milk and beer, acetic acid, and alcohol (Ullmann 1973; Sandler and Luckiewicz 1987). Its alloys are used in supporting constructions. Since its strength remains stable at temperatures down to about  $-250\text{ }^\circ\text{C}$  (Perry and Green 1997) and its thermal conductivity is high (208.8 W/m K, Loncin 1961), it is often used for food freezing equipment (e.g., plate food freezers). However, its strength is remarkably reduced at temperatures above  $150\text{ }^\circ\text{C}$ . The tensile strength of commercially pure aluminum is 69 MPa. Its strength increases through cold working (Perry and Green 1997). The strength of aluminum alloys (e.g., duralumin) is greater than that of the pure metal, but their resistance to corrosion is lower (Sinnott 1996). Therefore, in some cases, aluminum alloys are plated by pure aluminum metal to avoid direct contact with the food. The tensile strength of its alloy may approach that of low-alloy steel. It is very resistant against oxidation in humid air, but it is attacked by strong caustic solutions and acids (Table 2.1). Cleaning substances containing lye can be handled only if inhibitors (e.g., sodium metal silicate) are used.

### 2.3.1.4 Copper

Copper is characterized by its very good electrical and heat conduction properties ( $\lambda = 375\text{ W/m K}$ ) and its low-temperature ( $-250\text{ }^\circ\text{C}$ ) strength (Schimpke 1959). It is used in some equipment that comes directly in contact with food, e.g., beer brewing ingredients that have a pH below 6 in the prefermentation and fermentation steps of beer brewing. Furthermore, it may also be used in processing of chocolate and confectionery, if the manufactured products do not contain acid substances.

It has been used in the past in the processing of jams and tomatoes, but, due to the oxidation of ascorbic acid, it has been replaced by stainless steel. Because of its relatively good corrosion resistance against nonoxidizing acids, copper is used in equipment employed in starch hydrolysis with dilute hydrochloric acid.

The tensile strength of copper is about 360 MPa (Perry and Green 1997). Copper alloys, such as brasses and bronzes (>60 % Cu), are stronger than pure copper. Brasses are virtually not used for food equipment, but bronzes (especially aluminum and silicon bronzes) are often used in valves, taps, and other cast parts of equipment (Loncin 1961; Perry and Green 1997). Bronze is used in some food equipment after plating with nonoxidized metals (e.g., Ni, Cr).

### 2.3.1.5 Other Metals

Tin is used as a constituent of copper alloys and in coating steel or copper so as to avoid their direct contact with food. Nickel and chromium are constituent metals in steel and copper alloys. The addition of Ni increases toughness and corrosion resistance of steel alloys. Chromium increases strength and hardness. Monel 400 is a nickel–copper alloy (67 % Ni) that has good strength and quite good corrosion resistance properties against alkalis, organic acids, and salt (brine solutions). It is more expensive than stainless steel, but it may be used in reducing conditions, in which stainless steel would be unsuitable (Schimpke 1959; Sinnott 1996; Perry and Green 1997).

### 2.3.2 *Plastics–Rubber*

Plastics are usually resistant to corrosion, but their mechanical strength is limited (Table 2.1). Furthermore, their strength depends strongly on the temperature of the material. The upper temperature application limit of most temperature-resistant plastics lies at 250 °C. Therefore, in food processing equipment, plastics are mainly used for coating and parts that are not under high and continuous stress (e.g., parts of ventilators and pumps, pipes, fittings, small tanks, covers of vessels, filters, gaskets). In all cases, plastics must fulfill the requirements concerning the interaction of materials with food. This is especially important for plasticizers, which are added to influence the properties of the plastics and which are generally undesirable in the food system.

Plastics, as construction materials, can be divided into two main categories: thermoplastic and thermosetting materials (Sinnott 1996). Examples of commonly used thermoplastics are poly(vinyl chloride) (PVC), polyethylene, and poly(tetrafluoroethylene) (PTFE; Teflon). Depending on the plasticizers added, plastics could become softer or harder. Polyethylene, for example, can be distinguished into low- and high-density material. The tensile strength of low-density polyethylene is 15 MPa, while that of the high-density material is about double. Low-density



polyethylene can be used at temperatures up to 100 °C, while the high-density material can be applied at temperatures up to 130 °C. The thermal conductivity of both materials is 0.334 W/m K. PTFE has relatively low mechanical strength (7–25 MPa, Perry and Green 1997), but it is used when high temperatures prevail, as it withstands temperatures up to 250 °C (Loncin 1961). Examples of thermosetting materials are polyester and the epoxy resins. The tensile strength for polyester is 40–100 MPa and, for epoxy resins, it may reach 200 MPa (Perry and Green 1997). The thermal conductivity of polyester is 0.13–0.26 W/m K (Loncin 1961). Epoxy resins are also used as adhesive of plastic or even metal equipment parts. However, in this case, the application temperature should not exceed 100–180 °C (Ullmann 1973).

Rubber is used as part of equipment or machines coming directly in contact with food (e.g., gaskets, filters), as parts that must withstand friction (e.g., pumps), and in coating of metals. Rubber must be as pure as possible. Hard rubber has a tensile strength of 70–100 MPa and its thermal conductivity is about 0.4 W/m K (Loncin 1961). In conveyor belts, canvas may be more preferable than rubber.

### 2.3.3 *Glass–Ceramics*

Glass and ceramics are very resistant to acids and sufficiently resistant against lye. They are very hard and can withstand pressure of 100–400 MPa. However, they are very sensitive to bending (fragile). Their thermal conductivity is 0.62–1.45 W/m K. They are used in coating of other stable materials (e.g., in bins, vats) and in the construction of pipes and processing equipment for very sensitive products. Ceramics are also used in filtration (e.g., sand, porous silicate bodies), in ultrafiltration, and for insulation (glass wool). They can be used in enameling of metals to protect against corrosion (e.g., storage tanks) and for glass-fiber-reinforced plastics. Polyester resins, reinforced with glass fiber, have a relatively good strength up to 130 °C, are resistant to several chemicals, and can be easily formed. Therefore, they are often used for fittings and valves in connection with plastic pipes and vats. Ceramics can be also used in cutting blades, lasting longer than simple steel blades.

### 2.3.4 *Wood*

Wood was used in the past for the fabrication of various food processing equipment, but its use has been discontinued, due to hygienic (sanitary) and mechanical strength problems. At the present time, wood is used as an inexpensive material in some traditional food processes, such as fermentation tanks and storage containers for wine, pickles, and olives. The high acidity and the high salt (NaCl) content of brines in some of these products can cause severe corrosion problems even for expensive metallic construction materials, such as stainless steel.

## 2.4 Fabrication of Equipment

The requirements for construction of food processing equipment are to a great extent similar to those applied in building general processing equipment. However, due to the biological character of the processed food materials, certain limitations, influencing their quality and safety (e.g., temperature, moisture, pressure, contact with air), must be taken into consideration. The designer of food equipment must keep in mind the selection requirements of the final user in the food industry who will play a role in purchasing the constructed equipment, and a feedback of experience is indispensable (see Sect. 2.6 later in this chapter).

The following basic points must be taken into consideration for the proper design and construction of food equipment: strength, technological suitability, weak construction points, and fabrication and installation of equipment.

### 2.4.1 *Strength of Construction*

#### 2.4.1.1 General Aspects

The basic types of forces applied in a material are tension, pressure, and shear. Furthermore, combinations of these forces, such as bending or perforation, are often applied. The stress applied to machine materials is due to forces caused by mechanical, thermal, chemical, or physical processes (e.g., phase change of a processed material). Food equipment stresses may be distinguished as “internal” and “external” stresses.

Mechanical stresses may be due to static forces, as in silos or tanks (weight of the equipment and weight of its contents). Other examples of mechanical stresses are the pressure experienced by materials of construction during mechanical processing, such as homogenization, pressing, filtration, extruding, and pumping.

Thermal stresses develop at high or low temperatures during processing (expansion/contraction). They are especially pronounced in positions in which two different construction materials are joined. Furthermore, elevated temperatures may cause mechanical weakening of the material.

Chemical reactions influence directly or indirectly the strength of the construction material. Chemical reactions may cause corrosion or produce substances that cause mechanical stress (e.g., gases).

Physical stress may cause indirectly mechanical stress. Phase changes of the product may cause mechanical stress, such as when water is vaporized (development of pressure).

Internal stresses are related directly to the equipment, including static forces of the equipment and its contents, and forces caused by changes during food processing. External stresses are usually caused by external forces such as wind and snow. These stresses occur when the equipment is located outside buildings,

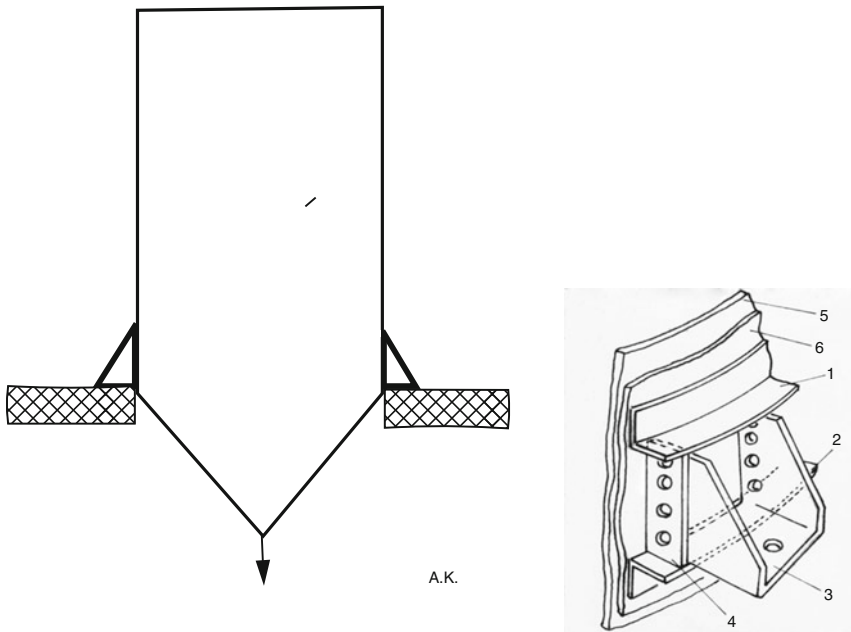
e.g., in silos, large tanks, and tall equipment, like barometric sterilizers, large evaporators, and distillation columns. However, external stresses may also be important in equipment located indoors, e.g., stresses due to seismic action or due to vibration of neighboring equipment.

Mechanical stresses can be controlled and minimized by proper selection of the construction materials, correct design of the equipment, and proper construction.

Recommended design stresses must be taken into consideration; e.g., the tensile strength of stainless steel 304 at 20–50 °C is greater than 500 N/mm<sup>2</sup>, but typical design stress for such a material is only 155 N/mm<sup>2</sup> (Sinnott 1996; Perry and Green 1997).

Thermal stresses in pipelines should be controlled by flexible connections or  $\Omega$  expansions.

Proper construction should apply sufficient tolerances against the risk of thermal expansions and contractions. Proper welding may reduce the risks of equipment corrosion or stresses, since welding is the weak point of several structures, due to the weakening effect of the local heat, produced during welding. Besides that, the electrolytic corrosion should be avoided by taking special constructive measures. In case, for example, of using steel bucket supports, in stainless steel equipment or tanks requiring free space beneath, welding should be done as indicated in Fig. 2.6.



**Fig. 2.6** Supporting equipment, tanks, and silos requiring free space beneath. A.K.: (1) upper ring-shaped steel, (2) lower ring-shaped steel; (3) bucket (U profile); (4) side-steel supporter; (5) apparatus stainless steel wall; (6) intermediate stainless steel plate

In storage silos (bins), material failure of the lower cone may be caused by uneven distribution and improper emptying of the particulate material. Silo failure is a potential explosion hazard for certain food powders. To prevent this problem, emptying of the particulate material should be facilitated by special devices and techniques. Metal support rings should be installed near the wider base of the metal cone, reinforcing the walls against excessive stresses.

#### **2.4.1.2 Sensitive Construction Points**

Sensitive and weak points in food processing equipment include (1) material joints and (2) parts for which a relative motion between equipment elements exists. Joints may be permanent (welded, riveted plates, parts connected with an adhesive) or flexible (screwed parts). Adhesives are frequently used in constructions, e.g., in pipelines (Ullmann 1973), but they do not withstand high temperatures, and the additives (plasticizers) they contain are not acceptable for direct food contact.

Welding, which is used extensively in joining various metal parts, should be polished in all surfaces coming into contact with food materials. Screws should be avoided in equipment parts contacting food. Screwed joints, used in external construction (supporting structures), should conform to sanitary requirements, e.g., wide-pitched screws and very short (hidden) nuts (Jowitt 1980). For the same reason, wide-pitched (thicker) coiled springs should be also preferred instead of thinner ones.

Bearings should be placed outside the food area, when a part of the equipment is stationary, while the other is rotating, e.g., shafts connecting an electric motor with agitators, extruder screws, scraped heat exchangers, or pumps. Food-grade gaskets should be used instead of full face ones, to avoid contamination.

#### **2.4.1.3 Proper Engineering**

In relating a given food processing technology to the construction of proper equipment, in addition to the sizing and economic factors, the interrelation of equipment with its environment (surroundings) must be taken into account.

The interrelation of equipment and its surroundings may or may not be desirable. For example, in heat exchangers, the transfer of heat between the product and the surrounding medium is desirable. On the other hand, undesirable interrelations include the leakage of equipment [loss of material (processed food), loss of heating medium (hot water or steam), inflow of air in vacuum] and contamination (inflow of microorganisms or undesirable fluids in food processing pipes).

## 2.4.2 *Fabrication and Installation of Equipment*

The principles and techniques used in the fabrication of process equipment for the chemical and other process industries are applicable to the food processing equipment. In addition, the food equipment must comply with strict hygienic (sanitary) standards and regulations, which will ensure the safety and quality of the food products.

### 2.4.2.1 **General Process Equipment**

Fabrication expenses account for a large part of the purchased cost of the process equipment. Mechanical details for the fabrication of general process equipment are given in various engineering codes, such as the American Society of Mechanical Engineers (ASME), the British Standards (BS), and the German Institute for Standardization (DIN).

The main steps in fabricating process equipment are cutting, forming, welding, annealing, and finishing (Peters and Timmerhaus 1990).

Cutting of the metal can be affected by shearing, burning, or sawing. Forming into the desired shape is accomplished by rolling, bending, pressing, pounding, or spinning on a die. Welding has replaced bolting in most metal constructions. Electric welding can be done by manual shielded arc or submerged arc. Stainless steel and nonferrous metals are welded by the Heliarc process (in inert He or Ar gas). The welded joints and main seams are tested by X-rays. Hydrostatic tests are required to detect any leaks.

Heat treatment (annealing) of the fabricated equipment is necessary to remove mechanical stresses, created during forming and welding, to restore corrosion resistance, and to prevent stress corrosion. The equipment is finished by sandblasting (abrasive) or mechanical polishing, and it may be painted. Final pressure tests at 1.5–2 times the operating pressure and other tests may be required by the codes or the inspector.

Metal cladding is sometimes used to reduce cost in corrosive environments: a thin sheet of an expensive corrosion-resistant material is used to clad (cover) a cheaper thick plate.

In the design of process vessels (tanks), empirical correlations are used to ensure the mechanical strength of the construction. Thus, the ratio of wall thickness to tank diameter ( $t/D$ ) is taken as  $t/D < 1/10$  for thin-walled vessels and  $t/D > 1/10$  for thick-walled vessels (Sinnott 1996). Empirical correlations are also used for liquid storage tanks.

### 2.4.2.2 **Food Processing Equipment**

The fabrication of food processing equipment must follow some special requirements, related to the materials of construction, the design, and the characteristics of

the various units. The requirements for hygienic design and operation are discussed in the next section of this chapter.

The materials used in food equipment and machines should not interact with food and should be noncorrosive and mechanically stable. For the majority of equipment used in direct contact with food, stainless steel (AISI 304) is employed. If the acidity of food products is high, AISI 316 is commonly employed.

If rubber and plastics are used in contact with foods, e.g., PVC, plasticizers that may migrate into the food should be contained. Tin, although nontoxic for normal dietary ingestion, should not be used in food equipment and machines if mechanical stresses occur, since its strength against stress is very low.

The cost of equipment/machines increases with (1) quality and quantity of stainless steel used, (2) total weight of the unit, (3) quantity of relatively expensive material used (e.g., insulation, special seals), (4) fabrication (e.g., smoothness of surfaces, type of welding), (5) antirust protection (e.g., double or electrolytic galvanization, special paints), and (6) quality of spare parts (e.g., bearings, electrical material).

In addition to the hygienic design (e.g., cleaning, sanitation), the following requirements are important in the construction of food processing equipment: (1) easy mechanical maintenance; (2) standardization of spare parts, important in seasonal processing, when the equipment is run continuously for a relatively short time; (3) durability and flexibility, important in seasonal processing and in switching from one product to another; and (4) high accuracy in some operations, like peeling, cutting, filling, packaging, and weighing.

The food contact surface of the equipment should be kept free of nonfood materials, like lubricants and greases, using gaskets, seals, and other insertions. Bearings and other mechanical parts should be isolated from the food.

### 2.4.2.3 Installation of Process Equipment

The process equipment is installed on various supporting structures, depending on the type and weight of the equipment and the nature of the processing operation.

Large and heavy equipment, e.g., barometric sterilizers and homogenizers, are installed directly on heavy ground foundations.

Large and tall equipment, requiring free space beneath it, like silos and storage tanks, are normally seated on bucket supports, welded on the surface of the equipment, near its center of gravity. Figure 2.6 indicates supporting of such equipment (see also Sect. 2.4.1 under Sect. 2.4.1.1). Between the stainless steel apparatus wall and the steel supporting its elements inserts a stainless steel plate welded on the apparatus wall. This eliminates apparatus damage due to electrolytic corrosion.

Supporting legs are used for short vessels and long structures, e.g., sorting tables and band dryers.

Equipment that has to be transported frequently within the plant from one area to another, e.g., silos containing semifinished products, can be installed on moving supports, hanging from the plant roof.

Equipment supports, made of carbon steel, like legs and bucket supports, should be welded to stainless steel patches, which are in turn welded on the processing equipment. This construction of equipment prevents electrochemical corrosion, caused by joining two dissimilar metals.

## **2.5 Hygienic Design of Food Processing Equipment**

Hygienic or sanitary design of food processing equipment is based on proper selection of construction materials and fabrication techniques, which will facilitate food processing and thorough cleaning of the equipment.

Hygienic design of process equipment must be accompanied by a thorough hygienic design of the whole food process and processing plant (Jowitt 1980; Brennan et al. 1990; Gould 1994). Engineering implications of hygienic process design should be considered from the outset of the design process, especially for new, untested food processing systems (Chap. 1). The principles of food processing sanitation are detailed by Kutsuyama (1993). A guide to the sanitary design of food plants and food processing equipment was published by Imholte (1984). Hygienic aspects of food processing equipment are discussed by Schomick and Thor (1976), Kopp and Gerhold (1977), Kessler (1981), and Kessler and Lund (1989).

The European Union (EU) research and development program LINK includes a project on advanced and hygienic food manufacturing, consisting of hygienic processing and food process simulation and modeling.

Hygienic design and operational requirements of various food processing equipments, e.g., pumps, heat exchangers, freezers, and dryers, are discussed in individual chapters on specific equipment of this book.

### ***2.5.1 Hygienic Standards and Regulations***

The design and operation of food processes and processing equipment should ensure the microbiological safety of the final food products. Design engineers, equipment manufacturers, and food processors should follow strict hygienic standards and government regulations.

Government regulations of food processing equipment are essential for the manufacture of safe and wholesome foods and the protection of public health.

In the USA, the following government agencies and private organizations have published sanitary standards for food processing equipment (Troller 1993):

- USDA (US Department of Agriculture), Washington, DC: (1) Publication MPI-2 “Accepted Meat and Poultry Equipment”; (2) Agriculture Handbook No. 191 “US Inspected Meat Packing Plants. A Guide to Construction, Equipment, Layout”; and (3) “Poultry Processing Equipment”
- US Department of Interior, Washington, DC: Bureau of Commercial Fisheries “Fishery Products and Processing Equipment”
- US Public Health Service, Washington, DC: FDA (Food and Drug Administration). GMPs
- IAMFES (International Association of Milk, Food, and Environmental Sanitarians, Inc.), Ames, Iowa: Committee on Sanitary Procedures “3-A Sanitary Standards”
- ASME, New York: ANSI-ASME F2-1 “Food, Drug and Beverage Equipment”
- BISSC (Baking Industry Sanitation Standards Committee), New York: “BISSC Sanitation Standards”
- AFDOUS (Association of Food and Drug Officials of the United States), Littleton, Colorado: “AFDOUS Frozen Food Code”
- National Sanitation Foundation, Ann Arbor, Michigan: (1) “Food Service Equipment Standards” and (2) “Food Preparation and Service Equipment”

The 3-A sanitary standards were developed originally for the milk industry, but they have been extended to other food products in the USA and other countries. They resulted from the collaboration of equipment manufacturers; the users of food equipment; the IAMFES; the Dairy and Food Industries Suppliers Association (DFISA); the Poultry and Egg Institute of America; and representatives of the USPHS/FDA and USDA.

A list of the 3-A standards and 3-A accepted practices is presented by Rao (1992). The 3-A standards refer mainly to milk processing equipment, including storage tanks, heat exchangers, pasteurizers, freezers, evaporators, drying equipment, and various fittings. The 3-A accepted practices include HTST pasteurizers and culinary (potable) steam production. Special E-3-A standards apply to processing equipment for egg products (IAMFES 1988).

In addition to the 3-A standards, the following two rules/regulations should be considered in the USA: the Pasteurized Milk Ordinance and the good manufacturing practices (GMPs) of the FDA (Chap. 1).

Equipment used in USDA-inspected food plants must have been approved and listed in the “Compendium of USDA Approved Equipment.” Obtaining such approval is the responsibility of the equipment supplier. In addition to the US Federal Regulations, the Departments of Health of some states have specific requirements for dairy processing equipment (Clark 1997). Problems arise when equipment used in a less regulated industry is applied to highly regulated food industries, like meat and poultry.



In addition to the hygienic design of food contacting surfaces, process equipment should be designed to protect from external contamination (e.g., covers for processing equipment, proper drainage of the outside surfaces).

In the European Union, certain general rules apply to the hygienic design of food processing equipment, in addition to the regulations of the individual member countries. European Council Directive 89/109/EEC of 22 December 1988 specifies the materials and articles that may come into contact with foods.

A review of the European regulations for hygienic design in food processing, with emphasis on milk, was presented by Grasshoff (1992). The European Hygienic Equipment Design Group (EHEDG) is developing guidelines and test methods for food processing equipment. A series of related technical articles was published by EHEDG (1997).

The design of modern food processing equipment should be based on databases of hygienic requirements and regulatory standards. Special attention should be given to the sealing spots of moving parts, e.g., rotating and reciprocating shafts, where microbial contamination is possible (Hauser 1992). Developments in hygienic design of food processing equipment and food plants in Europe are presented in the annual meetings of EHEDG (2001).

The EU “Machinery Directives” (e.g., 89/392 and 91/368) specify that food processing machinery must be designed and constructed as to avoid any risk of infection and sickness. EU documents, such as CEN/TC 153 (CEN, European Standardization Committee; TC, Technical Committee), specify machinery, safety, and hygienic requirements for various food industries. The standard CEN 1672-2 concerns food machinery, safety, and hygienic requirements.

The specific requirements for the dairy industry are very strict, which are not practically feasible for some other industries, e.g., baking. The European food industry has, in general, adopted the US 3-A standards within the framework of the standards being developed by the EHEDG.

Other specifications used in the food industry are the DIN requirements for fittings, the bulletins of the International Dairy Foundation (IDF), and the British Standards BS 5750. “CE” (Conformite Europeenne/Provisional European Norm) is used as evidence of compliance (Table 2.2).

A number of guidelines have been published by EHEDG, which are voluntary and complementary to the corresponding national and international hygienic standards. The EHEDG guidelines include the following:

- Microbiologically safe continuous pasteurization of liquid foods
- A method for assessing the in-place cleanability of food processing equipment
- Microbiologically safe aseptic packing of food products
- A method for the assessment of in-line pasteurization of food processing equipment
- A method for the assessment of in-line steam sterilizability of food processing equipment
- The microbiologically safe continuous flow thermal sterilization of liquid foods

**Table 2.2** Some European CEN specifications for food equipment

Document	Title: food processing machinery—safety and hygiene requirements
prEN 453	Dough mixers
prEN 1673	Rotary baking ovens
prEN 1674	Dough and pastry
prEN 1678	Vegetable cutting machines
prEN 12041	Molders
prEN 12331	Mincing machinery
prEN 12505	Centrifugals for processing edible oils and fats
prEN 12852	Food processors and blenders
prEN 13389	Mixers with horizontal shafts

*prEN* provisional European Norm

- The EC (European Community) Machinery Directive and food processing equipment
- A method for the assessment of bacterial tightness of food processing equipment
- Hygienic equipment design criteria
- Welding stainless steel to meet hygienic requirements
- Hygienic design of closed equipment for the processing of liquid food
- The continuous and semicontinuous flow thermal treatment of particulate foods
- Hygienic design of valves for food processing

The need for thorough hygienic design and operation of the entire food processing line is very important in food processing: A weak link in the processing line can nullify the whole hygienic operation.

### 2.5.2 *Cleaning of Food Equipment*

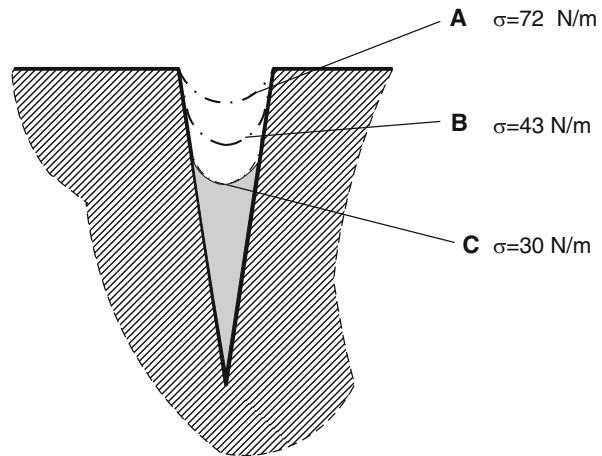
The principles of cleaning, rinsing, and sanitizing of food processing equipment are discussed by Loncin and Merson (1980), Schomick and Thor (1976), and Kessler (1981). Cleaning and sanitation should be considered an integral part of food process design and food processing operations (Plett 1992).

The food processing equipment should be designed to facilitate the removal and draining of all of the process effluents (steam condensate, waste solids, e.g., peels). All dead ends in tanks, containers, and piping should be eliminated.

Fouling is particularly important in heat exchangers and other installations involving fluid flow (e.g., tubes, filters, cyclones). Empirical models have been suggested to describe heat-induced fouling and its relationship to the overall heat transfer coefficient ( $U$ ) and the pressure drop ( $\Delta P$ ) (Fryer 1997).

The food processing equipment must be cleaned easily either by quick dismantling and cleaning of the parts or by cleaning-in-place (CIP) techniques. The equipment of small food processing plants is usually cleaned by periodic

**Fig. 2.7** Influence of surface-active substances in cleaning process (Thor and Schornik 1978). A water, B beer, C detergent with surface-active substances



dismantling of the principal units, such as pumps, plate heat exchangers, and filters. Quick dismantling and reassembling of process piping is facilitated by various hand-opening clumps.

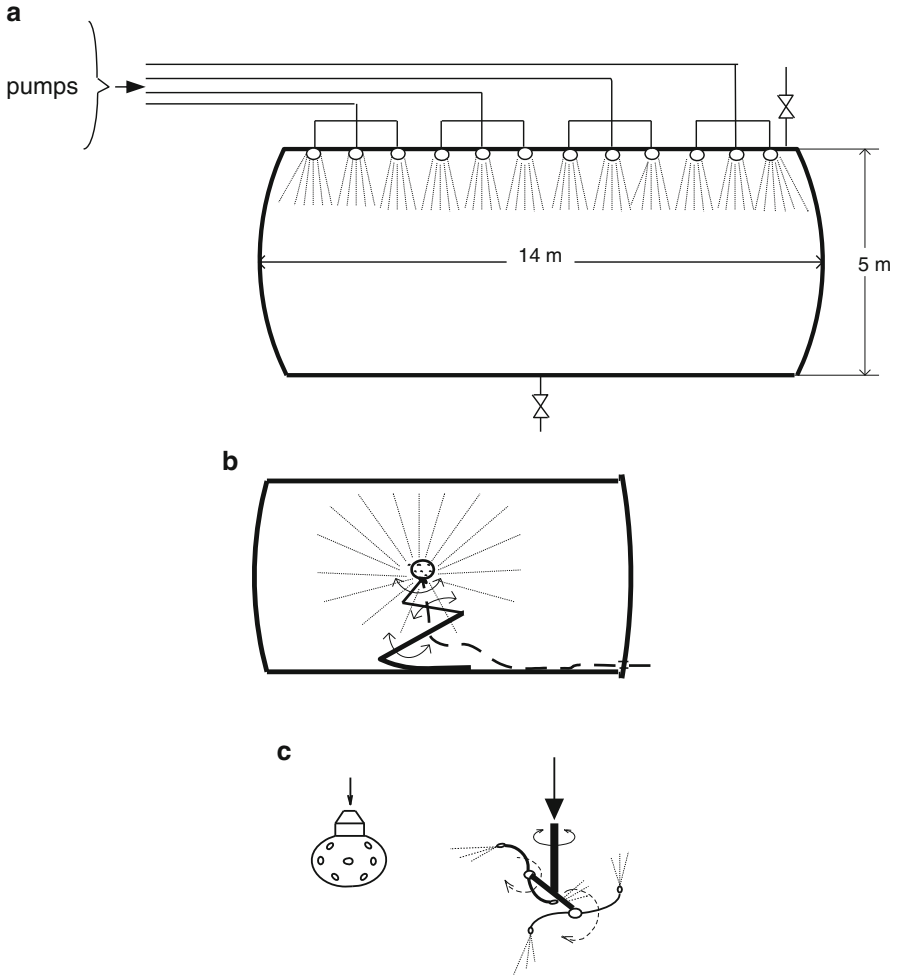
The design and installation of CIP systems in large food processing plants requires specialized experience in pipe flow, sanitation, processing operations, and process control (Jowitt 1980; Seiberling 1997).

The CIP system involves the following sequential operations: (1) prerinsing with cold (soft) water, (2) alkali wash (supplemented with sodium hypochlorite), (3) intermediate water rinse, (4) acid rinse, (5) final water rinse, and (6) rinse with sanitizing solution (sodium hypochlorite) or flushing with hot (90 °C) water.

The CIP system is essentially a chemical cleaning operation, in which the chemical solution is brought into intimate contact with all soiled surfaces. Addition of surface-active substances, reducing substantially the surface tension of water, facilitates the penetration of water and aqueous cleaning solutions into crevices of the equipment. Figure 2.7 indicates the influence of the surface tension of cleaning fluids, with respect to their penetration in narrow gaps.

The required tanks, pumps, pipes, valves, and heaters (heat exchangers or steam injection devices) are used as either single-use or reuse (recirculation) systems. In large continuously operated units, double seat valves enable the cleaning of a part of the processing equipment, while other processing areas continue production. Air-operated piston or diaphragm-type pumps are used to feed the chemical solutions. For safety reasons, the pumps and the chemical supply containers are enclosed in a separate compartment of the processing plant.

Ball spray or rotating nozzles are commonly used to clean process and storage tanks. Detailed description about the type of nozzles and their capacity in relation to



**Fig. 2.8** CIP installation (a) Steady nozzles, (b) portable nozzle, (c) types of nozzles

cleaning processes is given by Kessler (1981) and Loncin (1961). Figure 2.8c indicates a ball nozzle and a device with rotating nozzles. Cylindrical and rectangular tanks are cleaned using liquid feed rates of 8–12 L/min m<sup>2</sup> internal surface, while vertical silos require liquid rates of 25–35 L/min m tank circumference. The fluid pressure in cleaning varies according to the dimensions of the tank/equipment, the surface it has to be cleaned, the product it was processed or stored, and the kind of processing before cleaning. Usually this is  $3 \times 10^5$  to  $5 \times 10^5$  P. Ball or other spray devices are common in CIP installations (Fig. 2.8a). The ball nozzles vary according to the type, number, and position of their holes. In larger installations, the nozzles are usually fixed ball spraying devices. In smaller tanks, portable spraying installations are applied (Fig. 2.8b). In larger continuously operating installations,

double seat valves are used, which allow cleaning of a single part of the plant while other areas continue processing. The fluid pressure leaving the nozzles depends on the equipment that has to be cleaned. It is usually  $3.5 \times 10^5$  P. Adequate inclination (slope) of piping and process vessels is essential for self-draining of process and cleaning liquids.

Special CIP systems are applied to dry food processing equipment, such as conveyors (belt, screw, pneumatic), dryers (e.g., spray, rotary), and dry food processing lines (e.g., cereals) (Seiberling 1997).

Usually, food equipment must be cleaned daily, after a processing period. However, when different products are processed in the same equipment, cleaning also depends on the frequency of product changes. If CIP is applied, the required valves and automation must also be reliable.

Cleaning and rinsing of equipment is difficult for very viscous fluid or semisolid foods, like cream, yogurt, and fruit pulps. A cleaning system, used in the oil and chemical industries (pigging), has been suggested for cleaning such difficult food pipes. A plug (pig) of food-grade flexible material containing a magnet is forced through the pipeline, removing the viscous material, before flushing with water and applying the CIP system.

Effective CIP requires automation of the whole system. Microprocessor controllers (PLC) are used in connection with on-line sensors for temperature, level, flow rate, pressure, and valve position (Grasshoff 1992). The concentration of cleaning agents and organic effluents can be measured with pH meters, redox potential meters, and optical density meters. The degree of surface contamination can be determined by pressure drop measurements in the pipeline.

## **2.6 Selection of Food Processing Equipment**

### ***2.6.1 Selection of Equipment***

The selection of food processing equipment is based on the suitability for the intended application, the constructional and operational characteristics of the equipment, and the purchase and maintenance costs.

#### **2.6.1.1 Construction Characteristics**

In selecting food processing equipment, the following construction characteristics should be considered: dimensions/weight, cleanability, maintenance, standardization of spare parts, quality of materials, strength/durability, and automation.

##### **Dimensions/Weight**

In plant design, the space occupied by the processing equipment and its weight must be taken into consideration. These factors are especially important in multistory

food plants, i.e., where equipment is installed on several floors. The dimensions of the equipment are also important in extension or replacement of existing food processing lines.

### Cleaning Facility

Food equipment is usually cleaned daily after processing, but if the equipment is used in processing different products (e.g., a mixer), it must be cleaned before switching to a new processing program. In this case, easy and quick dismantling and assembling is essential, and joints and connections requiring minimum labor are necessary. If CIP is used, the valves and automation of the system should be reliable and resistant to the cleaning chemicals.

### Maintenance

Special attention should be paid to the quality of equipment parts that are worn out quickly, e.g., brushes, screens, nozzles, bearings, seals, conveyor belts, knives, and equipment surfaces contacting flowing solids, e.g., grains. Equipment parts, requiring frequent maintenance, should have easy and quick access.

### Standardization of Spare Parts

Equipment constructed of a relatively large number of standardized common parts, requiring periodic replacement of a small number of spare parts, is preferable. The use of the same standardized parts, even in different equipment, reduces the logistic cost of spare parts. Standardization facilitates maintenance and repairs, and less expertise is needed.

### Quality of Materials

The appropriate quality of materials, used in equipment construction, is important for avoiding interaction with the food and for equipment stability. Quality factors for the materials are the total weight of equipment (heavier equipment is usually more robust), the quality of material workmanship (surface smoothness, type of welding), the quantity of relatively expensive materials used (e.g., stainless steel, Teflon, insulation), the antirust protection (e.g., double or electrolytic galvanization, special paints), and the quality of basic constructional elements, such as bearings and seals.

### Firmness/Durability

Food machines and equipment must be stable and firm (robust), especially when they are strained due to frequent assembling and dismantling for cleaning and maintenance or due to moving, e.g., in flexible manufacturing. Robustness is especially required in seasonal processing, during which large amounts of raw materials are processed in a relatively short time and a significant part of the personnel is unskilled.

### Automation

Automation is applied successfully when food processing is continuous, the output is high, the labor cost is significant, and the factory is located in regions where industrial infrastructure exists. However, automation increases the cost; the automated equipment is usually more sophisticated and, therefore, more delicate, requiring skilled personnel for adjustment and maintenance or repairs.

#### **2.6.1.2 Operational Characteristics**

The operational characteristics are features facilitating the operation of food processing equipment. In selecting processing equipment, the following requirements should be considered: reliability, convenience, safety, instrumentation, ergonomics, efficiency, effectiveness, accuracy, and environmental impact.

### Reliability

Since food is perishable, storage time is relatively short. Fresh products, such as fish, milk, fruits, and vegetables, must be processed as soon as possible. This presumes high capacity and reliability of processing equipment, and downtime and breaking down during processing should be prevented. Equipment of plant utilities, participating indirectly in manufacturing of food, such as steam generation, process water, electricity, and refrigeration units, must also be reliable. Reliability is also important in food factories delivering on the basis of “just-in-time” agreements. However, since even for the best machines, there are limits in reliability, it is advisable to always have machines ready to replace the broken-down ones. Certainly, in the production of large volumes of products, such as tomato paste or frozen food, it is not possible to have spare evaporators or freezers for replacement. However, spare units to replace more delicate machines and instrumentation, which are part of such large units, should be available (e.g., pumps, fans, compressors, sensors for quality control).

## Convenience

Convenience in operating equipment and machines is especially important in cases where the personnel are less skilled. As indicated by Kehoe (1989), the future growth of “middle management” in the factory may shrink due to restructuring, since much of the work formerly performed by supervisors and middle managers is now superfluous and the operation of machines is entrusted to less skilled individual workers.

## Safety

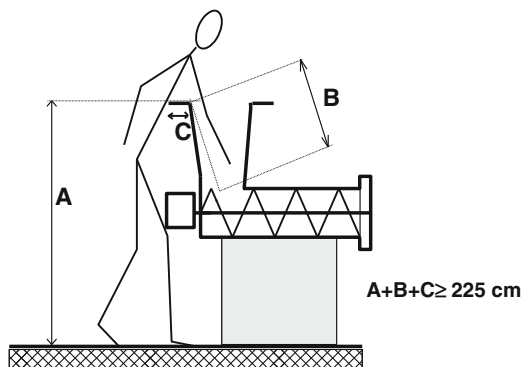
Special care must be devoted to protect personnel working with machines that have bare moving parts, such as cutting machines, fans, and milling and forming machines. In all cases, machine guarding to protect the operator and other employees in the machine area must be foreseen. The guarding measures may include constructional measures (Fig. 2.9), barrier guards, two-hand tipping devices, and electronic safe devices (e.g., automated stopping of machine in any human limb passes a certain limit of a safeguarded area).

Conveying, transportations inside of processing units, insufficient cleaning of processing installations, and proceedings of reparations are, according to the HSE, (Health and Safety Executive) UK, the major causes of accidents in food factories. Analytically the major injuries are due to the following causation (Table 2.3).

As indicated in Table 2.3, the majority of accidents are connected with food factory planning and manufacturing organization matters. With respect to food equipment used, meat processing accidents are often in the following branches:

- (a) Meat and fish processing (slicing, cutting/sawing, deboning, grinding, etc.)
- (b) Forming and packaging (wrapping, depositing and molding, bottling, thermoforming, etc.)
- (c) Moving machines including conveying (especially belt conveyors near personnel) and vehicles such as forklifts

**Fig. 2.9** Design measures protecting personnel in grinding machine





**Table 2.3** Causation of injury in food and drink manufacturing (2008–2009)

Causation	% of total accidents	Remarks
Manual handling	32	Lifting of heavy objects, etc.
Trips and slips	25	Mostly slips in wet and greasy floor
Hit by moving or falling objects	8	Overhead transportation, etc.
Moving machinery	8	Conveyors, robots, packaging machines etc.
Hit by moving vehicles	2	Especially forklifts
Totally	75	

A significant percentage of injuries are caused during reparation or manual cleaning of machines. Furthermore, measures must be undertaken to eliminate accidents that are due to fire, electric shock (e.g., electric accidents in connection to defective cables in a nasty environment) and explosion of dust material. Explosions may take place in mills, silos, and conveying of granular and powder food. Food industries and facilities in which most fire hazards are found are mills, edible oil manufacturing units, and storage of dry products.

With respect to explosions, the mixture of dust with air over certain analogies can cause explosion, or oil can easily burn out, if, e.g., some electric spark due to e-motors or friction between metal parts takes place. The concentration of food dust or powder that may give rise to explosions is low. For corn, it is  $73 \text{ g/m}^3$ , for wheat  $67 \text{ g/m}^3$ , for wheat starch  $30 \text{ g/m}^3$ , for rice starch  $60 \text{ g/m}^3$ , and for sugar  $30 \text{ g/m}^3$  (Hardex” Food Explosion in the Food Industry”).

With respect to fire, besides measures against oily effluents, the autoignition temperature of corn or fine foods in silos is important. For sugar, this is  $350 \text{ }^\circ\text{C}$ , for wheat  $480 \text{ }^\circ\text{C}$ , and for flour  $380 \text{ }^\circ\text{C}$ . Therefore, in cases such as in mills, silos, and conveying of granular and powder food, measures must be undertaken such as installing waterproof and not explosion-causing electric motors (V. van Amerom, Choose the right electric motors for hazardous locations, CEP, November 2011, [www.aioche.org/cep](http://www.aioche.org/cep)).

Some prescriptions for eliminating hazards due to electric motors are regulations and standards worked out by organizations such as OSHA (Occupational Safety and Health Administration) of the US Department of Labor and HSE (Health and Safety Executive in the UK) and prescriptions of standardized organizations such as CEN (the European Standardization Committee). Furthermore, there are also standards of national organizations of standardization such as the German DIN 40050 and the British BSEN 61241, the BSEN 1449 for systems preventing dust explosions, and the BSEN 14373 for explosion suppression devices and systems.

### Instrumentation

Food machines and equipment operate more efficiently when processing conditions are controlled continuously (Appendix C). This may require sophisticated instrumentation. The recent trend is, in addition to the usual indicating instruments, installed directly on the machines/equipment, to get all the process information on screens through computers. This also helps in developing CAD and CIM programs in food manufacturing. Optical weight instruments, for example, are very useful in combination with robots (see Sect. 12.6).

Equipment that can be fully automated through connection to computers may also be “telecontrolled” (operated from a distance), which is important in sophisticated continuous processing (e.g., edible oil manufacturing and milling) and in manufacturing of a number of special foods with the minimal possible contact of personnel with the products (e.g., baby foods).

### Ergonomics

Ergonomics (human engineering) is important in operation and maintenance of food processing equipment and machinery. In ergonomics, the relation between the dimensions/capabilities of the machines and the human dimensions/capabilities is important. Generally speaking, operation and repair of machines should require the minimal possible human effort (force). Furthermore, it should be noted that women usually have only two-thirds of the force of men. Human force depends on age and training. Correct ergonomics is also important in jobs in which constant human concentration is required, such as in several quality control tasks (e.g., working in a sorting machine, control of final packaging).

### Efficiency

A usual requirement of food processing equipment is that food processing should be accomplished in the shortest possible time. Long-time contact of the food with air, high temperature, humidity, and, in some cases, sun may reduce its quality (time-dependent microbial, enzymatic, and chemical changes of food). Processing may also reduce food quality. Thus, food quality increases the efficiency requirements of food processing equipment. Slight overdimensioning of processing units is useful.

### Effectiveness

In food manufacturing, the process requirements must be achieved, as in sterilization, where the preset time–temperature values must be reached. The same is also true for the case of drying, in which certain temperature–drying time conditions

must be applied, as well as the final product water activity. Chemical peeling of foods is another example of defined process conditions. Therefore, processing equipment must be operated effectively, especially in preservation processes.

### Accuracy

Many food processing operations do not require high accuracy in industrial practice. However, in most packaging operations (e.g., bottling), in weighing, and in confectionery processing, high accuracy is required. High accuracy is also required when robots are involved in food processing.

### Environmental Impact

“Environmentally friendly” machines and processing equipment are required mainly for legal reasons, but also for reducing the adverse effects on the health of people working in the food processing plant. Environmental burden includes equipment noise, odor, and effluents (water and air). Therefore, in selecting various machines and equipment for food plants, the requirements of equipment operation under environmental constraints must be met. The noise when personnel is working several hours per day near chutes, noise of equipment conveying and filling cans and bottles, as well as noise due to a large number of water jet cutting instruments (Chap. 4) are examples requiring hearing protection of the employees, as they may exceed 80 dB. Detailed protective measures against noise are described by HSE (series code L108, ISBN 978 0 7176 6164) (see also Sect. 2.6).

## 2.6.2 Testing of Equipment

Standard equipment is normally guaranteed by the manufacturers/suppliers and usually needs no testing of its performance before installation in the food processing plant. However, novel or complex equipment may need some form of testing, either in the pilot plant (small units) or in the processing plant. Testing procedures for various process equipment have been published by the American Institute of Chemical Engineers (AIChE 1960–1990). The following process equipment is covered: centrifugal pumps, rotary positive displacement pumps, centrifuges, evaporators, dryers, continuous direct heat dryers, heat exchangers, particle size classifiers, batch pressure filters, mixing equipment (impeller type), solids mixing equipment, paste and dough mixing equipment, and plate distillation columns.

As an example, the testing of a rotary positive displacement pump (Newtonian fluids) involves the following: definitions and description of terms (density, viscosity, Reynolds number, pressure drop, capacity, power, efficiency); instruments and

methods of measurement; test procedure, test conditions, test data, and performance criteria; acceptance test; computation and interpretation of results; performance characteristics (power, capacity, efficiency versus total pressure drop).

### 2.6.3 *Equipment Specifications*

Lists of equipment suppliers are given in Appendix E of this book. “Off-the-shelf” standard equipment, such as pumps, tanks, heat exchangers, and centrifuges, can be supplied from the stocks of equipment manufacturers. Specialized equipment may have to be fabricated by experienced manufacturers at a higher cost.

Equipment specification forms for various types of processing equipment are given by Walas (1988). Equipment forms, related to food processing equipment, include the following: pumps, fans, vacuum pumps, electric motors, heat exchangers, boilers, evaporators, packaged refrigeration systems, filter presses, centrifuges, screens, distillation columns, and process vessels.

The specification forms contain information on the type and properties of the product, the flow rate (capacity) and operating conditions (temperature, pressure), and other characteristic data. Several independent quotations of new equipment should be obtained from different manufacturers. Too strict specifications may significantly increase the cost of equipment. In some cases, secondhand equipment may be purchased, reducing the investment cost of the food plant.

Typical questionnaires of suppliers of processing equipment, given by Walas (1988), include information on dryers, mixers, distillation and extraction equipment, evaporators, and so on. For example, a dryer questionnaire should contain information on the type of product, capacity (kg/h), moisture content, particle size, bulk density, thermophysical properties, ambient air conditions, and materials of construction.

*Example 2.1* Estimate the cost of the main equipment used in the orange processing plant of Example 1.1 and shown in Figs. 1.4 and 1.5. The plant processes 20 t/h of oranges, with the following products: (1) 1032 kg/h of aseptically packed frozen orange juice concentrate 65 °Brix, (2) 460 kg/h of canned frozen orange juice concentrate 42 °Brix, (3) 1800 kg/h of aseptically packaged orange juice 12 °Brix in cartons, (4) 1660 kg/h of dried orange peels/pulp, (5) 60 kg/h of peel oil, and (6) 40 kg/h of fruit essence.

#### **Analytical Sizing of Equipment**

The following major equipments of the orange processing plant were sized analytically in the numerical examples 3.1, 6.1, 7.1, and 8.1 of this book:

- Pump (Example 3.1): a centrifugal pump for transferring 9000 kg/h of orange juice 12 °Brix through the pasteurizer, pressure drop 2 bar, and power 1 kW.
- Plate heat exchanger (Example 6.1): for the regeneration and heating sections of the pasteurizer (90 °C for 15 s). Flow rate of juice 9000 kg/h, heat transfer area

- 8.04 and 2.8 m<sup>2</sup>, and number of plates (1.60 m × 0.60 m) 10 and 4, for the regeneration and heating sections, respectively. In addition, the cooling section of the pasteurizer is estimated to require 2.8 m<sup>2</sup> heat transfer surface and 4 plates.
- Evaporator (Example 7.1): a three-effect falling film evaporator for concentrating 7000 kg/h of orange juice from 12 to 65 °Brix, using steam heating of the first effect at 110 °C. Evaporation rate, 5708 kg/h. Temperature of the first effect, 95 °C; the second, 81 °C; and the last, 50 °C. Heating surface of each effect, 60 m<sup>2</sup>, and total surface, 3 × 60 = 180 m<sup>2</sup>.
  - Dryer (Example 8.1): a rotary air-dryer for the dehydration of 9940 kg/h of orange peels and pulp from 85 to 10 % moisture content, producing 1656 kg/h of dried animal feed. Water evaporated, 8284 kg/h. Dryer dimensions, 2.4 m diameter × 14 m length, with a volume of 86.2 m<sup>3</sup> and wall surface 123 m<sup>2</sup>.

### Approximate Sizing of Equipment

The following processing equipment of the orange processing plant were sized approximately on the basis of their capacity, using data from the material and energy balances of Example 1.1: (1) orange washer of 20 t/h capacity; (2) orange inspection belt, 20 t/h; (3) orange grader/sizer, 20 t/h; (4) FMC juice extractors of 4 t/h orange capacity each or Brown juice extractors of 10 t/h orange capacity each (Kimball 1999; Nagy et al. 1993); (5) juice finisher of 10 t/h capacity; (6) centrifuge decanter for the juice, 10 t/h; (7) high-speed centrifuge for the peel oil, 10 t/h liquid; (8) distillation column (essence recovery unit) for feed 1900 kg/h and distillate (essence) 40 kg/h, with essence concentration ratio 1/47.5; (9) ion exchange columns for debittering 2000 kg/h orange juice; (10) storage/surge juice tanks of 2 m<sup>3</sup> capacity; (11) centrifugal pumps of 10 t/h capacity, 2-bar pressure head, and 1 kW power (in addition to the pasteurizer pump) and positive displacement pumps of 2 t/h capacity, 2-bar pressure head, and 1 kW power; (12) scraped surface freezer for 1 t/h orange juice concentrate 65 °Brix; (13) freezing tunnel for freezing 500 kg/h of orange juice concentrate 42 °Brix in small aluminum cans; (14) aseptic packaging line for single-strength orange juice in 1-L cartons; (15) can closing machine for aluminum 1000 cans/h; and (16) aseptic packaging unit for frozen concentrate 65 °Brix in plastic-lined drums.

### Cost of the Processing Equipment

The approximate cost of the main processing equipment of the orange processing plant is estimated using cost charts and indices found in the literature (Chilton 1960; Bartholomai 1987; Peters and Timmerhaus 1990; Kostaropoulos and Saravacos 1997) and cost quotations from equipment suppliers.

The cost data in Table 2.4 are expressed in USD (US dollars, \$), converted to year 2000 values, using the M&S index (Fig. 1.2).

### Fixed Capital

The total cost or the fixed capital (FC) of the processing plant can be estimated on the basis of the purchased cost of the main food processing equipment (CE). In general, the cost of food processing equipment, as a percentage of the fixed cost (FC), is higher than the cost of chemical processing equipment. FC includes the

**Table 2.4** Cost analysis of orange processing plant

Processing equipment		Cost, USD
Orange washing machine, 20 t/h	1	75,000
Orange inspection belt, 20 t/h	1	15,000
Orange grader/sizer, 20 t/h	1	50,000
Juice extractors FMC, 5 t/h	5 × 5 000	25,000
Juice finisher	1	50,000
Juice filtering centrifuge decanter, 10 t/h	1	50,000
Pumps 10 t/h, 2 bar, 1 kW—centrifugal	3 × 5 000	15,000
Positive displacement	2 × 5 000	10,000
Juice plate pasteurizer, 10 t/h	1	50,000
Juice sterilizer, 1800 kg/h, 12 plates 1.00 × 0.30	1	40,000
Ion exchange debittering for 2 t/h OJ	1	150,000
Evaporator (3 effects), evap. capacity 6 t/h, 180 m <sup>2</sup>	1	350,000
Distillation (essence) column, 1900 kg/h feed	1	150,000
Rotary dryer, 2.8 m × 14 m, 8.5 t/h evaporation	1	350,000
Scraped surface freezer, 1 t/h COJ 65 °Brix	1	80,000
Freezing tunnel, 400 kg/h canned COJ 42 °Brix	1	200,000
Aseptic packaging 2000 cartons/h (1 L) OJ 12 °Brix	1	200,000
Can closing machine, 1000 cans/min	1	100,000
Aseptic bulk packing, lined drums 2 t/h	1	60,000
Oil centrifugal separator, 10 t/h water emulsion	1	30,000
Total purchased cost of process equipment		(CE) = 2,050,000 USD

costs of equipment installation, piping, buildings and construction, electrical, instrumentation and control, engineering fees, and contingency (Table 1.2).

FC is related to CE by the empirical equation (1–2):  $FC = f_L CE$ , where the Lang factor ( $f_L$ ) can be taken as equal to 2.0 for food processing equipment (Chap. 1). A similar factor is suggested by Bartholomai (1987) (Chap. 1). Thus, the fixed capital of the orange processing plant will be

$$FC = 2.0 \times 2,050,000 = 4,100,000 \text{ USD}$$

**Note:** Solids waste treatment/disposal equipment may be required if the peel and pulp waste is not dehydrated and sold for animal feed. The pollution load of the wastewater is not heavy, and disposal to a local waste treatment plant may be preferable than building a medium-sized biological oxidation unit. No significant air pollution is expected from such a plant.

### Operating Cost/Economic Analysis

The economic analysis of the orange processing plants requires some cost data and calculations, as outlined in Chap. 1. The required data include the depreciation of the fixed capital and the costs of the raw material, labor, and utilities. In this

example, the cost of oranges is the most important cost component, amounting to about 70 % (Moresi 1984). This cost can vary widely, due to weather conditions (e.g., frosting) and agricultural policy/price support of the local government.

## 2.7 Directories of Equipment

Lists of manufacturers and suppliers of specific food processing equipment are given in Appendix E.

### 2.7.1 *Directories of Food Equipment*

ALRAD Equipment Corp. <http://www.alrad-equipment.com> Information on secondhand food machinery.

Bread Machinery Industry Association, <http://www.breadmachine.org> Information on bread machinery manufacturers and selection procedures.

CE. 1999. Chemical Engineering Equipment Buyers Guide. Chemical Engineering Magazine, McGraw–Hill, New York.

DECHEMA. Gesellschaft fuer Chem. Technik und Biotechnologie e.V. <http://www.dechema.de>

DFISA. 1995. Membership Directory of Products and Services. Dairy and Food Industry Supply Association, Inc., Rockville, MD. Worldwide list of companies manufacturing chemical industry machines, including food processing. List of companies participating inACHEMA Exhibition.

FDA, U.S. Department of Health and Human Services. Public Health Service. <http://vm.cfsan.fda.gov> Information on food equipment, construction materials, and manufacturing lines. GMPs.

FP. 2000. Food Processors' Resource. Equipment and Supplies. Food Processing Magazine, Putman Publ., Chicago.

FPM&SA. 1996. Blue Book of Buyers Guide. Food Processing Machinery & Suppliers Association, Alexandria, VA.

GMV, Holland Manufacturers of Machinery for Food Processing Industry. <http://www.fme.nl> Information on Dutch manufacturers of food machinery.

IAFST, International Association of Food Industries Suppliers (IAFIS). <http://www.iafis.org> Information on food industry suppliers, standards, and regulations (safety, hygienic, environment).

IFT. 2001. Classified Services to Food Industry Services. Institute of Food Technologists, Chicago [www.ift.org](http://www.ift.org)

IMT, Italian Machinery Technology, <http://www.ime.it> Information on Italian food machinery.

JFMMA. 1992. General Catalogue for Food Machinery in Japan. Japan Food Machinery Manufacturers Association, Tokyo.

National Food Processors Association (NFPA), <http://www.fpi-food.org> Information on food processing.

NSW Meat Industry Authority, <http://www.meat.nsw.gov.au> Standards for construction and hygienic operation of retail meat premises.

PPMA. Processing and Packaging Machinery Association, <http://www.ppma.co.uk> Information on processing machinery in the UK market. Classification of machines.

TAMI. 1995. Machinery for the Food and Beverage Industries. Taiwan Association of Machinery Industry, Taipei.

TEMA. Tubular Manufacturers Association Inc. <http://www.tema.org> Standards on tubular heat exchangers.

VDMA, German Machinery and Plant Manufacturers Association. <http://www.vdma.org> German machinery for food processing.

### **2.7.2 Exhibitions of Food Equipment**

ACHEMA, Exhibition–Congress, Chemical Engineering, Environmental Protection, and Biotechnology, Frankfurt, Germany

Anuga FoodTec, FoodTec Exhibition, Cologne, Germany

Food and Dairy Expo, Chicago, Illinois, USA

Food Hygiene Europe, Exhibition and Conference, EMAP Business Communications, Maarssen, The Netherlands

GIA, SIAL, MATIC, Food Manufacturing Exhibition, Paris, France

IFT Annual Meetings, USA

Interpack, International Fair Packaging Machinery, Packaging Confectionery Machinery, Dusseldorf, Germany

Parma Food Fair, Food Processing Equipment Exhibition, Parma, Italy

## **References**

AICHe (1960–1990) Equipment testing procedures. American Institute of Chemical Engineers, New York

Bartholomai A (1987) Food factories—process equipment costs. VCH, Weinheim

Brennan JC, Butters JR, Cowell NP, Lilly AEY (1990) Food engineering operations, 3rd edn. Applied Science, London

Cardarelli E (2000) Materials handbook: a concise desktop reference. Springer, Berlin

Chilton CH (1960) Cost engineering in the process industries. McGraw–Hill, New York

Clark JP (1997) Design of equipment for legal constraints. Paper presented at the annual IFT 97 meeting, Orlando, FL

Curiel GC (2001) Future requirements in the hygienic design of food factories. Paper presented at the symposium *Food Factories of the Future*, SIK–Swedish Institute of Food Preservation, Gothenburg, Sweden

EHEDG (1997) Guidelines and test methods. Trends Food Sci Technol



- EHEDG (European Hygienic Equipment Design Group) Secretariat: Campden Food and Drink Research Association. Chipping Campden, Gloucestershire, GL55 6LD, England
- EHEDG (2001) Food in Europe: building in safety. In: 11th EHEDG annual meeting, Valencia, Spain
- Fryer PJ (1997) Thermal treatment of foods. In: Fryer PJ, Pyle RL, RIELLY CD (eds) Chemical engineering for the food industry. Blackie Academic and Professional, New York, pp 331–382
- Gould WA (1994) Current GMP's in food plant sanitation. CTI, Timonium
- Grasshoff A (1992) Hygienic design. The basis for computer controlled automation. In: Food engineering in a computer climate. ICHEME, Taylor & Francis, London, pp 89–103
- Grassuck J, Houben KW, Zollinger RM (1994) DIN-Normen in der Verfahrstechnik. B.G. Teubner, Stuttgart
- Hall RS, Vatauvuk WM, Matthey J (1988) Estimating process equipment costs. Chem Eng 66–75
- Hauser G (1992) Hygienic design of moving parts of machines in the food industry. In: Food engineering in a computer climate, ICHEME, London, pp 1–12
- HSE (Series Code L108, ISBN 978 0 7176 6164)
- IAMFES (1988) International Association of Milk, Food, and Environmental Sanitarians, Ames
- Imholte TJ (1984) Engineering for food safety and sanitation: a guide to the sanitary design of food plant and food plant equipment. Technical Institute for Food Safety, Crystal
- Jowitt R (1980) Hygienic design and operation of food plant. Ellis Horwood, Chichester
- Kehoe PJ (1989) Will today's workers be able to operate tomorrow's factories? Paper presented at the 4th international conference on designing and engineering new food plants, renovations and expansions. *Food Plants '89*. Food Plant Strategies Inc., West Chester
- Kessler HG (1981) Food engineering and dairy technology. A. Kessler Verlag, Freising
- Kessler HG, Lund DB (1989) Fouling and cleaning in food processing. Druckerei Walch, Augsburg
- Kimball DA (1999) Citrus processing, 2nd edn. Aspen, Gaithersburg
- Kopp R, Gerhold E (1977) Reinigung und Desinfektion in der Lebensmittelbetrieben. Z Lebensmittel Technol Verfahrenstechnik 5:157–163
- Kostaropoulos AE, Saravacos GD (1995) Processing equipment and food quality. In: Charalambous G (ed) Food flavors: generation, analysis and process influence. Elsevier Science, London, pp 1043–1055
- Kostaropoulos AE, Saravacos GD (1997) Cost estimation of food processing equipment. Paper presented at the annual IFT meeting, Orlando, FL
- Kutsuyama AM (1993) Principles of food processing sanitation. Food Processors Institute, Washington, DC
- Loncin M (1969) Principles of process technology in the food industry [in German]. Sauerlander, Aarau
- Loncin M, Merson RL (1980) Food engineering. Academic, New York
- Moresi M (1984) Economic study of concentrated citrus juice production. In: McKenna B (ed) Engineering and food, vol 2. Elsevier Applied Science, London, pp 975–991
- Murray GT (1999) Handbook of materials selection for engineering applications. Marcel Dekker, New York
- Nagy S, Chen CS, Shaw PE (1993) Fruit juice processing technology. Agscience Inc., Auburndale
- Perry RH, Green DW (1997) Perry's chemical engineers, handbook, 7th edn. McGraw-Hill, New York
- Peters MS, Timmerhaus KD (1990) Plant design and economics for chemical engineers, 4th edn. McGraw-Hill, New York
- Plett E (1992) Cleaning and sanitation. In: Heldman DR, Lund DB (eds) Handbook of food engineering. Marcel Dekker, New York, pp 719–740
- Rahman S (1995) Food properties handbook. CRC, New York
- Rao MA (1992) Transport and storage of food products. In: Heldman DR, Lund DB (eds) Handbook of food engineering. Marcel Dekker, New York, pp 199–246
- Rao MA, Rizvi SSH (eds) (1995) Engineering properties of foods. Marcel Dekker, New York

- Sandler HJ, Luckiewicz ET (1987) Practical process engineering. McGraw-Hill, New York
- Saravacos GD, Maroulis ZB (2001) Transport properties of foods. Marcel Dekker, New York
- Schimpke P (1959) Technologie der Maschinebaustoffe, 15th edn. Verlag S. Hirzel, Stuttgart
- Schomick G, Thor W (1976) Aspekte der Reinigung und Desinfektion in der Lebensmittelindustrie. *Z Lebensm Technol Verfahrenstechnik* 8:225–228
- Seiberling DA (1997) CIP sanitary process design. In: Valentas KJ, Rotsterin E, Singh RP (eds) Handbook of food engineering practice. CRC, New York, pp 559–666
- Sinnott RK (1996) Chemical process design. In: Coulson JM, Richardson JF (eds) Chemical engineering, vol 6. Butterworths–Heinemann, London
- Tannine AY, Law BA (2001) Mechanization and automation in dairy technology. CRC, Boca Raton
- Thor W, Schornik G (1978) Reinigen, Desinfizieren, Nachspülen. In: Loncin M (ed) Hochschule Kurs: Ausgewählte Themen der Modernen Lebensmittel Verfahrenstechnik. Universität Karlsruhe, Karlsruhe
- Troller JA (1993) Sanitation in food processing, 2nd edn. Academic, New York
- Ullmann (1973) Enzyklopaedie der technische chemie, vol 3. Verlag Chemie, Weinheim
- Walas SM (1988) Chemical process equipment. Butterworths, London

# Chapter 3

## Mechanical Transport and Storage Equipment

### 3.1 Introduction

Mechanical transport of food materials may be divided into fluid and solid transport. The mechanical transport of air, gases, and vapors is carried out by fans, blowers, compressors, vacuum pumps, and ejectors, which are discussed briefly in Appendix D (Utilities). For the transport of liquids, semifluids, and suspensions, pumps are used. The transport of fluid foods by pumping in process pipelines is a well-developed technology, based on the theory of fluid mechanics, and applied extensively in the chemical process industries (Perry and Green 1997). The mechanical transport equipment is often used in combination with other food processing equipment, such as heating and cooling of water, air or steam, and fluidization and transport of particles.

The transport of solid foods in suspension (hydraulic and pneumatic transport) is based partly on theory and partly on practical experience. Mechanical transport in conveyors is mostly empirical, based on experience, taking into consideration the physical/mechanical properties of the food materials. Furthermore, in transport of bulk or packed products, mobile vehicles and cranes may be used (see vii, page 109).

Storage equipment is used extensively for liquid, semifluid, and solid food materials. The design and construction of food storage equipment is based on practical experience and economic materials of construction, taking into consideration the sensitivity of food quality to temperature and environmental conditions and the strict public health requirements for food products.

## 3.2 Mechanical Transport Equipment

### 3.2.1 Fluid Food Transport Equipment

The transport of fluid foods (liquids, emulsions, suspensions of particles, pulps) requires special mechanical equipment, like pumps, pipes, valves, and fittings. In addition to the mechanical and engineering aspects, the food handling equipment must meet the strict hygienic (sanitary) requirements, which will insure the quality and safety of the processed food products. The nature (composition) of the liquid must also be considered, avoiding damage or disintegration (e.g., fat separation in milk).

#### 3.2.1.1 Rheological Properties

The design of fluid piping and pumping systems requires rheological (viscometric) data for the food materials being transported (Steffe and Rao 1992; Steffe and Singh 1997; Rao 1999; Saravacos and Maroulis 2001).

For Newtonian fluids, the viscosity  $\eta$  (Pa s) is constant, i.e., independent of the shear rate  $\gamma$  ( $\text{s}^{-1}$ ), according to the Newton equation of fluid flow:

$$\tau = \eta\gamma \quad (3.1)$$

where  $\tau$  is the shear stress (Pa).

Most food fluids are non-Newtonian materials, for which the shear stress is a nonlinear function of shear rate. For time-independent fluid foods, the following models are commonly used:

$$\text{Bingham plastic: } \tau = \tau_0 + \eta\gamma \quad (3.2)$$

$$\text{Power law: } \tau = K\gamma^n \quad (3.3)$$

$$\text{Herschel-Bulkley: } \tau = \tau_0 + K\gamma^n \quad (3.4)$$

where  $\tau_0$  (Pa) is the yield stress,  $K$  ( $\text{Pa s}^n$ ) is the consistency coefficient, and  $n$  (–) is the flow behavior index of the fluid material. The Herschel–Bulkley model is also known as the generalized Bingham fluid or the yield-power-law model.

Table 3.1 shows some examples of rheological categories of Newtonian and non-Newtonian foods. Pseudoplastic, dilatant, and Bingham-plastic foods are time-independent materials, i.e., their rheological properties (constants) are not affected by the time of shearing. Thixotropic (time-thinning) and rheopectic (time-thickening) materials are time-dependent non-Newtonian materials.

The rheological constants ( $\tau_0$ ,  $K$ , and  $n$ ) are determined from experimental plots of rheological data  $\log(\tau)$  versus  $\log(\gamma)$ .

**Table 3.1** Examples of rheological categories of foods

Rheological category	Food material
Newtonian food	Water, vegetable oil, honey
<i>Non-Newtonian food</i>	
Pseudoplastic	Concentrated juice, pulp, milk
Dilatant	Dough
Thixotropic	Ketchup
Rheopectic	Mayonnaise
Bingham plastic	Jellies

For laminar flow in a circular pipe of internal diameter ( $d$ ) and length ( $L$ ), the Newton equation (3.1) is equivalent to the Poiseuille equation:

$$(d\Delta P/4L) = \eta(8u/d) \quad (3.5)$$

where  $u$  (m/s) is the mean velocity of the fluid.

Thus, in a pipe, the shear rate of Newtonian fluids can be calculated from the relationships

$$\gamma = (8u/d) = (32Q/\pi d^3) = (32m/\pi\rho d^3) \quad (3.6)$$

where  $Q$  ( $\text{m}^3/\text{s}$ ) is the volumetric flow rate,  $m$  (kg/s) is the mass flow rate, and  $\rho$  ( $\text{kg}/\text{m}^3$ ) is the density of the fluid.

By comparing (3.1) and (3.6), it follows that the shear stress at the wall in pipe flow becomes

$$\tau_w = (d\Delta P/4L) \quad (3.7)$$

In non-Newtonian fluids, the shear rate can be calculated from the Rabinowitsch–Mooney equation (Holland and Bragg 1995):

$$\gamma = (8u/d) = [3/4 + d \ln(8u/d) 4d \ln \tau_w] \quad (3.8)$$

The correction factor (in brackets) of (3.8) can be estimated graphically from a plot of experimental flow data ( $\Delta P$ ,  $Q$ ), converted to ( $\tau_w$ ,  $\gamma$ ), using (3.6) and (3.7).

The Reynolds number ( $Re$ ) in pipe flow for Newtonian fluids is given by the equation

$$Re = (dup)/\eta \quad (3.9)$$

The generalized  $Re$  number for non-Newtonian fluids is estimated from the equation (Steffe and Singh 1997):

$$Re = [(d^n u^{2-n} \rho)/(8^{n-1} K)] [(4n)/(3n + 1)] \quad (3.10)$$

An alternative method of calculation of the  $Re$  for non-Newtonian fluids is to estimate the apparent viscosity ( $\eta_a$ ) from (3.11) and use it in (3.9):

$$\eta_a = K\gamma^{n-1} \quad (3.11)$$

Most fluid foods are pseudoplastic ( $n < 1$ ), and their apparent viscosity ( $\eta_a$ ) decreases as the shear rate ( $\gamma$ ) is increased (shear-thinning materials). Very few fluid foods are dilatant ( $n > 1$ ).

Temperature has a negative exponential effect (Arrhenius) on  $\eta$ ,  $K$ , and  $\eta_a$ , while concentration ( $C$ , kg/m<sup>3</sup>) has an exponential positive effect, according to equation (Saravacos and Maroulis 2001)

$$\eta = \eta_0 \exp[(E_a/RT) + BC] \quad (3.12)$$

where  $E_a$  (kJ/mol) is the activation energy for flow,  $T$  is the absolute temperature, and  $B$  is a constant.

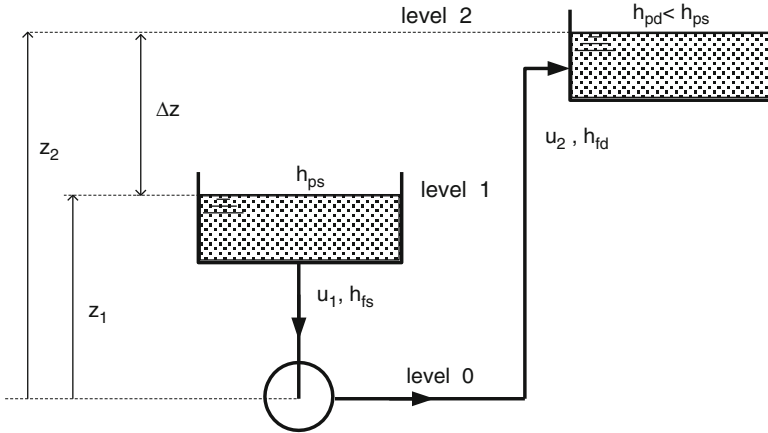
Concentration has a small negative effect on the flow behavior index, while temperature has a negligible effect. In general, clear juices and food fluids have a high activation energy (about 60 kJ/mol), while food suspensions and pulps have low ( $E_a$ ) values, even below 14.4 kJ/mol, the activation energy of water.

In fluid flow applications, time-dependent non-Newtonian fluids (thixotropic or rheopectic) can be treated as power-law fluids, assuming a constant shearing time. Similarly, the flow of viscoelastic fluids can be approximated by the power-law model, using empirical rheological constants.

Table 3.2 shows some typical rheological data of fluid foods, which can be used in the design of food pumping and piping systems (Rao 1999; Saravacos and Maroulis 2001). For design calculations, most fluid foods can be approximated by the power-law model, and therefore, the rheological constants ( $K$ ,  $n$ ) at a given temperature can define the flow of the product. The activation energy ( $E_a$ ) can be used to convert the flow data to other temperatures.

**Table 3.2** Characteristic of rheological constants of fluid food at 20 °C

Fluid food	$n$	$K$ (Pa s <sup><math>n</math></sup> )	$E_a$ (kJ/mol)
Orange juice, 12 °Brix	1.00	0.002	16
Orange juice, 42 °Brix	0.82	0.100	30
Orange juice, 65 °Brix	0.76	0.400	40
Clarified apple juice, 60 °Brix	1.00	0.060	50
Apple sauce, 12 °Brix	0.29	26.000	15
Tomato concentrate, 20 °Brix	0.33	25.000	20
Tomato concentrate, 30 °Brix	0.30	120.000	15
Vegetable oil	1.00	0.080	45



**Fig. 3.1** Pumping system

**3.2.1.2 Mechanical Energy Balance**

The energy required for transporting a fluid through a piping system or the pump work  $W$  (J/kg) is calculated from the Bernoulli equation or the Mechanical Energy Balance Equation (MEBE). Figure 3.1 shows a simple system, in which a pump transports the fluid from a lower level  $z_1$  (m), pressure  $P_1$  (Pa), and velocity  $u_1$  (m/s) to the corresponding higher levels ( $z_2, P_2$ , and  $u_2$ ). The reference level here is the pump inlet. The MEBE equation for the pumping system, including pump work and friction losses, is (Holland and Bragg 1995)

$$W_p = \Delta P / \rho + \Delta u^2 / \alpha + g \Delta z + E_f \tag{3.13}$$

where  $W_p$  is the pump work per unit mass of the fluid (J/kg),  $\rho$  is the density of the fluid ( $\text{kg/m}^3$ ), and

$$\Delta P = P_1 - P_2, \quad \Delta u^2 = u_2^2 - u_1^2, \quad \Delta z = z_2 - z_1, \quad g = 9.81 \text{ m/s}^2 \text{ (gravity constant),}$$

$$E_f = \text{friction losses (J/kg), and } \alpha = 1 \text{ (laminar flow), } \alpha = 2 \text{ (turbulent flow)}$$

The MEBE equation (3.13) can be written in the form of “heads,” i.e., heights (elevations) of the liquid being pumped in meters (m):

$$H = h_p + h_u + \Delta z + h_f \tag{3.14}$$

where  $H, h_p, h_u, h_f$  and  $\Delta z$  are, respectively, the pump (total), pressure, velocity, and friction heads (m) and  $\Delta z$  is the level height (Fig. 3.1) defined as

$$H = W_p / g; \quad h_p = \Delta P / \rho g, \quad h_u = \Delta u^2 / \alpha g, \quad \Delta z = z_2 - z_1 \quad \text{and} \quad h_f = E_f / g$$

In most food processing operations, the velocity head is small, compared to the important heads of pressure and friction losses. This is because the inlet and outlet velocities of food fluids are relatively low and usually close to each other, e.g., pumping from tank to tank. Low velocities are preferred in pumping, because of the potential mechanical damage of food quality at high velocities and shear rates.

The total head ( $H$ ) of a pumping system is defined by the equation

$$H = h_d - h_s \quad (3.15)$$

$$h_d = h_{sd} + h_{pd} + h_{fd} \quad (3.16)$$

$$h_s = h_{ss} + h_{ps} - h_{fs} \quad (3.17)$$

where  $h_d$  = discharge head;  $h_s$  = suction head;  $h_{sd} = u_2^2/2g + z_2$ , static discharge head; and  $h_{ss} = u_1^2/2g + z_1$ , static suction head;  $h_{pd} = P_2/\rho g$ , discharge surface pressure head;  $h_{ps} = P_1/\rho g$ , suction surface pressure head; and  $h_{fd}$ ,  $h_{fs}$  discharge and suction friction head, respectively.

The theoretical power ( $P_o$ , kW) required to pump a fluid at a rate  $m$  (kg/s) and pump work ( $W_p$ ) is

$$P_o = mW_p = mHg \quad (3.18a)$$

The actual power ( $P_a$ ), required by the electric motor to move the pump, is higher, and it can be estimated by dividing ( $P_o$ ) by the mechanical efficiency  $\eta_1$ , of the pump (e.g., 70 %) and the motor efficiency  $\eta_2$  (e.g., 90 %).

$$P_a = P_o/\eta_1\eta_2 \quad (3.18b)$$

### 3.2.1.3 Friction Losses

The energy losses due to friction in a pipeline ( $E_f$ ) are estimated from the empirical equation

$$E_f = 4f \left[ \left( \sum L_e \right) / d \right] (u^2/2) \quad (3.19)$$

where  $f$  is the friction (Fanning) factor, which is a function of the  $Re$  number and the flow behavior index of the fluid ( $n$ ), and  $\left( \sum L_e \right)$  is the summation of the equivalent lengths of the pipeline, valves, and fittings. The  $L_e$  values of the various fittings are given in the literature (Walas 1988; Perry and Green 1997) as function of the diameter ( $d$ ) of the pipeline (Table 3.3).

An alternative method of estimating  $E_f$  is to calculate first the friction loss of the straight pipeline, using  $\sum L_e = L$  in (3.19), and then estimate the friction losses in the various fittings, using empirical factors  $k_f$  from the literature (tables or nomograms) for the equation



**Table 3.3** Equivalent lengths ( $L_e$ ) for pipeline fittings (pipe internal diameter,  $d$ )

Pipeline fitting	$L_e/d$
45° Ell (L)	15
90° Standard ell (L)	32
Tee (T), line flow	60
Tee (T), branch flow	90
Gate valve, open	7
Globe valve, open	300

$$E_f = k_f(u^2/2) \quad (3.20)$$

The friction coefficient ( $f$ ) of the Fanning equation (3.19) is estimated from empirical equations or diagrams of the literature. For Newtonian fluids in laminar flow ( $Re < 2100$ )

$$F = 16/Re \quad (3.21)$$

For Newtonian fluids in turbulent flow, the standard ( $f$ ,  $Re$ ) diagram of the literature is used (Perry and Green 1997). Since, for hygienic reasons, food pipes are generally smooth, the roughness factor in the diagrams is neglected. Alternatively, the factor ( $f$ ) can be estimated from the simplified equation (explicit in  $f$ )

$$\left(1/f^{1/2}\right) = 3.6 \log(Re/7) \quad (3.22)$$

For non-Newtonian fluid foods, in laminar flow (the usual case of fluid foods), the friction factor can be estimated from an empirical equation, analogous to (3.21)

$$F = 16/\psi Re \quad (3.23)$$

where  $Re$  is the generalized Reynolds number (3.10) and  $\psi$  is a correction factor.

In pipeline calculations, most fluid foods can be approximated by the power-law model, for which the correction factor is  $\psi = 1$ . For fluids described by the generalized Bingham-plastic (Herschel–Bulkley) model, the correction factor is given by empirical equations and diagrams (Walas 1988; Steffe and Singh 1997) as a function of the  $Re$  and Hedstrom ( $He$ ) numbers. The ( $He$ ) number is defined by the equation

$$He = (\tau_o d^2 \rho) / (\eta_B)^2 \quad (3.24)$$

where  $\tau_o$  is the yield stress (Pa) and  $\eta_B$  is the Bingham (apparent) viscosity (Pa s).

The ( $f$ ,  $Re$ ) diagrams, for various  $He$  numbers, can also be used for turbulent flow of non-Newtonian fluid foods, i.e., at  $Re > 3000$ . The transition  $Re$  number (from laminar to turbulent flow) in Newtonian liquids is taken as 2100, while in non-Newtonian fluid foods, it depends on the flow behavior index ( $n$ ), varying from 1500 to 2500 (Steffe and Singh 1997).

**Table 3.4** Classification of food processing pumps

Pump category	Type of pump	
Positive displacement	Reciprocating pumps	Piston
		Diaphragm
	Rotary pumps	Progressive cavity
		Twin screw
		Gear
		Lobe
		Vane
Peristaltic		
Centrifugal	Radial flow pumps	
	Axial flow pumps	
Other	Jet pumps	
	Air-lift pumps	

### 3.2.1.4 Pump Characteristics

Pumps are mechanical devices used widely for transporting fluids and suspensions through piping systems in various processing and auxiliary plant operations. Main types of pumps used in food processing operations are the centrifugal and the positive displacement pumps (PDPs). Some other types of pumps, such as the injection and the air-lift pumps, are also used in special cases (Table 3.4).

As a general rule, the centrifugal pumps are used mainly for transporting large volumes of fluids, while the PDPs are more frequently used in volumetric flow (dosing) of liquids and in achieving higher pressures. The centrifugal pumps are further divided into radial flow and axial flow pumps. The distinction is based on the discharge of the fluid with respect to the axis of rotation of the pump. The PDPs are divided into reciprocating and rotary pumps. Common PDPs, used in food processing, are the progressive cavity, the eccentric screw, and the diaphragm pumps. Examples of rotary pumps are the gear, the lobe, the vane, and the peristaltic pumps.

#### Centrifugal Pumps

The centrifugal pumps (Fig. 3.2) are based on the conversion of velocity head into pressure head of the fluid by a rotating impeller (rotor). Most centrifugal pumps are of the radial volute type, i.e., the fluid enters the center of the impeller and it is discharged into a progressively expanding spiral.

The operation of centrifugal pumps is connected directly to an electric motor, and they operate at a fixed speed, e.g., 1750 RPM (or  $1750/60 = 29.2 \text{ s}^{-1}$ ). They can operate at various capacities by regulating the opening of the discharge valve. The centrifugal pumps are not self-priming, unless special constructional measures

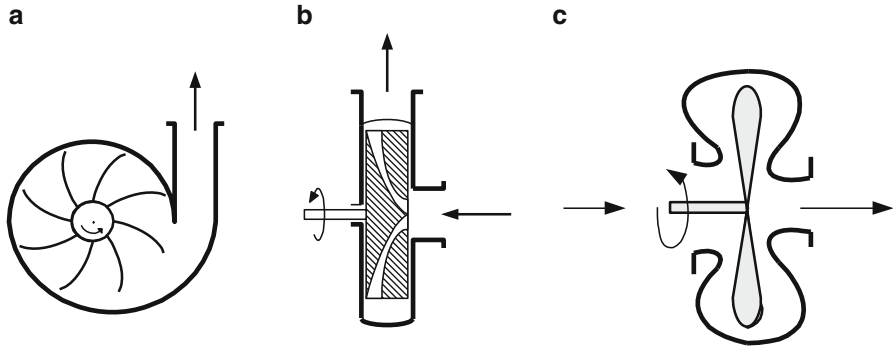
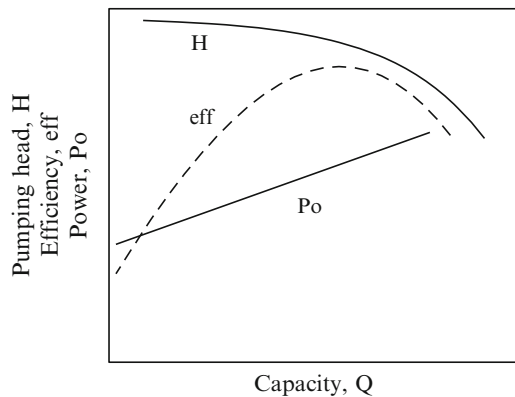


Fig. 3.2 Centrifugal pumps: (a, b) radial flow; (c) axial flow

Fig. 3.3 Characteristics of centrifugal pump

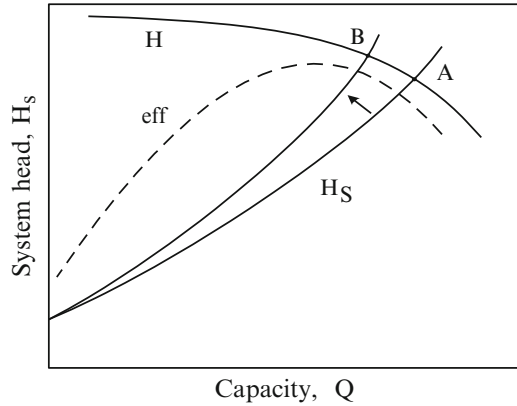


are taken. Such measures are, e.g., the installation of valves at the suction side of the pump and the filling of the pump with liquid before starting its operation.

The centrifugal pumps are used extensively for pumping simple (Newtonian) liquids, like water, aqueous solutions, juices, and oils, but can be also used for pumping liquids containing small particles. Pumps of special impeller and casing design can handle complex non-Newtonian fluids and suspensions of relatively low apparent viscosity. The vanes of the impellers of the centrifugal radial flow pumps usually run backwards for reducing the pump instability, which for constant speed is related to the number of intersections of the capacity curve  $H = f(Q)$  with the operating curve  $H = \text{constant}$  (Fig. 3.4). Centrifugal pumps are preferred, wherever applicable, because of their simple construction, easy maintenance, and low cost.

Characteristic pump curves (Fig. 3.3), provided by the manufacturer or obtained from experimental tests (AIChE 1964), show the pump head ( $H$ , m), pump efficiency (%), and pump power ( $P_o$ , kW) as functions of the volumetric pump capacity ( $Q$ ,  $\text{m}^3/\text{h}$ ). Note that the pump capacity is often expressed in US gallons per minute, GPM (1 GPM =  $0.227 \text{ m}^3/\text{h}$ ). It should be noted that centrifugal pumps can operate

**Fig. 3.4** Operation of centrifugal pump



without mechanical damage at zero capacity ( $Q = 0$ ), i.e., with the discharge valve completely closed, obtaining the maximum head.

The head ( $H_s$ ) of the pumping system is a nonlinear function of the pump capacity ( $Q$ ), according to (3.14). The normal operating point (A) of a given pump is the intersection of the pump head with the system head (Fig. 3.4). In a normal operation, the operating point (A) should be to the right of the maximum efficiency, so that any reduction in pump capacity will result in increased efficiency. This effect is illustrated by a throttling operation of the centrifugal pump, i.e., partially closing the discharge valve, resulting in a shift of the operating point from (A) to (B).

The following equations (pump laws) relate the centrifugal pump characteristics, capacity ( $Q$ ), head ( $H$ ), pump power ( $P_o$ ), speed of rotation (RPM), and impeller diameter ( $d$ ):

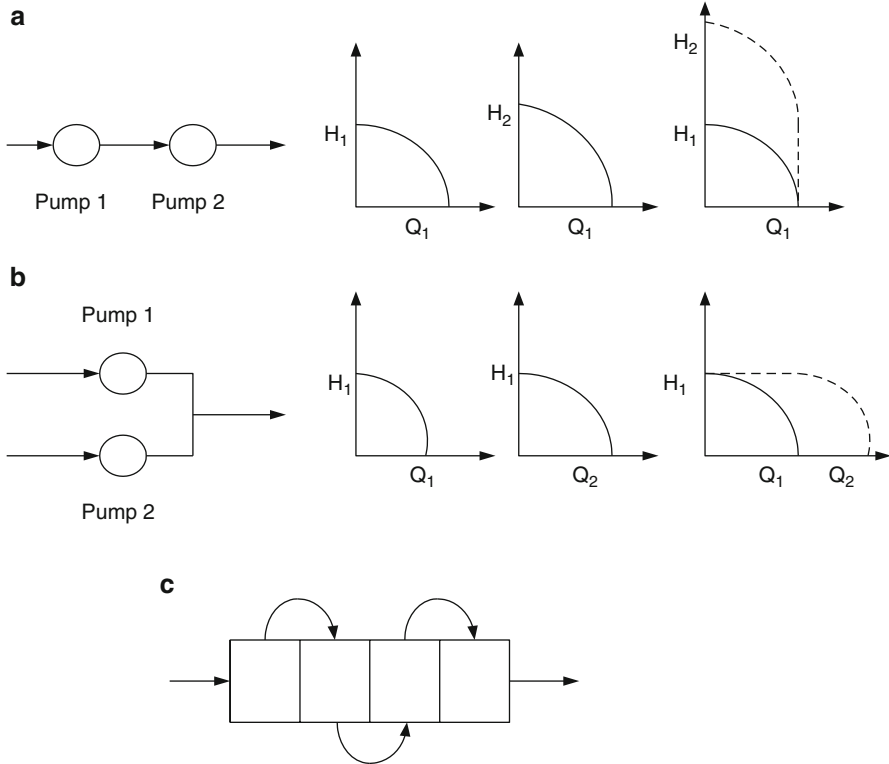
$$(Q_1/Q_2) = (\text{RPM}_1/\text{RPM}_2)(d_1/d_2)^3 \quad (3.25)$$

$$(H_1/H_2) = (\text{PIIM}/\text{PIIM}_2)^2(\delta_1/\delta_2)^2 \quad (3.26)$$

$$(P_{o1}/o_2) = (\text{RPM}_1/\text{RPM}_2)^3(d_1/d_2)^5 \quad (3.27)$$

These relationships can be simplified for the cases of constant impeller diameter ( $d$ ) and constant rotating speed (RPM).

The pumping head or the capacity of centrifugal pumps can be increased by serial or parallel assembly of pumps (Fig. 3.5). In several cases, this can be also achieved by using multiple-stage pumps. A two-stage small radial flow centrifugal pump, e.g., with a capacity  $50 \text{ m}^3/\text{h}$  at 1500 RPM, can pump up to a head of 20 m. If an 8-stage similar pump is used, the pumping capability increases to 100 m. Larger one-stage radial flow centrifugal pumps can pump, e.g.,  $2000 \text{ m}^3/\text{h}$  at 30 bar, or more when more stages are used. In comparison to the radial centrifugal pumps, the axial centrifugal pumps may have up to a 40-fold capacity, at pressures not



**Fig. 3.5** Combination of pumps: (a) serial, (b) parallel, (c) multistage

exceeding 3–4 bar. The efficiency of both types of pumps increases with their capacity (Walas 1988).

The Net Positive Suction Head (NPSH) is an important characteristic of centrifugal pumps, which insures that pumped fluid is available at the suction level of the pump. NPSH is defined by the equation

$$\text{NPSH} = h_s - h_{vp} \tag{3.28a}$$

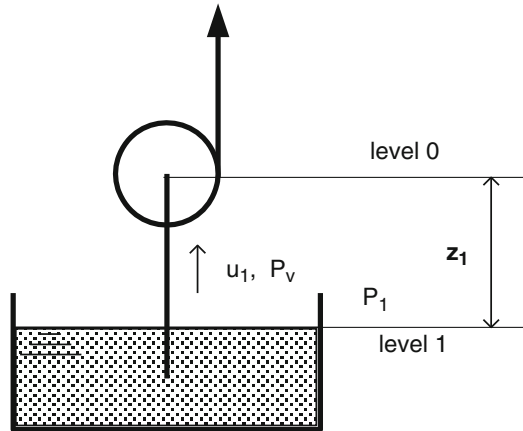
where  $h_s$  is the suction head (m) and  $h_{vp} = P_v/\rho g$  the vapor pressure head (m) of the liquid at the suction of the pump.  $P_o$  is the vapor pressure of the liquid at the suction temperature. It must be noted that the suction head ( $h_s$ ) includes the suction velocity, pressure, elevation, and friction heads (3.17). The elevation ( $z_1$ ) will be negative if the suction surface is below the suction level.

For efficient pump operation, the NSPH should be positive, i.e.,  $h_s > h_{vp}$ , or

$$P_1/\rho g + u_1^2/2g + z_1 - h_f > h_{vp} \tag{3.28b}$$

For boiling liquids,  $P_1 = P_v$  and  $P_1/\rho g = h_{vp}$  and, therefore,  $u_1^2/2g + z_1 > h_f$ . Since the liquid velocity at the suction level ( $u_1$ ) is usually low, the suction surface level

**Fig. 3.6** NPSH and cavitation in a centrifugal pump



should be positive ( $z_1 > 0$ ) and higher than the friction head ( $z_1 > h_f$ ). Practically, this means that the suction friction head should be minimized, e.g., by using a large diameter suction entrance, without valves and fittings, and locating the pump at the bottom of the process vessel (e.g., an evaporator).

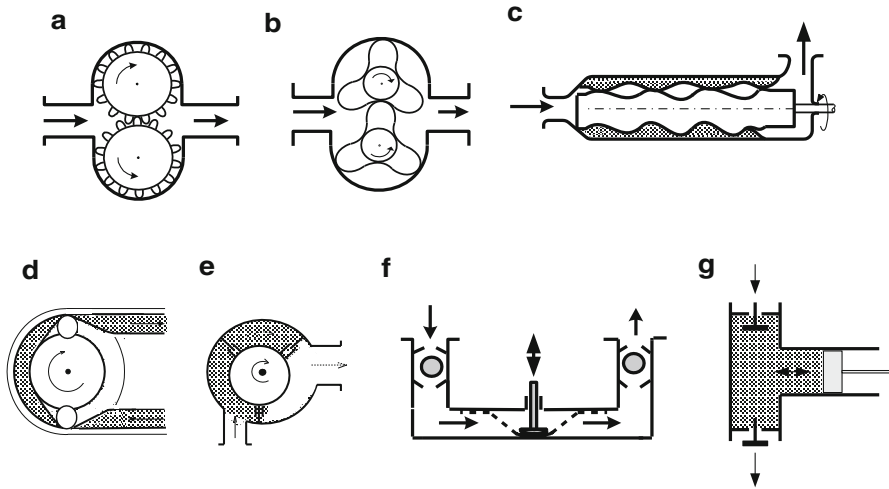
When the NPSH is negative, the operation of the pump will be difficult and erroneous, because of cavitation problems. In pumping of liquids, cavitation must be avoided. It occurs when vapor bubbles within a liquid, caused by constructional patterns, turbulence, etc., collapse suddenly due to condensation, resulting in a localized low pressure. The collapsing is followed by noise and vibration. Cavitation, besides reduction of the pumping efficiency, produces also stresses on the material of the pumping equipment, causing, in extreme cases, a breakdown.

Figure 3.6 shows diagrammatically a pumping system, in which cavitation may take place. The suction of the pump is above the liquid level ( $z_1 < 0$ ), and the NPSH may become negative when the suction pipe is long with high friction head, when the temperature of the liquid is high or at the boiling point ( $P_1 = P_v$ ), and when the liquid is at reduced pressure (vacuum). In these cases, the pump should be located below the liquid level ( $z_1 < 0$ ), assuring a positive NPSH.

NPSH data for a given pump should be provided by the pump manufacturer. The NPSH in a given pumping system should be calculated in the following cases (Bhatia 1982): (1) when the pump is installed at an appreciable height above the suction liquid level, (2) when the pump suction is connected to a tank under vacuum, (3) when the liquid has a high vapor pressure (volatile liquid), (4) when the suction line is very long, and (5) when the pumping system is at an altitude considerably higher than the sea level (low atmospheric pressure).

### Positive Displacement Pumps

The PDPs trap a volume of fluid, and they force it out mechanically against the existing process pressure. Their efficiency is higher than that of centrifugal pumps



**Fig. 3.7** Positive displacement pumps: (a) gear, (b) lobe, (c) progressive cavity, (d) peristaltic, (e) vane, (f) diaphragm, (g) piston

(Walas 1988). The most common PDPs used in food processing are the rotary pumps, with rotating gears, lobes, screws, etc. (Fig. 3.7). Reciprocating PDPs, such as piston (plunger), diaphragm, and peristaltic pumps, are used in limited applications. All PDP pumps are self-priming, with no NPSH or cavitation problems.

The rotary PDPs have no valves, and the liquid flow is continuous. The progressive cavity or eccentric screw pumps consist of a metallic screw rotor, rotating within a rubber or elastomer stator. These pumps are usually used for a gentle pumping of viscous fluids, which may also contain significant amounts of particles or pieces. They are easily disassembled for cleaning, but their weak point is the reduction of their efficiency, accompanied by stator wear. Such pumps can be used in pumping, e.g., 8 m<sup>3</sup>/h at a pressure up to 80 bar, or 400 m<sup>3</sup>/h at a pressure up to 6 bar. The lobe pumps are used for pumping products similar to those pumped by the progressive cavity pumps. Normally, they are used to pump 20–200 m<sup>3</sup>/h, at pressures up to 25 bar. The lobe pumps can pump liquids in both directions. The rotation speed depends on the volume pumped, and it usually varies between 20 and 500 RPM.

The function of the gear, screw, and lobe pumps is similar. In the gear pumps, two gears rotate in counter direction as indicated in Fig. 3.7, forwarding the fluid that enters the gap between the gear teeth. The capacity of both types of pumps is similar; however, the pressure achieved by the gear pumps can be higher (up to 100 bar). In the twin-screw pumps, two rotating parallel screws forward the fluid along the axis of the screws. The twin-screw pumps can pump liquids of a wide viscosity range (1–10<sup>5</sup> mPa s). Their flow is similar to that of piston pump with infinite long stroke. The lobe pumps work in a similar way with the gear pumps, but they have rotating lobes instead of gears.

The advantages of the gear, lobe, and progressive cavity pumps:

1. Continuous flow without turbulence and vibration.
2. High suction force.
3. Coupling with high rotation motors (up to 5000 RPM) is possible.
4. Pumping control by the rotation speed.
5. Reverse pumping is possible.

Lobe pumps are usually made of stainless steel. They can pump liquids of viscosities up to 100 Pa at capacities from 1 to 700 m<sup>3</sup> and differential pressures up to 30 bar. They provide pulsation-free flow and they conform to the 3-A and EHEDG hygienic standards.

The three types of rotary RDPs can be used in dosing applications. The gear and the twin-screw pumps are used in the chocolate, gelatin, fat, and molasses processing industry. At relatively low pressure (e.g., 15 bar), they can pump high volumes of fluids, e.g., 2000 m<sup>3</sup>/h at about 15 bar, while at threefold pressure, increase of pressure will reduce the flow rate by tenfold.

The vane pumps consist of a cylindrical chamber/shell in which vanes rotate. The chamber is divided into compartments by radially placed vanes. The vanes are assembled on an eccentrically placed rotor, and they are flexible in the radial direction of the chamber, securing water tightness between the compartments. The volume of the compartments varies as the rotor moves. The sucked fluid is discharged at a higher pressure as it is compressed into smaller compartments during rotation. They can be used for pumping of high viscosity fluids containing particles against a short head. Vane pumps, containing oil at the contact surfaces between the vanes and the chamber wall, are used as vacuum pumps in laboratory and small-scale vacuum applications.

The peristaltic pumps consist of a flexible rubber or plastic, friction-resistant tube, and a rotating eccentric device, or an eccentric wheel, with 2–4 smaller wheels adjusted on its periphery. The eccentric device or the small wheels, compress the tube, pushing the liquid, while rotating. The pump is quite simple, since the only essential parts are the rotating device and the tube, which should be replaced when worn out.

The peristaltic pumps are suitable for pumping cream, since no churning takes place. They can also be used in feeding filtrates, crystalline suspensions, and extraction of liquids from vacuum tanks. Their capacity may vary according to the dimensions of the pump and the speed of rotation of the eccentric devices. For a pump of maximal diameter of the rotating parts pressurizing the tube,  $d = 40$  cm and pump weight 8 kg, the pumping capacity at 20 RPM is 30 L/h and at 60 RPM is 90 L/h. A pump with a diameter  $d = 1$  m (weight 380 kg), at 20 RPM pumps 8000 L/h, while at 60 RPM is 24,000 L/h.

Advantages of peristaltic pumps:

1. Resistance to corrosion
2. Self-priming up to 9 m
3. Not damaged if run dry



4. Precise dosing of liquids
5. Reverse pumping possible
6. Operation at pressures up to 6 bar

The diaphragm pumps consist of a reciprocating plastic or rubber membrane, driven by an eccentrically rotating device, which sucks and forwards of a definite liquid volume at each movement. The diaphragm pumps are used in dosing of liquids and in pumping viscous nonhomogeneous liquids that cannot be handled by centrifugal pumps. The liquid volume pumped can be higher than that of a single piston pump, but the maximal pressure is about 30 % less than the pressure developed in a single-stage piston pump.

Advantages of the diaphragm pump:

1. Pumping non-homogeneous liquids.
2. Can run dry.
3. No leakage during operation.
4. Can be used for dosing applications, the worn out parts (mainly the membrane), can be replaced easily.
5. They are self-priming.

The reciprocating positive displacement (piston) pumps transport the liquid periodically by alternating suction and discharge strokes, employing special valves. An even fluid flow supply can be achieved by using more stages. The volumetric efficiency of the piston pumps falls with shorter strokes and higher discharge pressure. Accurate regulation is possible when the fluid flow rate is larger than 20 % of the maximum value. The maximal capacity of multistage piston pumps is ten times less than that of centrifugal radial pumps, but their maximal pressure is two to three times higher. Piston pumps can be used for nonhomogeneous products. In single-stage pumps, e.g., pumping 20 m<sup>3</sup>/h, the pressure developed may be up to 30 bar. Using multistage pumps, a tenfold increase of the pumped fluid volume can be achieved by a 50-fold increase of the pressure.

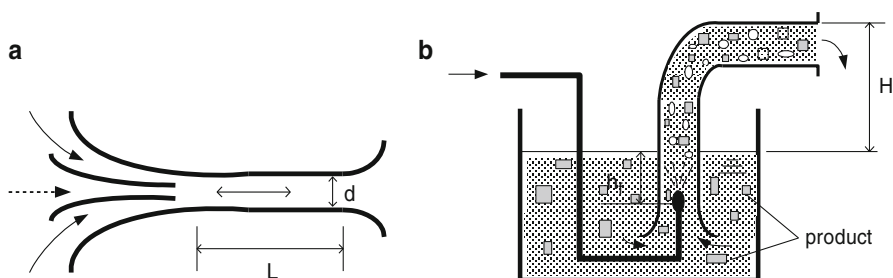
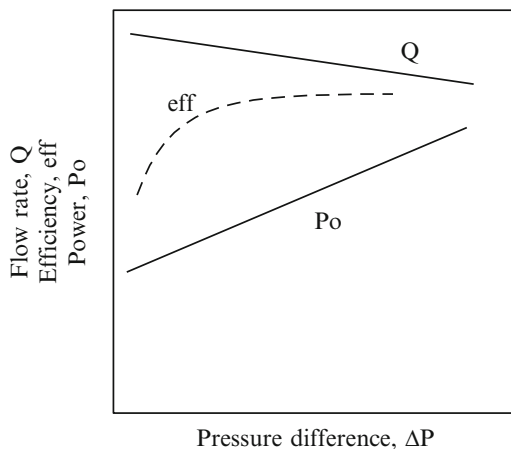
Piston pumps are used, e.g., in homogenizing equipment at pressures up to 250–300 bar (Chap. 4) and in high-pressure atomizers at pressures up to 100 bar, e.g., in spray dryers (Chap. 8).

Advantages of piston pumps:

1. Application of high discharge pressures is possible.
2. Can be used in dosing applications.
3. The volume discharged is almost pressure independent.
4. They are self-priming.

The performance characteristics of a rotary PDPs, provided by the pump manufacturer or obtained from experimental tests, are shown in Fig. 3.8. The pump characteristics (capacity  $Q$ , efficiency, and power  $P_o$ ) are usually plotted as a function of the total discharge pressure (AIChE 1968). The rotary PDP should not be operated at zero capacity (completely closed discharge valve), because of the danger of mechanical damage.

**Fig. 3.8** Performance of rotary positive displacement pump



**Fig. 3.9** Special pumps: (a) injection, (b) air lift

### Other Pumps

Two pumps of this category are the injection pump and the air-lift or “Mammoth” pump (Fig. 3.9).

The injection pumps consist of a Venturi tube and a nozzle injecting a fluid, usually steam, at high velocity, in the center of the tube (Fig. 3.9). They are often used for feeding steam boilers with recycled hot water and for reducing the pressure (vacuum generation) in food processing equipment, e.g., evaporators (Chap. 8). For a successful operation, the length of the Venturi pump ( $L$ ) must be about ten times larger than its shortest diameter ( $d$ ), and the nozzle must be as close as possible to the straight section of the Venturi tube. The efficiency of injection pumps is low (2–15 %), and they can transport, e.g., about  $20 \text{ m}^3/\text{h}$  fluid at 5 bar pressure.

The air-lift pumps are used for transporting liquids or light particles to a short height. They operate with pressurized air that is blown at the lowest part of a tube, immersed in the liquid. The air reduces the specific gravity of the fluid in the tube, resulting in the upstream movement of the liquid and the entrained particles. The maximum height of transport is about 50 m. The transport height ( $H$ ) depends on

the distance between the edge of the air-blowing tube and the fluid level ( $z_f$ ) and the density of the fluid with ( $\rho_m$ ) and without air ( $\rho_f$ ):

$$H = z_f(\rho_f/\rho_m - 1) \quad (3.29)$$

Since the air-lift and the injection pumps do not have mechanical moving parts, they can be used for transporting sensitive food products. The air-lift pumps are almost twice as efficient as the injection pumps.

### Requirements for Food Pumps

In addition to the general design and construction requirements, food pumps must meet special requirements, dictated by hygienic (sanitary) design and good manufacturing practices, as outlined in Chaps. 1 and 2.

Stainless steel (304 and 316) is the most widely used construction material, since it meets all of these requirements. Since stainless steel is an expensive material, in several pump applications, some less expensive materials can be used. Carbon steel may be used in special pumps for some preliminary food processing operations, such as hydraulic transport of raw fruits and vegetables.

Special plastic materials are used in some pump parts, e.g., Teflon, FEP (fluorinated ethylpropylene), epoxy resins, and fiber-reinforced plastics. In special applications (e.g., high temperature, corrosive fluids), glass-lined steel and ceramics may be used. Composite construction is sometimes used, e.g., stainless steel for the wet (fluid product) side of the pump and carbon steel for the dry (auxiliary) side (Bhatia 1982).

Hygienic requirements in pump design are presented by Jowitt (1980), Troller (1993), and the various codes, like 3-A (IAMFES 1988). Pumps should be disassembled and cleaned easily. Process parts and pipes should be preferably clamped instead of bolted. Smooth curves and shapes should be used, avoiding dead ends and turbulence-promoting sections. All fluid product parts of the pump should be completely self-draining. The whole pumping system should be suitable for CIP cleaning.

Packings and mechanical seals must be fabricated from food-approved materials, and they should be readily removable for inspection and replacement. The pumps should be installed on sanitary supports, with adequate clearance space to facilitate cleaning and maintenance.

### Pump Selection

Selection of the proper pump for a given food processing application is based on the pumping requirements of a particular product and the information on pump characteristics and cost, provided by the pump manufacturer. Pumping requirements include total head (m), volumetric capacity ( $\text{m}^3/\text{h}$ ), and product characteristics

(composition, density, rheological properties, density, temperature, etc.). Pump characteristics include performance curves (total head, efficiency, and power versus capacity), NPSH, materials of construction, pump dimensions, hygienic features, auxiliary equipment, and pump maintenance.

Pump cost is an important factor in pump selection, but hygienic design and product quality should be considered first. Pump capacity, pumping head, and efficiency are the basic pump parameters.

Centrifugal pumps are inexpensive, and they should be preferred if the food fluid is pumpable, i.e., it has low viscosity, and the product quality is not damaged by the pump impeller. They are especially efficient at high capacities ( $Q > 100 \text{ m}^3/\text{h}$  or 500 GPM) and relatively low heads ( $H < 100 \text{ m}$ ) (Walas 1988). Volute-type pumps are preferred, and the ratio of the discharge to suction diameters should be about  $(d_d/d_s) = 2/3$ .

The centrifugal pumps usually are linked directly to electric motors, and there is no need for speed reduction equipment. They are available in several construction materials, and they have low maintenance cost. They cannot run dry (without liquid), and they need some assistance in starting (pump priming). The cost of centrifugal pumps increases linearly with the increase in capacity (Fig. 2.3).

Positive displacement (usually rotary) pumps are suitable for pumping high viscosity food fluids and suspensions. They develop high heads ( $H > 100 \text{ m}$ ), and they have relatively low capacities ( $Q < 100 \text{ m}^3/\text{h}$ ). They operate at relatively low speeds ( $< 1000 \text{ RPM}$ ) and they need some variable speed device (special DC motor or mechanical speed reduction). Maintenance cost is higher than for the centrifugal pumps (gears and rotors more expensive than impellers). The PDPs can run dry, and they are self-priming.

Small PDPs, like diaphragm and peristaltic pumps, are often used as metering pumps for some food ingredients into food processing streams and tanks.

### 3.2.1.5 Pump Auxiliaries

The main auxiliaries of interest in the design and operation of pumping equipment are the pump drives (motors) and the mechanical seals (Bhatia 1982; Walas 1988).

#### Electric Motors

Electric motors are used to drive the pumps in most food processing applications. In special cases of large installations, like sugar refineries, where exhaust steam is available, steam turbines may be attached to centrifugal pumps for significant energy savings. Standards and specifications for electric motors are found in special publications of engineering and electrical national and international organizations, like the American National Standards Institute (ANSI), the Institute of Electrical and Electronics Engineers (IEEE), the National Electrical Code (NEC), and the International Electrotechnical Commission (IEC).

Most centrifugal pumps are driven by AC induction-type motors, operating between 900 and 3600 RPM. For variable speed operation, e.g., for PDPs, DC motors may be used. Variable speeds can also be obtained by mechanical speed reduction units attached to constant RPM motors.

The voltage of the electric motor depends on the pump power, varying from 220 to 4000 V for motor power 1–2000 kW, respectively. The required torque for starting the pump should be considered in the selection of the electric motor. Electrical equipment is discussed briefly in Appendix D (Utilities).

## Mechanical Seals

Connection of the rotating shaft of a pump to an electric motor should be protected against leaking of the pumped fluid. Two types of seals are used, the stuffing box and the mechanical seal (Bhatia 1982).

The stuffing box consists of packings of rings and sealing materials, like Teflon and graphite, attached tightly on the rotating shaft of the pump. Small amounts of process fluid may leak through the packing, lubricating the rotating shaft.

Mechanical seals, which are more expensive than stuffing boxes, allow little leakage of process fluids, and they meet the stringent rules of Environmental Protection Agency (EPA) and Occupational Safety and Health Administration (OSHA) against toxic substances. They consist of two parts, one stationary attached to the pump casing and the other attached to the rotating shaft of the motor drive. A sealing liquid in the intermediate space is used to lubricate the system. Mechanical seals utilize materials like stainless steel, Teflon, and graphite.

### 3.2.1.6 Process Piping and Valves

Piping, valves, and pipe fittings constitute a significant part of the investment in chemical and petrochemical plants, accounting up to 25 % of the fixed investment. Details on these large piping systems are given in Perry and Green (1997), Walas (1988), and Marks (1987). This information is especially important in large food processing plants handling liquids, such as vegetable oils, sugar syrups, and beverages, where large piping systems are installed.

In most food processing plants, handling sensitive fluid foods, like milk, juices, pulps, and soups, piping and valves, is important not only from the engineering standpoint but mostly from the hygienic and quality requirements of the food products.

## Piping

The size of pipes is usually characterized by the nominal diameter (nd), which is slightly larger than the outside diameter (od) of the pipe. The thickness of the wall is expressed by the Schedule number, which thus defines the inside diameter (id) of

the pipe. Pipe dimensions in literature and manufacturers' tables are given in inches or mm, and they should be converted to SI units (m) for engineering calculations.

Piping codes provide useful information on construction and dimensions of various types of pipes (Bhatia 1982), e.g., ANSI, American Society of Mechanical Engineers (ASME), and American Society for Testing and Materials (ASTM).

Pipes should be distinguished from tubes, used in heat exchangers and in refrigeration, which are identified by the outside diameter (od) and the tube wall thickness.

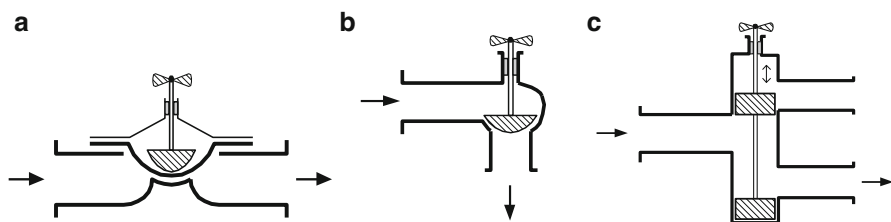
Stainless steel is the most widely used material of construction for pipes, valves, and fittings. Extruded plastic pipes, like PVC, can be used at temperatures up to 100 °C. In some applications, plastic-coated carbon steel or reinforced plastic pipes may be used.

For hygienic reasons, seamless (extruded) stainless steel pipes are preferred over the welded type. In long permanent pipelines, stainless steel pipes are joined usually by butt welding (without overlapping). In most food applications, the pipes must be occasionally taken apart (disassembled), and some type of joining must be used, like flanged gaskets and mechanical couplings. Mechanical couplings are preferred, because they can be disassembled for inspection and cleaning easier than the flanges. Gasket materials are made of food-grade synthetic elastomers (e.g., Neoprene) and Teflon. Screwed joints of small diameter pipes should be avoided, because they cannot be cleaned and sanitized effectively.

## Valves

In the design and applications of food piping systems, an average fluid velocity of 2 m/s is recommended. The cost of pipes is usually expressed on the basis of carbon steel pipe Schedule number 40. The cost of stainless steel 304 and 316 is, respectively, 1.5 and 2.0 times higher (Perry and Green 1997).

Valves control the flow in a piping system by blocking off the flow, by throttling, or by checking the direction of flow (diversion). The gate and the globe valves are widely used in chemical processing of gases and liquids, but they are not acceptable in food pipelines, since they cannot meet the strict hygienic requirements. Special valves, designed for hygienic operation and quick cleaning, are used in food pipelines (Jowitt 1980; Troller 1993), including the diaphragm, the plug and stem, and the flow diversion valves (Fig. 3.10). The diaphragm (membrane) valve is the most



**Fig. 3.10** Valves: (a) diaphragm, (b) plug and stem, (c) flow diversion

appropriate, since the fluid food does not come into contact with the opening mechanism of the valve. The diaphragm (membrane) is made of a food-grade plastic material, like Neoprene and Teflon, which should be replaced when worn out.

### 3.2.1.7 Hygienic Considerations

In addition to the general design and construction requirements, food pumps must meet special requirements, dictated by hygienic (sanitary) design and good manufacturing Practices, as outlined in Chaps. 1 and 2.

Stainless steel (304 and 316) is the most widely used construction material, since it meets all of these requirements. Since stainless steel is an expensive material, in several pump applications, some less expensive materials can be used. Carbon steel may be used in special pumps, used in some preliminary food processing operations, such as hydraulic transport of raw fruits and vegetables.

Special plastic materials are used in some pump parts, e.g., Teflon, FEP, epoxy resins, and fiber-reinforced plastics. In special applications (e.g., high temperature, corrosive fluids), glass-lined steel and ceramics may be used. Composite construction is sometimes used, e.g., stainless steel for the wet (fluid product) side of the pump and carbon steel for the dry (auxiliary) side (Bhatia 1982).

Hygienic requirements in pump design are presented by Jowitt (1980), Troller (1993), and the various codes, like 3-A (IAMFES 1988). Pumps should be disassembled and cleaned easily. Process parts and pipes should be preferably clamped instead of bolted. Smooth curves and shapes should be used, avoiding dead ends and turbulence-promoting sections. All fluid product parts of the pump should be completely self-draining. The whole pumping system should be suitable for CIP cleaning.

Packings and mechanical seals must be fabricated from food-approved materials, and they should be readily removable for inspection and replacement. The pumps should be installed on sanitary supports, with adequate clearance space to facilitate cleaning and maintenance.

Pumps used in food processing should be smooth and without dead ends and other flow obstacles to effective cleaning. The use of progressive pumps, whenever possible, facilitates often cleaning. The pipe bends should be smooth and rounded, with a centerline radius larger than the pipe diameter (Jowitt 1980). Hygienic (sanitary) couplings should be used for easy disassembling and cleaning. Cleaning of pipelines from difficult deposits can be facilitated by "pigging," i.e., pumping a plastic sponge ("pig") through the pipe.

In CIP applications, a turbulent flow of the cleaning/washing fluids is desirable, which is assured by an average fluid velocity of 1.5 m/s. The flow of the cleaning fluid should be against any dead ends in the piping system, which are cleaned by the resulting turbulence.

Pipes should be inclined by about 1 % to facilitate drainage. When not used for some time, they should be dried by passing through hot air. Pipe insulation is

necessary for cold pipes, e.g., in refrigeration systems, in order to prevent moisture condensation, which may induce microbial growth.

Other fittings in pipeline systems should be of hygienic design, e.g., electromagnetic flow meters, which are installed with a smoothed bore.

Pipe hangers should be constructed so that they do not contaminate the food plant floor and they can be inspected easily for hygienic requirements (Troller 1993).

### ***3.2.2 Pneumatic and Hydraulic Transport Equipment***

Solid food materials, in the form of pieces, granules, and powder, can be transported by pneumatic or hydraulic conveying, i.e., suspending in an inert fluid medium (air or water) and using fluid transport equipment and piping. Pneumatic conveying is widely used in several food processing plants and in food transport and storage facilities. Hydraulic conveying is used for the transport of some agricultural raw materials in food plants.

#### **3.2.2.1 Pneumatic Conveyors**

Granular food solids, grains, and powders can be conveyed to long distances through ducts with high velocity air streams. Typical applications include the unloading of granular foods from railroad cars and ships and the transport of such materials within the food processing plant. Food materials handled include wheat, corn, flour, beans, coffee, and granular sugar.

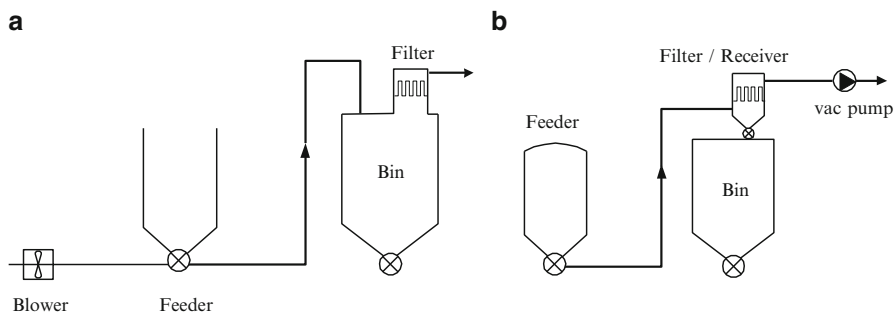
Although pneumatic conveying requires more energy than mechanical conveyors, it is generally preferred for its important advantages, particularly in large, continuous food processing plants. Dilute-phase conveying is normally used in food processing, while dense-phase systems are applied to conveying of inorganic materials, e.g., coal.

Physical and mechanical properties of food materials, needed in the design of pneumatic conveying systems, include particle density, bulk density, particle size distribution, moisture content and hygroscopicity, coefficient of sliding friction (angle of repose), and flowability. Particular care should be taken to prevent fires and explosions of some sensitive food powders (Walas 1988).

Two basic systems of pneumatic conveying are applied, i.e., the air-pressure and the vacuum system (Fig. 3.11). In addition, mixed systems of air-pressure/vacuum conveyors are used (Bhatia 1982; Mills 1990; Perry and Green 1997).

The pressure conveying system receives particulate material from one source and delivers it to more than one place (bins), while the vacuum system can receive material from several sources and deliver it to one receiving bin. Vacuum conveying is more expensive than pressure conveying, but it is preferred in transporting dusty products, since it reduces air pollution and explosion hazard.





**Fig. 3.11** Air-pressure (a) and vacuum (b) pneumatic conveying systems

**Table 3.5** Pneumatic conveying systems for food materials:  $\rho_b$ , bulk density;  $u$ , velocity; saturation, std  $\text{m}^3$  air/kg solids; power, kW h/t; conveying distance, 100 m

Food material	Bulk density $\rho_b$ ( $\text{kg}/\text{m}^3$ )	Air-pressure system			Vacuum system		
		Saturation	Power	$u$ (m/s)	Saturation	Power	$u$ (m/s)
Coffee beans	673	0.068	1.9	14	0.136	3.2	23
Corn	720	0.074	2.0	17	0.161	3.2	32
Flour, wheat	641	0.062	2.0	11	0.136	3.3	27
Malt	450	0.075	1.8	17	0.155	3.1	30
Oats	400	0.093	2.2	17	0.200	3.9	30
Starch powder	640	0.081	2.2	17	0.186	3.7	31
Sugar, granulated	800	0.093	2.7	18	0.186	4.6	33
Wheat	770	0.074	1.9	17	0.161	3.2	32

Empirical equations, rules, and data, based on experience and on engineering principles of fluid flow, are used in the design of pneumatic conveying systems (Bhatia 1982; Stoes 1982; Walas 1988; Perry and Green 1997). The calculations lead to the estimation of the pressure drop and the required power of the conveyor (see Example 3.2).

Table 3.5 shows typical design data of two pneumatic systems (air pressure and vacuum) for the transport of particulate food materials, such as grain, flour, and granular sugar (Stoes 1982; Walas 1988).

Required data for the design calculations are bulk density, air velocity, and length of the pipeline. The table provides estimated data for the required air saturation of the system (std  $\text{m}^3/\text{kg}$  solids) and the power (kW/t h). It should be noted that the ton in SI units is 1000 kg, while in the USA, the ton is often equal to 2000 lb, i.e., 908 kg.

Table 3.5 shows the significant effect of bulk density on the saturation (carrying air) and power requirements of pneumatic conveying. Thus, air-pressure conveying of wheat flour ( $\rho_b = 641 \text{ kg}/\text{m}^3$ ) requires a power of 2.0 kWh/t, compared to

2.7 h kW/t for granulated sugar ( $\rho_b = 800 \text{ kg/m}^3$ ). For vacuum conveying, the respective power requirements will be 3.3 and 4.6 kW/t h. It should be noted that in the SI system, the ton is 1000 kg, while ton used in the USA is often equal to 2000 lb, i.e., 908 kg.

The data of Table 3.5 indicate that the power and the carrying air requirements for vacuum conveying are almost double the requirements of air-pressure conveying, evidently due to the higher, nearly double, air velocities in the low-pressure operation. The minimum air velocity is about 15 m/s.

The pneumatic conveying systems of food particles and powders should be designed and operated so that fire and explosion are prevented and eliminated, following strict regulatory and legal requirements.

Explosion hazards exist in air conveying of particles and powders of size lower than 200  $\mu\text{m}$ . Explosion of air/particle mixtures requires a suitable solid concentration and a hot surface. The solid concentration must fall within the explosibility range, e.g., from 50 to 2000  $\text{g/m}^3$ . Solid concentrations higher than 5  $\text{kg/m}^3$  (i.e., air saturation lower than 0.2  $\text{m}^3/\text{kg}$ ), used in pressure and vacuum conveying (Table 3.5), are resistant to explosion (Mills 1999).

Hot surfaces, inducing explosion, include sparks, caused by mechanical, electrical, or electrostatic forces, overheated bearings, and welding of piping. The minimum ignition temperatures for sugar, coffee, and cocoa are 350, 410, and 420 °C, respectively. Explosion in closed-conveying systems or tanks can create a rapid rise of pressure up to 7 bar. The collection tanks of the air-conveying systems are the most vulnerable units to explosion damage. Special design and proper relief valves are required.

Although air is used as the normal conveying medium, an inert gas, like nitrogen, may be required for very explosive materials (more expensive operation).

The basic equipment of pneumatic conveyors includes the following units:

1. Air blower, usually of the positive displacement rotary type. The blower provides pressure drops up to 0.8 bar. A similar blower is used in vacuum conveying, with a pressure drop of 0.4 bar.
2. A solid feeder, usually of the rotating valve type.
3. A transfer line (duct), diameter 76.2–178 mm (3–7 in.) Schedule 40, or 200–305 mm (8–12 in.) Schedule 30. Length of the line 100 m or higher.
4. Smooth bends of long radius ( $r$ ), e.g.,  $r = 12$  (pipe diameter).
5. Dust collection equipment at the receiving bin (usually filter bags).

### 3.2.2.2 Hydraulic Conveying

Some agricultural raw materials, transported and stored in bulk in the yard of the food processing plant, are conveyed into the processing area by open water channels and flumes. The floating food materials, e.g., tomatoes, citrus fruit, sugar beets, are transported to the juice extractors by mechanical elevators, which may act also as washing equipment.

Transportation to longer distances against a pressure drop (e.g., to higher elevation) requires pumping and piping systems, specially designed for the particular application. Volute-type centrifugal pumps, with special impellers, which can handle large food pieces, are used. Food materials, like whole fruit, beets, carrots, potatoes, and fish, can be pumped without damage to the quality of the product. The pump may be constructed of expensive stainless steel or the less expensive cast iron, when allowed.

Hydraulic conveying of concentrated slurries (suspensions) is used for the transport of coal particles to long distances (Walas 1988). Empirical equations and data, obtained from such systems, can be utilized in the design of food conveying systems.

The velocity of a suspension in the pipeline should be such that the particles will not settle due to gravity, but at the same time, it should not be too high, which could damage the product quality and require excessive power. The critical velocity ( $u_c$ ) for this purpose is estimated from the equation (Walas 1988)

$$u_c = 34.6 C_v d u_t [g(S - 1)/d_p] \quad (3.30)$$

where  $u_t$  is the terminal (Stokes) velocity of the largest particle present,  $d$  is the pipe diameter,  $S$  is the ratio of suspension to liquid densities,  $C_v$  is the solid volumetric fraction, and  $g$  is the gravity constant. This equation holds for consistent units of both SI and US systems.

An important parameter in the design of hydraulic conveying is the ratio of the pressure drops of the suspension and the liquid which can be calculated from the empirical equation

$$(\Delta\Pi_s/\Delta\Pi_L) = 1 + 69 \Psi_w \left[ \gamma \delta (\Sigma - 1)/\theta^2 \Psi_\delta^{1/2} \right] \quad (3.31)$$

The drag coefficient  $C_d$  is calculated from the equation

$$C_d = 1.333g d_p(S - 1)/u_t^2 \quad (3.32)$$

The design velocity of the suspension ( $u$ ) is a function of the terminal velocity ( $u_t$ ) and the Fanning friction factor ( $f$ ):

$$u = 8.41u_t/f \quad (3.33)$$

For approximate calculations, the design velocity can be taken as 30 % higher than the terminal (Stokes) velocity ( $u_t$ ), i.e.,  $u = 1.3u_t$ .

From empirical data, the ratio  $(\Delta P_s/\Delta P_L)$  is approximately equal to the ratio of the densities of suspension and liquid, i.e.,  $(\Delta P_s/\Delta P_L) = \rho_s/\rho_L$ .

### 3.2.3 Mechanical Conveyors

#### 3.2.3.1 Introduction

Mechanical conveyors can be classified into motor-driven and gravity conveyors (Table 3.6). The motor-driven conveyors are further classified into steady and vibratory motion conveyors. Mechanical conveying can be steady or time interrupted. Steady (nonstop) conveying can be continuous or pulsated. However, a continuous conveying process is steady when certain mass is transported in definite time intervals. The steady-motion conveyors are distinguished into belt, roll, skate wheel, chain, and screw equipment. The vibratory conveyors can be classified according to the vibration mechanism used, which can be either electromagnetic or eccentric. Gravity conveyors are distinguished into skate, roller, and chute equipment.

Regarding the transport direction of the products, conveyors can be classified as horizontal, inclined, vertical, and combined direction conveyors. Most conveyors are able to convey products in both directions. The vertical conveyors belong to the elevators. The combined direction conveyors carry products, placed on trays, up and down, without changing the initial horizontal position of the trays (Fig. 3.12c). In some cases, a horizontal movement of the trays may follow the up or down motion of the trays. In food processing, the conveyors can be used mainly as transport equipment, or in connection with some processing operation (e.g., freezing or drying of the transported food). When equipment is used for conveying bulk dry products (e.g., corn and cereal grains), the conveying speed must not exceed certain limits (e.g., 2–4 m/s) to avoid dusting. Several conveyors or parts of them (e.g., belt, rolls, etc.) are standardized.

Combination of mechanical and pneumatic conveying can be used in moving boxes, weighing up to 150 kg. Thus, the vacuum forklift can load/unload boxes by application of vacuum, and the vacuum hoist lifting can load and move boxes on a monorail bridge to distances up to 40 m. Pneumatic conveying is described in Sect. 3.2.2 of this chapter, and forklift transport is discussed in Chap. 13.

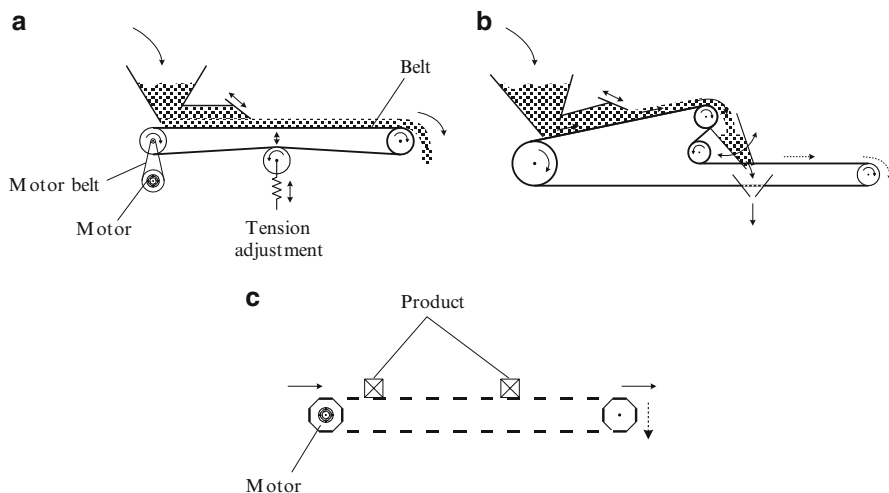
#### 3.2.3.2 Selection of Conveyors

Mechanical conveying is discussed in the technical literature, e.g., Perry and Green (1997), McCabe and Smith (1976), Walas (1988), Brennan et al. (1990), Huette (1960), and Feustel and Hemendiger (1987). Details on conveyors for specific industrial applications, including materials of construction, standards, performance, and cost, are given in catalogs of equipment manufacturers.

The selection of mechanical conveyors depends on the following factors: (1) type and properties of product to be conveyed, (2) capacity, (3) conveying distance, (4) transport direction, (5) packaging of product, (6) energy required, (7) product heating requirements, (8) hygienic (sanitary) and safety requirement, (9) automation, (10) degree of standardization, (11), flexibility, and (12) environmental impact.

**Table 3.6** Conveying and transport systems

Motion	Transport direction	Type of “conveyor”		Auxiliary device	
Steady motion	Horizontal and inclined	Belt	Uniform belt	Plain, cross slats	
			Segmented belt	Plates, boxes, flights	
		Roll			
		Chain	Suspended devices	Hooks, plates, buckets	
			Flights	Vertical plates, anchor	
			Magnet	Permanent magnet	
			Drag	Kart, rolls	
		Screw	Ribbon type		
			Blade type		
	Vertical	Chain	Suspended devices	Hooks, plates, buckets	
			Flights	Vertical, inclined plates	
			Magnet	Permanent magnet	
			Drag	Cart, rolls	
			Buckets	Fixed, swinging	
		Screw	Ribbon type		
Blade type					
Combined direction	Chain, cable	Up and down “paternoster”	Tray		
	Robot	Pick place			
Vibration	Horizontal	Vertical vibration	Straight trough	Electromagnetic or eccentric drive	
		Horizontal vibration			
	Inclined	Vertical vibration			
	Vertical	Vertical vibration	Circular trough		
Gravity	Inclined	Skate	Straight path, (circular)		
		Roll			
		Chute			
	Vertical	Skate	Circular path (Straight)		
		Roll			
		Chute			
Elevators	Vertical	Cable			
		Telescope mast			
Mobile media	Vertical–horizontal	Forklifts		Electric/diesel	
	Horizontal	Buggers		Diesel	
	Vertical–horizontal	Cranes, hoists			
Hydropneumatic	Vertical–horizontal	Push, pull system	Pumps, tubes,	Pumps, ventilators	



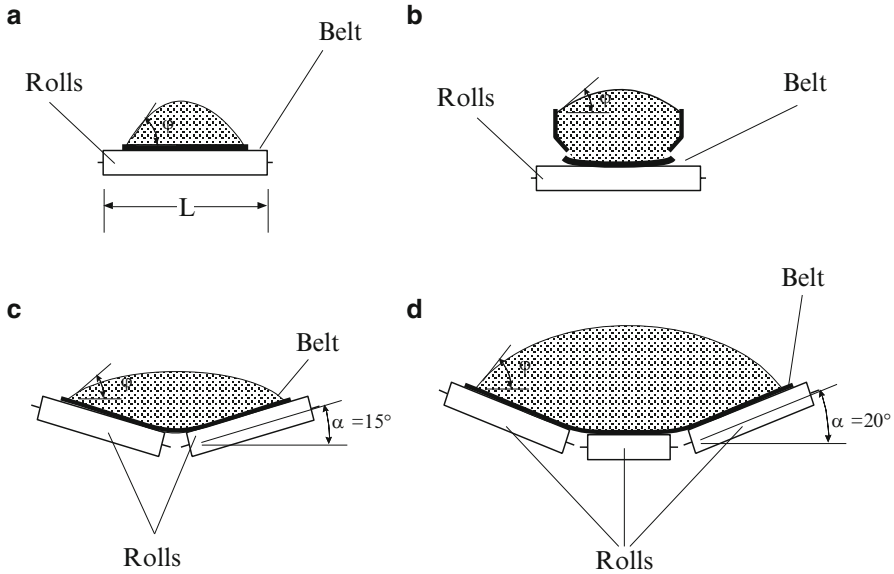
**Fig. 3.12** Belt conveyors (a), indirect drive (b), product removal (c)

### Uniform Belt Conveyors

Belt conveyors are used to convey, horizontally or inclined, granular products or larger packed or non-packed pieces. They consist of an endless belt driven by a drum (shaft) at one end of the belt, while a second drum lies at the other end (Fig. 3.12). The drum is driven either directly by a geared electrical motor (Fig. 3.12a) or indirectly by a transmission belt (Fig. 3.12b).

The belt is tensioned (stretched) by a spring mechanism, whenever necessary, due to thermal or overweight belt stresses, belt wear, or material accumulation on the shafts (drums), causing effectively an increase of their diameter. There is a wide range of belt dimensions. Belts are 0.4–2.5 m wide, they can be up to 100 m long, and their speed varies between 0 and 4.5 m/s. The length of a tensed belt can be increased by adjustment up to about 2 %. Belt loadings of various industrial products are given by Walas (1988) and conveyor manufacturers. Conveyor belts are usually standardized, e.g., DIN (Deutsch Industrie Normen) (Huette 1960).

The belts are usually made of synthetic rubber, steel, or canvass combined with steel wire and plastic materials (Perry and Green 1997). The belts can also be made of a continuous, meshed, or perforated sheet material. For hygienic reasons, plastics such as solid woven polyester and coated polyester are replacing solid woven cotton used in bakery (dough) conveyor belts. Coated solid woven polyester is resistant to stretch and to bacterial contamination, and it is cleaned and sanitized easily. The polyester is usually coated (surface of interface) with polyurethane or PVC. Its main disadvantages are edge abrasion (fraying) and difficulty in particle entrapment.



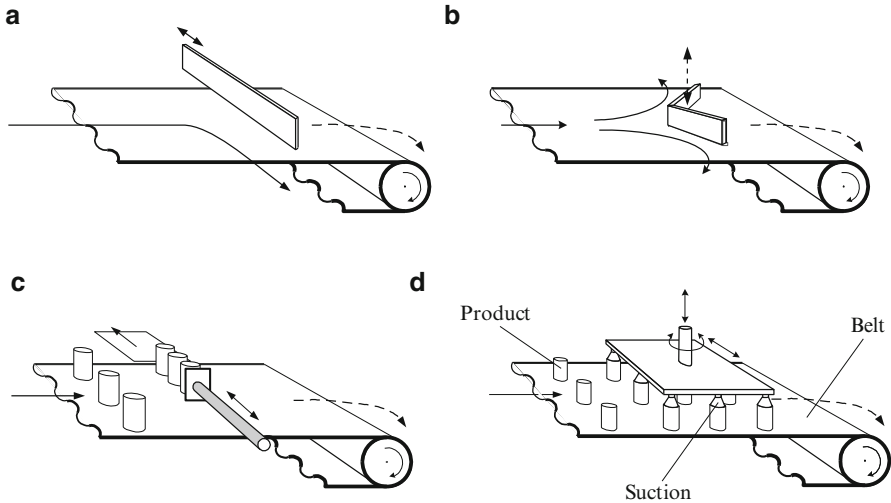
**Fig. 3.13** Supporting rolls of belt conveyors

A belt may be as long as required. However, if the length of the belt and the weight conveyed are too large, supporting rolls are necessary (Fig. 3.12a). The distance between the rolls varies according to the type and to the weight of the product. Rolls may be placed in every 0.8–2.0 m (Huette 1960) material.

The inclination of a belt depends on the material transported, and it should not exceed  $22^\circ$ . If the belts are covered with anti-slip material, or have cross slats, the inclination may increase up to  $45^\circ$  (Brennan et al. 1990). If the belts convey bulk product, the material placed on the belt must not exceed the angle of repose,  $\varphi$  (Fig. 3.13). This angle depends on the product, and it is  $10\text{--}30^\circ$ . If a larger quantity of bulk product has to be conveyed, as indicated in Fig. 3.13, more rolls are used to support the bended belt. In all cases, the rolls must be 10–20 % longer than the width of the belt (Feustel and Hemendiger 1987).

In the case that conveying is part of a processing operation of bulk products, special support devices take care for the even distribution of the food on the belt. As indicated in Figs. 3.12c and 3.14, it is possible to remove part or the whole conveyed food, at any position of the belt. Short belt conveyors can be part of a continuous weighing system (Chap. 13).

A special case of uniform belts is the magnetic conveyor. It is used in conveying empty, e.g., from a storage room to the filling station. It consists of a steel belt, rolling in front of a magnetic plate. The cans remain on the belt as long as the magnetic plate is on the other side. In such a conveyor, a 2 kW motor can transport, e.g., 600 cans per minute. Besides the significant output, an additional advantage of the magnetic conveyors is the low noise during transport.



**Fig. 3.14** Removal of products from belts

Advantages of the uniform belt conveyors:

1. Large capacity
2. No damage of transported material
3. Relatively low energy consumption
4. Possibility to remove the product at any place of the belt
5. Low maintenance cost
6. Low noise

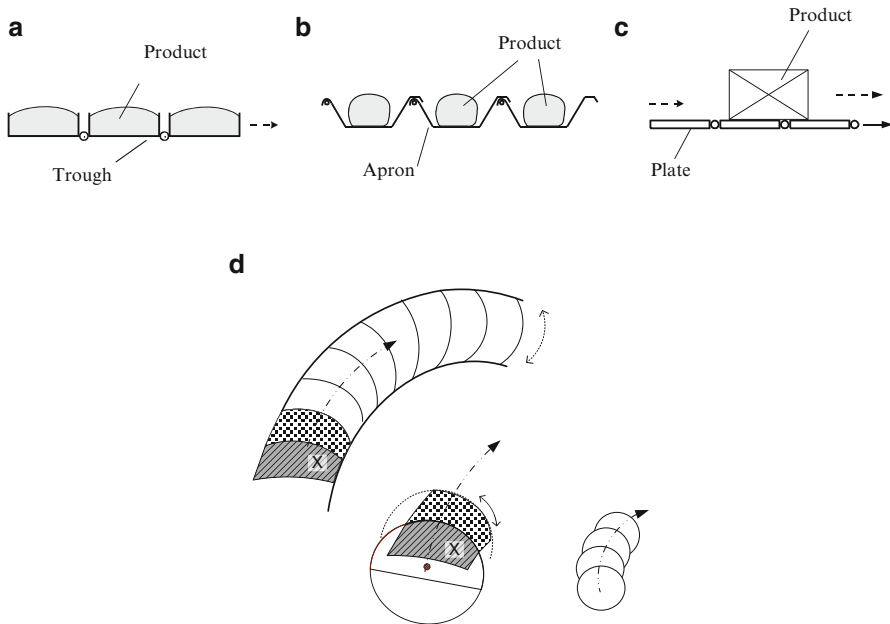
The disadvantages include:

1. Not suitable for curved paths
2. Inclination restricted
3. Not suitable for dusty products (powders)
4. Increased cost when the conveying distance is reduced

### Segmented Belt Conveyors

The segmented belts consist of adjoined segments, usually placed parallel to each other, as tightly as possible. Endless chains or cables, rolled on drums (shafts), drive the segments (Fig. 3.12d). As indicated in Fig. 3.15, the segments may be troughs (a), aprons (b), plates (c), or discs (d). In food processing, the most common types of segmented belts are the steel plate belts. They are used when too heavy products are to be conveyed, or when the temperature during conveying is higher than 100–120 °C, as, e.g., in belt ovens or belt can pasteurizers. The segmented belt can move on slide bars or on rolls at a maximum speed of 1.5 m/s (Huette 1960).





**Fig. 3.15** Segmented belt conveyors. (a) Trough, (b) apron, (c) plate, (d) discs

However, in most food processing operations, lower speed is required. Therefore, when higher capacity is required (e.g., biscuit ovens), wider belts are used. Segmented belts are usually standardized, e.g., DIN (Huette 1960).

The modular system (elements and modules, joined to form a belt) is increasingly used in the food industry. Use of small modules, e.g., 20 mm long, makes the conveyor belt very flexible. Their surface can be flat, or with flush grid, raised ribs, etc., for meeting the production requirements. Such belts have quite high open area, reaching in some cases up to 45 %. Such systems are suitable for applications where air must flow through the conveyor during processing.

Sprockets are used to drive the belts and the conveying noise is low. Side guards and flights, made of polypropylenes or polyethylene, can be easily added to the conveyors. Polypropylene has high traction resistance, high resistance to chemical agents, and good impact resistance. Both plastic materials are suitable for several food processing operations, because of their hardness, rigidity, low density, and resistance to chemical substances and temperatures up to 104 °C. Polyethylene resists fraying caused by friction and can be used at temperatures down to -50 °C. Another advantage of the modular belts is the easy maintenance (replacement of worn or defective parts). Their main disadvantage is the difficulty in cleaning.

In belt structures, the thickness of the end rolls should be reduced as far as possible. This enables the easy transfer of conveyed products from belt to belt. In belt installations, it must be taken into consideration that the curvature of the belt is

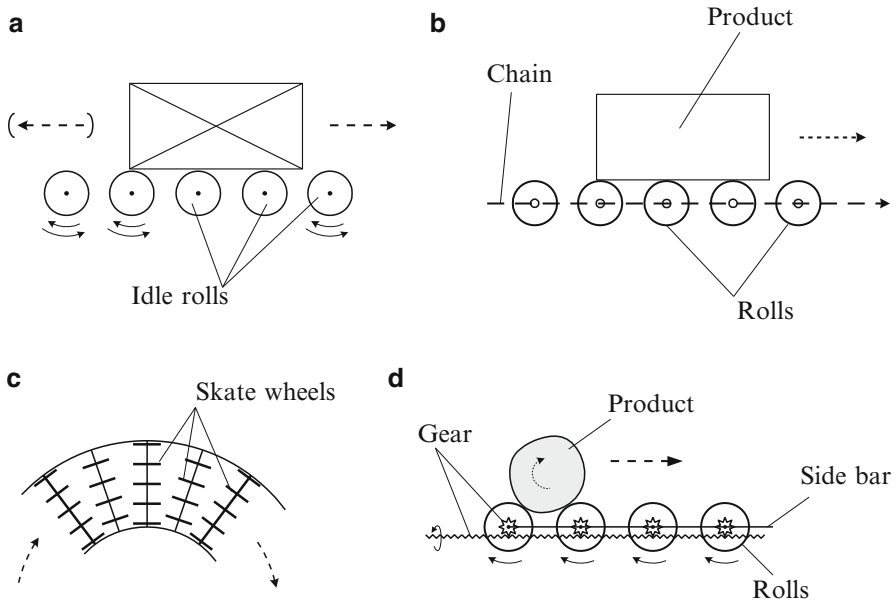
a function of its width. Usually, the radius of the curve is 1.7–2.5 times the belt width. The straight paths between two consecutive curves should be at least 2.0–2.5 times the belt width.

### Roll and Skate Wheel Conveyors

The roll conveyors consist of cylindrical steel rolls, which may be powered, or idle (Fig. 3.16a). The powered roll conveyors are chain driven (Fig. 3.16b). However, in some cases, since the rolls are locally fixed, conveying occurs by the rotation of the powered single rolls (Fig. 3.16c). Free-rotating rolls are used in conveying, using gravity. Roll conveyors are often used in conveying heavy products. Furthermore, they can be part of fruit and vegetable cleaning equipment, or they can be used in size sorting of such products, when the distance between the rolls changes progressively (Chap. 4).

Roll conveyors are manufactured in various types. For example, a roll conveyor used for inspecting boxes is split into two parts, each rolling at different speed, enabling the rotation of the boxes. Another conveyor is equipped with forklift pockets, enabling unloading by forklifts, even during conveying.

The skate wheel conveyors consist of coaxial wheels (Fig. 3.16d), which are usually idle (conveying by gravity) or chain driven. The skate wheel conveyors are more flexible than the rolls. They are mainly used in interconnecting belt conveyors



**Fig. 3.16** Roll and skate wheel conveyors. (a) Idle rolls, (b) powered rolls, (c) skate wheel rolls, (d) chain-driven rolls

and in conveying products in curved paths. The speed of belt-driven roll conveyors is 13–20 m/s (Brennan et al. 1990).

Advantages of roll conveyors:

1. Conveying of heavy products.
2. They can be powered or gravity driven.
3. It is possible to separate conveying from the drive.

Their disadvantages include:

1. They are heavy with significant inertia.
2. Their use in inclined paths is limited.
3. Their wear is significant.
4. They are quite noisy.

### Chain Conveyors

Chains are used to convey products horizontally, vertically, or inclined, in straight or curved paths. These paths may be “open” or “closed” (Table 3.7). In the closed paths, the conveyed product is confined in certain channels, such as tubes or troughs. Chains may be used in direct conveying of products or in conveying in connection with auxiliary devices attached to them (Table 3.6). The direct conveying is an “open conveying,” e.g., parallel chains on ground paths, transporting large pieces, such as barrels, milk containers, or pallets.

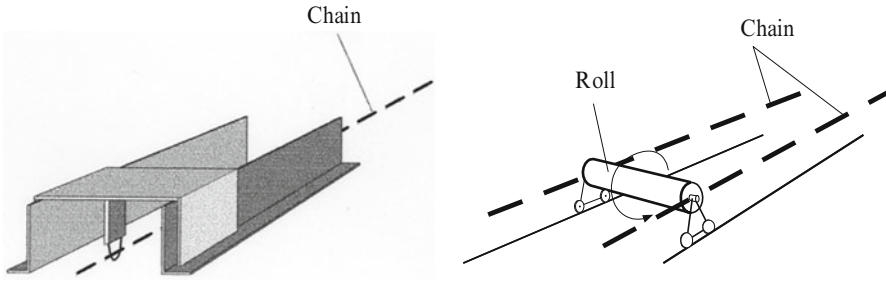
In the low level transport in the open system, buckets, rolls, carts, or plates are used. These devices move on slide ways, or they are fitted on wheels moving on rails or fixed pathways, such as grooves (Fig. 3.17). The buckets are used in conveying bulk products. The other devices are used to convey small or large pieces. In the overhead transport, the auxiliary devices are hooks or buckets.

In the closed system, example auxiliary devices of the chains are flights or anchors (Fig. 3.18). The flight conveyors can be used at a maximum inclination of 30 at speeds up to 0.60 m/s (Huette 1960; Feustel and Hemendiger 1987). They need more specific energy than the belt, but less than the screw conveyors.

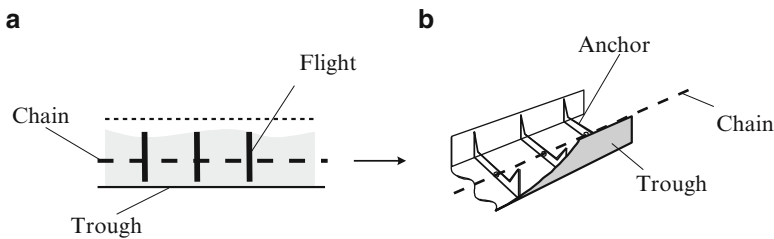
Advantages of flight conveyors:

**Table 3.7** Classification of chain conveyors

Type of chain	Path	Device
With device	Open	Bucket
		Roll
		Plate
		Cart
		Hook
	Closed	Flight
		Bucket
Without device	Open	(Chain)



**Fig. 3.17** Conveyor paths



**Fig. 3.18** Flight/anchor conveyors. (a) Flight, (b) anchor

1. High capacity
2. No dusting at conveying speeds lower than 0.6 m/s
3. Possibility to convey in air-tight troughs

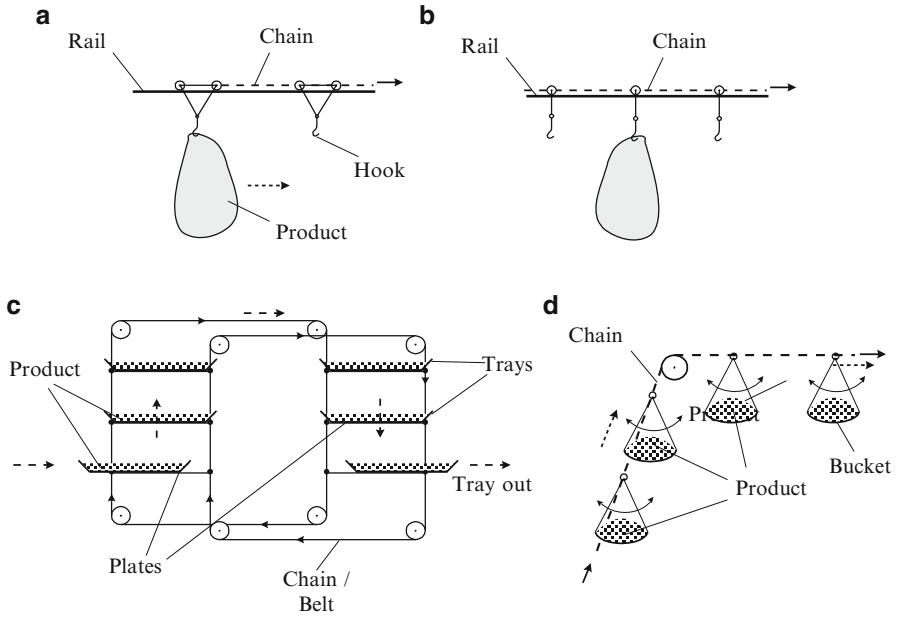
Their disadvantages include:

1. Not suitable for sticky process.
2. They are noisy.

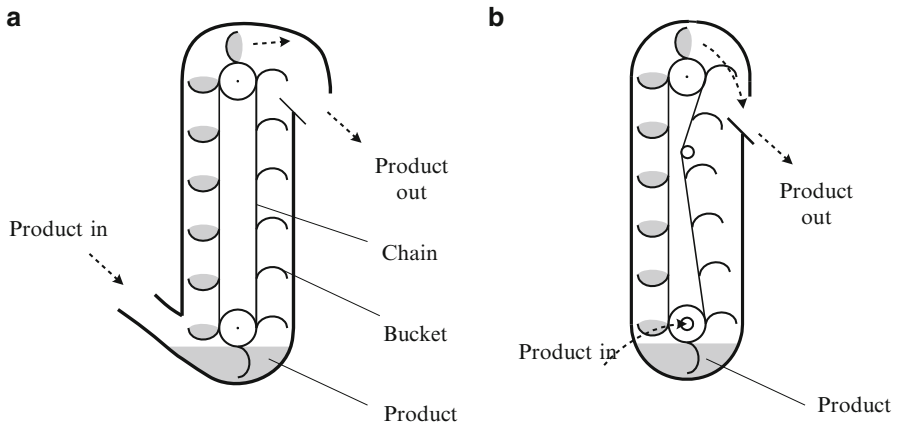
In the overhead chain conveyors, hooks, horizontal plates, or buckets are used (Fig. 3.19). These devices usually swing or are pivoted to the conveyor chain. Overhead hooks are often used in the meat and the poultry processing industries. Furthermore, they are used in conveying packaging materials in the fruit and vegetable processing plants. In slaughtering lines of pigs, overhead conveyors move at a speed of 12–16 cm/s. The horizontal plate conveyors (“paternoster”) are used to transport products in trays up and down, maintaining the horizontal position (Fig. 3.19c). The maximum speed of bucket conveyors is 1.3 m/s, when chains are used as the driving device, or 2 m/s, when belts are used (Feustel and Hemendiger 1987).

Figure 3.20 shows the mechanism of feeding and emptying of vertical bucket conveyors (elevators). Two common methods of emptying products from buckets are the centrifugal discharge (Fig. 3.20a) and the continuous discharge (Fig. 3.20b).

The bucket conveyors have the following advantages: (1) it requires less energy than the pneumatic conveyors and less space than the trough and belt conveyors and



**Fig. 3.19** Chain conveyors. (a, b) Hook conveyors; (c) up-and-down plate conveyor; (d) bucket conveyor



**Fig. 3.20** Bucket elevator feeding and discharge systems. (a) Centrifugal and (b) continuous discharge

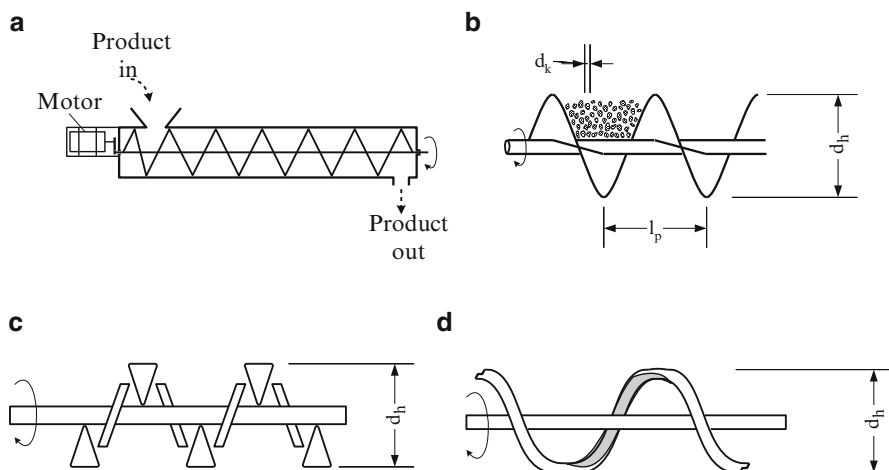
(2) vertical, horizontal, or inclined conveying is equally possible. Their disadvantages are (1) limited capacity and (2) fire or explosion danger, if the conveying system is defective or not clean.

## Screw Conveyors

Screw conveyors are used in transporting high-consistency, non-free-flowing products in all directions. However, their capacity is reduced when conveying products in inclined direction (Walas 1988). They are also used in emptying silos (Sect. 3.3.2.4 of this chapter). They consist of a helical device (shaft), rotating along the axis of a cylindrical vessel (Fig. 3.21). The helical shaft may be a screw-type spiral (Fig. 3.21a, b), a row of individual blades (Fig. 3.21c), or a continuous ribbon (Fig. 3.21d). Seats for the two ends of the helical axis are provided, if it is longer than 2–4 m. Shorter helical axes can sit on one side (end) only. The maximum length and diameter of the common types of screw conveyors, used in the food industry, are 100–120 and 40–60 cm, respectively. This conveyor type can be transported without disassembling. Assembled (immobile) conveyors may be up to 50 times longer. The diameter ( $d_h$ ) of a screw shaft depends on the diameter of the conveyed largest grain or particle ( $d_k$ ), e.g.,  $d_h = 12d_k$  for sorted large grain and  $d_h = 4d_k$  for non-sorted grain (Feustel and Hemendiger 1987). The pitch of the screw is  $l_p = (0.5–1.0)d_h$ . The speed of rotation of the screw varies from 16 to 140 rpm (Feustel and Hemendiger 1987; Walas 1988). Long screw conveying is avoided, because of the relatively high energy required due to friction and the problems that may arise, especially if dry, dust-containing products pack between the screw and the wall of the vessel. In this case, there is a danger of explosion if the temperature of the product is high or if some sparking (friction or electrical) occurs. In screw conveying of dry food, only 25–50 % of the vessel is filled. The capacity of food screw conveyors depends on the material and its condition, with a usual range of 25–40 m<sup>3</sup>/h, although higher conveying capacities are possible.

Advantages of screw conveyors:

1. Effective conveying of even packed products.
2. Good control of conveying capacity.
3. Conveying in all directions is possible.



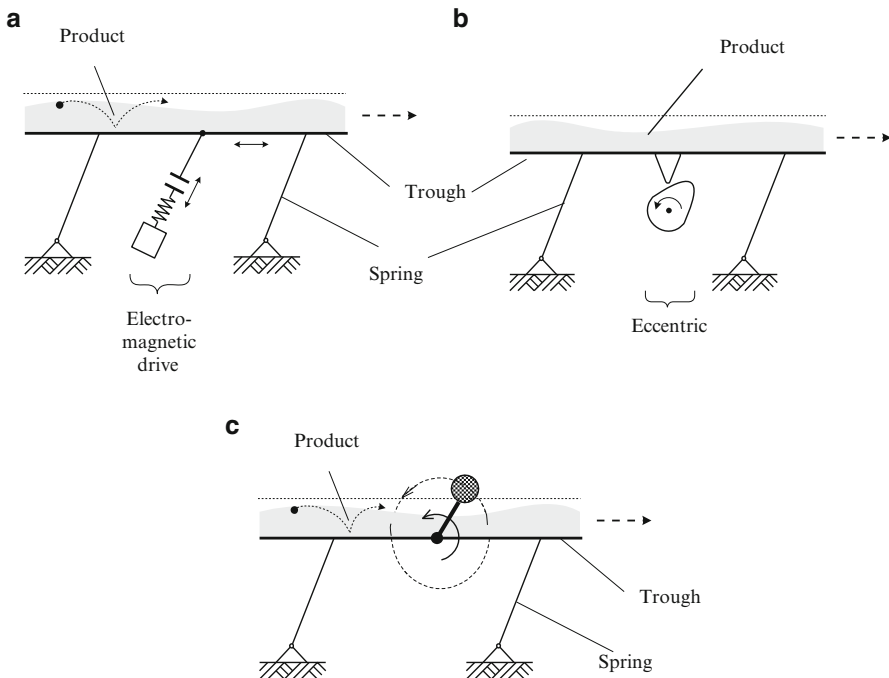
**Fig. 3.21** Screw conveyors. (a, b) Screw spiral, (c) individual blades, (d) continuous ribbon

Their disadvantages include:

1. High energy consumption.
2. Products are conveyed without much care.
3. Fire and explosion danger, if dust is packed in the conveyor.

### Vibratory Conveyors

The vibratory conveyors are used in transporting, horizontally or in inclined direction, bulk product ranging from loose materials to powders, placed in troughs or tubes. The product can be conveyed in straight, curved, or spiral direction and elevated to a new level (Table 3.6). The vibration can be vertical or horizontal (gliding transport). In the second case, if the size of the grains is not homogenous, some de-mixing of the product during conveying may take place (Hemming 1991). The vibration of the trough or tube is achieved electromagnetically or mechanically, e.g., by a rotating eccentric mechanism, e.g., out-of-balance rotating weights (Fig. 3.22). The trough or tube sits on springs. The frequency of vibration is high (up to  $6000 \text{ min}^{-1}$ ) and the amplitude does not exceed 1 mm (Huette 1960). The capacity of vibratory conveyors depends on the size and the moisture and fat



**Fig. 3.22** Vibratory conveyors. (a) Electromagnetic drive, (b) eccentric drive, (c) out-of-balance drive

content of the grains. It increases with the size of the grains and the bulk density of the product. However, high frequency and small amplitudes are preferred to prevent dusting due to friction. The vibratory conveyors may be up to 6 m long and 1.5–1.8 m wide. For longer conveying, a system of more conveyors is used. Vibratory conveyors can transport small (kg/h) to large amounts (t/h) using a relatively small motor (e.g., 3 kW). Since this type of equipment does not cause friction, it is often used in conveying sensitive products, such as potato chips. It is also used for conveying wet or even sticky grains like raisins. Due to its accuracy, it is also used in controlled feeding, such as dosing in of weigh balances (see Chap. 13).

Advantages of the vibratory conveyor:

1. They do not damage the conveyed products.
2. Good control of the flow rate.
3. Conveying in all directions possible.
4. Conveying of wet and sticky products possible.

Their disadvantages include:

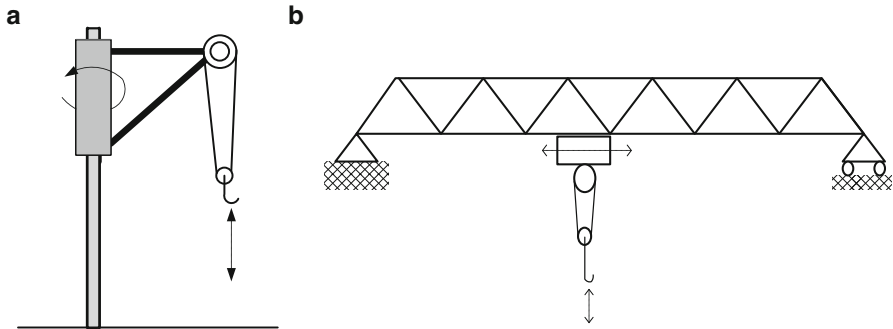
1. The conveyed product must be homogeneous.
2. Not suitable for large pieces and for long transport.
3. They are relatively noisy.

### Mobile Transport Systems, Hoists Cranes, and Elevators

For transports of bulk or packed products inside and at the site of the factory, mobile vehicles may be also used. Their main advantage is their flexibility: (a) not fixed location of the devices and (b) additional possibility of a three-dimensional transport. In the processing and storage of food inside the buildings, besides using conveyors, transport is also done by electric powered *forklifts*. They operate in almost any lift and transport application. Very important is their roll in the transport and placement of already palletized products (boxes, bags, etc.) in cold stores, in other storage operations, in the transport of materials required in several processes, and in loading/unloading of lorries. The load carried and elevated by forklifts depends on the end height of the products that are moved. For 3–4 m height, the load is usually about 2–3 t. Outside of the processing area, the forklifts usually have diesel engines. In short distance, transport of not very heavy loads is done by man-moved carts, small wagons, and low-lift pallet fork trucks.

For heavier products in permanent operation, *hoists* and *cranes* may be also used (Fig. 3.23). The ceiling-mounted cranes are more seldom in food processing. They are mainly used in loading/unloading operations such as large amount of bulk products or packed products placed in large shipment containers. The transport in vertical direction may be also done by elevators. There are two main types of elevators. Those that operate using cables and those equipped with hydraulic





**Fig. 3.23** Hoists (a) and cranes (b)

pressure telescope masts. The last ones are used in minor heights. In some cases such as storage of Swiss-type large round hard cheeses and in logistics in which the products are stored in shelves, the work is done by robots or mobile elevators operating between the shelves. In very large storages, the elevators oscillate on railways, placed in the very narrow corridors between the shelves, and the height of the storage room/shelves sometimes exits 30 m. The whole process is computer aided and full automated.

### Robots

In short distance, robots are also used in transport such as pick and place operations. This is either done as part of food processing (e.g., sorting) or at the end of applications such as filing and palletizing of ready products. More about robotics is described in Chap. 12.

### Hygienic Considerations

Perishable foods should be transported fast, avoiding microbial or chemical/bio-chemical deterioration. Fresh foods, such as fruits and vegetables, should not be bruised or damaged mechanically by the conveying equipment.

Belt conveyors are more hygienic than other mechanical transport equipment, e.g., screw conveyors. Smooth belts can be kept more hygienic than segmented, indented, or screen (perforated) belts, which can hold food residues, supporting microbial growth. Plastic and Teflon-coated belts may develop cracks, where food residues may adhere, resulting in undesirable microbial growth. Belts are cleaned and washed with detergents and water, using mechanical scrubbing devices, and installed at the return loop of the belt (Troller 1993). Antimicrobial substances, such as triclosan, could be used to sanitize the belts, provided that they are approved by public health authorities.

### 3.3 Food Storage Equipment

#### 3.3.1 Introduction

In food processing and manufacturing, storage may be short or long term. Short-term storage may be a preliminary stage of processing, as in the case of milk and tomato manufacturing, or it may be involved in a later stage, as in the case of adding supplementary substances. Long-term storage is used in securing a continuous flow of raw material in manufacturing, as, e.g., in the case of grains or in the storage of aseptically filled concentrated juice in tanks. In long-term storage, measures must be undertaken for protecting the product from spoilage or degradation.

In food processing, stored food may be solid, liquid, or viscous. Furthermore, for some applications, gases may be also stored. Storage equipment of solids includes silos, bins, boxes, and bags. Storage of liquid food may be done in vats, tanks, and large pouches (Table 3.8).

Storage equipment is distinguished between large scale (silos, tanks) and small scale (pallets, boxes, vats).

There are regulations defining the maximum dimension of large equipment, e.g., mobile tanks. The Euro-pallet has been adopted as an international standard (ISO). Regulations restrict the smallest dimension of European inland containers to 7.15 m.

Small containers are very popular for in-house transport and distribution of food products in urban areas. European regulations on small containers were established recently, following the recommendations of the cooperative research project COST 339 (2001).

#### 3.3.2 Storage of Solids

##### 3.3.2.1 Pallets

Pallets are usually made of wood, but there are also pallets made of cardboard, metal, and plastic materials. The metallic pallets are usually made of aluminum, while plastic containers are usually injection molded. ISO recommends pallet dimensions of  $0.80 \times 1.20$ ,  $1.00 \times 1.20$ , and  $1.0 \times 1.80$  m (Paine 1996). With respect to the direction of entry of the forklift, pallets are usually distinguished in

**Table 3.8** Basic types of food storage equipment

Product	Storage equipment
Solids (pieces, grains, powders)	Pallets, box pallets, bags, bins, silos
Liquids (low and high viscosity)	Vats, vessels, tanks, drums, pouches
Gases (air, N <sub>2</sub> , CO <sub>2</sub> , steam)	Tanks

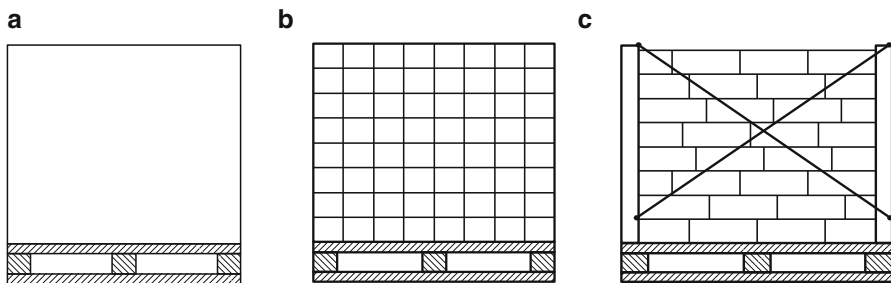
two- and four-way pallets. The main factors influencing pallet selection are use, firmness, and cost.

The use and firmness determine the service life of a pallet. Two main pallet categories are used, the single use (one way) and the reusable (return) pallets. Furthermore, there are pallets that are used mainly in transport or in long-term storage. In the second case, it is important to know the storage conditions (moisture, humidity, and temperature). The firmness of pallets is affected by vibration, e.g., during transport, and by the way they are loaded. Cross positioning of boxes (as in bricklaying of a wall) causes less stress to the pallet than serial placing, since, in the second case, bending of the pallet may occur, due to divided load. Pallets must also resist puncturing, caused by forklifts. For a construction material, e.g., wood, the pallet firmness is related to its weight. However, heavy pallets add weight in transport, and in cases such as cold storage, they require more refrigeration. This can be significant, especially if pallets are wet, since the weight of, e.g., a 30-kg wood pallet may increase by more than 5 kg if it is wet (Paine 1996). Furthermore, moisture causes rotting of the pallet, by shrinking when dried, and may affect the food, if mold is formed. For reusable pallets, repair cost and cleaning should be taken into consideration.

The cost of pallets increases with their firmness. However, a detailed analysis is required for finding the most profitable pallet storage, especially when choosing between one-way and reusable pallets.

### 3.3.2.2 Box Pallets

Box pallets are used in short- and long-term storage (e.g., fresh fruits, raisins, beans). They are either large boxes placed on pallets (Fig. 3.24a) or boxes incorporating pallets. Compared to bulk and silo storage, their advantages include (1) control of material losses due to spoilage, (2) increased processing flexibility, (3) they can be stacked, and (4) stored material less abused by mechanical stresses, meaning it can be aerated better.



**Fig. 3.24** Box pallets. (a) Pallet with box pallet on, (b) mesh wire box pallet, (c) pallet with superstructure

The disadvantages of box pallets are that (1) they need more floor space and more refrigeration load in cold storage, (2) they require more labor in handling, and (3) they are more expensive.

### Characteristics of Box Pallets

With respect to forklift handling, box pallets are distinguished, as in the case of plain pallets, into “two-way entry” and “four-way entry” units. Furthermore, there are simple box pallets; mesh wire containers, with fixed or collapsible walls (Fig. 3.24b); and pallets with superstructure (Fig. 3.24c), which have steel posts on the four corners, allowing much higher stacking. The last ones allow much higher stacking. Smaller box pallets can have wheels when it is required to be moved around in short distances.

Box pallets are made of wood, metal, or plastic materials. They may be constructed in any size, but the popular pallet dimensions are  $1.2 \times 0.8$  m (“Euro-Pallet”),  $1.2 \times 1.0$  m,  $1.2 \times 1.2$  m, and  $1.0 \times 1.0$  m. Since the products should not be stacked very densely, the height of box pallets is usually not more than 0.7 m.

The capacity of the box pallets depends on the bulk density of the product. For example, a “Euro-pallet” may store about 200 kg of fruits (e.g., apples, oranges), 460-kg legumes/pulses, or 350-kg raisins.

### Selection and Use of Box Pallets

Selection of box pallets depends on the products, firmness, transportation, available storage space, and environmental conditions.

With respect to the products, a maximum storage height should be maintained for avoiding squeezing or temperature rise. The height of food products, such as fruits, potatoes, and raisins, stored in box pallets, usually should not exceed 0.6–1.1 m. Metallic or plastic box pallets should be preferred when, e.g., sticky products like raisins are stored. If good aeration is required, as in the case of cold storage of fruits, the side walls of the boxes should be permeable, so that air may flow easily through the products.

If the frequency of handling and stacking is high, rigid box pallets (e.g., metallic or wooden) should be preferred. The kind and type of transport should be considered (forklifts, cranes). Two-way box pallets facilitate handling. When cranes are to be used, grips or other suitable handles should be provided.

The condition of room and space in which the box pallets are stored must be taken into consideration, e.g., transport corridors, easy stacking, and space for provisional storage.

Measures to reduce or avoid insect or animal (e.g., rodent) infestation and temperature and humidity control must be taken into consideration (e.g., disinfecting, covers on boxes, aeration, air conditioning, insulation, sun radiation reflecting roofs).

### 3.3.2.3 Bags

Bags are usually employed in short-term storage of powders or granulates. Bags are mostly square based, with one or two spouts on the top and the bottom. The larger bags may have some emptying arrangement, attached in their hopper. When transported or stored, bags may be hung from grips. Bags with only one spout may be hung from both sides (bottom and top). Very large bags may incorporate a steel frame.

Below are the advantages of bags:

1. They are easily filled, emptied, and transported, while hung.
2. The product is protected against insect/animal infestations.
3. They do not need much space for storage and emptying.
4. They increase manufacturing flexibility.

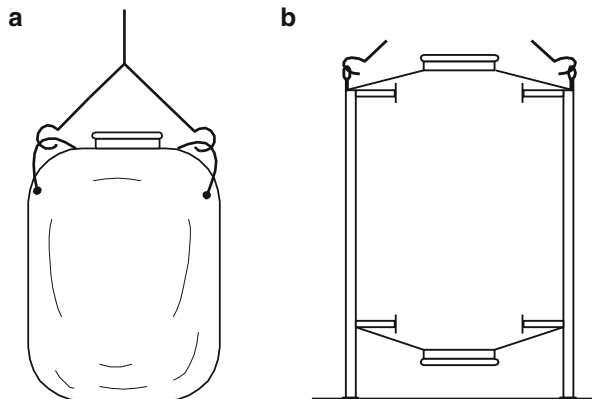
Their disadvantages include the following:

1. They are relatively delicate against external mechanical abuses.
2. They cannot be stacked very high.
3. The storage space is not utilized very efficiently.
4. Special supporting and hanging structure is required for extending their application.

#### Characteristics of Bags

There are simple bags or bags externally supported by a metal structure, e.g., hanging on a metallic frame (Fig. 3.25). Bags are made of simple plastics, woven plastic textiles, or multiply texture combinations, e.g., plastic/aluminum/plastic for juice concentrates.

**Fig. 3.25** Storage bags.  
(a) Simple bag; (b) metallic support structure



Depending on the type of bags, the popular dimensions, without metallic support, are 0.8–1.2 m (base) and 1.0–1.2 m (height). Bags with metal frame structure: 1.5–3.0 m (base), 2.0–7.0 m (height).

The capacity of bags depends on the type of bag and the bulk density of the product. For storage of grain (bulk density,  $800 \text{ kg/m}^3$ ), simple bags have a capacity of 1–2 t. Bags with metal structure support may have capacities 2.5–25 t.

### 3.3.2.4 Bins and Silos

Bins and silos are used in storage of large quantities of powder and granular food (flour, grain, etc.). Table 3.9 indicates some of the commonly used bins and silos.

Bins are smaller than silos and may be stationary or movable. Transport is carried out by hoists or forklifts, when the bins are not very heavy, e.g.,  $< 2 \text{ t}$  (Fig. 3.26). Bins are used for short-term storage, e.g., silo grains before shipment, or for blending products in powder or granular form. Silos are constructions enabling long-term storage of dry flowable food materials, such as grains. Sometimes, the silo contents are renewed steadily, as inflow and outflow of the material can take place at the same time.

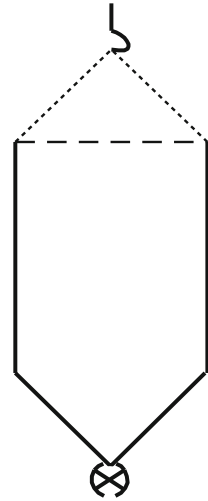
The following are the advantages of bins and silos:

1. Great variation of stored quantities.
2. The stored products are well protected (weather, rodents, etc.).
3. Reduced handling cost due to automation.

**Table 3.9** Classification of bins and silos

Characteristics	Type of bin or silo			
Capacity	$< 2 \text{ t}$	2–500 t	500–3000 t	$> 3000 \text{ t}$
Installation	Elevated	Elevated or on the ground	On the ground	On the ground
	(a) Legs			
	(b) Brackets			
	(c) Hanged			
Shape	Cylindrical or rectangular	Cylindrical or rectangular	Cylindrical or rectangular	Cylindrical
Mobility	Fixed or movable	Fixed or movable	Fixed	Fixed
Lower part	Hopper	Hopper	Hopper or flat	Flat
Emptying	By gravity	Auxiliary mechanisms	Auxiliary mechanisms	Auxiliary mechanisms
Location	In buildings or shelters	In buildings or shelters	In buildings or shelters	Outside
Material of construction	Steel/aluminum/plastics	Steel/aluminum	Steel	Steel/concrete
Conditioning	Product aeration	Product aeration or circulation	Product aeration or circulation	Product circulation

**Fig. 3.26** Transportable bin



4. Reduced ground/floor space requirement.
5. They may be installed outside the buildings.
6. Extension of total capacity by adding new units.

The disadvantages include:

1. Relatively low flexibility, with the exception of mobile bins.
2. Additional equipment required for filling, emptying, and aeration.
3. Significant running cost due to conditioning of stored products and maintenance cost, especially for auxiliary installations.
4. Precautions must be taken to prevent dust explosions.

#### Characteristics of Bins and Silos

Bins are mainly cylindrical tanks, with a hopper underneath. Silos are cylindrical or rectangular fixed constructions, with or without a hopper. Bins and silos have a hopper when they are elevated, i.e., when they stand on supporting pillars/legs or on brackets (Fig. 3.27). Depending on the way they are filled, e.g., free falling/dropping of product or product transported and filled pneumatically, their roofing can be conical or flat. Conical roofing is used when powders and granulates drop from one filling funnel into the bin, forming a product cone on the upper surface. The angle of the base of this cone is then the angle of repose (Perry and Green 1997).

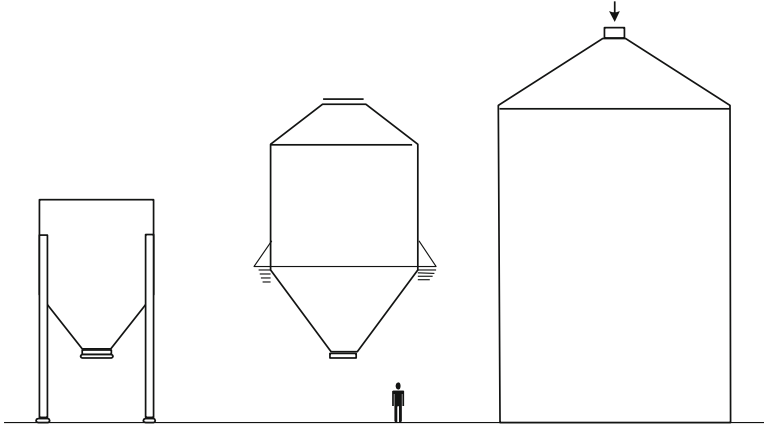


Fig. 3.27 Bins and silos

### Construction Consideration

Materials of construction for bins and silos include aluminum panels, galvanized steel panels, glass fiber, and reinforced plastics (smaller bins). Panel sheet joints are bolted, riveted, or welded.

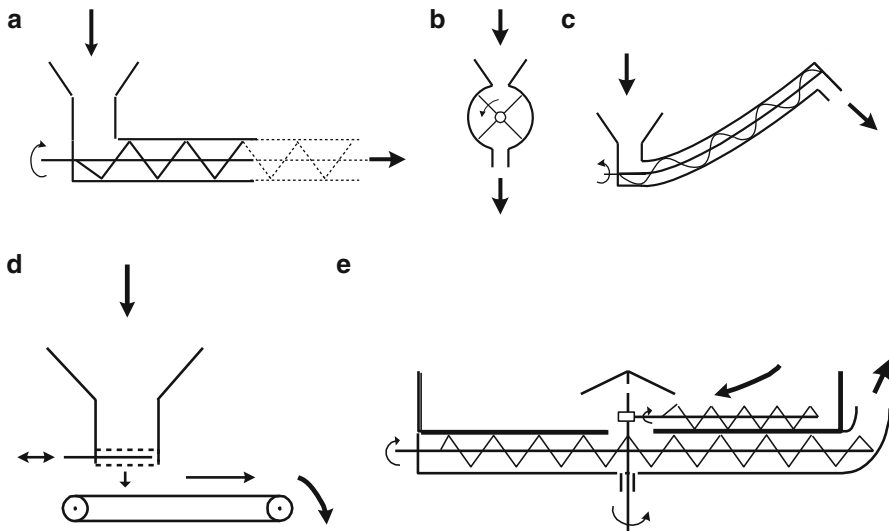
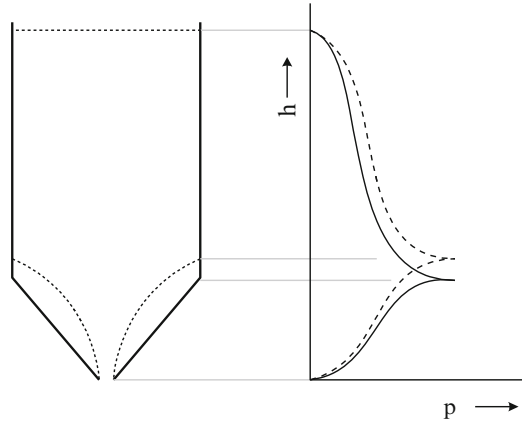
The dimensions of bins depend on their utilization. The diameter of the larger units is up to about 13 m, and the total height may be more than 18 m. An example of dimensions of a typical 500-t bin for grain is the following: cover height, 1–2 m; height of cylindrical part, 8–9 m; height of hopper, 4–5 m; and diameter, 2.7–3 m. Grain silos can be much larger, and their diameter and height may both exceed 24 m.

The capacity of bins varies from about 20 to 1000 t. Silos may be as large as 13,000 t.

Most bins last at least 20 years and most fans and motors about 5–10 years (Wilcke 1998). Since silos are installed outside of buildings, their construction materials should be corrosion resistant. Furthermore, since abrasion of silo walls, due to movement of granulates or powders, takes place, friction-resistant materials should be used. Pahl (1989) recommends for hoppers, which are more than any other silo parts affected by abrasion, the use of aluminum alloys and stainless steel. Sturdy constructions are also important because of external and internal pressures, such as wind, earthquakes, and pressure of products on the walls. Standards, e.g., the Australian Earthquake Code AS 2121 SAA for commercial silos and the Farm Silo Standard AS 2867, should be also taken into consideration, as far as possible. Side pressure on the silo wall increases from the upper surface of the product downward, reaching a maximum value at the point the hopper meets the cylindrical part of the silo. If during the emptying process, instead of mass flow, funnel flow takes place, the maximum point may be effectively moved further up (Fig. 3.28) (Stiess 1992; Pahl 1989; Dialer et al. 1984). Therefore, besides measures for avoiding funnel flow, measures for strengthening the whole construction should be considered,



**Fig. 3.28** Wall pressure in silos



**Fig. 3.29** Equipment for emptying of silos. (a) Screw feeder, (b) star feeder, (c) spiral feeder, (d) belt feeder, (e) planetary movement feeder

e.g., placement of metal rings in the silo circumference and use of corrugated sheets. Erection of silos and bins is easier, if the metallic sheets are screwed together. However, welded air- and dust-tight bins should be preferred, especially for short-term storage of very hygroscopic foods, such as fine sugar or flour.

**Emptying of Bins and Silos**

Emptying of bins and silos may be controlled through special arrangements at the lowest part of the hopper (Fig. 3.29). In some cases, these arrangements are also useful in blending operations. Examples of such mechanisms are screw feeders,

flexible spiral feeders, belt feeders, and star feeders (Perry and Green 1997). The capacity of a screw feeder, used in blending, may be up to 30 kg/h, if high accuracy (e.g., 1 %) is required. For silos without hopper, screw arms of planetary movement may be installed. Such screws rotate around the main axis of the cylindrical silo, in a very short distance from its base, sweeping all material toward a funnel hole, from which the material is then discharged. A 10-kW powered screw, rotating at 5–250 rpm around its axis, is adequate for discharge. Flexible spiral feeders may discharge and at the same time transport the material to a distance of 12–30 m. A combination of more such units may extend this length up to 80 m. The capacities may vary from 20 kg/h to 10 t/h. The pipes in which the screw spiral rotates may be 20–150 mm in diameter. As an example, for transport of 6 t/h to 10 m high, a power of 3 kW is required.

### Environmental Considerations

For long-term storage in silos, products must be flowable and resistant to spoilage. Therefore, products that are qualified for silo storage are low-moisture powders and granulates. The product's water activity ( $a_w$ ) plays an important role in silo storage (Table 3.10). Molds and yeasts may cause damage if  $a_w > 0.60$ –0.70. Caking and lumping of food particles may take place, when  $a_w > 0.35$ –0.50. When crystalline dried products, like sugar, are stored, sugar recrystallizes if its critical  $a_w$  is reached. The presence of sugar in starch increases cohesiveness.

Temperature fluctuations due to climate changes (e.g., significant temperature differences between summer and winter, day and night) should not influence the silo contents, since they cause migration and condensation of moisture on the coldest surfaces, resulting, e.g., in growth of molds in grains, flour, and sugar (Matz 1988). During summer, moisture in silos tends to accumulate on the top, while in winter, it tends to be accumulated on the side walls of the silos (Cloud and Morey 1991). It is important to equalize temperature differences in products stored in silos. This may be achieved by means of aeration or recirculation of the product. In extreme climates, bins are sometimes insulated or put in shelters. Aeration is done by means of perforated ducts at the bottom of silos. Air is blown slowly by radial ventilators. Recommended air flow for grains is 14 m<sup>3</sup>/h/m<sup>3</sup> of grain (Wilcke 1998; Cloud and Morey 1991). Aeration starts as soon as grains are stored and lasts

**Table 3.10** Equilibrium moisture content of grain at 15.5 °C

Product	Relative humidity (%)			
	50 %	60 %	70 %	80 %
Moisture	50 %	60 %	70 %	80 %
Corn	11.4	12.9	14.5	16.4
Wheat	12.3	13.7	15.2	16.9
Soybeans	8.6	10.5	12.8	15.7
Sunflowers <sup>a</sup>	–	8.0	10.0	12.0

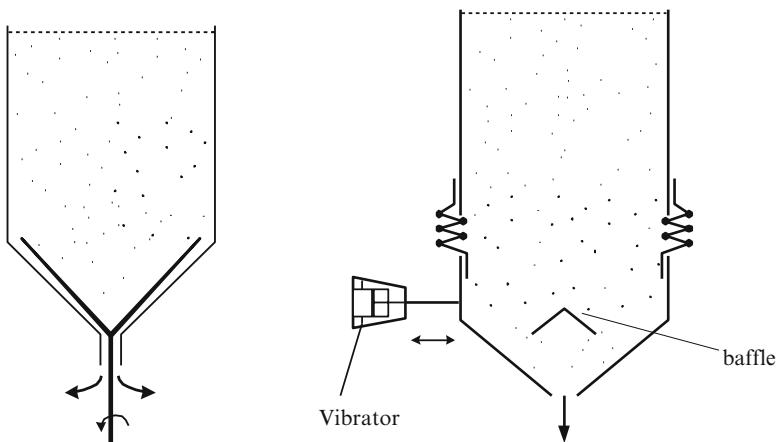
Data from Cloud and Morey (1991)

<sup>a</sup>Estimation based on comparative storability

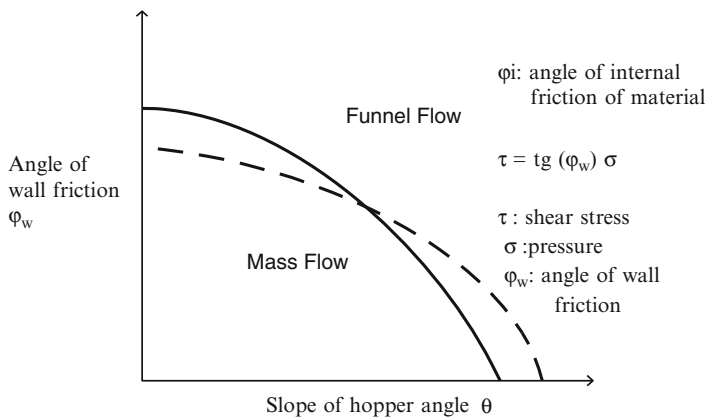
about 24 h. Thereafter, the frequency and duration of ventilation depends on the moisture content, the water activity of the product, and the temperature and humidity of the air. The ambient air temperature must be lower than that of air present in the grain. This way the ambient air, which is more dense, flows toward the wall of the silo displacing the warm air on its way upward. At ambient air temperature of about 15 °C and grain moisture of 16 %, a 24-h ventilation every 14 days is recommend. If moisture content rises to 18 %, a 24-h ventilation every 7 days is required. Aeration increases also the flowability of grain. For 1-year storage, the moisture content of grains should not exceed 13 %.

### Material Flowability

Flow properties of products are enhanced, when they are stored in air-tight silos (reduced environmental moisture absorption) and when bins are well aerated. Furthermore, smooth or even polished material surfaces and right hopper construction reduce the danger of funnel flow during emptying of silos (Stiess 1992). The angle of hoppers is usually 45–60°. Additional measures can be applied or increase flowability (Rumpf 1975; Perry and Green 1997). Some of these measures are as follows (see also Fig. 3.30): (1) addition/mixing of anti-caking fine powders, which impede agglomeration of granulates, e.g., addition of 3 % starch to sugar (Matz 1988); (2) blowing air upstream, which reduces the bulk density of granulates; (3) use of rotating “scrapers,” placed at the lower part of the hopper; and (4) use of storage “activators,” consisting of a flexible vibrator and a curved baffle, attached to the lower part of the hopper. The vibrator produces horizontal thrusts, which vibrate the activator, without influencing the rest of the bin. The curved baffle of the activator resolves the horizontal thrusts into strong vertical impulses. Usually, a vibrator can be operated continuously for 20,000 h.

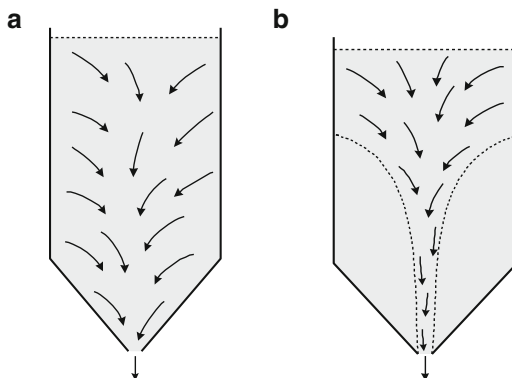


**Fig. 3.30** Measures for increasing flowability



**Fig. 3.31** Borders between mass and funnel flow in silos

**Fig. 3.32** Mass (a) and funnel (b) flow in silos

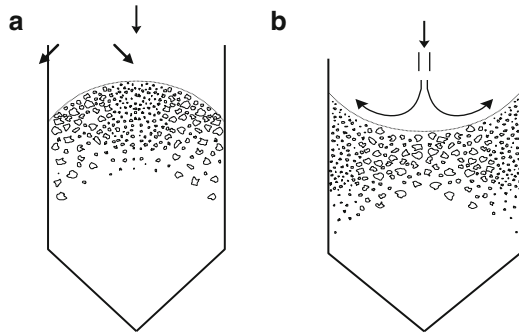


The factors influencing the flow of powders and granulates are analyzed by Rumpf (1975), Dialer et al. (1984), Stuess (1992), and Perry and Green (1997). All these analyses are based on the fundamental work of Jenike (1970). For good material flow, it is important to establish conditions of mass flow. Figure 3.31 indicates the borders between mass and funnel flow with relation to the hopper's angle  $\theta$ , the angle of friction of the material on the silo wall  $\varphi_w$  (kinematic friction), and the angle of the material's internal friction  $\varphi_i$ .

The flowability of particles (powders) is measured by various methods, including shear stress, Hausner ratio (tapped over loose packed particles), compression tests, static and dynamic angle of repose, funnel discharge tests, fluidization index, flowability tests, and rheological measurements (flow behavior index), (de Jong et al. 1999).

If funnel instead of mass flow of product takes place (Fig. 3.32), interlocking and friction of particles may form product arches/bridges in the silo, inhibiting material flow (Perry and Green 1997). In the case that the stored food does not

**Fig. 3.33** Nonhomogeneous filling of silos. (a) Free flow, (b) pressure flow



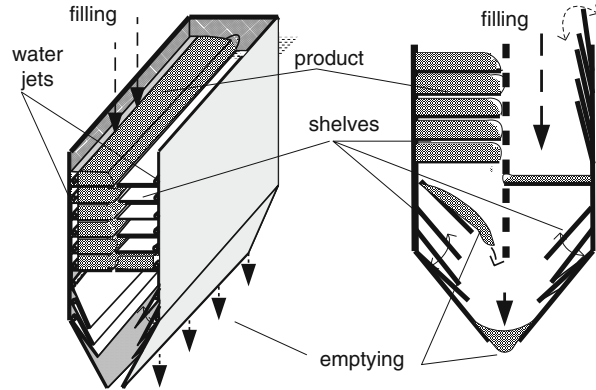
consist of homogenous granulates, the material flow may also depend on the size distribution of the granulates. With respect to the size distribution of granulates, non-homogeneity may be developed during filling of the silo. During free dropping, e.g., when a cone with the angle of repose is formed on the top of the heap, larger granulates may roll down to the side wall of the silo (Fig. 3.33) (Pahl 1989).

### Safety Considerations

Silos are one of the most dangerous equipments in the food industry. According to a report of the Health and Safety Executive UK (HSE 1994), 22 % of all fatal injuries of the food industry are caused with respect to silos. Therefore, special caution is required when personnel enters a silo. External and internal ladders must exist, and personnel should never work alone or enter silos during filling or emptying operations. Furthermore, filter respirators must be worn when presence of mold spores is suspected (Cyr and Johnson 2000). When powders are handled and stored, attention must be paid so that dust and air do not form explosive mixtures. Food belongs to weak explosion materials as its  $K_{st}$  value (bar m/s), which is an indicator of explosive mixtures (HSE 1996), is between 0 and 200. Nevertheless, explosion in silos may take place, if a critical fine powder-air mixture is present. Sudden collapse of product arches and bridges that may exist in silos supports such conditions. In all cases that fine dust-air mixture (e.g., higher than  $20 \text{ g/m}^3$ ) and high temperatures ( $>200 \text{ }^\circ\text{C}$ ) exist, a spark that may come up due to electric defects or friction between metals (e.g., handling equipment) can cause hazards. Therefore, dust collecting silos and bins must be equipped with explosion relief valves (HSE 1996) and be constructed according to appropriate standards such as BS 6467, Parts 1 and 2, for dust protected electrical equipment, and ANSI/NFPA 61-1995, referring to the prevention of dust explosions in agricultural and food product facilities.

For the storage of adhesive grain products such as dry grape raisins, the following silo has been proposed (Fig. 3.34). Such a silo protects the product up to its final processing and packaging, it allows a flexible handling of the product,

**Fig. 3.34** Filling and emptying of a silo for the bulk storage of adhesive corn products (raisins)



and it contributes in full automation, from storage up to the final packaging operation, improving the final quality of the processed raisins (Kostaropoulos and Saravacos 2003).

### 3.3.3 Storage of Liquids

#### 3.3.3.1 Vats and Vessels

Vats and vessels are used for temporary storage of relatively small quantities of liquid or highly viscous foods such as concentrated juice, fruit pulp, processed cheese, dough, etc. Vats and vessels are also used as auxiliary equipment in food processing. Some examples in which vats or vessels are used as auxiliary equipment are cheese processing (cutting of crude cheese), filling of marmalade, sausage processing, and several kinds of mixing. The upper ends of types of both equipments are open, but often covers are used.

The product kind, handling, and application determine the form and dimensions of a vat. If vats are used for draining processes, the relation of surface to height must be as large as possible.

The criteria of selection of vats and vessels are (1) product to be stored, (2) handling of the product, (3) environmental conditions, (4) materials of construction, and (5) hygienic considerations.

The advantages of vats/vessels are:

1. Economic storage of small quantities.
2. Flexibility, especially when mobile and the stored product can be carried to the final processing place (e.g., filling).
3. Transport of mobile units with forklifts or hoists is possible.
4. Better utilization of the processing site, e.g., elevation or hanging of vats, close to the main processing equipment.
5. Reduced risk of quality damage. For example, if some product happens to be of inferior quality, there is no risk of mixing it with the rest of the stored material.

The disadvantages of vats/vessels are as follows:

1. More costly, when large quantities are handled, e.g., a large silo costs less than three smaller units of equal total capacity.
2. Maintenance is more expensive.
3. More skilled personnel are required.
4. Danger of post contamination.
5. More space is required for large quantities, if used on the plant floor.

### Basic Characteristics

Vats or vessels may be fixed or mobile. Fixed elevated vats or vessels usually stand on metallic legs. Vessels that have free space underneath are supported by brackets. Mobile vats may have wheels at the end of their legs, directly below the vat, or they may be placed on mobile frames (Fig. 3.35). Vats and vessels can be also jacketed, when their contents are cooled, heated, or maintained at a constant temperature (see also heat transfer equipment, Chap. 6). Sometimes, such equipment is also insulated. Most vats and vessels have a circular perimeter, because (a) curved surfaces withstand better mechanical or thermal stresses and (b) they are easier cleaned up. However, there are some cases in which rectangular shape is also used. This happens, e.g., in curd draining vats or vats in which salting of cheese, packed in rectangular forms, takes place. Some jacketed equipment is rectangular, but the bottom may be curved. The bottom of vats and vessels may be spherical, inclined, regular, or irregular conical (Fig. 3.36).

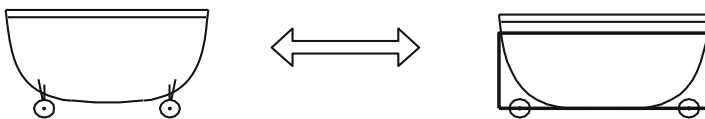


Fig. 3.35 Mobile vessels

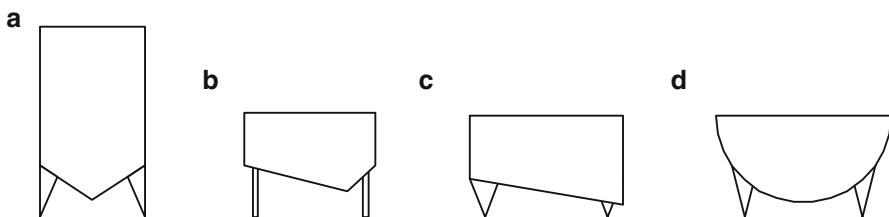


Fig. 3.36 Bottoms of vessels. (a) Regular conical, (b) irregular conical, (c) inclined, (d) spherical

## Construction Considerations

Most vats and vessels used in the food industry are made of stainless steel. Since products do not stay long in such equipment, usually AISI 304 stainless steel is sufficient. In some cases, plastic materials such as glass fiber strengthened polyester or aluminum are also used. For constructions, often 2–3-mm stainless steel sheets are used. The upper edge of the vats is commonly finished with a round rod, continuously welded to the body. For lifting, tipping, and emptying the vat contents, special lugs must be provided. Whenever frames or legs are used, for hygienic reasons, they are made of tubular steel or a similar structure without corners. In some cases, adjustable, e.g., ball-type feet, is used for adjustment of the equipment height. When insulation is used, this must be adequate and protected from moisture or mechanical damage. Therefore, it usually has a moisture barrier on the outside surface and is totally enclosed between two stainless steel surfaces. The outside surface is sometimes made of aluminum. The type of insulation that may be used for vats and vessels depend on the temperature difference between product and ambient temperature. For equipment maintained in the range 5–40 °C, a 50-mm thick glass fiber or mineral wool gives adequate heat protection. The thermal conductivity of mineral wool is similar to that of glass fiber, i.e., 0.033 W/m K at 15 °C (Perry and Green 1997).

In short-time storage of several liquids or semiliquids, coated carbon steel (e.g., glass or plastic-lined surface) or aluminum may be used. A less expensive material for vessels is plastics. Polyethylene vessels of food grade (without toxic plasticizers) may be used in four-way pallet containers for liquids with capacities of 800–1300 L. Such containers are lighter than the metallic ones, although for rigidity, wall thickness up to 1.25 cm may be required. One-piece construction (pallet container) and incorporation of heavy-duty ball valves and quick couplers increase the flexibility of such vessels. In some applications, vats and vessels should enable, if required, a safe switch for additional equipment, e.g., agitators.

The capacity of large cylindrical vats varies from 1000 L to more than 5000 L. Common dimensions of such vats include: diameter, 1.2–3.0 m and height, 1.0–1.2 m. Rectangular vats of the same capacity can be 1.0–7.0 m long, 1.0–1.5 m wide, and 0.5–0.7 m high. Smaller vats can have a capacity of 250–1000 L. For example, the dimensions of a 500-L cylindrical vat include: diameter of 0.70 m and height of 1.30 m. The capacity of small vessels may vary from 150 to 1000 L.

## Processing Aspects

Vats and vessels are usually elevated. Emptying takes place by gravity or pumps. Some types of vats, especially when they are used for semiliquid products (e.g., processed cheese), may be tipped over for emptying. Tipping over is done by a motor-driven gear mechanism on one side of the vat support. In equipment that is not frequently used, sometimes tipping is manual.



If the product has to be conditioned, vats or vessels must either enable good heat, and eventually mass transfer, during storage in the specially air conditioned rooms, in which they are placed (e.g., rooms for ripening of bread dough), or they must be jacketed. Insulation is required, when the product stays in a vessel a little longer, and its initial temperature must be maintained constant.

If a vat is part of a machine, as in the case of kneading equipment, then adjustment of the vat to this machine must be possible (e.g., quick coupling to pumps or pipes). If it is used for transporting meat between various stages of meat or sausage manufacturing, it must be mobile and equipped with the proper lugs that fit in the loaders and in the emptying devices. If it is used in connection with mixing or filling machines, it must have the right mechanism to allow thorough emptying (e.g., installation of scrapers in the case of marmalade and jacketing for heating of honey), adjustment for pumps, or even adjustment for dosing machines.

The surface of vats and vessels should be smooth, and corners or “dead ends” should be avoided. Furthermore, the application of effective cleaning solutions should be possible, and CIP should be foreseen. Open containers should be covered, whenever covering does not disturb processing (e.g., operation of agitators, cutting machines, etc.).

### 3.3.3.2 Tanks

#### Characteristics of Tanks

Tanks are mainly used for storage of liquid foods and fruit/vegetable concentrates and pulps. Two main categories of tanks, i.e., fixed and transportable, are used in food processing. The fixed tanks are subdivided into vertical and horizontal (Fig. 3.37). The vertical tanks are in general larger than the horizontal. Most tanks are cylindrical, but the horizontal tanks may have an elliptical cross section, for reducing their height. Product in tanks has little or no contact to the environment, as in the cases of controlled atmosphere storage (e.g., wine), or aseptic

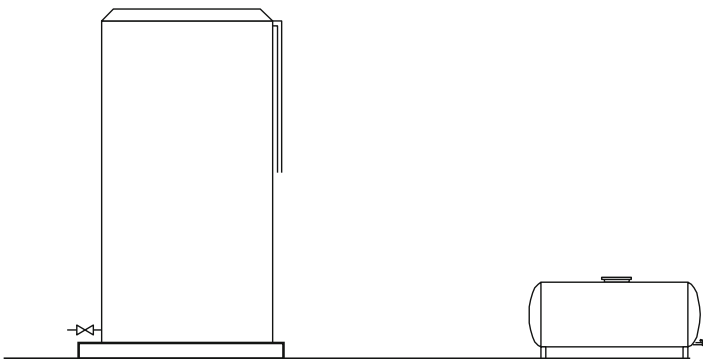
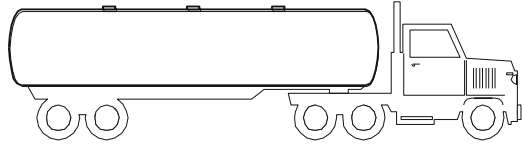


Fig. 3.37 Fixed tanks

**Fig. 3.38** Mobile tank

storage. Most tanks stand on the floor, although there are exceptions of smaller tanks that are elevated. Most tanks are stationary, but there are tanks that are transported by cranes, trucks (Fig. 3.38), railroads, or ships.

Tank trucks usually have (2–4) compartments and a maximum capacity of about 30 t.

They also have pumping systems for filling and discharge. The maximum capacity of rail trucks is about 130 m<sup>3</sup> or 120 t. The bottom of tanks must be inclined for draining (slope of 2–4°).

Larger tanks often have automation and control instruments, indicating temperature, liquid level, and actual weight.

Below are the advantages of tanks:

1. Significant quantities of liquids can be stored for a long term.
2. Full automation of filling, emptying, and product conditioning is possible.
3. Less skilled labor is required.
4. Good protection of the product (e.g., application of inert atmosphere and aseptic conditions) is possible.
5. Simultaneous filling and emptying is possible.
6. Good utilization of factory site (e.g., installation outside buildings) is possible.

The disadvantages of tanks include:

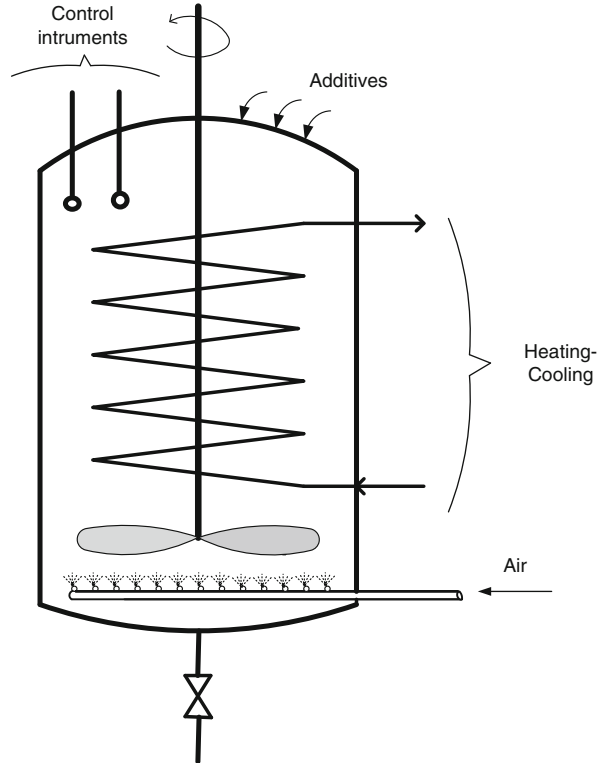
1. Susceptibility to external damage
2. Expensive, when made of stainless steel
3. Require more space than other liquid storage installations (e.g., lined concrete)

### Fermentation Tanks

Special tanks are used in the processing of fermented foods, such as olives, pickles, wine, and beer. Industrial fermenters used in the production of bio-products are discussed in books of biochemical engineering and biotechnology. Figure 3.39 indicates a common fermentation tank. In such tanks, besides several additives, air can be also added if required. The product in the tank may be continuously agitated and heated. Important in fermentation tanks is to have proper measuring and automation instrumentation for achieving and maintaining the required processing conditions.

Wood and concrete (cement) are used in lactic acid fermentations of olives, pickles, and sauerkraut. Expensive stainless steel tanks are subject to corrosion by

**Fig. 3.39** Fermentation equipment



the brines (aqueous solutions of about 10 % sodium chloride) used in the processing of these food products.

Large wooden vats are used in the fermentation of cucumbers (pickles) and cabbage (sauerkraut). Wooden barrels (oak or chestnut) of about 200 L capacity are used in olive fermentation (Luh and Woodroof 1988).

Wine is produced by fermentation of most grape juice in either coated concrete tanks or in stainless steel vessels. Wooden barrels are used in aging and storing of wine and other fermented liquors.

Special copper (bronze) or stainless steel tanks are used in beer processing. Lautering tubs, traditionally made of copper, about 40 m<sup>3</sup> capacity, are used to separate the liquid (wort) from the mash. Brew kettles, made of copper or stainless steel (about 80 m<sup>3</sup> capacity), are used for boiling the wort.

Large vertical tanks, made of stainless steel (capacity up to 400 m<sup>3</sup>), are used in the primary beer fermentation. Horizontal stainless steel tanks (capacity up to 200 m<sup>3</sup>) are used in the secondary (lager) beer fermentation at relatively lower temperature.

Rectangular stainless steel vats (10–15 m<sup>3</sup> capacity) are used in cheese fermentation, while yogurt and other fermented milk products (e.g., sour cream) are processed in vertical temperature-controlled tanks.

## Tank Regulations

In addition to the US Department of Transport (DOT) regulations, there are also the following international regulations for the transportation of food tanks:

1. EU (European Union) regulations.
2. Food Tanks-Food Hygiene Directive 93/43/EC. “Containers” for transport of bulk foods in liquid, granular, or powder form. Tanks should be marked “for foodstuffs only” in one or more European Union languages (Chapter IV, article 6 of Annex to the Directive). Put in force 14 July 1995 (EPTA 1997).

*Example 3.1* Design a pumping system for transferring the concentrated orange juice (COJ) 65 °Brix of Example 1.1 from the evaporator to the freezer and bulk packing. The flow rate of COJ is 1032 kg/h.

### Assumptions and Data

The 65 °Brix COJ has a density of 1320 kg/m<sup>3</sup> (Ting and Rouseff 1986). The COJ is assumed to be pseudoplastic fluid with rheological constants  $K = 2 \text{ Pa s}^n$  and  $n = 0.76$  at 20 °C (Table 3.1) (Saravacos and Maroulis 2001).

The COJ is transferred from the last (third) effect of the evaporator system (Example 7.1) which operates at a pressure of 0.123 bar and temperature 50 °C to the freezer/packing through a PDP. A stainless steel pipe of 20-mm internal diameter and 15 m long is assumed. Fittings: one gate valve open, one globe valve open, four standard 90° ells (bends). The freezer is a scraped surface heat exchanger.

The mean temperature of the COJ in the piping and freezer is assumed to be 0 °C, and the rheological constant ( $K$ ) follows the Arrhenius equation (3.12) with an energy of activation  $E_a = 40 \text{ kJ/mol}$ . The flow behavior index ( $n$ ) is assumed to be independent of temperature.

### Calculations

Cross-sectional area of pipe is  $A = \{3.14 \times (0.02)^2\}/4 = 3.14 \times 10^{-4} \text{ m}^2$ . Mass flow rate of COJ is  $m = 1032/3600 = 0.287 \text{ kg/s}$ . Density of the COJ 65 °Brix is  $\rho = 1320 \text{ kg/m}^3$ . Volumetric flow rate is  $Q = 0.287/1320 = 2.17 \times 10^{-4} \text{ m}^3/\text{s}$ . Mean velocity in the pipe is  $u = 2.17/3.14 = 0.7 \text{ m/s}$ .

Rheological constants are  $K(20) = 2 \text{ Pa s}^n$ ,  $n = 0.76$ .

Constant  $K(0)$  at 0 °C calculated from Arrhenius equation (3.12), neglecting the effect of concentration, is  $K(0)/K(20) = \exp\{(E_a/R)(1/273 - 1/293)\}$ ,

where  $E_a = 40 \text{ kJ/mol}$  and  $R = 8.314 \text{ J/mol K}$

$$\ln\{K(0)/K(20)\} = 4811(3.663 - 3.413) = 1.203$$

$$K(0)/K(20) = 3.33 \quad \text{and} \quad K(0) = 3.33K(20) = 3.33 \times 2 = 6.66 \text{ Pa s}^n.$$

Shear rate ( $\gamma$ ) in the pipe (laminar flow) is  $\gamma = 8u/d$ , or  $\gamma = 32Q/(\pi d^3)$ ,  $\gamma = 8 \times 0.7/0.02 = 280 \text{ s}^{-1}$ .

Apparent viscosity in pipe (3.11) is  $\eta_a = K\gamma^{n-1}$ ,  $\eta_a = 6.66 \times 280^{-0.24} = 1.7 \text{ Pa s}$ .

Reynolds number of COJ in the pipe is  $Re = (\rho u d)/\eta_a$   $Re = (0.7 \times 1320 \times 0.02)/1.7 = 10.87$  (laminar flow).

The pump work ( $W_p$ ) in the system is given by (3.13):  $W_p = E_f + (\Delta P/\rho) + \Delta u^2 + g\Delta z$ , where friction energy  $E_f = 4f \sum (L_e/d)(u^2/2)$ , pressure energy  $\Delta P/\rho = (P_2 - P_1)/\rho$ , and velocity energy  $\Delta u^2 = 0$  (the product velocity at the entrance and exit of the piping system is assumed to be equal). It is also assumed that  $\Delta z = 0$ , i.e., there is no elevation in the piping system.

The total equivalent length ( $\sum L_e$ ) is equal to the straight pipe length (15 m) plus the equivalent lengths of the fittings and the heat exchanger. The fittings have  $L_e = (7 + 300 + 4 \times 32) \times 0.02 = 8.7$  m (Table 3.2). The heat exchanger is assumed to mix and cool the product without pumping action and to have an equivalent friction length  $L_e = 3$  m. Thus,  $\sum L_e = 15 + 8.7 + 3 = 26.7$  m.

The friction factor ( $f$ ) of the pipe is estimated from (3.21) for laminar flow,  $f = 16/Re = 16/10.87 = 1.47$ . Thus, friction energy  $E_f = 4 \times 1.47 \times (26.7/0.02)(0.7)^2/2$ ,  $E_f = 1923$  J/kg.

The product (frozen slurry) is assumed to exit the piping system at a pressure 1.5 bar (0.5 bar above atmospheric). Therefore, the pressure energy will be  $(\Delta P/\rho) = (1.5 - 0.123)/1320 = 104.3$  J/kg.

Thus, the pump work will be  $W_p = 1923 + 104.3 = 2027.3$  J/kg

The power of the pump is estimated from (3.18a),  $P_o = mW_p/\beta$ , where  $\beta = 0.70$  is the pump efficiency.  $P_o = 0.287 \times 2027.3/0.70 = 831$  W, or  $P_o = 0.83$  kW.

In practice, a pump with a motor of 1 kW can be chosen for this pumping application.

*Example 3.2* Design a pressure pneumatic conveying system to transport wheat at a rate of 10 t/h from a bulk truck to a storage silo. The conveying line consists of a horizontal pipe of 20 m long, a vertical lift of 10 m, and three 90° elbows (bends).

### Data and Assumptions

Bulk density of wheat  $\rho_b = 770$  kg/m<sup>3</sup>, conveying velocity  $u = 30$  m/s, and coefficient of friction of bulk wheat = 0.5 (Bhatia 1982).

Assume a bend radius  $R = 0.70$  m. Then, the length of the 90° bend will be  $L_b = 2\pi R/4 = 2 \times 3.14 \times 0.7/4 = 1.1$  m.

Flow rate of product  $m = 10,000/3600 = 2.78$  kg/s. Assume pipe diameter is 10 cm. The empirical equations for pneumatic conveyors, suggested by Bhatia (1982), are used. For a more detailed analysis, the fluid flow calculations suggested by Walas (1988) can be used.

The energy ( $E$ ) and pressure drop ( $\Delta P$ ) of the conveying system are the sums of the energy losses ( $E$ ) and pressure drops ( $\Delta P$ ) of the product and the air.

### Product ( $E$ )

Energy to accelerate the product from zero to the conveying velocity,  $E_1 = mu^2/2 = 2.78 \times (30)^2/2 = 1251$  W

Energy to convey the product in the horizontal pipe,  $E_2 = mL_b fg = 2.78 \times 20 \times 0.5 \times 9.81 = 272.7$  W

Energy to move the product vertically,  $E_3 = mL_v g = 2.78 \times 10 \times 9.81 = 272.7 \text{ W}$

Energy to convey the product through the three bends  $E_4 = (\mu^2 N L_{bf})/R = (2.78 \times 30^2 \times 3 \times 1.1 \times 0.5)/0.7 = 5898 \text{ W}$ . Total product  $E = E_1 + E_2 + E_3 + E_4 = 7694 \text{ W}$ . Note the very high energy loss in the bends of the piping system (about 77 % of the total energy).

### Air ( $\Delta P$ ) and ( $E$ )

Flow rate of air (20 °C)  $Q = (\pi d^2/4)u = (3.14 \times (0.1)^2 \times 30)/4 = 0.235 \text{ m}^3/\text{s}$ .

The pressure drop of the air through the piping can be calculated from empirical tables of the literature, e.g., Bhatia (1982). For an air velocity of 30 m/s or 5900 FPM and a 10-cm (4-in.) pipe diameter, the  $\Delta P = 15 \text{ in. of water} = 15 \times 249 = 3735 \text{ Pa per } 100 \text{ ft } (30 \text{ m})$ . The energy equivalent of air flow  $\Delta P/\rho = (3735)/1.19$  or  $\Delta P/\rho = 3139 \text{ J/kg}$ , where the density of air at 20 °C is taken as  $1.19 \text{ kg/m}^3$ . The energy equivalent of air flow is  $E = 0.235 \times 1.19 \times 3139 = 878 \text{ W}$ .

### Power Requirement

The total power requirement will be  $P_o = 7694 + 878 = 8572 \text{ W} = 8.57 \text{ kW}$ .

A 10-kW rotary displacement blower of  $15 \text{ m}^3/\text{min}$  or 530 CFM can be chosen.

## References

- AICHe (1964) Centrifugal pumps (Newtonian liquids). AICHe equipment testing procedure. American Institute of Chemical Engineers, New York
- AICHe (1968) Rotary positive displacement pumps (Newtonian liquids). AICHe equipment testing procedure. American Institute of Chemical Engineers, New York
- Bhatia MV (ed) (1982) Solids and liquids conveying systems. Process engineering series, vol 4. Technomic, Westport
- Brennan JC, Butters JR, Cowell NP, Lilly AEV (1990) Food engineering operations, 3rd edn. Applied Science Publ, London
- Cloud HA, Morey RV (1991) Management of stored grain with aeration. University of Minnesota Extension Service
- COST 339 (2001) COST—transport small containers. European Commission, Directorate General for Energy and Transport, Brussels
- Cyr DL, Johnson SB (2000) Farm safety sheet. Cooperative extension service, University of Maine
- de Jong JAH, Hoffmann AC, Finkers HJ (1999) Properly determine powder flowability to maximize plant output. Chem Eng Prog 95(4):25–34
- Dialer K, Onken U, Leschonski K (1984) Grunzuege der Verfahrenstechnik und Reaktionstechnik. C.Hanser Verlag, Muenich
- EPTA (1997) European Portable Tank Association
- Feustel J, Hemendiger G (1987) Foerdern, Umslagen, Transportieren. In: Aufbereitung von Getreide und Saatgut. VEB Fachbuchverlag, Leipzig
- Hauser G, Mitchel R, Sommer K (1989) The design and construction of food processing equipment with particular regard to hygiene. In: Field RW, Howell JA (eds) Process engineering in the food industry. Elsevier, London, pp 143–158
- Heap R, Kierstan M, Ford G (1998) Food transport. Blackie Academic and Professional, London
- Hemming W (1991) Verfahrenstechnik, 6th edn. Vogel Verlag, Wuerzburg
- Holland FA, Bragg R (1995) Fluid flow for chemical engineers, 2nd edn. Edward Arnold, London

- HSE (1994) A recipe for safety. Health and safety in the food industry. Health and Safety Executive (UK). TOP 05 C800, 3/94
- HSE (1996) Dust explosion in the food industry. Health and Safety Executive (UK). Information Food Sheet No. 2, NIS/21/02, (2/96)
- Huette IIB (1960) Des Ingenieurs Taschenbuch, 28th edn. Verlag Von Wilhelm Ernst & Sohn, Berlin
- IAMFES (1988) International association of milk, food, and environmental sanitarians, Ames
- Jenike AW (1970) Storage and flow of solids. Bulletin 123 (4th printing). Utah University Engineering Experiment Station, Salt Lake City
- Jowitt R (1980) Hygienic design and operation of food plant. Ellis Horwood, London
- Kessler HG (1981) Food engineering and dairy technology. A. Kessler Verlag, Freising
- Kostaropoulos AE, Saravacos GD (2003) Silo storage of raisins. ICEF 9, Montpellier
- Lima J (1992) Meet your metering pump objectives. Chem Eng Prog 88(2):34–39
- Loncin M (1969) Die Grundlagen der Verfahrenstechnik in der Lebensmittelforschung. Sauerlaender, Verlag, Aarau
- Luh BS, Woodroof JG (1988) Commercial vegetable processing. Van Nostrand Reinhold, New York
- Marks LS (1987) Marks standard handbook for mechanical engineers, 9th edn. McGraw-Hill, New York
- Martinelli J, Carson JM (1992) Solve solids flow problems in bins, hoppers, and feeders. Chem Eng Prog 88(5):22–28
- Matz SA (1988) Equipment for bakers. Elsevier Science, London
- McCabe WL, Smith JC (1976) Unit operations of chemical engineering, 3rd edn. McGraw-Hill, New York
- Mermelstein NH (2000) Aseptic bulk storage and transportation. Food Technol 54(4):107–109
- Mills D (1990) Pneumatic conveying guide. Butterworth Heinemann, London
- Mills D (1999) Safety aspects of pneumatic conveying. Chem Eng: 84–91
- Mohsenin NN (1986) Physical properties of plant and animal materials. Gordon and Breach, New York
- Pahl MH (1989) Lagren, Foerdern und Dosieren von Schuettungen. TUEV Reinland, Koeln
- Paine FA (ed) (1996) The packaging users use's handbook. Blackie Academic and Professional, London
- Peleg M (1977) Flowability of food powders and method for its evaluation. J Food Process Eng 1:303–328
- Perry RH, Green DW (1997) Perry's chemical engineers' handbook, 7th edn. McGraw Hill, New York
- Rao MA (1992) Transport and storage of food products. In: Heldman DR, Lund DB (eds) Handbook of food engineering. Marcel Dekker, New York, pp 199–246
- Rao MA (1999) Rheology of fluid and semi-solid foods. Aspen, Gaithersburg
- Rao MA, Steffe JF (1992) Viscoelastic properties of foods. Elsevier
- Rumpf H (1975) Mechanische Verfahrenstechnik. C. Hanser Verlag, Munich
- Saravacos GD, Maroulis ZB (2001) Transport properties of foods. Marcel Dekker, New York
- Schubert H (1987a) Food particle technology. I. Properties of particles and particulate food systems. J Food Eng 6:1–32
- Schubert H (1987b) Food particle technology II. Some specific cases. J Food Eng 6:83–102
- Steffe JF, Singh RP (1997) Pipeline calculations for Newtonian and non-Newtonian fluids. In: Valentas KJ, Rotstein E, Singh RP (eds) Food engineering practice. CRC, New York, pp 1–35
- Stiess M (1992) Mechanische Verfahrenstechnik. Springer, Munich
- Stoes HA (1982) Pneumatic conveyors. Wiley, New York
- Ting SV, Rouseff RL (1986) Citrus fruits and their products. Marcel Dekker, New York
- Troller JA (1993) Sanitation in food processing, 2nd edn. Academic, New York
- Walas SM (1988) Chemical process equipment. Butterworths, London
- Wilcke B (1998) On-farm grain storage costs: consider all the factors. University of Minnesota Extension Service

# Chapter 4

## Mechanical Processing Equipment

### 4.1 Introduction

Size reduction or enlargement of solid foods can be attained by mechanical methods, without use of heat. Size reduction refers to the production of large or small pieces and several particle sizes. Enlargement includes agglomeration or coating of small food pieces or particles, which may be facilitated by adding small quantities of liquids or steam. In the case of liquids, size reduction of particles is achieved in the homogenization. The following sections, Sects. 4.2 and 4.3 deal with solid foods, while Sect. 4.4 deals with size reduction of liquids. Finally, mixing refers to liquid and solid foods and formation in operations dealing with extrusion and other processes giving the final shape/form of foods.

### 4.2 Size Reduction

#### 4.2.1 Introduction

In size reduction, food is cut into large or small pieces of certain or random shapes, or it is reduced to particles down of the micrometer range. There are several methods of size reduction discussed by Lawrison (1974), Rumpf (1965), and Zogg (1987). Basic criteria in classification of size reduction processes are (a) the final size of size-reduced products, (b) the kind and way the forces are applied, and (c) the construction characteristics of size-reduction equipment.

Based on the final size of the products, the following main methods of size reduction are distinguished: (a) cutting, (b) crushing, and (c) grinding.

Considering the kind and way the main forces are applied, the following classification may be made:



1. Main forces: (a) compression, (b) shear, and (c) impact. Quite often, various combinations of these forces are applied, such as bending (compression and tension), punching (compression and shear), or impact.
2. Application of forces: (a) pressure and/or friction of material placed between tool surfaces, (b) shear force on material, (c) collision between particles or impact between particles and tools, and (d) friction through medium surrounding the particles.

Based on the construction characteristics of equipment, size reduction may be classified according to the number of size reduction tools used and the kind of forces applied:

1. Use of two tools (compression of the material between two surfaces): (a) compression (e.g., presses), (b) compression and shear (e.g., gyratory crusher), (c) impact and shear (e.g., ball mill), and (d) shear (e.g., cutting)
2. Use of one tool (hitting the material with one tool): (a) impact (e.g., hammer mill) and (b) shear (e.g., attrition mill)
3. Size reduction through the surrounding medium (attrition of the material by air stream): (a) impact (e.g., counter jet mill) and (b) impact and shear (e.g., circular jet mill)

Figure 4.1 presents the different kinds of size reduction equipment and their range of application with respect to the end size of products. Details of the equipment of this figure are presented in the following sections of this chapter. As indicated in Fig. 4.1, the borders among the different categories of size reduction are not exact (Rumpf 1975; Perry and Green 1997; Zogg 1987). The following distinction of size reduction operations is suggested with respect to the final size of products:

- (a) Breaking:  $>0.15$  cm
- (b) Crushing: 0.15 cm–8 mm
- (c) Fine crushing: 8 mm–750  $\mu\text{m}$
- (d) Milling: 750–50  $\mu\text{m}$
- (e) Colloidal and fine milling:  $<50$   $\mu\text{m}$

Food products can be classified as hard, e.g., nuts or bones, or soft, such as fat (Loncin and Merson 1979). Furthermore, distinction is made between strong and weak materials. A hard material can be, e.g., an egg shell, or a strong material (e.g., bones). It can be brittle (e.g., zwieback toast bread) or ductile (e.g., dough) (Fig. 4.2). Some foods, such as gums, are elastic, while others are viscoelastic (e.g., meat, raisins). However, most foods combine more strength characteristics, due to their original texture, to their biological character (no absolute similarity among foods is possible), and to the fact that processing, handling, and storage conditions influence their texture and strength.

The main forces applied during size reduction are compression, impact, shear, or combinations of these forces. Brittle materials are broken down to smaller pieces or particles easier than viscoelastic or elastic materials. Grindability is often used for

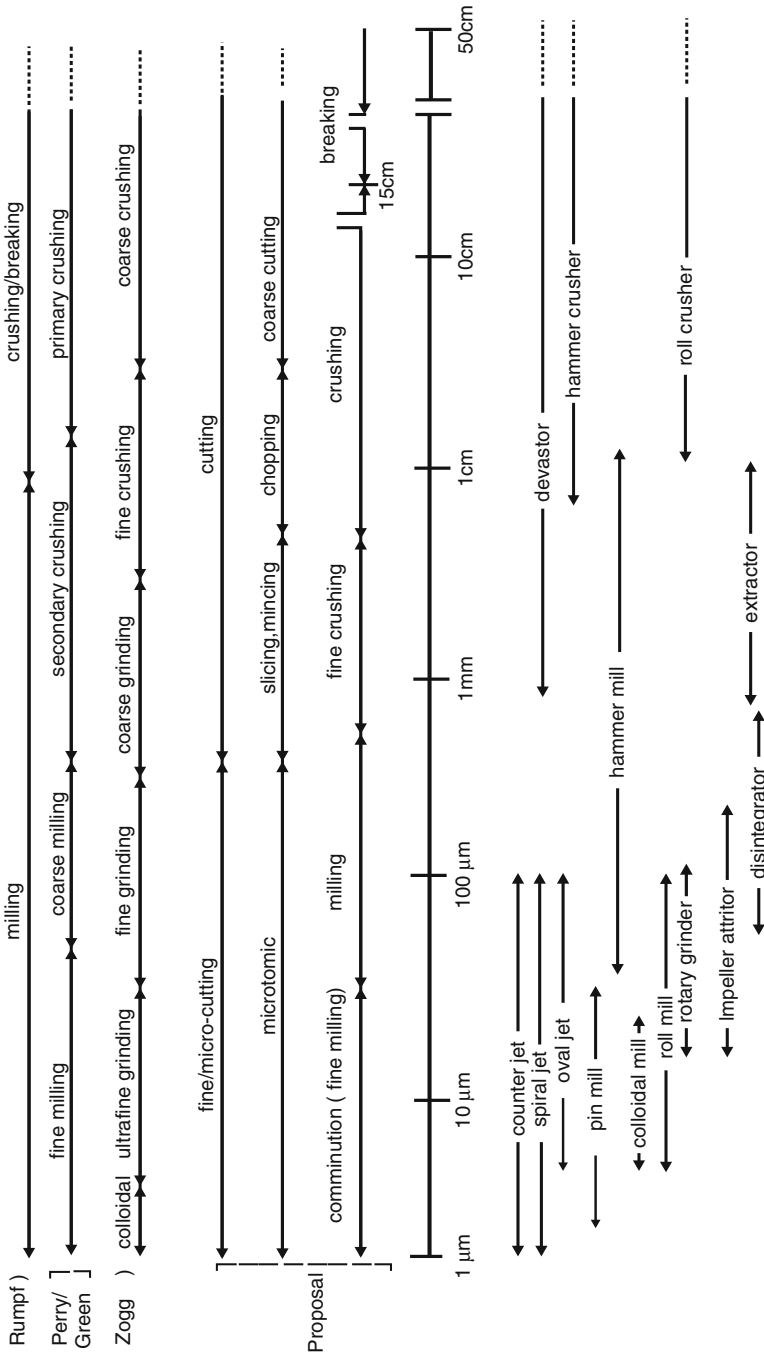
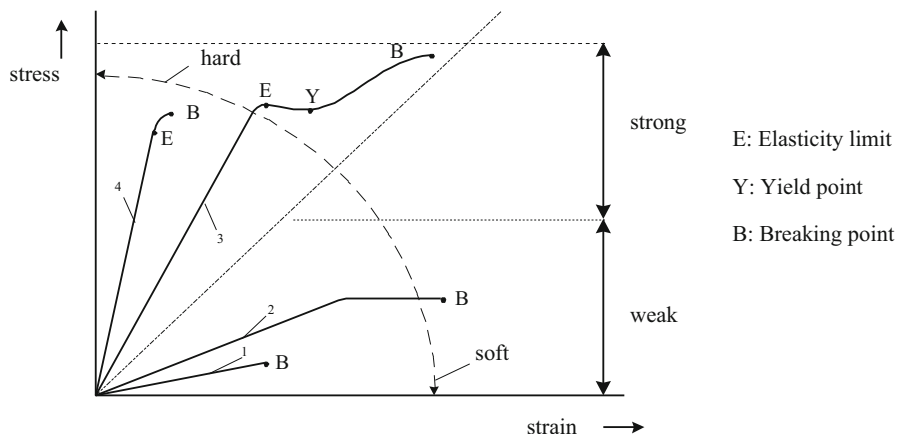


Fig. 4.1 Range of application of size reduction equipment. Data from Rumpf (1975), Perry and Green (1997), and Zogg (1987)



**Fig. 4.2** Stress-strain diagram for foods

characterizing the rate of size reduction by a certain size reduction equipment (mainly mill). It is defined as the amount of product that meets the requirements of a particular specification (e.g., kg of product passing through a screen of certain mesh per hour) (Perry and Green 1997). Grindability is related to the modulus of elasticity and hardness. Therefore, hardness is often used in estimations of size reduction, which in turn is estimated according to the scale of Mohs. This scale is based on a bilateral comparison of hardness. A harder material engraves the next material in the scale. Table 4.1 gives the hardness of several materials.

Size reduction is important for the following reasons:

- Getting the size that specific products required (e.g., chocolate powder, sugar powder, meat slices, etc.).
- Increasing the specific surface. This facilitates several processes, such as heat exchange, extraction, and chemical and biological reactions (e.g., blanching, sterilization, freezing, extraction of seed oil, acidification).
- Enhancing mixing and blending (e.g., spices, confectionery, and fruit mixtures).
- Gaining certain products (e.g., juice by squeezing, flour from wheat grain).
- Facilitating transport (e.g., meat carcasses, exact weighing of powders) and proportioning (e.g., in preparation of ready meals).

The disadvantages of size reduction can be related to economic factors or the influence of the process on the sensory characteristics and the nutritive value of the products. Some negative aspects of size reduction are:

- Increased energy requirement (e.g., the finer the size reduction, the higher the energy requirement).
- The cost of equipment increases significantly with the size reduction and the cutting precision.

**Table 4.1** Mohs hardness scale

Mohs hardness	Material	Category
10	Diamond	Hard
9	Corundum, sapphire	
8	Topaz	
7	Quartz, granite	
6	Feldspar, hornblendes	Medium hard
5	Bauxite, apatite	
4	Magnesite, limestone	
3	Marble, calcite	Soft
2	Gypsum, crystalline salt	
1	Talc, wax	

Data from Perry and Green (1997) and Loncin (1969)

- (c) Changes in taste and flavor, e.g., due to increased oxidation of products (nuts) and color (bleaching of flour). These changes increase with the length of storage. Aroma loss, due to escape of volatiles, is caused by heat production during grinding.
- (d) Loss of nutrients, e.g., vitamins during dicing or slicing of fruits and bran during polishing of rice.
- (e) Influence on texture, e.g., softening due to increased enzyme activity or hardening due to juice loss, when cells are broken down, and  $f_0$  increase of microbial attack, such as due to increase of the product-specific surface and release of nutritive substances.

## 4.2.2 Cutting

### 4.2.2.1 General Aspects

Cutting is applied to ductile, viscoelastic, and elastic materials. Products of cutting are large pieces (e.g., meat), slices, diced products (e.g., small cubes of fruits), flakes, and pulps. The main forces exercised are shear forces. Distinction is made between cutting up and dissecting. Methods of cutting up are slicing and dicing, while examples of dissecting are shredding and carving. Cutting of food is performed by knives, saws, shears, and thin wires. Table 4.2 presents a classification of cutting equipment and tools. The selection of the right cutting tool depends on the product, its condition (e.g., fresh or processed), and the desired quality of the cut. Knives and other cutting tools can be portable for manual use, or they may be part of machines.

The factors influencing cutting depend on the method applied. There is quite a great difference between manual and automatic cutting. However, there are some factors that influence both kinds of cutting, such as (a) product to be cut, (b) sharpness of cutting tool, (c) cutting force, (d) direction of force applied, and (e) cutting speed.

**Table 4.2** Classification of cutting tools

Basic type	Motion	Tool
Knife	One direction	Straight or curved knife
		Sickle
	Reciprocation	Straight knife
	Rotation	Disc Straight or curved knife, or sickle
Saw	Reciprocation	Knife
	Rotation	Disc
		Belt
Guillotine	Reciprocation	Inclined
	Rotation	Chopper
Wire	Fixed one direction	Single wire or system of vertical/horizontal wires
Shears	Shears	Parallel counter moving knives
Water jet	One direction	Water beam

The advantages of cutting processes are (a) wide product range of application (from meters to micrometers), (b) increasing the value added, (c) limiting of environmental pollution, and (d) screening out of undesired material that otherwise would burden processing.

The disadvantages of cutting processes are (a) large differentiation of required equipment; (b) skilled personnel; (c) low production per employee; (d) high safety requirements; and (e) frequent wear out of cutting tools.

At cutting, a relative motion between cutting tool and product is aimed. There are two main possibilities: (a) the cutting tool is fixed, while the product moves toward the tool, and (b) the cutting tool moves toward the fixed product that has to be cut. In some cases, both tool and product move in counter direction, increasing cutting effectiveness.

Basic element of almost all cutting equipment is the knives. When a knife cuts, two zones near the cutting edge are distinguished, the zone of plastic deformation, which lies directly on the cutting edge, and the zone of elastic deformation, which lies between the previous zone and the product (Fig. 4.3a). The effectiveness of cutting depends on the cutting edge ( $\alpha$ ) of a knife and the “cutting angle”  $\lambda$ , which is the inclination between the knife axis and the perpendicular to the cutting direction (Fig. 4.3b). Factors influencing the cutting edge are (a) the quality/hardness of metal, (b) the fineness (width,  $s$ ) of cutting blade, and (c) the wedge angle,  $\alpha$  (Fig. 4.3c). The finer a cutting blade and the narrower a wedge angle, the finer the cut. Nevertheless, due to strength and wear limits, there are also limits to the reduction of the width of knife blade and to the angle of its wedge.

Figure 4.4 indicates the forces exercised  $c$  and by a rotating disk knife. The force  $F$  during cutting depends on the normal force ( $F_N$ ), the tangential force ( $F_T$ ), and the cutting angle  $\lambda$ .

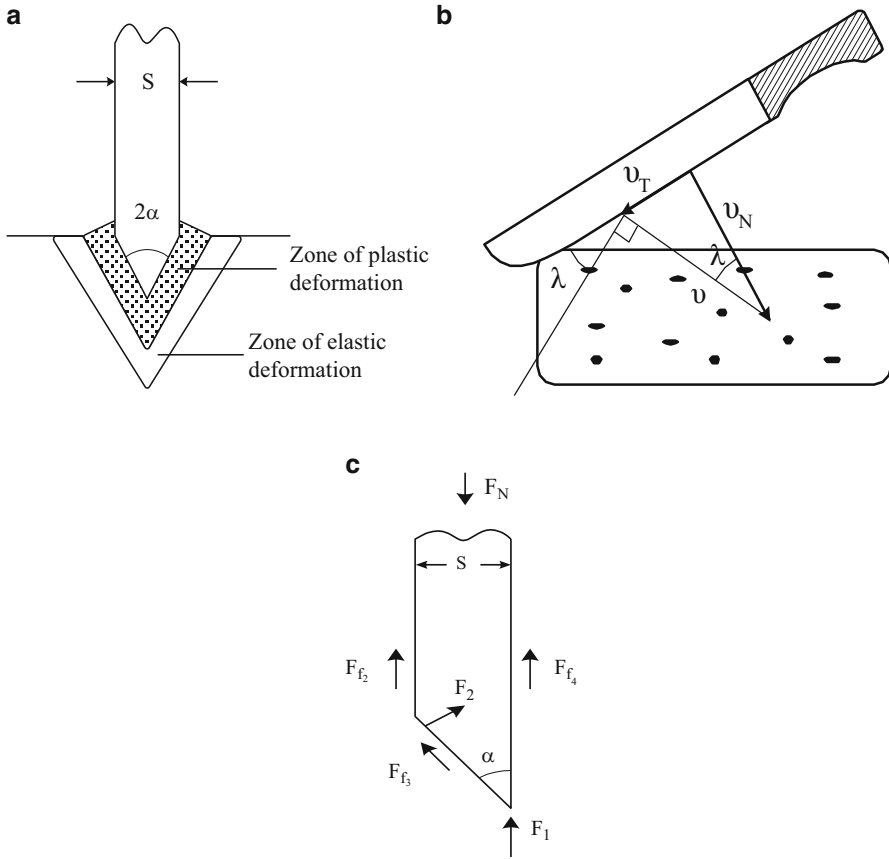


Fig. 4.3 Angles at knife cutting (see text)

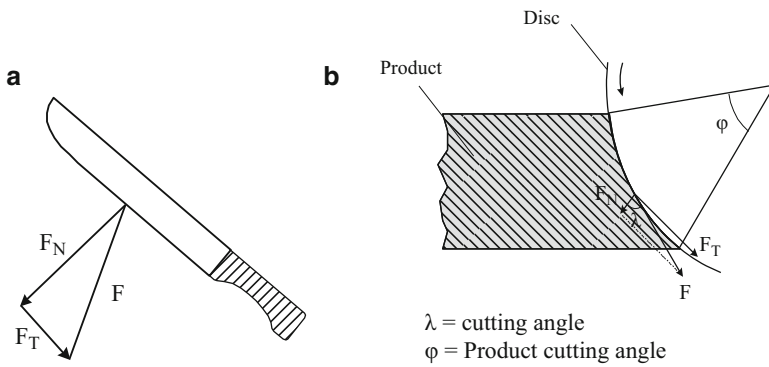


Fig. 4.4 Forces during cutting. (a) Hand knife; (b) cutting disk

**Table 4.3** Specific cutting forces of foods

Product	Specific cutting force (N/m)
Cabbage	1000–1200
Onions	1700–1800
Potatoes (fresh)	600–700
Meat (fresh)	5000–8000
Meat (frozen)	23,000–30,000
Fat	10,000–15,000
Fish (frozen)	3200–3700
Apple	330

Data from Tscheuschner (1986)

$$F = (F_N^2 + F_T^2)^{1/2} \quad (4.1)$$

where  $F_N = F \cos(\lambda)$  and  $F_T = F \sin(\lambda)$ . When  $\lambda = 0$ , the normal cutting force ( $F_N$ ) is

$$F_N = F_{f1} + F_{f2} + F_{f3} \cos(\alpha) + F_2 \sin(\alpha) + F_1 + F_M \quad (4.2)$$

where

$F_1$ , cutting resistance of the product;  $F_2$ , side force on the wedge of knife

$F_M$ , force for displacing the product mass  $M$  during cutting

$F_{f1} + F_{f2} + F_{f3} = F_R$ , friction forces on knife; and  $\alpha$ , wedge angle of knife (see also Fig. 4.3)

According to Dauriskij and Macihin (Tscheuschner 1986), the selection of the right type of cutting tool depends on the relation among the forces mentioned above:

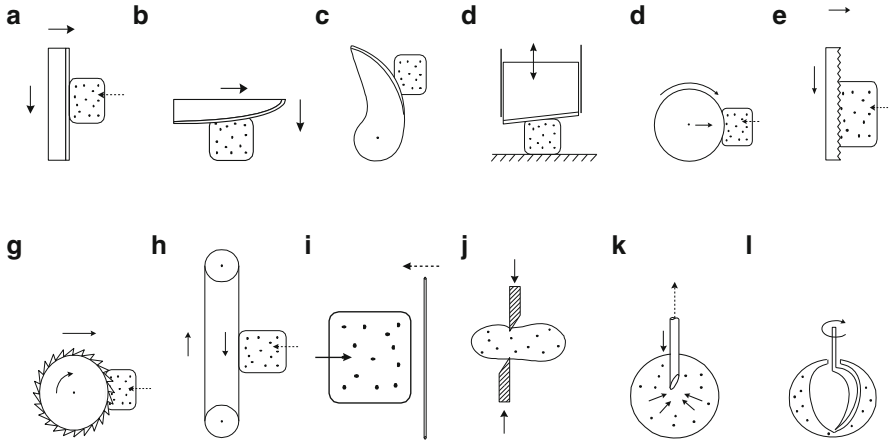
- For cutting fresh meat ( $F_1 \gg F_2; F_R$ ), the angle  $\alpha$  must be small.
- For cutting butter or margarine ( $F_R \gg F_1; F_2$ ), a cutting wire is recommended.
- For cutting hard fat or chocolate ( $F_2 \gg F_1; F_R$ ), the angle  $\alpha$  must be small or another size reduction method must be chosen (e.g., grinding, milling).

Table 4.3 shows the specific cutting force of some foods, as discussed by Dauriskij and Macihin (Tscheuschner 1986).

#### 4.2.2.2 Cutting Tools

##### Cutting Elements

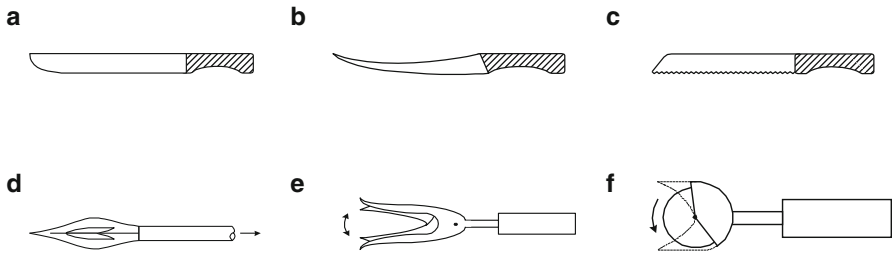
As indicated in Table 4.2, the basic cutting tools are knives, saws, guillotines, wires, and shears. Saws are effectively toothed knives. Guillotine is a type of knife related to choppers and shears, and it is composed of two knives. Therefore, besides knives,



**Fig. 4.5** Cutting elements (see text)

only wires constitute another basically different category of mechanical cutting tools. Figure 4.5 shows several cutting tools. As indicated in this figure, a simple knife may be straight (a) or curved (b, c). Knives can operate independently or they may be part of some other cutting mechanism, as in the case of shears (j), in which two knives swing parallel opposite to each other. The motion of simple straight and curved knives during cutting may be one way or reciprocating. However, there are also cases of simple knives rotating around their support at one end. Sickle knives (c) rotate or swing. Usually they have the form of a logarithmic spiral (Tscheuschner 1986). In some cases, as in meat cutters, two or more sickle knives are bound together to form a uniform knife system. In several cases, combinations of knives assembled in different ways (e.g., vertically or horizontally) cut products in certain form (e.g., cubes). For rotating knives (e), Tscheuschner (1986) recommends a ratio of disk diameter to disk thickness of 2.5/3.0. Saws (f, g, h) are either straight or have the form of discs. Straight saws reciprocate or saw in one direction only. This is the case when toothed band saws are used (h). These are especially used in cutting off relatively larger pieces of fresh meat or frozen products as meat and fish. They can be fixed or portable. Saws replace common knives, when the length of the actual cutting edge is significantly reduced. Guillotines (d) are oblique, thick blades slipping along guides. They are used in cutting large pieces, such as blocks of frozen food, in smaller ones. For safe use of guillotines, there is an OSHA regulation. Wires (i) are mainly used in cutting sticky products. Wire reduces the influence of adhesion, since its surface is smaller than that of blades. According to Dauriskij and Masihin (Tscheuschner 1986) in the range of wire thickness  $d = 0.1\text{--}1$  mm, the reduction of the required cutting power is proportional to the diameter of wires. Wire cuts better bread, producing less waste and crumb. Tube knives (k) may be used in boring food for sucking its juice. They are also used in removing blood from fresh slaughtered animals. Spiral or other types of knives





**Fig. 4.6** Portable cutting tools. (a) Steak knife; (b) boning knife; (c) saw-toothed knife; (d) sticking knife; (e) bone knife; (f) cutting wheel

(l) are used in special operations as, e.g., cutting the flesh around clingstone peaches.

National and international safety standards/regulations exist for several cutting machines. Such regulations have been prepared by *OSHA* (e.g., 29CFR-1910.212 about safety measures concerning the guards of guillotines, cutters, shears, and saws). Further standards for safety and hygiene of food processing machines have been prepared by the European Organization for Standardization (CEN). The following CEN standards refer to cutting machines (prEN = provisional European standards):

- (a) Slicing machines: No. prEN 1974
- (b) Vegetable cutting: No. prEN 1678
- (c) Rotating bowl cutters: No. prEN 12855
- (d) Mincing machines: No. prEN 12331
- (e) Band saw machines: No. prEN 12268
- (f) Circular saw machines: No. prEN 12267

### Portable Cutting Tools

Portable cutting tools for manual operation include knives, saws, and shears. Simple knives (Fig. 4.6) usually get their name from products they cut and operations in which they are involved (e.g., steak knife, boning knife, sticking knife). The blades are made by stainless steel. However, nowadays ceramic blades are also used. These as indicated in Chap. 2 may increase their corrosion resistance, cutting precision, and self-life of blades. Large portable cutting tools are electrical or air powered. In this case, since their weight may be significant, cutting tools are hung from a chain, connecting them to a swinging hoist mechanism, which secures a flexible operation in any position (Fig. 4.7). The weight of portable cutting tools varies between 1.5 and 2.5 kg. For safety reasons, parts of the blades and rotating discs and shears, not directly involved in the cutting, are covered. When tools are used in special operations (e.g., cutting of animal legs or horns), special covers are adapted for facilitating these operations (Fig. 4.6e, f). For portable and hand-operated food processing machinery and appliances, there are European

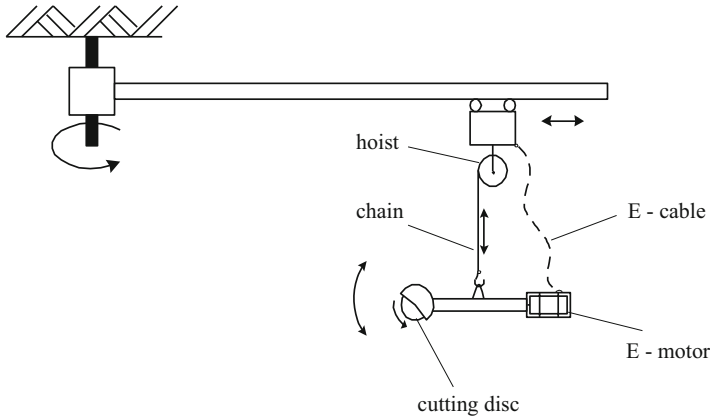


Fig. 4.7 Supporting mechanism of portable cutting tools

Table 4.4 Technical characteristics of portable cutting tools for meat

Cutting tool	Weight (kg)	Characteristic dimensions	Power	Remarks
Foot shear (pigs, lambs)	2.5	Clearance of open shear (70 mm)	Air, 140 bar	Speed (opening–closing of shear) (1–2 s)
Horn and leg shear (beef)	15	Clearance of open shear (120 mm)	Air, 220 bar	Speed of shear movement (2 s)
Saw disk (pig/lamb foot, brisk)	20	Disc diam. (280 mm)	Electric, 2 kW	Cutting depth (100 mm)
Disc saw (pig brisk)	20	Disc diam. (280 mm)	Electric, 2 kW	
Band splitting saw (beef)	60	Band length (500 mm)	Electric, 2 kW	Up to 60 beef per hour
Reciprocating breaking saw	7	Saw length (400 mm)	Electric, 1 kW	Splitting of all kind of animals

standards (CEN No. prEN 12984). Table 4.4 gives technical characteristics of some portable cutting tools, used in the meat industry.

### Cutting Equipment

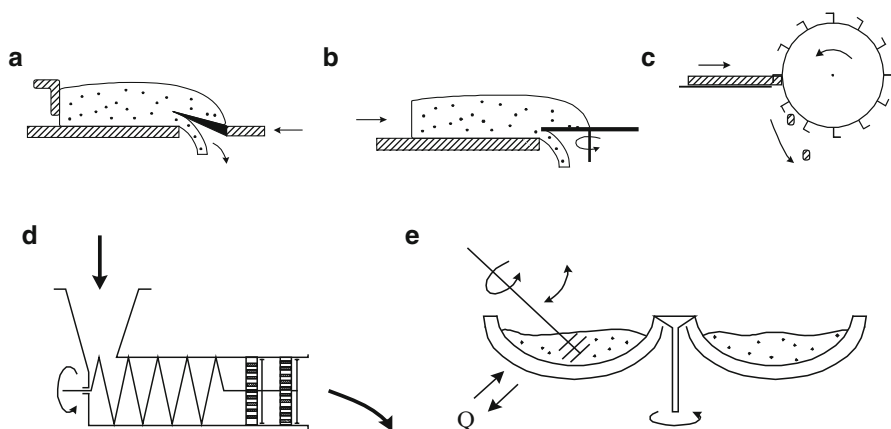
Most of size reduction machines are product specific. Special cutting machines have been developed for meat, fish, fruit, etc. Furthermore, even in the case of the same products, different types of machines are often used (e.g., peeling or cutting of fruits). In all cases, the previously described knives are basic elements of cutting equipment. The meat industry belongs to the food processing industries for which a great variety of machines has been developed. In some cases, such machines may be also used for other products as well (e.g., a meat cutter for cheese). A description of some common cutting machines is as follows:

### Band Saws

Such machines are used for cutting frozen products in straight pieces (e.g., cutting fish blocks in fish fingers). Bands are usually stretched between an upper and a lower wheel, which is driven electrically. Cutting is done on a processing table by the front band. The height of the processing table is adjustable, and it can also be removed when more thorough cleaning is required. The width and length of cutting bands/blades varies with the type and dimensions of machines. Bands are automatically adjusted to the right tension. The band can be automatically cleaned up during operation and easily removed for further cleaning. The motor compartment is sealed off from the processing area. All parts of the band, except that in the cutting area, are covered for safety reasons. Indicative values for a band are length, 1.5–2 m; width, 1–2 cm; and thickness, about 0.05 cm. Power requirement is about 2.5 kW. The overall dimensions of such machines are  $0.5 \times 0.8 \times 1.5$  m, and their weight is about 0.5 ton.

### Slicers/Dicers

Slicers cut products such as meat, ham, sausages, fish, cheese, fruits, vegetables, etc. into slices, whose thickness usually varies from 0.7 mm to 7 cm or even more. Slicers basically consist of one or more rotating discs or other kinds of knives, adjusted to cut products to the desired thickness. There are two possibilities: either the knives move toward the products (Fig. 4.8a) or the products move toward the knives (Fig. 4.8b). Products are fed automatically into slots or some other devices, lying below rotating knives that slice them. The thickness of a slice depends on the adjustment of knives. This adjustment can be controlled electronically (photocells, etc.), so that all slices maintain a more or less equal thickness, throughout the cutting of a whole piece. In advanced machines, an automatic correction of the slicing thickness, based on the remaining piece, guarantees little end cut loose.



**Fig. 4.8** Cutting equipment (see text)

Cutting quality is influenced by the speed of cutting, the product consistency, its temperature, and the quality of knives. The speed can be varied. Excessive speeds do not give good cut. Soft products have to be cooled down, if even and clean cuts are required. In cutting fresh beans by disk knives, a speed of 1500 rpm can be applied. For meat cutting, e.g., the optimal temperature lies between  $-5$  and  $5$  °C. Sharpness of knives is very important. If knives are not sharp or well adjusted, splintering of bones may take place, when cutlets or chops are cut.

The capacity of slicers may be up to 500 cuts/min. Their power requirement is 2.0–2.5 kW. The overall dimensions may be about  $2.0 \times 0.8 \times 1.5$  m and their weight about 300 kg. In dicers, the product is firstly cut into strips and subsequently chopped by bent or inclined knives, mounted around a rotor (Fig. 4.8c). The size and capacity of diced products (e.g., French fries) depends on the type of knives used. The larger the pieces, the larger the capacity. In cubers, e.g., it may vary from about 2 mm to more than 50 mm. The required energy is about 3–4 kW. The overall dimensions of such machines may be  $2 \times 2 \times 1.5$  m.

### *Meat Mincers*

The mincing machine is used for fine-“structured” mincing of products and especially for mincing different kinds of meat. It may be also used in the preparation of processed cheese. The machine (Fig. 4.8d) consists of a structured tube in which a work worm rotates, forwarding the material toward the other end of the cylinder, where it is compressed through a system of vertical plates and rotating knives, behind each plate. Usually 4-wing knives are used (Berszan 1986). The pitch of the worm may be larger at the beginning and smaller near its end. Thus, the compression is more intensive as the product draws near the plates. In some versions, a second worm with large pitch, or a shaft with paddles, rotates parallel and above the main worm, mixing the products before mincing. The number of vertical plates depends on the fineness of cutting. Usually 2–3 plates are used. The aperture of perforation of the plates decreases progressively. The rotating knives behind the plates cut the product, as it comes out of them. The capacity of larger machines is up to 10 tons/h. In the case of frozen products, the capacity is reduced to 2 tons/h. The power required for single worm machines is 15–20 kW. Machines with pre-mixer consume about 10 kW more. The length of a meat grinder is about 1.7 m, its width is about 1 m, and its height is about 1.5 m. The weight of a large meat grinder is 1.0–1.5 tons. In some cases, the meat mincers are provided with a refrigerator system, which reduces the heat developed during mincing.

### *Cutters*

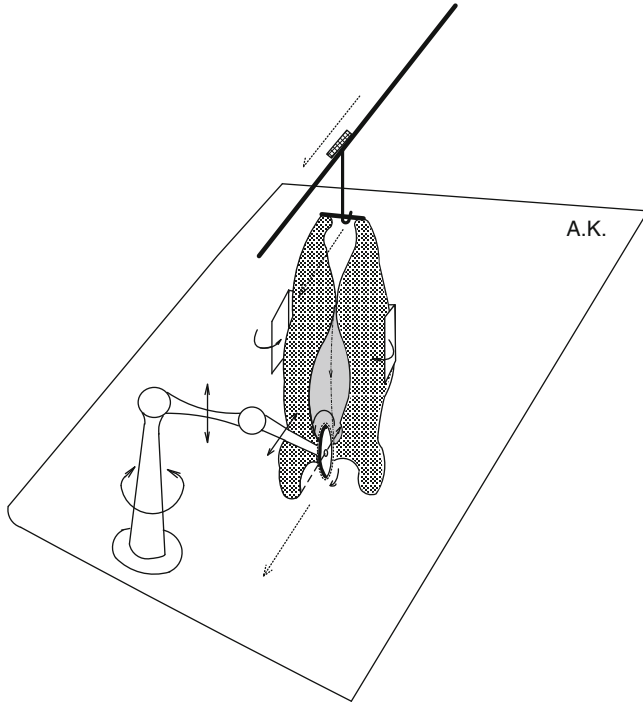
Cutters are very versatile machines used mainly in mincing, mixing, and emulsifying meat and added fat, etc., required in the preparation of fillings of salamis and sausages. In meat processing, the size reduction lies between small pieces and colloids (30 mm–5  $\mu$ m), Berszan (1986). Cutters can be also used in fine cutting of vegetables (e.g., spinach) and cheese. They are made up of a circular bowl (Fig. 4.8e) that rotates around a vertical axis. The product in the bowl is minced by 3–12

concentrically coupled rotating sickle knives (Berszan 1986). The knives rotate as close as possible to the surface of the bowl bottom, with speeds that can be adjusted between 40 and 5000 rpm. The higher the speed of rotation, the finer the cutting. Slow rotation is used for mixing (e.g., meat mash with salt and spices). The progressive addition of ingredients (e.g., spices), ice, or water can be regulated during processing. For processing different types of products, several adjustments are required. These include changing the speed of knives and their distance from the bowl bottom or even replacement of knives by other more suitable. The change of the distance of knives from the bottom of the bowl is progressive and can be automated. Replacement of knives must be rapid and easy. Filling of cutters is achieved by hydraulically elevating and tipping the content of carts, transporting the required material (e.g., meat) to the bowl. The bowl contents are emptied through an inclined rotating disk put sideways in the bowl. Through the combined rotation (bowl disk), the product is pushed out. The disk rests in a swinging arm beside the bowl and comes automatically in the right bowl position, when emptying is required.

Cutters are built in a great variety for meeting different requirements. Often double-jacketed bowls are used, so that cold water, hot water, or steam may flow between the walls, cooling or heating the bowl contents. Furthermore, bowls may be hermetically closed, for processing under vacuum or for using inert gases. If heating during processing is applied (e.g., mixing after mincing), no extra cooking of the processed mash is required. By processing under vacuum or inert gases, oxidation is avoided, thus products have a better consistency and the meat has a better color. For increasing productivity and for quality reasons, air evacuation must be done quickly. Usually, it lasts less than 1 min. The bowl rotates at low speed, adjustable between about 8 and 20 rpm. In most cases of preparing meat mash for sausages, meat at low temperature ( $-2$  to  $0$  °C) is preferred. This way, cutting is clear and smearing is avoided (Mueller 1991). The capacity of cutters depends on the kind of product cut, the type of mash produced, and the bowl volume. Usually, bowls contain 200–350 L, but there are also 550 L bowls. It is important for the quality of the products and the life of the machine to have a very well-balanced rotation of the bowl, which is achieved easier in smaller bowls. Machines should switch off automatically, if vibration during operation is excessive.

Furthermore, good central lubrication facilitates maintenance. Power requirement of the 200–300 L bowl cutters is 90–100 kW for the rotating knives and 3–4 kW for the rotating bowl, the cart elevator, and the rotating emptying disk. The length (including motor and gear box which is usually located on the side of the bowl) is about 3.0 m. The width is about 2.5 m and the height about 2.5 m (when the bowl cover is open). The weight of such a machine is about 3–4 tons. For smaller capacities (bowl capacity up to 50 L), there are machines combining the cutter—with the grinder functions.

Slicing, cutting, dicing, and shredding equipment is used widely as a preliminary step in several fruit and vegetable processing operations, such as canning, freezing, drying, cooking, and frying. Dicing is achieved by slicing the product and cutting into strips and subsequently into cubes. Shredding is performed in modified hammer mills, in which hammers are replaced by knives. Pulping equipment is used in



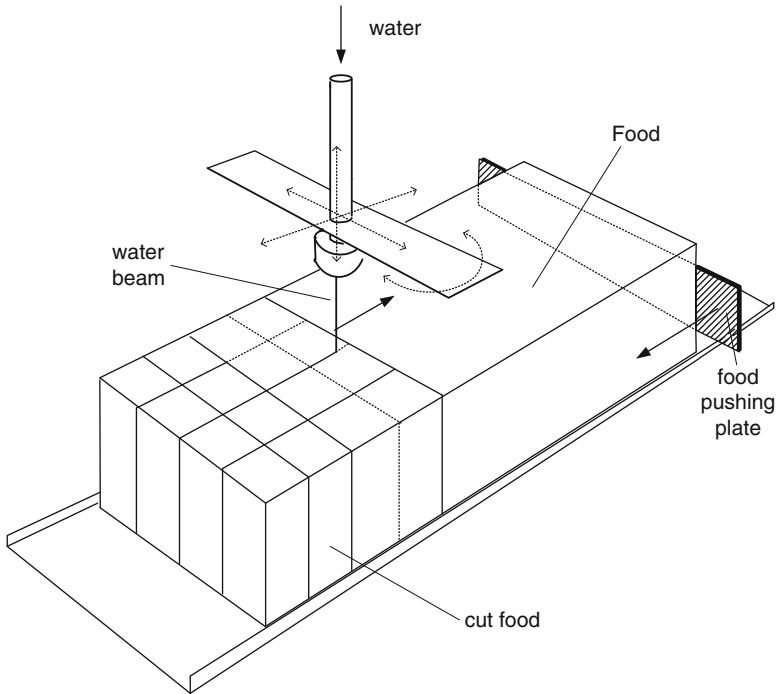
**Fig. 4.9** Robot in slaughtering operation

the extraction of fruit and vegetable juices (see sections on Mechanical Expression and Expression of Juices in Chap. 5).

#### *Other Cutting Tools*

*Robots* are also progressively used in cutting applications (Sect. 12.6). Nowadays, this occurs in large food processing units such as slaughter houses (Fig. 4.9), ready food meal preparation, and confectionary/bakery industries. Robots use all prescribed cutting devices, but they also use ultrasonic and water jet cutting devices. The slaughtering capacity of such a unit is up to 650 pigs/h. In splitting and in operations of further cutting of meat, the speed of cutting is about 400 pigs/h. The knives are cleaned by water of 85 °C after each operation.

*Ultrasonic cutting* devices, besides being used in meat processing operations, are also applied in cutting and slicing cheese, creamy foods, chocolate, confectionary products, and all types of frozen food. They are used for up to 15–20-cm deep cuts. They achieve clean and exact cut. Through vibration, the resistance during cutting is reduced, and little food adheres on the knives. The frequency of vibration is 20,000–40,000 cycles/s (20–40 kHz). Their productivity depends on the object they cut. Usually, it is about 100 cuts/min. Another benefit of ultrasonic cutting devices is that very little food remains on the devices after each action.



**Fig. 4.10** Robot in water jet cutting

*Water jet cutting* devices use pressurized “water beam.” Water is pumped to the product, through adjustable nozzles at max pressures of 620 MPa. They achieve exact kerfs of up to 0.2–0.3 mm, through water beams that are almost as thin as a human hair and flowing at 900 m/s. Therefore, they may be also used in slicing. Besides high cutting speed, further benefits are as follows: (a) their hygienic operation, since contamination of several bacteria is avoided, (b) the “nonthermal” operation of the process does not affect the structure and the consistency of food, and (c) the exact cutting reduces product wastes and is suitable for food portioning operations (Fig. 4.10). Their water consumption is approximately 0.5 gallons/min. In combination with robotic and electronic instrumentation such as laser technology and geodesic-based software, water jet cutting is also applied in *portioning* (Chap. 12).

#### 4.2.2.3 Selection of Equipment

Since there is a quite large variety of cutting equipment, their selection depends on the intended use. Nevertheless, there are some general guidelines in selecting of cutting equipment:

- (a) The cutting edge must be sharp, without reducing the firmness of the cutting tool. This requires fine cutting edges and hard material for reduced wear.
- (b) The cutting metal must be made of hardened stainless steel, steel containing 5 % chromium and corrosion-resistant tungsten carbide.
- (c) Cutting efficiency must be high. This requires exact cutting in relation to adequate cutting speed.
- (d) The energy requirements must be as low as possible. In more sophisticated machines, the dead time must be as low as possible (e.g., by automatically switching on or off).
- (e) Replacement must be easy and fast.
- (f) Safety must be high. All parts that are not directly involved in cutting must be covered. Automatic stopping of operation whenever there are problems. Covering of cutting blades whenever not in use.
- (g) Cleaning should be easy and thorough.
- (h) Increased versatility. Possibility of using the same machine with different cutting tools.

### ***4.2.3 Crushing and Grinding Equipment***

#### **4.2.3.1 Introduction**

Figure 4.1 indicates the limits between crushing and grinding. As mentioned earlier, the borders between crushing and grinding are not sharp. Taking into consideration the proposals of several authors and the construction characteristics of equipment (e.g., grindability and range of size reduction), in the present book, it is assumed that the border between crushing and grinding lies at “particle size” 750  $\mu\text{m}$ , taking as particle size the statistical length of particles. There are several quantities that may characterize the “particle size.” Characteristic size quantities of products can be the main dimensions, the statistical length, and the specific surface of a body. The main dimensions can be used only in the case of geometrical bodies, e.g., diameter and height of a cylindrical body. Statistical lengths are projections of certain dimensions of bodies. These are especially important when methods of image analysis of irregular particles are used.

Often, for statistical lengths, the following equivalent dimensions of particles are used (Rumpf 1975; Allen 1990; Stieß 1992): (a) the Feret diameter, (b) the Martin diameter, (c) the longest chord diameter, and (d) the Stokes diameter.

The statistical mean values of the three first diameters are determined usually with microscopic methods. The Feret diameter is the parallel distance in the measurement direction chord, which is perpendicular to two opposite and parallel tangents, drawn at the contour of the particle projection. The Martin diameter is the parallel distance in the measurement direction chord, which divides the projection of a particle into two equal parts. The longest chord diameter is the longest parallel in the direction of measurement chord. The Stokes diameter is the diameter of a



sphere that settles in a fluid with the same velocity as that of the real particle (Perry and Green 1997). The Stokes or hydrodynamic (settling) velocity is used in particle separations in fluids.

In estimating the size reduction, several particle analysis methods can be used. These include optical methods, methods based on the velocity of particle settling, measurement of the particle surface, the Coulter counter, and sieving. Sieving is important, not only because it is the relatively simplest and more often method used, but also because screens (sieves) are part of various equipment. This is, e.g., the case, when grinding must last until a certain size reduction is achieved. In this case, instead of wire woven screens, perforated metal screens are employed.

The screens used in determining the size of particles are standardized. For particle analysis, the following standards are commonly used (Allen 1990; Loncin 1969):

France: AFNOR X-11-501

Germany: DIN 4188

UK: BS 410

USA: Tyler and ASTM-E11 series

ISO: TC-24

The DIN series is based on the aperture (opening) and the thickness of wire, in mm. The Tyler series is based on the screen of 200 mesh (wire thickness, 53  $\mu\text{m}$ ; aperture, 74  $\mu\text{m}$ ). It is emphasized that the mesh number is not equal to the aperture, since in the measured length (1 in.), the wire thickness is also included. The ISO standardization is similar to that of DIN, and the BS and ASTM are similar to that of the Tyler series. Table 4.5 shows some values of DIN, Tyler, and ASTM standards (see also Table 5.1, Chap. 5).

Grindability is a quantity useful in selecting the right grinding or milling equipment (Perry and Green 1997). It indicates the facility of grinding and depends on the texture, the hardness, the moisture content, the water activity, and the degree of agglomeration of the materials and the way it is ground or broken down. An analytical determination of the influence of all these factors on grinding is not easy or possible. Therefore, grindability is determined experimentally in the laboratory, under controlled conditions (energy consumption, size reduction of the material).

Advantages of grinding are as follows: (a) preparation of material for further size reduction (e.g., fine milling); (b) preparation of particles for agglomeration (e.g., producing material for tableting); (c) preparation of food for processing (e.g., grinding of frozen coffee for freeze-drying); (d) production of final products (e.g., tea) or material disintegration; and (e) use in de-agglomeration (e.g., breakdown of undesired agglomerates, as high humidity milk powder or salt).

Disadvantages of grinding are as follows: (a) high energy requirement; (b) production of heat during grinding, which may damage food quality; (c) production of powder as by-product; (d) the process is often inefficient (e.g., a second grinding is required, if cracking or breaking is not easy); (e) uneven particle distribution is often obtained.

**Table 4.5** Comparison among different sieve standards

DIN aperture ( $\mu\text{m}$ )	DIN wire ( $\mu\text{m}$ )	TYLER (mesh)	TYLER aperture (mm)	TYLER wire (mm)	ASTM-E11 (No.)	BS-410 (mesh)
45	28	325	43	36	325	350
50	32					
56	36					
63	40	250	61	41	230	240
71	45					
80	50					
90	56	170	88	61	170	170
100	63					
125	80	115	124	97	120	120
160	100					
200	125					
250	160	60	246	179	60	60
...	...	...	...	...	...	...
1000	630	16	991	597	18	16
...	...	...	...	...	...	...
2000	1000	9	1981	838	10	8

Factors influencing grinding are (a) product to be ground (consistency, texture, moisture, etc.), (b) product hardness (formation of cracks), (c) initial size of material, (d) final size of particles, (e) rate of feeding the grinding machine, and (f) condition of grinding tools.

Grinding presumes stress of particles. This depends on the contacts between particles and grinding tool, or on the contact among particles themselves. Furthermore, stress is influenced by the number of contacts, their direction, and the frequency of the contacts (Dialer et al. 1984). Stressed material breaks when its deformation reaches certain product-specific limits (Fig. 4.11). Solid material breaks after being deformed (inelastic deformation). Elastic material returns to its original condition when stress is removed (elastic deformation). Brittle material breaks readily by small deformation, while elastic material breaks after significant deformation (Loncin and Merson 1979). However, although brittle materials must be much more stressed than elastic materials up to their break, elastic materials require much more work ( $W$ ) for the same result (Stiess 1994), e.g.,  $W_1 > W_2$  (Fig. 4.11).

Breaking is an energy absorption and a release process. The material accumulates elastic energy, which is then released for breaking. The mechanism of breaking is discussed by Rumpf (1965) and Bernotat and Schoenert (1988). The accumulated energy may be due to supply of heat, exothermic chemical reactions, mechanical or corrosive stress, and/or adsorption (Fig. 4.12).

Breaking starts at points of material “defects.” The larger the number or significance of defects, the easier the material breaks. Structure deformities and incorporation of foreign substances also count as material defects. Cracks appear in

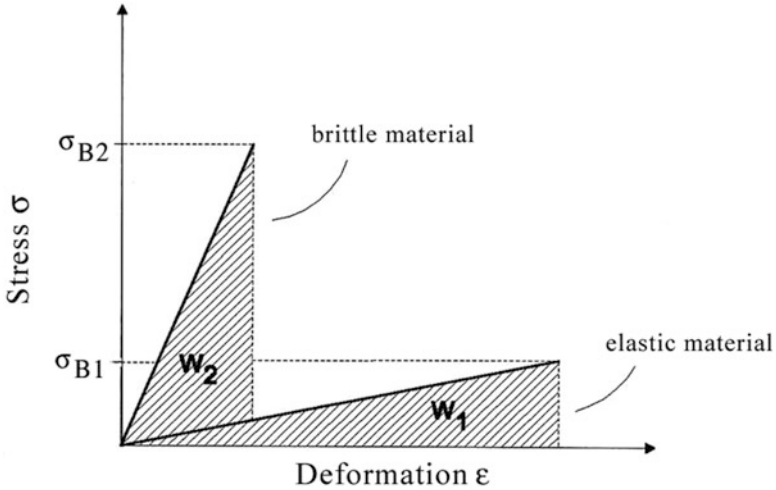


Fig. 4.11 The relation of stress and deformation of materials

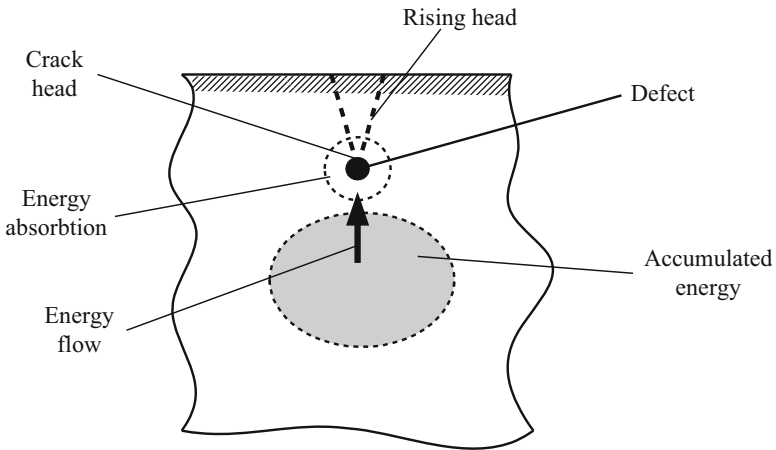


Fig. 4.12 Creation of material crack

defected positions. The further increase and expansion of these cracks depends on the relation between energy absorption and release. The energy released results in irreversible deformations in the micro area of the heads of cracks. Breaking is fast, if the “material resistance to cracking” ( $R$ ) is smaller than the “rate of energy release” ( $G$ ,  $J/cm^2$ ), which is also called “specific energy for propagation of breaking,” indicating the breaking speed of a material (Rumpf 1975):

$$G = -dW_{el}/dA_b \tag{4.3}$$

where  $W_{el}$ , the elastic energy absorbed ( $J$ ) and  $A_b$ , area at breaking point ( $cm^2$ ).

The calculation of “ $G$ ” is possible only for very simple bodies (e.g., tension of a very thin plate). If the propagation of a crack is fast ( $G > R$ ), much heat is produced in the head of a crack, deforming even the texture of the material. The rate of energy release “ $G$ ” is then effectively a material constant (Stiess 1994).

The smaller the particles, the lower the number and the significance of defects. Besides that, small particles accumulate less elastic energy, which may be not sufficient for supporting further breaking. Furthermore, in small particles, the number of plastic deformations in the contact positions increases, resulting in a reduction of stress (Dialer et al. 1984). Therefore, breaking of smaller particles is more difficult, and their further size reduction requires more energy. Anyhow, grinding is a very inefficient process, as only 1–5 % of energy input is used for the actual size reduction (Brennan et al. 1990). The rest of the energy is used for elastic deformations before breaking, for creating cracks, or for heat production.

There are several theories for calculating the energy that is required for size reduction (Loncin and Merson 1979), three of which are used more frequently, i.e., the Rittinger, Kick, and Bond “laws” (Perry and Green 1997; Fellows 1990; Brennan et al. 1990; Loncin and Merson 1979). These three laws are based on the following general equation:

$$dE/dx = -K/x^n \quad (4.4)$$

where  $dE$ , energy for accomplishing a change  $dx$  in the size of the material;  $x$ , size of the material;  $K$ , a material constant (depending on material and equipment); and  $n$ , an exponential factor. The energy ( $E$ ) is usually measured per unit mass of the material to be ground, e.g., kWh/ton.

### Rittinger

The Rittinger theory assumes that, for a certain size reduction, the required energy is proportional to the new surface, created after size reduction (Fig. 4.13a), i.e.,  $n = 2$ . Thus, the integrated equation (4.4) becomes

$$E = K(1/x_2 - 1/x_1)$$

where  $x_{1,2}$ , mean size of feed and final product and  $E$ , energy per unit mass required for creating the new surface. The Rittinger law gives better results in the case of fine grinding, since in this case the surface increase is significant.

### Kick

The Kick theory assumes that the energy required for a specific reduction of the initial size is proportional to characteristic size of the particle (e.g., longest chord

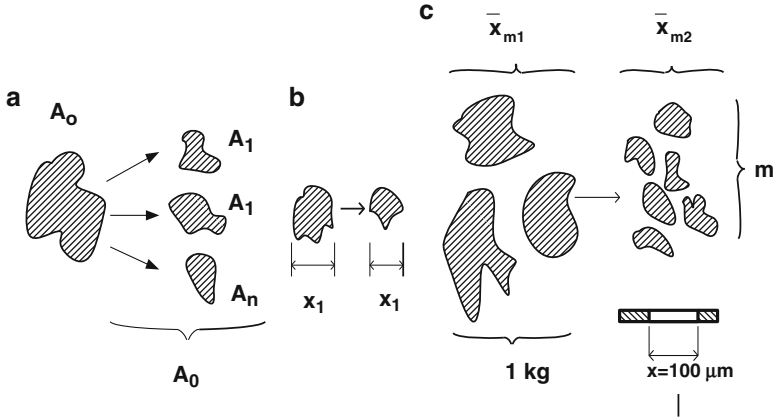


Fig. 4.13 Relations of size reduction in energy laws. (a) Rittinger; (b) Kick; (c) Bond

diameter), before and after size reduction (Fig. 4.13b). According to Kick,  $n = 1$ , and the integrated equation (4.4) becomes

$$E = K \ln (x_1/x_2) \tag{4.6}$$

where  $E$ , energy for reducing the particle size from a certain initial mean size to a new one and  $(x_1/x_2)$ , ratio of size reduction. The Kick law gives the required energy of size reduction of particles, up to their elastic deformation. The results of Kick law are better for coarse grinding, when there exist already many cracks.

**Bond**

According to the Bond theory,  $n = 3/2$ , and the integrated equation (4.4) becomes

$$E = K \left[ 1/x_2^{1/2} - 1/x_1^{1/2} \right] \tag{4.7}$$

where  $K = 10 W_b$  and  $W_b$ , bond work index. It indicates the energy in kWh/ton feed, required for size reduction of the unit mass of particles from a very large initial mean size  $(1/x_2^{1/2} = 0)$  to another size that can be sieved to 80 % by screens of aperture of 100  $\mu\text{m}$  (Fig. 4.13c). The Bond law can be used in size reduction of coarse up to fine particles (grinding and milling).

### 4.2.3.2 Particle Size Distribution

The size of biological particles usually follows the normal size distribution:

$$f(x) = \left[1/s(2\pi)^{1/2}\right] \exp\left[-(x - \xi)^2/2s^2\right] \quad (4.8)$$

where  $\xi$  is the mean size and ( $s$ ) is the standard deviation of the particles

Most particles, produced in industrial processing, follow the logarithmic normal distribution (Allen 1990; Perry and Green 1997).

$$f(\log x) = \left[1/2\pi^{1/2}\log s\right] \exp\left[-(\log x - \log \xi)/2(\log s)^2\right] \quad (4.9)$$

The industrial particles follow also the Rosin–Rammler distribution:

$$R = \exp(-x/x')^n \quad (4.10)$$

where  $R$ , the cumulative distribution of the particles larger than  $x$ ;  $x'$ , a characteristic size; and ( $n$ ), the uniformity index of the particles.

The particle size distribution is usually presented in graphical form, using special diagrams of cumulative distribution versus particle size. Normally, the residue cumulative distribution ( $R$ ) is used, defined as  $R = \int_x^\infty f(x)dx$ , i.e., the fraction ( $R < 1$ ) of all particles larger than ( $x$ ).

The log normal distribution is represented by a straight line on a diagram which coordinates the logarithmic probability ( $R$ ) versus  $\log(x)$ . The Rosin–Rammler distribution is represented as a straight line in a diagram of  $\log[\log(1/R)]$  versus  $\log(x)$ .

### 4.2.3.3 Crushing and Grinding Equipment

#### General Aspects

Grinding equipment used in the food industry has been adopted from the chemical industry. However, there are cases in which this equipment is either not used for foods or used in a quite modified form. This is especially the case of equipment of the chemical industry engaged in large size reduction as, e.g., in crushing of large pieces or minerals, in shredding, and in size reduction of very hard materials. On the other hand, there are cases in which equipment often used in size reduction of foods, such as the strainers, are not very common in the chemical industry. In food processing, most crushing and grinding concern sizes between a few cm and 0.5 mm. Furthermore, in food processing, the quality of the final product is more important than the exactness of its size. Therefore, since in many crushing/grinding

**Table 4.6** Food crushing and grinding equipment

Type of size reduction	Equipment		Size of end product	Reduction ratio (initial/final size)	Main force applied
Stress between two grinding tools	Roll crusher		>10 mm	4–6	Pressure and shear
	Roll mill		5–100 $\mu\text{m}$	>20	Pressure and (shear)
	Pan mill		0.05–1.0 mm	10	Pressure and shear
	Strainer			5–10	Shear and (pressure)
	Hammer mill		50 $\mu\text{m}$ –10 mm	10	Impact (and shear)
	Hammer crusher		>8 mm	5	Impact
Stress by one grinding tool	Disc	Pin disk	2–50 $\mu\text{m}$	>50	Impact (and shear)
	Grinder	Colloidal mill	5–20 $\mu\text{m}$	>50	Shear
		Disintegrator	>100 $\mu\text{m}$	>20	Impact and shear
	Rotary grinder		20–100 $\mu\text{m}$	10–25	Shear (and impact)
Stress due to relative motion of particles	Impeller attritor		20–300 $\mu\text{m}$	>30	Shear and impact
	Jet mill	Counter jet mill	1–100 $\mu\text{m}$	>50	Impact
		Spiral jet mill	1–100 $\mu\text{m}$	>50	Impact and shear
		Oval jet mill	5–100 $\mu\text{m}$	10–50	Shear

methods the temperature during grinding is high, they are not applicable to foods, unless special measures are taken, such as freezing the product before grinding, cooling it, or using inert gases during processing. Another example is the undesirable damage of food texture that may occur during size reduction. This may result in sensory changes and loss of valuable ingredients.

The crushing and grinding equipment (Table 4.6) is classified here according to the scheme proposed by Rumpf (1975), in which grinding of the material is done by two tools (e.g., two surfaces), by only one tool, or by attrition of moving particles (e.g., attrition between particles or between particles and the surrounding fluid).

Equipment using two tools for grinding includes machines that are primarily used in crushing/breaking relatively large, hard materials, such as (a) jaw crushers, (b) cone breakers (gyrators), (c) roll crushers, (d) roll mills, and (e) strainers.

In jaw crushers, the material is crushed between reciprocating plates, whose distance is larger in the upper part. In cone breakers, the material is crushed in the space between a ring with inclined inner sides and a cone rotating eccentrically.

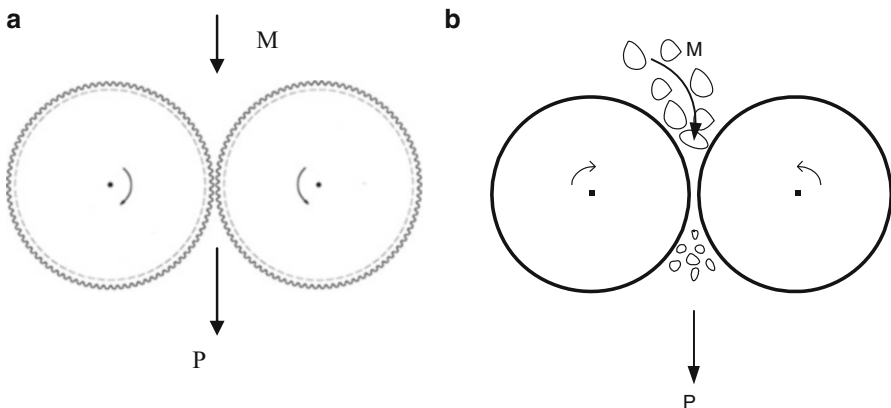
In roll crushers, the material size is reduced in the gap between two rolls counterrotating. Almost all equipment of the first two categories (jaw crushers and gyrators) is used in breaking/crushing large or very hard materials, which are not encountered in the food industry. Therefore, in the following presentation of equipment, only roll crushers, roll mills, and strainers will be considered.

### Product Between Two Crushing/Grinding Tools

#### *Roll Crushers*

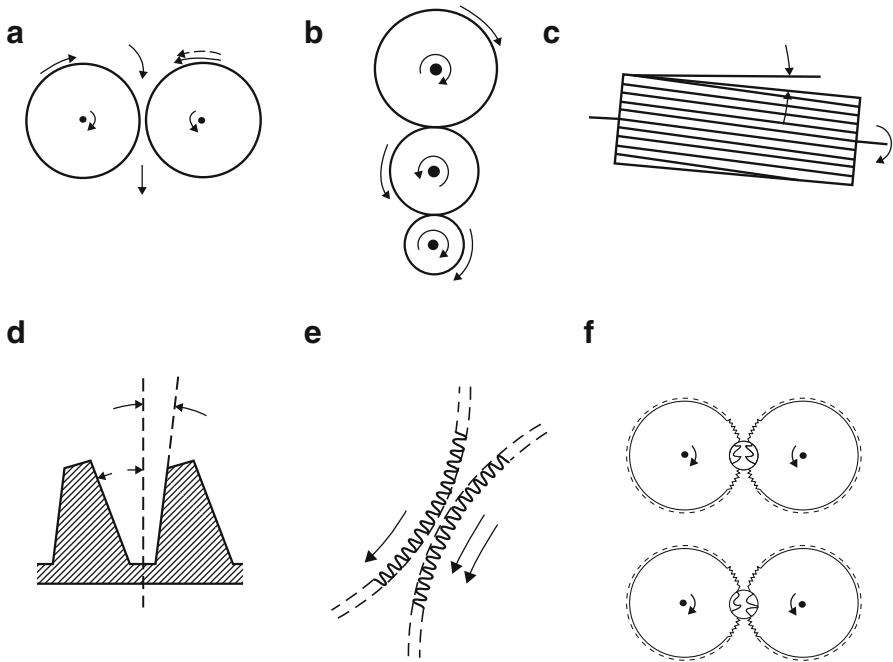
Roll crushers are used in size reduction of larger pieces, in coarse grinding (e.g., grinding of maize, coffee, frozen products), and in pre-grinding. Usually roll crushers have two counterrotating rolls that may either be smooth or have ripples, pins, or teeth (Fig. 4.14). The forces applied to the product crushed between smooth rolls are compression and shear. Toothed rolls exercise additional bending forces. In the case of smooth rolls, the angle of the nip is important. The surface of steel rolls is hardened to withstand wear. In using toothed rolls, ground materials should not be very hard. This type of crushers, besides brittle materials, can also crush or grind softer plastic or viscoelastic materials. Toothed roll crushers can be used for producing sizes down to 10 mm. Their advantage is relatively low energy consumption and very little dust production. The energy consumption of toothed rolls of 30 cm diameter is about 8 kW. The theoretical capacity of roll crushers ( $m$ ,  $\text{cm}^3/\text{min}$ ) based on the discharge of continuous solid ribbon of material, according to Perry and Green (1997), can be calculated as

$$m = slv/2.96 \quad (4.11)$$



**Fig. 4.14** Roll crushers. (a) Teethed; (b) smooth.  $M$  feed material,  $P$  product





**Fig. 4.15** Roll mills. (a) Two roll; (b) multiple roll; (c) corrugated; (d–f) grooved

where  $s$ , distance of rolls (cm);  $l$ , length of rolls (cm); and  $v$ , peripheral velocity (cm/min). The actual capacity is 25–75 % of the theoretical, depending on the roll diameter, feed irregularities, and product hardness.

*Notice:* Secondary force applied is put in parenthesis.

The advantages of roll crushers are (a) little dust production (especially for toothed rolls), (b) versatility through changing of rolls, (c) application to wide range of products (brittle, ductile, dry, moist), and (d) wide range in pre-grinding size reduction.

The disadvantages of roll crushers are (a) high wear, (b) grinding teeth vulnerable to hard materials, and (c) high energy consumption.

### *Roll Mills*

The roll mills are the main type of milling equipment used in the fine grinding of cereals (5–100  $\mu\text{m}$ ). They consist of counterrotating roll pairs (Fig. 4.15a) or, in some cases (e.g., wet fine milling), of a system of rolls (Fig. 4.15b) (Leninger and Beverloo 1975). After each grinding operation, sifting follows, separating oversize product, that is further ground. However, there are mills in which the product is ground twice (passes through two pairs of rolls) before it is sifted.

Grinding with roll mills depends on (a) product (kind, consistency, texture), (b) dimensions of rolls (length and diameter), (c) condition of roll surface (smooth, grooved, corrugated), (d) kind and number of flutings (if roll has flutings), (e) speed of rotation of rolls, (f) gap between rolls, and (g) moisture content of the product.

Usually the diameter of standardized rolls is 220–315 mm and their length 315–1500 mm (Macrae et al. 1993). The rolls may be smooth or grooved (fluted) or have corrugations. The corrugation runs along the axis of the whole length of the rolls, but inclined at slight angle ( $\alpha$ ) with respect to the axis (Fig. 4.15c). This inclination is 2–4° for the first rolls and increases to 8–10° in the last rolls of the mill. The number of grooves is 4–16 per cm of roll (Tscheuschner 1986). The first rolls have less grooves. The grooved or corrugated rolls are used for coarse grinding. The diameters of grinding roll pairs are equal, but their speed is different. The roll grooves have nips whose basic construction is indicated in angles in Fig. 4.15d. Each flute has a V-form of non-equal sides. One side is steeper than the other. The angles formed ( $\beta, \gamma$ ) depend on the type of rolls. According to Kent (1984), the angles in the USA and Canadian rolls are different from the UK rolls. The approximate values of these angles are  $\beta = 64\text{--}69^\circ$  and  $\gamma = 30\text{--}35^\circ$ . The rotation velocity of the faster roll of each pair is about 6–9 m/s. The difference of the speed of the rolls depends on the fineness of grinding and may be 2.5–2.7 for coarse and 1.5–1.8 for fine grinding (Macrae et al. 1993; Tscheuschner 1986). The difference of rotation speed of rolls depends also on the type of product ground. For wheat grinding, e.g., it is 1/2.5, while for rye grinding, 1/3. The gap between the rolls can be adjusted accurately. The gap depends on the type of product and the fineness of grinding. In the last stages of grinding (usually the wheat passes 4–7 times through the rolls), the gap becomes narrower. The following gaps (Table 4.7) are given by Kent (1984):

The burdening and abrasion of rolls requires their frequent replacement. Wear is especially high, when the gap between rolls is small and the speed of rotation high. The “indicator of abrasion” gives the metal loss of rolls in relation to unit power used (e.g., g/kWh) and depends on the material and method applied (wet or dry grinding). The kind of forces exercised during grinding depends on the type and the relative speed of the rolls (Bollin 1991) (Table 4.8).

As indicated in Table 4.8, the forces during grinding of grains depend on the position of the rolls (Fig. 4.15f). The position of rolls is sharp (S) when their “teeth” face downward during rotation (sharp angle) and dull (D) when facing upward. When grinding is started with new rolls, they are assembled in the dull–dull (D–D) position. As wearing of rolls goes on, the position is changed to the D–S or S–D systems (Kent 1984). In most cases, the speed of rolls is different, and therefore, besides compression, shear forces act as well. However, in the case that both

**Table 4.7** Gaps in roll mills

Break stage	Roll gap (mm)
First	0.50
Second	0.15
Third	0.09
Fourth	0.08

**Table 4.8** Forces exercised during roll grinding

Left		Right		Forces	Remarks
Condition of roll	Speed of roll	Condition of roll	Speed of roll		
Grooved rolls					
S	H	D	l	Cut-press-shear	S: Sharp
S	H	S	l	Cut-shear	D: Dull
D	H	D	l	Press-shear	h: High
D	H	S	l	Press-shear-cut	l : Low
Smooth rolls					
–	L	–	l	Press	
–	H	–	l	Press-shear	

smooth rolls have the same speed of rotation, especially in grinding soft products, plate-like particles are produced. In the case that the front or cutting angle is small (Fig. 4.15d), the cutting effect of the groove predominates, favoring the production of grits. In flour production, larger front angles are preferred (Macrae et al. 1993). In compressing a product, difficulties are caused by the liberated air in it. Therefore, in many machines, air sucking systems are provided. Furthermore, in roll milling, a high amount of energy lost is transformed into heat, elevating significantly the temperature of the rolls. Therefore, in some equipment, cooling mechanisms (e.g., circulation of water in rolls) are also provided.

In grain milling, there are two basic methods, i.e., dry and wet grinding. In dry grinding, the moisture content of the grains is about 16 %, while in wet milling it is higher. Wet grinding is especially applied to corn grinding in connection with wet processing, used in removing the oil-containing corn germ. The corn, in this case, remains in water for 20–40 h for absorbing the required moisture (Heiss 1991). Both methods (dry and wet) have advantages and disadvantages (Table 4.9).

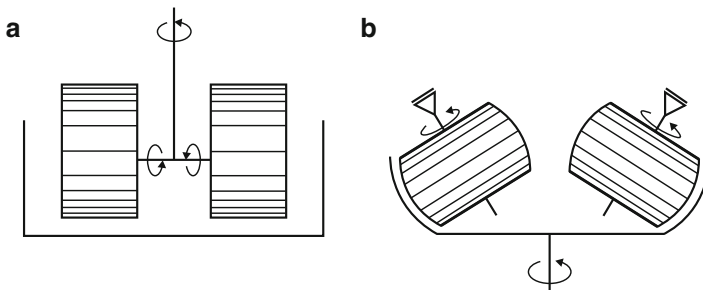
The capacity of new roll mills depends on the product (e.g., kind and condition of product), loading of the mill, the differential speed of the rolls, and the stage of grinding (product fineness). It is expressed as cm/100 kg/24 h. There is a quite large variation of milling systems and capacities. An indicative value for mills with low specific roll lengths is 2 cm/100 kg/24 h (values for wheat grinding). The energy consumption is about 35–45 kWh/ton. A traditional milling unit has about 14 roll mills. Recently, this number is lower, since there are machines with more roll pairs. The dimensions of a single pair roll mill is about (2.5–3.0) × (0.6–1.0) × (1.5–2.0) m and the weight is 4–6 tons.

### *Pan Mills*

Pan mills consist of 2–4 heavy rolls rotating around an axis in the center of a pan, in which the product to be ground is fed (Fig. 4.16a), or rolling while the pan rotates (Fig. 4.16b). This type of mills, which are used in grinding minerals, is not any more common in the food industry, because of their inadequate capacity in the required

**Table 4.9** Comparison of dry and wet milling

Kind of milling	Advantages–disadvantages
Wet milling	Advantages
	• No dust problems
	• Better efficiency in some cases as, e.g., in corn grinding in connection to starch production
	• Combination with water transport
	Disadvantages
• Greater wear of machines	
• Formation of lumps, if moisture is too much	
Dry milling	Advantages
	• Less machine wear
	• No lumping
	• Easier milling
	Disadvantages
• Danger of explosion	
• No possibility of combined water transport	

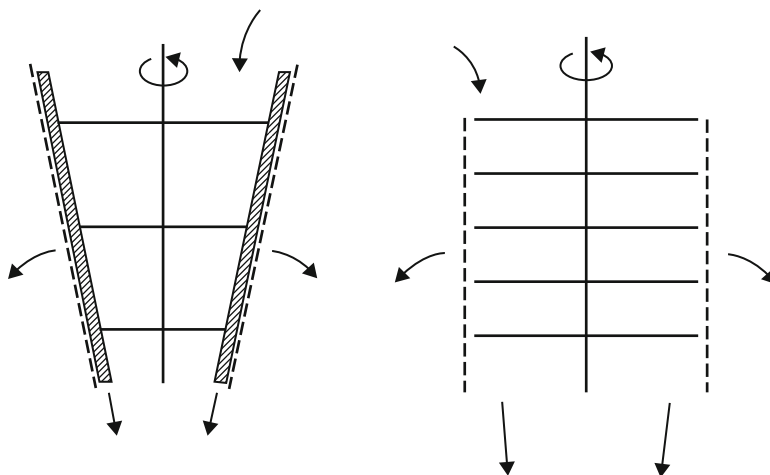


**Fig. 4.16** Pan mills. (a) Rotating rolls; (b) rotating pan

application. Nevertheless, they were used in crushing and grinding products such as olives and other oil containing seeds. The rolls were made of granite, for reducing wear, increasing pressure on material by their weight, and not influencing the material ground. The forces of rolls on the product during grinding are compression and shear (due to steady change of direction during processing). An indicative capacity for olives is 2–3 tons/h. Their main advantage is gentle processing (low temperature and speed). The energy consumption of the machines is related to the pan volume, e.g., a machine with two rolls and 500 L pan requires 22 kW.

*Strainers/Pulpers*

Strainers are used in pulping fruits and in separating the flesh of fruits and vegetables from their skin and seeds (Fig. 4.17). There are two main types, the extractor and the disintegrator. Both consist of tools (paddles) rotating near the



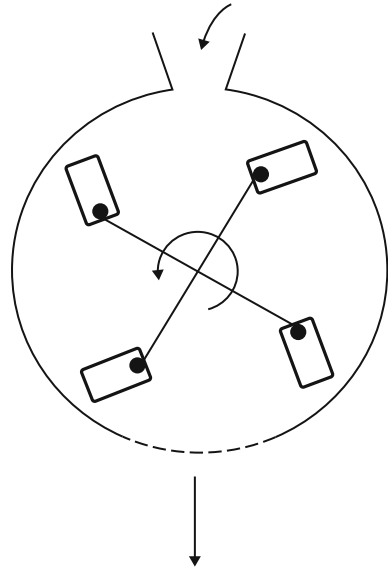
**Fig. 4.17** Strainers

surface of a cylindrical or conical screen. In the first type, the rotating paddles compress the product on the screen. In the second type, many rotating tools grind and compress the material through the screen. In both cases, the solid waste is rejected downward, while the soft part and the liquid pass through the screen. The fineness of the product depends on the screen used and the clearance between the screen and the rotating tools. This clearance is controlled by axial adjustment of the rotor. The rotation of the rotor in the extractor (1500–2000 rpm) is slower than in the disintegrator (up to 10,000 rpm). The minimum particle size of the extractor is 750  $\mu\text{m}$  and that of the disintegrator 75  $\mu\text{m}$ . The capacity of the strainers, depending on the processed product and the construction, can be 2–140 tons/h. The energy requirement of an extractor for tomato processing (capacity, 30 tons/h) is about 45 kW. The dimensions of such machines are about  $2.5 \times 1.5 \times 2.5$  m, and their maximum weight is about 3 tons.

## Product Impact

### *Hammer Mills*

The hammer mill is one of the most commonly used equipment for food size reduction by impact forces. It is used for producing a wide range of medium to fine particles. The ground product can be dry, moist, or even lumpy, soft, brittle, crystalline, or fibrous. Hammer mills consist of a rotor, including axially assembled metallic rods, rotating in a chamber (stator), whose the lower part has a replaceable screen (Fig. 4.18). Depending on the product fed and its final size requirement, different tools, called hammers or beaters (e.g., chip hammers, blade beaters, etc.), may be hung on the rods and swing. Some machines may have up to 20 tools hung

**Fig. 4.18** Hammer mill

(in the chemical industry, there are machines with  $>60$  tools). The product fed in the chamber is hit by the quickly rotating hammers, and it leaves the chamber, when it can pass through the sieve at its bottom. The fineness of the ground product depends on the product (consistency, moisture, etc.), the rotor speed, the type of tools used, the aperture of the sieve, and the clearance between rotating tools and chamber/sieve. Chip hammers, e.g., are used for grinding wheat straws for animal feed, roots, and fibrous material. Swing plates are used for grinding bones and lumpy materials. The end size of particles may vary from 10 mm to 50  $\mu\text{m}$ . The hammers/beaters usually rotate at 500–3000 rpm. Nevertheless, in some cases, as in micro-pulverizing of sugar, they may rotate faster (e.g., 6500 rpm). The faster the rotation, the finer the grinding of the product, if all other parameters remain constant. In some applications, temperature increase during grinding is prevented by air (e.g., 200–400  $\text{m}^3/\text{h}$ ) or other cooling method (e.g., using cooled jacketed walls).

The energy requirement of hammer mills in the food industry is usually 5–35 kW. Their specific energy consumption is about 0.2–2 kWh/ton (Dialer et al. 1986). The main external dimensions of hammer mills vary according to the number of hammers used. An indicative value for overall dimensions of a 20-hammer mill is  $1.7 \times 1.2 \times 1.3$  m. The weight of such a mill is about 0.6 tons (without the motor).

Advantages of hammer mills are that they (a) have relatively small volume, (b) can be used in the production of a wide range of particles that are of interest to food processing, (c) can be used in a great variety of foods (fibrous, moist, dry), and (d) have relatively reasonable energy requirement.

Disadvantage of hammer mills are as follows: (a) wear out (e.g., life of material is 7–8 weeks grinding 300,000 tons of sugar cane); (b) fines (powder) produced as by-product; (c) pre-grinding is required, if pieces are larger than 4 cm; and (d) temperature must be controlled, if high speed grinding is applied.

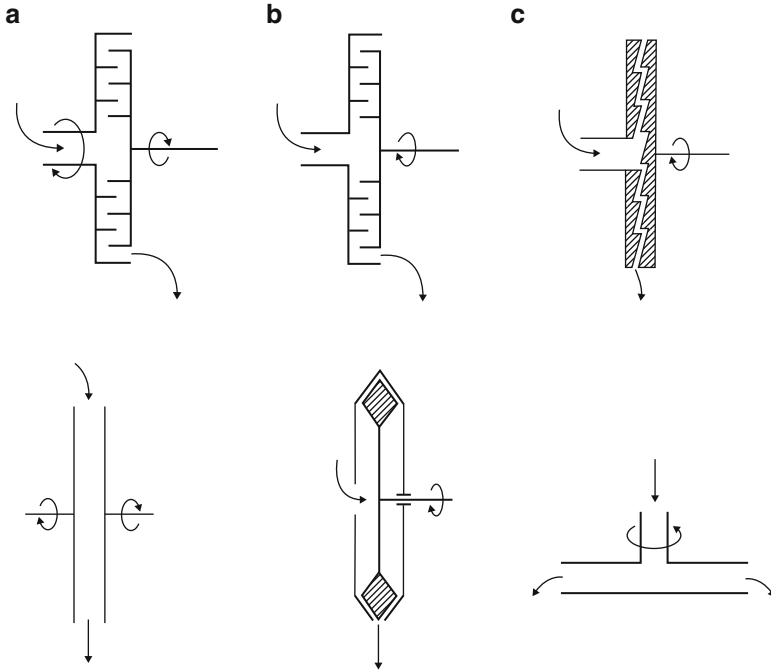
### *Hammer Crushers*

Hammer crushers, like most other large-scale crushers, are not often used in the food industry. Their use is restricted in pre-crushing of material that will be subsequently ground further. The machine is similar to the hammer mill. Its difference lies in the range of size reduction employed ( $>8$  mm). The hammer crusher is used for coarser grinding, and therefore, it is larger and more robust. Screens are firmer and hammers are also more compact. In some variations, no screens are used. The speed of rotation of the hammers is lower but their capacity high, since less thorough grinding is required. The capacity of the hammer crushers is higher than that of jaw or cone crushers (gyrators) of the same machine volume (Dialer et al. 1986). Indicative values of hammer crushers are size of particles, 50 cm–8 mm; speed of rotation, half of that of hammer mills; capacity, 50–140 tons/h; and dimensions,  $2.5 \times 1.5 \times 1.6$  m.

### *Disk Grinders*

Disk grinders are used for fine grinding of soft up to medium hard brittle materials. Furthermore, they can be used for dry as well as moist slurry materials. Some foods that are ground by disk grinders are starch, dry fruits, sugar, spices, and cocoa. There are two main categories of disk grinders, those with molded surfaces and those with flat surfaces (Fig. 4.19). Equipment of both categories consists of round discs parallel to each other. Material is fed continuously in the gap between the rotating discs. Depending on the type of the machine, one or both discs can rotate. In the case that both discs rotate, the second disk rotates in counter direction (Fig. 4.17b, c). Feeding of the product is usually done by means of a chute, shifting the product in the hole center of one of the two discs. For reducing the temperature increase, air is blasted during grinding or, in some constructions for avoiding oxidation, cooled inert gas is used.

In pin mills, the disk has several metallic pins, placed symmetrically and concentrically on the disk surfaces (Figs. 4.19a, b). The flat disk grinders may be vertical (Fig. 4.19d) or horizontal (Fig. 4.19f). In propeller equipment (Fig. 4.19e), half of the grinding chamber rotates in counter direction to that of the propeller in the center. Disk grinders are used for fine or very fine grinding. The forces during grinding in molded discs are impact and shear. When one disk rotates, the size of the ground particles is 50–5  $\mu\text{m}$ . If both discs counterrotate, the particle size may be reduced down to 2  $\mu\text{m}$ . Size reduction is controlled by adjustment of the gap between the discs and by screens placed on the lower part of the mill. Pin mills may grind, 0.05–6 tons/h. Depending on the product, end size of particles, and capacity, the energy consumption may vary from 3 to more than 100 kW.



**Fig. 4.19** Disk grinders (see text)

The specific energy consumption of impact grinders is 10–100 kWh/ton, at peripheral velocities 100–200 m/s (Stieess 1994). Usually, the peripheral velocity of the pin grinders is 80–160 m/s, and the diameter of the discs is up to 1 m.

Advantages of pin mills are as follows: (a) very fine grinding at relatively reasonable energy consumption, (b) little floor space required, and (c) wide range of application (dry, moist, slurry materials).

Disadvantages of pin mills are as follows: (a) low capacity, (b) high wear, and (c) narrow range of size reduction.

Colloid mills (Fig. 4.19d, f) are a variation of the flat discs and may be used in disintegration of viscous products and in fine grinding of grains. They are also used in the homogenization of fluids. Some applications are manufacturing of mustard, mayonnaise, and salad dressings, very fine grinding of animal or plant tissues for manufacturing baby foods and soups, and homogenization of milk, chocolate drinks, and juices. Furthermore, they are used in rice hulling and rice polishing and in confection grinding. Both or only one disk may rotate. The gap between the discs can be adjusted automatically down to less than 25  $\mu\text{m}$ . In the case one disk is stationary, this can be jacketed for cooling the mill during grinding. When using discs for fluids, their speed can be 1500–3000 rpm. The forces exercised on products are shear forces. For reducing wear, plates are made of toughened steel or corundum. The product is fed in the hole center of the upper disk and is



discharged from the sides. If there is no product between the discs, the machine stops automatically. The size reduction achieved is usually 20–5  $\mu\text{m}$ . In using a colloid mill for oat or rice hulling and polishing, usually only one disk rotates at about 18–20 m/s. At this speed, the rice is readily hulled after 1/3–1/2 turn of the disk (Tscheuschner 1986). The energy consumption depends on the viscosity of the product, the feed rate, and the temperature during processing. For 2000 L/h, about 30 kW is required. In equipment of the first category, impact forces during grinding dominate.

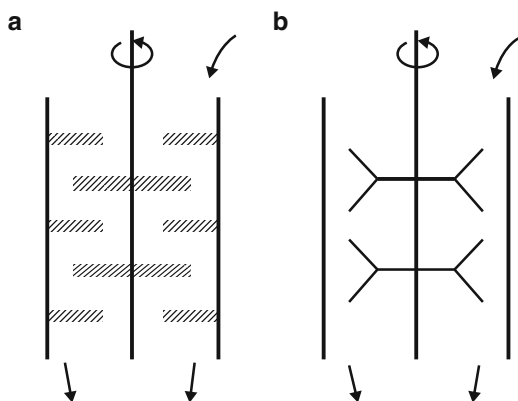
Advantages of colloid mills are as follows: (a) wide range of use (slurry-fluid materials), (b) no pressure required for homogenization, (c) simple construction, and (d) easy adjustment.

Disadvantages of colloid mills are as follows: (a) no wide application in solids, (b) wear of rotating plates, and (c) no fine grinding.

### *Disintegrators*

In disintegrators, the material is disintegrated coming in chambers in which several concentric blades or rods rotate with a peripheral velocity of 4–20 m/s. In some equipment, the tools simply rotate in cylinders (Fig. 4.20a) or they rotate between tools (e.g., bars) that are parts/extensions of the walls of the cylinders (Fig. 4.20b). This kind of equipment is often used in disintegrating packaging or other kind of waste material. For disintegrating lumps, food by-products, or products containing high amount of fatty substances down to 100 mm, there are machines rotating at 4000 rpm. The product flows along the vertical axis of the rotating tools. This way, feeding and discharge are facilitated, due to gravity. The average size distribution of particles may be influenced by the speed of the rotor and the type and number of rotating tools.

**Fig. 4.20** Disintegrators  
(see text)



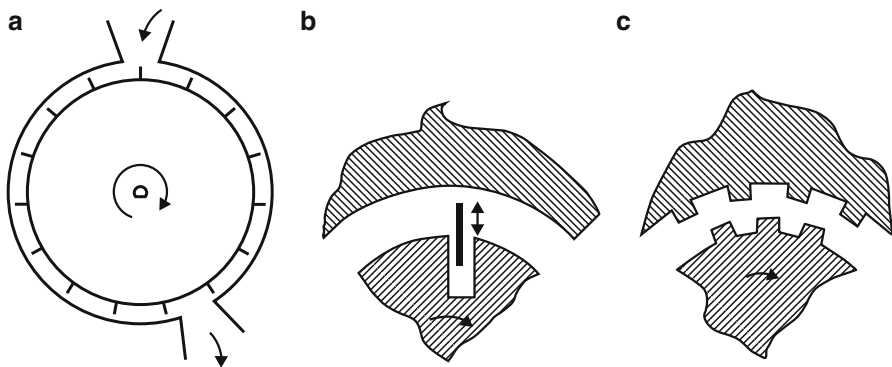
## Stresses Due to Relative Particle Motion

### *Rotary Grinders*

This kind of equipment grinds soft products, such as potato and other roots (final size of ground particles, 2–100  $\mu\text{m}$ ). They are also used in wet size reduction of products down to 1  $\mu\text{m}$ , suitable for dispersing and emulsifying. Such machines consist of concentric rolls or discs, rotating fast in cylindrical chambers or rings. The cylinders are grooved or provided with adjustable inclined or vertical knives. The periphery of the discs is engraved or curved, forming sometimes a kind of propeller. The product is fed into the gap between chamber and rotating devices (Fig. 4.21). Size reduction is done by shear/attrition. Attrition occurs among particles and between particles and chamber surface. Shear forces are also exercised by the rotating tools. Rotary grinders are used to produce small random-shaped pieces, which thereafter are directly used in further processing (e.g., sugar production from sugar beets, or starch from potatoes). Feed is usually smaller than 5 mm. In the case of sugar beets, rotors of 2 m diameter with 20–24 knives are used. The cutting speed is 4–10 m/s and the peripheral velocity of rotors, 7 m/s (about 67 rpm) (Tscheuschner 1986). Rotating grinders may process 15–35 tons/h potatoes. Indicative values of such equipment are as follows: dimensions, 1.7  $\times$  2.0  $\times$  2.5 m and weight, 2–2.5 tons. Small units may have rotors of 0.3–1.0 m diameter. Their peripheral speed may be about 5–30 m/s (50–500 rpm). Rotors can also rotate inside perforated cylinders (sieves). Their specific energy requirement is in the range of 20–180 kWh/ton.

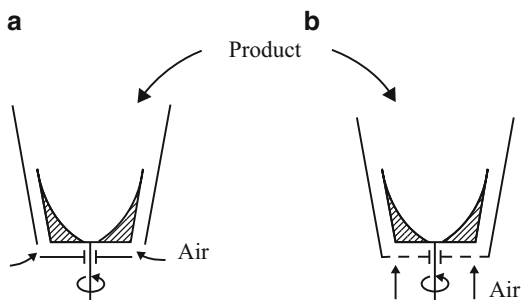
Advantages of rotary grinders are (a) high capacity; (b) relatively low wear of moving parts, due to slow rotation; and (c) grinding versatility through adjustment/change of knives/rotating discs.

Disadvantages of rotary grinders are (a) significant wear of knives/discs and channel wall/ring and (b) high specific energy consumption.



**Fig. 4.21** Rotary grinders

Fig. 4.22 Impeller attritors



### *Impeller Attritors*

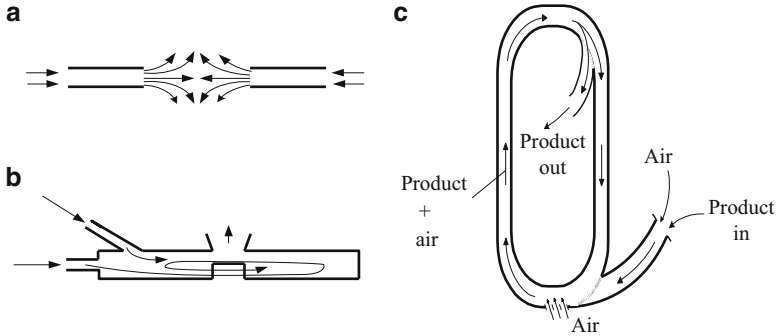
Impeller attritors are used in fine grinding of a great variety of soft and medium hard products. Some examples are chocolate crumb, powder coatings, baking mixes, fish meal, milk-sugar mixes, etc. They consist of a cylindrical or conical chamber and tools (e.g., anchor like blades), rotating on a perforated plate at the bottom of the chamber, while air may be blasted upward through the plate for reducing the temperature arising during grinding (Fig. 4.22). Tools rotate at 600–4500 rpm (the speed of smaller units can be even higher). Speed can be adjusted linearly. Particles are fed at the top. Size reduction is achieved through attrition among particles and by attrition of particles with the wall of the chamber and impact with the rotating tools. In some constructions, the wall is perforated, or screens control the final size of particles, which can be from 20  $\mu\text{m}$  to more than 100  $\mu\text{m}$ . Large particles ( $>30 \mu\text{m}$ ) are produced by collision between particles and chamber wall. The size and amount of fine particles depend on their average free path in the chamber, which is a function of the rate of feeding (Dialer et al. 1986). The larger the average free path, the more often collisions occur. Examples of capacities of impeller attritors are 120 kg/h (fish meal, particle size 100  $\mu\text{m}$ ) and 140 kg/h milk powder with sugar (particle size: 20  $\mu\text{m}$ ). Air flow is 1000–4500  $\text{m}^3/\text{h}$ . The maximum energy requirement of impeller attritors is 50 kW. The dimensions of larger units are  $2.5 \times 1.8 \times 1.8 \text{ m}$  and their weight is about 2 tons.

Advantages of impeller attritors are (a) particle size comparable to those produced by jet grinding, using relatively less energy; (b) easy control of particle size through linear adjustment of speed of rotation; (c) low product temperature; (d) simple construction; and (e) easy cleaning.

Disadvantages of impeller attritors are (a) additional screening required for better size distribution; (b) low capacity; (c) high specific energy consumption; and (d) high wear, if products are relatively hard.

### *Jet Mills*

In jet mills, particles of feed collide, as air sweeps them along. Three basic variations are (1) the counter jet mill, (2) the spiral jet mill, and (3) the oval jet



**Fig. 4.23** Jet mills (see text)

mixer. The jet mills are used for very fine grinding of hard or medium hard, temperature-sensitive particles. Their capacity varies from 0.05 up to 10 tons/h. In the counter jet mill, particles are ground as two air jets containing them impact when they meet. Both jets flow on the same axis, but they are blown from exactly the opposite directions (Fig. 4.23a). Both jet streams have the same velocity (500–1200 m/s). The consumption of compressed air (7 bar) can be up to 10,000 m<sup>3</sup>/h. Particles can be reduced down to 1–3 μm. If the particle size lies in the range of 5–10 μm, 98 % of particles fall in this range. The maximum size of counter jet mills (including a particle classifier) is about 5.5 × 5.5 × 8.0 m. In the spiral jet mill, the product is “injected,” by means of compressed air, in another high-speed air stream, rotating in a circular channel (Fig. 4.23b). Size reduction of 1–20 μm is achieved, through intensive attrition among particle and between particles and channel walls. The oval jet mixer (Fig. 4.23c) consists of a vertical oval channel in which air and particles circulate. New product is continuously fed into the lower part of the channel, where it meets high-pressure air or steam of 1.5–20 bar (Loncin 1969). The incoming particles are size reduced by the pressurized air/steam at the lower part of the channel and collisions with each other, as they circulate in the oval channel. In the upper part, the larger particles continue their way through the channel downward, while the smaller particles are sucked away. This method can combine drying with grinding.

Advantages of jet mills are: (a) production of very fine particles possible; (b) relatively little space required; (c) grinding of hard products with reduced equipment wear; (d) low operating temperature; (e) contamination-free processing possible; and (f) no moving parts and no extra foundation required.

Disadvantages of jet mills are (a) small capacity, (b) high energy requirement, and (c) high wear (especially in spiral jet and oval jet mixes).

#### 4.2.3.4 Selection of Equipment

Factors influencing the selection of crushing and grinding equipment are:

1. The texture and condition of the product to be ground
2. The temperature and oxidation sensitivity of the product
3. The production of fine by-products during grinding (wet and dry grinding)
4. The capacity required
5. The wear resistance of grinding tools

### 4.3 Size Enlargement

#### 4.3.1 Introduction

Any solid can agglomerate, if it is in particulate form and the particles are small enough. In food technology, enlargement of food may take place with or without significant mass changes. No significant mass change is observed when only change of volume of food, due to processing, takes place, as in puffing. Nevertheless, in all other cases, the mass of the new enlarged product, which may be created by coating or agglomeration, is different from that of each of its components (Schubert 1987a, b).

Agglomeration is used in producing several foods. Some examples are baking and pudding powder, aroma substances, ready to eat soups, compressed soup cubes, glazes, ready to cook mixtures, vegetable combinations, spices, instant drinks, vitamin drinks, production of chocolate, and further processing of milk powder. Agglomerates can be a final consumer food (e.g., powder for drinks) or products that are used in further food processing (e.g., starch for food consistency).

In agglomeration, solids come together to form new products, mainly through physical forces (not chemical reactions). The principal objective of agglomeration is to produce aggregates of particles of appropriate size and porosity, which are strong enough to withstand handling and can be dispersed readily, when used in liquids (Wollny and Schubert 2000). In food technology, the desired size of aggregates is usually about 100–250  $\mu\text{m}$ . Because some terms in agglomeration are not clear (e.g., granulate/agglomerate, pelletizing/granulation), the terms used in this chapter are listed in Table 4.10. The numerical limits of each type of agglomerate are indicative, since no accurate quantitative definitions are available.

Agglomeration (enlargement) depends on adhesion forces between similar or different materials, by compression or extrusion. These forces are desirable or not desirable (Pietsch 1967). Desirable forces contribute to the formation of large granules or pieces for direct consumption (e.g., instant products, candies, pastas, and flakes) or for use in further processing (e.g., crust for coating frozen fish and poultry, spice combinations, cocoa). Undesirable forces form clumps, deteriorate the homogeneity of products, or have negative influence on the flowability of

**Table 4.10** Agglomeration terms

Term	Explanation
Agglomerates	Solids created through methods of agglomeration, i.e., enlargement of fine solids, through physical methods
Fine solids	Solids: 0.001–10 mm that can be dispersed
Particles	The smaller fine solids
Powders	The next larger to particles solids
Granules	Grain-like products. Dimensions between powders and tablets Irregular or near irregular spherical shapes
Tablets	Compressed solids of certain shape with max. effective diameter <40 mm
Briquettes	Compressed solids of certain shape that are larger than tablets
Pellets	Solids created by pressing substances through holes or dies
Free structuring	Creation of agglomerates without pressure, including rolling agglomeration, spray drying, fluidized bed, and mixing methods
Key substances	Materials, besides binders, used in forming agglomerates

powders and grains. Undesirable forces also contribute to scaling and fouling; blocking valves, pipes, and filters; and falsifying measurements based on particle analyses. In using photometry instrumentation for particle analysis, falsified measurements due to agglomeration of investigated samples are significant, when the diameter of particles is smaller than 10  $\mu\text{m}$  (Pahl 1989).

Agglomeration can be achieved through free structuring and compression. In free structuring, the adhesion forces between solid particles are due to (a) material association, (b) nonmaterial association, and (c) form-related association. In material association, “bridges” between solids, such as crystallized substances or “fluid bridges,” are built, due to adsorption film or capillary forces (Schubert 1974). In nonmaterial association, van der Waals and electrostatic forces keep substances together. Form-related association exists in the case of fibers or other plaited materials (Rumpf 1975; Stuess 1992; Perry and Green 1997). The role of these associations is important for the strength of agglomerates. Furthermore, in agglomeration through free structuring, the granulation mechanisms (layering, coalescence, etc.) are important to the size distribution of granules (Perry and Green 1997). Compression may be carried out in different types of presses and extrusion devices. In compression, the adhesion forces between solid particles are also due to the prementioned associations, except the electrostatic ones.

In most cases of food agglomeration, binders are indispensable. Besides an increase of strength, homogeneity of granules depends also on the control of the quantity and rate of binder supply. A formulation of agglomerates may furthermore include flow aids, wetting agents, surfactants, and substances determining the final characteristics of the products, such as flavor modifiers and colors. Properties that determine the quality of agglomerates are the size and the porosity of powders or granules, their wetting ability, and their strength. For food, water is the most common binder. In most cases, it forms bridges between particles when crystallization of dissolved solids occurs. If the moisture of agglomerated material is high

and agglomeration lasts relatively long, porous granulates are produced. If moisture is low and agglomeration lasts relatively long, high-density granules of insignificant size variation are produced (Hemming 1991).

For foods, besides water, the following binders can be used: carbohydrates (several sugars such as glucose, lactose, etc.), polypeptides (e.g., powder of milk and cocoa, soy flour, etc.), and starches or starch derivatives, e.g., cornstarch or amylopectin (Heinze 2000). The binders used for food must not contain impurities and must meet the requirements of the food laws. In several cases of subsequent storage and final use of agglomerates (e.g., dissolution in preparation of drinks), combinations of binders and other additives are used. Such additives can be emulsifiers and antioxidants and substances that produce CO<sub>2</sub> when dissolved in water, which accelerates the dispersability of the agglomerates, when released. In instantized cocoa, emulsifiers added usually make 0.8–1.0 % of the total blend.

If no water is used, the other kinds of binders are usually more expensive than the key materials, and they are added in the lowest possible quantity. Their content does not exceed 2–10 % (Heinze 2000). If water is used as a binder, the high water content increases the moisture of the granules, requiring more energy for the subsequent drying. On the other hand, in agglomeration processes through free structuring, relatively high water content is required for increasing the size and porosity of the granules. In agglomeration of powders using low viscosity liquids, granulation occurs very close to the saturation of the mixture, and every agglomerate has its typical optimal moisture content (Perry and Green 1997). Key substances may be powders, or moist substances combined with dried or ground solids, filter cakes, or even ductile or slime materials, all in combination with fine dry solids (e.g., powder).

Advantages of agglomeration are:

- (a) Possibility of creating new solid substances through mixing solids (powders and granules) and/or liquids. This is important in adding ingredients like vitamins, aroma substances, taste materials, etc.
- (b) Influence on the porosity of solid materials. This way the capability for absorption of further substances may increase or decrease.
- (c) Influence on the product density. It helps in the separation of particles in liquids or influences the sinkability of granules in liquid.
- (d) Utilization of by-products and reduction of pollution. Powders arising during comminution may be further processed into granules, reducing also the pollution they cause.
- (e) Creating by-products of certain shape and form. This is done, e.g., by compression or extrusion of powder materials.
- (f) Influence on the solubility of food, through the production of *instantized products*.

Disadvantages of agglomeration are:

- (a) The strength of agglomerate created through mixing is low. If agglomerates are not properly processed (e.g., small size distribution, right humidity),

rubbing-off may take place in packaging the material or during handling and transport.

- (b) Fouling and scaling during processing may occur if material is not properly agglomerated or humidified/dried.
- (c) Dependence of agglomerate production on binding substances may cause additional technical problems or even increase the cost of production.
- (d) Special storage conditions of agglomerates and their raw materials are required.
- (e) Difficulties in keeping the original properties, when products of significant stickiness are used.
- (f) Relatively high energy is required, especially when compression is applied.

### ***4.3.2 Agglomeration Equipment***

#### **4.3.2.1 General Aspects**

Any solid mixer can be used for agglomeration of small amounts of solids, if proper binders are used. The two basic methods of agglomeration are free structuring and compression. The products of all free structuring methods have a low strength and a nearly spherical or irregular shape. The strength of compression products is much higher and their form depends on the molds or dies used. These processes are further distinguished according to the type of free structuring: (a) roll processes, (b) mixing processes, and (c) drying-related processes.

In roll processes, the initial agglomeration nuclei are enlarged during rolling in rotating pans or drums. Enlargement of particles through mixing can be done through intensive mechanical agitation or in fluidized beds. Combination of mechanical agitation and fluidized bed is also possible. In drying-related processes, such as spray drying and fluidized bed drying, fine particles build agglomerates with granules, before granules get completely dry (Table 4.11).

Compression processes are distinguished into (a) tableting processes, (b) roll-press processes, and (c) pelletizing processes.

In tableting processes, the agglomerates are fabricated through pressing of powders or granules in special molds, until the consistency of the agglomerate is achieved. In roll presses, two identical rolls run reversely. Powders or granules fed at the upper side between the rolls are carried along and compressed between the two rolls, whose clearance is adjustable. The surface of the rolls may be smooth or structured. In pelletizing processes, materials are pressed through perforated surfaces or dies, which determine the final shape of the pellets.

Agglomeration processes may be continuous or in batch. Main advantages of continuous processes are (a) high capacity, (b) constant quality, (c) low labor requirements, and (d) less skilled personnel required.



**Table 4.11** Methods and equipment of agglomeration

Main type of process	Type of machines	
Free structuring agglomeration		
Rolling	Rotating apparatus	Rotating pan, rotating drum
	Agitators	Oscillating, swinging, and slowly moving agitators
	Vibration	Specially formed vibrated surfaces
Mixing	In apparatus	High-speed agitators
	In air/gas stream	Fluidized beds
	Combination: apparatus-air/gas mixing	Air/gas steam, centrifugal and high-speed agitators
Drying agglomeration	Drying-related processes	Spray drying, fluidized bed drying
Compression agglomeration		
Tableting	Piston and molding press	Single punch press
		Rotary press
Roll press	Smooth roll surface	Double roll press
	Structured roll surface	Briquetting roll press
	Circularly perforated surface	Ring roll press
Pelletizing	Hollow rolls	Pellet mill

The advantages of batch process are (a) flexibility in product variations, (b) flexibility in often-changing of formulas, (c) high precision in mixing of small compounds, and (d) less sensitive to process changes.

#### 4.3.2.2 Free Structure Equipment

##### General Aspects

The agglomerates of structuring methods are almost spherical with a diameter of 0.3–2.0 mm. Binders are much more important in producing granules by these methods, than in compressed agglomerates. Water is the most important binder in food agglomeration. Furthermore, since moisture influences agglomeration time, further processing of agglomerates and strength of granules, especially for products created by structuring methods, it is very important in adjustment of moisture content to the right level for each product. Here, knowledge of the water activity and diffusivity properties of products is necessary. Since the strength of agglomerated granules, produced by free structuring methods, is low, it is possible to increase it by subsequent drying. In all cases of agglomeration, the basic aim is to bring in contact the appropriate new key substance (usually a powder) with the main material. In this procedure, further granulation depends very much on the granulation nuclei formed.

Agglomerates produced by structuring methods have the following advantages: (a) large external surface of granules; (b) good for processes in which fast heat exchange is required; (c) large overall heat transfer coefficients; and (d) possibility of mechanical transport in fluidized bed agglomeration, using methods applied to fluids.

Factors influencing the structuring methods are (a) the kind and quantity of binders, (b) the size of droplets when the binder is a liquid (water), (c) the position binders added, (d) the position of key substances (e.g., powders) added, (e) the temperature of binder and granules, and (f) the particle or granule size.

Advantages of structuring methods are (a) characteristics of instantized products; (b) give good results, when used in mixtures; (c) stability of granules; and (d) need less energy than press methods.

Disadvantages of structuring methods are (a) low strength of granules, (b) not very uniform size, (c) shape variation not possible, and (d) large-sized equipment.

Among agglomerates, instantized products are very important in food processing of soups and drinks and in several manufacturing methods, in which dried food in the form of powders or granules is used (e.g., in chocolate manufacturing). Instantized products are manufactured by intensive mixing of powders or during fluidizing and drying processes. Instantization of a powder usually does not change its equilibrium solubility. It only decreases the required time to be dissolved.

Basic properties judging the quality of instantized products are:

- (a) Dispersability. Instantized agglomerates must be dissolved easily and quickly in smaller units. This depends on the binding forces between the particles, their size, and porosity.
- (b) Wettability. When very fine particles stick together, liquids cannot penetrate in the granules easily. If the affinity of particles to liquids is low, elevated temperature of the liquid or pretreatment of the powder (e.g., coating with emulsifiers) helps.
- (c) Sinkability. Agglomerates should not float, sink, or stick on the surfaces of vats, cups, etc., in which they are being dissolved. Thus, dissolving of granules can be enhanced. Sinkability depends on the density/ porosity and size of the particles.
- (d) Flowability. This is important in weighing/filling, packaging, and storage of the instantized products. Furthermore, it is important with respect to vending machines of drinks (e.g., cocoa, coffee), in which instantized products are used.

As indicated in Table 4.11, free structuring equipment may be classified as rolling, mixing, and drying systems.

In *rolling agglomeration* (Fig. 4.24), the distinction of equipment is based on the way key substances (powders, particles) are brought into contact with the already existing bed of material.

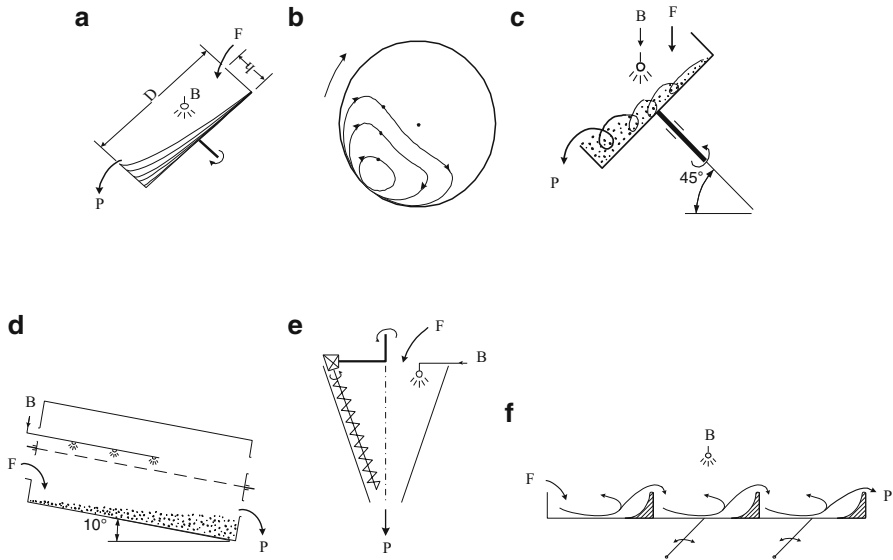


Fig. 4.24 Rolling agglomeration equipment (see text)

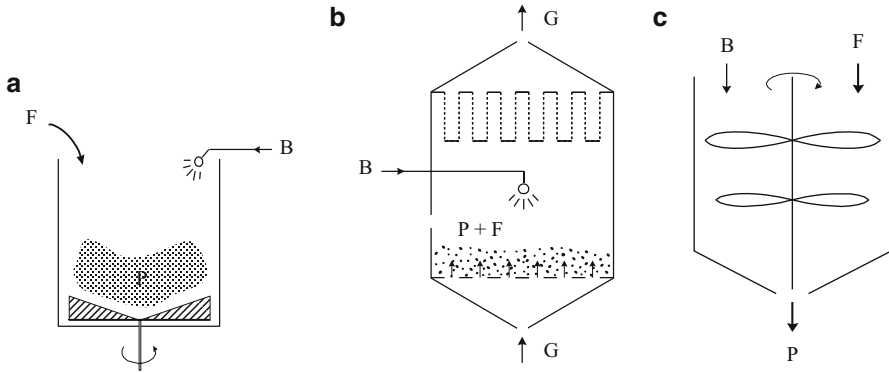
Rolling agglomeration is achieved by means of:

- Rotating walls that roll up the material, which subsequently falls down, before being taken upward again by the moving wall. Rolling up is done in rotating pans or drums (Fig. 4.24a–d).
- Agitators which move up granules and then leave them roll or fall back. This may be done in drum or vat equipment, in which helical coils or paddles rotate or swing slowly to moderately (Fig. 4.24e).
- Vibration. Equipment consisting of vibrating inclined beds forces granules to hop up and fall down continuously, while, due to the inclination of the vibrating bed, granules get rolling motion as well (Fig. 4.24f).

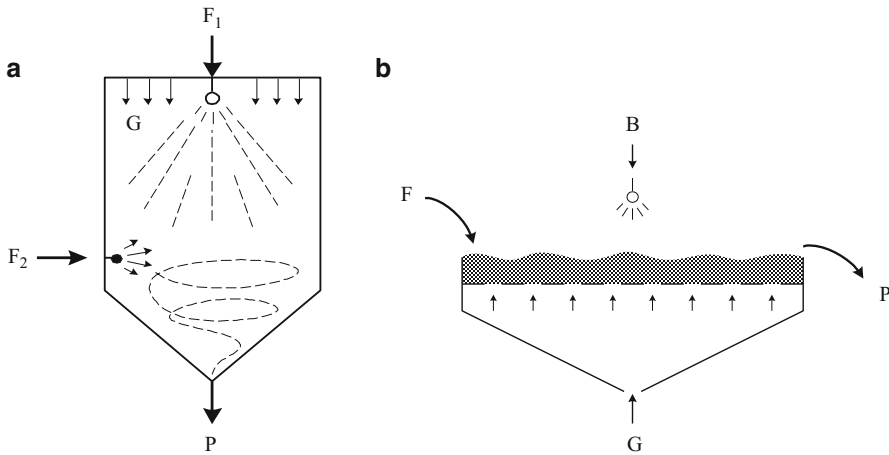
In *mixing agglomeration* (Fig. 4.25), key substances are enlarged by bringing them into contact by means of:

- High-speed rotating agitators, which mix the content of vats several times a minute (Fig. 4.25a).
- Fluidization of small granules in a gas stream. Particles come in contact with rotating small granules, forming agglomerates (Fig. 4.25b).
- Combination of the above two methods. Agglomeration takes place while the product is agitated in a gas stream (Fig. 4.25c).

In *drying agglomeration* (Fig. 4.26a, b), subsequent drying of the product is not necessary. Drying is required in other processes, when the moisture content, due to wetting with binders, is high. Agglomeration is achieved by bringing into contact already dried-out small granulates with the key substance, which is a wet powder of the same material (dried-out small granules).



**Fig. 4.25** Mixing agglomeration (see text). *F* feed, *P* product, *G* gas, *B* binder



**Fig. 4.26** Agglomeration in drying equipment (see text). *F* feed, *P* product, *G* gas, *B* binder

**Rolling Agglomeration**

*Rotating Pans*

This granulating equipment (Fig. 4.24a-c) consists of a round pan that rotates around its inclined axis. The diameter of the granules can vary between 0.5 and 2.0 mm. New material and binder are fed at the upper part of the pan in different positions from each other. Blades scrape any material sticking on the wall.

Factors influencing the efficiency of pan agglomeration are (a) inclination of the pan; (b) speed of rotation; (c) position of addition of binder; (d) position of addition of key material; and (e) relation ( $D/h$ ), where  $D$  is the diameter and  $h$  is edge of the pan.

The method can influence the following agglomerate properties: (a) size, (b) porosity, and (c) moisture.

The size distribution in the pan is not homogeneous. As indicated in Fig. 4.24c, smaller granules and particles rotate on the upper part of the bed. As they become larger, they move toward the lower part near the bottom of the pan. Finally, when they reach the appropriate predetermined size, they move to the surface of the pan, from which they are discharged.

The critical speed of rotation of the pan ( $n_c$ , 1/s) is very important in the rotation of granules:

$$n_c = 1/\pi \sqrt{g(\cos \alpha)/2D} \quad (4.12)$$

where  $\alpha$ , angle of inclination of pan;  $D$ , diameter of pan (m); and  $g = 9.81 \text{ m/s}^2$

If the rotation exceeds  $n_c$ , the relative motion between particles of the product in the pan stops. Another size, characterizing the limits of rotation is the Froude number (Fr). At speeds of rotation  $n = n_c$ ,  $\text{Fr} = 1$ . Since in agglomeration processes by rotation,  $n < 1$ , the Froude number is also  $< 1$ :

$$\text{Fr} = R\omega^2/g(\cos \alpha) = (\omega/\omega_c)^2 = (n/n_c)^2 \quad (4.13)$$

where  $R$ , radius of pan; (m)  $\omega = 60n$ ; and speed of rotation, (rpm).

The specific power ( $N_s$ ) required to agglomerate the mass  $m$  (kg/h) using a rotating pan is (Stiess 1994)

$$N_s = N/m \text{ (kW/kg)} \quad (4.14)$$

where:  $m$ , mass in the pan; (kg),  $N$ ; power required, (kW)

$$N = \pi^2/4 \cos \alpha \psi \varphi \rho_b g D^3 h n \quad (4.15)$$

$\psi$ , drift factor (for small  $D$ ,  $\psi = 0.4$ , for large  $D$ ,  $\psi < 0.4$ )

$D$ , diameter of pan (m)

$h$ , height of side wall (m)

$\alpha$ , angle of pan inclination

$n$ , speed of rotation of pan (1/s)

$\rho_b$ , bulk density of material in pan ( $\text{kg/m}^3$ )

$f$ , degree of pan filling ( $f = 0.1\text{--}0.3$ ),  $f = 4/\pi V_b/D^2 h$

$\varphi$  = filled fraction of pan (0.10–0.30)

The speed of rotation of a pan is  $n = (0.50\text{--}0.75) n_c$ . The pans rotate at an angle of  $45\text{--}55^\circ$ . The pan dimensions depend on the capacity requirements. In food processing, the diameter of pans usually does not exceed 2–3 m. The ratio ( $h/D$ ) can be fixed experimentally (Heinze 2000), and it may vary from 0.08 to 0.15 (shallow pans), up to 0.5 (deep pans). Depending on the type and quality of the raw material and the quality requirements of the final agglomerate, the capacity and the

required power of a pan apparatus may vary up to 25 %. Usually the capacity of a rotating pan ( $m$ ) is proportional to the square of its diameter ( $D^2$ ). For a rotating pan of 0.7 m diameter, and capacity of about 0.5 tons/h, the specific power requirement may be about 1 kWh/ton. The granules leaving the pan are spherical of about the same diameter.

Advantages of rotating pan are (a) easy handling, (b) good control, (c) versatility, (d) easy cleaning, and (e) continuous or batch processing.

Disadvantages of rotating pans are (a) many moving parts, (b) inclination mechanism complicates construction, (c) relatively large dimensions, and (d) open system (environmental effects).

### *Rotating Drums*

Agglomeration in a rotating drum is very similar to that of a rotating pan. The main difference is the homogeneity of agglomerates. The size of the pan agglomerate for a certain process is more or less constant, while the size distribution in a rotating drum varies. Therefore, the granules produced by rotating drum agglomeration are subsequently screened out, and the fine agglomerates are fed back to the drum for getting the desired size (Fig. 4.24d).

Drums are mainly used for large capacities and heavy duty materials. As in the case of rotating pans, binders are sprayed continuously over the rolled product during processing. They are slightly inclined at an angle up to  $10^\circ$  for facilitating emptying of granules formed. The speed of rotation is  $n = (0.30-0.55) n_c$  (usually  $n = 8-20$  rpm). The length to diameter ratio ( $L/D$ ) of drums is 2–5, and the degree of filling is low (2–3 %) (Heinze 2000). In the chemical industry and in metallurgy, there are drums with maximum dimensions of up to  $D = 3$  m and  $L = 15$  m and capacity of up to 100 tons/h. Similar capacities are achieved with rotating pans of  $D = 10$  m. The capacity of a rotating drum depends on the properties of the product and agglomerates processed. As a guide value, in processing 7.5 tons/h of fertilizers, a power of 11 kW is required (Walas 1988).

Advantages of rotating drums are (a) robust construction, (b) versatility in use, (c) large capacities in gentle mixing possible, (d) relatively good control, and (e) they may be used in batch and continuous processing.

Disadvantages of rotating drums are (a) relatively high energy required, (b) large dimensions (space), (c) inefficient use of total volume, and (d) nonuniformity of agglomerate size.

### Slow Agitation Equipment

In this category belongs batch equipment in which the product (mostly powder) is rolled by slowly moving agitators. An example of such equipment is the conical planetary mixer that is still being used in processing small quantities of agglomerates in the pharmaceutical industry (Tscheuschner 1986; Dialer et al 1986). In some cases, a double-walled mixer is useful for controlling the temperature of the

processed product (Fig. 4.24e): indicative values, 100–200 kg/batch; batch time, 20–40 min; and required energy, 10–20 kW (Perry and Green 1997). Such equipment may be used also in other kinds of processing as, e.g., mixing of pasty materials.

### Vibration Equipment

This type of continuous processing equipment consists of vibrating beds through oscillating movement of the supporting mechanism. Through vibration, small granules leap over hurdles until they leave the bed (Fig. 4.24f). However, they roll back quite a few times before the next hurdle, being enlarged this way through mixing with new key material under binder support (Tscheuschner 1986).

### Mixing Agglomeration Equipment

#### *High-Speed Agitation*

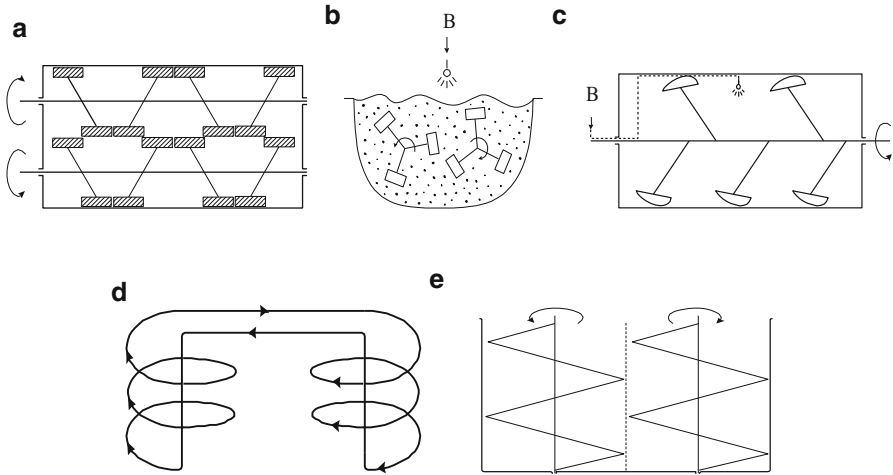
These processes, with some exceptions, are mainly batch operations. In all cases, high-speed rotating agitators bring into contact the material which agglomerates. Equipment is made up of a vat in which the product is mechanically fluidized by means of vigorously rotating agitators. This ensures short time of processing and mixing homogeneity, independent of particle/granule density and size. Variations in high-speed agitation equipment are basically due to differences in the agitating systems. Typical forms of agitators are angular paddles, plows, and helices. In all cases, the material is moved toward the ends of the vat and backward, while the binder is spread over it continuously. Agglomeration takes place in a fluidized zone. In some cases, additional agitators are used for breaking lumps that may be built, when the product becomes quite moist.

Factors influencing the size of agglomerates of this method are (a) construction of the equipment, (b) mixing intensity, (c) mixing time, and (d) moisture of the product.

Some typical equipment in this category is given below (Fig. 4.25). They are all used for batch processing, but variations have been developed for continuous use as well. The data given for each type of equipment are only indicative information, since exact values depend on the agglomerated product and the particular method of processing, e.g., binders used, length of process, etc.

#### 1. Twin Shaft Paddle Equipment (Forberg)

This equipment consists of one or two adjoined vats, in which two shafts with agitators rotate in opposite direction. Additional agitators are used for increasing the effectiveness of binders and reducing accumulation of lumps (Fig. 4.27a). Agglomeration lasts about 1 min and energy requirement is 0.2–2.0 kW/100 L (installed power, 15–30 kW). For 2000–3000 L vat volume, the ground space required is 4–7 m<sup>2</sup> and the weight of the machine is 3–5 tons. Advantages of the



**Fig. 4.27** High-speed agitation agglomeration (see text). *B* binder

system include independence of size and density of product and versatility in use. By proper type, number, and position of agitators, it is possible to achieve mixing, even at relatively low agitation speed ( $<100$  rpm).

## 2. Plow Equipment (Loediger)

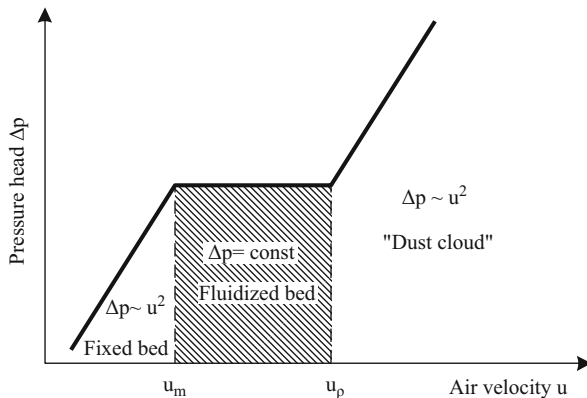
This equipment has plow-type agitators mounted on a single shaft, rotating in the middle of a cylindrical vat at 60–800 rpm (Fig. 4.27b). Different types of choppers, rotating vertically to the main product stream, are placed for reducing the formation of lumps (when the moisture of the product is high), or for increasing the distribution effect of key substances or binders. These choppers can rotate at high speed ( $>3000$  rpm). Volume of vats is up to 15,000 L and operational filling is about 50%. The required ground space for about 3000 L vat volume is 8 m<sup>2</sup>. Agglomeration lasts 1–4 min. The number of charges depends on formulation and quantity and can be 2–12/h. Power required is up to 2 kW/100 L. Advantages of the system include versatility in use, wide application (size of products 1–1000  $\mu\text{m}$ ), and simple construction.

## 3. Two-Helix Equipment (Ruberg)

This type of agglomerator consists of two identical cylindrical vats adjoined to each other (Fig. 4.27c, d). Along the axis of each vat, a helical agitator, almost as wide as the diameter of the vats, rotates. The material moves along the first shaft downward and continues following spirally upward around the wall of the first vat. Subsequently, the same flow procedure is repeated in the second vat, starting from the top of the shaft of the second vat. Agglomeration is intensive in counterflow between the two vats, and it lasts up to 3 min. Required ground space, motor power, and machine weight of a 3000 L vat are about 5 m<sup>2</sup>, 30 kW, and 4 tons, respectively. Advantages of the system include low speed of rotation, gentle mixing, and simple construction. Good mixing occurs readily by filling only 10% of the vats.



**Fig. 4.28** Influence of air velocity on fluidization pressure head



#### 4. Fluidized Bed Agglomeration

Agglomeration takes place while key materials and small granules are both whirled in a gas stream, which is usually air. Fluidization is achieved at operating air velocities ( $u$ ) between the minimum air velocity ( $u_m$ ) and the air velocity at which solids are pneumatically conveyed ( $u_p$ ) (Perry and Green 1997; Fig. 4.28).

For fluidized beds of granules,  $1.5 u_m < u < 5 u_p$  (Perry and Green 1997). A fluidized bed exists when the pressure drop ( $\Delta p$ ) across the bed balances the weight of the bed. The bed remains uniform if  $Fr < 1$ , where ( $Fr$ ) is the Froude number.  $\Delta p$  depends on the thickness of the bed, its porosity, and the density difference between granules and air.

The air velocity ( $u$ , m/s) for achieving fluidization of a bed of granules is given by the equation

$$u = [(\rho_s - \rho)g/\eta] [(d^2 \epsilon^3)(180(1 - e))] \quad (4.16)$$

where

$\rho_s$ , density of solid particles ( $\text{kg/m}^3$ )

$\rho$ , density of air ( $\text{kg/m}^3$ )

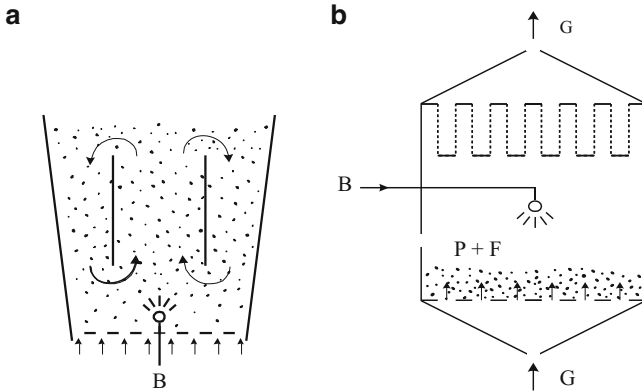
$g$ , acceleration due to gravity ( $\text{m/s}^2$ )

$\eta$ , viscosity of the fluid (Pa s)

$d$ , diameter of particles (m)

$\epsilon$ , porosity of the bed (void fraction)

Agglomerates produced in fluidized beds have less strength than those created by rotating methods; nevertheless they have better instantiziation properties. High humidity supports agglomeration. However, if the moisture content of agglomerates is high, then drying of granules is required. In fluidized bed agglomeration, significant powder may be produced due to attrition between particles. Therefore, in many cases, screening and recycling of powder is applied.



**Fig. 4.29** Fluidized bed agglomeration (see text). *B* binder, *F* feed, *P* product, *G* gas

Factors influencing agglomeration in a fluidized bed are (Perry and Green 1997) (a) liquid (binder) rate, which increases size, density, and strength of the granules; (b) liquid droplet size, which increases size and homogeneity of the granules; (c) air velocity, which increases attrition rate and initially decreases and later increases the granule growth; (d) bed height, which increases strength and density of the particles; and (e) bed temperature, which decreases strength and density of the particles.

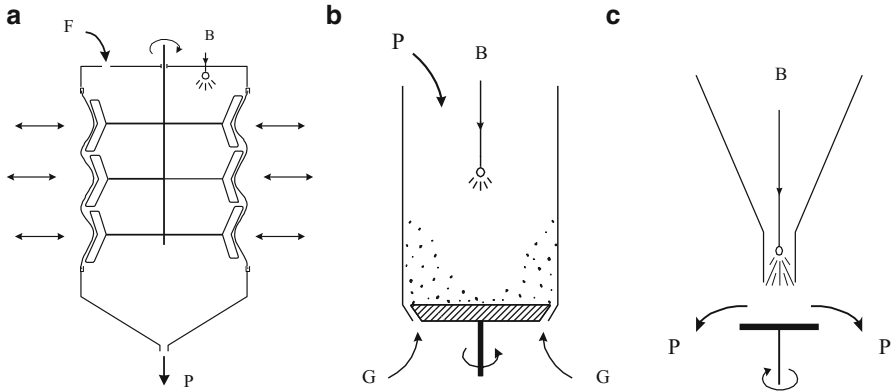
There are several methods of fluidized agglomeration (Fig. 4.29). They vary mainly in the way materials are fluidized.

#### *Fluidized Bed-Spray Agglomerators (Vometec, Glatt)*

Fluidization of granules takes place in a bed that is formed in a cylindrical or conical vat (wider at its upper part), as the material that comes in the equipment is blown by air, coming from the bottom of the vat (Fig. 4.29a). At the same time, binder is sprayed in the dispersed material. On the top of the vat, there are filters collecting dust or any other fine particles, which are then recycled. Capacity of such equipment in batch processes may be up to 2000 L. The floor space required is about 4–5 m<sup>2</sup> and the height may be up to 10 m. The required energy for air blasting and spraying of liquids is about 80 kW.

#### (a) Recycling Fluidized Bed Agglomerators (Wurster)

This type of equipment is similar to the fluidized bed-spraying agglomerator. Its main difference lies in a tube (in some cases a Venturi pipe), placed concentrically above the bottom of the conical vat (Fig. 4.29b). The fluidized bed is divided into two parts: the upward streaming bed in the central tube and that around it, flowing downward (similar to a spouted bed dryer, Chap. 8). The bed in the tube is formed as both air blown upward through the perforated bottom of the vat and binding fluid and also sprayed in the same direction,



**Fig. 4.30** Combined fluidized bed agglomeration

flowing through the central tube. The material falls then back to the lower part of the vat, through the gap formed between the central tube and the wall of the conical vat, creating the external part of the bed. There it is recirculated, as it is carried along by the air that is continuously blown through the perforated bottom of the vat. The larger granules are removed at the side of the vat. Agglomerates are formed after 3–5 recyclings. The volume of such equipment is up to 700 m<sup>3</sup> (Dialer et al. 1986).

(b) Combined Fluidized Bed Agglomeration

Systems combining air flow with agitation belong to this category (Fig. 4.30). Mixing is very intensive and very short (1–3 s). Therefore, the dimensions of such equipment are small. However, since the residence time of granules in such equipment is extremely short, control of particle size is difficult, and good dosing of the key materials is indispensable. Main benefits of such equipment are the little space required and the very short time of agglomeration.

Factors influencing the efficiency of such equipment are (a) pre-dosing of components, (b) binder quality, (c) properties of solids to be agglomerated, and (d) speed of rotation.

(c) Shugi Agglomerator

This equipment consists of a cylindrical vat/tube, in which agglomeration takes place, as air is blown by impellers installed in it, and sprayed binders are mixed, while moving downward. Air velocity and mixing are controlled by changing the type, number, and angle of impellers. The adjustable speed of rotation is 1000–3000 rpm. The volume of the cylindrical vat/tube is up to 400 m<sup>3</sup> and its height up to about 4 m. The capacity depends on the product agglomerated and on the size of the equipment. Since processing lasts only a few seconds, the cylindrical vat/tube has a small product hold up. The volume of air flowing is 10–30 m<sup>3</sup>/ton and its pressure 10–40 bar. Usual processing time is 3–10 s, capacity may vary between 0.3 kg and 30 tons/h, and energy

consumption is about 1–100 kWh/ton. In a variation of this machine, the wall of the processing chamber/vat is flexible, and it is moved by means of a mechanism, in which rolls press the wall externally as they move up and down.

(d) Centrifugal Agglomerator

In centrifugal agglomerating equipment, agglomeration is achieved by mixing key components of different density on a rotating disk. In another machine, mixing and agglomeration take place as key components are supplied on a rotating disk, heated and tumbled on a stator, which is a cylindrical wall surrounding the rotating disk. Disk and wall form effectively a high-walled pan, whose bottom is rotating, leaving a slit between it and the stationary wall. Air blown upward through the slit increases the mixing intensity of the material concentrated around the edge, where the disk meets the wall. This machine is also used in the manufacturing of pharmaceuticals (forming globular drugs).

### *Drying Agglomeration*

Drying agglomeration is accomplished during spray, or fluidized bed drying. In both cases, granules come in contact with powder that is whirled with them. High humidity in the agglomeration chamber is helpful. Binders may not be required, if either the granules are not completely dry or the powder and particles added flow through a moist environment, before contacting the dried granules. The agglomerates are instantized products.

(a) Spray Drying Agglomeration

In the spray drying tower, recycled powder of the already dried material is radially sprayed toward the center of the tower. In the whirling that takes place, agglomeration of the spray-dried granules occurs. If the additive powder is dry, it is added to the phase of the product which is not very dry. Otherwise, the powder must be wetted, e.g., by steam, before contacting the dried granules.

The stability and size of agglomerates depend on the (a) agglomerated material, (b) moisture and temperature of powder and spray-dried granules, (c) contact time of powder with granules, (d) size of the sprayed granules, and (e) relation of powder/granulate quantities.

The size of the granules may be controlled by proper spraying. The smallest droplets are produced, when pressure nozzles of a single material (product) are used. Two-media nozzles (product/air) produce larger droplets. Rotating discs, dispersing liquid that falls on particles, produce even larger droplets (Chap. 8).

(b) Fluidized Bed Agglomerators

This type of equipment is often used for subsequent drying of moist agglomerates. The fluidized granules come in contact with recycled powder of the dried material, and usually, for enhancing agglomeration, “atomized steam” is sprayed near the position that the powder is fed. The fluidized bed is divided in compartments by weirs. The position and size of compartments depend on the

type of drying. The flow of granules of the desired size is controlled by the height of the last weir at the end of the equipment.

Requirements of an effective fluidized bed agglomeration are (a) narrow size distribution, (b) low dust emission, (c) no size limitations because of static design (no adjustable moving parts), (d) avoiding post agglomeration, (e) continuous removal of larger agglomerates from the fluidized bed, and (f) no blockage of the air distribution plate by moist (therefore heavier) granules.

### 4.3.2.3 Compression Agglomeration

#### General Aspects

In food processing, compression agglomeration is less important than free structuring agglomeration. It is mainly used in confectionery (chocolate processing, sugar further processing, production of candies, etc.) and in extrusion (production of flakes, pellets, pasta, etc.). Compressed agglomerates usually are produced by compression of powders. In all cases, compression agglomeration requires more energy (2–4 times) than structuring agglomeration. Usually, the compressed products have less moisture and an amorphous structure. As indicated in Table 4.11, compression agglomeration equipment may be classified into tableting, roll press, and pelletizing systems.

Factors influencing pressure agglomeration are (a) raw material used (form, structure, stickiness, moisture content, etc), (b) power applied, (c) duration of compression, (d) temperature of the product during compression, and (e) binders used.

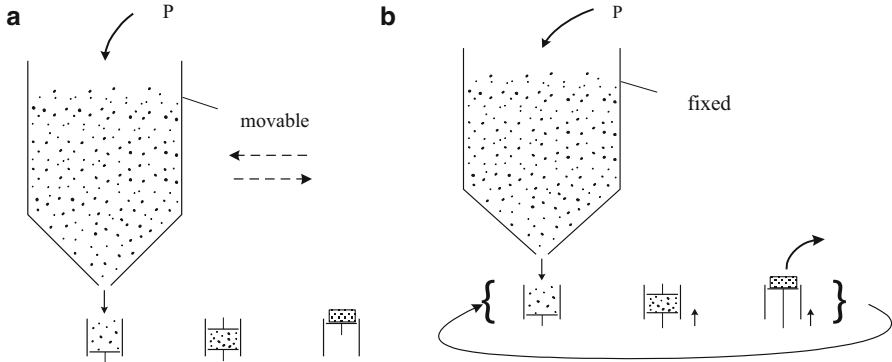
Advantages of compression agglomeration are (a) increased strength of agglomerates, (b) utilization of products that cannot be agglomerated otherwise, (c) variety of shapes and sizes, and (d) exact dosage of components.

Disadvantages of compression agglomeration are (a) high energy requirement, (b) low processing capacity, (c) wear out of equipment and tools, and (d) cost of auxiliary tools (molds, dies) used.

#### Compression Agglomeration Equipment

##### *Tableting Equipment*

Tableting equipment may be further distinguished into machines in which the filling funnel changes position, moving from mold to mold, while pistons and molds are fixed (Fig. 4.31a), and machines in which the filling funnel is fixed while the pistons with molds change position periodically (Fig. 4.31b). In the first case, reciprocating movement of the filling funnel occurs, stopping each time



**Fig. 4.31** Tableting agglomeration (see text). *P* product

exactly above the mold that has to be filled up. In the second case, molds are placed on a round table, which rotates and stops every time molds reach the funnel.

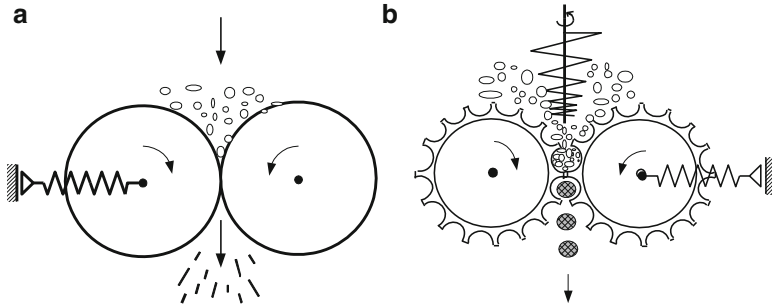
Advantages of tableting machines are their accuracy in making products of good strength, certain shape, and density. They can also guarantee precise dosing of constituent materials, which makes them indispensable in pharmaceuticals.

Tableting machines are used in the production of compressed products of exactly defined specifications (density, shape, form, etc.). Powder is filled in molds and compressed by reciprocating pistons. Often, two pistons are used, one forming the bottom of the mold, in which the material is compressed, and the second exerts the pressure required. After compression of the material between the two pistons, the upper piston removed and the lower pushes out the compressed agglomerate. Such machines are mainly used in the pharmaceutical industry, while in food processing they are used for producing candies.

The capacity of tableting machines depends on the type of material compressed and on the size of the tablets produced. Capacity is reduced as size is increased. The capacity of the rotating table machines is larger than that of the reciprocating machines. For about the same pressure on products and the same dimensions of products, the capacity of a rotating table machine can be 30 times larger (with 3–5 times more energy input).

Modern tableting machines are fully automated, and large ones can produce up to 1 million pieces per hour for tablet diameter of 11 mm and height of 8–9 mm. The depth of the cylinder that has to be filled with powder and compressed between the two pistons is 18 mm. The compression force depends on the capacity of the machines and is 50–100 kN. The speed of rotation of the round table with the molds is 30–100 rpm. Such machines do not require much space (1–2 m<sup>2</sup>). Their weight is 2–5 tons and the required power 10–15 kW.

Factors influencing tableting are (a) flow properties of material, (b) binders used, (c) adhesion of tablets on the compression pistons, and (d) facility of tablet removal after compression.



**Fig. 4.32** Roll pressing agglomeration. (a) Smooth; (b) structured rolls

### Roll Pressing Equipment

Roll pressing agglomeration equipment may be further distinguished between (a) smooth (Fig. 4.32a) and (b) structured pressing rolls (Fig. 4.32b). In both cases, two reversely rotating cylinders are used. In the first case, the surface of the cylinders is smooth, while in the second it may have structures depending on the shape the compressed products must get, or may have gear-wheel structure. Their main advantages are the utilization of relatively low value materials (e.g., by-products), transforming them economically to easy to handle useful products.

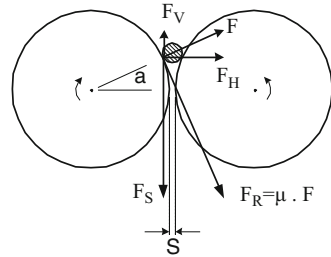
Roll press machines can produce large quantities of uniform products. However, these products are less uniform than those produced by tableting machines. Rolling machines consist of two metallic cylinders, one roll is fixed while the other is adjustable, so that the gap between the two rolls can be controlled. In calculations of roll systems, processing pressure, torque, and angle of nip are important. Processing pressure is needed for calculating the load on the bearings and fastening/support of the shaft of the cylinders. The torque is needed for calculating the required power consumption. The angle of nip determines the ability of rolls to grip material and drive it through the rolls. Larger angles of nip increase the time of compression. If the product to be compressed is very fine, then a snail gear moves the material toward the rolls. For forwarding granules/particles through the rolls, the force  $F_s > F_v$  or  $\mu > tg\alpha$ . For smooth rolls,  $\mu = 0.3$  which corresponds approximately to an angle  $\alpha = 30^\circ$  (Fig. 4.33).

$$F_s = F \sin \alpha \quad (4.17)$$

$$F_s = F_r \cos \alpha = \mu F \cos \alpha \quad (4.18)$$

Common dimensions of rolls are diameter,  $D = 0.8\text{--}1.5$  m, and width,  $b = 0.6$  m (Perry and Green 1997; Stieess 1992). Both cylinders rotate at the same speed. Rotation must be moderate, since very high speeds will increase the amount of air released during pressing. This air causes some kind of fluidization of the material waiting above the compression zone to be processed. Especially in the

**Fig. 4.33** Angle of nip in rolling processes



case of structured rolls (briquetting) and fine powder, this reduces the homogeneity of the compressed material (Stiess 1994). Speed of rotation is usually 5–40 rpm (Heinze 2000). Pressure ( $P$ ) depends on the type of machine and the product compressed. For compressing dry material by smooth rolls,  $P = 1\text{--}14$  kbar, and for compressing moist materials,  $P = 1\text{--}100$  bar (Rumpf 1975).

Factors influencing roll pressing of briquettes are (a) type of machine, (b) size of feed material, (c) size distribution of feed material, (d) shape and surface of feed material, (e) temperature of processing, (f) moisture content of products, (g) type and quality of binders, and (h) hardness and brittleness of product.

### *Pelletizing Equipment*

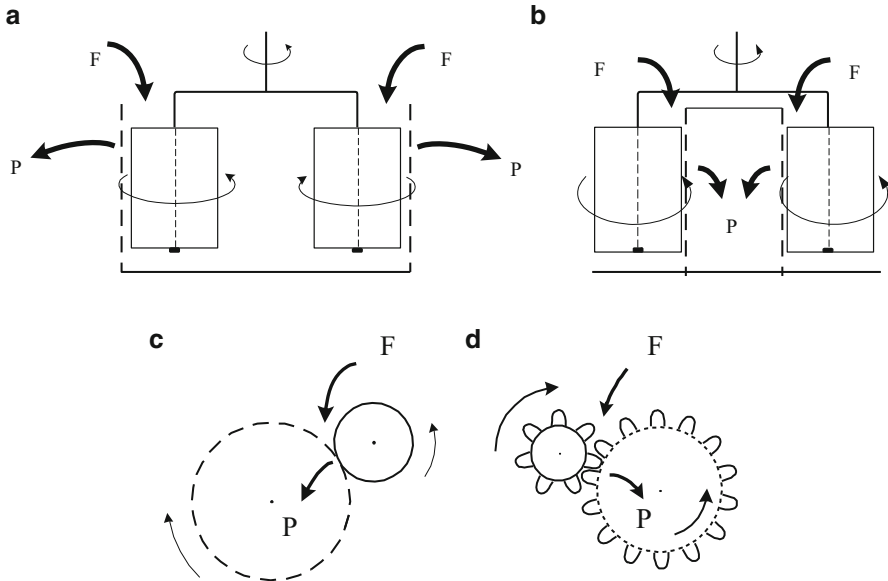
Pelletizing agglomeration machines are further subdivided into (a) screen pelletizers, (b) hollow rolls, and (c) extruders. In the first case, the material is agglomerated as it is pressed through screens. In the second case, rolls are perforated and the product is agglomerated as it passes through holes inside the rolls. In the third case, a screw drives and compresses the material against a perforated plate or through special dies. Extruders are discussed in the last part of this chapter (forming equipment).

Advantages of pelletizing machines are the possibility of yielding products of relatively high variety of constituents and solubility and processing of relatively moist materials. The different types of compression machines are analyzed in the following section. The data for equipment given are only indicative and may vary according to the material compressed.

In pelletizing machines, the key material is compressed through screens which determine the shape of the pellets formed. There are two basic variations: (a) fixed screens, while rollers or blades force the material to pass through them, and (b) material is pressed through perforated hole cylinders.

In the first category, screens are stationary while rolls or blades rotating over material press it through screens underneath (Fig. 4.34a, b). Pellets formed are cut to the desired length through scrapers lying on the internal or external surface of the whole cylinder. The capacity of such machines may vary significantly according to the kind of compressed material and the type of pellets produced. Indicative examples are product throughput of 1–300 kg/h and power requirement up to





**Fig. 4.34** Pelletizing equipment (see text)

3 kW, or product throughput of 2.5 tons/h and power requirement up to 22 kW. Pellets are usually cylindrical, and their diameter may vary between a few mm (e.g., 1–3 mm) and a few cm (e.g., 5 cm or even larger). The blades or rollers rotate at about 2 m/s, and the energy required for pressing may be around 10–20 kWh/ton. Slow rotation is beneficial as it keeps wear and noise below the acceptable limit of 80 db and facilitates the release of air of compressed material.

The second category of pelletizing machines is often used for producing pellets from moist materials. In this case, the material is pressed through a perforated cylinder by a counterrotating non-perforated cylinder (Fig. 4.34c). The diameter of such pellets is usually up to 5 mm. The capacity of such a machine may be up to 3 tons/h, and its energy requirement is about 5 kW/ton. A variation of perforated cylinders is that in which perforated gear wheels are used. This system is used for pelletizing hard materials which are pressed through nozzle bores situated between the teeth, along the whole width of the pitch of the gear wheels (Fig. 4.34d).

In the Hosokawa Bepex machines of this type, it is possible to influence the shape and dimensions of the pellets by placing different dies in the holes. Such machines may produce pellets of 1–10 mm. The diameter of gears is about 30 cm, their width is 4–10 cm, and the power requirement to drive such a system is 4–11 kW.

Factors influencing pelletizing are (a) resistance in forwarding the material through holes, (b) residence time of material in the holes, (c) pressure exercised, (d) moisture of material, binders used, and (e) dimensions of final product.

### 4.3.3 Selection of Agglomeration Equipment

In selecting agglomeration equipment, besides the general selection criteria of processing equipment, mentioned in Chap. 2, the following economic and technical criteria must be fulfilled:

- (a) Economic criteria: (1) Cost of equipment must be consistent with its capacity and quality; (2) price of binders or other additives must not be excessively high; (3) the relation of energy consumption to production capacity must be low; (4) wear of machine must be low; and (5) spare parts must be easily replaced and not expensive.
- (b) Technical criteria: (1) Capacity must be coherent with the type of processing requirement (batch/continuous processing); (2) quality of products, including texture, solubility, precision of composition, and shape, must be fulfilled; (3) noise of machines must not exceed 85 dB, and since in most cases raw material is in powder form, agglomeration equipment must be airtight; and (4) foundations should absorb vibrations, especially when reciprocating or fast running machines are used.

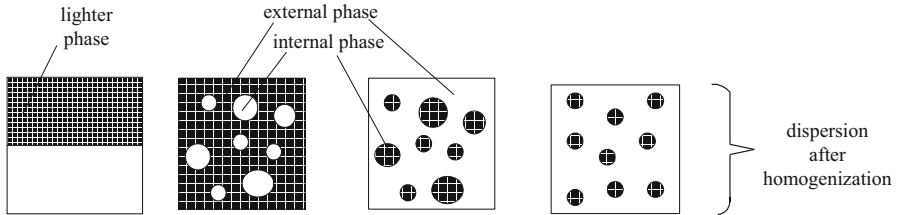
## 4.4 Homogenization

### 4.4.1 Introduction

In homogenization, uneven particles of liquid foods are reduced into smaller, more uniform units. Homogenization retards the separation of mixed liquids into separated groups and eliminates consistency variations. Homogenization enables better viscosity control, and it supports jelling at low temperatures. It facilitates cell rupture and comminution of fibrous materials dispersed in liquids.

Homogenization is a further step of emulsification. Homogenizers and emulsifiers are often used interchangeably with respect to equipment of emulsification (Fellows 1990). In emulsification of liquids, one or more liquids forming the internal phase are dispersed in another liquid, which forms the external continuous liquid phase, provided the liquids are immiscible (Fig. 4.35). Due to surface tension, the liquid droplets (internal phase) tend to form spheres. Subsequently, the small spheres tend to get together supporting the disintegration of the emulsion in separate continuous liquid phases. The physical properties and stability of an emulsion depend on the relation and type of the internal to the external phase. If the interfacial tension is high, the formation of emulsions is difficult, and furthermore, when these are formed, they are not very stable (Brennan et al. 1990).

Emulsification is governed by droplet disruption, due to energy input and re-coalescence of unstabilized droplets (Schubert and Karlstein 1994). The formation of such emulsions requires work input for overcoming the resistance to creation



**Fig. 4.35** Forms of emulsification and dispersion in a two liquid system

of new surfaces, caused by interfacial tension. This is accomplished in several ways. If the product has a very high viscosity or if the dispersed particles are quite large (e.g., fibrous particles), homogenization can be achieved by agitation. However, in most cases homogenization concerns low viscosity liquids. In this case, fluid droplets are broken down into smaller units by methods such as pressure, rotor stator, and ultrasound homogenization (Treiber 1978).

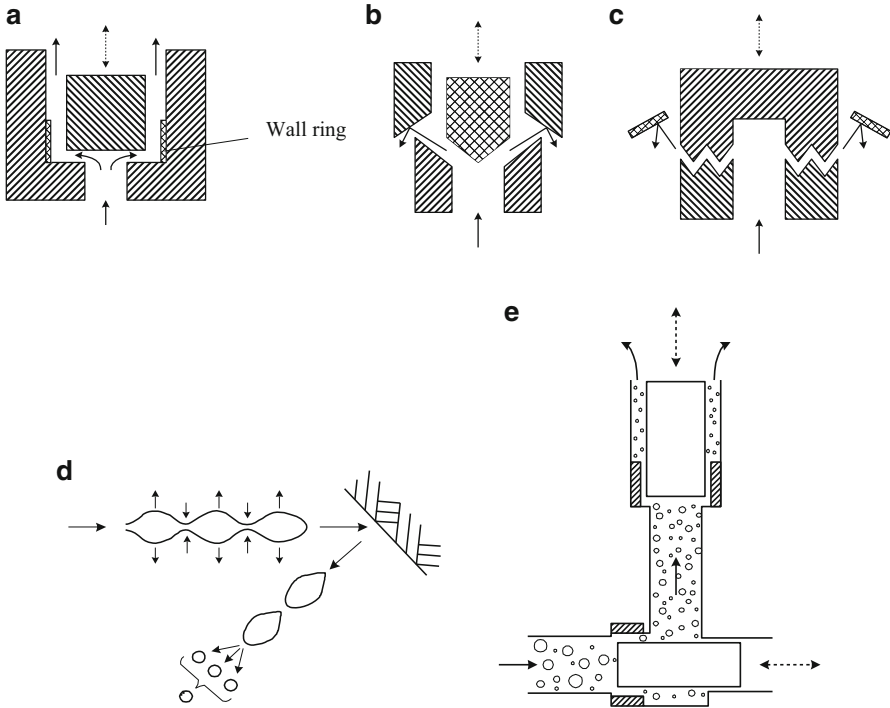
Some examples of application of homogenization to food processing are pulps, fruit and vegetable juices, vegetable oil, ketchup, baby food, salad sauces and creams, milk and milk products, liqueurs, gelatin, starch production, dispersion of gases in fermentation processes, dispersion of hops in beer production, and homogenization of cocoa in candy manufacturing.

The type of equipment used depends on the final size of particles and the output required. The higher the pressure, the smaller the particles. Pressures may vary from about 120 to 600 bar. If low pressure is applied, two-stage homogenization may be required. In high-pressure homogenization, the final particle size can be lower than 1  $\mu\text{m}$ .

## 4.4.2 Homogenization Equipment

### 4.4.2.1 Pressure Homogenization

Pressure homogenization is applied to liquids whose viscosity is less than 0.2 Pa s (Brennan et al. 1990). Pressure homogenizers consist of two main parts, the high-pressure pump and the homogenization valve, which is the most important element of the equipment (Fig. 4.36). The emulsion is fed at 1–2 bar pressure into a reciprocating pump, consisting of 3 or more plungers. The larger number of plungers secures constant product feeding and reduces machine vibration. Subsequently, the emulsion flows through the suction valves of the pump cylinders, during the withdrawal of the plungers, which follows each compression. The suction valves close, while each plunger moves forward again, compressing the contents of the corresponding cylinder through the discharge valves, to the homogenization valve. The pressure applied depends on the product and the final size of particles required. With respect to the product, it is noted that in liquids, consistency



**Fig. 4.36** Pressure homogenization valves (see text)

influences the process through the physical properties. In milk, e.g., the efficiency of homogenization decreases if the fat content increases, since fat increases the viscosity of the product. The pressure in homogenization may be 130–500 bar. Figure 4.37 indicates the influence of pressure on the mean particle of milk globules (Kessler 1981). The mean diameter of fat globules ( $d_m$ , m) in homogenized milk is given by the equation

$$d_m \sim (w/u_o)(\sigma/\rho\nu)(1/Re)^{1/3} \quad (4.19)$$

where

$w$ , width of valve gap (m)

$u_o$ , velocity at gap aperture (m/s)

$\sigma$ , interfacial tension (N/m)

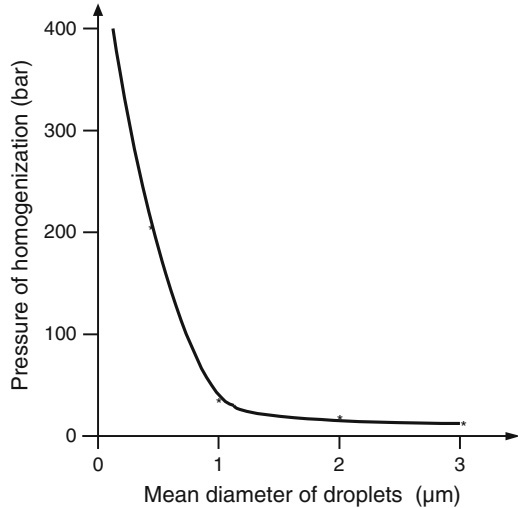
$\rho$ , density of the continuous phase ( $\text{kg/m}^3$ )

$\nu$ , kinematic viscosity of the continuous phase ( $\text{m}^2/\text{s}$ )

Re, mean Reynolds number in the valve gap

The type of homogenization valve is very important for the efficiency of homogenization. It consists basically of a plunger and a valve seat (Fig. 4.36a–c).

**Fig. 4.37** Influence of pressure on the mean diameter of milk globules



Between the plunger and the valve seat, a ring gap is formed. As compressed material arrives at the plug valve, it flows radially through the narrow ring gap and is then impacted on the surrounding wall ring. Valves with a sloped seat (Fig. 4.36b) need higher pressures than flat-seated valves. The valve efficiency increases (i.e., less pressure for the same result is required), if a flat-seated valve has grooved surface (Fig. 4.36c) (Kessler 1981). In this case, the droplets are compressed and expanded as they flow along the peaks of each groove. This probably facilitates the subsequent breaking when the droplet impacts on the wall (Fig. 4.34d). If the droplets are not small enough (which happens at relatively low pressures), the emulsion is not very stable. In this case, a second stage of homogenization is required (Fig. 4.36e). In a two-stage homogenization system, the pressure of the first stage can be 150–200 bar and that of the second stage about 20 % of it. In milk homogenization, one stage is enough, if fat globules are  $<0.7 \mu\text{m}$  and no clusters, due to casein subunits, are formed (Kessler 1981).

The ring gap can be adjusted by controlling the position of the valve plunger. The adjustable gap can be 15–300  $\mu\text{m}$  (Brennan et al. 1990). The product velocity in the ring is very high (200–300 m/s). According to Bernoulli's law, this high velocity causes a rapid pressure reduction and initiation of cavitation, which contributes to weakening the coherence of the droplets and finally to size reduction (disruption). Several efforts have been made to interpret the mechanism of particle size reduction (Treiber 1978; Kieffer 1977; Kurzhals 1977). Mulder and Walstra (1974) have summarized the forces that may act in homogenization. In pressure homogenization, the most important are shear, impact, cavitation, pressure gradient, and turbulence forces.

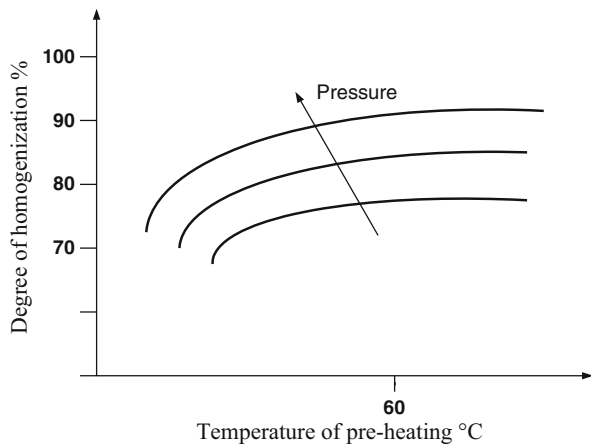
The energy loss during pressure homogenization is significant. As measurements on milk have shown, although the residence time of the product in the homogenization valve is extremely short, its temperature increases by about 4–5  $^{\circ}\text{C}$

(Klostermeyer 1991). However, this temperature increase is welcomed, since the “degree of homogenization” (i.e., the ratio of the volume of particles of the internal phase that is reduced below a certain size limit to the total volume of the internal material of the emulsion) increases when products are preheated (Kessler 1981) (Fig. 4.38). The preheating temperature depends on the product. Milk, e.g., is preheated to 60–70 °C and essential oils for lemonade to 25–40 °C. In the case that the equipment is used to treat aseptically processed food, homogenization valves and pressure pump are constructed in such a way that no contamination of the processed food occurs. In most constructions, this is achieved by using live steam around the vulnerable contamination points.

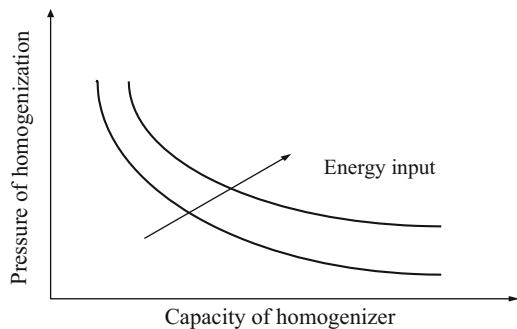
In some cases, such as in the homogenization of primary or intermediate food products (e.g., milk for cheese, fruit pulps for marmalades, citrus pulp for drinks), low-pressure homogenization (<70 bar) is enough. Besides reduced energy cost, this increases also the capacity, since the capacity of equipment depends on the pressure applied (Fig. 4.39).

Some indicative data of pressure homogenizers are given in Table 4.12. The size of a pressure homogenizer is determined by its motor and pump, since the volume

**Fig. 4.38** Influence of preheating on the degree of homogenization



**Fig. 4.39** Influence of pressure on the capacity of homogenization



**Table 4.12** Indicative technical data of homogenizers

Pressure (bar)	Capacity × 1000 (lit/h)	Power (kW)	Dimensions (m)	Weight <sup>a</sup> (tons)
100–550	28–14	95–225	2.0 × 1.5 × 1.5	5.0
140–550	13–5	75	1.5 × 1.5 × 1.5	2.5
200	10–25	110	1.5 × 2.0 × 2.0	3.0
350	0.5–5	35	1.0 × 1.5 × 1.0	1.0
200–300	5–3	43	1.0 × 1.0 × 1.5	3.0

<sup>a</sup>Without motor

of the homogenization valve is not more than 0.5–0.7 m<sup>3</sup>. The relation weight (tons)/volume (m<sup>3</sup>) is almost linear and can be approximated by the equation: (weight) = (0.7) × (volume) + 0.2. The power requirement of pressure homogenizers is 30–250 kW. High pressure reduces the equipment capacity.

#### 4.4.2.2 Colloid Mills

As mentioned in b, the description of crushing and grinding equipment (Fig. 4.19f), colloid mills can also be used in homogenization of liquids. In liquid homogenization, colloid mills are used when the viscosity of the product is relatively high (>1 Pa s) (Brennan et al. 1990). This kind of equipment is discussed in the Sect. 4.2.3 of this chapter. When a colloid mill is applied to homogenization, the disk rotates at 3000–15,000 rpm. The more viscous a product, the slower the rotation of the disk. The gap between the discs may be adjusted between 0.1 and 1.0 mm. The pressure during homogenization lies between 1.5 and 3.0 bar. At relatively high constant homogenization pressures, the influence of the gap between the discs on the capacity of the mill is not important. It becomes significant at low pressures (e.g., <1.5 bar). The capacity and power requirement of a colloid mill in homogenization depends on the processed product. It may be 2 to more than 30 m<sup>3</sup>/h, and the required energy may lie between 5 and 100 kW. In homogenization, e.g., of oil, capacities of 4000–40,000 kg/h and power consumption 6–75 kW have been reported. In using the same colloid mill in the homogenization of more viscous products, such as mayonnaise, containing about 80 % of oil and meat paste, the production is reduced to 1000–1200 kg/h and the power consumption can rise to 90 kW.

#### 4.4.2.3 Rotor-Stator Homogenizers

The construction of this homogenizer is very similar to the rotary grinder, described in the Sect. 4.2.3 (Fig. 4.21). The machine consists of a rotor assembled horizontally or vertically very near to a stator. Both are usually cylindrical or conical. The rotor can be also made of concentric discs. Both the stator and the rotor surfaces that face each other are “structured” (usually grooved). In the case of discs, their

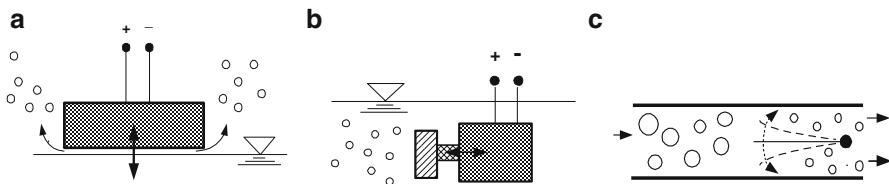
periphery, as indicated in Fig. 4.21, is either toothed or has a turbine-like construction. The product is size reduced by shear, impact, and cavitation forces, developed in the structured gap between the stator and the fast turning rotor (2000–8000 rpm). Such equipment is used in *homogenization* of products in the viscosity range, 1–30,000 mPa s (Treiber 1978). The particle size is controlled through the type of rotor used and its position with respect to the stator (width of the gap). The motor power of rotor-stator homogenizers is 8–100 kW for equipment with capacities 10–60 m<sup>3</sup>/h, and it can be up to 500 kW for capacities of 120 m<sup>3</sup>/h.

#### 4.4.2.4 Ultrasonic Homogenizers

In ultrasonic homogenizers, the homogenization of low viscosity liquids is carried out by alternative compression and tension, caused by high-frequency sound waves (18–30 kHz) (Fellows 1990). The particles formed by cavitation forces have size 1–2  $\mu\text{m}$ . There are two main categories of ultrasonic homogenizers, the electrically created and the mechanically induced. An example of electrically created size reduction is that produced by piezoelectric systems. A quartz, e.g., vibrates on the surface of water, producing very fine particles (Fig. 4.40a). This method is used for increasing the humidity in cold stores, since water particles in such rooms must be as fine as possible for reducing the formation of condensate and mold on the product. Another possibility is to produce sound waves through vibration of electromagnetic devices in the liquid (Fig. 4.40b). The mechanically induced ultrasound can be, e.g., created through metal blades vibrating at their resonant frequency as small particles (e.g., globules) fall on them, while flowing through tubes (Fig. 4.40c). Since the size distribution of particles created this way is wide, the homogenization process must be repeated if a more even size distribution is required. Products homogenized by these methods are oil emulsions, salad creams, ice creams, and baby food.

#### 4.4.2.5 High-Pressure Homogenization

See Chap. 12, Sects. 12.2.5 and 12.5.



**Fig. 4.40** Systems of ultrasound homogenization. (a) Quartz vibrator; (b) electromagnetic; mechanical vibrator



## 4.5 Mixing and Forming Equipment

### 4.5.1 Introduction

Mechanical mixing operations are used widely in the food processing industry to give new physical, rheological, and organoleptic properties to food products, to disperse components in multiphase mixtures, to improve heat and mass transfer, and to develop new food structures (Rielly 1997). The design and operation of mixing equipment depends on the physical and rheological properties of the initial components and the final products. Entirely different mixing systems are required for gas–liquid, liquid–liquid, solid–liquid, and solid–solid mixing. The theory of mixing is more developed in fluid (liquid–liquid) systems, while solid mixing is treated mostly empirically.

### 4.5.2 Fluid Mixing Equipment

The primary engineering characteristics of fluid mixers are the power (energy) requirements and the efficiency (uniformity) of mixing. Mixing of gases or liquids in a liquid is based on the mechanical agitation to disperse a component or a phase into another phase. Factors influencing mixing of liquids in agitated tanks/vessels:

#### 1. Mixing efficiency

- (a) Viscosity of liquid
- (b) Type of mixing device (propeller, paddle, etc.)
- (c) Position of mixing device (e.g., eccentricity, etc.)
- (d) Mounting of mixing device (e.g., angle of immersion)
- (e) Form of tank (e.g., cylindrical, parallelogram, etc.)
- (f) Form of bottom of tank (e.g., flat, inclined, etc.)
- (g) Baffles

#### 2. Additionally, factors that have to be considered in selection are:

- (a) Facility of cleaning
- (b) Required space
- (c) Construction (e.g., stability, materials used, open or closed type, filling and emptying, etc.)
- (d) Possibility of heat treatment (heating, cooling of liquid)

#### 4.5.2.1 Agitated Tanks

The basic mixing unit is the agitated tank, i.e., a vertical cylindrical vessel equipped with one or more impellers and baffles with specified dimensions for a given

application. Various types of impellers are used, depending on the volume of the vessel and the viscosity of the liquid. High-speed agitators include propellers, turbines, and hydrofoils, while anchors, paddles, ribbons, and screws are used for low-speed applications.

Mixing of low-viscosity liquids is improved by baffles on the walls of the vessel, which prevent the creation of vortices in the center of the tank. Baffles are ineffective in mixing very viscous or non-Newtonian fluids. Figure 4.39 shows diagrammatically a typical agitated tank, equipped with a propeller agitator and 4 wall baffles. Typical geometries of agitated tanks for fluid mixing are:

$$(H/D) = 1, (d/D) = 1/3, (h/D) = 1/3, \quad \text{and} \quad (B/D) = 1/10 \quad (4.20)$$

The mixing in agitated tanks is expressed by the Reynolds (Re) number, which is defined by the equation (Newtonian fluids)

$$\text{Re} = Nd\rho/\eta \quad (4.21)$$

where ( $N$ ) is the impeller rotational speed (1/s), ( $d$ ) is the impeller diameter (m), and ( $\rho, \eta$ ) are the density ( $\text{kg/m}^3$ ) and viscosity (Pa s) of the liquid, respectively. In agitated tanks, the following flow regimes are distinguished: laminar flow ( $\text{Re} < 10$ ), intermediate flow ( $10 < \text{Re} < 10,000$ ), and turbulent flow ( $\text{Re} > 10,000$ ). In liquids of low-viscosity liquids, turbulent flow ( $\text{Re} > 10,000$ ) can be obtained at high speeds. For non-Newtonian fluids, the (Re) number is estimated from the equation

$$\text{Re} = (\rho d^2)/(K\beta^{n-1}N^{n-2}) \quad (4.22)$$

where ( $K, \text{Pa s}^n$ , and  $n$ ) are rheological characteristics of the fluid, defined by the power law equation

$$\tau = K\gamma^n \quad (4.23)$$

( $\tau$ ) is the shear stress (Pa), and ( $\gamma$ ) is the shear rate (1/s) of the fluid (Saravacos and Maroulis 2001).

The characteristic constant ( $\beta$ ) is defined by the empirical equation (Holland and Brugg 1995)

$$\gamma = \beta N \quad (4.24)$$

The empirical constant ( $\beta$ ) is characteristic of the agitated system, with typical values of 10–13.

The shear stresses and shear rates vary widely within agitated tanks. The apparent viscosity of pseudoplastic (non-Newtonian) fluids decreases significantly ( $n < 1$ ) as the speed ( $N$ ) is increased (see Chap. 3). Thus, the mixing will be faster close to the agitator blades (propeller or turbine) than away from it, creating a

well-mixed volume of liquid, within a surrounding volume of unmixed liquid. For such systems, paddle or anchor agitators are more efficient, since they can mix the whole volume of the liquid.

#### 4.5.2.2 Power of Mixing

The power of mixing in an agitated tank is given by the empirical equation

$$Po/Fr = cRe^m \quad (4.25)$$

where

$$\text{Power number } Po = P_A / (\rho N^3 d^5) \quad (4.26)$$

$$\text{Froude number } Fr = N^2 d / g \quad (4.27)$$

( $P_A$ ) is the agitator power (W),  $g = 9.81 \text{ m/s}^2$  is the acceleration of gravity, and ( $c$ ) is a characteristic constant of the agitated system and the flow regime. The Froude ( $Fr$ ) number is a measure of the vortex, formed in the center of unbaffled agitated tanks. For baffled tanks and laminar flow,  $Fr = 1$ .

In laminar flow, Eq. (4.25) yields

$$P_A = c_L N^2 d^3 \eta \quad (4.28)$$

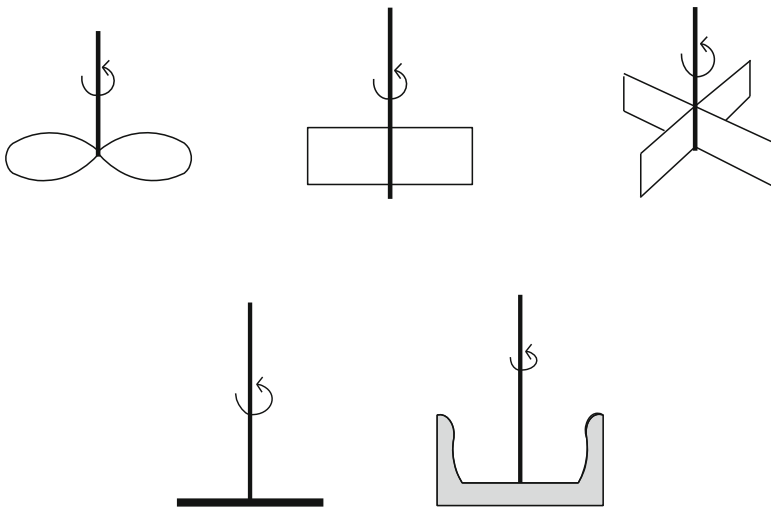
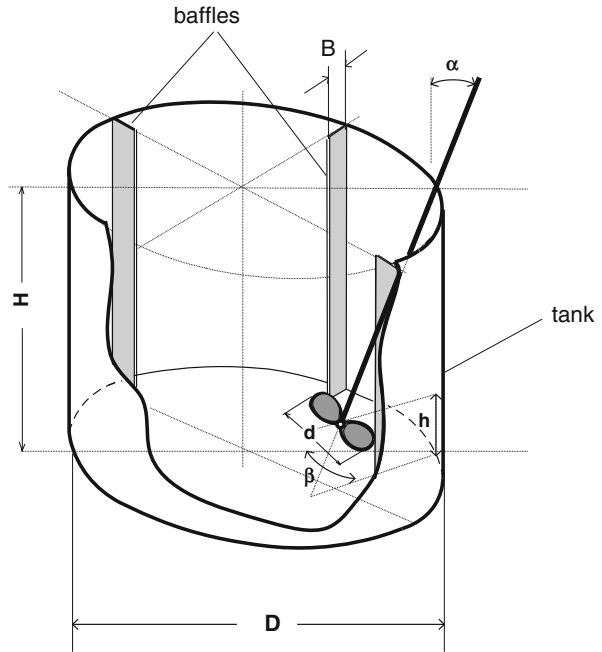
Thus, the power is proportional to the viscosity, but independent of the density of the liquid. In turbulent flow, the power is proportional to the density, but independent of the liquid viscosity. In the intermediate flow range, the agitation power is estimated from empirical equations or diagrams of  $\log(Po/Fr)$  versus  $\log(Re)$  for both Newtonian and non-Newtonian fluids (Perry and Green 1984; Walas 1988; Holland and Brugg 1995). The scale-up of mixing in food processing is discussed by Valentas et al. (1991).

#### 4.5.2.3 Industrial Mixers

Various types of industrial mixers are described by Dietsche (1998). In addition to the batch agitated mixers (Fig. 4.41), continuous in-line mixers are used, such as the static in-line (low shear) and the rotor-stator mixers for high shear, high viscosity, and particle disintegration. Colloid mills and pressure homogenizers, discussed earlier in this chapter, can be considered as continuous in-line mixers. Figure 4.42 presents some types of agitators.

Important factors in agitated tanks are their main dimensions ( $H$ ,  $D$ ), the diameter of the agitator ( $d$ ), its distance from the bottom of the tank ( $h$ ), and the

**Fig. 4.41** Agitated baffled tank;  $B$  baffle width,  $d$  impeller (propeller) diameter



**Fig. 4.42** Types of agitators

inclinations of the axis holding the agitator ( $\alpha$  and  $\beta$ ). In case of using baffles, important are also their number and their width ( $B$ ) (Fig. 4.42).

Mixers of suspended solids in aqueous systems are operated at speeds high enough to prevent the settling of the particles. The suspension of solids in liquids

is achieved by proper selection of the impeller type and the impeller/tank diameter ratio (Shaw 1992). High-shear mixers, suspension mixers, and colloid mills are described by Myers et al. (1999).

Gas-liquid mixers are used to absorb oxygen in aerobic fermentations. The absorption rate of oxygen in water solutions is controlled by mass transfer (see Chap. 11). High impeller (usually turbine) speeds are required to transfer the gas from the surrounding atmosphere, and the absorption is enhanced by supplying the gas through spargers at the bottom of the tank. Mechanical agitators are used on the surface of wastewater treatment tanks and pools to transfer oxygen from the atmospheric air into the water.

#### 4.5.2.4 Food Mixers

Food mixers are carried out, in addition to chemical process mixing, for improving food quality, e.g., for texture and color development. Food mixtures involve many ingredients, including liquids, powders, gases, and granular (particulate) solids. Some important ingredients are present only in minor quantities, which should be dispersed evenly and efficiently in the final mixture.

High viscosity and non-Newtonian fluids require special mixing equipment. Mixing patterns and product characteristics are related in complex manner. Scale-up of food mixers is based more on constant food properties than constant power/volume ratios.

Multistage or staged mixing of a minor ingredient may improve product quality. Efficient dispersion of minor expensive ingredients is essential.

High shear stresses, induced by agitators, are required for making fine dispersions and emulsions, while low shears are used for mixing solid particles/pieces in solid or liquid phases. Undesirable segregation of particles from mixed products should be considered.

Mathematical modeling, e.g., lamellar model mixing, can elucidate the mixing mechanism of complex food mixers, such as the Brabender Farinograph (Prakash and Kokini 1999).

#### 4.5.2.5 Selection of Mixers

The selection of appropriate fluid mixing equipment for a given application depends primarily on the viscosity of the liquid and the volume of the mixing vessel (Fig. 4.43). The mixing of viscous fluids requires large diameter impellers (e.g., paddles), which sweep a large portion of the tank volume. Large diameter impellers ( $d/D > 0.5$ ), operated at speeds  $N > 20$  rpm, are also needed for mixing non-Newtonian fluids, preventing the formation of a cavern (cavity) around the propeller. The power requirement is about  $2 \text{ kW/m}^3$  of liquid (Rielly 1997).

The power requirements of the agitated tanks range from 2 to 100 kW. The impellers can be top or side entering, depending on the volume of the vessel.

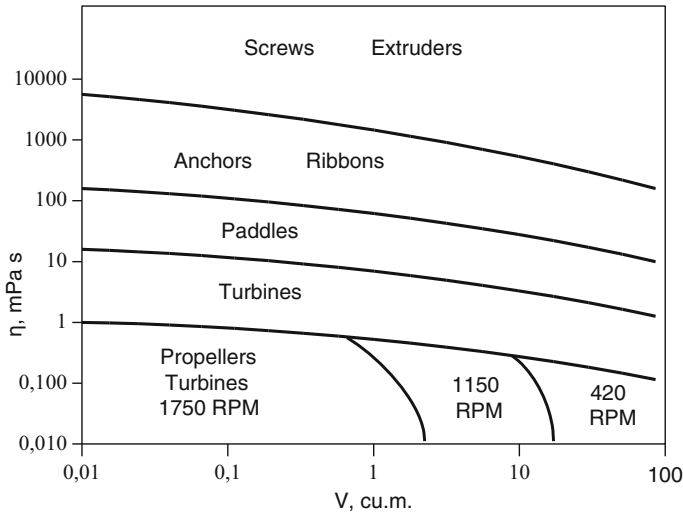


Fig. 4.43 Selection of fluid mixing equipment

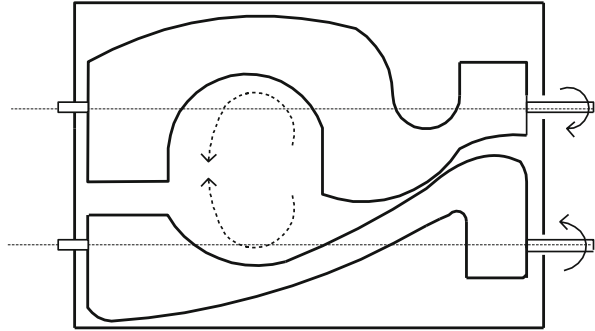
The superficial liquid velocity near the impeller depends on the viscosity, varying in the range of 0.1–0.3 m/s. Technical data on agitated tanks (volume, superficial velocity, and power) are given in the literature (Walas 1988) and by suppliers.

### 4.5.3 Paste and Dough Mixing Equipment

The mixing of food pastes and doughs is accomplished in specialized equipment, developed empirically by equipment manufacturers and industrial users (Uhl and Gray 1966; Bhatia and Cheremisinoff 1979; Walas 1988; Levine and Behmer 1997). Double planetary mixers are used for highly viscous fluids and pastes. The revolving stirrers may be raised hydraulically and immersed in another mixing tank, while the first tank is emptied. Dough mixing and processing are important operations in the baking, pasta, and cereal process industries. Doughs are more solid-like and viscoelastic than usual pastes. Protein (gluten-based) doughs are basic for bakery and pasta products (Levine and Behmer 1997). The two other food doughs are the starch based (cereals) and the fat based (cakes and pies).

Mixing of protein doughs increases their viscoelasticity and gas-holding capacity, essential requirements for bread making. Gluten development during dough mixing (kneading) is based on the alignment, uncoiling, extension, and folding of the protein molecules. Dough mixers are usually batch units, and they can be vertical (most common), horizontal, and high speed. For small capacities (110 kg material, 3.7 kW), the vertical double hook/paddle mixers are preferred. For capacities up to 350 kg (22.4 kW), the double spiral mixers are used. The power requirement of these mixers is in the range of 0.35–0.70 W/kg of mix.

**Fig. 4.44** Diagram of a Z-kneader



Spiral horizontal mixers, operating at speeds 35–70 rpm, have capacities of up to 1500 kg and power requirements of up to 100 kW. High-speed mixers (300–1200 rpm) are used for obtaining better quality products by faster mixing. A cooling jacket may be needed to remove the heat produced.

Kneaders or Z-blade mixers are used for doughs and pastes, which cannot be handled by anchors and helical ribbons. They are mounted horizontally and have two counterrotating blades. The blades have very close clearances with the walls of the trough for preventing buildup of sticky material on the wall. The kneaders achieve mixing by a combination of bulk movement and intense shearing as the material passes between the two blades or between the wall and one blade (Rielly 1997). Energy consumption per unit mass of doughs depends on the composition of the wheat (protein content) and the type of mixing equipment, e.g., 5–20 W h/kg. Figure 4.44 shows diagrammatically a Z-kneader.

## 4.5.4 Extrusion and Forming Equipment

### 4.5.4.1 Extruders

Extrusion is a complex food process combining several processing operations, such as mixing, cooking, kneading, heating, shaping, and forming. It is related to the palletizing agglomeration processes, discussed earlier in this chapter.

Extrusion is accomplished in a special screw conveyor, operated under controlled speed, pressure, temperature, and product flow. The shape of the extruded product is formed by forcing it through a specific die. Single or twin-screw extruders are used. Extruders have operational elasticity and versatility and do not affect environment. They act basically as positive displacement pumps, operating at high pressures and relatively low rotational speeds. In addition to the positive action of the screws, the product is also transported by drag flow, caused by friction with the barrel surface. The net flow is the difference between the forward drag flow and the backward pressure flow. The extruder screws are

designed with decreasing pitch, or with a constant screw pitch but with conical barrel, so that the product is compressed as it is conveyed from the entrance to the exit of the barrel (Levine 1992; Heldman and Hartel 1997).

Extrusion is divided into low-temperature (isothermal) and high-temperature or cooking extrusion. Low-temperature (cold) extrusion is actually a forming (shaping) operation, used in the processing of pasta, cereal, and special food products, e.g., coextruded food and confectionery products (Heldman and Hartel 1997; Fellows 1990). Extruders operate continuously and efficiently, and they can replace some other shaping equipment, if the higher investment can be justified for a given application. Pasta extruders operate at about 50 % moisture, 50 °C, and 50 rpm.

Extrusion cooking is more widely applied than low-temperature extrusion. It is operated at higher temperatures and pressures, producing several starch-based food products (Harper 1980; Mercier 1989; Riaz 2000; Guy 2001). Extrusion cooking, operated at high temperatures, can be considered, in addition to forming, as a HTST thermal process, reducing microbial contamination and inactivating spoilage enzymes.

Extrusion science and technology is based on the application of food chemistry and food process engineering to physical, chemical, and mechanical changes of food materials subjected to the flow, pressure, shearing, and temperature conditions of the continuous food extruder (Kokini et al 1992).

The physical properties (density, texture) of the extruded products can be designed by controlling the operating conditions of a given extruder (Weipert, Tscheuschner, Windhab 1993; Paulus and Cheftel 1989).

In the *single screw extruder* of Fig. 4.45, the extruder is divided broadly into three sections: conveying (feed charge zone A), kneading (compression zone B), and pressurizing (transport zone C). In the die (b), the influence of elasticity of the product is large. The elasticity energy is liberated as soon the product exits the die. The pressure drop  $\Delta p$ , (a), is a function of the elasticity properties of the extruded product. In zone A, the product usually consists of a humid heterogeneous mixture. In zone B, a homogenous paste-like, easy to flow matrix arises. Here the condition of the product is influenced by its viscosity, while the influence of its elasticity properties is reduced (Weipert, Tscheuschner, Windhab 1993).

*Twin-screw extruders* because of their advantages are usually preferred in the food industry over the single-screw units. The material to be extrusion cooked is usually a cereal powder (e.g., corn, wheat) at moisture content of 15–20 %, which is compressed and heated above the gelatinization temperature and then expanded through a die to puffed (porous) product of desired shape. They can operate at higher speeds, providing higher flow rates, higher shear rates, and better mixing as they are also effective in a backward mixing. In case the humidity of the product during extrusion is too low, water is added along with the product input. Additional benefits of the twin-screw extruders are:

- The product flow in the extruder is independent of the feeding charge.
- The heat distribution during processing is more even.
- Processing of even fatty and sticky products, or even high humidity products, which glide in the single-screw extruders, is possible.



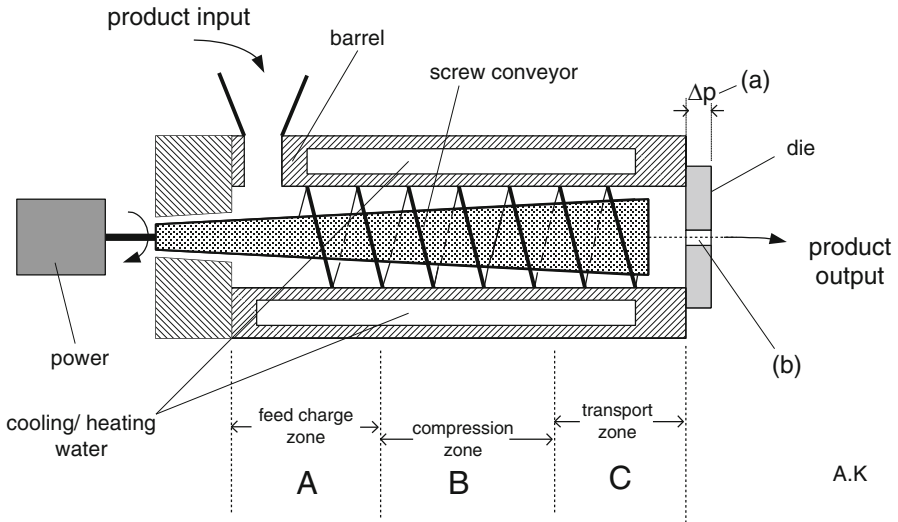


Fig. 4.45 Single-screw extruder

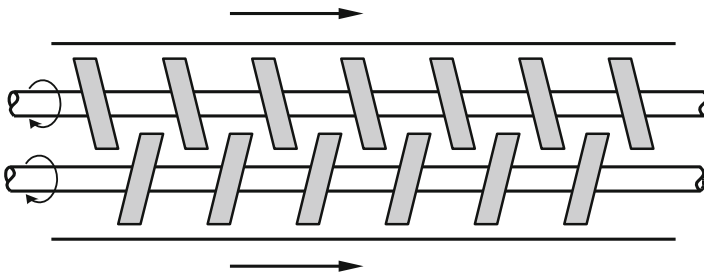


Fig. 4.46 Principle of twin-screw extruder

- Enables the post addition of substances by a provisory reversing operation of the screw conveyor rotation.
- Reduced length of the equipment.
- Possibility for an effective application even to powders.

Figure 4.46 shows diagrammatically two intermeshing corotating screws of a twin-screw extruder. The extruder is divided broadly into three sections: (1) conveying, (2) kneading, and (3) pressurizing. The extruder screws are designed with decreasing pitch, so that the product is compressed as it is conveyed from the entrance to the exit of the barrel (Levine 1992; Heldman and Hartel 1997).

Most extruders operate with no external heating, utilizing the heat produced by mechanical dissipation of the viscous forces in the pressurized particulate food material. However, if more accurate temperature control is required, the extruder barrel may be foreseen with external water circulation (Fig. 4.45).

The relative effect of external heat transfer to heat developed by heat dissipation of mechanical energy is characterized by the Brinkman number ( $Br$ ), defined by the equation

$$Br = (\text{mechanical energy})/(\text{heat energy at wall}) = (\eta u^2)/(\lambda \Delta T) \quad (4.29)$$

where ( $\eta$ ) is the viscosity of the material, (Pa s), ( $u$ ) is the velocity of the material in the extruder (m/s), ( $\lambda$ ) is the thermal conductivity (W/m K), and ( $\Delta T$ ) is the temperature difference between the barrel wall and the product in the extruder (K).

In most food extrusion processes, using low moisture particulate materials, the mechanical heat dissipation is higher than the heat transferred through the wall, i.e.,  $Br \gg 1$ .

The development of food (mostly cereal) shaping and extrusion equipment is discussed by Kokini et al. (1992), and the application or extrusion to various food products is described by Frame (1999) and Guy (2001). Twin-screw extruders can be used to produce various extruded foods of improved quality (Wiedmann 1992). The scale-up of extruders from pilot plant to industrial scale is outlined by Yacu (1992). Chang and Wang (1999) discuss the application of extrusion technology to the production of feeds. In scaling-up of extruders, the residence time distribution (RTD) and the specific mechanical energy (SME) should be kept constant.

Typical capacities of commercial extruders are 300 kg/h (snack foods), 1200 kg/h (cereals), and 9000 kg/h (pet foods). Normal operating conditions of extrusion cookers are pressure, 15–70 bar; temperature, 120–170 °C; rotational speeds up to 500 rpm; specific energy requirement, 0.02–0.1 kW/kg; total power, 5–200 kW; shaft torque, 70–2500 N m; and residence time, 20–90 s. Overall dimensions of the extruders are length, 2–4 m; width, 1–1.5 m; and height, 1.2–1.5 m.

#### 4.5.4.2 Forming Equipment

The forming equipment into various shapes and sizes is achieved by using various types of apparatus developed, in general, empirically. Figures 4.47, 4.48, and 4.49 present examples of equipment, used in connection with the prementioned three first types that are used in forming of food.

The forming equipment may be classified in four main categories:

- (a) Equipment modulates the product by cutting it to desired shapes and dimensions.
- (b) Using friction forces to achieve a differentiation in forming the initial product mass (e.g., in creating “dough balls” in the bread and candy industry).
- (c) Equipment shapes the product by pressing it through rotating rolls, by extrusion, and by pressing it using pistons. In the last two cases, the task is done in

Fig. 4.47 Cut forming

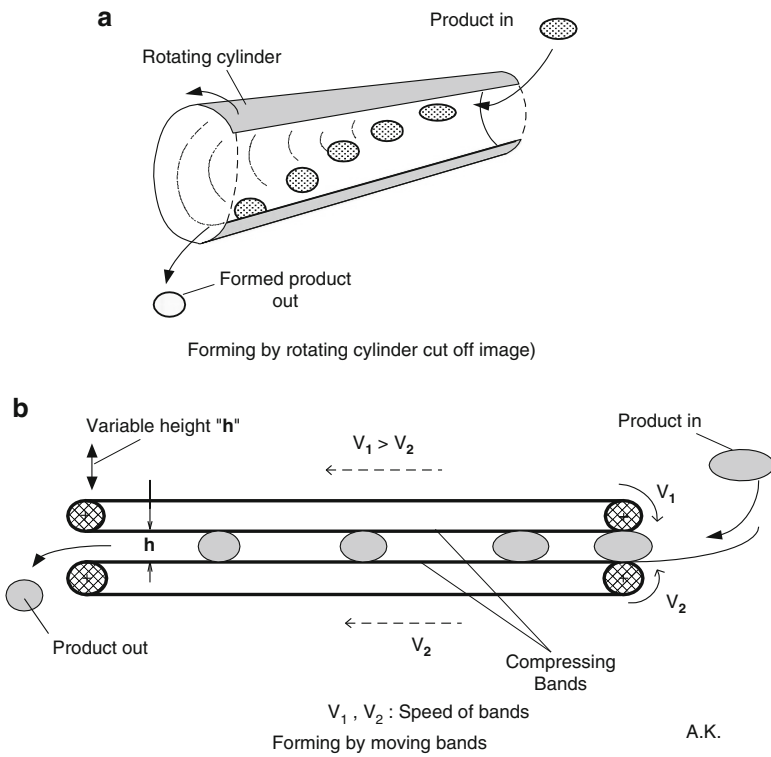
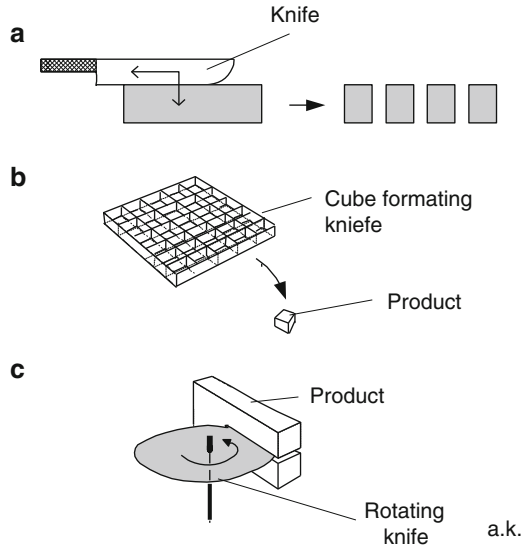
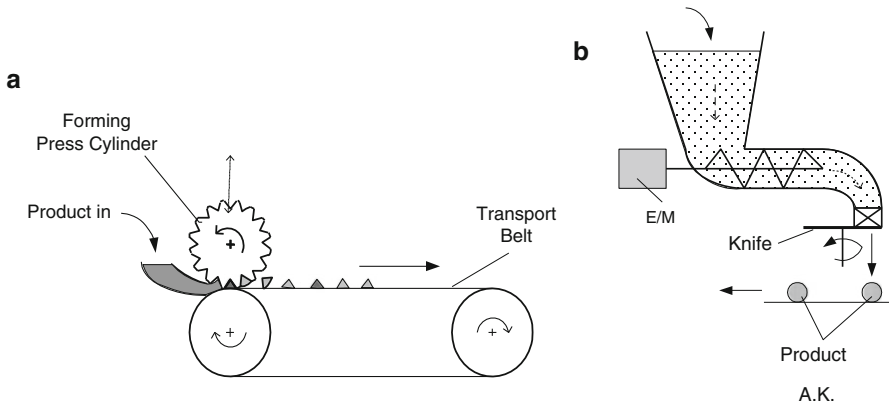


Fig. 4.48 Forming by friction



**Fig. 4.49** Forming by pressing

connection to special dies put at the end of the compressing instrument (e.g., extruder) giving it the desired shape and form.

- (d) Using molds in which the initially low viscous product (e.g., dough, chocolate mass, etc) is put to fill certain molds.

Figures 4.47–4.49 present examples of equipment, used in connection with the prementioned three first types that are used in forming of food.

The description of using forming equipment in the processing of bread and other baked products, biscuits, pies, and confectionary products is described by Fellows (1990) and Levine and Behmer (1997). Bread rolls that will expand to the required bread loaf shape when proofed are prepared in three stages, i.e., sheeting, curling, and sealing.

The engineering aspects of the sheeting operation are discussed by Levine and Behmer (1997). The conventional sheeting equipment (sheeters) is based on the reduction of dough thickness, by passing a slab through 2, 3, or more sets of rolls of varying distance between them. Sheeting can also be accomplished by mechanical extrusion. Laminated dough products consist of dough layers, interspersed with a separating agent, usually a shortening (fat) layer. Lamination is obtained by passing two or more dough sheets through sheeting rolls several times.

Pie coatings are formed by depositing a piece of dough into aluminum containers or reusable pie molds and pressing it with a die. A filling is then deposited into the casing, and a continuous sheet of dough is laid over the top, and the lids are cut by reciprocating blades. Biscuits are formed by pressing the dough in a shaped molding roller, cutting biscuit shapes from a dough sheet with a cutting roller, extrusion through a series of dies, or cutting biscuit shapes from an extruded dough sheet.

Equipment for forming bakery products is described by Matz (1989). Such equipment includes sheeters, laminators, loaf molders, and special forming and enrobing machines for cookies, crackers, pies, doughnuts, and cakes.

Confectionery products are formed into various shapes and sizes using individual molds, which are carried below a piston filler, depositing accurately the required hot sugar mass into each mold. The product is cooled in a cooling tunnel and ejected from the molds, using special ejection devices.

Coating and enrobing of food products with batter, chocolate, and other components are used to improve the eating quality of foods and to protect the product from the environmental effects (oxygen or moisture transfer). Chocolate is used to enrobe confectionery, ice cream, and baked goods. Corn syrup, flavorings, colors, and emulsifiers are also used. The thickness of a coating is primarily determined by the viscosity of the enrobing material. Enrobing is achieved by passing the product on a stainless steel conveyor beneath a curtain of hot liquid coating. The coating is applied by passing the product through a slit in the base of a vessel or by coating rollers. The coating is cooled by air in a cooling tunnel, and the coated foods are held at 22 °C for 48 h to allow fat crystallization. Batters are applied to fish, poultry, and potato products. A single layer of viscous batter is applied by passing the product through a bath of batter between two submerged mesh conveyors. Seasonings are applied from a hopper over a conveyor, followed by passing the product through a rotating drum, fitted with internal flights. Fluidized beds are also used for coating flavors on food particles (see section on Agglomeration in this chapter). Coating of fruits and vegetables for protection against moisture loss and microbial contamination is practiced by dipping, spraying, or brushing of paraffin and beeswax dispersed in an organic solvent (Krochta et al. 1994).

### ***4.5.5 Butter and Cheese Processing Equipment***

Depending on the final product, the operation of some butter and cheese equipment combines several mechanical processes, such as mixing, agitating, cutting, liquid–solid separation, forming, and even “partial extrusion.”

In *Butter drum processing*, the milk cream is battered as the drum containing it rotates (Fig. 4.50). It follows kneading through rotating gear wheels.

In *automated butter processing*, the milk cream is initially mixed before it is successively forwarded in a tube with screwdriver which compresses the product to its end, from which butter comes out through a relative narrow die (Fig. 4.51).

In several batch *cheese processing methods*, milk with additives (e.g., the enzyme rennet, etc.) is agitated in the cheese processor, up to the production of cut crude (Fig. 4.52). After draining of the liquid whey, the remaining product is put in forms, and it is compressed before being stored for ripening. This process can be also automated. The processing of milk and crude on a moving belt is done automatically (e.g., agitated and cut by instruments lying above the belt) until the crude is ready to be put in containers for pressing and final storage (ripening) (Fig. 4.53).

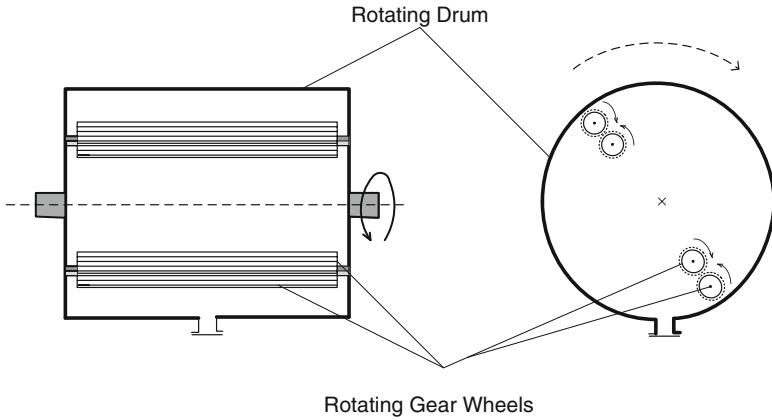


Fig. 4.50 Rotating butter drum

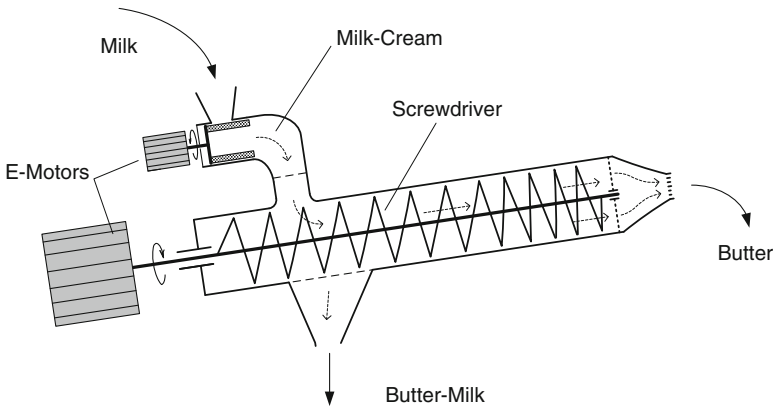


Fig. 4.51 Fritsch automated butter processor

### 4.5.6 Solid Mixing and Encrusting Equipment

Various types of equipment are used for the mixing and blending of solid particles and pieces, described in the technical literature (Bhatia and Cheremisinoff 1979; Walas 1988; Perry and Green 1997) and in suppliers' literature. Uniform blending of solid particles is very important for the quality of the food products. The blended product should be stable, and de-mixing and agglomeration should be prevented during storage and use (Johanson 2000).

The following are typical examples of solid mixers/blenders:

- (a) The ribbon mixers consist of helical blades, rotating horizontally, which can mix and convey particles in an horizontal U-shaped trough. Dual helical

Fig. 4.52 Cheese processor

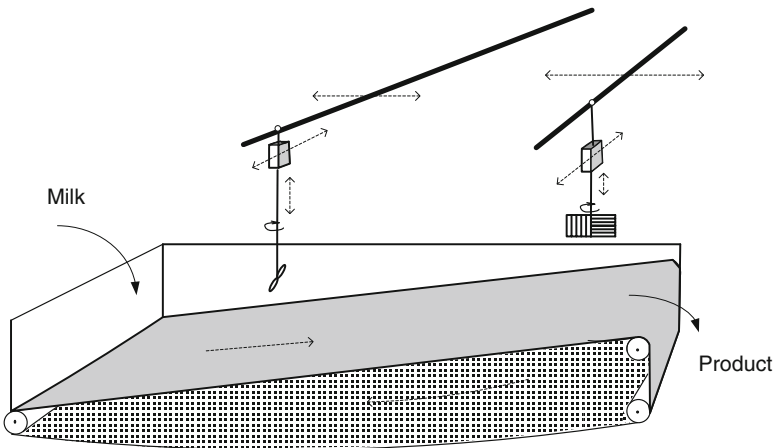
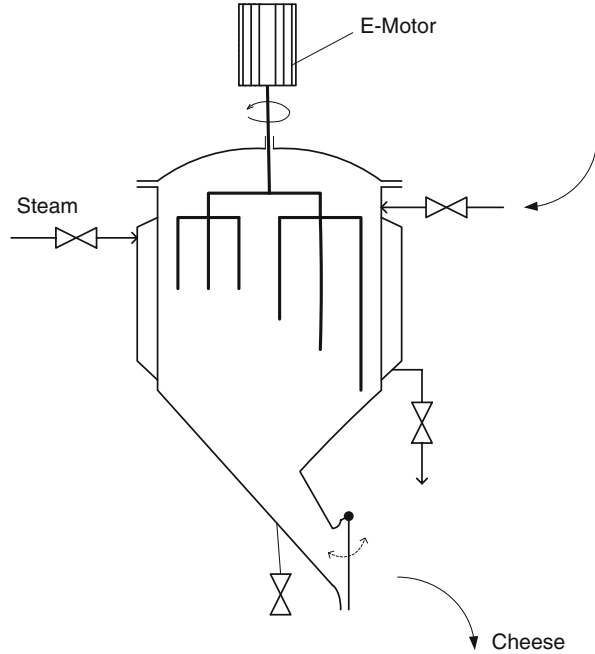


Fig. 4.53 Automated cheese processor

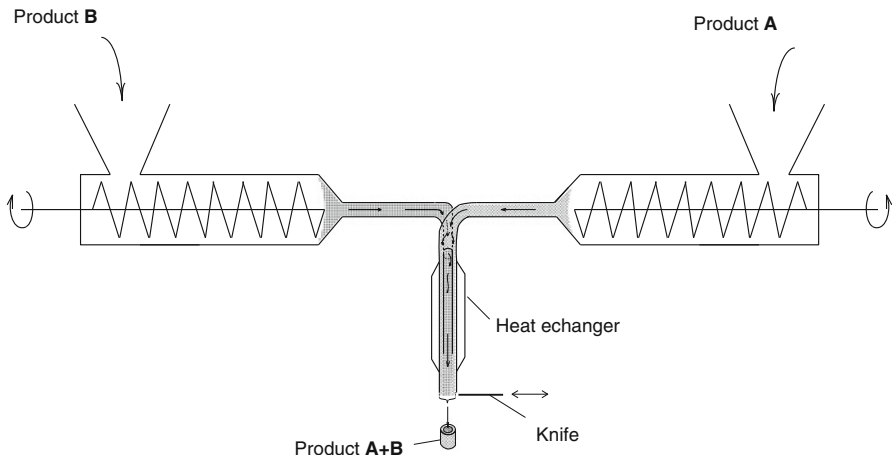
ribbons, rotating slowly at 15–60 rpm, can mix particles of bulk density about  $500 \text{ kg/m}^3$  and capacities up to  $50 \text{ m}^3$ .

- (b) The tumbling mixers consist of drum, double-cone, V-cone, or Y-cone blenders, rotating at 20–100 rpm. The particulate material splits and refolds in the legs of the blender as it rotates. The capacity of these mixers varies from  $0.1$  to  $7 \text{ m}^3$ .

- (c) The conical screw blenders are large inverted cone vessels of capacity  $35 \text{ m}^3$ , filled with particulate material, which is mixed with a vertical screw, orbiting around the periphery (epicyclic path) at about 3 rpm.
- (d) Two-cone screw blenders, operating on the same principle, can have a capacity of  $78 \text{ m}^3$ . The conical screw blenders are suitable for incorporating small amounts of a component into a larger mass of another material.
- (e) The mullers are used to blend intimately minor amounts of liquid into a major solid carrier. They consist of a circular pan with a central shaft in the bottom of the pan. Attached to the shaft are horizontal extensions that hold free-turning wheels, which rotate at slow speed around the periphery of the pan. Plows are attached to the shafts and directed the flow of the material to the wheels, which then pass over the materials in the pan. The mullers prevent the agglomeration of small particles during the mixing with the liquid. Small units have capacities of  $0.5\text{--}0.7 \text{ m}^3$  and require 5 kW power, while larger units have capacity of  $6 \text{ m}^3$  and power requirement 45 kW.

The description of using forming equipment in the processing of bread and other baked products, biscuits, pies, and confectionary products is described by Fellows (1990) and Levine and Behmer (1997).

Manufacturing of products consisting of separated different foods (e.g., jam or chocolate encrusted in dough as in croissants) or which consist of different layers or components (e.g., layers varied in color) is done by guiding the different components simultaneously as indicated in Fig. 4.54.



**Fig. 4.54** Encrusting



## References

- Allen T (1990) Particle size measurement, 4th edn. Chapman and Hall, London
- Bernotat S, Schoenert K (1988) Ullmann's encyclopedia of industrial chemistry, 5th edn, vol. B2, chap 5. Wiley, Weinheim
- Berszan G (1986) Maschinen der Fleischindustrie. Fachbuchverlag, Leipzig
- Bhatia M, Cheremisinoff P (1979) Solids separation and mixing. Technomic, Westport
- Bollin H (1991) Muellerei Technologie. In: Ostenroth D (ed) Taschenbuch fuer Lebensmittelchemiker und Technologen, vol 2. Springer, Berlin
- Brennan JG, Butters JR, Cowell ND, Lilley AE (1990) Food engineering operations, 3rd edn. Elsevier Applied Science, London
- Chang YK, Wang SS (eds) (1999) Advances in extrusion technology. Technomic, Lancasters
- Cleland DJ, Valentas KJ (1997) Prediction of freezing time and design of food freezers. In: Valentas KJ, Rotstein E, Singh RP (eds) Handbook of freeze engineering practice. CRC, New York
- Dialer K et al (1986) Grundzuege der Verfahrenstechnik und der Reaktionstechnik. C. Hanser, Munich
- Dietsche W (1998) Mix or match: choose the best mixers every time. Chem Eng 94(8):70–75
- Fellows PJ (1990) Food processing technology. Ellis Horwood, London
- Finne G (1982) Modified and controlled atmosphere storage of muscle foods. Food Technol 36:128–133
- Frame ND (ed) (1999) The extrusion cooking. Aspen, Gaithersburg
- Guy R (2001) Extrusion technology and applications. CRC, New York
- Harper JM (1980) Extrusion of foods. CRC, Boca Raton
- Heinze G (2000) Handbuch der Agglomerationstechnik. Wiley-VCH, Weinheim
- Heiss R (Editore) (1991) Lebensmitteltechnologie. Springer, Berlin
- Heldman DR, Hartel RW (1997) Principles of food processing. Chapman and Hall, New York
- Heldman DR, Lund DB (1992) Handbook of food engineering. Marcel Dekker, New York
- Hemming W (1991) Verfahrenstechnik, 6th edn. Vogel Verlag, Wuerzburg
- Henze J (1972) Bau und Einrichtung von Lagerräumen fuer Obst und Gemuese. Frankfurt: Kuratorium fuer Technik und Bauwesen in der Landwirtschaft e.V. Schrift 154
- Holland FA, Brugg R (1995) Fluid flow for chemical engineers, 2nd edn. Edward Arnold, London
- Johanson JR (2000) Smooth out solids blending problems. Chem Eng Prog 96(4):21–27
- Kent NL (1984) Technology of cereals. Pergamon, Oxford
- Kessler HG (1981) Food engineering and dairy technology. A. Kessler, Freising
- Kieffer P (1977) The influence of shearing stress on the size reduction of the inner phase of oil-in-water emulsion during high- pressure homogenization. Ph.D thesis in Germany, University of Karlsruhe
- Kokini JL, Ho CT, Karwe MV (eds) (1992) Food extrusion science and technology. Marcel Dekker, New York
- Kurzthals HA (1977) Untersuchungen ueber die physikalisch-technischen Vorgaenge beim Homogenisieren von Milch. In: Hochdruck-Homogenisiermaschinen. Dissertation, Technische Universitaet, Hanover
- Lawrison GC (1974) Crushing and grinding. The size reduction of solid materials. Butterwoths, London
- Leninger HA, Beverloo WA (1975) Food process engineering. D. Reidel, Dordrecht
- Levine L (1992) Extrusion processes. In: Handbook of food engineering. Marcel Dekker, New York
- Levine L, Behmer E (1997) Dough processing systems. In: Valentas KJ, Rotstein E, Singh RP (eds) Handbook of food engineering practice. CRC, New York
- Loncin M (1969) Die Grundlagen der Verfahrenstechnik in der Lebensmittelindustrie. Verlag Sauerlaender, Aarau

- Loncin M, Merson RL (1979) Food engineering. Principles and selected applications. Academic, New York
- Macrae R, Robinson RK, Sadler MJ (1993) Encyclopedia of food science and nutrition, vol 5. Academic, London
- Matz SA (1989) Equipment for bakers. Elsevier Science, London
- McCabe WL, Smith JC, Harriot P (1985) Unit operations of chemical engineering, 4th edn. McGraw-Hill, New York
- Meffert HFT (1965) Scrubbers. Annual report. I.B.V.T, Wageningen
- Mercier C (ed) (1989) Extrusion cooking. American Association of Cereal Chemists, St. Paul
- Mueller WD (1991) Fleischverarbeitung. In: Ostenroth D (ed) Taschenbuch fuer Lebensmittelchemiker und Technologen, vol 2. Springer, Berlin
- Mulder H, Walstra P (1974) The milk fat globule. University Press, Belfast
- Myers KJ, Reeder MF, Ryan D, Daly G (1999) Get a fix on high-shear mixing. Chem Eng Prog 95 (11):33–42
- Pahl MH (1989) Lagern, Foerdern und Dosieren v. Schuettgutern. Verlag TUEV, Rheinland
- Paulus KO, Cheftel CJ (1989) Progress in extrusion cooking. Bund für Lebensmittelrecht und Lebensmittelkunde e.V., Bonn
- Perry RH, Green D (1984) Perry's chemical engineers' handbook, 6th edn. McGraw-Hill, New York
- Perry RH, Green D (1997) Perry's chemical engineer's handbook, 7th edn. McGraw-Hill, New York
- Pietsch W (1967) Das Agglomerationverhalten feiner Teilchen. Staub-Reinhalt. Luft 27. Jahrgang 1:20–33
- Prakash S, Kokini JL (1999) Determination of mixing efficiency in a model food mixer. Adv Polym Technol 18(3):209–224
- Rao MA (1992) Transport and storage of food products. In: Heldman DR, Lund DB (eds) Handbook of food engineering. Marcel Dekker, New York
- Riaz MN (ed) (2000) Extruders in food applications. Technomic, Lancaster
- Rumpf H (1965) Die Einzellkornzerkleinerung als Grundlage einer technischen Zerkleinerungswissenschaft. Chemie Ingenieur Technik 37(3):187–202
- Rumpf H (1975) Mechanisch Verfahrenstechnik. C.Hanser, Munich
- Saravacos GD, Maroulis ZB (2001) Transport properties of foods. Marcel Dekker, New York
- Schubert H (1974) Haftung zwischen Feststoffteilchen aufgrund von Flüssigkeitsbruecken. Chemie Ingenieur Technik 46(8):333
- Schubert H (1987a) Food particle technology. I. Properties of particles and particulate food systems. J Food Eng 6:1–32
- Schubert H (1987b) Food particle technology II. Some specific cases. J Food Eng 6:83–102
- Schubert HA, Karlstein H (1994) Mechanical emulsification. In: Yano T, Matsuno R, Nakamura K (eds) Developments in food engineering. Part 1. Blackie Academic, London, pp 9–14
- Shaw JH (1992) Succeed in solids suspension. Chem Eng Prog 83(5):34–41
- Stiess M (1992) Mechanische Verfahrenstechnik, vol 1. Springer, Berlin
- Stiess M (1994) Mechanische Verfahrenstechnik, vol 2. Springer, Berlin
- Treiber A (1978) Emulsionstechnologie. In: Hochschulkurs, Ausgewahlte Themen der modernen Lebensmittel-verfahrenstechnik/Professor M. Loncin. Institut fuer Lebensmittel-verfahrenstechnik, Universitaet, Karlsruhe
- Tscheuschner HD (ed) (1986) Lebensmitteltechnik. Steikopff, Darmstadt
- Uhl Y, Gray JB (1966) Mixing theory and practice. Academic, New York
- Valentas KJ, Levine L, Clark JP (1991) Food processing operations and scale-up. Marcel Dekker, New York
- Walas SM (1988) Chemical process equipment. Butterworths-Heinemann, London
- Weipert H, Tscheuschner HD, Windhab E (1993) Rheologie der Lebensmittel. Behr's Verlag, Hamburg

- Wiedmann W (1992) Improving product quality through twin-screw extrusion and closed-loop quality control. In: Kokini JL, Ho CT, Karwe MV (eds) Food extrusion science and technology. Marcel Dekker, New York, pp 539–570
- Wollny M, Schubert H (2000) Gestalten der Eigenschaften von Instantprodukten mit dem Verfahren der Strahlagglomeration. *Chemie Ing. Technik* December 2000
- Yacu WE (1992) Scale-up of food extruders. In: Kokini JL, Ho CT, Karwe MV (eds) Food extrusion science and technology. Marcel Dekker, New York, pp 465–472
- Zogg M (1987) Einführung in die mechanische Verfahrenstechnik, 2nd edn. Verlag BG Teubner, Stuttgart

# Chapter 5

## Mechanical Separation Equipment

### 5.1 Introduction

Mechanical separations in food processing include two main operations, i.e., the removal of material or substances and their classification (Table 5.1). Removal is distinguished between removal of undesired parts (cleaning) and desired parts (separation).

Mechanical separation equipment is used extensively in the food processing industry, either in preparatory operations or in the main manufacturing and preservation operations. Mechanical processing operations such as size reduction, size enlargement, agglomeration, homogenization, and mixing, treated in Chap. 4, may involve some form of mechanical separation. Membrane separation processes, treated in Chap. 12, include micro-, ultra-, and nanofiltration, which are related to mechanical separations.

The basic materials involved in mechanical separations are discrete particles and solids, which behave differently than solutions or suspensions of dispersed materials. The mechanical equipment used in handling and processing particles has been developed empirically from practical experience, contrary to the fluid and gas handling equipment, which is based on fundamental physical and engineering principles. However, engineering principles and materials properties are used increasingly in the design and operation of solids handling equipment.

Mechanical separations are based on differences of density and size/shape of the food particles/pieces. They include solid/solid, solid/liquid, liquid/liquid, and solid/air operations. Solid/solid separations involve screening (sieving) of particulate foods (e.g., flour), cleaning and sorting of food pieces/particles (e.g., fruits, vegetables), and peeling, pitting, and dehulling of various plant foods (e.g., fruits/vegetables and cereals).

Solid/liquid separations are based on the size/shape of the food particles/pieces and the rheological (flow) properties of the liquid suspension. They include



sedimentation (clearing of wastewater effluents), filtration, and centrifugation (juices, oils, milk).

The mechanical liquid/liquid separations are based on differences of the liquid densities (e.g., oil–water separation). The solid/air separation is based on different densities of the materials (e.g., particles in cyclone) and on the fact that solids, unlike gases, cannot pass through fine-meshed (woven) textiles.

The properties of solid particles, related to mechanical processing, are discussed in Chaps. 3 and 4 (storage and transport of solids, size reduction, and size enlargement). The properties of solid foods are discussed by Lewis (1990), Mohsenin (1986), Peleg and Bagley (1983), and Jowitt et al. (1983, 1987). The characteristics of particles were reviewed by Schubert (1987a, b), and their analysis is described by Allen (1990). Appendix B gives some typical physical properties of foods.

Physical properties of solid particles of importance to separation processes are particle shape, size, and size distribution; particle density, bulk density, and porosity; elastic, plastic, and viscoelastic properties; wetting and flow properties; and electric, dielectric, and optical properties.

The particle size distribution is usually expressed as percent undersize ( $R$ ), i.e., the percent of particles that are smaller than a given size ( $x$ ). The data of particle (e.g., sieve) analysis are recorded in the following diagrams (Walas 1988): (a) cumulative ( $R$ ) versus  $\log(x)$ , (b) differential bar  $f(x)$  versus  $\log(x)$ , (c) differential histogram  $f(x)$  versus  $\log(x)$ , (d) logarithmic normal  $\log(R)$  versus  $\log(x)$ , and (e) Rosin–Rammler–Sperling diagram  $\log \log(1/R)$  versus  $\log(x)$ . Most of the food particles, produced by industrial processes, like size reduction and size enlargement, follow the logarithmic normal distribution, from which the mean particle size and the standard deviation can be estimated, as shown in Eqs. (4.9) and (4.10) (Chap. 4).

The particle (solids) density of dry food materials is about  $1500 \text{ kg/m}^3$ . The density of “wet” foods varies in the range of  $560 \text{ kg/m}^3$  (frozen vegetables) to  $1070 \text{ kg/m}^3$  (fresh fruit). The bulk density of food particles varies from  $330 \text{ kg/m}^3$  (instant coffee) to  $800 \text{ kg/m}^3$  (granulated sugar). The porosity of solid foods varies from about 0.1 to near 0.95 (freeze-dried and extruded products).

The flowability of food powders is characterized as: very cohesive, non-flowing, cohesive, easy flowing, and free flowing. The hydrodynamic properties of food particles are characterized by the Stokes equation, which describes the fall (settling) of a particle of given diameter and density in a fluid of known density and viscosity.

## 5.2 Classification Operations

The classification of raw food materials is very important before any further processing takes place. Two main categories in classification are (a) grading and (b) sorting. Grading is the separation of the products in quality categories, indicating the grade of their acceptability. In sorting, acceptable products are further classified according to predetermined physical or other characteristics.

### 5.2.1 Grading

Grading is the classification of food materials on the basis of commercial value, end usage (product quality), and official standards. Grading is necessary, e.g., for avoiding the further processing of blemished or spoiled products or products not meeting the quality requirements. Grading is done mostly by hand (e.g., inspection of fruits after washing), but when the physical characteristics are also indicative of product quality, grading can be done through machinery. In, e.g., rice, the white kernels are separated from the spoiled or from foreign matter optically, and the lighter unripe tomatoes can be separated from the ripe, according to their specific weight.

The effectiveness of hand grading depends on the following factors: (1) quality of the product, (2) quantity per inspector and min, (3) experience and physical condition of the inspector, (4) kind of inspection, (5) the ergonomics during work, and (6) the speed at which products move in front of the inspector.

The inspectors can assess a number of quality factors simultaneously and separate physically the product into certain quality categories, using sets of comparison standards, e.g., color cards or plastic models (Brennan et al. 1990). Fruits and vegetables are graded on the basis of state, federal, and international standards. Quality classifications, such as “free from damage” or “free from serious damage,” are used. Higher tolerances are used for minor rather than serious defects (Salunkhe et al. 1991).

The products should be properly illuminated and they should move relatively slow in front of the inspectors. Bad quality and large quantities result in bad grading. Tired or less experienced workers cannot inspect products efficiently. If, e.g., bottles or eggs pass in front of an illuminated plate or if the products steadily rotate such as in the case of fruits that are moved on conveyors, consisting of rotating rolls, the inspecting personnel gets quickly tired. The workers that inspect food must work comfortably. The products, e.g., must not exceed a distance larger than 80 cm from the worker, because an additional effort is needed to reach them. The speed of products moving in front of the workers inspecting them is product specific (Table 5.2).

Grading of larger quantities of food or products, such as grains, is based on testing of smaller quantities. The lots are taken out randomly and are subsequently evaluated in the laboratory, using proper instrumentation.

**Table 5.2** Speed of products (fruits) moving in front of inspecting personnel

Product	Speed of product (m/min)
Apples	35–45
Apricots	28–35
Berries	15–19
Cherries	20–25
Peaches	35–44
Plums	28–34

Besides skilled personnel, special machines are used increasingly for grading. The trend is to develop quality control methods that enable a continuous and quick estimation of the products. Nondestructive optical and physical methods, such as color measurements and use of X-rays, lasers, IR rays, and microwaves, are new promising methods (Knochel 2001; Clerjon and Damez 2001; Alderman et al. 2001). Most of the machines that are used in grading can be also used in sorting of food. The X-rays are also used in detecting foreign matter, such as glass splits and stones in even packed food. Machines having dimensions of  $1.3 \times 1.5 \times 2.5$  m can control 500 jars/min, detecting glass splits as small as 3 mm. Machine grading of a food product should be based on a representative index of quality, e.g., color, firmness, and pH, or a reasonable combination of these properties.

### 5.2.2 *Sorting*

Sorting, like grading, facilitates subsequent processing operations, such as peeling, pitting, blanching, slicing, and filling of containers. It is beneficial in heat and mass transfer operations, where processing time is a function of the size of the product (e.g., heat conduction, mass diffusion).

Sorting is done by equipment specific for each product or product category. It is based on the criteria indicated in Table 5.3.

Most of the mechanical sorters are based on the size of the materials, but some equipment utilizes differences in shape, density, and surface properties of the food pieces and particles.

Screens (flat or drum type) are used extensively in sorting various grains, seeds, crystals, and other food pieces/particles of relatively small size. Inclined screens, one on top of the other with horizontal and vertical oscillations, are effective in grain and seed sorting.

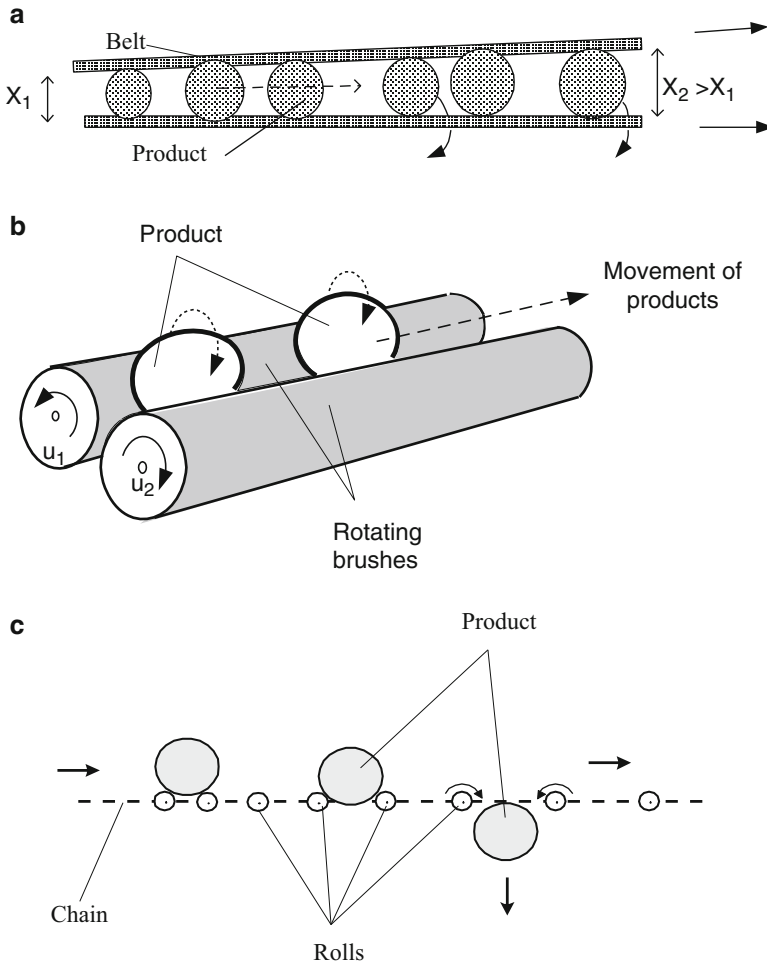
Sorting of fruits and vegetables may be related to quality classification, e.g., small-sized peas and okra are considered more tender and desirable than larger sizes, large potatoes are desirable for long French fries, the length of corn on the cob should not be higher than 150 mm, etc. (Salunkhe et al. 1991).

The shape of fruits and vegetables should be suitable for mechanical harvesting, handling, and processing. The size and shape of some fruits presents problems in processing operations, e.g., apples, mangoes, and papayas.

**Table 5.3** Criteria for sorting of foods

Category	Criteria
Physical criteria	Size, weight, shape
Technological criteria	Processing suitability or compatibility to existing equipment
Organoleptic	Texture, color, aroma, taste, ripeness, or freshness
Commercial	Attractiveness, tradition, variety, utility, price





**Fig. 5.1** Principles of size sorting machines. (a) Parallel belts and cables, (b) brush rollers, (c) roller sorter

Figure 5.1 indicates the principle of sorting of food, based on size. Products like several kinds of fruits can be sorted in diverging belt/cable sorters (Fig. 5.1a), diverting rollers (b), or roller sorters (Fig. 5.1b), which separate the fruits into various sizes by allowing them to pass through an increasing slot (opening). In the case shown in Fig. 5.1b, the rollers are brushes. This way the product (e.g., eggs) may be also round and round dry-cleaned during sorting as the rotation speed of two of the brush rollers may vary (e.g.,  $u_1 > u_2$ ).

The fruits move slowly through two parallel belts or cables, the distances of which increase in the direction of flow. The small fruit will fall first through the opening, followed by the next size. The various sizes of fruit are collected in padded

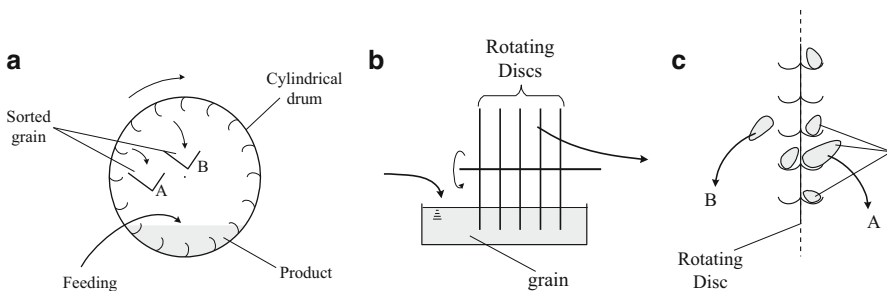
chutes, placed under the separator. The two belts may be driven at different speeds, subjecting the fruit to a more efficient separation.

The roller sorters are installed on a roller conveyor, so that the gap between them increases in the direction of flow of the food pieces. Thus, the fruits are separated in progressively increasing sizes, and they are collected in padded chutes under the conveyor. In many cases it is possible to combine classification/ sorting with computers, for the registration of the results of the classification automatically.

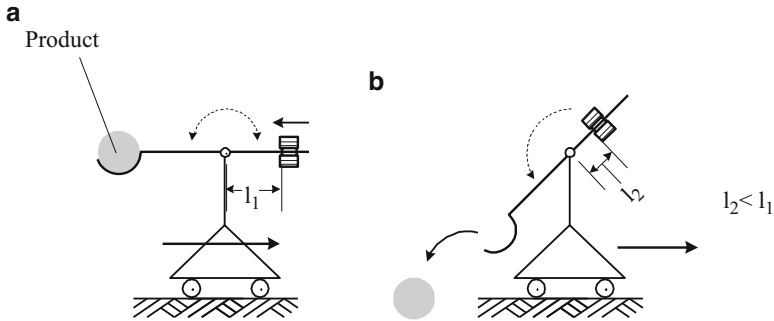
The spiral separators separate grains and seeds on the basis of shape. They consist of a vertical double helix through which the food particles fall by gravity. The round particles speed up as they roll down the internal helix, and they are thrown into the outer helix by the developed centrifugal force. The nonspherical particles are separated, as they move down through the internal helix at a lower speed.

Cylindrical and disk separators are used to separate nearly round grains (e.g., wheat) from long grains or particles (Fig. 5.2). The cylindrical unit consists of horizontal cylinder with hemispherical indents on the inside surface. The mixed grains are picked up by the indents and they are separated on the basis of their length, as they move up the cylinder. The longer grains fall down first, leaving the smaller grains, which fall in a different compartment. The fineness of the separation is controlled by the speed of rotation and the adjusted position of the separation edge in the cylinder. As in the following disk separator, the capacity of the cylindrical separator depends on the product to be separated. For sorting out, e.g., 10 % broken rice, the capacity of a cylindrical separator with dimensions  $3.5 \times 1.5$  m and which weighs 1 ton and consumes 3 kW is 5 tons/h. The equipment capacity is reduced to 3 tons/h, if the broken rice is 25 %.

The disk separator operates on the same principle with the cylindrical unit. The disk contains slightly undercut pockets, which can pick up and retain short grains, but long grains fall out. Thus, wheat grains can be separated from rye, oats, barley, etc. A number of different separations can be made in a single machine by installing banks of disks with different characteristics. The capacity of a relatively large disk separator may be up to 14 tons/h. Such units rotate with 100–135 rpm and require up to 3.5 kW.



**Fig. 5.2** Dry sorting of grains. (a) Cylindrical separator; (b, c) rotating disks



**Fig. 5.3** Weight sorter

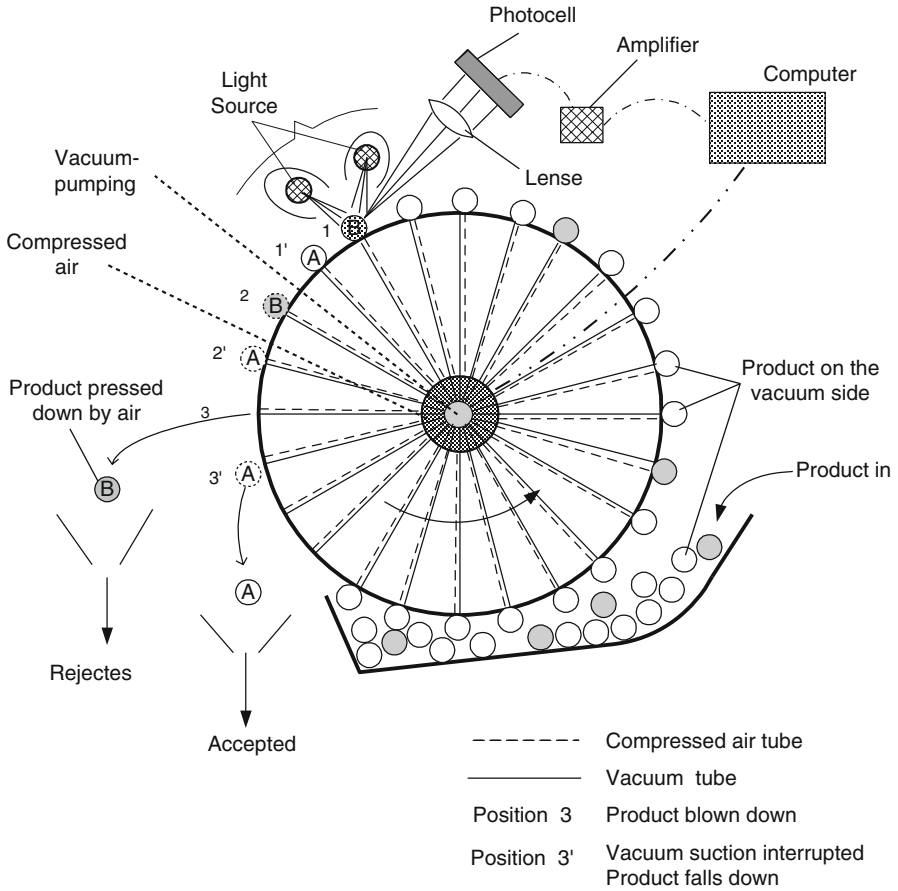
Separators based on different surface textures can be used to separate, e.g., weed seeds from wheat grain. They consist of a rotating drum of rough outside surface, which picks up the rough weed seeds and transfers them out of smoother grains, through an attachment/bouncing mechanism (Henderson and Perry 1955).

Weight sorters are used for valuable foods, like eggs, cut meats, and sensitive fruits, where accuracy in size separation and caution in handling are needed. Eggs can be sorted at the rate of 12,000/h. They are first inspected visually over tungsten lights (candling) to remove unfit eggs (Fellows 1990).

The weight sorter consists of a slanted conveyor which transports intermittently the eggs above a series of counterbalanced arms (Fig. 5.3). While the conveyor is stationary, the arms are raised and the eggs weighed. Heavy eggs are discharged into a padded chute, and light eggs are replaced in the conveyor belt to travel to the next weighing stop. Weight sorters, equipped with PLC sensors, can be operated in a computerized weighing packaging system (see Appendix C—Food Process Control).

The application of color sorting is widely used in the food processing industry. The operation of the color sorters is based on the reflection of incident light on a food piece/particle, which is measured by a photodetector. The reflected light is compared with preset color standards, and the rejected particle is removed from the product mixture by a short blast of compressed air (Grandison and Lewis 1996; Low and Maughan 1993) (Fig. 5.4). Color sorters can separate particles of sizes 2–10 mm (rice, coffee beans, frozen peas) at the rates of 100–1000 kg/h and some large units up to more than 10 tons/h. A large color sorting machine requires about 2–5 kW and 20–30 L/s air at 6–8 bar. It weighs about 700 kg and it has the basic dimensions (1.5–2.0) × (1.5–2.0) × (2.0–3.0) m. The capacity of a large tea sorting unit can be up to 20 tons/h.

Image processing can be used as a color sorting system (Fellows 1990). The food pieces/particles are fed on a roller conveyor, beneath a video camera. A composite image of each food piece is constructed by the computer, which is compared to preset color specifications, and the rejected particle is removed by an automatic mechanism. In bakery operations, the image analyzer can control the color of the product by controlling the gas/electricity supply to the oven.



**Fig. 5.4** Color sorting

Other food properties, on which a quick sorting can be established, are the constitution and, in the case of liquids, the viscosity of the products. Automated refractometers indicate the sugar content ( $^{\circ}$ Brix), while microwaves can be used for nondestructive water and fat content measurements.

## 5.3 Solid/Solid Separations

### 5.3.1 Screening

Screening (sieving) is the simplest mechanical operation for separating solid particles in a series of sieves with openings of standard size. The screening surface may consist of parallel bars, perforated or punched plates, and woven wire, silk, or

**Table 5.4** Typical sizes of standard sieves

USA, $\mu\text{m}$	Tyler, mesh	British, mm or $\mu\text{m}$	German, mm or $\mu\text{m}$
125 mm			
100"			
75"			
50"			
25"			2.5 mm
19"	0.742 in.		20.0"
9.5"	0.371"		10.0"
6.7"	3 mesh		6.3"
4.0"	5"		4.0"
1.7"	10"	1.68 mm	1.6"
1.0"	16"	1.0"	1.0"
850 $\mu\text{m}$	20"	850 $\mu\text{m}$	800 $\mu\text{m}$
500"	32"	500"	500"
250"	60"	250"	250"
150"	100"	150"	160"
90"	170"	90"	90"
75"	200"	75"	75"
63"	270"	63"	50"
45"	325"	45"	45"
38"	400"	38"	40"

plastic cloth. The screens may be flat or cylindrical. In all cases, a relative motion between product and screen is applied. Depending on the type of screen, this is achieved by vibration, shaking, or rotation of the screens.

### 5.3.1.1 Sieve Sizes

The openings of the sieves are usually squares, the dimension of which determines the size of the particles that can pass through (undersize) or remain on the screen (oversize). The industrial sieves are characterized by standard dimensions, which may be different in the various countries. Typical sizes of the standard sieve series, used in the USA, Britain, and Germany, are given in Table 5.4 (Walas 1988; Perry and Green 1984). See also Table 4.5 in Chap. 4.

The Tyler series is based on the concept of mesh, which is defined as the number of openings per linear inch (25,400  $\mu\text{m}$ ). The mesh number of a screening surface with square openings of dimension ( $a$ ,  $\mu\text{m}$ ) and wire diameter ( $d$ ,  $\mu\text{m}$ ) is given by the equation

$$N = 25,400/(a + d) \quad (5.1)$$

The Tyler series is based on the 200-mesh sieve with dimensions  $a = 75 \mu\text{m}$  and  $d = 53 \mu\text{m}$ . The ratio of the openings of two successive sieves is  $2^{0.5} = 1.41$  or  $2^{0.25} = 1.19$ .

The US standard series of Table 5.4 is the ASTM specification E-11-70. The Canadian standard series (8-GP-1d) is similar to the US standard. The British standard (BS-410-62) is very close to the US series. The German sieve series is the standard DIN 4188 specification. The ratio of two successive openings in this series is  $10^{0.1} = 1.25$ . The French standard sieve series (CAFNPR X-11-501) is identical with the German series, but the openings are given in mm instead of  $\mu\text{m}$ .

### 5.3.1.2 Sieving Equipment

The screens used in food processing are normally made of stainless steel, according to the general rules of hygienic design and easy cleaning (Chap. 2). Depending on the thickness and the application of sieves, their cleaning can be made by tapping, spraying, scraping, or brushing.

The screening process is facilitated by some kind of movement of the screening surface (vibration or shaking), which prevents the blocking of the screen openings with particles (blinding) and decreases the product flow rate and the separation efficiency of the screen.

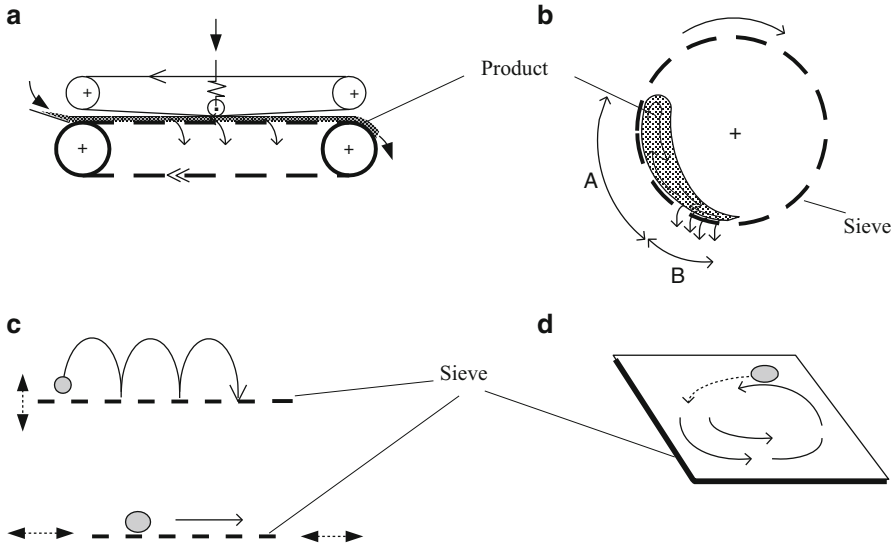
Screens can be classified in the following categories (Fig. 5.4): (1) grizzlies/belt screens, (2) trammels, (3) flat/vibrating screens, and (4) rotating sifters.

Efficient operation of screens is obtained when the particle bed is stratified, i.e., when the particles form layers of different sizes. Stratification is facilitated by vibration or shaking of the screens, which moves the small particles down to the screen surface so that they can pass easily through the screen (undersize). At the same time, the larger particles concentrate on the surface of the bed, being removed as the oversize product. The overall separation efficiency of industrial screens is the product of the separation efficiencies of the undersize and oversize products, varying from 85 to 95 %.

The design and specifications of screening equipment require physical and engineering data on the material to be separated, such as sieve size analysis, particle shape, density, hardness, flowability, moisture content, and temperature. The product flow rate, the separation required, and the type of screening (dry or wet) should be specified. In general, the efficiency of separation is reduced, when the product capacity (flow rate) is increased.

Moisture can cause agglomeration of the fine particles, which will not pass through the screen.

The following screening equipment is used for separating solid pieces and particles:



**Fig. 5.5** Screening systems: (a) belt, (b) rotating trommel, (c) vibrating flat, (d) rotating sifter

### Grizzlies/Belt Screens

Grizzlies or bar screens consist of horizontal or inclined ( $30\text{--}50^\circ$ ) parallel bars (or rods), which can separate relatively large pieces and lumps of particles (larger than 25 mm) from smaller particles. Grizzlies are used for scalping, i.e., removal of a small proportion (about 5 %) of large particles from a bed of otherwise medium- to small-sized particles. Blocking of the grizzlies by solid pieces/particles is prevented by using bars of trapezoid or wedge cross section. In some cases, the grizzlies or bars are part of an endless belt. A second belt, moving at a different speed, can be also used to improve separation (Fig. 5.5a).

### Trommels

Trommels or revolving screens consist of perforated cylinders (1–3 m diameter, 3 m long), rotating at about 15–20 rpm below the critical velocity (Fig. 5.4b). They are usually inclined at  $10\text{--}20^\circ$ , and they are used to separate particles in the size range of 10–60 mm (Walas 1988).

The critical velocity ( $N_{cr}$ , rpm) of trommels, at which the particles will not fall down because of the centrifugal force, is estimated from the equation

$$N_{cr} = 42.3/d^{0.5} \quad (5.2)$$

This simple relation is derived by equating the centrifugal and gravity forces ( $2m u^2/d = m g$ ), where ( $d$ ) is the diameter of the cylinder (m),  $u = (3.14 N d/60)$

is the peripheral velocity (m/s),  $m$  is the mass of the particle (kg), and  $g = 9.81 \text{ m/s}^2$ . As indicated in Fig. 5.5b, the actual sieving takes place only in a small part of the trommel (zone B), which is about 15–20 % of its circumference (Feustel et al. 1987).

Drum (trommel) screens are often used in various combinations (consecutive, parallel, or concentric) in the separation of grains and seeds.

### Flat Screens

Flat screens consist of flat screening surfaces of several sieve sizes, arranged vertically or in line and usually inclined, which can separate and classify various solid particles. Flat screens are usually vibrated at 600–7000 strokes/min and they can separate particles of sizes down to 400 mesh (38  $\mu\text{m}$ ).

Vibration can be vertical or horizontal (shaking or reciprocating screens), as shown in Fig. 5.5c. In the vertical vibration, the best sieving is achieved when there is resonance vibration and no contact between moving grain and screen (Feustel et al. 1987). Shaking and reciprocating screens are inclined slightly and vibrate at 30–1000 strokes/min, separating particles in the size range of 0.25–25 mm.

The width of the screens relates to the capacity (kg/h) of the system, while the length affects strongly the screening (separating) efficiency.

Typical operating characteristics of flat screens are capacities, 10–80 tons/h; screen dimensions,  $75 \times 150$  to  $200 \times 365$  cm; and motor power, 2–10 kW (Walas 1988). The overall dimensions of screening equipment, consisting of 30 screens, is about  $3 \times 4 \times 2.5$  m, and the weight is about 5–6 tons. Ultrasonic screening enables this process even to smaller particles (20  $\mu\text{m}$ ). It also reduces plugging in screens. In whey separation of cheese dairies, the productivity of such systems may be about 80  $\text{m}^3/\text{h}$ .

### Rotating Sifters

Rotating sifters consist of a series of square or round sieves (0.6–1.0 m), stratified on springs and placed atop of one another, which rotate in a gyratory motion. Such sieve systems may consist of more than 24 rotating sieves, which are grouped so that flour is classified in 4–8 categories (grades). A rotating shifter of a 30- $\text{m}^2$  filtering surface requires 2.2 kW. Its main dimensions can be  $2.5 \times 2.5 \times 2.5$  m and its weight 2.5 tons. Some gyratory sifters use bouncing balls on the sifting surface for auxiliary vibration and efficient separation (Fig. 5.5d).

### Screening Cloths

Most of the wire cloths are square mesh, but in some cases, an oblong weave may be used, which provides greater open area and higher capacity. Screens with relatively



large length-to-width ratio are preferred when moist and sticky materials tend to blind the square of short rectangular openings (Perry and Green 1984).

Synthetic woven materials, made from monofilaments (e.g., nylon) and Swiss silk, are used in light, standard, and heavy weights. The finer the wire of the cloth, the higher the screening capacity, although the operating life of the screen will be shorter. Worn or damaged screens should be replaced, because they will let oversize particles pass through and reduce separation efficiency.

### Magnetic Separators

Pieces and particles of iron and other ferrous metals (nickel and cobalt) are easily removed from food materials by magnetic separators. Electromagnets are preferred over permanent magnets, because they can be cleaned more easily (Fellows 1990). The principles of magnetic separations of solid particles are discussed by Perry and Green (1984).

Two simple magnetic separators which can be used in food in food processing are the magnetic drum and the magnetic pulley systems. A belt magnetic detector ( $1.2 \times 0.8 \times 1.0$  m) can detect iron balls of a diameter as small as 0.5 mm, by a belt conveying grain products at a speed of 6–60 m/min.

### Electrostatic Separators

Electrostatic (or high-tension) separation is based on the differential attraction or repulsion of charged particles in an electrical field. Electrical charging is accomplished by contact, induction, and ion bombardment. Some particles in a mixture are charged and they can be removed electrically, while the rest are separated by gravity. Particle sizes up to 1.5 mm (granular) or 25 mm (thin/long) can be separated. An application to food materials is the electrostatic separation of nuts from the shells (Perry and Green 1984).

#### 5.3.1.3 Sieving of Flour

One of the major applications of sieving in food processing is the separation of the various fractions of flour during the milling of wheat and other cereal grains. Scalping is the removal of the large particles from the flour, while dedusting is the removal of the very fine powder.

Grading of the flour is the classification of the flour into fractions of restricted particle size, like semolina and middlings. Narrow size distribution within a fraction can be obtained by closed cycle milling, in which the oversize stream from a sieve is returned to the mill for further size reduction. Size reduction equipment (mills) is discussed in Chap. 4.

### 5.3.2 Fluid Classification

Separation and classification of solid particles by fluids (air or liquids) is based on differences of density, shape, hydrodynamic surface, and electrical and magnetic properties of the materials in the mixture. Air classification is used to separate various fractions of food components, while wet sieving and hydrocyclones are used in some separations of fractions of food materials. Subsieve-size particles in the range of 2–40  $\mu\text{m}$  can be separated effectively using various fluid classifiers.

#### 5.3.2.1 Air Classifiers

Air classification of solid particles is a dry separation process, used in various food processing operations, like cleaning of raw food materials and fractionation of particulate food components.

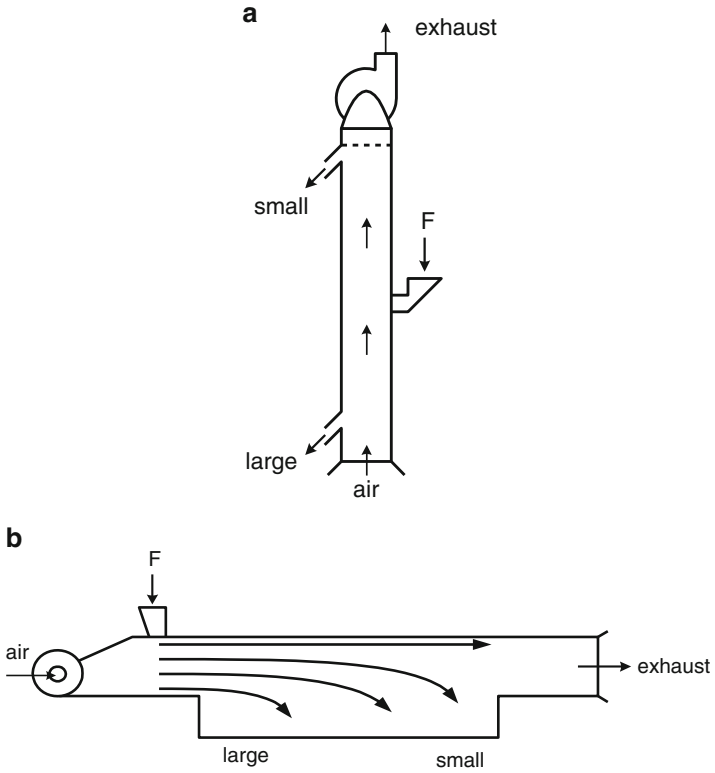
Equipment used in air classification of chemical and mineral products has been adapted to food products, taking into consideration the hygienic and quality requirements of food products.

Simple air classifiers are based on drag forces acting on particles by the airstream, which counteract the gravity forces. Aspiration classifiers are used to separate chaff (skins) from peas and grain in harvesting machines.

Figure 5.6 shows schematically two types of simple air classifiers. In the vertical classifier, the airstream will carry away the fine particles, leaving behind the larger (coarse) particles. In the horizontal classifier, the mixture of particles, carried by a horizontal air stream, is separated into various fractions according to the size and the density of the particles. The separation of particles is facilitated by passing the particle-containing airstream through a zigzag arrangement. Horizontal air classifiers of cleaning capacity 100 tons/h need 20 kW (90 % of it for the ventilators). The main dimensions and weight of such equipment are about  $2.5 \times 2.0 \times 2.5$  m and 3 tons, respectively.

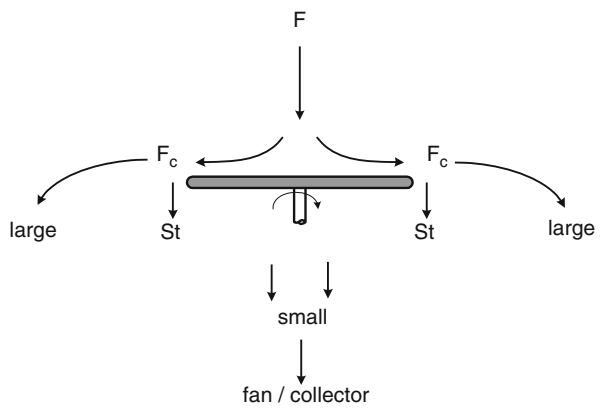
Most of the modern air classifiers are used to separate the protein fraction from the starch granules of ground cereals and legumes (Grandison and Lewis 1996), based on differences of size, shape, and density. Air classification is characterized by the cut size, defined as the size where the weight of particles below the cut size in the coarse fraction is the same with the weight of the particles above the cut size in the fine stream.

The basic elements of an air classifier are a rotating plate and air circulation fan, installed in a special separation chamber (Walas 1988; Perry and Green 1984). The basic forces acting on the particles in the air classifier are the centrifugal force ( $F_c$ ), the gravity force ( $F_g$ ), and the drag force, measured by the Stokes settling velocity of the particle ( $u_p$ ). Figure 5.7 shows the diagram of a rotating plate (disk), on which the particles are subjected to a centrifugal force, while air, sucked by a fan, removes the fine particles from the plate and separates them from the coarse particles.



**Fig. 5.6** Diagrams of simple air classifiers: (a) vertical, (b) horizontal.  $F$  feed

**Fig. 5.7** Diagram of rotating plate (disk) air classifier.  $F$  feed,  $F_c$  centrifugal force,  $St$  Stokes (gravity) force



Fine (undersize) and coarse (oversize) particles are discharged separately from the air classifier.

The centrifugal force  $F_c$  (N), acting on a solid particle of mass ( $m$ ) at a peripheral velocity  $u_p$  (m/s) of the rotating plate of radius  $R$  (m), is given by the equation

$$F_c = m u_p^2 / R \quad (5.3)$$

where  $m$  (kg) is the mass of the particle.

Air is blown on the surface of rotating plate at a radial velocity  $u_a$  (m/s), moving the small particles toward the periphery (edge). The velocity of settling by gravity in the air of a particle of equivalent diameter ( $d$ , m) is given by the Stokes equation

$$u_{St} = (d^2 \rho g) / 18\eta \quad (5.4)$$

where  $\rho$  is the particle density ( $\text{kg/m}^3$ ),  $\eta$  is the viscosity of the air (Pa s), and  $g = 9.81 \text{ m/s}^2$ .

The cut size ( $d_c$ ) in an air classifier is defined as the size of the particles which begin to settle in the air at the edge of the rotating plate, i.e.,  $u_{St} = u_a$ . Under these conditions, the centrifugal force is equal to the weight of the particle, i.e.,  $F_c = m g$ , and according to Eq. (5.3),

$$u_p^2 / R = g \quad (5.5)$$

Combining Eqs. (5.4) and (5.5), we obtain the relation for the cut size ( $d_c$ ):

$$d_c^2 = (18\eta R u_a) / (\rho u_p^2) \quad (5.6)$$

Equation (5.6) indicates that the cut size increases by increasing the radial air velocity ( $u_a$ ) or by reducing the rotational velocity ( $u_p$ ) of the particles.

The cut size separates the particles into two equal parts, i.e., the undersize and the oversize. The sharpness of separation is expressed by the ratio ( $k$ ), defined by the equation,

$$k = x_{0.75} / x_{0.25} \quad (5.7)$$

where ( $x_{0.25}$ ,  $x_{0.75}$ ) are the particle sizes corresponding to 75 and 25 % cumulative distributions (%  $R$ ). The theoretical sharpness ratio is ( $k = 1$ ), but in industrial separations, it may vary from 0.3 to 0.6 (Schubert 1987a, b).

Industrial air classifiers are described by Walas (1988) and Perry and Green (1984). Air classifiers used in food processing, particularly in separations of protein from starch, are discussed by Grandison and Lewis (1996). The rotating (separation) disk can be mounted either horizontally or vertically in the classifier. More than one rotating plates (or turbines) may be installed in one large air classifier.

In the milling of wheat flour, the protein fractions concentrate in the small particles (1–10  $\mu\text{m}$ ), while the starch granules are larger (15–40  $\mu\text{m}$ ), making possible the separation of the two components in air classifiers. Hard wheat contains about 13 % protein, while soft wheat contains only 7 %. Roller mills are more effective in milling soft rather than hard wheat. More effective milling of the wheat is achieved using impact mills, like pin disk and attrition disk mills (see Chap. 4).

In simple pin mills, only one set of pins rotates. Finer particles of wheat and fibrous materials can be obtained by rotating both sets of pins in opposite directions at different speeds, e.g., 6000–18,000 rpm. The optimum impact velocity for disintegrating most endosperm is about 200 m/s, which will not damage seriously the starch granules (Grandison and Lewis 1996).

Starch granules in legumes have sizes 16–21  $\mu\text{m} \times 2$ –28  $\mu\text{m}$ , and pin milling can separate effectively the small protein particles from the coarser starch granules.

### 5.3.2.2 Wet Classifiers

Wet classification is used extensively in the minerals industry, where particles of different density are suspended in water and separated in various types of solid/liquid classifiers. This method finds some applications in food processing, with examples of wet sieving, hydrocyclones, and separation of tomatoes in water tanks (see cleaning operations in this chapter).

#### Wet Sieving

Wet sieving is used to separate small-size particles which are difficult to go through the standard sieves, because they are sticky or they form agglomerates, when the humidity in the screening area is high. Typical example is the wet sieving of starch products, suspended in water. The suspending medium should be a liquid other than water (e.g., ethanol), when the particles are water soluble, e.g., sugar crystals.

#### Hydrocyclones

Hydrocyclones are similar to the normal solid/air cyclone separators. They are small inexpensive units, which can separate particles in the range of 5–300  $\mu\text{m}$ , which are suspended usually in water, e.g., protein/starch particles. The separation is based on differences in density of the particles, and it is also affected by the viscosity of the fluid suspension.

The characteristic diameter of the particles ( $d_{50}$ ) separates the mixture into 50 % undersize and 50 % oversize. The water suspension is fed to the hydrocyclone tangentially, forming a central vortex, which moves to the exit at the top of the cyclone, carrying the smaller particles (undersize). The coarse particles are thrown

by the self-generated centrifugal force to the walls of the cyclone, and they are removed from the bottom.

The high shear rates, developed within the cyclone, reduce significantly the apparent viscosity of the non-Newtonian (pseudoplastic) suspension, improving the efficiency of separation.

## 5.4 Solid/Liquid Separators

Solid/liquid separators are used in food processing: (a) for cleaning food liquid from undesirable particles and (b) for recovering useful food particles from water suspensions. They are also applied in the expression (expulsion) of juices and oils from fruits/vegetables and oilseeds.

The mechanical separation methods of solids are based on the particle size, shape, density, and concentration in the water suspension. The principle, scale-up, and applications of solid/liquid separations in the general field of process engineering are discussed by Cheremisinoff (1995) and Purchas and Wakeman (1986).

Four separation methods are used mainly in food processing, i.e., screening, sedimentation, filtration, and centrifugation. Screening is used for particles larger than 200  $\mu\text{m}$  and concentration 5–30 %. Sedimentation is applied to particles in the range 1–300  $\mu\text{m}$  and concentrations up to 25 %. Filtration and centrifugation are applied over a wider range of particle size and concentration.

### 5.4.1 Screens

Large pieces of food and waste materials are removed easily from water by grate screens, consisting of curved parallel bars. Smaller pieces and particles are separated by screens of various sizes and shapes (rectangular or circular). Vibration of the screens is required in most cases to facilitate filtration and remove the solids. The construction and operation of the screens are discussed in connection with the solid/solid separations earlier in this section.

### 5.4.2 Sedimentation Equipment

Gravity sedimentation equipment is applied to the clarification of food liquids from suspended particles (clarifiers) or to the concentration of solid particles (thickeners). Gravity settling of suspended particles in water solutions/suspensions can take place in three mechanisms:

1. Particulate settling, following the Stokes equation (5.4). The settling velocity is a function of the particle diameter and density, the viscosity of the liquid, and the gravitational force.
2. Zone or hindered settling. The particles fall together as a zone, creating a distinct clear water layer.
3. Compression regime. The particles are compressed by gravity to form a compressed bed.

Gravity sedimentation is used widely in the treatment of drinking water, industrial water, and wastewater. Due to the large volumes of water involved, large sedimentation tanks are required, which are designed on the basis of laboratory tests and practical experience (Perry and Green 1984).

The sedimentation tanks are fed with the water suspension at the center, while the clear water overflows from the sides and the concentrated particles (sludge) are removed from the bottom.

The settling velocity of water suspensions is estimated from laboratory tests in long or short tubes. The depth of the sedimentation tank should be sufficient for settling the smallest solid particles, while the diameter should be such that the upward velocity of the clear water should be lower than the settling (Stokes) velocity of the particles.

Depending on the particle concentration, the tank charge (load) of the settling tanks varies in the range  $0.3\text{--}3.0\text{ m}^3/\text{m}^2\text{ h}$  with residence times of about 10 h. From the total feed rate (kg/h) and the assumed load, the tank cross-sectional area ( $A$ ) and diameter ( $D$ ) are calculated. Diameters of 10–50 m are used, while the length of rectangular tanks may be as high as 80 m and the width 5–10 m. The depth of the sedimentation tanks varies from 3 to 5 m. Long agitating arms with scraping rakes, installed on a bridge and rotating slowly, are used to move and collect the settled particles (sludge) to the center of the tank, from where they are removed with special pumps.

Small metallic settling tanks, designed on the same principles of large installations, are used in the clarification or thickening of water or other liquid suspensions in the food processing plants. They consist of a cylindrical tank with a cone bottom, which are fed with liquid suspension in the center, while the clear liquid (water) overflows from the top and the sludge is removed from the bottom.

Sedimentation of colloidal and other difficult to settle particles in water is facilitated by the use of various flocculating agents, like alum (aluminum sulfate) and some polymeric materials, which form large agglomerates that settle faster into more compact sludges.

### 5.4.3 Industrial Filters

Two main types of solid/liquid filtration are used in food processing, i.e., cake filtration and depth (bed) filtration. In addition, microfiltration and ultrafiltration

(membrane separations) are used to separate very small particles of molecular size and microorganisms from water suspensions/solutions (Chap. 12).

In cake filtration, the particles form a layer of particles on the surface of the filter medium, which acts a screen of the particles during operation. In depth filtration, the particles are removed from the suspension within the bed, filling the pores of the filter medium. In both types of filtration, pressure drop and filtration rate are the basic quantities considered.

### 5.4.3.1 Cake Filtration

In cake filtration, the total pressure drop ( $\Delta p$ ) is given by the equation

$$\Delta p = \Delta p_m + \Delta p_c \quad (5.8)$$

where  $\Delta p_m$  and  $\Delta p_c$  are the pressure drops through the filter medium and filter cake, respectively, given by the following empirical equations:

$$\Delta p_m = (\eta R_m)(dV/A dt) \quad (5.9)$$

$$\Delta p_c = (\eta R C V/A)(dV/A dt) \quad (5.10)$$

where ( $R_m$ ) and ( $R$ ) are the resistances to flow of the filter medium and filter cake, respectively, ( $V$ ) is the volume of filtrate ( $m^3$ ), ( $C$ ) is the mass of particles deposited as cake per unit volume of filtrate ( $kg/m^3$ ), ( $A$ ) is the surface area of filtration ( $m^2$ ), and ( $\eta$ ) is the viscosity of the liquid (Pa s). The units of  $R_m$  are (1/m) and of  $R_c$  ( $m/kg$ ).

It should be noted that, at constant filtration rate,  $(dV/A dt) = u$ , where ( $u$ ) is the superficial filtration velocity (m/s) for the given pressure drop. Also, in dilute suspensions, ( $C$ ) is approximately equal to the concentration of solid particles ( $kg/m^3$ ).

In most industrial filters, the resistance of the filter medium ( $R_m$ ) is negligible, compared to the resistance of the filter cake ( $R$ ), and, therefore, the pressure drop ( $\Delta p_m$ ) can be neglected.

For constant pressure drop ( $\Delta p$ ), the filtration time ( $t$ ) to obtain a filtration volume of ( $V$ ) is found by integrating Eq. (5.10), neglecting the pressure drop through the filter medium:

$$t = (\eta R C / 2 \Delta p)(V/A)^2 \quad (5.11)$$

The total mass of cake deposited after volume ( $V$ ) of filtrate is calculated from the relation  $m = V C$ .

The specific cake resistance ( $R$ ) is approximately constant for incompressible cakes. For compressible cakes of colloid and gelatinous particles, the resistance ( $R$ ) increases significantly with the pressure drop ( $\Delta p$ ) according to the equation



$$R = R_o(\Delta p)^s \quad (5.12)$$

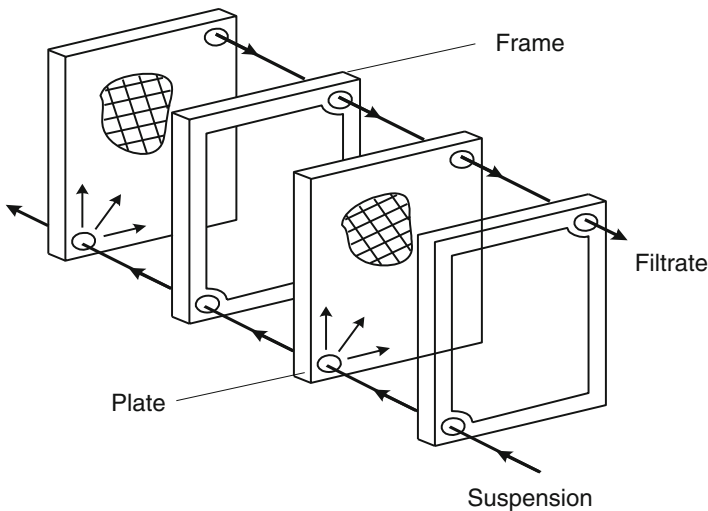
where ( $R_o$ ) is a constant and ( $s$ ) is the compressibility of the cake. The compressibility of hard solid particles, like salt or sugar crystals, is ( $s = 0$ ). For compressible colloid particles, ( $s = 0.8-1.0$ ).

The filter media used in industrial filtration should have good strength and wear resistance and low cost, e.g., woven fabrics of cotton, wool, nylon, and other synthetic materials.

### Plate-and-Frame Filters

Plate-and-frame filters, or filter presses, are batch-operated units, in which the suspension is filtered through the surface of plates, forming a cake within the supporting frames. The filtrate is collected through special piping and the cake is discharged, when the operation is stopped for cleaning. Figure 5.8 shows diagrammatically the principle of operation of a plate-and-frame filter.

The square filtering plates are made of stainless steel and they have dimensions of 15–150 cm and thickness of 1–5 cm. The filtering surface is made of a strong metallic screen, covered with a filter medium (woven fabric) during filtration. Depending on the type of filtered suspension, the operating pressure can vary from 2 to 20 bar. The total surface of a filter depends on the dimensions and on the number of plates used. Large units may have more than 100 plates with operating pressure up to 6 bar. The filtration area in such units may be up to 70 m<sup>2</sup> and the total length of the equipment may be 5–7 m. Its weight is about



**Fig. 5.8** Diagram of a plate-and-frame filter

1 ton and, in the case of, e.g., wine clarification, its filtering capacity may be about 1 ton/h.

When the filter cake is a useful product, it may be washed with water on the filter at the end of the operating cycle. The removal of the cake from the plates is facilitated with the flow of compressed air.

Filtration of colloidal and gelatinous particles is facilitated by using filter aids, i.e., inert powders which increase the porosity and the permeability of the cakes. Typical filter aids are diatomaceous earth, perlite, and cellulose paper. The filter aid is mixed with the water suspension before the filtration at proportions (filter aid/solid particles) of 1:1 to 1:5, for crystalline to slimy solids, respectively (Bhatia and Cheremisinoff 1979).

### Vacuum Rotary Filters

The vacuum rotary filters are used widely in the process industries, because of their advantages over the plate-and-frame filters. They are continuous and faster, and they require less labor, but they are more expensive than the batch filter presses. Figure 5.8 shows diagrammatically the principle of operation of a vacuum rotary filter.

The filter consists of a horizontal drum 0.3–3 m diameter and 0.3–4 m long, partially submerged in a trough containing the suspension and rotating slowly at 0.1–2 rpm. The surface of the cylinder is made of a metallic screen; it is covered with a filter medium, and it acts as the filtration surface. Vacuum is applied to the interior of the drum and filtration takes place under a constant pressure drop, which is equal to the atmospheric pressure minus the pressure in the filter. A cake of particles is formed on the filter surface, while the filtrate is collected inside the filter, from where it is removed by a special pump. The cake is removed continuously from the filtering surface by scraping with a doctor knife, before the filtration cycle is repeated.

Based on the integrated filtration in Eq. (5.11), the mean filtration rate in a vacuum filter is given by the following equation:

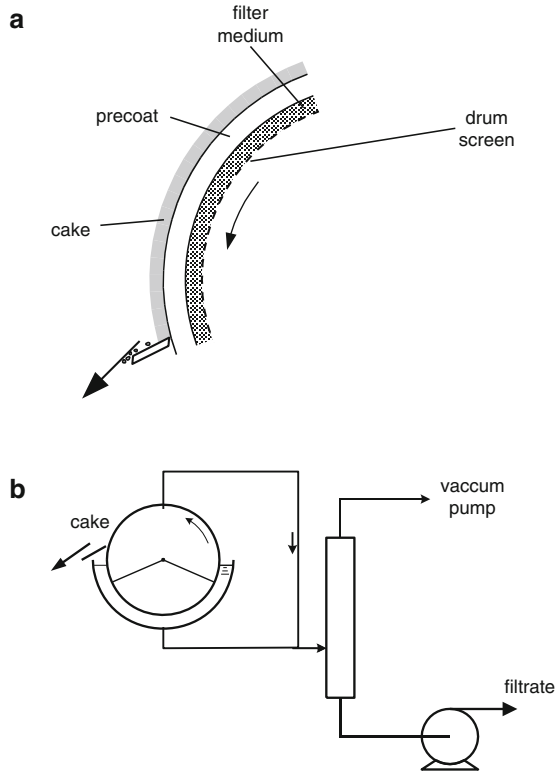
$$(V/At) = [(2\Delta p f)/(\eta CRt)]^{1/2} \quad (5.13)$$

where ( $f$ ) is the fraction of the submerged filtering area ( $0 < f < 0.5$ ).

The filter cake on the drum surface is usually washed with water before it is removed by scraping. Applying a stream of compressed air at the last stage of filtration facilitates removal of the washed cake. For this reason, the filter drum is divided into a number of sectors, which are connected successively to vacuum, atmospheric pressure, and air pressure, while the filter is rotated slowly.

Filtration of colloidal and compressible particles (e.g., juices, wine) is facilitated by precoating the filtering area with a filter aid, e.g., diatomaceous earth, before starting the filtration process. A layer of 5–15 cm thickness is formed on the

**Fig. 5.9** Diagram of a rotary vacuum filter with precoat operation



filtration surface by filtering a water slurry of the 7–10 % filter aid for 1–1.5 h, before starting the actual filtration. During filtration, the particles form a cake layer on the precoat, which is removed continuously by a slowly advancing “doctor” knife. Since part of the precoat is removed continuously together with the product cake, it becomes necessary to precoat again the filter, after some time of operation.

Vacuum rotary disk filters are similar in principle with the vacuum rotary filters (Fig. 5.9). They consist of a number of vertical disks connected through a manifold to the vacuum system. The perforated or screen disks are covered with a filter cloth, and they are divided into sectors for vacuum filtration, washing, and air pressure removal (Perry and Green 1984).

### Pressure Filters

The pressure coat filters are used when pressure drops higher than those obtained in rotary vacuum filters are required. They include pressure leaf filters and cartridge filters (Bhatia and Cheremisinoff 1979).

The pressure leaf filters consist of a horizontal pressure vessel, containing a series of parallel leaf filters, made of perforated metal or metallic screens, which act as

coated filters. The liquid suspension is forced by air pressure through the leaves and the clean product is collected in a manifold. Cartridge filters are small and inexpensive units that are used for the clarification of relatively small volumes of industrial liquids, containing low concentrations of solid particles. Filter cartridges consist of tubes 6–8 cm in diameter and 10–120 cm long, with a cylindrical filtration surface. The cartridges are placed in pressure housings, and the liquid to be filtered is forced through the cartridge by air pressure (Bhatia and Cheremisinoff 1979).

Two types of cartridges are used: (a) throwaway (expendable) filters, made of woven fibers, like cotton and synthetic materials, and (b) cleanable (reusable) cartridges, made of porous ceramics or stainless steel. Liquids cleaned with cartridges include boiler and cooling water, mineral oils, and alcohols.

### Filtration of Juices

Filtration of clarified fruit juices (e.g., apple and grape), wine, and beer is applied widely to remove various small particles and colloids, which may precipitate during storage and affect product quality. Normal cake filtration is difficult because the filter cake formed is compressible, resulting in reduced filtration rate and increased pressure drop. This problem is overcome by precoating the filter surface with a filter aid, which forms a porous layer and reduces the flow resistance.

A precoat layer of about 0.5–1.0 kg/m<sup>2</sup> is formed on the filtration surfaces of plate, leaf, or disk filters, by filtering a water slurry of 0.3–1.0 % of filter aid (diatomaceous earth, perlite, or cellulose paper) at a rate of about 20 L/m<sup>2</sup> for about 30 min. Filtration is improved by adding continuously a small amount of filter aid to the juice during filtration, using a dosimetric pump (McLellan 1993). Filtration is stopped when the pressure drop and the filtration rate reach preset limits. The cake, containing the filter aid, is backwashed and removed by scraping and vibration.

#### 5.4.3.2 Depth Filtration

##### Sand Filters

The depth or bed filters are used in cleaning potable and industrial water from small concentrations of small-sized solid particles. The particles are collected within the mass of the bed, which should be cleaned after some time of operation. Larger particles are removed previously by some less expensive separation process, like sedimentation.

Filter beds made of cleaned sand particles of size 0.6–1.2 mm are normally used as filter media. The close size distribution of the particles is necessary, since the pores are more uniform and they can collect the suspended particles more efficiently. By contrast, a bed of particles of wide particle size distribution would be blocked early in the filtration process, increasing sharply the pressure drop and reducing the filtration rate.

Gravity bed filtration is commonly used in water filtration with sand beds 70–80 cm deep on a layer of gravel 15–25 cm deep. Filtration takes place usually at a constant pressure drop, and the filtration rate decreases gradually with time. Operation at a constant filtration rate is possible by increasing the pressure drop with time, e.g., by raising the water level above the bed surface (controlling the opening of the valve of clean water discharge).

The filtration rate in sand filters is in the range of 4–10 m<sup>3</sup>/m<sup>2</sup>h, and the maximum operating pressure drop is 2 m of water (0.2 bar). When the maximum pressure drop is reached, the filtration is stopped and the sand filter is cleaned by backwashing with water. Clean water is forced from the bottom through the bed at a high flow rate (20–50 m<sup>3</sup>/m<sup>2</sup>h), dislodging the collected particles and carrying them out of the system. Bed washing is facilitated by simultaneous blowing of compressed air at 20–40 m<sup>3</sup>/m<sup>2</sup>h.

### Dual Media Filters

Dual media filters, consisting of a coal bed on top of a sand bed, are used for the filtration of quality potable and industrial water. The filters are enclosed in pressure vessels, and they are operated in a similar manner with the gravity sand filters. The carbon filter removes the undesirable odors and dissolved chlorine by adsorption.

The filter bed consists of a carbon layer of 0.25–0.50 m on a sand layer of 0.15–0.30 m, supported on a layer of gravel and an underdrain plate. High filtration rates are obtained (10–40 m<sup>3</sup>/m<sup>2</sup>h) with maximum pressure drops in the range of 0.8–1.7 bar (Bhatia and Cheremisinoff 1979).

### Sterile Filters

Sterile filters are used in the laboratory and the plant for the removal of microorganisms from various liquids, which are too sensitive for thermal sterilization. Microorganisms of sizes 0.5–10 μm (bacteria to fungi) can be removed with membrane filters of known openings and porosity. Typical sterile filters (Millipore) are made of cellulose membranes, 130 μm thick, with opening of 0.22 μm and porosity of 0.75. They are operated at pressure drops of 1–4 bar and temperatures up to 120 °C. For viruses (<0.1 μm) or for effective sterilization, fine filters or two-stage sterile filtration may be required (see Chap. 12).

## 5.4.4 Centrifuges

Centrifuges are compact but expensive equipment for efficient mechanical separations, used in both sedimentation (separation) and filtration applications of solid/liquids and liquid/liquids.

### 5.4.4.1 Centrifugal Separators

Centrifugal sedimentation is based on the application of the centrifugal force to separate particles and liquids of different size and density.

The Stokes equation (5.4) for settling velocity ( $u$ , m/s) of particles of size ( $d$ , m) in a centrifugal field of rotational speed ( $\omega$ , 1/s) at a distance ( $r$ , m) from the center of rotation is written as follows:

$$u = [\omega^2 r (\rho_s - \rho) d^2] / (18\eta) \quad (5.14)$$

where  $\rho_s$  and  $\rho$  are the densities of the particles and the liquid ( $\text{kg/m}^3$ ), respectively.

The liquid flow through a centrifuge is considered as a plug flow with a residence time  $t = V/Q$ , where ( $V$ ) is the holdup volume ( $\text{m}^3$ ) and ( $Q$ ) is the flow rate ( $\text{m}^3/\text{s}$ ). The time required to remove 50 % of the particles (of “cut diameter”  $d_c$ ) will be  $t_c = z/(2u)$ , where ( $z$ , m) is the thickness of the liquid in the centrifuge. The flow rate to remove 50 % of the particles will be  $Q_c = 2uV/z$ . Substituting the settling velocity ( $u$ ) from Eq. (5.14), the last relation becomes

$$Q_c = [\omega^2 r (\rho_s - \rho) d_c^2 / (9\eta)] (V^2 / z) \quad (5.15)$$

Equation (5.15) is equivalent to the following:

$$Q_c = 2u_g \Sigma \quad (5.16)$$

where ( $u_g$ , m/s) is the gravity settling velocity of the particles (diameter  $d_c$ ) and ( $\Sigma$ ,  $\text{m}^2$ ) is a characteristic parameter of the system, equivalent to the cross-sectional area of a gravity settling tank, which has the same settling capacity with the specific centrifuge (Perry and Green 1984).

By combining Eq. (5.16) with the Stokes (gravity) equation (5.4), the “sigma” parameter ( $\Sigma$ ) is given by the relation

$$\Sigma = V \omega^2 r / gz \quad (5.17)$$

Equation (5.17) for cylindrical centrifuges becomes

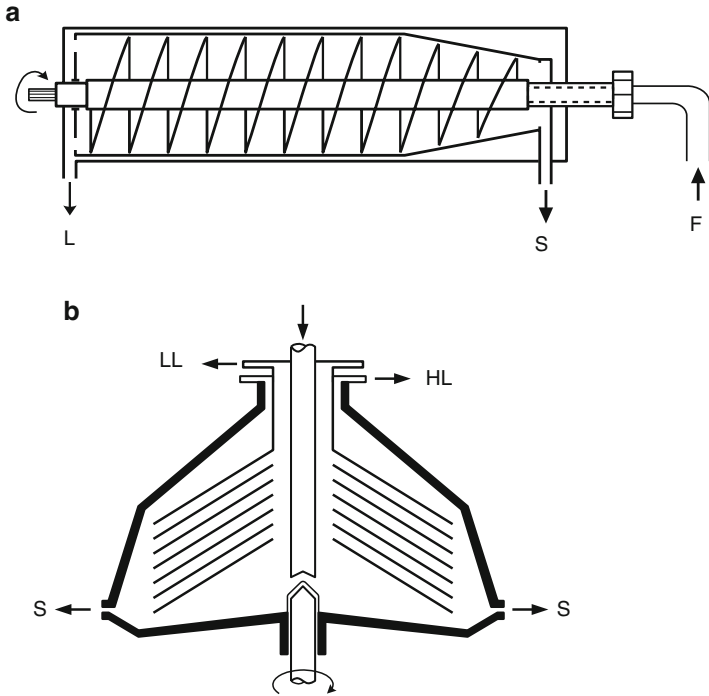
$$\Sigma = \pi b \omega^2 (3r_2^2 + r_1^2) / 2g \quad (5.18)$$

where ( $r_1, r_2$ ) are the distances (m) of the internal and external surfaces of the liquid for the center of rotation and ( $b$ ) is the length (m) of the active cylinder.

For disk centrifuges, the following equation is used:

$$\Sigma = [2\pi\omega^2(N-1)(r_2^3 - r_1^3)] / (3g \tan \theta) \quad (5.19)$$

where ( $N$ ) is the number of disks, ( $r_1, r_2$ ) are the internal and external radii and ( $2\theta$ ) is the cone angle of the disks.

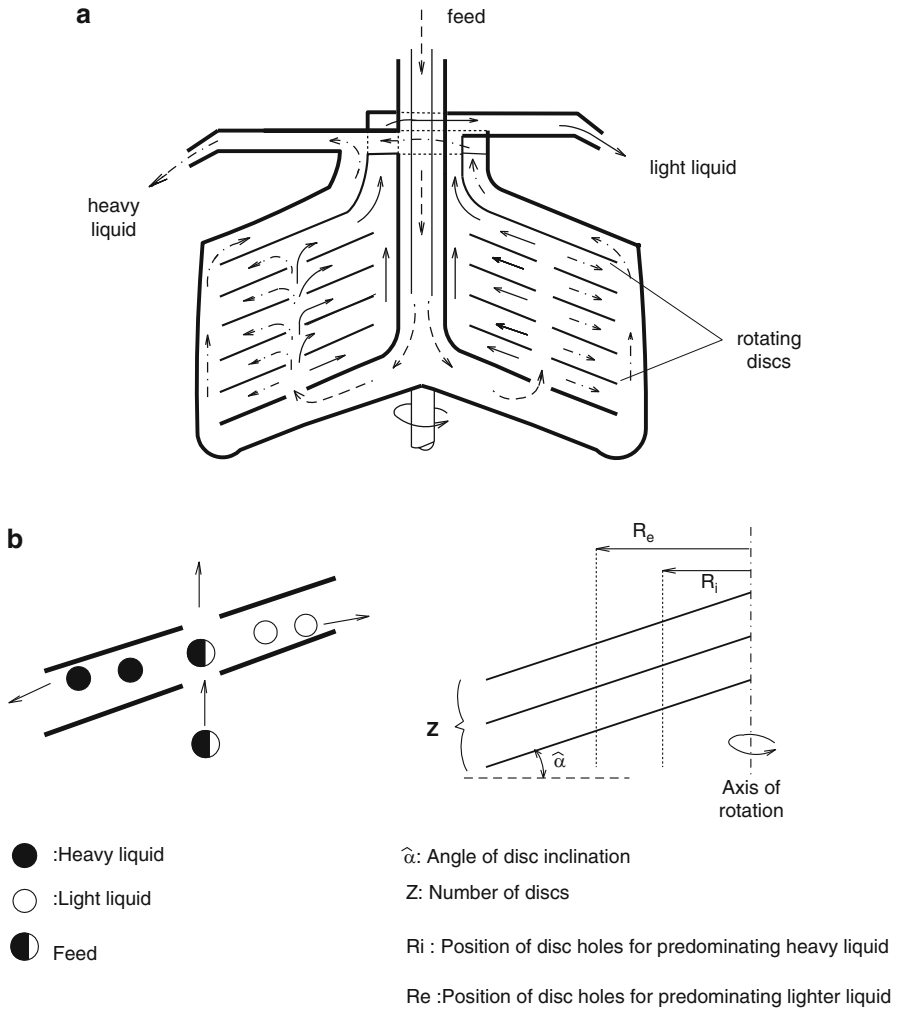


**Fig. 5.10** Diagrams of centrifugal separators: (a) horizontal screw filter, (b) disk separator. *F* feed, *L* liquid, *S* solids, *LL* light liquid, *HL* heavy liquid

Estimated values of the ( $\Sigma$ ) parameter of industrial centrifuges vary from 300 to 10,000  $\text{m}^2$ . It is evident that the separating capacity of industrial centrifuges is quite high, e.g., equivalent to a gravity settling tank of a cross section of 1000  $\text{m}^2$  (equivalent tank diameter of about 35 m).

Cylindrical, cone, and disk centrifuges are used for separation of particles and liquids of different densities. The cylindrical units give clear liquids and wet sludges, while the cone systems give dry sludges and cloudy liquids. Cylindrical and cone systems are combined in efficient continuous centrifuges, like the screw settler in Fig. 5.10a (decanter). Cylindrical or tubular (bowl) centrifuges are used in edible oil processing and in clarification of fruit and vegetable juices and sugar syrups.

Disk centrifuges (Fig. 5.10b) are mainly used in clarification of various liquids, like fruit juices and citrus oils. They consist of a centrifugal bowl 20–50 cm in diameter, with a series of cone disks. Perforated disks are used to facilitate the centrifugal separation of liquids of different density (e.g., cream/milk). The liquid feed mixture enters at the center of the bowl and it is separated by the centrifugal force into a light and a heavy stream, which are removed separately with special piping. Nozzle-discharge centrifuges are used when significant amounts of solid particles settle in the centrifugal field. They have small openings at the bottom sides of the bowl, through which the settled particles are removed continuously.



A.K.

**Fig. 5.11** Diagrams of a milk separator

The separation of skim milk from an initial milk quantity producing whole milk as well is done in a centrifugal separator with conic disks (Fig. 5.11a). The disks have holes laying exactly one over the other when the disks assembled in the equipment. The heavier phase of milk, i.e., the more water-containing part of the initial quantity of milk, slides down toward the periphery of the equipment. The lighter (fatter) part of milk slides upward toward the central axis of the centrifugation equipment. Finally, the two phases of the centrifuged milk use different exits to



leave the equipment. The efficiency of separation of the two phases of the milk depends on the speed of rotation, the inclination of the disks ( $\alpha$ ), and the number of disks (Fig. 5.11b). The position of the holes of the disks depends on the estimated concentration of fat in the initial milk.

#### 5.4.4.2 Filtering Centrifuges

Filtering centrifuges are used in food processing to separate effectively solid particles from water suspensions, e.g., in recovering sugar crystals from a crystallizer. The filter consists of a horizontal or vertical basket with perforated or wire mesh wall, which is rotated at high speed. The suspension is fed in the center of the basket and the solid particles are forced to the walls, forming a cake, through which filtration takes place, like in the normal pressure or vacuum filters.

The pressure drop through the filter cake in a rotating basket is given by the equation

$$\Delta p = \rho \omega^2 (r_2^2 - r_1^2) / 2 \quad (5.20)$$

where ( $\rho$ ) is the density ( $\text{kg/m}^3$ ) of the particles, ( $\omega$ ) is the rotation speed (1/s), and ( $r_1, r_2$ ) are the distances (m) of the internal and external surface of the cake ring from the center of rotation.

Assuming that the main resistance to filtration is the filter cake and neglecting the resistance of the filter medium, the integrated filtration equation (5.11), combined with the centrifugal equation (5.20), yields the following relation for the filtration rate ( $V/t$ ):

$$(V/t) = [\rho \omega^2 (r_2^2 - r_1^2)] (A_a A_L) / (2\eta RC) \quad (5.21)$$

where,  $A_a = 2\pi b (r_1 + r_2)$  and  $A_L = [2\pi b (r_2 - r_1)] / [\ln (r_2/r_1)]$ , and ( $b$ ) is the length of the basket.

For given centrifugal filtration, the filtration rate will decrease as the mass of the particles in the filter cake ( $C$ ) increases with the filtration time.

Various centrifugal filters are used in process engineering. The basket centrifuges consist of suspended vertical baskets 0.7–1.2 m in diameter and 0.5–0.8 m deep, rotating at speeds 600–1800 rpm. The filtration of the batch unit is stopped, when sufficient cake is formed, and the cake is washed with water. Subsequently, the basket is emptied and cleaned before the cycle is repeated. In the horizontal continuous centrifugal filters, the cake is washed and removed continuously, e.g., by a pusher-discharge system.

## 5.4.5 Mechanical Expression

### 5.4.5.1 General Aspects

Mechanical expression is used widely in the extraction of juices and oils from fruits, vegetables, and oilseeds. They are based on the application of pressure to disrupt the plant cells and release the contained juice or oil constituents. Mechanical pressure is also used in the expression of fish oils. The by-products of mechanical expression are solid residues like pomace or peels, which are either processed into animal feeds or are disposed in the land.

Mechanical expression does not include solvent extraction and water leaching of solutes from plant or animal materials, which are essentially mass transfer processes, and they are discussed in Chap. 11. Solvent extraction may be required to recover significant amounts of residual solutes from mechanically expressed materials, like oilseeds.

The mechanical expression of vegetables was reviewed by Cantarelli and Riva (1983). The expression process depends on the following factors (Brennan et al. 1990): (1) the applied mechanical pressure, (2) the yield stress of the food material, (3) the porosity of the cake formed, and (4) the viscosity of the expressed liquid.

Mechanical expression is a complex physical process with no satisfactory theory in the literature. The main engineering parameters of the process are the pressure drop ( $\Delta p$ ) and the flow rate of the liquid, which depend on the material and the equipment.

The following empirical equation relates the equilibrium pressure ( $p$ ) to the volume of the solid cake ( $V_c$ ) (Perry and Green 1984):

$$\log(p) = k + k'/V_c \quad (5.20)$$

where ( $k$ ,  $k'$ ) are empirical constants.

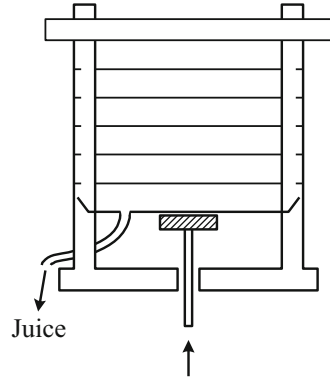
Mechanical expression of a liquid from a solid matrix is possible only if the solid is compressible, i.e., the compressibility factor ( $s$ ) of Eq. (5.12) is above zero ( $s > 0$ ). In incompressible solids ( $s = 0$ ), mechanical pressure cannot express the liquid, and other separation methods must be used.

The mechanical expression equipment is divided into batch and continuous presses, which are described briefly first. Because of its industrial importance and the variety of equipment used, the mechanical expression of fruit juices is discussed in more detail.

### 5.4.5.2 Batch Presses

#### Box and Pot Presses

The material to be expressed is wrapped in a canvas (cotton) cloth and is placed and compressed in a series of steel boxes, fitting the fixed and moving heads of a vertical

**Fig. 5.12** Batch box press

hydraulic press. The boxes are perforated with vertical drainage channels. An installation of 15 box presses will handle about 7 tons of cottonseed per 24 h, reducing the oil content from 30 to 6 %. Expression time is 20–30 min/batch, and the final pressure on the residual cake may reach 100 bar.

The material is enclosed in a cylindrical pot, with fiber pads or screens in the bottom and on the top, and it is compressed with a hydraulic ram entering from above. The pot press can handle fluid materials. It is used, e.g., for oil expression from olives and separation of cocoa butter from chocolate. Pot load per cycle is about 250 kg, and the final expression pressure can reach 400 bar (Fig. 5.12).

### Curb and Cage Presses

The curb and cage presses are used for the expression of solutes from fibrous materials, which do not require high pressures, like apple juice and olive or copra (coconut) oils. They consist of a cylindrical perforated vessel or a cage with fine longitudinal grooves on the walls, leading to larger drainage channels. The contained material is pressed slowly by a mechanical piston.

#### 5.4.5.3 Continuous Presses

Continuous presses are used widely for the expression of fruit juices and oils from various oilseeds. They are preferred over the batch presses because they require less labor and they are more efficient in processing large volumes of material. The screw press is the most popular equipment, because of its many advantages.

### Screw Presses

The screw press consists of a horizontal or vertical rotating screw, fitting closely inside a slotted or perforated curb (frame). Both screw and curb are tapered toward the discharge to increase the pressure on the material. The pressure can also be

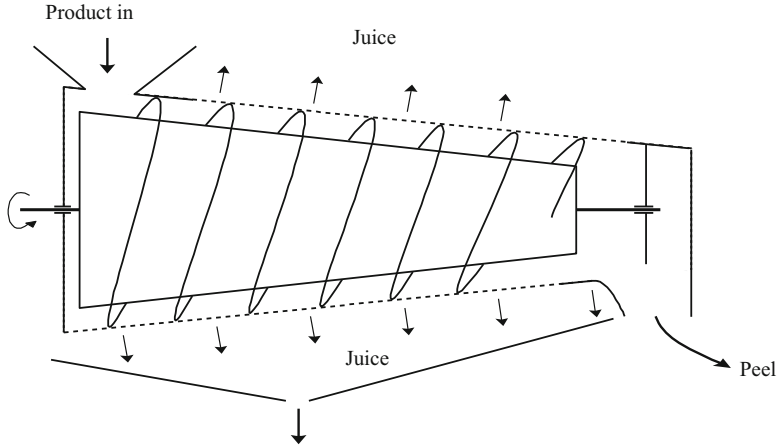
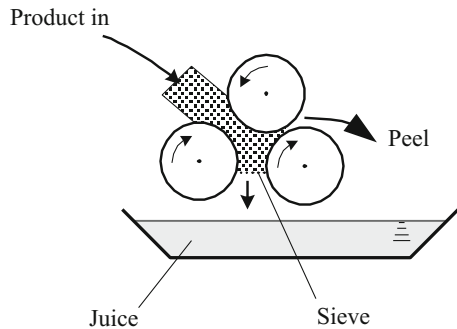


Fig. 5.13 Principle of screw press

Fig. 5.14 Roller press



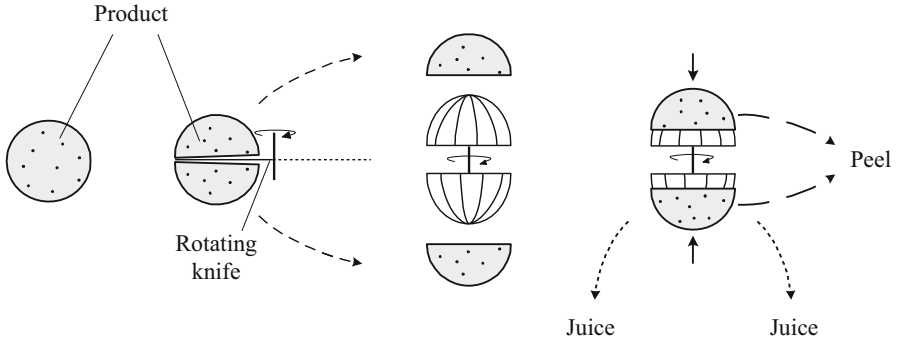
increased by varying the pitch of the screw. As the material is pressed by the screw, the liquid escapes through the openings of the curb (Fig. 5.13).

Shaft speeds of 5–500 rpm are used with very high pressures, up to 2500 bar. The capacity of the screw presses can reach 200 tons/24 h, and the residual oil in the press cake can be as low as 2 %.

Screw presses or “expellers” are used widely in the vegetable oil industry.

### Roller Presses

Continuous roller mills are used principally for expressing juice from fibrous food materials, such as sugarcane and some fruits. They consist normally of three rollers, which squeeze the material as it is forced to pass between them successively. The rolls are made of cast iron, and they are corrugated or grooved in various patterns (Fig. 5.14).



**Fig. 5.15** Fruit juice reamer

The sugarcane is macerated dry, but water is added during pressing for recovering the sugar juice. The pressed cake is scraped off the last roller with a knife.

### Belt Presses

The belt press combines the filtering and expression actions in one continuous operation. Initially, the belt press was used to dewater suspensions of wet materials like paper pulp, but recently, this system is applied in juice expression from various fruits (next section).

The slurry is enclosed between two serpentine belts and is pressed gradually by a series of rolls, forcing the liquid out. The pressures developed are relatively low, and expression is confined to easily remove solutes, like fruit juices. A belt press processing 3.5–5 tons of apples/h into juice (60-cm-wide belt) was described by Swientek (1985).

### Juice Reamers

The simple home reamers are used industrially in expressing orange and other juices (Fig. 5.13). The fruit is sliced with a sharp knife and the rotating serrated reamers extract the juice and pulp. The reamers are the basic elements of the high-capacity Brown citrus extractor (Fig. 5.15).

#### 5.4.5.4 Fruit Juice Expression Equipment

Pressing or expression is the most important operation in fruit juice processing, since it is related immediately to both economics (yield) and quality (composition) of the product. Expression equipment for two different types of juices, i.e., apple and citrus, is described briefly, because of the commercial importance and the

variety of the employed equipment. Some of the expression equipment used for apple juice can be applied to grape and other juices.

### Apple and Grape Juices

Extraction of juice from apple fruits can be accomplished if the following requirements are met (Cockram 1993): (a) pressing, which should be applied quickly, so that the juice is removed from the slower moving bulk material, (b) exit path to remove the expressed juice, (c) time to complete the process, and (d) bulk material to withstand the pressure, without appreciable movement.

The grapes are prepared for pressing in a stemmer/crusher, which is a rotating drum with perforations of 2.5 cm. The grapes are removed from the stems and are crushed by passing through the holes, while the stems are discharged from the center of the drum. Stems and seeds should be separated from the grapes before crushing and expression to prevent extraction of undesirable bitter components. The crushed grapes are pressed between two rotating cylinders to express the juice. Grape pigments, e.g., from Concord grapes, can be extracted into the juice by heating the crushed grapes at about 60 °C.

The pressing operation of the fruit mass is affected by the following factors:

- (a) Fruit quality. Ripe fruits yield the best quality and quantity of juice. Juice expression is difficult from overripe fruit.
- (b) Milling. The fruit pieces and particles should be of the proper size (not too small or too large). Special grinding mills with knives are required for apples.
- (c) Enzymes. Pectolytic and cellulose- or starch-splitting enzymes, added to the fruit mash, will facilitate juice expression. Enzyme pretreatment should be done at the optimum pH, temperature, and time. Excessive enzymatic breakdown results in a viscous mash, from which the juice cannot be expressed.
- (d) Press aids. They help juice expression by increasing the permeability of the fruit mash (cake). Common press aids are mixtures of wood fibers, paper fibers, and rice hulls. The proportion of each of these press aids added to the fruit mass is about 3–4 %.
- (e) Leaching. Water is added to the press cake to dissolve the residual solids, and pressing is repeated, increasing the overall yield of juice.

The following expression equipment is used for the expression of apple and grape juices:

- Rack and Frame Press  
“Cheese” cloths are used, containing fruit mash 5–8 cm thick, which are stacked and pressed under a hydraulic ram, forcing the juice out. At the end of pressing the cake, about 1 cm thick is removed from the cloths and the operation is repeated. No filter aid is used and the yield is low.
- Willmes Press  
The Willmes (bladder) press is used mostly in grape juice and wine processing. It is a pneumatic system, consisting of a perforated, rotatable, horizontal

cylinder with an inflatable rubber tube in the center. The cylinder is filled with grape mass, and the air bag compresses the material, forcing the juice out. The bag is then collapsed and the cylinder retracted. The rotation and pneumatic compression of the mash is repeated many times with increasing pressure.

- **Screw Press**

Screw presses are used in the expression of large quantities (9 up to 50 tons/h) of apple and grape juices with yields of about 80 %. Screw diameters range from 15 cm to 3 m. Press aids are normally used in screw presses. Screw presses made of stainless steel for fruit processing are expensive equipment, justified in large-scale continuous processing lines.

- **Bucher Press**

The Bucher press is a large complex and expensive unit, processing 5–7 tons/h of fruit with yield of about 85 %, which can reach 92 % with the use of enzymes and leaching. The unit consists of a rotating cylinder (basket) 2 m in diameter and 2 m long with a hydraulic piston at one end. The basket contains 280 small filter elements, which are flexible, grooved openings, covered with filter cloth. Juice flows through the cloth, down the grooves to the end of the press, where it is collected.

The fruit mash is added to the basket and the piston presses the mash and it is retracted. Then a new amount of mash is added and the pressing operation is repeated, until a high pressure is developed, reaching 190 bar, before the pressed mash is washed and dumped from the basket.

In addition to the high capital cost, the system has high operating and maintenance costs.

- **Belt Press**

The serpentine belt press is less expensive than the screw and Bucher presses, but it has lower efficiency (78–82 %). Capacities up to 30 tons/h can be achieved.

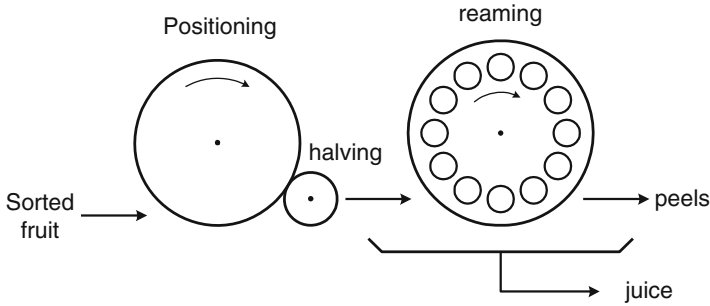
The belt press consists of two belts moving through a series of rollers. The belts are fed with a layer of 3–8 cm of fruit mass, which is compressed gradually until a compressed cake of about 0.5 cm is formed at the end of the line. The belts are difficult to clean after each operating cycle.

- **Screening Centrifuge**

Screening centrifuges (filtering centrifuges) can be used in the expression of juices from a fruit mass that has been treated with enzymes to release the juice from the cellular structure. Operating capacities can reach 10 tons/h, with juice yields of 85–90 %.

## Citrus Juices

Citrus juices, mainly orange, lemon, and grapefruit, are produced in large quantities, using special juice expression equipment. Due to the unique structure and composition of citrus fruits, some equipment developed for other fruit juices is applied only in limited cases.



**Fig. 5.16** Diagram of the Brown citrus juice extractor

Two different citrus juice expression systems, developed in the USA, are used worldwide, i.e., the Brown and the FMC extractors (Nagy et al. 1993; Kimball 1999). The citrus fruit is first washed and sorted into different sizes to accommodate the operation of the extractors, which are adjusted to handle specific sizes. The expressed juice is processed further mechanically to remove seeds, peel fragments, and vesicular membranes (rag), using screen finishers, similar to those of other juice processing systems.

The composition and quality of the citrus juices are affected strongly by the expression and finishing conditions, namely, mechanical pressure, shear, and residence time. If the finishing procedures are too rigorous or not rapid, bitter components (limonin and naringin) may be leached into the juice.

The Brown extractor is based on the same principle of the home reamer, i.e., the fruit is cut into halves and the juice is expressed by a mechanical reamer of appropriate size. Figure 5.16 shows a diagram of the commercial Brown extractor.

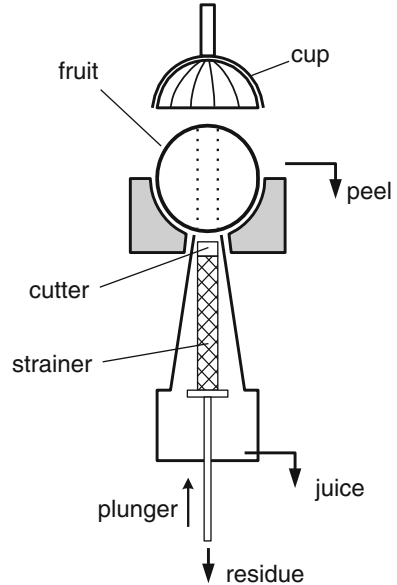
The sorted fruits are positioned in a vertical turntable for cutting into halves with a sharp knife. The fruit halves are oriented and picked up by rubber cups, mounted on tracks in a vertical turntable. Plastic serrated reamers on a vertical turntable express the juice from the approaching fruit halves. The reamers penetrate the fruit rapidly at first but slowly later as the point of maximum penetration is reached. The juice collects on a pan, while peels and rag (fruit membranes) are ejected separately. The citrus peels are used to express the peel oils and, finally, they are dehydrated to produce animal feed.

The FMC extractor operates on a completely different principle, i.e., the juice is extracted from the whole fruit, without halving and reaming, as shown diagrammatically in Fig. 5.17. The fruit is placed into the lower extraction cup of the appropriate size. The upper cup descends pressing the fruit, while a circular cutter below cuts a bore, which is removed from the bottom. The fruit is squeezed and the expressed juice is separated from the fruit residue (seeds, rag, and peel fragments) through the small-diameter strainer. The juice is collected in the cup below and the residue (pulp) inside the strainer is discharged from the bottom through the orifice tube (plunger).

The strainer of the FMC extractor acts as a prefinisher for the citrus juice. The squeezed peel of the fruit is discharged from the lower cup. The expressed oil is separated by centrifuges, and the peels are dried in air-dryers.



**Fig. 5.17** Principle of operation of the FMC citrus juice extractor



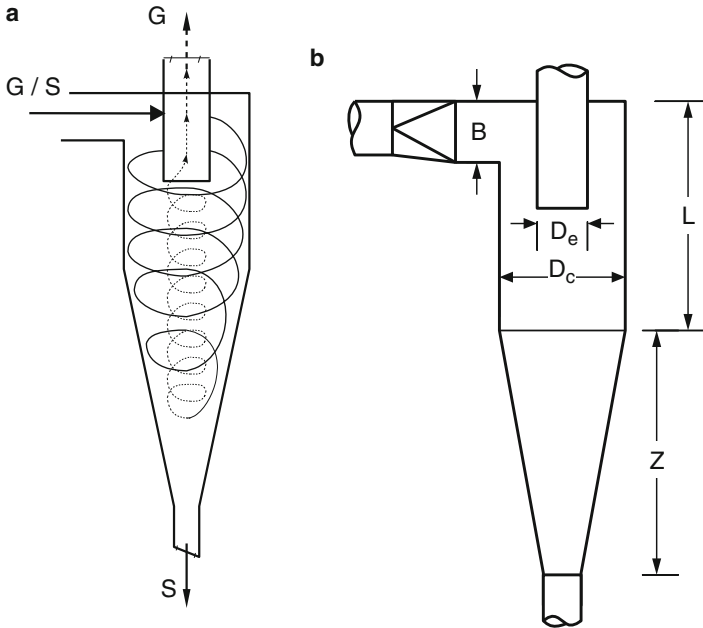
## 5.5 Solid/Air Separators

Solid/air separators are used in the recovery of solid food particles from exhaust air in various food processing operations, such as spray drying and pneumatic transport, in reducing air pollution from industrial air effluents, and in cleaning the atmospheric air in food processing plants. The industrial air exhaust streams may contain high particle concentrations (up to  $45 \text{ g/m}^3$ ), while the concentration of particles in the atmospheric air is less than  $1 \text{ mg/m}^3$ . The size of particles ranges from 1 to  $1000 \text{ }\mu\text{m}$ .

The design of solid/air separators is based on the same principles of the air classifiers (Sect. II1b), i.e., the hydrodynamic, centrifugal, and gravity forces. In addition, the electrostatic forces play a significant role in the separation of the small-sized particles. The most common separation equipments used in food processing are cyclones and bag filters. Wet scrubbers and electrical filters are mainly used in the chemical and mineral process industries and in power generation (Perry and Green 1984).

### 5.5.1 Cyclone Separators

Cyclones are simple and inexpensive units, which can remove effectively solid particles (and liquid droplets) larger than  $10 \text{ }\mu\text{m}$  from industrial gases and air. Figure 5.18 shows diagrammatically the flow pattern and the dimensions of a standard industrial cyclone.



**Fig. 5.18** Diagram of flow pattern in cyclone separator (a) and standard cyclone dimensions (b). *S* solids, *G* gas (air), *D<sub>c</sub>* cyclone diameter,  $L = Z = 2D_c$ ,  $B = D_e = D_c/2$

The particle/air mixture enters the cyclone tangentially, following a spiral flow pattern from top to bottom and a vortex flow from bottom to top, and exits from the collector. The solid particles are subjected to self-generated centrifugal force, thrown to the cyclone walls, from which they fall and are collected at the bottom. The air exits from the top of the cyclone, and it may contain significant amounts of small-sized particles. In order to eliminate the very small particles, which escape the cyclone and cause particulate pollution in the environment, bag filters of wet scrubbers should be installed after the cyclone.

In general, small-diameter cyclones (about 25 cm in diameter) are used in practice, because they are more efficient in removing the relatively small-sized particles.

The self-generated (no mechanical means) centrifugal force, developed by the cyclone spiral flow, is very large, due to the small cyclone diameter, reaching up to 1000 times the gravitational force. The separation efficiency of the cyclone is characterized by the cut diameter ( $d_c$ ) of the particles, which is defined by the analogous equation of air classification (5.6)

$$d_c^2 = (9\eta B)/(2\pi N \rho u) \tag{5.22}$$

where (*B*) is the entrance width (m) and *N* is the number of spiral “turns” of the cyclone, ( $\rho$ ) is the particle density (kg/m<sup>3</sup>), and (*u*) and ( $\eta$ ) are the air velocity (m/s)

and viscosity (Pa s), respectively. The value  $N=5$  is used for normal cyclone collectors. In cyclone design, the air (entrance) velocity is taken as  $u=15$  m/s. The cut diameter (or cut size) corresponds to a collection efficiency of 50 %.

The cut diameter is reduced and, therefore, the efficiency of the cyclone collector is increased by increasing the air velocity and/or the particle density or by reducing width of the cyclone entrance.

The efficiency of a cyclone collector is estimated from the Lapple diagram (Perry and Green 1984), as a function of the particle size ratio ( $d/d_c$ ). The efficiency drops sharply for small particles, e.g., to lower than 10 % at  $(d/d_c)=0.3$  and exceeds 90 % at  $(d/d_c)=3$ .

As an illustration, for milk powder of solids density  $\rho=1400$  kg/m<sup>3</sup> (low porosity) and a cyclone of 20 cm diameter and air velocity  $u=15$  m/s and viscosity  $\eta=0.02$  mPa s, the cut diameter will be  $d_c^2 = (9 \times 0.00002 \times 0.05) / (2 \times 3.14 \times 5 \times 15 \times 1400) = 1.36 \times 10^{-10}$  m<sup>2</sup> and  $d_c = 11.7$   $\mu\text{m}$ . It should be noted that, for particles smaller than  $(11.7)/3 = 3.9$   $\mu\text{m}$ , the collector efficiency will be less than 10 %, i.e., more than 90 % of the particles will pass through the cyclone. Thus, it becomes necessary to install another, more efficient collector after the cyclone, e.g., a bag filter, in order to collect most of the escaping particles and discharge a clean air stream into the environment.

Since, for efficiency reasons, the diameter of the cyclones should be small, a number of collectors, operated in parallel, will be required in order to handle large volumes of industrial gas (air) streams. The collectors are usually installed in parallel in compact structures (multiclones).

Small cyclone units and high air flows result in significant pressure drops ( $\Delta p$ ) and considerable power requirements (kW). The fan is installed either before (pressure) or after (suction) the collector. The suction installation is preferred because the exhaust air from the cyclone will be free of the large particles, which might damage the fan rotor.

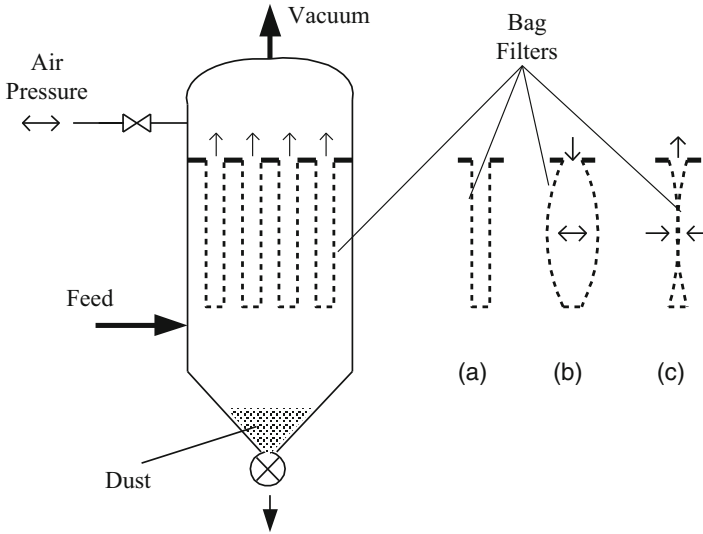
The pressure drop through the cyclone is proportional to the square of the air (entrance) velocity ( $u^2$ ), while the energy loss or “head” (in m of water) will be (Perry and Green 1984)

$$\Delta p/\rho = 4.7(u)^2 \quad (5.23)$$

where ( $\Delta p$ ) is the pressure drop (Pa), ( $\rho$ ) is the density of air (kg/m<sup>3</sup>), and ( $u$ ) is the air velocity (m/s). Thus, the “head” loss through the cyclone is about ten times higher than the velocity “head” ( $u^2/2$ ).

### 5.5.2 Bag Filters

Bag filters are usually made of woven cloth or felt, which act as surface filters (Fig. 5.19).



**Fig. 5.19** Bag filter. (a) Normal position; (b, c) filter shaking for cleaning

Small solid particles, passing through cyclone collectors, can be separated from industrial airstreams (or gas) by bag filtration, which is similar in principle with the solid/liquid filtration, discussed in Sect. 5.4.

Depending on their size ( $d$ ), the particles are collected mainly by inertia ( $d > 1 \mu\text{m}$ ) or electrostatic forces ( $d < 0.5 \mu\text{m}$ ). In bag filters, the particles form a mat on the surface, which acts as a filter medium, increasing the efficiency of filtration and the pressure drop. Filtration is interrupted when the pressure drop exceeds a preset limit and the filter is cleaned.

Bag filter design is based on the choice of a suitable fabric of felt which will give the optimum pressure drop ( $\Delta p$ )–superficial air velocity ( $u$ ) relationship for the longest operating cycle.

The pressure drop through a bag filter is given by the empirical equation (Perry and Green 1984)

$$\Delta\pi = K_{\psi}\eta\theta + K_{\delta}\eta\zeta\theta \quad (5.24)$$

where ( $K_c$ ) is the fabric resistance coefficient (1/m), ( $K_d$ ) is the particle layer resistance coefficient (m/kg), ( $u$ ) is the superficial air velocity (m/s), ( $w$ ) is the particle loading of the filter ( $\text{kg/m}^2$ ), and ( $\eta$ ) is the air viscosity (Pa s).

The particle layer resistance coefficient ( $K_d$ ) is related to the particle diameter ( $d$ ), the particle shape factor ( $\varphi$ ), and the porosity ( $\epsilon$ ) of the fabric by the Carman–Kozeny equation:

$$K_d = 160(1 - \epsilon)/(\varphi^2 d^2 \epsilon^3) \quad (5.25)$$

The fabric resistance coefficient ( $K_c$ ) is related to the pressure drop through the fabric ( $\Delta p_c$ ), according to Eq. (5.26):

$$K_c = \Delta p_c / \eta u \quad (5.26)$$

The pressure drop through the particle layer ( $\Delta p_d$ ) is given from the following equation, which is derived from Eq. (5.24):

$$\Delta p_d = K_d \eta C u^2 t \quad (5.27)$$

where ( $C$ ) is the concentration of the particles in the air ( $\text{k/m}^3$ ) and ( $t$ ) is the filtration time (s).

The fabrics used in bag filters are made of cotton, wool, nylon, Dacron, and Teflon. The bag filters have a diameter of 12–20 cm and length of 2.5–5.0 m, and they are often assembled in compartments, called “bag houses,” of 100–200- $\text{m}^2$  cloth surface. The diameter of large cylindrical bag filter compartments of, e.g., 120- $\text{m}^2$  cloth surface area, can be 3 m and their height 6–7 m. Their weight is about 2 tons and the power consumption is 1 kW.

The bag filters are cleaned either by shaking or by reverse flow of air. Shaking may be periodic, or after a preset pressure is built up, using a differential pressure instrument. Cleaning may be necessary when the pressure drop reaches 50–150 mm water (500–1500 Pa).

Superficial air velocities (air filtration rates) for woven filters are 0.5–2 m/min and for felt filters 2–5 m/min (Fig. 5.17a–c).

The bag filters are operated at temperatures up to 120 °C, depending on the type of fabric. The operating temperature should be at least 30 °C higher than the wet bulb temperature of the air to prevent moisture condensation on the filters.

### 5.5.3 Air Filters

Air filters are used to clean atmospheric air from small particles ( $d < 0.5 \mu\text{m}$ ) and produce very clean air for the pharmaceutical, biotechnological, semiconductor, and nuclear industries. They are also used in clean room technology (hospitals and some advanced food processing industries).

Concentration of particles in atmospheric air is normally lower than 12  $\text{mg/m}^3$ , which is much lower than the particle concentration in industrial gas (air) streams.

Air filters are essentially deep-bed filters, made of porous cellulose materials. The mechanism of deep air filtration includes mechanical sieving and electrostatic forces.

Two types of fibrous filters are normally used: (1) viscous filters, in which the filter medium is coated with a viscous mineral oil, which retains the dust, and the used filters are cleaned periodically and returned to service, and (2) dry filters, which are cheaper; are made up of cellulose pulp, cotton, or felt; and are discarded after use.

**Table 5.5** Technical characteristics of air filter materials

Material	Density (g/m <sup>3</sup> )	Maximum operating temperature in dry environment (°C)
Glass	1.38	250
Polyacrylonitrile	1.17	125
Polyester	1.38	150
Polyphenylene sulfide	1.40	180
Polypropylene	0.91	90
PTFE (Teflon)	2.30	250

The pressure drop in a certain air filter depends on the volume of filtered air. As an example, the pressure drop in a glass-fiber fine filter of 7.3-m<sup>2</sup> surface area and an efficiency, according to ASHRAE, of 45 % at 3000 m<sup>3</sup>/h is 65 Pa. The pressure drop becomes 110 Pa at 4250 m<sup>3</sup>/h air flow (air velocity: 3.2 m/s).

Sizes of normal filters are 0.5 × 0.5 m, which can handle up to 4500 m<sup>3</sup>/h at superficial air velocities of 1.5–3.5 m/s. They have a collection efficiency higher than 90 %, which can be increased at higher air velocities. The efficiency of air filters can be determined, e.g., according to ASHRAE standard 52–76 or DIN 24185. The operating cycles of air filters are about 1 week for the dry and 2 weeks for the viscous.

High-efficiency particulate air (HEPA) filters, developed in nuclear engineering, are used in some industrial applications. They are throwaway (disposable) filters of very high separation efficiency (99.97 % for particles 0.3 μm). Prefilters, removing larger particles, are used to protect these units.

Table 5.5 gives some technical characteristics of common types of filter materials.

### 5.5.4 Electrical Filters

Electrical filters are used to remove small particles from industrial gases and atmospheric air, based on electrical charging the particles, followed by collection on charged electrodes. Two types of filters are used: (1) electrical precipitators and (2) positively charged filters.

The electrical (or Cottrell) precipitators are large industrial installations used mainly in the chemical process industries and in power generating stations to remove various particles and fly ash from gaseous effluents, reducing air pollution. The particles, charged negatively from ionized gases, are collected in large positive plate electrodes, operated at about 50 kV, with efficiencies about 90 %. The gas velocity in the electrodes is about 2–3 m/s, and the precipitation (migration) velocity of the particles ranges from 5 to 15 cm/s. Electrical precipitators are complex installations and they have a high investment and maintenance cost (Perry and Green 1984).

Positively charged or two-stage precipitators are relatively small units, used mainly to clean atmospheric air from dust, smoke, and other particles, often as part of air-conditioning systems. The particles are charged positively by DC electrodes at about 13 kV and then collected on negative (grounded) electrodes operated at 6 kV. The collection efficiency is about 85–90 % and the filters should be cleaned, depending on particle loading, every 2–6 weeks.

### **5.5.5 Wet Scrubbers**

Wet scrubbers, or wet particle collectors, are used to clean industrial gases and air from small solid particles that escape simpler separators, like cyclones. The main collection mechanism is inertial deposition of the particles on the liquid (water) droplets. Wet scrubbers are also used to absorb various gases from air streams in connection with air pollution control.

The absorption of gases and vapors in liquids is basically a mass transfer operation, like distillation and solvent extraction, which is analyzed in Chap. 11.

The particulate scrubbers consist of two parts: (a) the contactor stage and (b) the entrainment stage. The entrained sprays and deposited particles are removed from the cleaned gas (air) by cyclone or impingement separators.

The wet scrubbers are divided into two general classes: (a) low-energy equipment, which includes the spray towers, the packed towers, and the cyclone scrubbers, which can remove particles larger than 1  $\mu\text{m}$ , and (b) the high-energy units, which include the venturi and the jet scrubbers, which can remove particles smaller than 1  $\mu\text{m}$ .

Wet scrubbers are used extensively in the chemical process industry (Green and Perry 1984). They are used in some food processing plants in connection with antipollution systems for cleaning exhaust gases and air from undesirable gases, e.g., odorous compounds in the refining of edible oils.

A serious disadvantage of wet scrubbers is the production of a stream of polluted wastewater, which must be treated with some wet separation method before it is discharged into the environment.

## **5.6 Removal of Food-Related Parts**

### **5.6.1 General Aspects**

The separation operations may be classified also as solid and liquid processes (Table 5.1). In removing material or substances of solid food, two subcategories are the removal of product-own parts (e.g., cherry stems or cherry stones) and the removal of product-unrelated (foreign) parts (e.g., dust, insects, etc.). Furthermore,

**Table 5.6** Methods of removal of product-own parts

Food parts	Undesired parts			Desired parts		
Location of food part	External parts			Internal parts	External	Internal
Method	Dry	Wet	Mixed	Dry	Dry	Dry
	Blistering	Peeling	Dragging	Brushing	Abrasion	Breaking
	Brushing	Steaming	Washing	Hand	Compression	Compression
	Breaking	Washing	Brushing	Screening	Cutting	Cutting
	De-hairing		Roasting	Suction	Hand	Hand
	Cutting		Brushing	Pitting		Milling
	Dehulling		Steaming	Coring		Suction
	Destemming		Brushing			
	Plucking		Washing			
	Hand		Soaking			
	Peeling		Brushing			
	Roasting					

the product-own parts can be internal (e.g., cherry stones, bones) or external (e.g., cherry stems, animal skin). The objective of a separation operation of product-own parts is to recover the separated materials or substances (e.g., juice from fruit, sugar from beets) or to remove undesired material or substances (e.g., fruit peels and filtrate residues).

In the removal of undesired external parts, dry, wet, or mixed methods are used. Table 5.6 gives some examples of methods used in removing external and internal food-own parts. Examples of dry methods are burning of chicken hair after plucking, knife peeling of onions and apples, brushing of oranges, and cutting and deboning of meat. Examples of wet methods are the washing of vegetables, the steaming of oysters, and the peeling of peaches in lye solutions. Mixed methods are the removal of potato peels and oyster shells by abrasion, just after steaming; the removal of chicken feathers by beating with rubber strap wheels, just after scalding; the suction of blood, just after slaughtering; and the removal of corn seeds, just after soaking. Mechanical wet and dry separations in foods include cleaning operations, which remove undesired product-unrelated (foreign) parts from foods.

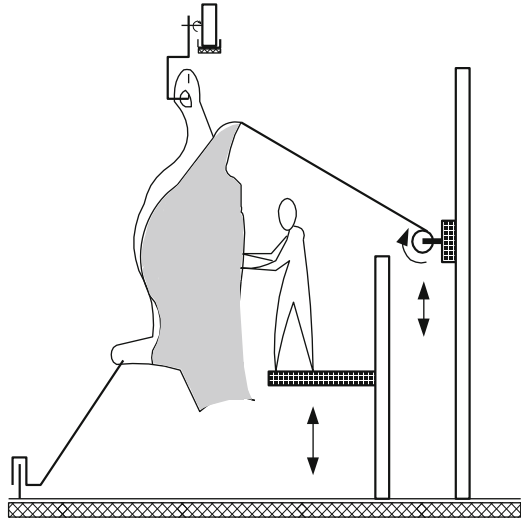
## 5.6.2 Removal of Undesired Own Parts

### 5.6.2.1 Separations in Animal Products

Special mechanical equipment is used for the separation of external and internal parts of animal products (meat and seafood). They are designed to remove bones (deboning), meat strings, fish fins, hair from pigs and chicken, feathers from chicken, skins from animal and fish, shells from mussels, and blood from animals.



**Fig. 5.20** Skinning of beef cattle



### Skinning

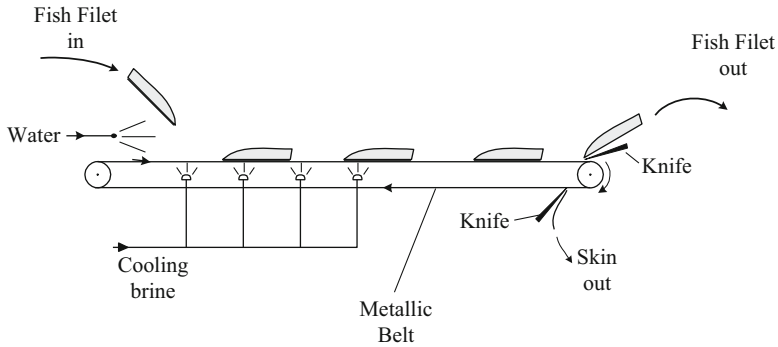
Skinning of animals is usually done manually, i.e., using the cutting tools described in Chap. 4 and the auxiliary hoist mechanism shown in Fig. 5.20. The workers work on a vertically adjustable platform (elevator), while a vertically movable hoist pulls the skin. This work is quite elaborative as the skin makes about 7–11 % of the live weight of beef cattle (Lienhop 1981), and the skin must be removed carefully without damaging the meat.

### De-hairing

De-hairing is applied to pigs and poultry. Two main methods of depilation are dragging and hair burning. Dragging is applied to pigs. Depilation is done after scalding at 60–80 °C, e.g., as the slaughtered pigs rotate on rubber cylinders, or it is done in the de-hairing tunnel. This equipment consists of several rows of scrapers (up to 22), which depilate the pigs, while they rotated and forwarded along the tunnel, due to the lattice supporting them and due to the spiral-shaped scraper. This way, all parts of the pig are de-haired. Water washes out hair and blood. This equipment has a capacity of more than 600 pigs/h. It requires 40 kW, 5 m<sup>3</sup> of water/h at 42 °C, and 0.85 m<sup>3</sup> of air/h at 6 bar. The machine weighs 15 tons. Burning is applied for de-feathering of poultry. The remaining hair is burned when poultry passes through a tunnel equipped with small gas burners.

### Cutting

In cutting of hoofs and other animal parts, equipment described in Chap. 4 is used. In some cases, as, e.g., in removing the skin of fish, special cutting devices have



**Fig. 5.21** Fish skin-removing machine

been developed. Figure 5.21 shows schematically a fish skin-removing machine. The skin of fish fillet, which is conveyed on a metallic belt, “sticks” on it, due to belt temperatures below 0 °C. The skin is separated from the rest of the fish by a knife at the end of the belt.

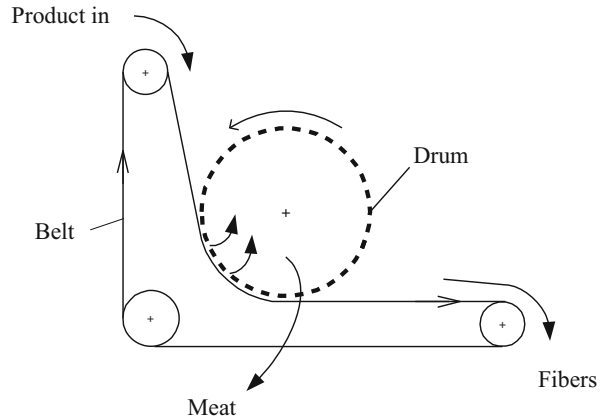
### Screening

Screening is used for separating desired from non-desired parts, when it is difficult or noneconomic to do it manually. According to Neuhaeuser (1991), it is distinguished between separating meat from bones (hard separation) and meat from fibers (soft separation). In separating bones from meat, it is recommended to choose “flat bones,” since the round bones contain also marrow. The bones with the residual meat are ground into 30–50-mm pieces and, subsequently, the mass is pressed at 350 bar in the hard-separator chamber, in which bones are retained, while the residual meat is filtered out. The capacity of such a machine is about 2 tons of input/h. It requires about 4 kW and weighs 600–700 kg with approximate dimensions of  $1.2 \times 1.2 \times 1.2$  m. For separating fibers from meat, the product is ground to about 18-mm particles. It is then pressed between a moving belt and a replaceable rotating perforated drum of 3-, 5-, and 8-mm apertures. The meat passes inside the drum, and the separated fibers are removed at the end of the belt (Fig. 5.22). This equipment can be also used in separating residual fish attached in other fish matter. In this case, the equipment may have the output of about 2 tons/h. It requires 4.5 kW, weighs approximately 1 ton, and has dimensions of about  $1.5 \times 1.5 \times 2.0$  m.

### Removal of Mussel Shells

The mussel shells are steamed in a cooker, containing a wire-meshed conveyor, which is filled with mussels at a layer up to 250 mm. The working pressure is 4 bar. The mussels open and are discharged in the cylindrical de-clamping equipment, in

**Fig. 5.22** Meat-fiber separator



which the shells are removed. This equipment consists of a rotating shaft with knives, working in a rotating perforated drum. After separation of the mussel meat from the shells, they are washed in a drum washing machine, in which small mussels and dirt are separated from the rest product. The capacity of a large cylindrical steaming unit can be about 10 tons/h. The steam consumption is 2 tons/h. The diameter is about 1 m and its length about 4–5 m. A large de-clamping unit may have the input capacity of about 30 m<sup>3</sup>/h. The unit requires 6 kW of power and is about 5–6 m long.

## Blood

Blood is removed immediately after stunning (electrical shock) of the animals in large slaughtering houses. It is aimed to pump out the blood as long as the heart is still in operation. For smaller animals, such as pigs and lambs, a carrousel-like unit can be used. The animals may lay or hang on the carrousel, while the blood is pumped out by a sticking knife (see Chap. 4), connected to a central pump through pipes.

### 5.6.2.2 Separations in Plant Products

The equipment for removing undesired own parts of plants is used to separate mainly food from shells, hulls, stems, and peels. They are also used for coring the seeds of fruits, such as apples or pears.

## Breaking

The breaking processes are described in Chap. 4. Nuts are broken as they come between usually conical rolls that rotate in opposite direction to each other. The

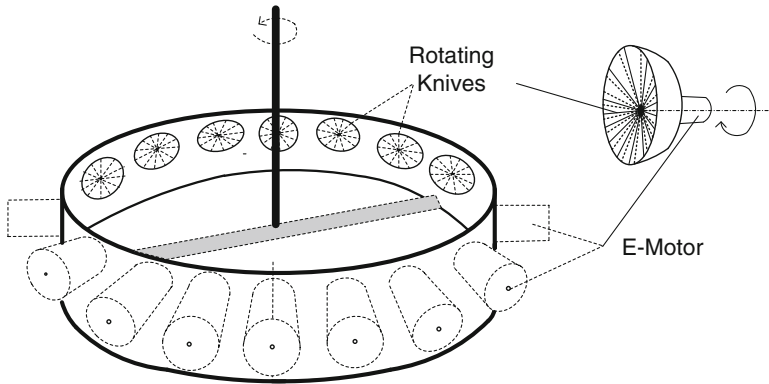


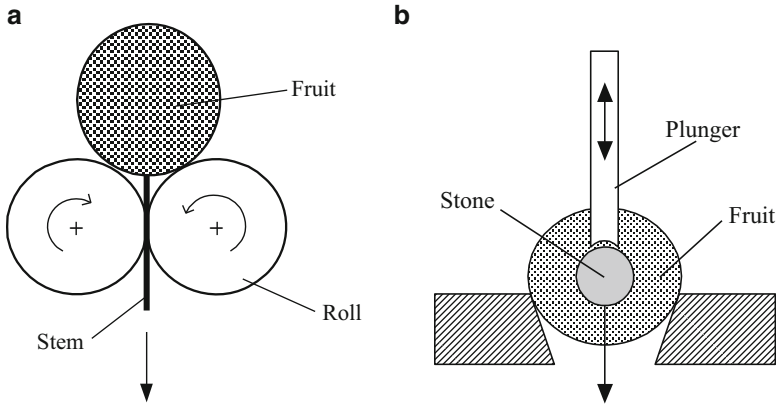
Fig. 5.23 Onion dehuller

clearance between the rolls is adjusted in such way that the shell, but not the kernel, breaks. In some cases, the rolls are grooved.

### Dehulling

Dehulling of onions and seed coats from legumes is usually carried out with abrasion machines (attrition mills), which contain carborundum as an abrasive material. Onions may be also dehulled in a bin in which inside, around the surface of it, there are independently rotating disk knives. Figure 5.23 indicates such a machine. A rotating paddle moves/agitates the onions toward the disk knives. The capacity of such a batch process machine, equipped with 14 disk knives, is about 600 kg/h. Recently, this knife technique has been further developed to satisfy also continuous processing.

Dehulling of cereals, such as wheat, is part of the milling process. Part of the broken hull of ground wheat contains starch endosperm that is subsequently separated during screening (Chap. 4). In rice, since the grains are usually not milled, it is aimed to perform dehulling with minimal possible breaking of grains. It is accomplished as rice is rubbed between the surface of a conical cylinder and the jacket around it or between two parallel flat disks, as in the case of the colloid mill (Chap. 4). In both cases, the surfaces are coated with a hard material (e.g., corundum) for increasing friction. In the flat-disk equipment, the rice leaves the dehulling surface after  $1/3$  to  $1/2$  turn. In this case, about 67 % of rice is dehulled, 11 % is not dehulled, 4 % of grain is broken, 1.2 % is rice flour, and 16.8 % is hulls (Tscheuschner 1986). The clean dehulled rice is further polished as it is rubbed again between a fixed and a rotating disk or between two disks of different rotation. In the case that only one disk rotates, its peripheral speed is 18–20 m/s (Tscheuschner 1986). The energy required to dehull, clean, and polish rice is about 75 kWh/ton final product (Garloff 1991). Dehulling or removal of skins



**Fig. 5.24** Principles of destemming (a) and pitting (b)

from onions and seed coats from legumes (hulls) is usually carried out with abrasion machines (attrition mills), which contain carborundum as an abrasive material.

### Brushing/Polishing

Brushing is done, e.g., for polishing fruits such as oranges and for removing a part of external contaminants (see also Fig. 5.1c). In products, like the oranges, brushing is combined with waxing. Usually, brushes placed on rotating rollers brush the product as it is conveyed. Waxing/brushing systems may have 8–30 rollers. Such a unit can be 2–3 m wide and 4–5 m long. Polishing of rice is carried out, e.g., in colloid mills (Chap. 4), removing the external layer (bran). The appearance and quality of breakfast cereals can be improved by polishing, e.g., removal of external insect or rodent injuries.

### Destemming

Destemming of fruits, like cherries, is accomplished by parallel pairs of rolls rotating reversely. The stems coming between the rolls are dragged downward. The rolls are smooth and coated with rubber. Furthermore, they are as close as possible to each other, for avoiding crushing of the fruits (Fig. 5.24a). Equipment used for removing apple stems has a capacity of 400–500 pieces/min and require 3 kW of power. The weight of the equipment is 2 tons.

## Pitting

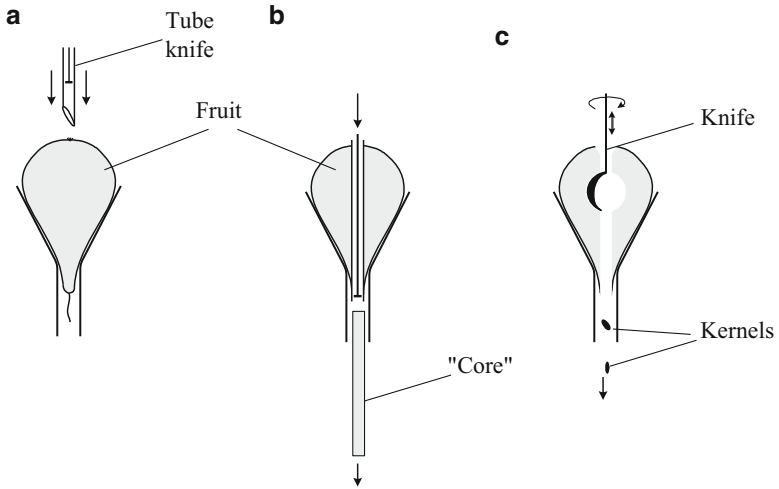
Pits are removed from some stone fruits, mainly peaches and apricots, before further processing (canning and freezing). Pitting is also applied to cherries, olives, and some dried fruits, like prunes (Fig. 5.24b). The product is placed in specially designed dies automatically. A plunger with a suitably shaped end penetrates the product quickly, pushing out its stone, before coming back quickly to its initial position. A machine of this type may have dimensions of  $1.7 \times 1.7 \times 1.7$  m and capacity of 1.5–2.0 tons of cherries/h.

In peaches, the two mechanical pitting systems used in food processing are the Filper torque pitter and the FMC pitter (Woodroof and Luh 1986). In the Filper torque pitter, the fruit, e.g., peach, is placed in a cup and held with spring-loaded arms, while cutting blades cut it into two halves, and the pit is pushed out. The peach halves are moved onto a belt, cup down, where they are peeled with sprays of hot lye and washed with water. In the FMC pitter, the peaches come in parallel belt cups (e.g., 8 cups across the belt). Aligning wheels under each cup adjust the peaches so that each fruit can be cut by two stationary blades at the suture, around the longitudinal axis of the fruit. Subsequently, the pit is cut in half with a circular saw, and the two pit halves are cut from the fruit. The fruit and the pit halves are then discharged to a shaker-type separator. The FMC pitter can align and pit 300 clingstone peaches/min, which is approximately 3 tons/h. The equipment consumes 2.6 kW and 30 L of water /min. It weighs 2.5 tons and has dimensions of  $4.5 \times 2.0 \times 2.0$  m. A similar pitting machine (capacity: 4 tons/h) weighs 0.6 tons and requires 1.2 kW and 50–60 L air at 3–4 bar of pressure.

## Coring/Scooping

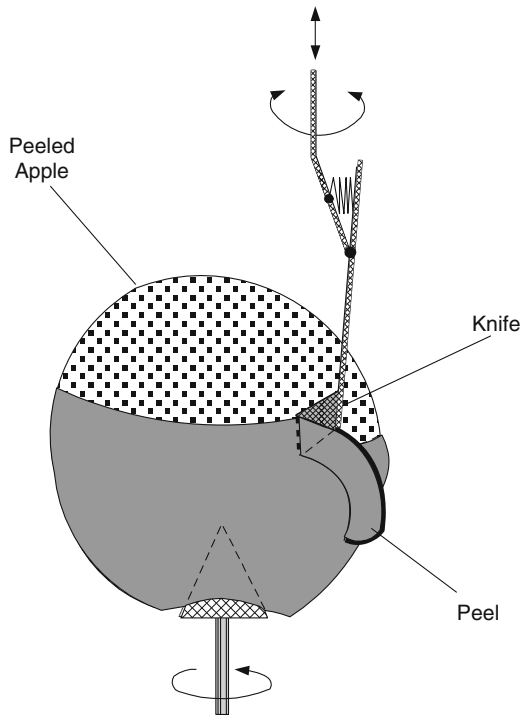
Tube knives or rotating curved knives do coring and scooping (Fig. 5.25). By coring, the cut kernel comes inside the tube knife, which is subsequently removed by a piston, as indicated in Fig. 5.25b. A tube knife is used, when the kernel is concentrated along the vertical axis of a product. Rotating knives are applied to vegetables, such as peppers, and fruits, such as pineapples. They are also used in scooping and removing nests of kernels or seeds (Fig. 5.25c).

Equipments used for coring peppers, pineapples etc., have capacities of 16,000–24,000 pieces/h. They require 2–3 kW of power and 150–200 L air/min at 4–5 bar, and they weigh about 1.5 tons. Equipments used only for scooping of already cored products (e.g., pineapples) have double capacity and need less energy. There is equipment in which coring is a step of the overall processing, which may include mechanical peeling and slicing or cutting of fruits or vegetables. In case of apples, the diameter of coring tubes usually is 11 mm. In apples, the capacity of a coring machine is about 26,000 fruits/h. The seed celling knives are self-adjustable according to the size of individual apples, for minimizing product losses. Ultrasonic screening enables this process even to smaller particles (20  $\mu\text{m}$ ). It also reduces plugging in screens. In whey separation of cheese dairies, the productivity of such systems may be about 80  $\text{m}^3/\text{h}$  (Fig. 5.26).



**Fig. 5.25** Schematic pitting and coring of stone fruits. (a) Coring, (b) removal of cut core, (c) scooping

**Fig. 5.26** Apple peeling



a.k.

### Cutting/Slicing

The capacity of a separate cutting equipment is about 50 apple pieces/h, requiring about 1.2 kW of power and 80 L of air/min and weighing about 0.5 ton. There is also cutting equipment used for peel shredding. Such equipment shreds and cuts, e.g., orange peels that are further utilized in processing of jam. In this case, the peel is the desired product. Typical equipment weighs about 0.5 ton, has dimensions of  $1.0 \times 0.8 \times 1.0$  m, requires about 1 kW power, and has a capacity of about 0.5 ton of cut product/h.

### Peeling

Peeling of raw food materials, such as fruits and vegetables, is necessary before further processing. The peels are removed mostly with wet peelers, using lye solutions or high-pressure steam. In some cases, dry peeling is used, e.g., onions and legumes. This includes flame peeling, abrasion, and peeling with knives. Flame peeling is used mainly for vegetables with thick and tough skins like peppers (pimientos) and eggplants, although sometimes flame peeling is also applied to remove thin skin, as that of onions. The food material is exposed to gas flames (temperatures up to 1000 °C) for a very short time, burning only the skin and not damaging the main product. The capacity of flame peelers is about 10 tons/h (Luh and Woodroof 1988).

Knives are used in the mechanical peeling of potatoes, onions, and some other tubers. A special onion peeling machine consists of a rotating pot with independent rotating knives located around its wall. The capacity of the unit depends on the volume of the pot and the number of knives. A pot of about 3.5 m in diameter and 2.0 m in height has the onion peeling capacity of 1.5 tons/h. The pot is filled to 50 kg during the operation that lasts up to 1.5 min/ batch. It has 4–30 rotating knives, requiring 0.2 kW each. The weight of the equipment is 2.5 tons.

Knife peeling is also used for some fruits, such as apples and citrus, which are difficult to be handled in wet peelers. In the mechanical peeler, stationary blades are pressed against the surface of the rotating fruit. Alternatively, the blades may rotate against the stationary fruit. Combination of knife and abrasion peeling is used for some food products. A knife apple-peeling equipment may have the capacity of 0.5–1 ton/h. It requires about 3 kW of power, 5–8 L of water/h, and 250 L of air/min (4–5 bar).

Lye peeling of fruits and vegetables, like peaches, apricots, and potatoes, is used as part of preprocessing of the product before canning, freezing, or dehydration. The main peeling equipment used in fruit and vegetable processing are the lye peelers and the flash steam peelers.

Lye peeling is carried out with a dilute solution of 1–2 % sodium hydroxide at a temperature of 100–120 °C for about 60 s (Woodroof and Luh 1986). Two types of lye peeling equipment are used, e.g., for peaches and potatoes: (1) the immersion (Draper) lye scalding, consisting of a long tank of dimensions of  $1.2 \times 0.4 \times 30$  m



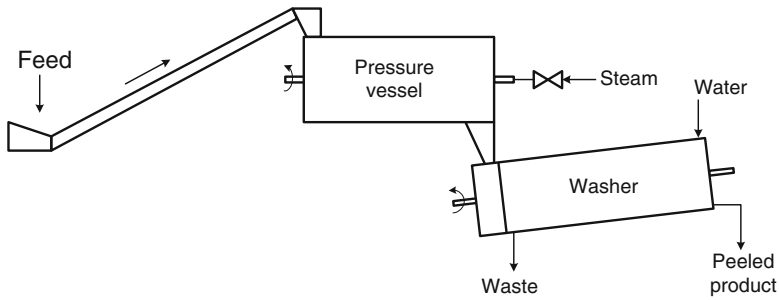


Fig. 5.27 Diagram of a pressure steam peeler

and capacity of about 20 tons/h, and (2) the lye-spray scalding, consisting of a conveyor belt moving slowly the fruit product (e.g., cup down peach halves), which are sprayed with the hot lye solution. The loosened skins are removed with sprays of wash water, and the residual alkali is normally neutralized by immersion in a 2 % solution of citric acid.

The “dry caustic peeling” uses concentrated sodium hydroxide (10–15 %) and infrared heating to peel the food material, e.g., potatoes, without the large amounts of water needed in the dilute-lye peeling process, cutting down considerably pollution of the environment.

The flash steam peeling method is used widely because of its important advantages over the lye methods. Less waste is produced, no chemicals are needed, the peels may be used as animal feed, and the pollution is minimal. The steam peeler consists basically of a pressure vessel, which is loaded with the food material and rotated slowly (5–6 rpm). Before processing products such as potatoes in retorting steam peelers, the products must be sorted out, so that they have almost similar shape and size. Figure 5.27 shows schematically a pressure (flash) steam peeler. It is important to flash the product quickly and cool it down immediately after steaming, so that the product is not overheated. Therefore, steam accumulators, which can supply quickly the required steam and large vapor condensing units, for assisting the quick vapor removal, are necessary. The capacity of such peeling units may be 16–30 tons /h. The volume of the pressure vessels can be 400–900 L. The overall dimensions of a large flash peeling unit may be  $3 \times 7 \times 5$  m. The volume of large steam accumulators can be about  $20 \text{ m}^3$ . After steaming, the separation of the peels is done in rotating drum washers in which water is sprayed. For potato, rotating brush cylinders (6–12 pieces) may be also used. Steam peeling can also be accomplished in vacuum operation, in which the product is heated at atmospheric pressure and then flashed into a vacuum chamber (Hoch 1999). This is especially important in tomato peeling, since it occurs at reduced temperature that does not affect significantly the color and consistency of the product. In vacuum peeling, instead of heating the product up to 120–130 °C, temperatures of only 50–60 °C are applied. A double vacuum tomato peeling unit with 25 tons/h of processing capacity (2 pressure vessels of 350 kg/charge each) requires about 13 kW and 15 L of air/min (pressure 6 bar) and consumes about 8 tons of water/h. It also

requires 900 kg of steam/h at maximum pressure of 15 bar. The unit (including conveyors, condenser, double pressure vessels, and washing equipment) requires a floor space of about 54 m<sup>2</sup>.

High-pressure steam (15 bar) heats instantly the surface of the food material in a pressure vessel; the moisture of the product under the skin is vaporized and, when the vessel pressure is released, the skin is loosened so that it can be removed easily with water sprays afterward. Pressure vessel capacities of 100–1250 L, product capacity per charge of 34–666 kg, total product capacity of 1–20 tons/h, and power requirement of 6–10 kW are required (Greensmith 1998). Relative losses of product flesh in peeling operations are abrasion, up to 40 %; lye peeling, 18 %; and flash steam peeling, 10 %. Steam peeling is used normally in potato peeling. However, lye peeling is preferred for peaches, since a smoother surface is obtained in the peeled fruit.

Both lye and steam peelers are used in tomato peeling at capacities of about 30 tons/h. Lye peeling results in better quality and less product losses, but the peel waste must be either recovered (as tomato concentrate) or treated before disposal (Hoch 1999).

### ***5.6.3 Removal of Desired Parts***

The goal of separation is often the recovery of certain food parts. These parts can be external or internal food parts (Table 5.6). External parts that can be further utilized in food technology are, e.g., the solid matter of soya, the rice bran, and the peels of oranges. Internal product parts that are the main goal or that can be further utilized after separation are juices (fruit and vegetable), oil (seeds, olives), fat (animal, milk), starch (cereals), and nuts. Several animal by-products, such as collagen (jellies), bones (feedstuffs), and intestines (sausages), can be also utilized. However, the equipment used in the utilization of these products will not be discussed here, since most of it has been already described in connection with other processes (e.g., juice or oil extraction, solid/liquid separation, and production of starch or nuts, in the grinding, milling, and breaking processes).

### ***5.6.4 Food Cleaning Operations***

#### **5.6.4.1 General Aspects**

The cleaning processes refer to the separation and removal of external undesired material that either adheres on food or on food equipment. In cleaning of equipment, lye and acid solutions and several sophisticated chemicals are used. The trend is to automate cleaning as far as possible by installing a computerized CIP system (see Sect. 2.5). Furthermore, it is aimed to manufacture equipment that

incorporates, in their construction materials, substances that make them resistant to microorganisms. In cleaning of equipment, rinsing, which follows washing with detergents, is also important. Details about washing and rinsing of food equipment and installations are discussed by Schornick and Thor (1976), Kopp and Gerhold (1977), Schluessel (1976), Loncin and Merson (1979), and Seiberling (1997).

For raw food, cleaning is an important preprocessing operation, which removes foreign materials and contaminants. Cleaning of raw food materials must remove completely the foreign materials and contaminants, resulting in an acceptable sound and nutritious product. The cleaning operation should not waste a large proportion of the product nor affect adversely the physical environment (pollution from the wastewater effluent). Cleaning from heavy foreign materials, such as stones and metal pieces, is necessary for protecting size reduction and milling equipment used downstream.

#### 5.6.4.2 Wet Cleaning

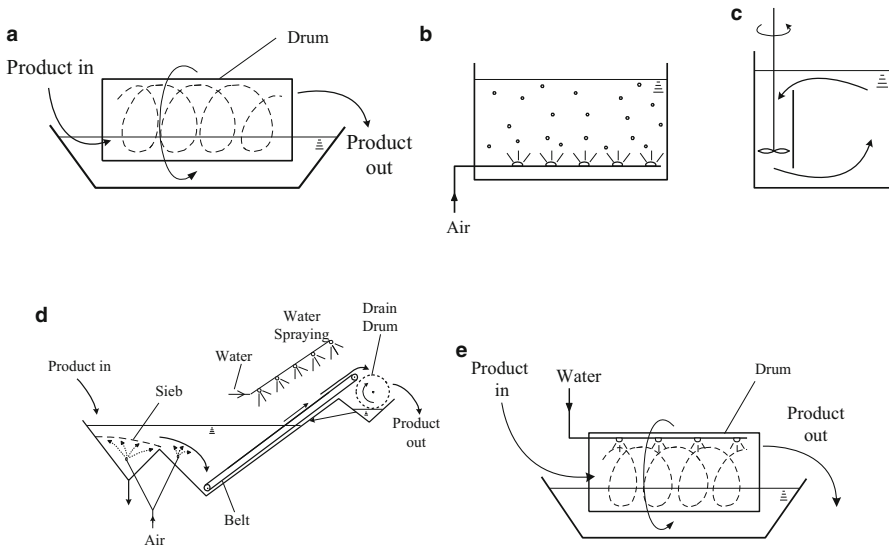
Most of the cleaning methods use water as a cleaning medium, and a limited number of dry cleaning processes are applied in food processing.

Wet cleaning is effective in removing firmly adherent soils from raw fruits and vegetables, allowing the use of detergents and sanitizers (Brennan et al. 1990). Capacity of wet cleaners for vegetables is 8–15 tons/h. Water conservation methods should be used (e.g., recirculation) to reduce the large amounts of water needed in some processing operations, e.g., in the canning of fruits and vegetables, up to 15 m<sup>3</sup>/ton of product may be used.

Besides soaking, in all wet cleaning equipment, a relative motion between the cleaning fluid and the product is applied. This can be achieved by the movement of the cleaning fluid, by the movement of the product, or by the movement of both. In soaking, the cleaning medium diffuses and separates the undesired dirt. The main categories of wet cleaning units are the soaking equipment, the spraying equipment, and the mixed systems in which two or more cleaning systems are involved.

Soaking of the raw materials in long tanks removes heavy contaminants, like stones and adhering soil. The efficiency of soaking is improved by relative movement of water against the product, e.g., using mechanical paddles or air currents at the bottom of the tank (Fig. 5.28b, c), or by moving the product by means of a rotating drum (Fig. 5.28a). Detergents may be used to remove the spray residues of agrochemicals from the surfaces of the fruits and vegetables, and chlorination of water may be required to prevent the growth of spoilage microorganisms.

Spray washers use less water and they are more efficient, due to mechanical action, than water soakers. It is important to use well-designed spraying nozzles and to maintain or replace them in time, since their efficiency falls as they are worn out by the fluid. Furthermore, the pressure exercised by water on the food must be also controlled, especially when delicate products are washed. In belt-type spray washers, the raw material is transported slowly on roller or vibratory conveyors under water sprays. Brushes and special rubber disks can remove the adhering dirt



**Fig. 5.28** Soak and spray washing equipment for fruits and vegetables: (a) soaking; (b, c) water circulation; (d, e) mixed washing systems

and contaminants from the sound product. The combination of soaking and spraying is sometimes used for more effective cleaning (Fig. 5.28c, d). The washer of Fig. 5.28c is quite common in washing of fruits and vegetables, due to its effective and gentle washing action. The equipment consists of two vessels and a conveying belt. In the first vessel, prewashing takes place, as the product is soaked. Air blown in the vessel improves the cleaning action. Stones or other heavy matter is collected on the bottom of the vessel. In the second vessel, soaking with the air-assisted water agitation is repeated. Subsequently, the product is sprayed with water as it is conveyed out of the second vessel. Finally, a perforated drum separates any remaining water from the washed product. Spray drum washers (Fig. 5.28d) consist of a rotating cylinder (reel), usually inclined slightly, made of longitudinal rods or wire mesh, which retain the fruit/vegetable product, while the debris is washed through. The rotating cylinder is partially immersed in water. A perforated long tube, installed in the center of the cylinder, supplies the water sprays. The washing capacity depends on the treated product. The capacity of a washing equipment as that of Fig. 5.28d, when used to wash spinach or other leafy vegetables, is only 25 % of what the same equipment that wash potatoes or other tubers has. An equipment that has dimensions of  $6.5 \times 1.8 \times 1.8$  m and weighs about 1 ton can wash 6 tons of potatoes/h and requires 6–7 kW power. A drum washer, like that of Fig. 5.28e, of the same capacity as the above washer, requires also 6–7 kW of power, but it has dimensions of  $4.0 \times 1.2 \times 1.8$  m, since due to the drum rotation, washing is more intensive.

The rotary brush washer consists of a trough-shaped frame with 6 or more brushes, rotating longitudinally, with economical use of water and capacities of 4–8 tons/h (Greensmith 1998).

Simple flotation in water may be used to separate bruised or rotten fruits or vegetables from sound products. Froth flotation can be used to separate foreign materials of the same size and density with the main product. The raw material is immersed in an emulsion of mineral oil/detergent, through which air is blown. The contaminants float at the surface and the product is separated from the bottom, e.g., clean peas.

### 5.6.4.3 Dry Cleaning

Dry cleaning by an air stream is based on the same aerodynamic principles discussed in Air Classifiers (Sect. 5.3). The most common operation of aspiration (winnowing) removes light materials (skins, leaves, etc.) from heavier food pieces, e.g., onions, peas, and beans (Fig. 5.6).

Screening, discussed under solid/solid separations, is used widely in dry cleaning of various food pieces and particles, like grains and seeds. In a 3-screen setup, the top screen (scalper) removes the largest pieces/particles, and the second screen collects the main product, while the bottom pan collects the undesirable product, the soil, and the debris. Depending on the shape of the grains, round, triangular, or slotted holes can be used (Henderson and Perry 1955).

Pneumatic separators or fanning mills consist of a set of screens and a fan for moving air through the grain, which removes chaff, dirt, and lightweight weed. A blowing or suction fan, i.e., an aspiration system, is used.

Combined cleaning methods are used for thorough separation of some raw materials, e.g., wheat, before milling: the wheat goes through a series of separations to remove various contaminants and separate the oversize and undersize fractions, like magnetic separation, screening, disk separation, washing, centrifugation, and drying (Brennan et al. 1990).

Brushing is applied in the dry cleaning of some fruits and vegetables. Electrostatic separation is discussed as a solid/solid separation method in Sect. 5.3.

## References

- Alderman J, O'Connor B, Sattler L, Galvin S, Brennan D (2001) Progress in development of low cost NIR spectrophotometer for process control. Paper presented at the Symposium food factory of the future. SIK—Swedish Institute of Food and Biotechnology, Gothenburg, Sweden, June 2001
- Allen T (1990) Particle size measurement. Chapman and Hall, London
- Bhatia M, Cheremisinoff P (1979) Solids separation and mixing. Technomic, Westport
- Brennan JG, Butters JR, Cowell ND, Lilly AEV (1990) Food engineering operations, 3rd edn. Elsevier Applied Science, London

- Cantarelli C, Riva M (1983) A survey of mechanical expression of vegetables. In: Cantarelli C, Pieri C (eds) *Progress in food engineering*. Forster, Switzerland
- Cheremisinoff PN (1995) *Solids/liquids separation*. Technomic, Lancaster
- Clerjon S, Damez JL (2001) A microwave sensor for meat process control. Paper presented at the Symposium Food Factory of the Future. SIK—Swedish Institute of Food and Biotechnology, Gothenburg, Sweden, June 2001
- Cockram S (1993) Juice extraction. In Downing DL (ed) *Juice technology workshop*, Special report no 67. New York Agricultural Experiment Station, Cornell University, Geneva, pp 4–8
- Fellows PJ (1990) *Food processing technology*. Ellis Horwood, London
- Feustel J, Hemendinger G, Pholer H (1987) *Aufbereitung von Getreide und Saatgut*. VEB Fachbuchverlag, Leipzig
- Garloff H (1991) *Reis*. In: Heiss R (ed) *Lebensmitteltechnologie*. Springer, Berlin
- Grandison AS, Lewis MJ (1996) *Separation processes in food and biotechnology industries*. Technomic, Lancaster
- Greensmith M (1998) *Practical dehydration*. Woodhead, Cambridge
- Henderson S, Perry RL (1955) *Agricultural process engineering*. Wiley, New York
- Hoch GJ (1999) Technologies with a peel. *Food Eng July*:82–85
- Jowitt R, Escher F, Halstromm B, Mneffert HFT, Spiess WEL, Vos G (1983) *Physical properties of foods*. Applied Science, London
- Jowitt R, Escher F, Kent M, McKenna B, Roques M (1987) *Physical properties of foods*, vol 2. Applied Science, London
- Kimball DA (1999) *Citrus processing*, 2nd edn. Aspen, Gaithersburg
- Knochel R (2001) Microwaves for non-destructive quality control. Paper presented at the Symposium Food Factory of the Future. SIK—Swedish Institute of Food and Biotechnology, Gothenburg, Sweden, June 2001
- Kopp R, Gerhold E (1977) Reinigung und Desinfektion in Lebensmittelbetrieben. *ZfL* 28 (5):157–163
- Lewis MJ (1990) *Physical properties of foods and food processing stems*. Ellis Horwood, Chichester
- Lienhop E (1981) *Handbuch of Fleischwaren-herstellung*. G. Hempel, Braunschweig
- Loncin M, Merson RL (1979) *Food engineering*. Academic, New York
- Low JM, Maughan WS (1993) Sorting by color on the food industry. In: Kress-Rogers E (ed) *Instruments and sensors for the food industry*. Butterworth Heineman, Oxford
- Luh BS, Woodroof JG (1988) *Commercial vegetable processing*, 2nd edn. Van Nostrand Reinhold, New York
- McLellan MR (1993) An overview of juice filtration technology. In: Downing DL (ed) *Juice technology workshop*. Special report no 67. New York Agricultural Experiment Station, Cornell University, Geneva, pp 23–28
- Mohsenin NN (1986) *Physical properties of plant and animal materials*. Structure, physical characteristics and mechanical properties, 2nd edn. Gordon and Breach Science Publishers, New York
- Nagy S, Chen CS, Shaw PE (eds) (1993) *Fruit juice processing technology*. AgScience, Auburndale
- Neuhaeuser S (1991) *Fleischwaren*. In: Heiss R (ed) *Lebensmitteltechnologie*. Springer, Berlin
- Peleg M, Bagley EB (1983) *Physical properties of foods*. Avi Publishing, Westport
- Perry R, Green D (1984) *Perry's chemical engineers' handbook*, 6th edn. McGraw-Hill, New York
- Purchas DB, Wakeman RJ (1986) *Solid/liquid equipment scale-up*. Uplands Press, London
- Salunkhe DK, Bolin HR, Reddy NR (1991) Storage, processing, and nutritional quality of fruits and vegetables, vol I and II, 2nd edn. CRC, Boca Raton
- Schuessler HJ (1976) Zur Kinetik von Reinigungsvorgaengen an festen Oberflaechen. *Brauwissenschaft* 29(9):263–268
- Schornick G, Thor W (1976) Aspekte der Reinigung und Desinfektion in der Lebensmittelindustrie. *ZfL* 27(8–9):225–228

- Schubert H (1987a) Food particle technology. Part I: properties of particles and particulate food systems. *J Food Eng* 6:1–32
- Schubert H (1987b) Food particle technology. Part II: some specific cases. *J Food Eng* 6:83–102
- Seiberling DA (1997) CIP sanitary process design. In: Valentas KJ, Rotstein E, Singh RP (eds) *Handbook of food engineering practice*. CRC Press, New York
- Swientek RJ (1985) Expression-type belt press delivers high juice yields. *Food Processing*, April, pp 110–111
- Tscheuschner HD (ed) (1986) *Lebensmitteltechnik*. Steinkopff, Darmstadt
- Walas SM (1988) *Chemical process equipment*. Butterworths, London
- Woodroof JG, Luh B (1986) *Commercial fruit processing*, 2nd edn. Avi Publishing, Westport

# Chapter 6

## Heat Transfer Equipment

### 6.1 Introduction

Heat transfer equipment is used in most food processing operations as an important part of the manufacturing or preservation processes. The transfer of energy to or from food materials during processing requires special equipment, which is designed and operated on the basis of the engineering principles of heat transfer and the experience and practice of food process engineering.

This chapter reviews the heat transfer coefficients and correlations of importance to food systems, and it describes briefly some heat exchangers and heaters used in food processing. Basic heat transfer equipment, used in industrial food processing, is described also in the following chapters of this book: 7 (evaporators), 8 (dryers), 9 (coolers, freezers), and 10 (blanchers, pasteurizers, sterilizers). Table 6.1 shows the basic heat transfer equipment used in food processing and food preservation operations.

Table 6.2 shows some special heat transfer equipment, described in this chapter.

Food heating processes may involve chemical, biochemical, and biological changes of the food material that must be considered simultaneously with the physical heating process. The main purpose of cooking, baking, roasting, and frying processes is to improve the eating quality of the food products.

### 6.2 Heat Transfer Coefficients

The operation of heating equipment is based on the transfer of heat from a heating medium to a food material, usually by forced convection. Natural convection, contact, and radiation heating may also be involved in some applications. The cooling equipment operates on the same principles, but heat is transferred from the food material to a cooling medium, which can also be a cold food stream.



**Table 6.1** Basic heat transfer equipment of food processing

Equipment	Function
Evaporators	Concentration of liquid foods
Dryers	Drying/dehydration of foods
Coolers	Preservation of fresh foods
Freezers	Food preservation
Blanchers	Inactivation of enzymes
Pasteurizers	Inactivation of enzymes and microbes
Sterilizers	Inactivation of microbes and microbial spores

**Table 6.2** Special heat transfer equipment used in food processing

Equipment	Function
Ovens	Baking, cooking of foods
Roasters	Thermal treatment of foods
Fryers	Deep-fat or dry frying of foods
Infrared heaters	Heating, drying of foods
Microwave heaters	Heating, thawing, or drying of foods

The heat transport within food materials is expressed by the two basic heat transport properties, thermal conductivity ( $\lambda$ , W/m K) and thermal diffusivity ( $\alpha$ , m<sup>2</sup>/s), defined by the Fourier equations for one-dimensional ( $x$ ) transfer:

$$q/A = \lambda(\Delta T/x) \quad (6.1)$$

and

$$\partial T/\partial t = \alpha(\partial^2 T/\partial x^2) \quad (6.2)$$

where ( $q/A$ ) is the heat flux (W/m<sup>2</sup>) and ( $\Delta T/x$ ) is the temperature gradient (K/m) in the ( $x$ ) direction.

Data on the thermal transport properties of foods are presented in tables, databanks, and books, such as Rahman (1995) and Saravacos and Maroulis (2001).

The thermal diffusivity ( $\alpha$ ) is usually calculated from the more common thermal conductivity ( $\lambda$ ), using the equation:

$$\alpha = \lambda/\rho C_p \quad (6.3)$$

where  $\rho$  is the density (kg/m<sup>3</sup>) and  $C_p$  is the specific heat (J/kg K) of the material.

Densities, specific heats, and other physical properties of foods are found in food properties books, e.g., Rahman (1995). Some typical physical properties of foods useful in the design and operation of heat exchangers and other food processing equipment are given in Appendix B of this book. Table 6.3 shows some typical thermal transport properties of foods and engineering materials, useful for heat

**Table 6.3** Typical thermal conductivities ( $\lambda$ ) and thermal diffusivities ( $\alpha$ ) of foods and engineering materials

Material	$\lambda$ (W/m K)	$\alpha$ ( $\times 10^{-7}$ m <sup>2</sup> /s)
Air	0.025	190.0
Water	0.62	1.0
Porous food	0.04–0.20	1.1
Wet food	0.50	1.3
Frozen food	1.5	5.0

transfer equipment (Rahman 1995; Saravacos and Maroulis 2001; Perry and Green 1997).

Heat exchangers and heat transfer equipment are characterized by the (film) heat transfer coefficient ( $h$ , W/m<sup>2</sup> K) and the overall heat transfer coefficient ( $U$ , W/m<sup>2</sup> K), defined by the equations:

$$q/A = h\Delta T \quad (6.4)$$

and

$$q/A = U\Delta T \quad (6.5)$$

In (6.4), ( $\Delta T$ ) is the temperature difference between the bulk of the fluid and the heat transfer surface. Equation (6.5) is applied to heat transfer through the wall of a heat exchanger, and ( $\Delta T$ ) refers to the overall temperature difference between the two fluids, e.g., heating medium and food material. The units of ( $\Delta T$ ) are degrees Kelvin (K), which are identical with degrees Celsius ( $^{\circ}\text{C}$ ).

The overall resistance to heat transfer ( $1/U$ ) through a wall of thickness ( $x$ ) and thermal conductivity ( $\lambda$ ) is given by the equation:

$$1/U = 1/h_1 + x/\lambda + 1/h_2 \quad (6.6)$$

where  $h_1$  and  $h_2$  are the (film) heat transfer coefficients of the two sides (1, 2) of the heat transfer wall.

Equation (6.6) applies to clean flat heat transfer surfaces and approximately to tubular surfaces of diameter larger than 25 mm (1 in.). For tubes of smaller diameter, the inner and outer diameters ( $d_i$ ,  $d_o$ ) must be considered, and (6.6) becomes

$$1/U_i = 1/h_i + (d_i/d_L)(x/\lambda) + (d_i/d_o)(1/h_o) \quad (6.7)$$

where ( $d_L$ ) is the log mean diameter, defined as

$$d_L = (d_o - d_i)/\ln(d_o/d_i) \quad (6.8)$$

In (6.7), the tube wall thickness ( $x$ ) is calculated as  $x = (d_o - d_i)/2$ .

In practice, the heat transfer surfaces of the heat exchangers are not clean, due to fouling, i.e., deposits which increase significantly the thermal resistance. Thus, a

**Table 6.4** Typical film heat transfer coefficients ( $h$ )

Heat transfer system	$h$ (W/m <sup>2</sup> K)
Air-drying	20–100
Baking oven	30–200
Air cooling	10–60
Air freezing	20–100
Water in pipe flow	5000
Falling film of water	4000
Condensing steam	10,000

fouling resistance term should be added to the overall resistance (6.6) and (6.7), as discussed in Sect. 6.4.

Table 6.4 shows some typical heat transfer coefficients ( $h$ ) in food heat exchange systems (Rahman 1995; Saravacos and Maroulis 2001).

### 6.3 Empirical Correlations of ( $h$ )

#### 6.3.1 General Correlations

Correlations of heat transfer data are useful for estimating the (film) heat transfer coefficient ( $h$ ) in various processing equipment and operating conditions. These correlations contain, in general, dimensionless members, characteristic of the heat transfer mechanism, the flow conditions, and the thermophysical and transport properties of the fluids. Table 6.5 lists the most important dimensionless numbers used in heat transfer operations (Saravacos and Maroulis 2001).

The Reynolds number ( $Re = uL/\nu$ ) is used widely in almost all correlations. In this number, the velocity ( $u$ ) is in (m/s), the length ( $L$ ) is in (m), and the kinematic viscosity or momentum diffusivity ( $\nu = \eta/\rho$ ) is in (m<sup>2</sup>/s). The length ( $L$ ) can be the internal diameter of the tube, the equivalent diameter of the non-circular duct, the diameter of a spherical particle or droplet, or the thickness of a falling film. In noncircular geometries, the characteristic length ( $L$ ) is taken as twice the hydraulic diameter ( $L = 2d_H$ ) of the flow channel, which is twice the hydraulic radius of the duct ( $d_H = 2r_H$ ), defined as  $r_H = (A/WP)$ , where ( $A$ ) is the cross-sectional area and ( $WP$ ) is the “wetted” perimeter.

Some dimensionless numbers are used also in mass transfer correlations, i.e.,  $Bi$ ,  $St$ , and  $j_M$ . In these numbers, the heat transfer coefficient ( $h$ ) is replaced by the mass transfer coefficient ( $k_c$ ).

Table 6.6 shows some heat transfer correlations of general application. For natural convection, the parameters ( $a$ ) and ( $m$ ) characterize the various shapes of the equipment and the conditions of the fluid (McAdams 1954; Perry and Green 1997; Geankoplis 1993; Saravacos and Maroulis 2001).

**Table 6.5** Dimensionless numbers in heat and mass transfer calculations

Number	Applications
Reynolds $Re = uL/\nu$	Flow processes
Nusselt $Nu = hL/\lambda$	Heat transfer
Prandtl $Pr = \nu/\alpha$	Heat transfer
Grashof $Gr = L^3g(\Delta\rho/\rho)/\nu^2$	Free convection
Graetz $Gz = GAC_p/\lambda L$	Heat transfer
Biot $Bi = hL/\lambda$	Heat transfer
Stanton $St = h/GC_p$	Heat transfer
Schmidt $Sc = \nu/D$	Mass transfer
Heat transfer factor $j_H = StPr^{2/3}$	Heat transfer
Mass transfer factor $j_H = StSc^{2/3}$	Mass transfer

*A* interfacial area (m<sup>2</sup>), *L* length (m),  $\alpha$  thermal diffusivity (m<sup>2</sup>/s), *C<sub>p</sub>* specific heat (J/kg K), *g* acceleration of gravity (8.91 m/s<sup>2</sup>),  $G = u\rho$  mass flow rate (kg/m<sup>2</sup> s), *h* heat transfer coefficient (W/m<sup>2</sup> K),  $\eta$  viscosity (Pa s),  $\rho$  density (kg/m<sup>3</sup>), *D* mass diffusivity (m<sup>2</sup>/s),  $\nu = \eta/\rho$  kinematic viscosity (m<sup>2</sup>/s), *u* velocity (m/s)

**Table 6.6** General heat transfer correlations

Heat transfer system	Correlation
Natural convection	$Nu = a(GrPr)^m$
Laminar inside tubes	$Nu = 1.86[RePr(d/L)]^{1/3}(\eta/\eta_w)^{0.14}$
Turbulent inside long tubes	$Nu = 0.023Re^{0.8}Pr^{1/3}(\eta/\eta_w)^{0.14}$
Parallel to flat plate (laminar)	$Nu = 0.664Re^{0.5}Pr^{1/3}$
Parallel to flat plate (turbulent)	$Nu = 0.0366Re^{0.8}Pr^{1/3}$
Flow past single sphere	$Nu = 2.0 + 0.60Re^{0.5}Pr^{1/3}$

Dimensionless numbers defined in Table 6.5. *a* and *m*, parameters of natural convection characteristic of the system (Perry and Green 1997); *L*, *d* length and diameter of tube. Long tubes (*L/d*) > 60.

The ratio of tube diameter to tube length (*d/L*) is important in the laminar flow (*Re* < 2100), but it becomes negligible in the turbulent flow in long tubes (*L/d* > 60). For shorter tubes, the ratio (*d/L*) should be included in the correlation.

The viscosity ratio ( $\eta/\eta_w$ ) refers to the different viscosity in the bulk of the fluid ( $\eta$ ) and at the tube wall ( $\eta_w$ ). This ratio becomes important in highly viscous fluids, like oils, in which the viscosity drops sharply at the high wall temperatures, increasing the heat transfer coefficient.

Several other correlations have been proposed in the literature for different heat transfer in fluid systems, like flow outside tubes, flow in packed beds, etc.

The heat transfer coefficients of condensing vapors have been correlated to the geometry of the tubes and the properties of the liquid film or droplets. Very high heat transfer coefficients are obtained by dropwise condensation. Most liquid foods are non-Newtonian fluids, and their apparent viscosity ( $\eta_a$ ) is related to the rheological constants (*K*, *n*) of the power-law model (see Chap. 3):

$$\eta_a = K\gamma^{n-1} \quad (6.9)$$

The shear rate  $\gamma$  ( $\text{s}^{-1}$ ) is defined by the equation (Rao 1999):

$$\gamma = 8u/d \quad (6.10)$$

where  $u$  (m/s) is the fluid velocity and  $d$  (m) is the internal tube diameter.

Most non-Newtonian liquid foods are pseudoplastic, i.e.,  $n < 1$ , and their apparent viscosity decreases as the shear rate (velocity, agitation) is increased (shear-thinning fluids). Therefore, the heat transfer coefficient will increase at higher flow velocities or speeds of agitation.

The empirical correlation for laminar flow of power-law fluids is similar to the correlation given in Table 6.6:

$$Nu = 2.0[(3n + 1)/4n]^{1/3} Gz^{1/3} (K/K_w)^{0.14} \quad (6.11)$$

The Graetz ( $Gz$ ) number is defined as  $Gz = (GAC_p)/\lambda L$  (Table 6.5). The viscosity ratio ( $\eta/\eta_w$ ) is replaced by the ratio of the flow consistency index at the bulk/wall ( $K/K_w$ ), and the flow behavior index ( $n$ ) is included in the correlation.

### 6.3.2 Simplified Equations for Air and Water

The heat transfer coefficient of air and water in some important operations can be estimated from simplified dimensional equations, applicable to specific equipment geometries and system conditions (Perry and Green 1997; Geankoplis 1993):

(a) Natural convection of air:

$$\text{Horizontal tubes, } h = 1.42(\Delta T/d_o)^{1/4} \quad (6.12)$$

$$\text{Vertical tubes, } h = 1.42(\Delta T/L)^{1/4} \quad (6.13)$$

(b) Air in drying (constant rate):

$$\text{Parallel flow, } h = 0.0204G^{0.8} \quad (6.14)$$

$$\text{Perpendicular flow, } h = 1.17G^{0.37} \quad (6.15)$$

(c) Falling films of water:

$$h = 9150\Gamma^{1/3} \quad (6.16)$$

(d) Condensing water vapors:

$$\text{Horizontal tubes, } h = 10,800 / \left[ (Nd_o)^{1/4} (\Delta T/d_o)^{1/3} \right] \quad (6.17)$$

$$\text{Vertical tubes, } h = 13,900 / \left[ L^{1/4} (\Delta T)^{1/4} \right] \quad (6.18)$$

where ( $\Delta T$ ) is the temperature difference (K),  $d_o$  is the outside diameter (m),  $L$  is the length (m),  $G$  is the mass flow rate ( $\text{kg/m}^2 \text{ s}$ ),  $\Gamma$  is the “irrigation” flow rate of the film ( $\text{kg/m s}$ ), and  $N$  is the number of horizontal tubes in a vertical plane.

### 6.3.3 Heat Transfer Factor

The heat transfer factor of various heating processes ( $j_H$ ) is related to the Reynolds number of the system ( $Re$ ) by the empirical correlation (Saravacos and Maroulis 2001):

$$j_H = mRe^n \quad (6.19)$$

where ( $m$ ) and ( $n$ ) are characteristic constants of the equipment/material system.

Regression analysis of compiled literature data on various heating operations of foods has yielded the following generalized correlation:

$$j_H = 0.344Re^{-0.423} \quad (6.20)$$

It is thus possible to estimate an approximate value of the heat transfer coefficient ( $h$ ) for a given flow condition ( $Re$ ), using the equation:

$$j_H = StPr^{2/3} = [h/(u\rho C_p)]Pr^{2/3} \quad (6.21)$$

As an illustration, the heat transfer coefficient ( $h$ ) of water, flowing in a circular tube of internal diameter 25 mm at 2 m/s and 20 °C, is calculated as follows: The thermophysical and transport properties of water at 20 °C are  $\rho = 1000 \text{ kg/m}^3$ ,  $\eta = 0.001 \text{ Pa s}$ ,  $C_p = 4180 \text{ J/kg}$ , and  $\lambda = 0.62 \text{ W/m K}$ . Thus,  $Re = (0/025 \times 2 \times 1000/0.001) = 50,000$ , i.e., the flow will be turbulent. The heat transfer factor will be  $j_H = 0.344 \times (50,000)^{-0.423} = 0.0032$ . The Prandtl number will be  $Pr = C_p\eta/\lambda = 4180 \times 0.001/0.62 = 5.74$ , and  $Pr^{2/3} = 3.22$ . From (6.21), the heat transfer coefficient will be approximately  $h = 0.0032 \times 1000 \times 2 \times 4180/3.22 = 8308 \text{ W/m}^2 \text{ K}$ .

It should be noted that the classical correlation for ( $h$ ) in turbulent pipe flow (Table 6.6) yields  $Nu = 0.023 \times (50,000)^{0.8} \times (5.54)^{0.33} = 235.1$  and  $h = 235.1 \times 0.62/0.025 = 5828 \text{ W/m}^2 \text{ K}$ .

For a viscous food product of apparent viscosity  $\eta_a = 1 \text{ Pa s}$ , flowing in the same tube at the same velocity of the previous example,  $Re = 50,000 \times 0.001 = 50$ , i.e., laminar flow.

The Prandtl number will be about  $Pr = 5.74 \times (1/0.001) = 5740$  and  $Pr^{2/3} = 330$ . The heat transfer factor will be  $j_H = 0.0032 \times (1/1000)^{-0.423} = 0.06$  and the heat transfer coefficient  $h = 0.06 \times 1000 \times 2 \times 4180/330 = 1520 \text{ W/m}^2 \text{ K}$ .

## 6.4 Heat Exchangers

The design of heat exchangers in the process industries is described in general chemical engineering books, such as Perry and Green (1997) and Walas (1988). The design procedures for heating gases and liquids have been standardized and computer packages are available for computer-aided design (CAD).

Several types of heat exchangers are used in food processing, suited to the diverse requirements of heating, cooling, sterilizing, baking, etc., of various food products. Although each type of the major equipment is described briefly in the specific applications of this book, the general principles of heat exchangers are outlined in this section.

Heat exchangers used in refrigeration and freezing equipment, e.g., evaporators and condensers of refrigerants, are discussed in detail in Chap. 9.

The heat load of a heat exchanger ( $q$ , kW) is the power required to heat the product ( $m$ , kg/s) by a temperature difference ( $\Delta T$ , K), according to the equation:

$$Q = mC_p\Delta T \quad (6.22)$$

where  $C_p$  (kJ/kg K) is the specific heat of the product.

### 6.4.1 Overall Heat Transfer Coefficients

The design and operation of heat exchangers is based on the overall heat transfer coefficient ( $U$ ), which is defined by the generalized form of (6.5):

$$q/A = U\Delta T_L \quad (6.23)$$

where  $U$  is the overall heat transfer coefficient,  $A$  is the heat transfer area, and  $\Delta T_L$  is the logarithmic mean temperature difference, defined in (6.26).

The overall heat transfer coefficient ( $U$ ) is calculated from the overall thermal resistance of the heat exchanger ((6.6) for flat surfaces), including the fouling resistance (FR):

$$1/U = 1/h_1 + x/\lambda + 1/h_2 + (\text{FR}) \quad (6.24a)$$

For tubes of diameter smaller than 25 mm, (6.7) becomes:

$$1/U_i = 1/h_i + (d_i/d_L)(x/\lambda) + (d_i/d_o)(1/h_o) + (\text{FR}) \quad (6.24b)$$

The overall heat transfer coefficient ( $U_i$ ) refers to the internal surface of the tube, which represents the major thermal resistance, since the food material flows usually inside the tubes and it creates most of the fouling. The heating (or cooling) medium flows outside the tubes, and it is characterized by higher heat transfer coefficients and negligible fouling. When the major thermal resistance is in the outside surface, the coefficient ( $U_i$ ) is replaced by the ( $U_o$ ) and the diameters ( $d_i$ ,  $d_o$ ) in (6.24a) and (6.24b) are switched.

The fouling factor (FR) or the corresponding “fouling coefficient”  $h_f = 1/(\text{FR})$  is difficult to predict accurately, and for this reason, empirical overall heat transfer coefficients ( $U$ ) are used in practice. Reliable ( $U$ ) values are obtained in pilot plant or industrial-scale measurements of heat transfer rates on similar equipment, processing similar products under similar operating conditions. Calculation of the (film) heat transfer coefficients of the product side ( $h_i$ ) from experimental values of ( $U$ ), using (6.23) or (6.24a) and (6.24b) and assuming a reasonable fouling resistance (FR), is useful for comparison with empirical correlations of ( $h$ ).

In most food heat exchangers, stainless steel is used, which has a comparatively low thermal conductivity ( $\lambda = 15 \text{ W/m K}$ ), and the thermal resistance of the wall ( $x/\lambda$ ) can become significant, particularly in thick-walled tubes or other heat transfer equipment. As an example, the wall resistance for a wall of 3-mm thickness will be  $(x/\lambda) = 0.003/15 = 0.0002 \text{ m}^2 \text{ K/W}$ . The heating medium is normally saturated steam with a typical heat transfer coefficient  $h_o = 10,000 \text{ W/m}^2 \text{ K}$  and a heat resistance of  $h_o = 0.0001 \text{ m}^2 \text{ K/W}$ . For a moderate fouling resistance  $\text{FR} = 0.0002 \text{ m}^2 \text{ K/W}$ , and an experimentally measured overall heat transfer coefficient  $U = 2000 \text{ W/m}^2 \text{ K}$ , the product side ( $h_i$ ) is calculated as follows from (6.24a) and (6.24b): Overall thermal resistance  $(1/U) = 0.0005 = 1/h_i + 0.0002 + 0.0001$ , and therefore,  $(1/h_i) = 0.0002 \text{ m}^2 \text{ K/W}$  or  $h_i = 5000 \text{ W/m}^2 \text{ K}$ .

Table 6.7 shows some typical overall heat transfer coefficients of various heat exchangers used in food processing, under normal operating conditions, i.e., not excessive fouling.

**Table 6.7** Typical overall heat transfer coefficients ( $U$ ) in heat exchangers

Heat exchange system	$U$ ( $\text{W/m}^2 \text{ K}$ )
Steam/water	2500
Water/water	2000
Water/liquid food	1500
Water or steam/viscous food	1000
Water or steam/vegetable oil	800
Water or steam/air (gas)	100
Air (gas)/air (gas)	30



## 6.4.2 Fouling of Heat Exchangers

Most of the food liquids tend to foul the surfaces of heat exchangers, used in the food industry, reducing significantly the heat transfer rate and damaging the food quality. Fouling is caused by precipitation of partially soluble salts (scaling), physicochemical reactions of food components (proteins, carbohydrates), precipitation of suspended particles, crystallization (freezing) processes, biological growth, and corrosion reactions (Hallstrom et al. 1988; Fryer 1997; Botts 1995).

Fouling forms an insulating solid layer on heat transfer surfaces, like food heaters and evaporators; it decreases the flow rates, increasing the pressure drop; and it provides a substrate for potential microbial growth. Most of the experimental work on fouling has been done on milk, which contains heat-sensitive components that are deposited on heated surfaces, e.g., milk proteins (lactoglobulin) and calcium/phosphate salts (milkstone).

Fouling is a two-step process, i.e., induction and fouling (Fryer 1997). Heat transfer equipment should be designed to reduce adhesion, control high temperature, and minimize residence time. Adhesion of particles to the heat transfer surface is prevented by proper hydrodynamic design (smooth surface) and high shear rates (high velocities or agitation speeds). High wall temperatures should be avoided, because they increase supersaturation of the salts; they also increase protein precipitation.

The major process variables affecting fouling are velocity and temperature. Additional fouling factors include concentration and characteristics of the foulant and equipment design, materials, and surface properties (Bott 2001).

The fouling resistance (FR) of (6.24a) and (6.24b) is difficult to determine accurately, and only approximate values have appeared in the literature. Table 6.8 shows some approximate values of (FR) for industrial fluids (Perry and Green 1997). As mentioned earlier, experimental data on the overall heat transfer coefficient ( $U$ ) are preferable, if available.

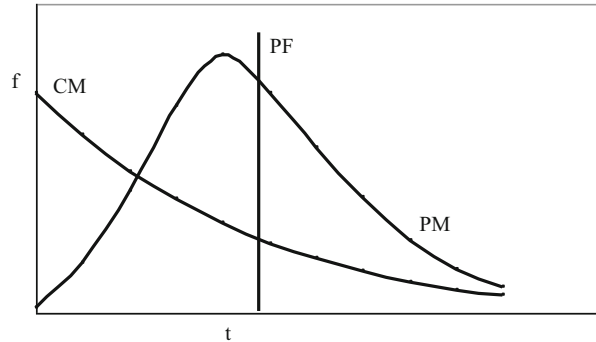
The fouling rate of a heat exchanger may be determined by estimating the overall heat transfer coefficient ( $U$ ) and the pressure drop ( $\Delta p$ ) as a function of time. The operation of the equipment must be interrupted and the heat exchange surface cleaned, when fouling exceeds an acceptable level. Empirical cleaning techniques have been developed for the various types of equipment. The operating and cleaning times must be optimized to reduce the operating cost. Recent advances in simulation, computational fluid dynamics (CFD), and surface science and engineering may reveal the mechanism of fouling and improve the cleaning operations.

The scheduling of heat exchanger operation and cleaning to mitigate (reduce) fouling can be optimized (O'Donnell 2001). Modeling and simulation of fouling of plate heat exchangers (PHE), related mostly to milk processing, can be used to optimize the operating and cleaning cost (Georgiadis et al. 1998a, b).

**Table 6.8** Approximate fouling resistances (FR) of industrial fluids

Fluid	FR (m <sup>2</sup> K/W)
Clean steam	0.00005
Distilled water	0.0001
Seawater	0.0002
Vegetable oils	0.0005
Polymer solutions	0.0010
Inorganic gases	0.0015

**Fig. 6.1** Residence time distribution in continuous flow equipment: *f* frequency of distribution, *t* time, *PF* plug flow, *CM* complete mixing, *PM* partial mixing



### 6.4.3 Residence Time Distribution

The residence time distribution in heat exchangers (heaters, coolers, evaporators, dryers, etc.) is important for the quality of the food product. The product should remain in the heat transfer equipment only for the minimum time required to accomplish the desired effect, e.g., sterilization, concentration, etc. Any additional residence time is undesirable, because the product may suffer heat damage to the quality and the nutritive value.

Three types of distribution are possible in continuous flow heat exchangers: (a) plug flow, where the product flows through and exits the equipment without mixing; (b) complete mixing, where the product is mixed thoroughly in the equipment and in exits gradually; and (c) intermediate mixing, where the product is partially mixed and it exits gradually from the equipment (Fig. 6.1).

The mean residence time ( $t_m$ , s) in a continuous flow equipment is related to the holdup volume ( $V$ , m<sup>3</sup>), the product flow rate ( $m$ , kg/s), and the density of the product ( $\rho$ , kg/m<sup>3</sup>) by the equation:

$$t_m = V\rho/m \tag{6.25}$$

It is obvious that, for a given product flow rate, short residence time is obtained with small holdup volume. Small holdup volumes are also desirable for the effective cleaning of the equipment.

### 6.4.4 Tubular Heat Exchangers

The simplest heat exchanger is the double-pipe type, which consists of two concentric pipes with the cold stream flowing in the inner tube and the heating medium in the annulus. Two basic operations are possible, cocurrent and countercurrent flow (Fig. 6.2).

The temperature differences, which characterize the operation of the heat exchangers (6.5), are defined at the two ends of the HE as follows (Fig. 6.2):

$$\text{Cocurrent HE : } \Delta T_1 = (T_{h1} - T_{c1}) \quad \text{and} \quad \Delta T_2 = (T_{h2} - T_{c2})$$

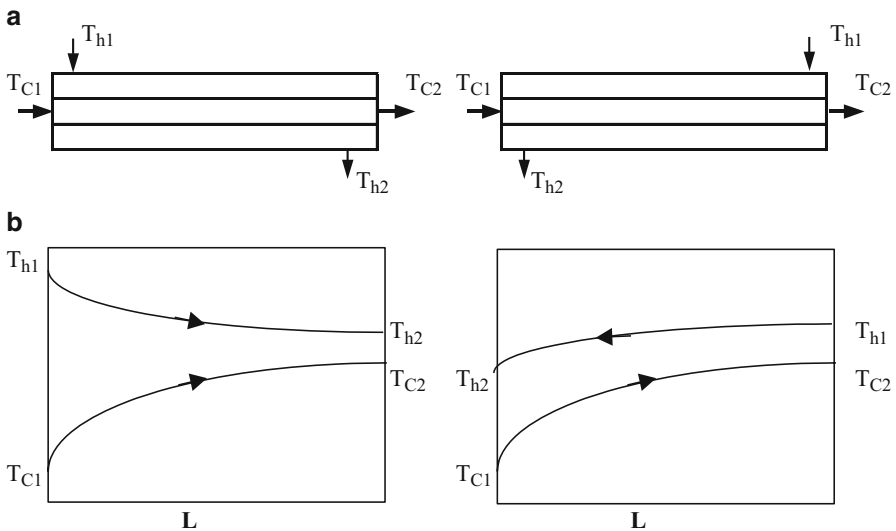
$$\text{Countercurrent HE : } \Delta T_1 = (T_{h2} - T_{c1}) \quad \text{and} \quad \Delta T_2 = (T_{h1} - T_{c2})$$

When the two temperature differences ( $\Delta T_1$  and  $\Delta T_2$ ) are not the same or not very close to each other, the overall temperature difference ( $\Delta T$ ) of (6.5) is taken as the log mean temperature difference ( $\Delta T_L$ ) is used, defined as follows:

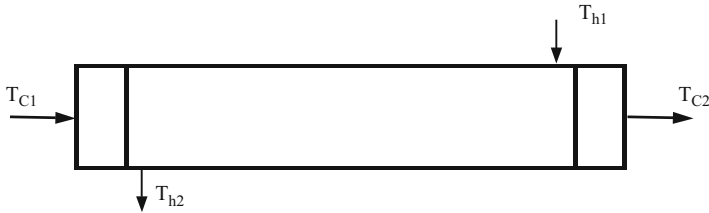
$$\Delta T_L = (\Delta T_1 - \Delta T_2) / \ln(\Delta T_1 / \Delta T_2) \quad (6.26)$$

When the two temperature differences ( $\Delta T_1$ ,  $\Delta T_2$ ) are equal or close to each other, the arithmetic temperature difference  $\Delta T_M = (\Delta T_1 + \Delta T_2) / 2$  should be used, instead of the ( $\Delta T_L$ ).

Tubular heat exchangers are suitable for heating pulp-containing fruit juices, which cannot be handled easily by the popular PHE. A preassembled double-pipe



**Fig. 6.2** Double-pipe heat exchangers. (a) Cocurrent and (b) countercurrent.  $T$  temperature,  $c$  cold stream,  $h$  hot stream,  $1$  entrance,  $2$  exit,  $L$  length



**Fig. 6.3** Schematic diagram of a countercurrent shell and tube heat exchanger. *h* heating medium, *c* cold stream, 1 entrance, 2 exit

unit, with diameters 1.5 and 2.5 in. (38 and 65 mm), pasteurizing about 7.5 t/h of pulpy orange juice, was described by Youngworth and Swientek (1987).

The double-pipe heat exchangers have the disadvantage of limited heat transfer surface, which led to the shell and tube heat exchangers, used widely in the chemical process industry. Figure 6.3 shows a diagram of a countercurrent shell and tube heat exchanger, which consists of a bundle of parallel tubes enclosed in a shell. In heating applications, the cold stream flows through the tubes with the heating medium (e.g., saturated steam) in the shell. The heat exchanger can be operated in cocurrent, countercurrent, or cross flow. Temperature differences are calculated following the notation of the double-pipe heat exchangers (Fig. 6.2).

Large heat transfer surfaces can be created by assembling many tubes of small diameter in a shell. The tubes are fixed on two tube sheets, creating two heads at the ends of the heat exchanger. Two or more tube passes may be used to increase the residence time of the tube fluid in the heat exchanger.

The shell and tube heat exchangers are less expensive than the other types of food heat exchangers, especially when high heat loads are transferred. They can be operated at higher temperatures and pressures than the PHE. However, they cannot be cleaned and sanitized easily, like the PHE.

The design and applications of the shell and tube heat exchangers are found in the Chemical Engineering literature, as in Perry and Green (1997), Walas (1988), and Bhatia and Cheremisinoff (1980). Detailed specifications on the dimensions of tubes and shells and on the construction of heat exchangers can be found in technical publications of suppliers of heat exchange equipment, such as the Tubular Exchangers Manufacturers Association (TEMA 1978).

Shell and tube heat exchangers are the basic heat transfer units in evaporation (Chap. 7) and refrigeration (Chap. 9).

The design of tubular and other heat exchangers considers not only the heat transfer rate but also the pressure drop in the system. The heat transfer coefficients tend to increase as the tube diameter is reduced, while the opposite effect is observed with the pressure drop. The heat transfer coefficient ( $h$ ), according to the empirical correlations, is proportional to the fluid velocity  $u^{0.33}$  in the laminar flow or to  $u^{0.8}$  in the turbulent flow. The pressure drop ( $\Delta p$ ) is proportional to the velocity ( $u$ ) in the laminar flow or to about the velocity ( $u$ )<sup>2</sup> in the turbulent flow. The optimum operation of a heat exchanger should combine the highest heat

transfer coefficient with a minimum pressure drop. The pressure drop is translated into power requirement (kW) for pumping the fluid through the heat exchanger.

The active length ( $L$ ) of a heat exchanger can be estimated from the following generalized equation, used for chemical engineering equipment, such as distillation and absorption columns:

$$L = (\text{LTU})(\text{NTU}) \quad (6.27)$$

where length of a transfer unit ( $\text{LTU} = (mC_p)/(\pi dU)$ ), and number of transfer units ( $\text{NTU} = (UA)/(mC_p)$ ). The pressure drop in a heat exchanger can be expressed on the basis of the number of transfer units, i.e.,  $\Delta p/(\text{NTU})$  in units of bar/(NTU).

Spiral-tube heat exchangers, with the product inside the tube and the heating medium (e.g., condensing steam) in the outside jacket, are used for the fast heating of liquids. High heat transfer coefficients can be achieved, since turbulence is obtained at lower ( $Re$ ) numbers. Spiral tubes are suitable for fast heating of liquids in UHT aseptic sterilizers (Chap. 10).

The helical (coiled) heat exchangers have provided some benefits such as compactness, high heat transfer rate, and improved mixing within the tube. Experimental heat transfer coefficients in the range of 3–9 kW/m<sup>2</sup> K were obtained at temperatures 90–150 °C, using water and pseudoplastic solutions (Coronel et al. 2000).

In a variation of coil heat exchanger, grain products are forwarded upward by vibration. The equipment may be used in a wide range of heating applications, from simple heating up to drying. It requires limited ground space and its capacity is about 1.5 t/h, which, depending on the product and process, lasts 5–25 min. The operational temperature may come up to 250 °C (Fig. 6.4).

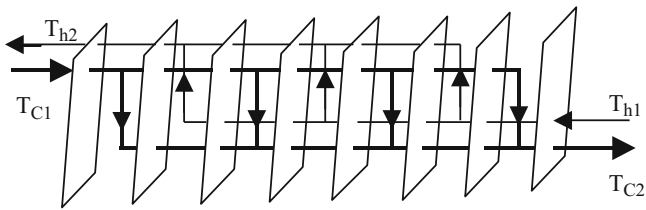
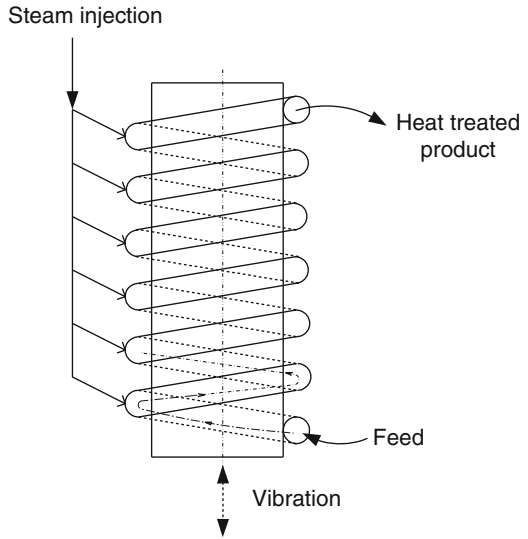
Concentric tube heat exchangers consist of double, triple, or more concentric tubes with associated entry and exit ports for the product and the heating/cooling medium (Lewis and Heppell 2000). Corrugated, instead of straight, tubes may be used to increase turbulence and heat transfer rate. In three or more concentric tubes, the heating/cooling medium and the product flow in alternate annuli and give the largest heat transfer area. They may be used in the final heating stage of UHT sterilizers.

### 6.4.5 Plate Heat Exchangers

The PHE are used widely in the food industry because of their high thermal efficiency, the compactness, and the hygienic and cleaning design. Higher heat transfer coefficients ( $h$ ) are obtained, due to the geometry of PHE, which promotes turbulent flow at low Reynolds numbers (Alfa-Laval 1969, 1971).

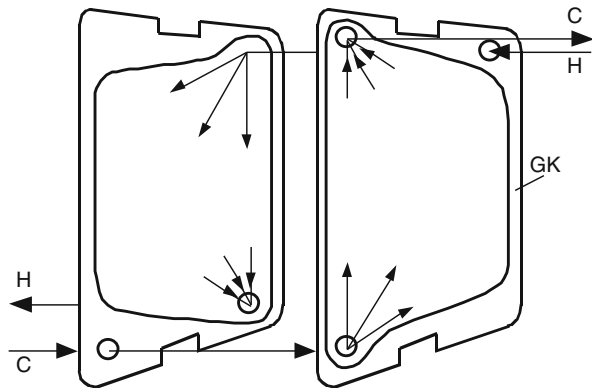
They consist of closely spaced thin plates, clamped together in a frame. A thin gasket seals the plates round their edges. The liquid product and the heating/cooling medium flow alternately in cocurrent or countercurrent fashion (Figs. 6.5 and 6.6).

**Fig. 6.4** Vibrating coil heat exchanger



**Fig. 6.5** Schematic diagram of a plate heat exchanger assembly

**Fig. 6.6** Diagram of flow through two adjacent plates in a plate heat exchanger. *C*, *H* cold, hot streams, *GK* gasket



The plates are corrugated (patterns of ridges) for increasing the rigidity of the plate and improving heat transfer by promoting turbulence.

Gaskets used for PHE include the elastomers nitrile butadiene (NBR) and isobutylene isoprene (IIR) for temperatures up to 135 °C and fluorocarbon polymers for higher temperatures (Carlson 1992).

Dimensions and capacities of PHE (Muller-Steinhagen 1997): standard plates of effective heat transfer areas 0.02–4.75 m<sup>2</sup>, plate thickness 0.6–0.9 mm, channel spacing (gaps) 2–6 mm, flow rates 0.5–5000 m<sup>3</sup>/h, connection diameters 25–400 mm, up to 1000 plates per pack, operating temperature –35 to 200 °C, and pressure up to 25 bar.

The heat transfer coefficient ( $h$ ) in PHE is correlated as Nusselt ( $Nu$ ) number to the Reynolds ( $Re$ ) and Prandtl ( $Pr$ ) numbers by empirical equations of the form (Fryer 1997):

$$Nu = aRe^mPr^{1/3} \quad (6.28)$$

Typical values for the parameters of this correlation for  $Re > 5$  are  $a = 0.352$  and  $m = 0.539$ .

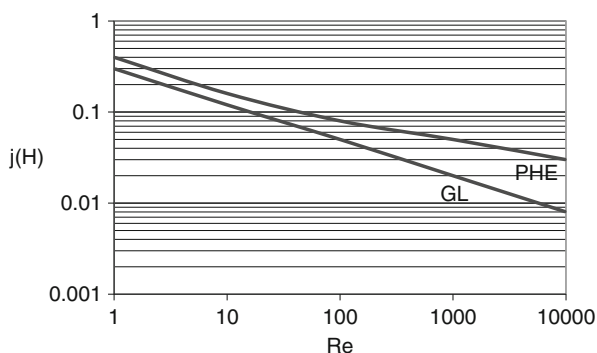
The ( $Re$ ) number is based on the equivalent diameter of the flow channel, which is four times the hydraulic radius, defined as the ratio of the cross-sectional area over the wetted perimeter.

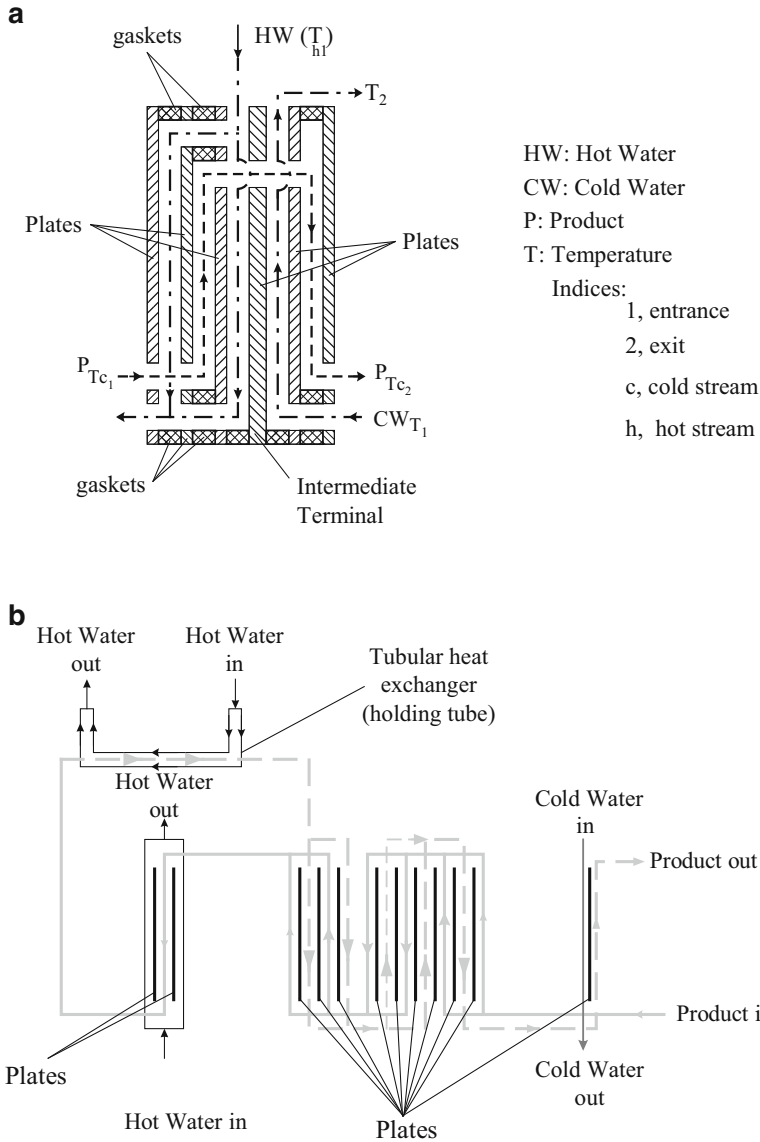
In general, the heat transfer coefficients in PHE are higher than those predicted by the classical correlations (Table 6.6). This is also shown by a comparison of the correlation of the heat transfer factor ( $j_H$ ) for PHE (Alfa-Laval 1971) to the generalized correlation of heat transfer in food systems (6.20), as shown in Fig. 6.7. The ( $j_H$ ) for the PHE is significantly higher than the generalized correlations of the heat transfer factor ( $j_H$ ) at  $Re > 10$ , reflecting the occurrence of turbulence at low  $Re$  numbers, due to the unique flow geometry of the plate system.

Figure 6.8 indicates a combination of PHE. The basic aim is to achieve as far as possible countercurrent heat flow and stimulation of quick heating, holding this heat for a certain short time, and successive cooling up of the liquid product.

The design (sizing) of a plate heat exchanger to handle a heat load of ( $q$ , W) is based on the calculation of the total heat transfer surface area ( $A_t$ ) from the basic

**Fig. 6.7** Correlations of heat transfer factor ( $j_H$ ) versus  $Re$  number. PHE plate heat exchangers, GL generalized correlation





**Fig. 6.8** Plate heat exchanger (PHE). (a) Liquid flows in a PHE; (b) flow diagram for typical heating/cooling application of liquid food with hot/cold water

equation (6.23). Typical overall heat transfer coefficients in PHE are  $3000 \text{ W/m}^2 \text{ K}$  (aqueous liquid foods of apparent viscosities up to  $1 \text{ Pa s}$ ) and  $800 \text{ W/m}^2 \text{ K}$  (vegetable oils). In PHE, the log mean temperature difference is approximately equal to the arithmetic mean temperature difference between the heating medium and the product.



The pressure drop ( $\Delta p$ ) in the PHE is given by an equation analogous to the known Fanning equation for pressure drop in straight tubes (Sinnot 1996):

$$\Delta p = 8j_p(L_p/d_e)(\rho u^2/2) \quad (6.29)$$

where ( $L_p$ ) is the total flow path (length) of the PHE and ( $j_p$ ) is the pressure drop factor, calculated from the empirical equation,

$$j_p = 1.25Re^{-0.3} \quad (6.30)$$

The total number of the required plates ( $N_t$ ) is calculated from the equation (Alfa-Laval 1971):

$$N_t = A_t/A_o = 2N_pN_s \quad (6.31)$$

where  $A_o$  is the surface area of one plate and ( $N_p, N_s$ ) are the numbers of plates in parallel and in series.

The design pressure of PHE decreases from about 25 to 5 bar, as the operating temperature is increased from about 0 to 200 °C (limitation due to rubber gasket materials). A typical industrial PHE may have plates of heat transfer surface 0.4 m<sup>2</sup>/plate and total surface up to 100 m<sup>2</sup> (250 plates).

### 6.4.6 Agitated Kettles

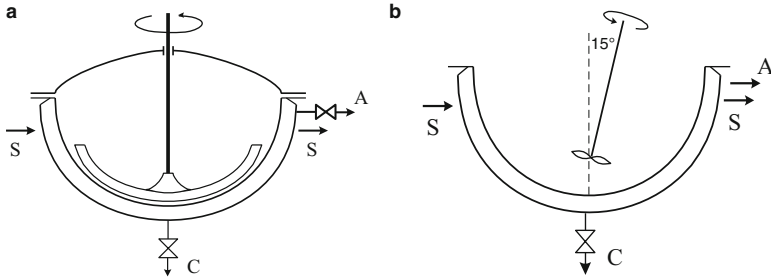
Agitated kettles and agitated vessels are used for heating (or cooling) viscous and highly non-Newtonian fluid foods, which cannot be handled in normal (plate) heat exchangers. Several types of agitators are used, such as propeller, paddle, blade, helical ribbon, and anchor (see Fig. 4.42). Figure 6.9 shows the diagram of two jacketed kettles with scraping anchor and propeller agitators, used for heating viscous and pulpy foods.

When propeller agitators are used, the propeller axis is inclined (about 15°) against the vertical central axis of the kettle, for reducing circulatory flow and swirling (Perry and Green 1997).

The heat transfer coefficient ( $h$ ) in the product side is calculated by the empirical correlation:

$$Nu = aRe^{0.67}Pr^{1/3}(\eta/\eta_w)^{0.14} \quad (6.32)$$

where the parameter ( $a$ ) depends on the type of agitator and the nature of the fluid. In agitated vessels, the ( $Re$ ) number is defined as  $Re = (d_i^2 N \rho)/\eta$ , where ( $d_i$ ) is the



**Fig. 6.9** Agitated kettles. (a) Anchor; (b) propeller agitator; *S* steam, *C* condensate, *A* air

**Table 6.9** Parameters (*a*) of empirical equation (6.32) for agitated vessels

Agitator type/fluid product	<i>a</i>
Paddle, <i>Re</i> < 4000	0.415
Paddle, <i>Re</i> > 4000	0.36
Blade—flat, <i>Re</i> < 400	0.54
Blade—flat, <i>Re</i> > 400	0.74
<sup>a</sup> Helical ribbon, <i>Re</i> > 130	0.238
Scraping anchor/Newtonian	0.55
Scraping anchor/pseudoplastic	1.474

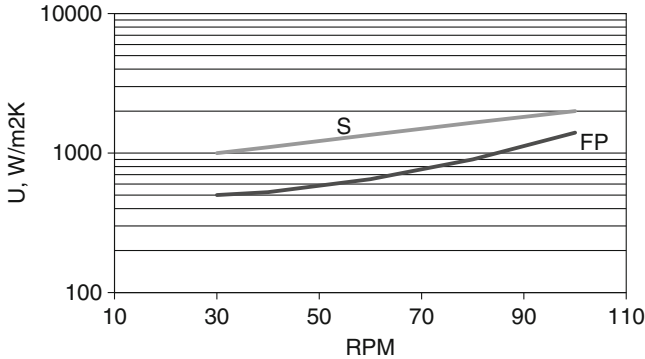
<sup>a</sup>The second part of (6.32) should be multiplied by  $(i/d)^{-0.25}$  where (*i*) is the pitch and (*d*) is the diameter of the agitator

diameter of the impeller and (*N*) is the speed of rotation,  $N = (\text{RPM})/60, \text{ s}^{-1}$ . The Nusselt number is defined as  $Nu = (hd_T)/\lambda$ , where ( $d_T$ ) is the tank (vessel) diameter.

Table 6.9 shows some (*a*) values for various types of agitators (Saravacos and Moyer 1967; Hallstrom et al. 1988; Singh 1992). The parameter (*a*) depends on the type of flow (*Re*), the geometry and location of the agitator (e.g., flat blade, curved blade, or retreating blade), and the presence of baffles in the vessel. Baffles have no significant effect on heat transfer in viscous pseudoplastic fluids.

Experimental data, obtained in heating food liquids and fruit purees in a 10 gal (40 L) agitated kettle, showed that the estimated heat transfer coefficient (*h*) correlated well with the empirical (6.32). Figure 6.10 shows the increase of the overall heat transfer coefficient (*U*) with increasing speed of agitation (Saravacos and Moyer 1967). It is evident that the (*U*) values of pseudoplastic fluids (e.g., fruit purees) increase at a faster rate with agitation than the (*U*) of Newtonian fluids (sucrose solution), due to the lower apparent viscosity at higher shear rates (shear-thinning effect).

A water-jacketed kettle may be used, when steam is not available as a heating medium in the food plant. The water-filled jacket is heated directly by combustion of a fuel (e.g., natural gas), producing steam and preventing any burn-on problem on the inside (product) surface of the kettle (Kennedy et al. 1987).



**Fig. 6.10** Overall heat transfer coefficients ( $U$ ) in an agitated kettle.  $S$  40 % sucrose solution,  $FP$  fruit puree. Data from Saravacos and Moyer (1967) and Singh (1992)

The batch (unsteady-state) heating in a jacketed and agitated vessel is expressed by the following integrated form of the heat transferred and heat absorbed by the product (Singh 1992):

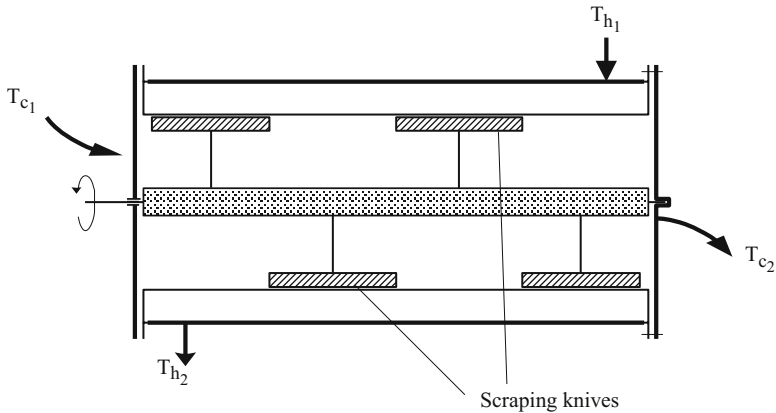
$$\ln[(T - T_1)/(T - T_2)] = [(UA)/(\rho VC_p)]t \quad (6.33)$$

where ( $T$ ) is the temperature of the heating medium (constant, e.g., steam), ( $T_1, T_2$ ) are the initial and final product temperatures, ( $U$ ) is the overall heat transfer coefficient, ( $A$ ) is the heated surface area, ( $\rho$ ) is the density, ( $V$ ) is the volume of the product, and ( $t$ ) is the time of heating (consistent SI units).

Agitated kettles are heated normally by saturated steam or hot water in the jacket, which give high heat transfer coefficients. In small food processing plants, where steam may not be available, heating by direct gas burning may create burn-on problems of the viscous products. In this case, the kettle can be heated with hot water or steam in the jacket, produced by gas burning (Kennedy et al. 1987). Better mixing and heating of viscous/particulate food products can be achieved with inclined (15–30°) agitators.

#### 6.4.7 Scraped Surface Heat Exchangers

The scraped surface heat exchangers (SSHEs) are used for heating or cooling highly viscous, fouling, and crystallizing liquid foods, such as margarine and ice cream. They are double-pipe heat exchangers with agitated scrapers in the inner (product) pipe and the heating or cooling medium in the outer pipe (Fig. 6.11). The scrapers often consist of several knives, positioned in such way that, besides scraping, a screw pumping effect is achieved. The SSHEs can be operated either horizontally or in vertical position.



**Fig. 6.11** Diagram of a scraped surface heat exchanger

The product is pumped through the SSHEs with a positive displacement pump, and high-pressure drops ( $\Delta p$ ) up to 10 bar may develop during operation. Pipe diameters commonly used are 15 cm (inside) and 20 cm (outside). The speed of agitated scraper is in the range of 500–700 RPM. The SSHEs are often used in series in double stacks (Perry and Green 1997). Due to the mechanical construction and the moving parts, SSHEs are more expensive than any other heat exchanger used in food processing. They can be justified only for heating/cooling fluid foods that cannot be handled in normal tube or PHE.

Heat transfer in SSHEs is accomplished by heating (or cooling) the product layer adjacent to the heat transfer wall and scraping and mixing it with the bulk of the fluid food. Back-mixing of the fluid in the agitated pipe may reduce the heat transfer rate. There are no reliable empirical correlations to predict the (film) heat transfer coefficient in SSHEs. The complex hydrodynamics of fluid food flow in SSHEs is discussed by Hallstrom et al. (1988). The flow patterns, mixing effects, residence time distribution, heat transfer, and power requirements of SSHEs are discussed by Harrod (1987).

The thermal design of SSHEs is based on empirical (experimental) overall heat transfer coefficients ( $U$ ), with typical values in the range of 500–1000 W/m<sup>2</sup> K. Due to the relatively thicker walls of the heat transfer pipe, temperature differences ( $\Delta T$ ) between the heating medium and the product of about 25 °C are used, which are much higher than the low ( $\Delta T$ ) used in PHE (about 5 °C).

SSHEs are relatively expensive equipment, and they can be justified only for very viscous fluids (viscosities higher than 10 Pa s) and particulate suspensions. Less expensive tubular heat exchangers should be used, whenever the food product can be pumped through a piping system, e.g., pseudoplastic tomato paste (Demetrakakes 1999).

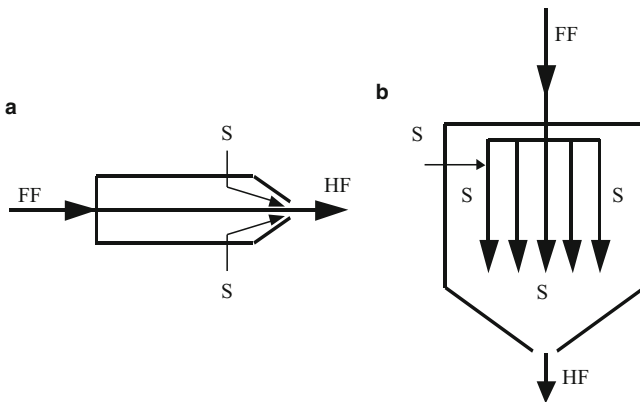
### 6.4.8 Direct Heat Exchangers

Direct heat exchangers are based on mixing of heating steam with the liquid food product, resulting in very fast heat transfer rate. The steam used for direct heating, e.g., of milk, must be clean, tasteless, and free of any dissolved gases and toxic components, coming from the steam boiler. The feed water to the boiler should be of culinary (potable) quality and contain no chemical additives. Mixing of steam with the liquid food can be accomplished by two methods (Hallstrom et al. 1988): (a) steam injection, by injecting steam into the fluid food through small holes, and (b) steam infusion, by mixing the steam with films and droplets of the liquid food, sprayed in a special vessel (Fig. 6.12).

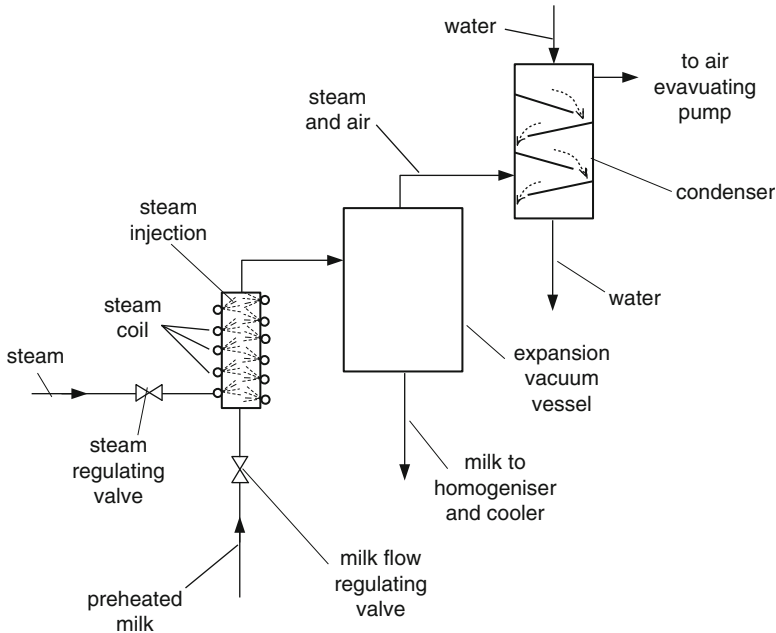
Figure 6.13 indicates an uperization milk equipment. The milk plus the injected water come in the expansion vacuum vessel, where the added water of the steam injection is removed through condensation in the following condenser. It is essential to control the whole flow process, so that the milk that finally leaves the expansion vacuum vessel has almost its initial water content.

Direct heating of foods minimizes fouling, by eliminating the heat transfer surface. The condensed water from the heating steam is usually removed by vacuum flashing, which reduces also the temperature and removes off-flavors and odors from the liquid product, as in UHT sterilization (Chap. 10).

Besides UHT sterilization, the direct steam infusion may be also applied in a wide range of application in the food industry. It may be used in plant sanitation (e.g., CIP), in-line cooking operations, precise pasteurization, defrosting of refrigeration heat exchangers, and confectionary and starch cooking, when in high-density products (up to 80 % solid content), and temperatures 140–170 °C are required, resulting a consistently clear final product. Some further advantages of direct steam injection equipment are their quick and accurate temperature control



**Fig. 6.12** Diagram of direct heating of liquid food: (a) steam injection; (b) steam infusion. *FF* fluid food, *HF* heated food, *S* steam



**Fig. 6.13** Uperization of milk equipment

(within less than 1 °C), the restricted pressure drop under normal flow rates (<0.14 bar), and their relatively low noise during operation (<80 dB).

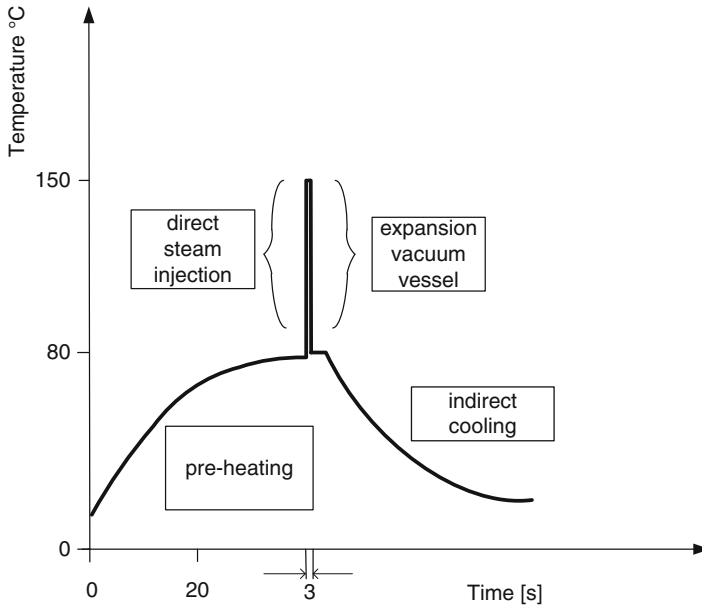
Figure 6.14 presents the time–temperature diagram of an uperization process. As indicated also in Chap. 10, the direct contact of steam with milk heats it up to about 150 °C. However, this contact lasts only up to 3 s (Fig. 6.14).

### 6.4.9 Baking and Roasting Ovens

Baking is used to prepare bread, biscuits, meats, vegetables, etc., for eating, by various heating processes. The term “roasting” has the same meaning, but it usually refers to the thermal treatment of meat, nuts, or coffee. Although ovens are synonymous to baking ovens (Fellows 1990), their use in connection to coffee, cocoa, and nuts is mainly related to the development of color and aroma.

The roasting equipment normally consists of a metallic perforated drum, partially filled with the product. The drum rotates while heated by hot air or flames. A roasting oven of overall dimensions  $1.5 \times 1.2$  m has a capacity of 3 t/h cocoa beans or hazelnuts, requiring about 30 kW electrical power. The roasting temperature can be controlled better by using pressurized hot water of 180 °C.

The ovens consist of either a compartment of several shelves or a tunnel through which the product is baked on a conveyor belt (Hallstrom et al. 1988). The heating



**Fig. 6.14** Uperization diagram of milk

medium of the ovens is usually hot air, sometimes mixed with steam, moved by either natural convection or forced circulation. Radiation heating from the oven walls to the product may be also involved.

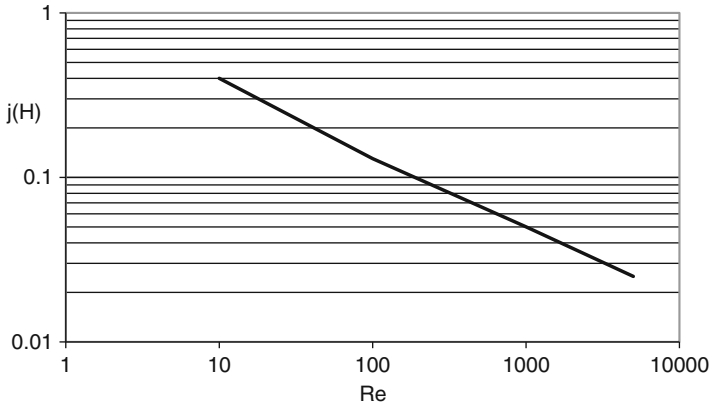
Ovens operate normally at atmospheric pressure, and the maximum temperature of the wet (high-moisture) product is 100 °C. The wet product is heated by the hot air or hot combustion gases until the surface layer is dried, forming a crust at 100 °C, while its interior remains at a lower temperature. Air temperatures of 150–250 °C are used in baking bread and meat. Heat and mass transfer in industrial cooking was analyzed by Hallstrom (1980).

The heat and mass transfer mechanisms of baking and roasting are similar to the mechanisms of air-drying (Chap. 8). The heat transfer coefficients of baking depend on the air velocity and temperature in the oven, varying in the range of 20–120 W/m<sup>2</sup> K (Hallstrom et al. 1988).

The heat transfer coefficient in convection ovens can be estimated from the following empirical correlation of the heat transfer factor (Saravacos and Maroulis 2001), which is based on published experimental data:

$$j_H = 0.801Re^{-0.39} \quad (6.34)$$

where the (dimensionless) heat transfer factor is defined as  $j_H = h/(\rho u C_p)$  and ( $h$ ) is the heat transfer coefficient (W/m<sup>2</sup> K), ( $\rho$ ) is the density (kg/m<sup>3</sup>), ( $u$ ) is the velocity, and ( $C_p$ ) is the specific heat (J/kg K) of the air (gases).



**Fig. 6.15** Heat transfer factor ( $j_H$ ) in a baking oven.  $Re$  Reynolds number

Figure 6.15 is a graphical representation of the empirical (6.34).

Heat transfer to the baking ovens can be (a) direct heating by combustion gases from a clean gas fuel, such as natural gas or LPG, or from an MW power source, or (b) indirect heating from heated oven walls, from steam tubes, or from electrical resistances (Fellows 1990). Direct heating is preferred, because it is faster and more efficient.

Two types of baking ovens are used in food processing and in catering, i.e., natural convection and forced circulation:

(a) Natural convection

Small compartment ovens are similar to home kitchens. In tunnel ovens, the product is baked while moving slowly on a conveyor belt, going through decreasing temperature regions. Steam may be injected in the first (entrance) region of the oven.

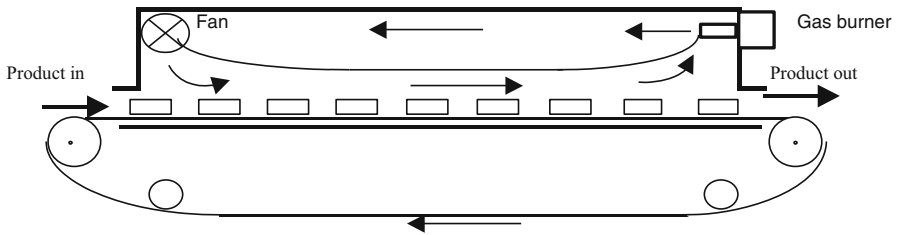
(b) Forced circulation

Small forced circulation ovens are used for baking bread and other products, placed on racks/trolleys or fixed/rotating shelves. Hot air (gas or oil burning) at 50–250 °C is circulated by a fan at velocities 1–10 m/s. In some applications electrical heating may be used, or live steam may be injected in the oven to accelerate the heat transfer process. The baking area of small ovens may be up to 12 m<sup>2</sup>, and the baking capacity 1000–1500 small (50 g) breads in each charge.

In large installations, tunnel ovens are used, similar to the natural convection ovens, but with baking areas (higher than 120 m<sup>2</sup>; they are equipped with fans at different locations, which recirculate the hot air, heated indirectly in heat exchangers (metallic surfaces) with hot combustion gases (Fig. 6.16). Commercial ovens are normally insulated to reduce heat losses.

Depending on the baked product, forced circulation ovens start with a preheating cycle of about 1 h, before loading with the product; baking (air) temperatures of





**Fig. 6.16** Diagram of a continuous forced circulation baking oven

150–220 °C are used, and the motion of belts or chains is continued after heating is stopped, to avoid mechanical damage due to thermal expansion during cooling. Mechanical and hydraulic systems are used to maintain the right tension of the long belt during operation (see Sect. 3.2.3).

Computer modeling and simulations can be utilized to optimize and control the operation of commercial ovens (Zanoni et al. 1997).

Conveyorized proofing and baking systems, retailer and wholesaler ovens, and other baking equipment are described by Matz (1987).

A traveling band baking oven that utilizes various heating systems is described by Mermelstein (1999). The oven is 0.40 m wide and 15 m long, and it can be heated by gas burning (radiating), air convection, high velocity-impingement jets, and microwaves.

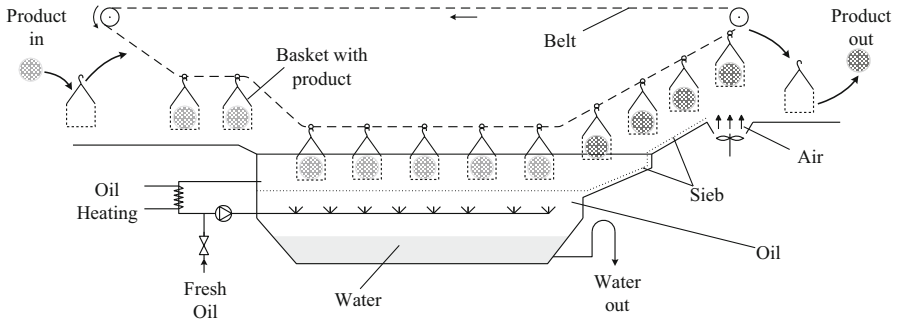
High heat transfer rates in ovens can be achieved by steam injection and steam condensation on the products. Combination of steam injection and air impingement improves heat transfer and increases product yield.

In the baking of biscuits, continuous ovens, with long metallic conveyor belts, are used. Such belts can be 40–45 m long, and they may be divided into three or more compartments, in which the temperature may rise progressively to 210–270 °C, with total residence time of 4–6 min. Multi-deck traveling belts are used for reducing the length of continuous ovens, used in baking products, such as French toast, Swedish rolls, and several cakes.

### 6.4.10 Fryers

Frying is used primarily to improve the eating quality of foods. At the same time, due to the high-temperature treatment, most of the spoilage microorganisms are inactivated, and a surface crust is formed, improving the preservation and the quality of the food product (Fellows 1990). Crust formation removes the free water from the food material, creating empty capillaries, which are filled with oil. The technology of frying of food products is described by Rossell (2001).

Frying can be accomplished either by shallow frying on a hot surface (pan) or by deep-fat frying in hot fat or vegetable oil. Film heat transfer coefficients in shallow



**Fig. 6.17** Continuous basket fryer

(contact) frying are higher ( $250\text{--}400\text{ W/m}^2\text{ K}$ ) than in deep-fat (convection) frying ( $200\text{--}300\text{ W/m}^2\text{ K}$ ). Oil temperatures  $160\text{--}180\text{ }^\circ\text{C}$  are used in the fryers.

Batch fryers are used in small applications, while continuous units are applied in large installations. The oil is heated by electrical resistances, gas, fuel oil, or steam. Screw or belt conveyors are used to transfer the product through the hot oil in an inclined draining section. Figure 6.17 shows a continuous fryer, using baskets for transferring the food product through the heated oil. Fryers and associated baking equipment are described by Matz (1987).

Depending on the product, a 5–6-m-long continuous fryer has a capacity of 1.5–2.0 t/h. The residence time in a continuous fryer may vary in the range of 3–30 min.

### 6.4.11 Radiation Heaters

Most of the heat transfer operations in food processing involve heat conduction and/or heat convection, while heat radiation is involved in limited cases. Radiation heating refers mostly to heating by infrared radiation (wavelengths of  $1\text{--}1000\text{ }\mu\text{m}$ ).

Thermal radiation from a body is a strong function of its absolute temperature,  $f(T^4)$ . The emissivity ( $e$ ) of a body is defined as  $e = W/W_B$ , where  $W$  and  $W_B$  are the radiated energies of the specific body and the black body ( $e = 1$ ), respectively. Polished metals have low emissivities (e.g.,  $e = 0.05$ ), but for normal stainless steel  $e = 0.6$ . Water and several food materials have emissivities higher than 0.9. Typical food emissivities are dough 0.85, lean beef 0.74, and fat beef 0.78 (Fellows 1990).

The heat exchange ( $q_{1,2}$ ,  $W$ ) between two “gray” (nonblack) surfaces (1) and (2), which are kept at temperatures ( $T_1$ , K) and ( $T_2$ , K), is given by the equation (Perry and Green 1997):

$$q_{1,2} = 5.675A_1\Phi_{1,2} \left[ (T_1/100)^4 - (T_2/100)^4 \right] \quad (6.35)$$

where ( $A_1$ ) is the radiating surface and ( $\Phi_{1,2}$ ) is the overall radiation exchange factor, defined by the equation:

$$1/\Phi_{1,2} = 1/F_{1,2} + (1/e_1 - 1) + (A_1/A_2)(1/e_2 - 1) \quad (6.36)$$

where ( $F_{1,2}$ ) is the “view factor,” i.e., how surface ( $A_1$ ) “sees” surface ( $A_2$ ), and ( $e_1$ ,  $e_2$ ) are the emissivities of the two surfaces. The view factors are given in Tables of the heat transfer literature (McAdams 1954; Perry and Green 1997).

Equation (6.35) can be written in the classical heat transfer form as

$$q_{1,2} = h_r A_1 \Delta T \quad (6.37)$$

where ( $h_r$ ) is a radiation “heat transfer coefficient” ( $\text{W}/\text{m}^2 \text{K}$ ) and ( $\Delta T = T_1 - T_2$ ) is the temperature difference between the two surfaces.

The radiation heat transfer coefficient can be calculated by combining (6.35) and (6.37).

When both heat convection and radiation are significant, the overall heat transfer rate can be calculated from the equation:

$$q_{1,2} = (h_c + h_r) A_1 \Delta T \quad (6.38)$$

where ( $h_c$ ) is the convection heat transfer coefficient.

#### 6.4.11.1 Infrared Heaters

The temperature of the infrared (IR) radiators determines the spectral distribution and the maximum emitted radiation flux. The penetration of IR radiation is limited. Short wavelength radiation ( $\lambda < 1.25 \mu\text{m}$ ) is preferred in food processing, because it has higher penetrating power (Hallstrom et al. 1988). Radiation heating should avoid the overheating and burning of the food surface.

The wavelengths of IR radiation used in food processing are given by Schormueller (1966). Two types of IR radiators are used in food processing: (a) gas heated, which give large wavelengths, and (b) electrically heated, which include the tubular and ceramic heaters (long  $\lambda$ ) and the quartz and halogen heaters (short  $\lambda$ ). Some high-intensity radiators require water or air cooling to avoid overheating.

Water vapor and carbon dioxide absorb part of the IR radiation, reducing the efficiency of IR heating of foods, e.g., during the end of the baking process, when the product may be sprayed with water.

IR radiation is used for the drying of vegetables, in baking/roasting, and in frying of foods. The main advantages are fast heating, high efficiency, and easy process control.

### 6.4.12 Heat Generation Processes

The need for faster heating of heat-sensitive food products has led to the development of the heat generation processes, which are based on the conversion of electrical energy into heat within the food material. Electrical heating can be achieved either as a result of friction during molecular rotation of water and other molecules (microwave or dielectric heating) or by the electrical resistance of the material to the passage of electric current (ohmic heating).

#### 6.4.12.1 Microwave and Dielectric Heating

The most common radiations used in electrical heating of foods are the microwaves (MW) at frequencies 915 or 2450 MHz, and dielectric or radio-frequency (RF) at frequencies 3–30 MHz ( $1 \text{ Hz} = \text{s}^{-1}$ ). The wavelengths ( $\lambda$ ) in the air, corresponding to these frequencies, are 915 MHz (32.8 cm), 2450 MHz (12.3 cm), and 3–30 MHz (10–1 m).

The heat generation rate ( $Q$ , W) per unit volume of a material is given by the equation:

$$Q = 0.56 \times 10^{-10} E^2 \epsilon' \omega \tan \delta \quad (6.39)$$

where ( $E$ ) is the electric field strength (V), ( $\omega$ ) is the frequency ( $\text{s}^{-1}$ ), ( $\epsilon'$ ) is the dielectric constant, and ( $\tan \delta$ ) is the loss tangent of the material, defined as  $\tan \delta = \epsilon''/\epsilon'$ , where ( $\epsilon''$ ) is the dielectric loss.

The dielectric constant ( $\epsilon'$ ) is a measure of the MW rate of penetration in the food. It indicates the ability of material (food) to store electrical energy. The dielectric loss ( $\epsilon''$ ) is a measure of how easily is this energy dissipated. In general, ( $\epsilon'/\epsilon''$ ) > 1.

The dielectric properties are difficult to predict and they are measured experimentally. They depend strongly on the composition of the food material, and they usually decrease with increasing temperature, with liquid water having the highest values. Typical values of dielectric constants and dielectric losses ( $\epsilon'$ ,  $\epsilon''$ ) are (Datta et al. 1995): water (80, 20), fruit (55, 15), meat (40, 10), vegetable oils (2.5, 1.5), and ice (3.2, 0.003).

The very low dielectric constants of ice are of importance in the microwave thawing of frozen foods, since the liquid water tends to be heated much faster than

the melting of ice, damaging the food quality. For this reason, microwave thawing should be controlled carefully (tempering of frozen foods).

In addition to the dielectric constants, the penetration depth of MW and RF radiation in the materials is of fundamental importance in heating applications. The penetration depth ( $d$ ), defined as the depth where the radiation intensity decays by 37 % ( $1/e$ ) of its surface value, is given by the equation:

$$d = l_0 \left( \epsilon' \right)^{0.5} / 2p\epsilon'' = l_0 / 2p \left( \epsilon' \right)^{0.5} \tan \delta \quad (6.40)$$

where ( $\lambda_0$ ) is the wavelength of the radiation in the air (Schiffmann 1987).

According to (6.40), the penetration of radiation in a material increases with the wavelength. Thus, MW radiation at 915 MHz penetrates more than the 2450 MHz radiation, i.e., 30 versus 10 mm.

Application of MW and RF to the heating of food products requires the knowledge of dielectric properties ( $\epsilon'$ ,  $\epsilon''$ ) and the thermal and transport properties ( $C_p$ ,  $\lambda$ ,  $\alpha$ ,  $D$ ) of the food materials.

The electrical properties of foods, related to MW and RF heating, were investigated in the COST bis cooperative project of the European Union (Jowitt et al. 1987). Applications of the electrical properties to food processing are discussed by Mudgett (1990, 1995), Kent (1987), Ohlsson (1987), and Datta et al. (1995).

Equipment used in MW-RF food processing is discussed by Decareau and Peterson (1986), Schiffmann (1987), Mudgett (1990), Reuter (1993), and Datta and Anantheswaran (2001). MW-RF equipment used in food dehydration is reviewed in Chap. 8. Magnetrons, waveguides, and applicators are used in various arrangements to produce and direct the radiation to the food product, which is usually moved on a conveyor belt. For pasteurization and cooking at temperatures below 100 °C, open conveying systems are used with a hood to keep the water vapors (or steam) and prevent surface drying out of the product. For high-temperature sterilization (110–130 °C), closed systems are used. When food in plastic trays or pouches is sterilized, overpressure (air or steam) is required to prevent bursting of the packages. The presence of steam during MW-RF treatment reduces also the corner and edge effects and the cold spots of the food products.

Food applications of MW-RF, in addition to drying (Chap. 8), include tempering of frozen foods, precooking of meat and other foods, and pasteurization and sterilization of foods.

Tempering of frozen foods is one of the most important MW-RF applications (Mermelstein 1999). The frozen product is heated to a temperature just below the freezing point and then allowed to fully thaw at low temperature, reducing sharply the normal thawing time. The process is applied to the packaged frozen food, without taking the packages apart, and it reduces significantly drip losses (more economical than conventional thawing). Thawing of frozen foods is discussed in Chap. 9.

MW-tempered frozen meat and fish (in bulk) can be processed fast by slicing, grinding, and forming into patties, which can be frozen again for storage.

MW heating is used in combination with hot-air and infrared heating (surface browning) in meat cooking.

Precooking of meat, poultry, and other foods by MW-RF is faster than conventional heating. The products are packaged in plastic or tray containers (Mermelstein 1997).

MW and RF pasteurization and sterilization of foods in plastic pouches and trays are in the development stage, and some technical problems must be solved before industrial application. Sterilization of foods in plastic pouches and trays can be accomplished by MW treatment of the containers immersed in water to prevent “cold spots” and edge effects (Hallstrom 1988).

Capacity and cost data of MW food installations were presented by Edgar (1986).

#### 6.4.12.2 Ohmic Heating

Ohmic or electric resistance heating refers to heat generation within the food material by electrical current. It is a function of the electrical resistance of the food product and the applied electrical potential. It is particularly suitable for heating pumpable particulate foods, in which the particles cannot be heated evenly with the food liquid during conventional (heat transfer) heating. The food suspension is heated by passing through special electrodes. The ohmic heating process is under development with the specific aim of UHT sterilization of particulate foods (Chap. 10).

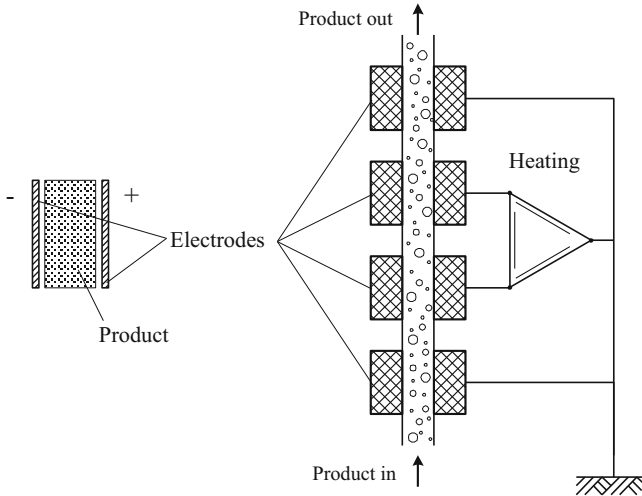
Low-frequency alternating current (50–60 Hz) is supplied to the ohmic heating column, which consists of four or more electrodes (Fig. 6.18). The electrodes are connected using stainless steel spacer tubes, lined with insulating plastics, e.g., polyvinylidene (APV 2000).

The heating column is mounted in a vertical position with the flow of product in the upward direction. Each heating section has the same electrical impedance, and the interconnecting tubes increase in length toward the outlet, to account for the increasing ionic mobility by the increased temperature.

Commercial-scale ohmic heating systems have been designed for power outputs of 75 and 750, corresponding to product capacities of approximately 750 and 3000 kg/h, respectively, for a temperature rise of water of 75 °C.

#### 6.4.12.3 Pulsed Electric Field

The application of pulsed electric field (PEF) in food preservation is a relatively new method. In pasteurization of liquids, these are exposed to high electric fields between 20 and 80 KV/cm for a few  $\mu$  s. Its main advantage is the application



**Fig. 6.18** Schematic diagram of an Ohmic heating unit

low temperature (up to 50 °C), which causes little harm to sensory characteristics of the processed food (more about this method in Chap. 12, Novel Food Processes).

### 6.4.13 Hygienic Considerations

Heat transfer equipment, used in food processing, should conform to the general hygienic requirements, outlined in Chap. 2.

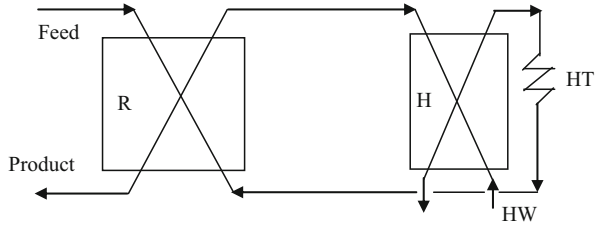
Ovens and roasters usually operate at high temperatures and in the dry state (low moisture), which destroy vegetative cells of contaminating bacteria. However, they should be cleaned on regular basis, applying cleaning schedules, established by experience, and depending on the product, the process, etc.

Heat exchangers should be cleaned by circulating water or water containing detergents. Heat exchangers should be dismantled easily for inspection and cleaning, using, for example, clamping closures. Leaking from hot or cold water tubes should be avoided or corrected. Leaks can be detected by visual inspection or pressure drop measurements (Troller 1993).

Jacketed vessels (kettles or SSHEs) should be provided with drains for immediate and complete drainage of unwanted product residues or cleaning/rinsing fluid.

*Example 6.1* Design a plate heat exchanger for the pasteurization of orange (OJ) of the orange processing plant of Example 1.1.

**Fig. 6.19** Diagram of the HTST pasteurizer of Example 6.1. *R* regenerator, *H* heater, *HW* hot water, *HT* holding tube



### Data and Assumptions

Flow rate of OJ 12 °Brix  $m = 20,000 \times 0.45 = 9000 \text{ kg/h} = 9000/3600 = 2.5 \text{ kg/s}$ .

The OJ is preheated in the regenerator from 20 to 70 °C and subsequently is heated in the heater/pasteurizer from 70 to 90 °C. The pasteurized OJ flows through the holding tube for 10 s and is then cooled from 90 to 40 °C in the regenerator by the incoming OJ. The pasteurizer is heated with hot water, which is heated by steam injection at 110 °C and exits at 90 °C.

Orange juice of 12 °Brix is considered as a Newtonian fluid with viscosity ( $\eta$ ) about 1.5 Pa s at 20 °C, 0.6 mPa s at 55 °C, and 0.4 mPa s at 80 °C. The viscosity of water at 100 °C is taken as 0.0025 mPa s (Saravacos and Maroulis 2001).

The specific heat of water and OJ is assumed to be independent of temperature,  $C_p(\text{water}) = 4.18 \text{ kJ/kg}$  and  $C_p(12^\circ\text{C}) = 3.86 \text{ kJ/kg}$ .

Thermal conductivity of water and OJ is taken approximately as  $\lambda = 0.65 \text{ W/m K}$ .

The density of OJ is taken as 1000 kg/m<sup>3</sup> and of water 958 kg/m<sup>3</sup> at 100 °C.

Figure 6.19 shows a simplified diagram of the proposed HTST pasteurizer (see also Fig. 6.7).

Assume a stainless steel plate heat exchanger for both regeneration and heater sections. Plate dimensions 1.6 m  $\times$  0.6 m with an effective heat transfer area 0.9 m<sup>2</sup>/plate.

Plate thickness 0.6 mm and channel spacing 3 mm.

### Flow Data

Mean velocity of OJ and water in the heat exchanger channel,  $u = (2.5)/(1000)(0.6 \times 0.003) = 1.4 \text{ m/s}$ .

The effective flow diameter ( $L$ ) of the channel is defined as  $L = 4 \times (\text{cross-sectional flow area})/(\text{wetted perimeter})$  or  $L = 4 \times (0.6 \times 0.003)/2(0.6 + 0.003) = 0.006 \text{ m}$ .

Temperatures: mean temperature of cold OJ in regenerator,  $T = (20 + 70)/2 = 45^\circ\text{C}$ ; hot OJ in the regenerator,  $T = (90 + 40)/2 = 65^\circ\text{C}$ ; hot OJ in heater,  $T = (70 + 90)/2 = 80^\circ\text{C}$ ; and hot water in heater,  $T = (110 + 90)/2 = 100^\circ\text{C}$ .

Reynolds numbers: cold and hot OJ in regenerator,  $Re = L\rho u/\eta = (0.006 \times 1.4 \times 1000)/0.0006 = 14,000$ .



Hot OJ in the heater,  $Re = (0.006 \times 1.4 \times 1000)/0.0004 = 21,000$ .

Hot water in the heater,  $Re = (0.006 \times 1.4 \times 958)/0.00025 = 32189$ .

*Heat transfer factors:* use the generalized correlation for the heat transfer factor  $j_H$  (Saravacos and Maroulis 2001), (6.20). For the OJ in the regenerator,  $j_H = 0.344 (14,000)^{-0.423} = 0.0061$ . For the OJ in the heater,  $j_H = 0.344 (21,000)^{-0.423} = 0.0051$ . For the hot water in the heater,  $j_H = 0.344 (32189)^{-0.423} = 0.0043$ .

Prandtl numbers,  $Pr = (C_p \eta / \lambda)$ : for the OJ in the regenerator,  $Pr = (3860 \times 0.0006)/0.65 = 3.56$ ,  $Pr^{2/3} = 2.31$ .

For the OJ in the heater,  $Pr = (3680 \times 0.0004)/0.65 = 2.37$ ,  $Pr^{2/3} = 1.77$ .

For the hot water at 100 °C,  $Pr = (4180 \times 0.00025)/0.65 = 1.61$ ,  $Pr^{2/3} = 1.37$ .

*Heat transfer coefficients:* from the heat transfer factors ( $j_H$ ), using (6.21),  $h = (j_H \rho C_p) Pr^{2/3}$ . For the OJ in the regenerator,  $h = (0.0061 \times 1.4 \times 1000 \times 3860)/2.31 = 14,270 \text{ W/m}^2 \text{ K}$

For the OJ in the heater,  $h = (0.0051 \times 1.4 \times 1000 \times 3680)/1.77 = 15,570 \text{ W/m}^2 \text{ K}$ .

For the hot water in the heater,  $h = (0.0043 \times 1.4 \times 958 \times 4180)/1.37 = 17,596 \text{ W/m}^2 \text{ K}$ .

Overall heat transfer coefficients ( $U$ ), (6.6): for the regenerator, assuming no fouling (clean heat transfer surfaces),  $1/U = 1/14,270 + x/\lambda + 1/14,270$ . The plate (wall) thickness is taken as  $x = 0.6 \text{ mm}$  and the thermal conductivity of stainless steel,  $\lambda = 16 \text{ W/m K}$ . Therefore,  $1/U = 2/14,270 + (0.0006/16) = 1.78 \times 10^{-4}$ , and  $U = 5618 \text{ W/m}^2 \text{ K}$ .

For the heater,  $1/U = 1/15,570 + (0.0006/16) + 1/17596 = 1.6 \times 10^{-4}$  and  $U = 6250 \text{ W/m}^2 \text{ K}$ .

### Plate Heat Exchangers

The design of heat exchangers must take into consideration the fouling of the heat transfer surfaces. In this example, the cloudy orange juice contains suspended particles and colloids and dissolved biopolymers, which may cause fouling during operation. In the absence of actual heat transfer data from similar operating systems, the design overall heat transfer coefficient are taken as equal to about 50 % of the calculated “clean” values of  $U$ , i.e.,  $U(\text{regenerator}) = 3000 \text{ W/m}^2 \text{ K}$  and  $U(\text{heater}) = 3500 \text{ W/m}^2 \text{ K}$ . Lower values must be taken with more viscous and severely fouling fluids.

The heat transfer duty of the regenerator will be  $q = 2.5 \times 3860 \times (70 - 20) = 482,500 \text{ W}$  and that of the heater  $q = 2.5 \times 3680 \times (90 - 70) = 193,000 \text{ W}$ . The temperature difference in the regenerator will be  $\Delta T = 65 - 45 = 20 \text{ °C}$  and in the heater  $\Delta T = 100 - 80 = 20 \text{ °C}$  (the log mean  $\Delta T$  is not needed in this example). Therefore, heat transfer area in the regenerator,  $A = (482,500)/(3000)(20) = 8.04 \text{ m}^2$ , and in the heater  $A = (193,000)/(3500)(20) = 2.8 \text{ m}^2$ .

Number of plates of (1.60 m  $\times$  0.60 m) dimensions (0.8 m<sup>2</sup> effective surface area) in the regenerator.  $N = 8/0.8 = 10$ , and in the heater,  $N = 2.8/0.8 = 3.5$  or 4 plates.

*Example 6.2* Design a shell and tube heat exchanger to heat 5 t/h of “hot break” tomato paste of 32 % TS from 50 to 100 °C. The heated paste is held at 100 °C for 15 s (sterilization), cooled to 30 °C and packed aseptically in plastic-lined drums.

### Data and Assumptions

Rheological properties of tomato paste 32 % TS,  $K = 100 \text{ Pa s}^n$ ,  $n = 0.3$  (20 °C), density  $\rho = 1130 \text{ kg/m}^3$ , specific heat  $C_p = 3500 \text{ J/kg K}$ , thermal conductivity  $\lambda = 0.55 \text{ W/m K}$ .

The rheological constant ( $K$ ) is related to the temperature with the Arrhenius equation and  $E_a = 20 \text{ kJ/mol}$ . The flow behavior index ( $n$ ) is independent of temperature (Saravacos and Maroulis 2001). Heating with saturated steam is at 120 °C, while the steam condensate leaves the HE as saturated liquid (120 °C).

*Reynolds number* Flow rate of paste  $m = 5000/3600 = 1.39 \text{ kg/s}$ .

Assume stainless steel tubes of 10 mm internal diameter and mean velocity of the paste  $u = 0.5 \text{ m/s}$ .

Shear rate of the paste in the tube  $\gamma = 8u/d = 8 \times 0.5/0.01 = 400 \text{ s}^{-1}$ .

Rheological constant ( $K$ ) at the mean temperature  $(50 + 100)/2 = 75 \text{ °C}$ :

$$K(75) = K(20)\exp\{E/R(1/348 - 1/293)\}, \quad (E/R) = 20,000/8.31 = 2406, \\ \ln[K(75)/K(20)] = -1.3, \quad K(75) = 0.272, \quad K(20) = 27.2 \text{ Pa s}^n.$$

Apparent viscosity of the paste at  $\gamma = 400 \text{ s}^{-1}$  and 75 °C,  $\eta = 27.2 \times (400)^{-0.7} = 0.41 \text{ Pa s}$ .

Reynolds number in the tubes  $Re = (0.5 \times 0.01 \times 1130)/0.41$ ,  $Re = 13.8$  (laminar flow).

*Heat transfer coefficient* Apply (6.11) for heat transfer in tubes in laminar flow:  $Nu = 2.0Gz^{1/3}(K/K_w)^{0.14}$  where the Graetz number ( $Gz$ ) is  $Gz = mC_p/\lambda L = (1.39 \times 3500)/(0.55)(10) = 884$ . The length of the pipe is assumed  $L = 10 \text{ m}$  (for a more detailed analysis a trial-and-error calculation will be needed).  $Gz^{1/3} = 884^{1/3} = 9.4$ . The ratio of the rheological constants at the bulk and wall temperatures is  $(K/K_w) = 100/27.2 = 3.7$ , and  $(K/K_w)^{0.14} = 1.2$ ,  $Nu = 2 \times 9.4 \times 1.2 = 22.6$ ,  $Nu = (hd)/\lambda = 0.01 \text{ h}/0.55 = 0.0182 \text{ h} = 22.6$ , and  $h = 1241 \text{ W/m}^2 \text{ K}$ .

The heat transfer coefficient ( $h$ ) can also be estimated from the generalized correlation of the heat transfer factor ( $j_H$ ) for food materials, (6.20), Saravacos and Maroulis (2001):  $j_H = 0.344(13.8)^{-0.423} = 0.113$ . The Prandtl number will be  $Pr = (C_p \eta)/\lambda = (3500 \times 0.41)/0.55 = 2609$  and  $Pr^{2/3} = 179$ . From (6.21) it follows that  $h = (0.113 \times 0.5 \times 1130 \times 3500)/179 = 1248 \text{ W/m}^2 \text{ K}$ .

The overall heat transfer coefficient ( $U$ ) in this heat exchanger includes the resistance of the heating (steam) side and the tube wall, which are considered very small, compared to the thermal resistance of the product side. Therefore, for design purposes, an approximate value  $U = 1000 \text{ W/m}^2 \text{ K}$  can be assumed, considering some fouling effect.

*Heat transfer surface:*

The log mean temperature difference in the heat exchanger will be  $\Delta T_M = (\Delta T_1 - \Delta T_2) / \ln(\Delta T_1 / \Delta T_2)$ , where  $\Delta T_1 = 120 - 50 = 70$  °C and  $\Delta T_2 = 120 - 100 = 20$  °C. Therefore,  $\Delta T_M = (70 - 20) / \ln(70/20) = 40$  °C.

The heat flux in the HE will be  $q = 1.39 \times 50 \times 3500 = 243,250$  W and the surface area,  $A = 243,250 / (40 \times 1000) = 6$  m<sup>2</sup>.

The number of tubes of the HE will be  $N = 5000 \times 4 / [0.5 \times 3.14 \times (0.0001) \times 3600 \times 1130] = 32$ .

The length of each tube in the HE will be  $L = 6/32 \times 3.14 \times 0.01 = 6$  m.

A double-pass heat exchanger with tubes 3 m long will be more practical.

*Example 6.3* Show that the heat transfer area of a tubular heat exchanger is smaller when operated in countercurrent than in cocurrent flow, under the same flow and heating conditions.

The heat transferred in cocurrent (1) and countercurrent (2) flow will be

$$q_1 = U_1 A_1 (\Delta T_{L1}) \quad \text{and} \quad q_2 = U_2 A_2 (\Delta T_{L2})$$

Since the heat transferred and the flow conditions are the same,  $q_1 = q_2$  and  $U_1 = U_2$ .

Therefore,  $A_1 (\Delta T_{L1}) = A_2 (\Delta T_{L2})$ . According to the definition of the log mean temperature difference, (6.26) and Fig. 6.2:  $\Delta T_L = (\Delta T_1 - \Delta T_2) / \ln(\Delta T_1 / \Delta T_2)$ . For cocurrent flow  $\Delta T_1 = (T_{h1} - T_{c1})$  and  $\Delta T_2 = (T_{h2} - T_{c2})$ , and for countercurrent flow  $\Delta T_1 = (T_{h1} - T_{c2})$  and  $\Delta T_2 = (T_{h2} - T_{c1})$ .

Thus, the ratio of the cocurrent to countercurrent log mean temperatures will be:  $\Delta T_{L1} / \Delta T_{L2} = \ln[(T_{h2} - T_{c1}) / (T_{h1} - T_{c1})]_2 / \ln[(T_{h1} - T_{c1}) / (T_{h2} - T_{c2})]_1$ . Referring to Fig. 6.2, it is shown that  $[(T_{h2} - T_{c1}) / (T_{h1} - T_{c2})]_2 < [(T_{h1} - T_{c2}) / (T_{h2} - T_{c2})]_1$ , and therefore  $\Delta T_{L1} / \Delta T_{L2} < 1$ .

Since it is  $A_1 (\Delta T_{L1}) = A_2 (\Delta T_{L2})$ , it is concluded that  $A_2$  (countercurrent)  $< A_1$  (cocurrent).

As an illustration, consider the heating of a food liquid from 35 to 70 °C in a tubular heat exchanger with heating medium water, which enters at 85 °C and leaves at 75 °C. Assuming similar heating conditions ( $q$ ,  $U$ ), the log mean temperature difference in cocurrent (1) and countercurrent (2) flow will be  $\Delta T_{L1} = (50 - 5) / \ln(50/5) = 19.5$  °C and  $\Delta T_{L2} = (40 - 15) / \ln(40/15) = 25.5$  °C and  $\Delta T_{L1} < \Delta T_{L2}$ .

Therefore,  $A_2 / A_1 = (\Delta T_{L1}) / (\Delta T_{L2}) = (19.5) / (25.5) = 0.76$ , i.e., the heat transfer area for a countercurrent operation is 24 % smaller than for the cocurrent system.

It should be noted that when  $(\Delta T_1)$  approaches  $(\Delta T_2)$ , the calculation of the log mean temperature  $(\Delta T_L)$  becomes difficult, and the arithmetic mean temperature difference should be used  $[\Delta T_M = (\Delta T_1 + \Delta T_2) / 2]$ .

## References

- Alfa-Laval (1969) Thermal handbook. Alfa-Laval, Lund
- Alfa-Laval (1971) Heat exchanger guide. Alfa-Laval, Lund
- APV (2000) Ohmic heating bulletin. APV Company, Crawley
- Bhatia MV, Cheremisinoff PN (1980) Heat transfer equipment. Technomic, Westport
- Bott TR (1995) The fouling of heat exchangers. Elsevier, Amsterdam
- Bott TR (2001) To foul or not to foul. *Chem Eng Prog* 97(11):30–37
- Carlson JA (1992) Understand the capabilities of plate-and-frame heat exchangers. *Chem Eng Prog* 88(7):26–31
- Coronel P, Sandeep KP, Palazoglou T (2000) Heat transfer coefficient determination in a helical heat exchanger. Paper presented at annual IFT meeting, Dallas, TX, 10–14 Jun 2000, paper 14A-40
- Datta AK, Ananthswaran RC (eds) (2001) Handbook of microwave technology for food applications. Marcel Dekker, New York
- Datta AK, Sun E, Solis A (1995) Food dielectric property data and their composition-based prediction. In: Rao MA, Rizvi SSH (eds) *Engineering properties of foods*, 2nd edn. Marcel Dekker, New York, pp 457–494
- Decareau RV, Peterson RA (1986) Microwave process engineering. Ellis Horwood, Chichester
- Demetrakakes P (1999) Getting out of a scrape. *Food Process*: 112–113
- Edgar R (1986) The economics of microwave processing in the food industry. *Food Technol* 40:106–112
- Fellows PJ (1990) Food processing technology. Ellis Horwood, London
- Fryer PJ (1997) Thermal treatment of foods. In: Fryer PJ, Pyle RL, Rielly CD (eds) *Chemical engineering for the food industry*. Blackie Academic and Professional, London, pp 31–382
- Geankoplis CJ (1993) Transport processes and unit operations, 3rd edn. Prentice-Hall, New York
- Georgiadis MC, Rotstein GE, Macchietto S (1998a) Modeling, simulation and optimization of milk heat treatment processes under fouling and effect on the plant's flexibility. In: *New frontiers in food engineering—CoFE 97*. AIChE, New York, pp 382–387
- Georgiadis MC, Rotstein GE, Macchietto S (1998b) Modeling and simulation of complex heat exchanger arrangements under fouling. *Comput Chem Eng* 22:S331
- Hallstrom B (1980) Heat and mass transfer in industrial cooking. In: Linko P, Malkki Y, Larinkari J (eds) *Food process engineering*, vol 1. Applied Science, London, pp 457–465
- Hallstrom B, Skjoldebrand C, Tragardh C (1988) Heat transfer and food products. Elsevier Applied Science, London
- Harrod M (1987) Scraped surface heat exchangers. A literature survey of flow patterns, mixing effects, residence time distribution, heat transfer and power requirements. *J Food Process Eng* 9:1–62
- Jowitt R, Escher F, Kent M, McKenna B, Roques M (eds) (1987) *Physical properties of foods-2*. Elsevier Applied Science, London
- Kennedy J, Terris S, Robe K (1987) Steam-jacketed kettle solves burn-on problem. *Food Process*: 110.
- Kent M (1987) Electric and dielectric properties of food materials. Science and Technology, London
- Lewis M, Heppell N (2000) Continuous thermal processing of foods. Aspen, Gaithersburg
- Matz S (1987) Equipment for bakers. Elsevier Science, London
- McAdams WH (1954) Heat transmission. McGraw-Hill, New York
- Mermelstein NH (1997) Interest in radiofrequency heating heats up. *Food Technol* 51(10):91–92
- Mermelstein NH (1999) Developing new baking processes. *Food Technol* 53(3):72–74
- Mudgett RE (1990) Developments in microwave food processing. In: Schwartzberg HG, Rao MA (eds) *Biotechnology and food process engineering*. Marcel Dekker, New York, pp 359–413
- Mudgett RE (1995) Electrical properties of foods. In: Rao MA, Rizvi SSH (eds) *Engineering properties of foods*, 2nd edn. Marcel Dekker, New York, pp 389–455

- Muller-Steinhagen, H. (1997). Plate heat exchangers: past-present-future. In: Engineering and food at ICEF 7 part I. Sheffield Academic Press, Sheffield, pp AA1-AA12
- O'Donnell BB (2001) Optimize heat exchanger cleaning schedules. *Chem Eng Prog* 97(6):56-60
- Ohlsson T (1987) Industrial uses of dielectric properties of foods. In: Jowitt R, Escher F, Kent M, McKenna B, Roques M (eds) *Physical properties of foods-2*. Elsevier Applied Science, London, pp 199-211
- Perry RJ, Green D (1997) *Perry's chemical engineers' handbook*, 7th edn. McGraw-Hill, New York
- Rahman S (1995) *Food properties handbook*. CRC Press, New York
- Rao MA (1999) *Rheology of fluid and semisolid foods*. Aspen, Gaithersburg
- Reuter H (ed) (1993) *Aseptic processing of food*. Technomic, Lancaster
- Rossell JB (2001) *Frying. Improving quality*. CRC Press, Boca Raton
- Saravacos GD, Maroulis ZB (2001) *Transport properties of foods*. Marcel Dekker, New York
- Saravacos GD, Moyer JC (1967) Heating rates of fruit products in an agitated kettle. *Food Technol* 29(3):54A-58A
- Schiffmann RE (1987) Microwave and dielectric drying. In: Mujumdar RS (ed) *Handbook of industrial drying*. Marcel Dekker, New York, pp 327-356
- Schormueller J (1966) *Die Erhaltung der Lebensmittel*. F. Enke Verlag, Stuttgart
- Singh RP (1992) Heating and cooling processes for foods. In: Heldman DR, Lund DB (eds) *Handbook of food engineering*. Marcel Dekker, New York, pp 247-276
- Sinnot RK (1996) Chemical process design. In: Coulson JM, Richardson JF (eds) *Chemical engineering*, vol 6. Butterworth-Heinemann, London
- TEMA (1978) *Standards of tubular exchanger manufacturers association*. Tubular Exchanger Manufacturers Association, New York
- Troller JA (1993) *Sanitation in food processing*, 2nd edn. Academic Press, New York
- Walas SM (1988) *Chemical process equipment*. Butterworths, London
- Youngworth H, Swientek RJ (1987) Tubular heat exchanger system handles 2000 gallons/h of orange and grapefruit juice with pulp. *Food Process*: 72-73.
- Zanoni B, Peri C, Pierucci S (1997) Computer model of bread baking control and optimization. In: Jowitt R (ed) *Engineering and food*, vol 2. Sheffield Academic Press, Sheffield, p H13-H

# Chapter 7

## Food Evaporation Equipment

### 7.1 Introduction

Evaporation is a physical separation process, which removes a volatile component from a liquid solution or mixture by vaporization, obtaining a concentrated product of the nonvolatile components. For liquid foods, evaporation removes most of the water, resulting in a concentrated product, which may be used as such or processed further, e.g., by drying.

Evaporation is used extensively in concentrating fruit and vegetable juices, milk, and coffee extracts and in refining sugar and salt. Reduction of the water content decreases weight and volume of the product, cutting storage and transportation costs and improving the storage stability of the product.

Evaporation is established as the major process of concentrating liquid foods, although some new methods offer certain special advantages, e.g., freeze concentration and reverse osmosis (see Chap. 12).

Evaporation is often used as a pre-concentration process, e.g., for skim milk and soluble coffee, before drying. The thermal efficiency of evaporators for removing water is much higher (e.g., 90 %), compared to the efficiency of dryers (e.g., 60 %). Energy savings are considerably higher in evaporation systems than in normal drying operations.

The engineering design of evaporators is based on the efficient transfer of heat from the heating medium (usually steam) to the liquid product, the effective vapor/liquid separation, and the utilization of energy (Minton 1986; Billet 1988). Technical data are provided by manufacturers of evaporation equipment (Alfa-Laval 1972; APV 1987).

In food applications, evaporation should preserve the quality of heat-sensitive products, and the evaporation equipment should conform to the hygienic requirements of cleaning and the good manufacturing practices (Chaps. 1 and 2). Evaporators are used also for concentrating liquid wastes, recovering useful by-products, and reducing the discharges of food plants to the environment.

## 7.2 Heat Transfer in Evaporation

Large amounts of heat energy must be transferred from the heating medium through the metallic walls of the evaporator to the boiling liquid. The heat requirements  $Q$  (kW) are determined by material and energy balances around each evaporator unit and on the whole system. Heat transfer at the wall/liquid interface is the most important transfer operation in evaporation, since the thermal resistances of the wall and the heating medium (saturated system) are considered much smaller. Heat transfer at the evaporation surface is directly related to the thermophysical properties and the flow pattern of the liquid.

### 7.2.1 Physical Properties

The physical properties of the liquid, which are of direct importance to evaporation, are the viscosity (or rheological constants), the thermal conductivity, the density, the specific heat, the surface tension, and the boiling point elevation (BPE). Data on the transport properties (viscosity and thermal conductivity) are found on Tables of Food Engineering literature and are discussed by Saravacos and Maroulis (2001). Physical properties of importance to evaporation are discussed by Chen (1993).

The surface tension of water is 73 dyn/cm or 73 mJ/m<sup>2</sup> (25 °C), and it decreases significantly when organic components are present in an aqueous system (Reid et al. 1987). The surface tension of liquid food materials is lower (about 30 dyn/cm<sup>2</sup>), due to the surface-active components present.

BPE is caused by solute/water interaction and it is undesirable in evaporation, since it requires a higher temperature of the heating medium to affect the same driving force (temperature difference). It is particularly high (e.g., 30 °C) in concentrated aqueous solutions of salts and alkalis (e.g., sodium hydroxide).

The BPE of liquid food is relatively low, and in most cases it can be neglected in heat transfer calculations. It becomes important in concentrated solutions of sugars and other low-molecular components. High-molecular components dissolved or dispersed in water like starch, pectins, and proteins give negligible BPE.

For sugar solutions, such as fruit juices, the following empirical equation can be used to estimate BPE (Chen and Hernandez 1997):

$$(\text{BPE}) = 0.33 \exp(4X) \quad (7.1)$$

where  $X$  is the mass fraction of the sugar. Thus, the BPE of a fruit juice will increase, during evaporation, from about 0.7 °C (20 °Brix) to 4.4 °C (65 °Brix).

### 7.2.2 Heat Transfer Coefficients

The heat transfer  $Q$  (W) at the heating surface is given by the general equation:

$$Q = UA\Delta T \quad (7.2)$$

where  $U$  is the overall heat transfer coefficient ( $\text{W}/\text{m}^2\text{K}$ ),  $A$  is the heating surface ( $\text{m}^2$ ), and  $\Delta T$  is the temperature difference between the heating medium (steam, vapors) and the boiling medium ( $^{\circ}\text{C}$  or  $\text{K}$ ). The overall heat transfer coefficient ( $U$ ) is usually determined experimentally or is taken from operating similar industrial or pilot-plant evaporators. Theoretical prediction of ( $U$ ) is difficult because of the fouling resistance at the heating surface, which cannot be quantified accurately. However, heat transfer analysis is useful in evaluating the thermal resistances of evaporation systems.

The overall thermal resistance of a heating system for evaporation is given by the equation:

$$1/U = 1/h_s + x/\lambda + 1/h_i + \text{FR} \quad (7.3)$$

where  $h_s$  and  $h_i$  are, respectively, the heat transfer coefficient at the heating (steam) and evaporation sides,  $x/\lambda$  is the thermal resistance of the evaporator wall, and FR is the fouling resistance. Equation (7.3) refers to plane heat transfer surfaces, and it can be applied approximately to tubes of relatively large diameter, e.g., 50 mm. For small-diameter tubes, the thermal resistances must be corrected by the ratio of outside-to-inside diameters.

The heating side is assumed to have negligible fouling resistance, since food evaporators use clean saturated steam and clean metallic surfaces. Thus, the resistance of the heating is relatively low, since high  $h_s$  values are obtained with saturated steam or water vapors. The wall resistance ( $x/\lambda$ ) is relatively low, since thin walls (low  $x$ ) and high thermal conductivity ( $\lambda$ ) characterize the evaporators.

The heat transfer coefficient at the evaporation surface ( $h_i$ ) is a function of the physical properties (mainly the viscosity) and the flow conditions of the liquid. It increases at high flow rates and high temperatures, and it can be estimated from empirical correlations (McAdams 1954; Perry and Green 1997; Minton 1986). Heat transfer coefficients in liquid films are of particular importance to falling film food evaporators, as discussed later in this section.

### 7.2.3 Fouling in Evaporators

Fouling is the formation of deposits on the heat transfer surface, which reduces heat transfer and evaporation rates and may damage the quality of the concentrated products. Fouling is costly to industrial operations because of the higher capital cost



**Table 7.1** Typical values of overall heat transfer coefficients ( $U$ )

Type of evaporator	Liquid food	$U$ (W/m <sup>2</sup> K)
Falling film, tubular	Fruit juices 12–65 °Brix	2000–600
Falling film plate	Milk 10–30 % TS	2500–1500
Rising film, tubular	Milk 10–35 % TS	2000–1200
Forced circulation	Sugar syrups 15–65 °Brix	2500–1500
Agitated film	Fruit/vegetable pulp	1500–700

(oversized plants), the energy losses, the higher maintenance, and the loss of production during shutdown for cleaning (Winton 1986).

Fouling includes scaling, which is the precipitation of inorganic salts (e.g., calcium) on the heating surface, particulate fouling (precipitation of proteins), corrosion fouling, biological fouling (attachment of microorganisms to the heat transfer surface), and solidification fouling (freezing or solidification of high melting components).

Fouling involves initiation, mass transport and attachment to the heating surface, and removal into the fouling liquid. In food evaporators and other heat transfer equipment, fouling is caused mainly by the adsorption and denaturation of food biomolecules, like proteins, pectins, and starch on the heated surface.

Empirical correlations of fouling resistance to the operating time of food evaporators for a specific application (e.g., sugar evaporators) are useful for determining the optimum cleaning cycle, i.e., how often will the evaporator be cleaned by interrupting its operation.

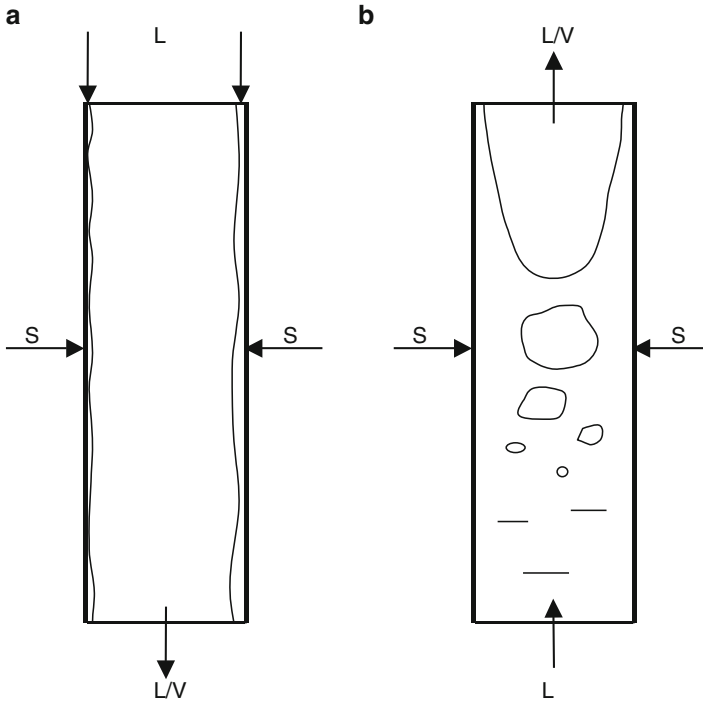
Use of fouling resistances (FR) or fouling factors in (7.3) gives only approximate values for a specific evaporator and product. Practically, it is more accurate to use reliable values of the overall heat transfer coefficient ( $U$ ) obtained under appropriate conditions. Typical values of ( $U$ ) for food evaporators are shown in Table 7.1.

## 7.2.4 Heat Transfer in Film Evaporators

Evaporation of water from falling or rising films is used extensively in food evaporators, because of their advantages, simplicity of operation, and low equipment and operating cost. Figure 7.1 shows schematically the principles of operation of the falling film and rising film evaporators.

### 7.2.4.1 Falling Film Evaporators

In the falling film evaporators, the liquid film falls by gravity in the vertical evaporation surface (inside the tube or plate), while heat is transferred through the wall by condensing steam. The mixture of liquid/vapors (L/V) exits the bottom



**Fig. 7.1** Diagrams of the principles of falling film (a) and rising film (b) evaporators. *L* liquid, *V* vapors, *S* steam

of the tube or plate and it enters a vapor/liquid separator, from which concentrated liquid is pumped out and water vapors are directed to a condensing system.

In falling films, the minimum liquid flow in kg/m s,  $\Gamma$  rate per unit length of the feed surface, or “irrigation rate” is given by the empirical equation (Minton 1986):

$$\Gamma_{\min} = 0.008(\eta s \sigma^3)^{1/5} \tag{7.4}$$

where ( $\eta$ ) is the viscosity (mPa s), ( $s$ ) is the specific gravity related to water, and ( $\sigma$ ) is the surface tension of the liquid (dyn/cm).

Thus, the minimum flow rate of water at 80 °C to form a film on a vertical surface would be:  $\Gamma_{\min} = 0.008(0.356 \times 68^3)^{1/5} = 0.008 \times 10.23 = 0.08$  kg/m s. A food liquid film can form at a lower flow rate than pure water (considerably lower surface tension), improving the heat transfer coefficient.

The minimum flow rate for a liquid food with a surface tension of 34 dyn/cm would be considerably lower, i.e.,  $\Gamma_{\min} = 0.08 (34/68)^{3/5} = 0.052$  kg/m s.

The Reynolds number of the falling film is given by the simplified equation (Perry and Green 1997):

$$Re = 4\Gamma/\eta \tag{7.5}$$

For water at 80 °C at the minimum flow rate, the Reynolds number will be  $Re = 4 \times 0.08/0.356 = 900$ , i.e., the flow is laminar.

Higher heat transfer coefficients ( $h$ ) are obtained in the turbulent flow regime, i.e., at  $Re > 2100$ . The following empirical equation can be used to estimate the heat transfer coefficient of water films in the turbulent flow regime:

$$h = 9150 \Gamma^{1/3} \quad (7.6)$$

The heat transfer coefficient ( $h$ ) of falling liquid films for turbulent flow is given by the general empirical equation:

$$h = 0.01(\varphi Re Pr)^{1/3} \quad (7.7)$$

where  $\varphi = (\lambda^3 \rho^2 g / \eta^2)$ ,  $Re = 4\Gamma/\eta$ , and  $Pr = C_p \eta / \lambda$ . When SI units are used, the factor  $\varphi^{1/3}$  has units of heat transfer coefficient ( $W/m^2K$ ).

As an illustration, the flow of a water film at 80 °C in a vertical surface at  $\Gamma = 0.5$  kg/m s is turbulent: viscosity of water at 80 °C,  $\eta = 0.356$  mPa s = 0.000356 Pa s, and  $Re = 4\Gamma/\eta = 4 \times 0.5/0.000356 = 5618$ . Taking  $\lambda = 0.67$  W/m K,  $\rho = 972$  kg/m<sup>3</sup>, and  $g = 9.81$  m/s<sup>2</sup>, the ( $\varphi$ ) factor becomes  $\varphi = [(0.67)^3 \times (972)^2 \times 9.81] / (0.000356)^2 = 21.8 \times 10^{12}$  and  $\varphi^{1/3} = 28,000$ . Also,  $Pr = (4100 \times 0.000356) / 0.67 = 2.2$  and  $Pr^{1/3} = 1.3$ . Therefore,  $h = 0.01 \times 28,000 \times 17.7 \times 1.3 = 6440$  W/m<sup>2</sup>K.

The experimentally determined overall heat transfer coefficient ( $U$ ) for evaporation of water at 80 °C was  $U = 2000$  W/m<sup>2</sup>K. Equation (7.3) can be used to determine the experimental heat transfer coefficient of the evaporation surface ( $h_i$ ), assuming no fouling:  $1/h_i = 1/U - x/\lambda - 1/h_s$ . The thickness of the tube wall is  $x = 3$  mm (2-in. tube, 10 gauge), and the thermal conductivity of the stainless steel  $\lambda = 15$  W/mK. The steam-side heat transfer coefficient is assumed to be  $h_s = 10,000$  W/m<sup>2</sup>K. Therefore,  $1/h_i = 1/2000 - 3/15,000 - 1/10,000$ , and  $h_i = 5000$  W/m<sup>2</sup>K (clean surface).

The simplified equation for water films (7.6) yields the following heat transfer coefficient, for  $\Gamma = 0.5$  kg/m s,  $h_i = 9150 \times (0.5)^{1/3} = 7264$  W/m<sup>2</sup>K. It is seen that (7.6) overestimates the heat transfer coefficient of boiling water. The general empirical equation (7.7) yielded also higher heat transfer coefficients than the experimental values, but it is useful for approximate estimations of various fluids. It predicts that the heat transfer coefficient is inversely proportional to the (2/3) power of viscosity, i.e.,  $h_i \propto (1/\eta^{2/3})$ .

The calculated heat transfer coefficient of the evaporation surface ( $h_i$ ) from ( $U$ ) depends strongly on the steam heat transfer coefficient ( $h_s$ ) and the fouling resistance, which are difficult to predict accurately. For this reason, the experimental overall heat transfer coefficient ( $U$ ) is more reliable in practice.

### 7.2.4.2 Rising Film Evaporators

The rising (climbing) film evaporators find fewer applications than the falling film systems, because of the longer residence time and the higher operating temperatures and pressure drops, which require more energy, and they may be detrimental to the quality of heat-sensitive food liquids, like fruit juices. However, the rising film systems do not require special feed distributors, they yield high heat transfer coefficients, and they do not foul as severely as the falling film units.

In the rising film system, the liquid begins to boil in the tube, producing vapor bubbles of growing size as the liquid rises by natural convection, and finally forms a film on the walls which rises to the top of the tube, entrained by the fast-rising vapors. Again, the (L/V) mixture is separated to the liquid, which may be recirculated or removed as a product, and the vapors, which are condensed in the condenser (Fig. 7.1).

In a rising film evaporator, the liquid feed enters the bottom of the vertical tubes, and the water evaporates gradually, as the liquid/vapor mixture moves upward. In ideal conditions, the evaporation surface is covered completely with a rising liquid film, and the vapors flow as bubbles, plug, or stratified vapor/liquid flow. At the top section of the tubes, the high-velocity vapors may entrain some liquid in the form of liquid droplets, reducing the product-side heat transfer coefficient. Thus, the volume fraction of the vapors in the evaporator tube plays an important role in heat transfer.

Experimental measurements of heat transfer in a pilot-plant rising film evaporator have shown that the following empirical equation can be applied (Bourgeois and LeMaguer 1984, 1987):

$$Nu = 8.5Re^{0.2}Pr^{1/3}S^{2/3} \quad (7.8)$$

where  $S$  is the slip ratio, i.e., the ratio of vapor to liquid velocities in the evaporator tube. The dimensionless numbers  $Nu$ ,  $Re$ , and  $Pr$  are determined at a mean location, using mean velocities and property values.

Experimental values with the evaporation of fruit juices in pilot-plant and industrial rising film evaporators have yielded overall heat transfer coefficients ( $U$ ) which decreased from about 1500 W/m<sup>2</sup>K at the bottom (about 15 °Brix) to nearly 1000 W/m<sup>2</sup>K at the top (about 60 °Brix) of the evaporator tube. The liquid film velocity at the bottom and the top of the evaporator were, respectively, 1.27 and 1.97 m/s. The respective vapor velocities were much higher (48.4 and 59.0 m/s).

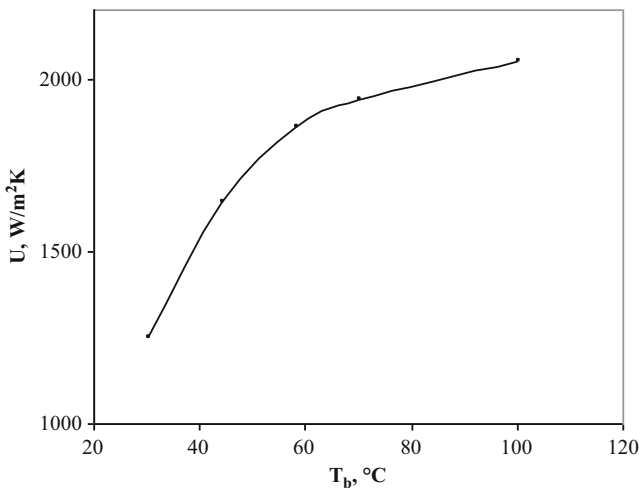
As with falling films, the surface tension of the liquid plays an important role in film formation. Food liquids with surface tension lower than that of water will cover the heating surface more effectively than pure water, resulting in higher heat transfer coefficients.

### 7.2.5 Falling Film Evaporation of Fruit Juices

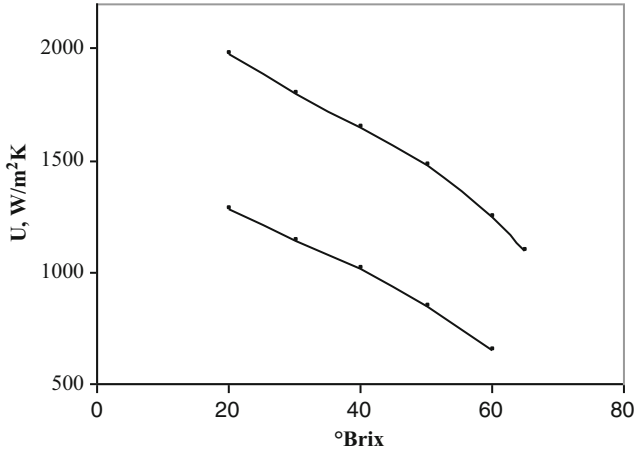
Falling film evaporators are used extensively for the concentration of fruit juices, and experimental data of heat transfer coefficients are useful for design and evaluation of the industrial units. Apple and grape juices of various compositions were used in experimental measurements, using a pilot-plant evaporator at the New York State Agricultural Experiment Station, Cornell University, Geneva, NY (Saravacos et al. 1970). The evaporator was a vertical steam-jacketed tube, 50 mm diameter and 3.3m long, with a heating surface of 0.46 m<sup>2</sup>. Evaporation data were obtained at various flow rates and boiling temperatures.

Figure 7.2 shows that the overall heat transfer coefficient ( $U$ ) of clarified Concord grape juice increased from about 1300 to 2000 W/m<sup>2</sup>K, as the boiling temperature was raised from 20 to 100 °C. Increased ( $U$ ) values are obtained by the considerable decrease of viscosity of the juice at high temperatures. Clarified juices are Newtonian fluids and the activation energy for flow increases sharply at higher concentrations, e.g., 50 kJ/mol at 60 °Brix (Saravacos 1970; Saravacos and Maroulis 2001).

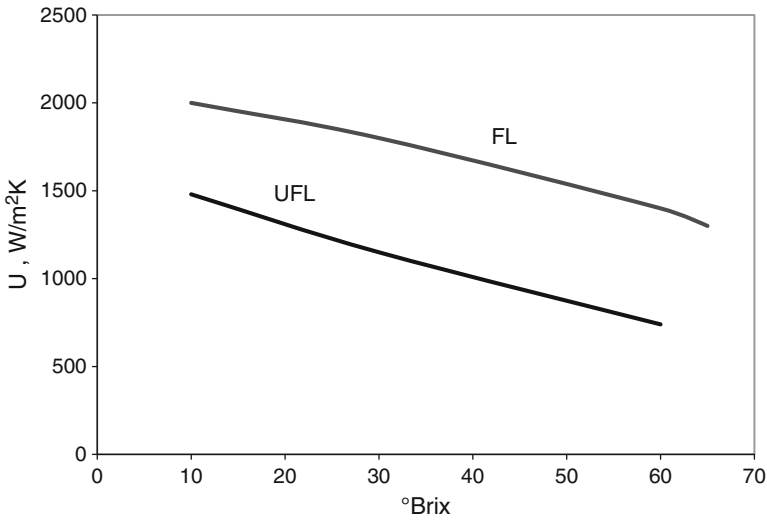
The overall heat transfer coefficients decrease significantly, as the juice is concentrated (Fig. 7.3). Thus, the ( $U$ ) values of filtered grape juice decreased from about 1900 to nearly 1200 W/m<sup>2</sup>K as the °Brix value (% soluble solids) was increased from 20° to 65 °Brix. Lower ( $U$ ) values were obtained in the evaporation of unfiltered grape juice, 1350–650 W/m<sup>2</sup>K. This significant reduction in heat transfer rate was evidently caused by fouling at the evaporator surface with particles and organic components (tartrates), which precipitated at the high concentration. It should be noted that the evaporation of the unfiltered juice was stopped at 60 °Brix, because of difficulties in operating effectively the system.



**Fig. 7.2** Increase of the overall heat transfer coefficient ( $U$ ) of clarified grape juice with the boiling temperature



**Fig. 7.3** Overall heat transfer coefficients ( $U$ ) of filtered (FL) and unfiltered (UFL) Concord grape juice at 55 °C



**Fig. 7.4** Overall heat transfer coefficients ( $U$ ) in the evaporation of filtered (FL) and unfiltered (UFL) apple juice

Similar heat transfer coefficients were obtained with filtered (depectinized) and unfiltered apple juice (Fig. 7.4). The depectinized apple juice yielded  $U$  values between 2000 and 1150  $W/m^2K$  in the range of 10–65 °Brix, while the cloudy (unfiltered) juice gave  $U$  values between 1480 and 740  $W/m^2K$  in the range of 10–60 °Brix (Saravacos et al. 1970). Depectinization (removal of dissolved colloidal pectins by enzyme treatment and filtration) is normally practiced in the production of apple juice concentrates.

### 7.3 Food Quality Considerations

Evaporation should minimize the undesirable changes in quality and nutritive value of heat-sensitive food materials. Such changes are losses of organoleptic quality (flavor, aroma, and color), losses of vitamins, and production of undesirable compounds (browning, caramelization).

Losses of aroma components during evaporation of fruit juices and aqueous extracts can be restored by aroma recovery in the distillate (Chap. 11) or by add-back of fresh juice.

Losses in food quality can be minimized by evaporation at low temperatures (vacuum operation), which, however, has the disadvantage of lower heat transfer coefficients, due to the higher viscosity of the concentrated product. A better approach, from the food engineering standpoint, is to use high-temperature/short-time evaporation, in which the heat-sensitive liquid food is concentrated fast at a high temperature, minimizing the losses of food quality. Such a system is the TASTE evaporator (thermally accelerated short-time evaporator), used in the concentration of citrus juices (Chen and Hernandez 1997).

Fouling of evaporation surfaces is a serious problem in the evaporation of food suspensions and pulps, because it not only reduces heat transfer and evaporation rate, but it may produce undesirable changes in food quality and in the hygienic operation of the equipment. Fouling may be minimized by proper evaporator design and operation. High fluid velocities are desirable, particularly with non-Newtonian (pseudoplastic) foods, since the apparent viscosity decreases at high shear rates. Mechanical agitation cleans the heating surface and reduces the apparent viscosity of such fluids.

### 7.4 Food Evaporators

Several types of evaporators are used for the concentration of liquid foods. The principal factors affecting the choice of an evaporation system are food quality, evaporation capacity, and energy/cost considerations. The food product quality depends primarily on the residence-time–temperature combination in the evaporator. Evaporation capacity is related to the heat transfer rate, and energy utilization is improved by energy-saving evaporation systems.

#### 7.4.1 *Material and Energy Balances*

The sizing of an evaporator is based on the estimation of the heat transfer surface area required for a given evaporation (and heat transfer) load. Material and energy balances, needed for sizing calculations, are estimated by the procedures discussed in Chap. 1.

**Fig. 7.5** Material and energy balances in an evaporator unit.  $m$  flow rates,  $T$  temperature,  $H$  enthalpy,  $A$  heating surface of heat exchanger

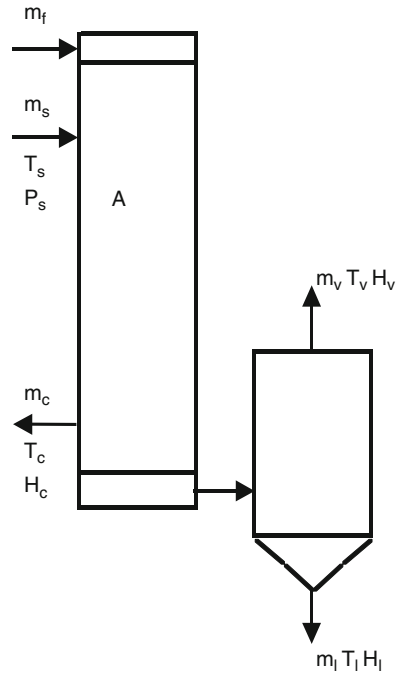


Figure 7.5 shows schematically the required quantities and process data for performing an elementary balance. The following assumptions are normally made for preliminary process design:

- The feed and the products enter and exit the evaporator as saturated liquids, i.e., at the boiling point for the given operating pressure.
- The boiling point rise (BPR) can be neglected, which is a reasonable assumption for food materials, except for high sugar concentrations, e.g., above 60 °Brix.
- The heating steam and the steam condensates are saturated (at the condensation/boiling point).
- Heat losses to the environment are neglected. The heat losses represent about 1–3 % of the total heat use, and they can be reduced by proper insulation of the evaporator equipment.

Analytical calculations of a multiple-effect evaporator are given in numerical Example 7.1.

### 7.4.2 Long Residence-Time Evaporators

Heat-resistant foods, like sugar solutions, syrups, tomato juice and tomato products, fruit jams and preserves, and salt solutions, can be evaporated in various types of evaporators, characterized by relatively long residence times (several minutes or a



few hours), high temperatures, and recirculation. High heat transfer coefficients are obtained by agitation and natural or forced recirculation of the fluid food (Minton 1986). In addition, forced recirculation reduces fouling.

#### 7.4.2.1 Jacketed Vessel Evaporators

Steam-jacketed pans or kettles (vessels) are used for the batch evaporation and concentration of heat-resistant food products, like tomato puree and ketchup. Mechanical agitation with scrapers is used to prevent fouling of the heating surface and increase heat transfer rate.

#### 7.4.2.2 Coil Evaporators

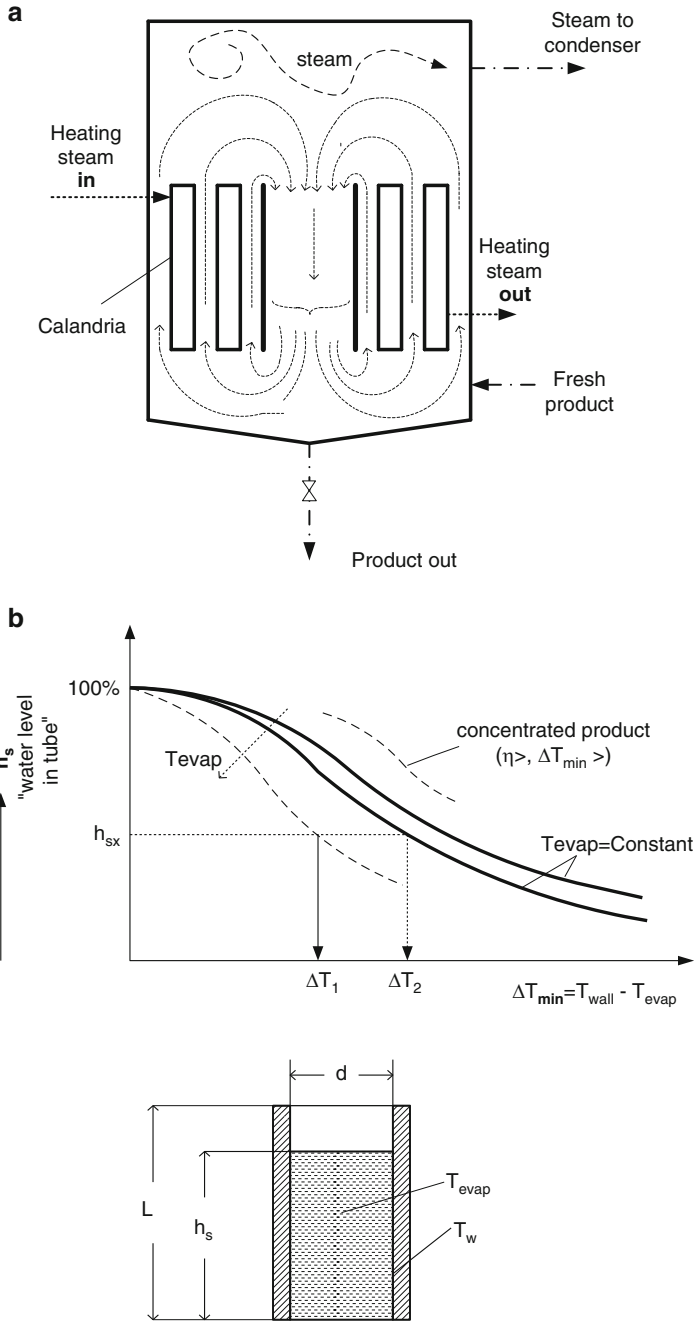
Steam coils, immersed in the evaporating liquid, may be used as a simple and effective heating system. The coil may be rotating to increase the heat transfer rate. Coil heating is used in the WURLING evaporator, developed for tomato products and fruit pulps in the USDA Western Laboratory (Morgan 1967). The high shear rates, developed at the coil/product interface, can reduce the apparent viscosity of the pseudoplastic fruit and vegetable products, increasing significantly the heat transfer coefficient (Saravacos 1974).

#### 7.4.2.3 Short-Tube Evaporators

Short-tube evaporators (calandria) consist of a bundle or basket of short tubes, 2–3-m long, heated outside by steam and immersed in the evaporating liquid and a wider central tube (Fig. 7.6). The liquid flows upward through the short tubes by natural convection, at velocities near to 1 m/s, and flows back in the bottom of the evaporator vat, through the middle wider tube. Some boiling takes place within the tubes. Short-tube evaporators are low-cost systems, effective for evaporation of low-viscosity liquid foods, like sugar solutions. Residence times of several minutes and relatively low evaporation capacities make this system unacceptable for the evaporation of large volumes at heat-sensitive liquid foods. As indicated in Fig. 7.6b, the circulation is influenced by the level of liquid in the short tubes and the temperature gradient between the wall and center of the tubes ( $\Delta T = T_{\text{wall}} - T_{\text{evap}}$ , see also Fig. 7.1).

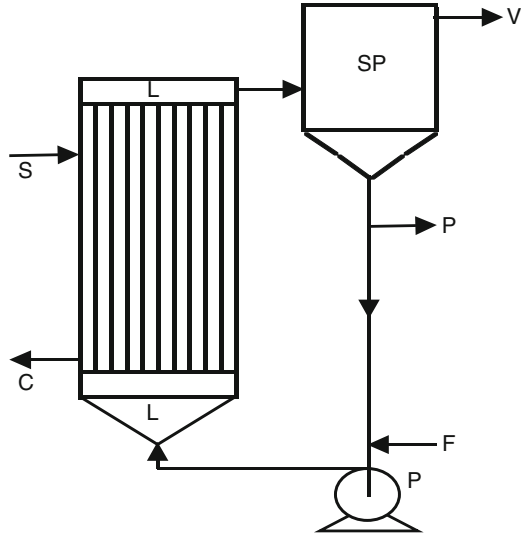
#### 7.4.2.4 Forced-Circulation Evaporators

Figure 7.7 shows a schematic diagram of a forced-circulation evaporator. The liquid is recirculated by a centrifugal pump through an external (or internal) heat exchanger at high velocity (3–5 m/s), where it is heated by condensing steam. Due



**Fig. 7.6** (a) Short tube ("Robert") evaporator (b) Main attributes of a short tube in a "Robert" evaporator ( $L$  = length of a tube,  $d$  = diameter of a tube,  $h_s$  = liquid level in the tube,  $T_w$  = Tube wall temperature,  $T_{evap}$  = Temperature of liquid in the tube)

**Fig. 7.7** Diagram of forced-circulation evaporator. *SP* separator, *P* pump, *S* steam, *F* feed, *C* concentrate, *P* product, *L* liquid, *V* vapor



to the high-pressure drop, the liquid does not boil within the heat exchanger tubes, but it is flashed into the liquid/vapor separator, which is usually maintained in a vacuum. High heat transfer coefficients are obtained, due to high liquid velocities, and fouling of the tubes is prevented. The residence time can be several minutes, and heat-resistant food liquids, such as sugar solutions, are evaporated effectively.

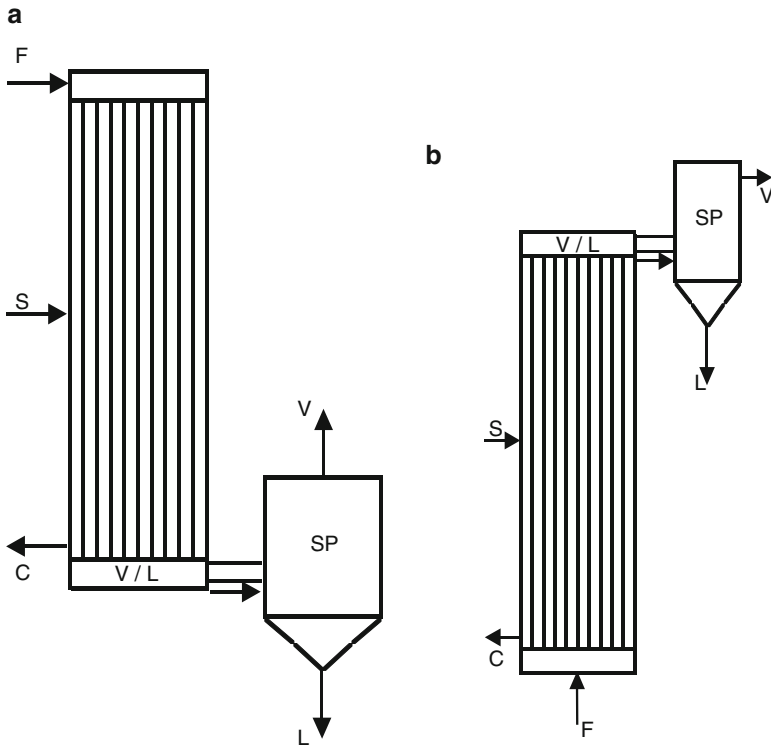
### 7.4.3 Short Residence-Time Evaporators

#### 7.4.3.1 Long-Tube Vertical Evaporators

Most of the heat-sensitive food liquids, like fruit juices and milk, are concentrated in long-tube vertical (LTV) evaporators of 25–50 mm diameter and 4–10 m length. Falling film evaporators are more widely used than rising film units (Fig. 7.1). Because of their length, many long-tube evaporators are often installed outside the plant building. Figure 7.8 shows schematic diagrams of the two types of LTV evaporators.

The falling film system is more popular, because of the high heat transfer coefficients, the low-pressure drop, and the short residence time (a few seconds). The preheated liquid feed must be distributed evenly at the top of the long tubes and the vapor/liquid mixture exiting the bottom is separated in a centrifugal or baffled separator. The concentrated liquid is removed with an appropriate pump (positive displacement, if very viscous), and the vapors are condensed in a surface or mixing condenser, followed by a vacuum system (see Sect. 7.6 of this chapter).

Forced falling film evaporators are used for the concentration of fruit and vegetable pulps (e.g., tomato products). A pump is used to recirculate the partially



**Fig. 7.8** Diagram of long-tube vertical evaporators. (a) Falling film and (b) rising film. *F* feed, *P* product, *S* steam, *C* condensate, *L* liquid, *V* vapors, *S* separator

concentrated product, improving heat transfer and reducing fouling of the evaporation surface.

The rising film evaporators do not need special feed distributors and they are less likely to foul, contrary to the falling film type. However, they operate at higher-pressure drops, meaning that the liquid temperature at the bottom of the tube may be considerably higher than at the top. They also have longer residence time. High vapor/liquid velocities (up to 100 m/s) develop at the exit of the tubes, due to the high evaporation rates in both types of evaporators.

A combination of rising and falling film concentrator (RFC) may have the advantages of both film evaporators (Moore and Hessler 1963; Moore and Pinkel 1968).

### 7.4.3.2 Plate Evaporators

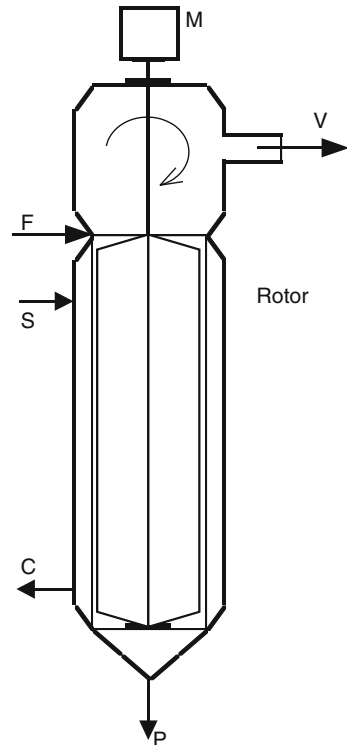
Plate evaporators, operating as falling film or combination RFC units, are similar in principle to the long-tube systems. They have the advantage of shorter length and they are installed inside the plant building. They can also be disassembled and cleaned more easily than the tubular systems.

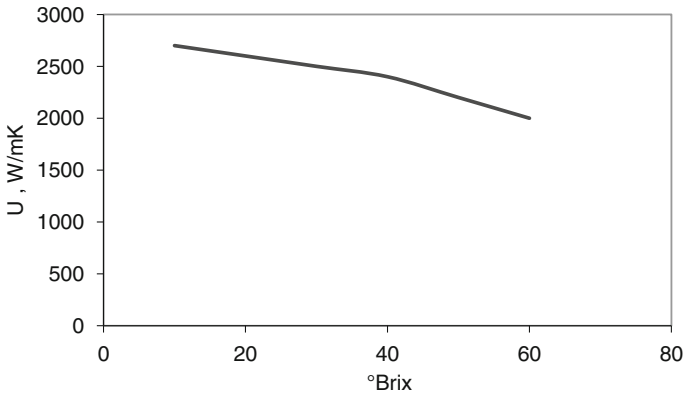
The plate evaporators are similar to the familiar plate heat exchangers (Chap. 6), with special designs for handling boiling viscous liquids and separating the water vapors produced during heating.

### 7.4.3.3 Agitated-Film Evaporators

Agitated-film evaporators are used in the processing of very viscous and fouling liquid foods or suspensions of particulates, which cannot be handled in normal tubular or plate evaporators. The main feature of these evaporators is a rotor within the evaporator body (vertical or horizontal), which agitates the viscous fluid, improving heat transfer and preventing fouling (Fig. 7.9). Various types of low-wear rotors are used, fixed, scraping, or hinged (Minton 1986). In the vertical units, the vapor/liquid separator and the motor can be placed either at the top or at the bottom of the unit. The agitated-film units are often used in combination with tubular film evaporators, when a very high solid concentration is required. The evaporation surface of agitated-film evaporators is limited, e.g., up to 10 m<sup>2</sup>, due to mechanical limitation (a single tube with an agitator). By contrast, tubular (e.g., falling film) evaporators can be constructed with a large number of tubes, i.e., large evaporation surfaces.

**Fig. 7.9** Diagram of agitated-film evaporator with top vapor/liquid separator. *M* motor, *F* feed, *P* product, *S* steam, *C* condensate, *V* vapors





**Fig. 7.10** Overall heat transfer coefficients ( $U$ ) in the evaporation of sucrose solutions at 100 °C in an agitated-film evaporator

In the vertical-type agitated-film evaporator, the rotor can be removed by a hydraulic lift for inspection or repairs. Pilot-scale agitated-film evaporators have a heating surface of less than 1 m<sup>2</sup>. They are 2.5–3.0 m high and they occupy less than 0.2 m<sup>2</sup> floor space. They can operate over a wide range of temperatures with evaporative capacity 1–3 tons water/h.

Agitated-film evaporators can be used as dryers of crystallizing salt solutions, e.g., sodium chloride (Dziak and Skoczylas 1996).

The overall heat transfer coefficient ( $U$ ) of an agitated-film evaporator is generally high, depending on the rotational speed of the blades and the feed rate of the liquid product.

High overall heat transfer coefficients ( $U$ ) of 2000–3000 W/m<sup>2</sup>K are obtained with very viscous fluids (Bhatia 1983).  $U$  values of 2700–2100 W/m<sup>2</sup>K were obtained in the concentration of sucrose solutions at 100 °C from 10 to 60 °Brix (Fig. 7.10), using a pilot-scale agitated-film evaporator (Marinos-Kouris and Saravacos 1974).

#### 7.4.3.4 Centrifugal Film Evaporators

The heat transfer coefficients of liquid films can be increased in a centrifugal field, which increases the hydrodynamic and rheological processes of heat and mass transfer systems. Spinning core evaporators, with very short residence time and high heat transfer coefficients, are suitable for concentrating very heat-sensitive food liquids. Heat transfer coefficients and retention of flavor components in a De Laval Centritherm centrifugal film evaporator were presented by Malkki and Veldstra (1967).

The heat exchange surface consists of rotating concentric disks, similar to those used in centrifugal separators. The disks are double walled and the heating medium

(e.g., steam) flows inside the disks, while the product is distributed by nozzles on the lower external surface of the disks and climbs up during rotation. The product layer is less than 0.1 mm thick, the liquid holdup volume is less than 1.5 L, and the residence time in the evaporator is less than 1 s.

Heat transfer coefficients in the range of 2000–10,000 W/m<sup>2</sup>K were obtained in concentrating corn syrups (0–60 °Brix), using a horizontal rotating disk at 200–1000 RPM (Yanniotis and Kolokotsa 1996). The industrial application of centrifugal film evaporators is limited, due to the high equipment and operating cost and the low evaporation capacity.

## 7.5 Energy-Saving Evaporation Systems

Evaporation and drying are the most energy-intensive unit operations of food processing. With increasing energy costs and concerns over the environmental impact of energy production, energy-saving and utilization systems have been developed and applied in the industry (ERDA 1977). Energy utilization can be improved by low investment (fine-tuning existing evaporators), moderate investment (modifying accessory equipment), or major investment (installing new energy-saving equipment).

The energy required for evaporation, expressed usually in the form of saturated steam, is used mainly to vaporize the water from the liquid food material. Theoretically, the evaporation of 1 kg of water requires slightly more than 1 kg of saturated steam, used as the heating medium, since the enthalpy (heat) of vaporization of water decreases as the pressure is increased. For example, evaporation of water at 100 °C requires 2.26 MJ/kg, and if saturated steam of 4 bar (absolute) pressure is used as the heating medium, the energy given up by its condensation will be 2.13 MJ/kg (Haar et al. 1983). Thus, the steam economy (SE) in this operation will be  $SE = 2.13/2.26 = 0.94$  kg water evaporated/kg steam (single-effect operation). In this example the liquid is assumed to enter and leave the evaporation unit thermally saturated (at the boiling point).

The steam economy of evaporators can be increased substantially, using various energy-saving systems, such as multiple-effect and vapor recompression. Table 7.2 shows typical steam economies of industrial evaporators (Kessler 1986; Hartel 1992; Chen and Hernandez 1997).

The steam economy (SE) in a multiple-effect evaporator system is approximately  $SE = 0.85N$ , where ( $N$ ) is the number of effects (Filho et al. 1984).

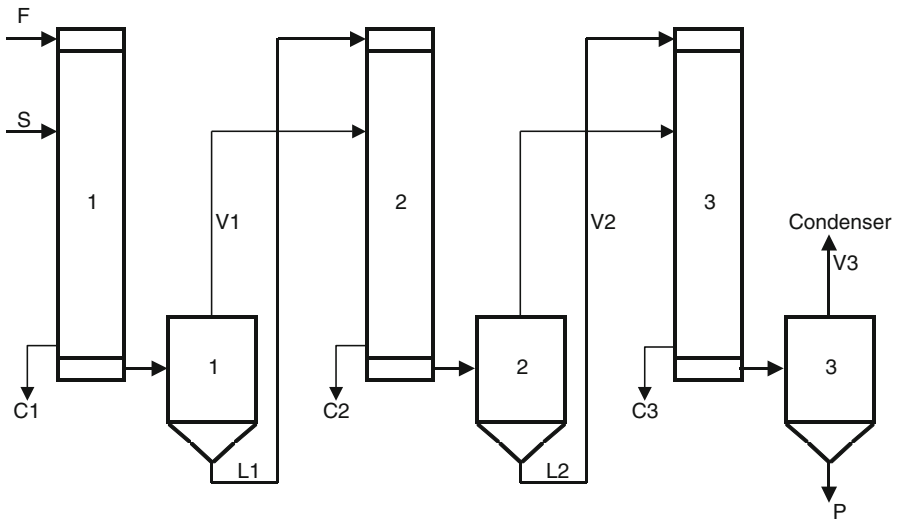
### 7.5.1 Multiple-Effect Evaporators

The multiple-effect (ME) evaporation system is based on the repeated use of the water vapors from one evaporation unit (effect) to heat the next effect, which

**Table 7.2** Steam economies (SE) of evaporator systems

Evaporator system	SE (kg water/kg steam)
Single effect	0.90–0.98
Double effect	1.70–2
Triple effect	2.40–2.80
Six effect	4.6–4.9
Thermocompressor, triple effect	4–8
Mechanical vapor recompression	10–30

Data from Kessler (1986) and Chen and Hernandez (1997)



**Fig. 7.11** Schematic diagram of a triple-effect, forward-feed evaporator. *F* feed, *L* liquid, *V* vapor, *P* product, *S* steam, *C* condensate

operates at a lower pressure. Thus, 1 kg of steam can evaporate more water, depending on the number of effects and the operating pressures.

Thermodynamic considerations lead to the need for decreasing pressure (and temperature) from one effect to the next. For heat-sensitive liquid foods, the temperature in the first effect should not be higher than 100 °C, while the temperature in the last effect should not be lower than, for example, 40 °C, in order to use cooling water at ambient temperature in the condenser of the last vapors. Assuming that the temperature difference ( $\Delta T$ ) in each effect is 10 °C, the maximum number of effects in a food evaporation system should be about  $N = 60/10 = 6$ .

Figure 7.11 shows diagrammatically a triple-effect evaporator with forward-feed operation (cocurrent flow of heating medium-steam/vapors and liquid). Forward-feed evaporators are preferred because the feed (low concentration, low viscosity) is evaporated more efficiently at high temperatures, without serious fouling. In



special cases, backward feed and parallel-flow multiple-effect evaporators may be advantageous, compared to the forward-feed system. Backward feed systems require pumps to transport the liquid from the last to the first effect, against an increasing pressure.

The steam economy (SE) in an ME system is higher than (1) but less than the number of effects ( $N$ ):

$$\left(\sum E\right) = \sum \mu_{oi}/\mu_{\sigma} \quad (i = 1, N) \quad (7.9)$$

where  $m_s$  is the steam consumption (kg/s) and  $m_{vi}$  is the evaporation rate (kg/s) of the ( $i$ ) effect. The SE is estimated from material and energy balances around each effect and over the whole system. The boiling temperature (and pressure) in the last effect of an ME system is limited not only from consideration of the cooling water temperature in the condenser but also from the high viscosity of the concentrated liquid food, which increases sharply as the temperature is lowered. High liquid viscosity means higher fouling and lower heat transfer coefficients, i.e., more expensive operation.

Simplified calculations of a triple-effect evaporator are given in Example 7.1.

The BPE has a negative effect on the operation of a multiple-effect evaporation system. In such a case, the vapors coming out of the vapor/liquid separator will be superheated by (BPE) degrees, but they will be condensed in the heater of the next effect at saturation temperature, losing the (BPE) superheat as available driving force ( $\Delta T$ ). For most liquid foods, the (BPE) is usually small (about 1 °C) and it can be neglected, except in very concentrated sugar solutions and juices (last effects and stages).

In some food evaporation systems, more than one evaporator units are used in the last effect for more economical operation. The vapors coming from the previous effect are split into two or more parts, and they are used to heat two or more stages, operating at the same pressure of the last effect. Each stage is fed with concentrating liquid from the previous stage. A simplified double-effect, three-stage evaporator is shown in Fig. 7.12. A more complex citrus quintuple-effect, 8-stage TASTE evaporator is discussed by Chen and Hernandez (1997) (TASTE = thermally accelerated short-time evaporator).

In the evaporation of large quantities of aqueous nonfood solutions (e.g., water desalination), the number of effects in ME systems may be much higher than in food evaporators, because higher temperatures in the first effect can be used, and the temperature difference ( $\Delta T$ ) per effect can be smaller. Thus, ME systems with 8–12 effects may be used, achieving significant reduction of the cost of evaporation. In very large desalination plants (e.g., from seawater), the multiple-stage flash (MSF) evaporation system is used with a large number of stages (25–50) and a small ( $\Delta T$ ) per effect.

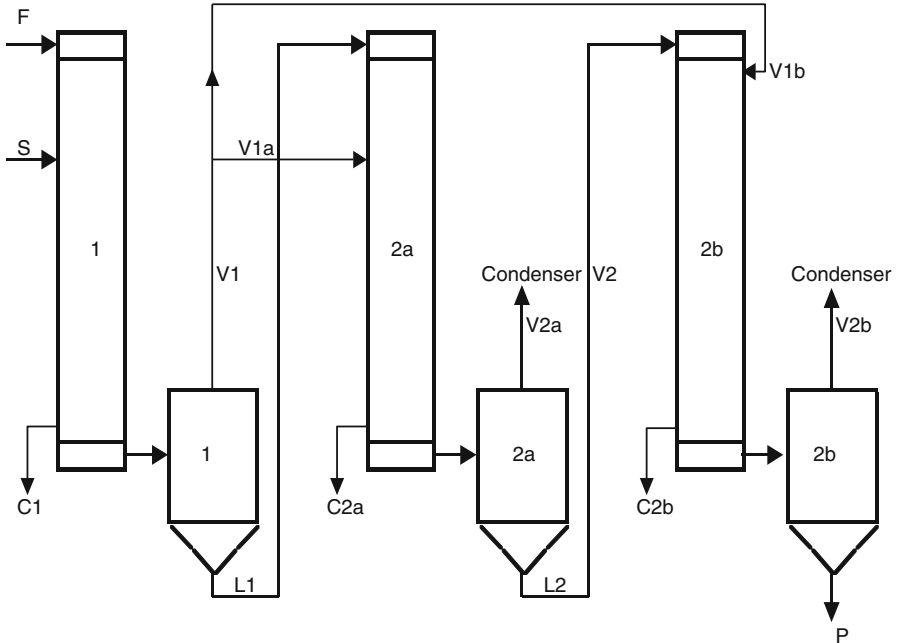


Fig. 7.12 Diagram of a double-effect, three-stage evaporator

### 7.5.2 Vapor Recompression Evaporators

Steam economies higher than those of multiple-effect systems can be obtained by vapor recompression evaporators, in which the vapors from the evaporation unit are compressed and reused as a heating medium. Recompression is achieved by either thermal or mechanical compressors (Fig. 7.13).

The thermocompressor system uses a steam ejector with high-pressure steam (about 7 bar) to increase the pressure and temperature of the water vapors and use the compressed mixture as the heating medium. The operation of the steam ejectors is described briefly in the Appendix D.

Material balances of the system indicate that part of the water vapors must be removed to the condenser for establishing an equilibrium balance in the system. The thermocompressor system is used when high-pressure steam is available at a low cost. Steam economies (SE) of 4–8 can be achieved, higher than those of typical multiple-effect food evaporators.

Mechanical vapor recompression (MVR) evaporators are used more extensively than the thermocompressor system, because of their high steam economy (higher than 10) and the lower operating cost, especially when electrical power is available at low cost.

The vapors are compressed mechanically and they are used as the heating medium of the evaporator unit. A small amount of heating steam is added to the

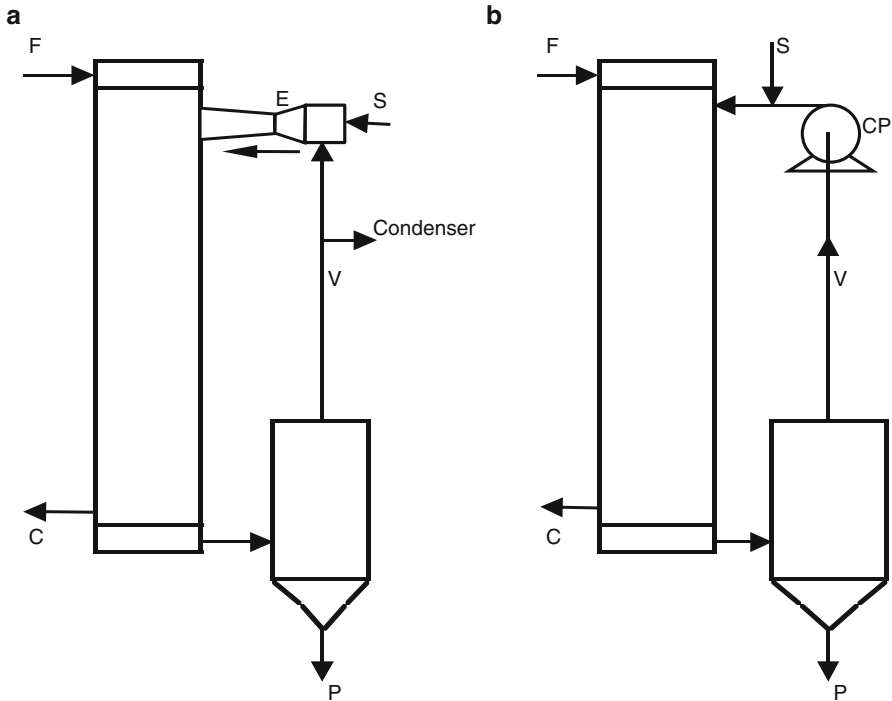


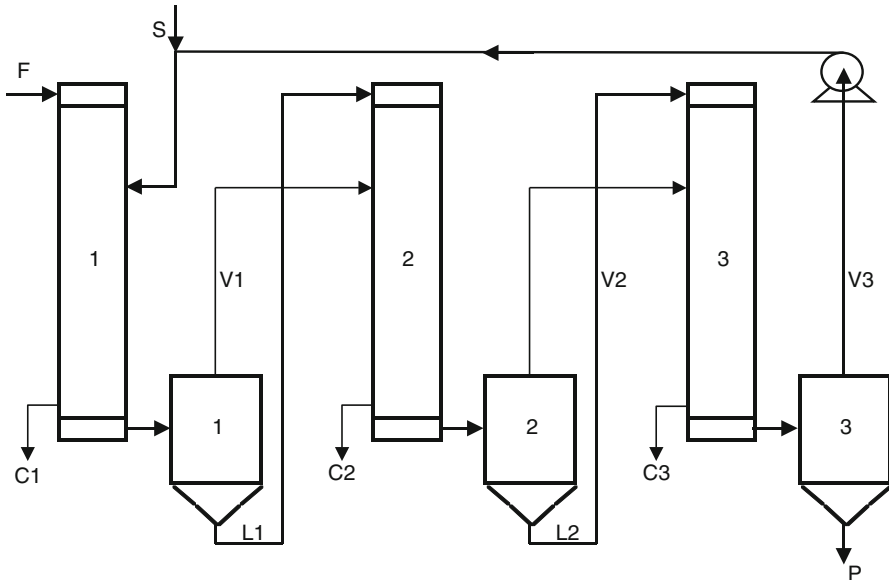
Fig. 7.13 Vapor recompression evaporators. (a) Thermal. (b) Mechanical compressor

system to make up the condensate formed during compression of water vapors. Sizing and cost data for both thermocompressor and MVR systems are given by Minton (1986).

Centrifugal compressors are used to compress the water vapors by a ratio of 1.4–2.0, increasing the temperature difference ( $\Delta T$  to 20.5 by)  $^{\circ}\text{C}$ . More economical operation is obtained with turbo fans, which operate at a lower compression ratio, e.g., 1.2 which corresponds to a ( $\Delta T$  of about)  $5^{\circ}\text{LowC}$ .  $\Delta T$ s can be applied to falling film evaporators with no appreciable boiling point rise and pressure drop in the tube.

Combined multiple-effect and vapor recompression systems, offering high steam economies and economic operation, are often used in the concentration of liquid foods. Figure 7.14 shows schematically a combination of a triple-effect evaporator with a mechanical vapor recompressor, which compresses the vapors of the last effect to heat the first effect.

Typical technical data on commercial evaporators of tomato products are shown in Table 7.3. The multistage (double- or triple-effect) falling film evaporators are supplied by three different manufacturers. Evaporators I and III are similar, free-falling film units, from the same manufacturer. Evaporators II, IV, and V are similar, forced falling film units, from a second manufacturer. Evaporator VI consists of a free-falling film evaporator (first stage), followed by an agitated-film evaporator (second stage), made by a third manufacturer.



**Fig. 7.14** Combination of a triple-effect evaporator with a MVR unit

As indicated in Table 7.3, for achieving the same product concentration, a triple-effect evaporator requires about 30 % less steam than the double-effect system. Furthermore, in comparison to the double-effect, a triple-effect evaporator consumes about 35 % less water but requires 20–40 % more electrical energy. With respect to the floor space, both units (the double- and the triple-effect evaporators of the same manufacturer) have the same overall dimensions. Both require 50–70 m<sup>2</sup> floor space and are 11–12 m high. The dimensions change, if the capacity of a unit varies. If, e.g., the capacity of a certain type of evaporator is tripled, the required floor space and height increase by 40 %. However, in such a case, the required cooling water and electrical energy are reduced by about 40 %. When an agitated-film evaporator is added to an evaporation system, the consumption of cooling water decreases, since the water vapors are better used (an extra effect), but more energy is required for the agitator.

Typical technical data on commercial falling film evaporators of tomato products are shown in Table 7.3.

### 7.5.3 Heat Pump Evaporators

Heat pump evaporators are relatively low-capacity evaporation systems, which utilize the heat pump system for evaporation of a liquid and the refrigeration system for condensing the water vapors. The system operates at low evaporation

**Table 7.3** Technical data of commercial tomato evaporators (see list of suppliers)

Evaporator type	Evaporator I double effect	Evaporator II double effect	Evaporator III triple effect	Evaporator IV triple effect	Evaporator V triple effect	Evaporator VI double-effect, falling/agitated film
Evaporation heat transfer area (m <sup>2</sup> )	40	72		72	118	96
Evaporator height (m)	11	12	11	11	19	15
Evaporation of water capacity (tons/h)	11	11	11	11	33	34
Raw tomatoes (tons/h)	14	14	14	14	34	
Tomato concentrate 30 °Brix tons/h	2.6	2.4		2.4	7.4	
Steam consumption (tons/h)	4	5.6	3.8	4	14	
Cooling water (m <sup>3</sup> /h)	80	380	80	250	750	100
Power consumption (kW)	110	50	110	78	118	130

temperatures, and it could be favorable for heat-sensitive liquid foods. However, industrial application of the system is limited, as in the case of the heat pump dryers (Chap. 8), because of low evaporation capacity and high operating cost.

### **7.5.4 Combined Reverse Osmosis/Evaporation**

Removal of a large portion of water from dilute food liquids by membrane techniques (mostly reverse osmosis) followed by falling film evaporation would be an economical concentration system, obtaining higher quality of heat-sensitive food fluids. The economics and operability of such a system should be examined in detail for each food system (Moresi 1988).

### **7.5.5 Water Desalination**

Evaporation is the main desalination method for water desalination, followed by reverse osmosis (Chap. 12). Multiple-effect evaporators, usually the falling film type, with a large number of effects (10–12) are used in medium-size applications to desalinate both brackish water and seawater. Thinner tubes, made of heat-conductive metals, instead of the stainless steel tubes of the food evaporators, and higher operating temperatures can achieve very high overall heat transfer coefficients, e.g., 8000 W/m<sup>2</sup>K. Vapor recompression evaporators with high heat economy are used in smaller installations. Scaling (fouling of the evaporation surface) is prevented by acid pretreatment.

For large capacities, the MSF evaporation system is used. It consists of a series of several heat exchangers (20–40), in which the feed water is preheated by the condensing vapors of flashing water. Small temperature differences are used between the two streams (e.g., 2–3 °C), and capacities of about 20,000 m<sup>3</sup>/day of desalted water are produced at the lowest desalination cost.

### **7.5.6 Waste-Heat Evaporators**

In large-scale evaporation applications, such as sugar refining and water desalination, significant economies can be achieved by using waste steam from power generation plants (dual-generation system). High-pressure steam is used to generate the required electrical power and the low-pressure steam (about 2 bar), rejected from the steam turbines, can be utilized as a heating medium in ME and MSF evaporators.

Hot exhaust gases, e.g., from air-dryers, can be utilized as a heating medium for evaporators. Such a system can be applied to the processing of citrus waste (peels

and pulp), which is normally dehydrated in a rotary air-dryer, heated by combustion gases. The exhaust hot gases can heat an evaporator, which can concentrate the citrus waste liquor (molasses) (Filho et al. 1984).

Energy-rich wastes from food processing plants can be utilized to produce process steam. For example, in cane sugar processing, steam for the evaporators can be produced by combustion of cane sugar bagasse.

## 7.6 Evaporator Components

The main components of the evaporation assembly are the preheater, the evaporator body, and the vapor/liquid separator. The evaporator accessories include the condenser, the vacuum system, the pumps and piping, and the process control system. The preheaters are shell and tube or plate heat exchangers, which are examined in Chap. 6. Process pumps and piping are discussed in Chap. 3.

### 7.6.1 Evaporator Bodies

Two main evaporator bodies are used mainly in food processing applications, i.e., the LTV and the plate evaporators.

#### 7.6.1.1 LTV Evaporators

The LTV evaporator consists of long tubes, usually 50 mm diameter and 6–12 m length for once-through operation or 4–7 m long for recirculation operation. Many vertical tubes (50–500), forming a bundle, are installed in a steam jacket, creating a large heat transfer area, e.g., 100–200 m<sup>2</sup>.

The evaporator tubes are normally made of stainless steel (304 or 316), highly polished to conform to the hygienic standards, e.g., 3-A (Chap. 2). The tubes are joined to the tube sheet by mechanical expansion, usually in a triangular layout, which gives more surface area for a given shell diameter (APV 1987).

Falling film evaporators are widely used in the evaporation of the heat-sensitive liquid foods, due to their superior heat transfer performance and the simplicity in construction. They operate mostly as once-through units with short residence time (a few seconds). However, partial recirculation of the liquid may be desirable for maintaining the liquid film in the evaporator tubes or plates, as in the last effect of a falling film evaporator, where the volume of the concentrated liquid is reduced to a point that the liquid film may break up, increasing the fouling rate. Recirculation in a falling film evaporator would have the added advantage of increasing the heat transfer coefficient but at a penalty of increased residence time (minutes) and energy (pump) cost.

The falling film evaporators require special distributors of the liquid feed at the top of the tubes, which ensure even distribution of the liquid in all tubes, preventing the formation of “hot spots” and fouling in the internal surface of the evaporation tubes. Two types are normally used, the trough (static system) and nozzle cone (dynamic system). Special liquid distribution nozzles are also used in falling film plate evaporators.

The mechanical design of LTV evaporators should consider the stability of the long vertical tubes in “upset” conditions, e.g., thermal expansion, vacuum operation, and mechanical vibration during operation. The evaporation system should conform to the construction and inspection codes of engineering societies and national agencies (Chap. 2).

### 7.6.1.2 Plate Evaporators

The plate evaporators consist of alternating liquid and steam plates, assembled in a similar manner with the plate heat exchangers (Chap. 6). The main difference between the two systems is that in the plate evaporators, the heating medium is saturated steam, while hot water or hot liquid stream is used for heating in the plate heat exchangers. In addition, plate evaporators are designed to handle evaporating liquid films and vapors produced during evaporation, which are separated in a vapor/liquid separator.

Two principal types of plate evaporators are used, i.e., the rising/falling and the falling systems. In addition, two special types of plate evaporators may be used for highly viscous food products, i.e., the Parafflow and the Parafash units (APV 1987). The usual plate evaporators are rising/falling film once-through units, with short residence time (a few seconds) and capacities up to 15,000 kg/h. Better heat transfer coefficients, shorter residence times, and higher capacities (up to 30,000 kg/h) are obtained with the falling film plate evaporators, which require special liquid distributors for effective operation.

The plate evaporators use special elastomer gaskets (nitrile-butadiene or isobutylene-isoprene rubbers), which can stand steam temperatures up to 120 °C (2 bar) and withstand normal vacuum operation, with boiling temperatures 40–95 °C (see Chap. 6).

## 7.6.2 Vapor/Liquid Separators

The mixture of vapors/liquid, exiting the evaporator body, must be separated effectively into the concentrated liquid and the vapors, which are subsequently led to the condenser. The vapors may contain significant amounts of product in the form of droplets or foam, due to entrainment, splashing, or foaming. Entrainment is caused by high-velocity vapors, produced by rapid evaporation. Foaming is caused by the presence of surface-active agents in the liquid food and the leaking of air into



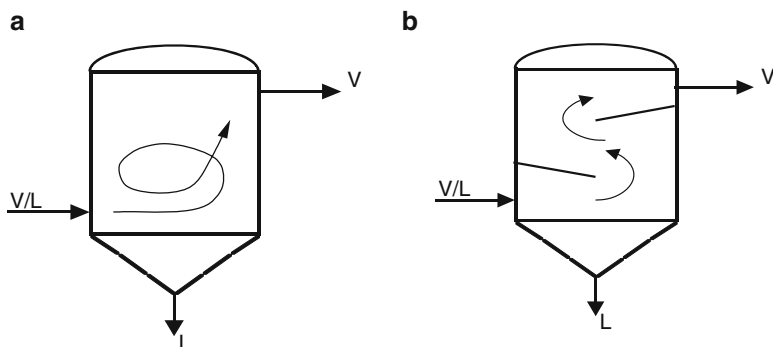


Fig. 7.15 Vapor/liquid (V/L) separators: (a) centrifugal, (b) baffled

the evaporator. Special design of the vapor/liquid separator or use of antifoam compounds can control foaming. Loss of product into the vapors and the condensate is undesirable not only for economic reasons, but it may create environmental problems in the disposal of the condensate.

Two main types of separators are used in industrial operations: (1) centrifugal or cyclone separators and (2) baffle separators (Fig. 7.15). In addition, gravity separators may be used, i.e., large tanks where vapor velocity is reduced sharply (Hahn 1986).

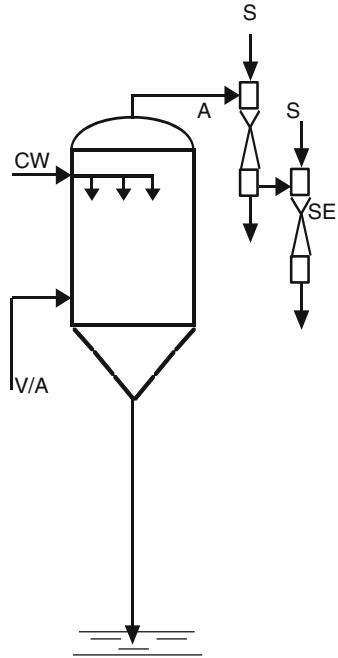
The velocity of the vapors entering the centrifugal separator should be lower than 100 m/s. The vapors enter tangentially the separator, and they develop a swirling motion, which throws the liquid droplets to the walls of the separator. Sizing of the centrifugal separators is similar to the analysis of the mechanical cyclones, as discussed in Chap. 5. Larger separators may be needed in high-vacuum operation, such as in the last effect of a multiple-effect evaporation system. The baffle separators are based on the change of the direction of vapor flow, due to mechanical obstacles (baffle plates). The liquid droplets are collected on the baffles, coalescing into a liquid, which flows by gravity downward.

### 7.6.3 Condensers

Vapors produced during evaporation are preferentially used as a heating medium in multiple-effect evaporators or in vapor recompression systems. Some vapors may be used for preheating the feed to the evaporator. The remaining vapors are condensed in two types of condensers, i.e., surface and mixing condensers.

Condensers are part of vacuum maintaining systems, since they remove the water vapors, which otherwise would increase the evaporation pressure. Large-diameter vapor pipes are required between the evaporator/separator and the condenser, for reducing the pressure drop, due to the high vapor velocity, in vacuum operation.

**Fig. 7.16** Barometric condenser and steam ejector vacuum system. *V* vapors, *A* air, *CW* cold water, *SE* steam ejector, *S* high-pressure steam



The surface condensers are actually shell and tube heat exchangers, cooled with cold water, and the condensate is collected as a separate stream, preventing the pollution of the environment. The condensate may be used for the recovery of aroma components in a distillation column.

In the less-expensive mixing condenser, the vapors are condensed by direct contact with the cooling water, and the mixture is discharged to the environment. In vacuum operation, the condensate/water mixture is extracted from the system by either a centrifugal pump or a barometric condenser (Fig. 7.16).

The barometric leg of the condenser should be at least 10.5 m, which is the liquid water column corresponding to atmospheric pressure (1.03 bar).

The barometric leg of the condenser should be at least 10.5 m, which is the liquid water column corresponding to atmospheric pressure (1.03 bar). The reduced pressure in the evaporator is achieved by condensation of vapors and the auxiliary action of the vacuum pump, which is necessary for removing any air leaks and incondensable gases present in fluid food material.

#### 7.6.4 Vacuum Systems

A vacuum maintaining system is necessary, in addition to the condenser, to remove any air leaks and incondensable gases present in fluid food material. Two principal

vacuum systems are used for food evaporators, i.e., the steam jet ejectors and the liquid-ring vacuum pump, which are directly attached to the condenser, as shown in Fig. 7.16.

The steam jet ejectors remove the non-condensable gases by entrainment in high-pressure steam, flowing at high velocities in a specially designed ejector. Two or more jet ejectors (steam pressure about 7 bar) in series are used to produce high vacuum (down to 1 mbar or lower).

The liquid-ring pump is a centrifugal pump with a liquid ring, which seals the rotor chamber and pumps out the air and condensable gases into the atmosphere. For high-vacuum operation, two-stage pump systems may be required (Bhatia and Cheremisinoff 1981). For normal evaporators, the liquid ring in the vacuum pump is water, but, for high-vacuum operation, oil and other low-vapor liquids are used. The vacuum equipment is reviewed briefly in Appendix D (Utilities).

### **7.6.5 Evaporator Control**

Efficient operation of the evaporator system requires process control, which is achieved mainly by simple or advanced control systems. The control system should respond to changes in feed composition and conditions and change the heat supply in order to maintain the specified product concentration. In all control systems, steam is the manipulated parameter, while product concentration (e.g., °Brix) and evaporation rate are the primary control variables.

The simple feedback control is based on monitoring and controlling the product quality by manipulating the heat (steam) input. This is a trial-and-error operation with a relatively wide variation of product quality. The feedforward and cascade control systems provide a faster response and a smoother variation of product quality by considering in advance any changes in the feed condition. Process instrumentation and control, e.g., programmed logic controllers (PLC), are reviewed in Appendix C.

### **7.6.6 Testing of Evaporators**

The testing and evaluation of performance of evaporators can be performed, using a procedure developed by the American Institute of Chemical Engineers (AIChE 1979) and mentioned in Chap. 2. Standardized measurements are made, after the evaporator has reached steady-state operation. The measurements include feed, product, and steam rates and temperatures; steam, evaporator body, and condenser pressures; cooling water temperatures; and entrainment of solids in the condensates. BPE and heat losses, if significant, are also estimated. The evaporator size is determined by the area ( $m^2$ ) of the heating surface, i.e., the interior surface of tubes or plates where the liquid is evaporated.

From material and energy balances, the following important quantities are obtained: evaporation rate (capacity), kg/h; steam consumption, kg/h; steam economy, kg evaporation/kg steam; mean temperature difference, K; and overall heat transfer coefficient,  $W/m^2K$ . The evaporation capacity and the overall heat transfer coefficient are the most important characteristics of the evaporator in a given application. Repeated test data during the operation of an evaporator are necessary to determine the fouling rate and the accompanying reduction of the overall heat transfer coefficient and evaporation capacity.

### 7.6.7 Hygienic Considerations

Hygienic (sanitary) guidelines and codes for food processing equipment (Chap. 2) are of particular importance to the design, operation, and cleaning of food evaporators. The most important hygienic problem is the fouling of evaporation surfaces, caused by deposition of food colloids and other food components, which reduces the heat transfer and evaporation rate (capacity). Fouling is an empirical function of the operation time, and periodic cleaning is necessary (Minton 1986). The operation cycle may be long (a week) for sugar evaporators and shorter for dairy units (a day), due to the precipitation of milk heat-sensitive proteins. CIP cleaning systems can be used for all the parts of food-contact equipment.

*Example 7.1* Preliminary design of a triple-effect evaporator for concentration of the orange juice of Example 1.1. The evaporator will concentrate the feed  $m_f = 7000$  kg/h of 12 °Brix to a concentrated product  $m_p = m_3 = 1292$  kg/h of 65 °Brix. Thus, the evaporation capacity of the evaporator system will be  $m_v = m_f - m_p = 7000 - 1292 = 5708$  kg/h. Figure 7.17 shows a process block diagram of the evaporation system, which is useful for setting up the required material and energy balances.

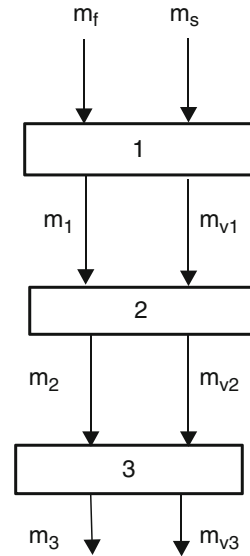
The following assumptions are made to simplify the preliminary calculations: feedforward triple-effect system. Feed enters the first effect and product leaves the last (third) effect at the corresponding boiling points, negligible boiling point elevation (BPE=0), and negligible heat losses. Saturated steam at 110 °C (1.43 bar) is used to heat the first effect, and saturated condensates are removed from each effect. The boiling point in the last effect is 50 °C (0.123 bar). Thus, available overall temperature difference  $\Delta T = 110 - 50 = 60$  °C. The whole evaporation system is assumed to be adiabatic, i.e., the heat transferred in each effect is identical:

$$Q_s = Q_1 = Q_2 = Q_3 \quad (7.10)$$

or

$$m_s \Delta H_s = m_{v1} \Delta H_1 = m_{v2} \Delta H_2 = m_{v3} \Delta H_3 \quad (7.11)$$

**Fig. 7.17** Process block diagram of the feedforward triple-effect evaporator (Example 7.1)



The heat transfer rate in each effect is given by the basic transfer equation (7.2). Therefore, (7.10) becomes

$$U_1 A_1 \Delta T_1 = U_2 A_2 \Delta T_2 = U_3 A_3 \Delta T_3 \quad (7.12)$$

From the engineering and construction standpoint, the evaporator bodies of the three effects should be preferably identical, i.e.,  $A_1 = A_2 = A_3$ , resulting in the equation:

$$U_1 \Delta T_1 = U_2 \Delta T_2 = U_3 \Delta T_3 \quad (7.13)$$

The overall heat transfer coefficients in the three effects will decrease in the order  $U_1 > U_2 > U_3$ , due to the increase of concentration and viscosity of the food liquid. Therefore, according to (7.13), the respective temperature differences will increase in the order  $\Delta T_1 < \Delta T_2 < \Delta T_3$ . Reliable data on the overall heat transfer coefficient ( $U$ ) are needed for the design of the evaporator. In the absence of direct data for the evaporation of orange juice of this example, the  $U$  values of unfiltered (cloudy) apple juice (Fig. 7.4) at the corresponding °Brix can be used as approximate values:  $U_1 = 1600 \text{ W/m}^2\text{K}$ ,  $U_2 = 1400 \text{ W/m}^2\text{K}$ , and  $U_3 = 700 \text{ W/m}^2\text{K}$ . An approximate (guessed) value for the intermediate heat transfer coefficient ( $U_2$ ) was assumed, since the concentration in the second effect is not known beforehand. Thus, (7.13) becomes

$$1600 \Delta T_1 = 1400 \Delta T_2 = 700 \Delta T_3 \quad (7.14)$$

The overall temperature difference (DT) is given by the equation:

$$\Delta T_1 + \Delta T_2 + \Delta T_3 = 60 \quad (7.15)$$

From the last two equations, it follows that  $\Delta T_1 = 13.6^\circ\text{C}$ ,  $\Delta T_2 = 15.4^\circ\text{C}$ , and  $\Delta T_3 = 31^\circ\text{C}$ . Therefore, the boiling temperatures at the three effects will be:  $T_1 = 96.4^\circ\text{C}$ ,  $T_2 = 81^\circ\text{C}$ , and  $T_3 = 50^\circ\text{C}$ .

It should be noted that the high temperature in the first effect ( $96.4^\circ\text{C}$ ) is sufficient to pasteurize the orange juice and inactivate the pectic enzymes (stabilization of the juice cloud). From steam tables (Haar et al. 1983; Appendix B), the heats of vaporization of water at the three boiling temperatures will be  $DH_s = 2230 \text{ kJ/kg}$  ( $110^\circ\text{C}$ ),  $DH_1 = 2266 \text{ kJ/kg}$  ( $96.4^\circ\text{C}$ ),  $DH_2 = 2306 \text{ kJ/kg}$  ( $81^\circ\text{C}$ ), and  $DH_3 = 2382 \text{ kJ/kg}$  ( $50^\circ\text{C}$ ).

The flow rates of steam and water vapors in the three effects are calculated from the equations:

$$2230m_s = 2.266m_{v1} = 2306m_{v2} = 2382m_{v3} \quad (7.16)$$

and

$$m_{v1} + m_{v2} + m_{v3} = 5708 \quad (7.17)$$

Thus  $m_s = 1978 \text{ kg/h}$ ,  $m_{v1} = 1945 \text{ kg/h}$ ,  $m_{v2} = 1912 \text{ kg/h}$ , and  $m_{v3} = 1851 \text{ kg/h}$ .

The steam economy of the triple-effect evaporator will be  $(SE) = (5708)/(1978) = 2.88$ .

The heat transfer area of each effect will be  $(7.12) A = (1978 \times 2230)/(1600)(13)(3.6) = 60 \text{ m}^2$ .

Assuming that tubes of 50 mm internal diameter and 10 m long are used, the required number of tubes per effect will be  $N = (60)/3.14 \times 0.05 \times 10 = 38$ . This is a medium-size evaporator, because of the medium evaporation rate (capacity) of the example (5708 kg/h).

The concentration of the juice in the intermediate (second) effect of the evaporator ( $X_1$ ) is calculated by a material balance:  $m_1 = m_f - m_{v1} = 7000 - 1945 = 5055 \text{ kg/h}$  and  $X_1 = 12 (7000/5055) = 16.6^\circ\text{Brix}$ .

The vapor velocities at the exit of the falling film evaporator effects are of importance to the design of the vapor/liquid separators. The vapor flow rates at the exit of the three effects will be  $m_{v1} = 0.54 \text{ kg/s}$ ,  $m_{v2} = 0.53 \text{ kg/s}$ ,  $m_{v3} = 0.514 \text{ kg/s}$ . The vapor densities in the three effects, taken from the steam tables, will be  $r_{v1} = 0.54 \text{ kg/m}^3$ ,  $r_{v2} = 0.243 \text{ kg/m}^3$ , and  $r_{v3} = 0.083 \text{ kg/m}^3$ . The cross-sectional area of each tube will be  $(3.14) \times (0.05)^2/4 = 0.002 \text{ m}^2$ . Therefore, the exit vapor velocity in the three effects will be  $u_1 = (0.54)/(38) \times (0.002) \times (0.54) = 8.3 \text{ m/s}$ ,  $u_2 = (0.53)/(38) \times (0.002) \times (0.243) = 29 \text{ m/s}$ , and  $u_3 = (0.514)/(38) \times (0.002) \times (0.083) = 81.5 \text{ m/s}$ . The highest vapor velocity is found, as expected, in the last effect, which operates at the lowest pressure (highest vacuum) of the system. The vapor velocities should be taken into consideration in designing the vapor/liquid

separators of the evaporator. It may be necessary to design a larger separator for the last effect in order to prevent liquid entrainment in the vapors.

## Notes

1. The simplified solution of this example is based on assumed values of the overall heat transfer coefficients ( $U$ ) in the three effects of the evaporator. The feed and product concentrations (°Brix) of orange juice are known, and so the corresponding ( $U$ ) values can be taken from a reference material (in this case, unfiltered apple juice, Fig. 7.4). However, the juice concentration in the intermediate (second) effect is not known, and a guess (approximation) is made, making the subsequent calculations a trial-and-error solution. The solution can be refined by repeating the calculations, using a new (improved) value of ( $U$ ), corresponding to the estimated concentration in the second effect. More detailed calculations of complex evaporation systems (e.g., considering the BPE in all effects) require computer programs, which can also optimize the energy use and cost of evaporation (Chen and Hernandez 1997; Holland and Liapis 1983).
2. The third effect of the given evaporator operates at a large temperature difference  $\Delta T_3 = 31$  °C and a high juice concentration (65 °Brix), condition which favor fouling of the evaporator surface. The operation can be improved and become more economical by splitting the third effect into two stages (Fig. 7.11).
3. The calculated steam economy of the triple-effect evaporator (2.88) can be improved by adding one or two (at the most) effects to the system or by using a MVR system, compressing the vapors of the last effect to heat the first effect (Fig. 7.13). The latter alternative would be more economical, with the added advantage of eliminating the need for a large condenser for all the vapors of the last effect.

## References

- AICHE (1979) Testing procedure for evaporators. American Institute of Chemical Engineers, New York
- Alfa-Laval (1972) Evaporation handbook. Alfa-Laval, Lund
- APV (1987) Evaporator handbook. Bulletin EHB-987. APV Crepaco, Rosemont
- Bhatia MV (1983) Transfer operations in process industry design and equipment. Technomic, Lancaster
- Bhatia MV, Chermisinoff PN (1981) Air movement and vacuum devices. Technomic, Lancaster
- Billet R (1988) Evaporation technology. VCH, Weinheim
- Bouman S, Brinkman DW, de Jong P, Waalewijn R (1988) Multistage evaporation in the dairy industry: energy savings, product losses and leaning. In: Bruin S (ed) Preconcentration and drying of food materials. Elsevier, Amsterdam, pp 51–60
- Bourgeois J, LeMaguer M (1984) Modeling of heat transfer in a climbing film evaporator. III. Application to an industrial evaporator. *J Food Eng* 3:39–50

- Bourgois J, LeMaguer M (1987) Heat transfer correlation for upward liquid film heat transfer with phase change. Application in the optimization and design of evaporators. *J Food Eng* 6:291–300
- Chen SC (1993) Physicochemical principles for the concentration and freezing of fruit juices. In: Nagy S, Chen CS, Shaw PE (eds) *Fruit juice processing technology*. Agscience, Auburndale, pp 23–55
- Chen SC, Hernandez E (1997) Design and performance evaluation of evaporators. In: Valentas KJ, Rotstein E, Singh RP (eds) *Handbook of food engineering practice*. CRC, New York, pp 211–252
- Dziak J, Skoczylas A (1996) The application of thin film evaporator for getting solid powders from liquid solutions. In: *Proceedings of IDS'96, vol. A*. Lodz Technical University, Lodz, pp 447–454
- ERDA (1977) *Upgrading evaporators to reduce energy consumption*. ERDA, U.S. Department of Commerce, Washington
- Filho JG, Vitali AA, Viegas FCP, Rao MA (1984) Energy consumption in a concentrated orange juice plant. *J Food Process Eng* 7:77–89
- Green D, Perry R (1997) *Perry's chemical engineers' handbook*. McGraw-Hill, New York
- Haar L, Gallagher JS, Kell GS (1983) *NBS/NRC steam tables*. Hemisphere, New York
- Hahn G (1986) Evaporator design. In: *Concentration and drying of foods*. Elsevier, London, pp 113–131
- Hartel RW (1992) Evaporation and freeze concentration. In: Heldman DR, Lund DB (eds) *Handbook of food engineering*. Marcel Dekker, New York
- Holland CD, Liapis AI (1983) *Computer methods for solving separation problems*. McGraw-Hill, New York
- Kessler HG (1981) *Food engineering and dairy technology*. Verlag A. Kessler, Freising
- Kessler HG (1986) Energy aspects of food preconcentration. In: MacCarthy D (ed) *Concentration and drying of foods*. Elsevier, London, pp 147–163
- Malkki Y, Veldstra J (1967) Flavor retention and heat transfer during concentration of liquids in a centrifugal film evaporator. *Food Technol* 21:1179–1184
- Marinos-Kouris D, Saravacos GD (1974) Distillation of volatile compounds from aqueous solutions in an agitated film evaporator. In: *Proceedings of GVC/AIChE joint meeting, Munich, vol. IV*
- McAdams WH (1954) *Heat transmission*. McGraw Hill, New York
- Minton PE (1986) *Handbook of evaporation technology*. Noyes, Park Ridge
- Moore JG, Hessler WE (1963) Evaporation of heat sensitive materials. *Chem Eng Prog* 59:87–92
- Moore JG, Pinkel EG (1968) When to use single pass evaporators. *Chem Eng Prog* 64:29–44
- Moresi M (1988) Apple juice concentration by reverse osmosis and falling film evaporation. In: Bruin S (ed) *Preconcentration and drying of food materials*. Elsevier, Amsterdam, pp 61–76
- Morgan AI (1967) Evaporation concepts and evaporation design. *Food Technol* 21:153
- Reid RC, Prausnitz JM, Poling BE (1987) *The properties of gases and liquids, 4th edn*. McGraw-Hill, New York
- Saravacos GD (1970) Effect of temperature on the viscosity of fruit juices and purees. *J Food Sci* 25:122–125
- Saravacos GD (1974) Rheological aspects of fruit juice evaporation. In: Spicer A (ed) *Advances in preconcentration and dehydration of foods*. Applied Science, London, pp 104–107
- Saravacos GD, Maroulis ZB (2001) *Transport properties of foods*. Marcel Dekker, New York
- Saravacos GD, Moyer JC, Wooster GD (1970) Concentration of liquid foods in a Falling film evaporator. Bulletin no. 4. New York State Agricultural Experiment Station, Cornell University, Geneva
- Schwartzberg HG (1977) Energy requirements in liquid food concentration. *Food Technol* 31 (3):67–76
- Yanniotis S, Kolokotsa D (1996) Boiling on the surface of a rotating disc. *J Food Eng* 30:313–325



# Chapter 8

## Food Dehydration Equipment

### 8.1 Introduction

Food dehydration, a traditional method of food preservation, is also used for the production of special foods and food ingredients and for the utilization of food plant wastes. A wide variety of industrial food drying equipment is used, developed mostly empirically but continuously improved by recent advances in drying technology and food engineering. In addition to the basic process engineering requirements, food dryers must meet the strict standards for food quality and food hygiene and safety.

Removal of water from the food materials is usually accomplished by thermal evaporation, which is an energy-intensive process, due to the high latent heat of vaporization of water (e.g., 2.26 MJ/kg at 100 °C).

Part of the water in “wet” food products can be removed by inexpensive nonthermal processes, like mechanical pressing/expression, filtration, centrifugation, or osmotic dehydration. Mechanical pressing is used effectively to remove 20–30 % of free water from solid food wastes, before thermal drying.

Dehydration of liquid foods, such as milk and soluble coffee, is normally preceded by efficient thermal evaporation. Energy-saving systems, such as multiple-effect and vapor recompression evaporators, which are very efficient in evaporation, cannot be applied to food dehydration.

The diversity of drying processes and equipment used in food processing is caused by the difficulty of handling and processing solid materials and the special requirements for the various food products. In addition, economics (investment and operation) is an important factor, especially for large-volume, low-cost products, such as dried skim milk. The equipment ranges from crude solar dryers to sophisticated spray dryers or freeze dryers.

Most food products are dehydrated in convective dryers, in which air is utilized for heating the product and removing the evaporated water. In contact dryers, heat is transported to the product through the walls (e.g., shelves) of the equipment.

In some dryers, heat may be transferred through radiation (infrared microwave). Osmotic dehydration, an alternative to thermal dehydration, is in the development stage.

## 8.2 Principles of Drying

The physical and engineering principles of drying are discussed by Mujumdar and Menon (1995). The process calculations used in the design and operation of industrial dryers are reviewed by Pakowski and Mujumdar (1995).

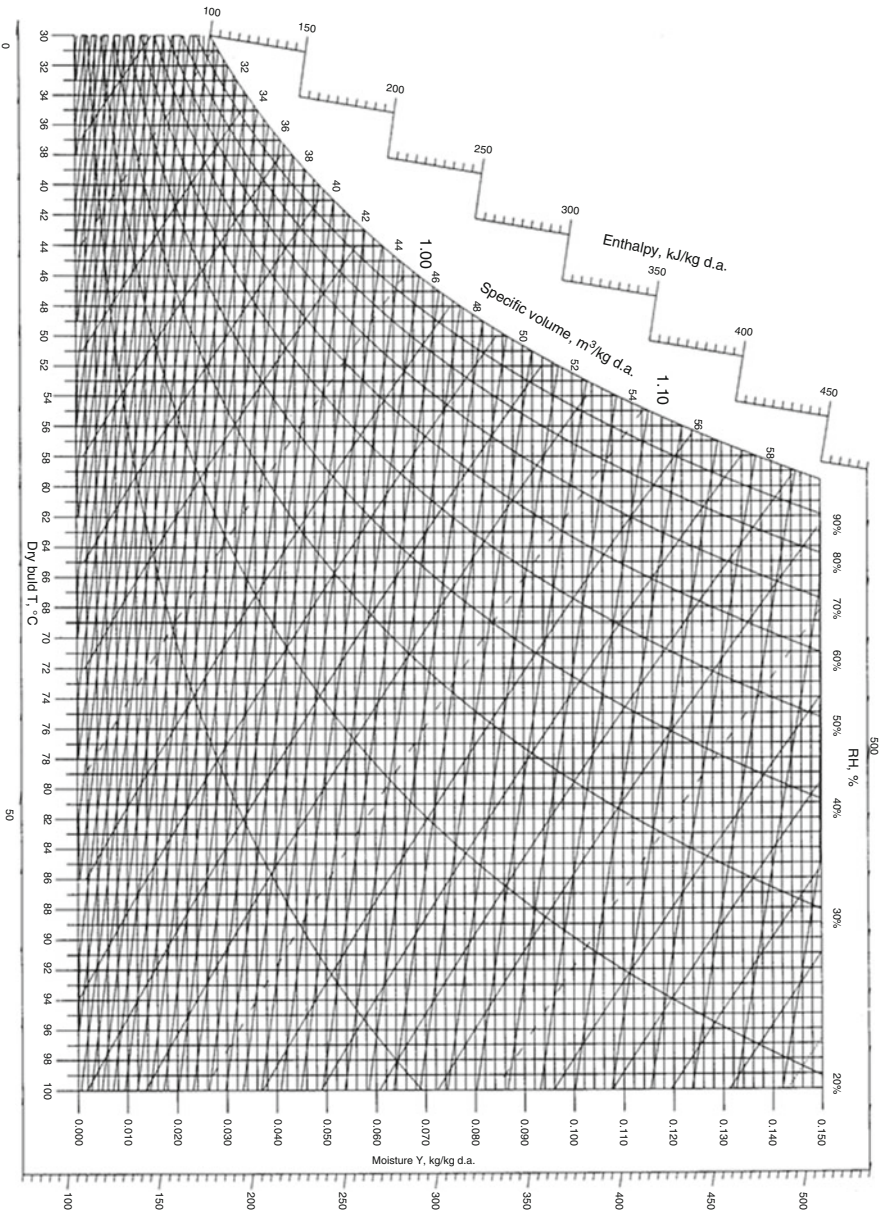
### 8.2.1 Psychrometric Calculations

The properties of air/water vapor mixtures are of fundamental importance to calculations of air-drying processes (convective drying). They can be calculated from material and energy balances or obtained from psychrometric charts (Fig. 8.1) or from computer programs, such as DryPACK (Pakowski 1998). The normal psychrometric charts refer to atmospheric pressure (1.013 bar). Psychrometric charts are available in the low-temperature region (used in refrigeration) and in the medium or high temperatures (used in air conditioning or drying).

The psychrometric chart is a graphical representation of the hygroscopic properties of the air, i.e., the dry and wet bulb temperatures ( $T$ ,  $T_w$ ), the moisture content  $Y$  (kg/kg dry air), the relative humidity (% RH), the specific enthalpy  $H$  (kJ/kg dry air), and the specific volume  $V$  (m<sup>3</sup>/kg dry air). Psychrometric data can be obtained also from the Mollier diagram, used in Europe. Figure 8.1 shows a chart in the temperature range of 30–100 °C, of interest to air-drying of foods. This chart, based on material and energy balance equations, was developed by Zogzas (2001).

Figure 8.2 shows a representation on the psychrometric chart of the process path of air in an adiabatic convective dryer. Fresh air enters the system at state (A) and it is heated at constant moisture content ( $Y$ ) to state (B), increasing its enthalpy by  $DH$  (kJ/kg dry air). The hot air is passed through the dryer at constant wet bulb temperature and enthalpy ( $H$ ), picking up moisture, and it is rejected at a higher moisture and lower dry bulb temperature (point C). In this process, the air is humidified, picking up moisture  $DY$  (kg/kg dry air). The psychrometric chart shows also the specific volume of air/water mixtures at various states, e.g., at points A, B, and C.

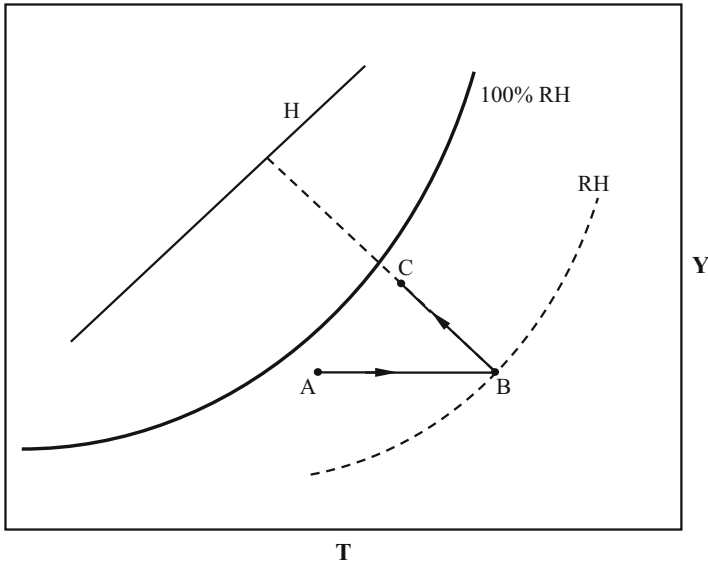
The process (ABC), shown in Fig. 8.2, represents a once-through process, i.e., without air recirculation. In several drying operations, air recirculation is often practiced for the purpose of recovering part of the rejected energy in the exhaust air. However, it is evident from the psychrometric chart that the capability of the air to absorb moisture is diminished as the air is humidified and the moisture content of the air is increased. The psychrometric chart and the computer programs allow the



**Fig. 8.1** Psychrometric chart in the range 30–100 °C (atmospheric pressure)

calculation of humidities and enthalpies of various mixtures of exhaust and fresh air.

The graphical or computer calculations of hygroscopic properties of the air are essentially representations of material and energy balances in the various streams of a drying system.



**Fig. 8.2** Process path of air in an adiabatic dryer: *AB* heating at constant humidity, *Y*; *BC* adiabatic humidification at constant wet bulb temperature (constant enthalpy, *H*); *RH* relative humidity

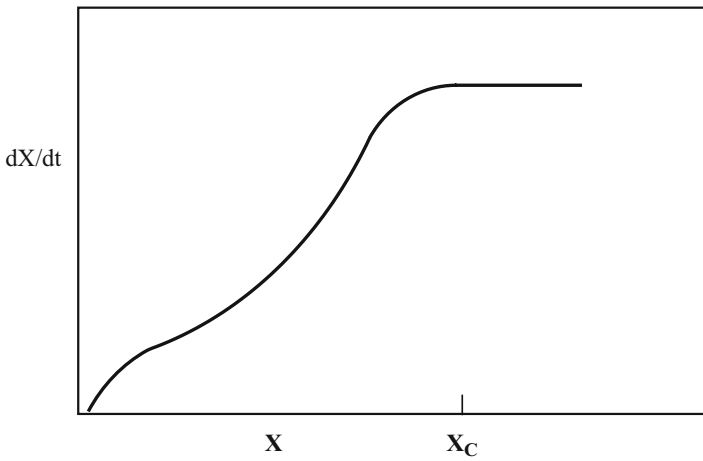
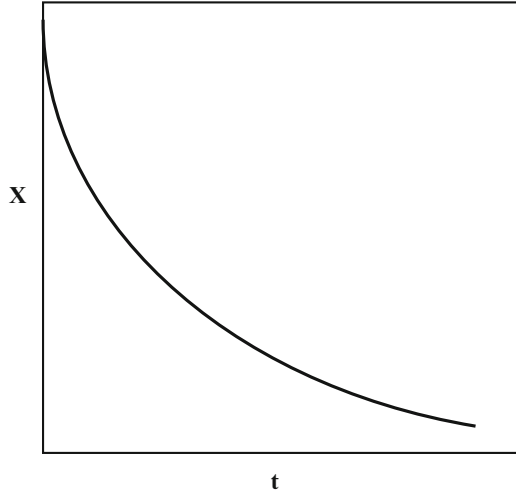
### 8.2.2 Drying Rates

The drying rates of food materials are usually determined experimentally, since it is very difficult to predict accurately the heat and mass transport rates on purely theoretical grounds (Molnar 1995). The drying tests are normally carried out on a layer of material, placed in an experimental dryer, which is operated under controlled conditions of temperature, air velocity, and humidity. The weight and the temperature of the sample are monitored by appropriate instrumentation as a function of time, obtaining the basic drying curve of moisture content  $X$  (kg/kg dry basis) versus time  $t$  (Fig. 8.3). The drying rate curve ( $dX/dt$  vs.  $X$ ) is obtained by differentiating the original drying curve (Fig. 8.4).

The drying rate curve may indicate a constant rate period, during which mass transfer from the surface of the material controls the drying process, depending mainly on the external conditions (air velocity, temperature, and humidity). Short constant drying rates may be observed in air-drying food materials of high moisture content or in washed products, containing free surface water. However, most food materials do not show any constant rate and they dry entirely in the falling rate period, during which mass transfer is controlled by the transport (diffusion) of water through the material to the surface of evaporation.

The drying rate of a food material during the falling rate period can be expressed by the empirical equation of thin-layer drying (Saravacos and Maroulis 2001):

**Fig. 8.3** Experimental drying curve



**Fig. 8.4** Drying rate curve

$$dX/dt = -K(X - X_e) \tag{8.1}$$

where  $X$  is the moisture content (dry basis) at time ( $t$ ),  $X_e$  is the equilibrium moisture content, and  $K$  (1/s) is the drying constant.

Integration of (8.1), assuming that  $K$  is constant, yields the empirical drying equation

$$\log[(X_o - X)/(X_o - X_e)] = Kt \tag{8.2}$$

The experimental drying data of Fig. 8.3 are usually plotted on semilog coordinates, obtaining the curve of drying ratio  $R$  vs.  $t$ , where  $R = (X_o - X)/(X_o - X_e)$ .

The equilibrium moisture content of the food material at the drying temperature can be taken from the literature (Iglesias and Chirife 1983; Wolf et al. 1985), determined experimentally, or estimated from empirical equations of the sorption isotherm of the material, such as the GAB equation (Saravacos 1995).

The empirical drying constant ( $K$ ) depends on the material and the (dry bulb) temperature of the air.

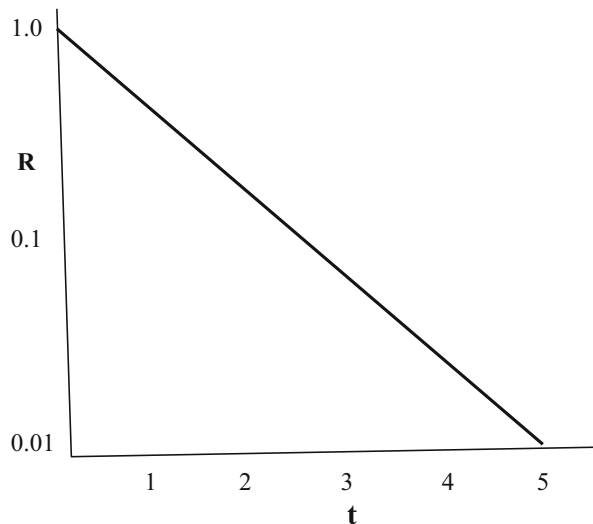
Actually, the drying constant of several food materials may change during the drying process, due to the significant changes in the physical structure of the material and, consequently, in the mass transport mechanism within the material. Water may be transported mainly by diffusion (liquid or vapor) or hydrodynamic/capillary flow.

From the changes of the slope of the drying ratio curve, two or more falling rate periods may be identified, obtaining two or more drying constants ( $K_1, K_2, \dots$ ). However, in general,  $K$  varies continuously with the moisture content ( $X$ ), and some empirical  $K(X)$  relationship may be used.

The drying constant ( $K$ ) increases exponentially with the temperature, and empirical models have been proposed for various materials (Marinos-Kouris and Maroulis 1995). Thus, the ( $K$ ) of shelled corn increases from about 0.2 1/h at 20 °C to 0.5 1/h at 60 °C.

Assuming that water transport within the food material can be expressed by the diffusion (Fick) equation, the effective moisture diffusivity ( $D$ ) can be estimated from the slope of the experimental drying ratio curve (Fig. 8.5). For a constant slope, the drying constant is related to the diffusivity  $D$  ( $\text{m}^2/\text{s}$ ) and the thickness  $L$  (m) of the material (slab or plate) by the diffusion-derived equation (Saravacos and Maroulis 2001)

**Fig. 8.5** Drying ratio curve.  $R = (X - X_e)/(X_o - X_e)$ ;  $X_o, X_e$ ,  $X$  moisture contents, initial, equilibrium, and after time ( $t$ )



$$K = p^2 D / L^2 \quad (8.3)$$

Thus, if the effective moisture diffusivity ( $D$ ) of the material is known at the given temperature and moisture content, the drying constant ( $K$ ) of the material at the given thickness ( $L$ ) of the slab can be estimated. For a spherical material, (8.3) becomes

$$K = p^2 D / r^2 \quad (8.4)$$

where  $r$  (m) is the radius of the sphere.

Equations (8.3) and (8.4) are rough approximations, which should be applied with caution. They are based on mass transport by diffusion, in which the rate is proportional to the square of thickness of the material. Actually, the diffusion mechanism may not be applicable to some food materials, due to their physical structure.

For diffusion-controlled drying, the thickness (or diameter) of the material should be as low as possible, i.e., drying of thin layers or particles of small diameter is desirable. At the same time, higher effective diffusivities are required to achieve short drying times.

Table 8.1 shows typical effective moisture diffusivities ( $D$ ) of some classes of food materials (Saravacos and Maroulis 2001). The energy of activation for diffusion is also given in the table, since it is a good measure of the effect of temperature on ( $D$ ).

High energies of activation for diffusion (strong temperature effects) are characteristic of liquid diffusion in nonporous food materials, while low energies indicate vapor diffusion in porous materials.

The following two examples of approximate calculations show the required times to dry a layer of 1 cm and a particle of diameter 1 mm of food material from 80 to 10 % moisture content:

For the 1-cm food layer, the effective diffusivity ( $D$ ) at the drying temperature is assumed  $10 \times 10^{-10}$  m<sup>2</sup>/s (Table 8.1), a rather high value, justified by the high bulk porosity of the material (Saravacos and Maroulis 2001). According to (8.3), the drying constant will be  $K = p^2 \times 10 \times 10^{-10} / (0.01)^2 = 9.86 \times 10^{-5}$  1/s or  $K = 0.355$  1/h. The material is dried from 80 % ( $X_0 = 4$  kg/kg db) to 10 % ( $X = 0.11$ ) moisture content. Assuming constant  $K$  value, the required drying time will be (8.2)  $t = [\log(4/0.11)] / (0.355)$  or  $t = 4.4$  h, which is a reasonable drying time. It should be noted that the effective moisture diffusivity of the material could

**Table 8.1** Typical values of effective moisture diffusivity ( $D$ ) and energy of activation for diffusion ( $E_D$ ) of food materials

Food material	$D$ ( $\times 10^{-10}$ m <sup>2</sup> /s)	$E_D$ (kJ/mol)
Highly porous	50	15
Porous	10	25
Nonporous starch/sugar	1	40
Nonporous protein/starch	0.1	50

be increased substantially by increasing the bulk porosity, for example, by puffing or extrusion cooking.

For the drying of porous food particles of 1 mm diameter, assuming  $D = 10 \times 10^{-10} \text{ m}^2/\text{s}$ , the drying constant will be  $K = p^2 \times 10 \times 10^{-10} / (0.0005)^2 = 0.04 \text{ 1/s}$ . The drying time for  $(X_o/X) = 4/0.11 = 36.4$  will be  $t = [\log(36.4)] / (0.04) = 39 \text{ s}$ . This is a reasonable residence time for a flash or spray drying system. However, if a nonporous particle of the same diameter is going to be dried in the same moisture ratio, the diffusivity will be lower, e.g.,  $D = 1 \times 10^{-10} \text{ m}^2/\text{s}$  for a starch/sugar nonporous material, and the drying time will be  $t = 39 \times 10 = 390 \text{ s}$  or 6.5 min. This is a very long time for a flash or spray dryer, and a fluid bed dryer may be more appropriate.

### 8.2.3 Food Dehydration Technology

The technology of food dehydration was developed largely from practical experience, but during the recent years, the principles of food science and chemical (process) engineering are used increasingly to analyze and improve this old technology. The technological aspects of food dehydration are discussed in specialized books, such as Van Arsdel et al. (1973), Barbosa-Canovas and Vega-Mrcado (1996), Baker (1997), and Greensmith (1998). Details on the dehydration of specific food products are presented by Mujumdar (1995) in the *Handbook of Industrial Drying*, i.e., Sokhansanj and Jayas (drying of foodstuffs), Raghavan (drying of agricultural products), Jayaraman and Das Gupta (drying of fruits and vegetables), Lewicki and Lenart (osmotic dehydration), and Pisecky (drying of dairy products). The dehydration technology of fruits and vegetables is discussed by Woodroof and Luh (1986), Luh and Woodroof (1988), Salunkhe et al. (1991), and Saravacos (1993).

The major dehydrated food products are fruits and vegetables, dairy products (milk, whey), soluble coffee, tea, and soups (MacCarthy 1986). Fruit and vegetable dehydration has received special attention due to the diversity of the raw materials, the sensitivity of food products, and the various types of drying equipment used for these products.

The terms “drying” and “dehydration” are used interchangeably in process engineering and in this book. However, in food science and technology, the term “drying” is traditionally used for thermal removal of water to about 15–20 % moisture (dry basis), which is approximately the equilibrium moisture content of dried agricultural products (e.g., fruits and grains) at ambient (atmospheric) air conditions. The term “dehydration” is traditionally used for drying foods down to about 2–5 %, e.g., dehydrated vegetables, milk, and coffee. The dehydrated foods usually require special packaging to protect them from picking up moisture during storage. The term “evaporated” is used sometimes for dried fruits, such as apples, of about 20 % moisture. The term “intermediate moisture foods” (IMFs) is used for semimoist dried foods (fruits, meat, etc.) of 20–30 % moisture content.



The main drying processes used for fruits and vegetables are sun drying, convective (air) drying, fluid bed drying, spray drying, and drum drying. Specialized drying processes include vacuum drying, freeze-drying, puff drying, and foam-mat drying.

Pre-drying treatments of fruits include slicing and sulfuring, while peeling and blanching are applied to vegetables. Dipping of grapes in alkali solutions, containing ethyl oleate, increases substantially the drying rate. Sulfuring (gaseous  $\text{SO}_2$  or sulfurous solutions), used to preserve fruit color, may be replaced by other treatments, which are safer to the consumers.

Dried and dehydrated foods are generally microbiologically stable, i.e., microbial growth is prevented by the low water activity ( $a_w < 0.70$ ). Protective packaging and some acceptable additives may be required to preserve the quality of the product (color, flavor, structure).

IMFs are dried to water activities of 0.90–0.70, corresponding to moisture contents 30–20 %, which prevent the growth of spoilage bacteria. The growth of yeasts and molds may be controlled by additives, such as sorbic acid (Davies et al. 1976). IMF foods are produced either by convective drying under mild conditions or by osmotic dehydration.

Process and storage calculations require knowledge of the equilibrium moisture properties (moisture sorption isotherms) of the dried food materials (Iglesias and Chirife 1983; Wolf et al. 1985; Saravacos 1995). The quality of dehydrated foods, especially fruit products, is affected strongly by the retention of characteristic volatile aroma components during the drying operation. Some dehydration processes result in improved aroma retention, e.g., vacuum drying and freeze-drying, spray drying, and osmotic dehydration (Saravacos 1993, 1995).

Figure 8.6 shows a process block diagram for the dehydration of diced potato (Greensmith 1998), which is useful for material and energy balances and for preliminary sizing of the process equipment.

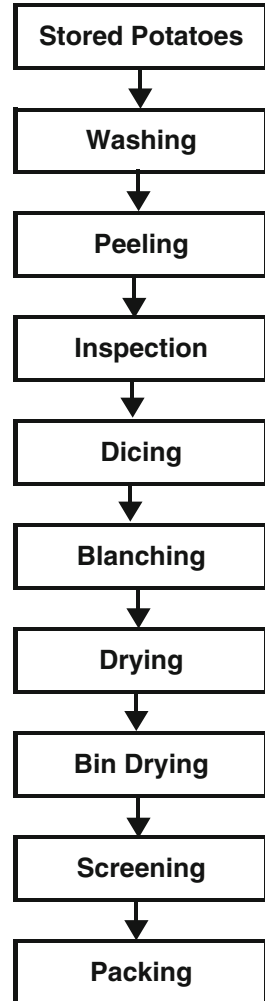
The equipment used in the pre- and post-drying operations (washers, peelers, blanchers, and packaging machinery) is discussed in various chapters of this book.

### 8.3 Design and Selection of Food Dryers

The design of industrial dryers in food processing is based mainly on practical experience, since handling and processing of solid and semisolid food materials cannot be described adequately by mathematical models and computer simulations. Recent advances in the application of transport phenomena, particle technology, and computer technology to food engineering can improve markedly the design and operation of food dryers.

Food dehydration is a heat and mass transfer process, involving handling of solids and particles. The drying process must be cost-effective and preserve or improve the quality of the product. Particular attention must be given to the safety, nutritional quality, and consumer acceptance (convenience) of the dehydrated food products.

**Fig. 8.6** Process block diagram of dehydration of diced potatoes



A detailed discussion of drying technology is presented by Mujumdar (1995) in the *Handbook of Industrial Drying*. A comprehensive list of definitions and terms used in drying was published (in German with English translation of terminology) by the German Society of Process Equipment (VDMA 1999a).

### **8.3.1 Heat and Mass Transfer**

Heat and mass transport within the food materials (internal transport) controls the drying rate of most food. The internal transport properties, i.e., mass diffusivity (moisture and solutes) and thermal conductivity/diffusivity, affect strongly the

drying rate, and they should be known or determined experimentally for each food material. A detailed discussion on the transport properties of foods, with particular emphasis on the drying processes, is presented by Saravacos and Maroulis (2001). Table 8.1 shows some typical effective moisture diffusivities of food materials of interest to drying. In general, both mass and thermal transport properties are affected strongly by the physical structure (porosity) of the material and to a lesser degree by the temperature and the moisture content. Detailed data on the thermal transport properties are presented by Rahman (1995).

Interphase (surface) heat and mass transfer is important in the early stages of drying, when the external drying conditions (air velocity, temperature, and humidity) have a decisive effect on the drying rate.

The surface heat transfer coefficient  $h$  ( $\text{W}/\text{m}^2\text{K}$ ) in a drying operation is defined by the equation

$$Q/A = hDT \quad (8.5)$$

where  $Q/A$  is the heat flux ( $\text{W}/\text{m}^2$ ) and  $(DT)$  is the temperature difference between the heating medium and the heated surface of the material (K).

The surface mass transfer coefficient  $h_M$  ( $\text{kg}/\text{m}^2 \text{ s}$ ) is defined by an analogous equation

$$J = h_M DY \quad (8.6)$$

where  $J$  is the mass transfer rate ( $\text{kg}/\text{m}^2 \text{ s}$ ) and  $DY$  is the difference of moisture content ( $\text{kg}/\text{kg}$  dry air) between the material's surface and the bulk of the drying medium (air).

The mass transfer coefficient  $k_c$  ( $\text{m}/\text{s}$ ), also used in the literature, is based on the driving force of concentration difference  $DC$  ( $\text{kg}/\text{m}^3$ ), according to the equation

$$J = k_c DC \quad (8.7)$$

The two mass transfer coefficients are interrelated by the equation

$$h_M = k_c r \quad (8.8)$$

where  $r$  ( $\text{kg}/\text{m}^3$ ) is the density of the transfer medium, i.e., the air.

For air–moisture systems of normal drying conditions (atmospheric pressure, temperature less than  $100^\circ\text{C}$ ), the air density is approximately  $1 \text{ kg}/\text{m}^3$  and, therefore, the two coefficients are numerically equal:

$$h_M (\text{kg}/\text{m}^2\text{s}) \approx k_c (\text{m}/\text{s}) \quad (8.9)$$

The interphase transfer coefficients are affected by the air velocity and temperature and the geometry of the transfer system. Approximate values of the coefficients are given in the literature (Rahman 1995; Green and Perry 1997).

The transfer coefficients are correlated by empirical equations for various systems, using the known dimensionless numbers Reynolds ( $Re = (u r d)/h$ ), Prandtl ( $Pr = (C_p h)/l$ ), Nusselt ( $Nu = h d/l$ ), Schmidt ( $Sc = h/rD$ ), and Sherwood ( $Sh = (k_c d)/D$ ).

The thermophysical and transport properties used in these numbers are the density  $r$  ( $\text{kg/m}^3$ ), specific heat  $C_p$  ( $\text{J/kg K}$ ), velocity  $u$  ( $\text{m/s}$ ), (equivalent) diameter  $d$  ( $\text{m}$ ), thermal conductivity  $l$  ( $\text{W/mK}$ ), viscosity  $h$  ( $\text{Pa s}$ ), mass diffusivity  $D$  ( $\text{m}^2/\text{s}$ ), heat transfer coefficient  $h$  ( $\text{W/m}^2\text{K}$ ), and mass transfer coefficient  $k_c$  ( $\text{m/s}$ ).

The Colburn analogies are employed to relate the heat and mass transfer coefficients, using the dimensionless heat and mass transfer factors ( $j_H$  and  $j_M$ ), defined by the following equations (Geankoplis 1993):

$$j_H = j_M \quad (8.10)$$

where  $j_H = St_H (Pr)^{2/3}$  and  $j_M = St_M (Sc)^{2/3}$

The Stanton numbers for heat and mass transfer,  $St_H$  and  $St_M$ , are defined as

$$St_H = Nu/RePr = h/\rho C_p u \quad \text{and} \quad St_M = Sh/ReSc = h_M/\rho D u = k_c/u \quad (8.11)$$

The Colburn heat and mass transfer analogy can be applied to air–moisture systems at atmospheric pressure for comparing the two transfer coefficients (Geankoplis 1993):

$$h/h_M = C_p \quad \text{or} \quad h/k_c = rC_p \quad (8.12)$$

For air at atmospheric pressure,  $r = 1 \text{ kg/m}^3$  and  $C_p = 1000 \text{ J/kg K}$ . Therefore, the two coefficients are numerically identical, if expressed in appropriate units:

$$h(\text{W/m}^2\text{K}) \approx h_M(\text{g/m}^2\text{s}) \approx k_c(\text{mm/s}) \quad (8.13)$$

The Colburn analogies can be simplified by assuming that the heat and mass transfer factors ( $j_H$  and  $j_M$ ) are functions of the Reynolds number only (Saravacos and Maroulis 2001). Regression analysis of several literature data has yielded the following two empirical equations:

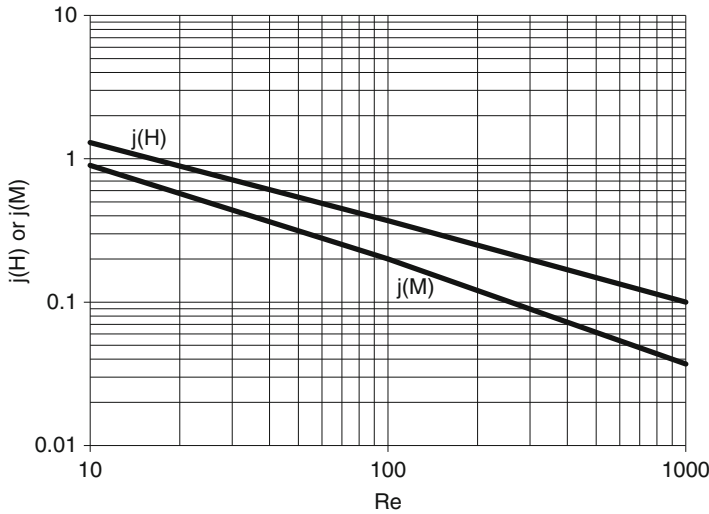
$$j_H = aRe^n \quad \text{and} \quad j_M = bRe^m \quad (8.14)$$

where  $a$ ,  $b$ ,  $m$ , and  $n$  are empirical constants. For convective (air) drying, (8.14) become

$$j_H = 1.04 \times Re^{-0.45} \quad \text{and} \quad j_M = 23.5Re^{-0.88} \quad (8.15)$$

Figure 8.6 shows typical regression lines of literature data on the transfer factors  $j_H$  and  $j_M$  for the convective drying of corn and rice.

Using the data of Fig. 8.7, the calculated heat and mass transfer coefficients shown on Table 8.2 were obtained. Equations (8.10) and (8.11) were used with the



**Fig. 8.7** Regression lines of literature data on heat and mass transfer factors ( $j_H$  and  $j_M$ ) for convective drying of corn and rice

**Table 8.2** Heat and mass transfer coefficients ( $h$ ,  $h_M/k_c$ ) in convective (air) drying of corn and rice

$Re$	$u$ (m/s)	$h$ (W/m K)	$h_M$ (g/m <sup>2</sup> s) or $k_c$ (mm/s)
10	0.1	30	97
100	1	104	292
1000	10	364	810

$Re$  Reynolds number,  $u$  air velocity

following thermophysical and transport properties of the air at 60 °C:  $r = 1$  kg/m,  $C_p = 1000$  J/kg K,  $h = 22$  mPa s,  $l = 0.03$  W/mK, and  $D = 3 \times 10^{-5}$  m<sup>2</sup>/s. The calculated Prandtl and Schmidt numbers are  $Pr = 0.81$  and  $Sc = 0.81$ .

The data on Fig. 8.7 and Table 8.2 show an analogy between the two transfer coefficients ( $h$ ,  $h_M$ ). Although of the same order of magnitude, the numerical values of the two coefficients are not the same, as predicted by the Colburn equation (8.10). This difference may be caused by the effect of food solids in the drying system, since the Colburn equation was derived for heat and mass transfer in gaseous systems.

### 8.3.2 Modeling and Simulation of Dryers

Mathematical modeling and simulations, used extensively in chemical engineering, especially in the processing of gases and liquids, are difficult to apply to complex drying operations involving handling and processing of solids and semisolids.

Nevertheless, these computer-based methods are useful in analyzing and optimizing drying processes for cost and product quality.

A generalized approach to the use of modeling in the design of convective dryers (conveyor belt, fluid bed, and rotary) was presented by Kiranoudis et al. (1994, 1996a, b). The mathematical model of each drying section involves material and energy balances, heat and mass transfer rates with constraints of temperature, product quality, and equipment construction characteristics.

Simplified models are used for heat and mass transfer in the dryer, and the drying rate ( $K$ ) is estimated from assumed values of effective moisture diffusivity (8.3). The effect of temperature was modeled by the Arrhenius equation with a typical energy of activation for diffusion, 35 kJ/mol (Table 8.1).

Simplified models were used for the estimation of the total and operating costs of the drying operation. The operating cost at various production capacities showed that the rotary dryer is the most economical unit, followed by the conveyor belt and the fluid bed dryers. However, the rotary dryer was the most expensive to build. Conveyor belt dryers appear to be the most appropriate drying equipment for food dehydration.

Modeling and simulation of dryers used in the processing of rice and vegetable slurries was presented by Bakker-Arkema (1986). Three types of dryers were considered: countercurrent flow packed bed dryer, concurrent flow rotary dryer, and cocurrent flow spray dryer. The models utilize moisture sorption isotherms, internal moisture transport, and external moisture transfer.

The modeling of convective dryers is based on the experimental values of the physical and transport properties and the drying kinetics (drying rate) of the material (Tsotsas 1998). Drying kinetics should be determined on both the single (small) particles and the bulk (integral) of the material. In addition to the basic heat and mass transport phenomena, the product quality should be considered. For example, mechanical damage to the product during drying, such as cracking and shrinkage, should be controlled.

Modeling has been applied to optimize the drying conditions of pasta (de Cindio et al. 1994). Internal moisture transport (diffusion) and mechanical stresses are causing cracking of the product, which can be controlled by increasing the air humidity in the dryer. A similar modeling, applied to rice fissure during drying, suggests high temperature but low drying rate to improve the quality (Abud-Archila et al. 2000).

Food process simulators, like OVENSIM (baking bread in a tunnel oven) (Skjoldebrandt et al. 1994), could be developed for drying processes. The computer program is useful for optimizing the food process and for training the plant operators.

Computational fluid dynamics (CFD) has been used to simulate and improve the operation of spray dryers, e.g., by reducing wall depositions (Langrish 1996). Commercial CFD packages, suggested for drying applications, include PHOENICS, FLOW 3D, FIDAP, and FLUENT (Chap. 1).

### 8.3.3 *Design of Industrial Dryers*

The design of industrial dryers is based largely on empirical knowledge, while modeling and simulation can generalize and improve the design procedure. The diversity of drying processes and dried products has resulted in a multitude of drying equipment, specific for each class of products. Thus, selection of a particular dryer becomes as important as the engineering design of the equipment.

The principles of dryer design are outlined in process engineering books, like Mujumdar (1995), Keey (1978), Strumillo and Kudra (1987), Walas (1988), Green and Perry (1997), Krischer (1963), and Kroll (1976). Practical aspects of dryer design and selection were presented by Williams-Gardner (1971), Bhatia (1983), Lee (1983), Cook and DuMont (1991), and Van't Land (1991). The scale-up of dryers in the process industries is an important aspect of drying technology (Genskow 1994).

The thermophysical, transport, and equilibrium (isotherms) properties of the material are very important in specifying the proper dryer and drying conditions. Mechanical properties of solids and solid particles are important in handling and processing of the various materials. Drying rates (kinetics of moisture removal) are useful for preliminary estimation of the drying time (8.2). The estimated time is taken as the approximate mean residence time in the dryer, an important parameter in dryer design.

The specifications of an industrial dryer should be listed in an equipment specification form (Chap. 2) and should include the properties of the wet and dried material, the temperature sensitivity and water activity of the product, the capacity and evaporation duty (kg/h), the energy supply and cost, the environmental impact, and the relationship to the other plant operations.

There are about 40 classes and over 100 subclasses of dryers, which are classified by different methods, based on type of operation (batch, continuous), type of feed (liquid, suspension, paste, granules, fibrous solids, porous solids, dense solids, and sheets), heating method (convection, contact, radiation, dielectric), and product sensitivity (vacuum, low temperature). The size of dryers can be small (up to 50 kg/h), medium (50–1000 kg/h), and large (above 1000 kg/h) (Walas 1988).

The capacity of the dryers can be expressed also as (kg) water evaporated per unit surface and unit time, which is very high in rotary dryers (about 50 kg/m<sup>2</sup> h) and low in tray dryers (about 1 kg/m<sup>2</sup> h).

The cost of drying is an important factor in dryer design, especially for large-volume products of relatively low value. Energy (fuel) is the major cost in drying operations (62 %), followed by capital and labor costs (Bhatia 1983).

The major energy use is for the evaporation of water (moisture), which varies considerably for the different dryers, e.g., from 3 MJ/kg water (spray dryers) to 6 MJ/kg (tray dryers). The energy efficiency of the dryers (ratio of the heat of evaporation to the heat input to the dryer) depends strongly on the type of dryer. It is

higher in contact than convective drying, e.g., 40–80 % versus 20–40 %. Rotary dryers are more efficient than tray, fluid bed, and spray dryers (Walas 1988).

Four categories of industrial dryer problems have been identified by Kemp and Gardiner (2000): (a) underperforming (corrected by performing material and energy balances, by drying kinetics, and by applying moisture equilibria), (b) materials handling, (c) product quality, and (d) mechanical breakdown.

### 8.3.4 Selection of Industrial Dryers

Simple empirical methods for dryer selection were proposed by Williams-Gardner (1971), Key (1978), Strumillo and Kudra (1987), Van't Land (1991), and Papagiannes (1992). These methods are qualitative and they do not cover the wide range of available industrial dryers. Selection of the optimal dryer type and size should satisfy all process and product requirements at minimum cost. On the other hand, selection of the wrong dryer may create serious difficulties in producing the desired quantity and quality of dried product.

Recent progress in computer applications has resulted in a number of selection procedures, which facilitate the selection of the proper dryer for each particular application.

Kemp (1999) and Kemp et al. (1997) have developed an expert system for dryer selection (DRYSEL), which has been tested in various industrial case studies. Dryer selection depends on (a) the equipment (mode of operation, heating, feeding), (b) the material (hard, sticky), and (c) the overall flow sheet (material flow rate, moisture content). The algorithm has a matrix structure with five steps:

1. Define the problem and supply the needed material and flow sheet data.
2. Make basic choices of feed/product form, operation/heating, or single stage or multistage.
3. Evaluate merit factors for individual dryers and perform approximate size estimation.
4. Study subtypes and refinements of the selected dryers.
5. Assess all remaining possible dryers and make final decision.

Batch dryers are used for solids throughputs (flows) below 50 kg/h, while continuous operation is preferred above 1000 kg/h.

The software program DRYSEL is a combination of a numerical calculation program and an advisory system. The merit factors are calculated and a rough sizing of the dryer is made. The reasons behind the possible choices are explained by the advisory system. The program may suggest several promising dryers, out of whom the final choice is made, based on the specific product. In a special case study of drying 2000 kg/h of corn cereal, a cascading rotary dryer was chosen.

A fuzzy expert system for selection of batch and continuous dryers was developed by Baker and Lababidi (1998, 2000). The combined fuzzy logic/expert system



is rule based, i.e., linguistic variables are used (e.g., temperature: high, low, very low) as opposed to numerical values.

The iterative approach to dryer selection involves dryer specifications, preliminary dryer selection, bench-scale drying tests, comparison of economic alternatives, and final pilot-scale tests. Proposed food dryers are layer (contact, convective, and special) and dispersion (fluid bed) dryers.

A typical example of interest to food dehydration is the following: a solids feed of 120 kg/h with temperature constraint of 60 °C, for which a vacuum tray dryer is recommended. For this application, freeze- and microwave-drying were eliminated on cost grounds.

An information system (DRYING) and a database (BAND) were developed by Menshutina and Poutchkov (2000), Tsoukanov et al. (2000), and Matasov et al. (1998) to facilitate the selection of the appropriate dryer for a given material. The system consists of expert estimations of dryer types and a library of calculations and design procedures. The input data for preselection of a dryer include dryer capacity, particle size distribution, particle aggregation, adhesiveness/cohesiveness, moisture content, explosiveness, toxicity, and drying time. A list of 32 types of dryers is given.

A practical database (DRYERBASE), listing commercially available dryers and dryer manufacturers, was developed by Tsotsas (2000). The dryers are classified into 25 main types, which are sorted by dryer type and dryer manufacturer (supplier). The ten most important industrial dryers of the general list are tray, tunnel, belt, drum, rotary, bin, flash, fluid bed, spray, and tumbler dryers.

The mode of operation can be batch, continuous, or combined. Heating can be convective or contact and operating pressure atmospheric or vacuum. The feed can be liquids, pastes, powders (<0.5 mm), grains (0.5–5 mm), and pieces (>5 mm).

A directory of dryers and drying systems (in German and English) was published by VDMA (1999b). It lists, in a matrix form, 35 suppliers and 65 drying systems, which include field of application, classification of dryers, and dryer construction (convection, contact, radiation, electrical, combined energy, and vacuum).

### ***8.3.5 Commercial Food Drying Equipment***

Application of the diverse types of process dryers to food dehydration should take into serious consideration the unique requirements of processing of foods and biological products. The strict product requirements for food dryers (organoleptic, nutritional, and functional) should be met at the lowest possible cost. Practical aspects of food dehydration and food dryers are presented by Greensmith (1998). Design and performance of food dryers are discussed by Barbosa-Canovas and Vega-Mrcado (1996), Crapiste and Rotstein (1997), and Baker (1997). The technology of dehydration of various food products, with emphasis on fruits and vegetables, is discussed by Woodroof and Luh (1986), Luh and Woodroof (1988), and Salunkhe et al. (1991).

**Table 8.3** Characteristics of food drying operations and equipment

Dryer type	Product form	Product temperature (°C)	Evap. capacity (kg/m <sup>2</sup> h)	Residence time
Sun drying	Pieces	Ambient	–	10–20 days
Bin or silo	Pieces, grains	30–50	–	1–3 days
Tray	Pieces	40–60	0.2–2	3–10 h
Tunnel	Pieces	50–80	5–15	0.5–3 h
Conveyor belt	Pieces	50–80	5–15	0.5–3 h
Rotary	Grains, granules	60–100	30–100	0.2–1 h
Drum	Sheet	80–110	5–30	10–30 s
Fluid bed	Grains, granules	60–100	30–90	2–20 min
Pneumatic flash	Grains, granules	60–120	10–100 <sup>a</sup>	2–20 s
Spray	Powder	60–130	1–30 <sup>a</sup>	10–60 s
Vacuum/freeze	Pieces	10–20	1–7	5–24 h

<sup>a</sup>kg/m<sup>3</sup> h, pieces >5 mm, grains and granules 0.5–5 mm, powders <0.5 mm

Preparation and pretreatment of raw food materials, especially fruits and vegetables, involving washing, peeling, slicing, blanching, and chemical treatment (e.g., sulfur dioxide, salts, sugar), is an integral part of the dehydration flow sheet (e.g., Fig. 8.6), and it is discussed by Greensmith (1998), Woodroof and Luh (1986), and Luh and Woodroof (1988).

The various types of drying operations and equipment, used in commercial food processing, are shown in Table 8.3. Selected operating characteristics were taken from the literature (Walas 1988; Green and Perry 1997; Crapiste and Rotstein 1997).

The description of the modern mechanical drying equipment is preceded by a brief overview of the ancient method of sun drying, which is still practiced today for drying certain fruits and other agricultural products and some fish.

The energy consumption depends on the type of dryer, varying from 3 to 6 MJ/kg water evaporated. Much higher energy consumption is required in vacuum and freeze dryers.

### 8.3.5.1 Sun Drying

Large quantities of grapes (raisins), apricots, figs, prunes, and dates are dried by direct exposure to sunlight in relatively hot and dry climates. Other sun-dried food materials include coffee beans, cereal grains, and fish. Sun-dried fruits contain about 15–20 % moisture, which is near the equilibrium moisture content at ambient air conditions, and they can be stored in bulk, without the danger of microbial spoilage. Typical operations for sun drying of grapes, figs, and apricots are as follows:

Seedless (sultana) grapes are usually pretreated by dipping in alkali solutions, containing vegetable oil or ethyl oleate, which increases the drying rate by

increasing the moisture permeability of the grape skin. Corinth (currant) raisins are not pretreated, since they have thin skins. The grape bunches are spread in trays and dried by exposure to direct sunlight. Wooden or paper trays may be used, placed on the ground, between the vines. The grapes may also be dried by hanging the bunches from a string, while they are covered by a transparent plastic cloth, which protects the product from adverse weather conditions. Some currant raisins are dried in the shade, resulting in higher quality. The sun drying time varies from 10 to 20 days, depending on the solar radiation. The sun-dried raisins are separated from the stems by mechanical equipment and stored in bulk before further processing and packaging.

The ripe apricots are usually cut into halves before sun drying on trays, placed on the ground.

Figs may be sun dried on the trees, after ripening. The dried figs are left to fall to the ground, and they may need further sun drying to reach the desired moisture content (15–20 %). Some large figs are sliced into halves to reduce the sun drying time.

Dried fruits, especially figs and apricots, may require fumigation treatment with sulfur dioxide or other permitted insecticides during storage and before packaging.

### 8.3.5.2 Solar Dryers

Solar drying is actually a form of convective drying, in which the air is heated by solar energy in a solar collector. Usually, flat-plate collectors are used with either natural or forced circulation of the air. Solar energy and, in general, renewable energy sources are important and economical, particularly during energy crises, when the cost of fuel energy increases sharply.

Figure 8.8 shows a simple solar dryer with a flat-plate solar collector connected to a batch tray dryer. The air movement is by natural convection, but addition of an

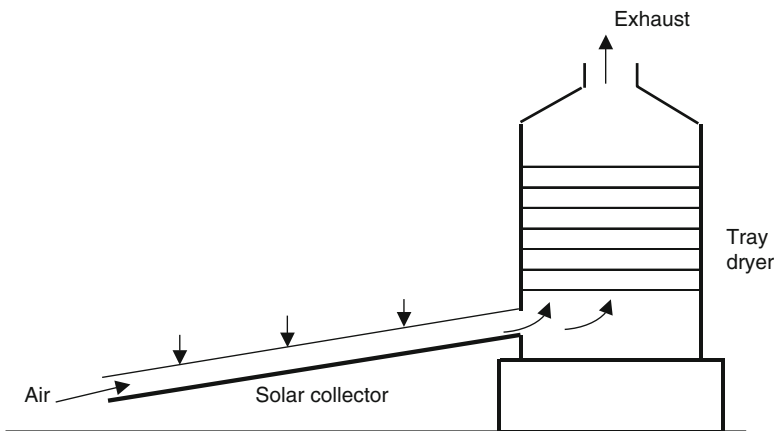


Fig. 8.8 Simple solar dryer

electrical fan will increase considerably the collector efficiency and the drying rate of the product.

Several types of solar collectors and drying systems have been proposed for drying various food and agricultural products, like fruits, vegetables, and grains. The common flat-plate collector consists of a black plate, which absorbs the incident solar radiation, a transparent cover, and insulation material.

The incident solar energy (insolation) varies with the geographical location and the season of the year. A typical insolation for a hot climate would be  $0.6 \text{ kW/m}^2$  with an average sunshine time of 7 h/day. This energy corresponds to about  $0.6 \times 3600 = 2.16 \text{ MJ/h}$  or  $15 \text{ MJ/m}^2 \text{ day}$  (Imre 1995). The evaporation of water at  $40^\circ\text{C}$  requires theoretically  $2.4 \text{ MJ/kg}$  and practically about  $3 \text{ MJ/kg}$ . Therefore, the mean evaporation rate of water will be about  $2.16/3 = 0.72 \text{ kg/m}^2 \text{ h}$  (intermittent operation 7 h/day).

The relatively low intensity of incident solar radiation is a serious problem for drying applications, where large amounts of thermal energy are required for the evaporation of water from the food material. Large surfaces of solar collectors are needed for drying significant amounts of food materials. For example, evaporation of  $1000 \text{ kg/h}$  of water (capacity of a typical mechanical convective dryer) would require about  $100/0.72 = 1400 \text{ m}^2$  of collector surface for a hot climate (intermittent operation 7 h/day). A larger surface would be required in a temperate zone.

Solar tunnel drying compares well with conventional convective drying, except for the lower capacity (kg water evaporated per hour) of the solar system (Fuller 1994). Solar drying is considered effective for relatively small drying operations of fruits, like grapes and apricots, under the climatic conditions of, for example, Southern Australia. Solar energy collected in this area for a continuous 30-h operation (including night) was estimated at  $20 \text{ MJ/m}^2$ , corresponding to about  $186 \text{ W/m}^2$  (continuous operation) or  $0.6 \text{ kW/m}^2$  (intermittent, 7 h/day operation).

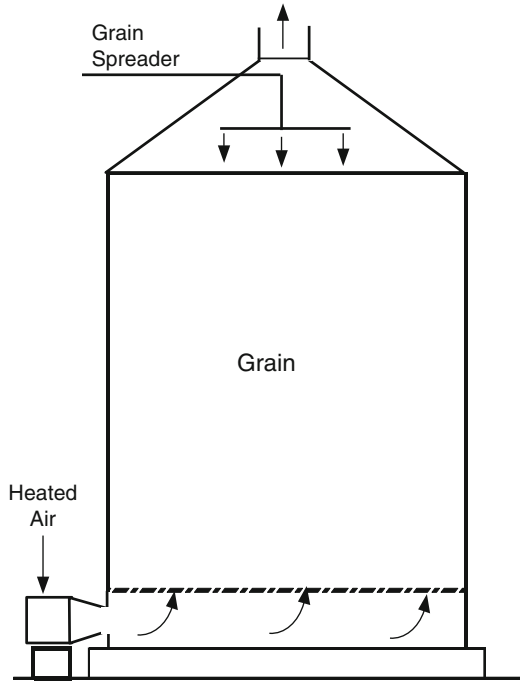
The problem of intermittent solar radiation (day–night) is usually met with the use of some form of auxiliary energy, like fuel or electricity. Thermal storage of solar energy can be also applied, using rock beds or water to absorb extra solar energy for night or cloudy weather use (Raouzeos and Saravacos 1986).

Some other solar collectors, proposed for solar drying, are (a) a low-cost tunnel collector  $1 \text{ m} \times 20 \text{ m}$  connected to a tunnel dryer for drying a batch of  $1000 \text{ kg}$  of grapes (Lutz and Muhlbauer 1986); (b) a solar collector with V-grooves, attaining temperatures  $50\text{--}70^\circ\text{C}$  at  $0.7 \text{ kW/m}^2$  insolation, used for drying chili in Malaysia; and (c) an evacuated tubular solar collector (glass tubes  $12.6 \text{ cm}$  diameter and  $2.13 \text{ m}$  length), capable of heating the air to  $90\text{--}110^\circ\text{C}$  (Yan and Hu 1994).

Solar collectors, integrated in the roof or the wall of a farm building, can provide heated air for drying grain in a bin or silo (Henrikson and Gustafson 1986). A conventional bin dryer is shown in Fig. 8.9.

Silo drying of grain usually reduces moisture content from about 20 to 18 %.

**Fig. 8.9** Batch bin (silo) dryer



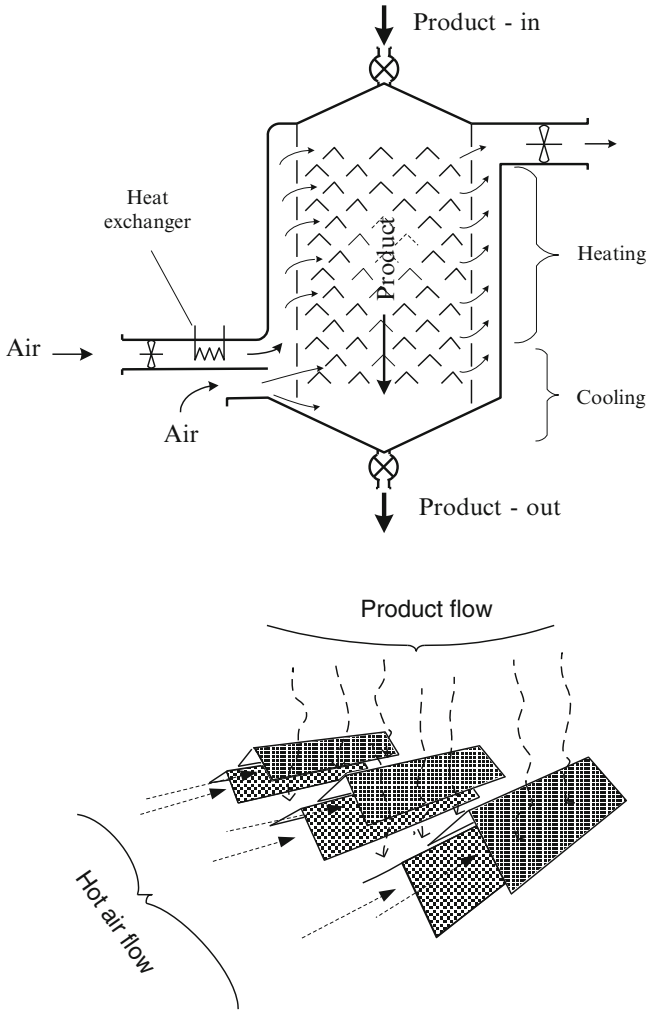
### 8.3.5.3 Bin, Silo, and Tower Dryers

Bin and silo dryers are used widely in the drying of agricultural products, notably grain (wheat, shelled corn, rice, soybeans, etc.), from an average harvest moisture of 25 % to a storage moisture of about 15 %. In addition to drying, mechanical aeration of the stored grain is needed to prevent local overheating and spoilage (Raghavan 1995). The aeration flow rate depends on the moisture content of the grain, varying usually from 45 to 90 m<sup>3</sup>/h m<sup>3</sup> of grain. The moisture content of cereal grains in silos increases about 3 % during the winter. Silo fans require about 2 kW of power for 1000 tons of bulk grain.

Figure 8.9 shows the diagram of a batch bin or silo dryer, which consists basically of a fixed bed of product (e.g., grain), through the bottom of which heated air is forced by a mechanical fan. The maximum safe temperature of the air depends on the stored food material, ranging from 43 °C (rice) to 60 °C (wheat). Efficient grain dryers require high air flow rates, e.g., 450 m<sup>3</sup>/h m<sup>3</sup> of grain.

In addition to the fixed batch dryers, recirculating batch, recirculating continuous, and portable grain dryers are also used (Raghavan 1995). The drying capacity of the grain dryers is about 2–4 tons/h for the batch, 3–9 tons/h for the portable, and above 15 tons/h for the continuous flow units.

Bin dryers are also used in finish drying of some vegetable materials, when the product is difficult to dry (low moisture diffusivity) in the primary dryer, without



**Fig. 8.10** Diagram of a continuous tower dryer

raising the temperature. Dehumidified air at near ambient temperature may be needed in finish drying of hygroscopic materials.

The tower dryer (Fig. 8.10) is a variation of the bin/silo dryer. Such dryers are used in reducing the moisture content of cereal grains after harvesting and before storage in silos. The tower dryers are usually metallic structures, composed of several similar units, each having dimensions  $3.5 \times 2.0 \times 18.0$  m. The product, after cleaning, is transported by bucket elevators to the top of the dryer, at a rate controlled by the emptying mechanism at the bottom of the unit (Chap. 3). Hot air, in cross flow, is drying the grain, which flows downward. The downstream movement, and thus the moisture of the grain, can be controlled by varying the

cross section of the upper and lower parts of the dryer. At the lower part of the tower dryer, ambient air is blown for cooling the grain.

The capacity of the tower dryer may be from 5 to more than 100 tons/h of fresh grain. The initial moisture content of the grain depends on the product, the harvesting area, and the climatic conditions of the harvesting season. For long-term storage, the moisture content must be reduced to below 16 %.

The temperature of the heating air is usually 70–100 °C. In heating grain that is utilized in baking processes, the drying temperature must not exceed 80 °C to avoid heat damage of the useful enzymes. More than two large fans are used to blow the drying air, each requiring 5–11 kW of power and blowing 20,000–30,000 m<sup>3</sup>/h. The specific energy consumption of tower dryers is about 5 MJ/kg water evaporated, and the total energy consumption of a tower dryer is 4–33 GJ/h.

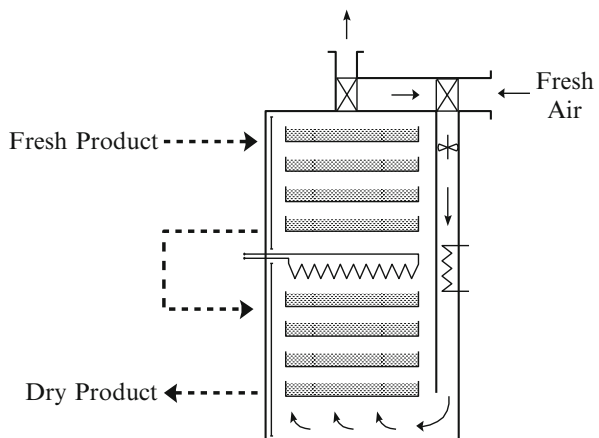
#### 8.3.5.4 Tray/Cabinet Dryers

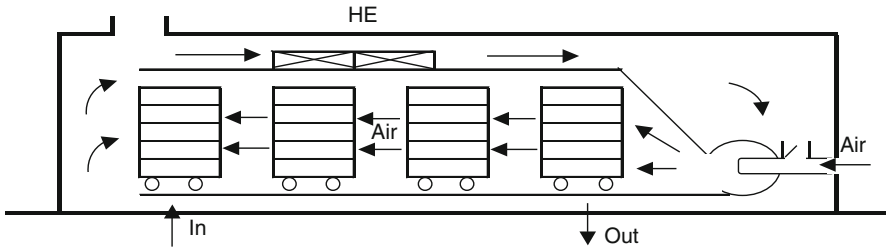
Tray or cabinet dryers are the simplest convective dryers, and they are used for drying relatively small batches of food materials in the form of pieces, such as sliced fruits and vegetables. They consist of a stack of trays, placed in a cabinet, and they are equipped with a heat exchanger and a mechanical fan for circulating the heated air through the trays (Fig. 8.11). The heat exchanger operates usually with steam, and part of the air is recirculated to recover part of the heat of the exhaust air or air/flue gases.

The trays may be placed on a mobile truck, moving on rails, for easy loading and unloading of the dryer. Large cabinet dryers can handle more than one truck of trays, making possible a semicontinuous operation.

A truck may contain about 30 trays with dimensions 80 cm × 80 cm × 5 cm. The amount of product loaded on a truck, containing 30 trays of dimensions 80 cm × 80 cm × 5 cm, each loaded with 5 kg, will be 30 × 5 = 150 kg (Greensmith 1998).

**Fig. 8.11** Cabinet (tray) dryer. *HE* heat exchanger





**Fig. 8.12** Diagram of countercurrent tunnel (truck) dryer. *HE* heat exchanger

Typical data for the tray dryer of Fig. 8.11 are ten perforated aluminum trays  $2.0 \times 2.0$  m of total area  $40\text{--}60$  m<sup>2</sup>, heating with 600 kg/h of steam of 5-bar pressure, air temperature of about 100 °C, electrical energy (fan) of 6–8 kW, and drying capacity of 5–12 tons/h of fresh fruits or vegetables.

### 8.3.5.5 Tunnel Dryers

The tunnel (truck) dryers are essentially an extension of the tray/cabinet dryers, with several trucks moving slowly in a long tunnel, while coming in contact with hot air in parallel, counter, or combined flow (Fig. 8.12).

The drying air is moved by mechanical fans and heated by heat exchangers, operating with steam at a pressure of about 7 bar. Partial recirculation of the air is practiced (about 50 % of the total air), as in other convective dryers.

The dryer is loaded successively with new trucks, while an equal number of trucks of the dried product are removed from the other end. Each truck (trolley) is loaded with about 50 trays. A typical drying time for vegetables is about 6 h (Greensmith 1998).

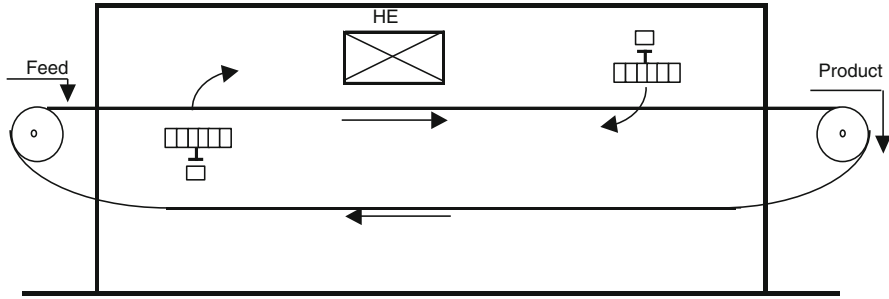
Tunnel dryers can be constructed from low-cost materials, and they are simple to operate. They are suitable for economic dehydration of fruits and vegetables, near the production farms. Since the production of most fruits and vegetables is seasonal, the dryers should be used for various products to increase their operating time.

### 8.3.5.6 Conveyor Belt Dryers

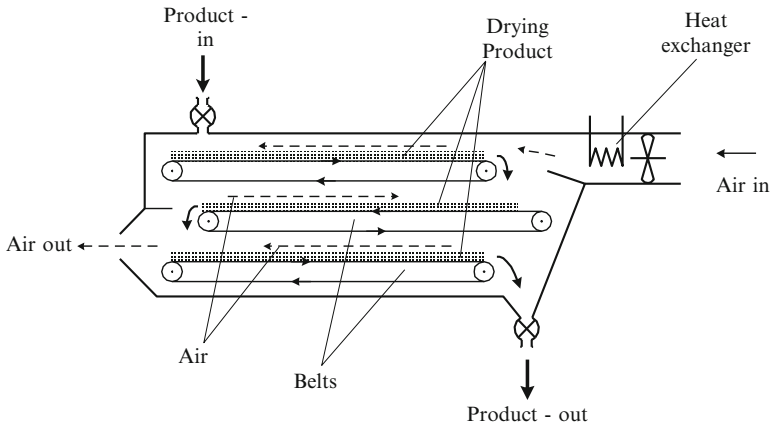
Figure 8.13 shows the diagram of a typical single-belt dryer, used widely in the dehydration of food materials. The size of the belt (band) of a typical medium-scale operation is 30–40 m long and 2.5–3 m wide (Greensmith 1998). High air velocities are used (3–6 m/s) for fast drying. The capacity (product throughput) of commercial belt dryers varies with the product in the range of 1000–3000 kg/h.

Heat for drying is supplied either by direct combustion of “clean” fuels (natural gas or LPG) or by indirect heat exchange from steam or oil flue gases. The heated





**Fig. 8.13** Single-belt (band) conveyor dryer (up and down through flow). HE heat exchanger



**Fig. 8.14** Diagram of a 3-belt dryer

air passes through the product and the perforated belt upward or downward with properly installed fans.

The loading of the trays depends on the bulkiness or compactness of the material. Higher loading is used with porous than nonporous materials. Typical depth of belt loading for vegetable materials is 5–12 cm.

Two or more passes (stages) may be needed for some drying operations. Changing the operation from stage to stage exposes new surfaces of the product to the drying medium, resulting in faster and more uniform drying (Fig. 8.14).

For economical reasons, belt drying of some vegetables is stopped at about 12–15 % moisture, and the drying is completed to about 5 % in a bin dryer (Fig. 8.9). Small or mobile bin dryers may be used.

Figure 8.14 shows diagrammatically a 3-belt conveyor dryer, suitable for fruit and vegetable dehydration. Each belt is 1–3 m wide and 10–30 m long. The drying capacity is about 2–15 kg/m<sup>2</sup> h and the specific steam consumption 1.8–2.0 kg/kg water. Total electrical power was up to 100 kW. Temperature ranges from 70 to 100 °C and air velocities from 0.5 to 1.5 m/s.

### 8.3.5.7 Rotary Dryers

The rotary dryers consist of an inclined long drum (cylinder), rotating slowly, through which the material (particles or grains) flows with a tumbling (cascading) action (flights) in cocurrent or countercurrent flow with the heating air/gases (Fig. 8.15). The dryer shell is inclined about  $5^\circ$  to the horizontal, and it is rotating by a gear mechanism at a peripheral velocity of 0.2–0.5 m/s. A cyclone dust collector may be needed at the exit of the exhaust gases.

The rotary dryer is characterized by high air/gas temperatures, high evaporation rates, and relatively short residence time. The dimensions of normal rotary dryers range in 1.5–3 m in diameter and 6–20 m in length. The evaporating capacity is about  $50 \text{ kg/m}^2 \text{ h}$  per heating surface or about  $60 \text{ kg/m}^3 \text{ h}$  per dryer volume (Walas 1988). The air/gas velocity ranges between 0.5 and 2.5 m/s.

Heating of the rotary dryers is either by steam tubes, installed along the inside of the cylindrical shell, or by combustion gases from natural gas, LPG, or oil. Rotary dryers usually operate at high temperatures and, therefore, they have high evaporative capacity. They are used mostly in drying food by-products and wastes (peels and pomace), where high temperatures are permissible and economics is important.

Application of rotary dryers to food products is limited to particulate materials, such as granulated sugar and some grains. Large food particles cannot be handled in this type of dryer, due to the relatively short residence time, the danger of overheating, and the mechanical damage (abrasion) of the products. Such materials are dried more effectively in conveyor belt dryers. Direct and indirect (steam) heated rotary dryers are used economically for commercial drying of fish meal (Fresland et al. 2000) and solid food wastes, e.g., citrus peel and pulp.

Rotary dryers are used widely in the chemical process industries, and their mechanical and operational characteristics are discussed by Bhatia (1983), Walas (1988), and Green and Perry (1997). Automatic control of rotary dryers can improve significantly the economic operation (Ventzas 1998).

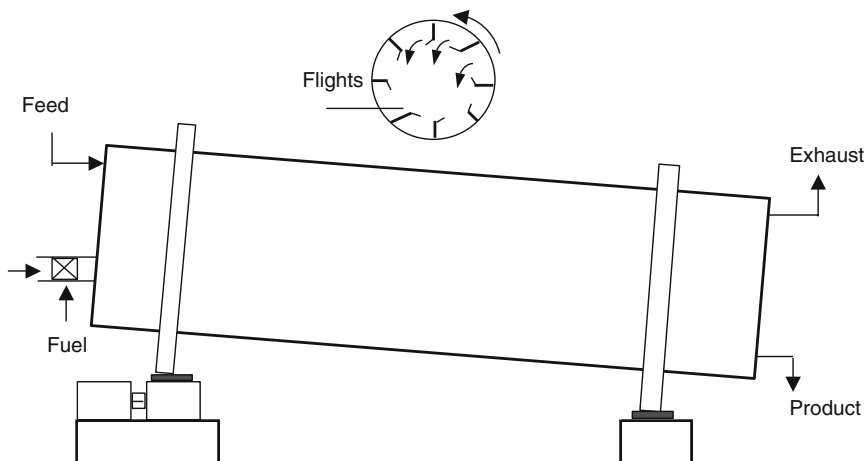


Fig. 8.15 Diagram of direct (fuel) heated rotary dryer

### 8.3.5.8 Fluid Bed Dryers

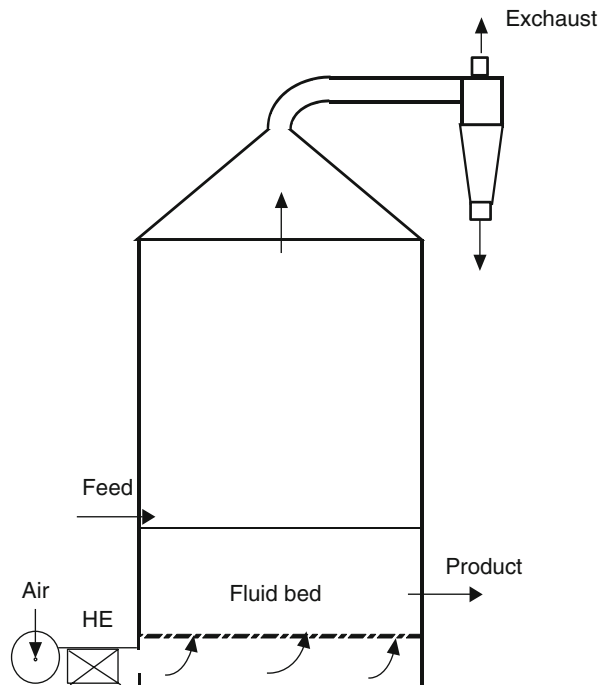
Fluid bed dryers are fast-drying equipment, which is based on the very high heat and mass transfer rate between the heating medium (hot air) and the fluidized granular material. They are efficient and economic units for drying food materials in granular form, like grains, peas, and other food particles. One of the basic elements of a fluid bed dryer is a bed of the material supported on a perforated plenum, through which hot air is passed, fluidizing and drying the material. A cyclone collector and other dust collecting equipments are installed before the centrifugal exhaust fan (Fig. 8.16). Basic requirement for this operation is the air fluidization of a bed of the particulate material (Hovmand 1995), which is affected by the size, shape, and density of the particles. Average particle size for efficient operation is 10–20 mm. A narrow particle size distribution is desirable, since it reduces entrainment of the smaller particles.

Rapid mixing of the solids leads to nearly isothermal operation throughout the bed and better process control. Residence time can be chosen in the order of minutes, in contrast to the pneumatic short-time operation (Vanecek et al. 1966).

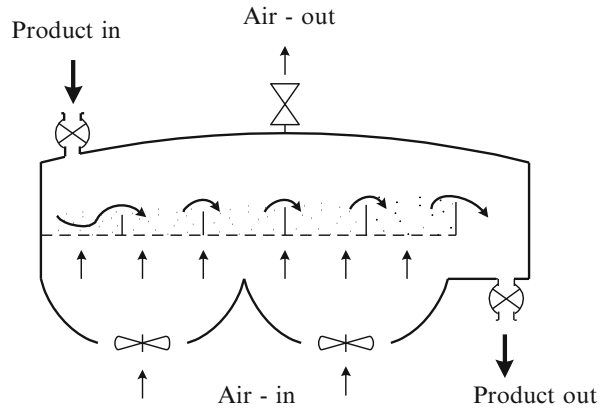
Fluid bed dryers are used for the efficient primary and secondary drying of paddy rice in the moisture ranges of 22–45 % and 22–26 %, respectively (Soponronnarit et al. 1996).

The vibrated fluid bed (VFB) system is used widely in industrial applications, because of its important operating advantages. Typical applications of VFB include

**Fig. 8.16** Diagram of fluid bed dryer



**Fig. 8.17** Diagram of compartment fluidized bed dryer



post-drying in spray drying systems, and agglomeration of food powders to produce soluble food granules (Chap. 4).

Technical data on fluid bed dryers are presented by Walas (1988) and Green and Perry (1997).

Figure 8.17 shows diagrammatically a wide fluidized bed dryer with five compartments and two fans. The dimensions of a typical fluidized bed dryer are length 5–7 m, width 1.5–2.5 m, and height 6 m. The water evaporating capacity of this dryer is 600–800 kg/h, the heating capacity 850–1100 kW, and the electric motor power 6 kW.

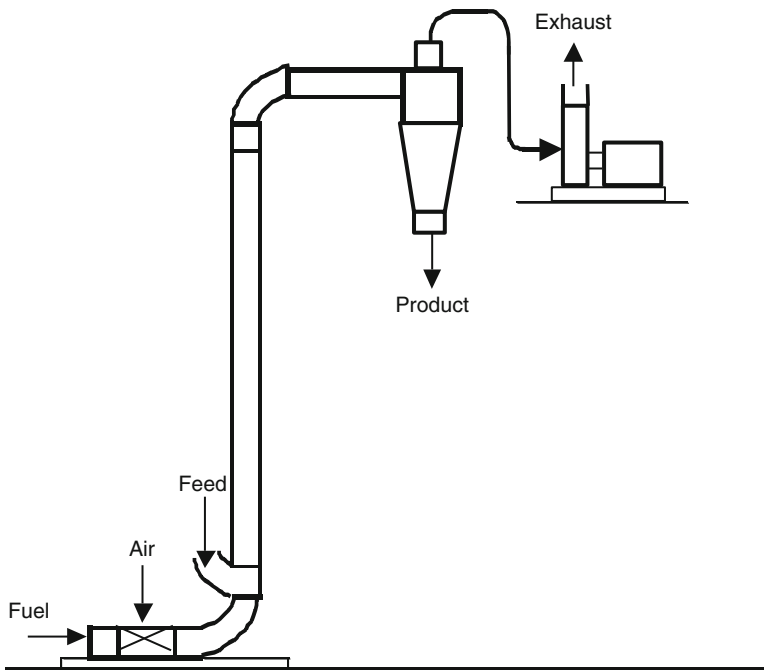
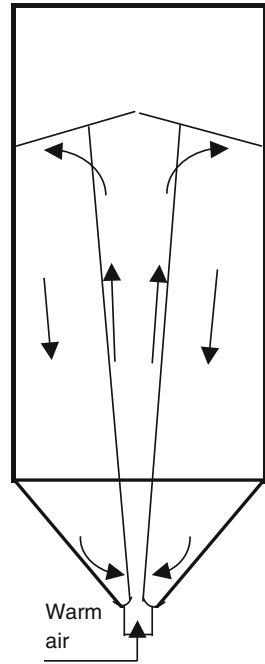
### 8.3.5.9 Spouted Bed Dryers

Spouted bed dryers are a special type of fluid bed equipment, in which the granular material is circulated vertically in a tall drying chamber. The heated gas enters as a jet at the center of the conical base of the vessel, carrying upward the granular material, which is dried partially and thrown to the annular space. The material in the bed moves slowly by gravity to the bottom, and the cycle is repeated continuously (Fig. 8.18). Spouted bed dryers are suitable for granular materials larger than 5 mm, such as wheat grain (Hovmand 1995).

### 8.3.5.10 Pneumatic/Flash Dryers

Pneumatic or flash dryers are used for efficient fast drying of particulate materials that can be transported pneumatically. Figure 8.19 shows diagrammatically a simple pneumatic dryer, which consists of a long drying tube (5–30 m), a particle collection system (cyclone), and heating/air moving equipment. Gas fuel is a convenient energy source.

**Fig. 8.18** Spouted bed dryer



**Fig. 8.19** Diagram of a simple pneumatic (flash) dryer

The terminal or entrainment velocity of the particles in the drying tube is estimated from the Stokes equation

$$u = d_p^2(r_s - r)/18h \quad (8.16)$$

where  $d_p$  is the mean particle diameter (m);  $r_s$  and  $r$  are the densities of solid particles and air ( $\text{kg/m}^3$ ), respectively; and  $h$  is the viscosity of the air (Pa s).

The mixture of hot air/gases moves the wet material from the bottom through the drying tube at a high velocity (15–30 m/s) and temperatures up to 130 °C. The material is dried fast, due to the high heat and mass transfer rates. However, since the once-through residence time in the drying tube is very short (1–5 s), recirculation of the product is often required, reaching residence times up to 1 min. The residence time in pneumatic drying can be increased using a special cyclone with high residence time, which acts as an additional dryer (cyclone dryer), after the product is passed through the main drying tube (Korn and Nowak 2000).

The residence time in pneumatic dryers can be increased by forming the ducting into a continuous loop (pneumatic ring dryer), as shown in Fig. 8.20. Heating of the drying air can be direct (gas fuel) or indirect (steam heat exchanger).

Figure 8.21 shows a rectangular flash dryer of dimensions  $(5\text{--}6) \times (4\text{--}4.5) \times (6\text{--}6.5)$  m. The wet food particles are fluidized by a rotating table (50–500 RPM) and air, blown at the bottom of the dryer, at the rate of 11,000–30,000  $\text{m}^3/\text{h}$ . The evaporative capacity of the dryer is 4.5–8.0 tons/h.

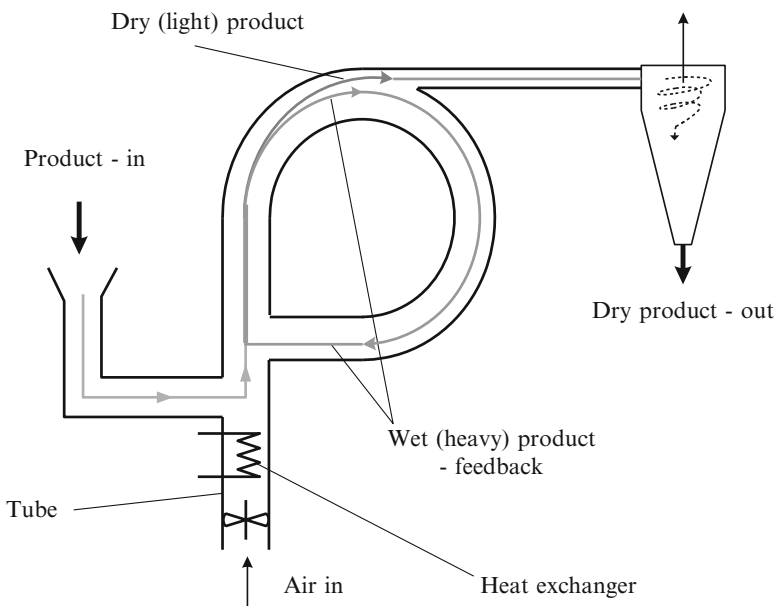
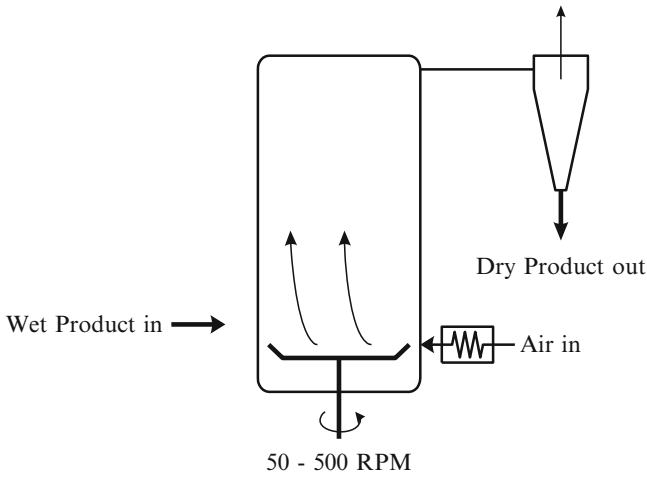
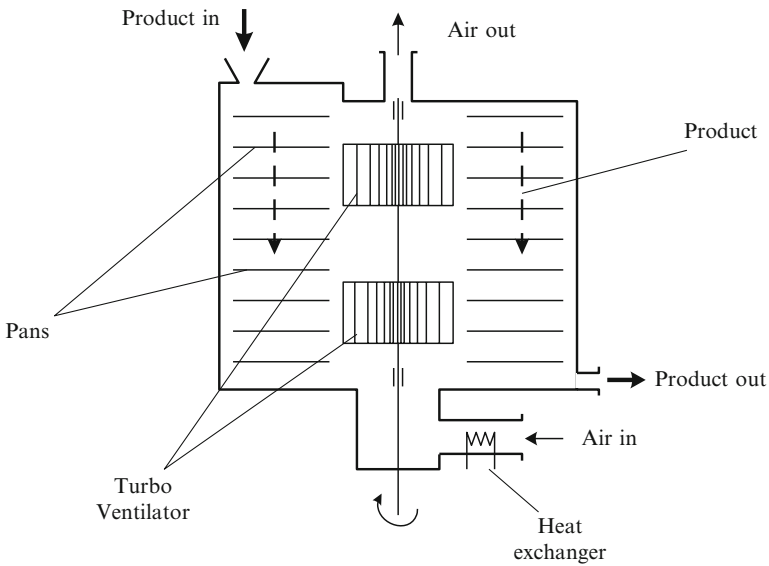


Fig. 8.20 Diagram of pneumatic ring dryer



**Fig. 8.21** Pneumatic (flash) dryer with centrifugal fluidizer

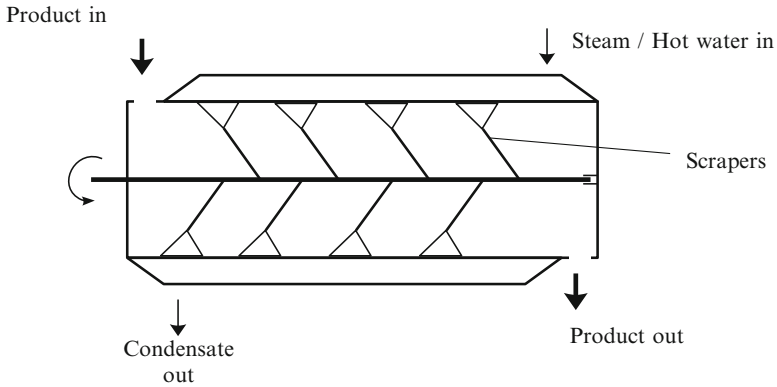


**Fig. 8.22** Diagram of turbo dryer

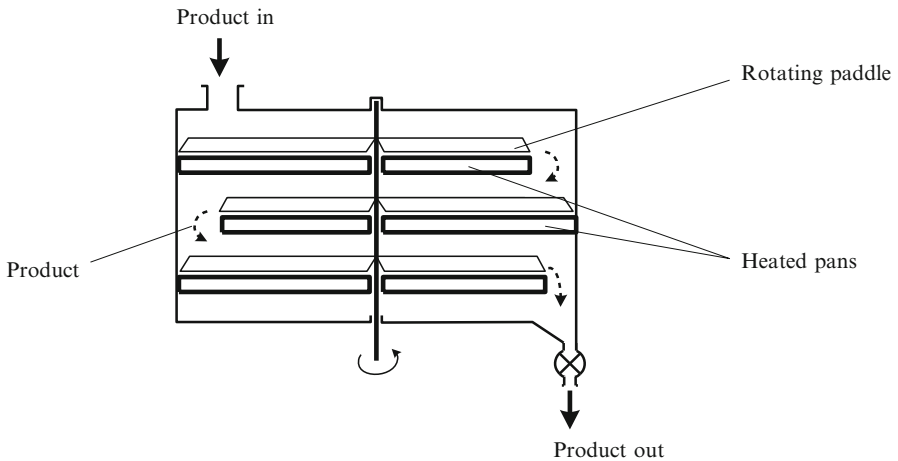
**8.3.5.11 Agitated Dryers**

The drying rate of food pieces and particles can be increased by mechanical agitation, as indicated in the following examples of drying equipment:

The turbo dryer (Fig. 8.22) is a special tray dryer with the particulate product flowing slowly down, following a helical path, while it is agitated by air blown



**Fig. 8.23** Diagram of an agitated horizontal dryer



**Fig. 8.24** Diagram of a pan dryer

countercurrently by two fans. The dimensions of such dryers are 6–8 m in diameter and 7–10 m in height. The product capacity is 2.5–8.0 tons/h and the water evaporation 2–4 tons/h. The specific heat consumption is 3.7 MJ/kg water evaporated. The electrical energy required for the fans is 16–20 kW.

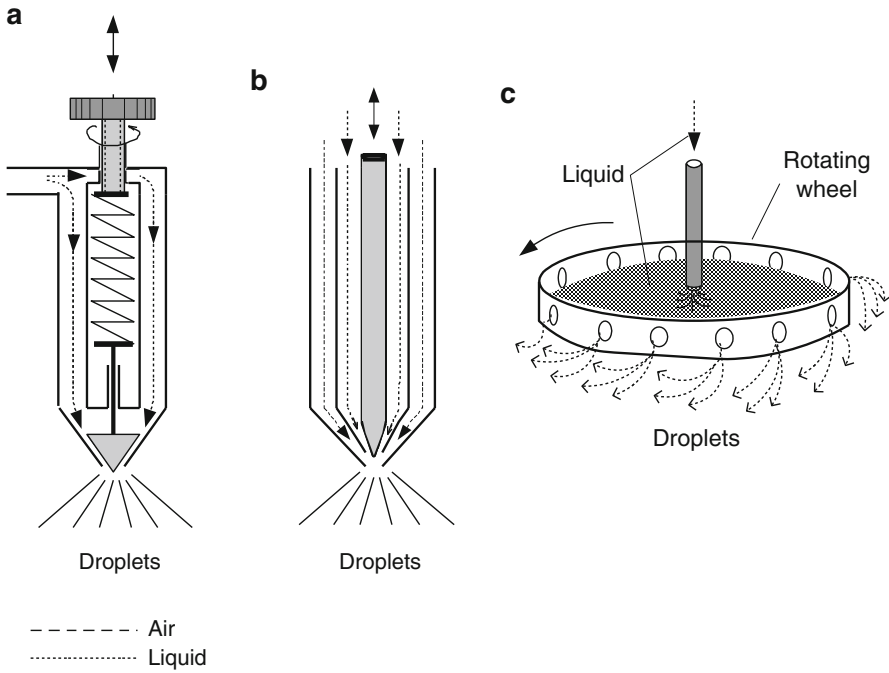
Figure 8.23 shows an agitated horizontal dryer of small size (diameter 0.7–1.5 m) with mechanical scrapers (spatulas), suitable for paste products. The evaporative capacity is about 95 kg/h.

A pan dryer with rotating paddles (scrapers), suitable for paste products, is shown in Fig. 8.24. Such dryers have diameters of 2–3 m, the number of heated pans is up to 15, and the total pan surface is 5–100 m<sup>2</sup>. The evaporative capacity can be up to 500 kg/h.

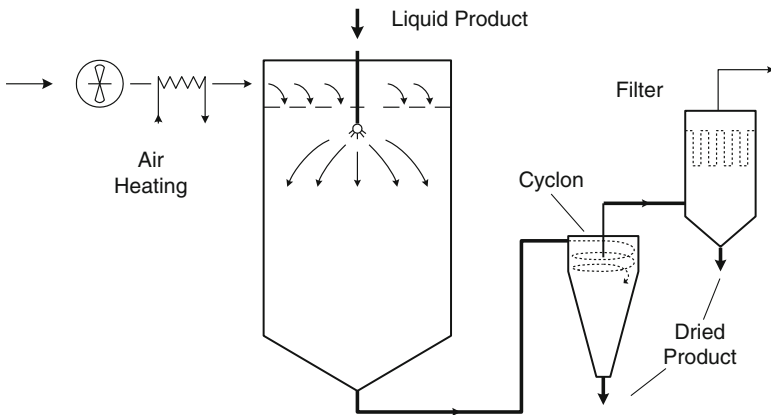


**8.3.5.12 Spray Dryers**

Spray dryers are used for drying liquid foods and food suspensions, which can be dispersed in the form of droplets in a stream of hot air. Figures 8.25 and 8.26 show the main components of cocurrent and countercurrent spray drying systems, which



**Fig. 8.25** Diagram of a cocurrent spray dryer



**Fig. 8.26** Simplified diagram of a counter-current spray dryer

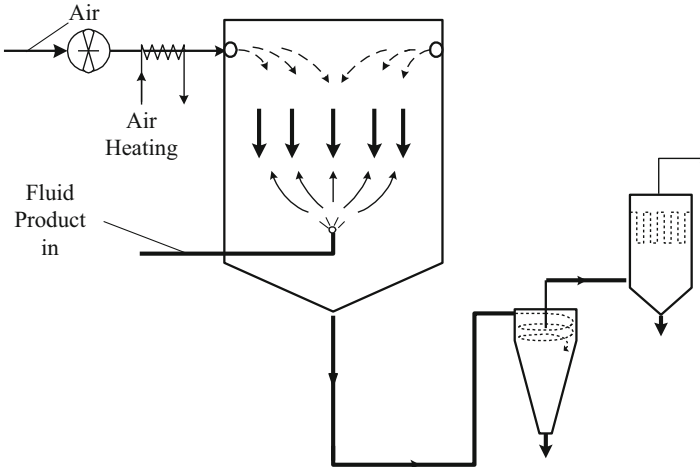


Fig. 8.27 Main types of atomization nozzles of spray dryers

consist of a spraying device, a large cylindrical drying chamber, a particle collection system (cyclone and bag filters) for the dried product, and the required heating and air moving equipment (Masters 1991; Filkova and Mujumdar 1995).

Concentrated food liquids, such as milk, coffee, and juices, are dispersed as droplets, using three types of atomizers, i.e., pressure nozzle, centrifugal (wheel), and two fluid (pneumatic) (Fig. 8.27). The high pressure of the liquid by using the nozzles (a) and (b) of Fig. 8.27 is achieved through piston pumps. Furthermore, the final control of the pressure in these nozzles is achieved through adjustment of needles in them (Kessler 1981).

The type of atomizer depends on the properties of the food liquid (concentration, viscosity) and the droplet size distribution desired (5–500  $\mu\text{m}$ ). Pressure nozzles, operating at 50–100 bar, produce nearly uniform size (narrow size distribution) of droplets; their capacity is limited to about 1000 kg/h liquid, and, therefore, multiple nozzles are needed in large spray dryers. The centrifugal wheel operates at very high speeds, 5000–25,000 RPM, with peripheral velocities of 100–200 m/s; it has a higher capacity than the pressure nozzle, and it gives a wider range of droplet sizes. The average droplet size, produced by the centrifugal wheel, is larger than the sizes produced by the pressure atomizers, an advantage in producing large, easily dissolved dried particles. The pneumatic nozzle operates at air pressure of 3 bar, requiring 0.5–0.6  $\text{m}^3$  air/kg liquid, and it is used mostly in small installations and pilot plants (Filkova and Mujumdar 1995).

The size and capacity of the spray dryers vary widely, with diameters up to 10 m and heights up to 30 m. In comparable capacities, dryers with pressure nozzles are higher than those using centrifugal atomizers, but the diameter of spray dryers with centrifugal atomizers is larger than that of dryers using pressure nozzles or pneumatic nozzles. Usually the diameter of dryers equipped with centrifugal atomizers

is 5–7 m, while that of those equipped with pressure or pneumatic nozzles usually is up to 4 m.

Hot air, usually mixed with “clean” combustion gases at high temperature (150–300 °C), is used as the drying medium in cocurrent or countercurrent flow with the liquid droplets, which are sprayed from the top of the drying chamber. The droplets dry rapidly, due to high heat and mass transfer rates in the system, producing food particles, which are collected either at the bottom or the cyclone collector system, before the air is exhausted to the atmosphere. The temperature of the exit air is 70–100 °C. The product is kept at a relatively low temperature (50–70 °C), due to the evaporative cooling in the dryer.

The residence time in spray dryers is short, e.g., 5–30 s, (approximate speed of air in a drying tower: 0.3 m/s) during which the material must be dried to the desired moisture content, without under- or overdried particles. Some spray drying systems include a post-drying section, such as a fluid bed dryer, installed in the bottom of the drying chamber, in which the residence time is controlled to obtain the desired moisture content of the particles. The fluid bed can also act as an agglomeration unit for increasing the size of the particles and improving their solubility and other functional properties (see Chap. 4). The food agglomerates are finish-dried in a fluidized bed, adding also small quantities of liquid ingredients to the product during recirculation (\*).

The heat consumption in spray dryers, due to high temperatures, is relatively high, about 6 MJ/kg water, and energy-saving systems are used (e.g., preheating of air) to improve the thermal efficiency.

Energy savings in spray drying can be achieved either by direct mixing of a part of the exhaust gases leaving the cyclones with fresh air or by indirect heating of the fresh air by the hot exhaust gases, using a heat exchanger. The method of partial mixing, for example, with 15–30 % exhausted warm air at 70 °C with fresh air, before heating both of them further up to about 155 °C, may save approximately 10 % of heat energy. The indirect heating of fresh air before its final heating by intervening a heat exchanger using exhausted air (e.g., 70 °C) may save about another 7–9 % heat energy in addition to that of the prementioned direct mixing of fresh air with exhausted air. However, this requires significant investment in an air/gas heat exchanger, which must have a relatively large exchange surface, due to the low gas/solid heat transfer coefficients.

Advances in spray drying of liquid foods are reviewed by Mermelstein (2001). Most of spray drying applications are related to the dairy industry (milk and whey products). Separation of small dried particles from the exhaust air/gases is achieved in cyclone separators, followed by bag filters. Bag filters of hygienic design are more effective than mechanical cyclone collectors in removing fine particles from the exhaust gases and preventing air pollution (Chap. 5).

An improved design of the spray drying chamber is based on the flow of the hot air from the top in the middle of the chamber, followed by the upward flow close to the walls, with exit at the top. In this system, the walls are kept at a relatively lower temperature, preventing the sticking and overheating of the drying droplets.

Safe operation of the drying chamber is required against spontaneous combustion and explosion, which may occur from overheated flammable and explosive powders, accumulating in the corners and crevices within the drying chamber. A fire suppression system, relief valves, and electrical insulation should be installed in the dryer.

### 8.3.5.13 Drum Dryers

Drum or roller dryers are used to dehydrate concentrated food liquids, purees, and pulp. The double-drum dryers (Fig. 8.28) consist of two counterrotating cylinders, heated internally with steam, which dehydrate quickly a layer of the material, spread on the outer surface. The dried product, in the form of flakes, is removed continuously from the drums, and a new layer is applied on the scraped surface. Single-drum dryers are also used in some applications (Figs. 8.29 and 8.30). The drums must be machined to very close tolerances, for both diameter and length, to allow close clearance operation (Moore 1987).

The drum dryers are usually operated at atmospheric pressure, but vacuum operation is possible, for heat-sensitive food products, by enclosing the drying system in a vacuum chamber. The size of the drum dryers varies in the range of diameter 0.4–1.2 m and length 1–3 m. Steam pressures of about 3–4 bar are used

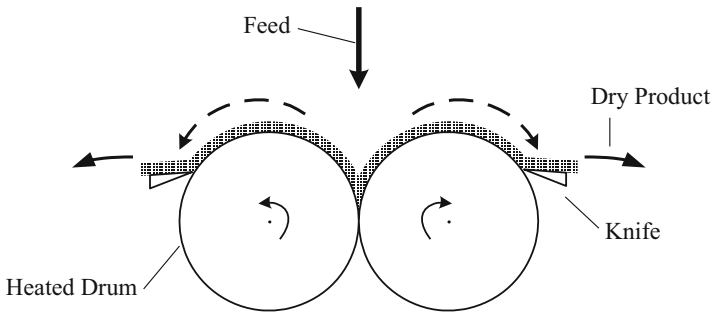
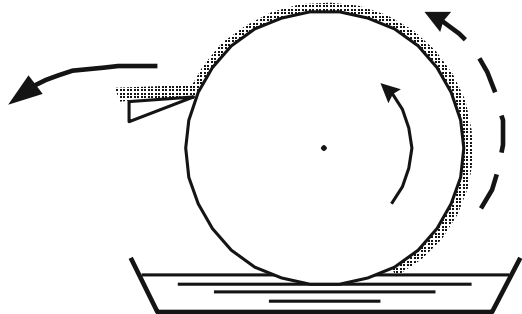
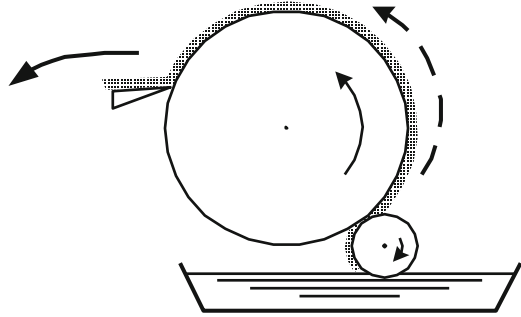


Fig. 8.28 Diagram of a double-drum dryer

Fig. 8.29 Diagram of a single-drum dryer



**Fig. 8.30** Diagram of single-drum drier with auxiliary roller



and the evaporative capacity is in the range 20–40 kg/m<sup>2</sup>h. The heat consumption of the drum dryers is relatively low (about 3 MJ/kg water evaporated), due to the direct heat transfer through the drum walls, without the interference of process heating air. Rotational speeds of the drums are 1–10 RPM (Walas 1988).

The drying rate is controlled mainly by heat transfer, since the material is dried as a thin film, in which mass transfer by diffusion is not controlling the process.

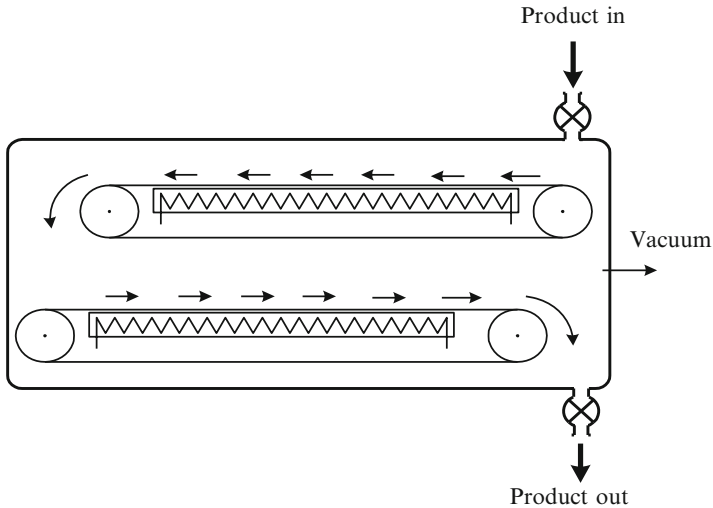
#### 8.3.5.14 Vacuum and Freeze Dryers

Vacuum and freeze dryers are the most expensive drying equipment, and they are used to dehydrate sensitive, high-value food products, like coffee, fruit juices, vegetable extracts, mushrooms, dairy products, meat, and chicken. The improvement of quality, functional properties, and nutritive value of these products justifies the added cost, compared to the conventional (convective) drying methods.

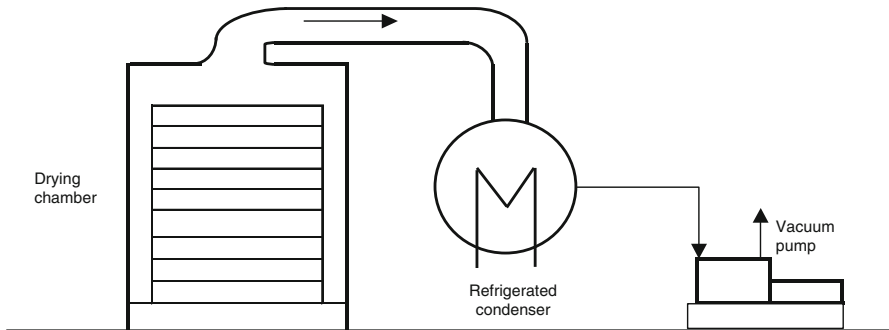
Vacuum and freeze dryers are mostly batch operations of lower capacity than convective dryers. They consist basically of a vacuum cabinet (typical size, 50-m<sup>2</sup> tray area), where the product is dried and spread on trays, and a condensing/vacuum system for removing the water vapors and maintaining the vacuum (Figs. 8.31 and 8.32). The main difference between the two processes lies in the operating pressure of about 10 mbar (8 °C) in vacuum compared to lower than 1 mbar (–20 °C) in freeze-drying, which results in evaporation of liquid water in vacuum drying and in sublimation of ice in freeze drying. Freeze-dried products retain their shape, and they have a very high porosity and they rehydrate instantly. Freeze dryers are more expensive because they require lower-temperature condensers, e.g., –30 °C, and higher vacuum pumps.

Freeze dryers are used mostly in the pharmaceutical industry and in drying expensive biotechnological products, where the high cost of drying is justified (Liapis and Bruttini 1995; Oetjen 1999). Application to foods is confined to heat-sensitive, high-quality, and relatively expensive products, e.g., instant coffee.

The principles and applications of freeze-drying in foods received much attention in the past (King 1971; Mellor 1978), but cost considerations and alternative



**Fig. 8.31** Diagram of a continuous vacuum dryer



**Fig. 8.32** Diagram of a batch freeze dryer

improved drying processes, like spray drying, have limited its application to only high-value food products.

Continuous vacuum dryers consist of a horizontal cylindrical vessel with a moving belt, on which a layer of food material (e.g., citrus juice) is dried with the aid of IR or MW heating. Typical capacity is about 50 kg/h dried product. Higher capacities can be obtained, using multiple-belt vacuum dryers.

Semicontinuous vacuum and freeze-drying systems have been developed for large industrial operations. In such a system, the drying chamber consists of a long cylindrical tunnel with one or two doors at the ends, equipped with special mechanisms to maintain the operating vacuum in the chamber. The tunnel is loaded with product-carrying trucks, and at the same time, dried product is removed from the other end.

The energy requirements for freeze-drying are much higher than in other dryers, e.g., 10 MJ/kg vs. 4 MJ/kg water evaporated, due to the extra needs for refrigeration and vacuum, and the higher heat of sublimation of ice (2.84 MJ/kg at  $-15\text{ }^{\circ}\text{C}$ ), compared to the heat of evaporation of water (2.26 MJ/kg at  $100\text{ }^{\circ}\text{C}$ ).

### 8.3.6 *Special Food Dryers*

Special food dryers are used in small-scale food processing operations to dehydrate some sensitive food products, especially fruits and vegetables (Saravacos 1993). They are mostly batch operations and their cost is, in general, higher than the cost of conventional dryers. Some of the special dryers are still in the development stage, and their commercial application will depend on the process economics and the acceptance of the new products by the consumers.

#### 8.3.6.1 **Microwave and Dielectric Dryers**

Microwave (MW) and dielectric or radio-frequency (RF) energy is used to remove water from food materials at atmospheric or in vacuum. The MW energy is usually applied at 915 or 2450 MHz (megacycles/s), while the frequency range of 1–100 MHz is used for the RF energy. Both types of electromagnetic energy can heat the materials by ionic or molecular motions or other mechanisms (Schiffmann 1995).

The basic advantage of MW and RF energy is that they heat the material internally, without the need of external convective or contact heat transfer (see Chap. 6). Water has a higher dielectric constant (about 8) than the other food components (about 2). Therefore, food materials of high moisture content absorb more MW or RF energy, facilitating the drying process. Free water can be removed more easily, because it absorbs more energy than adsorbed water.

The penetration depth of MW/RF energy (37 % decay of radiation intensity) is proportional to the free space wavelength and the square root of the dielectric constant and inversely proportional to the loss factor (6.40). Typical penetration depths are for RF at 40 MHz, 3 m; for MW at 915 MHz, 13 cm; and for MW at 2450 MHz, 4.9 cm. The wavelengths, corresponding to the above frequencies, are 7.5 m, 32.8 cm, and 12.3 cm, respectively. If the piece of the material is smaller than the wavelength, its center will be overheated, compared to the external surface, an important factor in drying applications.

Internal absorption of the MW/RF energy by a wet material will increase its temperature and vapor pressure, creating a puffing effect on the product and increasing the drying rate during convective or vacuum drying. MW/RF energy may be applied at the beginning, during, and at the final stages of drying.

Short MW pretreatment increases the moisture permeability of grape skins, facilitating subsequent sun drying or convective drying (Kostaropoulos and

Saravacos 1995). A similar effect is observed when food gels and other food materials are treated with MW energy before conventional drying (Drouzas et al. 1997).

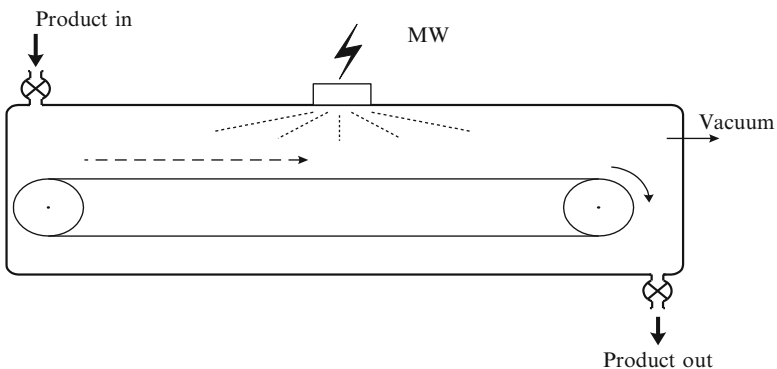
MW energy improves the vacuum- and freeze-drying operations of food materials by better energy (heat) absorption within the product or by the development of a porous structure (puffing) in the material, which increases substantially the effective moisture diffusivity (Drouzas et al. 1999).

Conversion of the normal AC current of 50–60 Hz to the high frequency of the MW/RF systems requires special electrical equipment. RF circuits use simple self-excited oscillators or plate-tuned grid type. MW generators consist of a DC power supply and a tube, e.g., a magnetron or a klystron. The MW energy is applied through waveguides or cavity applicators.

RF drying is used in various post-baking systems, following the commercial fuel-heated oven, increasing the production rate of cookies, biscuits, etc., by 30–50 %.

MW drying can be applied to pasta drying operations, reducing substantially the drying time of conventional hot-air drying and improving the product quality. In a typical application, 1500 kg/h of pasta can be dried, using 60 kW of MW energy at 915 MHz. Post-drying of some vegetables (e.g., onions) with MW energy can remove the residual moisture from 10 to 5 % in a shorter time than convective drying.

Figure 8.33 shows diagrammatically a continuous MW-vacuum dryer, suitable for food products. Typical dimensions of such dryers are diameter 2–3.5 m and length 11–12 m. The MW energy supply is 35–50 kW at 2450 MHz, and the drying capacity is 60 L/h.



**Fig. 8.33** Diagram of a continuous MW-vacuum dryer



### 8.3.6.2 Infrared Dryers

Infrared drying (IR) is used commercially in the drying of paints, coatings, and other films. IR in the wavelength range of 1–100 mm has a relatively small penetrating power, thus limiting the thickness of the treated materials. However, IR energy is less expensive than the MW/RF systems for drying applications (Ratti and Mujumdar 1885).

Industrial IR heat sources consist of electrically heated or gas-fired radiators. They are used in both convective (belt) or vacuum/freeze dryers for thin product layers.

### 8.3.6.3 Tumbling Dryers

The tumbling dryers consist of rotating cone or V-shaped vessels, which can be operated at atmospheric pressure or in vacuum. The vessels are jacketed to allow heating by steam or other medium. The sensitive food material slides inside the rotating vessels, drying at a fast rate and moderate temperature, which improves the quality of the product (Walas 1988).

### 8.3.6.4 Centrifugal Dryers

The centrifugal fluid bed (CFB) dryers consist of a cylindrical vessel with perforated walls, which rotates horizontally at high velocity and is heated by a cross flow air stream (Lazar and Farkas 1980; Jayaraman and Das Gupta 1995).

The piece-form food material moves through the rotating cylinder and is dried fast, due to the high heat and mass transfer rates in the centrifugal field. Centrifugal forces of 3–15 g's and air velocities up to 15 m/s are applied, which are much higher than in normal fluid bed drying.

CFB drying is suitable for pre-drying high-moisture food materials, like vegetables, followed by conventional drying (convective or vacuum). The capacity of the CFB dryers is relatively small (up to about 200 kg/h), limiting their economic commercial application.

### 8.3.6.5 Explosion Puffing

Explosion-puff drying is based on the development of a highly porous structure in fruit and vegetable materials, which increases greatly the drying rate of the product. The wet food material is dehydrated by conventional convective drying to about 25 % moisture and then heated in a rotating cylindrical vessel (“gun”) until a high pressure is developed (2–4 bar). The pressure is released instantly, producing a puffed product, which is dried fast to the desired moisture content in a conventional

dryer. The dehydrated porous product has improved rehydration properties, an important quality factor in many food products (Jayaraman and Das Gupta 1995).

### 8.3.6.6 Foam-Mat Drying

Foam-mat drying is used in small scale for the drying of sensitive food products, like concentrated fruit juices, fruit purees, and food slurries. The fluid food is foamed by incorporating a gas in a special mixer, using a foam stabilizer, if needed (Woodroof and Luh 1986; Salunkhe et al. 1991).

The foamed material is applied as a thin film (about 1.5 mm) on a perforated tray or belt and is dried at moderate temperatures and air velocities. Very fast drying is achieved, e.g., 15 min at 70 °C, and the product has a porous structure, which improves its rehydration properties. The operating cost of foam-mat drying is lower than vacuum drying, but, for commercial applications, large spray dryers are more efficient.

### 8.3.6.7 Acoustic Dryers

Acoustic or sonic dryers have been proposed to improve the drying rate of various food materials. Low-frequency sound waves increase considerably the heat and mass transfer rates at the particle/air interface (Mulet et al. 1999). The short drying times, achieved by sonic drying, improve the product quality, e.g., color, flavor, and retention of volatile aroma components. Food liquids of 5–75 % total solids have been dehydrated to low moistures, e.g., citrus juices, tomato paste, and corn syrups.

### 8.3.6.8 Osmotic Dehydration

Osmotic dehydration is used to remove part of the free water in food materials by the osmotic action of sugar or salt solutions. It is an ancient method of food preservation of fruits, vegetables, and fish, based on the reduction of water activity of the food material, which prevents or delays the growth of spoilage microorganisms in the product.

Osmotic dehydration is a nonthermal dehydration process, more efficient than conventional drying, operated at lower temperature, improving the product quality (color, volatile aroma, etc.). It is used to produce IMFs or as a pre-drying step, removing about 50 % of moisture, for conventional dehydration (convective or vacuum drying). IMF products (mainly fruits) contain 20–30 % moisture, and they need additional protection against spoilage, e.g., preservatives, low temperature, and freezing.

Mass transfer in osmotic dehydration involves the transport of water within the plant tissue, the transfer of water and natural solutes from the plant cells to the osmoactive solution, and the transfer of the osmoactive substance to the plant

material (Lewicki and Lenart 1995). The transport mechanisms depend mainly on the physical structure of the food material. The diffusion (Fick) model is generally used for transport calculations, assuming that the driving force is a concentration gradient, using the effective diffusivity ( $D$ ) as the principal transport property within the material (Saravacos and Maroulis 2001). Typical values of  $D$  in osmotic treatment for apples at 50 °C are  $10 \times 10^{-10}$  m<sup>2</sup>/s (water) and  $4 \times 10^{-10}$  m<sup>2</sup>/s (sucrose).

Osmoactive substances are sugars (sucrose, corn syrups) and dextrans at about 65 °Brix for fruits and sodium chloride (about 15 %) for vegetables and fish.

Equipment for osmotic dehydration is in the development stage before large-scale commercial application. It may be similar to extraction and leaching equipment used in chemical engineering. The food material should be cut into pieces, e.g., slices or cubes of 10 mm, to facilitate mass transfer. A typical process temperature is 50 °C. The diluted osmoactive solution should be concentrated in an efficient evaporator, before recycling in the osmotic process.

Energy requirements for the osmotic process include pumping and heating of the product and concentration of the diluted solution. They are estimated at 0.1–2.4 MJ/kg water removed, the highest values corresponding to the concentration of the diluted solution by evaporation (Lewicki and Lenart 1995). For comparison, convective drying requires about 3.5 MJ/kg water evaporated.

### 8.3.7 *Hygienic and Safety Considerations*

Dehydrated foods have a low water activity, which prevents or retards microbial growth and spoilage. Thus, food dryers have, in general, fewer hygienic (sanitation) problems than “wet” processing equipment.

High-temperature equipment, like drum dryers with surface temperatures above 120 °C, are practically sterile, but lower temperature units, like tray, conveyor, and fluid bed dryers, allow the growth of spoilage microorganisms. Contamination of some dryers may occur by adding back a dried product to the contents of the unit, a process used in some drying and agglomerating operations (Troller 1993).

Bacterial spores may survive the temperatures of convective dryers (up to 100 °C), and high microbial counts may be detected in some drying equipment. In such cases, wet cleaning of the equipment may be required, using the CIP sanitation system, if available. The equipment should be dried thoroughly with warm air before reuse.

The main hazards of drying equipment are fires and explosions. Fires may be caused by combustion of dried materials, volatiles, or fuels. Dust explosion may occur in the dryer, the ducts, or the cyclone collectors (Markowski and Mujumdar 1995).

Dust explosions are caused by overheated combustible materials (e.g., starch, flour, powders) or equipment contact surfaces in the drying system or by static electricity (Van't Land 1991).

The design, construction, and operation of drying equipment should comply with national and international fire protection laws and codes, like the National Fire Protection Association in the USA (NFPA 1992). The NFPA codes related to drying contain references on starch facilities, milling agricultural commodities, ovens and furnaces, exhaust systems for air-conveying materials, and pneumatic conveying systems for handling combustible materials (Crapiste and Rotstein 1997).

## 8.4 Energy and Cost Considerations of Drying

The cost of energy represents the major part of the operating cost of the industrial dryers. A typical cost breakdown for convective dryers is as follows (Bhatia): energy 62 %, capital cost 13 %, labor 10 %, overhead 10 %, and maintenance 5 %.

Industrial drying consumes about 12 % of the total energy used in manufacturing, e.g.,  $128 \times 10^9$  MJ/year in the UK and  $166 \times 10^9$  MJ/year in France (Strumillo et al. 1995). The major part of this large energy is used for drying food and agricultural materials.

The energy consumption in drying is used mainly for the evaporation of free water, desorption of sorbed water, or sublimation of ice in freeze-drying. Theoretically, evaporation of free water requires 2.26 MJ/kg at 100 °C or 2.36 MJ/kg at 60 °C. The heat of sublimation of ice at 0 °C is 2.84 MJ/kg, and higher energies are required for desorption of water, bound on food biopolymers. In addition, energy is required for sensible heating of the food material, the dryer, and the exhaust air and for mechanical movement of the process air (operation of fans). Thus, the total energy consumption varies in the range of 3–4 MJ/kg water in continuous convective dryers. It is higher in batch dryers (3–6 MJ/kg water), and it may reach 10 MJ/kg water in vacuum and freeze dryers.

It is obvious that economy in drying is related to the efficient use of energy and the development of new systems and equipment, which will operate more efficiently and reduce the energy losses. In addition to the economic reasons, energy saving will reduce pollution (chemical and thermal) of the environment and preserve the fuel reserves. Utilization of renewable energy resources, like solar, wind, and geothermal energy, can reduce the excessive use of fossil energy for industrial drying.

### 8.4.1 Heat Sources for Drying

The heat required for drying is provided mostly by direct heating (firing) with fuels (gas or oil) and saturated steam. In some rather small-size applications, heat is supplied in the form of hot water, infrared radiation, or microwave energy. Combustion of fuel (natural gas, LPG or liquefied petroleum gas, or fuel oil) is

the simplest and most economical energy source for drying applications. Saturated steam and hot water are more expensive than direct fuel combustion, because heat exchangers and condensers are needed, but they are preferred in some cases, when contamination of the food material with combustion gases may not be acceptable.

Natural gas, used for direct firing of the dryer, is suitable for agricultural and food drying (Kudra 1998).

High temperatures are obtained, which increase substantially the drying rate and shorten the drying time. The natural gas contains about 98 % methane and ethane, and its heating value is  $37.2 \text{ MJ/m}^3$ . The heating value of propane is  $50.4 \text{ MJ/kg}$ , and that of fuel oil is  $41.7 \text{ MJ/kg}$ .

The major limiting factor of using direct heating by natural gas and LPG fuels in drying is the presence of significant amounts of water vapor in the flue gases, produced by combustion of the hydrocarbons. Stoichiometric calculations indicate that flue (combustion) gases would contain 19 % by volume of water vapor, but in practice, lower concentrations are obtained, due to the use of excess air. As a result, the capacity of the heating air/gases to remove water in the dryer is reduced, and a low moisture content may not be reached easily for some food materials, which may require finish drying with low humidity air in, e.g., bin dryers.

### 8.4.2 Heat Recovery

Recirculation of the exhaust air/gases from the dryer is the simplest method of recovering part of the heat rejected to the environment. Almost all convective dryers use some form of recirculation, recovering only the sensible heat, since it is difficult to recover the latent heat of evaporation of water in the exhaust gases.

The thermal efficiency ( $N$ ) of a convective dryer is related to the recirculation fraction  $w$  (ratio of recirculated air to total air flow) by the equation

$$N = (T_2 - T_3) / [(T_2 - T_3) + (1 - w)(T_3 - T)] \quad (8.17)$$

where,  $T$ ,  $T_2$ , and  $T_3$  are the ambient, inlet, and exit air temperatures.

The amount of recirculation is limited by the increase in humidity of the air stream, which reduces the drying rate of the material, particularly in the early stage of drying.

Part of the exhaust heat can be recovered by heating the inlet air to the dryer, using some type of heat exchanger, e.g., thermal wheel, pipe, or plate heat exchanger (Strumillo et al. 1995).

Part of the latent heat of evaporation of water can be recovered by a complex system of heat exchangers between the exhaust gases and the inlet air (Moraitis and Akritidis 1996).

### **8.4.3 Energy-Efficient Dryers**

A number of efficient dryers have been developed, which can operate with less energy than conventional dryers. They operate mostly at high temperatures, and they have not found wide applications yet in the food processing industry.

#### **8.4.3.1 Superheated Steam Dryers**

The superheated steam dryer is an energy-saving unit, which is used commercially to dry materials that can tolerate high temperatures, such as coal, ceramics, sugar beet pulp, and wastewater sludge (Wimmerstedt 1994). The superheated steam or “airless” dryer operates with superheated steam, which is heated by a fuel gas and is recirculated in the dryer at about 100 °C, removing the moisture from the wet product. The water vapors are condensed in a heat exchanger, which heats cold water to about 95 °C (Stubbing 1994).

The dryer can operate at atmospheric pressure either batch or continuously. Stratification of the steam inside the dryer takes place with the steam at the upper layer, due to the difference in densities of air and steam, preventing their mixing in the dryer.

#### **8.4.3.2 Heat Pump Dryers**

The heat pump dryer uses electrical energy to generate heat by compression of a refrigerant (inverse of operation of the normal compression refrigeration cycle). It can recover the energy of condensation of water vapors in the closed system (Alves-Filho and Strommen 1996). The heat pump dryers can operate in a wide range of temperatures, from –20 °C (freeze-drying) to 30 °C. The system does not pollute the environment with exhaust gases, and it is suitable for areas where cheap electrical energy is available (e.g., Norway).

#### **8.4.3.3 Impingement Dryers**

Impingement jets of hot air are used in some industrial drying operations involving rapid drying of continuous sheets, such as paper and textiles (Mujumdar and Huang 1995). The high drying rates are obtained by the increased heat and mass transfer coefficients in the impingement systems.

Nozzle design and nozzle configuration are important factors in effective drying applications. Specific energy consumption in impingement dryers is about 3.1 MJ/kg water evaporated.

### 8.4.4 Cost Considerations

Reliable cost data for industrial dryers can be provided by manufacturers and suppliers of process equipment. To aid the price quotation, data for the particular application should be provided in an appropriate specification form (Chap. 2).

Preliminary cost estimation can be made on the basis of drying capacity (kg water/h), using empirical correlations, tables, and the Marshall and Stevens index (M&S index) of the *Chemical Engineering Journal* (Chap. 1). The exponent ( $n$ ) of the cost/capacity equation (1.3) for convective dryers varies in the range of 0.50–0.70 (Sztabert and Kudra 1995).

For preliminary cost estimates, the following equation gives the capital cost of drying equipment ( $C_E$  in USD, 1995):

$$C_E = (\text{M\&SI})AQ^n \quad (8.18)$$

where,  $Q$  is the capacity, defined either by the transfer area ( $\text{m}^2$ ) or the effective volume ( $\text{m}^3$ ) of the dryer. The coefficient  $A$  and the exponent  $n$  are characteristic of each type of dryer. Typical values of these parameters for industrial dryers are (Sztabert and Kudra 1995) belt conveyor dryer (stainless steel), basis  $Q =$  belt surface area,  $A = 21$ , and  $n = 0.59$  and direct (fuel gases) rotary dryer (carbon steel), basis  $Q =$  dryer volume,  $A = 17$ , and  $n = 0.69$ .

The total (installed) cost of drying plant ( $C_T$ ), which includes the costs of dryer, piping, motors, fans, instrumentation, buildings, and engineering, can be estimated from the equipment cost ( $C_E$ ), using the empirical relation (Van't Land 1991; Sztabert and Kudra 1995):

$$C_T = aC_E \quad (8.19)$$

The coefficient ( $a$ ) is taken equal to 2.25 for carbon steel and 2.75 for stainless steel (Chap. 2).

Typical prices of drying equipment, converted to year 2000 by the M&S index, are (Van't Land 1991; Sztabert and Kudra 1995):

- (a) Rotary dryer, carbon steel, steam tube heating, 1.83 m diameter and 18.30 m length, 290  $\text{m}^2$  transfer area, and 14.9 kW power motor: USD 450,000
- (b) Spray dryer, cocurrent open cycle, 5 m diameter, operating at 370 °C (air inlet)/105 °C (air outlet) temperatures, 1090 kg/h water evaporative capacity: USD 380,000

Costs of new, used, and salvage drying equipment are listed by Bhatia (1983). The cost of used dryers is roughly 50 % of the cost of the new equipment, depending on the condition and the age of the various units. The salvage value of dryers is about 5 % of the initial cost.

Comparative cost data for concentration and drying food processes were presented by Sapakie and Renshaw (1984). The relative cost of dryers is convective

1, drum 1, spray 1, vacuum 3, and freeze 6. It should be noted that the basis of cost comparisons should be the total evaporative capacity of the unit (kg/h) and not the specific cost per transfer surface ( $\text{m}^2$ ) or transfer volume ( $\text{m}^3$ ). For example, the specific cost of drum dryers per  $\text{m}^2$  is very high, compared to the specific cost of tray dryers, but their specific evaporative capacity ( $\text{kg}/\text{m}^2\text{h}$ ) is much higher, and the two dryers are approximately equivalent in cost, in terms of overall capacity (kg/h).

The cost of energy for drying applications is usually expressed as cost/GJ or cost/kg water evaporated, assuming the appropriate energy requirement in MJ/kg water evaporated, e.g., 3–5 MJ/kg (1 GJ = 1000 MJ). The cost of natural gas, LPG, and fuel oil depends on the location, and it may increase significantly during international oil (petroleum) crises.

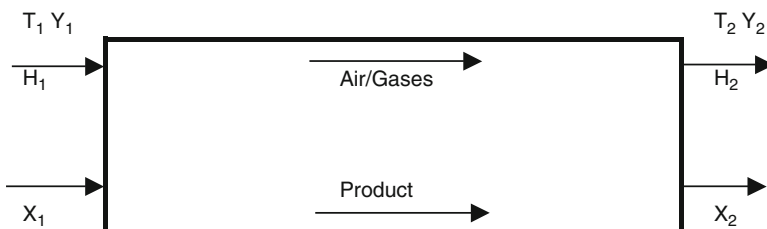
*Example 8.1* Design a rotary convective dryer to dry the by-products peels and pulp, produced in the orange processing plant of Example 1.1.

The plant processes 20,000 kg/h of oranges, producing  $49.7 \times 20,000/100 = 9940$  kg/h of peels/pulp of 15 % TS (total solids). The dried product (animal feed) will contain 10 % moisture. The total dry solids are  $9940 \times 0.15 = 1491$  kg/h, and the dried product (10 % moisture) will be  $1491/0.9 = 1656$  kg/h. The amount of water to be evaporated in the dryer will be  $m_w = 9940 - 1656 = 8284$  kg/h.

Because of the high evaporation duty, an efficient rotary dryer is selected. The product to be dried (animal feed) can tolerate relatively high temperatures and “clean” combustion gases. Therefore, an economical cocurrent dryer is proposed, heated directly with LPG. A simplified diagram of the dryer, useful for preliminary calculations, is shown in Fig. 8.34.

For approximate design estimation, the standard psychrometric chart is used to calculate the air and fuel requirements of the dryer. For more accurate estimation, analytical calculations, based on material and energy balances, can be performed, or a computer version of psychrometric and drying calculations, like the DryPACK software (Pakowski 1998), can be used.

The use of direct heating with combustion gases from the fuel introduces significant quantities of combustion water in the dryer, which should be taken under consideration in the calculations. Assuming that atmospheric air at 20 °C and 50 % RH (relative humidity) is used, its moisture content ( $Y_o$ ) and enthalpy ( $H_o$ ), taken from the psychrometric chart (Fig. 8.1), will be  $Y_o = 0.0075$  kg/kg db (dry air basis) and  $H_o = 67$  kJ/kg db. The air is heated by mixing with the



**Fig. 8.34** Diagram of a cocurrent rotary dryer of Example 8.1



combustion gases to  $T_1 = 300$  °C and, neglecting the combustion water, the moisture content will remain constant at  $Y_1 = Y_o = 0.0075$  kg/kg db, and the enthalpy will be  $H_1 = 340$  kJ/kg db (using a high-temperature psychrometric chart; Walas 1988).

The hot air/flue gases are passed adiabatically (constant  $H$ ) through the dryer, leaving at 80 % RH, a reasonable assumption for practical application. From the chart, the exit air/gases will have a (dry bulb) temperature  $T_1 = 57$  °C, a moisture content of  $Y_2 = 0.110$  kg/kg db, and the same enthalpy  $H_2 = H_1 = 340$  kJ/kg db.

The moisture pickup of the air/gases in the dryer will be  $\Delta Y = Y_2 - Y_1 = 0.110 - 0.0075 = 0.1025$  kg/kg db. The needed dry air to remove 8284 kg/h water in the dryer will be  $8284/0.1025 = 80,820$  kg db/h. Since the specific volume of the initial air (30 °C and 50 %) is  $0.840$  m<sup>3</sup>/kg (psychrometric chart), the volumetric air flow in the dryer will be  $80,820 \times 0.840 = 67,889$  m<sup>3</sup>/h. The mean air/gas velocity in the dryer will be  $u = 67,889/(3.14 \times 3600) = 6.0$  m/s.

The required enthalpy to heat the process air will be  $\Delta H = H_2 - H_o = 340 - 67 = 273$  kJ/kg db. The total energy required for heating will be  $80,820 \times 0.273 = 22,064$  MJ/h =  $22,064/3600 = 6.13$  MW. If the heating value of the LPG is 50 MJ/kg, the amount of fuel gas needed will be  $22,064/50 = 441$  kg/h LPG.

The presence of combustion water in the air/gas mixture will increase significantly the requirements for process air and fuel. Stoichiometric calculations indicate that the flue (combustion) gases of fuel gas will contain 19 % by volume combustion water. However, since excess air is used, the amount of water in the combustion gases can be assumed to be about 10 %, with approximately similar increases in the air and fuel requirements in the dryer. Thus, the air flow requirement for this example will be  $67,889 \times 1.1 = 74,678$  m<sup>3</sup>/h and the fuel requirement  $441 \times 1.1 = 485$  kg/h LPG.

The size of the rotary dryer for this application can be selected from performance data of direct heated rotary dryers (Walas 1988). A rotary dryer of 2.0 m diameter and 15 m length, similar to the one used for drying sugar beet pulp, appears to be a good approximation. The dryer will have a volume of 47 m<sup>3</sup> and 94.2-m<sup>2</sup> wall surface, with a specific evaporative capacity of  $8284/94.2 = 88$  kg/m<sup>2</sup> h, which falls within the range of capacities (30–100 kg/m<sup>2</sup> h), found in the literature (Table 8.3).

The air flow capacity of the above literature dryer is 75,960 m<sup>3</sup>/h, close to the air requirement of our example. The fan power is 52 kW and the motive power for the dryer is 11 kW.

Carbon steel is an economic and acceptable material of construction for this particular application.

## References

- Abud-Archila M, Bonazzi C, Courtois F, Bimbenet JJ (2000) Modeling drying kinetics of paddy rice with emphasis on breakage quality for optimizing operating conditions. Paper presented at the International Congress Engineering and Food ICEF 8, Puebla, April

- Alves-Filho O, Strommen I (1996) Performance and improvements in heat pump drying. In: Strumillo AC, Pakowski Z (eds) Proceedings IDS 96, vol A. Lodz Technical University, Lodz, pp 405–416
- Baker CGJ (ed) (1997) Industrial drying of foods. Blackie Academic and Professional, London
- Baker CGJ, Lababidi HMS (1998) Application of fuzzy expert systems in dryer selection. In: Acritidis CB, Marinos-Kouris D, Saravacos GD (eds) Proceedings IDS 98, vol A. Ziti, Thessaloniki, pp 448–455
- Baker CGJ, Lababidi HMS (2000) Developments in computer-aided dryer selection. In: Kerkhof PJAM, Coumans WJ, Mooiweer GD (eds) Proceedings IDS 2000, Noordwijk, paper no. 42
- Bakker-Arkema FW (1986) Heat and mass transfer aspects and modeling of dryers—a critical evaluation. In: MacCarthy D (ed) Concentration and drying of foods. Elsevier, London, pp 165–202
- Barbosa-Canovas GV, Vega-Mercado H (1996) Dehydration of foods. Chapman & Hall, New York
- Bhatia MV (1983) Transfer operations in process industries. Technomic, Lancaster
- Cao CW, Liu XD (2000) Experimental studies on impinging stream drying of particulate materials. In: Kerkhof PJAM, Coumans WJ, Mooiweer GD (eds) Proceedings IDS 2000, Noordwijk, paper no. 76
- Cook EM, DuMont D (1991) Process drying practice. McGraw-Hill, New York
- Crapiste GH, Rotstein E (1997) Design and performance evaluation of dryers. In: Valentas KJ, Rotstein E, Singh RP (eds) Handbook of food engineering practice. CRC, New York, pp 125–146
- Davies R, Birch GG, Parker KJ (eds) (1976) Intermediate moisture foods. Applied Science, London
- de Cindio B, Brancato B, Pollini CM (1994) Process modeling of pasta drying. In: Bimbenet JJ, Dumoulin E, Trystram G (eds) Automatic control of food and biological products. Elsevier, Amsterdam, pp 183–189
- Douglas PL, Sullivan GR (1994) Automatic moisture control of process drying in the agricultural and food industries. In: Keyy ARB, Rudolph V (eds) Proceedings IDS 94, vol A. University of Queensland, Brisbane, pp 327–334
- Drouzas AE, Tsami E, Saravacos GD (1997) Effect of microwave pre-treatment on the moisture diffusivity of fruits/vegetable materials. In: Jowitt R (ed) Engineering and food at ICEF 7. Part 1. Sheffield Academic Press, Sheffield, pp A57–A60
- Drouzas AE, Tsami E, Saravacos GD (1999) Microwave/vacuum drying of model fruit gels. *J Food Eng* 39:117–122
- Filkova I, Mujumdar AS (1995) Industrial spray drying systems. In: Mujumdar AS (ed) Handbook of industrial drying, vol 1, 2nd edn. Marcel Dekker, New York, pp 263–307
- Fresland O, Hostmark Y, Samuelson TA, Oterhals A (2000) Selecting drying technology for the production of fish meal. In: Kerkhof PJAM, Coumans WJ, Mooiweer GD (eds) Proceedings IDS 2000, Noordwijk, paper no. 177
- Fuller RJ (1994) Solar tunnel dryers vs. conventional dehydrators—a comparative study. In: Keyy RB, Rudolph V (eds) Proceedings IDS 94, vol A. University of Queensland, Brisbane, pp 343–349
- Geankoplis CJ (1993) Transport processes and unit operations, 3rd edn. Prentice Hall, New York
- Genskow LR (1994) Dryer scale-up methodology for the process industries. *Drying Technol* 12:47–54
- Green D, Perry R (1997) Perry's chemical engineers' handbook. McGraw-Hill, New York
- Greensmith M (1998) Practical dehydration, 2nd edn. Woodhead, Cambridge
- Henrikson R, Gustafson G (1986) Practical applications for using solar collectors for drying purposes in agriculture. *Drying Technol* 4:513–533
- Hovmand S (1995) Fluidized bed drying. In: Mujumdar AS (ed) Handbook of industrial drying, vol 1, 2nd edn. Marcel Dekker, New York, pp 195–248
- Iglesias HA, Chirife J (1983) Handbook of food isotherms. Academic, New York

- Imre L (1995) Solar drying. In: Mujumdar AS (ed) Handbook of industrial drying, vol 1, 2nd edn. Marcel Dekker, New York, pp 373–451
- Jayaraman KS, Das Gupta DK (1995) Drying of fruits and vegetables. In: Mujumdar AS (ed) Handbook of industrial drying, vol 1, 2nd edn. Marcel Dekker, New York, pp 643–690
- Key RB (1978) Introduction to industrial drying operations. Pergamon Press, Oxford
- Kemp IC (1999) Progress in dryer selection techniques. *Drying Technol* 17:1667–1680
- Kemp IC, Gardiner SP (2000) An outline method for troubleshooting and problem—solving in dryers. In: Kerkhof PJAM, Coumans WJ, Mooiweer GD (eds) Proceedings IDS 2000, Noordwijk, paper no. 177
- Kemp IC, Snowball IAG, Bahu RE (1997) An expert system for dryer selection. In: Proceedings 1st European Congress in Chemical Engineering ECCE 1, vol 2. AIDIC, Milan, pp 175–182
- Kessler HG (1981) Food engineering and dairy technology. Verlag A. Kessler, Freising
- King CJ (1971) Freeze drying of foods. CRC Press, New York
- Kiranoudis CT, Maroulis ZB, Marinou-Kouris D (1994) Modeling and design of convective dryers. *J Food Eng* 23:375–396
- Kiranoudis CT, Maroulis ZB, Marinou-Kouris D, Saravacos GD (1996a) Comparison of different types of industrial dryers: design and operation. In: Strumillo AC, Pakowski Z (eds) Proceedings IDS 96, vol A. Lodz Technical University, Lodz, pp 463–469
- Kiranoudis CT, Maroulis ZB, Marinou-Kouris D (1996b) Design and operation of convective industrial dryers. *AIChE J* 42(11):3030–3040
- Korn O, Nowak H (2000) Cyclone dryer: industrial applications. In: Kerkhof PJAM, Coumans WJ, Mooiweer GD (eds) Proceedings IDS 2000, Noordwijk, paper no. 420
- Kostaropoulos AE, Saravacos GD (1995) Microwave pre-treatment for sun-dried raisins. *J Food Sci* 60:344–347
- Krischer O (1963) Die wissenschaftlichen grundlagen der trocknungstechnik. Springer, Berlin
- Kroll K (1976) Trockner und trocknungsverfahren. Springer, Berlin
- Kudra T (1998) Natural gas: fuel of choice in industrial drying. In: Acritidis CB, Marinou-Kouris D, Saravacos DG (eds) Proceedings IDS 98, vol A. Ziti Publ, Thessaloniki, pp 488–495
- Langrish TAG (1996) Flowsheet simulations and the use of CFD simulations in drying technology. In: Strumillo AC, Pakowski Z (eds) Proceedings IDS 96, vol A. Lodz Technical University, Lodz, pp 40–51
- Lazar ME, Farkas DF (1980) Centrifugal fluidized bed dryers—a review of its applications and potential in food processing. In: Mujumdar AS (ed) Drying 80, vol 1. Hemisphere, New York, p 242
- Lee DE (1983) Thermal drying and dryers. In: Bhatia MV (ed) Transfer operations in process industries. Technomic, Lancaster
- Lewicki P, Lenart A (1995) Osmotic dehydration of fruits and vegetables. In: Mujumdar AS (ed) Handbook of industrial drying, vol 1, 2nd edn. Marcel Dekker, New York, pp 643–690
- Liapis AI, Bruttini R (1995) Freeze drying. In: Mujumdar AS (ed) Handbook of industrial drying, vol 1, 2nd edn. Marcel Dekker, New York, pp 309–343
- Luh BS, Woodroof JG (eds) (1988) Commercial vegetable processing, 2nd edn. Van Nostrand Reinhold, New York
- Lutz K, Muhlbauer W (1986) Solar tunnel dryer with integrated collector. *Drying Technol* 4:583–604
- MacCarthy D (ed) (1986) Concentration and drying of foods. Elsevier, London
- Marinou-Kouris D, Maroulis ZB (1995) Transport properties in the drying of solids. In: Mujumdar AS (ed) Handbook of industrial drying, vol 1, 2nd edn. Marcel Dekker, New York, pp 113–159
- Markowski AS, Mujumdar AS (1995) Safety aspects of industrial dryers. In: Mujumdar AS (ed) Handbook of industrial drying, vol 2, 2nd edn. Marcel Dekker, New York, pp 1277–1312
- Maroulis ZB, Saravacos GD (1986) Solar heating of air for drying agricultural products. *Solar Wind Energy* 3(2):127–134
- Masters K (1991) Spray drying handbook, 5th edn. Longman, London

- Masters K (1998) Developments in spray drying. In: Acritidis ACB, Marinos-Kouris D, Saravacos GD (eds) Proceedings IDS 98, vol A. Ziti, Thessaloniki, pp 666–667
- Matasov A, Menshutina N, Kudra T (1998) Information system for selection of dryer. In: Acritidis ACB, Marinos-Kouris D, Saravacos GD (eds) Proceedings IDS 98, vol A. Ziti, Thessaloniki, pp 624–629
- Mellor JD (1978) Fundamentals of freeze drying. Academic, New York
- Menshutina N, Pouchkov MN (2000) Principles of integration artificial intelligence and human experience to make drying easy. In: Kerkhof PJAM, Coumans WJ, Mooiweer GD (eds) Proceedings IDS 2000, Noordwijk, paper no. 263
- Mermelstein NH (2001) Spray drying. Food Technol 55(4):92–95
- Molnar K (1995) Experimental techniques in drying. In: Mujumdar AS (ed) Handbook of industrial drying, vol 1, 2nd edn. Marcel Dekker, New York, pp 41–70
- Moore JG (1987) Drum dryers. In: Mujumdar AS (ed) Handbook of industrial drying. Marcel Dekker, New York, pp 227–242
- Moraitis CS, Akritidis CB (1996) Energy saving in industrial drying plants by partial recovery of the latent heat of the exhaust air. In: Strumillo AC, Pakowski Z (eds) Proceedings of IDS 96, vol A. Lodz Technical University, Lodz, pp 489–496
- Mujumdar AS (ed) (1995) Handbook of industrial drying, 2nd edn. Marcel Dekker, New York
- Mujumdar AS, Huang B (1995) Impinging steam dryers. In: Mujumdar AS (ed) Handbook of industrial drying, vol 1, 2nd edn. Marcel Dekker, New York, pp 538–566
- Mujumdar AS, Menon AS (1995) Drying of solids: principles, classification, and selection of dryers. In: Mujumdar AS (ed) Handbook of industrial drying, vol 1, 2nd edn. Marcel Dekker, New York, pp 1–39
- Mulet A, Carcel J, Benedicto J, Rossello C, Simai S (1999) Ultrasound mass transfer enhancement in food processing. In: Barbosa-Canovas GV, Lombardo SP (eds) Proceedings CoFE 99. AIChE, New York, pp 74–85
- NFPA (1992) Natural fire codes subscription service, vols 1–12 and master index. National Fire Protection Association, Quincy
- Oetjen G-W (1999) Freeze-drying. Wiley, New York
- Okos MR, Narsimham G, Singh RK, Weitnauer AC (1992) Food dehydration. In: Heldman DR, Lund DB (eds) Handbook of food engineering. Marcel Dekker, New York
- Pakowski Z (1998) dryPACK v.3. Program for psychrometric and drying computations. TKP Omnikon, Lodz
- Pakowski Z, Mujumdar AS (1995) Basic process calculations in drying. In: Mujumdar AS (ed) Handbook of industrial drying, 2nd edn. Marcel Dekker, New York, pp 71–111
- Papagiannes GJ (1992) Select the right dryer. Chem Eng Prog 88:20
- Pisecky J (1995) Evaporation and spray drying in the dairy industry. In: Mujumdar AS (ed) Handbook of industrial drying, vol 1, 2nd edn. Marcel Dekker, New York, pp 715–742
- Raghavan VGS (1995) Drying of agricultural products. In: Mujumdar AS (ed) Handbook of industrial drying, vol 1, 2nd edn. Marcel Dekker, New York, pp 627–642
- Rahman S (1995) Food properties handbook. CRC, New York
- Raouzeos GS, Saravacos GD (1986) Solar drying of raisins. Drying Technol 4:633–649
- Ratti C, Mujumdar AS (1985) Infrared drying. In: Mujumdar AS (ed) Handbook of industrial drying, 2nd edn. Marcel Dekker, New York, pp 71–111
- Ruslan H, Daud WRW, Othman MY, Yatim B, Soplan K (2000) Solar assisted drying of chili using a V-grooved solar collector. In: Kerkhof PJAM, Coumans WJ, Mooiweer GD (eds) Proceedings IDS 2000, Noordwijk, paper no. 197
- Salunke DK, Bolin HR, Reddy NR (1991) Storage, processing, and nutritional quality of fruits and vegetables, vol 2, 2nd edn. CRC, Boca Raton
- Sapakie SF, Renshaw TA (1984) Economics of drying and concentration of foods. In: McKenna BM (ed) Engineering and food, vol 2. Elsevier Applied Science Publ, London, pp 927–937
- Saravacos GD (1993) Technological developments in fruit and vegetable dehydration. In: Charalambous G (ed) Food flavors ingredients and composition. Elsevier, Amsterdam, pp 389–404

- Saravacos GD (1995) Mass transport properties of foods. In: Rao MA, Rizvi SSH (eds) *Engineering properties of foods*, 2nd edn. Marcel Dekker, New York, pp 169–221
- Saravacos GD, Maroulis ZB (2001) Transport properties of foods. Marcel Dekker, New York
- Schiffmann RF (1995) Microwave and dielectric drying. In: Mujumdar AS (ed) *Handbook of industrial drying*, vol 1, 2nd edn. Marcel Dekker, New York, pp 345–372
- Skjoldebrandt C, Sundstrom B, Janestad H, Anderson C-G (1994) Simulation of food processes. A tool for training operators in production. In: Bimbenet JJ, Dumoulin E, Trystram G (eds) *Automatic control of food and biological products*. Elsevier, Amsterdam, pp 183–189
- Sokhansanj S, Jayas DS (1995) Drying of foodstuffs. In: Mujumdar AS (ed) *Handbook of industrial drying*, vol 1, 2nd edn. Marcel Dekker, New York, pp 589–625
- Soponronnarit S, Pachayawarakorn S, Wangji M (1996) Commercial fluidized bed paddy dryer. In: Strumillo AC, Pakowski Z (eds) *Proceedings IDS 96*, vol A. Lodz Technical University, Lodz, pp 638–644
- Strumillo C, Kudra T (1987) *Drying: principles, applications and design*. Gordon and Breach Science, New York
- Strumillo C, Jones PL, Zylla R (1995) Energy aspects in drying. In: Mujumdar AS (ed) *Handbook of industrial drying*, vol 2, 2nd edn. Marcel Dekker, New York, pp 1241–1275
- Stubbing TJ (1994) Airless dryers. In: Keey ARB, Rudolph V (eds) *Proceedings IDS 96*, vol A. University of Queensland, Brisbane, pp 559–566
- Sztabert Z, Kudra T (1995) Cost estimation methods for dryers. In: Mujumdar AS (ed) *Handbook of industrial drying*, vol 2, 2nd edn. Marcel Dekker, New York, pp 1227–1240
- Troller JA (1993) *Sanitation in food processing*, 2nd edn. Academic, New York
- Tsotsas E (1998) Achievements, challenges, and perspectives in modeling and design of convective dryers. In: Acritidis CB, Marinos-Kouris D, Saravacos GD (eds) *Proceedings IDS 98*, vol A. Ziti, Thessaloniki, pp 11–22
- Tsotsas E (2000) Dryerbase. A database listing commercially available dryers and their manufacturers. Institut fuer Verfahrenstechnik, Magdeburg University, Magdeburg
- Tsoukanov VA, Menshutina N, Goncharova SV (2000) Development of a data base system on basic and novel issues in drying. In: Kerkhof PJAM, Coumans WJ, Mooiweer GD (eds) *Proceedings IDS 2000*, Noordwijk, paper no. 407
- Van Arsdel WB, Copley MJ, Morgan AI Jr (eds) (1973) *Food dehydration*, vol 1, 2, 2nd edn. Avi, Westport
- Van't Land CM (1991) *Industrial drying equipment*. Marcel Dekker, New York
- Vanecek V, Drbohar R, Markvard M (1966) *Fluidized bed drying*. Leonard Hill, London
- VDMA (1999a) *Trocknungstechnik (Principles of drying technology)*. Verband Deutscher Maschinen und Apparatenbau e.V, Frankfurt/Main
- VDMA (1999b) *Product directory of dryers and drying systems*. Verband Deutscher Maschinen und Apparatenbau e.V, Frankfurt/Main
- Ventzas DE (1998) Moisture control of counter current flow dryer. In: Acritidis ACB, Marinos-Kouris D, Saravacos GD (eds) *Proceedings IDS 98*, vol A. Ziti, Thessaloniki, pp 630–637
- Walas SM (1988) *Chemical process equipment*. Butterworths, London
- Williams-Gardner A (1971) *Industrial drying*. Leonard Hill, London
- Wimmerstedt R (1994) Steam drying: history and potentials. In: Keey ARB, Rudolph V (eds) *Proceedings IDS 94*, vol A. University of Queensland, Brisbane, pp 3–11
- Wolf W, Jung G, Spiess WEL (1985) Sorption isotherms and water activity of foods. Elsevier, Amsterdam
- Woodroof JG, Luh BS (eds) (1986) *Commercial fruit processing*, 2nd edn. Van Nostrand Reinhold, New York
- Yan WJ, Hu YY (1994) Solar air heating for drying. In: Radndolph A, Keey RB (eds) *Drying 94* vol. University of Queensland, Brisbane, pp 367–374
- Zogzas N (2001) Computer program for psychrometric charts (personal communication). Department of Chemical Engineering, National Technical University of Athens, Athens

# Chapter 9

## Refrigeration and Freezing Equipment

### 9.1 Introduction

Refrigeration is used in cooling/chilling and freezing of foods. The freezing temperature of foods (around 0 °C) is the borderline between the cooling and the freezing processes. In food processing, low temperatures are applied (a) for preservation and (b) in facilitating other non-preservation processes or manufacturing products that are directly or indirectly related to foods. In preservation, the main aim is to extend the shelf life of fresh or processed products through cooling, chilling, freezing, and subsequent storage, by reducing the activity of microorganisms, enzymes, and chemical and biological reactions. In preservation, two main categories are distinguished: (a) the application of refrigeration without any other additional method and (b) the application of refrigeration in connection with some other methods of preservation.

Examples of using refrigeration for preservation without any additional method are the use of low temperatures for preserving fresh products, such as vegetables, through precooling and chilling; the cold storage of fruits, vegetables, meat, and fish; and the freezing of meat and fish. Examples of application of low temperatures in connection to some other methods of preservation are the freezing of vegetables following blanching and the cooling of milk, immediately after heating, in pasteurization. Examples of using low temperatures for facilitating other non-preservation processes or manufacturing products used directly in foods are (a) influencing the texture (e.g., fatty meat is cut easier when frozen), (b) influencing chemical and biological reactions (e.g., influence on color and ripening, stopping of wine fermentation), and (c) producing ice and cryogenic liquids.

There are several methods for reducing temperature, the most important being the following: (1) mechanical compression methods, (2) physical–chemical methods, (3) use of ice, (4) direct evaporation, and (5) electrical methods.

In the mechanical compression and the physical–chemical methods, low temperatures are created by evaporation of refrigerants. A “pump” provides a

permanent partial pressure reduction over a refrigerant (which is a liquid evaporating at relatively low temperature), so that temperature reduction, through the evaporation of the liquid, occurs. In the case of the mechanical methods, this “pump” is a compressor. In the physical–chemical (absorption) method, two heat exchangers (the absorber and the column generator) and a pump play the role of the compressor. In the absorber, which is a shell-and-tube-like heat exchanger, a weak aqueous ammonia solution, coming from another heat exchanger, the column generator, absorbs the ammonia vapors that come from the evaporator. The mixture creates a strong ammonia solution that is pumped back to the column generator, where it is heated indirectly with steam, resulting in evaporation of the ammonia. The ammonia vapors go to the condenser, while the liquid mixture, after the release of ammonia, becomes a weak ammonia solution.

In ice cooling, the temperature reduction is achieved by heat absorption during ice melting. In the vacuum method, the reduction of temperature is achieved by the evaporation of the excess water of the product (e.g., water on its surface), when placed in a vacuum chamber. In the electrical methods, the temperature reduction is achieved by the reverse of the Peltier effect (energy input for maintaining a temperature difference between the joints of two different metals, such as Cu–Constantan). Plank and Kuprianoff (1960) and Moersel (1967) describe several processes for producing low temperatures. However, in this book, only the compression refrigeration system will be discussed, since it is the most frequently used in relation to foods. Ice production, which is used in fish and sausage manufacturing and direct evaporation, will be discussed in connection with food refrigeration, since these three methods are mainly used in foods. The compression methods find the widest application, while ice is used in fish cooling and the direct evaporation in chilling of fresh vegetables.

The refrigeration equipment that is used for food may be classified as (a) refrigeration-producing equipment and (b) refrigeration-using equipment. Table 9.1 presents a classification of refrigeration equipment covering production and use of refrigeration. The refrigeration-using equipment may be further classified into equipment: (1) for applications above the freezing point of food (cooling), (2) for temperatures below the freezing point of food (freezing), (3) for distribution, (4) for retail, and (5) for ice production.

## 9.2 Refrigeration Equipment

### 9.2.1 Refrigeration Cycles

In compression methods, there are several variations of refrigeration cycles, but in all cases of simplified typical mechanical refrigeration cycles, four basic elements are distinguished (Fig. 9.1a): the evaporator (A), the compressor (B), the condenser (C), and the control or throttling valve (D). The evaporator is the element of the

**Table 9.1** Classification of refrigeration equipment

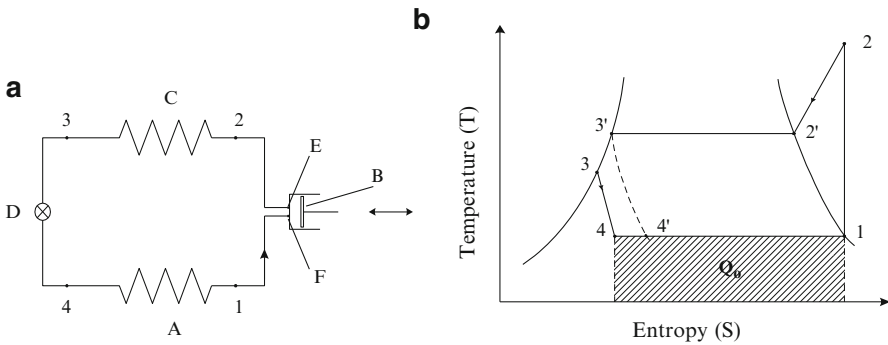
Main category	Use of refrigeration		Equipment and use		Type of equipment				
Production of refrigeration	Compression refrigeration		Compressors		Reciprocating				
					Rotary				
					Centrifugal				
					Screw				
			Evaporator		Indirect heat exchange		Direct heat exchange		
							Water-cooled		
					Condenser		Air-cooled		Evaporative type
									Other
			Pumps and fans						
			Intercooler						
			Oil separator						
			Receiver						
Valves and control system									
Use of refrigeration	Processing and preservation	Cooling	Solids	Continuous	Hydrocooling				
					Surface cooling				
					Tunnel				
				Batch	Evaporative				
					Tunnel				
					Surface cooling				
			Liquids	Continuous	Surface cooling				
					Batch	Surface cooling			
						Mixing			
				Freezing		Temperature down to – 40 °C	Continuous	Tunnel	
					Plate				
					Belt				
		Temperature <–40 °C	Batch		Fluidized bed				
					Tunnel				
					Plate				
		Brine	Immersion, spraying						
			Cryogenic liquids	CO <sub>2</sub>					
		N <sub>2</sub>							
Distribution		Truck		Compression refrigeration					
				Cryogenic liquids					
		Container		Compression refrigeration					
				Cryogenic liquids					

(continued)



**Table 9.1** (continued)

Main category	Use of refrigeration	Equipment and use	Type of equipment
	Retail	Closed type	Shelf cabinet Deep freezer
		Open type	Shelf cabinet
	Ice production	Production	Blocks
			Flakes
Tubes			
		Storage, transport	Screws, belts, bucket



**Fig. 9.1** Single-stage refrigeration cycle

refrigeration cycle coming directly or indirectly in contact with the food. In most cases, the heat exchange between product and evaporator is indirect, since a medium, such as air, glycol, etc., intervenes. Direct contact between product and evaporator exists in cases such as the freezing of food by plate freezing equipment. If a food processing equipment, using low temperatures, is small, the whole refrigeration-producing unit is part of this equipment. In larger equipment, only the evaporator is part of it. In large cold stores, only the evaporator is in the same area with the food.

The heat that flows from the product to the evaporator ( $Q_o$ ) causes the partial evaporation of the fluid refrigerant. The compressor, subsequently, sucks the evaporated refrigerant, while the suction valve (E) opens, and the discharge valve (F) closes. The continuous removal of the vapor over the liquid refrigerant secures the steady heat absorption from the environment. The sucked refrigerant vapor is subsequently compressed, while the suction valve closes and the discharge valve opens. The high-pressure hot refrigerant comes to the condenser, where it is liquefied by a cooling medium, which is usually water or air. Subsequently, the liquefied refrigerant is eventually subcooled (e.g., by indirect contact with low-temperature refrigerant), and it is cooled as it passes through the control

valve. Finally, the cool liquid refrigerant flows back into the evaporator. This cycle is repeated, and each time, a new amount of heat is taken away from the product, resulting in the reduction of its temperature.

As indicated in the  $T$ - $S$  diagram (Fig. 9.1b), the amount of the heat removed ( $Q_o$ ) is represented by the surface below the line 4-1. If no subcooling takes place, the amount of heat removed (area below 4'-1) is smaller. The lines, 2'-3' and 4-1, are isotherms ( $T = \text{constant}$ ) as well as isobars ( $p = \text{constant}$ ). The line 3-4 (3'-4'), indicating the throttling process, is isenthalpic ( $H = \text{constant}$ ). The actual process differs from the process described above, since there are losses during heat exchange and compression.

The process described above is a single-stage process. If very low temperatures (usually  $T < -20\text{ }^\circ\text{C}$ ) have to be created, a two-stage process is required (Fig. 9.2). Such a process consists effectively of two single-stage processes, in which two compressors are used: one compressor ( $B_1$ ) for the low-pressure stage (I) and a second ( $B_2$ ) for the high-pressure stage (II). The condenser of the low-pressure stage is the evaporator of the high-pressure stage. The equipment combining the condenser of stage I and the evaporator of stage II is the intercooler. The intercoolers may be classified as open- and closed-type units (Dossat 1978). In the open type, the liquid refrigerants, which come from both cycles, are mixed in a vessel (Fig. 9.2a). In the closed type, the compressed gas of the low-pressure stage is cooled down indirectly, e.g., as it passes through a coil submerged in the refrigerant of the high-pressure stage. In this case, the refrigerants of the two stages may be different. A two-stage compression is used, if the pressure ratio between the condenser ( $p_c$ ) and the evaporator ( $p_o$ ) exceeds certain limits. For ammonia  $p_c/p_o \propto 8$ . The pressure in the intercooler ( $p_m$ , bar) is given by (9.1) (Moersel 1967).

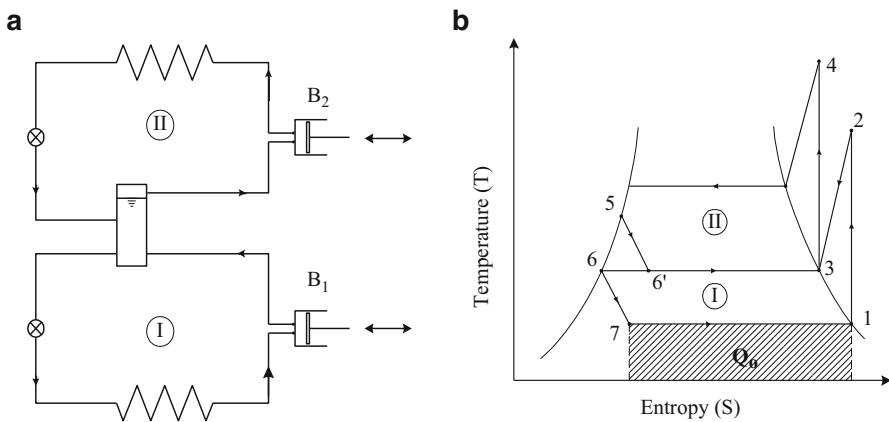
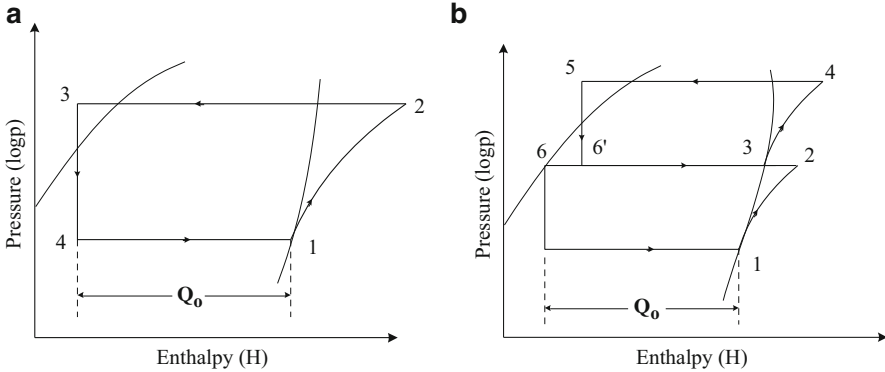


Fig. 9.2 Two-stage refrigeration cycle



**Fig. 9.3** Pressure–enthalpy diagrams for single- (a) and two-stage (b) compression

$$p_m = (p_c p_o)^{1/2} + 0.35 \quad (9.1)$$

Figures 9.1b and 9.2b indicate the one- and the two-stage refrigeration cycle in a  $T$ – $S$  diagram. However, in calculations, the pressure–enthalpy [ $\log(p)$ – $H$ ] diagram is preferred. In this diagram, the heat quantity  $Q_o$  absorbed is represented by a straight line (Fig. 9.3).

In comparing refrigeration equipment, the reference to certain condensation ( $T_c$ ) and evaporation ( $T_o$ ) temperatures is important. Often, in comparing one-stage compressor performances, the temperatures  $T_c = 25$  or  $30$  °C and  $T_o = -10$  or  $-15$  °C are used. In a two-stage compression, the reference temperatures are  $T_c = 25$  or  $-10$  °C and  $T_o = -25$  °C. However, a guarantee for an installation should not be given for these temperatures but for the temperatures that would be applied, because other factors could play a role in the final temperature development (Pohlmann et al. 1978).

In a refrigeration cycle, besides the abovementioned four basic elements, several other additional elements and controlling instruments are required. In cold stores, e.g., the condensed liquid refrigerant is collected in a container (receiver), before being further distributed to the evaporators. In the case that the distance between storage and machinery room (compressors and condensers) is large, pumps are also used for transporting the refrigerant to the evaporators. Furthermore, devices for defrosting the evaporators and for oil separation of refrigerants are required.

Evaporators differ in the way heat is transferred to them from the product. Since in almost all cases, a relative movement between products and the heat transfer medium exists, it is very important to maintain this relative motion (velocity) as high as possible. However, this should be done without significant negative effects on the product quality, such as product weight loss during cold storage or poor economic effectiveness of the process, due to energy increase caused by additional ventilation.

Advantages of refrigeration are (1) extension of the shelf life of the products with minor alternation of the original condition of food, (2) product application possible, even without packaging, (3) environmentally friendly, and (4) temperature scale-up possible.

The disadvantages of refrigeration are (1) expensive process; (2) weight loss of product, if process control is inadequate; (3) product freeze burn, if packaging and temperature not proper; (4) continuous supervision required; and (5) in freezing, the refrigeration chain must not be interrupted.

## 9.2.2 Compressors

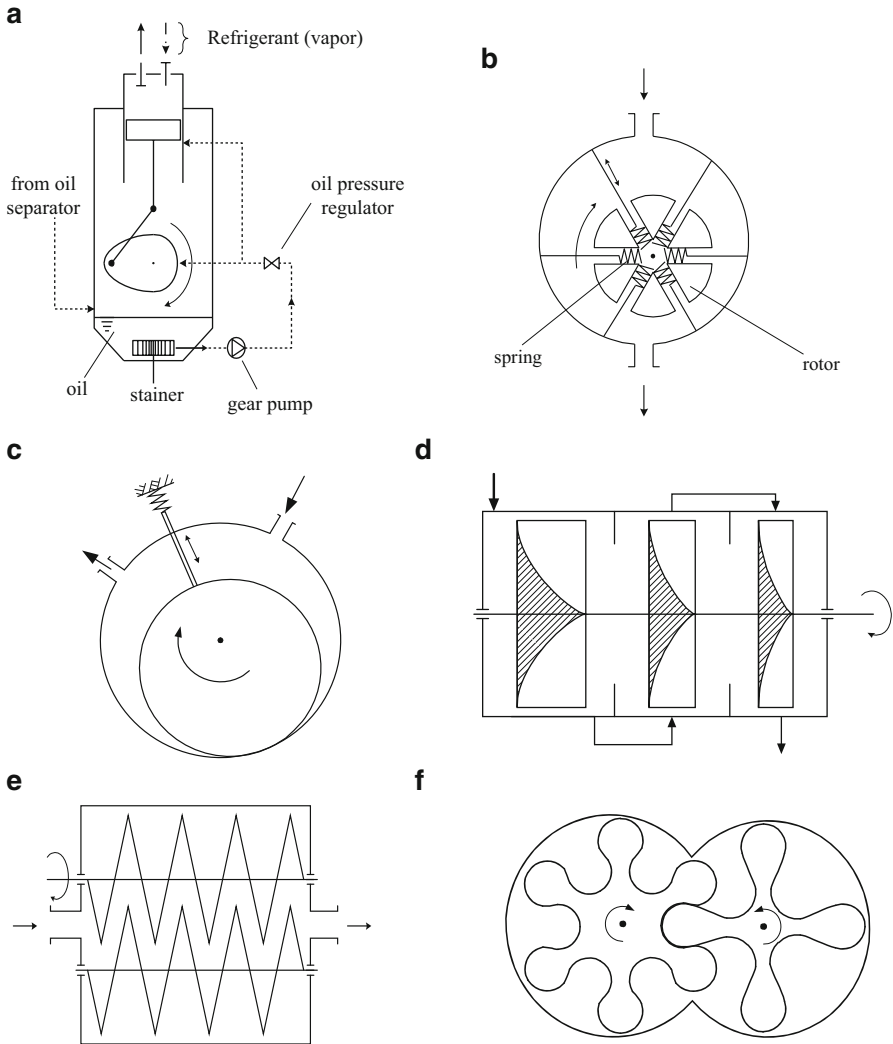
The main types of compressors used in the production of low temperatures are the reciprocating compressor, the rotary compressor, the centrifugal compressor, and the screw compressor. These compressors are used as single units or combined with others for increasing the required capacity or the versatility of a refrigeration system. In combined application, they can work parallel with other compressors of the same type or, in some cases (e.g., in the production of very low temperatures), with compressors of other types. The reciprocating compressor is used in systems of small to medium refrigeration capacities. The rotary compressor is used in the production of very small to small capacities. The centrifugal compressor is engaged in the production of very large capacities. The screw compressor is used in the production of medium to large refrigeration capacities.

### 9.2.2.1 Reciprocating Compressors

#### General Characteristics

The reciprocating compressor is the most common type of compressor used in compression refrigeration. It is used in the production of a very wide spectrum of refrigeration loads (0.5–350 kW) for applications above or below the freezing temperature ( $T_f$ ) of the food. A compressor basically consists of (a) cylinders with reciprocating pistons, (b) inlet and outlet valves, and (c) a lubrication system (Fig. 9.4a). A compressor usually has four or more cylinders. The larger number of cylinders, in addition to the capacity increase, results in a more smooth pumping of the refrigerant. Furthermore, pistons are often arranged in V, instead of line formation, for reducing vibration and the size of the machine.

The capacity of a reciprocating compressor depends on the following: (1) temperature of evaporation ( $T_e$ ), (2) temperature of condensation ( $T_c$ ), (3) number and size of the cylinders, (4) revolutions of the crankshaft (rpm), (5) losses in cylinder and valves, (6) condition and construction quality, (7) lubrication system, and (8) type of refrigerant.



**Fig. 9.4** Types of compressors (see text)

The capacity of a compressor depends on the displacement of its pistons. This depends on the volume of the cylinders and the piston speed. The displacement of the pistons ( $V_p, m^3$ ) and the piston velocity ( $u_z, m/s$ ) are given by (9.2) and (9.3), respectively:

$$V_p = 60 A h N z \tag{9.2}$$

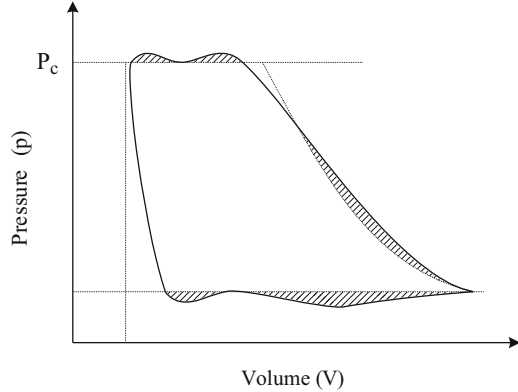
where  $A$ , area of the base of cylinder ( $m^2$ );  $h$ , the length of the stroke (m);  $N$ , the revolutions of the crankshaft (rpm); and  $z$ , the number of cylinders.

$$u_z = hN/30 \quad (9.3)$$

Small reciprocating compressors are advantageous, when performing at high loads. However, since small compressors have small cylinder volume, for increasing their load, high crankshaft revolutions ( $N$ ) are required. Nevertheless, a piston speed ( $u_z$ ) should not exceed 2.5 m/s, since, otherwise, the vapor velocity through the valves would be too high (Plank and Kuprianoff 1960). As a result, according to (9.3), the length of stroke ( $h$ ) decreases when the revolutions increase. Therefore, according to (9.2), for increasing the piston displacement and load, the only possibility is to increase the piston area ( $A$ ). But a significant increase of  $A$  would increase the blow-by effect of the pistons, reducing the compression efficiency (Dossat 1978). Therefore, according to good design practice, certain limits must be put to the relation piston area ( $A$ ) to length of stroke ( $h$ ) or to the relation cylinder bore diameter ( $d$ ) to stroke ( $h$ ). Thus, according to Plank and Kuprianoff (1960) and Dossat (1978), the ratio ( $d/h$ ) should be 1.0:1.2, and the crankshaft revolutions should not exceed 1200–1750 rpm. The larger the length of the stroke, the lower the piston velocity. For reducing the size of compressors, high crankshaft revolutions are preferred (usually 1200–1750 rpm). This results in a reduction of the ratio of machine weight to load capacity. However, for practical reasons, the piston speed cannot exceed 2.5 m/s (Plank and Kuprianoff 1960). A possibility of keeping the vapor velocity in acceptable limits would be the increase of the valve opening area. However, this would require very wide cylinders, but such construction is not possible, since a certain ratio of limits of cylinder diameter ( $d$ ) to stroke ( $h$ ) has to be considered. The volumetric efficiency ( $\epsilon$ ) of a cylinder is the ratio of the volume of suction vapor of refrigerant compressed per minute ( $V_a$ ) to the actual volume of the cylinder ( $V_z$ ). The volumetric efficiency decreases, when the compression ratio (high to low pressure) increases. The greater the pressure differences between evaporation and condensation, the lower the refrigeration load the machine performs. The volumetric efficiency of a reciprocating machine is reduced by losses in the cylinder and the valves. The loss in the cylinder is due to heat exchange with the environment and leakage, caused by wear. The loss in the valves is due to constructional restrictions and wear or inefficient adjustment. The indicator diagrams of compressors (pressure–volume diagrams) testify the reason of efficiency reduction, presenting the eventual sources of loss (Fig. 9.5). Such sources can be the delay in opening of valves, the leakage when these close, wet vapor, and “dead” space in the cylinder, due to construction restrictions. Pohlmann et al. (1978) and Dossat (1978) analyze several sources of reduction of the efficiency of reciprocating compressors on the basis of such indicator diagrams.

Water-cooling of the cylinders would move the compression toward the isothermal process, increasing the efficiency of the compressor. However, this is not practical, since it would also result in the discharge of saturated liquid from the compressor. Water-cooling is therefore restricted only to some systems using refrigerants of high discharge temperatures. Nevertheless, even then, this is not done for increasing the efficiency of the compressor but for reducing the rate of oil carbonization and the formation of acids, since both increase, when the discharge temperature increases (Dossat 1978).

**Fig. 9.5** Indicator diagram of reciprocating compressor



One reason of the wide use of reciprocating compressors is that several kinds of motors (electrical motors, diesel, gasoline engines, etc.) can drive them. This makes also their use possible in mobile units. The driving of reciprocating compressors can be direct or through v-belts.

Some indicative data of reciprocating compressors are volume of vapor sucked by piston displacement  $V_p = 100\text{--}250 \text{ m}^3/\text{h}$ , piston speed  $u_z = 2\text{--}3 \text{ m/s}$ , and revolutions of crankshaft  $N = 500\text{--}2000 \text{ rpm}$ . Reciprocating compressors in V arrangement, without motor, may have overall dimensions  $1 \times 1 \times 1 \text{ m}$ . Two-stage compressors have more cylinders in the first stage. A compressor of four cylinders may have, e.g., three cylinders in the first stage. Since the evaporation in a two-stage reciprocating compressor takes place at lower pressures than in a single-stage compressor, when the temperature of condensation is the same, the total refrigeration load of the single-stage compression is lower. For example, for the same swept volume and number of cylinders, the refrigeration load of a two-stage ammonia compressor, at  $T_c = 25 \text{ }^\circ\text{C}$  and  $T_o = -40 \text{ }^\circ\text{C}$ , is only about 20 % of that of the single stage ( $T_c = 25 \text{ }^\circ\text{C}$ ,  $T_o = -10 \text{ }^\circ\text{C}$ ). The weight of single- and two-stage compressors depends on the number of cylinders, varying between 1 and 3 tons, without the motor.

### Selection of Reciprocating Compressors

In selecting reciprocating compressors for a certain load, the brake power  $N_b$  (kW) can be estimated from (9.4).

$$N_b = Q_o / K_{th} \eta \eta_m \quad (9.4)$$

where  $Q_o$  is the refrigeration load (kW);  $K_{th}$ , the theoretical specific refrigeration load;  $\eta_I$ , the indicated efficiency (fractional), and  $\eta_m$ , the mechanical efficiency (fractional).

$K_{th}$  is estimated from data of the refrigeration cycle [e.g.,  $\log(p)$ – $H$ , diagram], taking into account the operating time, e.g., 16 h/day. The indicative efficiency ( $\eta_I$ ) takes into consideration the loss in the cylinders. For ammonia, it can be estimated by the method suggested by Linge (1950) and Moersel (1967), as a function of the ratio of evaporation to condensation pressures and the corresponding temperatures, the vapor volume displaced ( $V_d$ ), and the cylinder dead space ( $e = 2\text{--}8\%$ ). According to this method, for  $T_c = 25\text{ }^\circ\text{C}$ ,  $T_o = -25\text{ }^\circ\text{C}$ ,  $V_d = 50\text{ m}^3/\text{h}$ , and  $e = 4\%$ , the indicative efficiency is  $\eta_I = 0.78$ . The mechanical efficiency ( $\eta_m$ ) is usually 0.85–0.93 (Moersel 1967).

Advantages of reciprocating compressors are (1) wide range of application (processing, storage, retail); (2) wide range of refrigerants can be used; (3) for small capacities, possibility to construct them as compact units (including heat exchangers and condensers); (4) possibility to use them (two stage, booster) for producing very low temperatures, and (5) long manufacturing experience.

The disadvantages of reciprocating compressors are (1) vibration during operation, (2) being noisy, (3) capacity limitations, (4) being heavy and space occupying, and (5) many moving parts (i.e., many spare parts).

### 9.2.2.2 Rotary Compressors

In rotary compressors, a rotor is placed eccentrically in a stator/case. During rotation, the space between rotor and stator is reduced, resulting in compression of the vapor. There are several structures for achieving this progressive compression. In one case (Fig. 9.4b), the rotor is made up of blades that slide in ducts as the rotor moves. The contact between the ends of the blades and the case is steadily tight. Unequal compartments are formed as the blades rotate. The refrigerant vapor is sucked in the most spacious of the compartments and it is progressively compressed until its discharge. In another variation (Fig. 9.4c), a rotating cylinder is eccentrically positioned inside a larger cylinder, in which there are a suction and a discharge port. A diaphragm, which is in permanent contact with the internal cylinder with a spring device, is placed between the two ports. It provides steady separation of the space between the two cylinders during rotation of the internal cylinder. The refrigerant vapor, sucked in the equipment, is progressively compressed, as the interior cylinder rotates. A valve, placed outside the discharge port, can control the compression. For preventing freezing of the cylinder, caused by low suction temperatures, the external cylinder can be jacketed for heating. Advantages of the rotary equipment are the lack of valves and the small dimensions ( $0.5 \times 0.30 \times 0.25\text{ m}$ , without motor). Their main disadvantage is the relatively high wear of seal and stator wall and the difficulty to obtain high-pressure difference between suction and discharge ( $\Delta p < 5\text{ bar}$ ). For reducing the wear, the rotation of the cylinder in larger equipment is up to 750 rpm and for smaller than  $\Delta p < 5\text{ bar}$  1500 rpm, both putting limits to the capacity of the machine (swept volume, 30–40  $\text{m}^3/\text{h}$ , load about 120,000 kJ/h or 33.3 kW). Therefore, a rotary



compressor is suitable only for small equipment, acting as a booster, or for cases in which a reciprocating compressor, due to very low-pressure differences, would be less efficient.

### 9.2.2.3 Centrifugal Compressors

The centrifugal compressor is very similar to the centrifugal pump. It is mainly used in air conditioning of large installations, and it works competitively when large amounts of gas ( $>2000 \text{ m}^3/\text{h}$ ) have to be sucked and compressed at relatively low-pressure differences (1.4–2.0 bar per stage). Therefore, refrigerants of high molecular weight and more impeller wheels (usually 2–4) are used (Fig. 9.4d). The impeller wheels become progressively smaller in the direction of gas flow, for compensating the reduction of the gas volume due to compression in the previous stages. The compressors are usually assembled as compact units together with shell-and-tube heat exchangers. For reducing pressure losses, compact units are preferred, in which the heat exchangers are the largest part. The smallest vapor suction capacity, for profitability, is  $2000 \text{ m}^3/\text{h}$ . For achieving a propulsion of large quantities of gas, the rotors run at  $>3000 \text{ rpm}$  (Pohlmann et al. 1978). These units are usually used in large buildings/factories and in ships. The main advantage of centrifugal compressors is their ability to produce large scale of refrigeration load with relative small units. Further advantages are the entrainment of very low quantities of oil in the refrigeration system and the simple construction. Disadvantages for a food plant are the relative small pressure difference (evaporation–condensation) achieved and the economic limits, restricting the use to large-scale installations only.

### 9.2.2.4 Screw Compressors

The screw compressor is the newest development among refrigeration compressors. It can be engaged in producing temperatures as low as  $-50 \text{ }^\circ\text{C}$ . A screw compressor is best suited for loads, supplementing the refrigeration loads of reciprocating compressors, e.g., for ammonia,  $Q > 1,000,000 \text{ kJ/h}$  (278 kW) at  $T_c = 25 \text{ }^\circ\text{C}$  and  $T_o = -10 \text{ }^\circ\text{C}$  and  $Q > 300,000 \text{ kJ/h}$  (83 kW) at  $T_c = -10 \text{ }^\circ\text{C}$  and  $T_o = -40 \text{ }^\circ\text{C}$ . The basic element of the compressor is the counterrotating screws (rotors). One rotor (the male) has four lobes and the other (female) six lobes. They are fitted in a stator consisting of two cylinders intermeshing longitudinally (Fig. 9.4e, f). Usually one screw is connected, through a gearbox or belts, to the power source, driving the other during its rotation. The refrigerant enters at the one end, and it is driven along the axis, compressed between the lobes. The pressure difference between vapor inlet and vapor outlet depends on the refrigerant and can vary between 7 and 20 bar. The volumetric efficiency (i.e., the relationship between the effective vapor propulsion and the geometric volume) of the equipment depends on the “internal leakage” (vapor set back), caused when a minimum critical clearance between

stator and rotors is exceeded. For reducing the internal leakage, the screws must rotate at high speed ( $N > 3000$  rpm). The swept volume of such a compressor depends on the refrigerant and the temperatures used, and it can be 700–10,000 m<sup>3</sup>/h. For the same load, the swept volume of ammonia equipment is about 20 % larger than that of refrigerant R22. The required brake power depends on the refrigerant load. For smaller units, it may be about 20–150 kW, but for larger units exceeding 12 million kJ/h, it can be more than 700 kW. The dimensions of a screw compressor are not large. The length of a single screw may be 0.40–1.0 m and the diameter of the rotor 0.15–0.40 m. The maximum overall dimensions of a combined unit, including heat exchangers and motor, may be about 5.0 × 2.0 × 2.5 m. The maximal weight of such a unit (without the motor) may be up to 6 tons.

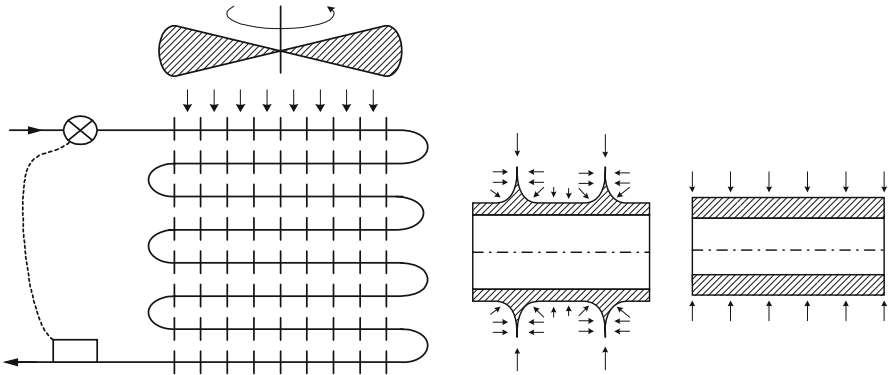
Advantages of screw compressors are (1) high specific output (with economizer); (2) small dimensions, i.e., less construction materials, less weight, and less space occupied, e.g., about 30 % lighter and 40 % less space than comparable reciprocating units; (3) less vibration, e.g., only 1/100 of comparable reciprocating compressors; (4) lower refrigerant losses (because of less vibrations); (5) no valves (therefore higher rotation speeds possible); (6) compared to centrifugal compressors, screw compressors can use high-pressure refrigerants; and (7) wide-range capacity control (the refrigeration load can be easily reduced from 100 % down to 10 %).

Disadvantages of screw compressors are (1) screw wear, the high speed of rotation and the tight contact of the lobes increase friction; (2) for achieving high speeds, gearboxes or other transmissions are required, which increase (about 5 %) the wear and the energy consumption; (3) if the manufacturing accuracy or the materials are poor, or if the bearings and screws are worn, internal leakage occurs, reducing the efficiency of the equipment (bearings should be replaced every 20,000 h); and (4) both screws have to be replaced at the same time, even though their wear is uneven.

### 9.2.3 Evaporators

Evaporators are heat exchangers (see Chap. 6) that are part of a refrigeration cycle, used in absorbing heat from the products that have to be cooled or from the environment. There are several ways to classify evaporators used in reducing the temperature of food. They can be classified according to the: (a) final use of equipment, (b) medium contacting the evaporator externally, (c) way that the evaporator transfers heat from the products to the refrigerant, (d) form of the heat-exchanging surface, and (e) construction of the equipment.

With respect to the final use, they can be distinguished between evaporators that are part of a food processing unit, e.g., fluidized bed freezer or plate freezer, and evaporators that are part of an installation, e.g., an installation in a cold storage room or in a building. The medium coming directly in contact with an evaporator



**Fig. 9.6** Blower evaporator with fins

externally can be a gas (usually air), a liquid (e.g., brine), or a solid (e.g., food product). The evaporators contacting a liquid directly can be forced or free convection units, which use a fan in the case, e.g., of air or a pump in the case, e.g., of water or brine cooling.

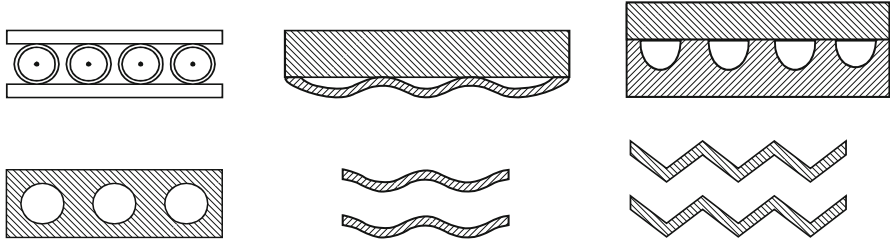
The way heat is transferred from a product to the evaporator can be direct, if no medium exists between the surface of the heat exchanger and the product, or indirect, if some fluid (gas or liquid) intervenes. The heat-exchanging surface can be a tube (coil) or a flat surface. A tube can be bare or finned (Fig. 9.6). The distance of fins must be  $>8$  mm for avoiding increased ice accumulation. Heat-exchanging flat surfaces of evaporators are double-wall structures. They can be plain or structured (Fig. 9.7). Fins on or in the tubes, or structured surfaces, increase the heat-exchanging surface area. The cooling medium in the evaporator can be cold water, brine, or a refrigerant liquid having a high boiling point. With respect to construction, the two main types are the flooded and the dry-expansion evaporators (Fig. 9.8).

Table 9.2 presents a classification of refrigeration evaporators, based on the external heated medium.

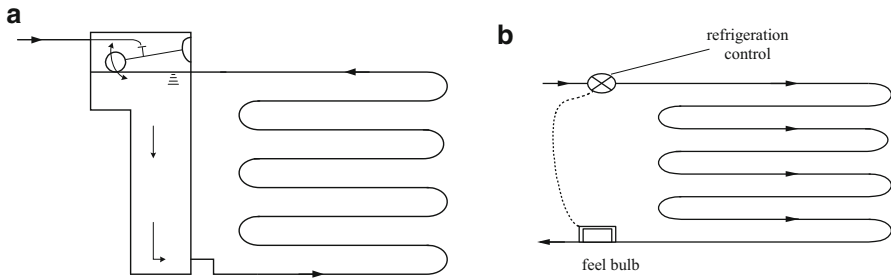
### 9.2.3.1 Forced Convection Air Coolers

#### General Characteristics

The air cooler is widely used for cooling air that is further used in food processing, food preservation, or air-conditioning applications. The air cooler may be, together with the other refrigeration-cycle elements, part of a food processing equipment, or it may be installed separately from the compressor and the condenser, in the room or equipment that needs low-temperature air. In most cases, the system used is the direct expansion, but in larger installations, the flooded system is also applied. The equipment basically consists of one or more fans; a bank of parallel tubes or plates,



**Fig. 9.7** Double-wall and structured plain surfaces



**Fig. 9.8** Flooded type (a) and dry-expansion (b) evaporators

in which refrigerant circulates; and the defrosting installation. The tubes and the plates can be bare or finned. The most commonly used tube evaporator is described as follows:

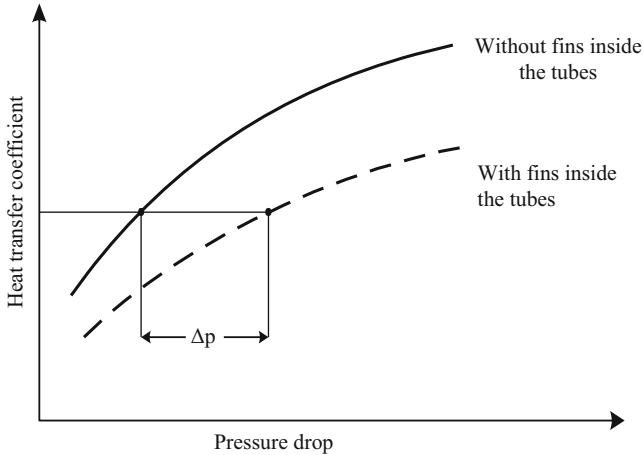
In the tube air cooler, air is blown through the tubes by means of a fan. The tubes of the air coolers, using no ammonia refrigerants, usually are made of copper. This increases the heat transfer rate and reduces corrosion problems. The heat transfer of air coolers is also enhanced, when small-finned tubes (coils) are used. When air is blown vertically on tubes of internal and external diameters 24 and 28 mm, respectively, the surface area of the tubes with fins is seven times larger and the external heat transfer coefficient three times larger than that of the corresponding bare-tube evaporators. Each air cooler usually has 1–4 axial fans. This kind of fan is used for blowing large amounts of air at relatively low-pressure differences. When this evaporator is used in cold stores, the air velocity must not be very high, because this causes drying of unpacked food. Usually, the air velocity through the evaporator tubes is about 2–3 m/s and that above the products about 0.10–0.25 m/s. In cold stores of frozen products, the air velocity is 0.5–2.5 m/s. High refrigerant and air velocity increase the overall heat transfer coefficient of the evaporator. When the tubes have fins, the distance between the fins depends on the desired air temperature and the “air throw” (how far air is blown). For a higher velocity and air throw, this distance must be relatively large. For increasing the surface of a heat exchanger, fins can be only 3–5 mm apart. However, in evaporators used for freezing of food, the distance between the fins of tubes should be higher than 8 mm. This reduces the

**Table 9.2** Classification of refrigeration evaporators

Heated medium	Type of evaporator	Type of heat exchanging surface	Examples
Gas	Forced convection	Bare	Cold storage, freezing tunnel, fluidized bed freezing equipment, multishelf produce sale case
		Finned	
		Plate	Shop refrigerators
	Free convection	Bare	Cold store rooms (coiled ceiling)
		Finned	
		Plate	Home freezer
Fluid	Bath and tube/plate	Bare	Cooling of liquids (brine), ice production
		Finned	
		Plate	
	Double pipe		Juice cooling, pasteurization (cooling stage)
	Shell and tube		Air conditioning, brine cooling
	Shell and coil		Quick cooling of liquids
	Double wall	Smooth	Freezing of juice
		Structured	Plate heat exchanger
		Jacketed	Scraped surface heat exchanger
	Baudelot		Juice cooling
	Solids	Double wall	Smooth
Structured			Cooling of dried grain (tower)
Jacketed			Meat cutter (preparation of meat mash)
Rotating coil			Crystallization

pressure drop, caused by ice accumulated between the fins. Fins are used when the heat transfer coefficient between the refrigerant and the internal surface of the tube ( $h_i$ ) is larger than between the tubes and the air blown on them ( $h_i > h_a$ ). If  $h_i < h_a$ , as in the case of forced circulation of liquids outside tubes, the fins should be inside the tubes. Nevertheless, although such a measure increases the heat transfer between the tube and refrigerant, it also increases the pressure drop in the tubes (Fig. 9.9). Therefore, a thorough analysis of the whole system is required, whenever such measures should be applied. When the evaporator lies in vats with agitated brine, then, since  $h_i = h_a$ , no fins are required.

In a cold store, according to Dossat (1978), the temperature difference between air incoming and leaving the air cooler is approximately equal to the temperature difference between the mean temperature of the evaporator and cold storage room. Usually the temperature differences between inflowing and outflowing air is about 6–7 °C. In cold store rooms, the air coolers are placed preferably above the doors, at about 0.6 m away from the walls, the ceiling, and the products (e.g., stacked boxes).



**Fig. 9.9** Pressure drop in the finned coil

Indicative values for large dry-expansion finned air coolers (e.g., capacity 70–80 kW) are heat exchange surface, 500–600 m<sup>2</sup>; refrigerant content, 60–70 kg; number of fans 3–4; energy consumption per fan, 0.5–0.8 kW ( $N = 3000\text{--}4000$  rpm); air-blown volume, about 20 m<sup>3</sup>/s; overall dimensions, 5.0 × 1.0 × 1.5 m; and empty weight, about 1 ton. The noise level of fans must be below 80 dB.

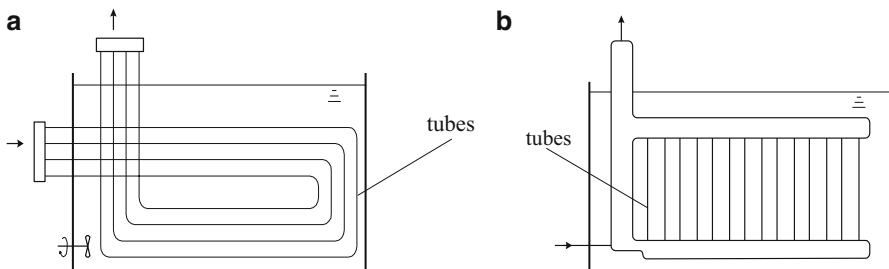
### Defrosting

An evaporator must be periodically defrosted for maintaining a high performance. The frequency and the length of each defrosting depend on the cooling system (temperature, air velocity, type of evaporator, etc.), the product cooled (kind of product, quantity, etc.), and the defrosting method applied. Frequent defrosting reduces the defrosting time. Usually, in air-cooling evaporators operating in rooms of high humidity, ice is accumulated quickly. Therefore, defrosting of such units may take place every one or every half an hour. Defrosting of small air coolers or other small evaporators can be done “naturally.” In this case refrigeration stops, and the fan operates until the ice on the evaporator is melted. Large evaporators are defrosted artificially. Common methods are spraying of evaporators with hot water, electrical heating, and reversing of the refrigeration cycle. In hot water defrosting, water is sprayed on the tubes by means of a distribution pan, located above the heat exchanger, while a second pan, with a drain connection underneath, collects the water. In the electrical system, an electrical resistance induces heat, defrosting the tube and keeping the pan under the tube ice-free. The reversed-cycle defrosting is based on reversing the role between the evaporator and the condenser.

The evaporator is heated, as it condenses the hot vapor that comes from the compressor. This system requires an additional expansion valve, for reducing the temperature of the refrigerant vapor that is sent into the condenser.

### 9.2.3.2 Bath and Tube Evaporators

Bath and tube evaporators consist of a bank of straight tubes, placed vertically or parallel in a bath, which is filled up with the liquid that has to be cooled (Fig. 9.10a, b). The liquid is often brine, which is subsequently pumped for use as secondary refrigerant. The equipment is applied in cooling large quantities of liquid and meeting of frequent fluctuations in refrigeration demand. The bath and tube evaporator is not used in the direct cooling of liquid food, due to sanitary restrictions, caused by the open-type construction of the bath and the dense placement of the tubes. The open-type construction results in contamination of the liquid by several substances (microorganisms, dust, etc.) and odor. The dense placement of the tubes reduces the volume of the evaporator, by increasing the quantity of liquid in the bath, and makes cleaning difficult. A pump circulates the liquid of the bath at 0.3–0.7 m/s. This kind of equipment is usually a flooded evaporator. Since relatively large quantities of refrigerants are required in flooded evaporators, ammonia, which is a relatively cheap refrigerant, is preferred. In this case, the evaporator is made of carbon steel or wrought iron, since ammonia in the presence of moisture attacks copper and brass. Since these evaporators are almost fully filled up with refrigerant, they have a high efficiency. The overall heat transfer coefficient of equipment, in which brine circulates at a rate of about 1 ton/h, may be about  $1400 \text{ W/m}^2 \text{ K}$  (Pohlmann et al. 1978). However, due to large dimensions and weight, this equipment is mainly used in large installations. A float control maintains the evaporator always filled up with refrigerant (Fig. 9.8). The upper tubes are less filled, since evaporated ammonia moves upward before leaving the equipment. Some indicative values of flooded evaporators of a capacity of 400,000 kJ/h (111.1 kW) are heat exchange surface area 50–52  $\text{m}^2$ ; overall dimensions,  $5.0 \times 0.5 \times 1.5 \text{ m}$ ; weight, 1.5 tons; and ammonia content, 650 L.



**Fig. 9.10** Bath and tube evaporators

Advantages of bath and tube evaporators are (1) high capacity, (2) relatively high overall heat transfer coefficients, and (3) possibility to overcome fluctuations of refrigeration demand.

Disadvantages of bath and tube evaporators are (1) not meeting the sanitary requirements for food, (2) being bulky and heavy, and (3) not being easily cleaned.

### 9.2.3.3 Shell-and-Tube Evaporators

The shell-and-tube evaporator is one of the most common types of heat exchangers. This heat exchanger can operate as flooded or as direct expansion equipment. It consists of a cylindrical shell containing parallel straight tubes, supported at their ends by tube sheets (Fig. 9.11). Two heads cover both ends of the shell. Depending on the type of equipment and the liquid (product) that has to be cooled, either the product or the refrigerant flows in the tubes. In the case that the product flows in the tubes, this comes in one of the compartments formed between the heads and the tube sheets and continues to flow to the similar second compartment at the other end of the equipment. The refrigerant flows through the compartment formed between the external surface of the tubes and the shell. In some cases, vertical baffles

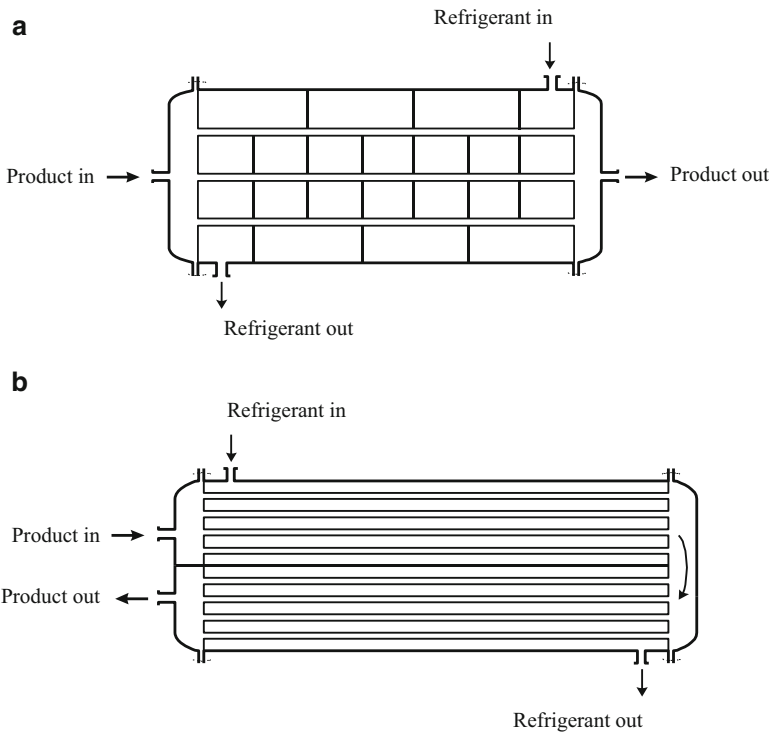


Fig. 9.11 Shell-and-tube evaporators. (a) Single pass and (b) double pass



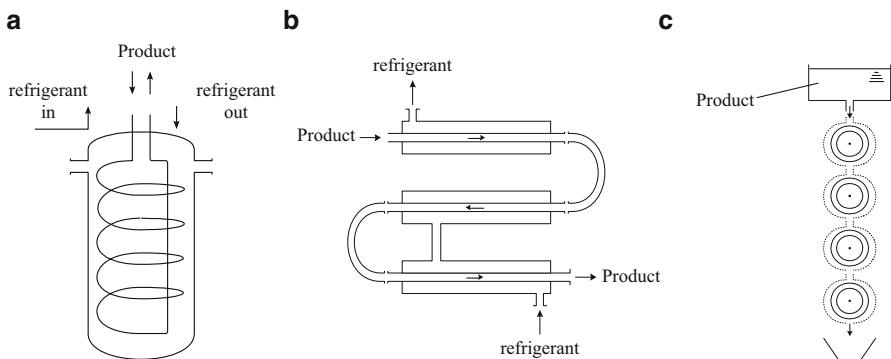
increase the flow path of the refrigerant liquid in the shell. There are several variations of such equipment. The product, e.g., may pass only in one direction through the tubes (one-way equipment, Fig. 9.11a) or change direction every time it arrives at the tube sheets (two or more passes equipment, 9.11b). The shell-and-tube evaporator is built in several variations and sizes and can be part of a larger installation or even of a mobile compact refrigeration unit of a food processing machine. It can be installed horizontally or vertically. Special care is required for the gaskets of the heads and for the connections between tubes and sheets. Tubes are welded, and, in construction, stress forces, due to rapid temperature change or fluctuations, must be considered. In refrigeration, the diameter of such units can vary, e.g., from 0.30 to 1.00 m, the overall length from 1.50 to 6.00 m, the weight from 0.3 to 5.5 tons, and the heat exchange surface from 3 to 150 m<sup>2</sup>. The overall heat transfer coefficient depends on the product, the refrigerant, and the applied conditions (temperatures, flow velocities), and it may be about 1000 W/m<sup>2</sup> K. The heat duty of large units, e.g., for brine or water-cooling, can be as large as 1000 kW ( $T = -5\text{ }^{\circ}\text{C}/+35\text{ }^{\circ}\text{C}$ ), Huette (1960).

Advantages of shell-and-tube evaporators are (1) sanitary operation, (2) little floor space required, (3) easily adapted to other equipment, and (4) relatively good heat exchange.

The disadvantage of shell-and-tube evaporators are (1) thermal stresses; (2) probable freezing up of product if flowing in tubes, and (3) high cost.

### 9.2.3.4 Shell-and-Coil Evaporators

This evaporator consists of a coil immersed in a tightly closed shell or vat (Fig. 9.12a). It can operate as a flooded (product in the coil) or as direct expansion heat exchanger (refrigerant in the coil). With respect to food, small units are often used as quick chillers of draft drinks. In this case, the refrigerant flows in the shell and the product (e.g., beer or juice) through the coil. Such units, besides quick



**Fig. 9.12** Liquid cooling evaporators. (a) Immersed coil; (b) two concentric tube; (c) Baudelot

chilling, have also the advantage of holdup capacity and operation under sanitary conditions. In the case that the product flows through the coil, its temperature should not drop below the freezing point.

### 9.2.3.5 Double-Pipe Evaporator

This equipment consists of two concentric tubes (Fig. 9.12b). Usually, the product flows in the central tube. Heads at the end of the tubes, which can be taken off, facilitate cleaning. The refrigerant flows in the annulus countercurrently to the product. The heat transfer coefficient of such equipment is 280–830 W/m<sup>2</sup> K (Huette 1960). In food, this unit is used mainly for cooling fluids (wine and brewing industry) or viscous products (e.g., concentrated juice), or it is part of pasteurization equipment or aseptic processing (e.g., cooling section of concentrated tomato pasteurization). The advantage of this heat exchanger is the sanitary conditions of production, the simple construction, and the easy cleaning. This equipment is strong; however, it is fixed in a certain place and often requires significant head-space, as the tubes are placed one over the other.

### 9.2.3.6 Baudelot Evaporators

This heat exchanger consists of several tubes that are laid parallel, one over the other (Fig. 9.12c). The refrigerant circulates in the tubes and the product flows outside, forming a thin film around the tubes. External irrigation of the tubes starts above the highest tube. The chilled product is collected in a vat below and along the lowest tube. When the refrigerant is ammonia, the overall heat transfer coefficient of this equipment is 280–830 W/m<sup>2</sup> K (Huette 1960). This equipment is simple, is heat transfer efficient, and can be cleaned easily. However, since it operates open, it requires very strict sanitary processing conditions. Even in this case, it should be used covered, for finish cooling of consumer juices or products that will be further processed immediately (e.g., milk for cheese making).

### 9.2.3.7 Double-Wall Evaporators

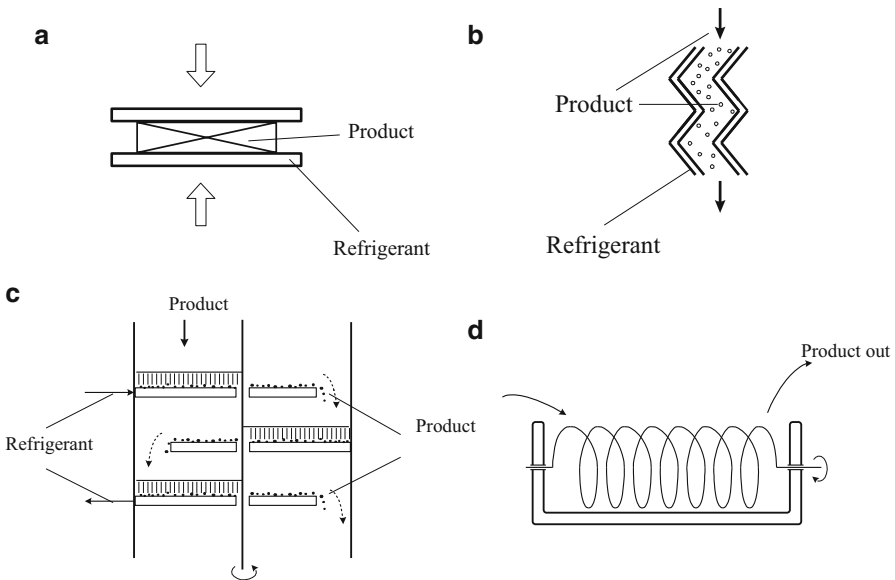
Double-wall design is extensively used in several kinds of heat exchangers. It is used, e.g., as an element of jacketed vats, in which heated products are cooled down to certain processing temperatures, or it is the cooling element of plate pasteurization equipment. In this case, a structured double wall (Fig. 9.7) is formed between two plates and the intermediate gasket. Double wall is also used in direct freezing. Since, for achieving high heat transfer, the distance between the cooling plates is small, highly viscous fluids cannot be processed. Furthermore, for overcoming the wall thermal resistance, a significant temperature difference is required.

### 9.2.3.8 Cooling/Freezing Evaporators for Solids

Solid food can be directly cooled or frozen by several special structures (Fig. 9.13). Some examples are (a) pressing food between several double-wall plates; (b) falling of food (granules) down, through structured cooled double wall; (c) sweeping food over cooled double-wall surfaces; and (d) agitating food by a refrigerant-containing coil, in a double-wall refrigerated vat. Since all these cases are connected to the processing method applied, they are discussed together with these methods.

#### Improvement of Heat Transfer in Evaporators

Factors increasing the heat transfer of evaporators are (1) using the right refrigerant for the required conditions, (2) thorough filling of the tubes with refrigerant, (3) no oil in the evaporator, (4) high velocity of refrigerant inside and fluid outside the evaporator, (5) high thermal conductivity of the tube wall, (6) avoiding the accumulation of ice on the heat exchange surface, (7) not very dense arrangement of tubes, (8) using not very thin fins, (9) small diameter of air cooler tubes, and (10) adequate pressing of the product on the freezing surface (direct freezing of solid food).



**Fig. 9.13** Double-wall evaporators for direct cooling and freezing of solid food

### 9.2.4 Condensers

Condensers in refrigeration are heat exchangers used for the liquefaction and further cooling of the vapors, discharged from the compressor. The liquefaction of the refrigerants can be achieved by (a) water counterflow in tube heat exchangers (e.g., shell and tube), (b) evaporative condensation, (c) condensation in a cooling tower, and (d) air (Fig. 9.14). The liquid refrigerant, before being distributed to the evaporators, is collected in a container, the receiver. The receiver, besides continuous feeding of the evaporators with refrigerant, is also used for keeping it during repairs, i.e., when the refrigeration cycle is stopped and not hermetically closed.

#### 9.2.4.1 Tube Condensers

The tube condensers are heat exchangers similar to the evaporators, described previously. Liquefaction of the refrigerant takes place, as cooling water flows in the tubes of, e.g., shell-and-tube heat exchangers or in the central tubes of double-pipe heat exchangers. The ammonia vapor, e.g., reaches the condenser after compression, at about 80 °C. After being condensed, by means of water of about 15 °C, it leaves the heat exchanger at about 25 °C. The liquid ammonia is subsequently cooled to 17–18 °C, before continuing its way to the control valve and to the evaporator. In all cases, counterflow between refrigerant and cooling

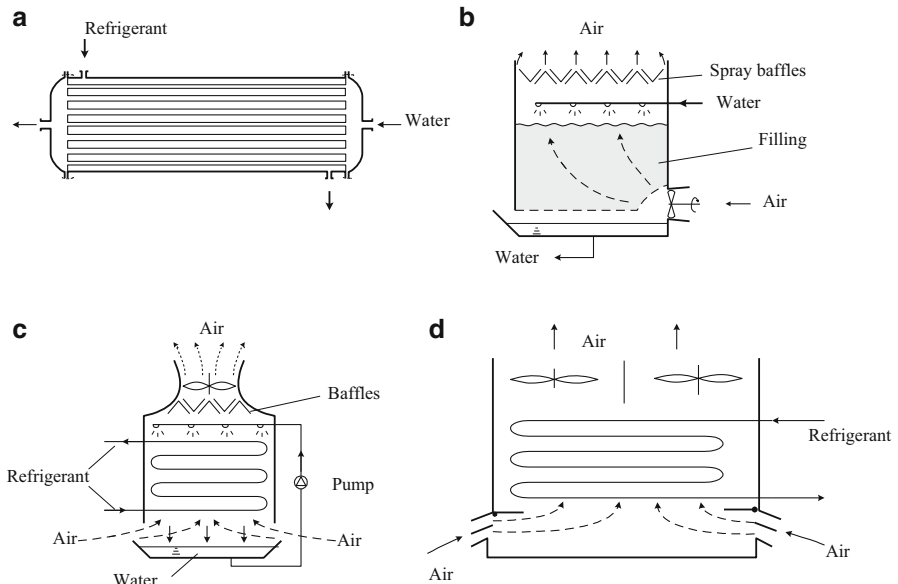


Fig. 9.14 Refrigerant condensers (see text)

water takes place. The velocity of water in the tubes is 1.0–1.5 m/s. The overall heat transfer coefficient of shell and tube, and double-pipe condensers, is about  $800 \text{ W/m}^2 \text{ K}$  (Huette 1960; Pohlmann et al. 1978). This type of condenser (especially the shell-and-tube equipment) is very widely used when plenty of cooling water is available. For water saving, the water leaving the heat exchanger is cooled, e.g., in a cooling tower and recycled. In the cooling tower, water is sprayed over packed material (often wood) filling the tower, while air is simultaneously blown through the space that is formed between the packing material. The cooled water is collected in a vat at the tower bottom. The quantity of water sprayed down is about  $30 \text{ L/MJ h}$  (Dossat 1978).

### 9.2.4.2 Evaporative Condensers

The evaporative condenser consists of a bank of parallel tubes, in which the refrigerant circulates. Water is sprayed from the top of the tubes downward, while air is blown from the bottom. The water that falls down is collected and pumped up, for spraying again (Fig. 9.14c). This condenser needs only about 5 % of the water that tube condensers consume, if no recycling takes place ( $1.3 \text{ L/MJ h}$ ) (Huette 1960). The overall heat transfer coefficient of this evaporator is  $350\text{--}700 \text{ W/m}^2 \text{ K}$ . The air velocity is 1.6–2.5 m/s. The dimensions of an evaporative condenser of 250 kW may be about  $3.5 \times 1.5 \times 3.5 \text{ m}$  and its weight 4.0–4.5 tons. The energy required by the fans can be 3–5 kW (Pohlmann et al. 1978).

### 9.2.4.3 Tower Condensers

The tower condenser is mainly used for high capacities. It consists of vertical long tubes in a shell. Water flows down spirally along the internal surface of tubes, from a vat on the top, by means of special nozzles, condensing the refrigerant in the shell. In a variation, this type of condenser also exists as flooded evaporator (refrigerant in the shell) for chilling water. The diameter of the tubes is about 60 mm. The overall heat transfer, due to the spiral motion of the water film, is high. For a tube diameter 60 mm and tube length 3 m, the overall heat transfer coefficient for ammonia condensation, depending on the temperature of the water and the velocity of the fluids, is  $700\text{--}1650 \text{ W/m}^2 \text{ K}$ . The water consumption in such a condenser is high (double of a shell-and-tube condenser). Tower condensers require little floor space (tower diameter, 1–2 m). However, for capacities of 550–1500 kW and for temperature difference  $\Delta T = 7 \text{ }^\circ\text{C}$ , their height can exceed 8 m. The weight of such equipment may be 6–15 tons, Huette (1960) and Pohlmann et al. (1978).

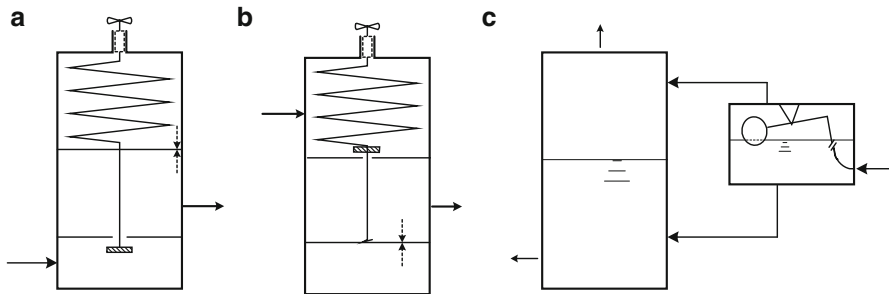
**9.2.4.4 Air Condensers**

This equipment does not need water for cooling. The condensation is achieved by means of air blown through the refrigerant-containing tubes. Large units, e.g., 150–350 kW at  $\Delta T = 7\text{ }^\circ\text{C}$ , have four or more air fans, blowing about 4.0–20.0 m<sup>3</sup>/s. The fans and the heat exchangers can be installed vertically or horizontally. Usually, condensers have maintenance-free three-phase current axial fans, with IP54 motor protection. All fans have two or more ventilation speeds, depending on the voltage controllable delta-star changeover. Low ventilation speed reduces the noise of the fans (<80 dB). The noise level can be measured according to the BS 848 part II or DIN 45635. The output of each fan motor may be >700 W. The heat-exchanging surface of such a condenser is about 200–400 m<sup>2</sup>. In the case that subcooling takes place, the refrigerant is collected in a receiver before being subcooled in an additional heat exchanger. The dimensions and weight of large air condensers (eight fans) may be 10.0 × 2.5 × 1.5 m and 2.5 tons, respectively.

**9.2.5 Capacity Control**

The capacity of refrigeration may be controlled by three main methods: (1) refrigerant flow control in the evaporator, (2) control of the capacity by the compressor; and (3) flow control of water in the condenser.

In the first case, the control valve controls the capacity through the refrigerant flowing in the evaporator. All control valves regulate the refrigerant flow so that (a) the incoming refrigerant compensates the amount evaporated and (b) a constant pressure difference between evaporation and condensation of refrigerant is maintained. Five main valves and control devices are used: the hand expansion valve, the automatic or pressure valve (Fig. 9.15), the thermostatic valve, the pressure float, and the capillary tube. The pressure float is used mainly in connection with floated evaporators and the capillary tube in small units and



**Fig. 9.15** Valves controlling evaporators in refrigeration

air-conditioning/heat pumps. In controlling the capacity through the compressor, the following possibilities exist: variation of the revolutions of the crank, intervention in the opening and closing of the valves, using cylinder bypass, and altering the cylinder volume. These methods are mainly applied to smaller compressors. In larger units, in which more compressors are used, control is done by the “on–off” operation of the compressors. Although this method is expensive, since more compressors are used for covering a certain load, it provides greater security with respect to load adequacy. Furthermore, it increases the versatility of the refrigeration system, and in the case that all compressors used are the same, the stock of spare parts is reduced. The control of water that flows in the condenser can also influence the refrigeration capacity, because it influences the high pressure of the system.

## 9.3 Refrigerants

### 9.3.1 Introduction

#### 9.3.1.1 General Aspects

The liquid refrigerants, used in food refrigeration cycles, may be distinguished into natural and artificial. Furthermore, distinction may be based on their applications. They may be classified in liquids that are suitable for cooling or freezing, for smaller or larger equipment (e.g., domestic and commercial application or industrial application), used as stationary or in the transportation of refrigerated food.

Here, only compression refrigeration will be discussed, as it is the most common in food. A form of non-compression refrigeration seldom used for foods is the absorption method, which is mainly used in the chemical industry, in cases that there is excess of thermal heat (e.g., thermoelectric plants) and in small less noisy domestic refrigerators in hotel rooms. The absorption refrigeration gained some acceptance in the food industry since the ozone depletion problem. The most commonly used fluid combinations in such installations are water (as the refrigerant) and lithium bromide (as the absorbent) or ammonia as the refrigerant and water as the absorbent. Besides the already mentioned cases, absorption refrigeration may be used in food processing factories, when significant hot water quantities are necessary in food processing.

Since the invention of the compression refrigeration, several refrigerants have been tested. However since 1897 (when the effective use of  $\text{NH}_3$  in vapor–compression systems was applied), this refrigerant dominated the refrigeration of food up to about 1930. After that, ammonia, although it has never ceased being used, was step-by-step replaced by the new refrigerants. These were chlorine-containing refrigerants such as chlorofluorocarbons (CFC) and later the hydrochlorofluorocarbons (HCFC). Finally, due to chlorine contribution in climatic concern about the ozone depletion potential (ODP) in the stratosphere of earth and partially in the

increase of the global warming potential (GWP), it was decided (Montreal-Protocol 1987) to replace CFC and HCFC, as in particular the first caused the ODP and the second increased significantly the GWP of our planet.

Table 9.3a–d gives an overview of the refrigerants that have been used up to the Montreal Protocol and thereafter. The refrigerants are indicated by their characteristic ASHRAE number, their molecular formula, and their chemical name. The tables give also several properties, such as the flammability, toxicity, and temperature of inflammation and evaporation, and their applications.

### 9.3.1.2 Chlorine-Containing Refrigerants

Table 9.3a presents several CFC and HCFC refrigerants that had been used up to 1992. Typical CFC refrigerants were R11, R12, and R502. Typical HCFC refrigerants were the R22, R123, and R124. The commercial production chlorofluorocarbon (CFC) started in 1931 with the production of R12, and 5 years later, the hydrochlorofluorocarbon (HCFC) R22 was introduced. R12 was used in smaller refrigeration equipment for temperatures not much lower than  $-5$  to  $-10$  °C. R22 was used when lower temperatures (e.g., freezing) were required. CFC and HCFC refrigerants (also called “Freon” in the USA) dominated in food refrigeration for about 40 years, as they had good thermodynamic properties and were nontoxic and nonflammable. Furthermore, both of them, especially R12, were well miscible with the mineral oil lubricants that were used with natural refrigerants such as ammonia.

The intensive research that started to invent new refrigerants suitable to replace the chlorine-containing products started effectively after the Montreal Protocol and is still going on. However, it must be pointed out that the invention of a perfect refrigerant is a utopia. Up to now most of the new refrigerants that replaced R22 require 5–15 % more energy. It is pointed out that R12 and R22 are still references in operations at comparable conditions.

### 9.3.1.3 Requirements of Refrigerants

An ideal refrigerant should fulfill several requirements such as:

Thermodynamic and Energy Requirements

- Large latent heat of evaporation.
- Evaporation of refrigerant (change of liquid to gas phase) at low pressure.
- The required heat for liquefaction of the refrigerant should be preferably low.
- Both evaporation and condensation of the refrigerant achieved at reasonable pressure.
- The volume of the evaporated gas must be low.
- The heat of evaporation should be large.
- Easy to handle and of low cost.



Table 9.3a Refrigerants up to 1992

Category	Type	ASHRAE number	Molecular formula	Chemical name (IUPAC)	Application	Properties	Remarks
Chlorine-containing refrigerants (up to 1992)	Chlorofluorocarbons (CFC)	R11	CCl <sub>3</sub> F	Trichlorofluoromethane	Ch	NF, <i>T</i> : 23.77 °C	For turbocompressors
		R12	CCl <sub>2</sub> F <sub>2</sub>	Dichlorodifluoromethane	C, AC	NF, NTx, <i>T</i> : -29.9 °C	Widest used refrigerant, up to 1989
		R13	CClF <sub>3</sub>	Chlorotrifluoromethane	F	FL, <i>T</i> : -81.5 °C	
		R13b <sub>1</sub>	CF <sub>3</sub> Br	Bromotrifluoromethane		<i>T</i> : -57.75 °C	
		R113	C <sub>2</sub> F <sub>3</sub> Cl <sub>3</sub>	Trichlorotrifluoroethane		<i>T</i> : -81 °C	
		R114	C <sub>2</sub> F <sub>4</sub> Cl <sub>2</sub>	Dichlorotetrafluoroethane	N, F	NF, <i>T</i> : 3.3 °C	
		R502	CHClF <sub>2</sub> · C <sub>2</sub> F <sub>5</sub> Cl			<i>T</i> : -45.0 °C NFL	Azeotrope
		R22	CHClF <sub>2</sub>	Chlorodifluoromethane	F, C	NF, Tx, <i>T</i> : -40.7 °C	
		R123	C <sub>2</sub> HF <sub>3</sub> Cl <sub>2</sub>	2,2-Dichloro-1,1,1-trifluoroethane	AC	NF, <i>T</i> : 23.8 °C	RP: R114
		R124	C <sub>2</sub> HF <sub>4</sub> Cl	2-Chloro-1,1,2,2-tetrafluoroethane	C, AC	NF, LTx, <i>T</i> : -11.0 °C	RP: R114
		R141	C <sub>2</sub> H <sub>3</sub> FCl <sub>2</sub>	1,1-Dichloro-1-fluoroethane		FL, <i>T</i> : 32 °C	RP: R114
		R142b	C <sub>2</sub> H <sub>3</sub> F <sub>2</sub> Cl	1-Chloro-1,1-difluoroethane	C, AC	FL, <i>T</i> : -10.0 °C	

*TFL* temperature of inflammation, *NFL* not flammable, *HTx* high toxicity, *T* temperature of evaporation, *C* cooling (-10/+40 °C), *F* freezing (-35/+40 °C), *AC* air conditioning (+6/+55 °C), *Ch* chilling >0 °C, *RP* replacement of "X" (e.g., (panel a) X = R114, (panel b) X = R12, (panel c) X = R502)

**Table 9.3b** Natural refrigerants

Category	Type	ASHRAE number	Molecular formula	Chemical name (IUPAC)	Application	Properties	Remarks
Natural refrigerants (up to 1992)	Natural	R717	NH <sub>3</sub>	Ammonia	F, C, AC	TFL: 651 °C, HTx, T: -33.3 °C, FL	
		R600	C <sub>4</sub> H <sub>10</sub>	Butane	C, AC	TFL: 430 °C, T: -12 °C FL	PR: R12, R134a
		R170	C <sub>2</sub> H <sub>6</sub>	Ethane	F	TFL: 530 °C, T: -88.6 °C	
		R744	CO <sub>2</sub>	Carbon dioxide	F, AC	NFL, T: -78.5 °C	
		R290	C <sub>3</sub> H <sub>8</sub>	Propane	F	TFL: 510 °C, T: -42.6 °C, FL	RP: R22, R404a, R407a
		R764	SO <sub>2</sub>	Sulphure dioxide		NFL, HTx, NFL	Not anymore used
		R600/R290	Blend		C		

TFL temperature of inflammation, NFL not flammable, FL flammable HTx high toxicity, T temperature of evaporation, C cooling (-10/+40 °C), F freezing (-35/+40 °C), AC air conditioning (+6/+55 °C), Ch chilling >0 °C, RP replacement of "X" (e.g., (panel a) X = R114, (panel b) X = R12, (panel c) X = R502)

**Table 9.3c** Refrigerants after 1992

Category	Type	ASHRAE number	Molecular formula	Chemical name (IUPAC)	Application	Properties	Remarks
No chlorine-containing refrigerants (after 1992)	"Single" hydrofluorocarbons (HFC)	R23	CHF <sub>3</sub>	Trifluoromethane			RP: R13, R503
		R32	CH <sub>2</sub> F <sub>2</sub>	Difluoromethane	C, AC	FL	RP: 502
		R125	CHF <sub>3</sub>	Pentafluoromethane	F	T: -48.5 °C (1 bar), NFL	RP: 502
		R134a	C <sub>2</sub> H <sub>2</sub> F <sub>4</sub>	1,1,2,2-Tetrafluoroethane	C, F, AC	NFL	RP: R12
		R143a	C <sub>2</sub> H <sub>3</sub> F <sub>3</sub>	1,1,1-Trifluoroethane	F	T: -47.4 °C (1 bar)	RP: 502
		R227	C <sub>3</sub> HF <sub>7</sub>	Heptafluoropropane	C, AC	T: -16.5 °C (1 bar), NFL	
		R152a	C <sub>2</sub> H <sub>4</sub> F <sub>2</sub>	1,1-Difluoroethane		T: -24.2 °C (1 bar), FL	

*TFL* temperature of inflammation, *NFL* not flammable, *FL* flammable *HTx* high toxicity, *T* temperature of evaporation, *C* cooling (-10/+40 °C), *F* freezing (-35/+40 °C), *AC* air conditioning (+6/+55 °C), *Ch* chilling >0 °C, *RP* replacement of "X" (e.g., (panel a) X = R114, (panel b) X = R12, (panel c) X = R502)

**Table 9.3d** Composition of Blends

Category	Type	ASHRAE number	Molecular formula	Chemical name (IUPAC)	Application	Properties	Remarks
	Blends			Refrigerants in Blend			
		R404a	$C_2H_5F_5-C_2H_3F_3-C_2H_2F_4$	R125, R143, R134a	F, C	T: -46.5 °C, NFL	FX-70, HP-62
		R407a	$CH_2F_2-C_2HF_5-C_2H_2F_4$	R32, R125, R134a	F, C	NFL, T: -45.6 °C	Klea 60
		R410	$CH_2F_2-C_2HF_5$	R32, R125	F, C	T: -52.7 °C, NFL	AZ20 (near azeotropic) Puron, Suva9100, RP: R22
		R413a	$C_3F_8-C_2H_2F_4-C_4H_{10}$	R218, R134a, R600a	F, C		Isceon 49, RR: R12
		R417a	$C_2HF_5-C_2H_2F_4-C_4H_{10}$	R125, R134a, R600a	F, C		Isceon 59, RP: R22
		R421a	$C_2HF_5-C_2H_2F_4$	R125, R134a			
		R422d	$C_2HF_5-C_2H_2F_4-C_4H_{10}$	R125, R134a, R600a			
		R507a	$C_2HF_5-C_2H_3F_3$	R125, R143a	F, C	T: 46.7 °C NFL	AZ50, RP: R502
		R508a	$CHF_3-C_2F_6$	R23, R116	F		RP: R13/R503
		R508b	$CHF_3-C_2F_6$	R23, R116	F		
		R510	$C_2H_6O-C_4H_{10}$	R170, R600	C		

TFL temperature of inflammation, NFL not flammable, FL flammable HTx high toxicity, T temperature of evaporation, C cooling (-10/+40 °C), F freezing (-35/+40 °C), AC air conditioning (+6/+55 °C), Ch chilling >0 °C, RP replacement of "X" (e.g., (panel a) X = R114, (panel b) X = R12, (panel c) X = R502)

### 9.3.1.4 Chemical Requirements

- Nontoxic
- No flammability
- Nonexplosive
- No equipment corrosiveness
- Chemical stability (no decay of refrigerant even at extreme situations)
- Easily detected by smell
- No problems in lubrication (e.g., compatible with lubricants)

## 9.3.2 Natural Refrigerants

Natural refrigerants besides air (R718) and water (R719) are:

Ammonia:  $\text{NH}_3$  (R717)

Carbon dioxide:  $\text{CO}_2$  (R744)

Propane:  $\text{C}_3\text{H}_8$  (R290)

Isobutane:  $\text{C}_4\text{H}_{10}$  (R600a)

In some cases, water and air are also considered for precooling or short-time chilling purposes of fresh vegetables and fruits. This is especially done when climatic conditions, such as air temperature and relative humidity, allow it.

Table 9.3b presents several natural refrigerants along with their applications and several basic properties of them. Natural refrigerants, such as R717 ( $\text{NH}_3$ ), R600/R600a (butane/isobutane), propane, and  $\text{CO}_2$ , have been used before 1989, and some of them are still being used.

### 9.3.2.1 Ammonia (R717)

Ammonia R717 ( $\text{NH}_3$ ) is a natural product with good thermodynamic properties in the most interesting temperature range for foods. It is the oldest refrigerant that is still quite extensively used, especially in larger units (e.g., cold stores). It is environmentally friendly and economical. Main negative characteristics of the refrigerant are its toxicity and relative corrosiveness. The gas of ammonia is very toxic. Air, containing  $>0.2$  vol.%  $\text{NH}_3$ , results in mortality of 0.5–1.0 % in 60 min. However, due to its intensive odor, its presence, caused by leakages, is easily recognized and hazards can be avoided on time. It is corrosive to several metals (except iron and cast iron). Ammonia absorbs large quantities of water and this is the main reason of its corrosiveness. Ammonia is flammable, but the energy required for its inflammation is 50-fold of that required for natural gas. Food in cold stores that is soaked with ammonia becomes useless [Huette II, Taschenbuch Kaelteanlagen].

### 9.3.2.2 Propane (R290) and Isobutane (R600a)

Propane R290 ( $C_3H_8$ ) and Isobutane R600a ( $C_4H_{10}$ ) are hydrocarbons, which have good thermodynamic properties, but they are flammable. Therefore, they are not recommended for refrigeration of vehicles. High-grade propane can be used in low temperatures replacing R22. It has relatively good thermodynamic properties, but it is flammable. Therefore, it is not used in the refrigeration in vehicles. Hydrocarbons propane and isobutane are used in domestic refrigeration equipment. Here they are efficient and less noisy.

### 9.3.2.3 Carbon Dioxide

Carbon dioxide R744 ( $CO_2$ ) has a similar long tradition in refrigeration technology as that of ammonia. It is not flammable, chemically stable, and effectively nontoxic. Breathing difficulty starts when the  $CO_2$  content in air exceeds 2.5 vol.%. It can be used in the refrigeration in transport. Restrictions in applications are the high pressure in condensation and the relatively low pressure in evaporation. Due to good thermodynamic efficiency, the  $CO_2$  compressors are not large, but the high pressure for condensation requires stronger construction, making the relevant equipment heavy. Carbon dioxide can be used in a cascade system. This overcomes the difficulties due to the very high-specific volume of ammonia vapor at temperatures below  $-35\text{ }^\circ\text{C}$ . Such  $CO_2$  systems are more efficient than the two-stage  $NH_3$  systems for low temperatures of the system in the range of  $40\text{--}55\text{ }^\circ\text{C}$ .

## 9.3.3 Fluorocarbon and Blend Refrigerants

### 9.3.3.1 Fluorocarbons

The replacement of the chlorine-containing refrigerants was done for CFC (R12) gradually, starting with the restriction of its availability. This occurred in 1995 in Europe and 1 year later globally. The use of HCFC R22 in new equipment was banned in Europe up to 2000. It should be gradually totally removed up to about 2015 in Europe and up to 2020 in the USA.

The replacers of chlorine-containing refrigerants belonged to three categories:

1. The enforced usage of already existing natural refrigerants
2. The development of the hydrofluorocarbons (HFC)
3. The use of certain azeotropic fluids and blends of already permitted refrigerants

In all cases, the basic effort was to approximate the operational conditions of the removed CFC and HCFC refrigerants. Typical HFC refrigerants were R23, R32, and R125.

Table 9.3c includes refrigerants that are in use after 1989. Two subcategories of the table are (a) the “single” HFC refrigerants and (b) the blends. Typical *single refrigerants* are the R23, the R32, and the R134a. The last one was developed as a replacer of R12. However, as all the HFC refrigerants, R134a is not miscible with mineral oils. Furthermore, its efficiency is relatively low, as its energy consumption is high. It is mainly used in domestic and automotive refrigeration. But since the product is an inert gas, besides refrigeration, it is also used in other applications such as in plastic foam blowing, as propellant of materials in the pharmaceutical and cosmetic industry, in air-drying (moisture removing from compressed air), and as solvent in organic chemistry.

Moisture in refrigeration systems plays a part in corrosion processes and in case of hermetic compressor systems in the degradation of wire coatings. High water concentration enforces hydrolysis. Hydrolysis, on the other hand, increases with temperature and impurities, which may act as catalysts. Water that freezes out may block expansion devices and stick several valves. Finally, excess of water in the circulated refrigerant degrades its quality by thinning. Therefore, the moisture level in the refrigerant should be carefully controlled.

### 9.3.3.2 Blends

The blends are a mixture of non-chlorine-containing refrigerants. The blends, R407 and especially R410a, are most common in domestic refrigeration, including air conditioning. R410a is an almost azeotropic product (AZ20). It is a high-pressure refrigerant with good per unit volume capacity. This results in the possibility to construct cheaper compressors. However, its rather high GWP is not satisfactory.

Table 9.4 indicates the basic combinations of blends. With the exception of R410a and R421, which are blends of two single compounds, all other are combinations of three compounds. Blends are usually mixture of R32, R125, and R134a. In some cases, R143a and R600/600a are part of mixtures as well. In a blend, R32 provides the heat, R134a reduces the pressure, and R125 reduces the flammability.

**Table 9.4** Composition of blends

Blends	Single hydrofluorocarbons (HFC)					Hydrocarbons (HC)		Number of single compounds pro-blend
	R32	R125	R134a	R143	R218	R600	R600a	
R404a		X	X	X				3
R407a	X	X	X					3
R410 (AZ 20)	X	X						2
R413			X		X		X	3
R417		X	X			X		3
R421		X	X					2
R422		X	X				X	3

**Table 9.5** Replacers of CFC and HCFC refrigerants and lubricants for replacers

CFC, HCFC refrigerant	Replacer	Lubricant	Application
R22	R407a	POE	Refrigeration
	R407c	POE	Refrigeration/AC
	R410a	MO or AB, POE	Refrigeration
	R417a	MO or AB, POE	Refrigeration
	R422d	MO or AB, POE	Refrigeration
	R438a	MO or AB, POE	Refrigeration/AC
R12	R423a	MO or AB, POE	Chillers
	R437a	MO or AB, POE	Refrigeration
	R123	POE	Chillers
	R134a	POE/PAG(*)	Refrigeration/chillers (*)AC—cars
R502	R404a	POE	Freezing
	R422a	MO or AB, POE	Freezing
R503	R508b	POE	Freezing
R13	R23	POE	Freezing

*AB* alkylbenzene, *POE* polyol ester, *MO* mineral oil, *AC* air conditioning

[Ref.: DuPont Refrigerants. US General Replacement Guide]

\*It indicates that R134a, may be also used in air conditioning (AC) of cars

Table 9.5 gives the replacers of the basic CFC and HCFC refrigerants that were used up to 1992. For R22, important replacers are R410a and R407 and 407a/c. For freezing, important replacers of R502 are R404a and R422d. For lower refrigeration capacities (chilling and automotive use), important replacers seem to be R134a and R423a.

## 9.4 Lubricants

### 9.4.1 Main Types of Lubricants

The introduction of new refrigerants in compression refrigeration resulted in changes in the application of lubricants. Two of the major categories of lubricants used in compression refrigeration are (a) mineral oils (MO) and (b) synthetics. The mineral oils were used with CFC and HCFC refrigerants, and they are still used in ammonia and HC. The synthetic lubricants were developed to match the requirements of the new refrigerants after banning chlorine in refrigeration liquids. Such lubricants were (a) alkylbenzenes (AB), (b) polyalkylene glycol (PAG), and (c) polyol esters (POE).



### **9.4.2 *Function of Lubrication***

Lubrication is very important in the compression refrigeration systems. Its application is quite versatile. The following are indicated contributions of lubricants in refrigeration systems:

1. Helping in removing heat excess
2. Sealing of unintentional gaps
3. Keeping the refrigeration system clean
4. Increasing the efficiency of the compressor
5. Reducing foams and noise
6. Reducing moisture in the system

High pressure in the refrigeration system and friction due to moving parts are two sources of heat generation. Lubricants come in contact with heated surfaces removing their heat excess and reducing friction, increasing the efficiency of the compressor system. At the same time, lubricants mainly of large molecular value seal fine gaps in leakages of the refrigeration system. The sealing effectiveness of a lubricant depends on factors such as the density and the viscosity of the lubricant and the pressure in the refrigeration system.

Lubricants are trapped in refrigerants in some extent. Although usually some kind of filtration of the refrigerant exists in refrigeration systems, the “mixed lubricants” (refrigerants with lubricants) assist in the transport of solid contaminants to the filter for their subsequent discharge. This is especially worthwhile when, e.g., some waxes in fluids or solids, such as fine residuals of the equipment manufacturing or the assembling process or dust, are present in the refrigerant–lubricant mixture. Furthermore, foaming must be managed, because besides its contribution to the reduction of the efficiency of the refrigeration system, it also increases noise during the operation of the compressor. Some lubricants may influence the moisture content of the refrigerant–lubricant mixture. This is the case when the lubricants are hygroscopic.

### **9.4.3 *Requirements for Good Lubrication***

The lubricants are mainly concentrated in the crankcase of compressors, or when being mixed with a refrigerant, they circulate all over the refrigeration system. The lubricant dissolved in any refrigerant depends on:

1. The pressure of the refrigerant vapor
2. The temperature of the lubricating oil
3. The length of time that the lubricant remains in contact with the refrigerant
4. The degree of lubricant miscibility of the refrigerant

The requirements of a good lubrication are:

1. Adequate miscibility of refrigerant and lubricant
2. Chemical stability
3. Physical stability
4. Small quantities in condensers and evaporators of the refrigeration system
5. Low wax content
6. High dielectric strength

The quantity of entrapped lubricants in the circulated refrigerant usually may be about 5 %. However, more lubricant may be present if not proper measures are taken. Such measures can be the installation of oil separators and care for enough low viscosity and increased miscibility.

The *miscibility* of lubricant oil with a refrigerant has some advantages if the right lubricant is used. In this case, the circulated oil returns to the compressor easily and lubricates even parts that cannot be otherwise easily reached. However, especially in the evaporator (cold side), the viscosity of lubricant in the refrigerant–lubricant mixture may increase, making difficult the return of the initial oil quantity back to the compressor. In such a case, besides the reduction of oil quantity in the crankcase, it influences negatively the heat transfer of the evaporator, as oil forms a film covering the inside part of the evaporator's surface.

The lubricant should neither react chemically with the refrigerant nor with the several parts of equipment or residuals in the refrigeration cycle. This is especially important in the high-pressure side of the system, in which the temperatures are relatively high, supporting chemical reactions. The lubricants should not be influenced by a probable presence of solid residuals in the solvent (refrigerant) which may act catalytically, enforcing high-temperature chemical reactions. The lubricant should have good flow ability in a broad range of temperatures. It should maintain the right viscosity at high as well as low temperatures. Therefore, generally, a low pour point of a lubricant is desirable.

Attention is also required to choose oil that is not degraded at relatively high compression temperatures. Such temperatures are usually above 100 °C, facilitating chemical reactions leading in the breakdown of oil in the refrigerant and eventually corrosion of several parts. The temperatures at which oil breakdown starts vary according to the type of the lubricant used. For *mineral oils* (MO) it is about 180 °C. For *alkylbenzenes* (AB) it is about 200 °C and for *polyol esters* (POE) it is about 250 °C. These data are valid for an environment without contaminants.

Even in relatively good miscibility of a lubricant with the refrigerant, small quantities of not mixed lubricant oils may be further present in the refrigeration cycle. This may cause problems in the heat exchangers (condenser, evaporator), the valves, and even some pipes after long operation. Therefore, it is desirable that the separated quantity of the selected lubricants remains low in the high as well as the low pressure of the refrigeration system.

In case of hermetic systems with rotary compressors, the dielectric properties of the refrigerant–lubricant mixture must ensure good insulating properties, as the mixture acts as insulation between the body of the compression unit and the motor.

### 9.4.4 *Choice of Refrigerant Lubricants*

For meeting the requirements of the new refrigerants, the selection of the proper lubricant is important. This is due to the fact that their quality may vary still for lubricants of the same type. Thus, since even minor alternations of the refrigerants may influence the efficiency of equipment, it is advisable to choose lubricants that follow the manufacturer's recommendations.

The mineral oil (MO) was used with CFC and HCFC refrigerants. It was and continues being used with natural refrigerants. The addition of hydrocarbons (HC) in the MO may help in thinning it, resulting to easier refrigerant-lubricant circulation. The MO cannot be used with HFC refrigerants as they are not mixable with them, forming a separate layer in the fluidized refrigerant. Nevertheless, in some cases, blends such as R410a, R422a, and R438 may alternatively use MO instead of POE lubricants. However, in a few cases of retrofits of older installations, POE lubricants that may be mixed with MO can be added in an already existing refrigeration system. But even in such a case, the modified lubricant does not seem to help its solubility in the already existing HFC refrigerant.

The synthetic polyalkylene glycol (PAG) lubricant was designed specially for meeting the requirements of R134a. It is a high-viscosity refrigeration lubricant that is well miscible with it, providing superior lubricity. Its pour point (the lowest temperature at which a fluid becomes semifluid losing its flow characteristics) is 44 °C. Generally, PAG is not compatible with mineral oils. It does not tolerate chlorine and is a nontoxic, fire resistant, and electrically insulating material. Its primary application is automotive air conditioning.

Probably the presently widest used lubricant along with HFC refrigerants is the polyol ester (POE). As indicated in Table 9.5, it is recommended in the lubrication of all systems containing refrigerants that replace CFC and HCFC refrigerants. POE has an excellent mixing with HFC, and it is also compatible with many lubricants in the market. POE has a very good viscosity in a broad range of temperatures. They can be used in quite low temperatures, because they keep their flowability, as they do not contain wax. However, its viscosity increases with temperature and it is, as PAG, very hygroscopic. This requires that the moisture content of the refrigerant-containing POE lubrication must be steadily controlled. Moisture may invade in the refrigerant by increased moisture in lubricants and improper handling of refrigerants or hygroscopic lubricants in assembling or retrofit operations or due to incorrect function of installed driers. High moisture can increase hydrolysis.

In this case that water reacts with esters, forming organic acids and alcohol. This process is influenced by temperature and acid value. Acids finally act, like impurities in the recalculated system, as catalysts of not desirable chemical reactions.

Finally, in the case of retrofits, it is indispensable that at least 95 % of the MO must be removed and the old installation must be well evacuated and special filter driers must be also used. In operation, the water in the refrigerants that contain POE lubricants is not influenced significantly if the moisture of the POE lubrication is below its saturation limits (i.e., < 3000 ppm). In this case, there is no free water, and ice crystals are unlikely to be formed.

### 9.4.5 Additives

Besides lubrication, additives put into the refrigeration system act as a complementary antiwear protection, protection against foaming, protection against factors related with chemical reactions, etc. The use of additives must be applied after testing the results of their probable activity. These substances should be well miscible with refrigerants, they should not influence negatively the dryer filters, they should not cause deposits (e.g., in valves), they should not be influenced by temperature changes, and they should not form negative chemical reactions with existing refrigerants and lubricants. Additives with copper-based nanoparticles may boost the heat transfer properties of a refrigerant. The presence of chlorine in the old R12 refrigerant formed protective films of metal chlorides against corrosion. Additives based on sulfur and phosphorus chemistry may improve the anti-drag function of a lubricant, and some additives are active in reduction of foams.

## 9.5 Cooling of Foods

### 9.5.1 Chilling

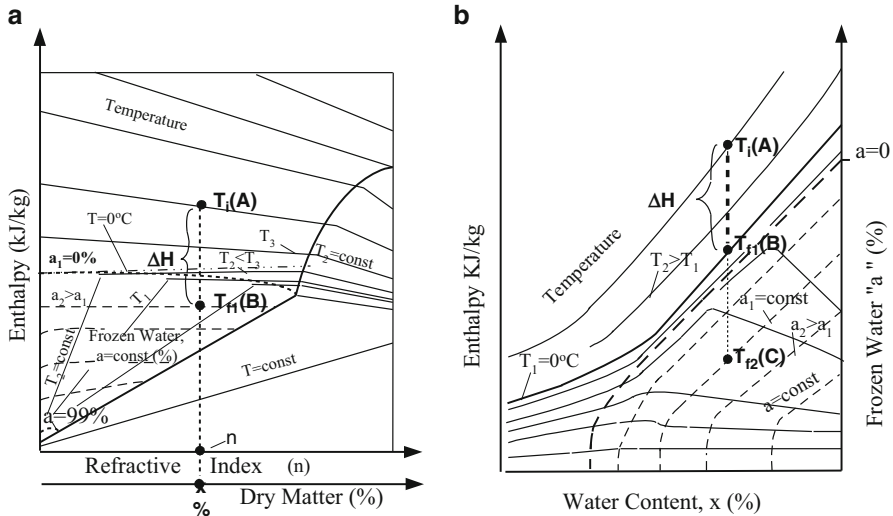
The chilling (cooling) of foods at temperatures close to 0 °C is applied to extend the shelf life of “fresh” products, i.e., products immediately after harvesting or processing. Chilling covers all foods: fruits and vegetables, meat, fish, dairy products, cereals, etc., and complex food composed of all these, such as ready meals. In chilling, two main tasks are (a) the fast reduction of the initial temperature of the product down to the desired low temperature and (b) maintenance of the final temperature over a longer period. The fast reduction of the temperature is achieved by cooling equipment, in connection to some processing operation or in connection to storage. The analysis and design of refrigeration processes for foods is discussed by Cleland (1990).

The maintenance at a constant low temperature over a longer period is part of storage technology (see Sect. 9.5 of this chapter). In both cases, the refrigeration load, i.e., the sensible heat ( $C_p \Delta T$ ) that must be removed, is important. In chilling, the specific heat of food above the freezing point is important. This is a function of the temperature of the product, which, with the exception of most fat, increases linearly with the temperature above 0 °C. Table 9.6 gives characteristic average values for the specific heat of foods at the temperature region above 0 °C. For most fat, the specific heat is almost constant at temperatures above 35–40 °C. Exceptions are sunflower oil, olive oil, and peanut oil, whose specific heat is almost constant at temperatures about 10–20 °C.

The specific heat  $C_p$ , for a temperature range ( $\Delta T$ ), can be also estimated, by using the equation  $C_p = \Delta H / \Delta T$ . The enthalpy change ( $\Delta H$ ) for the temperature range  $\Delta T$  can be estimated by using the Riedel diagrams. There are three types of

**Table 9.6** Indicative values of the specific heat ( $C_p$ ) of food

Product	$C_p$ (kJ/kg K)	Temperature ( $^{\circ}\text{C}$ )
Water-containing food	3.5–3.9	$T > 0$
Water-containing food	1.8–1.9	$T < 0$
Dry food	1.3–2.1	$T > 0$ and $T < 0$
Fat	1.7–2.2	$T > 40$
Fat	1.5	$T < 0$



**Fig. 9.16** Enthalpy–water content diagrams of Riedel

such diagrams. Two types (Fig. 9.16) give the enthalpy of several foods in relation to their temperature and water content. These diagrams also indicate the portion of food water that is crystallized, if the product is frozen. The third type of diagrams gives the enthalpy and the specific heat of fats and oils. They also indicate the portion of molten fats in relation to the temperature of the products. Figure 9.16a is used for fruits and vegetables (cases 1 and 2 in Table 9.7), while Fig. 9.16b is for all other cases in Table 9.7. As indicated in Fig. 9.16a, b, for cooling and freezing certain foods containing  $x\%$  dry substance (by weight) or  $\xi_a$  kg water/kg product, from an initial temperature  $T_i$  (Point A) to a final temperature  $T_{f1}$  (Point B), the heat  $\Delta H$  (kJ/kg) must be removed.

As indicated in Table 9.7 (extended application), these diagrams may be also used for other similar products. Such a case, e.g., is the use of the diagram that has been developed for juices, for estimating the specific heat and enthalpy of whole fruits and vegetables. In this case, if the dry matter of a fruit or vegetable is known, the specific heat is calculated by inserting the values of the Riedel diagram in the equation of the “mixing rule” (9.5), which relates the specific heat of a product ( $C_{Pr}$ ) to the specific heats of its constituents (average values).

**Table 9.7** Riedel diagrams for estimating the specific heat, the heat load of cooling/freezing of food, and the fraction of frozen water of food

	Product	Extended application	Reference
1	Fruit and vegetable juice	Fruits and vegetables	Riedel (1950a, b); DKV (8-02)
2	Sugar solutions		Riedel (1950a); DKV (8-06)
3	Fats and oils	Meat fat	Riedel (1955); DKV (8-10)
4	Lean beef	All other lean meats (fat less than 4 %)	Riedel (1957a, b, c); DKV (8-11)
5	Egg (albumen)		Riedel (1956a, b); DKV (8-12)
6	Egg (yolk)		Riedel (1957a); DKV (8-13)
7	Egg (whole)		Riedel (1957b); DKV (8-14)
8	Bread (white)	Wheat and rice starch Fat-free bakery products	Riedel (1959a, b); DKV (8-15)
9	Fish (lean)		Riedel (1956a); DKV (8-18)
10	Starch (potato)		Riedel (1959a); DKV (8-19)
11	Baking yeast		Riedel (1968); DKV (8-25)

$$C_{Pr} = \xi_w C_w + \xi_p C_p + \xi_c C_c + \xi_f C_f + \xi_s C_s \tag{9.5}$$

where

$C_w$  is specific heat of water (4.16 kJ/kg K)

$C_p$  is specific heat of protein (1.55 kJ/kg K)

$C_c$  is specific heat of carbohydrates (1.42 kJ/kg K)

$C_f$  is specific heat of fat (1.70 kJ/kg K)

$C_s$  is specific heat of salts (0.84 kJ/kg)

$\xi_w, \xi_p, \xi_c, \xi_f, \xi_s$  are content of water, proteins, carbohydrate, fat and salt, respectively (mass fractions).

For the calculation of  $\Delta H$  for fruits and vegetables, (9.6) is used

$$\Delta H = (1 - \xi_{dm})\Delta H_J + C_{dm} \cdot \xi_{dm} \cdot \Delta T = \Delta H_J - (\Delta H_J - C_{dm} \cdot \Delta T)\xi_{dm} \text{ (kJ/kg)} \tag{9.6}$$

where

$C_{dm}$  is specific heat of dry mater (1.21 kJ/kg °C)

$\xi_{dm}$  is content of dry matter (mass fraction)

$\Delta H_J$  is enthalpy difference for temperature change  $\Delta T$  of the juice (taken from the Riedel diagram).

In the same way, the specific heat of pork meat can be calculated if its fat content is known, by using the Riedel diagrams for fat (pork fat) and lean beef and the “mixing rule.”

## 9.5.2 Cooling Equipment

Refrigeration equipment, used in processing and preservation of food, may be classified into two main categories, (a) the cooling and (b) the freezing equipment. In cooling of food, the low temperatures applied lie between about 13 °C and their freezing point (Schormueller 1966). The cooling methods can be direct evaporation and direct or indirect heat exchange. Furthermore, distinction is made among methods applied to solids or to liquids and batch and continuous operation. In freezing, two main categories are (a) application of temperatures between the freezing point and  $-40$  °C and (b) application of temperatures below  $-40$  °C.

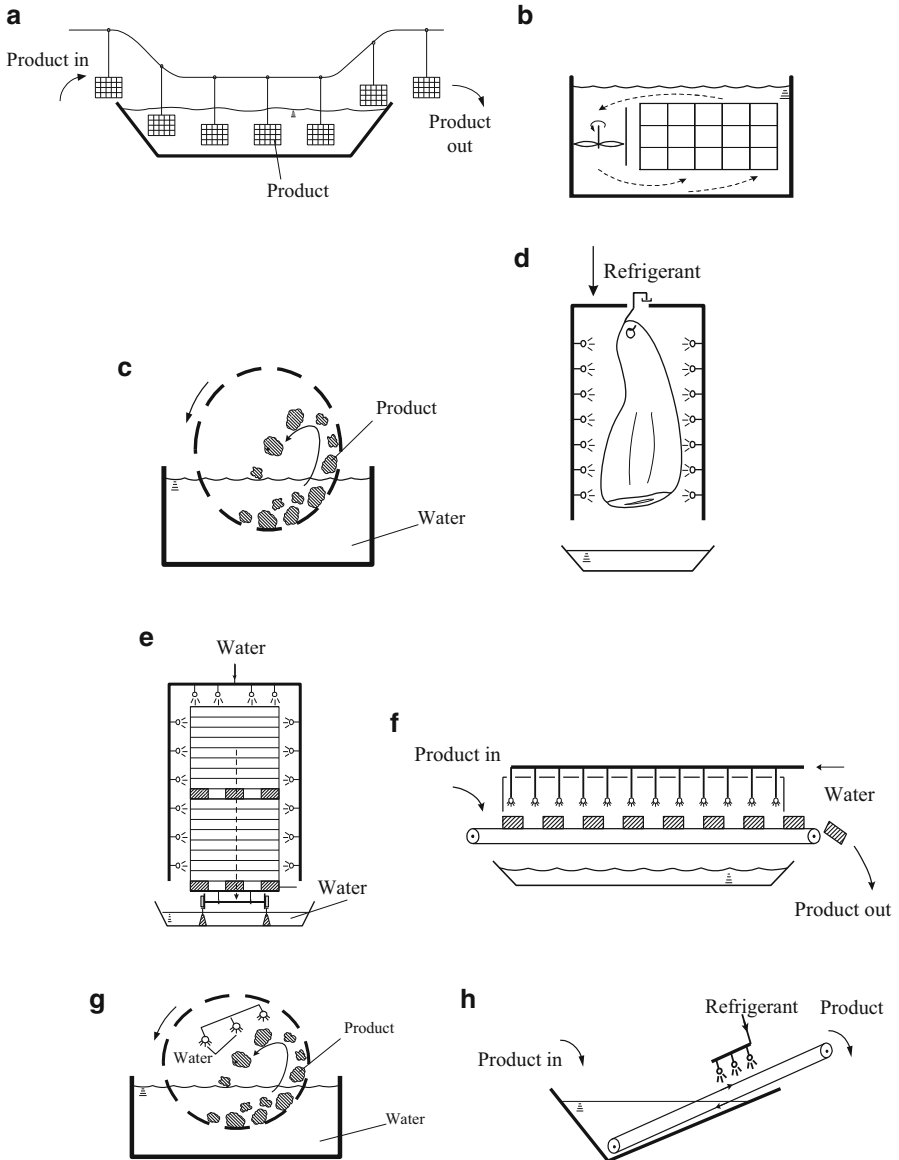
### 9.5.2.1 Cooling of Solids

Cooling of solids can be carried out by hydrocooling, contacting cold surfaces, direct evaporation of surface water, and air. In some cases, the equipment used is quite similar to that applied in heating processes for solids (e.g., drying).

#### Hydrocooling

Hydrocooling is usually a continuous method applied to cooling of solids. It is used often in precooling of vegetables and some fruits (e.g., oranges and peaches). However, it is also applied in precooling of other products (e.g., meat). In hydrocooling, cold water is used at temperatures between 15 and 0 °C. For achieving temperatures around 0 °C, ice can be also mixed with water. A relative motion between product and cooling water is required for increasing the efficiency of cooling. Relative motion increases cooling two- to fourfold (de Fremery et al. 1977). The circulation of the water or the movement of the product can achieve this relative motion. Since precooling is a preliminary stage of further processing, especially in many cases of fruits and vegetables, it can be combined with washing or short-term storage in water basins (e.g., tomato), which are also preliminary operations. Often, the water contains a mild disinfectant, such as chlorine (5 ppm), or an approved phenolic compound (Fennema 1975).

Figure 9.17 shows several hydrocooling methods. These can be classified into methods in which the product is immersed in a bath, (a), (b), and (c), or the product is sprayed, (d), (e), and (f), and to combined methods, in which the product is immersed and sprayed, (g) and (h). The method in Fig. 9.17a is continuous and can be used for sensitive products. The products, which are put in hanging meshed



**Fig. 9.17** Hydrocooling methods (see text)

boxes, are transported along a cool bath. In the equipment of the method in Fig. 9.17b, the product is immersed in a bath, while water circulates through the product. In the method in Fig. 9.17c, the relative motion between the product and the cool water is achieved by the rotation of a drum, which is partially immersed in cool water. Inside of the perforated drum, there are helical baffles, forwarding the



product during the drum rotation. At the same time, the product is lifted by the rotating drum up a certain height, and it falls back to the water (tumbling). This type of equipment is often used for leafy vegetables (e.g., spinach). The method can be continuous or batch (if there are no screw baffles in the drum). This kind of equipment is also preferably used in chilling of poultry because, in comparison to air cooling, less weight is lost. For poultry chilling, 1–3 drums may be used (the two or three drums, in series), in which poultry rotates in counterflowing ice–water mixture, for 20–30 min. The consumption of ice is 0.6–0.9 kg/kg poultry. Such equipment requires a surface area of 18–20 m<sup>2</sup>. The capacity of such drums is up to 6000 birds/h (de Fremery et al. 1977). Poultry, immersed in water for washing, precooling, and chilling, gains significant amount of water, especially in its skin and in its fatty tissue (about 8 %). USDA established tolerances, and an EU legislation (Regulation 2967/76) restrict the maximum water gain (James and Bailey 1990a, b).

The equipment in Fig. 9.17d, e is used for cooling meat. The method is called evaporative air chilling or spray chilling. The water activity of the surface of the product is maintained very high by wetting it with water sprayed through nozzles on both sides of the product. At the same time, cool air is blown on the food. In poultry, the carcasses can be sprayed with cold water (about 5 °C), 7–8 times in short burst intervals for about 1 h. This, together with cool air ( $T < 8$  °C), reduces the temperature of the carcass from about 30 °C down to 4 °C. The quantity of water used is 0.5 L/carcass (Mulder and Veerkamp 1990). This method was also tried in chilling pork and beef carcasses. The chilling of beef lasted more than 8 h (James and Bailey 1990a). Water of 2–3 °C was sprayed repeatedly from 11 nozzles. Each time, 1 L/nozzle was sprayed for 30 s (James and Bailey 1990b). In the case of fruits (Fig. 9.16e), up to stacked three pallet boxes move on rails through a tunnel, in which nozzles spray cold water, containing a protective fungicide. The capacity of a unit of 12 × 2 × 4 m, cooling apples with water of about 7 °C, can be 200–220 pallet boxes/h. The required energy for the pumping system is 8–12 kW. The equipment in Fig. 9.16f can be used as part of immediate further processing of products that are sensitive to mechanical stresses. In comparison to the immersion method, advantages of spray chilling are the reduced water consumption and water product absorption. Disadvantages are the inducement of microbial growth, due to high water concentration on the surface of the carcasses and the relatively higher total energy requirement. The equipment in Fig. 9.17h is similar to that of Fig. 9.17g. They differ in the additional spraying, occurring during the rotation. These machines are combination equipment, in which the product is immersed in cool water and sprayed. They are mainly used for fruits and vegetables. Water is cooled in a heat exchanger and recirculated.

### Vacuum Cooling

Vacuum cooling can be preferably used when the ratio of product surface to its mass is large. This is, e.g., the case of several leafy vegetables. Furthermore, the

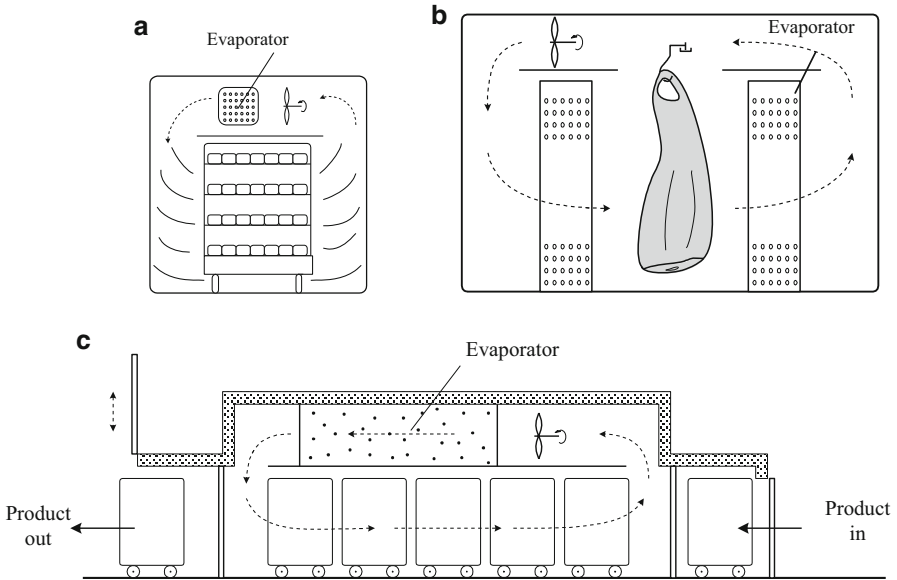
method presumes that there is no great resistance to water removal from the interior of the product to its surface, which can happen, e.g., when a waxy layer covers the surface of the product. Vacuum cooling is a batch method. The product is put in pallets placed on wagons or in mobile trays on rails, and it is transported into the vacuum chamber, in which the pressure is reduced to 5.3–6.5 mbar (4.0–5.0 mmHg) (James and Bailey 1990a, b). In some vegetables, pre-spraying of the product with water contributes to a better cooling. The removal of 1 % water reduces the product temperature by 5 °C (Fennema 1975). In cooling of several vegetables, this kind of cooling is economically comparable with hydrocooling, and it gives better-quality results. However, as in all methods requiring vacuum, relative high capital investment is required. A chamber of 5.5 × 1.8 × 2.0 m can cool 5 tons/h (five pallets, 1.20 × 1.00 m), using two vacuum pumps. The weight of such a chamber is about 12 tons, and the electrical power required, 40 kW.

### Surface Contact Cooling

Basically, equipment that is used for heating can be modified for cooling. In the case of the double-wall surfaces, cool water or brine is circulated, instead of hot water or steam. Surface equipment can be used in cooling of solids in the form of granulates. The process can be batch or continuous. An example of using such a double-wall machine in a batch process is the vat with a rotating helical stirring device, used in crystallization (Fig. 9.13c). The cooling medium circulates in the double wall, but there are variations in which, for increasing the heat exchange, the helical stirring device is a tube in which the cooling medium also circulates. A modification of the equipment used in drying can be also used in the continuous cooling of granulates (Fig. 9.13b). In this case, several double-wall disks, lying one over the other, cool the granules as they are swept by stirring devices or brushes, falling from one disk to the next, after an almost full rotation.

### Tunnel Cooling

Large food pieces can be chilled in heat-insulated tunnels, although, when storage follows, chilling is usually done in the rooms in which the products will be ultimately stored. Air cooling in tunnels does not require complicated installations and has also the advantage of cooling products of different size. The product comes into the tunnel in trolleys or racks (Fig. 9.18). Air, cooled in a finned-tube evaporator (Fig. 9.6), is recirculated after being blown to the product. The cooling time is reduced when low temperature and high air velocity are applied. Nevertheless, high air velocity increases the water loss of the product, and low temperatures, especially in combination with high air velocity, increase the possibility of surface or part-product freezing. Furthermore, increase of ventilation raises the required fan energy significantly. As James and Bailey (1990a) report, in cooling meat (140 kg beef), a fourfold increase of air velocity (from 0.5 to 2.0 m/s) results in a cooling time



**Fig. 9.18** Low-temperature tunnels (see text)

reduction of 18 %, but it also increases the energy consumption 64 times. In cooling of larger food pieces (e.g., carcasses), air temperature near the freezing point of food and air velocity around 1.0 m/s are used. In the batch system, the product does not move as long as it is in the tunnel, but in the continuous system, the trolleys enter and leave the tunnel from different doors (Fig. 9.18). In the continuous process, air is blown in counterflow to the movement of the trolley in the tunnel. The air cooler can be on the upper part or on the side of the tunnel.

### 9.5.2.2 Cooling of Liquids

Methods of liquid cooling may be batch or continuous. The equipment effectively consists of a heat exchanger, like those described in Chaps. 6 (heat transfer equipment) and 7 (evaporators) and in this chapter, and a pumping system. Basic equipment for liquid cooling is the plate heat exchanger, the scraped surface equipment, the double-wall vessel, the shell-and-coil equipment, the vacuum cooling equipment, and the equipment combining cooling with mixing.

#### Plate Heat Exchangers

The plate heat exchangers are double-wall constructions (Fig. 9.7) and are described in Chap. 6 (Figs. 6.4 and 6.5). This kind of equipment is, e.g., used in cooling of milk or juice continuously before storing in isothermal tanks. The same

equipment is also used for heating and subsequent cooling of liquids (e.g., pasteurization). It is very popular, because it has good heat transfer properties, it is flexible (its surface can be increased, if required), and it can be cleaned easily. Since the distance between the plates is small (only a few millimeters), the density and the viscosity of the liquids must be low. Often, the cooling medium is cold (iced) water, which moves in counterflow to the product. The maximum capacity of such equipment depends on the number of plates, the pump system used, the physical properties of the product (thermal conductivity, viscosity), and the final temperature of the product.

### Scraped Surface Exchangers

This type of equipment is used in cooling highly viscous liquids continuously. In vertical position, they are applied to manufacturing of ice (flakes). Horizontal equipment is used in manufacturing of ice cream. This heat exchanger is described in Chap. 6 (Fig. 6.9).

### Jacketed Vessels

The vessels and the agitated kettles are double-wall equipment described in Chaps. 3 and 6. The cooling medium flows between the surfaces, while several types of stirring devices agitate the product. At constant speed and constant initial temperature of the cooling medium, the heat transfer of the vessel/kettle, besides the kind of the product, depends on the agitation.

### Shell-and-Coil Equipment

The basic element of this equipment is the shell-and-coil heat exchanger. This heat exchanger is described in this chapter (Sect. 9.2.3, Fig. 9.12a). The continuously operating equipment is mainly used for cooling water and drinks quickly.

### Vacuum Cooling Equipment

The cooling time of liquids in agitated jacketed vessels is reduced, if vacuum is applied due to additional evaporative cooling. The method consists of a closed jacketed vessel that can be vacuumed (pressure 6 mbar). When vacuum is applied, the liquid of the vessel can be cooled from 90 °C to ambient temperature ten times faster.

## Combined Cooling with Mixing

Recirculation is one of the main methods of mixing. If this method is combined with cooling, it can be applied to flowable products, such as liquids and grains. The product comes out of the tank or silo gradually, and it flows back to them, after cooling in an efficient heat exchanger. This method can also be applied to food suspensions made up of liquid and solid components. The cooling of food is difficult when it is made up of a liquid (e.g., soup), in which fatty meat pieces are included. In this case, the much lower thermal conductivity of the solid pieces determines the cooling rate of the whole food. A possibility in this case could be the cooling of the two main components separately, before they are mixed in the vessel (James and Bailey 1990a).

## 9.6 Freezing of Food

### 9.6.1 Freezing

Freezing of food is a preservation method, combining long shelf life with good product quality. The products must be frozen as soon as possible after processing and maintained frozen up to thawing/consumption. Several authors have analyzed the freezing process and its effects on the final quality of food. Freezing damage of food is due to four reasons (Reid 1996): the chill damage, the solute-concentration damage, the dehydration occurring due to osmotic forces, and the mechanical damage from ice crystals. The mechanism of ice crystal formation and changes occurring during thawing were described by Fennema (1975), Fellows (1992), Heiss and Eichner (1995), and Schormueller (1966). The role of freezing rate on the quality of frozen food was analyzed by IIF (1975), Mardsen and Henrickson (1996), and Woolrich and Novak (1977). The effect of food properties on the freezing process was discussed by Heldmann (1992).

The quality of frozen foods depends on the: (1) good initial product quality; (2) correct application of additional processing methods, when required; (3) right freezing speed; (4) hygienic processing conditions; and (5) proper thawing.

Since freezing is a relatively expensive process and it neither kills microorganisms nor inactivates enzymes, it is very important to select products of very good initial quality. Furthermore, the hygienic conditions of food preparation and freezing must be very good to avoid any infection or contamination before freezing. Mechanical or thermal damage during the preparation for freezing must be avoided, because they result in the loss of valuable food components, increase the danger of post-contamination, and cause degradation of the quality of the final products. If, e.g., additional thermal processing, like blanching in the case of vegetables, is required, this should be effective but as minimum as possible, avoiding damage to

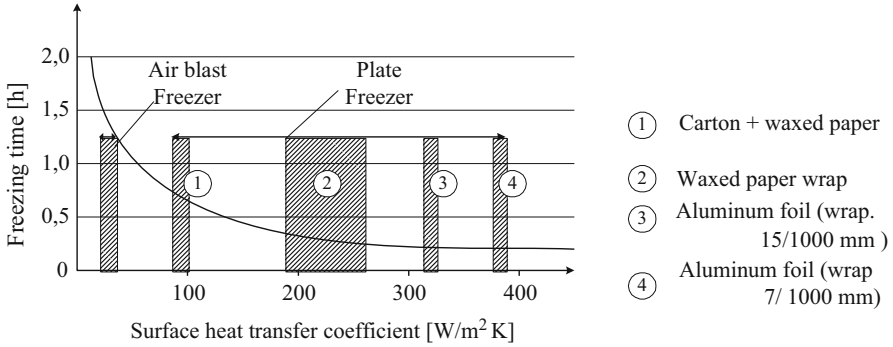
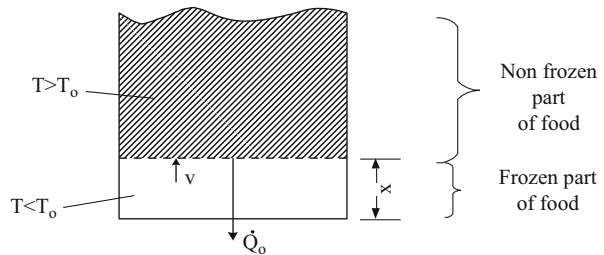


Fig. 9.19 Influence of packaging on the surface heat transfer coefficient

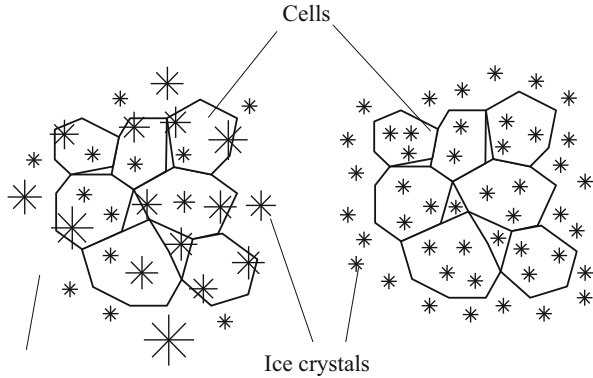
Fig. 9.20 Speed of freezing



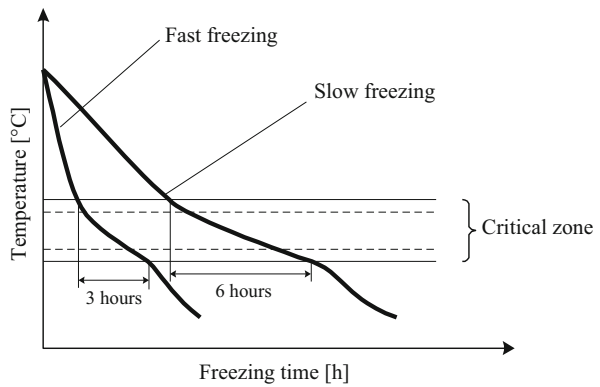
the initial high quality of the product (see p. 467). Packaging protects food from any post-contamination and reduces the weight loss during freezing or storage. However, although packaging of food before freezing contributes to the good final quality of the product, it has the disadvantage of retarding the freezing speed. As indicated in Fig. 9.19, the surface heat transfer coefficient of fine aluminum wrapping is four times higher than that of carton wrapping covered with wax (IIF 1972).

In comparing freezing methods and freezing of foods, the freezing speed (Fig. 9.20) is helpful. It gives the time that is required for the “cold front,” i.e., the borderline between frozen and unfrozen part of food, to move toward the side of the nonfrozen food (9.7). According to the recommendation of the International Institute of Refrigeration, the freezing speed ( $u$ ) is distinguished in four categories: the slow freezing,  $u = 0.1\text{--}0.2$  cm/h (bulk freezing in cold store rooms); the quick freezing,  $u = 0.5\text{--}3$  cm/h (blast freezing or plate freezing); the rapid freezing,  $u = 5\text{--}10$  cm/h (individual freezing of small pieces of food in fluidized freezers); and the ultra rapid freezing,  $u = 10\text{--}100$  cm/h (spraying with liquids or cryogenic freezing). For retail packages, freezing speeds  $u > 0.5$  cm/h and, for individual freezing, freezing speeds  $u > 5$  cm/h are considered satisfactory (IIF 1972):

**Fig. 9.21** Ice crystals in freezing of food cells



**Fig. 9.22** Zone of crystallization in food freezing

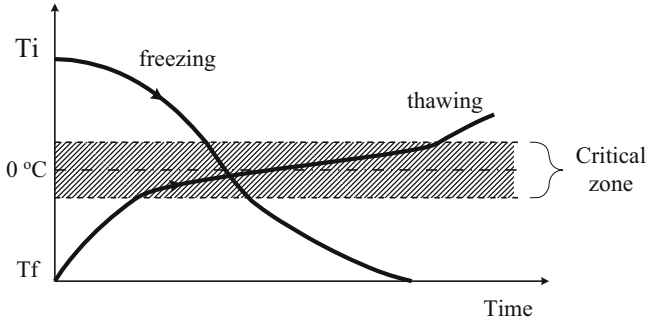


$$u = x/t \tag{9.7}$$

where  $u$  is freezing speed (cm/h);  $x$ , distance from the surface contacting the freezing medium (cm); and  $t$ , freezing time (h).

Generally, freezing must be done quickly, resulting in the production of small ice crystals, which do not damage the cells of the products very much (Fig. 9.21). The large ice crystals damage the cell walls and valuable substances are lost during thawing (Heiss and Eichner 1995). For reducing the number of large ice crystals in the food, the product must not remain for a long time in the critical temperature zone (Fig. 9.22), in which crystallization takes place (Heiss and Eichner 1995; Fellows 1990). Thus, the number and size of crystals formed depend on several factors, influencing the heat transfer. Such factors are the mass of the product that must be frozen, the method of freezing, the freezing conditions, and the packaging. However, the quality of the food does not always depend on the high speed of freezing. In the case of beef, there is no remarkable difference between meat frozen at freezing speeds 0.03 and 200 cm/h (Spiess and Kostaropoulos 1977).

Thawing plays also an important role in the final quality of food. When using conventional methods (hot air, warm water, or steam), thawing of a certain piece of



**Fig. 9.23** Freezing and thawing of food.  $T_i$  initial,  $T_f$  temperature

food lasts longer than freezing (Fig. 9.23). This happens because the thermal conductivity of ice is almost fourfold of that of water (ice, 2.2 W/m K; water, 0.6 W/m K). As thawing proceeds, the water on the external part of the food causes a relative delay in heat transfer toward the still frozen product core (Fennema 1975; Heiss and Eichner 1995). Of course this does not hold, when electromagnetic thawing methods, such as dielectric and MW heating, are applied.

Thawing with MW is faster, but the product must be homogeneous. MW thawing, e.g., is not suitable for meat containing much fat in layers or many bones, since these components have different dielectric properties than meat flesh. In any case, in thawing, the product temperature should not exceed 10 °C, since this could increase the danger of microbial spoilage (Spiess and Kostaropoulos 1977).

In calculations related to the freezing of food, the freezing point, the fraction of frozen water, and the freezing time of the products are important. The freezing point is important in thawing estimations and in avoiding damage of products that should be chilled near their freezing point, without crossing it (e.g., cold storage of fruits). Table 9.8 gives the freezing points of several foods (Spiess and Kostaropoulos 1977).

The fraction of frozen water is important in estimating the most economic and proper freezing temperature. Freezing is completed, when no significant increase in the freezing of water of a product takes place. This fraction varies from product to product. At the end of freezing of white bread, its frozen water is only about 62 %, while in strawberries, it is about 95 %. Figure 9.24 gives the fraction of frozen water of several foods, for temperatures below 0 °C (–15 to –30 °C). Usually, freezing is completed at –18 to –20 °C.

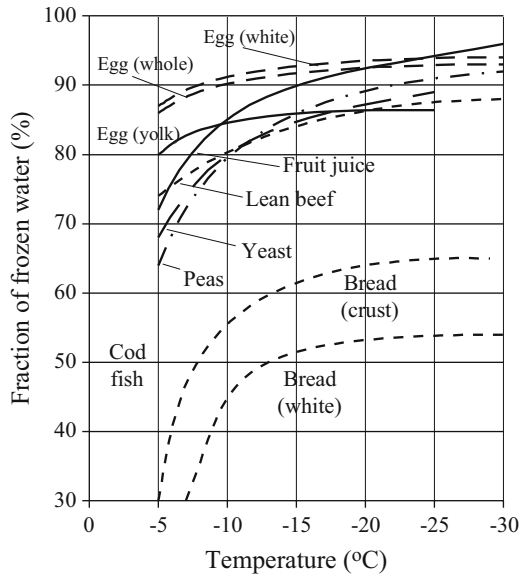
The fraction of frozen water can be estimated through the Riedel diagrams. As indicated in Fig. 9.16, diagrams (a) and (b) give also the fraction of water that is frozen, when the temperature of a product is reduced below its freezing point. In the case, e.g., of lean meat (Fig. 9.16a) and fruit and vegetable juice (Fig. 9.16b), when the temperature is reduced from point A to point C, whose temperature is below 0 °C, the curves  $a_x$  that pass through point C indicate the fraction of frozen water.



**Table 9.8** Freezing points of foods

Product	Initial freezing point (°C)
Meat	-0.6 to -1.2
Fish	-0.6 to -2.0
Milk	-0.5
Egg (white)	-0.45
Egg (yolk)	-0.65
Green salad	-0.40
Tomato	-0.9
Cauliflower	-1.1
Onion, peas, strawberries	-1.2
Peach	-1.4
Apple, pear	-2.0
Plum	-2.4
Cherry	-4.5
Nuts, chestnut	-6.7

**Fig. 9.24** Fraction of frozen water in foods



The freezing time of food is important in economic and technical analyses and estimations. It is important in estimating the output and the capacity of a unit, in selecting the right freezing equipment, in adjusting equipment for getting the best possible freezing result, and in manufacturing of proper equipment. In freezing time calculations, the Plank equation is used (9.8):

$$t_f = [\rho H_L / (T_f - T_A)] (Pa / h_c + Ra^2 / \lambda) \tag{9.8}$$

where:

$t_f$ , freezing time (s)

$\rho$ , density of food ( $\text{kg/m}^3$ )

$H_L$ , latent heat of crystallization (J/kg)

$T_i$ , initial temperature of food ( $^\circ\text{C}$ )

$T_A$ , temperature of the freezing medium ( $^\circ\text{C}$ ), characteristic dimension (e.g., thickness of product parallel to direction of prevailing heat transfer) (m)

$\lambda$ , thermal conductivity of the product ( $\text{W/m K}$ )

$h_c$ , surface heat transfer coefficient ( $\text{W/m}^2 \text{K}$ )

$R$  and  $P$ , constants for accounting the influence of the shape of the product. For sphere,  $P = 1/16$ ,  $R = 1/24$ ; for infinite plate,  $P = 1/2$ ,  $R = 1/8$ ; for infinite cylinder,  $P = 1/4$ ,  $R = 1/16$

Variations of this equation are presented by Schormueller (1966), IIR (1972), Brennan et al. (1990), Fellows (1990), Heldmann (1992), Singh(1995), Heiss and Eichner (1995), and Cleland and Valentas (1997). The Plank equation gives a rough estimate of the freezing time for basic geometric shapes, such as infinite plate, infinite cylinder, and sphere. According to this equation, the interrelation of freezing time of these three geometric shapes is  $t_{\text{plate}}:t_{\text{cylinder}}:t_{\text{sphere}} = 1.0:0.5:0.33$  (Heiss and Eichner 1995). However, since there are several limitations, restricting an accurate calculation of any food, several attempts have been undertaken to modify this equation or develop a new one. Nevertheless, although these attempts enable a more realistic approximation of the freezing time of real foods, application of the suggested solutions is still limited (Heldmann 1992; Singh 1995).

In estimating the required total heat load (i.e., including the latent heat) for freezing several foods, from initial temperatures above  $0^\circ\text{C}$  to lower temperatures, the Riedel diagrams can be used. Otherwise, the calculation includes the heat load  $Q$  (J) for reducing the temperature of a product from an initial temperature  $T_i$  to the freezing temperature, the load for removing the latent heat, and the load for reducing the temperature of the product from its freezing point to the final temperature  $T_f$  ((9.8), (9.10), and (9.11)).

$$Q = mC_p(T_i - T_o) \tag{9.9}$$

$$Q = H_L m \tag{9.10}$$

$$Q = mC_{pf}(T_o - T_f) \tag{9.11}$$

where  $m$  is the mass of the product (kg);  $H_L$ , latent heat (J/kg);  $T_i$ ,  $T_o$ ,  $T_f$  are initial, freezing, and final temperature of the product ( $^\circ\text{C}$ ); and  $C_p$ ,  $C_{pf}$  are specific heat (J/kg) of food above and below freezing, respectively.

The method of freezing has the following advantages: (1) good quality of final product, (2) extended shelf life of high-quality “raw products,” and (3) versatility in the field of catering.

The disadvantages of food freezing include (1) relatively expensive process; (2) the freezing chain must not be interrupted up to the final consumption; and (3) dependence on high-quality raw materials.

## **9.6.2 Freezing Equipment**

The freezing equipment can be classified according to the temperature applied (above or below  $-40^{\circ}\text{C}$ ), the processed product (solid, liquid), the freezing medium (air, cold surface, liquid), and the way of processing (continuous, batch). Freezing methods are described by Venetucci (1995), Heiss and Eichner (1995), Persson and Loedahl (1996), James and Bailey (1990a), Woolrich and Novak (1977), IIR (1972), Schormueller (1966), and Cleland and Valentas (1997).

### **9.6.2.1 Air Freezing Equipment**

Air is used in freezing food in tunnels, conveyor belts, and fluidized bed equipment. In all cases, air is blown countercurrently to the product, and depending on the freezing method, it is blown horizontally or vertically to the product. In tunnel freezing, the horizontal blow method prevails. In fluidized beds, air is blown vertically upward, and in belt freezing, both blowing methods are used. Since the specific heat of air is low, large air quantities are required for freezing.

#### **Tunnel Freezers**

Freezing in a tunnel is very similar to the tunnel cooling process. It is used in freezing of a wide range of products, extending from fine cut or minced products up to whole poultry or even half beef carcasses. It consists of an insulated room with one door or with two doors for a continuous operation (Fig. 9.24). The difference between the two types of tunnels is that in freezing, the air temperature is  $-30$  to  $-40^{\circ}\text{C}$ , the insulation of the chamber is thicker, and the air velocity is higher (3–6 m/s). This requires larger heat exchangers and more powerful fans. Larger air velocity (e.g., 10 m/s) would reduce the freezing time, but the benefit of such reduction is not so significant, if the increased energy consumption is taken into account, because the energy increases with the third power of the air velocity (Schormueller 1966; Heiss and Eichner, 1995). As in the case of cooling, the three main loading systems of a tunnel are (a) the push-through system, in which for each new trolley coming in the tunnel, a trolley with frozen product gets out; (b) the rack system, which is applied to freezing of carcasses; and (c) the chain drive system, in which the trolleys are pulled by a chain, in and out of the tunnel. When using trolleys, the product is first put on trays. If no large pieces, like poultry, are frozen, a trolley can be loaded with 40 trays and carry about 250–300 kg of product.

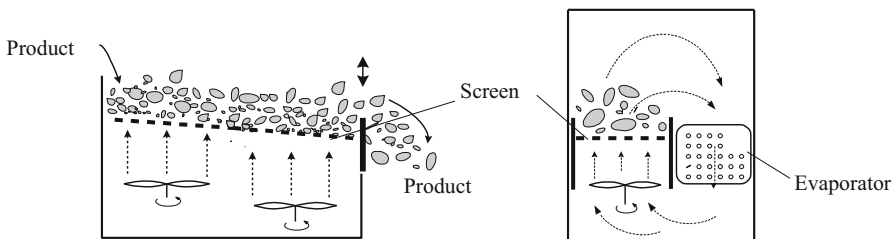
The freezing time depends on the size and thermal conductivity of the product. For product on trays, it lasts usually 1.5–6 h. There are single-row or double-row tunnels. Usually, the fans are in a channel above the trolleys. The heat exchangers are on both sides, and in the case of a double row, they are also between the trolleys. The capacity of a tunnel with 8 loaded trolleys is 1.5–4.0 tons/h. This corresponds to a specific capacity of about 25 kg/m<sup>2</sup> h of tray area. It is important to put the trolleys and trays in such a way that no free spaces between them are left.

The advantages of tunnel freezing are (1) flexibility, tunnels are suitable for a great variety of small product quantities; (2) easy cleaning; and (3) simplicity.

The disadvantages of tunnels include: (1) they require relatively large space; (2) more labor is needed than in belt or fluidized bed freezing; and (3) there is significant weight loss of product (2–3 %).

### Fluidized Bed

The fluidized bed method is an individual quick-freezing (IQF) method, used in freezing small whole or cut pieces of food (diameter up to about 3 cm and length up to about 12 cm), such as, peas, French fries, sliced or cut carrots, beans, mushrooms, etc. The food pieces are frozen individually, as they hover in the air that freezes them quickly. The equipment consists of an inclined screen, fans (usually radial) blowing air upward through the perforated bottom, and heat exchangers cooling the air to –40 °C (Fig. 9.25). The air, streaming upward, freezes the product, which at the same time is transported by the air cushion formed. The product is frozen quickly, because (a) it is surrounded by cold air and (b) the heat transfer between air and product increases, as there is a relative motion between the product and the transporting air. Examples of freezing time are peas, 3–4 min, and French fries and strawberries, 9–13 min. The product layer over the screen depends on the product, e.g., 3–25 cm (usually about 12 cm). In proper design, the weight loss of the product is less than 1.5–2 %. A wet product surface and a high freezing rate reduce weight loss. This is achieved when the air velocity increases, causing better heat transfer, as the air moves faster along the product, and the rotation or tumbling of the product during its transport also increases. However, since high air velocity and low temperature tend to dry the product, a small relative reduction of air temperature



**Fig. 9.25** Fluidized bed freezing

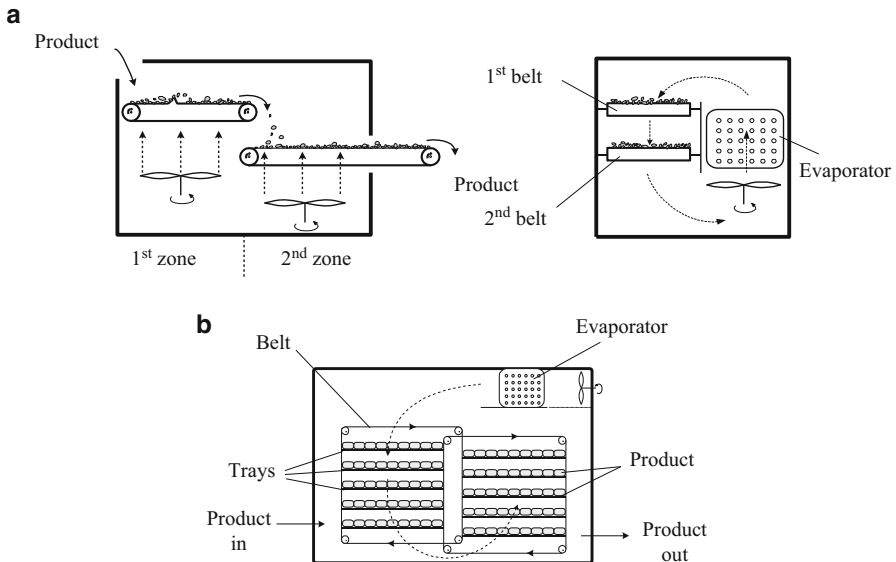
is beneficial. The capacity of fluidized bed freezing equipment varies between about 1 and 12 tons/h. The specific capacity for fruits and vegetables is about  $160 \text{ kg/m}^2 \text{ h}$ . The dimensions of a fluidized bed freezer are length, 2.0–11 m; width, 2–9 m; and height: 3–6 m.

The advantages of fluidized bed equipment are (1) large specific capacity, (2) reduced product weight loss, (3) small dimensions, and (4) not many moving parts.

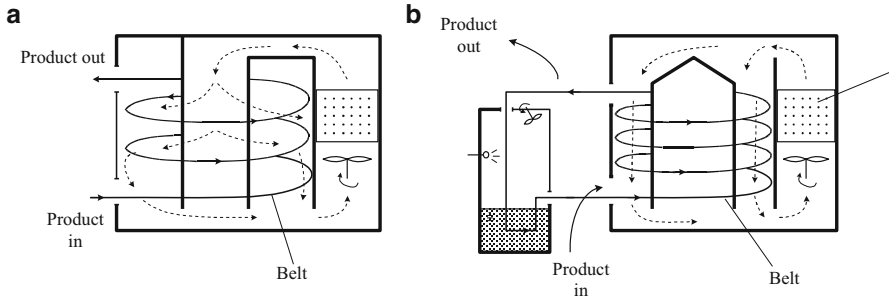
Disadvantages of fluidized bed equipment include (1) relatively high energy requirement, (2) not for universal use (only for small pieces), and (3) requiring homogeneity of the pieces.

### 9.6.2.2 Belt Freezers

This equipment consists of belts moving through a cold air stream (Figs. 9.26 and 9.27). The belts are either straight or curved, made of steel or plastic material, allowing air to pass through. In all cases, a special automatic mechanism maintains the tension of the belts constant. This kind of equipment is suited for freezing sensitive and relatively large or heavy pieces of food. Some examples of products frozen this way are apple slices, cauliflower, strawberries, artichokes, etc. Belt freezing equipment is also used in hardening of prefrozen food.



**Fig. 9.26** Belt freezing equipment. (a) Straight belt and (b) elevator belts



**Fig. 9.27** Curved (*spiral*) belt freezing equipment (see text)

- Straight belts

In some cases, the straight belts are separated into zones (Fig. 9.26a, b). In the first zone, the air recirculates vigorously, causing a surface freezing of the product (“crust freezing”). The freezing of the product is completed in the second zone. In some structures, buckles of the belt cause turning over of the product, contributing to more even freezing. Strawberries can be frozen in about 12 min and fish fillets in about 20 min. The capacity of belt freezing equipment is 0.2–6 tons/h. The overall length of such equipment is 5–13 m. For reducing the length, two or more belts may be placed one over the other. The overall width is 4–5 m. For increasing the versatility of the equipment, two or more belts may move parallel to each other, at different speeds. A single belt is usually 0.5–0.8 m wide. The heat exchanger lies in a separate part of the equipment, on the side of the belt. The overall height of the freezer is about 5 m. For freezing the same quantity of food, they require more floor space than the fluidized bed equipment, but about 30 % less than the spiral belt freezing equipment.

- Elevator system

In Fig. 9.26b, the freezing equipment consists of parallel belts carrying large loaded shelves moving up, and after reaching the highest position in the room, they move again down. It is effectively an elevator system, in which freezing can be controlled by the speed of the belts, and it takes place during the up-and-down movement of the shelves. This method is often used in hardening of products like packed ice cream. The capacity of hardening equipment of this kind depends on the type of ice cream and the desired texture of the product. They can harden, e.g., 20,000 L/h. The method is very flexible. Besides freezing control, through the speed of the belt, it is also possible to load and empty the shelves at different positions, enabling the parallel freezing of different products or packages of different size. The method saves room but it requires more energy in comparison to flat belt structures.

- Curved belts

Curved (*spiral*) belts are used for saving space. Two main types are the spiral and the semispiral freezing equipment, consisting of a combination of curved and straight belts. The spiral type is quite often used in freezing of hamburgers, fish

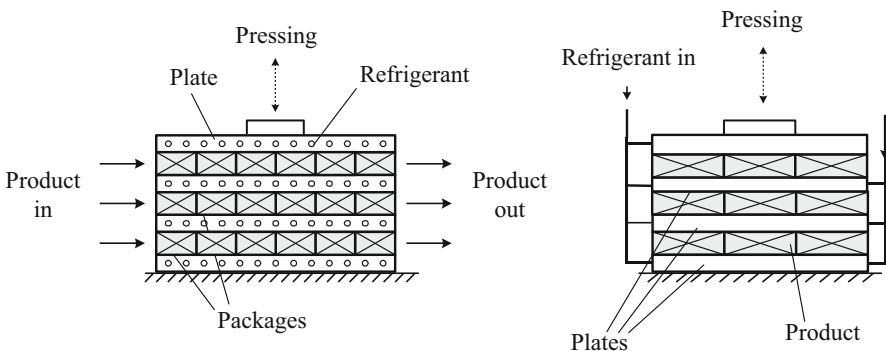
sticks, and ready meals. It is also used in hardening of frozen products. The combined type is mainly used in hardening. In the spiral construction, the length of the belt can exceed 300 m. The width is usually 4–7 m. Air is blown horizontally (Fig. 9.27a) or vertically through the product (Fig. 9.27b), which moves around a cylindrical core. In the first case the cylindrical core contributes to the air circulation. In both cases, this cylinder may contribute to the spiral movement of the belt, which winds around the core. Air is cooled in finned heat exchangers, placed in a separate room. The flexible belt is washed automatically after each full round. This may consist of hot water spraying, dipping in a detergent-containing vat, rinsing with cold water, and air-drying, before being reloaded. Large equipment may freeze continuously more than 5 tons/h. The specific capacity (about 40 kg/m<sup>2</sup> h) is not very high, due to the space occupied by the core. However, its main advantage is the continuous, gentle product transport and the flexibility in enabling the parallel freezing of products differing in size or in packaging. The floor space and height of an insulated room, containing a spiral freezing belt, may be 60–70 m<sup>2</sup> and 5–6 m, respectively.

Advantages of belt freezing equipment are (1) freezing of a wide range of delicate products, (2) freezing of wet and sticky products, (3) possibility to freeze also larger pieces, and (4) freezing of packaged or non-packaged food.

The disadvantages of belt freezing equipment include (1) relatively many moving parts (fans and belts), (2) relatively high energy consumption, (3) high initial capital, and (4) homogeneity of product distribution on the belt required.

### 9.6.2.3 Cold Surface Freezing

Food can be frozen quickly in plate freezing equipment (Fig. 9.28). It consists of several double-wall plates, in which a refrigerant circulates. Food is placed between the plates, which press the food by means of a hydraulic system lightly (0.06–0.1 bar), for reducing air pockets between cooling surface and packaging



**Fig. 9.28** Horizontal plate freezing equipment

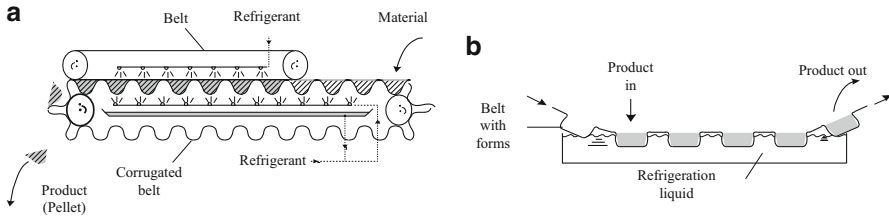
(Guthschmidt 1973). When freezing is finished, the plates separate and the product is removed for reloading. The double-wall plates (Fig. 9.7) are made of extruded aluminum alloy of food quality. If the equipment is used for freezing fish in ships, the aluminum alloy used must be also seawater resistant. The plates can be parallel or vertical. Vertical plates are used in freezing fish in ships, because they require less free headroom. The number of parallel plates can be 5–20. Their spacing (distance) is up to 7 cm, and their surface is 1.5–2.0 m<sup>2</sup> (e.g., 1.5 × 0.8 m or 2.0 × 1.1 m). Vertical plate equipment usually has 12–16 plates, lying 5–9.5 cm apart. The surface of the plates can be, e.g., 1.2 × 0.6 m. Plate equipment is used in freezing of whole fish, fish fillets, pieces of meat (e.g., chops) product packed in rectangular packages, and liquid slurries. The last product is frozen in plastic bags, hanging between vertical plates. The capacity of plate equipment is 6–13 tons/24 h. The refrigeration capacity of large units is about 75 kW. The freezing of a 5-cm fish block can last about 1.15 h. The specific capacity of a plate freezing equipment is about 160 kg/m<sup>2</sup> h. The product, before entering the plate freezing equipment, is placed on metal trays. This is done for avoiding the icing of the plates, due to water loss of the product. The parallel plates are placed in an insulated cabinet. In the continuous system, two doors are used, one for feeding and one (on the opposite side) for emptying. The automatic feeding is based on the push-through system. Each time that the freezing of products of a tray is completed, a new tray enters, pushing that with the frozen products out. In the vertical plate equipment, the product (mainly fish) is frozen unpacked. It is taken out of the plates during defrosting (heating of the plates). The great advantage of plate freezers is their good specific capacity. This is about four times as high as that of freezing tunnels (85 kg/m<sup>2</sup> h). The overall dimensions of a cabinet containing 20 parallel plates may be 3 × 2 × 2 m and its weight 1.8–2.0 tons.

#### 9.6.2.4 Liquid Freezing

##### Liquid Freezers

In all cases, the equipment used is not complicated. In liquid freezing, cryogenic liquids such as liquefied nitrogen (N<sub>2</sub>) and carbon dioxide (CO<sub>2</sub>), brines, and nontoxic mixtures of water and solutes (e.g., sugar–alcohol solution in water) or other liquids (e.g., propylene glycol/water mixture) are used (Persson and Loedahl 1996). The food to be frozen is either immersed in the liquid or sprayed. Freezing by liquids is very fast, due to low temperature and direct contact with the whole product surface. The rate of freezing, e.g., by spraying a product with liquid nitrogen is 2.5 times faster than in fluidized bed freezing and 25 times faster by liquid immersion (Spiess and Kostaropoulos 1977). In the case of liquid N<sub>2</sub> or CO<sub>2</sub> and in some cases of brine (e.g., freezing of fish or meat that will be used in sausage manufacture), the freezing medium may contact directly the food. In all other cases, only packaged food is immersed in liquids or sprayed. Poultry, e.g., is packed in plastic bags that are vacuumed or shrunk by short immersion in hot water before freezing (Heiss and Eichner 1995).





**Fig. 9.29** Pellet freezing equipment (see text)

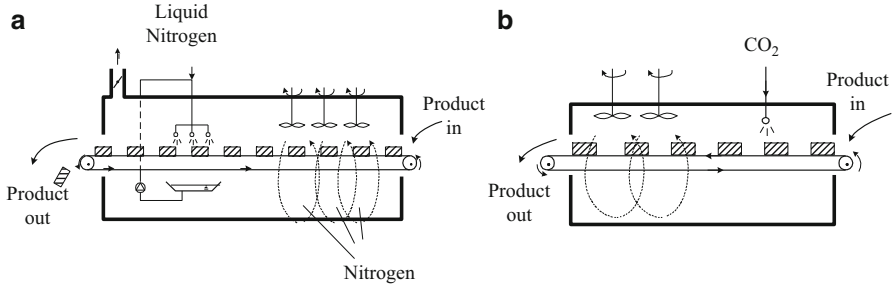
### Frozen Pellets

Liquids are also used in the production of frozen pellets. In this case, foods, such as dairy products, liquid egg, fruit pulps, sauces, and vegetable purees, are frozen between two parallel moving metallic belts (Fig. 9.29). The corrugated lower belt gives the shape of the pellets, while the upper belt is flat. A liquid, e.g., a propylene glycol/water mixture, is sprayed on the external sides of both belts (Fig. 9.29a). In a variation of this equipment, only the lower belt is used, which is immersed in the liquid as it moves forward (Fig. 9.29b). The capacity of corrugated belt liquid freezers is 0.2–1.5 tons/h. Packaging of pellets can be done in bags or cartons or, in the case of further processing in the same fabric, in pallet boxes (0.5 tons/box). These pallet boxes can be stacked five high in cold store rooms.

### Cryogenic Liquids

In the case of cryogenic  $N_2$ , a straight-belt-type freezing equipment is quite often used. However, if there is not enough space, spiral belts running around one or two cylindrical cores are used, or the product is directly immersed in liquid  $N_2$ . For small quantities, a batch process chamber can be used. A freezing unit of two spirals (one following the other) may have overall dimensions of  $12 \times 6 \times 5$  m. The distance between the belts can be up to 15 cm and their width can be 0.5–2.5 m. The freezing time of spiral belt freezing units depends on the kind and size of the products. Usually it varies between 20 and 90 min. The total surface of 1–2 belt spirals is 20–200  $m^2$ . Spiral freezing equipment using cryogenic  $N_2$  may require, for the motion of the belts and the ventilation of evaporated  $N_2$  gas, a power of 10–30 kW.

Figure 9.30 gives two examples of straight-belt equipment for freezing of food with cryogenic liquids. In freezing with  $N_2$  (Fig. 9.30a), the product is put on a metallic perforated belt, which brings it in an insulated cabinet. The belt is up to 12 m long and 1.5–2.5 m wide. Three zones are distinguished, i.e., the precooling, the freezing, and the equilibrium zone. In a 12-m-long equipment, in the first zone, which is about 5–6 m, the product is precooled down to about  $-70$  °C. Precooling is done, as the product passes through gas of just evaporated liquid  $N_2$ . In the second zone, which is 2–3 m long, liquid  $N_2$  ( $-196$  °C) evaporates, while it is sprayed



**Fig. 9.30** Cryogenic liquid freezing equipment. (a) Liquid nitrogen and (b) carbon dioxide

directly onto the food. Due to the high heat transfer coefficient of the liquid  $N_2$  during its evaporation, which is about  $2300 \text{ W/m}^2 \text{ K}$  (Dinglinger 1977), the product is frozen very fast, reaching a surface temperature of about  $-190^\circ \text{C}$ . The  $N_2$  gas is sucked and ventilated over the product entering the cabinet (first zone). In the third zone, the temperature of the product is equilibrated by air blown on its surface. The method can be used for packed and unpacked food. The capacity of  $N_2$  freezing equipment can be up to about 1.5 tons/h. If immersion in liquid  $N_2$  is used, freezing may last 15–100 s. For freezing 1 ton of small food particulates, a bath only 1.5 m long is required (Fellows 1990). Such a unit requires less than 1 kW power. However, since not all foods resist the freezing shock, caused by the sudden immersion in so low temperature, the method is restricted to products like berries, shrimp, and diced meat and fruits. In direct contact, 1 kg of liquid  $N_2$ , which corresponds to 1.245 L, may remove 330 kJ from a freezing product (Henrici and Haaf 1973). The liquid  $N_2$  consumption is 1–1.5 kg/kg product (Heiss and Eichner 1995). In some cases, for reducing the  $N_2$  consumption, the products processed by cryogenic  $N_2$  are frozen only on their surface. The final freezing is carried out in other equipment (e.g., belt freezers) or in cold stores at  $-20^\circ \text{C}$  (IIF 1972). This can be done only if the subsequent slower freezing speed does not influence the quality of the food.

The triple point of carbon dioxide ( $\text{CO}_2$ ) is  $-56.6^\circ \text{C}$  and 5.28 bar. Since it is expensive and not practical to work at so high pressure, the operation of the relevant equipment is based on cryogenic  $\text{CO}_2$  (“dry ice”). When liquid  $\text{CO}_2$  is released to the atmosphere, half of it becomes dry ice and the other half vapor. Both have the equilibrium temperature of  $-78.5^\circ \text{C}$ . Therefore, although  $\text{CO}_2$  spraying equipment used in freezing of food is very similar to that of liquid  $N_2$ , it differs in the location of spraying. Since the  $\text{CO}_2$  dry ice, produced during spraying, needs some time to sublime, spraying of the product with  $\text{CO}_2$  is done close to its entrance in the cabinet (Fig. 9.30b). According to Woolrich and Novak (1977), freezing can be done in equipment consisting of a rotating cylinder in which dry ice is mixed with the product in proper analogy. The dry ice can be stored and ground before it is mixed with food. A 25-m-long cylinder, of about 30 cm diameter, could freeze 0.5 tons/h. If the product is subsequently packaged, no dry ice should be enclosed,

since expansion of it later could damage the package. The overall cost of CO<sub>2</sub> freezing is comparable to that of N<sub>2</sub> freezing (Fellows 1990).

Advantages of cryogenic liquid freezing are (1) high freezing speed (high capacity, better quality), (2) low product weight loss during freezing (0.1–1.0 %), (3) low initial capital (1/3 of that of mechanical systems), (4) low floor space (specific capacity, 125 kg/m<sup>2</sup> h), (5) low maintenance cost (simple construction), and (6) easy handling.

The disadvantages of cryogenic liquid freezing include (1) cryogenic liquid expensive, (2) relatively high cryogenic liquid consumption, (3) dependence on relatively few cryogenic liquid suppliers, and (4) sophisticated storage installations. The plate equipment freezing and the cryogenic liquid freezing have better heat transfer coefficients than air blast freezing. Nevertheless, the overall fixed and operational costs of the plate freezing equipment are almost double as that of a fluidized bed (air blast) freezer (Woolrich and Novak 1977).

### **9.6.3 Thawing Equipment**

The industrial process of thawing has become important due to the expansion of food freezing in connection to catering. The thawing processes may be subdivided into convective, vacuum, contact heating, and electrical methods. The convective methods are further distinguished into methods using air, water, or steam. In all cases, the equipment used is very similar to that of other heat exchange processes (e.g., cooling, heating, drying).

#### **9.6.3.1 Convective Methods of Thawing**

In all convective thawing methods, the heat has to be supplied through the external surface of the product. Therefore, the surface heat transfer coefficient, in transferring heat from a fluid medium to the product, is important. Furthermore, the speed of thawing depends also on the thermal conductivity of the thawed product, since heat has to pass through the melted zone of the product to the thermal center of the frozen food. Air blast thawing is slower than water or steam thawing. However, this method is the most often used, because it requires less capital and can be used in all products. The thawing tunnel is very similar to those used in freezing, cooling, or drying. However, since thawing is slower than freezing, in most cases trolleys, instead of belts, are used. In water thawing, the product is put in containers or bags, which are immersed in warm water. The water thawing equipment, except for the temperature of water used, is similar to that described in hydrocooling.

The advantages and disadvantages of air and water thawing are as follows (Hallstrom et al. 1988):

Advantages of air thawing are (1) low capital cost for batch operation, (2) versatility, (3) batch and continuous operation possible, and (4) low mechanical maintenance cost.

Disadvantages of air thawing are (1) large flow rate and turbulence necessary, (2) oxidation risk, (3) risk of drying of thawed products, (4) possibility of bacterial hazards, (5) cleaning difficult, (6) odor problems, (7) difficulty to heat product uniformly, and (8) continuous flow operation expensive.

Advantages of water thawing are (1) large heat transfer coefficients, (2) uniform heating of the product surface; (3) batch and continuous operation possible, and (4) low labor cost.

Disadvantages of water thawing are (1) leaching of flavor components; (2) possibility of bacterial contamination; (3) reusing of water often necessary, but costly; (4) corrosion of equipment; (5) continuous operation expensive; and (6) cleaning difficult.

Steam can be also used in thawing of frozen food. However, although this method is fast, it has the disadvantage that condensed steam is added to the thawed product.

### 9.6.3.2 Vacuum Thawing

Vacuum thawing has the advantage of a rapid rate, which is caused by the high mass transfer rate, according to the equation (Hallstrom et al. 1988):

$$dm/dt = D_w \Delta p \quad (9.12)$$

where ( $m$ ) is the mass of the product (kg), ( $t$ ) is the time (s),  $D_w$  is the diffusivity of water vapor in the vacuum chamber ( $m^2/s$ ), and ( $\Delta p$ ) is the pressure drop at the surface of thawing (Pa).  $\Delta p = (p_s - p_a)$ , where ( $p_s$ ) is the vapor pressure of water at the thawing surface and ( $p_a$ ) is the vapor pressure of water in the vacuum chamber, which is practically equal to the air pressure in the chamber. In vacuum operation, both ( $D_w$ ) and ( $\Delta p$ ) will increase and, therefore, the thawing rate will increase sharply, according to (9.7). ( $D_w$ ) will increase due to the inverse relationship to the gas pressure, while ( $\Delta p$ ) will increase due to the sharp decrease of ( $p_a$ ) in the vacuum chamber. Vacuum thawing is a batch process and the thawing equipment has a relatively small capacity (less than 2 tons). However, since the thawing rate is increased, a greater number of operating cycles is possible per day. The thawing equipment consists basically of a vacuum vessel, loaded with trays of layers of frozen product, which are stacked on trolleys.

### 9.6.3.3 Contact Thawing

As in the case of cooling, it is possible to use double-wall surfaces for transferring heat to the product that has to be thawed. This method is applied when the frozen

food is available in small pieces. In this case, equipment similar to that of Fig. 9.13d is used. Semicylindrical jacketed vessels, equipped with a screw propeller in the center for agitating the frozen food, can thaw about 2.5 tons/h. The overall dimensions of such equipment are about  $5.0 \times 0.6$  m.

### 9.6.3.4 Electrical Thawing

The two main methods of electrical thawing are dielectric thawing and microwave (MW) thawing. In both methods, the electrical energy is transformed to heat, as polarization or movement of molecules in an electric field takes place (see Chap. 6). The heat generated depends on the frequency and the electrical properties of food such as the dielectric constant ( $\epsilon'$ ), indicating the efficiency of a product to accumulate electrical energy, and the loss factor ( $\epsilon''$ ), indicating the electrical energy that can be transformed into heat, when the product is placed in an electromagnetic field (Table 9.9).

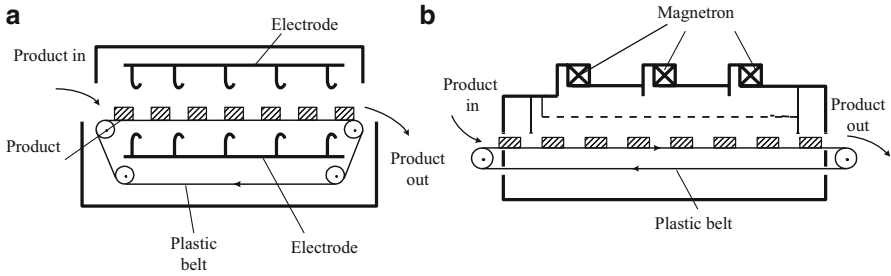
The main difference between the two methods lies in the frequency of the electromagnetic energy. In dielectric heating the frequencies are about 10 MHz, while in MW heating, certain radar frequencies for not interfering in other radar applications are used. These frequencies, according international agreement, are 915 and 2450 MHz.

In the dielectric heating, the frozen product is placed between plates or electrodes, which are connected to a source, supplying alternating high-frequency voltage. The frozen food forms the dielectric medium in an electrical capacitor. As electricity flows through the product, alternating from one plate to the other, heat is generated, thawing the food. In the case that larger blocks of frozen food (e.g., fish) with voids are to be thawed, this can be done after putting the iced blocks in trays filled up with water. The equipment consists of a rubber or plastic conveyor belt (about 1.5 m wide), which carries the food between electrodes or plates

**Table 9.9** Dielectric properties of food and packaging materials (2.45 GHz, 25 °C)

Product	Dielectric constant ( $\epsilon'$ )	Loss factor ( $\epsilon''$ )	Penetration (mm)
Beef	50	15	9
Beef (cooked)	35	12	10
Pork	58	16	
Pork (ham, cooked)	45	25	5
Potato	64	14	
Potato (puree)	65	21	7
Carrot	72	15	
Water (distilled)	77	11	16
Ice (-2 °C)	3	0.03	10 m
Polyethylene	2	0.001	28 m
Glass	6	0.005	10 m

Source: Data from Fellows (1990) and Schubert et al. (1991)



**Fig. 9.31** Electrical thawing equipment. (a) Dielectric and (b) microwave (MW)

connected to electrical current (Fig. 9.31a). Each plate system can be an independent source of electrical/heating energy. The number and the power of the dielectric units depend on the capacity of the equipment and the kind of the frozen product (size, dielectric properties). The electric capacity of each unit may be about 10–100 kW. A unit of 20 kW can thaw about 350-kg fish, 450-kg meat, or 600-kg cakes per hour. A large unit can be 25 m long and 1.5 m wide and requires 120–150 kW. Such a unit can thaw up to 2.5 tons/h. The thawing time depends on the size and the kind of product and lasts less than 1 h (e.g., for frozen fish blocks, 10–60 min).

The industrial MW equipment consists of a belt transporting the food to a chamber in which magnetrons supply the electromagnetic energy. Of course, no metallic trays or packaging material should come in the chamber. For a more even distribution of the electromagnetic energy, fans are placed in the position the MW radiation enters the chamber or in a pre-chamber before meeting the food on the belt (Fig. 9.31b). The main advantages of both electrical methods is the rate of thawing and the reduced weight loss during thawing, which is about 2–9 % in comparison to the conventional heating. Due to shorter time, *minutes than hours*, there is less danger of contamination during thawing. The disadvantage of dielectric heating is that it can be applied only to products of restricted size. The main disadvantage of MW is nonuniform heating.

## 9.7 Cold Storage

### 9.7.1 General Aspects

There are three main categories of cold stores: the cold stores for temperatures up to about 0 °C; the cold stores for frozen products, in which the temperature is usually about –20 °C; and the controlled atmosphere (CA) cold stores, in which the temperature is as in the first category, but the atmosphere basically consists of reduced O<sub>2</sub> and increased CO<sub>2</sub>. The basic equipment of these three cold store

categories is the same. All have compressors, condensers, and evaporators. They differ in the type of compressor (e.g., two-stage reciprocating compressor for cold storage of frozen products), the type and dimensions of the evaporator, and the additional equipment required (e.g., humidifiers, scrubbers, etc.).

The efficient operation of a cold store depends on the following factors: (1) buildings (correct design and construction), (2) equipment (refrigeration load, reliability, flexibility), and (3) management (organization, in- and outflow policy).

These factors are interdependent. The correct stacking, e.g., depends on well-designed corridors, doors, and storage room. Successful cooling requires sufficient refrigeration load, good stacking, and efficient management. Management is important since the refrigeration efficiency depends also on the good maintenance of equipment and installations and the loading/emptying policy.

The shelf life of the products in all cold food depends on: (1) the kind of the products stored (in fruits, e.g., if they are climacteric), (2) the initial quality (e.g., ripeness, injuries), (3) the initial microbial count, (4) the temperature, and (5) the relative humidity of storage.

In all cases, the product exiting the cold storage should not have off-odors, and its texture should be as near to the initial as possible. For keeping away off-odors, mixed storage of products in the same room should be avoided, or in the case that this is not possible, only tightly packed foods should be stored together. Furthermore, the air in the cold storeroom should be renewed several times per day. With the exception of the CA storage, depending on the stored product, this renewal could take place up to six times per day. Preservation of the firmness (texture) of the products is especially important for fresh fruits and vegetables. This depends on holding the water, which means minimization of the products' weight losses.

In selecting the evaporators, compressors, and condensers of a cold store, the maximum refrigeration (heat) load is required. This is estimated for the case that the cold store room is full. With respect to the estimation of the refrigeration load in cold storage in temperatures above 0 °C, it is distinguished between chilling and storage cooling. The main aim of chilling is to reduce the temperature of the product from the ambient temperature to the storage temperature, as soon as possible. The refrigeration load in storage is needed for maintaining the temperature of the product constant during storage. Usually, chilling takes place in the cold storage rooms, when batches of products enter the room. In this case, the maximum refrigeration load is estimated for the refrigeration required for chilling the last batch of product, plus the refrigeration required for maintaining the temperature of the rest of the filled-up room constant. Examples of calculating the refrigeration load for storage are given by Pohlmann et al. (1978), Fellows (1990), Henze (1972), and van Beek and Meffert (1981).

The refrigeration load of a cold storage room ( $Q$ ) includes calculations for the removal of the following heat loads:

(1) sensible heat of the product and its packaging ( $Q_s$ ); (2) latent heat/water crystallization ( $Q_L$ ) (storage of frozen products); (3) heat of respiration  $Q_R$  (when fruits and vegetables are stored); (4) heat produced by the air blowers ( $Q_V$ ); (5) heat due to renewal of air ( $Q_A$ ); (6) heat due to leakage through walls, ceiling, and floor

( $Q_B$ ); and (7) heat produced by personnel, light, and forklifts entering the cold storage room ( $Q_P$ ).

The total refrigeration load for chilling ( $Q_{Ch}$ ) or freezing ( $Q_F$ ) is estimated on the basis of 1 h. The refrigeration load for storage ( $Q_{St}$ ) is estimated for 24 h. For the final refrigeration load that must be supplied by the compressors ( $Q_o$ ), the actual time of operation ( $t$ ) must be also taken into consideration. The total load for each case is as follows:

1. Chilling:

$$Q_{Ch} = Q_s + Q_R + Q_V + Q_B \quad (9.13)$$

$$Q_{OCh} = Q_V/t_{Ch} \quad (9.14)$$

2. Freezing:

$$Q_F = Q_s + Q_L + Q_V + Q_B \quad (9.15)$$

$$Q_{OF} = Q_F/t_F \quad (9.16)$$

3. Storage:

$$Q_{St} = Q_L + Q_V + Q_A + Q_B + Q_P \quad (9.17)$$

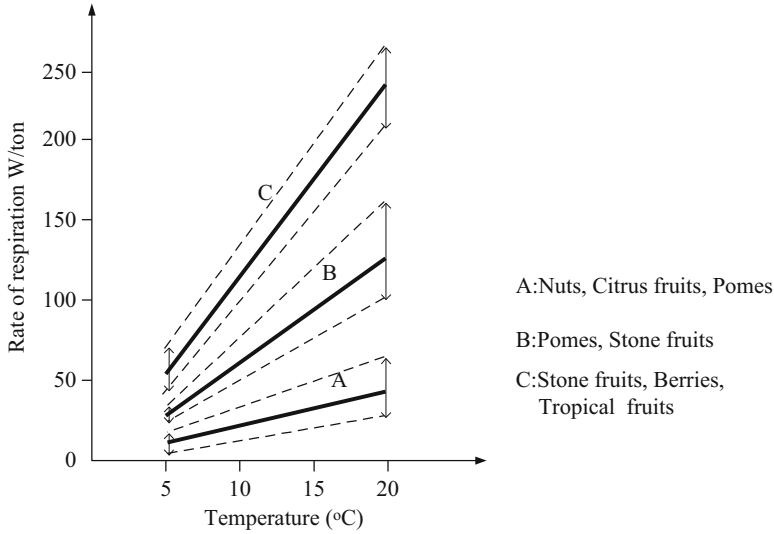
$$Q_{Ost} = Q_{St}/t_{St} \quad (9.18)$$

The storage requirements of perishable food products and commodities are listed in tables published by the International Institute of Refrigeration (1967), the Institute of Food Science and Technology (1982), the ASHRAE (1989), Henze (1972), Dossat (1978), and Rao (1992). The tables contain data for several foods, recommendations about storage temperature, relative humidity, rate of respiration, expected storage life, etc. The tables of ASHRAE/Rao and Dossat use English units (BTU, lbs, etc.).

For estimating the heat transfer from a fluid medium to the products and the further transfer of refrigeration to its thermal center, the heat transfer coefficients and the physical properties of the products, thermal conductivity, thermal diffusivity, and specific heat, are necessary. Such properties can be found in Lewis (1990), Rao (1992), Saravacos and Maroulis (2001), Rha (1975), Rao and Rizvi (1995), and Kostaropoulos (1971). Some useful properties for design of food processing equipment are given in the Appendix B of this book.

The estimation of the sensible heat (reduction from the ambient temperature to the storage temperature,  $Q_s$ ) has been described previously, in Chilling (Sect. 9.3). The latent heat  $Q_L$  (heat for freezing the water in the product or the water lost by the product during storage) can be calculated as mentioned in Sect. 9.4. The refrigeration load due to the respiration of fruits and vegetables  $Q_R$  can be estimated by multiplying the quantity of products  $m(t)$  stored by the rate of respiration  $H_R$  (W/ton).





**Fig. 9.32** Rate of respiration of fruits, in relation to their temperature

The respiration rate of fruits and vegetables is product specific and increases with the temperature. Fruits and vegetables are classified, according to their rate of respiration, into four categories (Fennema 1975): (a) rapid,  $H_R > 150$  W/ton (e.g., asparagus, green peas, green beans); (b) moderately rapid,  $H_R = 72\text{--}150$  W/ton (e.g., Brussels sprouts, spinach, strawberries); (c) moderately slow,  $30\text{--}80$  W/ton (e.g., apples, carrots, celery); and (d) slow,  $<30$  W/ton (e.g., cabbage, grapes, lemons, oranges). Fruits could be classified as follows: (a) tropical fruits, berries, and some stone fruits, (b) pomes and some stone fruits; and (c) nuts, citrus fruits, and some pomes. Figure 9.32 gives the rate of respiration in relation of the temperature for products of these three categories. The respiration rates for a large number of fruits and vegetables are given by Hansen (1967a, b).

The motors of air blowers produce heat, which depends on the power (kW), the number, the position (e.g., inside the rooms or in channels), and the length of operation of the blowers. For estimating the heat for cooling the new air coming in the cold store, the quantity of the new air and the difference between the air enthalpy before and after entering the cold store are needed (9.19). The enthalpies can be obtained from the psychrometric chart (enthalpy–humidity), discussed in Chap. 8:

$$Q_R = n\rho V_A(H_{Aa} - H_{Ac}) \quad (9.19)$$

where  $n$  is the number of air changes per 24 h;  $\rho$ , density of air ( $1.29 \text{ kg/m}^3$ );  $V_A$ , volume of each air inflow ( $\text{m}^3$ ); and  $H_{Aa}$ ,  $H_{Ac}$ , enthalpies of ambient and cold storage air (J/kg).

The estimation of the heat leakage is based on (9.20). The estimation is made for every wall, for the ceiling, and for the floor of each cold storage room. In the case that no values for the heat transfer coefficient ( $U$ ) exist, either rough values (e.g.,  $U = 0.2\text{--}0.9 \text{ W/m}^2 \text{ K}$ ) are taken as recommended by Pohlmann et al. (1978) or they are calculated analytically, as already discussed in Chap. 6. The analytical calculation  $U$  takes into consideration the internal surface heat transfer coefficient  $h_i$  ( $\text{W/m}^2 \text{ K}$ ), the external heat transfer coefficient  $h_e$  (outside the cold store room), and the thermal conductivities of the materials composing the walls, the ceiling, and the floor of the cold storage room. For the external surfaces of the cold storage rooms (if no wind blows), the approximate (natural convection) value  $h_e = 8 \text{ W/m}^2 \text{ K}$  may be used. The surface heat exchange coefficient for the inside surface is higher:

$$Q_B = \sum (UA\Delta T) \tag{9.20}$$

where  $U$  is the overall heat transfer coefficient for the walls, ceiling, and floor, respectively ( $\text{W/m}^2 \text{ K}$ );  $A$ , area of walls, ceiling, and floor, respectively ( $\text{m}^2$ ); and  $\Delta T$ , difference between the temperature on the external side of the walls, the ceiling, and the floor and the temperature of the cold storage room.

For estimating the heat produced by personnel, light, and opening of the doors during cold storage, an extra value  $Q_o = (0.06\text{--}0.12) \times Q_{oSt}$  is usually added.

### 9.7.2 Reduction of Weight Loss

As indicated in Fig. 9.33, the weight loss of food ( $\Delta W/W$ ) depends on the relative humidity (RH), the storage temperature ( $T$ ), and the velocity of the circulated air ( $u_a$ ), in the cold storage room. The weight loss is reduced, if in a storage room, at constant temperature, the relative humidity increases and the storage time decreases. Furthermore, at constant RH and temperature, the weight loss of stored non-packaged food increases, when the velocity of the circulated air is increased.

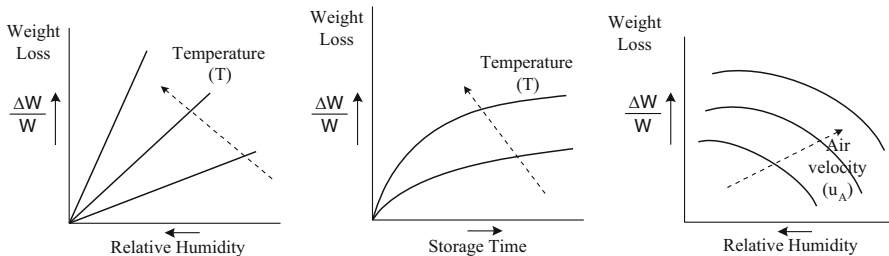
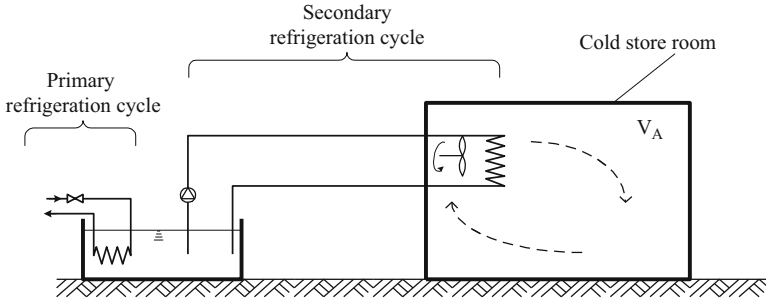


Fig. 9.33 Factors influencing the weight loss of food



**Fig. 9.34** Double refrigeration cycle

The measures that can be taken to reduce the weight loss of non-packaged, cold-stored food are:

1. Reducing the temperature difference between inblowing and outblowing air of an evaporator
2. Reducing the air velocity of the air blower
3. Use of humidifiers
4. Use of CA storage.

### 9.7.2.1 Temperature Adjustment

The temperature difference ( $\Delta T$ ) between in- and outblowing air of an evaporator can be reduced from about 7 to 5 °C, if oversize evaporator surfaces are used. A further reduction is possible, if indirect refrigeration is applied. This is, e.g., the case when cooled ethylene glycol solution is pumped in the evaporator of the air blaster, because the pump can regulate the inflow of refrigerant more accurately than several types of valves (Fig. 9.34).

Low air velocity reduces the weight loss of food. However, there are limits in the reduction of the air velocity, since air must reach the entire product stacked in the cold store room. In a cold storeroom, air blown by the air coolers circulates passing through the stacked product. The air coolers are placed in the room, as described in the section of air-cooling evaporators, preferably high above the door, at a distance from the ceiling and wall, allowing unhindered air in- and outflow. A uniform air distribution in the cold store is very important. Therefore, the stacked product should be placed in such a way that no possibility of “easy air escape” between the stacks exists. The air velocity near the product is usually about 0.1 m/s. In the storage of frozen products, the velocity is 0.5–2.5 m/s. The air circulation is 10–15 times per hour in cold storage and 25–30 times per hour in freeze storage. In the case of chilling, the circulation of air can be more than 70 times per hour (Pohlmann et al. 1978). The height of the stack is related to the volume of the room. The rooms of multi-floor cold stores, controlled atmosphere cold stores, and meat cold stores with racks are not high. The ground cold storage rooms for fruits and vegetables are

preferably high, since they offer maximization of volume in relation to the external surface of the cold store. The height of a storeroom of a capacity of 300–350 tons may be 6–7 m. Cold storerooms for frozen products can be even higher. In multi-floor buildings, the rooms are usually 3–5 m high.

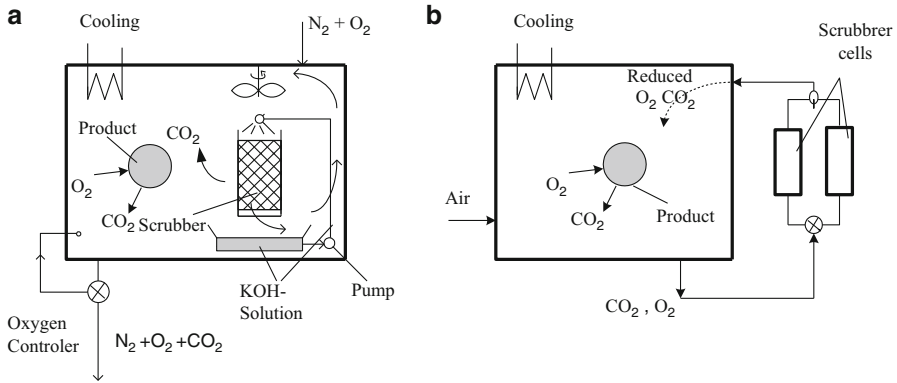
### 9.7.2.2 Humidification

Humidifiers are mainly used in relatively small cold storage rooms. In order to reduce the danger of mold growth, the water droplets, dispersed in the air of the cold storage room, must be as small as possible. This way the water condensation on the surface of the products is almost avoided. To achieve this kind of distribution, nebulizers are used. They consist, e.g., of piezoelectric crystals or other devices, vibrating in the water or on its surface, at an extremely high frequency. Such a device may nebulize (disperse droplets from liquid water) 1–4 kg water/h and consume about 0.5 kW. Their dimensions are about  $0.5 \times 0.5 \times 1.0$  m.

### 9.7.2.3 Controlled Atmosphere

The controlled atmosphere (CA) storage can be applied to a wide range of foods (fruits and vegetables, ready meals, fresh meat, fish, and baked products). It reduces the weight losses during storage, as it makes possible the increase of the relative humidity in the cold storage room, up to 95 %. Significant research work has been done in determining the best CA conditions for storage of food. Henze (1972) and Gorini et al. (1990) describe the use of CA in fruits and vegetables, Finne (1982) discussed the use of CA in muscle foods, Wolf et al. (1975) describe the use in ready meals, and Knorr and Tolins (1985) discuss the effect of carbon dioxide-modified atmosphere in the compressibility of stored baked foods. In CA storage, the products are enclosed in air-tight rooms. Oxygen and carbon dioxide are reduced to 4–5 %. When starting CA storage of, e.g., fruits (apples), the initial oxygen (21 %) is reduced by catalytic combustion, after mixing it with propane or methane, to about 5 %. Such equipment, e.g., for reducing oxygen of 70 m<sup>3</sup>/h inflowing air consumes 5 kg/h propane and 2 kW electrical energy. Their overall dimensions are  $1.5 \times 1.0 \times 1.5$  m, and their weight is about 0.5 ton. Finally, the oxygen in the cold storage atmosphere is stabilized at 3 %, since the products consume also an amount of oxygen during respiration. Further reduction of oxygen is possible (e.g., in ultralow oxygen “ULO” storage), but in any case, oxygen should not be less than 1 %, because anaerobic conditions would prevail, with the consequence of formation of ethyl alcohol and undesirable physiological changes (Gorini et al. 1990).

During storage, it is important to maintain the oxygen and carbon dioxide concentrations constant, since in several products, increase of carbon dioxide and/or decrease of oxygen, above or below certain limits, can damage the products (Fennema 1975; Fellows 1990). There are many combinations of oxygen–carbon



**Fig. 9.35** Scrubbers for controlled atmosphere storage

dioxide. Henze (1972), e.g., gives only, for apple and pear varieties, 16 and 20 such combinations, respectively. The carbon dioxide content in the storage atmosphere depends on the temperature in the room and the product stored. In vegetables, it can vary according to Gorini et al. (1990) between 0 % (e.g., cucumber, 12 °C) and 14 % (asparagus, 1 to 4 °C).

The carbon dioxide is maintained constant through scrubbers. These are devices located inside or outside of the CA cold storage rooms, removing excess carbon dioxide. There are two methods for removing excess carbon dioxide, the chemical and the physical method (Meffert 1983). In the chemical method (Fig. 9.35a), substances such as dry lime, suspensions of lime in water, lye solutions, etc., can be used for absorbing carbon dioxide. In the physical method (Fig. 9.35b), carbon dioxide is absorbed in water or adsorbed in activated carbon. The activated carbon is one of the most often used substances in scrubbers. The construction of activated carbon scrubbers is simple. The unit consists of two cells, and each cell must be regenerated every 20 min with fresh air at ambient temperature. The adsorption capacity of a relatively large, e.g., for two-cell activated carbon units, is 50–450 kg  $CO_2/24$  h. The advantages of such equipment are simple construction, low water absorption, and low electrical consumption. The overall dimensions of such equipment are  $1.5 \times 2.0 \times 2.0$  m, the weight is about 1.5 tons, and the required power is 4–5 kW. The disadvantages of such units are the capacity reduction at carbon dioxide concentrations below 2 % and the possibility of aroma absorption, when it is used in the storage of certain fruits. However, in several cases this capability is advantageous, since intensive aroma is developed, when the products are ripe, and significant ethylene is also produced, which are undesirable.

Activated carbon reduces also ethylene in the storeroom, retarding ripening. In the case that the products produce significant amounts of ethylene, as in the case of kiwi fruit, special scrubbers (ethylene converters) can be used, which consist of special catalyst bed fillings. Such units can keep the ethylene concentration in cold storerooms of fruits and vegetables below 0.1 ppm. They may circulate up to

500 m<sup>3</sup>/h and require 7-kg ethylene-reducing substance of 10 tons per month and about 6 kW power (60 % for pumping the gas through the converter).

## 9.8 Ice Manufacturing

Ice was for a long time the most important source of cooling or cold storage. Until a few years ago, it was very important in cooling of railway wagons, for the transport of fresh products, as peaches or grapes. Nowadays, with respect to food, it is still used in two direct cooling applications, (a) chilling of processed food, such as minced meat in the cutter, or chilling poultry after slaughtering and (b) cooling of fresh food, such as fish at sea and ashore, or vegetables.

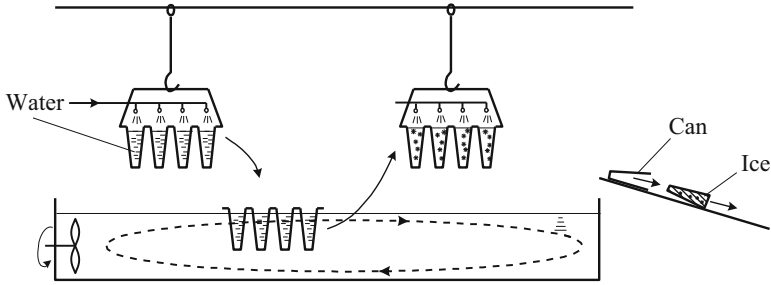
Ice is very important especially in the cooling of fish, since this kind of cooling has following advantages:

1. It is harmless in direct contact with food.
2. As it comes directly in contact with fish, it reduces its temperature rapidly.
3. The cooling temperature is just above the freezing point of fish.
4. It keeps fish moist (other methods dry it) and glossy.
5. Ice washes away slime, reducing bacterial growth.
6. It is a natural thermostat.

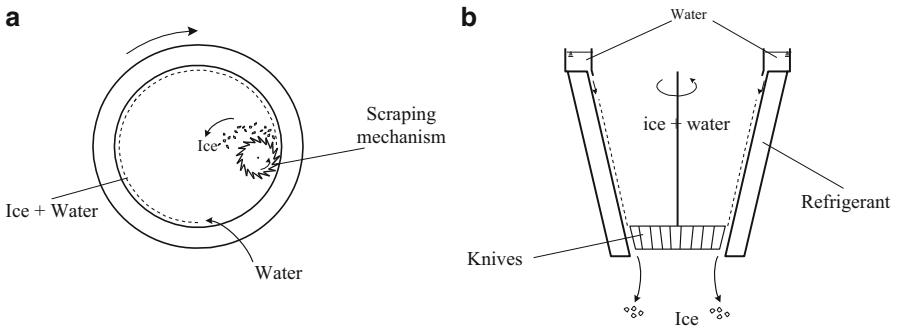
The largest ice-producing installations are harbors of fishing ships. Such installations consist of ice manufacturing and ice storage units and installations for automatic loading of ice to ships or transport vehicles. The ice-producing capacity of large units exceeds 150 tons/day, and the capacity of large ice storage units may exceed 300 tons.

Three types of ice can be manufactured: the “dull ice,” the “clear ice,” and the distilled water ice. In the first type, tap water is used and the natural salts of water are evenly distributed in the ice. In the second type, air is blown in the water during the ice production, and the natural salts are concentrated in the core if the ice formed. In the third category, distilled water is used, and this way the ice is free of any contamination or salts. The equipment of ice manufacturing can be classified in block and small ice equipment. In the past, the block ice was more important, while now the small ice manufacturing prevails, as this type is more flexible and requires less space and the whole process, from production to consumption, can be automated.

In the ice-block production (Fig. 9.36), water is filled in identical cans. The cans have a square cross section, and they are larger in the upper than in the lower part. The cans are either dipped in a cold brine bath (e.g., calcium chloride) or they have double walls in which refrigerant circulates (jacketed cans). In the first case, the cans stay in the brine bath until the contained water is frozen. There are different sizes of cans. A 25-kg ice block is, e.g., produced by a can whose upper side is about 0.2 m, its lower about 0.16 m, and its height about 1.0–1.1 m. The cans are grouped in 5–6 pieces, and all cans of a group are filled with water. If the temperature of the



**Fig. 9.36** Ice-block manufacturing



**Fig. 9.37** Flake-ice manufacturing

filling water is not low (e.g., below 10–15 °C), the water is chilled. When ice blocks are created, the cans are taken out of the brine by a hoist/crane system; they are dipped in water of ambient temperature, until the ice contacting the can surface is molten; and finally they are dumped and emptied automatically. Agitators circulate the brine, for increasing the heat transfer. The capacity of a unit of 90 cans is 3 tons of ice block per 24 h. A 25-kg ice block is frozen in about 18 h. The main dimensions of a bath of about 7-m<sup>3</sup> brine are 4.5 × 2 × 1.5 m. An ice-block unit requires 460–670 kJ/kg refrigeration, including heat losses. In some cases, air is blown in the lower part of jacketed cans.

Small ice is produced as “snow” flakes and in different simple geometrical forms (e.g., cylinders, cubes, etc.). Besides direct production methods, small ice can be also produced by grinding ice blocks. Flakes are manufactured by scraping off iced surfaces. Ice is formed on the internal or external frozen surface of jacketed cylinders, as water trickles down. Knives or other similar devices scrape the ice formed on the jacketed surface (Fig. 9.37). Such equipment can produce about 25 tons of ice in 24 h. When “snow,” or ice with relative much nonfrozen water, is produced, ice pellets can be formed by pressing. In creating small ice pieces of simple geometrical formation, cylinder ice and tube ice are two common structures. They are produced by freezing water in tubes.

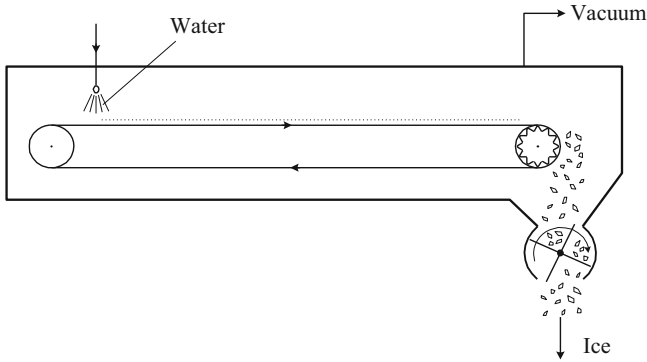


Fig. 9.38 Vacuum belt ice-producing equipment

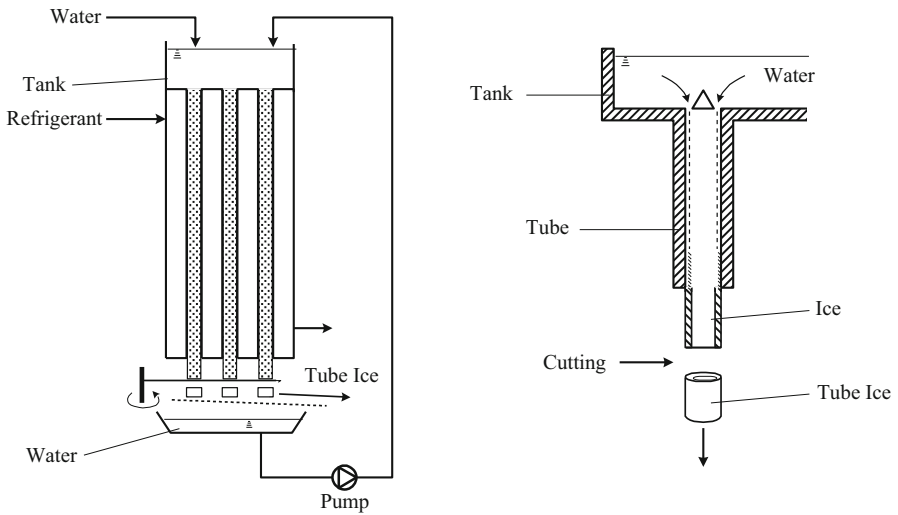
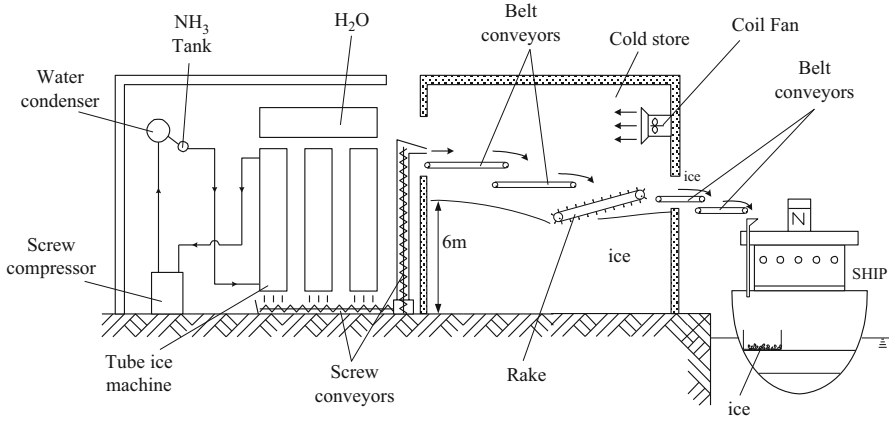


Fig. 9.39 Tube-ice manufacturing

In a variation of the above described flake-ice unit, the flakes are formed on a metallic belt (Fig. 9.38). The belt is in a vacuum chamber (pressure 6.1 mbar or 4.58 mmHg), in which the temperature is  $-3\text{ }^{\circ}\text{C}$ . Water is spread on one end of the belt, and at the other end, the ice layer formed on the surface of the belt breaks in flakes, as the belt turns around.

Tube ice is manufactured as water, flowing inside tubes, is frozen (Fig. 9.39). The tube ice machine consists of a vertical tube and shell heat exchanger and a water tank on the upper part. A special water distributor on the top of each tube controls the water flow so that a steady film is formed on the inner surface of the tubes. The water freezes quickly due to the refrigerant that contacts the tubes externally. The excess of water is collected below the tubes and is sent back to





**Fig. 9.40** Ice manufacturing, storage, and loading installation

the water tank. A rotating device cuts ice in the form of tubes, as it glides down and exits the low end of the tube. Harvesting is done during the nonfreezing cycles of the equipment. The size of the ice tubes depends on the diameter of the heat exchanger tubes and the cutting. Production can start properly after 10–15 min. The capacity depends on the initial temperature of water, the evaporating temperature, and the length of the freezing cycle. A unit of 25 m<sup>2</sup> can produce 18 tons s/h. The floor space of such equipment is only 15 % of the space required by equivalent ice-block installations. The power consumption requirements of a medium or large ice production plant are about 37 kWh/ton.

Small ice is stored bulk, up to 6 m high (Fig. 9.40). Air coolers provide auxiliary refrigeration compensating heat leakage from the environment of the cold store room. Loading is done automatically, by using screw conveyors or belts, operating high above the bulk stored ice and providing a uniform, loose filling of the cold store room. Emptying is done also automatically. Scoop or rake systems move the ice toward screw conveyers. Ice is then transported, by a system of screw elevators and belts, to the final destination (e.g., a ship).

*Example 9.1* In a cold storage room, 312 tons of apples must be precooled and stored for 5 months. The well-insulated storage room is rectangular and its dimensions are 20 × 16.5 × 6.0 m. The external wall of the narrow side (16.5 m) is located northward, and the opposite wall adjoins a corridor. One of the long side walls is external and is located westward. The opposite wall adjoins a cold storage room for frozen products. The ceiling is flat. The temperatures in the apple cold storage room and its surroundings are:

Cold storage room, 2 °C

Corridor, 10 °C

Ambient (maximal external temperature during the storage period), 35 °C

Old storage room for frozen products, −18 °C

Ground temperature, 15 °C

The apples are delivered at 25 °C at the rate 6 tons/h, for 8 h/day, and are precooled in 20 h. They are packed and stored in wooden boxes (60 × 40 × 32 cm; tare, 2 kg), containing 20-kg fruits each, which are stacked on wooden Euro pallets (120 × 100 × 10 cm; tare, 5 kg).

The specific heat of apples and wood are 3.77 kJ/kg K and 1.89 kJ/kg K, respectively. The overall heat transfer coefficients ( $U$ ) of the insulated walls, floor, and ceiling are assumed as follows:

External walls (north and west),  $U_N = U_W = 0.16 \text{ W/m}^2 \text{ K}$ ; wall between apple storage and frozen products,  $U_E = 0.17 \text{ W/m}^2 \text{ K}$ ; wall between apple storage and corridor,  $U_C = 0.24 \text{ W/m}^2 \text{ K}$ ; ceiling,  $U_D = 0.12 \text{ W/m}^2 \text{ K}$ ; and floor,  $U_B = 0.22 \text{ W/m}^2 \text{ K}$ .

Estimate (a) the refrigeration load required for precooling and cooling the apples and (b) the power of an ammonia reciprocating compressor for supplying this load, if the refrigerant condensation temperature is 25 °C and the subcooling is 15 °C.

**Assumptions**

It is assumed that 120 tons of apples will be precooled and 192 tons will be cold stored. The delivery of apples lasts 6.5 days, and precooling is completed after 3 days (72 h). The maximal refrigeration load required is when the last delivery of 6 tons of apples is precooled, and the precooling of the previous 19 deliveries (19 × 6 = 114 tons) has to be accomplished.

Precooling (120 tons, 20-h Basis)

1. Sensible heat of apples

$$\begin{aligned} Q_s &= mc_a(T_{ia} - T_{fa}) = 120,000 \times 3.77 \times (25 - 2) \\ &= 10,405 \text{ MJ} \end{aligned}$$

2. Sensible heat of wooden boxes and pallets

The cold storage room has a capacity of 15 × 14 = 210 pallet stacks, each stack consisting of three pallets. Each pallet contains 5 × 5 = 25 boxes, containing 45 × 20 = 500 kg of apples.

The height of a loaded pallet is (5 × 32) + 10 = 170 cm. The height of a stack is 3 × 170 = 510 cm and its weight 1500 kg. There is a 90-cm free space above the stacks, for air circulation. For precooling of the 120-ton apples, the number of boxes will be 120,000/20 = 6000 and the number of pallets 6000/25 = 240.

The sensible heat of boxes will be  $Q_{\text{box}} = 6000 \times 2 \times 1.89 \times (25 - 2) = 521.6 \text{ MJ}$ .

The sensible heat of pallets will be  $Q_{\text{pal}} = 240 \times 5 \times 1.89 \times (25 - 2) = 52.2 \text{ MJ}$  (about 10 % of the boxes).

The sensible heat of both boxes and pallets will be  $Q_{\text{box}} + Q_{\text{pal}} = 573.8 \text{ MJ}$ .

3. Heat of respiration of apples

Assume heat of respiration of apples at 2 °C,  $r = 14.6 \text{ W/ton}$ ,  $Q_r = 120 \times 14.6 \times 20 \times 3600 = 126.1 \text{ MJ}$ .

## 4. Heat due to the ventilation fans

Assume six fans of 0.6 kW each,  $Q_v = 6 \times 0.6 \times 20 = 72 \text{ kWh} = 260 \text{ MJ}$ .

Total cooling requirement,  $Q_T = 10,405 + 573.8 + 126.1 + 260 = 11,364.9 \text{ MJ}/20 \text{ h} = 157.8 \text{ kW}$ .

5. Heat loss due to thermal leakage,  $Q = UA\Delta T$ 

Heat transfer areas: north and south walls,  $A_N = A_S = 94 \text{ m}^2$ , west and east walls.

$A_W = A_E = 114 \text{ m}^2$ . Area of ceiling and floor,  $A_D = A_B = 330 \text{ m}^2$ . Heat losses:

$Q_N = 0.16 \times 94 \times (35 - 2) = 0.5 \text{ kW}$ ;  $Q_W = 0.16 \times 114 \times (35 - 2) = 0.602 \text{ kW}$

+ 5 % solar radiation = 0.632 kW;  $Q_E = 0.17 \times 114 \times (2 - (-18)) = 0.36 \text{ kW}$ ;

$Q_C = 0.24 \times 94 \times (10 - 2) = 0.18 \text{ kW}$ ;  $Q_D = 0.12 \times 330 \times (35 - 2) = 1.31 \text{ kW}$

+ 25 % solar radiation = 1.64 kW;  $Q_B = 0.22 \times 330 \times (15 - 2) = 0.94 \text{ kW}$ .

Total heat leakage  $Q_L = Q_N + Q_W + Q_C + Q_D + Q_B - Q_E = 0.50 + 0.632 + 0.18 + 1.64 + 0.94 - 0.36$ , or  $Q_L = 3.53 \text{ kW}$  (about 2 % of the total precooling requirement).

Total refrigeration load for precooling the 120 tons of apples,  $Q_{\text{pcl}} = 157.8 + 3.53 = 161.33 \text{ kW}$ .

## Cold Storage (192 tons, 24 h Basis)

1. Heat absorption due to weight loss: it is assumed that the total water loss during the entire storage period (5 months) is 10 % of the weight of the apples (31.2 tons), corresponding to a water loss of 208 kg/24 h. Since the heat of evaporation of water at 2 °C is 2.5 MJ/kg, the heat absorption will be  $Q_{\Delta W} = -208 \times 2500 = -520,000 \text{ kJ} = -144 \text{ kWh}$ .

2. Respiration rate:  $Q_r = 192 \times 14.6 \times 24/1000 = 67.3 \text{ kWh}$ .

3. Thermal leakage:  $Q_L = 3.53 \times 24 = 84.7 \text{ kWh}$ .

4. Heat loss due to the fans:  $Q_v = 6 \times 0.6 \times 24 = 86.4 \text{ kWh}$ .

5. Air renewal: volume of the cold storage room  $V = 1881 \text{ m}^3$ . From the psychrometric chart of the temperature range 0–50 °C (Zogzas 2001), the enthalpy change of water from ambient temperature 25 °C to cold storage temperature 2 °C will be  $\Delta H = 51 - 13 = 38 \text{ kJ/kg}$ , and the air density  $\rho = 1.22 \text{ kg/m}^3$ . Assuming three renewals of room volume per 24 h, the heat load will be  $Q_A = 3 \times 1881 \times 1.22 \times 38 = 261.6 \text{ kWh}$  (for 24 h).

Total cold storage requirements for the 192 tons of apples,  $Q_T = 67.3 + 84.7 + 86.4 + 261.6 - 144 = 356 \text{ kWh}$ . If the compressor, supplying this cooling load, is operated 14 h per 24 h, its capacity will be  $356/14 = 25.4 \text{ kW}$ .

The refrigeration load for precooling and cold storage will be  $161.3 + 25.4 = 186.7 \text{ kW}$ . Assuming an addition of 5 % refrigeration for meeting extra requirements, such as personnel entering the cold storage room, electric lights, and fluctuations of the temperature in the adjoining rooms, the total refrigeration load will be  $186.7 + 9.3 = 196 \text{ kW}$ .

### Compressor

Assume that a reciprocating ammonia compressor will be used, operating at the standard conditions of evaporator  $T_e = -15^\circ\text{C}$ ,  $p_e = 2.3$  bar and condenser  $T_c = -15^\circ\text{C}$ ,  $p_c = 8.3$  bar. The heats of evaporation of ammonia at the evaporator and condenser temperatures are 1310 and 1170 kJ/kg, respectively, with the corresponding densities  $\rho_e = 2$  kg/m<sup>3</sup> and  $\rho_c = 8$  kg/m<sup>3</sup> (Perry and Green 1997).

The amount of ammonia required for the refrigeration load 196 kW will be  $196/1310 = 0.15$  kg/s or  $0.15 \times 3600 = 540$  kg/h, corresponding to  $540/2 = 270$  m<sup>3</sup>/h.

The mechanical power of the compressor  $P$  is given by the equation  $P = \text{refrigeration load}/\text{COP}$ , where COP is the coefficient of performance, i.e., the ratio of the refrigeration produced to the work supplied. The theoretical COP, i.e., the efficiency of the reversed Carnot cycle, is given by the equation  $\text{COP} = T_c/(T_c - T_e)$ . In this example,  $\text{COP} = 258/(298 - 258) = 6.45$ , and therefore,  $P = 196/6.45 = 30.4$  kW. If the mechanical efficiency of the compressor is 75 %, the required power of the compressor will be  $P = 30.4/0.75 = 40.5$  kW.

### Notes

1. The COP of the compressor increases significantly, if the temperature difference between the condenser and the evaporator is reduced. Thus, for a refrigeration system operated at  $T_c = 25^\circ\text{C}$  and  $T_e = -5^\circ\text{C}$ , we have  $\text{COP} = 268/(298 - 268) = 8.93$ , and  $P = 196/8.93 = 21.9$  kW. The mechanical power of the compressor of this example will be  $21.7/0.75 = 29.2$  kW.
2. The actual coefficient of performance COP can be calculated as the ratio  $\text{COP} = \Delta H_{\text{ref}}/W_{\text{comp}}$ , where  $\Delta H_{\text{ref}}$  is the refrigeration load (heat removed) and  $W_{\text{comp}}$  is the mechanical power supplied by the compressor. Both these quantities can be obtained from the pressure–enthalpy diagram of the refrigerant (ammonia) (Perry and Green 1997). The actual COP is usually similar to the theoretical COP, calculated from the equation  $\text{COP} = T_c/(T_c - T_e)$ .
3. Most of the refrigeration load (90 %) is needed for precooling the apples, and only about 10 % is used for maintaining the cold storage temperature.
4. The water evaporated from the apples during storage (208 kg/24 h) is assumed to be removed from the storage room with the renewal air. Cooling and heating balances of frosting and defrosting of the cooling coils in the cold storage room are not considered in this example.

### References

- ASHRAE (1989) ASHRAE handbook—fundamentals—refrigeration. American Society of Heating, Refrigeration and Air-Conditioning Engineers, Atlanta
- Brown WE (1992) Plastics in food packaging. Marcel Dekker, New York
- Brennan JC, Butters JR, Cowell NP, Lilly AEV (1990) Food engineering operations, 3rd edn. Applied Science Publ, London

- Buchner N (1995) Aseptic processing and packaging of food particulates. In: Willhoft EMA (ed) Aseptic processing and packaging of particulate foods. Blackie Academic and Professional, London
- Cleland AC (1990) Food refrigeration processes—analysis, design and simulation. Elsevier, London
- Cleland AC, Valentas KJ (1997) Prediction of freezing time and design of food freeze. In: Valentas KJ, Rotstein E, Singh RP (eds) Handbook of food engineering practice. CRC Press, New York, pp 71–123
- de Fremery D, Klose AA, Sayre RN (1977) Freezing poultry. In: Desrosier NW, Tressler DK (eds) Fundamentals of food freezing. AVI, Westport
- Deitrich WC et al (1977) Freezing vegetables. In: Desrosier NW, Tressler DK (eds) Fundamentals of food freezing. AVI, Westport, pp 87–91
- Dinglinger G (1977) Gefrieren von Lebensmitteln mit kryogenen Fluessigkeiten. Zeitschrift Für Lebensmittel-Technologie und-Verfahrenstechnik 4:130
- DKV Arbeitsblaette der Deutscher Kaeltetechnischer Verein (“Working sheets” of the German Association of Refrigeration). Presented in Kaeltetechnik 11/1950; 6/1954; 3/1956; 2/1957; 11/1957; 12/1957; 2/1958; 2/1959; 4/1960; 12/1960; 9/1968. C.F. Mueller Verlag, Karlsruhe
- Dossat RJ (1978) Principles of refrigeration. Wiley, New York
- Fellows PJ (1990) Food processing technology. Ellis Horwood, Chichester
- Fennema OR (1975) Chilling storage of food. In: Karel M, Fennema OR, Lund DB (eds) Physical principles of food preservation. Marcel Dekker, New York
- Finne G (1982) Modified- and controlled atmosphere storage of muscle foods. Food Technol 36 (128):133
- Gorini FL, Zerbini EP, Testoni A (1990) The controlled atmosphere storage of fruit and vegetables. In: Gormley TR (ed) Chilled foods. The state of the art. Elsevier Applied Science, London, p 201
- Gutschmidt J (1973) Lebensmittel. In: Ulmanns encyclopaedie der technischen chemie. Verlag Chemie, Weinheim
- Hallstrom B, Skjoeldebrand C, Tragardh C (1988) Heat transfer and food products. Elsevier Applied Science, London
- Hansen H (1967a) Spezifisch Waerme und Atmungswaerme von Obst DKV Arbeitsblatt 8-21. Kaeltetechnik 19, Heft 2
- Hansen H (1967b) Spezifisch Waerme und Atmungswaerme von Gemuese DKV Arbeitsblatt 8-22, Kaeltetechnik 19, Heft 3
- Heiss R, Eichner K (1995) Haltbarmachen von Lebensmitteln, 3rd edn. Springer, Berlin
- Heldmann D (1992) Food freezing. In: Heldmann DR, Lund DB (eds) Handbook of food engineering. Marcel Dekker, New York
- Henze J (ed) (1972) Bau und Einrichtung von Lagerräumen fuer Obst und Gemuese. KTBL=Schriften- Vertrieb in Landwirtschaftsverlag GmbH, Hiltrup
- Henrici H, Haaf S (1973) Kaeltetechnik. In: Ulmann encyclopaedie der technischen chemi, vol 3. 4th ed. Verfahrenstechnik II and Reaktionsapparate. Verlag Chemie, Weinheim
- Holland JM (1963) High frequency baking.. Paper presented at the annual meeting of the Biscuit and Cracker Institute, UK
- Huetten IIB (1960) Des Ingenieurs Taschenbuch, 28th edn. Verlag Von Wilhelm Ernst & Sohn, Berlin
- IIR (1967) Recommended conditions for cold storage of perishable produce. IIF, Paris
- IIR (1972) Recommendations for processing and handling of frozen foods. Annexe au Bulletin de l’Institut International du Froid (IIF), 177, boulevard Malesherbes, 75 Paris-17e
- James SJ, Bailey C (1990a) Chilling systems for foods. In: Gormley TR (ed) Chilled foods. The state of the art. Elsevier Applied Science, London
- James SJ, Bailey C (1990b) Chilling of beef carcasses. In: Gormley TR (ed) Chilled foods. The state of the art. Elsevier Applied Science, London

- Jowitt R, Escher F, Hallstrom B, Meffert HFT, Spiess WEL, Vos G (eds) (1983) Physical properties of foods. Applied Science Publishers, London
- Kostaropoulos AE (1971) Waermeleitzahlen von Lebensmitteln und Methoden zu deren Bestimmung. Fachgemeinschaft Lufttechnische und Trocknungs-Anlagen VDMA, Frankfurt/M
- Knorr D, Tomlins R. Effect of CO<sub>2</sub> modified atmosphere on stored backed goods. *J. Food Sci* 50:1172
- Lewis MJ (1990) Physical properties of foods and food processing systems. Ellis Horwood, London
- Linge K (1950) Liefergrad and indizierter Wirkungsgrad von Amoniak-Verdichtern. *Kaeltetechnik* (2). C.F.Mueller Verlag, Karlsruhe
- Mardsen JL, Henrickson RL (1996) Meat and meat products. In: Mallett CP (ed) *Frozen food technology*. Blackie Academic and Professional, London
- Meffert HFT (1983) History, aims, results and future of thermophysical properties work within COST 90. In: Jowitt R, Escher F, Hallstrom B, Meffert H, Spiess W, Voss G (eds) *Physical properties of foods*. Applied Sciences, London, pp 229–268
- Moersel H (ed) (1967) *Taschenbuch Kaelteanlagen*. VEB Verlag Technik, Berlin
- Mulder RWAW, Veerkamp CH (1990) Evaporative air-chilling of poultry. In: Zeuthen P et al (eds) *Processing and quality of foods*. Elsevier Applied Science, London
- Pearson SF (2003) New natural and alternative refrigerant. Polycywebsite/Edinburgh/webpapers/6cpearson.doc. The Star Refrigeration Ltd
- Persson PO, Loedahl G (1996) Freezing technology. In: Mallett CP (ed) *Frozen food technology*. Blackie Academic and Professional, London
- Perry R, Green D (1997) *Perry's chemical engineers' handbook*. McGraw-Hill, New York
- Plank R, Kuprianoff J (1960) *Die Kleinkaeltemaschine*, 2nd edn. Springer, Berlin
- Pohlmann W, Maake W, Eckert HJ (1978) *Taschenbuch fuer Kaeltetechniker*, 16th edn. C.F. Mueller Verlag, Karlsruhe
- Rahman S (1995) *Food properties handbook*. CRC Press, New York
- Rao MA (1992) Transport and storage of food products. In: *Handbook of food engineering*. Marcel Dekker, New York
- Rao MA, Rizvi SSH (1995) *Engineering properties of foods*. Marcel Dekker, New York
- Reid DS (1996) Basic physical phenomena in the freezing and thawing of plant and animal tissues. In: Mallett CP (ed) *Frozen food technology*. Blackie Academic and Professional, London
- Rha C (1975) *Theory, determination and control of physical properties of food materials*. Reidel, New York
- Riedel L (1950a) Mollier-Diagramm fuer Obst- und Gemuesesaefte. *Kaeltetechnik* 2:201
- Riedel L (1950b) Der Kaeltebedarf beim Gefrieren von Obst und Gemuese. *Kaeltetechnik* 2:195
- Riedel L (1955) Kalorimetrische Untersuchungen ueber das Schmelzverhalten von Fetten und Oelen. *Fette, Seifen, Anstrichmittel* 57:771
- Riedel L (1956a) Enthalpie-Konzentrations-Diagramm fuer Eiklar. *Kaeltetechnik* 8:374
- Riedel L (1956b) Kalorimetrische Untersuchungen ueber das Gefrieren von Seefischen. *Kaeltetechnik* 8:374
- Riedel L (1957a) Enthalpie-Konzentrations-Diagramm fuer Rindfleisch. *Kaeltetechnik* 2:38
- Riedel L (1957b) Enthalpie-Konzentrations-Diagramm fuer Eigelb. *Kaeltetechnik* 2:38
- Riedel L (1957c) Enthalpie-Konzentrations-Diagramm fuer Volleimasse. *Kaeltetechnik* 342
- Riedel L (1959a) Kalorimetrische Untersuchungen ueber das Gefrieren von Weissbrot und Mehlprodukten. *Kaeltetechnik* 2:38
- Riedel L (1959b) Kalorimetrische Untersuchungen ueber das Gefrieren von Weissbrot und anderen Mehlprodukten. *Kaeltetechnik* 11:41
- Riedel L (1968) Kalorimetrische Untersuchungen an Backhefe. *Kaeltetechnik* 9:291
- Saravacos GD, Maroulis ZB (2001) *Transport properties of foods*. Marcel Dekker, New York
- Schormueller J (1966) *Die Erhaltung der Lebensmittel*. F. Enke, Stuttgart
- Schubert H, Grueneberg M, Walz E (1991) Erwaermung von Lebensmitteln durch Mikrowellen: Grundlagen, Messtechnik, Besonderheiten. *Z Lebensm Technol Verfahrenstechn* 4:14–21

- Singh RP (1995) Principles of heat transfer. In: Kulp K, Lorenz K, Bruemmer J (eds) Frozen and refrigerated doughs and batter. American Association of Cereal Chemists, St. Paul
- Spiess WEL, Kostaropoulos AE (1977) Zum tiefgefrieren von Lebensmitteln. *Z Lebensm Technol Verfahrenstechn* 4:125–129
- Taylor AA (1987) Optimal chilling and electrical stimulation parameters for hot boning. In: Romita A, Valin C, Taylor AA (eds) Accelerated processing of meat. Elsevier Applied Science, London
- Van Beek G, Meffert HFTh (1981) Cooling of horticultural produce with heat and mass transfer by diffusion. In: Thorne S (ed) Developments in food preservation, vol 1. Elsevier Applied Science, London
- Venetucci JM (1995) Cryogenic and mechanical food-freezing equipment for the baking industry. In: Kulp K, Lorenz K, Bruemmer J (eds) Frozen and refrigerated doughs and batters. American Association of Cereal Chemists, St. Paul
- Wolf W, Spiess WEL, Jung G, Lai JF, Gork FP, Jungnickel W, Bomar MT, Prochazka E (1975) Die CA-Lagerung von vorgefertigten kalten Speisen. Report of the Bundesforschungsanstalt fuer Ernaehrung, Karlsruhe
- Woolrich WR, Novak AF (1977) Refrigeration technology. In: Desrosier NW, Tressler DK (eds) Fundamentals of food freezing. AVI, Westport
- Zogzas N (2001) Computer program for psychrometric charts (personal communication). Department of Chemical Engineering, National Technical University of Athens, Athens

# Chapter 10

## Thermal Processing Equipment

### 10.1 Introduction

Thermal processing is primarily concerned with the application of heat to destroy (inactivate) microorganisms (m.o.) and enzymes, which can cause spoilage of foods and health hazards to the consumers. Thermal processing involves heating of foods at various time–temperature combinations, which define the three main thermal processes, i.e., blanching, pasteurization, and sterilization. The objective of thermal processing is the long-time and safe preservation of sensitive foods, preferably at ambient (room) temperatures. Traditionally, thermal processing has been applied to the canning of foods, packaged in metallic containers, and preserved for long times (longer than 6 months).

Thermal processing includes, in addition to canning, the following food processing operations: (a) blanching (heat inactivation of spoilage enzymes in vegetables prior to further processing), (b) pasteurization (inactivation of pathogenic and spoilage m.o. and enzymes), and (c) aseptic processing (long-term preservation of foods with minimum heat damage).

High-temperature processing may have, in addition to preservation, some other desirable effects on the food product, such as improvement of eating quality (cooking), softening of some hard foods, and destruction of some undesirable components, like the trypsin inhibitor in legumes.

Thermal treatments (heating), aimed mainly at improvement of eating and other qualities of foods, like baking, cooking, and frying, are discussed in Chap. 6 of this book. Low-temperature preservation (refrigeration and freezing) is described in Chap. 9.

The major problem of thermal processing is the significant damage in the nutritional (vitamins, proteins) and organoleptic (sensory) quality (taste, color, and texture) of foods, particularly when exposed to high temperature for a relatively long time. This problem is resolved by using high-temperature short-time processing methods, aseptic packaging, and special food containers.



Thermal processing is accomplished either by in-container sterilization, e.g., traditional canning or by continuous flow processing, e.g., pasteurization or aseptic processing.

Thermal processing is also used in the bulk storage of fluid foods, usually combined with refrigeration. Gentle thermal processing is used recently in the minimal processing/preservation of foods.

The design of thermal processing equipment is based on the heat inactivation of unwanted enzymes and microorganisms and the heat transfer from the heating medium to the food product.

## 10.2 Kinetics of Thermal Inactivation

The kinetics of thermal inactivation deals with the destruction of enzymes and microorganisms (m.o.) involved in the spoilage of foods, taking into consideration the protection of public health. The same kinetic principles are applied in the evaluation of thermal processing on the nutritional and sensory quality of processed foods.

### 10.2.1 Inactivation of Microorganisms and Enzymes

The heat resistance of the m.o. runs from high (spore-forming bacteria) to relatively low (vegetative cells). Some enzymes can be as heat resistant as the spore-forming bacteria, e.g., catalase and lipoxidase (Teixeira 1992; Heldman and Hartel 1997; Ramaswamy and Singh 1997).

The kinetics of thermal inactivation usually follows a first-order chemical reaction, although the mechanism may be more complex. At a given temperature, the rate of inactivation of a population ( $N$ ) of m.o. is given by the equation

$$dN/dt = -kN \quad (10.1)$$

where ( $k$ ) is the reaction constant and ( $t$ ) is the time.

Integration of (10.1) yields

$$\ln(N/N_0) = -kt \quad (10.2)$$

where ( $N_0$  and  $N$ ) are the initial and final numbers of m.o. after time of heating ( $t$ ) at the given temperature. The material is assumed to be heated instantaneously to the processing temperature and to cool rapidly, after remaining constant for the specified time ( $t$ ).

Equation (10.2) is usually applied in the following more practical form:

$$\log(N/N_0) = -(t/D) \quad (10.3)$$

where ( $D = 2.3/k$ ) is the decimal reduction time, expressed usually in minutes.

The ( $D$ ) value is the time (min) required for 90 % reduction (one log cycle) of a population. It is determined as the inverse of the negative slope of a semilog survivor plot of  $\log(N/N_0)$  versus time ( $t$ ).

The inactivation (destruction) of m.o. is determined by measuring the survivors, i.e., the m.o. which can grow in a standard microbiological medium. The ( $D$ ) value characterizes the heat resistance of an m.o. at a given temperature.

Equation (10.3) can be used for the heat inactivation of spoilage enzymes and the determination of the corresponding ( $D$ ) values at a given temperature.

The thermal death time curve is obtained by plotting  $\log(D)$  versus the corresponding temperature ( $T$ ), according to the equation

$$\log(D/D_0) = -(T - T_0)/z \quad (10.4)$$

where the values ( $D, D_0$ ) correspond to the temperatures ( $T, T_0$ ).

The inverse of the negative slope of this line is the ( $z$ ) value, i.e., the temperature rise required to reduce the ( $D$ ) value by one log cycle (90 %). For most m.o. of interest to thermal processing, the ( $z$ ) value is about 10 K or °C (18 °F).

The thermal death time ( $F$ ) required to obtain the specified inactivation (reduction of the m.o. population) is a multiple of the decimal reduction time ( $D$ ), e.g.,  $F = 12D$  for the inactivation of spores of toxic anaerobic bacterium *Clostridium botulinum*. In the thermal processing of low-acid foods ( $\text{pH} > 4.5$ ), a reference temperature of  $T_0 = 121$  °C (250 °F) is normally used. The ( $F$ ) value (usually in minutes) at a given temperature ( $T$ ) is converted to the equivalent ( $F_0$ ) at the reference temperature ( $T_0$ ) by the equation

$$\log(F_0/F) = (T - T_0)/z \quad (10.5)$$

Table 10.1 shows some typical values of the decimal reduction time ( $D$ ) of m.o. and enzymes, used in thermal process calculations (Ramaswamy and Singh 1997; Heldman and Hartel 1997).

**Table 10.1** Decimal reduction time ( $D$ ) of m.o. and enzymes

m.o. or enzyme	Temperature (°C)	$D$ (min)
Thermophilic bacteria $\text{pH} > 4.5$	121	2–5
<i>C. botulinum</i> $\text{pH} > 4.5$	121	0.1–1.5
<i>C. pasteurianum</i> $\text{pH} < 4.5$ .	100	0.1–0.5
Lactobacilli, yeast, mold $\text{pH} < 4.5$	65	0.5–1.0
Peroxidase	121	3

In the thermal processing of low-acid foods, the destruction of the spore-forming bacterium *C. botulinum*, which produces a poisonous toxin, is of primary concern. An  $(12D)$  inactivation is considered adequate for product safety. Thus, for a strain of *C. botulinum* with  $D(121) = 0.5$  min, the thermal process time at  $121^\circ\text{C}$  will be  $F_o = 12 \times 0.5 = 6$  min. Note that a process of  $F_o = 6$  min will be equivalent to a destruction of only  $(6/3) = (2D)$  of a thermophilic bacterium of  $D(121) = 3$  min. It is obvious that a more severe thermal process will be required for adequate heat inactivation of this heat-resistant m.o., e.g.,  $(5D) = 5 \times 3 = 15$  min, which will be more than adequate for *C. botulinum*. For very heat-resistant m.o. ( $5D$ ) to ( $7D$ ), inactivation is normally used (Lewis and Heppell 2000).

The effect of temperature on the thermal process time ( $F$ ) and the decimal reduction time ( $D$ ) can be also expressed by the Arrhenius equation and the  $Q_{10}$  ratio. The Arrhenius equation for the ( $D$ ) value is

$$\ln(D/D_o) = -(E/R)(1/T - 1/T_o) \quad (10.6)$$

where ( $E$ ) is the energy of activation (kJ/mol), ( $R$ ) is the gas constant (8.31 J/mol K), and ( $T, T_o$ ) are the temperatures (K) corresponding to ( $D, D_o$ ).

By combining (10.4) and (10.6), the following equation is obtained, which relates the energy of activation ( $E$ ) to the ( $z$ ) value:

$$E = 2.3R(TT_o)/z \quad (10.7)$$

As an illustration, for ( $z$ ) = 10 K and  $T = 373$  K,  $T_o = 393$  K, and  $R = 8.31$  J/mol K, (10.7) yields  $E = 2.3 \times 8.31 \times 373 \times 393/10 = 280.17$  kJ/mol.

Activation energies in the range of 210–476 kJ/mol are reported in the literature for the thermal inactivation of various m.o. (Lewis and Heppell 2000). These values are very high, compared to the activation energies of physical and chemical changes (reactions).

The  $Q_{10}$  ratio represents the increase of reaction rate by an increase of the temperature by  $10^\circ\text{C}$ , which in the case of ( $D$ ) values is defined as

$$Q_{10} = D_T/D_{T+10} \quad (10.8)$$

By combining (10.4) and (10.8), the following relation is obtained:

$$\log Q_{10} = 10/z \quad (10.9)$$

Thus, for the usual value of ( $z$ ) = 10, the ratio  $Q_{10} = 10$ , i.e., the decimal reduction time ( $D$ ) decreases by ten times, when the temperature is increased by  $10^\circ\text{C}$ . It should be noted that for most chemical reactions, the ratio  $Q_{10}$  is about 2, i.e., the inactivation of m.o. is about five times faster than a chemical reaction.

## 10.2.2 Thermal Damage to Food Components

Although some thermal processes may cause desirable changes to foods, like cooking and improvement of eating quality of foods, most heat-induced chemical and biochemical changes are undesirable, e.g., nonenzymatic browning and vitamin, taste, texture, and color deterioration.

Most thermal damage reactions are described by first-order kinetics, similar to the inactivation of m.o. and enzymes (Heldman and Hartel 1997). The rate of thermal damage to food components is much slower than the thermal inactivation of the heat-resistant m.o. and enzymes, i.e., significantly higher  $D$  and ( $z$ ) values and lower Arrhenius activation energies.

Characteristic values ( $D_{121}$ , min and  $z$ , °C) for damage to food components are ascorbic acid (931 min and 17.8 °C), nonenzymatic browning (384 min and 35.5 °C), thiamine (254 min and 25.4 °C), vitamin A (43.5 min and 20 °C), and chlorophyll (15.4 min and 45 °C).

The cooking value ( $C$ ) of potatoes at temperature ( $T$ ) with respect to a reference temperature of 100 °C is given by the relation  $\log(C/C_0) = (T - 100)/z$ , which is analogous to the effect of temperature on the ( $D$ ) value (10.4), but with a ( $z$ ) value about three times higher (about 30 °C) (Lewis and Heppell 2000).

The significant differences in ( $z$ ) values indicate that high-temperature and short-time thermal processes can yield sterilized products with minimum heat damage to important food components.

## 10.3 Heat Transfer Considerations

### 10.3.1 General Aspects

The principles of heat transfer and some important heat transfer equipment used in the thermal processing of foods are reviewed in Chap. 6. The thermophysical and transport properties needed in heat transfer calculations are discussed in detail by Rahman (1995) and Saravacos and Maroulis (2001).

The heat transfer coefficients ( $h$ ,  $U$ ) used in thermal processing are defined by (6.4), (6.5), and (6.6). Empirical correlations of ( $h$ , W/m<sup>2</sup> K) in various fluid systems are presented in Table 6.6. Useful correlations of the heat transfer factor ( $j_H$ ) with the Reynolds number ( $Re$ ) have been developed, based on published experimental data (Saravacos and Maroulis 2001). The following correlations are related to the thermal processing of foods:

$$\text{Retort sterilization : } j_H = 1.034Re^{-0.50} \quad (10.10)$$

$$\text{Aseptic processing : } j_H = 0.85Re^{-0.45} \quad (10.11)$$

where  $j_H = h/u\rho C_p$ , ( $u$ ) is the fluid velocity (m/s), ( $\rho$ ) is the density ( $\text{kg/m}^3$ ), and ( $C_p$ ) is the specific heat of the fluid (J/kg K).

In the thermal processing of food materials, the thermal resistances within the product ( $L/\lambda$ ) and at the heating medium/product interface ( $1/h$ ) are of paramount importance. The ratio of these resistances is expressed by the Biot ( $Bi$ ) number, which is defined by the equation

$$Bi = hL/\lambda \quad (10.12)$$

where ( $L$ ) is the characteristic dimension of the product (radius or half thickness).

For small Biot numbers ( $Bi < 0.2$ ), heat transfer is limited by surface convection, while for ( $Bi > 0.2$ ), heat conduction within the product limits the heat transfer rate. The ( $Bi$ ) number becomes very important in thermal processes where both heat conduction and convection take place, as in the continuous aseptic processing of particulate (suspended solids) foods.

Heat transfer in continuous thermal processing equipment, such as pasteurizers and aseptic processing systems, is analyzed by classical steady-state heat transfer calculations, discussed in Chap. 6.

### 10.3.2 Unsteady-State Heat Transfer

Heat processing in food containers (cans, flexible plastic) is an unsteady-state heat transfer operation, which is analyzed by simplified equations or numerical/computer methods.

The unsteady-state heat transfer of a fluid food product by convection (natural and forced) is similar to the heat transfer in a well-agitated vessel (6.31):

$$\log[(T_h - T)/(T_h - T_o)] = -[(UA)/(2.3VC_p)]t \quad (10.13)$$

where ( $T_h$ ) is the temperature of the heating medium, ( $T, T_o$ ) are the initial and final temperature of the product (after time,  $t$ ), ( $U$ ) is the overall heat transfer coefficient, ( $A$ ) is the heat transfer area, ( $V$ ) is the volume of the container, and ( $C_p$ ) is the specific heat of the product. SI units are used throughout.

Equation (10.13) can be written in the simplified form:

$$\log[(T_h - T)/(T_h - T_o)] = -(1/f_h)t \quad (10.14)$$

where,

$$f_h = (2.3VC_p)/(UA) \quad (10.15)$$

The heating time parameter ( $f_h$ ) is the time (usually in minutes) required to reduce the temperature ratio by 90 % (one log cycle), or the inverse negative slope of the semilog (temperature–time ratio) curve. It is analogous to the ( $z$ ) value of the thermal death curve.

Unsteady-state cooling of fluid foods in containers by convection can be expressed by an equation analogous to (10.14), replacing ( $T_h$ ) by ( $T_c$ ) and ( $f_h$ ) by ( $f_c$ ). It is assumed that the product attains a constant temperature ( $T$ ) at any time, due to the convection and mixing in the container.

Unsteady-state heating of solid and semisolid foods in containers is expressed by the empirical equation:

$$\log[(T_h - T)/j(T_h - T_o)] = -(1/f_h)t \quad (10.16)$$

Here, the temperature ( $T$ ) refers to the slowest heating point (center) on the container.

The remaining symbols used in this equation are similar to those of (10.14), except for the heating rate lag factor ( $j$ ), which is defined by the equation

$$\xi = (T_\eta - T_{\pi o})/(T_\eta - T_o) \quad (10.17)$$

The ( $j$ ) and ( $f_h$ ) parameters, defining the heat penetration curve (10.16), are estimated by plotting experimental heat penetration data of  $\log(T_h - T)$  versus ( $t$ ) (Fig. 10.1). The heating time parameter is determined from the slope of the curve and the lag factor ( $j$ ) from the temperatures ( $T_o$ ) and ( $T_{po}$ ). The pseudo-initial temperature ( $T_{po}$ ) is estimated from the extrapolation of the heating line to time zero ( $t = 0$ ).

In the thermal processing of foods, the heat penetration curve (Fig. 10.1) is traditionally plotted as  $\log(T_h - T)$  versus ( $t$ ) with the scale of the ordinate  $\log(T_h - T)$  inverted (Fig. 10.2). Thus, the temperature difference between the retort and the center of the food container ( $T_h - T$ ) starts as the highest initial value at ( $t = 0$ ), and it tends asymptotically to reach zero at infinite heating time. In Fig. 10.2, heating of the product starts instantly at ( $t = 0$ ), i.e., the “come-up” time is neglected.

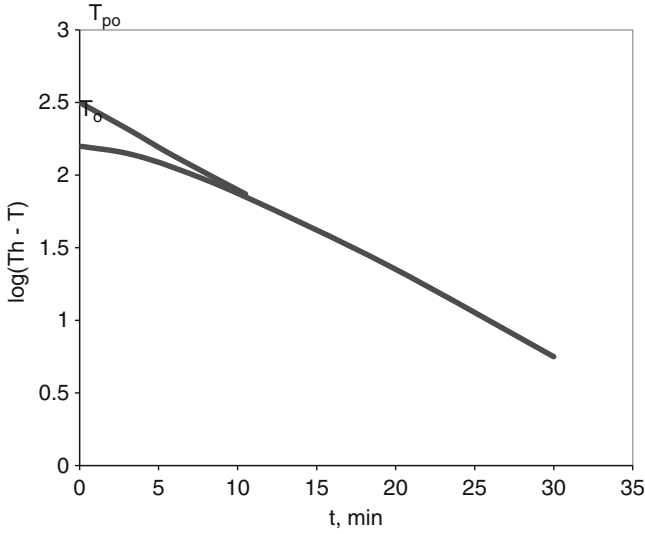
The heating time factor ( $f_h$ ), in conduction-heated foods, is related to the thermal diffusivity ( $\alpha$ ) of the food product in a cylindrical container (can), according to the equation (Teixeira 1992):

$$f_h = 0.398 / [(1/r^2 + 0.427/L^2)\alpha] \quad (10.18)$$

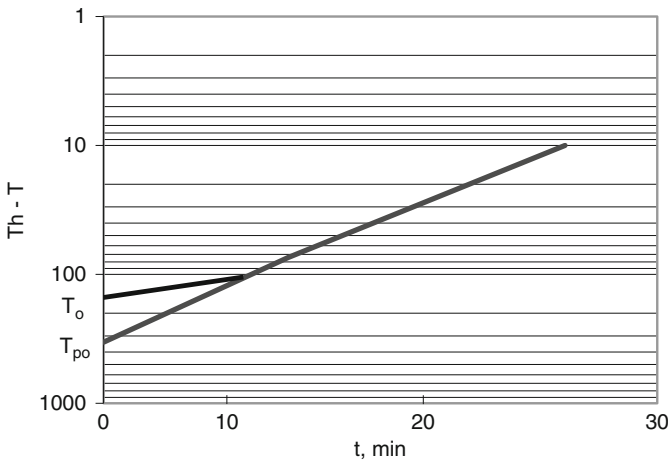
where ( $r$ ) is the radius and ( $L$ ) is the half height of the cylindrical container ( $L = H/2$ ).

If SI units are used, the ( $f_h$ ) parameter will be obtained in seconds, which should be converted to the commonly used thermal process time (min).

The thermal diffusivity of the food materials at thermal processing temperatures does not vary much ( $\alpha = 1.0$  to  $1.5 \times 10^{-7}$  m<sup>2</sup>/s) (Saravacos and Maroulis 2001). Therefore, the value of ( $f_h$ ) depends mainly on the dimensions (size) of the



**Fig. 10.1** Heat penetration curve.  $T_o$ , initial temperature;  $T_{po}$  pseudo-initial temperature



**Fig. 10.2** Inverted heat penetration curve. ( $T_o$ ,  $T_{po}$ ) initial and pseudo-initial temperatures

container, if the product is heated by conduction. However, in many food products, heat transfer by convection may be important, and therefore, experimental determination of ( $f_h$ ) is necessary.

Cooling curves for conduction-heating foods in cans are plotted in a similar manner with the heat penetration curve (Fig. 10.1), from which the characteristic parameters ( $f_c$  and  $j_c$ ) are estimated.

In some food products, the heating (heat penetration) semilog curves may consist of two straight line sections, which can be estimated from two ( $f_h$ ) parameters.

The “broken” heating lines are an indication of physicochemical changes in the food product, induced by heat, which may have a significant effect on its thermal transport properties. Such a change has been observed in the heat-induced gelatinization of starch materials, which changes (increases) significantly both thermal conductivity and thermal diffusivity (Saravacos and Maroulis 2001).

In unsteady-state thermal processing (canning), the retort (sterilizer) reaches the operating temperature ( $T_h$ ) at a certain time, the so-called “come-up” time, after heating (steam) is turned on. Based on industrial practice, only 42 % of the “come-up” time is considered as process time at ( $T_h$ ). Thus, in thermal process calculations, the heat penetration curve (Fig. 10.1) should start at a corrected ( $t = 0$ ), after 42 % of the “come-up” time. The heating time parameter ( $f_h$ ) does not change appreciably with the “come-up” time, but the lag factor ( $j$ ) should be based on a pseudo-initial temperature, which is estimated from the extrapolation of the heating line to the corrected zero time ( $t = 0$ ).

## 10.4 Thermal Process Calculations

Process calculations, used to estimate the thermal process time in food processing, are based on the integration of thermal inactivation of undesirable microorganisms and enzymes with heat transfer data in the food system under consideration. Historically, thermal process calculations for foods in closed containers were developed first, because of the importance of canning in food preservation. Calculations for continuous thermal processing were developed later with respect to the aseptic processing of foods.

### 10.4.1 In-container Sterilization

Calculation of the thermal process time in closed containers (cans) is more difficult than in continuous flow systems, because it involves unsteady-state heat transfer, which is inherently more complicated than simple steady-state operations. Two basic calculation methods are commonly used, i.e., the general and the formula methods. The theoretical calculations of the thermal process time should be supported by tests of inoculated packs (process validation), containing about 10,000 viable spores per container (Downing 1996).

#### 10.4.1.1 General Method

The improved general method, a version of the original method of Bigelow, is based on the integration of the lethality of the test microorganism with heat penetration data in the food container. Thermal processes are defined by the  $F_o$  value delivered to the product, i.e., the equivalent time, or integrated lethality (min), at the reference temperature, which for low-acid foods is 121 °C. In acid



foods, the reference temperature is normally 100 °C or lower (Ramaswamy and Singh 1997). Essential data for process calculations are the inactivation parameters ( $D$ ,  $z$ ) and the heat penetration characteristics ( $f_h$ ,  $j$ ). In canning, the thermal process calculations are based on the inactivation of the putrefactive anaerobe *C. sporogenes* NFPA (National Food Processors Association) No. 3679 or PA 3670 (Downing 1996).

The lethality ( $L$ ) of the test m.o. at a temperature ( $T$ ) is calculated from the equation

$$\log(L) = (T - 121)/z \quad (10.19)$$

By definition, the lethality at 121 °C (250 °F) is ( $L$ ) = 1. The lethality drops sharply at temperature below 121 °C, and it becomes negligible at  $T < 100$  °C (when the reference temperature is 121 °C).

The process lethality value ( $F_o$ ) should be equal or the integral or the summation of the lethality at all process temperatures:

$$F_o = \sum^t (L\Delta t) \quad (10.20)$$

The summation of (10.20) is calculated by using time–temperature data from the heat penetration curve of the can center and calculating the lethality ( $L$ ) at each temperature. This is a trial-and-error procedure, with repeated calculations until the summation of lethality becomes equal to the  $F_o$  value. The process calculations are facilitated by the application of computers, using simple programs (Teixeira and Shoemaker 1989; Teixeira 1992; Downing 1996).

The calculation of the thermal process time by the general method is shown schematically in Fig. 10.3. Two-trial processes ( $0At_p$ ) and ( $0Bt'_p$ ) are shown, with one of them yielding the desired process time ( $t_p$ ), e.g., the area ( $0At_p$ ) =  $F_o$ . It is evident that cooling of the product has a significant sterilizing effect on the process time.

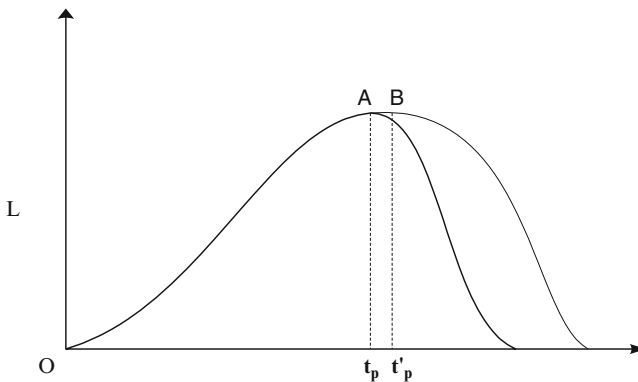


Fig. 10.3 Thermal process calculation diagram (general method)

### 10.4.1.2 Formula Method

The thermal process time ( $B$ , min) in a food container can be calculated from the following Ball formula (Ball and Olson 1957; Downing 1996; Ramaswamy and Singh 1997):

$$B = f_h \log[j(T_h - T_o)/g] \quad (10.21)$$

where ( $T_h$ ,  $T_o$ ) are the heating medium (retort) and initial temperatures, respectively, and the parameters ( $f_h$ ,  $j$ ) are obtained from the heat penetration curve (Fig. 10.1). The thermal process parameter ( $g$ ) is defined as the difference between the retort temperature and the temperature of the center of the container ( $T_{\max}$ ) at the end of heating ( $g = T_h - T_{\max}$ ).

The value of ( $g$ ) is a function of the heating characteristics of the container ( $f_h$ ,  $j$ ) and the thermal inactivation of the test m.o. ( $D_{121}$ ,  $z$ ).  $\log(g)$  is estimated from tables and diagrams of the literature (Downing 1996) as a function of the ratio ( $f_h/U$ ) versus  $\log(g)$  at various ( $j$ ) values. The parameter ( $U$ ) is calculated from the sterilizing time ( $F_o$ ) according to the equation

$$\log(U) = \log(F_o) + (121 - T_h)/z \quad (10.22)$$

where ( $U$ ) becomes equal to ( $F_o$ ), when the retort and the reference temperatures coincide ( $T_h = 121$  °C).

The formula method assumes a cooling rate factor  $j_c = 1.41$ , which may be different from the experimental heating rate factor ( $j_h$ ) of the specific food system.

The thermal process time for food containers exhibiting broken heat penetration lines is calculated from the equation

$$B = f_{h1} \log[j(T_h - T_{po})] + (f_{h2} - f_{h1}) \log(g_1) - f_{h2} \log(g_2) \quad (10.23)$$

where ( $f_{h1}$ ,  $f_{h2}$ ) are the heating time parameters of sections 1 and 2 of the broken penetration line (similar to Fig. 10.2),  $g_1 = (T_h - T_1)$ , and  $g_2 = (T_h - T_2)$ , where  $T_1$  is the temperature at the break point and  $T_2$  is the temperature at the end of heating ( $T_{\max}$ ). The parameters  $\log(g_1)$  and  $\log(g_2)$  are determined from the literature tables (Downing 1996) as functions of ( $U/f_h$ ). For simplification, the cooling time parameter is assumed to be the same with the heating rate ( $f_c = f_h$ ).

The formula method (10.21) assumes that the retort (sterilizer) attains the processing temperature ( $T_h$ ) instantaneously (at  $t = 0$ ). However, the total process time ( $B_T$ ), from the moment the heating was turned on, must be corrected for the “come-up” time (CUT):  $B_T = B + 0.42$  (CUT). Note that the effect of the CUT is included in the calculations of the general method (10.20).

The mathematical procedures for estimating the sterilization time in food containers were reviewed by Hayakawa (1977, 1978). A shortcut method for calculating the thermal process time with optimum retention of food quality was presented by Thijssen et al. (1978). Heat transfer modeling, taking into account

non-isothermal retort operation and based on very a heat-resistant m.o. with  $D_{121} = 8.9$  min,  $z = 11.4$  °C, and  $E = 250$  kJ/mol, was presented by Teixeira and Balaban (1997).

The formula method is still used widely for thermal process calculations, although some new modifications have been proposed (Stumbo 1973; Pham 1987, 1990). Computerized data acquisition and evaluation of thermal processing (canning) of foods is provided by software packages, such as FMC's NumeriCAL (Weng and Park 1997).

### 10.4.1.3 Commercial Sterility

Commercial sterility of the low-acid foods ( $\text{pH} > 4.6$ ) requires the destruction of the toxin-producing m.o. *C. botulinum*, usually  $F_o = 2.8$  min (at 121 °C). According to the US FDA, commercial sterility in canning is defined as the process in which all *C. botulinum* spores and all other pathogenic bacteria have been destroyed, as well as more heat-resistant organisms which, if present, could produce spoilage under normal conditions of non-refrigerated canned food storage and distribution (Downing 1996). It is essential that strict sanitation principles be followed, while raw materials (foods and packaging materials) prepared for processing (canning).

Inoculated packs, containing selected spoilage microorganisms, are required to validate (confirm) the thermal process times, calculated from microbial kinetics and heat penetration curves. These tests are particularly important for some food products, which exhibit irregular heating curves, e.g., canned spinach. Once the theoretical calculation is established and validated for a specific product, the procedure can be used to estimate the process time in a variety of container (can) sizes.

## 10.4.2 Continuous Flow Thermal Processes

The continuous thermal processes include thermal pasteurization and sterilization, which are carried out in heat exchangers, followed by packaging of the product in various containers. Continuous processing of one-phase fluid foods (not containing particulates) in flow pasteurizers and sterilizers is practiced widely in the food industry, e.g., milk and fluid dairy products and fruit juices. Thermal processing of two-phase (particulate) foods in continuous systems has found, until now, limited applications.

### 10.4.2.1 One-Phase Fluid Foods

The fluid food is heated to the process temperature and is held at this temperature for the specified processing (sterilizing or pasteurizing) time ( $F_T$ ). Thermal

inactivation of the spoilage and health concern agents (bacteria or enzymes) is required to be accomplished entirely at the process temperature, i.e., while the product is in the holding tube of the system. Preheating and cooling effects are neglected, because very fast heat transfer rates are employed.

The length of the holding tube ( $L$ ) is calculated from the following equation (Downing 1996):

$$L = (F_T)u_{\max} \quad (10.24)$$

The maximum velocity ( $u_{\max}$ ) is the velocity of the fastest moving element of the fluid, i.e., the element with the shortest residence time in the holding tube. For a fluid in laminar motion ( $Re < 2100$ ), the maximum fluid velocity in the center of the tube is twice the average fluid velocity ( $u_{\text{avg}}$ ):

$$u_{\max} = 2u_{\text{avg}} = 2(4m\rho)/(\pi d^2) \quad (10.25)$$

where ( $m$ ) is the flow rate of the product (kg/s), ( $\rho$ ) is its density (kg/m<sup>3</sup>), and ( $d$ ) is the tube diameter (m).

The calculations are normally based on tubes of circular cross section, but other flow geometries can also be used, substituting the tube diameter with an equivalent flow dimension.

The maximum velocity in the turbulent flow ( $Re > 2100$ ) is closer to the average velocity ( $1.25u_{\text{avg}}$ ). Thus, (10.25), which is used in practice, overestimates the maximum fluid velocity, resulting in overprocessing of the product and affecting adversely the food quality.

Non-Newtonian (mostly pseudoplastic) fluid foods have different velocity distribution in the holding tube, which is affected by the rheological constants of the fluid (Loncin and Merson 1979; Rao 1999).

The thermal processing time ( $F_T$ ) at the given temperature ( $T$ ) can be the sterilizing value ( $F_o$ ) at the sterilization temperature (e.g.,  $F_o = 4.5$  min at 121 °C) or a pasteurizing value for a standard m.o. or enzyme at the given pasteurization temperature.

#### 10.4.2.2 Two-Phase Foods

The calculation of thermal processing of two-phase foods (consisting of a fluid food and suspended food particles or pieces) is more difficult than in fluid foods, resulting in limited applications of this method, until now. The main problems are the residence time of the food particles, the heat transfer between the fluid and the particles, and the biological validation of thermal inactivation of the process.

## Fluid Flow and Heat Transfer Considerations

Fluid flow and heat transfer in the holding tube are very important in continuous thermal processing.

The presence of food particles and pieces in the fluid changes the velocity distribution and the residence time in the holding tube. The residence time distribution (RTD) in aseptic processing of particulate foods can be measured by optical, magnetic, and chemical methods (Sastry 1997). The flow profile of food suspensions at high solid concentration tends to be more uniform than the fluid foods (Liu et al. 1994). Thus, in concentrated suspension, the maximum velocity may be taken conservatively as the average velocity, resulting in a possible overprocessing.

It is recognized that the main resistance to heat transfer is within the food particles, which have a relatively low thermal conductivity ( $\lambda$ ), i.e., high Biot numbers ( $Bi = h_p L / \lambda$ ). The fluid to particle heat transfer coefficient ( $h_p$ ) can be estimated directly by attaching thermocouples to the stationary or moving particles, or indirectly by measuring color changes of liquid crystals or thermochromic paints, coated on acrylic spherical particles (Stoforos 1992). Another indirect method is the use of biological time–temperature indicators to estimate the temperature changes in the holding tube.

Pilot plant measurements of the heat transfer coefficient of marker particles in 25 % salt or 25 % salt and 0.12 % CMC solutions yielded the following empirical correlation (Stoforos 1992):

$$Nu = 2.0 + 1.51Re^{0.54}Pr^{0.24}(d_p/d_t)^{1.09} \quad (10.26)$$

where ( $d_p$ ,  $d_t$ ) are the particle and inside tube diameters, respectively.

The RTD in the holding tubes can be represented by a log-normal or a gamma function distribution.

## Validation of the Aseptic Processes

The aseptic process is designed around the slowest moving particle of the food suspension, and a reliable validation procedure is required by the Health Authorities to approve a commercial process.

The Food and Drug Administration (FDA) in the USA requires that the food processor should demonstrate the ability of this process to commercially sterilize every portion of the food product produced. A thermal process should be based on the following elements: identifying a sterilizing value ( $F_o$ ) for the product, developing a conservative method that predicts the total lethality of the thermal process, quantitative verification of the lethality delivered by means of a bio-indicator, and listing the critical factors of each process and the procedures to be used for controlling these factors.

A joint research effort by industry, government, and universities established the procedures for filing acceptable petitions to the FDA for aseptic processes of particulate (two-phase) food products (Larkin 1997). The food industry should capitalize on the advantages and challenges of the new aseptic processes (Swartzel 1997).

Biological validation of aseptic processes must be based on a microorganism, enzyme, or chemical marker, which behaves thermally like the target spoilage microorganism or enzyme, i.e., it must have similar ( $z$ ) value and activation energy. Typical markers are the m.o. *B. stearothermophilus* ( $z = 10\text{ }^{\circ}\text{C}$ ) and *C. sporogenes* ( $z = 12.5\text{ }^{\circ}\text{C}$ ) and the immobilized enzymes peroxidase ( $z = 10\text{ }^{\circ}\text{C}$ ) and  $\alpha$ -amylase ( $z = 7\text{ }^{\circ}\text{C}$ ). The chemical marker thiamine has a very high ( $z$ ) value,  $z = 48\text{ }^{\circ}\text{C}$  (Hendrickx et al. 1994).

## 10.5 Thermal Processing Equipment

### 10.5.1 General Aspects

The industrial equipment used in the thermal processing of foods is divided into two broad categories, in-container sterilizers and continuous flow processing equipment. The majority of canned foods are still produced by various in-container retorts (sterilizers). Pasteurization of liquid foods is practiced with continuous flow pasteurizers, while aseptic processing, using continuous flow sterilizers, has found many applications in fluid foods.

Due to the strict public health requirements and quality needs of the food products, the good manufacturing practices (Chap. 1) are of particular importance to the canning industry (Downing 1996). Federal, state, and international regulations and directives should be adhered to by the food processors.

The personnel of thermal processing food plants must be trained to adhere to the strict rules and specifications of the public health authorities. The supervisors of the operators of canning low-acid foods are required to attend the special “better process control” schools, approved by the FDA and NFPA, and held periodically in US universities. A similar short course “Thermal Processing: Principles, Practicalities, Calculations” is organized in the UK by the Campden and Chorleywood Food Research Association, Chipping Camden, Gloucestershire, England.

### 10.5.2 In-container Sterilizers

In-container retorts (sterilizers) are used extensively in canning several food products in various hermetically sealed containers, made of metallic cans (tinplate or aluminum), glass, and plastic materials (rigid or flexible pouches). The heating medium is usually saturated steam, steam/air mixtures, and hot water. Heating of

the cans in still retorts by sprays of hot water provides faster heating and a good temperature control (Ohlsson 1994). Relative motion of cans and heating (or cooling) medium increases considerably the heat transfer rate.

Modern retorts are automated and equipped with PLC (programmable logic controllers) or sequential event controllers. Microprocessor controllers use product-specific software. The controllers can store processing programs for a range of canned food products. The real-time process controllers (Appendix C) have found limited applications in the canning industry.

Since sterilization in cans is still the most important in-container thermal process, the canning operations are discussed briefly here, with special reference to the processing equipment.

### 10.5.2.1 Canning Operations

Canning of foods involves several food processing operations, which are described in detail in the literature (Downing 1996; Gould 1996). The processing equipment used in canning includes, in addition to the sterilizers, various other units, such as washers, mechanical separators, peelers, and can closing machines, which are described in Chap. 5 (Mechanical Separators) and Chap. 13 (Packaging Equipment) of this book. The equipment used in the canning of a typical vegetable, peeled tomatoes (Fig. 10.4), is described briefly here (Downing 1996; Gould 1992).

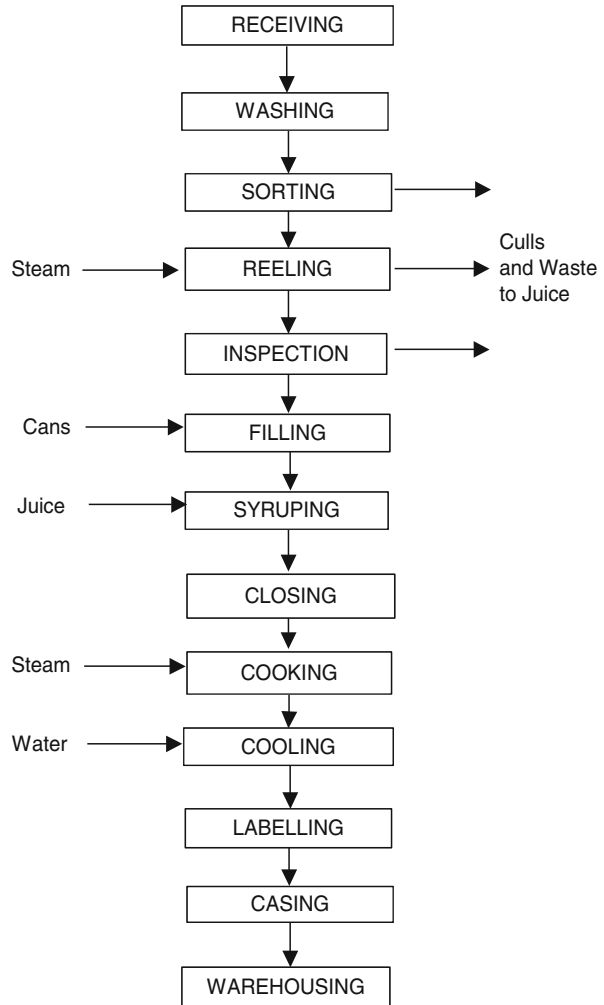
#### (i) Receiving

Raw materials, ingredients, and packaging materials should be inspected, upon arrival to the plant, to ensure that they are suitable for food processing. Products susceptible to microbial spoilage should be stored at low temperatures to minimize the growth of spoilage microorganisms.

High-volume raw materials, sensitive to mechanical handling and to high temperatures, like tomatoes, are received by truck from the growing field and are used for processing, without any considerable delay, which might cause microbial spoilage at the relatively high temperatures of the processing season. The receiving area for the raw material should be separate from the processing sections of the food plant. Hygienic handling procedures, specified by good manufacturing practices, should be followed (Gould 1994).

Some raw materials should be separated into edible parts and waste prior to a particular process, e.g., removal of peas from shells (vining) and husking of corn. Special equipment of adequate capacity for quick processing should be available in the processing plant.

**Fig. 10.4** Simplified process block diagram of canning peeled tomatoes



## (ii) Washing

The purpose of washing is to remove the soil and foreign material from the food product and reduce considerably the spoilage bacteria, present in the food. Low microbial load of the product increases significantly the efficiency of the sterilization processes. Washing improves also the appearance and the quality, in general, of the processed product (Downing 1996).

In the washing of fruits and vegetables, a combination of soaking and spraying of the products is applied. Common washers are revolving drums in which the food product is tumbled, sometimes in combination with high-pressure water sprays. Some mechanically sensitive foods, e.g., tomatoes, may be damaged by tumbling,



and they are washed by dumping and floating in water basins. Water conservation in washing operations should be practiced, since the cost of freshwater and wastewater treatment is significant (Appendix D).

### (iii) Inspecting/Sorting

Inspection of the product can be done by trained workers, who remove any defects (culls) from the washed product, which moves slowly on an inspection belt. Modern plants use mechanical inspection systems for color, texture, size, shape, and density of the product. Laser, X-ray, infrared, and image analysis systems can also be used. Inspection machinery of capacities up to 50 tons/h can detect undesirable objects and eject them from the moving belt by a series of air jets and pneumatically activated flaps (Chap. 5).

Although machine inspection has advanced remarkably, human inspection is still practiced in many food processing plants.

### (iv) Grading

Fruits and vegetables are graded automatically by methods based on their weight, size, and color. Grading utilizes mechanical separation methods, discussed in Chap. 5.

### (v) Blanching

Most vegetables and some fruits are blanched (short thermal treatment) to inactivate the undesirable enzymes, expel the air from the product, soften the hard product, and improve the food quality.

Hot water at 88–99 °C and steam at atmospheric pressure are used in special blanching equipment, like the rotating hot water and the steam blanchers. The blanching time depends on the product, e.g., in vegetables, it is about 2–3 min (Luh and Woodroof 1988).

Blanching equipment is specially designed for individual products. The aim is to apply the shortest blanching time that accomplishes the desired objective (Sect. 9.5 of this chapter). Immediate cooling down of the blanched vegetables is very important for controlling heat effects and changes in soluble and heat-labile nutrients (Dietrich et al. 1977).

The blanching equipment should produce the minimum wastewater, which is usually loaded with high amounts of organic components, leached from the product. Continuous steam blanchers reduce water pollution substantially, but they are mechanically more complex and costly. For several vegetables, an alternative to blanching is to apply MWs (microwaves). This reduces the loss of nutrients. However, MW blanching is almost equally effective to water blanching when the

relation surface to volume of the products is small (e.g., spinach leaves) (Ramesh et al. 2006). Immediate cooling down of blanched vegetables is very important for controlling heat effects and changes in soluble and heat-labile nutrients (Coffelt and Winter 1973).

#### (vi) Peeling

Peeling of some fruits and vegetables is necessary to improve the quality of the processed product. Mechanical peeling and coring is used for some products, such as apples. Steam and lye peelers are used extensively, because of their efficiency and high capacity (Chap. 5). High-pressure water sprays remove the loosened peels from the product, which moves on belts, equipped with special rolls and fingers.

Hot lye (alkali) solutions and wetting agents are used for peeling of fruits, e.g., peaches. Lye peeling is followed by spraying the product (water jets 3–7 bar) in rotary washers. Root vegetables are peeled more efficiently with steam peelers, since lye peeling may result in excessive solids and wastewater pollution.

Abrasive peeling is based on the rubbing action on the fruit or vegetable against an abrasive surface (brushes or rollers), which loosens the peels. Abrasive peelers may be used following steam or lye treatment. Flame peeling is used mainly for pimientos (peppers), which are difficult to peel with other methods. Details of the peeling processes are given in Chap. 5 (Mechanical Separations).

#### (vii) Cutting

Size reduction follows peeling and washing of the raw materials. Some fruits and vegetables are cut into various sizes and shapes, using special cutting equipment, such as slicers, dicers, shredders, and strip cutters (Chap. 4, Size Reduction Equipment).

#### (viii) Filling

The containers (cans) in small-volume plants are still handled by hand from the cases of container manufacturers. In large food processing plants, cans are received in pallets and they are handled mechanically. The cans are usually washed before filling, by flushing with water in the inverted position to facilitate the draining of excess water. The can closures (lids) are fed into hoppers above the filling machines (Chap. 13, Packaging Equipment).

The peeled and cut products are filled into clean containers (cans) mostly by mechanical operations and in some cases manually. Liquids and semisolids, temporarily stored in hoppers, are filled easily, using mechanical devices (syrups, brine, fruit juices, jams, soups, etc.). Filling of solids may require both mechanical and manual operation (Chap. 13). Special additives may be added to the product during

the filling operation, like firming agents (calcium salts) for tomatoes or citric acid, to reduce the  $\text{pH} < 4.3$  in some vegetables, which prevents the germination and growth of *C. botulinum*.

The headspace of the fill-in weight for liquid products can be adjusted automatically, using a predetermined volume or by inclining the filled cans on the conveyor to allow the surplus liquid to overflow. For viscous materials, a plunger forces a predetermined volume into the can. Solid food products are filled from hoppers of predetermined volume (Downing 1996). Dosing of food materials into various packages is discussed in Chap. 13.

The containers (cans) are transported on horizontal straight or rotary chain conveyors. Plastic belts 60–70 cm wide are also used for normal tin cans and aluminum, plastic, and composite containers.

#### (ix) Exhausting

The filled containers, before closing, are subjected to a short heating treatment in order to remove the air from the product, which might impede heat transfer and can cause damage (overpressure) during processing. Exhausting assures a reasonable vacuum in the closed container after processing. The product is preheated by hot water or steam in an exhaust box, which may require several minutes, especially for large cans and solid product occluding significant volume of air.

Exhausting of fluid foods can be accomplished easily by hot filling the container immediately before closing the containers.

Vacuum and steam flow closing systems eliminate the need for thermal exhausting in various canning operations.

#### (x) Closing

High-speed closing machines are used to close (seal) automatically the metallic and flexible containers, as described in Chap. 13. Double-seaming machines can operate at speeds higher than 1000 cans/min for particulate foods in light tin plate, deep drawn aluminum, composite, and plastic containers. Fluid and semifluid canned foods can be closed at speeds up to 1500 can/min (Downing 1996).

Glass container closing machines are, in general, slower than the comparable size metallic containers, but small glass containers can be filled and closed at speeds comparable to the speeds of metallic cans.

The containers must maintain a reasonable vacuum (e.g., 250 mmHg), which can be produced by hot filling, steam injection, or mechanical vacuum. Steam vacuum is produced by injecting live steam into the headspace of a container before capping, which replaces all the air, and as it condenses, a vacuum is formed. Mechanical vacuum is produced by clinching the filled cans at low temperature, subjecting them to vacuum for a very short time, and sealing them rapidly. A pre-vacuuming step is necessary for cans containing solid foods, which occlude

considerable amounts of air. The vacuum in sealed containers can be detected in processing lines (up to 2000 containers/min), using a pressure/vacuum monitor (Dud Detector), which operates on an electromagnetic impulse (tap) on each container (Downing 1996).

#### (xi) Sterilizing

The sterilization (cooking and cooling operations) and the equipment used are discussed in detail in the following sections of this chapter.

#### (xii) Labeling/Casing/Warehousing

Container coding should give information on the plant, product, and style of pack, the day and hour of pack, and the processing time on which the product was packed. This information is necessary for detecting the particular lot of pack, when some problem arises during storage or sale of the product.

Labeling of cans, glass jars, and other containers is done with special labeling machines, or the ready to fill packages are already labeled. This is the case with several plastic (rigid or flexible) packages and with externally lacquered cans. Labeling machines use laser or ink printing just before or after filling.

Labeling of food products should comply with the food labeling regulations of national authorities. In the USA, the FDA regulations (FDA Title 21) describe the requirements of food labeling, which should give the name of the food, net quantity of contents, ingredient lists, nutritional labeling, claims, and miscellaneous.

Most canned foods are cased in shipping cartons and stored in warehouses. In some cases, the cans are stored in bulk for some time, and they are labeled and cartoned before they are shipped. Tin cans and glass jars are usually wrapped with plastic film and stacked on wooden strips 25 mm thick or in pallets. The temperature and humidity of the can storage rooms should be controlled.

Thermophilic bacteria can survive some thermal processes, but they will not grow in the canned product, as long as the storage temperature is below the range of thermophilic growth of 49–66 °C.

Pallet sizes and palletizing operations are discussed briefly in Chap. 3 (Storage of Solids).

#### (xiii) Can Sizes

The sizes of typical metal cans for consumer canned foods, used in the US food processing industry, are given in special tables, such as in NFPA (1982; 1984) and Downing (1996).

The dimensions of cylindrical metallic cans in the USA are denoted by the external diameter ( $d$ ) and height ( $h$ ), expressed in inches—16th of an inch, e.g., a (307 × 409) can has dimensions =  $(3^{7/16}) \times (4^{9/16})$  in.

Typical food cans and their approximate capacity (mL) are (202) × (204), 100 mL; (303) × (406), 480 mL; (307) × (409), 583 mL; (401) × (411), 846 mL; and (603) × (700), 3108 mL. Some popular cans are known with a characteristic number, e.g., No. 2 (307) × (409), No. 2<sup>1/2</sup> (401) × (411), and No. 10 (603) × (700). The approximate capacity of a given food container can be estimated from its geometric dimensions, using SI units (mm) and neglecting the thickness of the metal.

In the EU (European Union), the most common can size for fruits and vegetables is the (1/1) can with dimensions 99 × 122 mm and capacity 900 mL, which is close to the US No. 2<sup>1/2</sup> can. Other types of can sizes in the EU are the DIN 2011 and 2013 for fruits and vegetables, the DIN 2043 and 2044 for fish, and the DIN 2018 for meat products (Schormueller 1966).

#### (xiv) Typical Thermal Processes

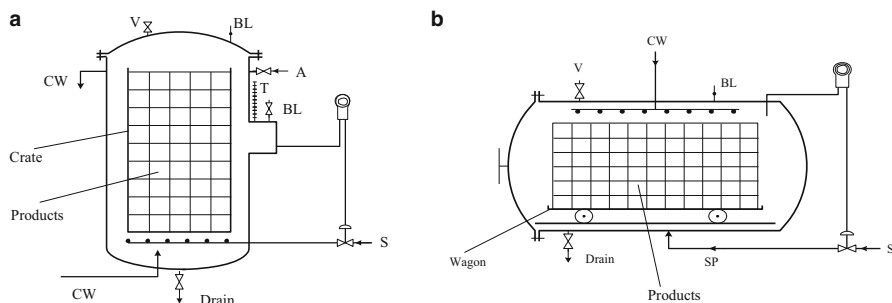
Thermal process times/temperatures for canned foods depend on the can size of the food product. In general, acid foods (pH < 4.5) are processed less severely (100 °C) than nonacid foods (121 °C). Typical thermal processes (Downing 1996; Luh and Woodroof 1988) are whole tomatoes in No. 2 cans, 100 °C and 45 min for static retort, or 14 min for agitated retort; whole tomatoes in No. 10 cans, 100 °C and 100 min for static retort, or 25 min for agitated retort; peach halves in No. 2<sup>1/2</sup> cans, 100 °C and 20 min for agitated retort; peas in (81 × 111 mm, 480 mL capacity) cans, 121 °C for 20 min in a static retort; cream style corn in (81 × 111 mm, 480 mL capacity) cans, 121 °C for 65 min in a static retort; and boned chicken in (81 × 111 mm, 480 mL capacity) cans, 121 °C for 80 min in a static retort.

Most of the thermal process times given in the literature refer to water cooling of the sterilized cans. For air cooling of the cans, the process time is about 20–30 % shorter, because the product remains at elevated temperatures longer than in water cooling.

#### 10.5.2.2 Batch Sterilizers

Batch sterilizers (retorts) are used in many small- and medium-size food processing plants, because of their low cost and simple operation. The batch sterilizers include the still retorts, the rotary batch retorts, the crateless retorts, and the retorts for glass and flexible containers (Downing 1996).

Batch retorts are convenient for thermal processing of several different food products, particularly when the raw material is seasonal and/or relatively small volume, such as fruits and vegetables. In such cases, optimization of retort use is important to reduce processing costs (Simpson et al. 1997).



**Fig. 10.5** Still retorts: (a) Vertical and (b) horizontal. *S* steam, *SP* steam spreader, *T* thermometer, *V* vent, *BL* bleeder, *CW* cold water, *A* air

### (i) Still Retorts

Two types of still retorts (autoclaves) are commonly used, the vertical and the horizontal units, which are shown diagrammatically in Fig. 10.5. The vertical retorts consist of a steel cylindrical vessel of dimensions about (1.5 m diameter)  $\times$  (2.5 m length), with a hinged large top cover, which can be closed hermetically during processing. They are equipped with all the necessary piping, valves, and instruments, specified by regulations and technical publications for the canning industry (NFPA). The retorts should be constructed following special mechanical and safety specifications, such as those of the ASME code for unfired pressure vessels (Chuse and Eber 1984).

The sterilizers are located in a special area of the food processing plant (the “cook room”), which must comply with the regulations of the public health authorities and the good manufacturing practices (Gould 1994). Close supervision of the operation of the “cook room” is essential to ensure the successful and safe production of canned foods.

Efficient use of the retorts must meet certain construction and operation requirements, established by experience, some of them general and some specific. Thus, the steam in still retorts is introduced through steam spreaders, i.e., perforated pipes located at the bottom. Vents, i.e., valves for removing air from the retort, are always placed opposite to the steam spreaders, usually at the top of the retorts. Bleeders (small valves of diameter 1.6–3.2 mm) should be placed on the top and near the instrument wells for letting a small amount of steam to escape continuously into the atmosphere during thermal processing. The purpose of bleeding is to remove any amount of air that may be introduced into the retort with the steam during processing. Air piping and valves are required for air-overpressure processing (equalizing the container pressure during cooling, especially of glass containers). The retort temperature should be measured with a mercury thermometer, installed at a specified location on the retort, and recorded in a recorder/controller. A pressure gauge and a pressure relief valve are also required. Thermocouples are also used in temperature recording and control.

The cans are placed in crates (baskets), which are loaded into the retort by chain hoists. The vertical retorts are normally loaded with about 1000 No. 2 or 400 No. 10 cans in 3–4 crates. Saturated steam of line pressure 6 bar is used for heating the retort. The sterilized cans are cooled in the retort, using cold water, introduced through a pipe at the bottom. The heated water is removed through an overflow pipe at the top of the retort.

The horizontal retorts consist of a long steel vessel of about 2.5 m diameter and up to 10 m length, with one or, in some cases, two hinged large side doors, which should be closed hermetically. If the thermal processing time is 50 min (including loading and emptying the retort), the retort capacity is less than 1000 No. 2 cans. Several retorts are used to increase the plant capacity, making the operation nearly continuous. The cans are placed in trucks or trolleys, which are loaded into the retorts moving on special tracks. The steam is introduced into the retort through a long perforated pipe, located in the bottom. Venting and bleeding valves are located on the top. Cooling water is introduced normally from the top and removed from the bottom.

In the two-door horizontal retorts, the entrance is facing the can preparation area, while the opposite door faces the processed product storage area, which should maintain a low humidity.

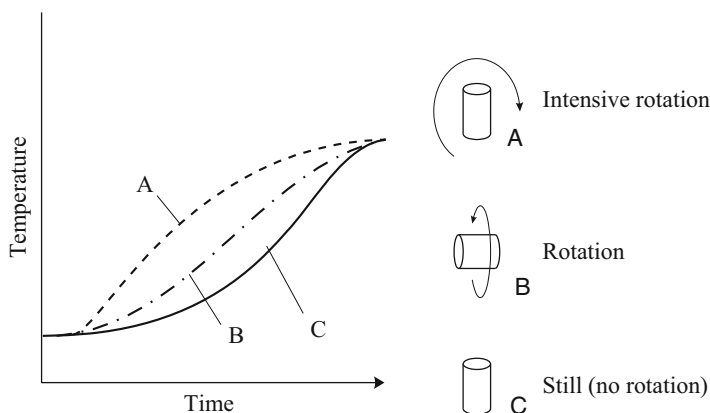
Cooling of large (e.g., No. 10) and flat cans with water requires overriding air pressure to prevent the bulging, i.e., mechanical distortion of the cans, due to excessive internal pressure, particularly during the initial stage of cooling. The high pressure developed within the cans is due to the increased pressure of water vapor at high temperatures and the pressure of the entrapped air or other gases.

Cooling of the cans with water, after retorting, should be fast, so that the inside can temperature should reach quickly a temperature of about 38 °C, in order to prevent the growth of any surviving thermophilic bacteria. However, lower temperatures should be avoided, since the metallic cans may be corroded (rusted), due to the condensation of moisture on the can surface (in humid climates).

The still retorts have the basic disadvantage of low heating rates of the cans, due to low heat transfer coefficients of natural convection between the heating medium (steam or water) and the cans. Improvement of the heat transfer rate is achieved by forced convection of the heating medium and/or agitation of the food containers. Fast-heating retorts include the batch rotary sterilizers, and the special sterilizers, discussed below in this chapter.

## (ii) Batch Rotary Sterilizers

The heat transfer rate within the food containers can be increased substantially by axial rotation of the cans in a horizontal retort, reducing the process time (Teixeira 1992; Downing 1996). The rotary system is particularly effective for convection-heated food products. The air in the headspace of the cans forms a bubble, which induces agitation of the food contents during the rotation in the retort. The rotary units, e.g., the FMC orbital retort, are particularly effective for large cans



**Fig. 10.6** Effect of can rotation on the temperature rise in the can

(603 × 600 or 603 × 700) containing difficult to heat foods, like cream style corn and soups. They have a capacity of about up to 600 cans, and they can be automated to operate semicontinuously. The speed of rotation depends on the canned product, varying from 6 to 45 RPM.

The rotational speed and the type of rotation (axial or “end-over-end”) influence significantly the sterilization time, as shown in Fig. 10.6 (Schormueller 1966; Heiss and Eichner 1996).

### (iii) Crateless Retorts

Crateless retorts reduce labor requirements for loading and unloading the cans in batch sterilizers. The cans are loaded in bulk from the top of the retort, which contains preheated water. After the retort is filled with the cans, steam is introduced from the top, displacing the water. The retort is closed and steam sterilization is accomplished in the prescribed time. The cans are cooled with water in the retort, introduced from the top, and then they are discharged in a water canal, below the retort, for final cooling (Fig. 10.7).

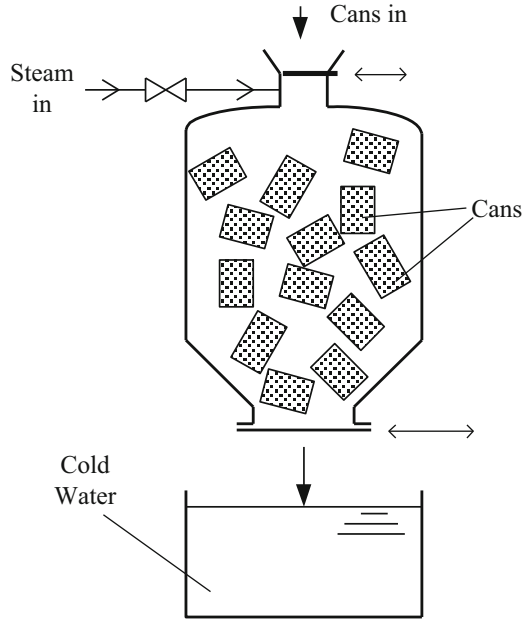
The crateless retorts can be operated as a semicontinuous system, by using a series of retorts, which are loaded and unloaded successively (Downing 1996).

### (iv) Retorts for Glass and Flexible Containers

Glass containers are thermally processed and cooled in water under overriding air pressure to prevent the pop-up (rejection) of the glass lids and breakage of the glass by the internal pressure, developed during processing. Flexible packages, e.g., pouches, cannot withstand high internal pressures, and they must be also processed and cooled under overriding pressure.



**Fig. 10.7** Principle of operation of a crateless retort



The retorts used for glass and flexible containers are basically the same with the retorts for metal cans, with special arrangements of air piping and valves (NFPA technical publications).

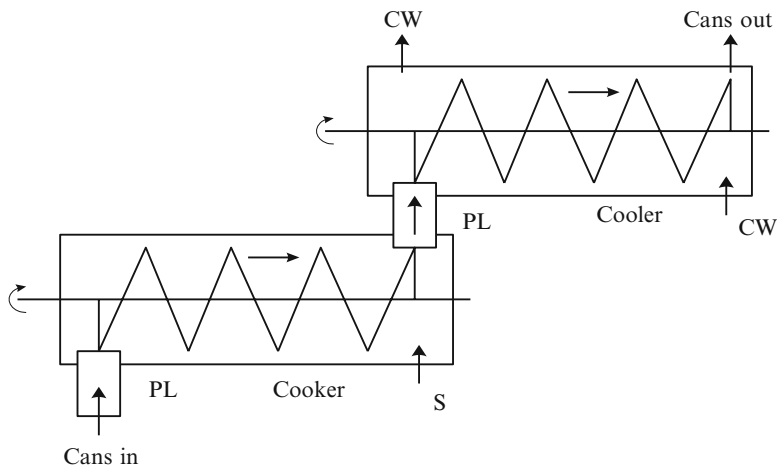
The glass or flexible containers are loaded into the retort, and they are covered with enough water, so that its level is about 15 cm above the top layer of the containers.

### 10.5.2.3 Continuous In-container Sterilizers

Continuous in-container sterilizers are used widely in medium-size and large food processing plants, because of their advantages over the batch systems, i.e., higher production rate, lower operating cost, better process control, and improved food product quality. Two main continuous systems are commonly used, i.e., the rotary cooker/coolers and the hydrostatic sterilizers.

#### (i) Rotary Cookers/Coolers

The rotary cooker/coolers (FMC) consist of two horizontal pressure shells (vessels) equipped with a rotating spiral reel mechanism, in which the cans move progressively through the prescribed cycles of heating, holding, and cooling. Special



**Fig. 10.8** Schematic diagram of a rotary cooker/cooler

pressure feeders (pressure locks) transport the cans into the pressure cookers and from the cookers to the atmospheric water coolers (Fig. 10.8).

The rotary system improves significantly the heat transfer to the canned product and reduces the processing time. Steam is applied at the bottom of the cooker, which is equipped with the proper venting, bleeding, and temperature recording/controlling accessories. The rotary cooler uses cold water ( $2/3$  full), in counterflow with the cans.

Acid foods, like tomatoes, are processed in rotary cookers/coolers at atmospheric pressure, followed by continuous cooling with cold water.

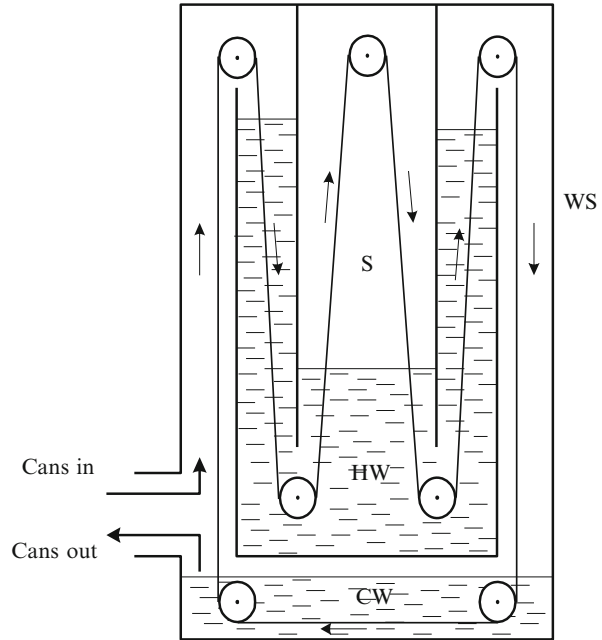
The cans enter and leave the pressure cooker through pressure locks (PL). The pressure cooker is heated with live saturated steam (S), and cooling is achieved with cold water (CW) in the cooler, which operates normally at atmospheric pressure. In some systems, the cans are preheated in a separate pressure preheater, before entering the pressure cooker. Typical dimensions of a continuous rotary system are shell diameter, 1.5 m; shell length, preheater 3.5 m; cooker, 10 m; and cooler, 10 m. The capacity of large systems is up to 5000 of No. 2 cans and steam consumption, about 150 kg/1000 cans.

The continuous rotary sterilizers have high capacity, and they provide fast sterilization, due to the rotation of the cans, but they are limited to small-sized cans, and they require good control of the pressure locks during processing.

## (ii) Hydrostatic Sterilizers

Hydrostatic sterilizers operate under pressure, which is maintained by water legs (columns), eliminating the need for closed pressure vessels and pressure locks. They consist basically of four chambers: (1) the hydrostatic “come-up” feed leg,

**Fig. 10.9** Hydrostatic sterilizer. *S* steam, *HW* hot water, *CW* cold water, *WS* cold water sprays



(2) the sterilizing chamber, (3) the hydrostatic discharge leg, and (4) the cooling section (Fig. 10.9). There are variations of the sterilizer structure, with the four basic chambers split into more sections, which are interconnected at their lower part.

The hydrostatic sterilizer is a tall installation, usually higher than 10 m, because of the need of a hydrostatic leg (column of water) to compensate for the steam pressure in the sterilizing chamber. Thus, a processing temperature of 121 °C (absolute pressure of about 2 bar) requires a column of water 11.2 m high. Obviously, higher temperatures (pressures) will require higher hydrostatic legs.

The water temperature in the three legs varies from 16 °C to 102 °C, while the steam chamber is maintained at a processing temperature of 116–130 °C.

The cans are transported through the sterilizer by a chain conveyor at a velocity of 0.5–2.0 m/min, depending on the product and the can size. More than one container size can be processed simultaneously by using separate chain conveyors, moving at different speeds. The cans are fed automatically in horizontal can holders, which are attached to the conveyor chain. Each holder can carry up to 35 No. 2 cans. High capacities of the sterilizer are obtained using wide conveyor chains, which can carry more cans. Large hydrostatic sterilizers have capacities up to 2000 cans/min (120,000 cans/h).

All can sizes can be used, and the containers are subjected to a gentle agitation during processing, in contrast to the operation of the rotary cookers/coolers. The cans progress through the preheating leg to the sterilizing chamber, where they may

have to travel two or more passes in order to complete the required process time. Subsequently, the cans go through the discharge leg, where they are cooled partially with water before they pass through a cooling section with water sprays. The cans finally enter a water cooling canal at the bottom of the sterilizer, from which they are discharged, while the chain conveyor repeats the processing cycle with a fresh supply of cans.

The hydrostatic sterilizers require a large capital investment and they can be justified for large thermal processing on the basis of reduced energy (steam) cost, better process control, and improved quality of the canned products.

The hydrostatic sterilizers have the advantages of very high capacity, parallel processing of different sizes of cans and different products, small floor space requirement, and gentle continuous processing.

However, they require high initial investment, temperature control is difficult, and they are subject to environmental damage, since, due to their height, they are installed outside the plant buildings.

#### **10.5.2.4 New In-container Sterilizers**

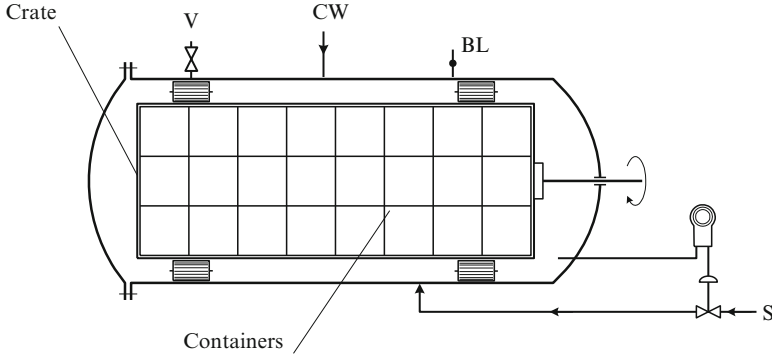
In addition to the traditional types of in-container sterilizers, described previously, there are some new in-container sterilizers, which have found wide industrial applications, because of their important advantages. They are all characterized by faster heat transfer rates, resulting in improved food quality and safety of the processed food products.

##### **(i) Circulating Water and Steam Sterilizers**

Various types of horizontal retorts are used, utilizing hot water or hot water sprays to improve heat transfer in stationary or rotating cans, loaded in special crates (Downing 1996). Most of these sterilizers were developed by European equipment manufacturers.

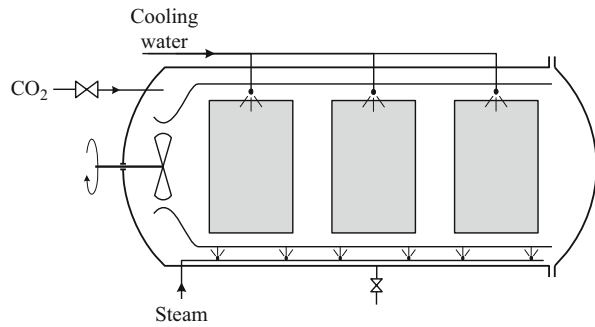
Increased heat transfer rates are achieved by sprays of hot water, can rotation or agitation, or recirculation of steam or hot water. Most of these sterilizers are suitable for overpressure thermal processing, using combinations of water, steam, and air to achieve the desired temperature and pressure (different than the saturation pressure). Overpressure is required in the processing of food products packaged in plastic pouches, plastic trays, or plastic cups. Various types and sizes of food containers can be processed.

In the Stock "Rotomat," crates loaded with cans are rotated in a horizontal pressure sterilizer, while they are heated by circulating hot water or water sprays. The water is reheated by steam injection, and it is recirculated in the system at high flow rate, using a special centrifugal pump. The cans are finally cooled with sprays of cold water. Water pressure and steam temperature are used in various combinations to provide the specified process temperature for the particular packaged food



**Fig. 10.10** Horizontal rotating sterilizer. *S* steam, *CW* cooling water, *V* vent, *BL* bleeder

**Fig. 10.11** Circulating steam sterilizer (Stork–Lagarde)



product. Special packages of food products can be used in this system, e.g., table trays of prepared foods. Figure 10.10 shows schematically a horizontal rotating sterilizer.

The MultPAX system utilizes several heating media, e.g., steam, trickle (spray) water, or immersion in pressurized water.

The Stork–Lagarde circulating steam sterilizer uses a fan to circulate the saturated steam through the crates and cans of the horizontal retort (Fig. 10.11). The forced circulation of steam increases significantly the heat transfer coefficient and reduces the thermal process time. The cooling time is also reduced by circulating cooling water or cold carbon dioxide, produced from dry ice.

Besides the already mentioned methods of in-container sterilizers, the *Shaka* equipment is a batch process sterilizer autoclave, which introduces a forth and back agitation of the products during heat processing. This is achieved by a linear vibration/shaking of the products in the autoclave. The containers (cans, jars, pouches, trays, etc.) are loaded in baskets horizontally in the direction of shaking. The packed products are agitated through about 150 horizontal shakes/min, resulting in faster heat transfer to the product. This reduces the processing time and affects a more homogenous product and a better quality of the heated food. It is claimed that

this way, the sterilization time is reduced by more than 25 %, compared to that of a rotary batch sterilizer, depending on the packed product. In certain soups, the sterilization time may be 90 % or less. The method was developed by the British Zinetec Ltd., and several sterilization equipment manufacturers (e.g., Alpac, Steriflow) developed equipment based on the patented Zinetec method.

(ii) Track Flow Sterilizers

The track flow sterilizers consist of a long serpentine pipe (duct) of rectangular cross section, which acts as a track to the rolling food cans, which are heated to the sterilization temperature by a stream of hot water. Water, heated by steam injection, pushes the cans, which roll at about 200 RPM, increasing the heat transfer rate. The sterilized cans are cooled by cold water, which replaces the hot water in the pipe (Fig. 10.12).

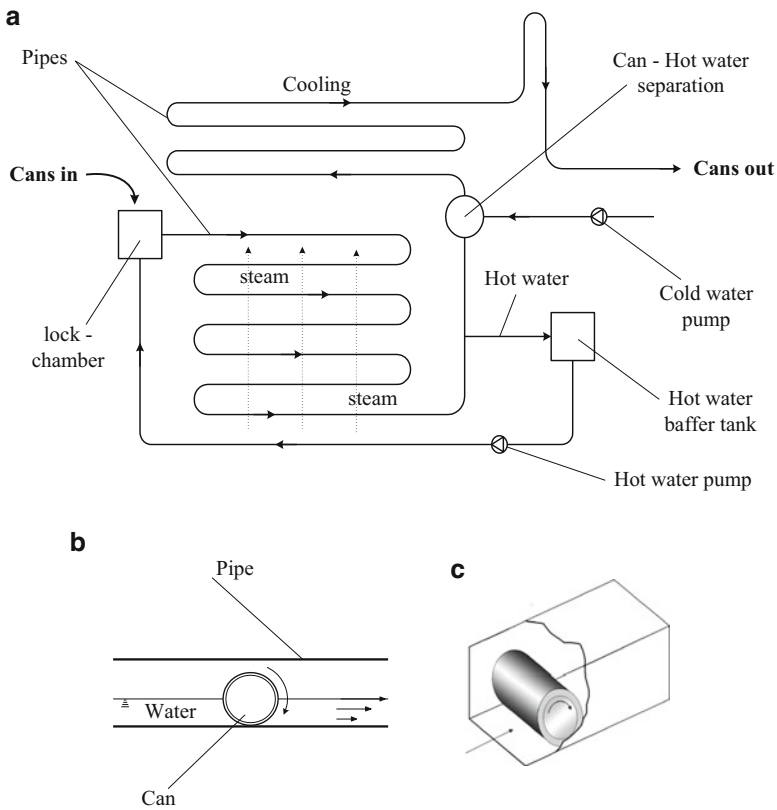


Fig. 10.12 Track flow sterilizer systems: (a) hydroflow; (b) hydrolock and (c) rolling can

Two types of track flow sterilizers are applied: (1) the hydroflow system, consisting of metallic pipes/tracks, which guide the cans through different zones of the sterilizer, and (2) the hydrolock system, in which the cans roll in a pressurized chamber, following a serpentine track. The upper part of the chamber is filled with steam, while the lower part contains water. The cans enter and leave the chamber through a hydrolock valve, which maintains the chamber pressure constant.

The capacity of the track flow sterilizers depends on the length of the pipe, and it is about 250 cans/min (15,000 cans/h) for sterilizing No. (1/1) EU cans (equivalent to No. 2<sup>1</sup>/<sub>2</sub> cans).

### (iii) “Flash 18” Sterilizers

In the “Flash 18” system, the sterilization operations are accomplished in a pressurized chamber, which is maintained at an overpressure of 18 psig (1.24 bar). The food product (usually viscous food) is heated to the thermal processing temperature either directly by steam injection or indirectly in a scraped surface heat exchanger (Chap. 6). Some of the “cooked” flavor, produced during heating at elevated temperatures, may be removed by short vacuum treatment, which reduces the product temperature by about 3 °C. The hot product is filled into (non-sterile) cans, which are sealed and held at the processing temperature for the prescribed process time. The sterilized cans are subsequently discharged to the atmospheric pressure and cooled with water sprays to the desired temperature.

Glass and flexible packages can be processed in the “Flash 18” system, provided that water cooling is applied with overriding air pressure, which prevents mechanical damage due to the high internal pressure of the containers during the initial stage of cooling.

### (iv) Flame Sterilizers

Flame sterilizers are used for some solid food products, which are packed without a fluid medium, like syrup or brine. Due to the high-temperature differences developed, very high heat transfer rates are obtained, reducing significantly the processing time and, thus, improving the product quality.

The cans are heated by direct exposure to the flames of gas burners at temperatures of about 1200–1400 °C. To prevent overheating and surface burning by the flames and combustion gases, the cans are rotated rapidly during heating (Casimir 1975; Halstrom et al. 1988; Fellows 1990). The flame sterilization process is applied to small food cans, which can withstand the high internal pressure, developed during thermal processing.

### 10.5.3 Continuous Flow (UHT) Sterilizers

#### 10.5.3.1 General Aspects

Continuous flow or ultrahigh-temperature (UHT) sterilization, followed by aseptic packaging, is used mainly to sterilize low-viscosity fluid foods, like milk and fruit juices. It is also applied to viscous foods, while application to particulate (two-phase) foods is under development.

UHT-sterilized food products are packaged in consumer containers (laminated cartons of various sizes) or in institutional and commercial-size packs of 55 US gallon (208 L) or larger (fruit purees, tomato concentrates, etc.). The packaged products can be stored at ambient temperatures for several months, sometimes up to 2 years.

UTH processing results in better-quality food products, due to the different kinetics of thermal inactivation of microorganisms and food nutrients. High temperatures favor nutrient retention, while destroying more effectively the spoilage microorganisms. As explained earlier in this chapter, when the sterilization temperature is increased by 10 °C, the lethality (rate of inactivation) of m.o. increases by ten times, while the destruction of nutrients (e.g., thiamine) and some sensory quality factors (e.g., color, flavor) increases only by a factor of (3).

The equipment used for UHT sterilization is similar to the HTST pasteurization system. The design of the UHT sterilizers is based on the assumption that all the required thermal lethality is delivered to the liquid food in the holding tube, neglecting the effects of the “come-up” and the early cooling periods. Such an assumption is valid for the direct (steam) heating of the liquid product, due to the very fast heating. However, in indirect heating systems, the contribution of preheating and cooling on the lethality is significant, amounting to significant overprocessing, which, in practice, is taken as a safety factor.

The UHT sterilization processes may range from 93 °C/30 s to 149 °C/2 s for acid and low-acid foods, respectively (Lewis and Heppell 2000), as shown in Table 10.2.

Figure 10.13 shows a simplified diagram of a UHT sterilizer of milk, using direct (steam) heating. The indirect heating UHT systems look like the HTST pasteurizer of Fig. 10.15.

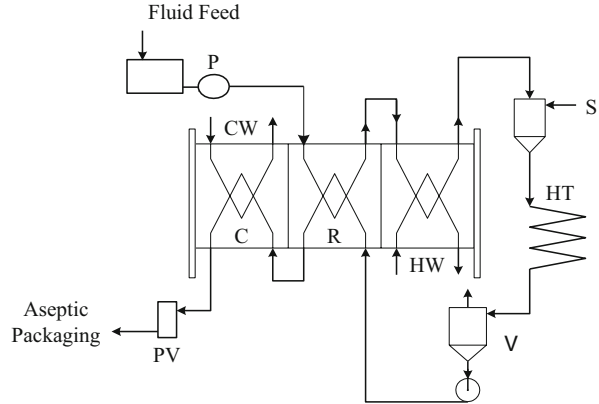
The UHT sterilizer can be divided into two sections, based on the central section of holding tube, i.e., the sterile (downstream) and the non-sterile (upstream)

**Table 10.2** Typical UHT sterilization processes (temperature  $T$ /time  $t$ )

Fluid food product	UHT process
Acid foods pH < 4.5	93–96 °C/30–15 s
Low-acid foods pH > 4.5	135–149 °C/30–1 s
Milk (USA)	138 °C/2 s
Milk (UK)	$T > 135$ °C/ $t > 1$ s
Flavored milks (UK)	$T > 140$ °C/ $t > 2$ s



**Fig. 10.13** Diagram of a UHT sterilizer using direct heating



sections. All parts of the downstream system should be sterilized by steam at 130 °C for 30 min, immediately before processing.

The UHT sterilization system operates at pressures above the atmospheric, and a back-pressure valve must be used to keep the fluid food at the high pressure before it exits the system at the packaging section.

As shown in the diagram of Fig. 10.13, the liquid food (milk) from the supply tank (T) is fed by a positive displacement pump (P) to the regenerator (R), where it is preheated by the sterilized product. Subsequently, it is preheated with hot water (HW) in a heat exchanger (H) and then heated directly to the sterilizing temperature by steam (S) injection or infusion (Chap. 6). The heated milk passes through the holding tube (HT) in the required process time ( $F_o$ ), and it is flashed into the vacuum chamber (V), from which it is pumped to the regenerator (R). Vacuum flashing removes the added water from the milk. The partially cooled milk is cooled further with cold water (CW) in a heat exchanger (C), before it is discharged through a back-pressure valve (PV) into the aseptic packaging section.

### 10.5.3.2 Pumping

Rotary positive displacement (PD) pumps are normally used for pumping the liquid food through the sterilization system. They can develop high pressures, and they are gentler than centrifugal pumps in mechanically handling sensitive foods, particularly if they contain suspended colloids or particles (Chap. 3). Slow-moving pumps of hygienic design, like lobe or progressive cavity pumps, which are not leaking at high pressures, are preferred.

Back-pressure pumps, instead of the usual back-pressure valves, may be installed before the packaging section of sterilizing systems, handling particulate liquid foods (Lewis and Heppell 2000).

### 10.5.3.3 Direct Heating

Direct heating is used to heat fast the liquid foods to the process temperature, improving the quality of the sterilized sensitive product (e.g., milk). The preheated liquid may be heated either by steam injection (introduction of steam into a stream of liquid) or by steam infusion (introduction of the liquid into a steam chamber), as discussed in Chap. 6. Heating rates of about 200 °C/s can be obtained, i.e., the liquid product can reach the sterilization temperature (e.g., 150 °C) in about 1 s.

Culinary (potable) steam should be used, since part of the steam condensate remains in the sterilized product. The directly heated product is diluted by the steam condensate, e.g., by 10–15 % for heating the liquid from 75 to 145 °C (Lewis and Heppell 2000). Most of the condensate, along with “cooked” milk flavors, is removed from the product by vacuum flashing.

Direct heating sterilizers are more complex and more costly than the indirect heating systems, but they produce a better-quality product. The regeneration efficiency of the direct heating systems is less (about 50 %) than the direct systems.

### 10.5.3.4 Indirect Heating

Indirect heating in the UHT sterilizers utilizes plate heat exchangers, tubular heaters, or scraped surface heat exchangers.

#### (i) Plate Heat Exchangers

The plate heat exchangers are used in low-viscosity applications, such as the UHT sterilization of fruit juices (e.g., 93 °C/30 s). The liquid product should not contain excessive suspended particles (e.g., fruit pulp), which can cause serious fouling of the heat transfer surfaces. The plate heat exchangers achieve the highest heat transfer coefficients, and they are the lowest cost heating system for a given sterilization capacity (Chap. 6).

#### (ii) Tubular Heat Exchangers

Tubular heat exchangers are, next to the direct heaters, the fastest heating units in UHT processing, an important advantage in sterilizing low-acid liquid foods at high temperatures. Small-diameter tubes and very high fluid velocities are used, resulting in high heat transfer coefficients ( $h$ ). The high fluid velocities reduce considerably the fouling rate of the heating tubes. Heating rates of 5 °C/s are obtained, i.e., heating of the liquid to 150 °C will take about 30 s (Chap. 6).

In heating pulp-containing food products, shell and tube heat exchangers with relatively large diameter are used for fast and economic operation. A typical

example is the heating of 20 ton/h of tomato pulp from 30 to 100 °C in a shell and tube heat exchanger. Using the analytical procedure of Example 6.2, and assuming heating with steam at 110 °C and an overall heat transfer coefficient  $U = 1500 \text{ W/m}^2 \text{ K}$ , the required heat transfer surface area will be 20 m<sup>2</sup>. If the internal tube diameter is taken as 50 mm (2 in.), the number of 6-m-long tubes will be about 20.

The tubes are used also in the form of coils, surrounded by a jacket for the heating medium (steam or hot water) or the cooling water. Due to the small diameters and the high fluid velocities, excessive pressure drops can develop in the system, e.g., 100 bar. For this reason, reciprocating (piston) pumps may be required for tubular heating systems. Cleaning of tubular heaters is necessary after 14–16 h of operation.

### (iii) SSHE Heaters

The scraped (or swept) surface heat exchangers (SSHE) are used for viscous and particulate fluid foods that cannot be handled in other heating systems. They can operate for a long time without substantial fouling (Chap. 6). The heating rate in viscous/particulate products is slow with residence time up to 3 min. The long residence time is needed for adequate heat penetration into large food particles (e.g., 25 mm), which is a basic requirement of efficient sterilization. Typical rotor diameters are 50–123 mm and operating speeds 150–600 RPM for heating and 80–200 RPM for cooling (Reuter 1993).

### (iv) Ohmic Heating

Ohmic heating, i.e., heating by electrical current of low frequency (50–60 Hz), is suitable for particulate foods, since both liquid and food particles can be heated at the same rate, overcoming the difficulty of slow heat conduction into the solid particles. Electricity is absorbed equally by both liquid and particles, provided that they have the same electrical conductivity (Chap. 6). Ohmic heating was developed by the UK Electricity Research Council, and it is commercialized by the APV Co. (Lewis and Heppell 2000).

The ohmic heater consists of four or more electrical housings, mounted in a vertical position with the product flowing upward and a vent valve to ensure that the column is always full. The design of the heater takes into account the increase of electrical conductivity with increasing temperature. A feed-forward process control system is required, since the common feedback system is not satisfactory.

The ohmic heating system can heat fast the food particles, and there is reduced risk for fouling. It is more energy efficient than microwave heating, which is difficult to apply at high temperatures and pressures. Development units of capacities up to 3 ton/h are used in various tests (Reuter 1993). Ohmic heating is reviewed in Chap. 6.

## (v) Aseptic Packaging

The UHT-sterilized food products are packaged aseptically in various laminated cartons for the consumers, in bags, or they are packed in large sterilized containers and tanks for commercial use. The aseptic packaging equipment and containers are discussed in Chap. 13.

### 10.5.4 Thermal Pasteurizers

#### 10.5.4.1 General Aspects

Pasteurization is a mild heat treatment, which is used to inactivate pathogenic and spoilage microorganisms and enzymes with minimal changes of food quality. The pasteurized food products have a limited storage life, in contrast to sterilized packaged foods, which can be stored at ambient temperatures for several months, or even years. Originally developed for the elimination of pathogenic microorganisms from milk and to protect the public health, pasteurization is now applied to several other food products, e.g., fruit juices, beer, liquid eggs, and ice cream.

The time–temperature combinations of the various pasteurization processes are based on the same principles with thermal sterilization, i.e., the kinetics of microbial/enzyme inactivation, the heat transfer rate, and the kinetics of food quality damage.

Table 10.3 shows some pasteurization processes for food products (Fellows 1990; Lewis and Heppell 2000).

The pasteurization time–temperature combinations may have small variations in the various countries, particularly in the case of fluid milk, due to public health concerns. Pasteurization is recently extended to all fruit juices to eliminate pathogenic bacteria, such as *Listeria* and *E. coli* 0157.

Pasteurization is normally carried out in hot water or steam heating systems, in a way analogous to thermal sterilization. It can also be accomplished using microwave energy, but the process cannot compete with the common thermal methods (Chap. 6).

Thermal pasteurization can be accomplished using in-container or continuous flow systems. Continuous operation is mainly used in both pasteurization systems.

**Table 10.3** Pasteurization processes for liquid food products

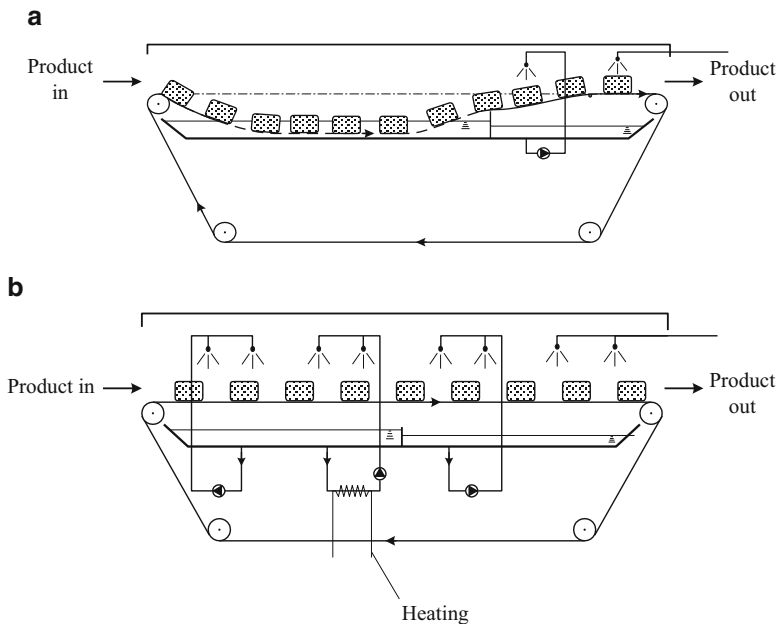
Food product	Temperature (°C/time)
Milk grade A (USA)	63/30 min, 77/15 s
Milk (UK)	63/30 min, 72/15 s
Fruit juices	85/15 s
Liquid eggs (USA)	60/3.5 min
Liquid eggs (UK)	64.4/2.5 min
Beer	65/20 min

### 10.5.4.2 In-container Pasteurizers

In-container pasteurizers are normally used for the thermal pasteurization of canned or bottled juices, high-acid fruits in syrup, beer, carbonated beverages, and some other foods, which are subsequently stored at refrigeration temperatures. Temperatures lower than 100 °C are applied, i.e., the equipment is operated at atmospheric pressure. The food containers can be heated by hot water sprayed over the product, by dipping in a hot water bath or by steam. In all cases, cooling is achieved by cold water. Carbonated beverages and glass containers are heated and cooled slowly for avoiding thermal shock.

Figure 10.14 shows schematically two common tunnel pasteurizers, one with a hot water bath and the other with recirculating hot water sprays. The bath-type pasteurizing tunnels have conveyor belts of 3–4 m wide, they are 10, 20, or 30 m long, and they can pasteurize 3000, 7000, or 12,000 No. (1/1) EU (No. 2<sup>1</sup>/<sub>2</sub> US) cans or equivalent number of glass containers in 30 min. If steam is used, the pasteurization time is 5 min shorter and the capacity increases by about 10 %.

In the spray water tunnel, the packaged product travels at a slow speed on the belt, and it is heated to the process temperature with sprays of hot water. The food containers remain at the desired temperature (e.g., 65 °C) for the prescribed time, e.g., 30 min, and then they are cooled with water sprays at room temperature, before they are discharged from the tunnel. The total residence time in the tunnel may be



**Fig. 10.14** Tunnel pasteurizers for food containers. (a) Water bath and (b) water sprays

up to 1 h. Two parallel belts may be used, one over the other, to increase tunnel capacity. The hot and cold water are circulated through centrifugal pumps, located at the bottom of the tunnel.

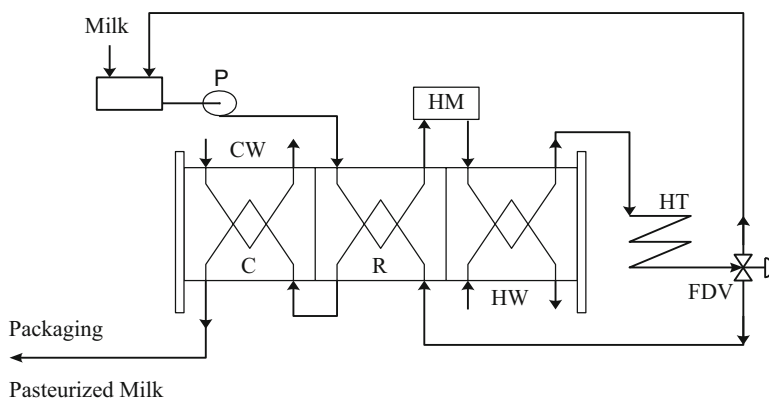
### 10.5.4.3 Continuous Flow (HTST) Pasteurizers

The early batch pasteurizers, used in the dairy industry, have been replaced almost entirely by continuous flow pasteurizers. The batch “holder” or “vat” pasteurizers consisted of a tank (vat), which was filled with the milk, heated to the desired temperature, and held for the specified time before cooling and filling the containers (bottles).

The continuous pasteurizers use effective heat exchangers to heat and cool the liquid food, while recovering most of the heat used in the system. The plate heat exchangers, described in Chap. 6, are extensively used in food pasteurizing operations, involving low-viscosity food liquids. In some cases, other types of heat exchangers may be needed to pasteurize viscous fluid foods and pulps, such as the scraped surface and the tubular units. Figure 10.15 shows diagrammatically the principal parts of a high-temperature short-time (HTST) pasteurizer.

The HTST pasteurization system, shown in Fig. 10.14, is typical of the widely used milk pasteurizers (Lewis and Heppell 2000). It is basically a plate heat exchanger system, consisting of the following sections:

1. The supply tank, equipped with a float to regulate the flow of the liquid.
2. A positive displacement or a centrifugal pump, with flow control, for moving the liquid through the system. In milk pasteurization, a homogenizer may be used also as pumping equipment.
3. The preheater/regenerator heat exchanger which heats the raw feed by the outgoing pasteurized product.



**Fig. 10.15** Diagram of a continuous HTST pasteurizer. *P* pump, *HM* homogenizer, *HW* hot water, *HT* holding tube, *FDC* flow diversion valve, *CW* cooling water, *C* cooler, *R* regenerator

4. The heating section, where the liquid is brought to the pasteurization temperature by hot water, which has been heated by direct steam injection at a temperature (2–10 °C) higher than the pasteurization temperature.
5. The holding tube of proper length to affect the minimum process time; the flow diversion valve, which returns to the supply tank any under-processed liquid; and the cooling section for cooling the pasteurized product below 10 °C, before it is filled into sterilized containers.

The heat recovery in the regeneration section of the system is measured by the regeneration efficiency (RE), which is defined as the ratio of the heat recovered to the maximum possible recoverable heat, and it is calculated from the equation

$$(\text{RE}) = (T_2 - T_1)/(T_3 - T_1) \quad (10.27)$$

where  $T_1$  and  $T_2$  are the temperatures of the unpasteurized liquid at the entrance and exit of the regeneration section, respectively, and  $T_3$  is the temperature of the pasteurized liquid at the entrance of the same section. A well-operated HTST pasteurizer may reach a regeneration efficiency of 90 %.

The plates of the heat exchangers, especially in the regeneration section, should be tested regularly for leaks of the gaskets and for mechanical integrity, which might result in contamination of the pasteurized liquid (milk) with unpasteurized liquid. Leaks in the other sections of the HTST system might dilute the food liquid with water. No insulation is required, if the system is operated below 100 °C.

Fouling of the heat exchangers with deposits is not a serious problem, but the whole unit should be cleaned and sanitized regularly, e.g., every 16–20 h of continuous operation. The design of the holding tube should be based on efficient and hygienic operation. Fouling of the holding tube by deposits may reduce its cross-sectional area, increasing the velocity of the liquid, and, therefore, reducing the residence time. As a result, the food liquid may be underpasteurized.

Pasteurization process control is necessary to keep the temperature very close to the desired process temperature, usually  $\pm 0.5$  °C. It should be noted that at the pasteurization temperature, a change of 1 °C would change the lethality by 25 % (for  $z = 10$  °C). To compensate for a small temperature drop in the holding tube, especially for long residence time, the liquid is heated to a higher temperature.

The minimum residence time in the holding tube is calculated on the basis of the maximum velocity, which is assumed to be  $2 \times (u_{\text{avg}})$  for laminar (streamline) flow and  $1.25 \times (u_{\text{avg}})$  for turbulent flow, where  $(u_{\text{avg}})$  is the average velocity (see (10.25)).

The efficiency of pasteurization is checked periodically by biochemical or microbiological tests, such as the alkaline phosphatase (ALP) test, used extensively for milk and dairy products (Lewis and Heppell 2000). The enzyme phosphatase is slightly more heat resistant than microbial pathogens, like mycobacterium tuberculosis, which must be inactivated thoroughly according to public health regulations. A positive ALP test means underpasteurized milk, which may have resulted from contamination of pasteurized milk with raw milk.

The main problems of milk HTST pasteurizers are as follows: (1) The danger of post-pasteurization contamination, which may start after the liquid product exits the holding tube. Special attention should be given to the cleaning and sanitizing of the equipment and (2) The growth of thermoduric (heat-resistant) bacteria, like *B. aureus*, which can grow at refrigeration temperatures and cause food poisoning. Good hygienic conditions can eliminate this m.o. from raw milk.

Some heat-resistant enzymes may survive the pasteurization process, such as peroxidase and lipase. The enzyme lactoperoxidase in milk is inactivated at 80 °C/15 s, which is a more severe process than normal milk pasteurization. Thus, detection of lactoperoxidase in pasteurized milk is an indication that the product has not been over-pasteurized (“high-temperature pasteurized milk”).

Fruit juices (pH < 4.5) are pasteurized at 85 °C/15 s or 95 °C/2 s to inactivate the spoilage microorganisms (yeasts, molds, lactic, and acetic acid bacteria) and the undesirable enzymes. Citrus juices require higher-temperature pasteurization in order to inactivate the pectic enzymes, which destroy the fruit colloids or “cloud.”

### 10.5.5 Thermal Blanchers

Blanching is a short heat treatment used primarily to inactivate deteriorative enzymes in most vegetables and some fruits, prior to further processing (freezing, dehydration, and canning). In addition, blanching has some other beneficial effects on the processed foods, such as expulsion of air (oxygen), reduction of microorganisms, and improvement of texture and quality of the product.

The blanching time–temperature process is estimated using the basic principles of thermal processing, i.e., inactivation kinetics and heat transfer ( $D$  and  $z$  factors). Deteriorative enzymes include lipooxygenase, polyphenoloxidase, polygalacturonase, chlorophyllase, catalase, and peroxidase. The last enzyme is the most resistant in fruit/vegetable materials, and it is used as an indicator of the blanching efficiency (Luh and Woodroof 1988; Fellows 1990).

Like sterilization, blanching is optimized by considering the minimum time to inactivate the undesirable enzymes with the minimum damage to the quality of the product, keeping the cost of the operation at a minimum. The operating cost includes the energy used and the pollution of water, discharged to the environment. The food quality is evaluated by the loss of nutrients, notably vitamin C, and organoleptic characteristics, such as color, texture, and flavor.

Blanching is normally affected at atmospheric pressure and temperatures 88–98 °C, using steam, hot water, or microwave energy as heating media.

Steam blanching has the advantages of smaller losses of water-soluble food components and production of less waste. However, steam blanching is less effective for some products, such as leafy vegetables, and it is more expensive than water blanching. Steam blanchers consist of a belt or chain conveyor, which transports slowly the vegetable product through the steam chamber, followed by water or air cooling. The residence time in the blancher depends mainly on the size of the vegetable pieces, varying from 2 to 10 min.

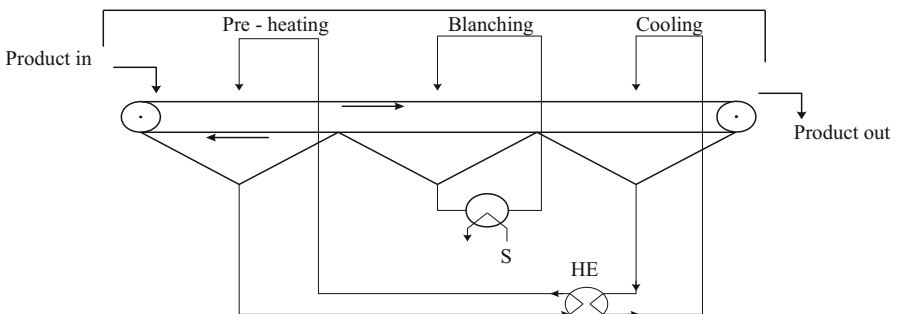


Several designs of hot water blanchers are used, based on the efficient use of water and energy:

1. The rotary hot water blancher consists of cylindrical mesh drum, partially submerged in hot water, rotating slowly on a spiral reel, and moving forward the food pieces by a series of flights (Downing 1996). The residence time is controlled by the rotational speed (RPM).
2. The immersion hot water blancher transports the vegetable material through a hot water tank by a conveyor belt, moving at the required speed.
3. The pipe or hydraulic blancher, in which the food material is suspended in water, heated to the blanching temperature, and pumped through a holding tube to receive the required process time–temperature combination.
4. The IQB (individual quick blanching) system is a three-stage blanching process, in which the vegetable pieces are heated rapidly in thin layers by steam, followed by holding in a deep bed, where temperature equilibration takes place, after which the material is cooled down (Fellows 1990). The method has the advantages of short residence time, improved yield, and reduced wastewater.
5. The recirculating water blancher consists of a conveyor belt, loaded with the product, which passes through three sections, i.e., preheating, blanching, and cooling (Fig. 10.16). The hot water for blanching is heated by steam and is recirculated through the central section. The recirculating preheat water is heated in a heat exchanger by the recirculating cooling water. The heat recovery of the system is 70 %, the water consumption is about 1 m<sup>3</sup>/10 ton of product, the steam consumption is very low (16.7–20 kg product/kg steam), and the wastewater effluent is negligible (Hallstrom et al. 1988; Fellows 1990) (Fig. 10.16).

### 10.5.6 Hygienic Considerations

Hygienic requirements of thermal processing equipment are very strict, since contamination may result in spoilage and health hazards to the consumers. For these reasons, public health regulations and good manufacturing practices should be



**Fig. 10.16** Diagram of a recirculating water blancher. *S* steam, *HE* heat exchanger

followed thoroughly. Retorts should be maintained and inspected regularly, and operators should be certified (Kutsuyama 1993; Troller 1993).

In milk pasteurizers, cooling water should be tested twice yearly for excessive numbers of coliform bacteria. A small pressure difference (0.15–0.30 bar) should be maintained between the pasteurized and raw milk to prevent contamination. A similar pressure differential should exist between the milk and the cooling/heating medium.

Although blanchers and cookers, operated at temperatures above 60 °C, should have no problems of microbial growth, excessive foaming may cause contamination in areas of the equipment, away from the product/blanching surfaces. Cookers should be vented properly to remove steam and prevent undesirable condensation (see also CIP).

*Example 10.1* Design the holding tube of a UHT aseptic sterilizer for homogenized milk at 135 °C at a flow of 1800 kg/h.

### Data and Assumptions

The homogenized milk is heated up to 100 °C through the regeneration and heating sections of a plate heat exchanger system, similar to the one described in the HTST pasteurization of orange juice of Example 6.1. The milk is heated further by steam injection to 135 °C, and it is maintained at this sterilization temperature for the required time, after which it is flashed to remove the off-flavors and it is cooled in the regeneration and cooling sections (see Fig. 10.10).

The density of the milk is assumed to be  $\rho = 1000 \text{ kg/m}^3$  and its viscosity  $\eta = 0.3 \text{ mPa s}$ . The mean velocity in the holding tube (HT) is assumed to be  $u = 0.5 \text{ m/s}$ .

### Calculations

The flow rate of the milk in the HT will be  $m = 1800/3600 = 0.5 \text{ kg/s}$ . The (inside) tube diameter ( $d$ ) is fixed, once the flow rate ( $m$ ) and the mean velocity ( $u$ ) are chosen:  $m = (\pi d^2/4)u\rho = (3.14d^2 \times 0.5 \times 1000)/4 = 0.5 \text{ kg/s}$  and  $d^2 = 0.00127 \text{ m}^2$ , or  $d = 0.036 \text{ m} = 36 \text{ mm}$  (1½ in.). The Reynolds number in the HT will be  $Re = (0.5 \times 0.036 \times 1000)/0.0003 = 60,000$ , i.e., the flow is highly turbulent. The length of the holding tube ( $L$ ) is calculated from (10.24),  $L = (F_T)u_{\max}$ , where the maximum velocity in the tube (turbulent flow) is  $u_{\max} = 1.25u$ , i.e.,  $u_{\max} = 1.25 \times 0.5 = 0.625 \text{ m/s}$ . The sterilizing value at 135 °C ( $F_{135}$ ) is calculated from the assumed ( $F_{121}$ ) = 4.5 min using (10.5):  $\log(F_{121}/F_{135}) = 135 - 121/10$ , assuming  $Z = 10$  °C. Thus,  $\log(F_{121}/F_{135}) = 1.4$ ,  $(F_{121}/F_{135}) = 25$ , and  $F_{135} = F_{121}/25 = 4.5/25 = 0.64 \text{ min} = 9.84 \text{ s}$ . The length of the HT will be  $L = 9.84 \times 0.625 = 6.15 \text{ m}$ .

### Heat Losses from the Holding Tube

The heat losses from the holding tube (HT) may reduce the sterilization temperature (135 °C), affecting the efficiency of the process.

The temperature at the outside surface of the HT is assumed to be approximately 135 °C, since the thermal resistances of the tube wall and the milk/tube interface are negligible (no fouling resistance is considered).

The natural convection heat transfer coefficient ( $h$ ) at the tube/air interface will be (6.12):  $h = 1.42(\Delta T/d)^{0.25}$ , where  $\Delta T = 135 - 20 = 115$  °C and  $d$  (outside tube diameter) = 50 mm = 0.05 m. Therefore,  $h = 1.42(115/0.05)^{0.25} = 9.8$  W/m<sup>2</sup> K. The outside surface of the HT will be  $A = 3.14 \times 0.05 \times 6.15 = 0.97$  m<sup>2</sup>. The heat loss due to natural convection from the HT will be  $q = hA\Delta T = 9.8 \times 0.97 \times 115 = 1093$  W.

Assuming that the specific heat of the milk is 3800 J/kg K, the temperature drop, due to heat loss of 1093 W, will be  $\Delta T = (1093)/(0.5 \times 3800) = 0.6$  °C.

This small temperature drop can be compensated by heating the milk to 135.6 °C before entering the holding tube and avoiding the need for thermal insulation of the tube.

### Note

Thermal radiation losses from the holding tube at 135 °C are considered negligible, compared to the heat convection losses. Radiation losses become important at higher temperatures.

## References

- Ball CO, Olson FCW (1957) Sterilization in food technology. McGraw-Hill, New York
- Britt IJ, Tung MA, Yao Z, Paulson AT (1997) Heat transfer and temperature distribution in pasteurizing processes for packaged foods. In: Engineering and food at ICEF 7 part 2
- Casimir DI (1975) Flame sterilization. CSIRO Food Res Q (Australia) 35:34–39
- Chuse R, Eber SM (1984) Pressure vessels: ASME code simplified. McGraw-Hill, New York
- Coffelt RJ, Winter FH (1973) Evaporative cooling of blanched vegetables. J Food Sci 38(1):89–91
- Dietrich et al (1977) Freezing vegetables. In: Desrosier NW, Tressler DK (eds) Fundamentals of food freezing. AVI, Westport
- Downing DL (ed) (1996) A complete course in canning, 13th edn. CTI, Timonium, Books I, II, and III [http://eproofing.springer.com/books/mainpage.php?token=SZV-TV\\_pH48J0svXqHJmTNJkUPrmu8-Z5GHKK9XmAa8](http://eproofing.springer.com/books/mainpage.php?token=SZV-TV_pH48J0svXqHJmTNJkUPrmu8-Z5GHKK9XmAa8)
- FDA Title 21 (2010) Guide of federal regulations. Superintendent of Documents, U.S. Government Printing Office, Washington
- Fellows PJ (1990) Food processing technology. Ellis Horwood, London
- Gould WA (1992) Tomato production, processing, and technology. CTI, Timonium
- Gould WA (1994) CGMP's/food plant sanitation. CTI, Timonium
- Gould WA (1996) Unit operations for the food industries. CTI, Timonium
- Hallstrom B, Skjoeldebrand C, Tragardh C (1988) Heat transfer and food products. Elsevier Applied Science, London
- Hayakawa K-I (1977) Mathematical methods for estimating proper thermal processes and their computer implementations. Adv Food Res 23:73–141
- Hayakawa K-I (1978) A critical review of mathematical procedures for determining proper heat sterilization processes. Food Technol 32(3):59
- Heiss R, Eichner K (1996) Haltbarmachen von Lebensmitteln. Springer, Berlin
- Heldman DR, Hartel RW (1997) Principles of food processing. Chapman and Hall, New York
- Hendrickx M, Maesmans G, de Cordt S, Tobback P (1994) Evaluation of the integrated time-temperature effect of thermal processes on foods. In: Yano T, Matsuno R, Nakamura K (eds)

- Developments in food engineering part 2. Blackie Academic and Professional, London, pp 692–694
- Kessler HG (1981) Food engineering and dairy technology. Verlag A. Kessler, Freising
- Kutsuyama AM (1993) Principles of food processing sanitation. Food Processors Institute, Washington
- Larkin JW (1997) Continuous multiphase aseptic processing of foods. *Food Technol* 10(10):43–44
- Lewis M, Heppell N (2000) Continuous thermal processing of foods. Aspen, Gaithersburg
- Liu S, Pain J-P, Fryer PI (1994) Flow of solid-liquid food suspensions. In: Yano T, Matsuno R, Nakamura K (eds) Developments in food engineering part 2. Blackie Academic and Professional, London, pp 752–754
- Loncin M, Merson RL (1979) Food engineering. Academic, New York
- Luh BS, Woodroof JG (1988) Commercial vegetable processing, 2nd edn. Van Nostrand Reinhold, New York
- NFPA (1982) Thermal processes for low-acid foods in metal containers, 12th edn. National Food Processors Association, Washington, Bulletin 26-L
- NFPA (1984) Thermal processes for low-acid foods in glass containers, 5th edn. National Food Processors Association, Washington, Bulletin 30-L
- Ohlsson T (1994) Progress in pasteurization and sterilization. In: Matsuno R, Nakamura K, Yano T (eds) Developments in food Engineering part 1. Blackie Academic and Professional, London, pp 18–23
- Pham QT (1987) Calculation of thermal process lethality for conduction-heated canned foods. *J Food Sci* 52:967
- Pham QT (1990) Lethality calculation for thermal processes with different heating and cooling rates. *Int J Food Sci Technol* 25:448
- Rahman S (1995) Food properties handbook. CRC Press, New York
- Ramaswamy HS, Singh RP (1997) Sterilization process engineering. In: Handbook of food engineering practice. CRC Press, New York, pp 37–69
- Ramesh MN, Wolf W, Tevini D, Bognar A (2006) Microwave blanching of vegetables. *Food Sci* 67(1):390–398
- Rao MA (1999) Rheology of fluid and semisolid foods. Aspen, Gaithersburg
- Reuter H (ed) (1993) Aseptic processing of foods. Technomic, Lancaster
- Sancho MF, Rao MA (1992) Residence time distribution in a holding tube. *J Food Eng* 15:1–19
- Saravacos GD, Maroulis ZB (2001) Transport properties of foods. Marcel Dekker, New York
- Sastry SK (1994) Continuous sterilization of particulate foods by ohmic heating. In: Yano T, Matsuno R, Nakamura K (eds) Developments in food engineering part 2. Blackie and Professional, London, pp 769–771
- Sastry SK (1997) Measuring residence time and modeling the aseptic processing system. *Food Technol* 10(10):44–46
- Schormueller J (1966) Die Erhaltung der Lebensmittel. F. Enke Verlag, Stuttgart
- Simpson R, Revecó J, Rozas C (1997) Criteria for optimum design and operation of canned food plants: batch processing. In: Jowitt R (ed) Engineering and food at ICEF 7. Supplement. Sheffield Academic Press, Sheffield, pp SK17–SK20
- Stoforos NG (1992) An overview of aseptic processing of particulate foods. In: Charalambous G (ed) Food science and human nutrition. Elsevier, Amsterdam, pp 663–677
- Stumbo CR (1973) Thermobacteriology in food processing, 2nd edn. Academic, New York
- Swartzel KR (1997) The time is now for the U.S. to capitalize on aseptic processing and packaging of particulate foods. In: Frontiers on food engineering—proceedings of CoFE 5. AIChE, New York, pp 187–190
- Teixeira A (1992) Thermal process calculations. In: Heldman DR, Lund DB (eds) Handbook of food engineering. Marcel Dekker, New York, pp 37–69
- Teixeira AA, Balaban MO (1997) Estimation of thermal death rate constants from inoculated pea puree undergoing thermal processing. In: Jowitt R (ed) Engineering and food at ICEF 7 part 2. Sheffield Academic Press, Sheffield, pp K57–K60

- Teixeira AA, Shoemaker CF (1989) Computerized food processing operations. Van Nostrand Reinhold, New York
- The Almanac of the canning, freezing, and processing industries. Annual publication. E.E. Judge and Sons, Westminster
- Thijssen HAC, Kerkhof PJAM, Liefkens AAA (1978) Shortcut method for the Calculation of sterilization yielding optimum quality retention for conduction heating of packed foods. *J Food Sci* 43:1096–1101
- Weng Z, Park D (1997) Lethality-based control of thermal processes for shelf stable foods in batch and hydrostatic sterilizers. In: *Frontiers on food engineering—proceedings of CoFE 5*. AIChE, New York, pp. 153–159
- Williams A, Adams JB (1997) A time-temperature integrator to quantify the effect of thermal processes on food quality. In: Jowitt R (ed) *Engineering and food at ICEF 7 part 2*. Sheffield Academic Press, Sheffield, pp K9–K12

# Chapter 11

## Mass Transfer Equipment

### 11.1 Introduction

Mass transfer operations are used in several food process industries in various physical separations of components from liquids or solids for recovering valuable products, or for removing undesirable food or nonfood components. They differ from mechanical separations (Chap. 5) in the controlling transport mechanism, which is mass transfer at the molecular level, while mechanical separations are based on differences in macroscopic size, shape, and density of solid particles or pieces.

Separation of components from mixtures at the molecular level requires special devices (systems) and significant amounts of energy. Separation of, e.g., salt from seawater requires a system (evaporation, crystallization, or pressure membrane) and supply of adequate energy, while dissolving salt in water is a spontaneous process, increasing the entropy of the system, according to the second law of thermodynamics (King 1982).

Typical mass transfer operations, used in food processing, are (1) distillation, used in recovering volatile components from liquids; (2) solvent extraction or leaching, used in recovering solutes from liquids or solids; (3) gas absorption for absorption or removal of gas solutes in liquids; (4) adsorption and ion exchange for removing undesirable components from fluids; and (5) crystallization for separating dissolved salts from solutions. In all these operations, the controlling mechanism is a mass transfer within the liquid or solid phase and at the phase boundaries (Table 11.1).

In some mass transfer operations, like distillation, heat transfer is involved, but it does not constitute a rate-controlling process. In some other transfer operations, both heat and mass transfer are involved, e.g., evaporation (Chap. 7) and drying (Chap. 8), which are traditionally treated as heat transfer operations, since heat transfer is usually the rate-controlling mechanism.

**Table 11.1** Mass transfer operations (separations) in food processing

Operation	Basis of separation	Applications
Distillation	Volatility	Recovery of volatiles
Extraction/leaching	Solubility	Sugar from beets, oil from seeds
Absorption	Solubility	Absorption of O <sub>2</sub> , CO <sub>2</sub>
Adsorption ion exchange	Sorption capacity	Removal of components
Crystallization from solution	Solubility	Granular sugar, salt

In addition to the mass transfer operations listed in Table 11.1, there are some newer separation processes applied to food processing, notably membrane separations (ultrafiltration and reverse osmosis) and supercritical fluid (carbon dioxide) extraction. These operations are treated as novel food processes in Chap. 12.

Mass transfer operations are based on two fundamental physical processes, i.e., phase equilibria and mass transfer. Both processes are controlled by molecular forces, and they are evaluated and predicted by molecular dynamics or empirical correlations (Reid et al. 1987).

Phase equilibria indicate the ultimate concentrations of the components of two phases, if left long enough to reach thermodynamic equilibrium, i.e., when the activity of each component is equal in both phases. Vapor/liquid equilibria are used in the analysis of distillation, liquid/liquid and liquid/solid equilibria are needed in extraction and leaching processes, and gas/solid and liquid/solid equilibria are essential in adsorption and ion exchange operations.

Phase equilibria are calculated by equating the partial pressure of the various components in the two phases. The partial pressure of a component in ideal liquid solutions is proportional to its concentration and vapor pressure (Raoult's law). In nonideal solutions, the partial pressure is also proportional to its activity coefficient, which is usually higher than one. Aqueous solutions of volatile components have very high activity coefficients, making easier the removal of food volatiles during distillation. Empirical equations have been developed for the estimation of activity coefficients in complex mixtures, using computer techniques.

Mass transfer rates in separation processes are important for the quick attainment of thermodynamic equilibrium. Mass transfer in gases and liquids is fast, due to the molecular motion, and in liquids, it can be enhanced by mechanical mixing or high flow velocity (turbulence).

Mass transfer in solid foods is slow, and it is controlled by molecular diffusion or other transport mechanisms (Gekas 1992). The effective diffusivity of water and solutes in foods depends on the molecular, micro-, and macro-structure of the solid matrix (Aquilera and Stanley 1999; Saravacos and Maroulis 2001). Empirical models, based on regression analysis of experimental data, have been suggested to estimate the mass diffusivity in various food materials.

The equipment used in mass transfer operations has been developed mainly in the chemical and petrochemical industries. Well-designed equipment is available for mass transfer operations involving gases and liquids, e.g., distillation columns and absorption towers. Equipment for solid/fluid operations, like leaching,

adsorption, and ion exchange, has been developed from empirical and industrial experience, and it is specific for a given separation system and product (Schweitzer 1988; Walas 1988; Wankat 1990; Perry and Green 1997).

Equipment used in food mass transfer operations is basically similar to the established chemical engineering equipment, with particular attention to hygienic (sanitary) design and to corrosion, due to the presence of free water in almost all food products.

## 11.2 Distillation Equipment

Stripping or exhausting is the removal of a volatile component from a mixture by steam or gas (air), usually in a multistage column. Distillation is the recovery of a valuable component by vaporization and condensation, usually in several stages. Distillation usually combines stripping with fractionation of volatile components in a column, consisting of both stripping and fractionation sections.

The design and operation of stripping and fractionation columns requires vapor/liquid equilibrium data for the estimation of the theoretical separation stages and hydraulic and mass transfer data for the design and efficient operation of the column.

### 11.2.1 Vapor/Liquid Equilibria

In ideal solutions, the partial pressure ( $p_i$ ) of a component ( $i$ ) in the liquid phase is given by the Raoult's law:

$$p_i = x_i p_i^{\circ} \quad (11.1)$$

where ( $x_i$ ) is the mole fraction (concentration) of ( $i$ ) and ( $p_i^{\circ}$ ) is the vapor pressure of ( $i$ ) at the given temperature. The ( $p_i^{\circ}$ ) is taken from tables or is calculated from the Antoine equation as a function of the temperature (Reid et al. 1987).

#### 11.2.1.1 Activity Coefficients and Relative Volatilities

Food (aqueous) mixtures (solutions) of volatile components are highly nonideal, and the partial pressure ( $p_i$ ) is given by the equation:

$$p_i = \gamma_i x_i p_i^{\circ} \quad (11.2)$$

where ( $\gamma_i > 1$ ) is the activity coefficient of ( $i$ ) in the mixture.



The vapor phase in food systems can be considered as ideal, i.e., the Dalton law is applicable:

$$p_i = y_i P \quad (11.3)$$

where ( $y_i$ ) is the mole fraction (concentration) in the vapor phase and ( $P$ ) is the total pressure.

The assumption of an ideal vapor phase is reasonable, since most food processing operations are carried out at the atmospheric pressure or in vacuum. Nonideal gas phases characterize high-pressure operations (e.g.,  $P > 10$  bar), such as supercritical fluid extraction.

At equilibrium, the partial pressure of a component ( $i$ ) is the same in both phases, i.e.,:

$$y_i P = \gamma_i x_i p_i^\circ \quad (11.4)$$

or

$$v_i = (\gamma_i \pi_i^\circ / \Pi) \chi_i = K_i \chi_i \quad (11.5)$$

where ( $K_i$ ) is the partition coefficient of component ( $i$ ) between the two phases. It should be pointed out that, for a given system, ( $K_i$ ) is directly proportional to the activity coefficient ( $\gamma_i$ ). The activity coefficients are preferred in most distillation applications, since they can be calculated and correlated, using computer techniques.

The relative volatility of component ( $i$ ) to component ( $j$ ) is defined by the equation:

$$\alpha_{ij} = (y_i/x_i)/(y_j/x_j) = (y_i/y_j)(x_j/x_i) \quad (11.6)$$

For ideal mixtures,

$$\alpha_{ij} = p_i^\circ / p_j^\circ \quad (11.7)$$

For nonideal mixtures at relatively low pressures (ideal vapor phase),

$$\alpha_{ij} = (\gamma_i/\gamma_j)(p_i^\circ/p_j^\circ) = (K_i/K_j) \quad (11.8)$$

The vapor/liquid equilibrium data at a constant pressure are usually plotted in ( $y$ - $x$ ) diagrams, according to the equilibrium equation:

$$y_i = (\alpha_{ij} x_i) / [1 + (\alpha_{ij} - 1) x_i] \quad (11.9)$$

### 11.2.1.2 Nonideal Mixtures and Azeotropes

The activity coefficients of the various components of a nonideal mixture are determined experimentally or correlated in semiempirical or empirical relations. Various types of equilibrium stills are used to measure the concentrations of the vapor and liquid phases ( $y_i, x_i$ ) from which the activity coefficient ( $\gamma_i$ ) is calculated, according to (11.2). The activity coefficients are strong functions of concentration of the liquid mixtures, reaching unity (1) at concentrations ( $x_i = 0$ ) and ( $x_i = 1$ ).

Empirical correlations, used to correlate the activity coefficients, include the Margules (two-parameter), the van Laar (two-parameter), and the Wilson ( $n$ -parameter) equations. The Wilson equation and its modifications (e.g., the NRTL equation) are suited for computer calculations of phase equilibria of multicomponent mixtures. A generalized correlation for multicomponent equilibrium data is the UNIQUAC (Universal Quasi-Chemical) equation. The UNIFAC (Universal Function Activity Contribution) method is based on the contributions of certain structural parameters of the components of the liquid mixture, like relative volume and surface area, which are given in thermodynamic tables (Reid et al. 1987).

Phase equilibrium data on multicomponent mixtures of chemicals and petrochemicals are available in data banks, like the DECHEMA collection (Gmehling et al. 1984).

In multicomponent liquid mixtures, like chemicals and petroleum, equilibrium data are often available in the form of the partition coefficient ( $K_i = y_i/x_i$ , (11.5)) in various tables and diagrams. A useful application of ( $K_i$ ) is the estimation of the bubble and dew points for mixtures at a constant pressure. The bubble point of liquid mixture is the temperature at which the liquid begins to boil, at which the following equation applies (Perry and Green 1997):

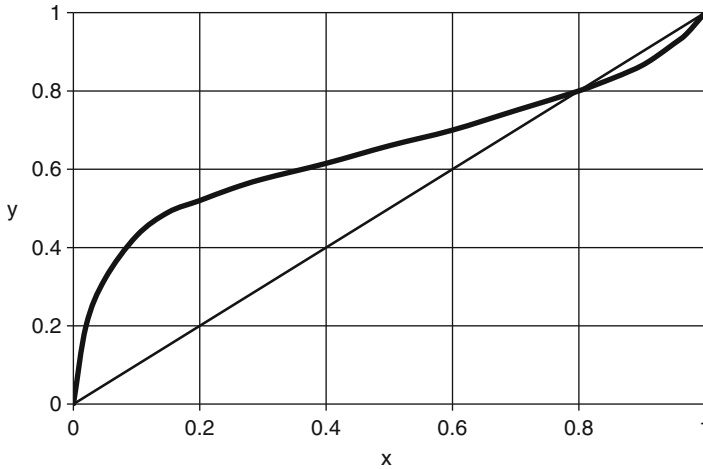
$$\sum K_i x_i = 1 \quad (11.10)$$

By analogy, the dew point of a vapor mixture, at a constant pressure, is the temperature at which the mixture begins to condense, and the following equation applies:

$$\sum (y_i/K_i) = 1 \quad (11.11)$$

Some highly nonideal mixtures, like ethanol/water, form azeotropes, i.e., the mole fraction (concentration) of a component is identical in both vapor and liquid phases, and the equilibrium curve (11.9) crosses the diagonal ( $y = x$ ). The ethanol/water azeotrope at atmospheric pressure is  $y_i = x_i = 0.894$  (mole fraction), or 95 % ethanol by volume, with a minimum boiling point of 78.1 °C. Figure 11.1 shows a ( $y-x$ ) diagram for ethanol/water.

Partially soluble components, like organic aroma compounds in water, form azeotropes, with the equilibrium line becoming horizontal and crossing the



**Fig. 11.1** Vapor/liquid equilibrium diagram of ethanol/water at atmospheric pressure. Azeotrope at  $y=x=0.894$

diagonal. At low concentrations, the partially soluble components are very volatile in water, due to the strong intermolecular forces exerted. For purposes of vapor/liquid equilibria, all organic components are considered partially soluble in water, even such “insoluble” compounds like hydrocarbons.

In a partially soluble system, two liquids are formed, e.g., a lower water layer (W), saturated with the organic component (A), and an upper layer of the organic component (A), saturated with water (W). At equilibrium, the partial pressure of each component is the same in the double-layer liquid and in the vapor space above. The relative volatility of the partially soluble component (A) in the water layer can be calculated, assuming an ideal vapor phase (Dalton law, (11.3)), and that Raoult’s law (11.1) is applicable to both liquid phases for the solvent, i.e., water and organic component in the lower and upper phases, respectively. Under these assumptions, the following approximate equation is derived for the relative volatility  $\alpha_{AW}$  (Robinson and Gilliland 1950):

$$\alpha_{AW} = (x_A^A/x_A^W)(p_A^0/p_W^0) \quad (11.12)$$

where  $(x_A^A, x_A^W)$  are the mole fractions of (A) in the phases (A) and (W), respectively, and  $(p_A^0, p_W^0)$  are the vapor pressures of (pure) components (A) and (W) at the equilibrium temperature (the water temperature in very dilute mixtures).

From (11.10), it follows that the relative volatility of a partially soluble component in water (very small  $x_A^W$ ) can be high, even for high-boiling components, i.e., compounds of vapor pressure lower than that of water ( $p_A^0 < p_W^0$ ).

### 11.2.1.3 Volatile Food Aromas

The volatile components (aromas) of foods are organic compounds, usually partially soluble in water, which form highly nonideal aqueous solutions. The high activity coefficients of these compounds in very low (ppm) concentrations (infinite dilution activity coefficients) vary widely, depending on their molecular structure and the interactions with the water and the other food components (notably sugars).

Figure 11.2 shows the activity coefficients ( $\gamma_i$ ) of some alcohols and esters, related to food aroma, as a function of the sucrose concentration in dilute aqueous solutions. The ( $\gamma_i$ ) values range from about 4 (ethanol) to above 1000 (ethyl butyrate). The experimental data shown in Fig. 11.2 are compared with the modified UNIFAC method (Saravacos et al. 1990).

The activity coefficients increase significantly, when the sugar concentration is increased, evidently due to a “salting-out” effect. Similar values of activity coefficients were reported by Bruin (1969) and Sancho et al. (1997).

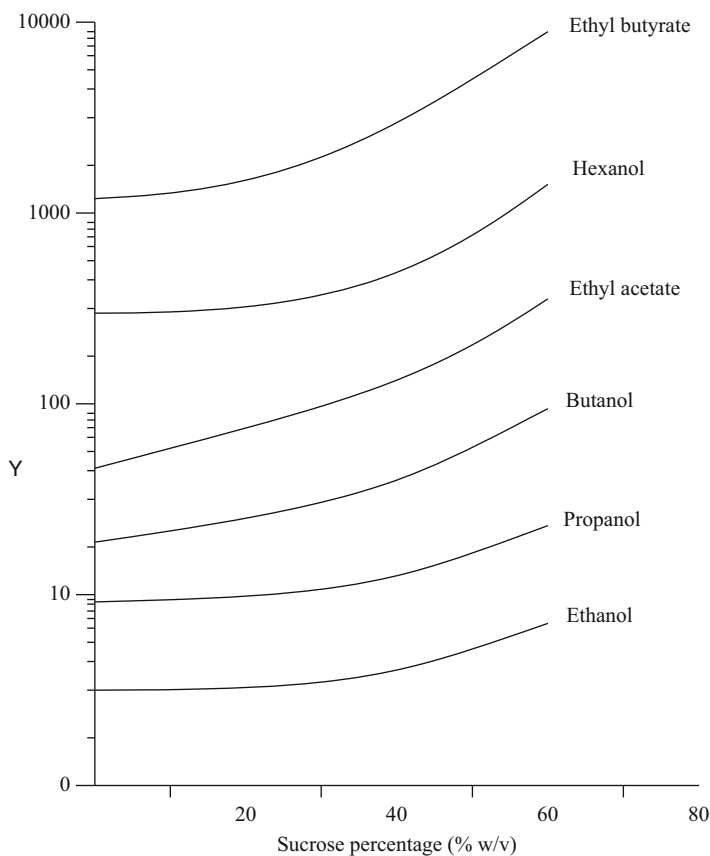
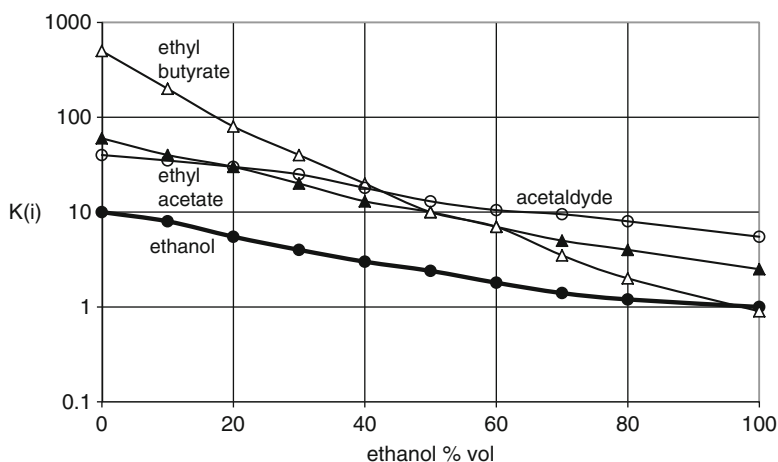


Fig. 11.2 Activity coefficients ( $\gamma$ ) of some fruit aroma compounds

**Table 11.2** Relative volatilities  $\alpha_{AW}$  of volatile aroma compounds in water

Component in aqueous solution	Relative volatility ( $\alpha_{AW}$ )		
	Water	15 % sucrose	60 % sucrose
Ethyl anthranilate	3.9	4.8	18.7
Ethanol	8.3	8.9	14.5
<i>n</i> -Propanol	9.5	10.0	18.5
<i>n</i> -Butanol	14.1	15.0	43.0
<i>n</i> -Amyl alcohol	23.0	24.7	105.0
Hexanol	31.0	34.0	195.0
Ethyl acetate	205	265	986
Ethyl butyrate	643	855	6500

**Fig. 11.3** Partition coefficients ( $K_i$ ) of vapor/liquid equilibria for some food volatiles in ethanol solutions

For practical applications, the relative volatilities of aroma components (A) to water (W) are more useful than the activity coefficients. Some values of the relative volatility ( $\alpha_{AW}$ ), determined from experimental activity coefficient ( $\gamma_i$ ) data (Marinos-Kouris and Saravacos 1974; Saravacos 1995), are shown in Table 11.2.

In general, partially water-soluble compounds, like ethyl acetate and ethyl butyrate, are more volatile than water-soluble components, like ethanol. Methyl anthranilate, an aroma component of Concord grapes, has a low relative volatility (but higher than one), due to its low vapor pressure (boiling point of 266.5 °C at atmospheric pressure), compared to the vapor pressure of water (11.10).

In the distillation of wine and ethanol-fermented products, the volatility of aroma components decreases, in general, as the ethanol concentration is increased. Figures 11.3 and 11.4 show the change (decrease) of the partition coefficient ( $K_i$ ) at increasing ethanol concentrations. These changes in volatility are important in the

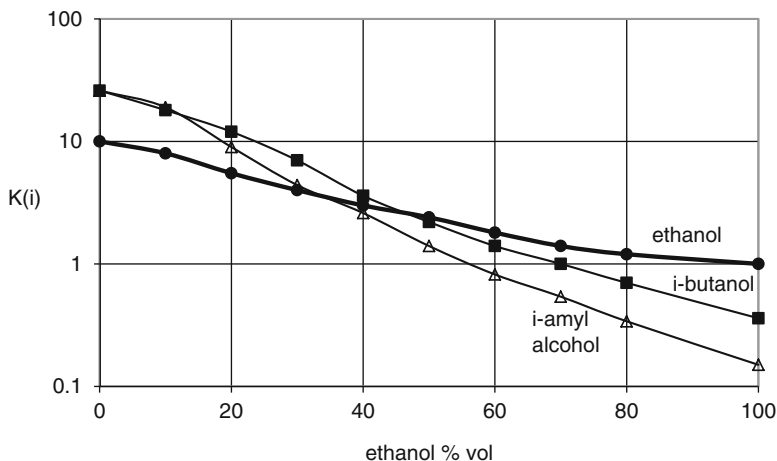


Fig. 11.4 Partition coefficients ( $K_i$ ) of some alcohols in ethanol solutions

distillation of ethanol-fermented liquids for the production of brandy and other alcoholic drinks (Saravacos 1970).

Of particular importance is the volatility of the higher alcohols of the fermented liquids, like propanol, butanol, amyl alcohol, and their isomers (known as “fusel oils”), which must be separated from the distilled product in the distillation column.

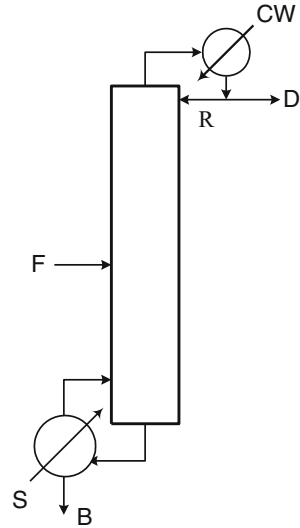
The volatility ( $K$ -value) of aroma compounds is high at low ethanol concentrations, i.e., when water is the main component of the mixture. These compounds are more soluble in ethanol, which reduces their activity coefficients and relative volatilities. At higher ethanol concentrations, e.g., above 50 % mole fraction, the partition coefficient ( $K$ ) drops below (1), i.e., the compound is less volatile than water in the liquid mixture.

### 11.2.2 Determination of Equilibrium Stages

The separation of volatile components of liquid mixtures is usually achieved in a series or equilibrium stages, operated countercurrently in distillation columns. Single-stage separators can separate partially a component, because of equilibrium limitations. Single-stage or flash units are used to separate some components from food liquids, e.g., off-flavors from milk in a HTST (aseptic) sterilization process.

Most stripping (removal) and fractionation (enrichment) of volatile components in a mixture is carried out in columns, using various types of trays (plates), each one of which acts as a vapor/liquid equilibrium stage. Since thermodynamic equilibrium is not possible to be reached in a tray liquid/vapor contactor, the number of trays, for a given separation, is always greater than the number of theoretical stages.

**Fig. 11.5** Diagram of a continuous distillation column



Some distillation columns, usually of low capacity, operate in continuous vapor/liquid contact, without discrete separation stages (trays). These units are known as packed columns or towers, and they are discussed in Sect. 4.3 of this chapter.

Most of the industrial distillation columns are operated as continuous units, although there are some batch columns, used in small-scale operations. Distillation systems, used in separating complex mixtures in the chemical and petrochemical industries, consist of a number of continuous distillation columns, operated and controlled by computers. The food processing industry uses limited distillation processes of medium to small size, some of them batch operated.

Figure 11.5 shows diagrammatically a simple continuous distillation column. The unit consists of a long vertical column, containing the required number of trays, made up of the stripping (lower) and the fractionating (upper) sections. The trays (perforated, bubble cups, or valves) allow the counterflow of liquid and vapors, after thorough mixing to approach equilibrium. The column is equipped with a reboiler at the bottom, which produces the required vapor flow upward, and a condenser at the top, which supplies the required liquid flow downward.

Feed (F) is introduced near the middle of the column, while a distillate (D) is received from the top and a residue (B) is obtained from the bottom. Steam (S) is used to heat the liquid in the reboiler, and cooling water (CW) is used in the condenser. The column is designed to separate a component from the feed of concentration ( $x_F$ ) to a distillate ( $x_D$ ) and a residue ( $x_B$ ).

In most distillation columns, a total condenser is used, i.e., all the vapors coming out of the first (top) tray are condensed, and the liquid condensate is split into two streams, the distillate product and the reflux, which is returned to the column. In some columns, a partial condenser may be used, with the vapors coming out of the condenser as a product in equilibrium with the liquid condensate, which is returned

to the column as the reflux. In this case, the condenser acts as an additional separation stage of 100 % efficiency.

The number of theoretical stages in a distillation column is estimated either graphically or by analytical methods. In both methods, vapor/liquid equilibria of the system are required. These methods were developed for the distillation of binary mixtures, but they have been modified and extended to be used for multicomponent systems.

### 11.2.2.1 Graphical Methods

The McCabe–Thiele diagram is the most common graphical method used for the calculation of the theoretical (equilibrium) stages of distillation. It is also used in the calculation of separation stages of absorption and extraction processes (King 1982; Perry and Green 1997).

Figure 11.6 shows a McCabe–Thiele diagram for the separation of an ethanol/water mixture. Vapor/liquid equilibrium ( $y_n, x_n$ ) data in graphical form (Fig. 11.1) at the given pressure (usually atmospheric) are used. The basic assumption of the McCabe–Thiele method is the constant molar flow of liquid ( $L$ ) and vapor ( $V$ ) in the two sections of the column, which results in straight-line operating lines.

The operating lines of the fractionating and stripping sections of a column are given by the following equations, respectively:

$$y_n = (L/V)x_{n-1} + (D/V)x_D \tag{11.12}$$

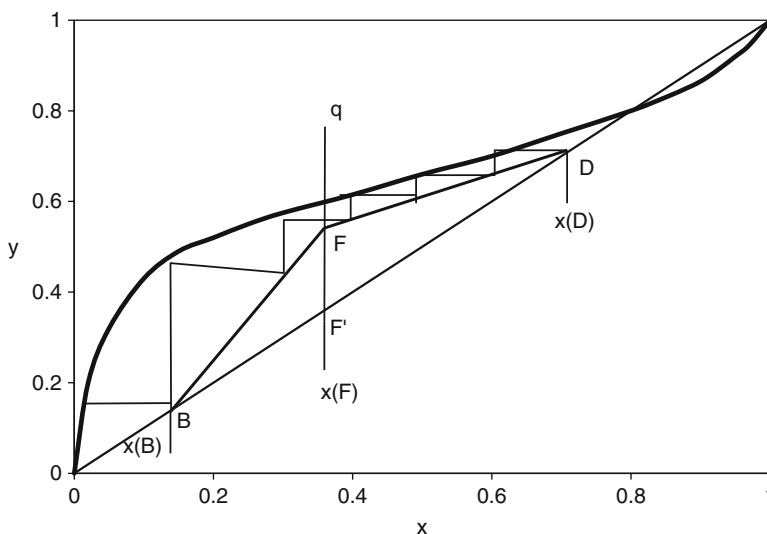


Fig. 11.6 McCabe–Thiele diagram for distillation of ethanol/water



$$y_m = \left( L'/V' \right) x_{m-1} - \left( B/V' \right) x_B \quad (11.13)$$

where  $(L, V)$  and  $(L'/V')$  are the liquid/vapor flow rates of the fractionating and stripping sections and  $D, B$  are the flow rates of the distillate and the residue (bottoms), respectively.

In the operating lines, the composition of the vapors leaving a stage ( $n$  or  $m$ ) is related by material balances to the composition of the liquid coming from the previous (above) stage ( $n - 1$ ) or ( $m - 1$ ), and the compositions of the distillate ( $x_D$ ) or residue ( $x_B$ ).

The operating lines of the two sections of the column are straight lines with slopes  $(L/V)$  and  $(L'/V')$ , respectively, if the molar flows are constant. The stripping line is plotted from the bottom point (B), defined from the given bottom concentration ( $x_B$ ), with a slope of  $(L'/V')$ . Similarly, the fractionating line is plotted from the top point (D), defined by the given concentration ( $x_D$ ), with a slope of  $(L/V)$ .

The two operating lines intersect at point (F), which corresponds to the feed concentration ( $x_F$ ). The line (F'F) is known as the “ $q$ -line,” and it represents the thermal condition of the feed. It is plotted from point (F') with a slope of  $[q/(q - 1)]$ . The values of  $q$  are the following:  $q = 1$  (saturated liquid, i.e., liquid at its boiling point),  $q = 0$  (saturated vapors), and  $0 < q < 1$  (vapor/liquid mixture). In the example of Fig. 11.6, the feed is assumed to enter the column as a saturated liquid, i.e.,  $q = 1$ , and the “ $q$ -line” has a slope  $[q/(q - 1)] = \infty$ , i.e., it is a vertical line drawn from point (F'). It should be noted that the “ $q$ -line” becomes horizontal when the slope is  $[q/(q - 1)] = 0$ , i.e., when  $q = 0$  or when the feed is saturated vapors.

The number of theoretical stages ( $N$ ) is determined graphically by constructing rectangular steps between the operating and the equilibrium lines, starting from the top (point D) and ending at the bottom (point B). In the example of Fig. 11.6, the number of theoretical stages is nearly  $N = 5$  (3.5 fractionating and 1.5 stripping). The separation of ethanol in the stripping section is easier (less stages needed) because of the high volatility of ethanol at low concentrations. The actual trays of the distillation column of Fig. 11.6 would be equal to the theoretical stages divided by the column efficiency (11.17). Thus, for an efficiency of 60 %, the required plates will be equal to  $[5/0.6] = 8.3$ . The number of plates should be rounded off, e.g., in this case (9) distillation plates. The theoretical stages can be a fractional number.

Adding theoretical stages to the top of the ethanol/water distillation column will increase slightly the ethanol concentration of the distillate ( $x_B$ ), which will approach asymptotically the concentration of the azeotrope ( $y = x = 0.896$ ). This azeotrope can be broken, and nearly pure ethanol can be produced by operating the distillation column in vacuum (pressure lower than 130 mbar), or by azeotropic distillation, i.e., adding a compound to the mixture, like benzene, which increases the volatility of ethanol in the aqueous solution.

The reflux ratio ( $R$ ) in a distillation column is defined as the liquid ratio  $R = (L/D)$ , which returns to the column from the condenser. If ( $R$ ) is known, the operating line of the fractionating section (11.12) can be written as follows:

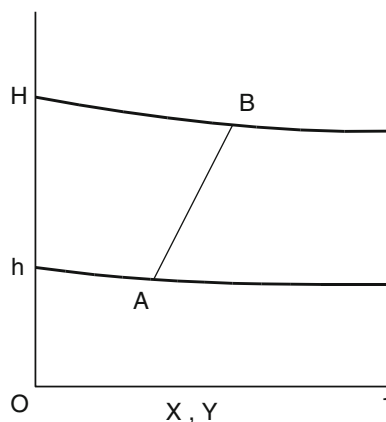
$$y_n = [R/(R + 1)]x_{n-1} + [1/(R + 1)]x_D \quad (11.14)$$

When the two operating lines intersect on the equilibrium ( $y_n, x_n$ ) line, the number of theoretical stages becomes infinite, i.e., the mixture cannot be separated by the particular column arrangement. This limiting operating condition is known as the minimum reflux ratio ( $R_{\min}$ ). The opposite condition is the total reflux ( $R_{\infty}$ ), in which the slope of the operating line becomes equal to (1), i.e., it coincides with the diagonal line. In the total reflux operation, the number of stages becomes minimum ( $N_{\min}$ ). For economic reasons, the distillation columns are operated between the two extremes of total reflux and minimum reflux, usually at  $R = (1.1-1.5)R_{\min}$ .

The McCabe–Thiele diagram is a relatively simple graphical method, which is applicable when the operating lines are straight lines (equal molar flows). However, in many nonideal mixtures, including the system ethanol/water, significant differences in the enthalpy of the mixtures result in variable molar flows, i.e., nonlinear operating lines. For such systems, analytical stage-to-stage methods or the Ponchon–Savarit graphical method can be used.

The Ponchon–Savarit diagram is an enthalpy–concentration diagram for both the liquid and the vapor phases. A typical diagram, resembling the equilibrium enthalpy ( $H, h$ ) concentration ( $y, x$ ) data for ethanol/water, is shown in Fig. 11.7. The two enthalpy lines (vapor and liquid) are joined by the “tie lines” (AB), which represent the enthalpy of the liquid ( $h$ ) and the vapor ( $H$ ), which are in thermodynamic equilibrium ( $y_n, x_n$ ). The number of theoretical stages, required to affect a given separation, is determined graphically by applying repeatedly material balances between the two phases (King 1982).

**Fig. 11.7** Ponchon–Savarit diagram. ( $H, h$ ) molar enthalpies of saturated vapors and liquid, respectively. AB equilibrium “tie” line



### 11.2.2.2 Analytical Methods

Analytical methods are used in approximate calculations of the theoretical stages in distillation and other separation processes. They are particularly useful when a large number of stages are involved, such as when the operating lines are very close to the equilibrium lines, and in calculations of multicomponent systems, where the graphical methods are difficult to be applied. The analytical calculations can be included in computer calculation packages.

The most common analytical method is the Fenske–Underwood–Gilliland calculation method, which involves the determination of the minimum number of theoretical stages ( $N_{\min}$ ) at total reflux, the minimum reflux ratio ( $R_{\min}$ ) with infinite number of theoretical stages, and the number of stages or theoretical plates ( $N$ ) for the given finite reflux ratio ( $R$ ). This method is used in binary and multicomponent mixtures for the separation of two “key” components, i.e., the light and heavy “keys” (Perry and Green 1997).

The Fenske equation estimates the ( $N_{\min}$ ) for the separation of a binary mixture of relative volatility ( $\alpha$ ) into a distillate (top) product ( $x_D$ ) and a residue (bottom) product ( $x_B$ ) at total reflux ( $R = \infty$ ):

$$N_{\min} = \log[x_D(1 - x_B)/x_B(1 - x_D)]/\log(\alpha) \quad (11.13)$$

The Underwood equations estimate the minimum reflux ratio ( $R_{\min}$ ), for the same separation:

$$\alpha x_F/(\alpha - \theta) + (1 - x_F)/(1 - \theta) = 1 - q \quad (11.14)$$

$$R_{\min} + 1 = \alpha x_D/(\alpha - \theta) + (1 - x_D)/(1 - \theta) \quad (11.15)$$

where ( $x_F$ ) is the mole fraction of the feed and ( $\theta$ ) is an empirical parameter ( $1 < \theta < \alpha$ ), connecting (11.14) and (11.15). The Underwood equations can be extended to  $n$  components (multicomponent systems).

The limiting operating conditions ( $N_{\min}, R_{\min}$ ) are used in the empirical Gilliland diagram  $\{(N - N_{\min})/(N + 1)$  versus  $(R - R_{\min})/(R + 1)\}$  to estimate the number of stages ( $N$ ) at a given reflux ratio ( $R$ ). The Gilliland diagram is expressed by the empirical equation:

$$(N - N_{\mu\nu})/(N + 1) = 1 - \varepsilon\chi\pi\left\{\left[\frac{(1 + 54.1\Psi)}{(1 + 117.2\Psi)}\right]\left[\frac{(\Psi - 1)}{\Psi^{0.5}}\right]\right\} \quad (11.16)$$

where  $\Psi = (R - R_{\min})/(R + 1)$ .

Economic analysis shows that the optimum reflux ratio is in the range of  $(1.1\text{--}1.5)R_{\min}$ , and the corresponding optimum number of stages (plates) is in the range of  $(1.5\text{--}2)N_{\min}$ .

Detailed (rigorous) calculations of the theoretical separation stages in multicomponent mixtures can be made by numerical, computer, and simulation

methods, like the Lewis–Mathieson and Thiele–Geddes stage-to-stage computation methods (Perry and Green 1997; Holland 1981). These complex methods are applied to the design, operation, and control of continuous distillation systems, used in large-scale chemical, petrochemical, and petroleum processing.

### 11.2.2.3 Column Efficiency

The actual number of trays ( $N_T$ ) in a distillation column is estimated from the number of theoretical stages or plates ( $N$ ) according to the equation

$$N_T = N/E_o \quad (11.17)$$

where ( $E_o$ ) is the overall column efficiency, which for distillation columns varies from 0.50 to 0.70.

The overall column efficiency depends primarily on the tray or Murphree efficiency, defined by the equation

$$E_M = (v_v - v_{v+1})/(v_{v\varepsilon} - v_{v+1}) \quad (11.18)$$

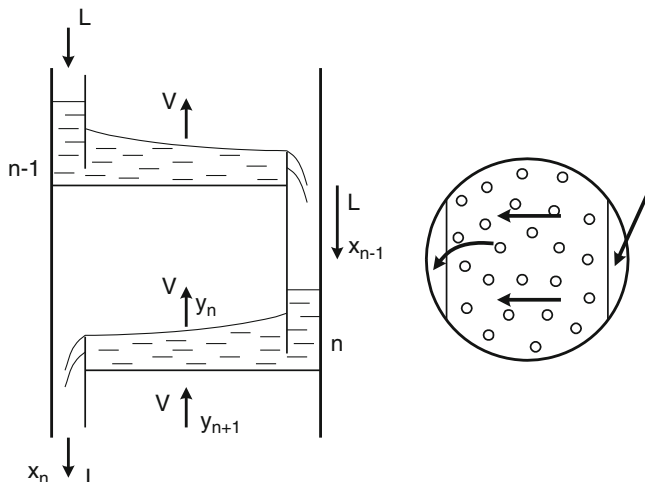
where ( $y_n, y_{n+1}$ ) are the mole fractions of the vapors coming out of the ( $n$ ) and ( $n + 1$ ) stages, respectively, and ( $y_{n\varepsilon}$ ) is the mole fraction of the vapors in equilibrium with the liquid ( $x_n$ ), coming out of the ( $n$ ) stage.

The Murphree efficiency of distillation columns is determined by detailed mass transfer and flow analysis of the vapor/liquid mixture in a tray (AIChE 1958).

The efficiency of distillation columns can be estimated from the empirical correlation and diagram of o'Connell (Perry and Green 1997). The efficiency is inversely proportional to the product of the liquid viscosity and the relative volatility of the key component. The viscosity is known to have a negative effect on mixing, while high relative volatilities increase the escaping tendency of the volatile components, reducing the residence time and the efficiency.

The distillation trays are the most important column component, since they must provide enough residence time and mixing for the liquid and the vapors to approach thermodynamic equilibrium, and subsequently separate the two phases effectively for the next vapor/liquid stage contact. Bubble cup and sieve (perforated) trays are commonly used, with valve trays and other specialized designs applied to some distillations. Sieve trays are preferred in the distillation of fermented food liquids, particularly in the stripping section of the column, because they can handle better the food suspensions, without being fouled and plugged.

Figure 11.8 shows diagrammatically the operation of a distillation sieve tray. The liquid (L) flowing down through the downcomers from tray to tray spreads on each (sieve) tray, and it comes in intimate contact with the vapors, rising from the bottom through the main body of the column. The liquid is held on the sieve by the vapors up-flowing through the tray perforations. In large diameter columns



**Fig. 11.8** Diagram of a simple distillation tray

(above 1.5 m), the active tray area is divided into smaller sections, which are connected to appropriate downcomers.

Bubble cap and valve trays can hold the liquid, without flowing through (dripping), even without upward vapor flow. Tray hydraulics, i.e., flow conditions for vapors and liquids in the column (normal operation, flooding, etc.), are discussed in Perry and Green (1997) and in specialized distillation books (Kirschbaum 1969; Billet 1973; van Winkle 1967).

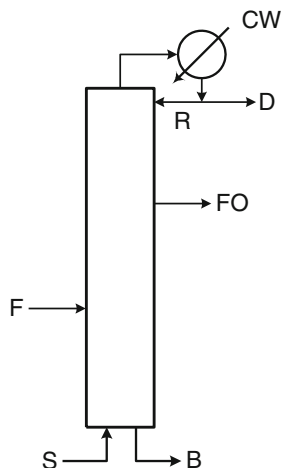
## 11.2.3 Food Distillation Equipment

### 11.2.3.1 Ethanol Distillation

Distillation is used in the production of brandy and other alcoholic beverages from wine and other ethanol-fermented liquids. Traditional brass (copper) stills of small capacity are used to separate the ethanol and other volatiles in simple one-stage distillations. Partial fractionation of ethanol is obtained by partial reflux in the piping of the still, obtaining distillates of about 50 % ethanol by volume.

Fractional distillation of alcoholic beverages in medium to large-scale operations is carried out in batch or continuous distillation columns made of stainless steel. Figure 11.9 shows the diagram of a continuous distillation column, producing ethanol of high concentration, about 95 % by volume (190° proof), used in the preparation of alcoholic beverages and spirits. The column produces a mixture of “fusel oils” as a side cut between the feed and the condenser. The stripping section in this column is heated by live steam directly at the bottom, instead of the usual reboiler heat exchanger.

**Fig. 11.9** Diagram of a simple distillation tray



The fusel oils are mixtures of higher alcohols (propanol, butanol, amyl alcohol, and some of their isomers), which, due to their volatility (Fig. 11.4), are concentrated at an ethanol concentration of about 50 % on trays located between the feed and the overhead condenser. Their presence in the alcoholic beverages is undesirable, because of the adverse effect on the quality (flavor) of the product.

A three-column distillation system may be used for the production of 95 % ethanol by volume, free of fusel oils, aldehydes, and other oxygenated compounds: (1) a stripping column heated with live steam; (2) a fractionating column, which produces ethanol 95 % plus aldehydes at the top, water residue at the bottom, and a fusel oil side cut; and (3) an aldehyde column, producing ethanol 95 % at the bottom and an aldehyde-rich product at the top.

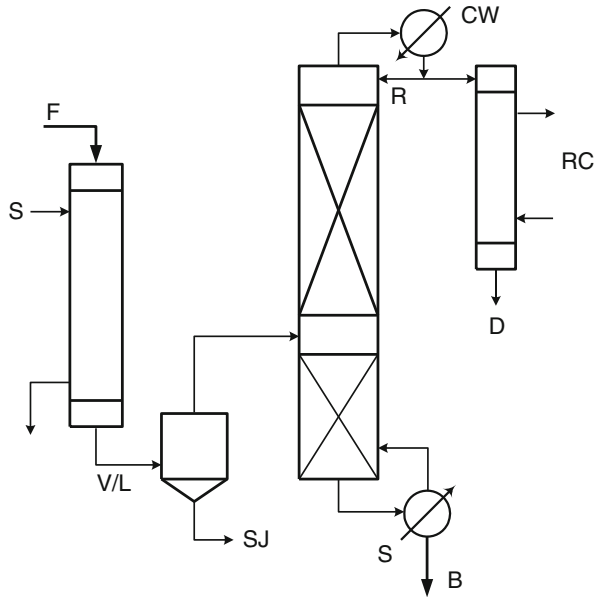
Ethanol distillation for the production of alcoholic beverages and spirits is governed by strict regulations, concerned with taxation, like the US Bureau of Alcohol and Cigarettes.

### 11.2.3.2 Essence Recovery Units

Recovery of aroma or volatile components is practiced in the processing of fruit juices and other fluid foods, usually in connection with evaporation and dehydration processes.

The fruit aroma consists normally of volatile organic compounds, such as esters, alcohols, and oxygenated compounds, which are lost or changed during evaporation, drying, and other physical and thermal processing operations. These compounds are partially soluble in water, and therefore, they have high activity coefficients and high relative volatilities. Concentration of fruit juices by evaporation or drying of aroma-containing foods results in considerable losses of most aroma components from the concentrated or dehydrated product (Saravacos 1995; Karlsson and Tragardh 1997).

**Fig. 11.10** Simplified diagram of an essence recovery unit at atmospheric pressure. *F* feed, *S* steam, *V/L* vapor/liquid, *SJ* stripped juice, *R* reflux, *CW* cooling water, *RC* refrigerated condenser, *D* distillate, *B* aqueous residue



Aroma recovery is accomplished mainly by stripping/distillation processes, but some novel food processes, like supercritical fluid extraction and pervaporation, can also be applied (Chap. 14). Solvent extraction and solid/fluid adsorption can also be used, as discussed briefly later in this chapter.

The design and operation of essence (aroma) recovery equipment is based on vapor/liquid equilibria of aroma components/water and on distillation techniques (Roger and Turkot 1965; Moyer and Saravacos 1968; Sulc 1984; Lazarides et al. 1990).

Figure 11.10 shows a simplified diagram of a classical essence recovery unit, operated at atmospheric pressure. The principle of the classical system is to strip the fruit juice of most volatile components and concentrate them by fractional distillation into an aqueous solution of about 100–200 times the original concentration in the juice (Moyer and Saravacos 1968).

The essence recovery system consists of a flash evaporator, e.g., a falling film tubular or plate unit, which evaporates between 10 and 30 % of the juice. The evaporator is heated with steam (*S*) and the vapors are separated from the liquid in the (*V/L*) separator. The vapors are introduced into the stripping section of the distillation column (*DC*), which is heated by steam (*S*) in a reboiler, from which the bottom residue (*B*) is removed. An overhead condenser, cooled with cold water (*CW*), provides the required reflux ratio (*R*), and the distillate is further cooled in a refrigerated condenser (*RC*).

Compared to normal distillations of nonpolar mixtures, the stripping and distillation of aqueous volatile compounds present some problems, which are discussed briefly below.

## Stripping of Aromas

The stripping of the various aroma components depends primarily on their relative volatility in the fruit juices. Although the activity coefficients and relative volatilities in aqueous solutions of sugars are high, a significant fraction of volatiles may be retained in the concentrate, due to a diffusion-controlled trapping mechanism (Chap. 8; Saravacos and Maroulis 2001). Thus, while in food dehydration the objective is high aroma retention (fast drying), in essence recovery the aroma components should be allowed to approach thermodynamic equilibrium (better mixing, longer residence time).

Very volatile aroma components, like esters, are easily stripped by evaporating a relatively small portion of the juice, e.g., 10 %. Thus, most aroma components in some fruit juices, like apple juice, can be recovered in the condensate of the first effect of an evaporator, which may be up to 25 % of the original water in the juice. However, higher boiling aroma components, like methyl anthranilate (Concord grape juice) and some carboxylic acids, may require removal of about 40 % water for substantial stripping (Saravacos and Moyer 1968).

In some cases, stripping of volatile components from food liquids, without further food concentration, may be required in order to remove undesirable components from the product. For instance, high-boiling methyl anthranilate, the characteristic aroma in Concord grape, may be undesirable in wines prepared from this grape juice. In this case, a stripping column, with about ten trays may be used to strip by steam about 90 % of the methyl anthranilate (Saravacos et al. 1969).

Vacuum stripping of aromas from heat-sensitive food liquids, like orange juice, requires special vacuum pumps, which can collect most of the volatiles in the liquid ring of the pump (Bomben et al. 1967, 1973). Sealing liquids, used in the vacuum pumps, include water and ethanol solutions and should be refrigerated during operation at about 2 °C to prevent loss of volatiles in the exhaust gases. Vacuum stripping is carried out at temperatures 45–80 °C, and an inert gas stream (nitrogen or air) may be injected in the bottom of the column to increase the stripping capacity. Condensing of the stripped volatiles from the carrier gas requires low-temperature condensers and cold traps.

## Fractionation of Aromas

The fractionation of aroma components is carried out in distillation columns, using packed columns for small- and medium-size capacities and trays (sieve, bubble cap, or valve) for large capacities. The packed columns are discussed in Sect. 4.3.

The number of theoretical stages is estimated on the basis of separation of two key components, one of which is water and the other a flavor characteristic component of the particular food product. The key aroma component should have a relative volatility lower than the very volatile compounds, so that its recovery by



distillation will ensure that all other components are recovered. Graphical or analytical methods can be used for the estimation of the required separation stages.

In the essence recovery from food liquids, the concentration of the volatile components is generally low (ppm range), and therefore, water is the major component in the distillation column. The column efficiency ( $E_o$ ) in water-rich distillations is relatively low (about 50–60 %), due to the difficulty of mixing water/vapors effectively. This is caused by the high surface tension of pure water, which retards effective mass transfer between phases.

Typical columns of essence recovery contain about ten trays of 1 m diameter and 5 m high (distance between trays is about 0.5 m).

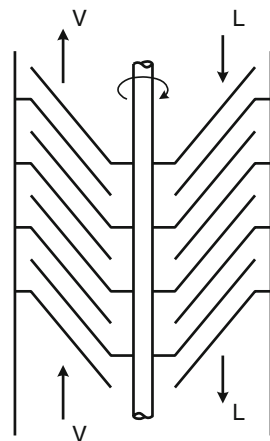
Fractionation of high-boiling flavor compounds requires high-vacuum columns and other specialized distillation equipment (see Sect. 2.3.4).

### 11.2.3.3 Spinning Cone Stripping Column

The spinning cone stripping column (SCSC) is a special distillation column, developed in Australia, capable of recovering aromas and removing undesirable volatile components from fruit juices and other food liquids. It is operated at low temperatures and short residence times with effective vapor/liquid mixing and high mass transfer rates, distinct advantages over the conventional plate columns, which are operated at atmospheric pressure (high temperatures) with long residence time and high-pressure drops, damaging the quality of sensitive products.

The basic SCSC unit consists of a column, about 1 m diameter and 3 m high, with alternating stationary and rotating truncated cones, which act as contacting stages for liquid and vapors flowing countercurrently (Fig. 11.11). The preheated liquid is fed at the top of the column, while live steam is injected at the bottom, acting as a stripping medium. The volatile components are condensed in refrigerated condensers at the top, and the stripped product is obtained at the bottom.

**Fig. 11.11** Principle of spinning cone stripping column



The system operates at a relatively high vacuum (boiling temperatures 25–35 °C), maintained by a special vacuum pump, equipped with a cold liquid ring, which traps any volatiles from the exhaust air (Casimir and Craig 1990; Gray 1993).

The capacity of a standard (1 m × 4 m) SCSC unit is 10,000 L/h, and the residence time is less than 1 min. The moving cones are attached to a shaft, which rotates at 250–550 RPM. The rotating finned cones and the centrifugal force develop turbulence and high heat and mass transfer rates for the falling liquid film and the rising vapors. The estimated separation efficiency of the SCSC units is about 20 NTU/m, much better than the approximate 6 NTU/m in conventional packed columns (see Sect. 4.3 in this chapter).

The SCSC unit can be used for the removal of undesirable volatiles from fruit juices, e.g., sulfur dioxide from grape juice, and in the recovery of valuable volatiles from sensitive food liquids, which are damaged by high-temperature stripping.

The spinning cone distillation column is particularly suited for the preparation of alcohol-free or nonalcoholic wines, which contain less than 0.5 % ethanol (Mermelstein 2000). Wine de-alcoholization can be carried out by evaporating a relatively large portion of wine, e.g., 30–40 %, in a falling (tubular or plate) film or agitated-film evaporator at atmospheric pressure. Stripping of ethanol requires evaporation of higher portions of liquid than stripping of volatile esters and other aromas, because of its lower relative volatility (Saravacos 1974).

The SCSP de-alcoholization process involves first the recovery of the volatile aromas (esters, etc.) in a low-temperature column ( $T < 30$  °C) and, second, the stripping of ethanol at a higher temperature (about 35 °C), resulting in a stripped wine. The volatile aromas, recovered in the first stripping, are returned to the stripped wine, obtaining a full-flavored nonalcoholic product.

The SCSC unit can be used to enrich the ethanol content of weak wines or alcoholic spirits to desirable levels for better flavor and quality, without the need to add distilled alcohol.

Nonalcoholic wine can be produced by membrane separation processes, like reverse osmosis and pervaporation, as discussed briefly in Chap. 12.

#### 11.2.3.4 Molecular Distillation

Molecular or short-path distillation is applied to the separation of high-boiling and heat-sensitive food components, such as flavors, vitamins, and monoglycerides. The mixture is first separated from the volatile components by normal vacuum evaporation or distillation.

Molecular distillation is an expensive process, requiring very high vacuum (about 0.01 mbar), which is achieved by special vacuum pumps. For small, laboratory-size applications, an oil rotary (ballast) pump, followed by an oil diffusion pump, may be used. For pilot plant and industrial applications, a rough vacuum pump, e.g., steam jets or liquid ring pump, is used to reach a vacuum (absolute pressure) of about 10 mbar (see Appendix D). The very high vacuum

required is obtained by using a rotary dry pump, followed, if necessary, by an oil diffusion pump.

The molecular still consists basically of a film evaporator, which is surrounded by a condenser. The high-boiling compounds are evaporated and condensed very fast on the condenser surface, which is located very closely to the evaporator. The short distance (short path) between evaporator and condenser is smaller than the mean free path of the molecules at the prevailing pressure and temperature of the still.

## 11.3 Solvent Extraction/Leaching Equipment

The analysis and design of solvent extraction and leaching is similar to the procedures used in distillation processes. Empirical correlations are used for liquid/liquid equilibria, while experimental data are essential for solid/liquid systems. Approximate methods are used for the estimation of equilibrium stages, and the extraction/leaching equipment is more specialized than the generalized distillation systems.

### 11.3.1 Liquid/Liquid and Liquid/Solid Equilibria

Liquid/liquid extraction is based on the thermodynamic equilibrium between two partially soluble phases, the extract and the raffinate (Fig. 11.12): In a simple three-component system, the two liquid phases consist of the following: (1) the raffinate, containing mainly the residue (A), the solute (B), and small amount of solvent (S), and (2) the extract, containing mainly the solvent (S), part of the solute (B), and small amount of residue (A).

The equilibrium is expressed by the empirical equation

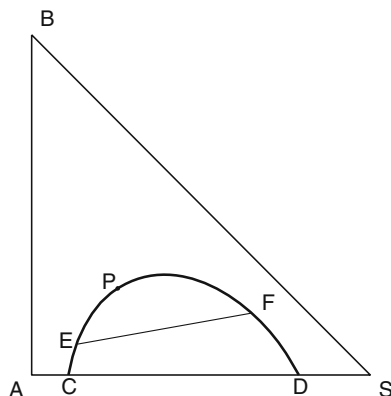
$$Y = KX \quad (11.19)$$

The concentrations of the solute in the extract ( $Y$ ) and raffinate ( $X$ ) phases are usually expressed as mass fractions of the mixture. The partition or distribution coefficient ( $K$ ) is analogous to the volatility coefficient of vapor/liquid equilibria, and it is related to the activity coefficients of the solute in the raffinate ( $\gamma_r$ ) and extract ( $\gamma_e$ ):

$$K = \gamma_r/\gamma_e \quad (11.20)$$

The activity coefficients of various liquid systems are correlated in various empirical relations, like the Wilson and UNIFAC equations (Reid et al. 1987). Liquid/liquid mixtures, used in solvent extraction, are nonideal systems, facilitating the separation in a relatively small number of stages.

**Fig. 11.12** Right-triangular liquid/liquid equilibrium diagram. *A* residue, *B* solute, *S* solvent, *P*, plait point; (EF), tie line



The liquid/liquid equilibrium data are presented in right-triangular diagrams (Fig. 11.20), or modified McCabe–Thiele and Ponchon–Savarit diagrams (Fig. 11.21).

The Orthogonal triangle diagram of Fig. 11.12 shows a typical liquid/liquid extraction system in which the solvent (*S*) is partially soluble with the residue (*A*), e.g., water. The solute to be extracted is completely soluble in both (*S*) and (*A*). The two phases are confined within the curve (*CPD*) of the diagram, with the “plait” point (*P*) representing the common composition of both extract (*DP*) and raffinate (*CP*) phases. The “tie” line (*EF*) connects two equilibrium points of the raffinate (*E*) and the extract (*F*).

The modified McCabe–Thiele diagram for liquid/liquid extraction uses as coordinates the mass fractions *Y* (extract) and *X* (raffinate) of the solute (*B*), defined by the equations

$$Y = B/(A + B) \text{ extract phase, } X = B/(A + B) \text{ raffinate phase} \quad (11.21)$$

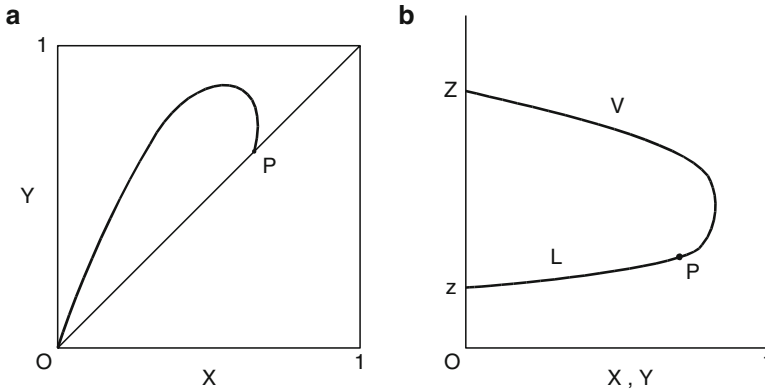
It should be noted that the amount of solvent (*S*) does not enter the McCabe–Thiele diagram.

The common equilibrium point of the two phases or “plait” point is represented by point (*P*) on the modified McCabe–Thiele diagram (Fig. 11.13).

The role of solvent in extraction is analogous to the enthalpy (heat content) in distillation, which enters quantitatively into the Ponchon–Savarit diagram, as shown in Fig. 11.7.

The ordinates of the Ponchon–Savarit diagram for liquid/liquid equilibria are  $Z = S/(A + B)$  for the extract (line *ZP*) and  $z = S/(A + B)$  for the raffinate (line *zP*). Equilibrium (“tie”) lines connect the solvent (*V*) and the raffinate (*L*) phases.

Solid/liquid equilibria are determined experimentally, assuming that the solute is completely soluble in the solvent and that it is not sorbed on the inert solid. Under these conditions, equilibrium is expressed by the simple equation



**Fig. 11.13** McCabe–Thiele (a) and Ponchon–Savarit (b) diagrams for liquid/liquid extraction for a partially soluble (two-phase) system.  $P$  plait point

$$Y_e = X \quad (11.22)$$

where ( $Y_e$ ) is the mass fraction of the solute (B) in the extract and ( $X$ ) is the concentration of solute in the liquid remaining in the pores of the solids, after reaching equilibrium.

The solubility of solids in liquids is discussed by Reid et al. (1987).

The solid/liquid equilibrium data can be plotted on modified Ponchon–Savarit and McCabe–Thiele diagrams, in a similar manner with the liquid/liquid equilibria. The ordinates of the modified Ponchon–Savarit diagram for solid/liquid equilibria are the concentrations of the inert solid ( $A$ ) in the solid (underflow) and in the extract (overflow), defined by the equations

$$z = A/(B + S) \quad \text{underflow} \quad (11.23)$$

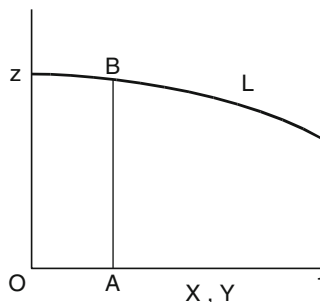
$$z = A/(B + S) \quad \text{overflow} \quad (11.24)$$

where  $A$ ,  $B$ , and  $S$  are the amounts (kg) of inert solid, solute, and solvent, respectively.

For the normal extraction case of an inert solid that is completely insoluble in the solvent, the overflow line coincides with the  $X$ -axis, i.e.,  $Z=0$  (Fig. 11.14). The equilibrium “tie” lines, e.g., line (AB) are vertical lines, which facilitate the graphical construction of the equilibrium stages between the equilibrium and the operating lines.

In the modified McCabe–Thiele diagram for leaching, the coordinates are the mass fractions of the solute ( $B$ ) in the extract ( $Y$ ) and the residue ( $X$ ), respectively, as defined in liquid/liquid equilibria (11.21).

**Fig. 11.14** Modified Ponchon–Savarit diagram for liquid/solid leaching. AB, tie (vertical) line



### 11.3.2 Determination of Equilibrium Stages

Liquid/liquid (L/L) extraction is carried out usually in a countercurrent operation of extract (solvent) and raffinate (residue), either in a series of mixing tanks or in a column, similar to distillation columns. Although fractionating columns for enriching the solute have been proposed, in most practical applications only the stripping section is utilized. Solute purification and solvent recovery are obtained by other separation processes, notably distillation, if the solvent is volatile (the usual case).

The number of theoretical stages in an (L/L) extraction is determined using the modified McCabe–Thiele or Ponchon–Savarit diagrams. The equilibrium line is plotted, using literature or experimental data, and the operating line is constructed from material balances of the given system, in analogy with distillation. In extraction, the solvent ( $V$ ) and raffinate ( $L$ ) flows are taken as mass flow rates (kg/h) and the concentrations ( $Y, X$ ) as mass fractions. In concentrated solutions, the operating lines of the McCabe–Thiele diagram are nonlinear.

In dilute (low-concentration) solutions, straight equilibrium and operating lines facilitate the graphical constructions. The equilibrium line ( $Y = KX$ ) is plotted from the origin of the coordinates with a slope of ( $K$ ). The operating line, representing the overall material balance in a countercurrent column, takes the form of a straight line with a slope of ( $L/V$ ):

$$Y_1 - Y_{n+1} = (L/V)(X_0 - X_n) \quad (11.25)$$

where ( $X_0, X_n$ ) are the solute concentrations in the raffinate and ( $Y_1, Y_{n+1}$ ) are the solute concentrations of the extract at the entrance (stage 1) and exit (stage  $n$ ) of the column, respectively. For pure solvent, entering the last stage ( $n$ ),  $Y_{n+1} = 0$ , and the operating line goes through the origin of the coordinates.

In multistage separations ( $K$  approaching unity), graphical construction of the (theoretical) stages is difficult near the origin of the equilibrium and operating lines, and a log–log plot can improve the numbering of stages. An alternative is to use the Kremser equation, discussed in Sect. 4.3, which, for extraction, becomes

$$N = \log[R(1 - E) + E]/\log(E) \quad (11.26)$$

where  $E = (KV)/L$ , extraction factor, and  $R = (X_n - Y_{n+1}/K)/(X_0 - Y_1/K)$ , extraction ratio.

The number of (theoretical) extraction stages ( $N$ ) can also be determined from the graphical solution of the Kremser equation (Perry and Green 1997).

The (L/L) extractors have lower efficiencies (20–30 %) than the distillation columns, because of the difficulties in mixing the liquid phases, i.e., inefficient mass transfer. The efficiency can be improved by thorough mixing, using agitation, vibration, etc.

Solid/liquid extraction (leaching) is usually carried out in fixed beds of solids, contained in a series (battery) of vessels. A leaching operation can be visualized as a series of stages, with the extract ( $V$ ) flowing countercurrently with the liquid (usually water) residue ( $L$ ), while the inert solids remain fixed in the beds. The solvent removes gradually the solute from the liquid residue, reaching equilibrium at each stage (thorough mixing, sufficient residence time).

The number of stages can be determined graphically, using the modified McCabe–Thiele or Ponchon–Savarit diagrams. Graphical construction of the stages is facilitated by the assumption that the equilibrium line coincides with the diagonal line ( $Y = X$ ).

For low concentrations of the solute in the inert solid and in the extract, a straight operating line similar to the (L/L) extraction (11.25) is obtained, assuming constant flows of liquid underflow ( $X$ ) and extract ( $V$ ). The number of (theoretical) stages ( $N$ ) can be calculated from the Kremser equation (11.26) or the Kremser diagram of the literature.

The efficiency of the solid/liquid extractors is very high, about 90–95 %, due to the thorough mixing and the relatively long residence time in each stage.

### 11.3.3 Mass Transfer Considerations

Solvent extraction of liquids and leaching of solids are controlled by mass transfer of the solutes from the material to the transfer interface. Although other mechanisms may be involved, mass transfer within liquid and solid materials is usually assumed to take place through molecular diffusion, and the transport rate is expressed by an effective or apparent diffusivity ( $D$ ), which is an overall transport coefficient, based on the diffusion (Fick) equation (Saravacos and Maroulis 2001). In some cases, other transport mechanisms, like capillary and hydrodynamic flow, are prevalent and they should be taken into consideration.

Diffusivity data of solutes in liquids are presented by Cussler (1997) and Reid et al. (1987). Diffusivity ( $D$ ) in liquids is related to the molecular (particle) size of the solute and the viscosity of the mixture (Stokes–Einstein equation), or the molecular solute/solvent interactions (Wilke–Chang equation). Typical values

of ( $D$ ) of solutes in dilute water solutions (25 °C) are sodium chloride,  $12 \times 10^{-10}$  m<sup>2</sup>/s; sucrose,  $5 \times 10^{-10}$  m<sup>2</sup>/s; and lactalbumin,  $0.7 \times 10^{-10}$  m<sup>2</sup>/s.

Diffusivity data in solids are more variable, depending strongly on the microscopic and macroscopic structure (homogeneous, porous, fibrous, etc.) of the material. Prediction and correlation of ( $D$ ) in solids is difficult, and experimental data are required for each material at given conditions (Saravacos and Maroulis 2001). Data on ( $D$ ) of importance to leaching are given by Schwartzberg and Chao (1982) and Schwartzberg (1987), e.g., oil (soybean flakes)/hexane,  $1 \times 10^{-10}$  m<sup>2</sup>/s, and coffee solubles (coffee beans)/water,  $1 \times 10^{-10}$  m<sup>2</sup>/s. The ( $D$ ) of solutes increases when the porosity of the solid is increased. Large molecules, like lipids and proteins, have smaller diffusivities than smaller molecules, like sugars.

Various mechanical and hydrothermal pretreatments of the solid foods are used to increase the transport rate of solutes and improve leaching efficiency, e.g., slicing, flaking, and steam injection. Slicing of beets and fruits and flaking reduce the thickness (diffusion path) of the material, without serious damage of the cells, which would release cell components into the solution and make difficult the solid/liquid separation. Heating by steam or water modifies the cellular structure (e.g., denaturation of proteins) increasing the solute diffusivity.

Recovery of oil from oilseeds containing above 22 % oil is accomplished by mechanical expression, usually screw presses (Chap. 5), followed by leaching with an organic solvent, e.g., hexane. Mechanical pressing can remove up to 90 % of the oil in the seeds. Direct solvent leaching is applied to oilseeds containing less than 22 % oil, e.g., soybeans.

The oilseeds are prepared for leaching by cleaning, cracking, dehulling, heat/water conditioning, and flaking (Aquilera and Stanley 1999). Heat (steam) conditioning of oilseeds at 70–75 °C denatures the proteins, facilitates flaking, and reduces the viscosity of the oil. Flakes about 0.5 mm thick are prepared by pressing the conditioned seeds in rotating smooth cylinders. Solvents used include hexane, chlorinated hydrocarbons, and alcohols. Oil is removed from the seed flakes by a combination of mechanisms, including washing of surface oil, and diffusion through the cellular components and the pores of the material.

Sugar beets are cut into long, thin slices (cossettes), which are heated to 50–60 °C to denature the proteins and increase the diffusivity of sucrose, without leaching of nonsugar components.

Extraction (leaching) of solubles (sugars) from apple pomace with water, following mechanical expression (Chap. 5), can improve juice recovery and process economics.

Water extraction of soluble solids from roasted coffee beans is facilitated by the high porosity of the beans, developed during thermal treatment (roasting). In the processing of decaffeinated soluble coffee, the diffusion of caffeine in water is controlling the process.

Leaching of soluble solids from ground malt and adjuncts into water is an important step in beer processing. The malt is treated with water at 63–68 °C for 1–2 h. The fermentable solutes are obtained by a combined extraction–filtration process (lautering). The leaching efficiency is increased by optimum combination of particle size, bed depth, temperature, and water content.



### 11.3.4 Food Extraction and Leaching Equipment

The simplest extraction and leaching equipment is the mixing/settling tank, in which the solvent is mixed thoroughly with the liquid or solid to be extracted until equilibrium is reached, and then the two phases are separated mechanically into the extract and the raffinate (residue). The stage efficiency of mixer/settlers increases substantially, when the agitation power (kW) is increased (Perry and Green 1997).

For more efficient and economical separation, multistage extraction (leaching) systems are used. Multistage countercurrent extraction in liquid/liquid (L/L) systems is performed in extraction columns, which are similar to the stripping section of a standard distillation column. The solvent (extract) flow is similar to the vapor flow (V), while the raffinate flow resembles the flow of the liquid (L) in the stripping column. It is assumed that (L/L) equilibrium is reached in each (theoretical) stage, which can be approached by thorough mechanical mixing of the two phases.

Equipment used in liquid/liquid extraction is discussed by Walas (1988) and Perry and Green (1997). Most of this (L/L) extraction equipment is used in the chemical and petroleum industries, with a few applications to food processing. Countercurrent extraction columns are generally used with the heavy phase fed at the top and the light at the bottom. The columns are analyzed either as plate (tray) or packed tower systems. Their efficiency depends mainly on the mass transfer between the two phases, and various types of mixing and agitation are used to increase the efficiency. Instead of a column efficiency value, the height of an equivalent theoretical plate (HETP) or the height of a theoretical unit (HTU) are used. Typical values of these heights vary, depending on the column, from 0.125 to 1 m, i.e., there are from 1 to 8 equilibrium stages per meter of column height.

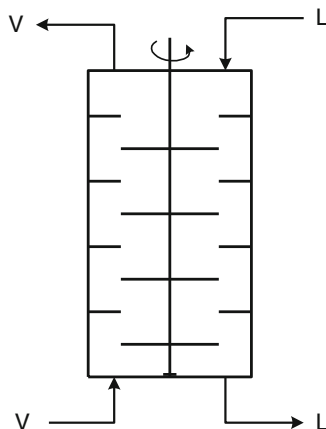
Industrial (L/L) solvent extraction columns include the sieve tray, the rotating disk (RTC), the Oldshue (paddle agitation), the Scheidel (packing and agitation), the pulsed columns, the Graesser rotary raining cup extractor, and the centrifugal extractor, used in the extraction of sensitive products (short residence time), like antibiotics (Walas 1988).

The RTC column (Fig. 11.15) consists of a vertical cylindrical vessel with circular baffles (rings) on the walls and a series of rotating flat discs, mounted on a shaft in the center of the column. The liquid (e.g., water solution) is fed from the top, while the (lighter) solvent is fed countercurrently from the bottom. The extract is received at the top, while the raffinate is removed from the bottom. The RTC is used in the solvent extraction of caffeine from aqueous solutions in the manufacture of decaffeinated soluble coffee.

The capacity of RTC columns varies from 100 to 500 m<sup>3</sup>/h, maximum loads of 40 m<sup>3</sup>/m<sup>2</sup> h, and diameters in the range of 1–4 m.

Leaching of solutes from solids is usually carried out in static (fixed) beds of particulate material, prepared to the appropriate size and physicochemical condition and to facilitate mass (diffusion) transport of the solute. The bed of material,

**Fig. 11.15** Diagram of a rotating disk L/L extraction column. *L* aqueous solution, *V* organic (insoluble) solvent



resting on a false bottom, is enclosed in vertical cylindrical vessels, which can stand high-pressure operation of volatile solvents. The solvent is fed to a distributor at the top, while the extract can be recirculated through the solids, before it is removed from the system.

For better efficiency, multistage equipment is used for the leaching of solids. In a true multistage countercurrent operation, the solid particles should be moved from stage to stage by special (slurry) pumps, in counterflow with the stage-to-stage flow of the solvent (extract). Such systems are difficult to use in food processing, and the multistage countercurrent static-bed system is commonly used (Walas 1988; Brennan et al. 1990).

The static-bed system is operated semicontinuously as follows: A series of static-bed cells (vessels) are leached with solvent flowing from cell to neighboring cell until the extract is nearly saturated with the solute. The first cell, containing the spent (leached) residue, is taken off and discharged, while the solvent feed is switched to the next (second) cell. The solvent flows from stage to stage until the recently filled last cell, from which it is taken off as concentrated extract. The first cell, after emptying, washing, and loading with the particulate solids, becomes the last cell of the series, from which the enriched extract is removed. The cycle is repeated when the second cell is exhausted and the spent residue is discharged.

In the leaching of sugar beets with water, 10–14 extraction cells are used, each with a volume of 4–12 m<sup>3</sup> and height to diameter ratio of 1.5. Leaching time is 60–100 min, and 110 kg of sugar solution 12–16 °Brix is produced per 100 kg beets. The extraction efficiency (mass transport rate) is increased considerably by heating the solution between the cells.

Similar multistage countercurrent static-bed systems are used for the leaching of oil from oilseeds with organic solvents and soluble solids from ground roasted coffee and tea. In the processing of instant coffee and tea, 5–8 extraction cells are used with cycle time ½ to 1 h. Ratios of water/solids are 7/2 to 5/1, and the extracts contain 25–30 % soluble solid.

Moving-bed (continuous) leaching equipment is described by Walas (1988) and Brennan et al. (1990).

Examples of continuous leaching equipment are the following:

1. The Bollmann bucket elevator with perforated buckets carrying each about 40 kg of particulate material in solvent bath, contained in a closed vessel. The residence time of the solids in the extractor is about 1 h, and the solvent (extract) is recirculated through the top of the vessel, and it is removed from the bottom, after approaching equilibrium, into the next stage of extraction.
2. The Hildebrand extractor, in which the solids are transported with screw conveyors through three sections (two vertical and one horizontal) in countercurrent flow with the solvent/extract (Fig. 11.16).
3. The Bonotto multi-tray tower extractor, in which the trays rotate, while the solid particles are scraped and discharged from tray to tray (similar to the agitated tray pan dryer (Fig. 8.24)).
4. The Rotocell extractor, which consists of about 18 wedge-shaped cells in a rotating shell, enclosed in a stationary tank. Fresh solvent is charged to the last cell and the drained solutions are pumped countercurrently to each cell in series. The Rotocell is used in the leaching of sugar beets and oilseeds.

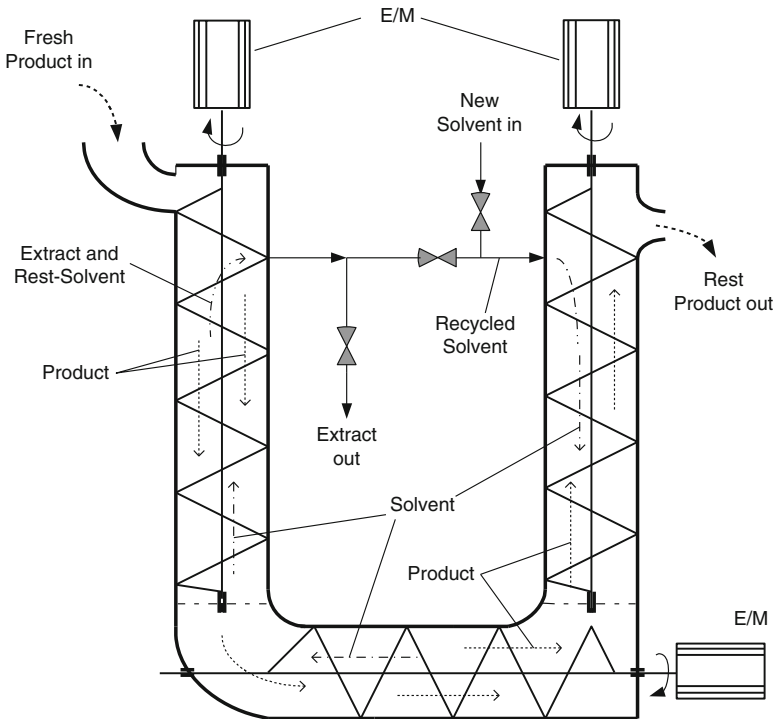
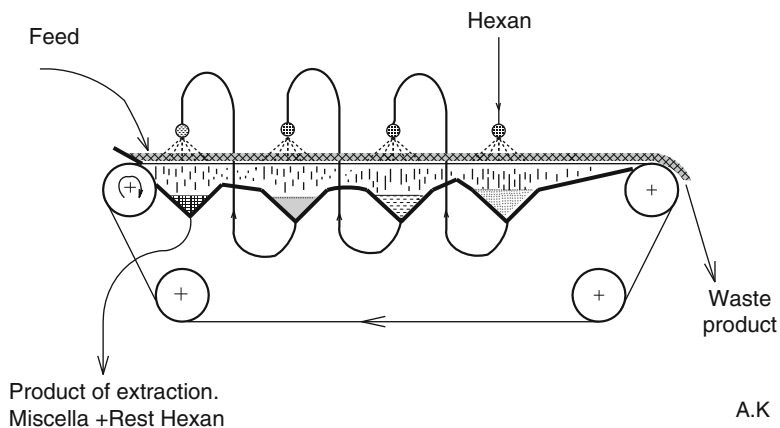


Fig. 11.16 Hildebrand extractor



**Fig. 11.17** DeSmet extractor

5. The screw extractor, similar to the screw expression equipment, used in the expression of fruit juices (Chap. 5). Such equipment can be used in the leaching of sugar beets, where the cossette pieces move countercurrently at a slope against the hot water solution.
6. The DeSmet, in which the solids are carried by a band, while the solvent flows countercurrently (Fig. 11.17).

### 11.3.5 Curing

#### 11.3.5.1 Introduction

Curing is a preservation process which improves the sensory characteristics of certain foods. It is used mainly in the treatment of meat, poultry, and fish with salt and other additives, and it covers also processes such as smoking and drying. *Marination* is a curing process, when seasonings and spices are added to the food material. Curing involves the diffusion of solid or liquid substances in solid foods. When applied to meat, curing may include also substances such as nitrates, nitrites, ascorbates, sugars, and several other chemicals or substances that improve its color, taste, and flavor. Curing is a diffusion process, but its theoretical interpretation is more complicated than the simple liquid or gas diffusion process.

In curing, besides the solvent, the composition and the macro- and microscopic structure of the cured food are very important. Therefore, engineering estimations in curing processes are based mainly on empirical knowledge.

The curing rate of meat increases when the moisture content, the temperature, the salt concentration, and the acidity of the meat are increased. The size or thickness and the fat content of the meat have a negative effect on the curing rate.

The nitrate content and bacteria in the meat contribute to the conversion of nitrate to nitrite, enhance the color, and act as a preservative. The activity of bacteria has an optimum of pH 5.8–6.0

### 11.3.5.2 Curing Processes

Fast curing is an economic process, but in some products, the high speed of curing may reduce the quality of foods. This is when the high diffusion rate (fast curing) is related to a higher processing temperature, which reduces the food flavor and the preservation time. Cooked ham, a popular cured pig meat product, is cooled down to 4 °C, before injected with brine. The ham is then tumbled, placed in metallic forms, and soaked in hot water or steamed until the temperature in the center of the product is about 68–75 °C. Subsequently, the product is cooled as fast as possible, packed, and stored at 0–2 °C.

The main curing processes are dry and wet curing and soaking, wet curing, muscle injection, artery injection, combination methods (e.g., dry and wet curing combinations with vacuum or/and warm brine application), tenderizing, and smoking.

#### Dry and Wet Curing and Soaking

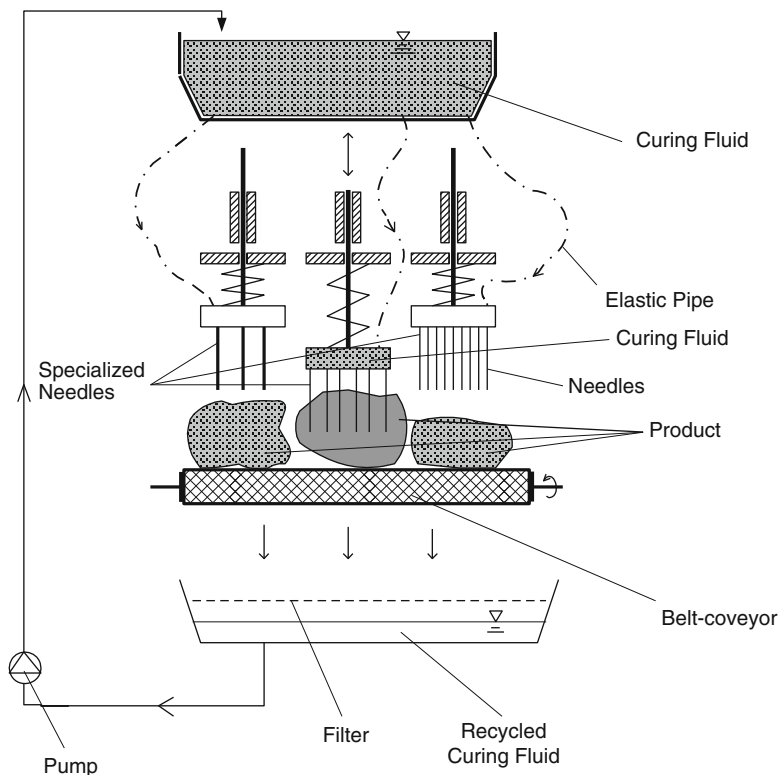
*Dry curing.* The product is covered with additives such as salt and other curing ingredients, and it is stored in more or less controlled temperature until a certain amount of the curing additives is absorbed. Covering of the product with salt and ingredients may be repeated during a long period of storage. Usually in such processes, the form of food influences the rate of curing. For equal weight of products, the diffusion of curing medium lasts longer in a thicker cubic product than in a thinner slab one.

*Wet curing* is carried out with brine of pH about 6.0. The addition of dextrose, lactose, or maltose helps to increase the product acidity. The acidity of the product is relatively low. But if it exceeds, e.g., pH 7.0, spoilage of the brine and product may be evident. The relation (brine quantity)/meat may be from 1/2 to 1/3.

*Soaking* in brine may last for more than 24 h. Methods such as dry and wet curing and soaking give products of good quality, but it must be pointed out that the end quality of the products, besides curing processing, depends also on the initial quality of the raw material.

#### Muscle Injection

Brine is injected in meat through fine needles (Fig. 11.18). There is equipment having more than 180 hypodermic needles, which sometimes are set in diversified



**Fig. 11.18** Needle curing injection

small groups according to the types of products that have to be processed (fat content, bones, toughness of the cured product). In this case, there is a specialization of each group of needles of the equipment, for meeting the specific requirements of the food product. There are also machines constructed to fit to a modular system that increases their versatility. The method using needles for the brine injection reduces the required time of curing, as the injected ingredients start diffusion initially deeper in the product. The thinner the needles, the less are the damages of fibers. The temperature of the injected brine solution must be almost equal to that of the meat (4–8 °C). Usually, the injected quantity is approximately 12–15 % of the fresh product weight. The injection process is performed in two steps, applying a relatively low overpressure (1.5–2.0 bars). This way, the fibers of the product are damaged minimally and less material is required, due to less losses. In case the meat pieces are relatively thick (>10 cm), curing injection is often preferably done before tendering. Tenderizing in this case helps to a subsequent more even distribution of the already injected substances.

## Artery Injection

Artery injection is applied to fresh meat, injecting the curing solution through the arteries of larger meat parts. This way, a thorough distribution is achieved and the brine leaches away the remaining blood as well.

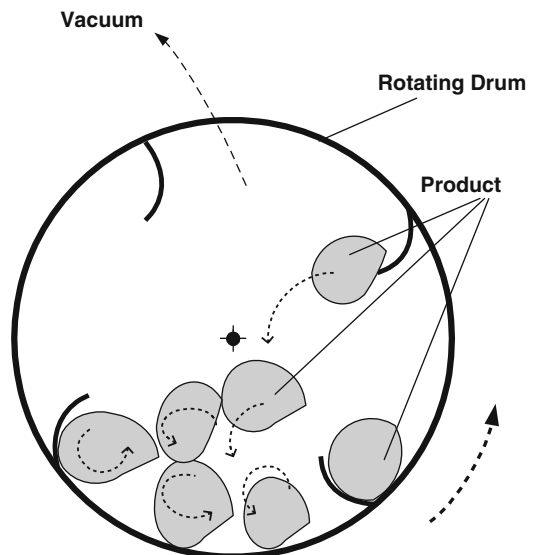
## Combined Methods of Curing

In case of vacuum application, the exit of air facilitates diffusion of salt and other ingredients into meat fibers, as meat expands and the curing operation is faster. Usually, a time of 10 min is required to load and empty the vacuum curing equipment and another 20 min for the processing of meat. Furthermore, the application of vacuum contributes to the increase of the absorption of marinade, reduces oxidation of the product, and reduces weight lose in subsequent cutting and cooking operations. Vacuum also improves the color and flavor of the products and extends their shelf life. Warm brining (temperature 36–38 °C) helps in the loosening of fibers and the increase of chemical reactions. It is often used in manufacturing products that do not stay for a long time in cold storage.

## Tenderizing

Tenderizing is done in tumbling or, in case of heavy duty applications, in massaging equipment. The main reason is to minimize the toughness of the connecting fibers of muscles, which result in a negative eating experience. A tumbler consists of a drum, with some fittings in it (Fig. 11.19). The tenderizing of the product such as

**Fig. 11.19** Tumbling drum



meat, bone-in and boneless poultry, or low profile products such as fish is carried up as the kettle drum rotates. The entrained product falls down, in the lower part inside the drum after about a half rotation. When it falls, it hits products that are already in the lower part of the drum, waiting to be carried up. The process is repeated continuously. This way a reaction between the protein of the products and the added brine solution is speeded up, providing a tendered product of better sensory characteristics. Both methods, tumbling and massaging, are similar. In massaging in the drum, instead of fittings, there are special small blades intensifying the tendering process. In tumbling, the drum rotates at 8–12 RPM along its axis. The entire tumbling operation lasts about 10–20 h. Each tumbling of the product lasts 15 min per hour. In the remaining 45 min, the product rests, until tumbling restarts for another 15 min. A tumbling process may also last for 1–4 continuous hours in a total tumbling period of 10–20 h. The tumbling equipment operates in rooms of about 10 °C. The temperature during processing is kept under control by additional measures, such as the use of tumbling equipment that can be cooled by glycol systems. The tenderizing process is enhanced when it is performed in vacuum. A large drum of 10 m<sup>3</sup> may tumble about 15 ton a day.

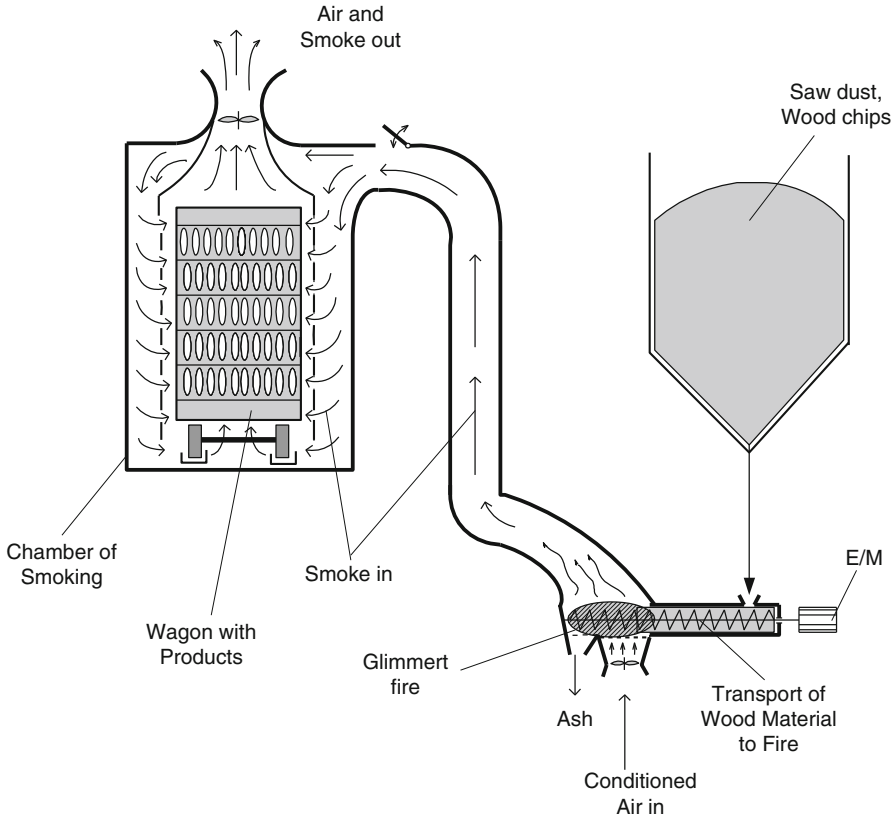
#### Automation of Curing Processes

For practical reasons, equipment that combines tenderizing with other curing process may be used, reducing the processing time. In addition to modular systems, automation is important in curing processes, especially for products that are designated to be consumed in not too long time. In such systems, the steady temperature and the pH value control of the processed material are important. Furthermore, they are provided with special filters for cleaning recycled processing curing liquids, and the equipment is provided with a CIP (Clean in Place) system.

#### Smoking

Smoking in food is applied for sensory and, nowadays less, for preservation reasons. Besides meat and fish that were among the first foods preserved by smoking, some other products are smoked, such as peppers, cheese, eggs, and fruits, and even some drinks such as beer and Scottish whiskey. The characteristic odor and taste of smoked foods depend to a significant extent on the kind of smoke and the method of smoking. The kind of smoke depends very much on the wood used. Generally, hard wood is better than soft wood (e.g., beech, hickory, apples). Wood shavings, saw dust, or wood chips are normally used (Fig. 11.20). The influence of the type of wood is reduced, when the size of the wood pieces becomes smaller. When larger pieces of wood are used, the heated wood is continuously rubbed against a rotating disc, producing smoke and serving to maintain the fire on wood alive (Fig. 11.21). There are more than 200–300 substances in the smoke of wood. In food preservation, substances such as phenols and formaldehyde are





**Fig. 11.20** Chamber-hot smoking

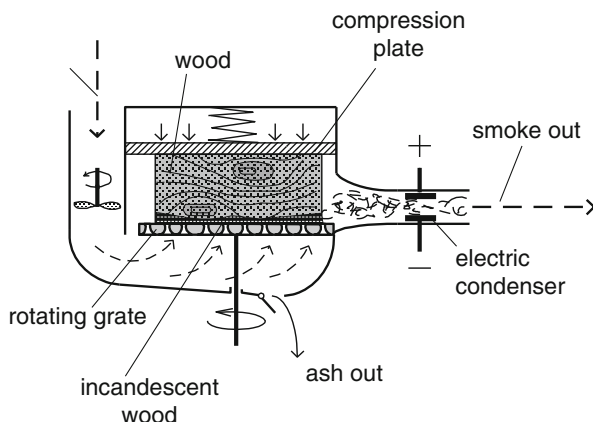
important. The first acts against microorganisms and the second against yeasts and molds. In sensory aspects, smoke may influence the color, the taste, the odor, and the texture of products.

Sensory changes caused by smoke include the following: color (products become brown), taste (reduced palatability), texture (firmer due to partial drying), and flavor (aroma influenced by carboxylic acid and polycyclic reactions). However, recently, as in smoke there are carcinogenic substances (e.g., polycyclic aromatic hydrocarbons such as benzopyrene), the smoke is filtered out.

Three methods of smoking can be distinguished as cold smoking, warm drying, and water smoking.

*Cold smoking* process is applied to products that must be preserved longer. It lasts several hours or even days, and it is performed at temperatures 8–26 °C. In some cases, higher temperatures may be applied (e.g., 30–55 °C). The air humidity varies between 60 and 100 %, and smoke prevents molding of the surface of the food products in the first days of the product input, when the product (e.g., sausages) is still wet. The method is rather a traditional drying process, accomplished in smoke chambers by using hard wood for producing smoke. The high salt

**Fig. 11.21** Electrostatic accretion of smoke



content of the meat and the reduced water content discourage the invasion of molds and microorganisms in the food. The products are hung above glowing fire, which must be maintained steady by slow agitation.

*Warm drying.* In this process, temperatures at about 60 °C are used. According to the type of meat and the desired quality of the final product, this process may last from hours up to several days. The heating in the smoking chamber is mainly induced by installed heat exchangers which are part of other heating sources, serving a better control of the overall temperature.

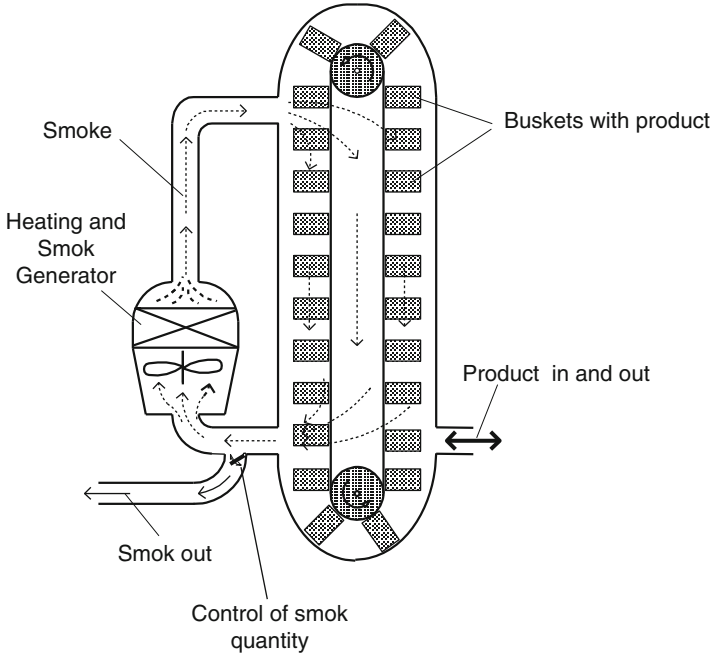
*Hot smoking.* This kind of smoking is also called “water smoking.” Heating is independent of smoking. The products are hanging in small wagons (about 1 × 1 × 2 m) that get in full air-conditioned tunnel chambers (Fig. 11.20). In the case of a continuous process, more wagons may follow each other in a tunnel. When curing meat, the product is washed up, pre-dried, smoked, cooked, water cooled, and air cooled before exiting the tunnel. In another case, the products are put in small baskets being moved (circulating) in a smoked chamber (Fig. 11.22).

The fish hot smoking process in tunnels is similar to that of meat products. Here, the processing is as follows: washing, pre-salting, splitting, pre-drying with warm air, smoking, refined cooking, cooling with air, and packaging.

For a better control of smoking, smoke may pass through electric condensers, ionizing its particles which successively adhere on the products that have to be smoked (Fig. 11.21). Hot smoking is prevailing nowadays, because preservation is not the prime objective of the consumers.

## 11.4 Gas/Liquid Absorption Equipment

Gas absorption and desorption (stripping) are physical separation processes, in which a gas component of a mixture is absorbed or desorbed in a liquid, using single- or multistage absorption equipment, in a similar operation with distillation



**Fig. 11.22** Continuous smoking

and liquid/liquid extraction. In food processing, absorption and desorption (stripping) of oxygen and carbon dioxide in aqueous solutions/liquid foods are the most important systems (aerobic fermentations, deaeration of liquid foods, carbonation of beverages). In addition, absorption/desorption of sulfur dioxide in some fluid food systems (fruit juices, wine) is of interest.

### 11.4.1 Gas/Liquid Equilibria

Most of the gas/liquid operations in food processing involve dilute aqueous solutions, which simplify the analysis of gas/liquid equilibria and the design of separation equipment.

In dilute solutions, the gas/liquid equilibria are expressed by the Henry law:

$$p_i = H_i x_i \quad (11.27)$$

where  $(p_i, x_i)$  are the partial pressure (bar) and mole fraction of component ( $i$ ) and  $(H_i)$  is the Henry law constant (bar/mole fraction). Equilibrium or solubility of gases in liquids is expressed either as the Henry law constant ( $H_i$ ) or, more appropriately, by its inverse ( $1/H_i$ ) in units of mole fraction/bar. Typical solubility

data for gases/water at 25 °C of interest to food processing (Perry and Green 1997) are as follows:

Oxygen,  $1/H_i = 2.3 \times 10^{-5}$  mole fraction/bar =  $2.3 \times 32 \times 10^{-5}/18 = 4 \times 10^{-5}$  g/g water bar or 40 ppm/bar. The solubility of oxygen in air at atmospheric pressure ( $P \approx 1$  bar) in water is about  $40/5 = 8$  ppm.

Carbon dioxide,  $1/H_i = 8 \times 10^{-4}$  mole fraction/bar =  $8 \times 44 \times 10^{-4}/18 = 19.6 \times 10^{-4}$  g/g water bar or 1960 ppm/bar = 0.2 % by weight.

Nitrogen,  $1/H_i = 1.2 \times 10^{-5}$  mole fraction/bar =  $1.2 \times 28 \times 10^{-5}/18 = 1.8 \times 10^{-5}$  g/g water bar = 18 ppm/bar.

For atmospheric air at 1 bar, the solubility of nitrogen in water becomes  $18 \times (4/5) = 14.4$  ppm.

In food processing, the gas phase is considered as ideal (relatively low pressures), and the Dalton law is applicable ( $p_i = y_i P$ ), where ( $y_i$ ) is the mole fraction of component ( $i$ ) in the gas phase and ( $P$ ) is the total pressure. Thus, the equilibrium relationship of (11.27) becomes

$$y_i = m_i x_i \quad (11.28)$$

where  $m_i = H_i/P$ .

The gas/liquid equilibrium constant ( $m_i$ ) is equivalent to the distribution coefficient ( $K_i$ ) of the vapor/liquid- and liquid/liquid-phase equilibria.

## 11.4.2 Determination of Equilibrium Stages

Absorption and desorption (stripping) of gases in solutions can be carried out in agitated vessels and in columns/towers. In the agitated vessels, equilibrium (one stage) is approached by vigorous mixing. Agitated vessels are used for the transfer of oxygen in aerobic fermentations, and their construction and power requirements are discussed in Chap. 5 (mixing). Multistage countercurrent absorption is carried out either in tray columns or in packed towers.

### 11.4.2.1 Tray Columns

Design of tray columns is similar to the design of distillation and liquid/liquid tray columns, discussed earlier in this chapter. For dilute solutions, common in food applications, the gas ( $G$ ) and liquid ( $L$ ) flow rates in countercurrent columns are considered constant, and overall material balance in the column yields a straight operating line:

$$y_1 - y_2 = (L/G)(x_1 - x_2) \quad (11.29)$$

where  $(y_1, y_2)$  are the mole fractions of the component in the gas at the inlet (bottom) and outlet (top) of the column, respectively, and  $(x_1, x_2)$  are the corresponding mole fractions in the liquid.

The number of equilibrium stages ( $N$ ) can be determined graphically, using the McCabe–Thiele diagram, in which both equilibrium and operating lines are straight lines with slopes  $(m)$  and  $(L/G)$ , respectively. The number of stages can also be calculated analytically, in analogy to extraction, using the Kremser equation:

$$N = \log[R_a(1 - 1/A) + 1/A]/\log(A) \quad (11.30)$$

where  $R_a = (y_1 - mx_2)/(y_2 - mx_2)$ , absorption ratio and  $1/A = (mG/L)$ , absorption factor.

If pure liquid is used at the top of the column ( $x_2 = 0$ ), the absorption ratio is  $R_a = (y_1/y_2)$ .

An equation similar to (11.30) can be used for the calculation of ( $N$ ) of a stripping column, substituting ( $R_a$ ) with  $R_s = (x_2 - y_1/m)/(x_1 - y_1/m)$ , stripping ratio, and  $(1/A)$  with  $A = (L/mG)$ , stripping factor.

The efficiency of the tray columns, used for absorption and stripping operations, is generally lower than the efficiency of the distillation and extraction columns (about 10–15 %), due to the poor mixing of the gas with the liquid and inefficient mass transfer.

### 11.4.2.2 Packed Towers

Absorption of gases in liquids in the chemical process industries is usually carried out in packed towers, which use various packing materials to affect gas/liquid contact and mass transfer, instead of the tray columns, used in distillation and extraction. Packed towers are continuous separation systems, the separating capacity of which is measured by the number of theoretical transfer units (NTU) instead of the number of theoretical stages ( $N$ ) of the multistage systems.

In dilute solutions, which are characteristic of gas/liquid absorption in food systems, the height of absorption or stripping towers ( $Z$ ) is equal to the product of the number of theoretical transfer units (NTU) times the height of transfer unit (HTU):

$$Z = (\text{NTU})(\text{HTU}) \quad (11.31)$$

For absorption towers,  $(\text{NTU}) = \int [dy/(y - y_e)]$  and  $\text{HTU} = G/K_g aP$ .

The integral  $\int [dy/(y - y_e)]$  is estimated graphically or analytically from  $(y_2)$  to  $(y_1)$ , where  $(y_1, y_2)$  are the mole fractions of the gas component being transferred at the inlet (bottom) and outlet (top) of the column, respectively, and  $y_e$  is the mole fraction of the gas in equilibrium with the liquid entering the column at the top ( $y_e = mx$ ). For clean absorption liquid,  $x_2 = 0$  and  $y_e = 0$  at the top of the column. ( $G$ ) is the gas flow rate ( $\text{kmol/m}^2 \text{ s}$ ), ( $K_g$ ) is the mass transfer coefficient

( $\text{kmol/m}^2 \text{ s Pa}$ ), ( $\alpha$ ) is the specific surface of the packing ( $\text{m}^2/\text{m}^3$ ), and ( $P$ ) is the total pressure (Pa).

For stripping (desorption) towers, the following analogous relationships are used:

$$\text{NTU} = \int [dx/(x_e - x)] \quad \text{and} \quad \text{HTU} = L/K_1\alpha\rho_M \quad (11.32)$$

The integral  $\int [dx/(x_e - x)]$  is estimated graphically or analytically from ( $x_2$ ) to ( $x_1$ ), where ( $x_2, x_1$ ) are the liquid mole fractions of the component at the inlet (top) and outlet (bottom) of the stripping tower, respectively, and ( $x_e$ ) is the mole fraction in the liquid which is in equilibrium with the gas phase ( $x_e = y/m$ ). For clean stripping gas,  $y_2 = 0$  and  $x_e = 0$  at the bottom of the tower. ( $L$ ) is the liquid flow rate ( $\text{kmol/m}^2 \text{ s}$ ), ( $K_1$ ) is the liquid overall mass transfer coefficient (m/s), ( $\alpha$ ) is the specific surface of the packing ( $\text{m}^2/\text{m}^3$ ), and ( $\rho_M$ ) is the molar liquid density ( $\text{kmol/m}^3$ ).

The overall mass transfer coefficients ( $K_g$ ) and ( $K_l$ ), based on the gas and liquid phase, respectively, are characteristic parameters of the mass transfer system, related to the geometry and flow conditions of the equipment and to the physical and transport properties of the materials involved (Perry and Green 1997; Saravacos and Maroulis 2001).

For dilute solutions, the number of theoretical transfer units in a countercurrent absorption tower can be estimated by the Colburn equation, which is analogous to the Kremser equation:

$$\text{NTU} = \ln[R_a(1 - A) + A]/[1 - (1/A)] \quad (11.33)$$

where the absorption ratio ( $R_a$ ) and the absorption factor ( $A$ ) are defined as in the Kremser equation for absorption columns (11.30). The same equation (11.33) can be used for estimating the (NTU) of packed stripping towers, substituting ( $R_a$ ) with the stripping ratio ( $R_s$ ) and ( $A$ ) with the stripping factor ( $1/A$ ), as defined in the Kremser equation (11.30).

An alternative method of determining the height of a packed tower ( $Z$ ) is the equation

$$Z = N(\text{HETP}) \quad (11.34)$$

where  $N$  is the number of theoretical stages of a multistage countercurrent column of equivalent separating capacity with the absorption tower and HETP is the height of an equivalent theoretical plate ( $m$ ). The number ( $N$ ) is more easily determined with methods developed in distillation, and it can replace NTU, provided that data on HETP are available. In some systems, NTU and HTU may coincide with  $N$  and HETP.

Experimental and operating data on HTU and HETP of various packing materials have been correlated empirically with the flow conditions of absorption and stripping equipment (Perry and Green 1997; Walas 1988).

### ***11.4.3 Gas Absorption and Stripping Equipment***

Gas absorption or desorption (stripping) equipment is carried out in agitated vessels, absorption towers, or gas scrubbers.

#### **11.4.3.1 Agitated Vessels**

Agitated vessels are used for simple, one-stage operations, like absorption of oxygen in aerobic fermentations. The design and operation (power requirements) of the agitated vessels are discussed in Chap. 5 (mixing). Special impellers (turbines) and baffles are required for efficient dispersion and absorption of gases in liquids (Perry and Green 1997).

Absorption of oxygen in water and aqueous solutions presents certain difficulties, due to its very low solubility. High power (kW) is required for dispersing and absorbing oxygen gas in water (increasing the mass transfer coefficient). The optimum mass transfer rate is about 2.2 kg O<sub>2</sub>/kWh.

Surface agitators are used in the aerobic treatment of wastewater, transferring oxygen from the atmosphere to the liquid biomass. Oxygen can also be supplied to liquid media by gas spargers (distributors), installed at the bottom of the treatment tanks.

Removal of air, oxygen, and other dissolved gases from food liquids is usually accomplished by vacuum stripping in single-stage equipment. For efficient operation, large specific surface of the liquid is required, obtained by spraying the product into the vacuum vessel.

Absorption of carbon dioxide in liquid foods, e.g., carbonated beverages, is easier than oxygen absorption, due to the higher solubility of the gas in water. According to Henry law, the solubility of carbon dioxide increases linearly with the partial pressure, and this explains the need for pressurized packaging of the carbonated beverages.

#### **11.4.3.2 Multistage Columns and Packed Towers**

Tray columns and packed towers are used, when relatively large numbers of stages are needed. The simplest multistage system for gas absorption is the bubble column, which consists of a column, with the liquid flowing downward and the gas bubbling through the liquid from the bottom and exiting at the top. The bubble columns have a relatively low separation efficiency (high HTU or HETP values). Spray towers

operate in a similar manner, with the liquid falling from the top in the form of sprays (droplets) and the gas introduced at the bottom of the tower.

More efficient absorption is achieved in tray columns and absorption towers, operated in countercurrent flow of liquid and gas. Sieve trays are commonly used in columns, similar to the distillation and liquid/liquid extraction equipment, but with lower efficiencies (10–15 %).

Packed towers are preferred for smaller operations (diameter less than 1.5 m) and in systems where high-pressure drop is not accepted, e.g., in vacuum operation. Porcelain, metal, and plastic materials in the form of rings, cylinders, and saddles are used (Perry and Green 1997). The effectiveness of the packing materials depends on their specific surface ( $\alpha$ ,  $\text{m}^2/\text{m}^3$ ) and the packed porosity ( $\epsilon$ ), expressed by the packing factor  $F = \alpha/\epsilon^3$  in units ( $\text{m}^2/\text{m}^3$ ). The HETP values of packed materials range from 0.3 to 0.5 m.

### 11.4.3.3 Gas Scrubbers

Gas scrubbers are used to remove small particles and undesirable gases from industrial exhaust gases, for the primary purpose of reducing environmental pollution (Perry and Green 1997). They are usually installed after the mechanical cyclone collectors, which are efficient for removing particles larger than 1–5  $\mu\text{m}$  (Chap. 5, Mechanical Separations).

Cyclone scrubbers are mechanical cyclones in which an absorbing liquid (water or aqueous solutions) is sprayed from several nozzles in a central manifold. The gas comes into intimate contact with the liquid, and it leaves the cyclone near equilibrium (one-stage operation).

The ejector-venturi scrubbers use high-velocity jets of water to create a suction and absorb the gas, in a parallel-flow operation. Large quantities of water are required, which should be disposed in the environment without creating pollution problems.

Scrubbers are necessary to reduce air pollution in some food processing plants. Certain food processing operations produce undesirable gases and volatiles, which cause air pollution (mainly offensive odors) in the area surrounding the food plant. Food processes, involved in air pollution, include air drying, solvent extraction and refining of edible oils, coffee processing, fermentation, and baking. Air scrubbers, usually installed after dust collection equipment (cyclones or air filters), operating with water or dilute alkaline solutions, can remove most of the offensive gases from the exhaust streams (see Chap. 5).

## 11.5 Adsorption and Ion Exchange Equipment

Adsorption and ion exchange equipment is used to adsorb solute components from liquids or gases with the purpose of clarifying the fluid of unwanted materials or recovering valuable components. The separation is affected by physical adsorption on solid adsorbents or ion exchange resins, which are regenerated for repeated use.



Commercial adsorbents include activated carbon, silica gel, activated alumina, and molecular sieves, while ion exchangers include cation and anion exchange resins. Batch adsorption and ion exchange equipment (fixed beds) is used in most applications. Desorption of the adsorbed components is accomplished by washing the fixed bed or by increasing the temperature. Regeneration of the ion exchange beds is achieved by washing with salt or alkali solutions.

### 11.5.1 Adsorption Equilibria and Mass Transfer

The adsorption capacity of a solid adsorbent is determined by measuring the amount of the solute component as a function of its partial pressure or concentration in the fluid phase. Various empirical equations are used to express this relationship, the simplest of which is the Freundlich equation, which for a gas/solid system becomes (Perry and Green 1997)

$$w_i = K p_i^n \quad (11.35)$$

where ( $w_i$ ) is the amount of adsorbed component (kg/kg adsorbent), ( $p_i$ ) is the partial pressure of the solute component in the gas phase (Pa), and ( $K$ ,  $n$ ) are characteristic constants of the system. For systems favoring adsorption,  $n < 1$ . For liquid/solid adsorption, the partial pressure is replaced by the concentration ( $C$ ) of the solute component in the liquid phase ( $\text{kg/m}^3$ ).

More complex sorption relationships, such as the Langmuir, the BET, and the GAB equations, have been used to express the fluid/solid equilibria in food systems.

Fluid/solid equilibrium data are usually presented as component mass fraction ( $w_i$ ) versus relative pressure ( $p_i/p_o$ ), where ( $p_o$ ) is the vapor pressure of component ( $i$ ) at the given temperature of the system. These plots are known as the sorption isotherms of the solute component/solid adsorption system, and they are used extensively in food science and engineering.

The separating specificity and capacity of solid adsorbents depends primarily on the physical and chemical structure of the material. Special processes are used to prepare efficient adsorbents for a specific application, e.g., activated carbon is prepared by burning some of its liquid components, increasing the porous structure and specific surface area. Molecular sieves (special aluminosilicate compounds), due to their pore structure, have a much higher sorption capacity at lower partial pressures than silica gel, making them more effective in removing small amounts of solutes from the fluid phase, e.g., a better desiccating agent.

The volumetric mass transfer rate from a gas or liquid phase to a solid adsorbent ( $J$ ,  $\text{kg/m}^3 \text{ s}$ ) is given by the equation

$$J = k_g \alpha (p_i - p_{ie}) \quad (11.36)$$

where ( $p_{ie}$ , Pa) are the equilibrium concentration of component ( $i$ ), ( $k_g$ ) is the mass transfer coefficient of the gas phase ( $\text{kg/m}^2 \text{ s Pa}$ ), and ( $\alpha$ ) is the interfacial area ( $\text{m}^2/\text{m}^3$ ).

For liquid-phase volumetric mass transfer, the rate equation becomes

$$J = k_L \alpha (C_i - C_{ie}) \quad (11.37)$$

where  $(C_i, C_{ie})$  are the concentrations of component  $(i)$  in the liquid and at equilibrium, respectively ( $\text{kg/m}^3$ ) and  $(k_L)$  is mass transfer coefficient in the liquid phase (m/s).

The mass transfer coefficients can be estimated from empirical correlations of the mass transfer factor ( $j_M$ ):

$$j_M = a Re^m \quad (11.38)$$

Regression analysis of published data on mass transfer coefficients in food systems (Saravacos and Maroulis 2001) has yielded the following average values of the constants of (11.37): ( $a = 1.11, m = -0.54$ ). The Reynolds number is defined as  $Re = dG/\eta$  or  $Re = dL/\eta$ , where  $(d)$  is the particle diameter (m) and  $(\eta)$  is the fluid viscosity (Pa s).

The mass transfer factor is defined by the equations

$$j_M = k_G P / G \quad \text{or} \quad j_M = k_L \rho / L \quad (11.39)$$

where  $(G, L)$  are the gas or liquid flow rates ( $\text{kg/m}^2\text{s}$ ), respectively,  $P$  is the total pressure (Pa), and  $(\rho)$  is the liquid density ( $\text{kg/m}^3$ ).

Physical properties of the adsorbents, which affect mass transfer and adsorption capacity, are the particle diameter  $(d)$ , bulk density  $(\rho_b)$ , bulk porosity  $(\epsilon)$ , and specific surface area  $(\alpha)$ . Typical values of these properties for commercial adsorbents are  $d = 1\text{--}4$  mm;  $\rho_b = 500\text{--}800$   $\text{kg/m}^3$ ;  $\epsilon = 0.25\text{--}0.35$ ; and  $\alpha = 1000\text{--}3000$   $\text{m}^2/\text{m}^3$ .

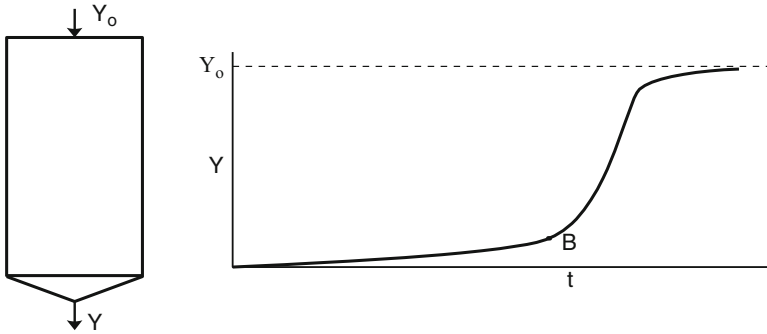
## 11.5.2 Adsorption Equipment

Adsorption of components from fluids is accomplished in fixed vertical beds of porous granular adsorbents. The fluid flows usually from the top down through the bed, while regeneration is carried out by upward flow of the regenerant solution.

Figure 11.23 shows diagrammatically the operation of an adsorption bed with the characteristic breakthrough curve.

A fluid of initial solute concentration  $(Y_o)$  is fed from the top through the bed, and the concentration of the effluent  $(Y)$  is recorded. Initially, all the adsorbent in the bed is active, and the effluent concentration is nearly zero. However, after some time of operation, the concentration  $(Y)$  starts to rise sharply, e.g., at the “break” point (B). After all the adsorbent is saturated with the solute, the effluent concentration reaches asymptotically the initial solute concentration  $(Y_o)$ .

The fixed adsorption bed is designed on the basis of material balances and equilibrium relationships, in a similar manner with the design of packed absorption towers. The resulting design equation is



**Fig. 11.23** Breakthrough curve in an adsorption column

$$\partial Y / \partial z = (1/\text{HTU})(Y - Y_e) \quad (11.40)$$

where  $(Y, Y_e)$  are the concentrations of the solute in the bed at bed depth  $z$  and at equilibrium, respectively, and  $(\text{HTU})$  is the height of one transfer unit, defined by the equation: for the gas phase,  $(\text{HTU}) = G/k_G\alpha$  and for the liquid phase,  $(\text{HTU}) = L/k_L\rho$  (11.41), where  $(\rho)$  is the liquid density ( $\text{kg}/\text{m}^3$ ).

The height of the adsorption bed ( $Z$ ) is calculated from (11.41), e.g., from a graphical solution (Walas 1988), using appropriate parameters.

### 11.5.3 Ion Exchange Equipment

Ion exchange separations are based on the exchange of cations and anions from a solution or food liquid with the ions of an ion exchange resin. Synthetic polymer resins are designed to separate specific ions from various liquids.

Commercial ion exchange columns range up to 4 m diameter and bed heights of 1–3 m. Sufficient free space above the bed should be allowed for bed expansion during operation and regeneration, which can exceed 50 %. The particle size of the ion exchange resins ranges from 0.3 to 0.8 mm and 18 to 04 mm. The resin beds are supported by a layer of about 0.2 m at the bottom. Construction details of the ion exchange columns are given by Walas (1988).

The ion exchange rate is affected by the mass transfer resistances of the resin particulate system. At low solute concentrations, which is the case of most food applications, film diffusion is the controlling mechanism.

The capacity of ion exchange resin is about 2 meq/g of resin, which corresponds to the removal of about 0.2 kg of calcium carbonate/kg of resin (softening or demineralization of hard water). The bulk density of the ion exchange resins varies from 600 to 900  $\text{kg}/\text{m}^3$ . Liquid flow rates in the ion exchange beds range from 14 to 18  $\text{m}^3/\text{m}^2 \text{ h}$ .

Regeneration of the cation exchange resins is usually accomplished by upward flow of sodium chloride solutions, while alkali solutions are used to regenerate the anion exchange resins. Mixed beds, consisting of two layers of cation and anion exchange resins of differing bulk densities, are regenerated by salt and alkali solutions, introduced from the top and the bottom, with the waste solutions removed from the middle of the bed.

The operating cycle of an ion exchange system includes the following: (1) passing of the process stream through the bed for the proper time, (2) rinsing the bed and recovering any occluded valuable solution, (3) backwashing of the bed to remove accumulated materials and reclassify the particle size distribution, (4) regeneration of the bed for the proper time, and (5) rinsing of the bed to remove any occlude regenerant.

### ***11.5.4 Food Applications***

#### **11.5.4.1 Water Treatment**

Removal of odors, chlorine, and other undesirable compounds from drinking and process water can be accomplished by adsorption in activated carbon beds. Regeneration of the spent adsorbent is usually achieved by controlled burning in special furnaces.

Softening and demineralization of drinking, process, and steam boiler water are the most important applications of ion exchange separations. Softening and removal of carbonates can be accomplished using two cation exchange beds, one weak acid, and a second strong acid resin. Complete demineralization of water with simultaneous removal of silicates can be accomplished with four columns, in the following order: strong acid, weak alkali, strong alkali, and mixed bed. Regeneration is accomplished with acid (hydrochloric acid) and alkali (sodium hydroxide).

Fouling of the ion exchange beds with suspended particles can be prevented by pre-filtration of the water through carbon beds or other filters. Some macroporous resins can handle suspended materials during operation, which are rejected from the resins by vigorous backwashing, before regeneration.

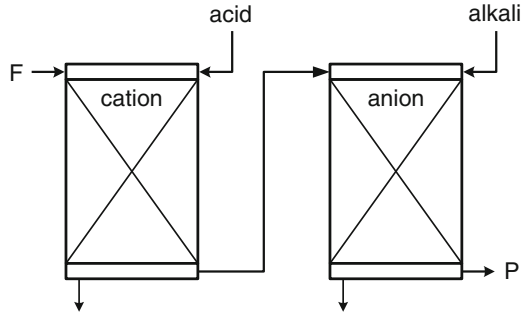
Special ion exchangers are used to remove from drinking and process water some specific mineral ions, which may be toxic or radioactive, such as nitrates, lead, barium, strontium, and cesium.

Figure 11.24 shows a system of cation/anion exchange columns used in water softening.

#### **11.5.4.2 Recovery of Valuable Components**

Recovery of valuable proteins from food and biotechnological solutions/suspensions can be accomplished with special ion exchange resins. A typical application is

**Fig. 11.24** Diagram of a cation/anion exchange column system. *F* feed water, *P* product (deionized) water



the recovery of proteins from cheese whey. Depending on the pH of the liquid, the proteins behave either as cation or anion components, and thus anion or cation exchange resins are used for their recovery. Elution of the adsorbed proteins is affected either by altering the pH or increasing the ionic strength (Grandison and Lewis 1996).

Industrial enzymes (e.g., amylase) can be recovered from fermentation liquids or from food materials with special ion exchange resins (combinations of strong anion and strong cation exchangers).

#### 11.5.4.3 Removal of Undesirable Components

Adsorption and ion exchange beds are used for the removal of various undesirable components from food liquids, either as a pretreatment step during further processing or a final step for improving the quality of the food product. Typical applications are decolorizing of sugar solutions and liquid foods, decaffeination of soluble coffee, demineralization of dairy products and fruit juices, and debittering of citrus juices.

Demineralization of food liquids (e.g., cheese whey) with ion exchangers can remove undesirable ions, such as Na, K, Mg, Cl, phosphate, citrate, and lactate. A system of strong cation, followed by a weak anion exchanger, may be used, followed by regeneration with strong acid and alkali.

Demineralization of cane, beet, and hydrolyzed sugar solutions with ion exchangers is applied in clarifying and preparing sugar solutions for further processing by evaporation, followed by crystallization.

Bitter components of citrus (grapefruit and navel orange) juices, like limonin and naringin, should be removed, particularly when present in considerable concentrations (Nagy et al. 1993; Kimball 1999). The juices are first clarified by centrifugation or membrane ultrafiltration (UF) and then debittered in beds of special ion exchange resins, made of divinylbenzene polymer (Cheryan 1998). The bed removes practically all the limonin and about 90 % of the naringin, and it is regenerated with a weak alkali solution. The saturated bed is regenerated after about 20 h of operation. The operating cycle includes 2 h of debittering and 4 h of

regeneration. The debittered clear juice is combined with the separated fruit pulp to make the regular cloudy citrus juice (see also Chap. 12).

Simultaneous debittering and deacidification of citrus juices can be achieved with special ion exchange resins. Ion exchange resins and adsorption materials, used in food processing, must be nontoxic and approved by national food authorities, such as the FDA in the USA.

## 11.6 Crystallization from Solution Equipment

Commercial crystallization from solution is used to separate and recover various solutes from solutions, by cooling or evaporating the solvent. Crystallization of ice in freeze concentration and fat fractionation by crystallization from melt are treated in Chap. 12.

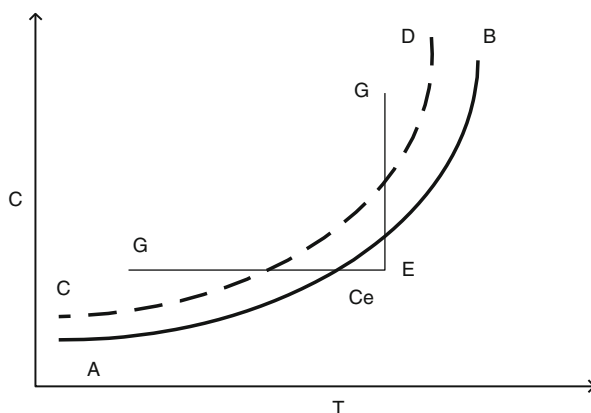
Like the other mass transfer operations, crystallization from solution is based on phase equilibria (solubilities) and mass transfer rates.

### 11.6.1 Solubility Considerations

In food processing, most crystallizations take place from aqueous solutions, e.g., sugar and salt. The solubility of a solute in water ( $C$ ) is expressed in crystallization calculations as a mass ratio, i.e., kg solute/kg of water, and it increases significantly with the temperature, as shown in Fig. 11.25.

Below the saturation line (AB), the solution is undersaturated. By cooling a solution from point (E) at constant concentration  $C$  (no evaporation), the solution can cross the supersaturation line (CD) and reach an unstable state (F), where fast crystallization may start.

**Fig. 11.25** Solubility–temperature diagram. AB, saturation; CD, supersaturation



A similar condition may be created by concentrating the solution at constant temperature ( $T$ ), e.g., by evaporation, when a supersaturation point ( $G$ ) may be reached, starting fast crystallization. The area between saturation and supersaturation is the unstable state.

The supersaturation of a solute is expressed by the difference  $\Delta C = C - C_e$ , where  $C_e$  is the equilibrium concentration (on the saturation line).

### 11.6.2 Nucleation and Mass Transfer

Crystallization from solution starts with nucleation, followed by crystal growth. Nucleation (formation of several microscopic nuclei) is either heterogeneous (foreign particles) or homogeneous (particles of the same material).

The rate of homogeneous nucleation ( $N$ , nuclei/m<sup>3</sup> s) is given by reaction-rate kinetics, which is simplified to the empirical equation

$$N = k(\Delta C)^i \quad (11.41)$$

The nucleation constants ( $k$ ,  $i$ ) depend on the geometry of the system and the agitation rate.

The nucleation can be enhanced by adding small crystals (about 1  $\mu\text{m}$  size) to the saturated solution, as in the seeding of sugar crystallizers.

Crystal growth of the nuclei of the solution is limited by the mass transfer from the bulk of the solution to the surface of the growing crystals (molecular or turbulent diffusion). The growth rate of crystals is usually expressed as the rate of increase of a linear dimension ( $L$ ) of the crystal ( $dL/dt$ ), which is related linearly to the supersaturation ( $\Delta C$ ), according to the McCabe law:

$$(dL/dt), = (K/\rho)(\Delta C) \quad (11.42)$$

where ( $K$ ) is the mass transfer coefficient (m/s) and ( $\rho$ ) is the density of the crystals.

The crystal growth rate is a function of the mass transfer coefficient ( $K$ ), which increases at high agitation rates and lower viscosity of the solution. The growth of crystals is affected by the presence of foreign substances in the solution, resulting in the production of crystals of special sizes and shapes, e.g., in the crystallization of sodium chloride.

The crystallization kinetics (nucleation and crystal growth) is investigated in the laboratory and the pilot plant, using the mixed suspension mixed product removal (MSMPR) continuous crystallizer (Mullin 1993; Nyvlt 1971). In analyzing the operation of the MSMPR crystallizer, in addition to the usual material balances and mass transfer rates, the population balances of the system should be considered (Randolph and Larson 1971).

### 11.6.3 Industrial Crystallizers

The industrial crystallizers are classified according to the method of obtaining supersaturation, i.e., by cooling, evaporation, or mixed operation. The crystallizing suspension is called “magma,” while the saturated solution, remaining after removing the crystals, is known as “mother liquor.”

The yield of a crystallizer ( $Y$ , kg) is given by the simplified material balance equation:

$$Y = W[C_1 - C_2(1 - V)] \quad (11.43)$$

where  $W$  is the initial mass of the solvent (water), ( $C_1$ ,  $C_2$ ) are the concentrations of the solute before and after crystallization, and ( $V$ ) is the fraction of water evaporated (kg water/kg initial solution).

Cooling crystallizers consist of a cooling/separation system, resembling the forced circulation evaporator (Chap. 7), with the heater replaced by a cooling (shell and tube) heat exchanger. In the draft tube baffled (DTB) crystallizers, the recirculation is carried out in a draft tube, which is installed in the crystallizer. Crystallization by cooling of viscous solutions is accomplished in scraped surface heat exchangers (Chap. 6), e.g., in margarine and ice cream production.

Evaporative crystallizers are similar to the forced circulation evaporators (Chap. 7) with an additional crystallization vessel below the vapor/liquid separator for the growth of the crystals (Oslo crystallizer). Simultaneous evaporation and cooling crystallizers operate without external heat exchangers, with the cooling effect provided by vacuum evaporative cooling of the saturated solution (Walas 1988).

Production of large crystals can be obtained by recirculation of the magma within the crystallizer and removal of the small crystals by dissolving in an outside vessel. Large crystals are produced in a crystallization column at the bottom of the crystallizer (elutriation leg).

*Example 11.1* Design a distillation column to recover the ethanol from a fermentation solution, containing 5 % of ethanol, using the simplified method. The composition of the distillate and the bottom products will be 89 % and 0.1 % ethanol res.

#### Data and Assumptions

The column is assumed to operate at atmospheric pressure with steam heating the reboiler and water cooling the total condenser. The mean relative volatility of ethanol/water in the column is taken  $\alpha = 4$ .

The feed is assumed to enter the column as saturated liquid ( $q = 1$ ). The molar flow rates of liquid and vapors in the stripping and enriching sections of the column are assumed constant, although the ethanol/water system is highly nonideal. A more accurate analysis of the ethanol/water distillation can be made using numerical stage-to-stage calculations or the Ponchon–Savarit graphical method.



It should be noted that the maximum concentration of the distillate in an atmospheric distillation is 0.896 mole ethanol, i.e., the azeotrope of ethanol/water (95 % ethanol by volume).

### Theoretical Stages and Trays

The minimum number of stages ( $N_{\min}$ ) at total reflux will be, for  $x_D = 0.89$ ,  $x_B = 0.001$  (11.13):

$$N_{\min} = \log\{(0.89)(0.999)/(0.001)(0.11)\}/\log(4) = 6.5$$

The minimum reflux ratio ( $R_{\min}$ ) for infinite number of stages will be given by the Underwood equations (11.14) and (11.15), for  $x_F = 0.05$ ,  $q = 1$ , and  $\alpha = 4$ :

$$(4 \times 0.05)/(4 - \theta) + (1 - 0.05) = 0 \quad \text{and} \quad R_{\min} + 1 = (4 \times 0.89)/(4 - \theta)$$

from which  $\theta = 3.13$  and  $R_{\min} = 3.04$ .

Assume that the reflux ratio is  $R = 1.2R_{\min} = 1.2 \times 3.04 = 3.65$ . Then  $(R - R_{\min})/(R + 1) = (3.65 - 3.04)/4.65 = 0.131$ . From the Gilliland diagram (Perry and Green 1997) or from the Gilliland correlation (11.16),  $(N - N_{\min})/(N + 1) = 0.46$ . For  $N_{\min} = 6.5$ ,  $N = 12.9$ .

Assuming a column efficiency of 65 %, the number of trays of the column will be  $N_T = 12.9/0.65 = 19.83$  or  $N_T = 20$ .

### Column Sizing

The column diameter and height are estimated as follows: material balances in the column,  $F = D + B = 500$  kmol/h and  $x_D D + x_B B = x_F F$ . For  $x_D = 0.89$ ,  $x_B = 0.001$ , and  $x_F = 0.05$ ,  $D = 27.6$  kmol/h and  $B = 472.4$  kmol/h. In terms of mass flow, considering the molecular weights of ethanol (46) and water (18),  $D = 1184$  and  $B = 8517$  kg/h.

The column diameter is calculated on the basis of vapor flow in the upper (enriching) section, which is usually higher than in the lower (stripping) section. For the reflux ratio  $R = L/D = 3.65$ , the liquid flow in the enriching section will be  $L = 3.65 \times 27.6 = 100$  kmol/h. The liquid/vapor ratio in this section (slope of the operating line) will be  $L/V = R/(R + 1) = 3.65/4.65 = 0.78$  and  $V = 100.74/0.78 = 129.15$  kmol/h.

Assume that the mean molar concentration of ethanol in the enriching section is 50 % with a corresponding mean molecular weight of  $0.5 \times 46 + 0.5 \times 18 = 32$ . Therefore, the mass flow of the vapors will be  $V = 129.15 \times 32 = 4133$  kg/h.

The vapor density in the enriching section at a mean temperature of 90 °C will be approximately 0.4 kg/m<sup>3</sup>. Therefore, the volumetric flow rate of vapors will be  $V = 4133/0.4 = 10,332$  m<sup>3</sup>/h or  $V = 10,332/3600 = 2.87$  m<sup>3</sup>/s.

The vapor velocity in distillation columns is selected on the basis of flooding (maximum) velocity, which for this system can be taken as 1.5 m/s. The vapor velocity is taken as  $0.8 \times 1.5 = 1.2$  m/s.

Therefore, the column cross section (for vapor flow) will be  $A = 2.87/1.2 = 2.39 \text{ m}^2$ , and the column diameter will be  $d = (4A/\pi)^{1/2} = (4 \times 2.39/3.14)^{1/2} = 1.74 \text{ m}$ .

Sieve (perforated) trays are selected, since they are inexpensive and they can be cleaned more easily than the complex tray arrangements. The distance between the trays is taken empirically for this system as equal to 50 cm. Therefore, the column height will be equal to  $20 \times 0.5 = 10 \text{ m}$ .

Summarizing, a column 1.74 m diameter and 10 m height will be suitable for the proposed separation.

#### Note

The design of the reboiler and the condenser of the column is carried out with the conventional procedure of designing shell and tube heat exchangers (see Example 6.1).

*Example 11.2* Estimate the height of a countercurrent liquid/liquid extraction column to remove 90 % of the caffeine from an aqueous solution of 3 % caffeine, using an immiscible organic solvent.

#### Data and Assumptions

Assume a partition coefficient for solvent/solution  $K = 2.5$  and a constant mass flow rate ratio liquid/solvent  $(L/V) = 1.5$ .

Use both the graphical (McCabe–Thiele) and the analytical (Kremser) methods.

#### Graphical Method

For such a dilute system, straight equilibrium and operating lines can be assumed:  $Y_e = KX$  or  $Y_e = 2.5X$  and  $Y = 1.5X$ . Feed  $X_2 = 0.03$ , product  $X = 0.003$  (mass fractions).

The following graphical representation (McCabe–Thiele diagram) of the extraction process is easily constructed:

Since this is a dilute system, constant flow rates can be assumed, i.e., the operating line is a straight line,  $Y = 1.5X$ . The equilibrium line is also a straight line,  $Y = 2.5X$ .

Graphical construction between the operating and equilibrium lines, starting from  $X_2 = 0.03$  and stopping at  $X = 0.003$ , yields number of stages  $N \approx 3.5$ .

Kremser equation:

The absorption factor  $A = L/KV = 1.5/2.5 = 0.6$  and the stripping factor  $1/A = 1/0.6 = 1.67$ .

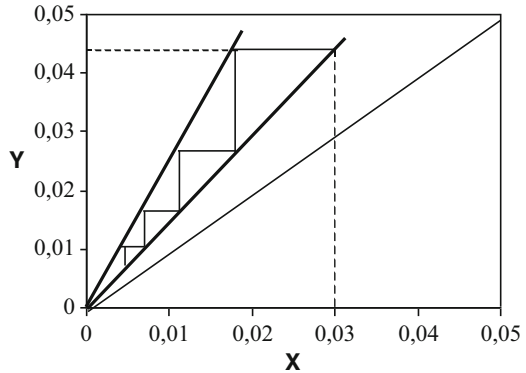
Kremser equation (11.26):

$$N = \log\{10(1 - 0.6) + 0.6\} / \log(1.67) = 0.663 / 0.223 = 3$$

The efficiency of the extraction column depends on the mass transfer between the immiscible phases, and it can be increased by agitation, e.g., the RTC column (Fig. 11.26). Assuming an efficiency of 30 %, the number of plates will be  $3/0.3 = 10$ . If the distance between the plates is taken as 30 cm, the height of the column will be  $10 \times 0.3 = 3 \text{ m}$ .

The diameter of the column will depend on the mass flow rate (kg/h) of the solution (L).

**Fig. 11.26** McCabe–Thiele diagram for extraction of Example 11.2



## References

- AICHe (1958) Bubble tray manual. American Institute of Chemical Engineers, New York
- AICHe (2000) Distillation in practice. CD-ROM. American Institute of Chemical Engineers, New York
- Aquilera JM, Stanley DW (1999) Microstructural principles of food processing and engineering, 2nd edn. Aspen, Gaithersburg
- Billet R (1973) Industrielle destillation. Verlag Chemie, Weinheim
- Bischoff G et al (1978) Fleischverarbeitung. Mermann Schroedel Verlag KG, Hannover
- Bomben JL, Mannheim HC, Morgan AI Jr (1967) Operating conditions for aroma recovery by new vacuum stripping method and evaluation of aroma solutions. *Fruchtsaft Ind* 12(2):44–53
- Bomben JL, Bruin S, Thijssen HAC, Merson LR (1973) Aroma recovery and retention in concentration and drying of foods. *Adv Food Res* 20:1–112
- Brennan JC, Butters JR, Cowell NP, Lilly AEV (1990) Food engineering operations, 3rd edn. Applied Science Publ, London
- Bruin S (1969) Activity coefficients and plate efficiencies in distillation of multicomponent aqueous solutions. Doctoral thesis, Wageningen University, Wageningen, Holland: H. Veenman and Zonen N.V.
- Casimir DJ, Craig AM (1990) Flavor recovery using the Australian spinning cone column. In: Spiess WEL, Schubert H (eds) *Engineering and food*, vol 3. Elsevier Applied Science, New York, pp 100–117
- Cheryan M (1998) Ultrafiltration and microfiltration handbook. Technomic, Lancaster
- Cussler E (1997) Diffusion mass transfer in fluid systems, 2nd edn. Cambridge University Press, Cambridge
- Frendeslund J, Gmehling JA, Rasmussen R (1977) Vapor-liquid equilibria using UNIFAC. Elsevier, Amsterdam
- Gekas V (1992) Transport phenomena of foods and biological materials. CRC Press, New York
- Gmehling J, Onken U, Arlt W (1984) Vapor-liquid equilibrium data collection. Chemistry data series vol 1, parts 1–8. DECHEMA, Frankfurt/Main
- Grandison AS, Lewis MJ (1996) Separation processes in the food and biotechnology industries. Technomic, Lancaster
- Gray C (1993) History of the spinning cone column. In: Downing DL (ed) *Juice technology workshop*. NY State Agr. Exp. Station, Cornell University, New York, pp 31–37. Special report no. 67
- Heiss R (1991) Lebensmitteltechnologie. Springer, Berlin
- Heldman DR, Hartel RW (1997) Principles of food processing. Chapman and Hall, New York
- Holland CD (1981) Fundamentals of multicomponent distillation. McGraw-Hill, New York

- Hui YH (ed) (1996) *Bailey's industrial oil and fat products*, vol 4, 5th edn, Edible oil and fat products. Wiley, New York
- Karlsson HOE, Tragardh G (1997) Aroma recovery during beverage processing. *J Food Eng* 34:179–178
- Kimball DA (1999) *Citrus processing*, 2nd edn. Aspen, Gaithersburg
- King CJ (1982) *Separation processes*. McGraw-Hill, New York
- Kirschbaum E (1969) *Destillier und Rektifizierteknik*. Springer, Berlin
- Lazarides H, Iakovidis A, Schwartzberg HG (1990) Aroma loss and recovery during falling film evaporation. In: Spiess WEL, Schubert H (eds) *Engineering and food*, vol 3. Elsevier Applied Science, New York, pp 96–105
- Lewis MJ (1990) *Physical properties of foods and food processing systems*. Ellis Horwood, Amsterdam
- Marinos-Kouris D, Saravacos GD (1974) Distillation of volatile compounds from aqueous solutions in an agitated film evaporator. In: *Proceedings joint GVC/AIChE meeting*, vol IV, paper G5-3, Munich, Germany
- Mermelstein NH (2000) Removing alcohol from wine. *Food Technol* 54(11):89–92
- Moyer JC, Saravacos GD (1968) Scientific and technical aspects of fruit juice aroma recovery. In: *Proceedings of 7th international fruit juice congress*, Cannes France
- Mullin J (1993) *Crystallization*, 3rd edn. Butterworths, London
- Nagy S, Chen CS, Shaw PE (eds) (1993). *Fruit juice processing technology*. Agscience, Auburndale
- Nursten HE, Williams AA (1967) Fruit aromas: a survey of compounds identified. In: *Chemistry and Industry (UK)*, March 25, pp 486–497
- Nyvt J (1971) *Industrial crystallization from solution*. Butterworths, London
- Perry RH, Green D (1997) *Chemical engineers' handbook*, 7th edn. McGraw-Hill, New York
- Prausnitz JM, Lichtenthaler RN, de Azevedo EG (1999) *Molecular thermodynamics of fluid phase equilibria*, 3rd edn. Prentice-Hall, Englewood Cliffs
- Prospectus of companies: (a) GEA Food solutions, (b) DCE Inc., (c) Stork Food and Dairy Systems
- Randolph AD, Larson MA (1971) *Theory of particulate processes*. Academic, New York
- Reid RC, Prausnitz JM, Poling BE (1987) *The properties of gases and liquids*, 4th edn. McGraw-Hill, New York
- Robinson C, Gilliland E (1950) *Elements of fractional distillation*. McGraw-Hill, New York
- Roger NF, Turkot VA (1965) Designing distillation equipment for volatile fruit aromas. *Food Technol* 19(1):69–73
- Sancho MF, Rao MA (1993) Factors influencing aroma recovery and concentration. In: Downing DL (ed) *Juice technology workshop*. N.Y. State Agr. Exp. Station, Cornell University, Geneva, New York, pp 47–53. Special report no. 67
- Sancho MF, Rao MA, Downing DL (1997) Infinite dilution activity coefficients of apple juice aroma compounds. *J Food Eng* 34:145–158
- Saravacos GD (1970) Volatility of wine aroma components in ethanol solutions. New York State Agricultural Experiment Station, Cornell University, Geneva, New York. Personal communication
- Saravacos GD (1974) Recovery of volatile aroma compounds during evaporation of fruit juices. In: *Proceedings of 12th international congress agricultural and food industries*. C.I.I.A, Paris
- Saravacos GD (1995) Mass transport properties of foods. In: Rao MA, Rizvi SSH (eds) *Engineering properties of foods*, 2nd edn. Marcel Dekker, New York, pp 169–221
- Saravacos GD, Maroulis ZB (2001) *Transport properties of foods*. Marcel Dekker, New York
- Saravacos GD, Moyer JC (1968) Volatility of some aroma compounds during vacuum-drying of fruit juices. *Food Technol* 22(5):89–95
- Saravacos GD, Moyer JC, Wooster GD (1969) Stripping of high-boiling aroma compounds from aqueous solutions. In: Paper presented at the 62nd annual meeting of the American Institute of Chemical Engineers (AIChE), Washington, DC

- Saravacos GD, Karathanos VT, Marinou-Kouris D (1990) Volatility of fruit aroma compounds in sugar solutions. In: Charalambous G (ed) *Flavors and off-flavors*. Elsevier, Amsterdam, pp 729–738
- Schormueller J (1966) *Die Erhaltung der Lebensmittel*. Ferdinand Enke Verlag, Stuttgart
- Schwartzberg HG (1980) Continuous countercurrent extraction in the food industry. *Chem Eng Prog* 76(4):67
- Schwartzberg HG (1987) Leaching. Organic materials. In: Rousseau RW (ed) *Handbook of separation process technology*. Wiley, New York, pp 540–577
- Schwartzberg HG, Chao RY (1982) Solute diffusivities in the leaching processes. *Food Technol* 36(2):73–86
- Schweitzer PA (ed) (1988) *Handbook of separation techniques for chemical engineers*, 2nd edn. McGraw-Hill, New York
- Sherwood TK, Pigford RL, Wilke CR (1975) *Mass transfer*. McGraw-Hill, New York
- Sulc O (1984) Fruchtsaftkonzentrierung und Fruchtsaftaromaseparierung. *Confructa Studien* 28 (3):258–318
- Treybal R (1980) *Mass transfer operations*, 3rd edn. McGraw-Hill, New York
- Tscheuschner HD (1986) (Herausgeber) *Lebensmitteltechnik*. Steinkopff Verlag
- Van Smith JM, Nesh HC, Abbot NM (1996) *Introduction to chemical engineering thermodynamics*, 5th edn. McGraw-Hill, New York
- Van Winkle M (1967) *Distillation*. McGraw-Hill, New York
- Walas SM (1985) *Phase equilibria in chemical engineering*. Butterworths, London
- Walas S (1988) *Chemical processing equipment*. Butterworths, London
- Wankat PC (1990) *Rate-controlled separations*. Elsevier Science, New York

# Chapter 12

## Equipment for Novel Food Processes

### 12.1 Introduction

A number of novel food processing and preservation methods and equipment have been developed and applied or evaluated for commercial application. They are the result of research and development efforts in food science and technology and in other process technologies. Some of these processes are already applied commercially in the food industry, such as membrane separations and supercritical solvent extraction, while most of the others are still in the development and evaluation stages. Some technical, economic, and public acceptance difficulties must be resolved, before large-scale application.

The reasons for developing novel food processes are improvement of food quality and more economic operation. Conventional food operations, such as thermal separations (evaporation, distillation) and thermal processing (pasteurization, sterilization), may cause undesirable heat damage to the quality of sensitive foods, due to the high temperatures used. Advances in novel separation technologies, achieved in chemical engineering and chemical process industries, have been adapted successfully in food processing systems at a competitive cost with existing methods. Membrane separations and supercritical fluid (SCF) extraction are typically new processes adapted successfully in food processing.

In the area of food preservation, the novel processes are at different stages of development, with food irradiation being closer to commercial application, followed by high-pressure processing (HPP) and, finally, electrical pulse processing. All these methods are more expensive than conventional preservation processes, but they may become competitive, when large units are installed and operated.

A common advantage of all the novel food processes is the use of less energy per unit of product processed, which is an important consideration in view of rising energy costs and possible worldwide energy shortages in the future. The most important novel food processes are reviewed in this chapter. Commercial

equipment is available for membrane separations (reverse osmosis and ultrafiltration) and supercritical extraction at competitive cost. Pilot plant and small-scale commercial equipment are available for food irradiation, freeze concentration, and HPP.

## 12.2 Membrane Separation Equipment

Membrane separations are rate-controlled processes, based on the preferential permeation or rejection of various solute molecules in semipermeable polymer or inorganic membranes. Mechanical pressure is, in general, the driving force through the thin membranes, although concentration or ionic charge differences may be utilized in some membrane separations. Membrane separations are low-energy operations, and they are less expensive than the conventional thermal separations, i.e., evaporation and distillation. Typical examples of membrane separations are ultrafiltration (recovery of proteins), reverse osmosis (desalination of water), and pervaporation (separation of ethanol).

Membrane separations are replacing conventional mechanical and mass transfer separations (Chaps. 5 and 11), because of their economic, energy, and technological advantages (Weber and Bowman 1986).

Ultrafiltration is a competitive process compared to mechanical filtration (Bemberis and Neely 1986).

Membrane separations are classified according to the size of the molecule or the particle being separated from a solution or suspension. The following membrane separation processes are applied to the food processing industry (Perry and Green 1997; Cheryan 1998; Grandison and Lewis 1996):

1. Reverse osmosis: ions and molecules 0.1–1 nm (water desalting)
2. Nanofiltration: molecules 0.5–10 nm (whey desalting)
3. Ultrafiltration: macromolecules 1–100 nm (protein recovery)
4. Microfiltration: particles 0.5–3  $\mu\text{m}$  (removal of microorganisms)
5. Pervaporation: molecules 0.2–1 nm (separation of ethanol)
6. Electrodialysis: ions 0.1–0.5 nm (water desalting)

### 12.2.1 Mass Transfer Considerations

The fundamental physicochemical and transport properties of food components, related to membrane separations, are discussed by Matsuura and Sourirajan (1992).

The mechanism of solute transfer through the membranes depends on the physical structure of the membrane, which is usually a synthetic polymer or a porous ceramic material. In reverse osmosis and gas separation applications, the membranes are macroscopically nonporous and homogeneous materials, through

which solutes are transported by a molecular (Fickian) mechanism. In porous (ultrafiltration) membranes, viscous flow of the solution may dominate, with contributions from molecular diffusion and other transport mechanisms. In most cases, the activity coefficients of the transported molecules are close to unity (1), and the chemical potential can be replaced by the concentration gradient as the driving force, allowing the application of the diffusion (Fick) equation. In most food applications, the concentration of the solute molecule is low, and the Henry law and the permeability equation are applicable (Saravacos and Maroulis 2001).

The transport rate of a solute through a membrane of thickness ( $z$ , m) is given by the permeability equation, which is a combination of the Fick and Henry laws:

$$J = (DS/z)(\Delta P) \quad (12.1)$$

where ( $J$ ) is the mass flux ( $\text{kg/m}^2\text{s}$ ), ( $\Delta P$ ) is the pressure drop (Pa), and ( $DS$ ) is the permeability of the membrane ( $\text{kg/m s Pa}$ ), and  $DS = D/H$ , where ( $D$ ) is the diffusivity of the solute in the membrane ( $\text{m}^2/\text{s}$ ), ( $S$ ) is the solubility of the solute in the membrane ( $\text{kg/m}^3$ ), and ( $H$ ) is the Henry constant ( $\text{kg/m}^3\text{Pa}$ ). The pressure drop is defined as ( $\Delta P$ ) = ( $p_f - p_p$ ), and ( $p_f, p_p$ ) are the feed and product pressures. The flux has the SI units of ( $\text{m/s}$ ), but practical units, such as  $\text{L/m}^2\text{h}$ ,  $\text{gal/ft}^2\text{day}$ , or  $\text{ft/day}$ , are used. The following conversion factors can be used for the various flux units:  $1 \text{ US gallon/ft}^2\text{day} = 1.7 \text{ L/m}^2\text{h} = 0.47 \text{ }\mu\text{m/s}$  and  $1 \text{ L/m}^2\text{h} = 0.28 \text{ }\mu\text{m/s}$ .

Equation (12.1) is difficult to use in practice, since the membrane thickness ( $z$ ) and the solubility and diffusion constants ( $S, D$ ) are not known accurately. For this reason, the following simplified equations for the flux are used in membrane separations (Cheryan 1998):

$$J = A(\Delta P) = (\Delta P)/R_m \quad (12.2)$$

where  $A = (SD)/z$ , the overall permeability of the specific membrane, and  $R_m = 1/A$ , the overall membrane resistance to mass transfer. In membrane separations, the flux ( $J$ ) is usually expressed in volumetric, instead of mass units, i.e.,  $\text{m}^3/\text{m}^2\text{s}$  or  $\text{m/s}$  (for low flow rates,  $\mu\text{m/s}$ ). Thus, the units of the overall permeability ( $A$ ) become  $\text{m/s Pa}$ , and the overall resistance ( $R_m$ ) will be  $(\text{s Pa})/\text{m}$ .

When the osmotic pressure ( $\Pi$ ) of the solution is important (e.g., in reverse osmosis), and when there are additional resistances to flow, like fouling ( $R_f$ ) and concentration polarization ( $R_p$ ), the flux equation becomes

$$J = (\Delta P - \Delta \Pi) / (R_m + R_f + R_p) \quad (12.3)$$

where  $\Delta \Pi = (\Pi_f - \Pi_p)$  and ( $\Pi_f, \Pi_p$ ) are the osmotic pressures of the feed and product stream, respectively (Perry and Green 1997).

In ultrafiltration and microfiltration, the flux of permeate is governed by the flow through porous media, according to the Darcy equation:



$$J = K(\Delta P/\eta z) \quad (12.4)$$

where ( $\eta$ ) is the viscosity of the liquid (Pa s) and ( $K$ ) is the flow (Darcy) permeability (kg/m). Equation (12.4) can be written as

$$J = \Delta P/(\eta r_m) \quad (12.5)$$

where ( $r_m$ ) is the flow (Darcy) resistance. It should be noted that the overall and flow resistances differ by the viscosity term ( $\eta$ ), i.e.,  $R_m = \eta r_m$ .

The flux in ultrafiltration or microfiltration membrane separation systems with negligible osmotic pressure is given by the following modification of (12.3):

$$J = \Delta P/\eta(r_m + r_f + r_p) \quad (12.6)$$

The rejection ( $R$ ) of a solute in a membrane separation is calculated from the equation

$$R = 1 - (C_p/C_f) \quad (12.7)$$

where ( $C_p$ ,  $C_f$ ) are the solute concentrations (kg/m<sup>3</sup>) in the product and feed, respectively.

### 12.2.2 Membranes and Membrane Modules

Polymeric membranes are used in most membrane separations, with inorganic (ceramic) membranes applied in some cases. The composition and preparation of separation membranes are presented by Cheryan (1998). Polymeric membranes should have a precise pore size distribution and a thin skin on the surface about 0.5–1  $\mu\text{m}$  thick. The method of preparation determines greatly the physical (and selective) structure of the membrane. Two general types of membranes are used commercially, flat sheets and hollow fibers.

The most common polymeric membranes are cellulose acetate, polyamides, polysulfones, polyacrylonitrile, polyethersulfones, and polypropylene. Experimental trials are needed to determine the suitability of a membrane for a particular separation.

Membrane stability during use is very important, since the polymeric materials are sensitive to temperature and pH. The following temperature limits should be taken into consideration: cellulose acetate,  $T < 30^\circ\text{C}$ ; polyamides and polysulfones,  $T < 80^\circ\text{C}$ ; and ceramic,  $T < 130^\circ\text{C}$ . A narrow pH range is recommended for cellulose acetate (3–8), while polysulfones can be operated over a wider range (3–11).

The commercial membrane modules must provide the separation membranes in a usable form and in economic designs. The modules must maintain membrane

integrity against damage and leaks, provide sufficient mass transfer, control polarization, and permit cleaning when necessary, with minimum waste of energy and water (Perry and Green 1997).

Efficient membrane modules include the following (Cheryan 1992, 1998):

1. Hollow fiber–capillary systems with outer diameter of the capillaries about 93  $\mu\text{m}$ , used mainly in reverse osmosis. The liquid flows from the shell into the capillary. In ultrafiltration, the liquid flows from the interior of tubes 0.25–6 mm diameter.
2. Tubular modules of 12–25 mm diameter, supported on the perforated or the porous walls of stainless steel tubes. The liquid flows from the interior of the tube outward.
3. Spiral-wound modules are inexpensive arrangements, providing large separation surface. Many membrane layers are wound to produce module diameters up to 400 mm. The liquid feed flows from the outside, and it is separated into as permeate, which flows in an internal tube, and retentate, which is removed as the side product.
4. Plate and frame modules, resembling the mechanical pressure filters (Chap. 5).

Ceramic modules are usually monoliths of tubular capillaries with typical channel size of 3 mm. Many monoliths are incorporated into a modular housing. A typical commercial module of ceramic membranes has a length of 90 cm, diameter of 15 cm, and channel diameter of 2.5 mm.

## ***12.2.3 Membrane Separation Systems***

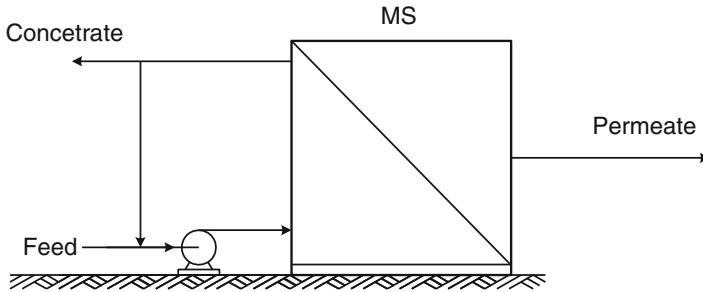
### **12.2.3.1 General Considerations**

Most membrane separations are single batch-operated units, with limited application of the multistage systems. Figure 12.1 shows the operating principle of a separation unit, consisting of the membrane module, the feed pump, and the accompanying piping for separating the feed into a permeate and a concentrate. The feed pump can be centrifugal pump for low pressures and positive displacement (piston type) pump for high pressures (Chap. 3). Depending on the separation process, the main product may be the permeate (e.g., desalted water by reverse osmosis) or the concentrate or retentate (e.g., recovered protein by ultrafiltration).

The operating pressure depends on the separation process, and it varies in the following ranges: reverse osmosis, 35–100 bar; nanofiltration, 10–30 bar; ultrafiltration, 5–15 bar; and microfiltration, 3–5 bar.

Recirculation (“feed and bleed system”) of the liquid concentrate is necessary in most applications to increase the efficiency of separation.

Reduction of flux of the permeate may be caused by membrane compaction, concentration polarization (discussed in the section on reverse osmosis), or membrane fouling. Fouling is a serious problem in all membrane separations, and it is



**Fig. 12.1** Diagram of a membrane separation (MS) system. Feed and bleed operation

caused by plugging the membrane pores or by cake (gel) formation on the membrane surface.

Fouling can be prevented by the selection of the proper membrane, e.g., cellulose acetate is a low-fouling polymer. Process configuration (module type) and flow rate can also control fouling. High shear rates, caused by high flow rates at the membrane surface, reduce fouling by removing any deposits formed. An economic balance should be made to determine the optimum flow rate for minimum fouling and cleaning cost for the membranes. The operating pressure should also be optimized in relation to fouling and energy (pumping) cost.

Proteins are the major foulant in membrane separations, especially in ultrafiltration and microfiltration, because of their complex and sensitive physicochemical structure. Calcium salts in dairy products and hard water can also cause serious fouling (scaling). Other fouling materials are fats and oils, polysaccharides, microbial slime, and humic substances.

Membrane fouling can be reduced by various operating procedures, such as pulsating flow (periodic increase of pressure), backflushing, and washing with water.

Cleaning and sanitizing of fouled membranes involve physical removal of fouling substances, chemical removal of foulants, and hygienic (sanitary) treatment to remove all viable microorganisms (Cheryan 1998). Detergents, heating, and mechanical energy (high velocity) are utilized in a systematic cleaning procedure, similar to the cleaning of food process equipment (Chap. 2). Special care should be taken in cleaning the polymeric membranes, which are sensitive to the cleaning chemicals, the pH, and the temperature, compared to the cleaning of stainless steel processing equipment. Cellulose acetate is very sensitive to both temperature and pH, and polyamides are sensitive to chlorine. Ceramic membranes are resistant to chemicals and temperature, but care should be taken in cleaning the gaskets, epoxy resins, etc., which are part of the membrane module.

Turbulent flow is essential during membrane cleaning, employing fluid velocities in the range of 1.5–2 m/s in tubular systems. Hollow fibers, used in ultrafiltration, operate in the laminar region, but the shear rates developed are high enough to facilitate the cleaning. Cleaning time should be about 30–60 min and the temperature should not exceed 60 °C.

The cleaning water should be free of iron, which may deposit a yellow fouling film on the surface of the cleaned membrane. Silicates should be removed from the cleaning water, preventing severe fouling of the membranes. Permeate from reverse osmotic desalting units is suitable for cleaning various membranes (Cheryan 1998).

### 12.2.3.2 Design of Membrane Systems

The design of membrane separation systems can be carried out using simplified software, developed by membrane suppliers. Software used for reverse osmosis is described by Brauns (2001).

### 12.2.4 Reverse Osmosis and Nanofiltration

Reverse osmosis (RO) is used to remove water from aqueous solutions and suspensions, employing tight membranes, which retain the dissolved molecules, ions, and suspended materials. The applied pressure must be higher than the osmotic pressure of the solution in order to overcome the membrane resistance and the resistances of concentration polarization and membrane fouling, according to the flux equation (12.3). Nanofiltration (NF) is a more selective separation process than RO, retaining the dissolved molecules and the polyvalent ions, but allowing the permeation of the monovalent ions, along with the water. RO operates at pressures 35–100 bar, while lower pressures (10–30 bar) are applied in NF.

The osmotic pressure of aqueous solutions and food liquids depends on the size and concentration of the dissolved molecules (% total solids in water), as shown in the following example (Cheryan 1998):

1. Sodium chloride: 1 %, 8 bar; 3 %, 35 bar
2. Sucrose: 25 %, 27.2 bar; 53 %, 107 bar; 65 %, 200 bar
3. Milk, nonfat: 9 %, 7 bar
4. Whey: 6 %, 7 bar
5. Orange juice: 11 %, 16 bar
6. Apple juice: 15 %, 20 bar
7. Coffee extract: 28.5 %, 35 bar

According to solution thermodynamics, very high osmotic pressures are obtained in concentrated solutions of small molecules and (monovalent) ions, e.g., salt (sodium chloride) and sucrose solutions. The elevated osmotic pressures limit the application of RO in the production of concentrated salt and sugar solutions (clear juices).

### 12.2.4.1 RO Systems

Two major RO membranes are used in practice, i.e., the skinned asymmetric and the composite membranes. The composites are prepared by polymerizing a thin coating on loose membranes.

Membranes are rated for (water) flux and percentage rejection of the solutes. Good RO membranes, used in water desalting, may have rejections up to 99.7 % (estimated on the basis of rejection of sodium chloride). The rejection of nanofiltration membranes is based on magnesium sulfate (Perry and Green 1997).

Concentration polarization of RO membranes is caused by increased flux of water, due to high-pressure differential, resulting in fouling and scaling of the membrane surface by precipitated salts. It can be reduced by increasing the cross-flow velocity of the solution, by adding anti-scalants in the feed solution, or by operating at lower pressure gradients. Hollow-fiber and spiral-wound membrane modules operate at lower fluxes with less polarization problems. Membrane fouling with various colloids and silt (soil particles) can plug RO membranes, causing a sharp reduction of the permeation rate. Concentration polarization can be prevented by pre-filtration, pH adjustment, and chlorination.

### 12.2.4.2 Food Applications of RO

The most important commercial application of RO is in the desalting of brackish water and the desalination of seawater to produce potable and process water (Perry and Green 1997). The RO process competes with evaporation in small and medium installations, while evaporation is favored in large-scale applications, using multi-effect systems. Potable water should contain less than 500 ppm of total dissolved solids (TS), while the concentrations of the brackish and seawater are about 1500 and 30,000 ppm TS, respectively. Water recovery in the desalting of brackish water is high (70–90 %) and low in seawater (25–30 %). Energy requirements for brackish water desalting are low (about 1 kWh/m<sup>3</sup>), compared to the high-energy requirements for seawater (about 6 kWh/kg).

RO is used in combination with ion exchange (Chap. 11) to produce demineralized water, suitable for steam boilers and other specialized applications. The water is first filtered off the suspended substances, then it is treated in an RO unit to remove most of the dissolved solids, and finally it is treated in an ion exchange system to remove any residual salt ions (Nishimura and Koyama 1992).

RO is used in the concentration of fruit juices, sugar solutions, and dairy products. Due to the high osmotic pressure of sugar solutions, most applications of RO are in preparing concentrates up to about 25–30 °Brix. Further concentration is obtained by evaporation.

RO is used as a pre-evaporation step in the concentration of milk and fruit juices, removing most of the water, before the final concentration in the evaporator. Milk is concentrated by a factor of 2–3, using RO (Grandison and Glover 1994).

Concentration of the milk by 1.5 times is used for the preparation of yogurt. Whey is concentrated from 6 to 24 % TS. Nanofiltration is used to separate monovalent ions (sodium chloride) from polyvalent ions and other solids of the whey. It is also used in the deacidification of citrus juices, by removing (permeating) hydrogen ions.

Thermodynamic analysis of combined UF–RO concentration of tomato juice has shown the advantages of the membrane processes over conventional evaporation. Concentration of cloudy orange juice by RO is limited by membrane fouling with pectins and precipitated hesperidin (a citrus glycoside). Combination of RO and falling film evaporation reduces the cost of concentration of apple juice (Moresi 1988).

Concentration of citrus aqueous essence with RO (83 bar) results in significant losses of flavor components, when the percentage of ethanol is increased (Braddock et al. 1991). This may be related to the changes in relative volatility of flavor compounds in ethanol solutions (Chap. 11).

RO can be used to concentrate wine by removing ethanol and water through a selective membrane. The concentrate is diluted with water to prepare de-alcoholized wine (Mermelstein 2000), while the permeate can be distilled to recover the ethanol. Pressures of about 30 bar and temperatures 7–13 °C are used. De-alcoholization of wine can also be accomplished by another membrane separation process, pervaporation, discussed later in this chapter.

### 12.2.5 Ultrafiltration

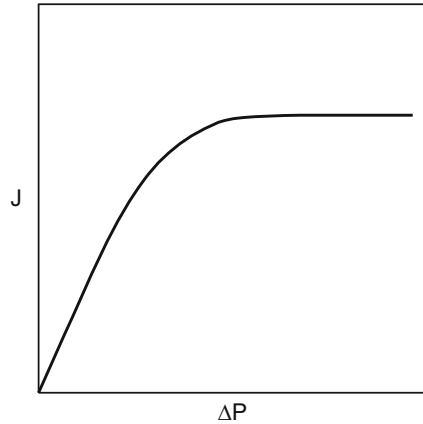
Ultrafiltration (UF) is used to separate macromolecules and small particles (concentrate) from solvents (water), ions, and small molecules (permeate). It can replace evaporation, which may damage heat-sensitive food products. The most important application of UF is in the dairy industry, where milk and whey proteins are separated from water, lactose, and other solutes. UF is also finding applications in biotechnological processing and in the treatment of wastewater.

#### 12.2.5.1 UF Systems

UF membranes include cellulose acetate, polyamides, polysulfones, polyvinylidene fluoride, and polyvinyl alcohol–polyethylene copolymers. Ceramic membranes, based on porous alumina and carbon substrates, are also used (Perry and Green 1997).

UF membranes are characterized by their permeability and retention properties. The membrane permeability is determined by the pore size distribution and the thickness of the active layer. Permeability data are reported at standard conditions, e.g., at  $(\Delta P) = 3.43$  bar and  $T = 25$  °C. New membranes may have permeabilities of 0.1–1 mm/s, which are reduced considerably during process operation.

**Fig. 12.2** Diagram of concentration polarization.  $J$  flux,  $\Delta P$  pressure drop



The separating capacity of the UF membranes is characterized by the molecular weight cutoff (MWCO), the maximum size of the molecules that will pass through. The size of polymer molecules is expressed by their molecular weight, e.g., dextran 250 is a dextrin of molecular weight 250,000 or 250 kDa, where 1 kDa = 1000 Da. The separation of polymer molecules is not sharp, since the pore size of UF membranes is not uniform but dispersed, following the normal or log normal distribution models. The MWCO of UF membranes is determined experimentally, using dextrans of known molecular weight, and it is in the range of 2–300 kDa.

UF membranes are produced in various modular forms: tubular (diameters 5–25 mm), hollow fiber–capillary (diameters about 0.25 mm), spiral wound, and plate and frame. The hollow fibers require clean feeds, such as protein solutions. The tubular systems are used when the feed contains significant amounts of suspended particles, such as cloudy fruit juices.

Concentration polarization is a serious problem of UF and other separation membranes, reducing significantly the flux of permeate at higher operating pressures (Fig. 12.2). At low pressures, the flux ( $J$ ) increases linearly with the applied pressure ( $\Delta P$ ). However, above a certain pressure, the flux increases slowly or becomes independent of the applied pressure. An equilibrium is established between concentration of the solute on the membrane surface and dispersion into the flowing liquid. Polarization is reduced by cross flow of the liquid, parallel to the membrane surface, which removes the accumulated solute. Flow geometry and flow rate are important factors in controlling concentration polarization. Most of the mechanical energy, used in UF separations, is consumed to reduce concentration polarization.

Fouling of UF membranes is caused by plugging of small pores, selective plugging of larger pores, and cake formation of adsorbed macromolecules and particles. Fouling is evidenced by sharp decline of the membrane flux, after the system has operated for some time. When the flux drops below a predetermined low level, operation is interrupted and the membrane is cleaned.

Fouling can be reduced by choosing non-fouling membranes, such as cellulose acetate and by proper operating procedures. Cleaning procedures and addition of anti-fouling agents are similar to the procedures used for RO membranes.

UF separation systems operate at temperatures in the range 5–45 °C. In general, the flux of permeate increases with increasing temperature, mainly because of a reduction of the liquid viscosity. It must be noted that the viscosity of the concentrated sugar solutions drops sharply as the temperature is increased (high activation energy). However, temperature has a much smaller effect (low activation energy) on the (apparent) viscosity of non-Newtonian (pseudoplastic) solutions/suspensions, and, consequently, on the flux of the permeate (Saravacos and Maroulis 2001).

Rejection ( $R$ ) of macromolecules and suspended particles by UF membranes (12.7) is between 0.9 and 1.0, while for small molecules and ions,  $R = 0$ –0.1. Flux rates in UF vary over the wide range of 5–500 L/m<sup>2</sup>h. Pumping energy consumption is in the range of 0.5–5 kWh/m<sup>3</sup> permeate. The flux rate is related to the membrane, fouling, and concentration polarization resistances, by the generalized form of the Darcy equation (12.6).

Diafiltration is a special case of UF, in which a solvent (water) is added to the concentrate side of the membrane system, facilitating the removal (permeation) of unwanted solutes or ions from the concentrated product. Water is added either batchwise or continuously. Typical applications of diafiltration are the removal of lactose from the protein concentrate of UF-treated whey and the fractionation of proteins with removal of low-molecular-weight components, e.g., ions, sugars, and ethanol (Grandison and Lewis 1996).

### 12.2.5.2 Food Applications of UF

UF has found some important applications in food processing, especially in dairy technology, juice technology, water technology, and wastewater treatment (Cheryan 1998; Grandison and Lewis 1996).

Recovery of proteins from cheese whey is the most important dairy application of UF systems. The whey is separated into a protein concentrate and an aqueous permeate containing lactose and minerals, which may be further concentrated by RO or evaporation. Concentration factors of 5–20 are used, resulting in protein concentrates containing 35–65 % total solids.

UF concentration of whole milk (2–5 times) is used in the preparation of special types of cheese (e.g., feta) and yogurt. Higher concentrations can be obtained with skim milk.

UF is used in combination with RO and ion exchange in the cleaning and desalting of drinking and process water. Hollow-fiber UF membranes of 20 kDa (MWCO) are used at pressures about 3 bar with water fluxes 15–75 L/m<sup>2</sup>h. Energy use is about 0.5 kWh/m<sup>3</sup> of water.

UF is used to clarify fruit juices, replacing conventional juice clarification technology (enzyme treatment, filter aids, cake filtration), with significant operating



and economic advantages (Cheryan 1998). The time-consuming conventional operation is replaced by the one-step UF process, obtaining higher juice yields (68–96 %). Polymeric membranes of 30 kDa (MWCO) are used with flux rates of 35–300 L/m<sup>2</sup>h.

UF ceramic membranes are suitable for juice clarification, because they are more stable and more easily cleaned than polymeric membranes. Typical UF ceramic membranes, used for the clarification of apple juice, have pores, 0.2 µm; tube diameter, 4 mm; and length, 85 cm. High flux rates of 400–500 L/m<sup>2</sup>h are obtained with pressures 1–7 bar (McLellan 1993; McLellan and Padilla-Zakour 1992).

Combination of UF clarification and RO concentration can yield clarified juice concentrates up to about 35 °Brix. Higher concentrations require thermal evaporation.

UF is used in combination with ion exchange to debitter citrus juices (removal of bitter components, limonin and naringin). The cloudy juice is passed through a UF membrane system to remove suspended particles and colloids, which would plug the ion exchange resins (Cheryan 1998). The bitter components from the clarified juice are adsorbed on resins, e.g., divinylbenzene copolymer, and the debittered juice is mixed with separated pulp (see Chap. 11).

Inorganic (metal oxide) UF membranes (30–40 kDa MWCO) in tubular modules of 30 mm diameter have been used to clarify apple juice at pressures up to 25 bar, replacing cake filtration (Swientek 1987a, b, c). The large diameter tubes reduce fouling and facilitate cleaning of the membranes.

Wine and beer can be clarified by UF membranes, replacing chemical treatment and cake filtration. UF membranes of 0.45 µm pores will retain yeasts and other microorganisms, eliminating the need for thermal pasteurization.

UF and RO separations can be used in the treatment of wastewater of food processing plants, reducing pollution and recovering water for reuse. A pilot plant system of dairy wastewater treatment was described by Voros et al. (1999). The system consisted of dual-media (sand) filtration, a UF module (5 bar), and a RO unit (17 bar). Wastewater must be chlorinated and treated with activated carbon and anti-scaling chemicals, before feeding the RO unit. Economic analysis showed the feasibility of the installation in industrial scale.

### **12.2.6 Microfiltration**

Microfiltration (MF) is used to remove particles of size larger than 0.2 µm from solutions and suspensions, including large molecules, particles, and microorganisms (yeasts and bacteria). It can replace conventional clarification processes and UF in the treatment of wine, beer, and corn syrups (Perry and Green 1997; Cheryan 1998; Grandison and Lewis 1996).

### 12.2.6.1 MF Systems

MF membranes are usually made of porous polymeric materials of tortuous (sponge) structure, or inorganic agglomerates and sinters of microparticles (metal, metal oxide, graphite, or ceramic). Ceramic membranes are made of monoliths with channels of 2–6 mm diameter. Teflon MF membranes with large pores are made by stretching the polymer film.

MF membranes are rated for pore size and liquid flux. The pore size is characterized by special tests, such as the bubble point method and the retention of particles or bacteria of certain sizes.

The bubble point method is based on the flow of a gas through the porous membrane, which is filled with a liquid of known surface tension ( $\gamma$ , N/m) and contact angle with the membrane ( $\theta$ ). The pressure drop ( $\Delta p$ , Pa) required to force a gas bubble through a pore is given by the equation (Cheryan 1998)

$$\Delta p = 4\gamma \cos(\theta)/d \quad (12.8)$$

where ( $d$ ) is the diameter of the pore (m). For perfect liquid wetting,  $\cos(\theta) = 1$ .

The pore size distribution of a membrane is determined by increasing the applied pressure, which will result in bubbling the gas in pores of smaller diameter ( $d$ ). Pore diameters as small as 1 nm (0.001  $\mu\text{m}$ ) can be measured (ASTM 1992).

Retention of microorganisms (bacteria) or latex particles of certain sizes, e.g., *Pseudomonas diminuta* of mean diameter 0.3  $\mu\text{m}$ , can be used for pore size determination.

Microfiltration of dilute suspensions (e.g., below 0.5 %) is normally carried out by “dead-end” filtration, i.e., flow perpendicular of the membrane surface. Suspensions of higher concentration are treated by cross-filtration (flow parallel to the membranes surface), which is used in most membrane separations (RO, UF) to reduce membrane fouling.

MF and other separation membranes are asymmetric, i.e., they have a tight layer (skin) on the top of a more porous structure. The membranes are usually operated with the skin in contact with the feed liquid. However, liquids with high solid loads are better filtered with inverted membranes, which retain the large particles in their pores. Periodic flushing of such membranes with water is necessary to maintain the liquid flux at acceptable levels.

The modules and equipment used in MF are similar to those described for RO and UF separations, i.e., spiral-wound, tubular, hollow-fiber, and plate systems. In addition, rotating disk and cylindrical systems are used (Cheryan 1998). In some cases, pleated sheet cartridges are used, applying “dead-end” filtration.

The spiral-wound modules are preferred, because they are cheaper, but they are difficult to operate with particles larger than 200  $\mu\text{m}$  (fouling). In such cases, it may be economical to use a mechanical filter for removing (prefiltering) the large particles and then use MF. Like UF, tubular MF modules tend to foul less, and they can be cleaned more easily than the spiral-wound or hollow-fiber systems.

Inorganic membranes are more commonly used in MF than in UF or RO. Ceramic membranes consist of two layers, i.e., a porous support with pores 10  $\mu\text{m}$  or larger and an active coat of smaller pores. They are used as tubular monoliths, and they are particularly suited for high-temperature and high-pH applications. A large diameter (30 mm) tubular system with metallic oxide UF membranes has been used to clarify apple, replacing diatomaceous filtration (Swientek 1987a).

Operating conditions of the MF units are, pressures at 1–15 bar and temperatures at 50–90 °C. Temperature has a positive effect on the flux of juices and sugar solutions, where the viscosity decreases sharply at higher temperatures. However, temperature may have a negative effect on the flux of MF membranes treating protein suspensions, due to the precipitation (coagulation) of proteins at high temperatures. High Reynolds numbers in tubular systems increase turbulence liquid flux.

### 12.2.6.2 Food Applications of Microfiltration

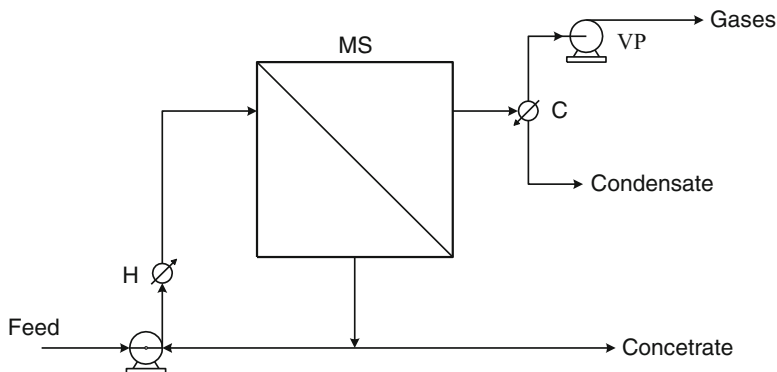
Microfiltration is applied to several separations in food processing, similar to those of ultrafiltration. Clarification of fruit juices, wine, and beer by MF can replace conventional mechanical filtration, eliminating the use of filter aids and reducing the process time and, finally, the process cost. Fouling of MF membranes (plugging with large particles) is a problem, which limits its widespread application.

MF can be used to remove bacteria and other spoilage microorganisms from liquid foods, such as milk, wine, and beer. The milk concentrate can be sterilized separately and recombined with the sterile milk permeate. The use of MF membranes for sterilization is governed by strict public health (e.g., FDA) regulations. Fouling of MF membranes is caused mainly by protein components of the foods. The bovine serum albumin (BSA) is normally used as a model protein in fouling studies. Membrane fouling is reduced by backflushing, pulsing, and washing, similar to treatment of UF membranes.

Scale-up of membrane plants is almost linear: after a certain size is reached, capacity is increased by adding more modules to the system. Thus, pilot plant tests and data can be used directly in the design of large commercial installations.

### 12.2.7 Pervaporation

Pervaporation (permeation and evaporation) is a separation process, in which one component of a liquid mixture is separated through a permselective membrane. The component is first sorbed preferentially into the membrane, then transported by diffusion through the membrane, and finally desorbed into the permeate space. Pervaporation is part of the gas separation processes, used widely in chemical engineering (Perry and Green 1997). Most of the membrane separations operate



**Fig. 12.3** Diagram of a pervaporation system. *MS* membrane separation, *H* heater, *C* condenser, *VP* vacuum pump

on the principle of mass transfer by solution/diffusion [Equation (12.1); Saravacos and Maroulis 2001]. Pervaporation is a rate-controlled, not an equilibrium, process.

In food systems, pervaporation is used either to remove water from liquids through hydrophilic membranes, or organic components through hydrophobic membranes.

The pervaporation membrane system includes heating and recirculation of the feed, condensation of the volatile component, and a vacuum pump to remove the inert gases (Fig. 12.3).

A typical application of pervaporation is the separation of water (5 % by volume) from the ethanol azeotrope mixture, using a hydrophilic membrane (see Chap. 11). It can be used for the concentration of fruit juices, by removing only water through an appropriate membrane, while the volatile components are retained in the juice concentrate. The aqueous essence (aroma solution) of fruit juices can be concentrated, removing the water through a hydrophilic membrane.

The volatility of food aroma components during pervaporation can be analyzed by methods discussed in Chap. 11. The UNIFAC method was applied by Baudot et al. (1997) to explain the separation effect of pervaporation membranes. The effect of ethanol to the relative volatility of aqueous aroma compounds (Chap. 11) is related directly to the pervaporation process (Karlsson and Tragardh 1994).

Pervaporation is used for the de-alcoholization of wine, instead of the thermal distillation (spinning cone column) process, described in Chap. 11. Hydrophobic (special rubber) membranes are used to remove ethanol to a level below 0.5 % (Mermelstein 2000). The process is carried out near room temperature, applying a small pressure difference. De-alcoholized wine contains all the wine components, except the ethanol, and it needs no addition of dilution water, like the RO-treated wine.

Ceramic membranes with selective permeability properties are used in various chemical engineering separations, replacing expensive distillation or adsorption equipment. They are more resistant to high temperature and fouling than polymeric membranes (Wynn 2001).

### 12.2.8 Electrodialysis

Electrodialysis (ED) is a membrane separation process, used to separate electrolytes from nonelectrolytes to exchange ions between solutions. Separation is based on the migration of ions through permselective membranes.

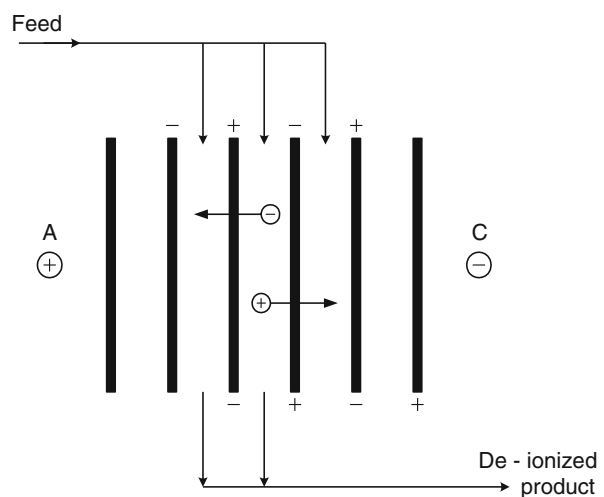
The ED membranes consist of swollen gels of polymers with fixed ionic charges. Cation exchange membranes consist of polystyrene copolymerized with divinylbenzene and then sulfonated. Anion exchange membranes consist of quaternary anions attached on polystyrene–divinylbenzene polymers.

The positive and negative ion exchange membranes are placed alternatively in a stack, containing several membranes, similar to plate and frame filtration system. The ions are induced to migrate by an electric potential, as shown diagrammatically in Fig. 12.4, the anions passing the anion exchange membrane and the cations the cation exchange membrane.

Electrodialysis competes RO in desalting brackish water (salt concentrations of 500–5000 ppm TDS). However, it is not economical for desalination of seawater (concentrations above 25,000 ppm TDS).

ED is used in food processing mainly for de-ashing (demineralization) of whey before evaporation and spray drying. It can be used for deacidification of citrus juices (Grandison and Lewis 1996).

**Fig. 12.4** Diagram of electrodialysis ion separation



ED membranes may have an operating life of about 7 years. Their replacement represents about 50 % of the total annual cost, followed by the energy cost of about 20 %.

## 12.3 SCF Extraction

SCF extraction is based on the separation of components of a mixture by a SCF, i.e., a fluid operating above its critical temperature and pressure (Perry and Green 1997; Johnston and Penninger 1989; Prausnitz et al. 1986). Carbon dioxide and water are the main SCFs used industrially, with carbon dioxide preferred in food processing, because of its advantages (nontoxic, moderate operating pressures and temperatures, easily removed, inexpensive).

SCFs have considerable solvent capacity and favorable transport properties, i.e., lower viscosities and higher diffusivities than the normal liquids. SCF extraction is used commercially in the decaffeination of coffee and the extraction of flavor components from plant materials.

### 12.3.1 Supercritical Fluids

The critical properties are important in choosing SCF for commercial extraction. Values of critical properties are given in tables and data banks of the chemical engineering literature (Reid et al. 1987). Table 12.1 shows the critical pressure ( $P_c$ ), temperature ( $T_c$ ), and volume ( $V_c$ ) of carbon dioxide and water. In practice, the operating pressures and temperatures of SCF extraction are considerably higher than the critical values. The very high temperatures and pressures of supercritical water prevent its commercial use in SCF extraction of food products.

SCFs behave as dense gases, occupying all available volume as a single phase, but they cannot be condensed as liquids by increasing the pressure. The density of the SCFs depends on the pressure and temperature, varying in the range of 400–700 kg/m<sup>3</sup>, i.e., it is significantly lower than the density of liquids (water, 1000 kg/m<sup>3</sup>), an important advantage in extraction operations.

The transport properties of the SCFs are between those of liquids and gases. Thus, the viscosity of SCF carbon dioxide is about 0.5 mPa s, significantly lower than, e.g., the viscosity of liquid hexane (3 mPa s). The molecular diffusivity of SCF carbon dioxide at 40 °C is about  $10 \times 10^{-10}$  m<sup>2</sup>/s, i.e., about one order of magnitude higher than the diffusivity in the liquid state ( $1 \times 10^{-10}$  m<sup>2</sup>/s). It should

**Table 12.1** Critical properties of carbon dioxide and water

Fluid	$P_c$ (bar)	$T_c$ (°C)	$V_c$ (L/kmol)
Carbon dioxide	73.8	31.1	73.9
Water	221.2	374.1	57.1

be noted that viscosity ( $\eta$ ) and diffusivity ( $D$ ) in gases are connected with the known relationship  $(\eta) \times (D) = \text{constant}$  (Saravacos and Maroulis 2001).

The favorable transport properties are desirable in extraction operations, since low viscosities facilitate the penetration of the SCF into the particulate beds and reduce power requirements in transferring the fluid through the system. Higher diffusivities increase mass transfer and approach to equilibrium, i.e., higher extraction efficiency.

Phase equilibria between the SCF solvent (e.g., carbon dioxide) and the food component to be extracted are required for quantitative analysis of the extraction process (see Chap. 11). Equilibrium is expressed by the solubility of the component at a given temperature and pressure, which is usually determined by experimental methods. Theoretical prediction is difficult, but there are some empirical thermodynamic approaches (Grandison and Lewis 1996; Reid et al. 1987). In general, solubility increases when the pressure is increased and the temperature is reduced.

The following rules apply for the SCF carbon dioxide solvent (Grandison and Lewis 1996):

1. The solubility of low-molecular-weight and low polarity organic compounds, like hydrocarbons, alcohols, carboxylic acids, esters, and aldehydes, is very high (complete miscibility).
2. Macromolecules and highly polar molecules (sugars, starch, proteins, salts) are insoluble. The solubility of some insoluble components can be increased by the addition of entrainers, e.g., ethanol, acetone, and ethyl acetate. For example,  $\beta$ -carotene is solubilized in carbon dioxide–ethyl acetate mixtures.

Water has a positive function in the SCF extraction of food solids. It is sorbed by the dry food materials, which are expanded, facilitating the transport of solvent and solute in the mixture.

### ***12.3.2 SCF Extraction Processes and Equipment***

Most of the pilot plant and commercial supercritical extraction equipment is batch-operated, because of the difficulty of continuous feeding of solid materials into high-pressure vessels (Bruno and Ely 1991). Expensive alloy materials are used for the pressure vessels, e.g., stainless steel 316, Hastelloy, and Inconel (Bohm et al. 1990). Special attention should be given to the safety aspects of the high-pressure equipment. A hazard analysis of the supercritical plant is useful in pinpointing the most dangerous parts of the equipment than could fail under defined operating conditions (Randhava and Calderone 1985).

SCF extraction of components of different solubility can be achieved by increasing the pressure progressively. Fractionation of various components can be accomplished by dissolving all extractants at high pressure and temperature (of carbon dioxide) and reducing the pressure successively, separating each component at the corresponding equilibrium pressure (cascade operation) (Grandison and Lewis 1996).

### 12.3.3 SCF Extraction in Food Processing

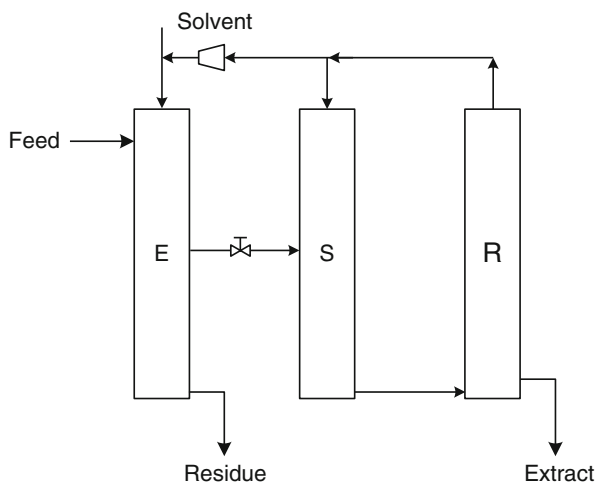
SCF extraction with carbon dioxide has found two major applications on food processing, decaffeination of coffee and extraction of hop flavor components (Perry and Green 1997). Other potential applications of SCF, which are expensive at the present time, include (Grandison and Lewis 1996; Swientek 1987b) oilseed extraction (e.g., soy beans), replacing hexane (King and List 1996); lecithin purification (degumming), instead of chemical treatment; fractionation of fish oils; and lowering cholesterol levels in egg yolk and butterfat.

The decaffeination of coffee and tea by SCF is economically competitive with the chemical extraction processes, and it has the advantage of no chemical residues in the food product. Coffee contains about 1 % caffeine, while tea may contain up to 3 %. The extraction of caffeine is facilitated by wetting the coffee beans with water, which tends to dissolve and desorb caffeine from the solid materials.

The operating conditions of a decaffeination plant are pressure at 300 bar and temperature at 40 °C (McHugh and Krukonis 1994). Figure 12.5 shows the principal parts of a coffee decaffeination plant.

The green coffee beans are loaded into the high-pressure extraction vessel. Fresh and recirculated carbon dioxide at a supercritical pressure and temperature is introduced into the extractor with a high-pressure pump. After extraction, the extract is transferred through an expansion valve to the separator, which operates at a lower pressure and separates it into two phases, the aqueous caffeine extract and the carbon dioxide, which is recycled. The caffeine can be recovered, e.g., by adsorption on an activated carbon column. Water is introduced into the separator to facilitate the separation of caffeine from the carbon dioxide. It should be noted that caffeine is more soluble in water (e.g., 3 % at 25 °C) than in carbon dioxide (0.1 %); the solubility of carbon dioxide in water at 25 °C is 0.16 % by weight (Chap. 11).

**Fig. 12.5** Principal parts of a SCF decaffeination plant for coffee. *E* extractor, *S* separator, *R* recovery unit





## 12.4 Crystallization from Melt

Crystallization from melt is based on the same principles of crystallization from solution, as discussed in Chap. 11. Instead of the supersaturation ( $\Delta C$ ) of solutions, the driving force for crystallization is the subcooling ( $\Delta T$ ) of the melt. Two major applications of interest to food processing are freeze concentration and fat fractionation.

### 12.4.1 Freeze Concentration

The freeze concentration of aqueous food liquids is based on the crystallization of ice and its mechanical separation from the concentrated solution. It has the advantages of low-energy requirements and better quality retention than conventional evaporation, but it has not found wide applications due to economics.

The freeze concentration process consists of two basic operations, i.e., crystallization and separation.

#### 12.4.1.1 Crystallization of Ice

Crystallization of ice from water or aqueous solutions involves nucleation and ice growth, which preferably are carried out in separate equipment. In freeze concentration, most of the nucleation (formation of small crystals) takes place in the scraped surface heat exchanger, used to cool the feed solution below its freezing point. Controlled crystallization (crystal growth) is carried out in a stirred crystallizer with recirculation of the solution through the cooler.

The freezing point depression ( $\Delta T_f$ ), i.e., the temperature difference between the freezing points of water and solution ( $^{\circ}\text{C}$ ), in dilute solutions, is a linear function of the molality ( $m$ ) of the solution (moles of solute per kg of solution), and it can be estimated from the simplified equation (Hartel 1992):

$$\Delta_f = km \quad (12.9)$$

where the constant ( $k$ ) depends on the molecular weight, the latent heat of fusion, the freezing point of water, and the gas constant ( $R$ ).

Typical values of  $\Delta T_f$  for apple juice are  $1^{\circ}\text{C}$  at 11 % TS and  $10^{\circ}\text{C}$  at 50 % TS (total solids). The freezing point depression is similar to the boiling point elevation during evaporation of aqueous solutions (Chap. 7). It is much higher in solutions of low-molecular-weight solutes, such as sugars, than macromolecules, such as starch and proteins.

The water fraction ( $X$ , kg/kg solution), which must be removed for concentrating a solution from ( $C_o$ ) to ( $C$ ), is given by the equation

$$X = 1 - (C)/(C_o) \quad (12.10)$$

Most of the water is removed from the solution during the initial stages of the concentration process.

The mechanism of ice crystallization and crystal growth is analogous to the mechanism of crystallization of solutes from solution (Huige 1972; Mullin 1993). Nucleation is predominantly heterogeneous, and it takes place on the walls of the scraped surface heat exchanger, used for subcooling the feed and the recirculated solution. In general, large crystals are desired, without solute inclusions, which can be separated easily from the concentrated solution.

Crystal growth involves diffusion of water molecules to the crystal surface and transfer of the heat of ice formation away from the crystal. The rate of crystal growth increases linearly with increasing subcooling. However, the increased viscosity of the concentrated solution tends to decrease the growth rate.

Increasing the residence time in the crystallizer results in ripening of the crystals with an increase in the mean crystal size. Large spherical crystals can be obtained by long residence time in the agitated crystallizer, which are easier to separate in the wash column (Van Pelt and Jansen 1988).

### 12.4.1.2 Ice Separation

Separation of the ice crystals from the concentrated solution is carried out in wash columns, which are preferred over the conventional filters and centrifuges.

The wash column consists of a vertical cylinder, which is fed at the bottom with the slurry of ice/concentrated solution from the crystallizer. The slurry is pushed upward with a perforated piston, which allows the draining and removal of the concentrated solution from the bottom. The ice bed, moving slowly upward, is washed with water, which is returned to the column from the ice melter, installed over the top.

The washed ice crystals are scraped from the top of the column and transported as a suspension to the heated melter, producing clean water, part of which is recirculated and the rest is received as the product.

### 12.4.1.3 Food Applications

Freeze concentration can be applied for the production of freshwater from the sea, but this process is more expensive than conventional thermal evaporation and newly developed reverse osmosis (RO).

Potential applications of freeze concentration in food processing include concentration of citrus juices (oranges, grapefruit, mandarin), skim milk, coffee

extracts, vinegar, and beer. Improvement of the process could reduce the cost and make the process more competitive. A three-stage countercurrent system is more efficient than single crystallizers, because the ice is separated at the lowest solute concentration (lowest viscosity) and the ice crystals can grow faster in lower concentrations. Thus, shorter residence times can be used, i.e., smaller size equipment. Larger wash columns with capacities of 10–20 ton/m<sup>2</sup> h water are more economical (Van Pelt and Jansen 1988; Van der Malen and van Pelt 1983). The economics of freezing were also discussed by Swinkels WJ (1988).

## ***12.4.2 Fat Fractionation***

Crystallization from melt is applied in the fractionation of various fats in the edible oil industry. It is also used in forming, coating, and enrobing operations involving chocolate (Chap. 4).

Fat crystallization follows a mechanism similar to the crystallization of ice and the crystallization from solution, i.e., nucleation followed by crystal growth. Fractionation of fats can separate various fat components from natural fat and oil mixtures, e.g., palm oil and butter fat. Three commercial processes are used, the dry, the detergent, and the solvent fractionations (Grandison and Lewis 1996).

### **12.4.2.1 Dry Fractionation**

Crystals of different composition can be obtained from a lipid mixture by changing the cooling rate. Crystals of poor quality, with liquid occlusions (oleins), are formed by rapid cooling. Dewaxing and winterization of vegetable oils, e.g., cottonseed, is accomplished by cold storage in large horizontal tanks, followed by mechanical filtration. The separated solid stearins have melting points of 25–50 °C, and they can be used as margarines, without the need of hydrogenation.

Three filtration systems are used to separate the fat crystals from the liquid fractions, i.e., the vacuum drum filter (Chap. 3), the vacuum flat-band filter, and the pressure filters.

The flat-band filter consists of a stainless steel belt operating under vacuum, fitted with a recycling device for the clarification of the liquid fraction. Filtration temperatures range from 2 °C (soybean oil) to 45 °C (tallow).

The pressure filters of fat crystals include low-pressure membrane and high-pressure filters. Special membranes, made of oil-resistant rubber combined with neoprene, are fitted to plate frames, which facilitate the filtration by air pressure and the removal of stearin cakes. Membrane filters consume considerably less energy than vacuum filters. High-pressure filters, particularly the hydrofilter presses (Krupp), are used for the filtration of stearin crystals from palm oil.

### 12.4.2.2 Detergent Fractionation

Typical application of detergent fractionation is the Lipofrac process of Tetra Laval. An aqueous detergent (sodium laureth sulfate) and an electrolyte (magnesium sulfate) are added to the crystallizing fat mixture, which disperse the crystals and agglomerate the oil droplets. The crystal suspension is separated by centrifugation. The process is applied to the fractionation of palm oil.

### 12.4.2.3 Solvent Fractionation

Nonpolar (hexane) or polar (isopropyl alcohol) solvents are used for the fractionation of palm oil. The fats are dissolved in the solvent, and fractional crystallization is accomplished from solutions of low viscosity by cooling, e.g., to 20 °C. Filtration is usually by vacuum drum filters, which are enclosed in a tight space to prevent loss of the solvent and air pollution. Higher separation efficiencies and faster rates are obtained then by dry filtration.

SCF extraction can be used in fat fractionation, if the economics is favorable.

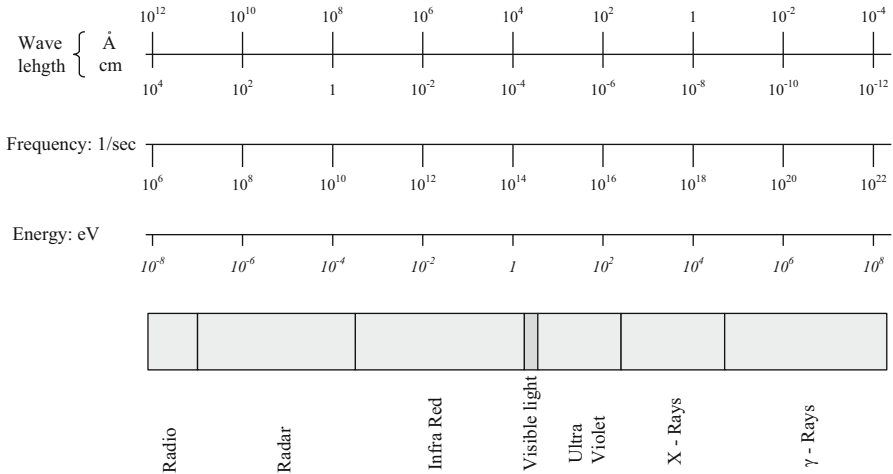
## 12.5 Nonthermal Food Preservation

Novel food preservation processes have been investigated and tested with the objective of replacing at least partially the established thermal preservation methods, i.e., pasteurization and sterilization. The basic reason for seeking alternative preservation methods, especially for heat-sensitive foods, is the significant thermal damage of food quality (nutritive and organoleptic) during thermal processing. Mild preservation methods are needed for inactivation of foodborne microorganisms which may cause health hazards in unprocessed or minimally processed foods (Barbosa-Canovas et al. 2000b).

Three nonthermal preservation processes have received special attention during the recent years, i.e., irradiation, high-pressure, and pulsed electrical field processing. The oldest of these, irradiation, is already applied in small scale to some food and packaging materials. HPP needs further development before wider application. Electrical pulse processing is still in the early stages of testing and development.

The new food preservation methods reduce the levels of the vegetative microbial cells by about 5 log cycles, without destroying the more resistant spores. They must be subjected to the required food safety tests and evaluation used in conventional thermal processing.

The equipment used in these novel processes is mostly pilot plant size or custom designed, and it is difficult to obtain sufficient economic data for comparison with conventional preservation equipment.



**Fig. 12.6** Diagram of electromagnetic radiation

### 12.5.1 Food Irradiation

Ionizing radiations can inactivate spoilage and pathogenic microorganisms in an analogous mechanism with heat. However, enzymes are more resistant to radiation than heat, so that a combination of heat and irradiation may be indicated in some cases. The ionizing radiations have smaller wavelengths than the UV rays (Fig. 12.6). They include gamma rays, X-rays, high-energy electrons,  $\alpha$ -rays, and neutrons. In food preservation, only gamma rays, X-rays, and high-energy electrons are used.

#### 12.5.1.1 Review of Food Irradiation

The systematic research on food irradiation started in 1958, with the irradiation of potatoes for inhibiting the growth of sprouts at a maximum rate of 0.1 kGy. In 1973, the maximum rate for the same process and product was increased to 0.3 kGy (FAO 1988). The controlled use of ionizing radiation to prevent sprouting of potatoes was permitted in Canada in 1960. The Atomic Energy of Canada Ltd. used, in cooperation with members of the potato industry, a pilot mobile cobalt 60 irradiator for the irradiation of 400 tons of potatoes in 4 months in 1961–1962.

In 1962, the USA allowed the use of ionizing radiation in semicommercial installations, to kill insects in cereals and sterilize bacon. This development, however, was interrupted in 1968, when the FDA asked for a detailed evidence of safety with respect to secondary toxic impact, e.g., due to mutations in the inactivated microorganisms and insects. The FDA recalled also the irradiation permission for bacon, designated to the army. However, since then, research in

this field continued and resulted in the permission of irradiation for certain foods and at specified irradiation dosages in more than 15 countries up to 1980.

In 1980, the JECIF (Joint Committee on Irradiation of Foods) of FAO, WHO (World Health Organization), and IAEA (International Atomic Energy Agency), after receiving the results of a 10-year international research program on the safety of application of 10 kGy irradiation on foods, decided that this dosage is harmless in relation to food. Based on this decision, the Codex Alimentarius published in 1983 prescriptions for using ionizing radiation in foods. In 1986, the EU (European Union) decided that no further experiments on animals were necessary for proving the safety of irradiated foods at dosages up to 10 kGy, and in 1988, in a meeting of FAO, IAEA, WHO, ITC-UNCTAD, and GATT in Geneva, it was decided that the international trade of food, irradiated up to 10 kGy, should be permitted (Moy 1992). Today, in many countries, several kinds of food are irradiated and sold up to this level. According to Loaharanu (1992), food irradiation units were installed up to 1992 in 32 countries, and trade of irradiated food was approved in more than 50 of them. In these 32 countries, more than 160 irradiation units were installed up to 1992 (IAEA 1973). In, e.g., the Netherlands and Belgium, the production at the beginning of 1990 exceeded the 20,000 tons per year. France installed a large unit near Marseille in 1987.

### 12.5.1.2 Food Preservation by Irradiation

The general aspects of food preservation by ionizing radiations were discussed by Diehl (1977), Diehl (1990), Josephson and Peterson (1982) and Satin (1996). Most of the operating data on food irradiators are obtained in pilot plants, installed at Universities, Research Institutes, or Manufacturers of Equipment, e.g., the new electron accelerator facility at Texas A&M University (Mermelstein 2000). The Food Irradiation Coalition is a group of food trade associations, concerned with the application and acceptance of food irradiation (Adams 2000).

Irradiation sterilization of food packaging materials (mainly plastic films) must comply with the regulations of food legislature before they are used commercially (Barmore 2000; Hansen 2000). Because of the different requirements of preservation of various food products (fruits and vegetables, meat, poultry, fish, etc.), special pilot plants are required at different locations. Transportable irradiations could be used in field testing (Swientek 1987c).

An irradiation process must fulfill the following requirements, for being appropriate to foods:

1. Be able to penetrate the food
2. Radiate enough energy for processing large quantities of food in short time
3. Should not create sources of secondary radiation
4. Should not cause chemical or toxic reactions
5. Should not be carcinogenic
6. Should not have a negative impact on the organoleptic properties of food

**Table 12.2** Penetration of different radiations

Radiation	Material	Penetration
Ultraviolet	Milk	0.01–0.02 cm
Gamma rays	Air	1000–2000 cm/MeV
X-rays	Water	10–20 cm/MeV
High-energy electrons	Air	3000 cm/MeV
	Water and food	≈0.5 cm/MeV

### 7. Should not reduce the nutritional value of the food

The penetration of radiation in the food depends on its energy, measured in keV or MeV. Table 12.2 presents the penetration of several kinds of radiation in food and water, which is the main component of most foods. For food applications, only gamma rays, X-rays, and high-energy electrons can penetrate the foods satisfactorily (Kuprianoff and Lang 1960).

The efficiency of irradiation of a product is related to the energy absorbed by the material, which is measured in Gy (gray), which is the absorption of 1 J/kg or 100 erg/g material (1 J = 10<sup>7</sup> erg). In the past, the unit rad was used (1 Gy = 100 rad). In food applications, the irradiation dosage is usually expressed in kGy (equivalent to 10<sup>5</sup> rad or 0.1 Mrad). In food preservation, three dosage regions are distinguished:

- (a) Low irradiation: 0.05–1.00 kGy
- (b) Medium irradiation: 1–10 kGy
- (c) High irradiation: 10–75 kGy

The reduction of a microbial population from ( $N_0$ ) to ( $N$ ) is given by the equation

$$(N/N_0) = \exp(AEt) \quad (12.11)$$

where ( $A$ ) is the area of microorganisms (cm<sup>2</sup>), perpendicular to radiation; ( $E$ ) is the radiation dose, i.e., the number of electrons absorbed per (cm<sup>2</sup>) of surface per second; and ( $t$ ) is the irradiation time (s).

For estimating the dosage  $E$  (12.11), the electron flow ( $\mu\text{A}/\text{cm}^2$ ) is measured, and the number of electrons is estimated, assuming that 1  $\mu\text{A}$  corresponds to the flow of  $6.25 \times 10^{12}$  electrons/s (Kuprianoff and Lang 1960).

In general, the smaller the biospecies (microorganism, spores of microorganisms, enzymes), the larger the dose required for its destruction. On the average, spores and enzymes require 3–7 times more radiation energy than microorganisms for their inactivation.

Table 12.3 gives the dosages required to inactivate various microorganisms (Anonymous 1988).

Although several irradiation tests on meat, e.g., in cans at doses exceeding 30 kGy and for hams at 45 kGy were satisfactory, irradiation sterilization is still not allowed (i.e., at dosages larger than 10 kGy). Nevertheless, irradiation in the

**Table 12.3** Applications of food irradiation

Area of application	Dosage (kGy)	Examples of irradiated foods
<i>Low dosage (up to 1 kGy)</i>		
Sprout inhibition	0.05–0.15	Potatoes, onions, garlic
Pest disinfection (insects)	0.15–0.75	Cereals, nuts, fresh fish, fresh pork meat, dry fish, and meat
Retardation of physiological reactions and destruction of non-sporogenic microorganisms	0.25–1.00	Fresh fruits and vegetables. Parasite control, <i>Trichinella</i> in fresh pork
<i>Medium dosage (1.0–10 kGy)</i>		
Improvement of preservation	1–3	Fresh fish, strawberries. Control of pathogens in poultry
Destroying of most sporogenic microorganisms		
Control of pathogenic microorganisms	3–10	Spices, nuts, refrigerated fresh meat. Microbial disinfection of dried enzyme preparations
Technological improvement of food	2–7	Preservation of grape juice and improvement of nut rehydration
<i>High dosage (10–75 kGy)</i>		
Sterilization of food packages	10–30	Spice and enzymatic preparations. Sterilization of food in packages
Industrial sterilization in combination with heat treatment	>30	Beef and pork meat, poultry, crustaceans, and ready meals

medium range is also important, since at this dosage salmonellas (major source of gastrointestinal infections) are eliminated. Irradiation of strawberries, e.g., at 2 kGy extends their shelf life to 15 days. In Ukraine, wheat is irradiated for killing insects (WHO 1988).

### 12.5.1.3 Sources of Food Irradiation

The ionizing radiations are part of the electromagnetic radiations (Fig. 12.6), which include the ultraviolet (UV) radiation that can be used in the disinfection of water, used, e.g., in hygienic processing of oysters. However, the UV and the neutrons can be sources of secondary radiation, and the  $\alpha$ -rays do not penetrate deeply. Therefore, in food preservation, gamma rays and X-rays and high-energy electrons may have potential applications. X-rays are produced by high-energy machines, and they have penetrations similar to those of gamma rays. However, only 10 % of the electrical energy input is transformed into X-radiation (Kuprianoff and Lang 1960). Therefore, in food preservation, only gamma rays and high-energy electrons can be used practically.

Gamma rays are produced by irradiators consisting of packaged cobalt-60 ( $^{60}\text{Co}$ ) or cesium-137 ( $^{137}\text{Cs}$ ) radionuclides of strength up to about 1 MCi (MegaCurie),



where  $1 \text{ Ci} = 3.7 \times 10^{10} \text{ Bq}$ ; 1 Bq (Becquerel) is equal to one fission per second. Cobalt-60, with a half-life of 5.3 years, is produced by irradiation of nonradioactive cobalt-59 with neutrons. Cesium-137, with a half-life of 30 years, can be produced from nuclear fission by-products, and it is in less demand than cobalt-60. In both cases (cobalt-60 and cesium-137), the energy of radiation is not larger than 1.3 MeV, which is the upper limit for gamma radiation, that will not induce secondary radiation (WHO 1988). The advantage of using gamma rays in food irradiation is that the irradiated energy is constant and that no complicated mechanical installations are required. Their disadvantages are the dependence on a relatively restricted number of radiation materials and the continuous radiation, even when the source is not used.

The energy limit of the electron-beam radiation that does not induce secondary radiation is 10 MeV, where  $1 \text{ eV} = 1.6 \times 10^{-19} \text{ J}$  (IAEA 1973). Gamma rays have a higher penetration power than electrons (Étienne and Buyle 1984). The high-energy electrons are produced by linear accelerators or Van de Graaff electrostatic generators (Karel 1975). The penetration of the electrons is a function of their energy and the density of the material. The penetration of electrons has a nonuniform distribution, with a maximum within the material. The penetration depth ( $d$ , mm), which is defined as the depth at which the dose is equal to the dose at the surface, is given by (12.12) (Boaler 1984):

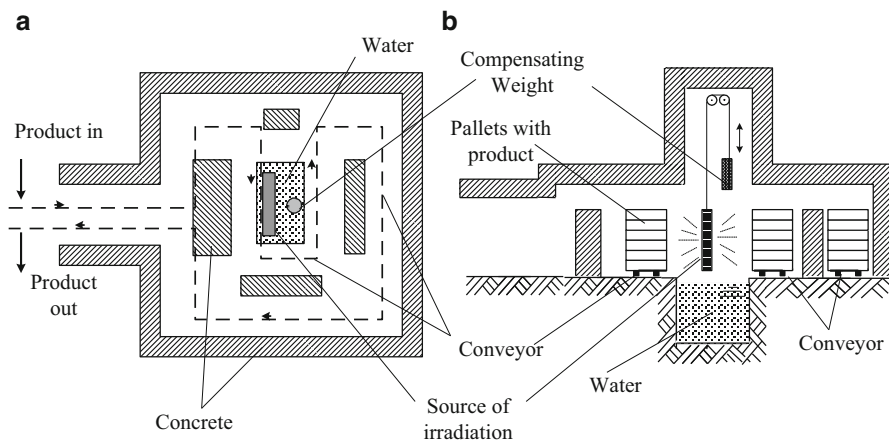
$$d = (4E - 10)/\rho \quad (12.12)$$

where ( $E$ ) is the electron energy (MeV) and ( $\rho$ ) is the density of the material ( $\text{g/cm}^3$ ).

Thus, for an accelerator of  $E = 5 \text{ MeV}$ , the penetration in water ( $\rho = 1 \text{ g/cm}$ ) will be  $d = 10 \text{ mm}$ . Because of the uneven distribution, irradiation from both sides of the material will have an effective penetration of  $2.4 d = 24 \text{ mm}$ . The advantage of the electrons is that the radiation occurs only as long as the machine is in operation. The disadvantages are the lower penetration and the more complicated structure of irradiator.

In irradiation installations, the main cost is due to the sheltering (protection) and transportation of the units, which makes up about 56 % of the total investment. A typical installation for cobalt-60 irradiation is shown diagrammatically in Fig. 12.7. The products, which are loaded on pallet boxes, are put in the racks of a conveyor system. The loaded racks are conveyed into the irradiation installation which is made of (a) the irradiation chamber, (b) the elevation mechanism for the irradiation elements, (c) the water pool, and (d) the ventilation.

The irradiation procedure is as follows: The pallet boxes are conveyed into the irradiation chamber, after passing through a labyrinth-like corridor. A chain mechanism or a conveyor on the floor is used. The labyrinth-like corridor is required to prevent the leakage of radiation to the environment. The pallet boxes are conveyed around the irradiation source (e.g., cobalt-60), which consists of piles or radioactive plates, encapsulated in larger plates (Karel 1975). Both types of irradiators are hung in the center of the irradiation chamber. A water pool is installed under the



**Fig. 12.7** A food irradiation installation with isotopes (a) ground plan and (b) cross section

irradiation source for submerging the irradiation elements, when repairs are made or in emergencies. The hanging mechanism holds the cobalt-60 elements always in the right position. The pallet boxes with the irradiated products, after turning around the irradiation elements, leave the chamber through a second labyrinth-like corridor, and they are automatically unloaded. The whole installation has thick concrete walling.

#### 12.5.1.4 Cost of Irradiation

The cost of food irradiation depends on the purpose of irradiation, the treatment, the volume and the type of food, the type and efficiency of the radiation source, the cost of transportation of food to and from the irradiation installation, and the cost of any supplementary processing (e.g., freezing or heating before or during irradiation). A rough cost estimate for food irradiation is 20–400 USD per ton (FAO 1988). According to another estimate, the cost of low-dose irradiation of food (e.g., inhibiting sprouting of potatoes) is 10–15 USD per ton (IAEA, 91). The cost of high-level irradiation (e.g., ensuring hygienic spices) is 100–250 USD per ton. The cost of irradiation in comparison to heat treatment is 10–20 % less, when applied to the disinfestation of fruits.

The cost of irradiation installations is affected strongly by the civil engineering works (buildings and other permanent installations), which cost more than the irradiation equipment. The irradiation units must be located in predetermined sites in which the products must be transported for processing and then taken away again, if the food distribution system is not adjusted to the irradiation installation. This increases the processing cost and makes the trade less flexible.

The cost of irradiation is almost proportional to the irradiation rate. However, when using cobalt-60, or any other radioactive material, since the radiation is permanent, the processing should be continuous. If the time of operation of a pasteurizing installation (e.g., 2 kGy) is doubled, the overall cost of irradiation is reduced by 50–60 %/kg of product. Due to the fact that a cobalt-60 source radiates in all directions, and not only through the processed food, it has been estimated that only about 40 % of the irradiation energy is utilized (Kuprianoff and Lang 1960). Furthermore, the cobalt-60 loses 12 % of its radiation power every year, independently if it is used or not (IAEA 1973). Therefore, if interruptions in processing take place (e.g., due to repairs, defects of products, etc.), the efficiency of the unit is reduced further. The total cost (including buildings) of a cobalt-60 installation of food irradiation of 1.6 MCi would be about 8–9 million USD, out of which 3.5–4.0 million would be equipment cost (prices of 1992).

### 12.5.2 High-Pressure Processing

HPP has the potential of producing foods of improved quality and safety.

It can preserve foods by inactivating spoilage and pathogenic microorganisms without heating. Pressures in the range 1–8 kbar (100–800 MPa) can inactivate vegetative cells, but they are ineffective for spores and enzymes. Combined HPP and heat treatment can sterilize various food products.

HPP is based on the same principles of the thermal processing technology, i.e., kinetics of microbial inactivation, enzyme and nutritional changes, and process design and evaluation, as discussed in Chap. 10. Combined HPP and heat treatment is analyzed by similar procedures (Hendrickx 1999).

HPP is suitable for inactivation of foodborne pathogens in raw foods and fruit juices, which are not thermally pasteurized. For example, a 5-log inactivation of pathogenic *E. coli* O157:H7 can be achieved with HPP treatment of unheated apple and other fruit juices.

HPP treatment of fruit juices can be accomplished in continuous pressure systems, which consist of piston pressure pumps (modified homogenizers), developing pressures up to 3 kbar. The pressurized juice is expanded to atmospheric pressure instantly, destroying the vegetative microbial cells (Mermelstein 1999). Homogenizer systems, processing up to 5 tons/h juice, have been designed.

Most of the HPP applications are hydrostatic batch systems, due to the difficulty of continuous operation at very high pressures. High-pressure steel vessels, resembling autoclaves, are loaded with the food product and pressurized hydraulically (isostatic operation). Water and liquid foods are the pressure transfer media (Knorr 1997). After the required process time, e.g., 1–10 min, the vessel is depressurized, the product is removed, and the cycle is repeated.

Batch sterilization in pressure vessels (e.g., 215 L capacity) can be achieved at 6.9 kbar and 100 °C for a process time of 1.5 min and cycle times 6–8 min. The processing capacity of a proposed 5-vessel (215 L) system is about 90 tons/day

(Meyer et al. 2000). The estimated processing cost for this system is about 0.10 USD/kg product (2000 prices).

HPP in the presence of carbon dioxide has been suggested to pasteurize and stabilize the cloud of orange juice (inactivation of enzymes), e.g., 3.5 kbar and 8.6 min residence time (Kincal 2000). The food products entering the HPP vessels should be at a low temperature, e.g., 5 °C, since pressurization above 1 kbar increases the temperature by about 20 °C.

HPP technology can be applied, alone or in combination with other processes, to the preservation of minimally processed fruits and vegetables (Palou et al. 2000).

High pressure may be also applied to **homogenization**. Application of pressures up to 15 kbars requires proper equipment design, high strength, and highly abrasive materials, including developments related to new ceramic technologies. Such a process occurs in special homogenization valves. The liquids pass through very narrow gaps, creating conditions of high shear and turbulence along with acceleration, impact, and pressure drop, resulting in disintegration of particles and reducing their size down to 0.2–2 µm. The actual size of particles depends on the pressure and type of the processed product.

### ***12.5.3 Pulsed Electric Field Processing***

Pulsed electric field (PEF) processing is used for the inactivation of spoilage and pathogenic microorganisms in various food products. The food material is placed between electrodes, and microbial inactivation is achieved through dielectric breakdown of the bacterial membranes (Barbosa-Canovas and Zhang 2001). Similar microbial inactivation can be affected by other nonthermal processes being investigated, e.g., oscillating magnetic fields, light pulses, and ultrasound.

Microbial inactivation is a function of the particular electric field (maximum discharge rate/electrode distance) and the number of pulses applied (total treatment time). Typical PEF conditions for pasteurization of fruit juices are electric fields of 30–60 kV/cm and pulse duration about 1 µs (Barbosa-Canovas et al. 2000a).

Factors affecting the inactivation of microorganisms by PE, include the: (a) electric field, (b) the wavelength applied, (c) the ionic etc.

PEF processing is at the development and testing stage, and it is suitable for batch or continuous nonthermal pasteurization of food products, improving their quality and safety. A PEF processing unit combined with aseptic packaging facilities is installed at the Ohio State University.

### 12.5.4 Nanotechnology

Nanotechnology is concerned with materials of sizes in the range of 0.5–10 nm, as shown in Fig. 12.8. Nanoparticles find applications in Biology, Microbiology, and Materials Science (Fig. 12.8).

In food engineering, nanoparticles are applied in packaging, in membrane filtration, and in special particle processes, such as emulsification.

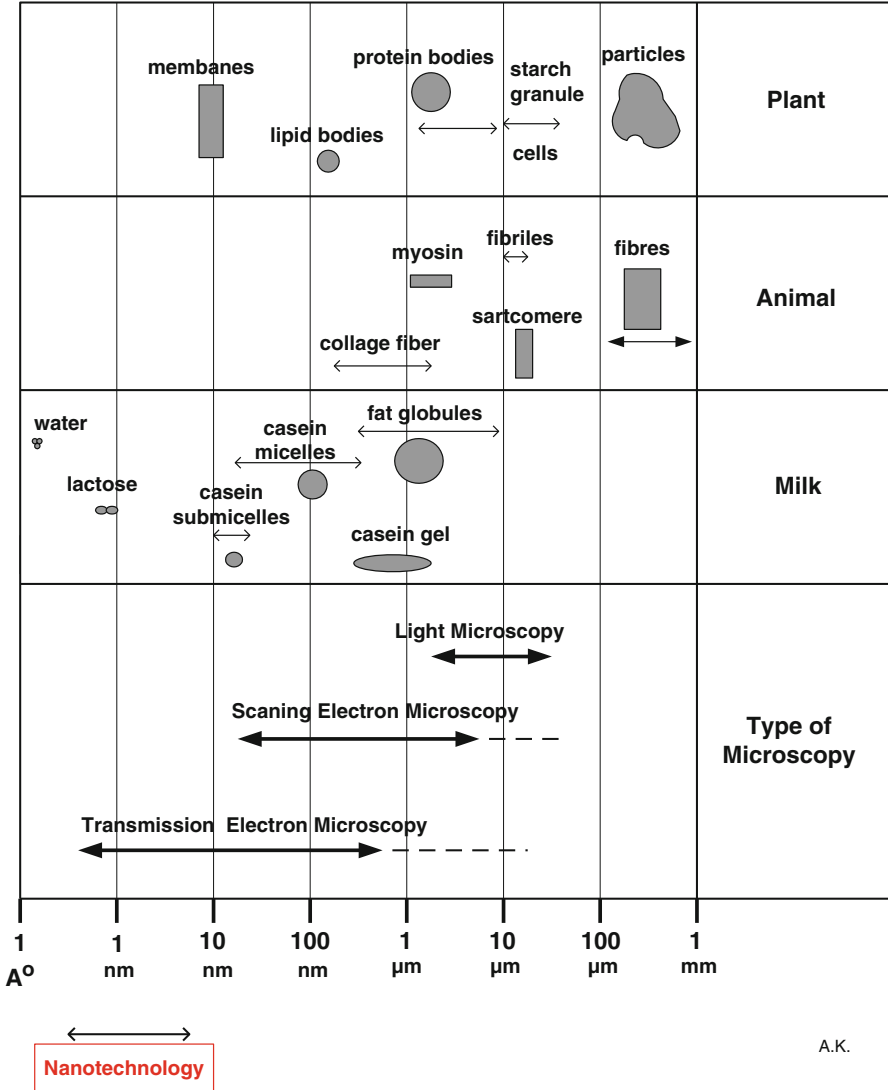


Fig. 12.8 Particle sizes and microscopy applications

## 12.6 Robotics

Robots are relatively new in food technology. Their application in the food and beverage industry has been intensified in the last 10 years. They were firstly introduced in packaging (pick and place) and palletizing operations and some further operations of the baking industry. In the meanwhile, their operation is extended, among others, to operations of the meat, poultry, fish, the confectionary, and the cheese industry.

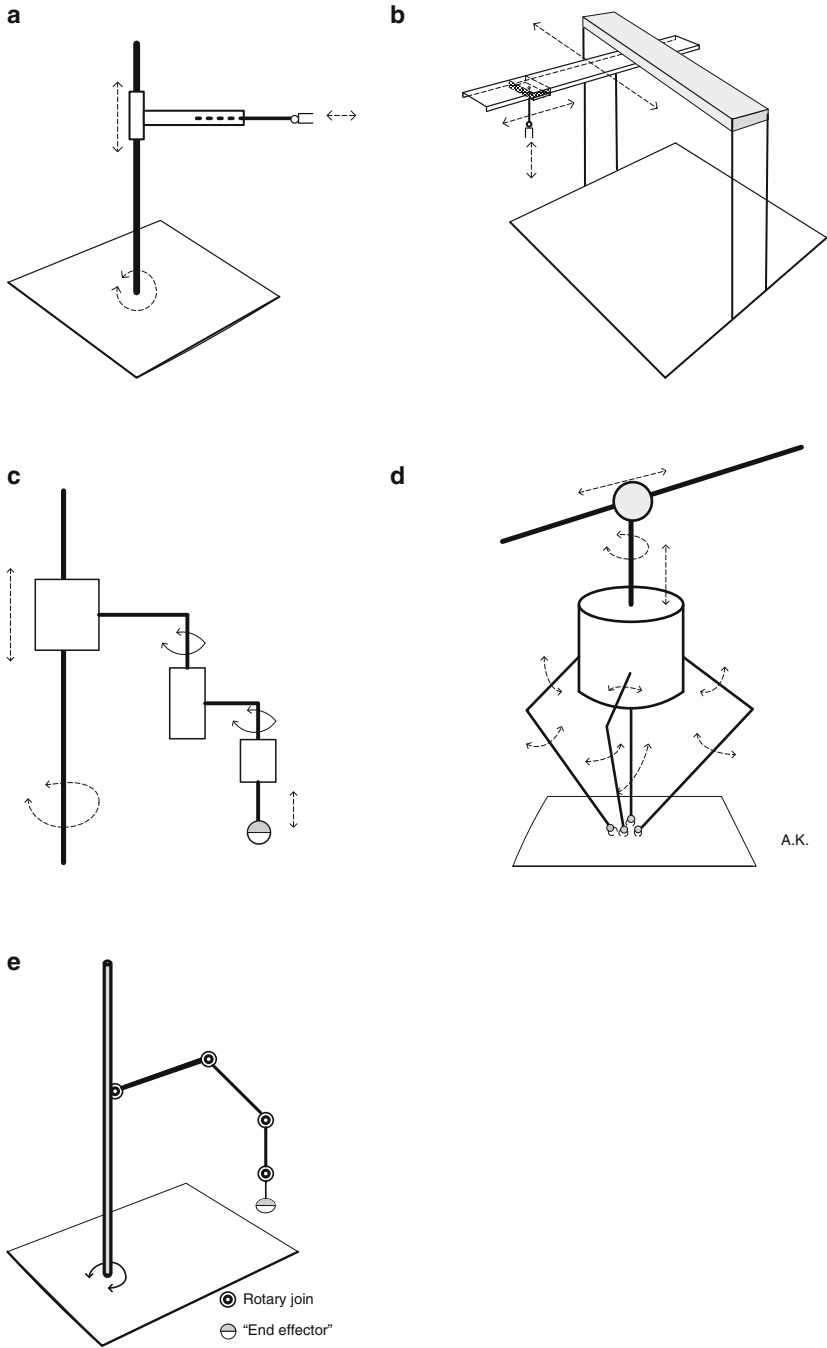
Basic elements of the robot applications in the food industry are the following:

- Versatility in their use, since they enable to perform several or even different operations almost simultaneously.
- Reduction of contamination due microbiological infections of food during processing, caused by inadequate sanitary conditions of the engaged personal or processing equipment, creating healthier foods.
- Reliable and exact work. They can handle products and accomplish the work exactly.
- Advantage in operation of quick, repeatable processes, which exhaust personal, resulting in gradual reduction of their productivity and increased operational failures. Such an example is control and pick out of non-desired objects during conveying of processed food.
- Application in less favorable working condition, such as quite high or low temperatures and operations causing dust.
- Operation in dangerous conditions.

Several types of robots have been developed for meeting the wide range of their use. Usually, they are classified according to their application (e.g., industrial, medical, etc.) and according to their kinematics (e.g., stationary or mobile robots). Another possibility is to classify them, as indicated below, according to the type and “path” of their “mobile branches/arms” (Fig. 12.9):

- (a) Cylindrical robots
- (b) Cartesian/gantry robots
- (c) SCARA robots
- (d) Delta-type robots
- (e) Articulated robots

In the *cylindrical* robot, the axes correspond to a cylindrical coordinate system. The robot consists of a vertical axis ( $Z$ ) that is able to rotate and a unit able to move up and down along the vertical axis  $Z$ . Attached to this unit sits a branch/arm bearing at its end the “end effector” (i.e., the final part of the arm, providing attachment to tools, such as grips). This branch can move in direction  $Y$  (Fig. 12.9a). In the *Cartesian robot*, the linear or prismatic joints of its axes lie in the same direction of Cartesian coordinates. The “end effector” of the robot is



**Fig. 12.9** Basic types of robots (a) Cylindrical robots, (b) Cartesian/gantry robots, (c) SCARA robots, (d) Delta-type robots, (e) Articulated robots

located nearest to the position of the object (Fig. 12.9b). The SCARA (Selective Compliance Assembly Robot Arm) consists of a rigid Z axis, but pliable (slightly compliant) in the XY axes (Fig. 12.9c). This enables the “end effector” to put, e.g., a round pin in a hole without bending. The Delta-type robot consists of parallel arms, supporting this orientation to the “end effector” (Fig. 12.9d). Articulated robots are mainly one-arm units that are fitted with one or more rotary joints, providing great flexibility to the “end effector” (Fig. 12.9e).

All robots consist of the following basic elements: the main axes, the branches/arms, the “end effectors,” and the joints. The selection of the right robot depends on the required job in connection with the rest factory. Besides the product that has to be handled, important factors are the following:

1. The weight of the product
2. The environment of fabrication (e.g., temperature, moisture etc.)
3. The operational “speed” of the robot
4. The accuracy and versatility required
5. The space provided in the factory
6. The extension to auxiliary instrumentation
7. Increasing manufacturing productivity
8. Maintenance and operational limits

Finally, it is essential to have the right and, as far as possible, simple software that will enable a satisfactory operation of the robot in connection to the processing requirements. An example of combining robotics with skills of other branches is their use in proportioning of food for further processing. Here, besides robotics, the involvement of cutting/slicing techniques (e.g., water jet cutting; see Chap. 4) is required as well as further developed “geodetic” software and laser techniques for estimating the special and overall dimensions of certain food pieces and instrumentation for estimating the food consistency (e.g., weight, eventually fat in meat, etc.) (Chap. 4), especially in portioning operations.

Technical restrictions are as follows:

- The maximum load which some recent robots can lift and carry is approximately 500 kg.
- The robots must be well constructed to withstand certain temperatures, moisture, and dust conditions. Robots may be used in packaging operations and inside low-temperature ice cream storage rooms. This helps to avoid condensation that occurs at normal higher temperature conditions. The range of temperatures in which robots can operate nonstop is  $-30\text{ }^{\circ}\text{C}$  to  $+50\text{ }^{\circ}\text{C}$ , provided they are constructed for extreme limits. This is especially important for low temperatures, such as that in freezing processes, due to restrictions in the viscosity of the lubricants used. In this case, the robots must be able to work with lubricants appropriate for this purpose. In the case that the temperatures are even worse, then further measures must be taken to protect the robot. Moisture is especially important to washing/cleaning operations. In cases in which the robots are directly involved in processing (not only handling packed products), they must



be often cleaned (e.g., washed out with pressurized water or steam). In applications such as meat slaughtering, the cutting tools must be cleaned and disinfected almost after every operation. This may be done, e.g., by using water at 85 °C. The high technology electronics used in robots or in instruments in connection with robots must be protected from *dust*. Therefore, robots that are used in such environments must fulfill construction requirements of the **IP Code Standards**. Usually, for robotprotection from dust and liquid ingress, satisfaction of the high standards IP68 and even IP69K is required. The IP68 foresees protection from dust ingress and long-term exposure up to a specific pressure. The IP69K foresees total dust ingress, as well as steam-jet cleaning protection. The IP69K standard extends the IEC 60529 rating system (International Electrotechnical Commission enclosures) by adding high-pressure and high-temperature washing applications (temperatures about 70 °C and pressures about 80 bars).

- The *speed* of robots varies with their main type. Usually, the SCARA robots are faster than the Cartesian robots but less quick than the Delta-type robots, which may achieve speeds of 120–150 pick and place cycles per minute. Some robots already achieve higher such speeds. In applications of meat processing, robots can prepare about 360 burgers/h and more than 800 hotdogs/h in packing. Usually, in packaging process, a robot is more than four times faster than a worker. In food “assembling” operations, the speeds of robots are: 30–90 pieces/min for sandwiches and 30–450 pieces/min for pizza. The speed of handling (pick and place) of pralines may vary about 300 pieces/min. In palletizing, the simple layer handling palletizers are faster and cheaper than robots. However, the speed of layer handling palletizing equipment is rated in layers/min, while that of robots by picks/min. In slaughtering of pigs, a robot may process about 600 pigs/h. This speed varies according to the operation requirements and the overhead conveyor transporting the pigs (see p. 148). In large round Swiss-type hard cheese, robots are used in picking and replacing the product in the ripening storage shelters, after rubbing/brushing it on both sides automatically. Their speed is about 115 cheeses/h. In palletizing, robots are more efficient than layer handling palletizers, in handling products in bags. In some cases, hybrid solutions (i.e., robot-layer handling palletizer combination) are also used.
- Great benefit of robots is their accuracy and versatility. They can be used in exact cutting in the meat processing and in decorations in the confectionary industry. Their versatility is very wide. Besides that, they perform different operations, as, e.g., transport and sorting during processing, almost simultaneously.
- The robots can save processing space in the factory. Except the less time they need in processing of certain types of work, they can be placed on floor near prevailing operations, or ceiling, or wall mounted. Furthermore, there are mobile robots, enabling their adjustment to different processes, whenever this is necessary.
- Robots are quite often used in connection with further special instrumentation. This is, e.g., the case in meal preparing portions, requiring similarity. The size and condition of food may be “investigated” by high technology instrumentation

(e.g., laser, vision, etc.) preparing the robot to accomplish the right operation (e.g., choose the right cutting or other tools). In this case, such instruments send this information to computers, which successively forward it to the robot, after doing necessary interventions. Cameras, e.g., in connection with robots, allow them to place foods exactly in the right desired position for quality control, further processing, and packaging or to place them in trays. The choice of the right, fast, and easy replacement of the attached grippers, usually operating mechanically or pneumatically (e.g., in case of vacuum caps as “grippers” for picking up objects), is essential.

- Productivity is increased, whenever the manufacturing facilities are well engaged. The productivity of workers is reduced, when they must do monotonous high speed work. In such cases, even the quality of the manufactured products is reduced. Robots may overtake such work, extending also manufacturing to three shifts, if this is required. The robots, in cooperation with computers and rest automation systems, help in a “holistic” successive approximation of the whole manufacturing process.
- Robots may work for long periods continuously. However, as every machine, they need to be maintained. Usually, this takes place in about 10,000 h of nonstop operation. Furthermore, care must be devoted, in the tools used in the “end effector.” According to the type and length of time of work, tools can be necessary to be replaced or conditioned in equipment, such as cutting instruments of the meat industry.

## References

- Adams P (2000) E-beam and x-ray irradiation. Paper presented at the 2000 IFT annual meeting, Dallas, TX, June, paper no. 6-5
- Anonymous (1988) Food irradiation. WHO and FAO, Geneva
- ASTM (1992) Test F316-86. Standard test method for pore size characteristics of membrane filters by bubble point and mean flow pore test. In: Annual book of ASTM standards. American Society for Testing and Materials, Washington
- Barbosa-Canovas GV, Zhang QH (2001) Pulsed electric fields in food processing. Technomic, Lancaster
- Barbosa-Canovas GV, Congora-Nieto MM, Swanson BG (2000a) Processing fruits and vegetables by pulsed electric field technology. In: Alzamora SM, Tapia MS, Lopez-Malo A (eds) Minimally processed fruits and vegetables. Aspen, Gaithersburg, pp 223–235
- Barbosa-Canovas GV, Pothatehakamury VR, Palou E, Swanson BG (2000b) Nonthermal preservation of foods. Marcel Dekker, New York
- Barmore C (2000) Packaging materials and irradiation: current materials approved, future needs, and roadblocks. Paper presented at the 2000 annual IFT meeting, Dallas, TX, June, paper no. 6-6
- Baudot A, Souchon I, Marin M (1997) A thermodynamic approach to volatile bioproducts separation by pervaporation process. In: Jowitt R (ed) Engineering & food at ICEF 7, part 2. Sheffield Academic Press, Sheffield, pp L29–L32
- Bemberis I, Neely K (1986) Ultrafiltration as a competitive unit process. Chem Eng Prog 82:29–35
- Boaler VJ (1984) Electron accelerator for food processing. J Food Eng 3(4):285–294

- Bohm F, Heinisch PS, Widner E (1990) Design, construction and operation of a multipurpose plant for commercial gas extraction. In: *Supercritical fluid science and technology*. American Chemical Society (ACS) symposium series, no. 406
- Braddock RJ, Sadles GD, Chen CS (1991) Reverse osmosis concentration of aqueous-phase citrus essence. *J Food Sci* 56:1024–1029
- Brauns E (2001) Calculation of cross-flow reverse osmosis at your desk. *Desalination Water Reuse Q* 10(4):18–25
- Bruno JT, Ely JF (1991) *Supercritical fluid technology: reviews of modern theory and applications*. CRC, New York
- Cheryan M (1992) Concentration of liquid foods by reverse osmosis. In: Heldman DR, Lund DB (eds) *Handbook of food engineering*. Marcel Dekker, New York, pp 393–436
- Cheryan M (1998) *Ultrafiltration and microfiltration handbook*. Technomic, Lancaster
- Diehl JF (1977) Preservation of food. In: *Physical chemistry*, vol 9. Pergamon Press, London
- Diehl JF (1990) Lebensmittelbestrahlung- Risiko oder Fortschritt? *Industrielle Obst und Gemueseverarbeitung* 75:59–63
- Drioli E, Calabro V, Molinari R, de Cindio B (1988) An exergetic analysis of tomato juice concentration by membrane processes. In: Bruin S (ed) *Preconcentration and drying of food materials*. Elsevier, Amsterdam, pp 103–114
- Etienne JC, Buyle R (1984) Electromechanical engineering aspects of irradiator design. *J Food Eng* 3(4):265–284
- Grandison AS, Glover FA (1994) Membrane processes of milk. In: Robinson RK (ed) *Modern dairy technology*, vol 1. Chapman and Hall, London
- Grandison AS, Lewis MJ (1996) *Separation processes in the food and biotechnology Industries*. Technomic, Lancaster
- Hansen PA (2000) Regulatory issues concerned with approval of new packaging for irradiation. Paper presented at the 2000 IFT annual meeting, Dallas, TX, June, paper no. 6-7
- Hartel RW (1992) Evaporation and freeze concentration. In: Heldman DR, Lund DB (eds) *Handbook of food engineering*. Marcel Dekker, New York, pp 341–392
- Hendrickx M (1999) Recent developments in high-pressure processing. Paper presented at the 1999 IFT annual meeting, Chicago, IL, paper no. 30-3
- Huige NJJ (1972) Nucleation and growth of ice crystals from water and sugar solutions in continuous stirred tank crystallizers. Ph.D. Dissertation, Technical University of Eindhoven
- IAEA (1973) *Food irradiation proceedings of a symposium*. International Atomic Energy Agency, Wien
- Johnston KP, Penninger JM (eds) (1989) *Supercritical fluid science and technology*. American Chemical Society (ACS) symposium series, no. 406
- Josephson ES, Peterson MS (1982) *Preservation of foods by ionizing radiation*. CRC, Boca Raton
- Karel M (1975) Radiation preservation of foods. In: Fennema OR (ed) *Principles of food science*. Marcel Dekker, New York
- Karlsson HOE, Tragardh G (1994) Aroma compound recovery with pervaporation—the effect of high ethanol concentrations. *J Membr Sci* 91:189–198
- Kincal D (2000) Preservation and enhancement of the juice cloud with a continuous high-pressure carbon dioxide system. Paper presented at the 2000 IFT annual meeting, Dallas, TX, June, paper no. 39F-1
- King JW, List GR (eds) (1996) *Supercritical fluid technology in oil and lipid chemistry*. American Oil Chemists Society (AOCS) Press, Champaign
- Knorr D (1997) Engineering aspects of novel non-thermal food processes. In: Jowitt R (ed) *Engineering & food at ICEF 7, part 1*. Sheffield Academic Press, Sheffield, pp AA25–AA30
- Kuprianoff J, Lang K (1960) *Strahlenkonservierung und Kontamination von Lebensmitteln*. Steinkopf Verlag, Darmstadt
- Loaharanu P (1992) Status of irradiation worldwide. Joint FAO/IAEA Division of Nuclear Techniques in Food and Agriculture, International Atomic Energy Agency (IAEA), Wien

- Matsuura T, Sourirajan S (1992) Physicochemical and engineering properties of food in membrane separation processes. In: Rao MA, Rizvi SSH (eds) *Engineering properties of foods*, 2nd edn. Marcel Dekker, New York, pp 311–388
- McHugh M, Krukonis V (1994) *Supercritical fluid extraction. Principles and practice*, 2nd edn. Butterworths, London
- McLellan MR (1993) An overview of juice filtration technology. In: Downing DL (ed) *Juice technology workshop, Special report 67*. Cornell University, Geneva, pp 23–28
- McLellan MR, Padilla-Zakour O (1992) A study of ceramic membrane filtration for apple juice processing. In: Downing DL (ed) *Processed apple products workshop, Special report 65*. Cornell University, Geneva, pp 9–12
- Mermelstein NH (1999) High-pressure pasteurization of juice. *Food Technol* 53(4):86–90
- Mermelstein NH (2000) New e-beam research facility exemplifies the value of pilot plants. *Food Technol* 54(10):96–98
- Meyer RS, Cooper KC, Knorr D, Lelieveld HLM (2000) High pressure sterilization of foods. *Food Technol* 54(11):67–72
- Moresi M (1988) Apple juice concentration by reverse osmosis and falling-film evaporation. In: Bruin S (ed) *Preconcentration and drying of food materials*. Elsevier, Amsterdam, pp 61–76
- Moy G (1992) Foodborne disease and the role of food irradiation. In: CEC/ICGFI seminar on public information on food irradiation for Europe, Marseilles, France, September
- Mullin J (1993) *Crystallization*, 3rd edn. Butterworths, London
- Nishimura M, Koyama M (1992) Reverse osmosis. In: Usada Y, Nakagawa T (eds) *Membrane science and technology*. Marcel Dekker, New York
- Palou E, Lopez-Malo A, Barbosa-Canovas GV, Welti-Chanes J (2000) High hydrostatic pressure and minimal processing. In: Alzamora SM, Tapia MS, Lopez-Malo A (eds) *Minimally processed fruits and vegetables*. Aspen, Gaithersburg, pp 205–222
- Perry RH, Green D (1997) *Chemical engineers' handbook*, 7th edn. McGraw-Hill, New York
- Prausnitz JM, Lichtenthaler RN, Azevedo EG (1986) *Molecular thermodynamics of fluid phase equilibria*, 2nd edn. Prentice-Hall, Englewood Cliffs
- Randhava R, Calderone S (1985) Hazard analysis of supercritical extraction. *Chem Eng Prog* 81(6):59–62
- Reid RC, Prausnitz JM, Poling BC (1987) *The properties of gases and liquids*, 4th edn. McGraw-Hill, New York
- Saravacos GD, Maroulis ZB (2001) *Transport properties of foods*. Marcel Dekker, New York
- Satin M (1996) *Food irradiation. A guidebook*, 2nd edn. Technomic, Basel
- Swientek RJ (1987a) Metallic membrane filtration. *Food Process* 48(1):74–75
- Swientek RI (1987b) Supercritical fluid extraction separates components in foods. *Food Process* 48(7):32–36
- Swientek RJ (1987c) Transportable irradiator allows field testing. *Food Process* 48(4):160–161
- Swinkels WJ (1988) Freeze concentration: advances and economics. Paper presented at the American Institute of Chemical Engineers National Meeting, Denver
- Thijssen HAC (1974) Freeze concentration. In: Spicer A (ed) *Advances in preconcentration and dehydration of foods*. Applied Science, London
- Van der Malen BGM, van Pelt WHJM (1983) Multistage freeze concentration economics and potential. In: Cantarelli C, Peri C (eds) *Progress in food engineering*. Foster-Verlag, Künsnacht
- Van Pelt WHJM, Jansen HA (1988) Freeze concentration economics and applications. In: Bruin S (ed) *Preconcentration and drying of food materials*. Elsevier, Amsterdam, pp 77–86
- Voros NG, Fountoukides E, Magoulas KG, Maroulis ZB, Papadimitriou J (1999) A combined UF/RO wastewater treatment system: design, operation and economic assessment. *Int Desalination Water Reuse Q* 9(3):26–31
- Weber WF, Bowman W (1986) Membranes replacing other separation technologies. *Chem Eng Prog* 82(11):23–28
- WHO (1988) *Food irradiation. A technique for preserving and improving the safety of food*. WHO and FAO, Geneva
- Wynn N (2001) Pervaporation comes of age. *Chem Eng Prog* 97(10):66–72

# Chapter 13

## Food Packaging Equipment

### 13.1 Introduction

#### 13.1.1 General Aspects

Packaging of food consists of the operations shown in Fig. 13.1. These operations may be distinguished in package preparing operations, product preparing for filling operations, filling in packages, closing (sealing), control of filled packages, and preparation for storage and shipment. The equipment used in feeding the food into the filling unit depends on the nature and properties of the food. For liquids, pumps or gravity is used. For granulates or small pieces, transfer can be done pneumatically, by special pumps, gravity, or belts. Larger pieces are transferred to the packaging line by conveyors or trucks. Before being packaged, the product is stored shortly in feeding tanks or other containers. Depending on the filling technique, the tank may be open or closed. The product in closed tanks may be under pressure or in vacuum. When using trucks or conveyors, mounted on the ceiling, the short storage may be in intermediate bulk containers (Chap. 3), replacing the fixed short storage equipment. In all cases, the main aim of short storage is to have a product of constant properties. Therefore, if, e.g., a liquid food consists of mixed components, it is continuously agitated to secure homogeneity in consistency and temperature.

The packages are either ready to fill or partially ready to fill, or they are constructed in the food processing plant shortly before filling. Typical ready-to-fill packages are glass and metallic containers, woven textile package (e.g., jute bags), and some plastic containers. Packages, partially ready to fill, are mainly cartons, cardboard, and some special kinds of material such as “sleeve” packages, e.g., nets used for fruits and vegetables or sausages (“salami skin”). This type of packages is formed shortly before filling (e.g., laminated cartons used in packaging of frozen fish fillets or in aseptic packaging of liquids). Packages constructed before filling include the blown-mold, the thermoformed, and the tube-formed packages. The packages that come directly into contact with food are usually sterilized before

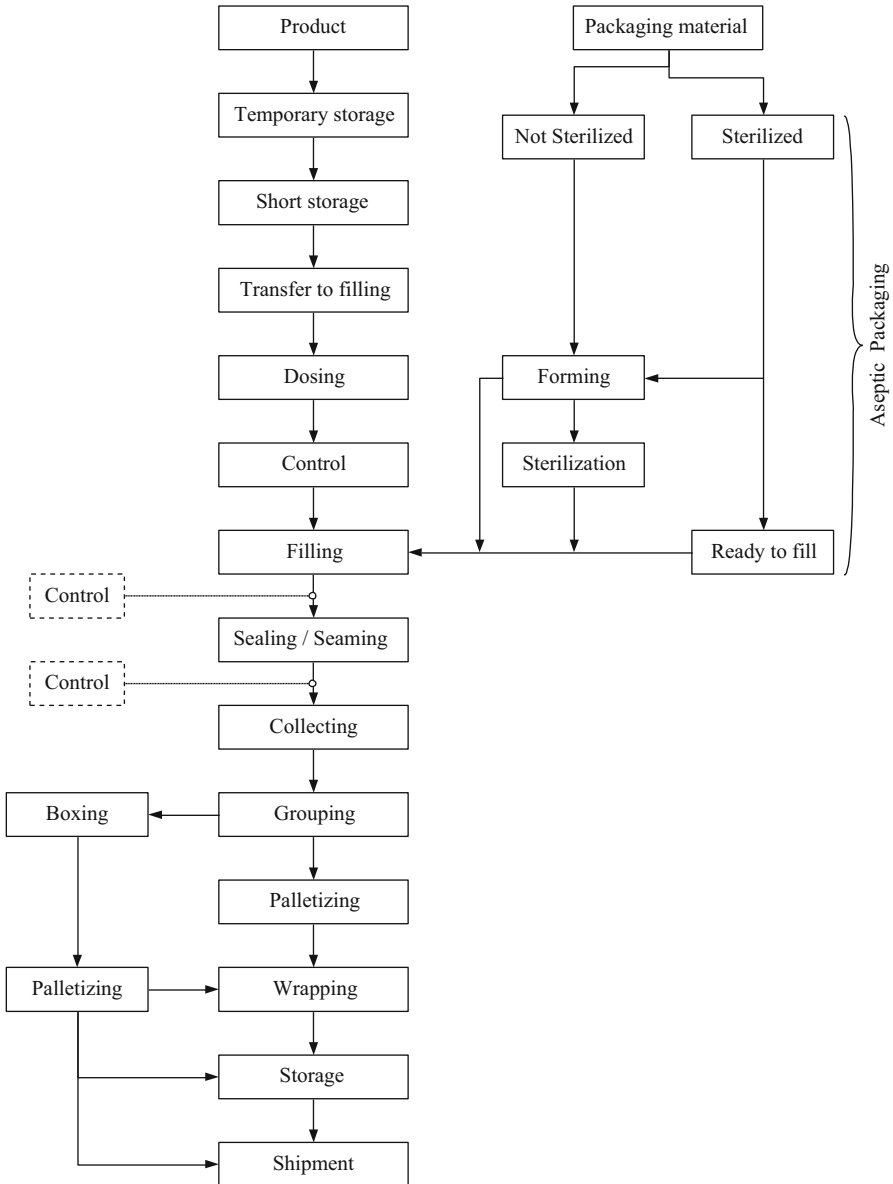


Fig. 13.1 Food packaging processes

filling. The method of sterilization depends on the packaging material, the product, and the way a container is constructed. The laminated cartons and the plastic films are usually sterilized chemically (e.g., hydrogen peroxide), while the glass and metallic containers are sterilized by hot air or steam.

“Filling” consists of transferring the product from the short storage to the dosing device and then to the filler and the placement and preparation of the package to receive the product (e.g., air evacuation of the container). Filling can be done under atmospheric conditions, in vacuum, in modified atmosphere, or aseptically. Filling is followed by closing of the containers. The plastic bags are heat-sealed or closed mechanically by clips. Cartons are heat-sealed or glued. Cardboard boxes are closed by adhesive plastic or paper tapes. Bags are stitched or closed by clips. Metal cans and bottles or jars are closed mechanically. The metal cans are seamed and the jars and bottles are closed by using several types of caps, e.g., caps that are not deformed during closing (screw and twist caps) and caps that are deformed (crimped aluminum and crown caps) (Robichon and Savina 1996). The cartons are either sealed by glue or they are closed mechanically (e.g., interconnection/locking, clips).

The filled and sealed packages are grouped and put on trays, in cardboard boxes, or directly on pallets. The grouped packages may be further wrapped by plastic film or kraft paper. In some cases, the packs are tightened together by tape or wire.

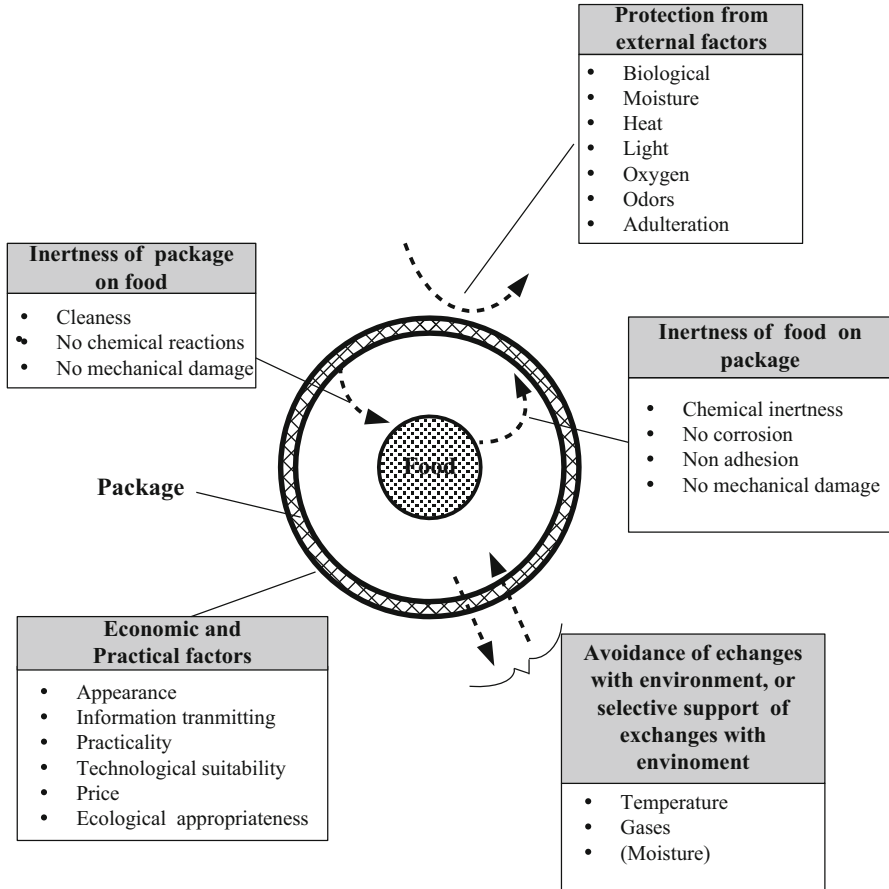
In packaging, the equipment can operate alone or as a monoblock, in which more than one operation take place, e.g., filling and sealing. In larger equipment, forming, filling, and sealing are partial operations in the same machine. Equipment standing alone is more flexible, but its capacity is not as high as that of the monoblock. Therefore, it is mainly used in smaller manufacturing units, in which a larger variety of products is often produced. However, this type of packaging line requires more space (Rice 1997). Monoblock equipment is used in vacuum, modified atmosphere, and aseptic packaging, since in these operations sealing must be done immediately after filling.

Packaging and packaging materials are discussed in the following books, among others: Robertson (1993), Luciano (1995), Brody and Morsh (1997), Soroka (1998), and Hanlon et al. (1999).

In addition to the general characteristics of the packaging machines and packaging material, in most cases of food packaging, the specific product characteristics are also very important, and packaging equipment requires special design to meet the specific product needs. Two examples of product categories, for which a significant number of special packaging equipment have been developed, are the confectionary packaging equipment (Hooper 1998) and the beverages (Giles 2000).

### ***13.1.2 Packaging Characteristics***

Even the best processing method is practically useless, if the right package or equipment is not available. The aseptic process, e.g., was familiar several years ago, but the widespread application of the method was achieved by the introduction of the aseptic form–fill–seal (FFS) packaging system. The same holds also for several products packed in modified atmosphere or for gas-containing foods and for the sterilization of food in plastic pouches.



**Fig. 13.2** Factors influencing the choice of food packages

The main objectives of food packaging are to meet the technical, safety, technological, economical, and ecological requirements. Figure 13.2 indicates the factors that must be taken into account when choosing food packages.

### 13.1.2.1 Technical Considerations

Food packaging must include the following considerations: (1) protection of the food from mechanical stress, (2) creation of conditions that protect the food from the physical environment, and (3) protection of food and the packaging material from chemical reactions.

Most foods are delicate products and, therefore, they need protection against stress conditions, which can occur during transportation (dynamic stress) or during storage (static stress). Furthermore, the packaging material must be strong enough



to withstand mechanical stress due to processing methods (e.g., pressure differences during the sterilization process in an autoclave or in seaming of cans). Factors influencing the firmness of packages include the main material used (glass, metal, etc.), the quality of the material, the weight/quantity of the material (e.g., the thickness of plastic film), the design of the packaging material (e.g., laminated plastic film, corrugated kraft paper, etc.), and the design/construction of the package (e.g., the wall thickness of cans was reduced from 0.3 to 0.1 mm, after the introduction of the drawn iron process) (Robertson 1993).

The environmental conditions, such as temperature, humidity, light, oxygen, odors, and insects, influence strongly the food. In many cases, these factors are harmful or reduce the value of foods. High temperature is usually not desired during storage; it accelerates chemical and biological reactions, resulting in the faster degradation or spoilage of food. Humidity is often desired, if the proper low temperature is also applied, but there are products, such as the dried foods, which must be stored at low air humidity. Oxygen and light have negative effects on oils and fats and on some vitamins. They can also induce undesired chemical reactions. Odors influence the organoleptic properties of food, and insects, besides damaging the food, can be also a source of microbiological contamination.

The package must not be affected chemically by the food nor the food by the package. The composition of food (e.g., fat content) and several methods of food preservation (e.g., acidification, salting, heating) may cause problems to several metallic and plastic containers. Therefore, metal containers, e.g., must be provided with the proper varnish (enamel), and plastic packages must not be used, if they contain harmful plasticizers.

### 13.1.2.2 Safety Considerations

Food packaging must consider the following safety aspects: (1) protection of fresh products from deterioration, (2) protection of fresh and processed products from contamination, and (3) protection of food products from adulteration.

As a general rule, the food must be safe, meaning that fresh or preserved/processed food must be completely harmless to the consumer. Properly packaged fresh and preserved foods must be protected from quick degradation or contamination, e.g., due to dirt or environmental pollution. In most cases, packaging helps food to maintain its initial condition during storage, as far as possible. A special case is aseptic packaging, in which pasteurized or sterilized food retains the initial safety condition, due to proper packaging. Packaging guarantees also no adulteration after processing of food.

### 13.1.2.3 Technological Considerations

Technological considerations of food packaging include the following: (1) feasibility of the processes, (2) improving the quality of food, and (3) compatibility of packaging with existing processing equipment.

Several preservation methods (e.g., sterilization in cans) can be applied only if the food is packaged. Packaging is furthermore especially important, when it is part of a certain food preparation, as, e.g., in the case of tea bag and sausages. However, there are cases that packaging restricts the application of food processing methods. The aluminum, e.g., or other metallic packages are not suitable for microwave processing. Therefore, the thermal, mechanical, and other physical properties of food are very important in choosing the right package, in relation to the processing method applied.

Packaging may also contribute to the preservation or to the improvement of food. Several foods, such as various wines and cheeses, ripen better under controlled conditions provided by packages. Packaging can be also essential in protecting food from losing water (weight) and aroma substances. Packaging is also important in facilitating processes, such as the dosing, standardization, and control of food, and it enables the transportation, handling, and, in many cases, the storage of food products.

#### **13.1.2.4 Economic Considerations**

The following economic considerations are important in food packaging: (1) cost of packages, (2) attractiveness, (3) transmission of information, and (4) marketing.

Most foods are not luxury products and cannot afford the cost of very expensive packages. Therefore, one of the main criteria in choosing the right package is its price. The role of packaging is very important also in trade. Attractive packaging supports the sales and is one of the best advertisers of its contents. Attractive packaging, along with technical and technological characteristics of packages, facilitating food consumption, such as easy-to-open containers, one-way packages, packages combining several items (e.g., in ready meals), etc., is a factor contributing very much to the promotion of the food. Packaging is also very important in transmitting messages to the consumers. These can be, e.g., nutritional or technical messages; they can refer to the preparation or safeness of food, or they can be simply advertisement. The package can also facilitate marketing by giving information about the cost of food and the date and place it has been manufactured, as well as mentioning any guarantees given by the manufacturer.

#### **13.1.2.5 Ecological Considerations**

Ecological considerations of food packaging include recycling and disintegrations of packages.

Since consumers become more and more aware about environmental priorities, the packaging material must be either recyclable or it should be disintegrated. New methods in packaging technology extend the use of more ecological materials, such as paper and glass. In the case of glass, e.g., the increase of the container strength

and the weight reduction improved their economic efficiency and competitiveness over other materials. When reused, glass bottles can be normally refilled up to 10–15 times.

### ***13.1.3 Packages and Packaging Materials***

The main packaging materials used for food are metal (tinplate, aluminum), glass, paper and its products, and plastics. In addition to the pure packaging materials, combined packaging materials, such as film laminates, plastic-coated glass, or metal, are used.

For more than 200 years, metal cans remain in the market. Their main advantage is their good retort ability and ability to protect their content in long-lasting periods, including strength. Developments such as the two-piece containers and the easy-to-open cans (peelable can lid) gave an upturn (boost) to the sales of cans. The two-piece metal containers dominate in the market of the smaller cans and about 70 % of small cans (mainly due to canned drinks) are foreseen with easy-to-open lids.

However, in the last years, permanent attempts take place, for developing retortable packages from other nonmetal materials. This effort is especially intensive in the sector of plastic containers. The development of retortable plastic materials and the consumers' preference to less long-life foods in connection to increased choice diversity and convenience boost the development of new products that favor the nonmetal containers. This consumption trend is also supported by developments in trade and logistics. The small flat plastic or even paper combined packages (boxes, trays, tubes) are easier placed in shelves of retail shops. They can be also used in packaging of frozen foods. The contribution of basic and technology research in this field is essential. Recently, even retortable carton packages and the incorporation of *nanomaterials* in packaging media have been developed and will probably open new fields. A recent example is the nanoclays that can improve the barrier properties of plastic films and other materials, making them less gas permeable and more antagonistic to metal containers also in this sector. Other nanomaterials incorporated in, e.g., plastic packages can be used as indicators of the freshness of products, as their color changes according to the storage conditions.

#### **13.1.3.1 Metal**

Metal is used to fabricate cans, tubes, aerosol containers, and larger containers, such as barrels and drums. It is also used in the fabrication of thin aluminum sheets, trays, and bottle and jar caps. For containers, the most frequently used form by far is the cylindrical. The metal cans are the most common type of metal container. There are two main types of metal can, the tinplate and the aluminum cans. Both are used in a very wide range of foods. The aluminum and the smaller tinplate containers are

made of two pieces, while the larger tinplate and a part of the smaller cans are made of three pieces. Tinplate cans are made of 0.15–0.50-mm low-carbon mild steel that is coated 0.4 and 2.5  $\mu\text{m}$  on the two sides. Thinner cans are constructed by the drawn and ironed method and the use of corrugated tinplate. The containers are enameled (4–12  $\mu\text{m}$ ), to avoid or reduce the interaction between food and the metal container. There are several types of internal enamel used, e.g., phenolic, epoxy phenolic, acrylic, oleoresinous, and vinyl. Most containers are enameled before being constructed, but if the tinplate is stressed significantly during the construction of the container, as in the case of the drawn and ironed can, the container is enameled after its construction (Robertson 1993; Schormueller 1966). In the construction of aluminum containers for food, the metal used must be at least 99.5 % pure. They do not need to be enameled externally, since they are corrosion resistant, due to the aluminum oxides covering the surface of the containers. Nevertheless, they are coated internally, in the absence of the protective oxide layer, when there is no oxygen (Schormueller 1966). The aluminum cans are lighter, but they require 35 % more material for achieving the same strength with the tinplate cans (Joslyn and Heid 1963).

The tubes are used in packaging, e.g., mayonnaise, mustard, and ketchup. They have the advantage of easy handling and preventing food from oxidation. In the food sector, the aerosol containers are used, e.g., for packaging of cream, mayonnaise, and syrups for ice cream. There are two main types, the type in which the propellant gas contacts directly the food and the type in which the food is in a flexible bag. The material of the container is usually tinplate, and the gas propellant is nitrous oxide, carbon dioxide, or nitrogen (Franz and Fuhrmann 1968; Robertson 1993).

Larger containers are used for packaging of liquids and products like fruit pulps. They are also used as protection of other packages, such as the aseptically filled bags. The thin aluminum films are used as gas barrier in laminated films and in packaging of products like chocolate. They are usually 0.005–0.200 mm thick. However, aluminum films, to be effective gas barriers, must be more than 0.015 mm thick, as at this thickness, the aluminum film does not have pores.

The aluminum food trays are made by compressing 0.02–0.25-mm-thick aluminum sheets into molds (Reichardt 1963). Usually, they are not coated. They are used in baking and in packaging of ready meals and frozen food. The metal caps for bottles are made of aluminum, while the larger lids are made of steel. In all cases, the caps and the lids are coated, or they have cork- or rubber-like additions. The twist caps are made of aluminum.

### 13.1.3.2 Glass

Glass is a very good material for food packaging, as it does not influence the food, it is not corroded, it can be sterilized, it is gas and moisture tight, it is transparent, and it can be cleaned up relatively easily. The disadvantages of glass are its brittleness, its weight, and its disability to withstand sharp temperature changes. Further weak

points of glass containers are their reduced construction accuracy and their closure. The bottles are manufactured by the double-blow method and the wide-mouth jars by the press-blow method (Jasrzebski 1959). In both cases, the dimensions and the homogeneity of the glass package cannot be so accurate as the metal containers. The reduced dimensional accuracy of glass bottles, e.g., can cause problems when using high-speed bottling equipment. Furthermore, the inhomogeneity of the wall thickness increases the breaking possibility of the glass containers. The abrupt change of temperature must not exceed 40 °C.

With respect to the closure, leakage is possible, if it is not properly constructed, because it is made of other materials (e.g., metal). However, in the last years, the closures have been improved significantly. Besides, the still popular crown cap has proved to be a good airtight closure of bottles over many decades. Cork is still used in closing bottles of wine. In addition, aluminum twist caps are used, especially in connection with the one-way closures and other hermetic closures. The caps and lids consist of an inside metallic coated shell (steel or aluminum) and an impermeable sealing material, which may be natural or synthetic rubber, polyvinyl chloride material, or other appropriate plastic (Downing 1996). There is a quite wide variety of closing systems, which are usually patented. Capping can be achieved, e.g., by screw-on, crimp-on, roll-on, and push-on closing equipment.

The external coating of glass containers with 0.2 % polyurethane-based plastic film and better design has increased the strength against impact forces by 50 % and reduced the weight of bottles by 40 %. It reduced also the attrition between bottles during conveying in the filling station.

### 13.1.3.3 Paper, Carton, and Cardboard

Paper is very widely used in food packaging, to wrap products and to create bags, cartons, cardboard, and their products, because of its relatively low price, the possibility to be used in combination with other materials (e.g., in laminates), its low weight, the diversification in many quality categories, the almost neutral behavior against food, and it being environmentally friendly. The disadvantages of paper are its low strength against mechanical stress, the low moisture resistance, the inability to be sealed, and that it is attacked by insects and microorganisms. According to the treatment of the pulp, used in paper manufacturing, there are two main paper categories used for packaging, the fine sulfite paper and the coarse sulfate paper. The packaging paper may be further subdivided into: kraft and vegetable parchment paper, bleached paper, greaseproof paper, glassine paper, and tissue paper. Kraft and parchment paper belong to the sulfate paper category. The sulfite category, besides sulfite paper, includes the greaseproof, the glassine, and the tissue paper (Fellows 1990). All these types of paper are produced in several varieties.

In relation to packaging, the sulfite paper is used for small bags and pouches, for foil laminating and for making waxed papers. The kraft paper is used in wrapping and in the manufacturing of multi-ply papers, corrugated board, cardboard, and

their products (bags, sacks, boxes, etc.). Kraft paper is a strong heavy duty paper, weighing 70–300 g/m<sup>2</sup>. It can be water repellent and, with the exception of fresh fruits and vegetables and dry products (e.g., sugar, cereals), it is mostly used in wrapping as a secondary protective packaging of food. The vegetable parchment paper has a greater wet and oil strength than kraft paper. It weighs 12–75 g/m<sup>2</sup> and it has almost the tensile strength of the kraft paper. The sulfite paper weighs 35–300 g/m<sup>2</sup> and it is used for grocery bags and labels, since it gives very good printing results. The greaseproof paper, weighing 40–150 g/m<sup>2</sup>, is used in packing baked and fatty products. It is fat resistant, but it loses this property if it is wetted. The surface of the glassine paper is smooth; it is fat resistant and about half as heavy and strong as the kraft paper. The tissue paper is light (20–50 g/m<sup>2</sup>); its strength is low and it is used in wrapping fruits for protecting them from dust and dirt (Robertson 1993; Fellows 1990). Papers can also be waxed, if water resistance and sealability are required. Waxed papers are used in bread wrapping and for inner lining of cereal cartons. However, since wax sealing is not so strong and wax also tends to crack when the paper temperature is low, wax coating is often replaced by plastic coating. This is, e.g., the case in cartons that are used for frozen food.

In manufacturing paper bags, paperboard consisting of 3–6 plies of kraft paper weighing 65–114 g/m<sup>2</sup> each is used, which is strong against tension stress. In manufacturing cartons for food, a white board, made of bleached chemical pulp, which weighs at least 250 g/m<sup>2</sup>, is used. Generally, the board is stiff and it creases without cracking. Cardboard is thicker and heavier than paperboard, and it consists of 2–5 plies of kraft paper; it is about 1.00–3.00 mm thick, weighing about 560–1800 g/m<sup>2</sup> (Robertson 1993). There are two main forms of cardboard, the solid and the corrugated. The solid cardboard is used in creating paper drums and boxes. The corrugated cardboard is used for wrapping and for making boxes. The board is coated with polyethylene or polyvinyl chloride, for achieving sealability. A simple corrugated board is a fluted kraft paper, which is used as a cushion against impact stresses. Nevertheless, the corrugated cardboard that is used for boxes is a multi-ply material, consisting of a combination of plain and corrugated kraft paper. The plain kraft paper usually weighs 205 g/m<sup>2</sup> and the corrugated 127 g/m<sup>2</sup> (Robertson 1993). The height and the number of flutes of the corrugated configuration determine the type of the cardboard (Table 13.1). If the height of the flutes is small and the number of flutes per meter is large, then the corrugated cardboard gives rigidity to the package. If the height of flutes is large and the number of flutes per meter is small, the packaging material is suitable for protecting the packed product against impact forces. For heavier materials, more layers of corrugated and plain paper are used. In these combinations, the configuration of plain to corrugated paper is constant, or it may vary. In the case that the configuration does not remain constant, three different types of corrugated–plain combinations may form together the whole packaging material. Carton may be now also used for retortable aseptically filled containers.

**Table 13.1** Typical cardboard dimensions

Category	Kind of corrugation	Thickness or flute height of corrugated cardboard (mm)	Corrugations or flutes per m
Type A	Large corrugation	>4.5	110–116
Type B	Small corrugation	2.0–3.5	152–159
Type C	Medium corrugation	3.5–4.5	123–137
Type E	Microcorrugation	<2.0	294–313

Data from Souverain (1996) and Robertson (1993)

### 13.1.3.4 Plastics

Plastic materials are widely used in food packaging. Their applications cover different types of packages. They are used in bags, pouches, and containers, for wrapping, and as components of compound and laminated packaging media. Some reasons of the rapid expansion of plastics use in packaging are their relatively low price, their easy processing, the possibility to modify their properties, the good relation of weight to firmness, the possibility of thermal sealing, and the possibility to use them in combination with other packaging materials. Disadvantages of the plastics are their low resistance to high temperatures, restrictions in using for food due to substances added for enhancing their physical properties, and environmental pollution-related problems. Plastics can be classified according to their texture into flexible (e.g., film) and rigid (e.g., plastics used for containers). Another possibility is to classify them on the basis of the raw material used. In this case, they are distinguished into natural (e.g., rubber), and synthetic plastics (produced mainly by polymerization, concentration, and addition of chemical compounds of smaller molecular weight) (Reichardt 1963). The plastic properties can be influenced in many ways, such as change of the molecular size, the method of preparation, the addition of substances, and radiation.

Plastics can be used as they are or in a modification, but very often they are used in combination with other plastics or other materials, for enhancing their properties or for giving them new properties. The laminated plastics that are produced by co-extrusion are especially important. The plastics that are most common in food packaging are polyethylene (PE), polyvinylidene chloride (PVdC), polypropylene (PP), polyesters (PET), cellulose, and rubber hydrochloride (Miltz 1992; Hernandez 1997).

Polyethylene (PE) is one of the most common plastics. There are two basic forms, the high density (HDPE) and the low density (LDPE). Both types can be heat-sealed (sealing temperature: 121–170 °C) and are suitable for shrink wrapping. The HDPE has 95 % crystalline form and can be used up to 120 °C, while the LDPE has 60 % crystalline form and can be used in temperatures up to 90 °C. The PE is cheaper than the other plastic films and has relatively good mechanical properties. The lowest temperature at which PE can be used is –60 °C. The LDPE is the most

elastic plastic material and as strong as PVC in impact stress, but it has a low tensile strength and it is very soft. Its moisture permeability is very low, but it has a relatively high gas permeability and its resistance to oils and odors is low. The HDPE is stronger but more brittle than the LDPE. It is used also in replacing multilayer paper bags especially in cases that the product must be protected from moisture. Generally, stiffness, tensile strength, and chemical resistance of PE increase with density, but gas and vapor transmission, elongation, low-temperature impact strength, and environmental crack resistance decrease when the PE density is increased (Reichardt 1963; Schormueller 1966; Brown 1992; Robertson 1993).

PVdC has low moisture, gas, fat, and alcohol permeability. It is a little less elastic than PE and it is an odor barrier. In packaging, it is much used because of its good stress crack resistance. PVdC shrinks at relatively low temperatures, but at 150–170 °C, it shrinks about 30 %. Due to its low moisture, gas, and odor permeability, it is widely used in wrapping many foods, or as gas and moisture barrier in compound packages. Its use is extended from frozen products to fresh and dried food. PVdC is also used in vacuum packaging and in coating other materials. It is heat-sealed with other materials or with itself and withstands hot filling and retorting (e.g., retorted foil pouches, trays, and plastic tubes). Often several new types of packages require the development of new packaging equipment. This is mainly developed in the laboratories and workshops of the companies delivering the related packaging materials. However, occasionally, they are also developed in laboratories or workshops of large food processing companies, which poses the new invention. PVdC, like PE, is used as moisture barrier and in sealing packages that are made of materials that cannot be heat-sealed. However, since PE is cheaper, it is mostly preferred in cases in which gas tightness is also required (Joslyn and Heid 1963; Schormueller 1966; Robertson 1993).

Polypropylene (PP) has about the same elasticity as PVdC. Its tensile strength is four times that of PE and it is very widely used in making rigid plastic packages but also as flexible packaging material. The low-density PP is one of the few plastic materials that combines economy with the toughness that is necessary to form double seam seals (Brown 1992). Its moisture and fat permeability is low, but it is permeable to many gases and air. It is heat-sealed, and fine tapes of this material are used in making woven bags. PP is also used in making caps and closures for bottles and thin-walled pots by the blow-mold method. PE becomes brittle at temperatures near the freezing point (Joslyn and Heid 1963; Schormueller 1966; Robertson 1993).

Polyesters (PET) have significant tensile strength in a wide range of temperatures (–60 to 150 °C). They have relatively low moisture, gas, and aroma permeability and chemical resistance. They are very often used for beverage containers, except milk (Brown 1992). They are used for bags which contain frozen products and are subsequently put in boiling water. PET is used for creating bottles by the blow-mold method and as external film in laminates with PE (Schormueller 1966; Dominghaus 1969; Robertson 1993).



Polyamide (PA) is a strong material and its tensile strength is three times that of PE and 1/3 that of PET, and it is ten times harder than PE. The PA, which is also known as “nylon,” has a low water permeability (40 times less than PET) and a low gas permeability (comparable to that of PET). It can be used at temperatures between  $-40\text{ }^{\circ}\text{C}$  and above  $100\text{ }^{\circ}\text{C}$  (the melting point of nylon-6 is  $215\text{ }^{\circ}\text{C}$ ). Therefore, it is used for boil-in bags or in cases in which the packed products will be thermally processed. They can be sealed by the high-frequency or the flash heat method (Reichardt 1963; Dominghaus 1969; Nehring and Krause 1969; Robertson 1993).

*Polytetrafluorethylene* (PTFE), known also as Teflon, is very heat resistant, has very low coefficient of friction, has nonadhesive properties, and is chemically inert. It can be used at temperatures up to  $230\text{ }^{\circ}\text{C}$ . However, since it is expensive, it is used only in connection with thermal-resistant coatings of containers that are reused and in cases when stickiness must be avoided. A common use in packaging technology is the PTFE coating of the heat sealing elements (Werner 1955; Robertson 1993).

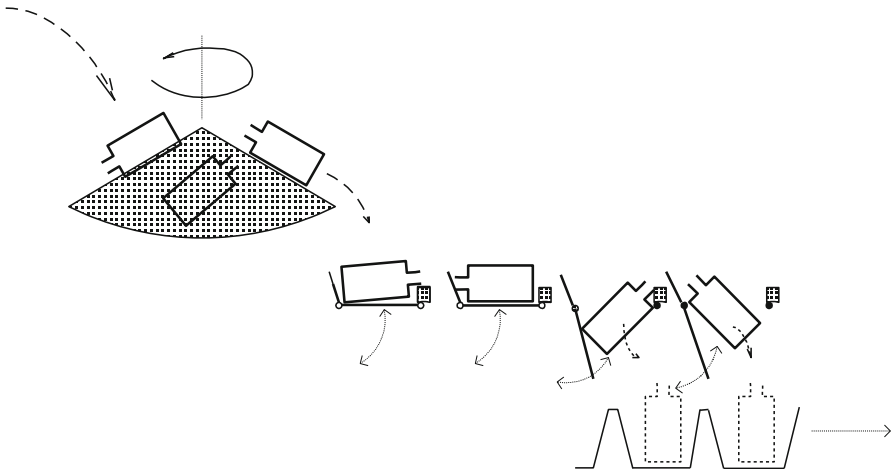
Rubber hydrochloride has the tensile strength of PVC, the elasticity of PVdC, and almost the same shrink property. It can be used up to  $90\text{ }^{\circ}\text{C}$ , but it becomes brittle at low temperatures (Reichardt 1963; Schormueller 1966).

Two types of cellulose are used in packaging, cellulose acetate (CA) and regenerated cellulose (RC). The tensile strength of both types is three times that of PE and the hardness of CA is half of that of PA. The water permeability of both types is very high. However, cellulose, since it is cheap, environmentally friendly, very transparent, resistant to oil if not wetted, and can be used at temperatures between  $-50$  and  $100\text{ }^{\circ}\text{C}$ , is often used in packaging food. The RC is used in packaging of dry and other non-moist materials. With lacquers making it waterproof or in connection with PE, it is also used in wrapping moist food. The CA is mainly used to protect fruits from dust and in “transparent windows” of carton packages (Jasrzebski 1959; Joslyn and Heid 1963; Schormueller 1966).

## 13.2 Preparation of Food Containers

### 13.2.1 *Unscrambling*

Ready-to-fill packages (bottles, jars, cans) usually come to the filling line from the container manufacturing plants, packed on pallets. They are subsequently arranged in the packaging line (e.g., a belt conveyor) orderly, e.g., by special de-palletizers. However, there are cases that the containers are disordered. This happens, e.g., when plastic bottles are emptied in hoppers for automatic feeding. In this case, the bottles are set in order by an unscrambler, aided by compressed air. There are several types of such units.



**Fig. 13.3** Unscrambling bottles

In all cases, the containers are recirculated, until they come to the right position. Damaged bottles are automatically removed. In some systems, parallel belt elevators run in vertical funnels, taking the bottles from a hopper upward. On the upper part of the funnels, only bottles having the mouth up are conveyed to filling. There is equipment with more than 20 funnels. In another system, the bottles rotate in an open inclined drum, until they come to the right position. Unscramblers are also used in feeding caps to the bottle closing machine. The capacity of plastic bottle drum-type unscrambling equipment may exceed the 20,000 bottles/h. The capacity of the funnel-type unscrambler is higher. All types of equipment can unscramble plastic bottles of different dimensions. They require about 600 L of air/h at 6 bar of pressure and the installed power is about 10 kW. In the unscrambling of caps, the capacity is higher. An inclined drum-type unscrambler may have overall dimensions of  $3.0 \times 2.0 \times 2.0$  m. The height of funnel-type unscramblers is 3.0–5.0 m. Figure 13.3 indicates basic operations of a bottle unscrambler.

### 13.2.2 Fabrication and Forming of Packages

The fabrication and forming of various kinds of food packages is described by Robertson (1993), Wilhoft (1995), Mallett (1996), Bureau and Multon (1996), and Paine (1996). In forming of containers, two main categories are distinguished, i.e., the erection of prefabricated containers (cartoning) and the film-based packages, formed shortly before filling. Often several new types of packages require also the development of new packaging equipment. This is developed in the laboratories and workshops of the companies delivering the related packaging materials, but occasionally also in installations of large food processing companies. Sometimes

the companies that pose the innovation, reverse engineering on not owning the new innovation equipment manufacturers, that are able to realize the required new packaging machinery (Butte 1989).

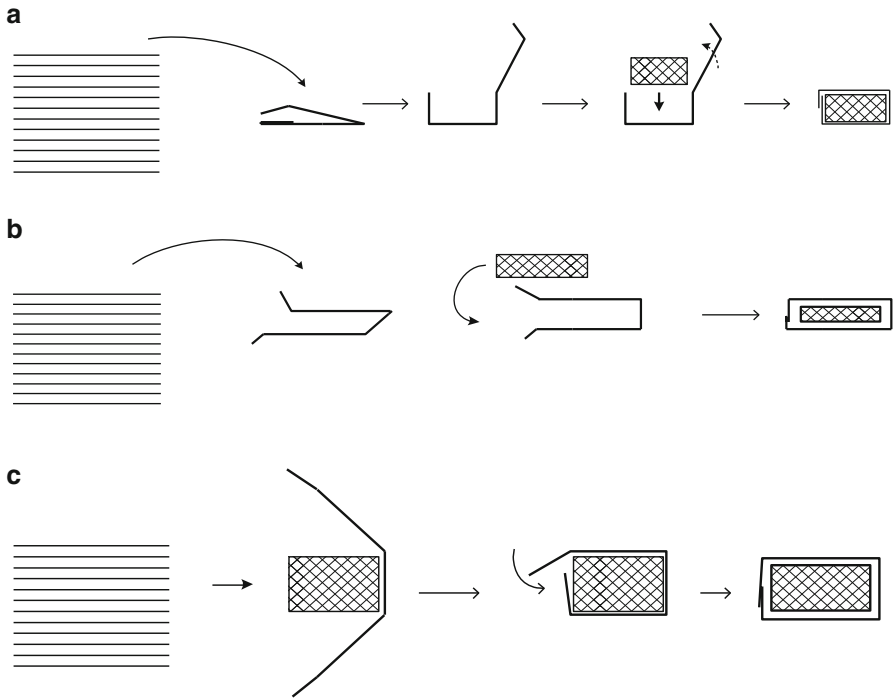
### 13.2.2.1 Metal Containers

Only very large canning companies manufacture the metal containers themselves. In most other cases, the metal containers are manufactured in special factories which deliver them to the canning factory “just in time,” or in the case of periodically operating canning factories, the containers are stored until the next processing period. If the finished products are not shipped out immediately, they are stored in the room that is emptied, as the containers are removed for filling. The basic construction of rigid containers (cans, bottles, drums, etc.) is not covered in this book. However, the construction of paper and plastic containers during the packaging operations, in the food processing plants, is discussed briefly here.

### 13.2.2.2 Cartons and Cardboard Packages

The erection of packages is mainly applied in connection to rectangular carton and cardboard containers. The cartons, which consist of laminated paperboard, 0.3–1 m thick (Paine 1996), are used in packaging of frozen and dried products. In many cases, they are also used as an additional package of paper or plastic bags. The cardboards are mainly made of corrugated kraft paper and used for packing grouped smaller containers.

The cardboard blanks, which come folded in packs, are placed in the packaging equipment magazines. Each folded cardboard blank is shaped to a box, after being picked up automatically by suckers from the magazine. A machine can have 2–4 suckers. Besides the sucker system, it is possible to use robots, which take the prefabricated packages from a separate pack or pallet and place them in interchangeable forming mold systems, in which the cardboard blanks are compressed by plungers. A machine may have more than 2 mold systems, which can be quickly replaced by others, if new sizes of packages must be formed. Packages can be top loaded (Fig. 13.4a), end loaded (Fig. 13.4b), or wrapped around the product (Fig. 13.4c) (Harrison and Croucher 1996; Behra and Guerin 1996). After erecting and filling the product, the packages are heat-sealed or sealed with adhesives (glued). In food packaging, the heat-sealed or glued cartons prevail, since they give more protection against microorganisms and adulteration than containers formed mechanically. In addition, gluing or sealing requires half as much time as mechanical locking (interconnecting) of the carton parts. However, when using glue for packages that will be filled with frozen products, the glue must be of quality suitable for low temperatures. The capacity of cartoning equipment is 1200–20,000 packages/h (Harrison and Croucher 1996). The power consumption is about 5 kW. The dimensions of a conveyor 1.5 m long, may be  $4.0 \times 1.5 \times 1.5$  m and the weight 1.0–1.5 tons.



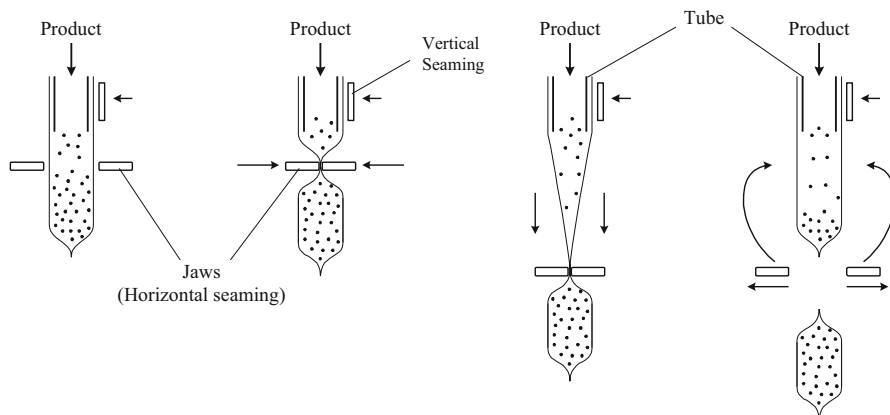
**Fig. 13.4** Methods of forming cartons. (a, b, c) Packaging stages in different types of cartons

### 13.2.2.3 Film-Based Packages

In the construction of plastic packages, distinction is made between packages created by using plastic film and packages created by extruding plastic granulates. In using films, there are three main methods: (a) the tube method, which is used in creating bags and rectangular packages, (b) the pouch method, and (c) the thermoforming method, which is mainly used in creating cups.

#### Tube Packages

The tube-type package is widely used in packaging liquid foods and in the aseptic packaging. In almost all cases, laminated material is used. The tube material depends on the product and the method of packaging. Usually, it consists of polyethylene, aluminum, paper, and other 2–3 materials. Aluminum is used for gas sealing, polyethylene in direct contact with food and for heat sealing, and paper for giving rigidity. Aluminum film thicker than 9  $\mu\text{m}$  is a perfect gas barrier (Church 1994).



**Fig. 13.5** Forming of tube packages (jaw-pull system)

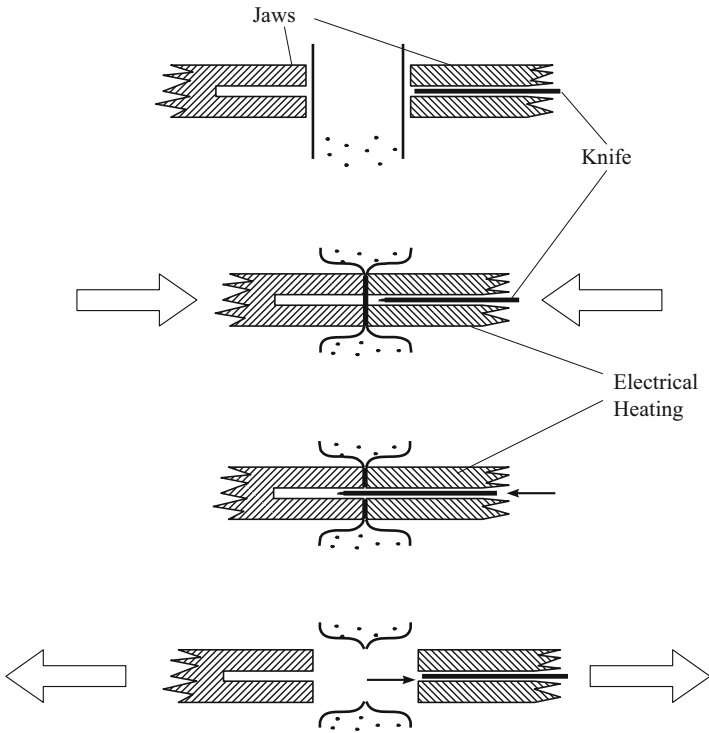
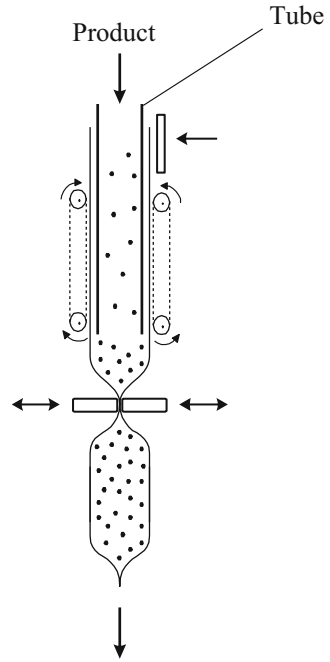
A significant part of equipment used in making tube packages is monoblock. Bags are formed by pulling the film out from a reel downstream. The film is wound around a metallic tube and both its ends are sealed vertically together, forming a plastic tube. There are two possibilities of sealing: the lap and the fin seal. The first is more stable, while in the second, the printed “messages” on the package surface look better, as the seam disturbs less. Horizontal jaws seal the plastic tube in exact distance, as it slips downstream along the metallic tube. Every second sealing, the filling of the bag follows, which is done through the metallic tube. There are two main variations in moving the plastic tube vertically. In the first variation, the film is pulled down, each time that the jaws seal the plastic tube downstream (Fig. 13.5). In the second variation, the movement of the plastic tube is done by roll belts (Fig. 13.6). In both cases, the filled and sealed bags are separated from the plastic tube by knives, incorporated in one of the two jaws (Fig. 13.7).

The tube system enables the creation of several types of packages (Fig. 13.8). It is possible, e.g., to create a rectangular package, if the lower part of the cross section of the tube is a tetrahedron (Fig. 13.8). The capacity of a tube-packaging machine depends on the type of the bag formed. For simple-form bags (Fig. 13.5), it is about 4000–6500 packages/h for packages of 200–1000 mL. For more complicated forms, such as flat-bottomed bags, the capacity is lower (about 2500 packages/h). In a variation, the tube and the pouch machine can produce two bags at the same time, doubling their capacity. The power consumption is 4–20 kW. They also need about 30 m<sup>3</sup> of compressed air/h at 6 bar of pressure. The overall dimensions, including a roll of film, are about 2.0 × 1.5 × 2.0 m and the weight of such a machine is about 1.5 ton.

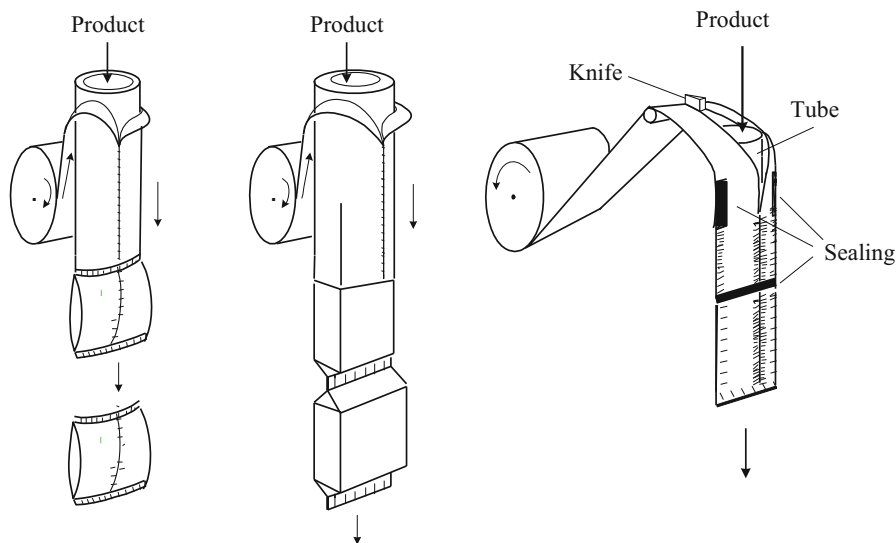
### Pouch Packages

Bags are created by the pouch method, using film that comes from two reels and seamed on four sides, at capacities up to 8000 packages/h. The pouch equipment

**Fig. 13.6** Forming of tube packages (belt-driven system)



**Fig. 13.7** Cutting of the bags from the tube bag

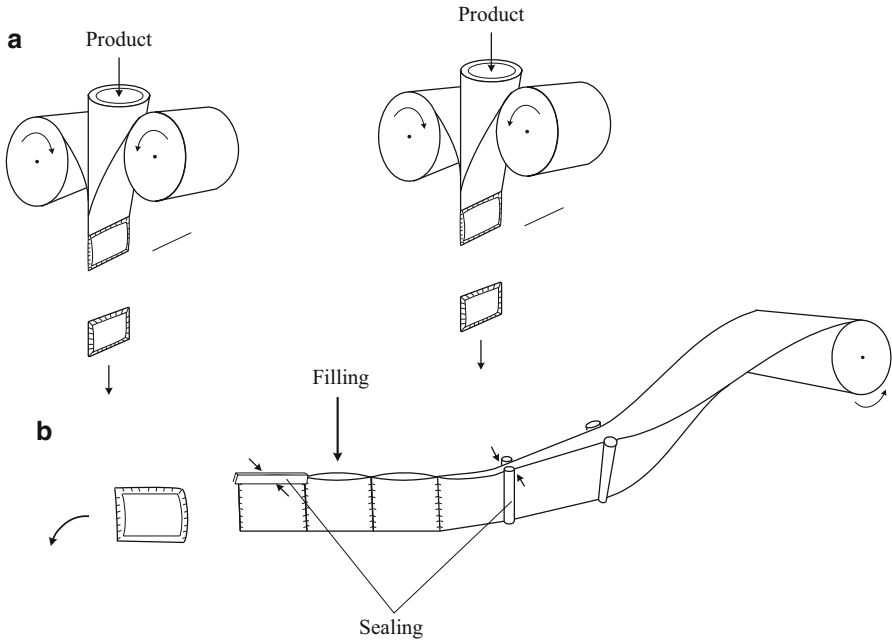


**Fig. 13.8** Tube-formed packages

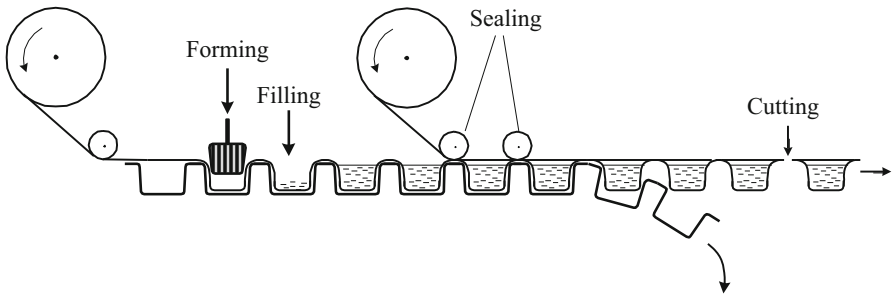
can be used for a wide range of products. Quite often, it is used for packaging powders and nuts. In the pouch method, there are two variations (Fig. 13.9). In the first variation (horizontal movement of pouches), the bags are formed by further sealing of a folded film, and the two vertical sides and the upper side of the pouch are sealed, after filling with the product (Fig. 13.9a). In the second variation (vertical movement of pouches), the pouches are created by sealing the films, rolled out of two reels (Fig. 13.9b). This system is similar to the tubular packaging system (Fig. 13.8). In both types, the films are sealed on three sides, while the fourth side is sealed after the pouch is filled with product through a tube. Both types have higher capacity than the tube equipment, but the capacity of the horizontal equipment is a little higher, e.g., 5000–12,000 packages/h (pouch size: 250–180 mL). The power requirement is 3–10 kW and the compressed air (6 bar) consumption is 8–15 m<sup>3</sup>/min. The overall dimensions of the horizontal pouch equipment, including the roll, are 7.0 × 2.5 × 3.0 m and its weight is 1.5–2.0 tons. The dimensions of the vertical variation are similar to those of the tubular equipment.

### Thermoformed Packages

Thermoformed cups or trays are used for packaging milk products such as yogurt and ice cream, juice, jam, dressings, ready meals, etc. They are formed as indicated in Fig. 13.10. Cups, e.g., are formed by pressing the laminated film that comes stretched over a mold (die) that has the shape of the package that will be created. The film comes from a roll and it can be either preheated, e.g., in an infrared



**Fig. 13.9** Forming of pouch packages Horizontal, (a), and Vertical (b), filling of pouches

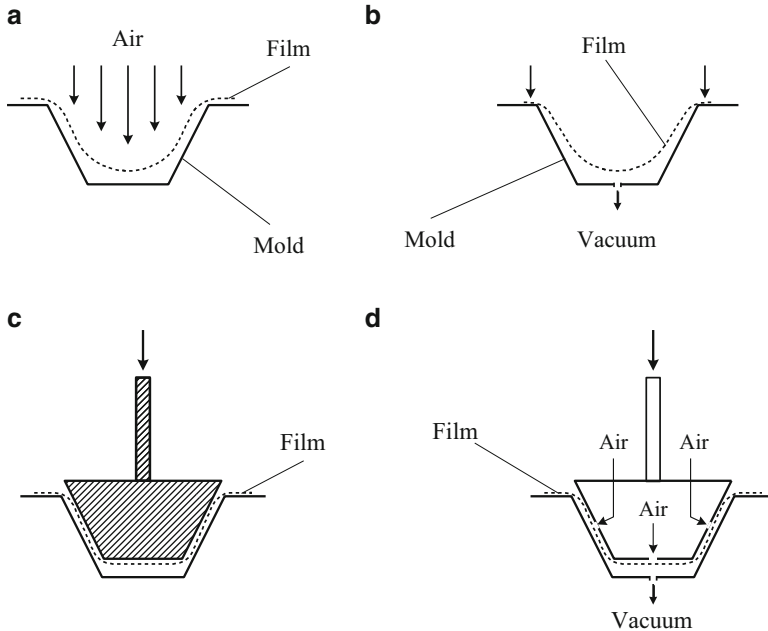


**Fig. 13.10** Thermoforming, filling, and sealing of cups

(IR) radiant panel heater (Robertson 1993), or heating takes place in the mold. The heating temperature is about 155–160 °C (Harrison and Croucher 1996).

The thermoforming is done in one of the following ways (Fig. 13.11): Air presses the preheated soft film in the mold (Fig. 13.11a). Negative pressure is applied between the mold and the heated film sheet (Fig. 13.11b). A heated plunger presses the film in the mold (Fig. 13.11c). A plunger pushes the stretched film in the mold, while pressurized air is blown on the film (Fig. 13.11d). At the same time, the air of the mold is sucked out through a hole at its bottom.



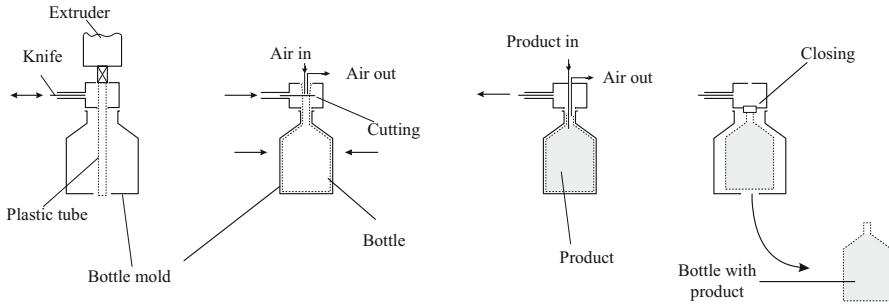


**Fig. 13.11** Thermoforming processes of cups: (a) to (d) (see text)

The space between the plunger and mold is exactly that of the wall and the bottom thickness of the cup that will be created. The air, besides forming, also cools down the formed cup. The thickness of the laminated plastic material that is to be thermoformed depends on the package that will be produced (physical properties, strength), e.g., 75–200  $\mu\text{m}$  (Robertson 1993). For most frozen food applications, e.g., Harrison and Croucher (1996) suggest the following combinations: bottom web, 125  $\mu\text{m}$  (nylon 75  $\mu\text{m}$  and polyethylene 50  $\mu\text{m}$ ), and top web, 70  $\mu\text{m}$  (nylon 20  $\mu\text{m}$  and polyethylene 50  $\mu\text{m}$ ). Nylon, or in some cases regenerated cellulose, is added for providing the necessary rigidity. The thickness of polyethylene must be at least 50  $\mu\text{m}$  for leak stability (Paine 1996). The capacity of a cup thermoforming equipment depends on the number of the parallel molds, the thermoforming method applied, and the packaging material used. Usually, it is about 6000–8000 packages/h for cups 20–40 mm deep. The deeper the cup, the lower the capacity. The power requirement is 8–10 kW. The pressurized air consumption is 24–30 L/h (6 bar), and 300–400 L/h water is required for cooling (12–15  $^{\circ}\text{C}$ ). The dimensions, including the filling and sealing section, are  $5.0 \times 1.5 \times 2.0$  m and the weight is about 2 tons.

### Blow-Mold Packages

This method is used for filling liquids in plastic containers. The forming and filling of containers are almost simultaneous. The containers are formed by extruding



**Fig. 13.12** Blow-mold formed package

powder plastics in molds, in which air is blown (Fig. 13.12). The mold consists of two parts. When the blown material takes the form of the mold and it is cooled, the two parts of the mold go apart and the ready package is removed. Blow-mold equipment can produce and fill low-viscosity products, about 400 bottles/h (1 L/bottle). At this capacity, the electrical energy requirement is about 12 kW, and the pressurized air consumption is up to 100 L/min (10 bar). The dimensions of such machine are  $1.5 \times 1.5 \times 2.5$  m.

## 13.3 Filling Equipment

### 13.3.1 General Characteristics

Filling of food is a very important processing operation, since it can directly influence the shelf life of the packed products and the precision of the information printed on the package. There are several systems of food filling in containers (metal, glass, plastic, etc.). In all cases, the main aim is to bring the products safe into the containers, satisfying also the declaration printed on the package about its contents. If food is not filled properly, contamination of fresh or frozen products, or recontamination of already pasteurized or sterilized food, can occur. Furthermore, if the package does not contain the right quantity or the right combination or constituents of food, it violates the labeling laws. Therefore, as explained below, several techniques have been developed, overcoming these difficulties.

Generally, the following aspects are important in filling of food in packages: (1) hygienic (sanitary) conditions, (2) coordination with other related packaging steps, (3) high capacity, (4) no waste of product, (5) precision, and (6) flexibility.

In securing hygienic conditions, measures must be taken that the food will not be contaminated during filling. These measures refer to the construction of filling equipment, the environment of filling equipment, and the packages used. The constructional measures include the selection of the proper material and the choice

of solutions for reducing the accumulation of microorganisms and facilitating the cleaning of the filling valves and the other parts of equipment contacting with food. To reduce the danger of environmental contamination, food must be filled as soon as possible in the container. Depending on the container and the product that has to be packed, special measures must be taken for not allowing aerobic microorganisms to enter the container during filling. Such measures are, e.g., the sterilization of containers and the filling under controlled atmosphere conditions. For the sterilization of containers, steam, hot air, or chemicals can be used. For reducing or eliminating the danger of environmental contamination of the products, steam or hot air in slight overpressure, vacuum, modified atmosphere, or aseptic conditions can be applied. For securing hygienic filling conditions, the equipment must be cleaned frequently and thoroughly. Therefore, CIP and easy and fast dismantling of the parts that cannot or are not cleaned by CIP should be provided.

The coordination of the different packaging operations, as well as the coordination between packaging and the other food processing operations of a food factory, is essential. A delay in any of the processing steps (forming, filling, sealing, etc.) may paralyze the whole packaging line. Therefore, for achieving a good synchronization of the different packaging steps, adjustments on each packaging equipment should be possible. Furthermore, the equipment of a packaging line should be able to “cooperate” with equipment of other processing operations. For example, excessive product should be prevented from coming to packaging, resulting in a bottleneck. On the other hand, if the removal of packed food does not keep in step with the packaging line, a bottleneck will be created. Solutions such as, e.g., the use of buffer round tables, accumulating packed or non-packed food for a short time, or diversion to other packaging lines, should be foreseen, for the case that a packaging line would be temporarily out of operation for repair, due to sudden malfunction.

The output of filling equipment is related to the average and to the instantaneous output. The first gives the average production rate (packages/min) in a certain production shift, and it is needed to estimate the planned production. The second gives the rate (e.g., packages/min) under steady-state conditions and it is the output that equipment manufacturers state in their guarantees (Perry and Green 1997). Usually, packaging processes are fully automated, resulting in a high capacity. However, the higher the capacity of the equipment, the greater the reliability requirements must be. That means that the service rules must be followed strictly.

Care must be taken to avoid overflowing of food, during filling. If the movement of the containers or their filling is not gentle, product may spill around the containers, which, besides material loss, will soil the filling area, creating a source of microbiological contamination.

Most food processes do not require high accuracy, packaging being an exception. The filling equipment, like most of the rest of machines of a packaging line, must work precisely. Besides the necessity of coordination with other packaging machines, the quantity of the product filled must be in agreement with the label declaration of the container. The modern packaging systems have the possibility to keep the weight tolerance borders narrow. However, since products consisting of

nonuniform pieces are difficult to keep in such narrow borders, a slight move of the filling set weight toward the upper weight tolerance is recommended. Precision is also required in the way that several solid foods or mixed products are placed in the package. Frozen fish fingers, e.g., must be placed one besides the other gently, single fruits are placed in specially designed receptacles avoiding any bruising, and ready meals are placed in separate position of the same package (e.g., tray). More care and accuracy is required for packaging of fragile or delicate foods, such as fine bakery and confectionary products and eggs. In the last years, the use of robots in such operations has increased considerably.

A filling machine must be flexible. In food factories manufacturing seasonal products, a filling machine has to be adjusted to process different foods. In some cases, this adjustment has to be done fast. If frequent adjustment is required, the filling equipment must be also robust.

Factors influencing the choice of filling equipment are (1) product that has to be filled, (2) filling conditions, (3) capacity, (4) packaging material, and (5) packaging appeal.

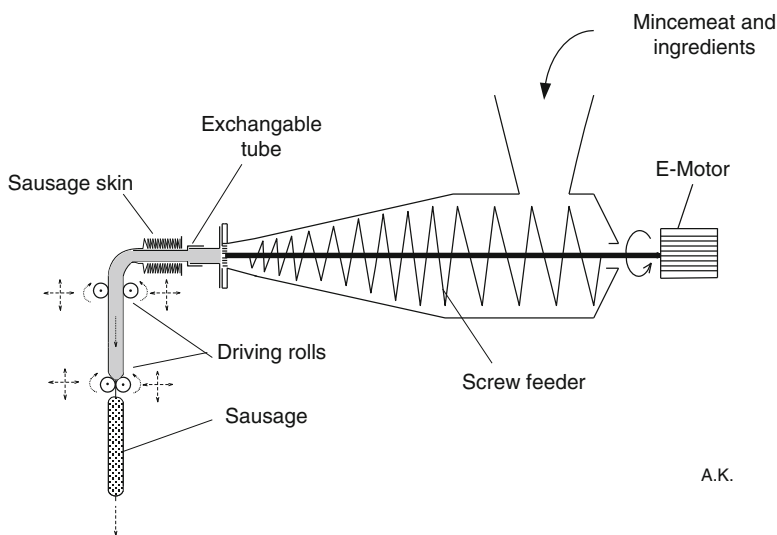
The flowability of food is very important in filling. Food that has to be filled can be liquid, solid, or mixtures of liquid and solids, gas and liquid, and gas and solid. The solid food can be in the form of granules, powder, or pieces. Mixtures of gas/liquid and solid/gas exist, e.g., in bottles or cans of carbonated drinks and bags with coffee, respectively. Low-viscosity liquid food (e.g., beverages, oil, etc.), most granulates, and a part of powders have a high flowability and they can be transferred by gravity. High-density liquid food, such as concentrates and some granulates and powders, may need additional force to flow. In this case, the product is transferred by positive or negative pressure (vacuum) or combination of these conditions. Increasing the temperature can increase the flowability of viscous liquid food by reducing the viscosity. Honey, e.g., can flow easier if it is heated. The flowability of some products can be also improved, if special measures are taken. The flowability, e.g., of raisins which are sticky, is increased, if they are dipped in oil and then dried, and that of salt is improved if permissible additives are used (Domke 1977).

Two main methods of filling of liquids (e.g., juice) are practiced, the cold and the hot filling. In cold filled juices, the aroma and vitamin loss is minimized, and thus the products can justify premium price. A disadvantage of cold filling is the requirement of refrigeration facilities. In the hot method, applied to juice, the product is pasteurized before filling, which occurs at a temperature above 82 °C (Castberg et al. 1997). Cooling is done after sealing. A similar procedure is followed in the sterilization of fruit in cans. The application of vacuum or modified atmosphere and the aseptic filling influence the choice of the filling equipment.

The capacity requirements influence the choice of filling equipment. Filling systems, in which pressure and suction (vacuum) are combined, have high capacity. For liquids, hot filling is faster than cold filling. If higher capacity is required, monoblock equipment, or carrousel, instead of in-line filling, is preferred. In filling of powders, suction systems are preferred, since pressure filling could increase dust and the danger of explosion in the packaging room.

Packaging materials influence the choice of filling equipment. High filling and sealing capacities are required, especially if packages have to be formed in adjusted equipment, shortly before filling. Plastic materials are widely used, especially in connection with small bag and carton packages. Filling and sealing of these materials is simple and high output is possible. The glass and metallic containers come ready to fill, and therefore, the capacity of the corresponding filling machines can be very high, if several filling heads are used.

The packaging appeal may also influence the choice of the filling equipment. Special measures must be taken, when powders or difficult flowing solid products must be filled in bulk. Bags, containing powders or material with high average particle length to particle width (e.g., 1:500), may look “half empty” after filling. This happens because the very low bulk density of such needlelike products immediately after the filling (e.g., for flour, less than  $0.4 \text{ ton/m}^3$ ) increases when the bags are transported and stored. Therefore, care must be taken for increasing the bulk density of such products before or during filling. Due to flowability requirements and since the time between filling and sealing is very short, it is difficult to find a satisfactory filling solution, whenever high filling rates are required. Measures commonly applied are high-frequency vibration (e.g., 20–60 Hz), increasing the packaging density by more than 30 %, compression before or during filling, and shock compression (Domke 1977; Perry and Green 1997). Filling operations of food may be also part of the final processing of viscous foods, when the packaging medium is eatable (e.g., sausages, Fig. 13.13) or deals with filling food in “containers” of any type.



**Fig. 13.13** Filling of sausages

### 13.3.2 Dosing

A filling process may be simply the transfer of food into the package, or it can be a more complex operation. Dosing is an essential part of filling, determining the quantity of a product that has to be filled in a certain container. This operation can be done by the following methods (Fig. 13.13): volumetric filling, filling to a certain level, weight filling, time-controlled filling, and counting filling.

- (a) The volumetric filling equipment (Fig. 13.14a) is the most commonly available system. It is used in filling low- and high-viscosity foods. The filling accuracy is reasonable and the speed of filling high. In the volumetric filling, the filler transfers the product to a container until a predetermined volume is reached. The volume can be controlled, e.g., either by measuring the flow rate of the product or by using containers of known volume, in which the product is pre-filled. The high-capacity machines have more than one volumetric filling heads.

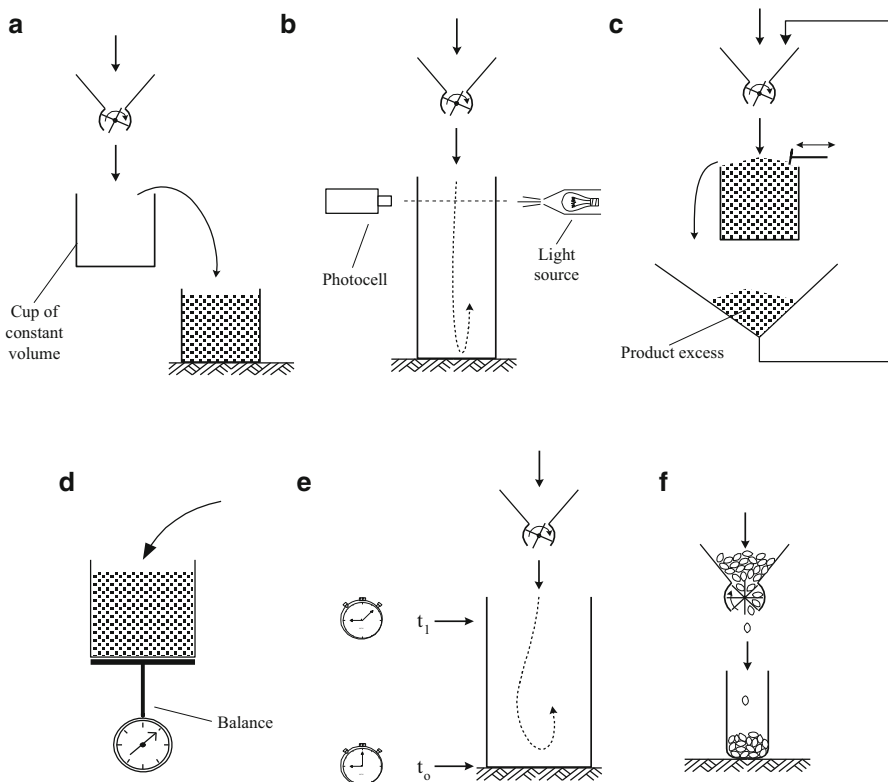


Fig. 13.14 Systems of dosing in filling of foods in packages: (a, b, c, d, e, f) (see text)

- (b, c) In the filling to a level system (Fig. 13.14b), the product flows until it reaches a certain height in the container. This type of filling is mainly used in filling liquids in transparent bottles, because consumers usually associate the volume of equal liquids and containers, with the level in the container. The filling stops, when, e.g., a beam sent through the bottle to a photocell on the other side is interrupted by the rising liquid. A special case is the maximum filling, in which the container is filled up to its maximum. Any overflowing excess material is collected and recycled (Fig. 13.14c).
- (d) In weight filling (Fig. 13.14d), the weight of the product is checked continuously before filling, or filling and weighing are done simultaneously. In the pre-weighing system, the weight of the product is checked as it is carried, e.g., on belts (Fig. 13.22) or as it moves along in cups of known tare, which are part of a scale. When the weight of the product in the cup reaches the preset weight value, the food is emptied automatically into the container. This system has been highly developed, because of the progress in computer techniques. Modern systems consist of a group of electronic balance cups, transmitting the weight information to a microprocessor, incorporated in the weighing unit. This unit can be part of the filling equipment or it can stand alone.
- (e) The time-controlled filling (Fig. 13.14e) is used in filling small amounts, when the properties of the product, the container, and the speed of filling remain constant. However, since all these variables cannot remain absolutely constant, the accuracy of the weight of the product is not very high.
- (f) Counting filling (Fig. 13.14f) is used in packaging pieces of food. It is used, e.g., in filling fresh fruits and vegetables, such as oranges, lemons, garlic, onions, etc., in small net packages, pieces of fresh or frozen meat or fish in trays, and pieces of processed food, such as creams, chocolates, meatballs, etc., in containers. The method is used, when accuracy of the weight of products is of minor importance.

Usually, the filling equipment includes the sealing units and, in some cases, the forming of packages. In filling, the capacity of machines varies considerably with the product. The capacity in filling of preformed packages with liquids is high, as well as that of filling cans. The capacity falls when the viscosity of the product and the weight of the package increase. Some examples of technical data of filling equipment are:

1. Filling/sealing of jars with jam or honey (rotary action): 5000–25,000 jars/h. Energy requirement, 4 kW; compressed air, 500 L/min; dimensions, 1.5 × 2.0 × 2.0 m; and weight, 4–5 tons.
2. Filling and sealing of plastic cups with yogurt, cream, liquid soups, fruit jelly (cup diameter/height: 95/130 mm): 2000–25,000 cups/h. Energy requirements, about 40 kW; air consumption, 120–150 L/h (6 bar); dimensions, about 6.5 × 4.0 × 3.5 m; and weight, about 5 tons.
3. Filling of bottles: the capacity of filling equipment depends on the number of filling heads (fillers). For a given filler type (e.g., carousel), it increases almost

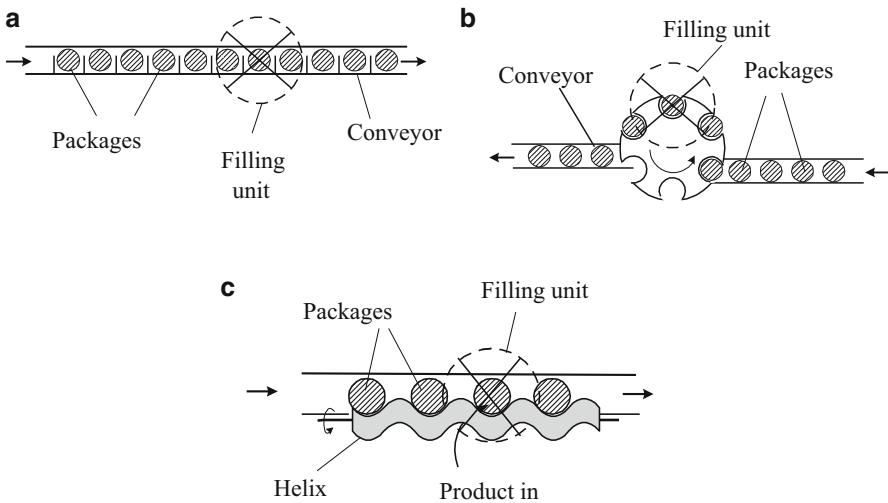
linearly with the number of fillers. A carrousel bottle filling equipment, e.g., with 16 fillers, has a capacity of 8000 of 1-L bottles/h. Equipment with 32 fillers has the capacity of 18,000 bottles/h and equipment with 64 fillers the capacity of 36,000 bottles/h. In the food industry, there are units with more than 180 fillers. Dimensions: diameter, 1.5–3.0 m; height, 1.5–2.0 m; weight, 1.5–4.0 tons; power requirement, about 2–7 kW; air consumption, about 50–100 L/h.

4. Carrousel filler of particulate products (mushrooms, grain corn, meatballs, diced tomatoes) with 30–45 filling stations. Maximum range of containers dimensions 191–127 mm. Range of maximum output: 40,000–60,000 cans/h. If the filling stations increase to 60, the output for free-flowing products (e.g., juice or milk) can go up to 90,000 containers/h.

### 13.3.3 Product Transfer Systems

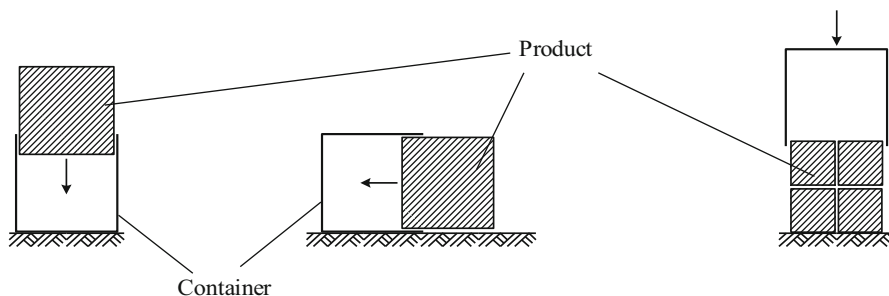
Basic elements in dosing are the product transfer system, the containers, and the filling valve. The product must be transferred steadily to the control unit (volumetric, weight control, etc.) and subsequently to the filling valve. The valve opens, letting a certain amount of product into the package, only if a container is already there. The synchronization of the container arrival with the opening of the filling valve is essential.

There are two main systems in conveying round containers to the right filling position, the in-line and the rotary wheel system (Fig. 13.15). In the in-line system, the containers come to certain belt positions under the filling unit (Fig. 13.15a), or they are conveyed by a rotating wheel (Fig. 13.15b). Belts are used to convey also



**Fig. 13.15** Container conveyance systems to the fillers. (a, b, c) Different types of the relation: Filling unit-Container conveyance system





**Fig. 13.16** Inlaying of products in packages. (a, b, c) Different systems of inlaying products in packages

containers of other shapes. The speed of the rotary helix system (Fig. 13.15c) is higher than that of the wheel system. The synchronization is done through adjustments in the speed of the belt or the rotation of the wheel and the helix, respectively.

The position of the package, in relation to the product that will be filled, depends on the product and the filling method (Fig. 13.16). Usually, packages are under the filler (Fig. 13.16a), but in some cases of solid materials, the containers may be on the side (Fig. 13.16b), as, e.g., in the filling of a certain number of frozen fish pieces in cartons. In some other cases, the containers come downward over the product, as, e.g., in packaging of prearranged food. In the last case, the package and its contents are turned over before sealing (Fig. 13.16c).

The systems used in transferring food into containers depend on the nature and the consistency of the products. Basically, transfer can be done by (1) gravity, (2) pressure, (3) isobaric transfer, (4) negative pressure (vacuum), and (5) combined transfer.

Gravity is used when the product flows easily, as in the case of low-viscosity liquids and nonadhesive granules. It is especially useful when processing goes from upper to lower floors. Pressure can be applied almost in all cases. It can increase the flow rate of flowable products and the transfer of viscous food. Isobaric transfer (constant pressure during transfer) of food is useful when the products are sensitive to pressure gradients. Negative pressure (vacuum) is applied in sucking liquids, granulates, or powders up to the filler. High airtightness is required, when the product is easily oxidized or contamination with aerobic microorganisms may occur. The combined processes counterbalance the negative points that each method may have, when applied alone. Pressure systems, e.g., may be more economic, if product transfer is also gravity assisted.

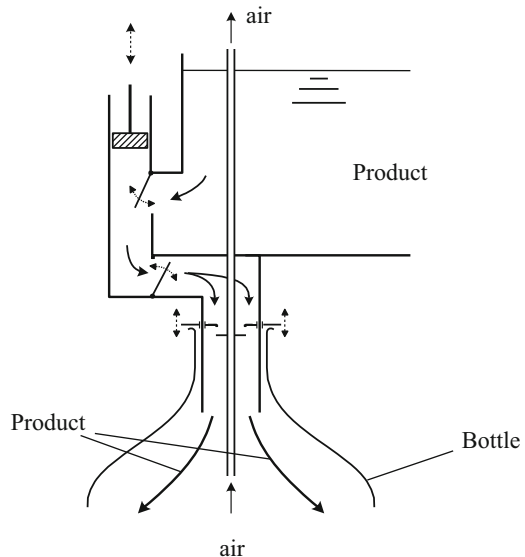
Pressure is applied to liquids or viscous products by pumps. Piston, diaphragm, gear, screw, and rotary pumps are normally used (see Chap. 3). These pumps, besides product transfer, are an essential element of the volumetric and the time-controlled dosing systems. Piston pumps are very common, operating exactly like gear pumps, and can transfer certain foods of varying viscosity at a steady rate. The diaphragm pumps, as well as the gear pumps, are both used in dosing. They work accurately, but the diaphragm pumps are used in transferring smaller quantities and

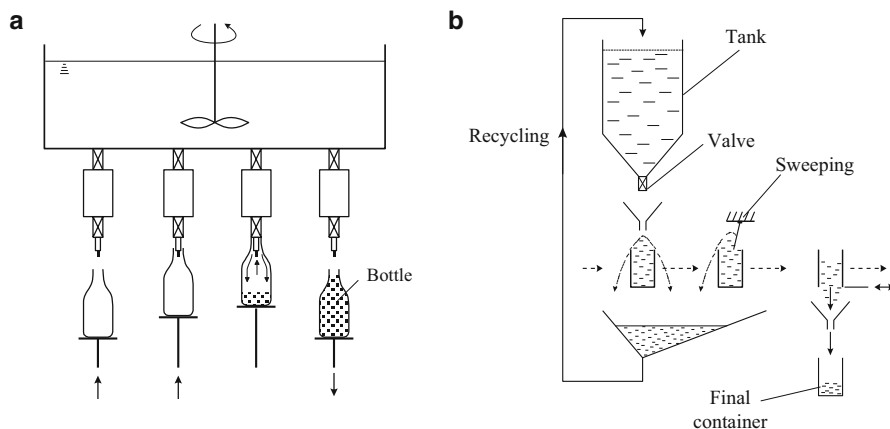
less viscous products. The screw pumps, as well as the rotary pumps, are used in transferring larger quantities of liquids, granules, and powders. The sensitive products are conveyed by belts and vibrating surfaces (Chap. 3). These conveying systems are also used in connection with weight filling. When exact weight is required, a system of belts or vibrating surfaces is used, in which there is a differentiation in the speed or in the vibration of each conveying element.

### 13.3.4 Valves

Several types of valves are used for filling liquid and comminuted solids. In some packages, e.g., bags and drums, used in aseptic filling, the valves are integrated in the packages. In bottle filling, the valve of the filler opens automatically, when the filler passes through the mouth of the bottle and reaches a certain position (Fig. 13.17). Usually the bottles are lifted by pistons progressively (Fig. 13.18). At the same time, the valve of the filler opens gradually and the liquid enters in the bottle, while the air in the bottle is discharged through a concentric tube. The filling of larger containers is often done in two stages: (a) the largest amount is filled quickly, and (b) the product is added to the partially filled container, until it reaches the preset amount. Usually, in powders and granulates, this additional quantity is conveyed by vibrating devices. In liquids, the additional quantity is controlled by varying of the aperture of the filling valve.

**Fig. 13.17** Principle of bottle filling valve



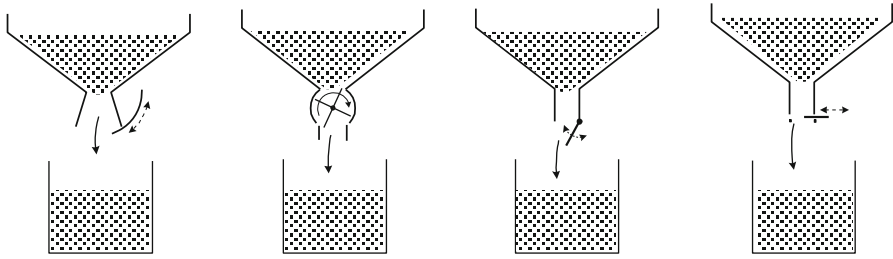


**Fig. 13.18** Exact filling of bottles (a) and subsequent control, in filling of packages (b)

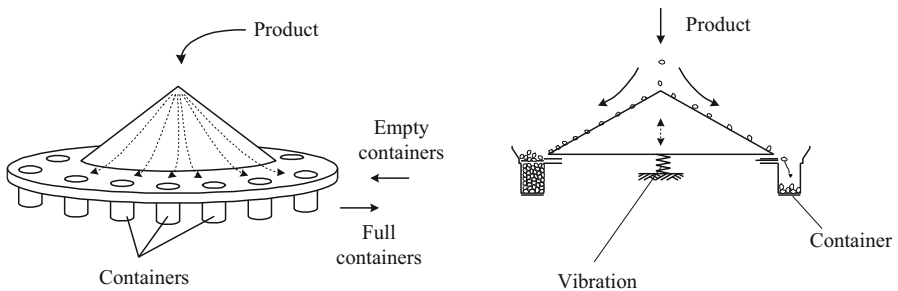
Depending on the type of filling, the liquid flows in the bottles by gravity, by pressure, or in an isobaric way. The bottles are vacuum-filled, if the concentric tube of the filler is connected to a low pressure system, which sucks the air of the bottle, resulting in the inflow of the liquid. The same tube may be used to introduce gas (e.g., carbon dioxide) in filling carbonated drinks. In some filling systems of bottles, carbon dioxide is also used to push the air out of the container before filling and to equalize the pressure between bottle and surroundings until the bottle is filled.

In the filling of granulates and powders, the flow of the products from a chute is controlled by gates and other devices such as augers. Figure 13.19 indicates some kinds of such gates. In filling of granules or powders, it is also possible to use a pre-filling container matching the exact volume that has to be filled. The pre-filling container is fixed on a carrousel. In the first step, the container is filled up completely, while in the second step, any excess product is “swept” away, and the overflowing product is recycled. In the third step, the pre-filled container is emptied into the package (Fig. 13.16b). This method can be used only in nonsensitive and flowable products, such as rice, lentils, etc. If rigid containers are used (e.g., metal cans), the sweeping of the excess product can be done directly on the final container.

In filling of fruits, olives, and several kinds of small vegetables, a possibility is to use ducts or round conical stainless steel tables, with round holes matching the position of the containers underneath (Fig. 13.20). The product that is discharged on the table is forwarded toward the holes, filling the containers. Valves (e.g., gate or rotary) stop the further flowing, when certain weight or volume is reached. For checking the weight of each container, load cells, on which the containers rest, are connected to microprocessors. When liquids with particulates are filled, the type of dosing equipment determines the maximum size of particulates that can be filled along with the liquid. By using piston fillers, the particulates should not exceed 25 mm and, for rotary pumps, 12 mm (Buchner 1995). Lobe and screw pumps



**Fig. 13.19** Filling of granules and powders



**Fig. 13.20** Filling of fruits in containers

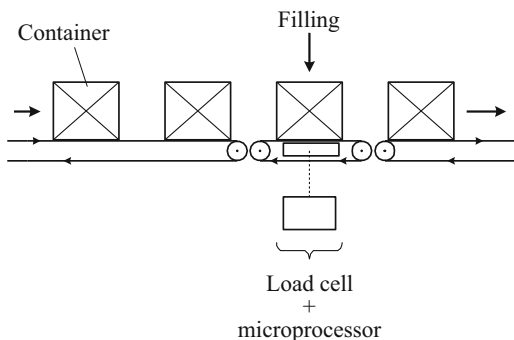
damage solids, if they are larger than a few mm. When particulates are large (e.g., peach halves in syrup), the two components are filled in the container separately.

The filling of liquids is done from the top of the containers (e.g., barrels). However, if a product can be easily oxidized, then filling starts from the lower part of the container, so that the filler is always dipped in the liquid. Finally, the filler is elevated as the liquid level goes up (Robichon and Savina 1996). The filling from the bottom is also recommended, when flammable liquids are filled. In the filling of flammable liquids and powders that may cause explosions, standardized safety regulations must be followed. For explosion-proof operation of, e.g., powders, there are the European Standards EN 50.0014 and EN 50.016 with classification EEXPIIT 3.

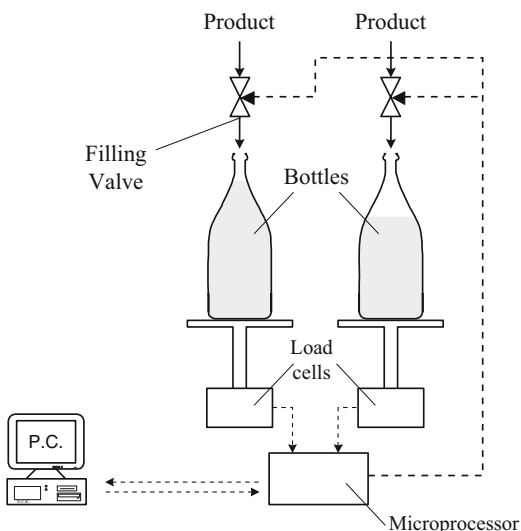
### 13.3.5 Weighing

Weighing scales are used to check the weight of the product before or after filling. The weight of the empty or filled packages can be measured during transport, using, e.g., conveyor scales. In the same way, conveyor scales can weigh larger containers (e.g., barrels) during filling (Fig. 13.21). A variation of the small-package conveyor scales has also the possibility to sort packages according to their weight, conducting

**Fig. 13.21** Continuous weighing during conveying

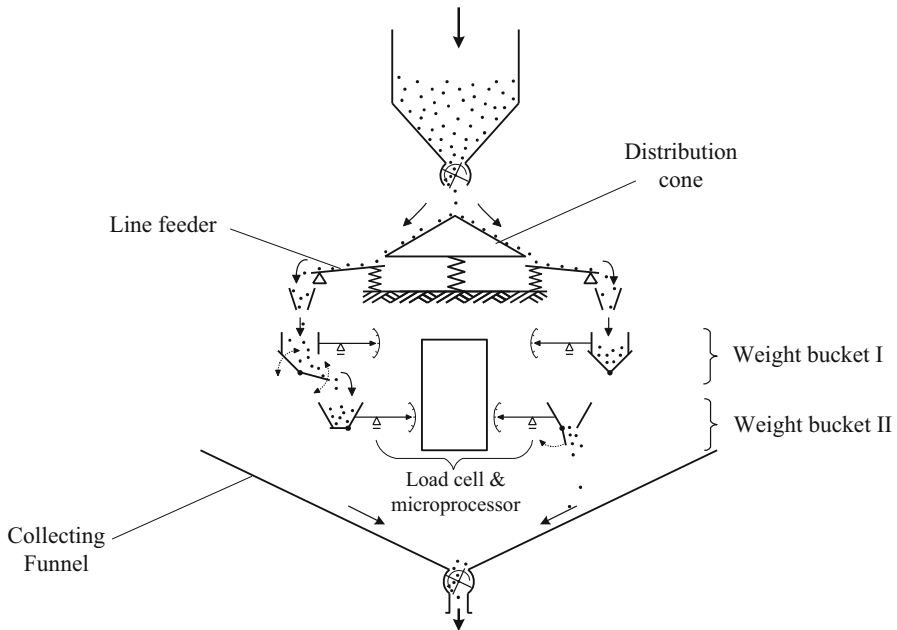


**Fig. 13.22** Continuous weighing during filling



them to different conveyors, after weighing. Scales are often part of complex packaging equipment. In bottle filling and closing equipment, the bottles are weighed during filling, since each bottle rests on a load cell individually. The information about the actual weight is sent to a microprocessor and a PC system, which controls the filling process. This way, any required adjustments in filling, e.g., due to deviations in the density or the temperature of the product, are executed automatically (Fig. 13.22). Scales are also used in calculating the net weight of the product. This is necessary, if the tare is not constant and, therefore, the filled quantity has to be steadily adjusted.

By weighing powders, granulates, and small pieces continuously, the scales act also as dosing equipment. For quick and accurate weight measurement, multihead balances are used (Fig. 13.23). Such units may have 3–24 scales (“cups”). They consist of a vibrating cone, linear feeding pans, two rows of cups, and a collecting chute. The feed to the balance is distributed around evenly by the vibrating cone.



**Fig. 13.23** Multihead weighing

The product comes to the linear feeder pans, which transfer it by vibration to feed buckets. Microprocessors collect the weight information of the weight buckets continuously and, through a computer, calculate the best bucket-content combination, approaching the set weight value. If the calculated weight combination is acceptable, the weight buckets open and this amount is transferred to the chute and then to the collecting funnel. A valve then sends the product of each combination to the filler. The buckets whose contents did not match the set value in any combination are emptied in the weighing buckets below. The upper weight buckets are refilled and any new bucket combination, matching the preset weight value, is again emptied in the collecting chute. Such scales can also be used for exact mixing of products (e.g., different small pieces of vegetables) in predetermined analogies. The weights are also delivered as twin units. These have double collecting funnels, enabling two different kinds of weighing at the same time (e.g., simple and mixed product weighing).

Table 13.2 gives some data for multi-weight and conveyor scales. The maximum weighing capacity and the weighing speed are larger in the multi-weight scales.

The weighing capacity of conveyor checkweighers can vary from a few grams to several kilograms. In weighing of food, it is possible to choose among several weight capacity categories, e.g., scales for up to 1, 5, 50, and 150 kg. The smaller the weight capacity, the higher the accuracy and the weighing speed (number of weighings per min). The weighing speed of multihead scales (e.g., 16 heads) is 150–200 weights/min. The dimensions of a conveyor scale, without the auxiliary

**Table 13.2** Technical data of weighing scales

	Multi-weight scale		Conveyor scale	
Max. weighing capacity (kg)	1	5	35	150
Weighing range (kg)	0.01–1.0	0.05–5.0	0.04–35.0	1.5–150
Weighing speed (weight/min)	200	150	120	100
Accuracy (g)	0.5–1	0.1	1	4
Volume (mL/package)	4000			

feeding and takeaway conveyors, are  $0.5 \times 0.4$  m (the height is adjustable), and the weight of a unit is about 100 kg. Usually, the multiscale units are placed above monoblock units. The height and the diameter of a multihead scale are 2.0 m in packaging FFS equipment. In this case, the total height is about 4.0–5.0 m.

Weighing in connection with modern computer techniques is also useful or even indispensable in several food manufacturing processes from raw material delivery up to the creation of final products. In several cases, weighing also contributes in the choice and the appropriate adjustment of processing equipment. In connection with the incoming raw materials and weighing, besides economic considerations, it is also part of instrumentation applied in classification and logistic operations. Such an example is the estimation of the humidity of incoming raw corn products requiring drying prior to their storage in silos.

In connection with processing operations, weighing may be used, e.g., in estimating the relation of the further processed, to the rejected products. This may reduce losses by introducing better adjustments of equipment used in processes such as peeling, cutting, and screening. Finally, correct weighing before further processing improves the final quality of products when it is applied in connection with formulations or in connection with the initial quality of products. Such examples in fruits are the relation weight–color and weight–texture and slicing or portioning operations and the relation between weight and meat fat content.

## 13.4 Closing Equipment

### 13.4.1 Closing of Food Packages

The methods of closing packages of food depend on the (1) packaging material, (2) food in the package, (3) processing and storage conditions, (4) packaging equipment, and (5) strength required.

In glass and metal containers, closing is done by mechanical means. This is, e.g., the case of closing glass containers with metallic or plastic caps and the double seaming of cans. Plastic packaging or combined materials, such as plastic-laminated aluminum and cardboard paper, are mainly heat-sealed. Paper and cardboard packages are closed with adhesives or by mechanical means (e.g.,

sewing). The method of closing is also influenced by the food contents. If, e.g., food in a glass or paper package must be protected from air oxidation, heat sealing is applied besides capping, and plastic-laminated aluminum is additionally used. The materials used in closing containers must not affect the food. This is especially important in selecting the proper adhesives or sealing materials being used in connection with caps. Processing and storage conditions play also a role in selecting the proper closure. Seaming must withstand high pressure during sterilization of cans, and the adhesives, used in closing of cartons, must withstand the low temperatures during freezing and storage. Closures must withstand the mechanical stresses exercised by packaging equipment, since mechanical and thermal stresses during capping, seaming, and sealing are unavoidable. A closure, in a broader sense, is a joint between two packaging materials. All joints are especially burdened by mechanical stresses, during handling and storage. Closures must withstand this stress, especially when there is a pressure difference between package contents and environment. The equipment used in closing of packages must be able to meet all the above challenges.

### **13.4.2 Glass Closures**

In glass containers, the joints are only in the closure of the container. The elements used are metallic caps, plastic caps, and cork. Since glass is inert, there are no problems due to the contact of different materials. However, since glass is rigid, the cap used must be flexible enough to resist mechanical stress and maintain tightness. This is especially important, when pressure differences between the container contents and its environment exist. The equipment used for closing glass containers is versatile, since often they have been developed in connection with patented cap systems. For wide openings (e.g., jars) with threaded neck or a neck for crimping, metallic closures or covers are used. In both cases, the closures or the cover has a plastic seal for better tightness. This can be a natural or synthetic rubber, a sheet polyvinyl chloride, or other suitable plastic materials (Downing 1996). However, for securing an even better airtightness, a coated aluminum sheet can be sealed on the mouth of the container, below the cap, as well (Hugel and Pajeau 1996). For bottles, the crown cap (an invention since the turn of the century) still gives good sealing effect, especially in bottles containing gas/liquid mixtures (e.g., carbonated drinks, beer). However, since the introduction of the one-way bottle with threaded neck, roll-on aluminum caps are used. These caps are also provided with a tamper-evidence ring (Robertson 1993). In closing of bottles, usually monoblock carousel equipment is used (filling and closing in one equipment). As in the case of the bottle filling equipment, the bottles that must be closed rest on pistons which elevate, press, and twist the bottles against the caps, which come to the closing head, automatically. The capacity of a closing machine depends on the number of heads it has. The output of crown capping equipment, e.g., varies between 3000 and 90,000 bottles/h, if the heads are between 3 and 36. The operation of equipment



closing bottles with natural cork is similar. In this case, a 24-head equipment can close 25,000 bottles per hour. The dimensions and the energy consumption of bottle closing equipment are similar to those of filling units of the same output.

### 13.4.3 Closing of Metallic Containers

In metallic containers, the joints are especially important in the three-piece can. The junction of the can end seams, with the side seam, is a particularly weak point of such cans. However, the three-piece can has been now replaced to a great extent by the two-piece can, in which only one double seam exists. The closing equipment closes a can in two steps, by using two different roller die profiles (Robertson 1993; Downing 1996). During closing, steam is often blown through jets on the surface of the can contents. The steam expels the air and it contributes to the can tightness, due to the vacuum created in the headspace of the can, after the condensation of the steam.

In can packaging of products, such as nuts or several powders, mechanical vacuum or modified atmosphere can be applied. This is done continuously, e.g., in carousel seaming machines, provided with airtight space for every can placed on pistons automatically (Fig. 13.24). Can seaming machines consist of two carrousel, corresponding to the two closing steps. The capacity of can seaming equipment can be more than 60,000 cans/h. The energy requirement of such equipment is about 10 kW. The dimensions of the machine are about  $3.5 \times 2.5 \times 2.5$  m and its weight is 5–7 tons. The capacity of vacuum or modified atmosphere equipment is less, but they require about 60 % more energy.

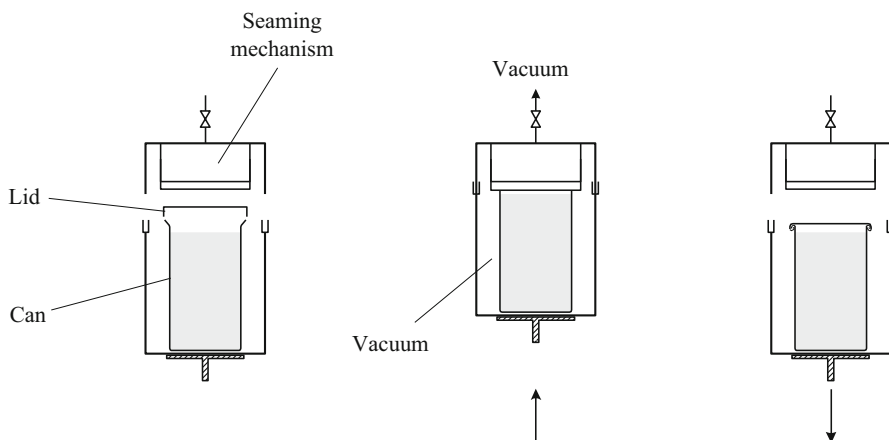


Fig. 13.24 Vacuum seaming of cans

### 13.4.4 Closing of Plastic Packages

In plastic packages, the sealing technique is used to make packages (e.g., bags) or to close them after filling with food. In larger equipment, sealing is done in a monoblock machine, in which forming and filling also take place. This holds well for tube bags, pouches, and to a great extent cups and aseptic filling or when modified atmosphere is applied. Monoblock equipment is also used in the blow-mold method, in which, besides the formation of bottles, filling and closing take place. The quality of a seal depends on the material to be sealed, its thickness, the pressure exercised during sealing, and the duration of heating. There are two main methods, the hot and the cold sealing, which differ in the temperature and pressure during sealing. Cold sealing is generally faster. In the frozen food industry, cold sealing of the packaging material prevails, since it resists better the low temperatures (Brown 1992). In hot sealing, the temperature depends on the material to be sealed. Sealing in in-line pouch forming is usually at 155–160 °C. When polyethylene with oriented polypropylene is used, the temperature is 110–120 °C, since polypropylene begins to harden above 130 °C (Harrison and Croucher 1996). Electrically heated bars or plates are normally used for sealing. The laminated top film is used in closing plastic cups just after filling. The film is heat-sealed automatically by special bars that are able to seal, e.g., 84 cups at a strike (Buchner 1995). The sealing capacity of plastic cups, for low- to medium-speed machines, is 50–150 packages/min. In cold seaming, the capacity of high-speed equipment can come up to 750 packages/min (Harrison and Croucher 1996). In plastic containers, airtight aluminum covers are used, which are laminated for sealing and increasing the cover stability. The covers may also be crimped mechanically over the edge of the container. In sealing, it is important to have uniform distribution of heat over the whole surface contacted. It is also important that the surface to be sealed is clean and that heating is stopped just before the temperature of the sealing bar or the heating plate exceeds the preset values. In vacuum sealing (Fig. 13.25), the plastic bag containing the product is sealed automatically, when the air in the bag is evacuated. The heating seal heads have Teflon strips to avoid sticking. The pressure

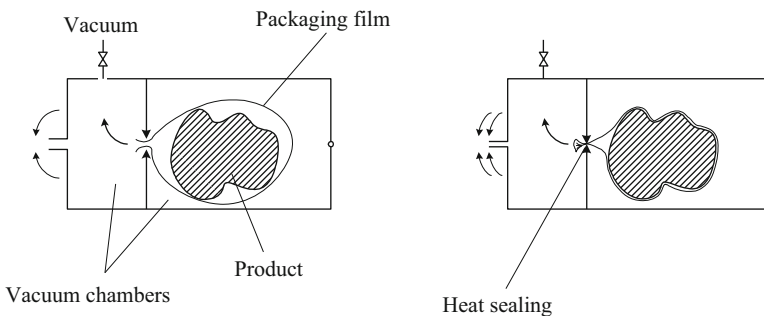


Fig. 13.25 Vacuum sealing of plastic packages

exercised during sealing is about 4 bar. The required energy of a relatively small unit (capacity: 15–40 bags per minute), including the vacuum pump, is 9–15 kW. The dimensions are  $2.0 \times 1.5 \times 1.5$  m and its weight, with the vacuum pump, is 500–600 kg.

### 13.4.5 Closing of Cartons and Cardboard

Coated cartons can be heat-sealed or closed using glue. Heat-sealed cartons are used in packaging of frozen food. When sealed with adhesives, the bonding speed and tack of glue depend on the speed of the gluing equipment, the porosity of the package, and the duration of contact of the surfaces that have to be sealed. Boxes are sealed with adhesive kraft paper or with plastic tapes coated with adhesive. A box tape-closing machine of a capacity of 1500–2000 boxes/h, in which the boxes are sealed with a tape, applied as the boxes are conveyed under it, may consume 2.0 kW of electrical energy and 50 L of air/min, and have dimensions of  $2.5 \times 0.8 \times 2.0$  m and a weight of 350 kg.

## 13.5 Aseptic Packaging

In aseptic packaging, a pasteurized or sterilized product is put in a sterilized container without coming in contact with its environment. Therefore, no additional thermal treatment after packaging is required. However, particular precautions are required to avoid any post-sterilization contamination of the product (Fig. 13.26). These precautions include sterilization and control of the following: (1) chamber in

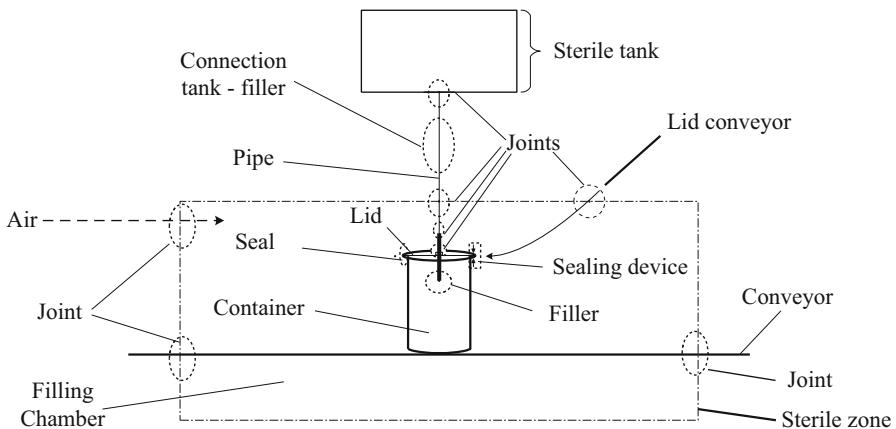


Fig. 13.26 Hazard points in aseptic packaging

which the product is filled and sealed, (2) filler and filling valves, (3) sealing devices, (4) conveying systems, (5) container, (6) air, (7) joints between tubes and chamber, (8) pipe, (9) lid, and (10) sterile tank.

In aseptic systems, precaution should be taken so that uncontrolled air from outside does not enter the chamber during entrance and exit of the containers or due to leakages. Sterilization of the system is accomplished by steam, hot air, chemicals, or ultraviolet (UV) radiation. In the case that blow-mold containers are used, the high temperature during extrusion in creating the containers (180–230 °C, 3 min) reduces greatly the microorganisms, but such containers should be used only in the aseptic packaging of high-acid products (Reuter 1988).

For the sterilization of the filling chamber and the mechanical parts, wet steam at atmospheric pressure can be used, if high-acid beverages are to be filled. Superheated atmospheric steam may be used for low-acid products. In hot air sterilization, the air temperature must be 330–350 °C and the sterilization time at least 30 min. The fillers, which are a very sensitive part of the aseptic system, are sterilized by pressurized steam or superheated water (130–135 °C, 2 bar) (Buchner 1995). They should be also easily dismantled for frequent thorough cleaning.

Chemical sterilization is achieved using hydrogen peroxide and several detergents. These detergents are normally used in cleaning the filling line together with the pasteurization equipment in the CIP (cleaning-in-place) systems.

Packages made of laminated film are sterilized by hydrogen peroxide. The packaging material is sterilized shortly before being used in the construction of packages (e.g., bags) by dipping in hot hydrogen peroxide. The concentration of hydrogen peroxide must not exceed 35 % (Buchner 1995; Robertson 1993). The same hydrogen peroxide method can be also applied to sterilizing film that is further thermoformed to cups. In all cases that hydrogen peroxide is used, it is subsequently removed by blowing sterilized air or by evaporating by means of a hot cylinders (90 °C), contacting the film after sterilization.

Eventual residue of hydrogen peroxide should be less than 0.05 ppm. In hydrogen peroxide sterilization, it takes about 5 min to reach the evaporation temperature and 10 min to sterilize the packaging material. In another method, the film forming the container is delivered pre-sterilized (Robinson 1995).

The metallic rigid containers are sterilized by steam. For tinplated cans and their lids, superheated steam or hot air in the range of 260 °C is used (Downing 1996). The temperature of tin containers is maintained at 220–260 °C for 45 s, while aluminum cans are heated at the same temperature for 36 s (Reuter 1988). For aluminum foil/paperboard “semirigid” containers, used in filling of high-acid products, hot air (116 °C for 45 s) can be used (Downing 1996). Another possibility is to use a combination of hydrogen peroxide vapor and hot air (Downing 1996). Polystyrene plastic cups can be sterilized, immediately after deep drawing, by steam at 165 °C (6 bar) for 1.4 s. Their lids are sterilized at the same temperature for 18 s. The cups are cooled during heating externally, so that no deformation due to elevated temperature occurs (Reuter 1988). The heating of the caps and lids is done simultaneously and just before filling and sealing.

In some sterilization processes, UV radiation can be additionally used, since UV promotes the breaking of the hydrogen peroxide into hydroxyl radicals, increasing the sterilization effect (Robertson 1993). Besides that, light overpressure of 1.0–1.5 bar protects the filling chamber from aerobic contaminants. According to Turtschan (1988), the loss of intensity of UV radiators, used in sterilization of plastic cups, is only 50 % of the initial value, after 3000 h of operation.

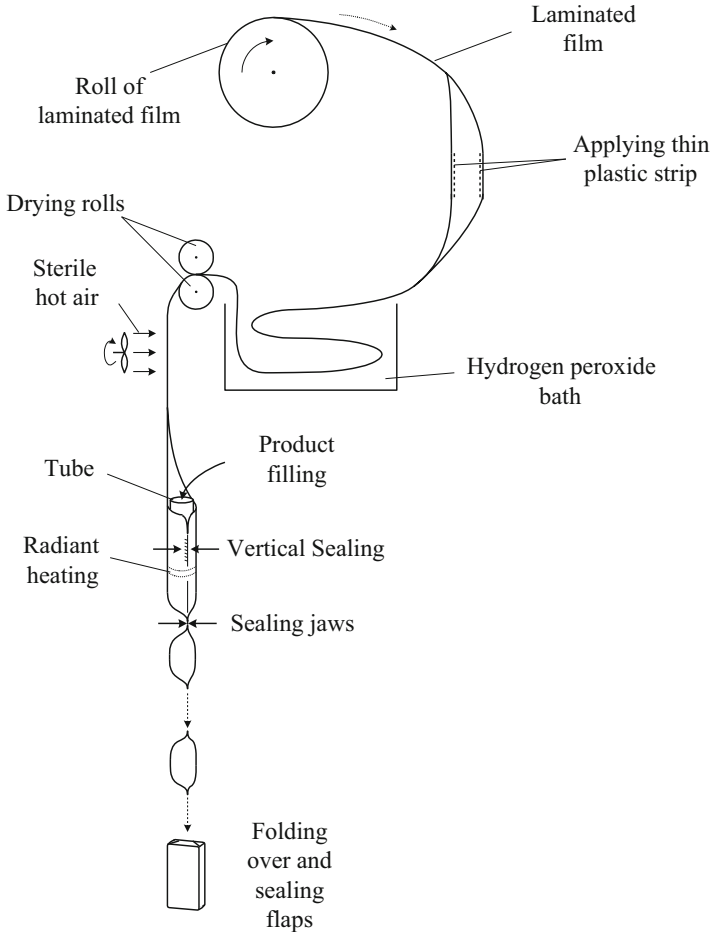
Air used in connection with aseptic packaging (e.g., hot air sterilization, automation control) should be cleaned in sterilized filters. The sterilization of the filters can be done by hot air (300–350 °C) and by pressure steam (Downing 1996; Buchner 1995).

In most cases of aseptic packaging, monoblock equipment is used, since this compact unit allows a better control of the processing conditions. The FFS equipment especially has contributed significantly to the expansion of aseptic packaging of liquid foods.

Aseptic packaging processes and equipment are described by Reuter (1988), Wilhoft (1995), and Downing (1996). Basically, the aseptic methods may be subdivided into the FFS methods in which the whole process takes place in the same monoblock equipment and the methods in which single filling and closing equipment are closed in an aseptic environment, in which the sterilized containers are supplied (e.g., Dole and Combibloc systems). The following two examples of monoblock equipment illustrate the aseptic packaging of food.

Figure 13.27 shows the aseptic packaging of the Tetra Pack FFS system. The laminated film that will be used in making the package is delivered in rolls (about 50 kg/roll). This quantity is enough for a 1-h operation when 250-mL T-Brik packages are produced and filled (Downing 1996). From a reel, the film passes through rolls stretching and stabilizing it. Subsequently, the thin strips of plastic material are added on both edges of the stretched film. The strips will facilitate the forming of a vertical seam, when the film is formed into a tube. The film is subsequently sterilized by dipping in hot hydrogen peroxide solution (30–35 % by weight), followed by drying. In sterilization followed by drying, large equipment, producing up to 6000 cartons/h, consumes up to 2000 mL/h hydrogen peroxide (Reuter 1988). Drying is achieved by light compression between two hot rolls and subsequent blowing of sterilized air. After that, the package is formed and simultaneously filled through the tube, as described in “Filling.” Shortly, before the tube formed leaves the central filling tube, it is heated once again to 110 °C, for safety reasons. The reel with the film is on the ground level and the reel off is matched to the production of packages. The height of the upper part of the monoblock equipment is 4–5 m and contains the preparation of the film for filling. The height of the lower part is almost equal to the upper, and it contains the forming, filling, and sealing sections. The energy consumption of equipment of the above capacity is 29 kW. It consumes also 27 m<sup>3</sup> of air/h and 2.4 kg of steam/h.

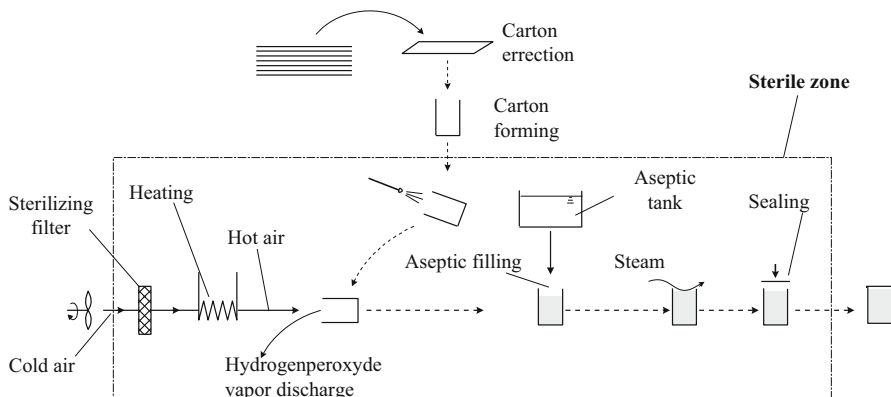
In the Combibloc method (Downing 1996), prefabricated carton containers are formed shortly before their sterilization by spraying hydrogen peroxide in a monoblock equipment (Fig. 13.28). Drying of the sterilized containers is done by sterile hot air (200 °C) blown into the ready-to-fill carton. The sterilized product



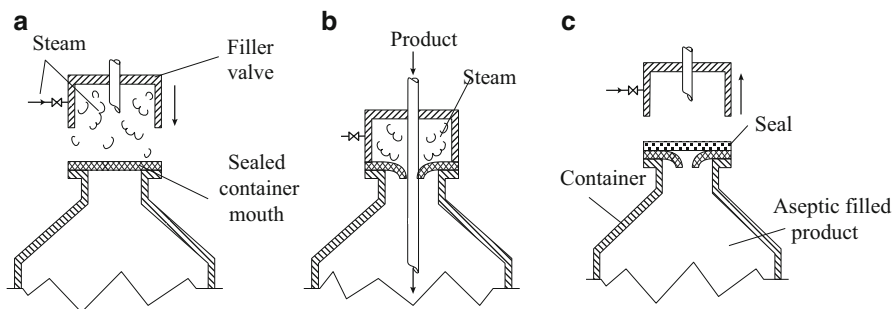
**Fig. 13.27** Principle of Tetra Pak system aseptic FFS monoblock equipment

flows from a tank to the fillers. Sterilized cold air is fed into the tank for avoiding the development of a vacuum, while it is emptied. Before sealing the container, steam is blown on the surface of its contents. This results in the creation of a vacuum on the headspace of the container, after it is sealed. The top seal is treated with ultrasonic energy.

In addition to small packages, aseptic packaging is also applied to large containers. Thus, tomato and fruit concentrates are packed directly in large metallic drums or in laminated plastic bags (e.g., 20 kg), which are put in fiber drums for mechanical protection. The drums and the bags come sterilized and sealed. Figure 13.29 shows the aseptic filling of a sterilized container. Basic elements in this process are the container's sealed mouth and the filler valve. The sealed mouth of the container is punched by the filler entering in the bag. At the same time, steam



**Fig. 13.28** Principle of Combibloc system aseptic packaging



**Fig. 13.29** Valve for aseptic filling of sterilized container. (a, b, c) Valve filling stages in aseptic sterilized container

ejected around the filler provides sterility, and due to the overpressure exercised, air does not enter the bag during filling (Fig. 13.29b). When the filler is removed, the bag is sealed in steam atmosphere automatically (Fig. 13.29c). Filling units can fill and seal more than 60 drums/h. The contents of such bags can be used later in further processing.

Larger quantities of aseptically preserved fruit or tomato concentrates can be stored in large tanks (Downing 1996). The storage capacity of such tanks may exceed 150 tons. The smaller tanks (e.g., up to 2–20 tons) can be made of stainless steel. They are often placed in the food processing factory for extending the period of production, in processing seasonal crops, such as tomato. The larger tanks can be also made of concrete that is internally lined with an epoxy-like synthetic resin. Such tanks are installed outside of buildings and are filled with nitrogen after sterilization and sealed up to their filling. The aseptic storage of large quantities makes also possible the processing of certain products far from the area they have been harvested. This is, e.g., done by transporting aseptically filled tanks by trucks or railcars.

The aseptic packaging of products has many advantages since: (1) a great variety of packages can be used; (2) in comparison to other heat treated products, higher quality is achieved, since heat transfer is faster; (3) the process is faster; (4) a variety of heat processes for the same package can be applied; and (5) less heat-resistant packages can be used.

Disadvantages of aseptic packaging are that (1) the method can be applied only to relatively few fluid foods; (2) if solids are contained in the fluid, they must not exceed the size of 25 mm (however, recent developments allow aseptic processing of such suspensions); (3) relatively high investment is required; (4) high safety measures are required; and (5) high coordination of all processing steps must be achieved.

## **13.6 Group Packaging**

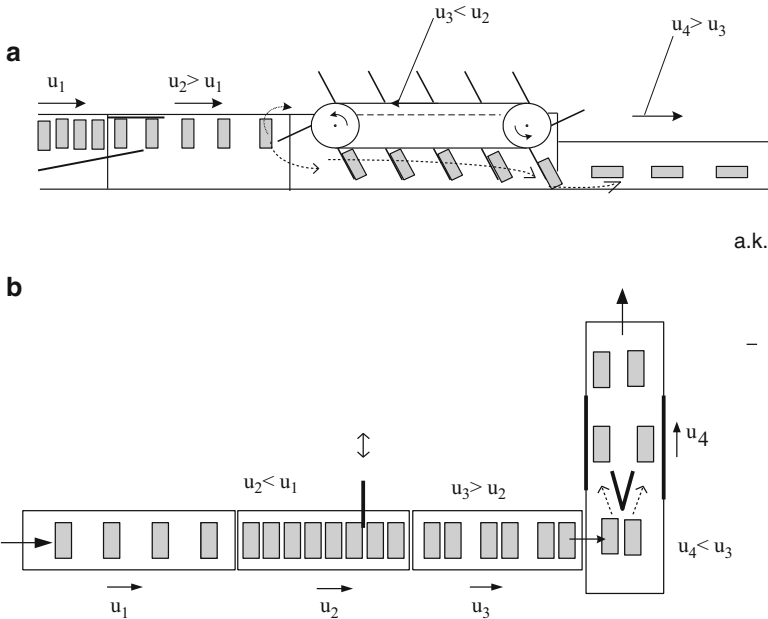
### ***13.6.1 Grouping of Packages***

Methods and procedures of grouped packaging of finished products are described by Paine (1996), and Bureau and Multon (1996). The single packages, coming out of the filling and packaging equipment, are arranged in groups for further packaging. This is done by controlling the package flow and orientation on the belt, after leaving the single packaging line (Fig. 13.30). The single packages can be then put on cardboard trays, in cardboard boxes, or directly on pallets if the single packages are large (e.g., barrels). The filling of smaller packages in cardboard boxes is carried out as in the case of product packaging in the single cartons. Examples of further packaging in cardboard boxes are cartons with frozen products and powders; bags of pasta products, rice, etc.; and bottles. The further packing on trays is mainly done for food designated to be sold in supermarkets. The trays are wrapped for the transport, and in the supermarket, the contents of the trays are reloaded or placed on the shelf as they are. Larger quantities of grouped packages are palletized automatically. This is done either by palletizing equipment (palletizers) or robots.

### ***13.6.2 Wrapping***

Smaller quantities of products and even full pallets can be “enveloped” by wrapping with plastic film. Enveloping protects the products from mechanical damage during transport and storage; facilitates the trade, especially in connection with trade methods, such as self-service and “cash-and-carry” shopping; provides weather protection; and gives transparency to the enveloped product. For all these reasons, enveloping has grown sharply in the last years. According to Paine (1996),





**Fig. 13.30** Lining up of products (ground plan). (a) Further conveyance to single packages, (b) Further Grouped conveyance (e.g. double) of packages

enveloping can be done by one of the following methods: (a) shrink wrapping, (b) stretch wrapping, and (c) vacuum packaging.

Shrink wrapping requires a tunnel in which the grouped wrapped package is heated, e.g., by hot air. Special equipment is used for enveloping groups of few products such as fruits on trays; grouped small packages, such as drinks, small cartons, etc.; and also larger quantities on pallets. Figure 13.31 shows the shrinkage of several plastic films in relation to the temperature. Plastics, such as PVdC and rubber hydrochloride, shrink by 50 % at temperatures 150–230 °C. At temperatures higher than 250 °C, most other films shrink to more than 40 % (MPE 1975).

Figure 13.32 shows the enveloping and shrinking of small packages. The blanks, e.g., trays, are put in the magazine of the monoblock equipment. From the magazine, they are sucked and placed automatically one after the other on a conveyor belt. The grouped product is put and aligned on the horizontal blank. The forming and hot-melt gluing of the tray follows, which is done by the wraparound method. The filled tray is wrapped with plastic film. Finally, the wrapped filled tray passes through a tunnel in which the film is shrunk by heating with hot air or infrared radiation. The capacity of such machines is usually 1500–3000 trays/h. It requires about 7 kW of electrical energy (without heating). The length of a monoblock equipment (tray erection, packaging, wrapping, shrinking of film) is 6.0–7.0 m, the width is about 0.5 m, the height is 1.5–2.0 m, and the weight can be about 3 tons. Vacuum wrapping of grouped products is seldom. It is done for smaller groups of packages for weather reasons.

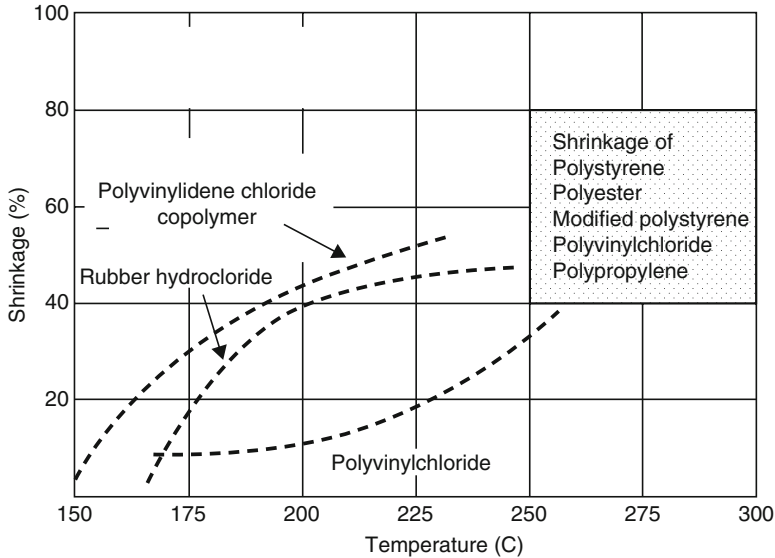


Fig. 13.31 Effect of temperature on shrinking of plastic film

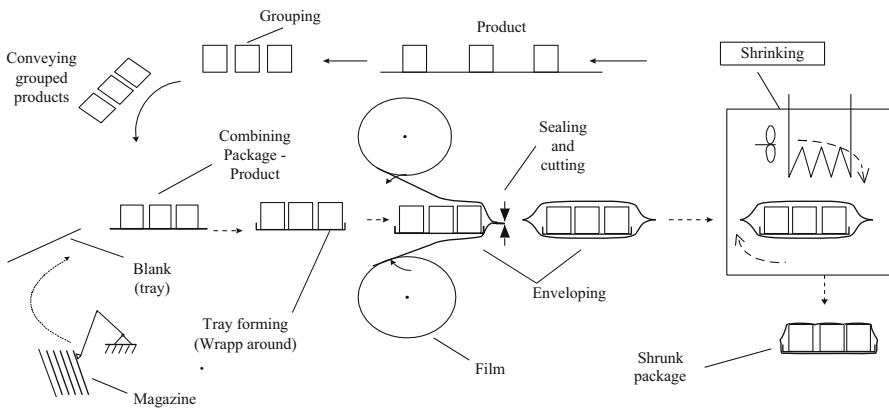
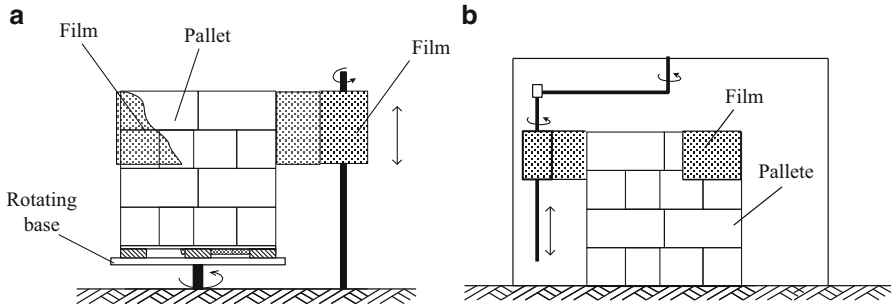


Fig. 13.32 Enveloping small packages

There are two main methods for stretch wrapping of packages with film. In the first method (Fig. 13.33a), the pallet is placed on a rotating plate. A vertical plastic film roll is placed next to the product that has to be wrapped. One end of a film sheet is fixed on the side of the stacked products, and wrapping is accomplished as the pallet rotates, pulling the film from the vertical roll. In some setups, it is possible to extend wrapping to the top of the pallet. An equipment  $4.0 \times 4.0 \times 3.5$  m can wrap about 40–50 pallets/h. The weight of such a wrapping machine is 2.0–2.5 tons and its energy consumption 4 kW. The pallet weight put on the rotating plate of such an



**Fig. 13.33** Film-wrapping equipment. (a) Steady wrapping pole, (b) Rotating wrapping pole

equipment can be up to 4 tons. In the second method, the pallet is placed directly on the ground (Fig. 13.33b), and there is no limit on the total weight of the loaded pallet. The plastic roll is attached to a crane jib, which can move around the pallet. The capacity of this system is 40–50 pallets/h depending on load size and configuration. The unit requires up to 1 kW, and the jib can rotate around the pallet at 0–12 RPM variable speed. Indicative dimensions of such a wrapping equipment are  $2.5 \times 2.3 \times 3.0$ , and the weight of the installation is about 2.5 tons.

Strapping is done in a similar way. The product that has to be strapped is placed in a ring-formed structure, which contains the wire or tape that strap the packed products around. A strapping equipment usually requires about 0.7 kW of power and has overall dimensions of  $2.5 \times 0.5 \times 2.0$  m. Its weight is 0.2 ton, and it can accept pallets or packed products of up to 1.4 m in height or width for strapping.

### 13.6.3 Palletizing

In palletizing, single containers (e.g., cans) or wrapped-up packages are put on pallets for facilitating the transport and storage of the products. Automatic placement of products on pallets can be made by palletizers or robots. Palletizing has been developed to one of the most important branches of materials handling, due to the expansion of trade in the last 20 years and the evolution in the logistics, including the ex-factory distribution system (e.g., the “just-in-time delivery” system). This development is also connected to the progress in computer and automation technology. The widespread introduction of the bar codes, from 1980 onward, which enable the automatic control of each delivery (Souverain 1996), has played a significant role in this development. A comprehensive description of the palletizing and the robot systems was presented by Thibault (1996). There are two main types of palletizers, the high-level (Fig. 13.34) and the low-level palletizers (Fig. 13.35). Both types consist of two sections. In the high-level palletizer, the grouped packages come to the first section, at the level of a full pallet, and they are laid on a pallet resting on an elevator plate with rolls. When the first row of the pallet is full, the

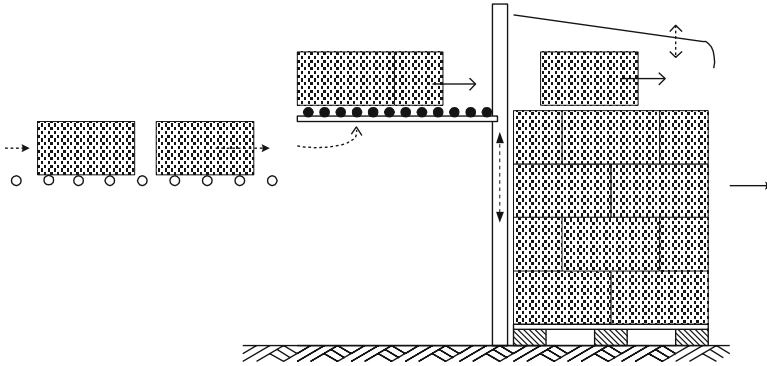


Fig. 13.34 High-level palletizer

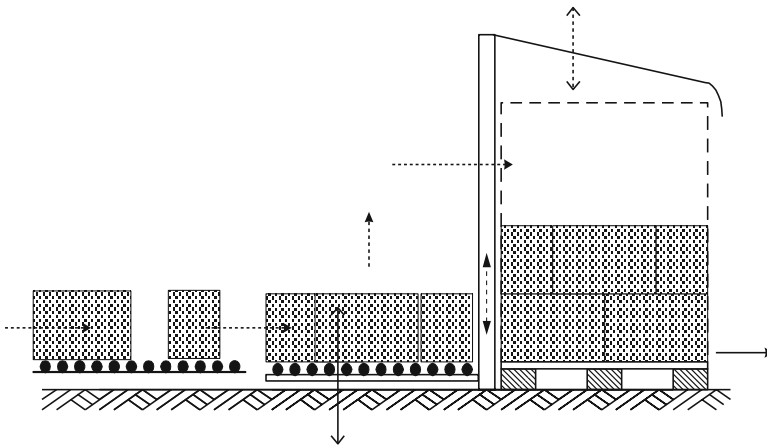
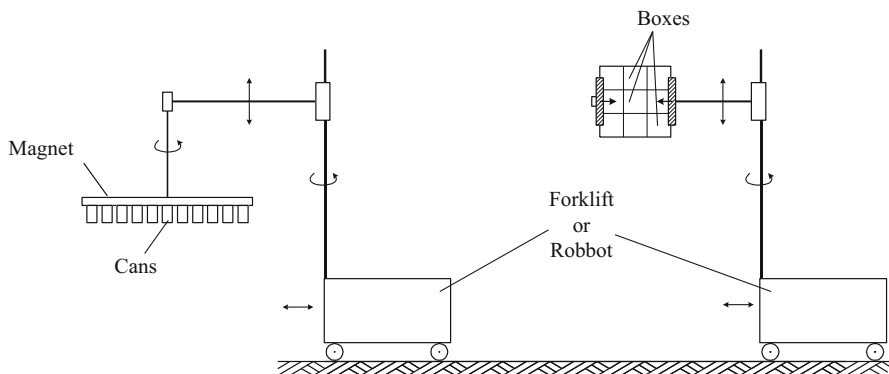


Fig. 13.35 Low-level palletizer

pallet is lowered by means of the elevator to the level of the first grouped packages' row. This procedure is repeated until a whole pallet stack is formed. The pallet stack moves/rolls subsequently to the next section, waiting for its transport to storage or to be shipped.

In the low-level palletizer (Fig. 13.35), there is a pallet-like elevator plate with rolls in the first section. An empty pallet is placed in the second part. The grouped products move on the palletizer elevator plate with rolls. When the elevator plate is one row full, it is elevated with the grouped products up to the top of the pallet of the second section of the palletizer, and it is stacked on the top of the pallet. Thereafter, the elevator returns back to be reloaded for stacking new grouped packages on those stacked just before. When a pallet pile is complete, it is carried away, e.g., by a lift truck. A palletizer may be able to load more than 10 layers/min. Its energy consumption is 9–15 kW. Usually, the plate elevator of a palletizer can carry and



**Fig. 13.36** Handling of containers

stack each time 200–250 kg. The overall dimensions of such a unit are  $5.0 \times 2.5 \times 3.0$  m and its weight is about 5 tons.

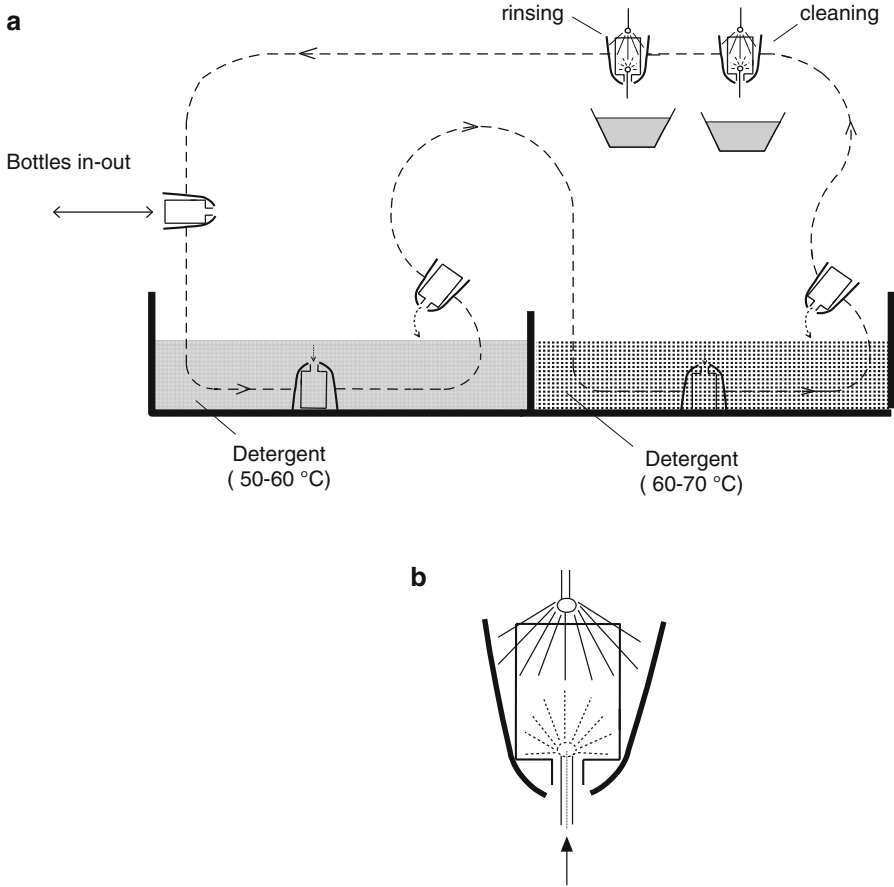
Robots can be also used in palletizing. They have the advantage of flexibility and work under unfavorable conditions. Palletizers and robots can be also used in putting products in larger containers (e.g., boxes, box pallets). In this case, the containers are raised, and when they are exactly above the their final destination, they are gently moved down. According to Swientek (1993), the food manufacturers are the biggest users of robots in palletizing in Japan. The holding of containers can be done in several ways. Cans can be held by magnetic force. Boxes can be held by bracket holders or suction (Fig. 13.36). Almost all equipment used in palletizing can be also used in de-palletizing.

## 13.7 Cleaning of Packaging Media

The food containers are cleaned before putting products in it. For relatively short time storage of solid food such as fruits and vegetables, usually plastic or wooden boxes or containers are used. The containers (boxes) that are filled with fruits such as apples and peaches can carry about 20 kg/box. The smaller ones usually containing “one row” of fruits carry 3–5 kg of products. Bags and sacks are used for small piece, grain, and ground-products (Chap. 3). Liquids or liquid-containing products are packed in glass, plastic, or metal containers.

The containers (usually plastic containers for products of about 20 kg) used to transport and store fruits and vegetables with short-time cold storage, before filling them in fields, are cleaned up passing continuously through tunnels in which they are washed out by pressurized water and steam. The recycled bottles and jars are cleaned in installations such as the indicated in Fig. 13.37.

One possibility is to soak the containers firstly in baths containing adequate warm detergent whose quality depends on the type and the spoil condition of the



**Fig. 13.37** Cleaning of bottles. (a) Processing line, (b) Rinsing of bottles

containers. Those emptied from detergent containers are successively guided in a second bath containing hotter detergent. The containers are then sprayed internally and externally by a 3–4 % NaOH solution and rinsed out by pressurized water. The glass containers are kept up to 90 °C during the cleaning process, but gradually for avoiding thermal stress, this temperature is reduced to the environment temperature.

## References

- Behra G, Guerin J (1996) Technology of packaging under film. In: Bureau G, Multon JL (eds) Food packaging technology, vol 2. VCH, New York
- Brody A, Morsh KS (1997) Wiley encyclopedia of packaging technology, 2nd edn. Wiley, New York

- Brown WE (1992) *Plastics in food packaging*. Marcel Dekker, New York
- Buchner N (1995) Aseptic processing and packaging of food particulates. In: Wilhoft EMA (ed) *Aseptic processing and packaging of particulate foods*. Blackie Academic and Professional, London
- Bureau G, Multon JL (eds) (1996) *Food packaging technology*, vol 1 and 2. VCH, New York
- Butte DA Manufacturing strategy? What is it. Why do you need one. How to develop and implement one. *Food Plants '89*
- Castberg HB, Osmundsen JI, Solberg P (1997) Packaging systems for fruit and non-carbonated beverages. In: Ashurst PR (ed) *Production and packaging of non-carbonated fruit juices and fruit beverages*. Blackie Academic and Professional, London
- Church N (1994) Developments in modified-atmosphere packaging and related technologies. *Trends Food Technol* 5(November):335–352
- Dominghaus H (1969) *Kunststoffe I*. VDI, Frankfurt
- Domke K (1977) Zufuhrungsprobleme bei der Verpackung von Lebensmitteln. *Ernaehrungswirtschaft-Lebensmitteltechnik* 2:79–86
- Downing DL (ed) (1996) *A complete course in canning*. CTI Publications, Timonium
- Fellows PJ (1990) *Food processing technology*. Ellis Horwood, London
- Franz C, Fuhrmann R (1968) Vorteile der aerosols setzen sich immer mehr durch. *Neue Verpackung*. 259–260
- Giles GA (ed) (2000) *Handbook of beverage packaging*. CRC, Boca Raton
- Hanlon JH, Kelsey RJ, Fornico HE (1999) *Handbook of packaging engineering*, 3rd edn. Technomic, Lancaster
- Harrison P, Croucher M (1996) Packaging of frozen foods. In: Mallett CP (ed) *Frozen food technology*. Blackie Academic and Professional, London
- Hernandez R (1997) Food packaging materials, barrier properties, and selection. In: Valentas KJ, Rotstein E, Singh RP (eds) *Handbook of food engineering practice*. CRC, New York
- Hooper JH (1998) *Confectionary packaging equipment*. Aspen, Gaithersburg
- Hugel R, Pajean G (1996) Glass used for packaging. In: Bureau G, Multon JL (eds) *Food packaging technology*, vol 1 and 2. VCH, New York
- Jasrzebski Z (1959) *Engineering materials*. Wiley, New York
- Joslyn MA, Heid JL (1963) *Food processing operations*, vol 2. AVI, Westport
- Luciano RA (1995) *How to write packaging machinery specifications*. Technomic, Lancaster
- Mallett CP (ed) (1996) *Frozen food technology*. Blackie Academic and Professional, London
- Miltz J (1992) *Food packaging*. In: Heldman DR, Lund DB (eds) *Handbook of food engineering*. Marcel Dekker, New York
- MPE (1975) *Modern packaging encyclopedia and planning guide*, vol 12. McGraw Hill, New York, p 40
- Nehring P, Krause P (1969) *Konserventechnisches Handbuch*. Enke Verlag, Stuttgart
- Paine FA (ed) (1996) *The packaging user's handbook*. Blackie Academic and Professional, London
- Perry RH, Green DW (1997) *Perry's chemical engineers' handbook*. McGraw Hill, New York
- Reichardt A (1963) *Lebensmittelverpackung*. In: Ullmanns *Enzyklopaedie der technischen Chemie*, 3rd ed. vol 11, Verlag Chemie, Weinheim
- Reuter H (ed) (1988) *Aseptic packaging of food*. Technomic, Lancaster
- Rice J (1997) New options in filling. *Prepared Foods* 8:93–98
- Robertson GL (1993) *Food packaging*. Marcel Dekker, New York
- Robichon P, Savina JP (1996) Technology of bottling beverages. In: Bureau G, Multon JL (eds) *Food packaging technology*, vol 2. VCH, New York
- Robinson CJ (1995) The ECRA neutral aseptic system. In: Wilhof EMA (ed) *Aseptic processing and packaging of particulate foods*. Blackie Academic and Professional, London
- Schormueller J (1966) *Die Erhaltung der Lebensmittel*. F. Enke, Stuttgart
- Soroka WG (1998) *Fundamentals of packaging technology*, 2nd edn. Technomic, Lancaster

- Souverain R (1996) Information and consumer protection. The role of packaging. In: Bureau G, Multon JL (eds) Food packaging technology, vol 1. VCH, New York, pp 25–32
- Swientek B (1993) Robotics: get a grip on it. Prepared Foods 5:80–83
- Thibault J (1996) Palletization, handling, storage of full packs: Developing toward robots and flexible packaging workshops. In: Bureau G, Multon JL (eds) Food packaging technology. VCH, New York
- Turtschan A (1988) Aseptic packaging in prefabricated plastic cups. In: Reuter H (ed) Aseptic packaging of food. Technomic, Lancaster
- Werner W (1955) Kunststoffe und ihre Verarbeitung. In: Huette, 28th edn. Berlin: W. Ernst
- Wilhoft EMA (ed) (1995) Aseptic processing and packaging of particulate foods. Blackie Academic and Professional, London



# Appendix A: Notation and Conversion of Units

## Notation

<i>A</i>	Transport area, m <sup>2</sup>
<i>Bi</i>	Biot number
BOD	Biological oxygen demand
<i>Br</i>	Brinkman number
<i>C</i>	Concentration, kg/m <sup>3</sup>
<i>C</i>	Cost
<i>C<sub>d</sub></i>	Drag coefficient
<i>C<sub>p</sub></i>	Heat capacity at constant pressure, kJ/mol K chemical
COD	Oxygen demand
<i>D</i>	Thermal resistance, min
<i>D</i>	Mass diffusivity, m <sup>2</sup> /s
<i>D</i>	Diameter, m
<i>d</i>	Diameter, m
<i>Dn</i>	Dean number
<i>E</i>	Electric field strength, V
<i>E</i>	Activation energy, kJ/kmol
<i>E<sub>a</sub></i>	Activation energy for viscous flow, kJ/kmol
<i>E<sub>D</sub></i>	Energy of activation for diffusion, kJ/mol
EU	European Union
<i>F</i>	Force, N
<i>F</i>	Thermal death time, min
<i>f</i>	Fraction
<i>f</i>	Friction factor
FC	Fixed cost
<i>Fo</i>	Fourier number
FR	Fouling resistance
<i>Fr</i>	Froude number
<i>G</i>	Mass flow rate, kg/m <sup>2</sup> s

$g$	9.81 m/s <sup>2</sup>
$Gr$	Grashof number
$Gz$	Graetz number
$H(h)$	Height, "head," m
$h$	Height, m
$h$	Heat transfer coefficient, W/m <sup>2</sup> K
$h(H)$	Enthalpy, kJ/kg
HE	Heat exchanger
HTST	High temperature short time
$j$	Lag factor
$J_A$	Mass flux of A, kg/m <sup>2</sup> s or kmol/m <sup>2</sup> s
$j_H$	Heat transfer factor
$j_M$	Mass transfer factor
$K$	Flow consistency coefficient, Pa s <sup><i>n</i></sup>
$K$	Drying constant, 1/s
$K$	Partition coefficient
$k_c$	Mass transfer coefficient, m/s
$L$	Lethality, min
$L$	Length, m
LTU	Length of transfer unit
$M$	Molecular weight, kg/kmol
$m$	Mass flow rate, kg/s
$N$	Number
$N$	Rotational speed, 1/s
$n$	Flow behavior index
NTU	Number of transfer units
$Nu$	Nusselt number
$P$	Pressure, Pa or bar
$P$	Permeability, kg/m s Pa
$Po$	Power, W
$Pr$	Prandtl number
$Q$	Volumetric flow rate (capacity), m <sup>3</sup> /s
$q$	Heat transport rate, W
$R$	Flux ratio
$R$	Gas constant, 8.314 kJ/kmol K
$R$	Resistance
$R = (X - X_e)/(X_o - X_e)$	Moisture ratio
$r$	Radius, m
$r_i$	Inside radius, m
$r_o$	Outside radius, m
$Re$	Reynolds number
RPM, rpm	Rounds per minute
$S$	Solubility, kg/m <sup>3</sup> Pa
$Sc$	Schmidt number

$Sh$	Sherwood number
$St$	Stanton number
$T$	Temperature, K, °C
$T$	Tension, N
$t$	Time, s
$T_g$	Glass transition temperature, K, °C
$U$	Overall heat transfer coefficient, W/m <sup>2</sup> K
$u$	Velocity, m/s
UHT	Ultrahigh temperature
USD	U.S. dollars (\$)
$V$	Volume, m <sup>3</sup>
$W$	Weight, kg
$W$	Work, J
$w$	Loading, kg/m <sup>2</sup>
$X$	Moisture content, kg/kg dm
$x$	Distance, size
$x$	Mole fraction, liquid phase
$Y$	Mass fraction gas phase, kg/kg dm
$y$	Mole fraction, vapor phase
$z$	Temperature factor, °C
$Z$	Height, m

### Greek

$\alpha$	Thermal diffusivity, m <sup>2</sup> /s
$\alpha$	Relative volatility
$\Gamma$	Film flow rate, kg/m s
$\gamma$	Activity coefficient
$\gamma$	Shear rate, 1/s
$\Delta P$	Pressure drop, Pa
$\Delta T$	Temperature difference, K
$\epsilon$	Porosity
$\eta$	Efficiency (fractional)
$\eta$	Viscosity, Pa s
$\eta_a$	Apparent viscosity, Pa s
$\theta$	Angle of cone/plate
$\lambda$	Thermal conductivity, W/m K
$\mu$	Coefficient of friction
$\nu$	Momentum diffusivity (kinematic viscosity), m <sup>2</sup> /s
$\xi$	Mass fraction
$\pi$	3.141
$\rho$	Density, kg/m <sup>3</sup> or mol/m <sup>3</sup>
$\sigma$	Surface tension, N/m

$\tau$	Shear stress, Pa
$\varphi$	Shape factor
$\omega$	Rotational speed, rpm/60, 1/s

### Subscripts

A	Component A (diffusant)
B	Component B (medium)
b	Boiling
c	Cooling
c (cr)	Critical
D	Diffusion
e	Equilibrium
G	Gas
h	Heating
id	Ideal
K	Knudsen
L	Liquid
L	Logarithmic
M	Mean
o	Dilute, initial
p	Particle
v	Vapor
w	Wall

### Multipliers of SI units

h (hecto)	$\times 100$
k (kilo)	$\times 1000$
M (mega)	$\times 1,000,000$
G (giga)	$\times 1,000,000,000$
c (centi)	$\times 0.01$
m (milli)	$\times 0.001$
$\mu$ (micro)	$\times 0.000001$
n (nano)	$\times 0.000000001$

### Conversion to SI Units

From	To SI units	Multiply by
atm (760 Torr)	bar	1.013
bar	Pa	$1 \times 10^5$
Btu	kJ	1.055
Btu/h	W	0.293
Btu/h ft <sup>2</sup>	W/m <sup>2</sup>	3.154

(continued)

(continued)

From	To SI units	Multiply by
Btu/h ft °F	W/m K	1.729
Btu/h ft <sup>2</sup> °F	W/m <sup>2</sup> K	5.678
Btu/lb	kJ/kg	2.326
cP	Pa s	0.001
cuft	m <sup>3</sup>	0.0284
cuft/lb	m <sup>3</sup> /kg	0.0624
cuft/min (CFM)	m <sup>3</sup> /s	0.5 × 10 <sup>-3</sup>
ft	m	0.305
ft-lb	J	1.355
ft/min (FPM)	m/s	0.0051
ft of water	Pa	2990
gallons (U.S.)	m <sup>3</sup>	3.785 × 10 <sup>-3</sup>
gallons (Imperial)	m <sup>3</sup>	4.543 × 10 <sup>-3</sup>
gallons/min (GPM)	m <sup>3</sup> /s	0.063 × 10 <sup>-3</sup>
hp	kW	0.745
hp (boiler)	kW	9.80
in (inches)	m	0.0254
in Hg	Pa	3386
kcal	kJ	4.18
kg force (kp)	N	9.81
L (lit, l)	m <sup>3</sup>	0.001
lb force	N	4.45
lb mass	kg	0.454
lb/cuft	kg/m <sup>3</sup>	16.02
lb/ft <sup>2</sup>	Pa	47.9
lb/ft <sup>2</sup> h	kg/m <sup>2</sup> s	0.00133
lb/ft s	kg/m s	1.488
lb/in. <sup>2</sup> (psi)	Pa	6894
miles	km	1.609
mm water	Pa	9.81
P (poise)	Pa s	0.10
Pa	N/m <sup>2</sup>	1.00
Pa s	kg/m s	1.00
RPM (rpm)	1/s	1/60
sq ft (ft <sup>2</sup> )	m <sup>2</sup>	0.093
sq in (in. <sup>2</sup> )	m <sup>2</sup>	0.645 × 10 <sup>-3</sup>
ton (metric)	kg	1000
ton (US, short)	kg	907.2
ton-refrigeration	kW	3.51
Torr (mmHg)	Pa	133.3
W	J/s	1.00

$K = °C + 273$

$°C = (°F - 32)/1.8$

## Appendix B: Selected Thermophysical Properties

**Table B.1** Thermodynamic properties of saturated water and steam

$T$ (°C)	$P$ (bar)	$\rho_l$ (kg/m <sup>3</sup> )	$\rho_v$ (kg/m <sup>3</sup> )	$\Delta H_v$ (kJ/kg)
0.01	0.0061173	999.78	0.004855	2500.5
1	0.0065716	999.85	0.005196	2498.2
2	0.0070605	999.90	0.005563	2495.8
3	0.0075813	999.93	0.005952	2493.4
4	0.0081359	999.95	0.006364	2491.1
5	0.0087260	999.94	0.006802	2488.7
6	0.0093537	999.92	0.007265	2486.3
7	0.0100209	999.89	0.007756	2484.0
8	0.0107297	999.84	0.008275	2481.6
9	0.0114825	999.77	0.008824	2479.3
10	0.012281	999.69	0.009405	2476.9
12	0.014027	999.49	0.010668	2472.2
14	0.015988	999.24	0.012075	2467.5
16	0.018185	998.93	0.013641	2462.8
18	0.020644	998.58	0.015380	2458.1
20	0.023388	998.19	0.017308	2453.3
22	0.026447	997.75	0.019441	2448.6
24	0.029850	997.27	0.021797	2443.9
26	0.033629	996.75	0.024395	2439.2
28	0.037818	996.20	0.027255	2434.4
30	0.042455	995.61	0.030399	2429.7
32	0.047578	994.99	0.033849	2424.9
34	0.053229	994.33	0.037629	2420.2
36	0.059454	993.64	0.041764	2415.4
38	0.066298	992.92	0.046281	2410.6
40	0.073814	992.17	0.05121	2405.9

(continued)

**Table B.1** (continued)

$T$ ( $^{\circ}\text{C}$ )	$P$ (bar)	$\rho_l$ ( $\text{kg}/\text{m}^3$ )	$\rho_v$ ( $\text{kg}/\text{m}^3$ )	$\Delta H_V$ ( $\text{kJ}/\text{kg}$ )
42	0.082054	991.39	0.05657	2401.1
44	0.091076	990.58	0.06241	2396.3
46	0.100938	989.74	0.06875	2391.5
48	0.111706	988.88	0.07563	2386.7
50	0.12344	987.99	0.08308	2381.9
52	0.13623	987.08	0.09114	2377.0
54	0.15012	986.13	0.09985	2372.2
56	0.16522	985.17	0.10925	2367.4
58	0.18159	984.18	0.11939	2362.5
60	0.19932	983.16	0.13030	2357.6
62	0.21851	982.13	0.14204	2352.8
64	0.23925	981.07	0.15465	2347.9
66	0.26163	979.98	0.16819	2343.0
68	0.28576	978.88	0.18269	2338.0
70	0.31176	977.75	0.19823	2333.1
72	0.33972	976.60	0.21485	2328.1
74	0.36978	975.43	0.23261	2323.2
76	0.40205	974.24	0.25158	2318.2
78	0.43665	973.03	0.27180	2313.2
80	0.47373	971.79	0.29336	2308.1
82	0.51342	970.54	0.31631	2303.1
84	0.55585	969.27	0.34072	2298.0
86	0.60119	967.98	0.36666	2292.9
88	0.64958	966.66	0.39420	2287.8
90	0.70117	965.33	0.42343	2282.7
92	0.75614	963.98	0.45441	2277.5
94	0.81465	962.61	0.48723	2272.4
96	0.87688	961.22	0.5220	2267.2
98	0.94301	959.82	0.5587	2261.9
100	1.0132	958.39	0.5975	2256.7
102	1.0877	956.95	0.6385	2251.4
104	1.1667	955.49	0.6817	2246.1
106	1.2503	954.01	0.7273	2240.7
108	1.3388	952.51	0.7754	2235.3
110	1.4324	951.00	0.8260	2229.9
112	1.5313	949.46	0.8793	2224.5
114	1.6358	947.91	0.9353	2219.0
116	1.7461	946.34	0.9941	2213.5
118	1.8623	944.76	1.0559	2208.0
120	1.9848	943.16	1.1208	2202.4
122	2.1139	941.54	1.1889	2196.8
124	2.2496	939.90	1.2603	2191.2
126	2.3924	938.24	1.3351	2185.5
128	2.5425	936.57	1.4134	2179.8

(continued)

**Table B.1** (continued)

$T$ (°C)	$P$ (bar)	$\rho_l$ (kg/m <sup>3</sup> )	$\rho_v$ (kg/m <sup>3</sup> )	$\Delta H_V$ (kJ/kg)
130	2.7002	934.88	1.4954	2174.0
132	2.8657	933.18	1.5811	2168.2
134	3.0393	931.45	1.6708	2162.4
136	3.2214	929.71	1.7646	2156.5
138	3.4122	927.96	1.8625	2150.6
140	3.6119	926.18	1.9647	2144.6
142	3.8211	924.39	2.0713	2138.6
144	4.0398	922.58	2.1826	2132.5
146	4.2685	920.76	2.2986	2126.4
148	4.5075	918.92	2.4195	2120.3
150	4.7572	917.06	2.5454	2114.1
152	5.0178	915.18	2.6786	2107.8
154	5.2896	913.29	2.8131	2101.5
156	5.5732	911.38	2.9581	2098.3
158	5.8687	909.45	3.1028	2088.8
160	6.1766	907.50	3.2564	2082.3

Data from Haar et al. (1984)

**Table B.2** Properties of water and air (20 °C)

Property	Water	Air (dry)
Density ( $\rho$ ), kg/m <sup>3</sup>	1000	1.3
Specific heat ( $C_p$ ), kJ/kg K	4.18	1.1
Viscosity ( $\eta$ ), m Pa s	1.0	0.018
Thermal conductivity ( $\lambda$ ), W/m K	0.60	0.025
Thermal diffusivity ( $\alpha = \lambda/eC_p$ ), m <sup>2</sup> /s	$1.4 \times 10^7$	$1.7 \times 10^5$
Mass diffusivity ( $D$ ), m <sup>2</sup> /s		
Water/water	$1 \times 10^{-9}$	–
Air/water	–	$1.9 \times 10^{-9}$
Air/air	–	$1.8 \times 10^{-5}$

Note: The properties of water vapor/air mixtures are obtained from the psychrometric charts or related equations/programs (see Figs. 8.1 and B.1)

**Table B.3** Physical and thermal properties of liquid foods (20 °C)

Liquid food	$\rho$ , kg/m <sup>3</sup>	$C_p$ , kJ/kg	$\eta$ , mPa s	$\lambda$ , W/mK
Milk	1030	3.8	2	0.48
Clear apple juice 12° Brix	1050	3.6	1.5	0.46
Clear apple juice 65° Brix	1320	2.2	80	0.35
Vegetable oil	920	1.8	70	0.17
Honey	1350	2.0	9000	0.33

Note: For Theological constants of typical non-Newtonian food fluids, see Table 3.2



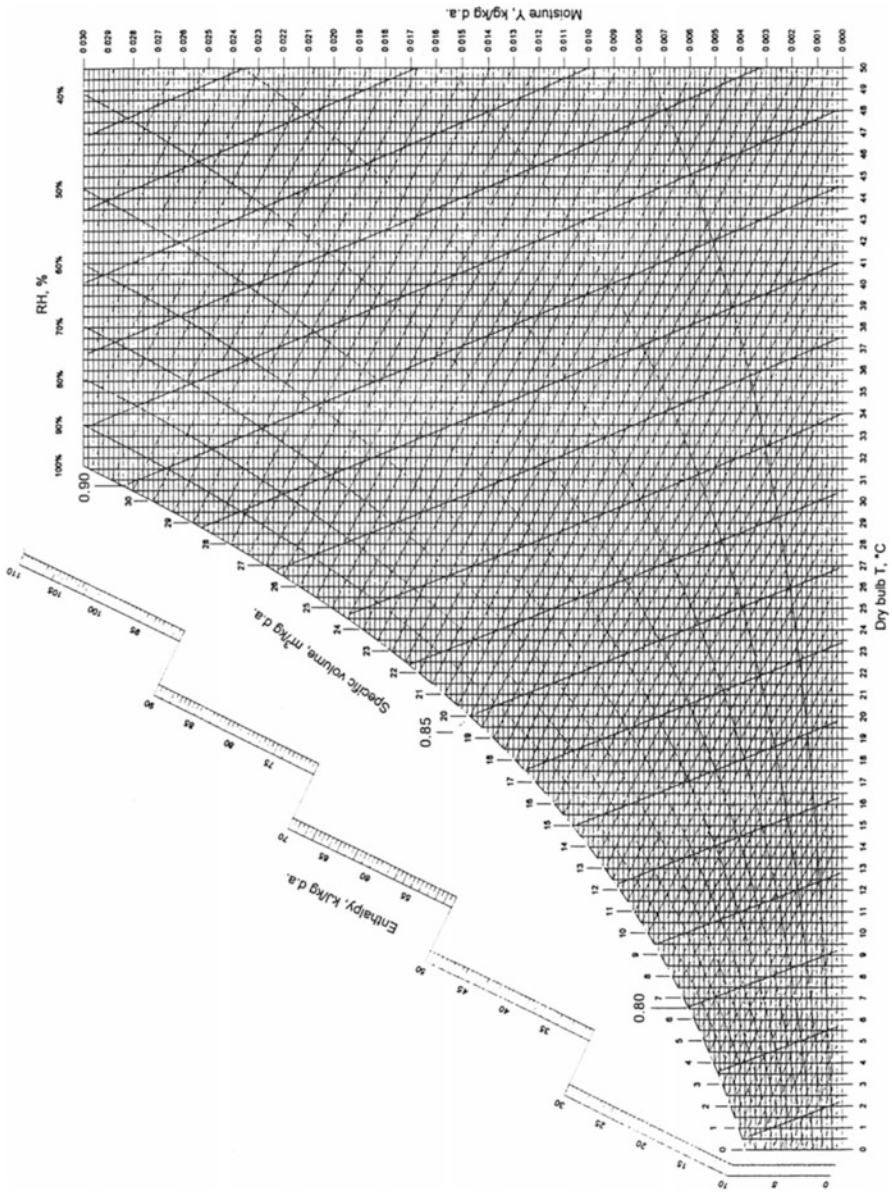


Fig. B.1 Psychrometric chart in the range 0–50 °C. See Fig. 8.1

**Table B.4** Typical physical properties of solid foods

Food product	$X^a$ , kg/kg dm	$\epsilon$ , —	$C_p$ , kJ/kg K	$\lambda$ , W/mK	$D^b$ , $\times 10^{-10}$ m <sup>2</sup> /s
Potato, raw	3.00	0.10	3.6	0.45	5
Potato, dried	0.05	0.15	2.0	0.10	1
Potato, puffed	0.05	0.50	2.0	0.06	0
Carrot, dried	0.05	0.40	2.0	0.08	15
Corn	0.20	0.10	2.1	0.20	0.5
Rice	0.20	0.10	2.1	0.20	0.5
Bread	0.80	0.50	2.8	0.40	2
Pasta	0.15	0.10	2.1	0.20	0.3
Apple, dried	0.30	0.40	2.2	0.20	2
Raisins	0.25	0.10	2.2	0.20	1
Minced beef	0.75	0.15	2.8	0.40	1.5
Codfish	0.50	0.20	2.5	0.30	2

*Notes*

<sup>a</sup> $X$  moisture content,  $\epsilon$  porosity,  $C_p$  specific heat,  $\lambda$  thermal conductivity,  $D$  moisture diffusivity  
<sup>b</sup>Approximate values of  $D$  at other temperatures can be obtained, using the Arrhenius equation with energy of activation for diffusion  $E = 40$  or  $20$  kJ/mol for low- and high-porosity materials, respectively (data from Saravacos and Maroulis (2001))

Average thermo-physical properties for certain food categories

Physical property	Food category	Value	Remarks
Thermal Conductivity $\lambda$ [W/m °C]	(a) Significant water content ( $t > t_F$ )	0.40–0.50	$t$ : Actual product's temperature
	(b) Significant water content ( $t < t_F$ )	0.50–1.20	$t_F$ : Freezing temperature
	(c) Dry food	0.04–0.06	
	(d) Fat, Oil	0.12–0.25	
Thermal Diffusivity $a \times 10^{-8}$ [m <sup>2</sup> /s]	(a) Significant water content ( $t > t_F$ )	$13.9 \times 10^{-8}$	$t > t_F$
	(b) Significant water content ( $t < t_F$ )	$69.5 \times 10^{-8}$	$t < t_F$
	(c) Dry food	$11.1 \times 10^{-8}$	$t > t_F$ , $\rho = 250$ kg/m <sup>3</sup> , $\theta = 20$ °C
	(d) Fat, oil	$8.3 \times 10^{-8}$	$t > t_F$
Specific heat $c$ [kJ/kg °C]	(a) Significant water content ( $t > t_F$ )	2.7–3.9	Depending on water content
	(b) Significant water content ( $t < t_F$ )	1.5–2.3	
	(c) Dry food	1.3–2.1	When $t < t_F$ , $c = 1.3$ kJ/kg °C
	(d) Fat, oil	1.7–2.5	
Viscosity (dynamic) $\eta$ [Pa s]	(a) Great water content, low temperature	$2 \times 10^{-3}$ – $2 \times 10^{-4}$	Water content, 80 %, $t < 40$ °C or: Water content, 70–80 %, $t > 40$ °C
	(b) Middle water content, low temperature	$2 \times 10^{-1}$ – $2 \times 10^{-2}$	Water content = 30–60 %, $t = 20$ – $50$ °C

(continued)

(continued)

Physical property	Food category	Value	Remarks
	(c) Low water content, middle up to high temperature	$4-3 \times 10$	Water content, >30 %, $t = 20-60^\circ\text{C}$ (up to $120^\circ\text{C}$ )
	(d) Very low water content, middle temperature <b>or:</b> low Water content, low temperature	$2 \times 10^2-$ $4 \times 10^2$	Water content 1030 %, $t = 60^\circ\text{C}$ <b>or:</b> Water content: 10-30 %, $t < 50^\circ\text{C}$

Notes: Data from Kostaropoulos (1971), Kostaropoulos (1979), and Kostaropoulos (1981)

## References

- Fooddb (2000) Food properties database. European Cooperative Project. <http://www.nel.uk/fooddb/>
- Haar L, Gallagher JS, Kell GS (1984) NBS/NRC Steam tables. Harper & Row, New York
- Hayes GD (1987) Food engineering data handbook. Longman Scientific and Technical, London
- Jowitz R, Escher F, Hallstrom B, Meffert HFT, Spiess WEL, Vos G (1983) Physical properties of foods. Elsevier Applied Science, London
- Jowitz R, Escher F, Kent M, McKenna B, Roques M (1987) Physical properties of foods, 2nd edn. Elsevier Applied Science, London
- Kostaropoulos ASE (1971) Waermeleitzahlen von Lebensmittel und Methoden zu deren Bestimmung. Bulletin No. 16. LTV/VDA, Frankfurt
- Kostaropoulos AE (1979) Die Bedeutung der Stoffeigenschaften in der Lebensmitteltechnik, Zeitschrift für Lebensmittel-Technologie und—Verfahrenstechnik, 30(4):133–136. ISSN 0341-2938
- Kostaropoulos AE (1981) Letter to the editor. Food Technol 35(10):33–34
- Lewis MJ (1990) Physical properties of foods and food processing systems. Ellis Horwood, London
- Mohsenin NN (1960) Physical properties of plant and animal materials. Structure, physical characteristics and mechanical properties. Gordon and Breach Science, New York
- Mohsenin NN (1978) Thermal properties of foods and agricultural materials. Gordon and Breach Science, New York
- Okos MR (ed) (1986) Physical and chemical properties of food. ASAE, St. Joseph
- Rahman S (1995) Food properties handbook. CRC, New York
- Rao MA (1999) Rheology of fluid and semisolid foods. Aspen, Gaithersburg
- Rao MA, Rizvi SSH (eds) (1995) Engineering properties of foods, 2nd edn. Marcel Dekker, New York
- Saravacos GD, Maroulis ZB (2001) Transport properties of foods. Marcel Dekker, New York
- Singh RP (1993) Food properties database. CRC, New York
- Urbicain MJ, Lozano JE (1997) Thermal and rheological properties of foodstuffs. In: Valentas KJ, Rotstein E, Singh RP (eds) Handbook of food engineering practice. CRC, New York

## Appendix C: Control of Food Processing Equipment

Control and automation of food processes, processing equipment, and processing plants increases significantly the process efficiency and maintains the quality of the food products. Process control brings accuracy, repeatability and flexibility of production in food processing plants. Control of scheduling of batch processes increases the utilization of food processing equipment (see Sect. 2.6.1.2).

Control of food processes and food processing equipment is more difficult than chemical processing, because food properties are not well known and sometimes variable, and food processes are often difficult to model and simulate.

Process control should be considered early in the design process, with electrical and control engineers working together with food process engineers. Process instrumentation and control equipment is provided by specialized suppliers.

Process block diagrams (PBD) and process flow diagrams (PFD) are essential in the design of control systems. They are used to perform material and energy balances, and visualize the various food processing units, before preparing the process control and the piping and instrumentation diagrams (PCD, PID).

Simple control systems include the following elements: sensors (e.g., temperature), actuators (e.g., valves), comparator, and controller. These functions are combined into the programmed logic controllers (PLC), which are attached to a computer.

In food processing, temperature, pressure, moisture, and flow rate are the most common process parameters measured with sensors. Parameters of food quality, such as viscosity, texture, color, and flavor (volatile components), are difficult to measure on-line, and therefore cannot be controlled easily. Computer-aided machine vision, and modern techniques, like fiber optics, are used in control sensors.

The simple “on–off” or proportional controllers (P) have large “dead” response times and they cannot correct effectively the process errors. Improved control is achieved by using combination systems, such as proportional + integral (PI), or proportional + integral + derivative (PID) action. Feedback control systems are used

mostly in food processing, while feedforward systems are difficult to apply, because of inadequate modeling of the complex processes.

PLCs are used to monitor and control various process units. Supervisory control and data acquisition (SCADA) systems, used in other industries, can be applied to food process control. The PLCs of the various process units transmit information through a server to the central computer control system

Load cells, attached to microprocessors and PLCs, are used widely in weighing, filling, and packaging operations (see Chap. 13).

Advanced process control and computer integrated manufacturing (CIM), used in chemical processing, can be applied to food processing, if adequate process data are available. It involves adaptive control, expert control, and neural control. Food process simulators, based on mathematical modeling of processes/equipment, e.g., dryers or sterilizers, can be used to train the operators of food processing plants and improve plant efficiency and product quality.

Suppliers of basic food processing equipment (e.g., pasteurizers and sterilizers) usually provide specialized control equipment for their food processing units.

## References

- ACoFoP IV (1998) Automatic control of food and biological processes. In: International symposium, SIK, Gothenburg, Sweden
- ASAE (1990) Food processing automation. ASAE, St. Joseph
- ASAE (1995) Food processing automation. ASAE, St. Joseph
- Bimbenet JJ, Trystram G (eds) (1990) Automatic control of food processes. ENSIA, Paris
- Bimbenet JJ, Dumoulin E, Trystram G (eds) (1994) Automatic control of food and biological processes. Elsevier Science, Amsterdam
- Coughanowr DR (1991) Process systems analysis and control, 2nd edn. McGraw-Hill, New York
- Hubbard MR (1999) Choosing a quality control system. Technomic, Lancaster
- Kress-Rogers E, Brimelow JB (eds) (2001) Instrumentation and sensors for the food industry. CRC, New York
- Martin T (2000) Process control: designing processes and control systems for dynamic performance. McGraw-Hill, New York
- McFarlane I (1983) Automatic control of food manufacturing processes. Applied Science, Essex
- Mittal GS (ed) (1997) Computerized control systems in the food industry. Marcel Dekker, New York
- Moreira RG (2001) Automatic control for food processing systems. Aspen, Gaithersburg

# Appendix D: Food Plant Utilities

## Industrial Water

Water is required in several food processing operations, such as steam generation, washing of raw materials, cooling, and addition to food products. Water is supplied from deep wells, or from clean rivers and lakes. Water pretreatment may involve removal of suspended solids by sedimentation and filtration, and breakpoint chlorination. Potable water used as food ingredient may require some physicochemical treatment like carbon filtration, and membrane treatment (UF or RO).

Water reuse can reduce wastewater, using the above mechanical and physicochemical methods.

## Steam Boilers

Steam boilers (steam generators) are an important part of the food processing plant, providing process steam for heating, blanching, sterilization, peeling, cleaning, evaporation, and drying.

In some large processing plants, e.g., beet sugar refineries, cogeneration installations are used, producing both process steam and electricity, with better utilization (up to 80 %) of the fuel energy and reduction of the thermal and material pollution of the environment. Two cogeneration systems are used: (1) the topping system, in which high-pressure steam (e.g., 120 bars) produces power (electricity), while the exhaust low-pressure steam (about 2 bars) is used for process applications; (2) the bottoming system, in which high-pressure combustion gases operate gas turbines and the exhaust gases are used to produce process steam. Closed cycle gas turbines operate with high pressure air, heated by combustion of fuel gas, oil, or combustible organic wastes.

Process steam boilers produce 5–200 tons/h steam at a pressure of about 20 bars, which is reduced to about 2 bars, near the steam consumption. Steam generators are usually housed in a separate room for safety and noise reasons. In food processing, natural gas or LPG are the usual fuels, because they are clean and do not pollute the environment. The feed water for steam boilers is normally treated with chemicals, ion exchange, or membranes to remove the undesirable salts, which may cause scaling or corrosion. Production of culinary (potable) steam, used for direct injection in foods, should comply with the hygienic requirements of public health authorities.

## Air Moving and Vacuum Equipment

Fans and blowers are used widely in food plants to move process air in heating, cooling, drying, and air conditioning equipment. Centrifugal and coaxial fans are used for relatively low pressure drops, while blowers and compressors operate at higher pressures.

The fans are characterized by the capacity ( $\text{m}^3/\text{h}$  or cfm)–pressure drop (mm water or inches water) curves, which are similar to those of centrifugal pumps (Chap. 3). Compressors for moving air are similar to the compressors used in refrigeration (Chap. 9).

Industrial vacuum pump equipment includes steam ejectors and liquid (water) ring pumps. The water ring pumps can operate in wet environments, like vacuum evaporation and drying. Steam ejectors require high-pressure steam (about 10 bars). Multistage (e.g., three-stage) ejectors are used to create and maintain vacuum down to about 5 mbar in industrial processing equipment. Liquid ring pumps cannot reach vacuum lower than 10 mbar, because of vapor pressure limitation.

Rotary mechanical pumps, similar to rotary (Roots) blowers, can produce high vacuum, below 1 mbar, which is needed in freeze-drying and in some vacuum distillation equipment (Ryans and Bays 2001).

Air conditioning is applied in food plants either for comfort (offices) or for storage of some products.

## Electrical Equipment

Electrical equipment, used in food processing plants, includes electric motors, electric heating, illumination, and control equipment. Electric motors are particularly important, since they operate most of the food processing equipment.

Alternating-current motors of constant or variable speed are normally used, while direct-current motors are used in some applications. The voltage of motors is 220 V for relatively small motors (up to 100 kW). Higher voltage is required, e.g., 440 V, for motors up to 250 kW.

The speed of the alternating-current motors (rpm) is related to the current frequency (Hz) and the number of poles ( $p$ ), according to the equation

$$\text{rpm} = 120\text{Hz}/p$$

Thus, for 60 Hz current (EU) and two poles,  $\text{rpm} = 3600$ . For 50-Hz current (USA),  $\text{rpm} = 3000$ .

Direct-current motors operate at 115, 230, or 600 V.

## **Waste Treatment**

Food process and plant design, and operating food processing plants should consider environmental pollution problems caused by liquid, gas, and solid discharges from the plants. The pollution control laws and regulations of the country and the region should be taken into consideration in selecting the appropriate measures for the specific processing plant.

Waste pollution is the major problem in food processing, since large amounts of water are used in washing the raw materials, in cleaning, and in cooling operations. Air pollution is important in some food plants with particulate and odorous emissions. Management of solid wastes concerns several food processing plants.

Water and solid wastes from small food processing plants, located near agricultural land, can be disposed to the fields by spray irrigation and soil mixing, if the waste load is not excessive, and if no toxic substances are present. Disposal of wastewater to municipal treatment plants is an alternative, if the treatment cost is acceptable.

## ***Wastewater Treatment***

Large quantities of water are used in the washing of fruits and vegetables prior to processing. Wastewater may contain significant amounts of organic compounds (BOD, COD), suspended solids, and oils. Clean water regulations impose strict limits on the pollutants discharged into rivers, lakes, and seas.

Wastewater may require pretreatment, primary, secondary, and tertiary treatment, before it is discharged to the environment or reused. Pretreatment includes neutralization and removal of oils. Primary treatment involves sedimentation, screening, and filtration. Secondary (biological) treatment involves bio-oxidation of organic compounds in ponds, activated sludge, or biofilters. Tertiary treatment may include adsorption and membrane separations.

The equipment used in wastewater treatment is similar to some of the food processing equipment, described in this book. Examples are filters, membrane systems (MF, UF, RO), gas absorption and adsorption. Economic, high capacity



systems are required in wastewater treatment, in contrast to the specialized, more expensive and efficient equipment used in food processing.

### ***Solid Wastes***

Reduction of solid wastes from food processing plants is of primary importance, e.g., by using more efficient peeling processes. Solid wastes can be used in composting and biogas (methane) production. Production of dehydrated food by-products for animal feeds is an economic alternative, e.g., wastes from sugar, citrus, and fish processing. Land disposal of nontoxic solid wastes may be applied, if the food processing plant is located in an agricultural area, away from populated areas.

The reduction of waste in food processing may be an important challenge for Food Engineering. However, the success in reducing waste or factors that may surcharge the whole process even up to the final product, sometimes may be even related with operations of the production of raw materials. Therefore, good cooperation between the producers and deliverers (e.g., farmers, importers, and preliminary storage and transport facilities) is important.

There are many examples of this fact in plant or animal deliveries up to the final stage of food processing. Here, it is only mentioned a case in the peaches' canning industry. It refers to the role of thinning of the peaches in early stages (e.g., about 4 months before harvesting) in the incidence of split pits. The choice of the right time of action in this agricultural process influences the later fragility of the peach kernels (Drogoudi et al. 1977). A misfortune in thinning increases the percentage of kernel splits in the following canning operations. This causes additional labor during online control, or even quality degradation of the final products.

The early reduction of losses along the food chain is also important in saving energy during processing. Energy misspending, may be achieved, by applying effective but less energy-requiring processes. Here, it could be mentioned, e.g., the low temperature blanching.

Finally, the utilization of peeling and meat-processing wastes could reduce the environmental pollution and further increase the value of waste products. In canning of several plant products, such as potatoes and asparagus, the waste may come up to 50 % of the initially deliveries in a food-processing factory. The choice of the right further processing method (e.g., heat treatment in peeling of potatoes instead of a chemical one) can make waste products further useful as feed (see also Sect. 2.6).

## ***Gas Pollution***

Gas and vapor exhausts may create air pollution problems in the environment of food processing plants, especially if the plant is located close to residential areas. For example, particulate (dust) pollution from spray dryers can be reduced and prevented by proper design of separation equipment, such as cyclones and bag filters.

Odorous gas discharges from edible oil plants and fish processing (e.g., fish meal drying) can be treated in wet scrubbers, using water or alkaline solutions (Chap. 11). Offensive fish odors require special scrubbing solutions, such as chlorine compounds.

## **References**

- Alley ER (2000) *Water quality control handbook*. McGraw-Hill, New York
- Avallone EA, Baumeister T (eds) (1987) *Marks' standard handbook for mechanical engineers*. McGraw-Hill, New York
- Bhatia MV, Cheremisinoff PN (1981) *Air movement and vacuum systems*. Technomic, Lancaster
- Clifford GE (1984) *Heating, ventilating and air conditioning*. Reston Publishing, Reston
- Drogoudi PD, Tsiouridis CG, Pantelidis G (1977) Effects of crop load and time of thinning on the incidence of split pits, fruit yield, fruit quality, and leaf mineral contents in « Andros » peach. In: 23rd conference of EEEO in Chania, Crete, October 1977
- Droste RL (1997) *Theory and practice of water and wastewater treatment*. Wiley, New York
- Eckenfelder WW (1989) *Industrial water pollution control*. McGraw-Hill, New York
- Fink B (1984) *Standard handbook for electrical engineers*. McGraw-Hill, New York
- Jorgensen R (1970) *Fan engineering*. Buffalo Forge, Buffalo
- NAFM (1952) *Standards, definitions, terms and test codes for centrifugal, axial, and propeller fans*. National Association of Fan Manufacturers, Detroit
- Perry RH, Green D (1984/1997) *Chemical engineers handbook*, 6th and 7th edn. McGraw-Hill, New York
- Roberts TC (2002) *Food plant engineering systems*. CRC, Boca Raton
- Ryans J, Bays J (2001) Run clean dry vacuum pumps. *Chem Eng Prog* 97(10):32–41
- Tchobanoglous G, Franklin RL (1991) *Wastewater engineering, treatment, disposal, reuse*, 3rd edn. McGraw-Hill, New York
- USPH (1967) *Air pollution engineering manual*. U.S. Public Health Service, Cincinnati
- Vadagriff RL (2001) *Practical guide to industrial boiler systems*. Marcel Dekker, New York

# Appendix E: Manufacturers and Suppliers of Food Equipment

Directories and Equipment Exhibitions are given in Chap. 2 of this book. Representative suppliers of processing equipment, described in the individual chapters of the book, are presented in the following partial lists.

## Chapter 2: Design and Selection of Food Processing Equipment

### *Cleaning/Sanitizing Equipment*

*Note:* The numbers in parentheses following the name of the firm, indicate the type of cleaning equipment supplied: (1) high pressure/water jet; (2) vapor; (3) ultrasonic; (4) mechanical means; (5) CIP; (6) gas/liquid disinfection.

AmeriVap (2), (6)  
1292 Logan Circle  
Atlanta, GA 30318, USA  
Tel.: (800) 763 7687  
Fax: (404) 350 9214  
e-M: [sales@AmeriVap.com](mailto:sales@AmeriVap.com)

Batech (5), (6)  
421 rue de Conflans  
95220 Herblay, France  
Tel.: +33 39 781230  
Fax: +33 39 780360  
e-M: [batech.utec@wanadoo.fr](mailto:batech.utec@wanadoo.fr)

Aseptomag (5)  
Bachweg 3  
3401 Burgdorf, Switzerland  
Tel.: +41 34 4262929  
Fax: +41 34 426 2928  
e-M: [info@aseptomag.ch](mailto:info@aseptomag.ch)  
<http://www.aseptomag.ch>

Better Engineering (1)  
8361 Town Center Court  
Baltimore, MD 21236-4964, USA  
Tel.: (800) 229 3380  
Fax: (410) 931 0053  
<http://www.betterengineering.com>

Branson Ultrasonics Corporation (3)  
 41 Eagle Road, Danbury, CT 06813-  
 1961, USA  
 Tel.: (203) 7962298  
 Fax: (203) 796-0320  
 e-M: [info@bransoncleaning.com](mailto:info@bransoncleaning.com)

BOC Edwards Pharmaceutical  
 Systems (Calumatic) (3)  
 Postbus 111 (Steenstraat 7)  
 5100 AC Dongen, Netherlands  
 Tel.: +31 162 313454  
 Fax: +31 162 312552  
<http://www.boc.com>

Cryoblast (6)  
 6505 West Calumet Road  
 Milwaukee, WI 53223, USA  
 Tel.: (414) 236 2095  
 Fax: (414) 371 0610  
 e-M: [cryonomic@artimpex.com](mailto:cryonomic@artimpex.com)  
<http://www.artimpex.com>

Europe Hydro (5), (6)  
 42 Boulevard Emile Genevoix  
 93230 Romainville, France  
 Tel.: +33 148 442815  
 Fax: +33 148 430178  
 e-M: [europelhydro@wanadoo.fr](mailto:europelhydro@wanadoo.fr)

Greco Brothers Inc. (3)  
 1 Greco Lane, Providence, RI 02909,  
 USA  
 Tel.: (401) 421 9306  
 Fax: (401)274 8910  
<http://www.grecobrothers.com>

Hammelmann (1)  
 Zum Sundem 13-21  
 59302 Oelde, Germany  
 Tel.: +49 2522 760  
 Fax: +49 2522 76444  
<http://www.hammelmann.de>

Landa (1), (4)  
 4275 NW Pacific Rim Blvd.  
 Camas, WA 98607-8801, USA  
 Tel.: (800) 547 8672  
 Fax: (360) 833 9200  
 e-M: [info@landa.com](mailto:info@landa.com)

R. Bosch (1), (3)  
 Stuttgarter Str. 130  
 71301 Weiblingen, Germany  
 Tel.: +49 7151 1401  
 Fax: +49 7151 142818  
 e-M: [vt@boschpackaging.com](mailto:vt@boschpackaging.com)

Seiberling (6)  
 11415 Main Street  
 Roscoe, IL 61073, USA  
 Tel.: (815) 623 7311  
 Fax: (815) 623 2029

Tennant (1), (4)  
 701 North Lilac Drive  
 P.O. Box 1452  
 Minneapolis, MN 55440, USA  
 Tel.: (763) 540 1200, (800) 553 8033  
 Fax: (763)513 2142  
 e-M: [info@tennantco.com](mailto:info@tennantco.com)

Tri-Clover  
 9201 Wilmore Road  
 Kenosha, WI 53141, USA  
 Tel.: (414) 494 5511  
 Fax: (414) 494 7104

## Chapter 3: Mechanical Transport and Storage Equipment

### *Pumps, Pneumatic, Hydraulic Transport*

*Note:* The numbers in parentheses following the names of firm, indicate the type of the pump mainly supplied. (1) centrifugal/radial flow pump; (2) centrifugal/axial flow pump; (3) piston pump; (4) diaphragm pump; (5) progressive cavity pump; (6) twin-screw pump; (7) gear pump; (8) lobe pump; (9) vane pump, (10) peristaltic pump; (11) jet pump.

AEA Technology pic (3), (6), (8), (11)  
Harwell  
Didcot  
Oxfordshire OX11 0QJ, UK  
Tel.: +44 1235 821111  
Fax: +44 1235 432916  
e-M: [enquirv@aeat.co.uk](mailto:enquirv@aeat.co.uk)

Alfa Laval AB (1), (8)  
(Alfa Laval Flow)  
Box 73, Rudeboksvägen 3  
221 00 Lund, Sweden  
Tel.: +46 46 3670 00  
Fax: +46 46 367182  
e-M: [info@alfalaval.com](mailto:info@alfalaval.com)

Allweiler AG (1), (2), (9), (10), (11)  
Allweilerstr. 1  
Postfach 1140  
78315 Radolfzell, Germany  
Tel.: +49 7732 860  
Fax: +49 7732 86436  
e-M: [service@allweiler.de](mailto:service@allweiler.de)

APV (1), (3), (8)  
P.O. Box 4  
Gatwick Road  
Crawley RH10 2QB, UK  
Tel.: +44 1293 527777  
Fax: +44 1293 535104  
<http://www.apv.com>

Bran + Luebbe GmbH (3), (4)  
Werkstrasse 4  
22844 Norderstedt, Germany  
Tel.: +49 40 522 02 0  
Fax: +49 40 522 02 444

Dairy Engineering Co. (APV-Gaulin)  
(1), (3), (8)  
5783 North Sheridan Blvd.  
Arvada, CO 80002-2847, USA  
Tel.: (303) 423 2332  
Fax: (303) 423 0740  
e-M: [applications@dairveng.com](mailto:applications@dairveng.com)

Fryma-Koruma Maschinen AG (8)  
Postfach 235 Theodorshofweg 6  
4310 Rheinfelden, Switzerland  
Tel.: +41 61 8364141  
Fax: +41 61 8312000  
e-M: [achimgr@romacolzaruma.com](mailto:achimgr@romacolzaruma.com)

Hudson Pump and Associates, LLC  
(FBM) (1), (2)  
3524 Craftsman Boulevard  
Lakeland, FL 33803, USA  
Tel.: (863) 665-PUMP (7867)  
Tel.: (800) 780-7867  
Fax: (863) 666-5649  
e-M: [info@hudsonpump.com](mailto:info@hudsonpump.com)

KSB Aktiengesellschaft (1), (2)  
 Johann-Klein Strasse 9  
 67227 Frankenthal, Germany  
 Tel.: +49 6233 86 0  
 Fax: +49 6233 8634 01  
 e-M: [info@ksbgroup.com](mailto:info@ksbgroup.com)

KWW-Depa-Via (4), (7), (9), (10)  
 Postfach 111240  
 4 Dusseldorf 11, Germany  
 Tel.: +49 211 59560  
 Fax: +49 211 5956111

Mono Pumps Ltd (5), (8)  
 Martin Street  
 Audenshaw  
 Manchester M34 5DQ, UK  
 Tel.: +44 161 339 9000  
 Fax: +44 161 2142146  
 e-M: [info@mono-pumps.com](mailto:info@mono-pumps.com)

Moyno, Inc. (Robbins & Myers Inc.) (5)  
 P.O. Box 960  
 Springfield, OH 45501-0960, USA  
 Tel.: (877)4UMOYNO or  
 (877) 486 6966  
 Fax: (937) 327 3177  
 e-M: [mipinfo@movno.com](mailto:mipinfo@movno.com)

Netzsch Mohnopumpen GMBH (5),  
 (8), (9)  
 Geretsrieder Strasse 1  
 84478 Waldkraiburg, Germany  
 Tel.: +49 8638 630  
 Fax: +49 8638 67981  
 e-M: [info@nmp.netzsch.com](mailto:info@nmp.netzsch.com)

Nikkiso Pumps America, Inc. (1), (2),  
 (3), (4), (6)  
 6100 Easton Road  
 P.O. Box 427  
 Plumsteadville, PA 18949, USA  
 Tel.: (215) 766 7867  
 Fax: (215) 766 8290  
 e-M: [sales@nikkisoamerica.com](mailto:sales@nikkisoamerica.com)

Pompe Cucchi Sri (3), (4), (6), (7)  
 Via dei Pioppi, 39  
 20090 Opera (MI), Italy  
 Tel.: +39 02 57606287  
 Fax: +39 02 57602257  
 e-M: [sales@pompecucchi.it](mailto:sales@pompecucchi.it)

Sulzer Weise GmbH (1), (2)  
 Postfach 3027  
 D-76642 Bruchsal, Germany  
 Tel.: +49 7251 7 62 01  
 Fax: +49 7251 7 64 01  
 e-M: [helga.stemberger@sulzer.ch](mailto:helga.stemberger@sulzer.ch)

Verder Liquids (4), (7), (10)  
 Utrechtsweg 4A Postbus 1  
 3450 AA Vleuten, Netherlands  
 Tel.: +31 677 9211  
 Fax: +31 677 1402  
 e-M: [info@verder.com](mailto:info@verder.com)

Waukesha Cherry-Burrell (8), (9)  
 611 Sugar Creek Road  
 Delavan, WI 53115, USA  
 Tel.: (800) 252 5200 or 414 728 1900  
 Fax: (800) 252 5012 or 414 728 4904  
 e-M: [custserv@gowcb.com](mailto:custserv@gowcb.com)

## ***Mechanical/Pneumatic Conveying***

*Note:* The numbers in parentheses following the name of the firm, indicate the type of conveyor mainly supplied: (1) belt/uniform; (2) belt/segmented; (3) modular chain; (4) roller/skate; (5) chain; (6) bucket; (7) screw; (8) vibratory; (9) spiral; (10) magnetic (11) pneumatic.

Allpax (1), (2), (3), (4)  
13510 Seymour Myers Blvd.  
Convington, LA 70433, USA  
Tel.: (985) 893 9277  
Fax: (985) 893 9477  
e-M: [info@allpax.com](mailto:info@allpax.com)  
<http://www.allpax.com>

Apia Transitube (9)  
Atalante Apigne  
35650 Le Rheu, France  
Tel.: +33 299 146233  
Fax: +33 299 146235  
e-M: [apia-sa@infonie.fr](mailto:apia-sa@infonie.fr)  
<http://www.rennes-atalante.fr/directorv/apia.htm>

Azo (8), (11)  
Industriegebiet Ost  
Rosenberger Strasse 28  
74706 Osterbrucken, Germany  
Tel.: +49 62 91 92-0  
Fax: +49 62 91 8928  
e-M: [zentrale@azo.de](mailto:zentrale@azo.de)

Beumer Maschinenfabrik GmbH &  
Co. KG (1), (6), (7), (8)  
Postfach 12 54  
59267 Beckum, Germany  
Tel.: +49 25 21 24 0  
Fax: +49 25 21 24 280  
e-M: [beumer@beumer.com](mailto:beumer@beumer.com)  
<http://www.beumer.com>

Bühler AG (8), (11)  
Industriestrasse  
9240 Uzwil, Switzerland  
Tel.: +41 71 955 11 11  
Fax: +41 71 955 33 79  
e-M: [buhler.uzwil@buhlergroup.com](mailto:buhler.uzwil@buhlergroup.com)

Caustier France (1), (2), (4), (5)  
110 Avenue Georges Caustier  
660 Perpignan, France  
Tel.: +33 468 544343  
Fax: +33 468 555133  
e-M: [commercial.fr@caustier.com](mailto:commercial.fr@caustier.com)

Charles Walker (1)  
John Escritt Road  
Bingley, BD 16 2SU, UK  
Tel.: +44 1274 560211  
Fax: +44 1274 569002  
e-M: [sales@charleswalker.co.uk](mailto:sales@charleswalker.co.uk)

Conveyors, Incorporated (7)  
620 South Fourth Avenue  
Mansfield, TX 76063, USA  
Tel.: (817) 473 4645  
Fax: (817) 473 3024  
e-M: [sales@convevorsinc.net](mailto:sales@convevorsinc.net)

Dma (1), (2), (3)  
Eugen Diesel Stasse 8  
37671 Hoexter, Germany  
Tel.: +49 5271 9706-0  
Fax: +49 5271 970699  
e-M: [dma@dma-foerdertechnik.de](mailto:dma@dma-foerdertechnik.de)

Eurobelt Systems S.L. (3)  
Topacio 39  
47012 Valladolid (Spain)  
Tel.: +34 983 217480  
Fax: +34 983 217481  
e-M: [eurobelt@eurobelt.com](mailto:eurobelt@eurobelt.com)  
<http://www.eurobelt.com>

Ewab Components & Development (2)  
Laduvägen 1  
592 40 Vadstena, Sweden  
Tel.: +46 143 75025  
Fax: +46 143 75030  
<http://www.ewab.com>

Fmc, FoodTech (2), (4), (5), (6), (7)  
 Food Processing Systems  
 2300 Industrial Avenue  
 Box A  
 Madera, CA 93639, USA  
 Tel.: (559) 661 3200  
 Fax: (559) 661 3222  
 e-M: [fpsd.info@intl.fmcti.com](mailto:fpsd.info@intl.fmcti.com)

Heliveyor (4)  
 Kristalli Str. 1  
 12131 Athens, Greece  
 Tel.: +30 1 5771619  
 Fax: +30 1 5749040

Krones (1), (2), (4), (5), (11)  
 Boehmerwald Strasse 5  
 93068 Neutraubling, Germany  
 Tel.: +49(94 01)70-0  
 Fax: +49 (94 01) 70 24 88/70 32 39  
 e-M: [sales@krones.de](mailto:sales@krones.de)

Manipul (4), (11)  
 Brasil 220-Lanis (1824)  
 Buenos Aires, Argentina  
 Tel./Fax: 54114208-2101  
 (switchboard)  
 e-M: [info@manipul.com](mailto:info@manipul.com)

McNichols Conveyor Co. (1), (3), (5)  
 26211 Central Park Blvd.  
 Southfield, MI 48076, USA  
 Tel.: (800) 331 1926  
 Fax: (248) 357 6078  
 e-M: [sales@mcnicholsconveyor.com](mailto:sales@mcnicholsconveyor.com)

Moellers (1)  
 Sudhoferweg 93  
 Beckum 592690, Germany  
 Tel.: +49(2521)88144  
 Fax: +49 (2521) 88100  
 e-M: [postmaster@moellers.de](mailto:postmaster@moellers.de)

Nerak (2), (3), (6)  
 Ffrwdgrech Industrial Estate  
 Brecon, Powys LD3 8LA, UK  
 Tel.: +44 1874 612900  
 Fax: +44 1874 612918/612915  
 e-M: [info@nerak-wiese.co.uk](mailto:info@nerak-wiese.co.uk)

Olympia Conveyors (1)  
 Santa Barbara, CA 93109, USA  
 Tel.: (805) 9675185  
 Fax: (805) 9671282  
 e-M: [olympia23@home.com](mailto:olympia23@home.com)  
<http://www.olvmplaconveyors.com>

Praezi Foerdertechnik (7), (9)  
 Brockstra\_e 12  
 49163 Bohmte  
 Brock Strasse 12  
 49163 Bohmte, Germany  
 Tel.: +49 5471 80 50  
 Fax: +49 5471 80520  
 e-M: [pft@praezi.de](mailto:pft@praezi.de)

Saturn (1), (2)  
 7 Faraday Place  
 Stephenson Way Industrial Estate  
 Thetford, Norfolk IP24 3RG, UK  
 Tel.: +44 1842 766109  
 Fax: +44 1842 766312  
 e-M: [satumfabrications@totalise.co.uk](mailto:satumfabrications@totalise.co.uk)

Schreyer (1), (2), (3), (4)  
 6, rue de l' Artisanat  
 67700 Saverne, France  
 Tel.: +33 (0) 388 913459  
 Fax: +33 (0) 388 712440

Stork (2), (4), (6)  
 Ketelstraat 2  
 1021 JX Amsterdam, Netherlands  
 Tel.: +31 (20) 6348911  
 Fax: +31 (20) 6369754  
 e-M: [info@stork-food.com](mailto:info@stork-food.com)



Transnorm System (1), (4)  
 Förster Strasse 2  
 31177 Harsum, Germany  
 Tel.: +49 5127/402-0  
 Fax: +49 5127/4400  
 e-M: [Vertrieb-Systeme@transnorm.de](mailto:Vertrieb-Systeme@transnorm.de)

Trapo Nederland (1), (4)  
 Merwedeweg 7 (5) NL-3621 LP  
 P.O. Box 86  
 3620 AB  
 Breukelen, Netherlands  
 Tel.: +31 (346) 26 41 74  
 Fax: +31 (346) 26 47 74  
 e-M: [info@trapo.nl](mailto:info@trapo.nl)  
<http://www.trapo.nl>

Turatti (2), (4), (7), (8), (10)  
 Viale Regina Margherita 42  
 30014 Cavazere (Venezia), Italy  
 Tel.: +39 0 426 310731  
 Fax: +39 0 426 310500  
 e-M: [turatti@iol.it](mailto:turatti@iol.it)

Uni-Kettentechnik (2), (3)  
 Münster Strasse 57a  
 48431 Rheine, Germany  
 Tel.: +49 5971 15092  
 Fax: +49 5971 54016

Vebe Teknik AB (5)  
 Huvudkontor  
 574 95 Bjoerkoeby, Sweden  
 Tel.: +46 383 31200  
 Fax: +46 383 31191  
 e-M: [info@vebe-teknik.se](mailto:info@vebe-teknik.se)  
<http://www.vebe-teknik.se>

Vibra-Pro Co. Inc. (8)  
 Boise, Idaho, ID 83701, USA  
 Tel.: (208) 362 5548  
 Fax: (208) 362 5568  
 e-M: [engineering@vibapro.com](mailto:engineering@vibapro.com)

Vibra Screw (7), (8), (9)  
 755 Union Blvd.  
 Totowa, NJ 07512, USA  
 Tel.: (973) 256 7410  
 Fax: (973) 256 7567  
 e-M: [info@vibrascrewinc.com](mailto:info@vibrascrewinc.com)  
<http://www.vibrasrewinc.com>

### ***Storage Containers, Bins, Silos***

*Note:* The numbers in parentheses following the name of the firm indicate the type of storage equipment mainly supplied: (1) containers; box pallets, (2) silos; (3) Silo emptying (e.g. activator).

Capp-Plast (1)  
 Via Galcanese 105f  
 59100 Prato, Italy  
 Tel.: +39 (574)43811  
 Fax: +39 (574) 37734  
 e-M: [exports@capp-plast.com](mailto:exports@capp-plast.com)  
<http://www.capp-plast/capp>

CombiteX/CEPI (1)  
 Via Partisani 8  
 47010 Predappio, Italy  
 Tel.: +39 543 940514  
 Fax: +39 543 940534  
 e-M: [cepi@cepisilos.com](mailto:cepi@cepisilos.com)  
<http://www.capisilos.com>

Manipul (3)  
 Brasil 220-Lanis (1824)  
 Buenos Aires, Argentina  
 Tel./Fax: 54114208-2101  
 (switchboard)  
 e-M: [info@manipul.com](mailto:info@manipul.com)

Mucon (Kemutec) (3)  
 Springwood Way  
 Macclesfield  
 Cheshire SK10 2ND, UK  
 Tel.: +44 1625 412000  
 Fax: +44 1625 412001  
 e-M: [sales@mucon.com](mailto:sales@mucon.com)  
<http://www.mucom.com>

TNT Materials Handling (1)  
 Units 7-10 Park Lane Trading Estate  
 Park Lane  
 Oldbury, West Midlands B69 4JX, UK  
 Tel.: +44 121 5445154  
 Fax: +44 121 5445912

Vebe Teknik AB (1), (2), (3)  
 Huvudkontor  
 574 95 Bjoerkoeby, Sweden  
 Tel.: +46-383 312 00  
 Fax: +46-383 311 91  
 e-M: [info@vebe-teknik.se](mailto:info@vebe-teknik.se)  
<http://www.vebe-teknik.se>

Vibra Screw (1), (3)  
 755 Union Blvd.  
 Totowa, NJ 07512, USA  
 Tel.: (973) 256 7410  
 Fax: (973) 256 7567  
 e-M: [info@vibrascrewinc.com](mailto:info@vibrascrewinc.com)  
<http://www.vibrascrewinc.com>

Warwick Container Systems (1)  
 Leamington SPA  
 Warwicks CV31 3JT, UK  
 Tel.: +44(1926)314120  
 Fax: +44 (1926) 88571  
 e-M: [post@warwickcontainer.demon.co.uk](mailto:post@warwickcontainer.demon.co.uk)

Wisag (Alucon) (1)  
 Oerlicon Str. 88  
 8057 Zurich, Switzerland  
 Tel.: +41 4 2263600  
 Fax: +41 4 2261200  
 e-M: [info@wisag.ch](mailto:info@wisag.ch)  
<http://www.wisag.ch>

Zeppelin (2), (3)  
 Leuthold Strasse 108  
 88045 Friedrichshafen, Germany  
 Tel.: +49 (7541) 2020  
 Fax: +49 (7541) 202491  
 e-M: [zentralfh@zeppelin.com](mailto:zentralfh@zeppelin.com)  
<http://www.zeppelin-industrv.com>

## Chapter 4: Mechanical Processing Equipment

*Note:* The numbers in parentheses following the name of the firm, indicate the type of equipment mainly supplied: (1) cutting ; (2) meat grinding; (3) sawing; (4) grinding; (5) crushing; (6) milling; (7) colloid mills; (8) jet mills; (9) agglomeration; (10) coating; (11) mixing; (12) extruding; (13) homogenizing; (14) hammer mills; (15) roller mills; (16) forming; (17) kneading.

***Size Reduction Equipment***

Alexanderwerk (1), (5), (9)  
 Kippdorf Strasse 6-24  
 P.O. Box 10 01 63,  
 42801 Remscheid, Germany  
 Tel.: +49 2191 795216  
 Fax: +49 2191 795350  
 e-M: [imaschinen@alexanderwerk.com](mailto:imaschinen@alexanderwerk.com)  
<http://www.alexanderwerk.com>

Amandus Kahl Hamburg (5), (6), (9)  
 Diesel Strasse 5-9  
 21465 Reinbek, Germany  
 Tel.: +49 4072771-0  
 Fax: +49 4072771-100  
 e-M: [info@amandus-kahl-group.de](mailto:info@amandus-kahl-group.de)  
<http://www.amandus-kahl-group.de/>

Amandus Kahl Hamburg Companies  
 Neuhaus Neotec  
<http://www.neuhaus-neotec.de>  
 F.H. Schule Muehlenbau  
<http://www.schulerice.com>  
 Berthold Wachtel  
<http://www.amandus-kahlgrou.de/hm/wachtel>

APV Baker (12), (13), (16)  
 Manor Drive  
 Paston Parkway  
 Peterborough PE4 7AP, UK  
 Tel.: +44 1733 283000  
 Fax: +44 1733 283001  
 e-M: [email@apvbaker.com](mailto:email@apvbaker.com)  
<http://www.apvbaker.com>

Atlantic Coast Crushers, Inc. (5)  
 128 Market Street  
 Kenilworth, NJ 07033, USA  
 Tel.: (908) 259-9292  
 Fax: (908) 259-9280  
 e-M: [info@gocrushers.com](mailto:info@gocrushers.com)  
<http://www.gocrushers.com>

Atritor (4), (8)  
 P.O. Box 101  
 Coventry CV65RD, UK  
 Tel.: +44 24 76662266  
 Fax: +44 24 76665751  
 e-M: [Sales@atritor.com](mailto:Sales@atritor.com)  
<http://www.atritor.com>

BCH (1), (11)  
 Spring Place, Millfold  
 Whitworth, Lancashire OL12 8DN, UK  
 Tel.: +44 1706 852122  
 Fax: +44 1706 853010  
 e-M: [info@bchltd.com](mailto:info@bchltd.com)  
<http://www.bchltd.com>

Biro (1), (2)  
 1114 West Main Street  
 Marblehead, OH 43440, USA  
 Tel.: (419) 798 4451  
 Fax: (419) 798 9106  
 e-M: [sales-department@birosaw.com](mailto:sales-department@birosaw.com)  
<http://www.birosaw.com>

British Rema Lucas Works (8)  
 Sheffield Road  
 Dronfield, Sheffield S18 2HX, UK  
 Tel.: +44 1246 411771  
 Fax: +44 1246 417216  
 e-M: [processeng@britishrema.co.uk](mailto:processeng@britishrema.co.uk)  
<http://www.britishrema.co.uk>

Buehler (6), (12)  
 Industriestrasse  
 9240 Uzwil, Switzerland  
 Tel.: +41 71 955 11 11  
 Fax: +41 71 955 33 79  
 e-M: [buhler.uzwil@buhlergroup.com](mailto:buhler.uzwil@buhlergroup.com)  
<http://www.buhlergroup.com>

Cleextral (12)  
 ZI de Chazeau  
 42700 Firminy, France  
 Tel.: +33 477403131  
 Fax: +33 477403123  
 e-M: [cleextral.sales@hol.ff](mailto:cleextral.sales@hol.ff)  
<http://www.cleextral.com>

Clivanexport (17)  
 P.O. Box 1003  
 38110 Volos, Greece  
 Tel.: +30 421 95217  
 Fax: +30 421 95262  
 e-M: [cliva@hol.gr](mailto:cliva@hol.gr)

Dadaux S.A. (1), (2)  
 Le Bouchaud  
 39800 Bersaillin, France  
 Tel.: +33 3 84 85 51 71  
 Fax: +33 3 84 85 53 92  
 e-M: [info@dadaux.com](mailto:info@dadaux.com)  
<http://www.dadaux.com>

Esmach (17)  
 Via Vittorio Veneto  
 36040 Grisignano di Zocco(VI), Italy  
 Tel.: +39 (444) 614777  
 Fax: +39 (444) 614708  
 e-M: [export@esmach.it](mailto:export@esmach.it)  
<http://www.esmach.it>

Fitzpatrick (4), (5), (8), (14)  
 832 Industrial Drive  
 Elmhurst, IL 60126, USA  
 Tel.: (630) 530 3333  
 Fax: (630) 530 0832  
 e-M: [info@fitzmill.com](mailto:info@fitzmill.com)  
<http://www.fitzmill.com>

F.L. Smidth Inc./Fuller (15)  
 2040 Avenue C  
 Bethlehem, PA 18017-2188, USA  
 Tel.: (610) 264 6011  
 Fax: (610) 264 6170  
 e-M: [info@flsmidth.com](mailto:info@flsmidth.com)

Forberg (9), (11)  
 Hegdal  
 3261 Larvik, Norway  
 Tel.: +47 33 133434  
 Fax: +47 33 133435  
 e-M: [forberg@forberg.no](mailto:forberg@forberg.no)  
<http://www.forberg.no>

Gebr. Loedige (9), (11)  
 Elsener Strasse 7-9  
 33102 Padebom, Germany  
 Tel.: +49 5251 3090  
 Fax: +49 5251309123  
 e-M: [info@loedige.de](mailto:info@loedige.de)  
<http://www.loedige.de>

Glatt (9)  
 Process Technology  
 79589 Binzen, Germany  
 Tel.: +49 7621 664-0  
 Fax: +49 7621 64723  
 e-M: [mail@glatt.de](mailto:mail@glatt.de)  
<http://glatt.de>

Guerin Pierre (13)  
 179 Grand'Rue  
 BP 12, 79210 Mauze, France  
 Tel.: +33 549 263058  
 Fax: +33 549 263484  
 e-M: [pierreguer.in.sa@wanadoo.fr](mailto:pierreguer.in.sa@wanadoo.fr)

Hoegger-Alpina  
 Ringstr. 14  
 9201 Gossau, Switzerland  
 Tel.: +41 71 3886363  
 Fax: +41 71 3886300  
 e-M: [info@tippertie.ch](mailto:info@tippertie.ch)

Hosokawa Micron Corp. (4), (5), (6),  
 (9), (10), (11), (14)  
 5-14, 2-Chome, Kawaramachi  
 Chuo-ku, Osaka 541-0048, Japan  
 Tel.: +81 6 6233-3968  
 Fax: +81 6 6229-9261  
 e-Mail: [inter@hmc.hosokawa.com](mailto:inter@hmc.hosokawa.com)

Hosokawa Companies/Selection

Hosokawa Bepex (D), e-M:  
[compaction@bepex.hosokawa.com](mailto:compaction@bepex.hosokawa.com)

Hosokawa Micron Powder (USA),  
e-M: [info@hmpps.hogokawa.com](mailto:info@hmpps.hogokawa.com)

Hosokawa Alpine (D)

Hosokawa Schugi (NL), e-M:  
[general@hschugibv.hosokawa.com](mailto:general@hschugibv.hosokawa.com)

Kalmeijer (16)

Fruchtweg 11-13

2526 KE, The Hague, Netherlands

Tel.: +31 70 3888950

Fax: +31 70 3890238

e-M: [info@kalmeijer.com](mailto:info@kalmeijer.com)

Kobiro (16)

36 Fujiwashizuka, Harue-cho

Sakai-gun, Fukui 9190411, Japan

Tel.: +81 776 51 5100

Fax: +81 776 51 5103

<http://www.kobird.co.jp>

Machinefabriek M.A. Rademaker (16)

Plantijnweg 23

4104 AK Culemborg, Netherlands

Tel.: +31 3450 18880

Fax: +31 3450 16485

Maschinen-und Muehlenbau

Wittenberg (6)

Dresdener Strasse 16

06886 Lutherstadt Wittenberg,

Germany

Tel.: +49 34 91 43 90

Fax: +49 34 91 43 93 85

e-M: [info@muehlenbau.de](mailto:info@muehlenbau.de)

<http://www.muehlenbau.de>

MikroPul (4)

Welserstrasse 9-11

51149 Köln, Germany

Tel.: +49 2203 9391-0

Fax: +49 2203 9391-293

e-M: [info@mikropul.de](mailto:info@mikropul.de)

<http://www.mikropul.de>

Netzsch-Condux (4), (5), (6), (8), (11),  
(14)

Sedan Strasse 70

95100 Selb, Germany

Tel.: +49 9287/7970

Fax: +49 9287/79749

e-M: [info@nft.netzsch.com](mailto:info@nft.netzsch.com)

<http://www.netzsch-mahlen.de>

Nivoba (4)

P.O. Box 40

Industrieweg 1

Veendam, Netherlands

Tel.: +31 59 861 9456

Fax: +31 59 861 2194

e-M: [info@nivoba.nl](mailto:info@nivoba.nl)

<http://www.nivoba.com>

Norfo (1), (3)

12, Sandemandsvej

3700 Roenne, Denmark

Tel.: +45 5695 7272

Fax: +45 5695 7799

e-M: [mail@norfo.com](mailto:mail@norfo.com)

Reon (16)

2-3 Nozawa-machi

Utsunomiya 320, Japan

Tel.: +81 286 65 1111

Fax: +81 286 66 1013

RMS Roller-Grinder, Inc. (5)

27116 Grummand Ave.

Tea, SD 57064-8113, USA

Tel.: (605) 368 9007 or

(888) 283 9337

Fax: 605 368 2411

e-M: [rollergrind@dtgnet.com](mailto:rollergrind@dtgnet.com)

<http://www.rmsroller>

Romaco/Fryma-Koruma (7), (13)

Theodorshofweg

4310, Rheinfelden, Switzerland

Tel.: +41 61 8364141

Fax: +41 61 8312000

e-M: [fiymakoruma@romaco.com](mailto:fiymakoruma@romaco.com)

Roncaglia (6)  
 Viale Reiter, 51/2-P.O. Box 519  
 41100 Modena, Italy  
 Tel.: +39 59 218899  
 Fax: +39 59 247000  
 Telefax: +39 59 218820 (series)  
 e-M: [info@roncagliaopr.it](mailto:info@roncagliaopr.it)  
<http://www.pianeta.it/roncaglia>

Ruberg-Mischtechnik (9), (11)  
 Halbstaedter Strasse 55  
 33106 Padebom, Germany  
 Tel.: +49 5251 173630  
 Fax: +49 5251 1736-99  
 e-M: [info@ruberg.com](mailto:info@ruberg.com)  
<http://www.ruberg.de>

Schutte Pulverizer Company, Inc. (14)  
 Buffalo Hammer Mill  
 61 Depot Street  
 Buffalo, NY 14206, USA  
 Tel.: (716) 855 1555  
 Fax: (716) 855 3417  
<http://www.hammermills.com>

Seewer (16)  
 3400 Burgdorf, Switzerland  
 Tel.: +41 34 4208111  
 Fax: +41 34 4208199  
 e-M: [info@ch.rondodoge.com](mailto:info@ch.rondodoge.com)  
<http://www.ch.rondodoge.com>

SFK (1), (3)  
 Tranformervej 9  
 2730 Herlev, Danmark  
 Tel.: +45 44 503700  
 Fax: +45 44 923710  
 e-M: [info@sfktech.com](mailto:info@sfktech.com)  
<http://www.sfktech.com>

Simpson Technologies Corporation  
 (11), (15)  
 751 Shoreline Drive  
 Aurora, IL 60504-6194, USA  
 Tel.: (630) 978 0044  
 Fax: (630) 978-0068  
 e-M: [jdmcmillin@simpsonotech.com](mailto:jdmcmillin@simpsonotech.com)  
<http://www.simpsonotech.com>

Talsabell (1), (2)  
 Plo. Industria VSalucl, 8  
 46950 Xirivella, Valencia, Spain  
 Tel.: +34 963 132178  
 Fax: +34 963 132180  
 e-M: [talsa@talsanet.com](mailto:talsa@talsanet.com)  
<http://www.talsanet.com>

Toy Rene (6), (11)  
 Route de Reclusages  
 41800 Momtoire, France  
 Tel.: +33 254 850110  
 Fax: +33 254 726067

Urschel (1)  
 2503 Calumet Ave., P.O. Box 2200  
 Valparaiso, IN 46384-2200, USA  
 Tel.: (219) 464 4811  
 Fax: (219) 462 3879  
 e-M: [info@urschel.com](mailto:info@urschel.com)  
<http://www.urschel.com>

Vomm (12)  
 Via Curiel, 252  
 20089 Rozzano—Milano, Italy  
 Tel.: +39 2 5751 0808  
 Fax: +39 2 5751 0909  
 e-M: [vomm@vomm.it](mailto:vomm@vomm.it)  
<http://www.vomm.it>

Wenger (12)  
 Suite 510 Northpointe Circle I  
 7505 N.W. Tiffany Springs Parkway  
 Kansas City, MO 64153, USA  
 Tel.: (816) 891 9272  
 Fax: (816) 891-8969  
<http://www.wenger.com>

Werner & Pfleiderer (12), (16), (17)  
 Frankfurter Strasse 17  
 71732 Tamm, Germany  
 Tel.: +49 7141 202 0  
 Fax: +49 7141 202 111  
 e-M: [info@wpib.de](mailto:info@wpib.de)  
<http://www.wpib.de>

Wilhelm Fette (9)  
 Grauberstrasse 24  
 21493 Schwarzenbek, Germany  
 Tel.: +49 4151 120  
 Fax: +49 4151 3797  
<http://www.fette.com>

Wolfking (1), (2)  
 6 Industrivej, DK-4200 Slagelse,  
 Denmark  
 Tel.: +45 58 502525  
 Fax: +45 58 501031  
<http://www.wolfking.dk>

### ***Agglomeration Equipment***

Amandus Kahl GmbH & Co  
 Diesel Strasse 5-9  
 21465 Reinbek, Germany  
 Tel.: +49 4072 7710  
 Fax: +49 4072 771100  
 e-M: [info@amandus-kahl-groupe.de](mailto:info@amandus-kahl-groupe.de)

Gebr. Loedige GmbH  
 Maschinenbau  
 Elsenerstrasse 7-9  
 33102 Padebom, Germany  
 Tel.: +49 5251 3090  
 Fax: +49 5251 309123  
 e-M: [info@loedige.de](mailto:info@loedige.de)  
<http://www.loedige.de>

Glatt GmbH  
 Process Technology  
 79589 Binzen, Germany  
 Tel.: +49 7621 664-0  
 Fax: +49 7621 64723  
 e-M: [info@glatt.de](mailto:info@glatt.de)  
<http://www.glatt.de>

Hosokawa Bepex GmbH  
 Postfach 1152  
 D-74207 Leingarten, Germany  
 Tel.: +49 7131 9070  
 Fax: +49 7131 907301  
 e-M: [info@hbpx.hosokawa.com](mailto:info@hbpx.hosokawa.com)  
<http://www.bepex.com>

Hosokawa Schugi B.V.  
 29 Chromstraat  
 8211 AS Leystad, Netherlands  
 Tel.: +31 320 286660  
 Fax: +31 320 223017  
 e-M: [schugi@hmbv.hosokawa.com](mailto:schugi@hmbv.hosokawa.com)

Lurgi AG  
 Lurgi Allee 5  
 60439 Frankfurt/M, Germany  
 Tel.: +49 69 58080  
 Fax: +49 69 58083888  
 e-M: [kommunikation@lurgi.de](mailto:kommunikation@lurgi.de)  
<http://www.lurgi.com>

Ruberg-Mischtechnik K.G.  
 Halbstaedter Strasse 55  
 33106 Padebom, Germany  
 Tel.: +49 5251 173630  
 Fax: +49 5251 173699  
 e-M: [info@ruberg.com](mailto:info@ruberg.com)

Maschinenfabrik Gustav Eirich  
 Waldduemer Strasse 50  
 74736 Hardheim, Germany  
 Tel.: 06283-51-0  
 e-M: [eirich@eirich.de](mailto:eirich@eirich.de)

## Chapter 5: Mechanical Separation Equipment

*Note:* The numbers in parentheses following the name of the firm, indicate the type of equipment mainly supplied: (1) washing; (2) peeling; (3) dehulling; (4) pitting; (5) sorting; (6) color/electronic sorting; (7) dry cleaning; (8) metal detection; (9) air filters, (10) liquid filters; (11) sieving; (12) pressing; (13) centrifugation; (14) air-solid separation; (15) decanters; (16) liquid mixers.

Allgaier (11)  
 P.O. Box 40  
 73062 Uhingen, Germany  
 Tel.: +49 7161 3010  
 Fax: +49 71 61 324 52  
<http://www.allgaier.de>

Barco Companies:  
 Elbicon (6)  
 Industieterrein Nieuwland  
 3200 Aarschot, Belgium  
 Tel.: +32 1655 1310  
 Fax: +32 1655 1315  
 e-M: [elbicon@barco.com](mailto:elbicon@barco.com)

APV (13), (16),  
 P.O. Box 4  
 Gatwick Road  
 Crawley RH10 2QB, UK  
 Tel.: +44 1293 527777  
 Fax: +44 1293 535104  
<http://www.apv.com>

Pulsar Industrial Research (6)  
 P.O. Box 2048  
 5600 CA Enidhoven, Netherlands  
 Tel.: +31 40 292 2622  
 Fax: +31 40 292 2633  
 e-M: [pulsar@pusarr.nl](mailto:pulsar@pusarr.nl)

Alfa Laval AB (Alfa Laval Flow) (10),  
 (13), (15), (16)  
 Rudeboksvaegen 3, Box 73  
 221 00 Lund, Sweden  
 Tel.: +46 46 36 70 00  
 Fax: +46 46 36 71 82  
 e-M: [info@alfalaval.com](mailto:info@alfalaval.com)  
<http://www.alfalaval.com>

Bch (2), (11), (16)  
 Spring Place, Millfold,  
 Whitworth, Lancashire OL12 8DN, UK  
 Tel.: +44 1706-852122  
 Fax: +44 1706-853010  
 e-M: [info@bchltd.com](mailto:info@bchltd.com)  
<http://www.bchltd.com>

Barco (6)  
 Pres. Kennedypark 35  
 8500 Kortrijk, Belgium  
 Tel.: +32 56 262 611  
 Fax: +32 56 262262  
<http://www.barco.com>

Bm-k+k (1), (2)  
 P.O. Box 46  
 3440 AA Woerden, Netherlands  
 Tel.: +31 348 435440  
 Fax: +31 348 435499  
 e-M: [k+k@BMA-nl.com](mailto:k+k@BMA-nl.com)



Buehler (3), (6), (7)  
 Industriestrasse  
 9240 Uzwil, Switzerland  
 Tel.: +41 71 955 11 11  
 Fax: +41 71 955 33 79  
 e-M: [buehler.uzwil@buehlergroup.com](mailto:buehler.uzwil@buehlergroup.com)  
<http://www.buehlergroup.com>

Bucher-Guyer (12)  
 8166 Niederweningen ZH,  
 Switzerland  
 Tel.: +41 1 857 22 11  
 Fax: +41 1 857 23 41  
 e-M: [foodtech@bucherguyer.ch](mailto:foodtech@bucherguyer.ch)  
<http://www.bucherguiver.ch/foodtech>

Dorr-Oliver (7), (10), (14)  
 174 West Str. South  
 Orilla, ON, Canada L3V6L4  
 Tel.: (705) 325 6181  
 Fax: (705) 325 2347  
 e-M: [dorr-oliver@glv.com](mailto:dorr-oliver@glv.com)

Durand Freres (5), (7)  
 ZI Lamay-Billard, BP 1049  
 86060 Poitiers, France  
 Tel.: +33 549605200  
 Fax: +33 549605214  
<http://durandfreres.com>

Eshet Eilon (5)  
 Kibbutz Eilon 22845, Israel  
 Tel.: 972 4 9858102  
 Fax: 972 4 9807150  
<http://www.eshet.co.il>

Fai (1), (13)  
 BP 328  
 29413 Lndemeau, Cedex, France  
 Tel.: +33 298852315  
 Fax: +33 298 852179  
 e-M: [freezeagro@eurobretagne.fr](mailto:freezeagro@eurobretagne.fr)  
<http://www.freeze-agro-ingenierie.com>

F.H. Schule (3), (7), (11), (14)  
 Diesel Strasse 5-9  
 21465 Reinbek  
 P.O. Box 1246  
 21452 Reinbek, Germany  
 Tel.: +49 40 72771-700  
 Fax: +49 40 72771-710  
 e-M: [schule@amandus-kahl-group.de](mailto:schule@amandus-kahl-group.de)  
<http://www.greefa.nl>

Finis (2)  
 Equipment B.V. Industrieterrein “de  
 Rieze”  
 de Bolanden 1  
 Ulft, 7071 PW, Netherlands  
 Tel.: +31 315 695569

Flex-Kleen (9), (14)  
 955 Hawthorn Drive  
 Itasca, IL 60143, USA  
 Tel.: (630) 775 0707  
 Fax: (630) 875 3212  
 e-M: [flexkleen@aol.com](mailto:flexkleen@aol.com)  
<http://www.met-pro.com/flexkleen.htm>

Flottweg (12), (15)  
 Industrie Strasse 6-8  
 84137 Vilsbiburg, Germany  
 Tel.: +49 8741 3010  
 Fax: +49 8741 301300  
 e-M: [mail@flottweg.com](mailto:mail@flottweg.com)  
<http://www.flottweg.com>

Fmc FoodTech (1), (2), (4), (5), (16)  
 Food Processing Systems  
 2300 Industrial Avenue  
 Box A  
 Madera, CA 93639, USA  
 Tel.: (559) 661 3200  
 Fax: (559) 661 3222  
 e-M: [fpsd.info@intl.fmcti.com](mailto:fpsd.info@intl.fmcti.com)

FBR-EPLO Spa (1), (2), (5), (4)  
Via Amaldo da Brescia 12/A  
43100 Parma, Italy  
Tel.: +39 521 267511  
Fax: +39 521 267676  
[news@fbr-elpo.it](mailto:news@fbr-elpo.it)

GEA-Westphalia (13)  
59302 Oelde, Germany  
Tel.: +49 2522 770  
Fax: +49 2522 772950  
e-M: [info@gea-westphalia.de](mailto:info@gea-westphalia.de)  
<http://www.westphalia-separator.com>

Greefa(9)  
P.O. Box 24  
4190 CA Geldermalsen  
Langstraat 12  
4196 JB Tricht, Netherlands  
Tel.: +31 345 578100  
Fax: +31 345 578200  
e-M: [info@greefa.nl](mailto:info@greefa.nl)

Hosokawa-Alpine (14)  
Postfach 101109  
86001 Augsburg, Germany  
Tel.: +49 821 59060  
Fax: +49 821 573558  
e-M: [inter@hmc.hosokawa.com](mailto:inter@hmc.hosokawa.com)

Infastaub (9)  
Niederstedter Weg 19  
Postfach 17 62  
61348 Bad Homburg v.d.H., Germany  
Tel.: +49 6172 30 980  
Fax: +49 6172 30 98 90  
e-M: [infa@infastaub.de](mailto:infa@infastaub.de)  
<http://www.infastaub.de>

Jongia (16)  
J. Wattstraat 8  
P.O. Box 284  
8901 BB Leeuwarden, Netherlands  
Tel.: +31 58 2139715  
Fax: +31 58 2129787/2124970  
<http://www.jongia.com>

Kepa (1)  
Codrington Str. 8  
11257 Athens, Greece  
Tel.: +30 1 8215224  
Fax: +30 1 8839411  
e-M: [kefa@tee.gr](mailto:kefa@tee.gr)

Kiremko (1), (2)  
P.O. Box 5  
3417 ZG Montfoort, Netherlands  
Tel.: +31 348 472244  
Fax: +31 348 471307  
e-M: [kiremko@pi.net](mailto:kiremko@pi.net)

Kuhl Corporation (1)  
P.O. Box 26  
39 Kuhl Road  
Flemington, NJ 08822, USA  
Tel.: (908) 782 5696  
Fax: (908) 782 2751  
e-M: [hyk@kuhlcorp.com](mailto:hyk@kuhlcorp.com)  
<http://www.kuhlcorp.com>

Luwa (9)  
Wilstrasse 11  
8610 Uster, Switzerland  
Tel.: +41 1 943 5151  
Fax: +41 1 943 5152  
e-M: [info@luwa.ch](mailto:info@luwa.ch)  
<http://www.luwa.ch>

Maf-Roda (1), (2), (5)  
B.P. 112  
82000 Montauban, France  
Tel.: +33 5 63 2770  
Fax: +33 5 63 0785  
e-M: [maf-roda@wanandoo.fr](mailto:maf-roda@wanandoo.fr)

Nivoba (12), (13)  
P.O. Box 40  
Industrieweg 1  
Veendam, Netherlands  
Tel.: +31 59 861 9456  
Fax: +31 59861 2194  
e-M: [info@nivoba.nl](mailto:info@nivoba.nl)  
<http://www.nivoba.com>

Safeline (8)  
 Kaiser Strasse 100  
 52134 Herzogenrath, Germany  
 Tel.: +49 2407 9113110  
 Fax: +49 2407 59659  
 e-M: [safeline@safelinegmbh.de](mailto:safeline@safelinegmbh.de)  
<http://www.safeline.co.uk>

Loma Systems (8)  
 Southwood  
 Farnborough  
 Hampshire GU14 ONY, UK  
 Tel.: +44 1252 893300  
 Fax: +44 1252 513322  
 e-M: [sales@loma.co.uk](mailto:sales@loma.co.uk)  
<http://www.loma.com/>

Odenberg (1), (2), (6)  
 4038 Seaport Boulevard  
 West Sacramento, CA 95691, USA  
 Tel.: (916) 371 0700  
 Fax: (916) 371 5471, (800) 688 8396  
 e-M: [odbsac@ix.netcom.com](mailto:odbsac@ix.netcom.com)

Pieralisi (1), (13), (15)  
 Via Don Battistoni, 1  
 60035 Jesi (Ancona), Italy  
 Tel.: +39 731 2311  
 Fax: +39 731 231239  
 e-M: [info@pieralisi.com](mailto:info@pieralisi.com)  
<http://www.pieralisi.com>

Protec (6)  
 Via Nazionale Est, 19  
 43044 Collecchio (Parma), Italy  
 Tel.: +39 521 800800  
 Fax: +39 521 802311  
 e-M: [protec@rsadvnet.it](mailto:protec@rsadvnet.it)

Romaco/FrymaKoruma (16)  
 Theodorshofweg  
 4310 Rheinfelden, Switzerland  
 Tel.: +41 61 8364141  
 Fax: +41 (61) 8312000  
 e-M: [frvmakoruma@romaco.com](mailto:frvmakoruma@romaco.com)

Russel Finex (11)  
 Zandvoorstraat 20  
 Industriepark Noord C20  
 2800 Mecheln, Belgium  
 Tel.: +32 15 275919  
 Fax: +32 15 219335  
 e-M: [info@russelfinex.be](mailto:info@russelfinex.be)

Sharples (13), (15)  
 995 Meams Rd  
 Warminster, PA 18974, USA  
 Tel.: (215) 443 4000  
 Fax: (215) 443 4234

Sofil (10)  
 7, Blv. Luis XI, B.P. 0507  
 37205 Tours Cedex 3, France  
 Tel.: +33 247 385262  
 Fax: +33 247 385366  
 e-M: [info@sofil.com](mailto:info@sofil.com)  
<http://www.sofil.com>

Sortex (6)  
 Pudding Mill Lane  
 London E15 2PJ, UK  
 Tel.: +44 181 5190525  
 Fax: +44 181 5195614  
 e-M: [sales@sortex.com](mailto:sales@sortex.com)

A.B.L. srl (2), (4)  
 Via dell'Artigianato 5/2  
 41032 Cavezzo (Mo), Italy  
 Tel.: +39 535 58927  
 Fax: +39 535 58903  
 e-M: [info@ablCavezzo.it](mailto:info@ablCavezzo.it)

Sfk (1)  
 Tranformervej 9  
 2730 Herlev, Danmark  
 Tel.: +45 44 503700  
 Fax: +45 44 923710  
 e-M: [info@sfktech.com](mailto:info@sfktech.com)  
<http://www.sfktech.com>

Schenk/Seitz (USF), (9), (10),  
Filterbau GmbH  
Bettringer Strasse 42, Germany  
Postfach 20  
73550 Waldstetten  
Tel.: +49 71 4 01-0  
Fax: +49 71 4 01-107  
<http://www.schenk-filters.de>

SRC Vision (6)  
Luchthawenweg 47A  
5657 EA Eindhoven, Netherlands  
Tel.: +31 40 2922222  
Fax: +31 40 2922228  
e-M: [srcvmarketing@compuseve.com](mailto:srcvmarketing@compuseve.com)

Turatti (1), (2)  
Via Regina Margherita 42  
300014 Cavazere, Italy  
Tel.: +39 426 310731  
Fax: +39 426 310500  
e-M: [turatti@iol.it](mailto:turatti@iol.it)

Veronesi (13)  
Via Don Minzoni  
40050 Villanova di Castenaso  
Bologna, Italy  
Tel.: +3951 6054511  
Fax: +3951 6054511  
e-M: [sac@veronesi.separatori.com](mailto:sac@veronesi.separatori.com)  
[www.veronesi.separatori.com](http://www.veronesi.separatori.com)

USF Johnson Screens (11)  
1950 Old Highway 8  
New Brighton, MN 55112, USA  
-or-  
P.O. Box 64118  
St. Paul, MN 55164, USA  
Tel.: (651) 638 3900  
Fax: (651) 638 3244

USF (5), (10), (14)  
2118 Greenspring Drive  
Timonium, MD 21093, USA  
Tel.: (410) 252 0800  
Fax: (410) 560 2857  
<http://www.usffiltration.com>

USF Companies:  
Seitz Filters (Germany)  
Schenk Filters (Germany)  
Johnson Screens (USA)  
Hydrotech (Sweden)

Zanicheli-Zacmi (1), (2)  
Via Manitoba 65  
43100 Parma, Italy  
Tel.: +39 521 243737  
Fax: +39 521  
e-M: [zacmi@pn.intel.it](mailto:zacmi@pn.intel.it)  
<http://www.popnet.it/zacmi>

## Chapter 6: Heat Transfer Equipment

Actini  
Pare de Montigny  
74500 Evian-Les-Bains, France  
Tel.: +33 50 70 7474  
Fax: +33 50 70 7475  
e-M: [actini@actini.com](mailto:actini@actini.com)  
<http://actini.com>

Alfa Laval AB (Alfa Laval Flow)  
Rudeboksvaegen 3, Box 73  
221 00 Lund, Sweden  
Tel.: +46 46 36 70 00  
Fax: +46 46 36 71 82  
e-M: [info@alfalaval.com](mailto:info@alfalaval.com)  
<http://www.alfalaval.com>

API Schmidt-Bretten  
Pforheimer Strasse 46  
75015 Bretten, Germany  
Tel.: +49 7252 530  
Fax: +49 7252 53200  
e-M: [webmaster@apischmidt-bretten.de](mailto:webmaster@apischmidt-bretten.de)  
<http://www.apischmidt-bretten.de>

APV  
P.O. Box 4  
Gatwick Road  
Crawley RH10 2QB, UK  
Tel.: +44 1293 527777  
Fax: +44 1293 535104  
<http://www.apv.com>

Bm-k+k P.O. Box 46  
3440 AA Woerden, Netherlands  
Tel.: +31 348 435440  
Fax: +31 348 435499  
e-M: [k+k@BMA-nl.com](mailto:k+k@BMA-nl.com)

Frigoscandia (FMC)  
1719 Cannon Road  
P.O. Box 98  
Northfield, MN 55057, USA  
Tel.: (507) 645 9546  
Fax: (507) 645 6148  
e-M: [info-nfs@fmc.com](mailto:info-nfs@fmc.com)  
<http://www.frigoscandiaequipment.com>

GEA  
Dorstener Strasse 484  
44809 Bochum, Germany  
Tel.: +49 234 9801087  
Fax: +49 234 9801087  
e-M: [pr@gea-ag.com](mailto:pr@gea-ag.com)  
<http://www.geaag.com>

PPM  
Vaverrigatan 2  
29134 Kristianstadt, Sweden  
Tel.: +46 44204400  
Fax: +46 44204420

Rossi & Catelli  
Via Traversetolo 2/A  
43100 Parma, Italy  
Tel.: +39 521 240345  
Fax: +39 521 242690  
e-M: [rcatelli@tin.it](mailto:rcatelli@tin.it)

Societe Lagarde  
BP 35  
100 route de Valence  
26201 Montelimar Cedex, France  
Tel.: +33 4 75 00 79 10  
Fax: +33 4 75 01 58 84  
e-M: [lagarde@lagarde-autoclaves.com](mailto:lagarde@lagarde-autoclaves.com)  
<http://www.lagarde-autoclaves.com>

Waukesha Cherry-Burrell  
611 Sugar Creek Road  
Delavan, WI 53115, USA  
Tel.: (800) 252 5200 or (414) 728 1900  
Fax: (800) 252 5012 or (414) 728 4904  
e-M: [custserv@gowcb.com](mailto:custserv@gowcb.com)

## Chapter 7: Food Evaporation Equipment

Alfa Laval AB  
 Box 73, Rudeboksvägen 3  
 221 00 Lund, Sweden  
 Tel.: +46 46 367000  
 Fax: +46 46 367182  
 e-M: [info@alfalaval.com](mailto:info@alfalaval.com)

APV Systems  
 Drying and Evaporation and Unit  
 Systems  
 395 Fillmore Avenue  
 Tonawanda, NY 14150, USA  
 Tel.: (716) 744 2256 (800) 828 7391  
 or (800) 828 7667  
 Fax: (716) 744 2379  
 e-M: [apv@apvsystems.com](mailto:apv@apvsystems.com)  
<http://www.apv.com>

Aqua-Chem, Inc.  
 7800 North 113th Street  
 Milwaukee, WI 53224, USA  
 Tel.: (414) 961-2830  
 Fax: (414) 961-2723  
 e-M: [business@aquachem.com](mailto:business@aquachem.com)

Atlas Industries  
 Baltropvej 160  
 2750 Ballerup, Denmark  
 Tel.: +45 44 89 02 00  
 Fax: +45 44 89 04 00  
 e-M: [atlas-stord@atlas-stord.dk](mailto:atlas-stord@atlas-stord.dk)

Entropie  
 17 rue Thiers  
 B.P. 6103  
 78176 St.-Germain-en-Laye Cedex,  
 France  
 Tel.: +33 1 30 618200  
 Fax: +33 1 30 614498  
 e-M: [entropie@compuserve.com](mailto:entropie@compuserve.com)

Fenco  
 Via Verdi 11  
 P.O. Box 223  
 43100 Parma, Italy  
 Fax: +39 521771052/0521200716  
 e-M: [fenco@tin.it](mailto:fenco@tin.it)  
<http://www.fencospa.com> or [www.fenco.it](http://www.fenco.it)

FranRica (FMC)  
 2807 So, Hwy 99-95205  
 Box 30127  
 Stockton, CA 95213, USA  
 Tel.: (209) 948 2811  
 Fax: (209) 948 5198  
 e-M: [fpsd@intl.fmcti.com](mailto:fpsd@intl.fmcti.com)  
<http://www.fmcfoodtech.com>

GEA-Wiegand  
 Einstein Strasse 9-15  
 76275 Ettlingen, Germany  
 Tel.: +49 7243 7050  
 Fax: +49 7243 705330  
 e-M: [info@gea-wiegand.de](mailto:info@gea-wiegand.de)  
<http://www.gea-ag.com>

Luwa  
 Wilstrasse 11  
 8610 Uster, Switzerland  
 Tel.: +41 1943 5151  
 Fax: +41 1943 5152  
 e-M: [info@luwa.ch](mailto:info@luwa.ch)

Rossi & Catelli  
 Via Traversetolo 2/A  
 43100 Parma, Italy  
 Tel.: +39 521 240345  
 Fax: +39 521 242690  
 e-M: [rcatelli@tin.it](mailto:rcatelli@tin.it)

Swenson Process Equipment, Inc.  
 26000 Whiting Way  
 Monee, IL 60449-8060, USA  
 Tel.: (708) 331 5500, 210-5062  
 Fax: (708) 331 5559, 587-2225  
 e-M: [webmaster@swenson-equip.com](mailto:webmaster@swenson-equip.com)  
<http://www.swenson-equip.com>

Waukesha Cherry-Burrell  
 611 Sugar Creek Road  
 Delavan, WI 53115, USA  
 Tel.: (800) 252 5200 or (414) 728 1900  
 Fax: (800) 252 5012 or (414) 728 4904  
 e-M: [custserv@gowcb.com](mailto:custserv@gowcb.com)

Unipektin  
 Claridenstrasse 25  
 CH-8022 Zuerich, Switzerland  
 Tel.: +41 1 2065444  
 Fax: +41 1 2065455  
 e-M: [info@zh.unipektin.ch](mailto:info@zh.unipektin.ch)  
<http://www.unipektin.com>

## Chapter 8: Food Dehydration Equipment

*Note:* The numbers in parentheses following the name of the firm, indicate the type of equipment mainly supplied: (1) fluid bed dryers; (2) tower dryers; (3) silo driers; (4) cabinet dryers; (5) belt dryers; (6) vacuum dryers; (7) freeze dryers; (8) spray dryers; (9) tunnel dryers; (10) microwave dryers; (\*) more than one type of equipment.

Aeroglide Corp. (\*)  
 P.O. Box 29505  
 Raleigh, NC 27626-0505, USA  
 Tel.: (919) 851 2000  
 Fax: (919) 851 6029  
<http://www.aeroglide.com>

APV Pasilac LTD (\*)  
 Denton Holme  
 Carlisle, Cumbria CA2 5DU, UK  
 Tel.: +44 228 34433  
 Fax: +44 228 401060  
<http://www.invensvs.com>

APV Anhydro AS (\*)  
 Drying and Evaporation  
 Oestmarken 7  
 2860 Soeborg, Denmark  
 Tel.: +45 39 692911  
 Fax: +45 39 693880  
<http://www.invensys.com>

Arthur White Process Plant Ltd (1)  
 Stapeley Manor, Stapeley  
 Natwich, Chesire CW5 7JL, UK  
 Tel.: +44 782 321317

Atlas-Stord Denmark A/S (\*)  
 Islevdalvej 148  
 2610 Roedovre, Denmark  
 Tel.: +45 70 271214  
 Fax: +45 70 271215  
 e-M: [atlas-stord@atlas-stored.dk](mailto:atlas-stord@atlas-stored.dk)  
<http://www.Atlas-Stord.com>

Babcock-BSH AG (\*)  
 Park Strass  
 47829 Krefeld, Germany  
 Tel.: +49 2151 448430  
 Fax: +49 2151 448592  
 e-M: [verfahrenstechnik@babcock-bsh.de](mailto:verfahrenstechnik@babcock-bsh.de)  
<http://www.babcock-bsh.de>

Cimbria Manufacturing AS (2), (3)  
 Faarto vej 22  
 7700 Thisted, Denmark  
 Tel.: +45 961 79000  
 Fax: +45 961 79019  
 e-M: [holding@cimbria.com](mailto:holding@cimbria.com)

Criofarma (7)  
 S. del Francese 97/2L  
 10156 Torino, Italy  
 Tel.: +39 11 4701769  
 Fax: +39 11 4701981

GEA Niro Atomizer AS (8)  
 Gladsaxevej 305  
 2860 Soeborg, Denmark  
 Tel.: +45 31 691011  
 Fax: +45 31 691414  
<http://www.niro.dk>

GIG (1)  
 Industrie Str. 21, P.O. Box. 151  
 4800 Attnag-Puchheim, Austria  
 Tel.: +43 7674 63033  
 Fax: +43 7674 65800

Krauss Maffei Verfahrenstechnik  
 GmbH (\*)  
 Krauss Maffei Strasse 2  
 8000 Munich 50, Germany  
 Tel.: +49 89 88990  
 Fax: +49 89 889932 99  
 e-M: [info@krauss-maffei.de](mailto:info@krauss-maffei.de)  
<http://www.krauss-maffei.de>

LAW (2), (3)  
 Ave. Du General De-Gaulle, BP 15  
 60304 Senlis Cedex, France  
 Tel.: +33 4 4530500  
 e-M: [cfai@wanadoo.fr](mailto:cfai@wanadoo.fr)

Mavag (6)  
 Kleiner Letten  
 8213 Neunkirch, Switzerland  
 Tel.: +41 52 6870202  
 Fax: +41 52 6870220  
 e-M: [info@mavag.com](mailto:info@mavag.com)

National Drying Machinery Co (5), (9)  
 2190 Hornig Road  
 Philadelphia, PA 19116, USA  
 Tel.: (215) 464 6070  
 Fax: (215) 464 4096  
 e-M: [info@nationaldrying.com](mailto:info@nationaldrying.com)  
<http://www.nationaldrying.com>

Pavan Mapimpianti (4), (9)  
 27 Via Europa  
 35015 Galliera Veneta (PD), Italy  
 Tel.: +39 49 9423111  
 Fax: +39 49 5959794  
 e-M: [marketing@pavan.com](mailto:marketing@pavan.com)  
<http://www.pavan.com>

Proctor & Schwartz Inc. (\*)  
 251 Gibraltar Rd  
 Hersham, PA 19044, USA  
 Tel.: (215) 443 5200  
 Fax: (215) 443 5206  
<http://www.proctor.com>

ZWAG (6), (10)  
 Conradin Zscokke Strasse  
 5312 Doettingen, Switzerland  
 Tel.: +4156 409101  
 Fax: +4156 453739



## Chapter 9: Refrigeration and Freezing Equipment

*Note:* The numbers in parentheses following the name of the firm, indicate the type of the refrigeration equipment mainly supplied. (1) compressors; (2) freezing equipment; (3) ice; (4) controlled atmosphere; (5) cryogenic liquids; (\*) More than one type of equipment

Axima Refrigeration  
Neuwiesen Strasse 15  
8400 Winterthur, Switzerland  
Tel.: +41 52 262 8080  
Fax: +41 52 262 0003  
e-M: [info-refch@axima.eu.com](mailto:info-refch@axima.eu.com)  
<http://www.axima.eu.com>

Air Liquide (5)  
Tour Manhattan  
92095 Paris La Defense Cedex, France  
Tel.: +33 1 47767676  
Fax: +33 1 44925121  
e-M: [ventures@airliquide.com](mailto:ventures@airliquide.com)

APV (2)  
2936 Foster Creighton  
Rosemont, IL 60018, USA  
Tel.: (615) 255 0342  
Fax: (615)242 6758

BUUS Refrigeration (3)  
Elseovej 219  
Froeslev, Denmark  
Tel.: +45 97 744033  
Fax: +45 97 744037  
e-M: [buus@buus.dk](mailto:buus@buus.dk)

Frigofrance (3)  
Place de la Bastille-Les Couets  
44340 Bouguenais, France  
Tel.: +33 240 320606  
Fax: +33 240 650488  
e-M: [contact@geneglance.com](mailto:contact@geneglance.com)

Frigoscandia Inc. (\*)  
P.O. Box 3984  
Bellevue, WA 98009, USA  
Tel.: (425) 8832244  
Fax: (425) 882 0948  
e-M: [info@frigoparts.com](mailto:info@frigoparts.com)

GEA Grasso Int. B.V. (\*)  
Parallel Weg 27  
5223 AL's-Hertogenbosch,  
Netherland  
Tel.: +31 73 6203911  
Fax: +3173 6214210  
e-M: [marketing-orders@grasso.nl](mailto:marketing-orders@grasso.nl)

GEA-Technofrigo Dell'Orto Europa  
S.p.A. (\*)  
ViaMateotti 161  
40013 Castelmaggiore (Bologna),  
Italy  
Tel.: +39 51 718511  
Fax: +39 51 714261  
e-M: [juelichsuw@geag.com](mailto:juelichsuw@geag.com)

Gram (2)  
AaGramVej 1  
6500 Vojens, Denmark  
Tel.: +45 7320 1000  
Fax: +45 7320 1005  
e-M: [sales@gram-equipment.com](mailto:sales@gram-equipment.com)

Isocold (4)  
Via Ai Vodi, 46  
38015 Lavis (Tn), Italy  
Tel.: +49 461 246655  
Fax: +49 461 246748  
e-M: [info@isocold.it](mailto:info@isocold.it)

Jackstone Froster Ltd. (2)  
 Uni 31, Wilks Ave. Hawley Road  
 Questor Estate  
 Dratford, Kent DAI 1JS, UK  
 Tel.: +44 1322 26418  
 Fax: +44 1322 24890  
 e-M: [sales@jackstoneffoster.com](mailto:sales@jackstoneffoster.com)

Kobelco Compressors (1)  
 3000 Hammond Ave.  
 Elkhart, IN 46516, USA  
 Tel.: (219) 295 3145  
 Fax: (219) 293 1641  
 e-M: [Kobelco@rogers-machinery](mailto:Kobelco@rogers-machinery)

Linde AG (5)  
 P.O. Box 501610  
 5000 Koeln, Suerth, Germany  
 Tel.: +49 2236 60101  
 Fax: +49 236 390837  
 e-M: [info@linde.de](mailto:info@linde.de)

Mycom (1)  
 13-1, Botan 2  
 Koto-Ku, Tokyo 135-8482, Japan  
 Tel.: +81 3 3642 8088  
 Fax: +81 3 3643 7094  
 e-M: [kaisouki@mycomj.co.jp](mailto:kaisouki@mycomj.co.jp)

Samifi Babcock (1)  
 ZI Sud, Rue Jean Jaures  
 61200 Argentan, France  
 Tel.: +33 233 122350  
 Fax: +33 233 122351  
 e-M: [samifi61@imaginet.fr](mailto:samifi61@imaginet.fr)

Stal-York (1), (2), (3)  
 60187 Norrkoeping, Sweden  
 Tel.: +46 11 139800

Sulzer-Escher Wyss (\*)  
 Hardstr. 319  
 8023 Zurich 5, Switzerland  
 Tel.: +1 278 3344  
 Fax: +1 2782202

York Intenat. Corp. (\*)  
 631 South Richland Ave.  
 York, PA 17403, USA  
 Tel.: +771 7890  
 Fax: +771 7381

York International companies (\*)  
 Sabroe  
 Stal  
 Gram  
 Frick  
 York Refrigeration

York Refrigeration (1), (3)  
 P.O. Box 1810  
 8270 Hoejberg, Aarhus, Denmark  
 Tel.: +45 87 367000  
 Fax: +45 87 36 7005  
 e-M: [yorkref@yorkref.com](mailto:yorkref@yorkref.com)

Ziegra Eis (3)  
 Ernst Grote Strasse 7  
 30916 Isamhagen, Germany  
 Tel.: 511 9024440  
 Fax: 511 613 8042  
 e-M: [ice@ziegra.com](mailto:ice@ziegra.com)

## Chapter 10: Thermal Processing Equipment

### *Blanchers*

Cabinplant International  
 Roesbjergvei 9  
 5683 Haarby, Denmark  
 Tel.: +45 6473 2020  
 Fax: +45 6473 1253  
 e-M: [cpi@cabinplant](mailto:cpi@cabinplant)  
<http://www.cabinplant.com>

Lyco Manufacturing  
 115 Commercial Drive  
 Columbus, WI 53925, USA  
 Tel.: (414) 623 1152  
 Fax: (414) 623 3780  
 e-M: [lyco@lycomfg.com](mailto:lyco@lycomfg.com)  
<http://www.lycomfg.com>

Key Technology  
 150 Avery St.  
 Walla, WA 99362, USA  
 Tel.: (509) 529 2161  
 Fax: (509) 527 1331  
 e-M: [uptime.info@keyww.com](mailto:uptime.info@keyww.com)  
<http://www.keyww.com>

### *Sterilizers and Pasteurizers*

Alfa Laval AB  
 (Alfa Laval Flow)  
 Rudeboksvaegen 3, Box 73  
 221 00 Lund, Sweden  
 Tel.: +46 (46) 3670 00  
 Fax: +46 (46) 36 71 82  
 e-M: [info@alfalaval.com](mailto:info@alfalaval.com)  
<http://www.alfalaval.com>

APV  
 P.O. Box 4  
 Gatwick Road  
 Crawley RH10 2QB, UK  
 Tel.: +44 (1293) 527777  
 Fax: +44(1293)535104  
<http://www.apv.com>

Allpax  
 13510 Seymour Myers Blvd.  
 Convington, LA 70433, USA  
 Tel.: (985) 893 9277  
 Fax: (985) 893 9477  
 e-M: [info@allpax.com](mailto:info@allpax.com)  
<http://www.allpax.com>

APV Crepaco  
 935 West Bryn Mawr  
 Rosemont, IL 60018, USA  
 Tel.: (708) 678 4300  
 Fax: (708) 678 4307

Armfield (Miniature Equipment)  
 Bridge House  
 West Street  
 Ringwood, Hampshire BH24 IDY, UK  
 Tel.: +44 1425 478781  
 Fax: +44 1425 470916

Barriquand Sterilflow  
 32 rue de Cambrai  
 75019 Paris, France  
 Tel.: +33 1 40370845  
 Fax: +33 1 40380699  
 e-M: [Barriquand.Sterilflow.  
 Paris@wanadoo.fr](mailto:Barriquand.Sterilflow.Paris@wanadoo.fr)

Biaugeaud Henri  
 465 av Aristide Briand  
 94111 Arcueil Cedex, France  
 Tel.: +33 42 537740  
 Fax: +33 42 531126

Bm-k+k (1), (2)  
 P.O. Box 46  
 3440 AA Woerden, Netherlands  
 Tel.: +31 348 435440  
 Fax: +31 348 435499  
 e-M: [k+k@BMA-nl.com](mailto:k+k@BMA-nl.com)

Dixie Canner Co.  
 786 East Broad Street  
 Athens, GA 30601, USA  
 Tel.: (706) 549 1914  
 Fax: (706) 549 0137  
 e-M: [sales@dixiecanner.com](mailto:sales@dixiecanner.com)  
<http://www.dixiecanner.com>

FMC Corporation  
 Food Processing Division  
 2300 Industrial Ave.  
 Box A, Madera, CA 93639, USA  
 Tel.: (209) 661 3200  
 Fax: (209) 661 3222  
 e-M: [fpsa.info@intl.fmcti.com](mailto:fpsa.info@intl.fmcti.com)

GEC Alsthom-ACB  
 Prairie au duc  
 44945 Nantes Cedex 9, France  
 Tel.: +33 40 411404  
 Fax: +33 40 470151

Iwai Kikai Kogyo  
 3-17-10 Higashi-Kojiya  
 Ota-Ku, Tokyo 144 0033, Japan  
 Tel.: +81 337 44155  
 Fax: +81 337 417150  
 e-M: [iwai@mail.magical3.egg.or.jp](mailto:iwai@mail.magical3.egg.or.jp)

Lagarde  
 100 route de Valence  
 26 200 Montelinar, France  
 Tel.: +33 75 017833  
 Fax: +33 75 015884  
 e-M: [lagarde@lagarde-auto](mailto:lagarde@lagarde-auto)

Lubeca-Scholz  
 Heinrich Strasse 1-5  
 48653 Coesfeld, Germany  
 Tel.: +49 2541 7450  
 Fax: +49 2541 82741  
 e-M: [korr@sholz-mb.de](mailto:korr@sholz-mb.de)

Microthermics (Miniature equipment)  
 5042-F Departure Drive  
 Raleigh, NC 27616, USA  
 Tel.: (919) 878 8045  
 Fax: (919) 878 8032  
<http://www.microthermics.com>

Pick Heaters  
 P.O. Box 516  
 West Bend, WI 53095, USA  
 Tel.: (414) 338 1191  
 Fax: (414) 338 8489  
 e-M: [info@pickheaters.com](mailto:info@pickheaters.com)  
<http://www.pickheaters.com>

Rossi & Catelli  
Via Traversetolo 2/A  
43100 Parma, Italy  
Tel.: +39 521 240345  
Fax: +39 521 2422690  
e-M: [rcatelli@tin.it](mailto:rcatelli@tin.it)

Stock America Inc.  
Corporate Headquarters  
995 Badger Circle  
Grafton, WI 53024, USA  
Tel.: (262) 375 4100  
Fax: (262) 375 4101  
<http://www.stockamerica.com>

Stork  
Ketelstraat 2  
1021 JX Amsterdam, Netherlands  
Tel.: +31 20 6348911  
Fax: +3120 6369754  
e-M: [info@storck-food-dairy.com](mailto:info@storck-food-dairy.com)

Stork Food Machinery  
3525 West Peterson Ave  
Chicago, IL 60659, USA  
Tel.: (312) 583 1455  
Fax: (312) 583 8155

Tetra Pak (De Laval)  
333 West Wacker Drive  
Chicago, IL 60606, USA  
Tel.: (312) 553 9200  
Fax: (312) 553 5151

Turatti  
Via Regina Margherita 42  
300014 Cavazere, Italy  
Tel.: +39 426 310731  
Fax: +39 426 310500  
e-M: [turatti@iol.it](mailto:turatti@iol.it)

Waukesha Cherry-Burrell (8), (9)  
611 Sugar Creek Road  
Delavan, WI 53115, USA  
Tel.: (800) 252 5200 or (414)728 1900  
Fax: (800) 252 5012 or (414)728 4904  
e-M: [custserv@gowcb.com](mailto:custserv@gowcb.com)

Zanicheli-Zacmi  
Via Manitoba 65  
43100 Parma, Italy  
Tel.: +39(521) 243737  
Fax: +39 (521) 243701  
e-M: [zacmi@pn.intel.it](mailto:zacmi@pn.intel.it)  
<http://www.popnet.it/zacmi>

## Chapter 11: Mass Transfer Equipment

### *Distillation Equipment*

APV Crepaco  
345 Filmore Ave  
Tonawanda, NY 14150, USA  
Tel.: (716) 692-3000  
Fax: (716) 692 1715

Artisan Industries  
73 Pond Street  
Waltham, MA 02254, USA  
Tel.: (617) 893-9193  
Fax: (617) 647-0143

Distillation Engineering Co  
105 DorsaAve.  
Livingstone, NJ 07039, USA  
Tel.: (201) 992-9600

Flavourtech Americas, Inc.  
(Spinning Column)  
Graton, CA 95444, USA  
Tel.: (707) 829-6216  
Fax: (707) 829-6211  
[www.flavourtech.com](http://www.flavourtech.com)

Koch-Otto York  
Package Plants Div.  
42 Intervale Rd.  
Parsippany, NJ 07054, USA  
Tel.: (973) 299 9200  
Fax: (973) 299 9401  
<http://www.modular-process.com>

Pope Scientific Inc. (molecular  
distillation)  
351 N. Dakota Woods Blvd.  
Saukville, WI 53080, USA  
Tel.: (262) 268-9300  
Fax: (262) 268-9400  
<http://www.popeinc.com>

UIC GmbH (Molecular Distillation)  
D-63755 Alzenau-Hoerstein,  
Germany  
Tel.: (49) 6023 950100  
Fax: (49) 6023 950266  
<http://www.UIC-GmbH.de>

Unipektin  
Claridenstrasse 25  
CH-8022 Zuerich, Switzerland  
Tel.: +41 1 206 54 44  
Fax: +41 1 206 54 55  
info@zh.unipektin.ch  
<http://www.unipektin.com>

### ***Ion Exchange Equipment***

Alimentech (Bucher/CH)  
Wellington House  
2 Kentwood Hill  
Tilchurst, Reading RG3, UK  
Tel.: +44 754 420440  
Fax: +44 734 420631

Illinois Water Treatment Co  
Alcoa Separations Technology Group  
Rockford, IL 61105, USA  
Tel.: (815) 877 3041

## Chapter 12: Equipment for Novel Food Processes

### *Membrane Processing*

Millipore (Amicon)  
24 Cherry Hill Drive  
Danvers, MA 01923, USA  
Tel.: (617) 777 3692, (800) 426 4266  
Fax: (781)533 3110  
<http://www.millipore.com>

Berghof  
Harret Strasse 1  
72800 Enningen, Germany  
Tel.: +49 7121 8940  
Fax: +49 7121 894100  
e-M: [logistic@berghof-automation.de](mailto:logistic@berghof-automation.de)  
<http://www.berghof.com>

Dow Chemical Co.  
Liquid Separations Systems  
Midland, MI 48674, USA  
Tel.: (800) 447 4369  
Fax: (989) 832 1465  
e-M: [dowciq@dow.com](mailto:dowciq@dow.com)

E.I. du Pont de Nemours  
1007 Market Street  
Wilmington, DE 19898, USA  
Tel.: (800) 441 7515  
Fax: (302) 999 4754  
e-M: [info@dupont.com](mailto:info@dupont.com)  
<http://www.dupont.com>

Film Tec Corp.  
7200 Ohms Lane  
Edina, MN 55439, USA  
Tel.: (612) 897 4386

Graver Separations, Inc.  
200 Lake Drive  
Newark, DE 19702, USA  
Tel.: (302) 731 3539

Hydranautics Inc. (Nitto-Denko)  
401 Jones Rd.  
Oceanside, CA 92054, USA  
Tel.: (619) 901 2500  
Fax: (619) 901 2478  
e-M: [info@hvdronautics.com](mailto:info@hvdronautics.com)

Ionics, Inc.  
65 Grove Street  
Watertown, MA 02472, USA  
Tel.: (617) 926 2500  
Fax: (617) 926 4304  
e-M: [CorpMark@postoffice.ionics.com](mailto:CorpMark@postoffice.ionics.com)

Koch Membrane Systems  
850 Main Street  
Wilmington, MA 01887, USA  
Tel.: (978) 698 7000  
Fax: (978) 698 5208  
e-M: [deskbos@kochind.com](mailto:deskbos@kochind.com)  
<http://www.kochmembrane.com>

Nitto-Denko  
10th Floor, East Tower, Gate City  
Ohsaki  
1-11-2, Ohsaki, Shinagawa, Tokyo  
141-0032, Japan  
Tel.: +81 3 57402101  
Fax: +81 3 57402250  
<http://www.nitto.com>

Osmonics  
5951 Clearwater Drive  
Minnetonka, MN 55343, USA  
Tel.: (800) 848 1750, (612) 933 2277

PCI Membrane Systems, Inc.  
 Laverstock Mill  
 Whitchurch, Hapshire RG28 7NR, UK  
 Tel.: +44 1256 896966  
 Fax: +44 1256 893835  
 e-M: [pcims@compuserve.com](mailto:pcims@compuserve.com)  
<http://www.com/products/pci/>

PCI Membrane Systems  
 1615 State Route 131  
 Suite 100  
 Milford, OH 45150, USA  
 Tel.: (513) 575 3500  
 Fax: (513) 575 7393  
 e-M: [pcimsinc@compuserve.com](mailto:pcimsinc@compuserve.com)

Sulzer Chemtech Membrane Systems  
 Neukirchen D-66540, Germany  
 Tel.: (49) 6821 79234  
 Fax: (49) 6821 79250  
 e-M: [corporate.communications@sulzer.com](mailto:corporate.communications@sulzer.com)  
<http://www.sulzer.com>

### ***Supercritical Extraction Equipment***

Arthur D. Little Corp.  
 CF Systems Corp.  
 25 Acorn Park  
 Cambridge, MA 02140, USA  
 Tel.: (617) 498 5000  
 Fax: (617) 498 7200  
<http://www.adl.com>

Autoclave Engineers (Snap-tites Inc.)  
 2930 W 23rd Street  
 Erie, PA 16506, USA  
 Tel.: (814) 838 5700  
 Fax: (814) 833 0145  
 e-M: [snaptite@snap-tite.com](mailto:snaptite@snap-tite.com)

Tech-Sep  
 Division of Rhone-Poulenc  
 5 Chemin du Pilon St.  
 Maurice de Beynost-Bp 347  
 01703 Miribel Cedex, France  
 Tel.: +33 72 012727

US Filter Corp.  
 181 Thornhill Rd.  
 Warrendale, PA 15086, USA  
 Tel.: (412) 772 1337

Separex  
 5 Rue J. Monod-BP9  
 54250 Champigneulle, France  
 Tel.: +33 3 833 2424  
 Fax: +33 3 8331 24 83  
<http://www.separex.com>

SITEC  
 Sieber Engineering AG  
 Aschbach 621  
 8124 Maur/Zurich, Switzerland  
 Tel.: +41 1 9822070  
 Fax: +41 1 982 2079  
 e-M: [sieber@sitec-hp.ch](mailto:sieber@sitec-hp.ch)  
<http://www.sitec-hp.ch>



Thar Desgns, Inc.  
730 William Pitt Way  
Pittsburg, PA 15238, USA  
Tel.: (412) 826 3939  
Fax: (412) 826 3215  
<http://www.thardesigns.com>

### ***Freeze-Concentration Equipment***

GEA-Niro  
Gladsaxevej 305  
2860 Soebotg, Denmark  
Tel.: +45 39545454  
Fax: +45 39545800

Sandvic  
81181 Sandviken, Sweden  
Tel.: +46 26 260000  
Fax: +46 26 261022  
e-M: [info.group@sandvik.com](mailto:info.group@sandvik.com)

Sandvik Process Systems  
21 Campus Rd.  
Totowa, NJ 07512, USA  
Tel.: (201) 790 1600  
Fax: (201) 790 3377  
e-M: [spsusa.info@sandvik.com](mailto:spsusa.info@sandvik.com)

### ***High-Pressure Processing Equipment***

ABB Pressure Systems AB  
S-22186 Lund, Sweden  
Tel.: +46 46 36 10 94  
Fax: +46 46 36 31 91

Gee Alsthom  
Prairie au Duc  
44945 Nantes, Cedex 9, France  
Tel.: +33 2 40411616  
Fax: +33 2 40470151  
<http://www.ind.alstom.com>

Flow International Corp.  
(Avure Technologies)  
2350 64th Ave. South  
Kent, WA 98032, USA  
Tel.: (206) 813 3346  
Fax: (206) 813-3280  
<http://www.flowcorp.com>  
<http://www.avure.com>

### ***Food Irradiation Equipment***

E-Beam, Inc.  
118 Melrich Rd.  
Cranbury, NJ 08512, USA  
Tel.: (877)413 2326  
e-M: [ebeam@ebeamservices.com](mailto:ebeam@ebeamservices.com)

SureBeam Corp.  
Division of Titan Corp.  
3033 Science Park Rd.  
San Diego, CA 92121, USA  
Tel.: (858) 552 9500  
<http://www.titan.com>

Sterigenics International, Inc.  
P.O. Box 5030  
Fremont, CA 94537, USA  
Tel.: (800) 777 9012  
<http://www.sterigenics.com>

### **Chapter 13: Food Packaging Equipment**

*Note:* The numbers in parentheses following the name of the firm, indicate the type of packaging equipment mainly supplied. (1) Dosing, (2) Aseptic-, Modified Atmosphere, (3) Vacuum (4) Bottle and jar filling, (5) Carton filling and closing, (6) Cup filling, (7) Form-Fill-Seal/Aseptic and non aseptic (bags, pouches), (8) Blow mold bottle/container forming-filling-sealing (9) Filling and seaming of cans, (10) Bottle and jar closing/capping etc., (11) Forming (errection) and closing cartons and boxes, (12) Clip-fasting and bag sewing, (13) Shrink packaging (small packages), (14) Packaging into boxes (and eventually closing) of boxes for shipment, (15) Bag and net filling, (16) Palletizing, (17) Wrapping for shipment, (18) Weighing/Checkweighing, (19) Unscrambling

Adelphi Manufacturing Co. Ltd. (1),  
(4), (10), (19)  
Olympus House  
Mill Green Road  
Haywards Heath  
West Sussex RH161XQ, UK  
Tel.: +44 1444 472300  
Fax: +44 1444 440272  
e-M: [sales@adelphi.uk.com](mailto:sales@adelphi.uk.com)

Alpma (17)  
13 Rue Morice  
92110 Clichy, France  
Tel.: +33 141272800  
Fax: +33 142702986

American Can International (9)  
75 Holly Hill Lane  
Greenwich, CT 06830, USA  
Tel.: (203) 552 200

Albro Dico Gravfil (19)  
Henwood  
Hythe Road  
Ashford  
Kent TN24 8DS, UK  
Tel.: +44 1233 629161  
Fax: +44 1233 639560  
e-M: [asfordsales@gei-int.com](mailto:asfordsales@gei-int.com)

Angelus Sanitary Can Mach. Co. (9)  
4900 Pacific Boulevard  
Los Angeles, CA 90058, USA  
Tel.: (213) 583 2171  
Fax: (213)5875607  
e-M: [angelus@angelusmachine.com](mailto:angelus@angelusmachine.com)

A. Lorenzo Barroso (12)  
 Poligono Industrial "El Cros"  
 Cidel Torrent de Mada, P.O. Box 73  
 08310 Argentona Barcelona, Spain  
 Tel.: +34 937 998300  
 Fax: +34 937 998288  
 e-M: [alorenzobarroso@alorenzo-barroso.com](mailto:alorenzobarroso@alorenzo-barroso.com)

Benco Pack (2), (3), (6), (7), (16)  
 Industria Macchine Automatiche  
 Via Toscana, 1  
 29100 Piacenza, Italy  
 Tel.: +39 523 578047  
 Fax: +39 523 613892  
 e-M: [bencopack@tin.it](mailto:bencopack@tin.it)

Bizerba USA (18)  
 31 Gordon Road  
 Piscataway, NJ 08854, USA  
 Tel.: (732) 8190121  
 Fax: (732) 8190429  
 e-M: [admin@bizerbausa.com](mailto:admin@bizerbausa.com)

C&V (9), (10)  
 Pilmann Strasse 18  
 38112 Braunschweig, Germany  
 Tel.: +49 531 23170160  
 Fax: +49 531 23170161  
 e-M: [info@rhv-service.de](mailto:info@rhv-service.de)

Dawson (4), (16)  
 Stephenson way  
 Thetford  
 Norfolk IP243RU, UK  
 Tel.: +44 1842 75 3505  
 Fax: +44 1842 75 3508  
 e-M: [info@dawson-U.K..com](mailto:info@dawson-U.K..com)

DeLaval (Tetrapak) (2)  
 P.O. Box 39  
 14721 Tumba, Sweden  
 Tel.: +46 8530 66000  
<http://www.delaval.com>

Dixie Union France (3), (7)  
 Zone Industrielle  
 35606 Redon Cedex, France  
 Tel.: +33 299 712188  
 Fax: +33 299 714181  
 e-M: [dixie.union@wanadoo.fr](mailto:dixie.union@wanadoo.fr)

Dizma (5), (7)  
 Abruzzi, 16, Z.I. 36015, C.P.  
 68 Schio, Italy  
 Tel.: +39 445 575400  
 Fax: +39 445 575778  
 e-M: [dizma@dizma.it](mailto:dizma@dizma.it)

Elecster (7), (14)  
 P.O. Box 39  
 37801 Toijala, Finland  
 Tel.: +358 201 541 211  
 Fax: +358 201 541 400  
 e-M: [sales@electer.fi](mailto:sales@electer.fi)

Electronic Weighing Systems (18)  
 664 Fisherman Street  
 Opa Locka, FL 33054, USA  
 Tel.: (305) 685 8067  
 Fax: (305) 685 2440  
 e-M: [info@electronicweighing.com](mailto:info@electronicweighing.com)

Femia Industrie (4), (9)  
 31 boulevard de Bouvets  
 92741 Nanterre, France  
 Tel.: +33 147 968200  
 Fax: +33 147 170665

Ferrum (3), (4), (9)  
 5102 Ruppenswil, Switzerland  
 Tel.: +41 62 8891311  
 Fax: +41 62 8891211  
 e-M: [conserven@ferrum.ch](mailto:conserven@ferrum.ch)

Franco Boni (3), (5), (9), (12)  
 Via Guareschi 5  
 43030 Parma, Italy  
 Tel.: +39 521 681850  
 Fax: +39 521 681887

FranRica (2)  
 P.O. Box 1928  
 Stockton, CA 95201, USA  
 Tel.: (209) 948 2811  
 Fax: (209)948 5198  
 e-M: [info@fmc.com](mailto:info@fmc.com)

GEA Finnah (2), (6), (7)  
 Einstein Strasse 18  
 48663 Ahaus, Germany  
 Tel.: +49 2561 6850  
 Fax: +49 2561 68513  
 e-M: [gea-finnah@com.de](mailto:gea-finnah@com.de)

Gram Equipment A/S (6)  
 Aage Gramsvej  
 DK-6500 Vojens, Denmark  
 Tel.: +45 73 201000  
 Fax: +45 73 201005  
 e-M: [contact@gram-equipment.com](mailto:contact@gram-equipment.com)

Hassia (4), (6), (7)  
 Postfach 1120  
 63689 Ranstadt, Germany  
 Tel.: +49 6041 810  
 Fax: +49 6041 81213  
 e-M: [info@Hassia.de](mailto:info@Hassia.de)

Hoegger Alpina (3), (12), (15)  
 9202 Gossau SG, Switzerland  
 Tel.: +41 71 3886363  
 Fax: +41 71 3886300  
 e-M: [info@tippertie.ch](mailto:info@tippertie.ch)

Ishida (18)  
 44 Sanno-cho  
 Shogoin, Sakyo, Kyoto, Japan  
 Tel.: +81 75 7714141  
 Fax: +81 75 7511634  
 e-M: [webood@sf.ishida.co.jp](mailto:webood@sf.ishida.co.jp)

Krones (4), (14), (16)  
 Böhmerwald Strasse 5  
 D-93068 Neutraubling, Germany  
 Tel.: +49 9401 700  
 Fax: +49 9401 70 24 88/70 32 39  
 e-M: [sales@krones.de](mailto:sales@krones.de)

KHS (1), (4), (16)  
 Juchostr. 20  
 44143 Dortmund, Germany  
 Tel.: +49 231 5690  
 Fax: +49 231 1541  
 e-M: [info@khs-ag.com](mailto:info@khs-ag.com)

Lubeca-Scholz (9), (10)  
 Heinrich Strasse 1-5  
 48653 Coesfeld, Germany  
 Tel.: +49 2541 7450  
 Fax: +49 2541 82741  
 e-M: [korr@sholz-mb.de](mailto:korr@sholz-mb.de)

Lymac (16), (17)  
 Zone Industrielle-Voie Bleue  
 69280 Sainte Consorce, France  
 Tel.: +33 4 78442695  
 Fax: +33 4 78442205

Marden Edwards (13)  
 2 Nimrod Way, Femdown Industrial  
 Estate  
 Wimborne, Dorset BH21 7SH, UK  
 Tel.: +44 1202 861200  
 Fax: +44 1202 861400  
 e-M: [me@mepack.co.uk](mailto:me@mepack.co.uk)

Meca Plastic (3), (5), (7), (11), (14)  
 137 Rue Du Professeur Paul Milliez  
 94506 Champigny Sur Marne, France  
 Tel.: +33 1 45 166261  
 Fax: +33 1 45 166263  
 e-M: [Info@Mecaplastic.Com](mailto:Info@Mecaplastic.Com)

Morray Engineering (12), (17), (18)  
 Anglia Way  
 Braintree  
 Essex CM7 3RG, UK  
 Tel.: +44 1376 322722  
 Fax: +44 1376 323277  
 e-M: [sales@morray.com](mailto:sales@morray.com)

Multivac (3), (10), (14)  
 2 Passage Fernand Leger, Parc  
 d'Enterprises  
 de Esplanade, St Thibault de Vignes  
 77462 Lagny-sur-Mame Cedex,  
 France  
 Tel.: +33 1 64 121314  
 Fax: +33 1 64 127530  
 e-M: [muf@multivac.fr](mailto:muf@multivac.fr)

Nova Socimec (4), (5), (6), (16)  
 4 rue Jules Ferry  
 28190 Courville-sur-Eure, France  
 Tel.: +33 23 723215  
 Fax: +33 23 7237691  
 e-M: [nova.socimec@wanadoo.fr](mailto:nova.socimec@wanadoo.fr)

Ocme (2), (4), (5), (10), (11), (13),  
 (14), (16), (17)  
 Via del Popolo, 20/A  
 43100 Parma, Italy  
 Tel.: +39 521 275111  
 Fax: +39 521 272924  
 e-M: [marketing@ocme.it](mailto:marketing@ocme.it)

Omori Machinery (16), (17)  
 2761, Nishikata, Koshygaya  
 3430822 Saitama, Japan  
 e-M: [koho@omori.co.jp](mailto:koho@omori.co.jp)

Otandu (3)  
 20560 Onati, Spain  
 Tel.: +34 943 782652  
 Fax: +34 943 780819  
 e-M: [envase@packaging.ulma.es](mailto:envase@packaging.ulma.es)

Packaging Machinery Corp.(PFM),  
 (1), (2), (3), (5), (7), (18)  
 1271 Ringwell Ave.  
 NEWMARKET, ON L3Y7V1,  
 Canada  
 Tel.: +1 305 8366709  
 Fax: +1 305 8367763  
 e-M: [info@pfmusa.com](mailto:info@pfmusa.com)

Paker Becm (4), (5), (7), (11)  
 ZA de Chartres-Gellainville  
 5, rue Gustave Eiffel, B.P. 347  
 28630 Gellainville, France  
 Tel.: +33 37 285030  
 Fax: +33 37 301888

Poly-Clip System (12)  
 Westerbachstr. 45  
 60489 Frankfurt, Germany  
 Tel.: +49 69 78060  
 Fax: +49 69 7806360  
 e-M: [service@polvclip.de](mailto:service@polvclip.de)

Posimat (19)  
 Av. Arraona 17-23  
 Poligono can Salvatella  
 8210 Barbera del Valles/Barcelona,  
 Spain  
 Tel.: +34 93 7297616  
 Fax: +34 7298856  
 e-M: [sales@posimat.com](mailto:sales@posimat.com)

Rapak Liquid Packaging (5), (17)  
 Butlers Leap  
 Clifton Road, Rugby  
 Warwickshire CV213RQ, UK  
 Tel.: +44 1788 570612  
 Fax: +44 1788 546903  
 e-M: [malcolm.shipwaw@etc.dssp.com](mailto:malcolm.shipwaw@etc.dssp.com)

R. Bosch Verpackungsmaschinen  
Stuttgarter Str. 130  
71301 Weiblingen, Germany  
Tel.: +49 7151 1401  
Fax: +49 7151 142818  
e-M: [vt@boschpackaging.com](mailto:vt@boschpackaging.com)

R. Bosch Packaging Companies  
Hammac Hoeller  
Hoefliger & Karg  
Hesser

Rommelag (2), (4), (8)  
Mayennerstrasse 18-20  
71332 Weiblingen, Germany  
Tel.: +49 751 54077-79  
Fax: +49 751 15526  
e-M: [Webmaster@rommelag.com](mailto:Webmaster@rommelag.com)

Rossi Catelli (2)  
Via Traversetolo 2/A  
43100 Parma, Italy  
Tel.: +39 521 240345  
Fax: +39 521 242690  
e-M: [rcatelli@tin.it](mailto:rcatelli@tin.it)

Rovema (7), (17)  
Industriegebiet Annerod  
6301 Femwald, Germany  
Tel.: +49 641 4090  
Fax: +49 641 409212  
e-M: [info@rovema.de](mailto:info@rovema.de)

Sandiacre Packaging Machinery (7)  
101 Lilac Grove-Beeston  
Nottingham NG9 1PF, UK  
Tel.: +44 115 9678787  
Fax: +44 115 9678707  
e-M: [steve.milner@molins.com](mailto:steve.milner@molins.com)

Scholle Corp. (2), (4), (14)  
200 West North Ave.  
Northlake, IL 60164, USA  
Tel.: (312) 562 729

Serac (2), (4), (7), (8), (10)  
Route de Mamers  
72400 La Ferte-Bernard, France  
Tel.: +33 243 602828  
Fax: +33 243 602839  
e-M: [serac@serac.fr](mailto:serac@serac.fr)

Sidel (1), (2), (3), (4), (6), (7), (14),  
(16), (17)  
Av.de la Patrouille de France  
Octeville sur Mer, BP 204  
76053 Le Havre Cedex, France  
Tel.: +33 232 858687  
Fax: +33 232 858100  
e-M: [sales@fra.sidel.com](mailto:sales@fra.sidel.com)

#### Siedel Packaging Companies

Remy Equipment (e-M: [mail@fra.remv.sidel.com](mailto:mail@fra.remv.sidel.com))  
HEMA (e-M: [mail@hema techn.com](mailto:mail@hema techn.com))  
Girondine (e-M: [la.girondine@wanadoo.fr](mailto:la.girondine@wanadoo.fr))  
Cermex (e-M: [cermex@cermex.fr](mailto:cermex@cermex.fr))

SIG Holding (1), (2), (3), (4), (5), (7),  
(10) (11), (13), (17)  
8212 Neuhausen Rhine Falls,  
Switzerland  
Tel.: +41 52 6746123  
Fax: +41 52 6746556  
e-M: [info@sig-group.com](mailto:info@sig-group.com)

#### SIG Packaging Companies

SIG Simonazzi, Italy  
SIG Pack, Switzerland & US  
SIG Pack/Eagle Packaging  
([eaglepack@compuserve.com](mailto:eaglepack@compuserve.com))  
SIG  
Sapal, Switzerland ([sales@sapal.ch](mailto:sales@sapal.ch))  
SIG Doboy (<http://www.doboy.com>)

Sima (9)  
Via G. Galilei 18  
42027 Montecchio, Emilia (RE), Italy  
Tel.: +39 522 863036  
Fax: +39 522 863035  
e-M: [sima@cpssoftware.it](mailto:sima@cpssoftware.it)

Stork (2), (4), (10), (16)  
Ketelstraat 2  
1021 JX Amsterdam, Netherlands  
Tel.: +31 20 6348911  
Fax: +31 20 6369754  
e-M: [info@stork-food-dairy.com](mailto:info@stork-food-dairy.com)

T.A. Shore Co. (18)  
Northern Court, Vernon Road  
Basford, Nottingham NG6 OBJ, UK  
Tel.: +44 155 9757531  
Fax: +44 155 9770164  
e-M: [info@tascol.co.uk](mailto:info@tascol.co.uk)

Thimonnier (1), (2), (4), (7), (18)  
11 avenue de la Paix  
69650 St Germain au Mont d'or  
France  
Tel.: +33 472 081919  
Fax: +33 472 081900  
e-M: [info@thimonnier.com](mailto:info@thimonnier.com)

Toyo Jidoki Co. Ltd (3), (7), (18)  
18-6 Takanawa 2-chome  
Minato-ku, Tokyo 105-0013, Japan  
Tel.: +81 3 5447 2696  
Fax: +81 3 5447 2692  
e-M: [saisho@tvj.co.jp](mailto:saisho@tvj.co.jp)  
<http://www.tvj.co.jp>

Universal Filling Machine Co. (4), (10)  
Pound Lane  
Kingsnorth, Ashford  
Kent TN23 3JE, UK  
Tel.: +44 1233 643666  
Fax: +44 1233 634431  
e-M: [mail@universalfilling.com](mailto:mail@universalfilling.com)

Waldner (4), (17)  
Im Weissen Bild  
88239 Wangen/Algaeu, Germany  
Tel.: +49 7522 9860  
Fax: +49 7522 986280  
e-M: [waldnermeta@t-online.de](mailto:waldnermeta@t-online.de)

Ward Bekker System Ltd (7), (18)  
Spring Lane  
Malvern  
Worcs WR136NP, UK  
Tel.: +44 1684 565566  
Fax: +44 1684 565553  
e-M: [sales@wardbekker.co.uk](mailto:sales@wardbekker.co.uk)

Wolf (1), (7), (13)  
Bettenhausener Strasse 3  
35423 Lich-Birklar, Germany  
Tel.: +49 6404 91820  
Fax: +49 6404 918283  
[info@wolf-pack.de](mailto:info@wolf-pack.de)

Yamato (18)  
5-22 Saenba-cho  
Akashi 673, Japan  
Tel.: +81 78 912 2228  
Fax: +81 78 912 3039  
e-M: [scales@yamatocorp.com](mailto:scales@yamatocorp.com)

Zanichelli Meccanica (Zacmi) (4), (9)  
Via Mantova 65  
43100 Parma, Italy  
Tel.: +39 521 243737  
Fax: +39 (521)243701  
e-M: [sales@zacmi.it](mailto:sales@zacmi.it)

## Appendix C

### Controllers

ABB Control  
Tel.: +46 31 3392  
Fax: +46 40 550027  
<http://www.abb.com>

Allen-Bradley  
Industrial Control Group  
Milwaukee, WI 53204, USA  
Tel.: (414) 382 2000  
Fax: (414)382 4444  
<http://www.ab.com>

BRIC  
21 Caristrap Street  
Browmaville, ON, Canada L1C 3T6  
Tel.: (905) 623 4847  
Fax: (905) 626 7342  
<http://www.bricengineeredsystems.com>

Danfoss  
6430 Nordborg, Demark  
Tel.: +45 74 88 2222  
Fax: +45 74 490949  
e-M: [danfoss@danfoss.com](mailto:danfoss@danfoss.com)  
<http://www.danfoss.com>

Datapaq (Temperature Profiling)  
Deanland House  
160 Cowley Road  
Cabridge CB4 4GU, UK  
Tel.: +44 0 1223 423141  
Fax: +44 0 1223 423306  
e-M: [alc@datapaq.co.uk](mailto:alc@datapaq.co.uk)  
<http://www.datapaq.com>

Etoile International  
111 rue Cardinet  
75017 Paris, France  
Tel.: +33 47668186  
Fax: +33 42675904  
e-M: [etoile.inter@magic.fr](mailto:etoile.inter@magic.fr)  
<http://www.etoileinternational.fr>

Foxboro/APV  
33 Commercial Street  
Foxboro, MA 02035, USA  
Tel.: (866) 746 6477, (508) 549 2424  
<http://www.foxboro.com>

Geffan  
54 me Marc Sequin, BP 2297  
68069 Mulhouse, France  
Tel.: +33 389 591030  
Fax: +33 389 590856  
<http://www.geFran.it>

Honeywell  
P.O. Box 2245  
Morristown, NJ 07962-2245, USA  
Tel.: (800) 525 7439  
<http://www.honeywell.com>

IDS  
Nobelstrasse 8  
76275 Ettlingen, Germany  
Tel.: +49 7243 2180  
Fax: +49 7243 218100  
e-M: [info@ids.de](mailto:info@ids.de)



Krohne  
 Usine des Ors, BP 98  
 23103 Romans Cedex, France  
 Tel.: +33 4750 54400  
 Fax: +33 4750 54460  
 e-M: [flunel@krohne-sa.com](mailto:flunel@krohne-sa.com)  
<http://www.krohne.com>

Siemens  
 Prozess-Automatisierung  
 Richard Strauss Strasse 76  
 Munich, Germany  
 Tel.: +49 89 9221 3149  
 Fax: +49 89 9221 3366  
<http://www.ad.siemens.de>

Philips Analytical  
 Building KW  
 Achtesweg Noord 5  
 5651 Eindhoven, Netherlands  
 Tel.: +31 40 2766976  
 Fax: +31 40 2766328  
 e-M: [analytical.info@philips.com](mailto:analytical.info@philips.com)  
<http://www.us.analytical.philips.com>

Total Control Systems (TCS)  
 2515 Charleston Place  
 Fort Wayne, IN 46808, USA  
 Tel.: (800) 348 4753  
 Fax: (260) 484 9230  
 e-M: [info@tcsimeters.com](mailto:info@tcsimeters.com)

## Appendix D

### *Utilities*

*Note:* The numbers in parentheses following the name of the firm, indicate the type of equipment mainly supplied: (1) steam production; (2) water and effluent treatment

Aqua Chem (2)  
 (Water Technologies)  
 3001 E. John Sevier Hwy  
 Knoxville, TN 37914, USA  
 Tel.: (865) 544 2065  
 Fax: (865) 546 4330  
 e-M: [jflores@aqua-chem.com](mailto:jflores@aqua-chem.com)

Beckart Environmental Inc. (2)  
 6900 46th Street  
 Kenosha, WI 53144, USA  
 Tel.: (262) 656 7680  
 Fax: (262) 656 7699  
 e-M: [inbox@beckart.com](mailto:inbox@beckart.com)

Babcock & Wilcox (1)  
 20 S. Van Buren Ave.  
 Barberton, OH 44203-0351, USA  
 Tel.: (800) BABCOCK, (330)  
 753 4511  
 Fax: (330) 860 1886  
<http://www.babcock.com>

BMA (2)  
 De Bleek 7  
 3447 GW-Woerden, Netherlands  
 Tel.: +31 348 435 435  
 Fax: +31 346 435 399  
 e-M: [info@bma-nl.com](mailto:info@bma-nl.com)  
<http://www.bma-nl.com>

Buss (2)  
Hohenrainstrasse 10  
4133 Pratteln 1, Switzerland  
Tel.: +41 61 8256600  
Fax: +41 61 8256813  
e-M: [info.buss@coperion.com](mailto:info.buss@coperion.com)  
<http://www.busscompounding.com>

Cleaver-Brooks (Aqua-Chem Inc.) (1)  
7800 N. 113th Street  
Milwaukee, WI 53224, USA  
Tel.: (414) 359 060.  
Fax: (414) 577 315.  
e-M: [info@cleaver-brooks.com](mailto:info@cleaver-brooks.com)  
<http://www.cleaver-brooks.com>

Garioni Naval (1)  
Viale de Caduti 3  
25030 Castelmella, Italy  
Tel.: +39 30 2681541  
Fax: +39 30 2640910  
e-M: [carioninaval@compurserve.com](mailto:carioninaval@compurserve.com)

Krofta (2)  
401 South Street  
Dalton, MA 01227, USA  
Tel.: (413) 236 563.  
Fax: (413) 236 691.  
e-M: [info@kroftach.com](mailto:info@kroftach.com)

Larox (2)  
Tukkikatu 1  
53101 Lappeenranta, Finland  
Tel.: +358 5 66881.  
Fax: +356 5 6688277  
e-M: [info@larox.com](mailto:info@larox.com)  
<http://www.larox.com>

Standard Kessel Lentjies (2)  
Baldustrasse 13  
47126 Duisburg, Germany  
Tel.: +49 203 452.  
Fax: +49 203 4521.  
e-M: [info@standardkessel.de](mailto:info@standardkessel.de)  
<http://www.standardkessel.de>

Loos International (1)  
Nuerenberger Strasse 73  
91710 Gunzenhausen, Germany  
Tel.: +49 9831 5625.  
Fax: +49 9831 5692253  
e-M: [vertrieb@loos.de](mailto:vertrieb@loos.de)

# Index

## A

- Abrasive peeling, 521
- Acoustic/sonic dryers, 408
- Adiabatic dryer, 370
- Adsorption and ion exchange
  - commercial adsorbents, 592
  - equilibria and mass transfer, 592
  - equipment, 593
  - physical properties, 593
- Agglomeration equipment
  - advantages, batch process, 190
  - fluidized bed, 189
  - mechanical agitation, 189
  - pelletizing process, 189
  - selection, 207
  - solid mixer, 189
  - tableting process, 189
- Agitated horizontal dryer, 397–398
- Agitated kettles
  - food processing plants, 312
  - heat transfer coefficient ( $U$ ), 311, 312
  - jacketed kettles, 310
  - propeller agitators, 310, 311
  - ( $Re$ ) number, 310
  - scraping anchor, 310, 311
  - and vessels, 310
  - types, 310, 311
  - water-jacketed kettle, 311
- Agitated vessels, 590
- Agitated-film evaporators, 346–347
- Air classifiers
  - characteristics, 247
  - circulation fan, 247, 249
  - drag forces, 247
  - dry process, 247
  - equipment, 247
  - industrial, 249, 250
  - rotating plate, 247–249
  - simple, 247, 248
  - stokes force, 248
- Air condensers, 445
- Air coolers
  - cold store, 436
  - defrosting, 437, 438
  - equipment, 434
  - heat transfer, 435
- Air freezing equipment
  - belt, 476–478
  - blowing methods, 474
  - fluidized bed method, 475, 476
  - tunnel, 474, 475
- Air-lift pumps, 102
- Ammonia R717 ( $NH_3$ ), 452
- Artery injection, 582
- Aseptic packaging, 539, 683–685
  - advantages, 688
  - combibloc method, 685, 687
  - disadvantages, 688
  - sterilization
    - chemical, 684
    - filling chamber, 684
    - hydrogen peroxide, 684
    - metallic rigid containers, 684
    - monoblock equipment, 685
    - precautions, 683
    - UV radiation, 685
  - Tetra Pack FFS system, 685, 686
- Aseptic process, 516, 517
- Automated butter
  - processing, 226

**B**

- Back-pressure pumps, 536
- Bags, food storage
  - advantages, 129
  - characteristics, 129–130
  - disadvantage, 129
  - powders/granulates, 129
- Baking and roasting ovens
  - air temperatures, 316
  - color and aroma, development, 315
  - computer modeling and simulations, 318
  - continuous forced circulation, 317, 318
  - conveyorized proofing, 318
  - forced circulation, 317
  - heat and mass transfer mechanisms, 316
  - heat transfer factor ( $j_H$ ), 316, 317
  - heating medium, 315
  - high heat transfer rates, 318
  - mechanical and hydraulic systems, 318
  - metallic perforated drum, 315
  - multi-deck traveling belts, 318
  - natural convection, 317
  - radiation heating, 316
  - wet product, 316
- Batch freeze dryer, 404
- Batch rotary sterilizers, 526–527
- Batch sterilizers (retorts)
  - cooling, cans, 526
  - horizontal retorts, 526
  - rotary system, 526
  - still retorts, 525
  - thermal processing, 524
- Baudelot evaporators, 441
- Belt conveyors
  - advantages, 116
  - disadvantages, 116
  - inclination, 115
  - magnetic conveyor, 115
  - polyurethane/PVC, 114
  - spring mechanism, 114
  - steel wire and plastic materials, 114
  - transmission belt, 114
- Belt freezers
  - cold air steam, 476
  - curved, 477, 478
  - elevator system, 477
  - straight, 476, 477
- Bernoulli equation, 91
- Bigelow, 511
- Bin dryers, 387, 389
- Bins and silos
  - advantages, 130, 131
  - characteristics, 131

- construction, 132–133
    - disadvantages, 130, 131
    - emptying, 133–134
    - environmental considerations, 134–135
    - material flowability, 135–137
    - safety, 137–138
  - Blanching, 20, 375, 384, 421, 468, 520–521, 543
  - Blends, 454, 455
  - Bond theory, 170
  - Box pallets
    - bags, 129, 130
    - characteristics, 128
    - disadvantages, 128
    - selection and use, 128
  - Bucket conveyors (elevators)
    - advantages, 121
    - centrifugal continuous discharge, 120
    - disadvantages, 121
  - Butter drum processing, 226
- C**
- CA *See* Controlled atmosphere (CA)
  - Cake filtration
    - colloid particles, 253
    - constant filtration rate, 253
    - fruit juices, 257
    - gelatinous particles, 253
    - plate-and-frame/filter presses, 254, 255
    - pressure coat, 256
    - pressure drop, 253
    - vacuum rotary, 254, 256
  - Canned foods, 514, 517, 518, 523–525
  - Canning operations, 518–524
  - Canning peeled tomatoes, 519
  - Capacity control, 445–446
  - Carbon dioxide R744 (CO<sub>2</sub>), 453
  - Cation/anion exchange column system, 596
  - Cation exchange resins, 595
  - Cavity pumps, 100
  - Centrifugal agglomerator, 201
  - Centrifugal compressors, 352, 427, 432
  - Centrifugal film evaporators, 347–348
  - Centrifugal fluid bed (CFB), 407
  - Centrifugal pumps
    - cavitation, 98
    - characteristic pump curves, 95
    - multiple-stage pumps, 96
    - NPSH, 97
    - rotating impeller (rotor), 94
    - speed, 94
  - Chain conveyors, 120

- advantages, 120
- auxiliary devices, 119
- disadvantages, 120
- open/closed system, 119
- vertical bucket conveyor (*see* Bucket conveyors (elevators))
- Chamber-hot smoking, 584
- Cheese processing methods, 226
- Chemical process and plant design, 5–14
  - computer-aided process, 14
  - economic analysis
    - cost indices, 9, 10
    - equipment costs, 8, 9
    - fixed capital investment, 7, 8
  - equipment
    - calculations, 5
    - corrosive fluids, 6
    - heat and mass transfer, 5
    - plant installation, 6
    - purchasing, 6
    - unit operations, 5
  - manufacturing
    - breakeven point, 13
    - manufacturing cost, 11
    - profitability, 11–13
- Chlorine-containing refrigerants, 447
- CIP *See* Cleaning-in-place (CIP)
- Circulating water and steam sterilizers, 531–533
- Citrus juices, 597
- Cleaning-in-place (CIP) system
  - ball spray/rotating nozzles, 70, 72
  - fouling, 69
  - hand-opening clumps, 70
  - oil and chemical industries (pigging), 72
  - operations, 70
  - pipeline, 72
- Closing equipment
  - cartons and cardboard, 683
  - glass closures, 680
  - metallic containers, 681
  - paper and cardboard packages, 679
  - plastic packages, 682, 683
- Clostridium botulinum*, 505, 506, 514, 522
- Coil evaporators, 342
- Cold smoking process, 584
- Cold storage, 489–493
  - analytical calculation, 489
  - categories, 485, 488
  - chilling, 486
  - estimation, 487
  - factors, 486
  - heat leakage, 489
  - heat transfer, 487
  - motors, 488
  - properties, 487
  - refrigeration load, 486, 487
  - requirements, 487
  - respiration, 488
  - weight loss, reduction of
    - CA, 491–493
    - factors, 489
    - humidification, 491
    - RH, 489
    - temperature adjustment, 490, 491
- Cold surface freezing
  - advantage, 479
  - automatic feeding, 479
  - double-walled plates, 479
  - horizontal plate equipment, 478
  - vertical plate equipment, 479
- Colloid mills, 181, 182, 212, 216, 218, 281, 282
- Commercial food drying equipment, 383, 384
- Commercial sterility, 514
- Compression agglomeration
  - advantages, 202
  - disadvantages, 202
  - factors, 202
  - food processing, 202
  - pelletizing equipment, 205–206
  - roll pressing equipment, 204–205
  - tableting equipment, 202–203
- Compressors, 427
  - application, 427
  - centrifugal, 432
  - COP, 499
  - mechanical power, 499
  - reciprocating (*see* Reciprocating compressor)
  - refrigeration load, 499
  - rotary, 431
  - screw, 432, 433
  - types, 427
- Computational fluid dynamics (CFD), 380
- Computer-aided design (CAD)
  - computer packages, adoption, 28
  - heat exchangers, 300
  - software, 14
  - 2D flow sheets, 22
- Condensers, 358–359
  - air, 445
  - evaporative, 444
  - liquefaction, 443
  - refrigeration, 443
  - steam ejector vacuum system, 359
  - tower, 444

- Condensers (*cont.*)
  - tube, 443, 444
- Continuous distillation column, 558
- Continuous flow thermal processes
  - maximum velocity, 515
  - one-phase fluid foods, 514
  - two-phase foods, 515
- Continuous in-container sterilizers, 528
- Continuous leaching equipment, 578
- Continuous pasteurizers, 541
- Continuous smoking, 586
- Controlled atmosphere (CA)
  - advantages, 492
  - chemical method, 492
  - ethylene concentration, 492
  - oxygen and carbon dioxide, 491
  - respiration, 491
  - scrubbers, 492
  - storage, 491
- Convective thawing methods
  - advantages, 483
  - disadvantages, 483
  - heat transfer coefficient, 482
  - sair blast, 482
  - thermal conductivity, 482
- Conveyor belt dryers, 390, 391
- Cooling crystallizers, 599
- Cooling equipment, 462, 464–468
  - categories, 462
  - liquids
    - batch/continuous, 466
    - jacketed vessels, 467
    - plate heat exchangers, 466, 467
    - recirculation, 468
    - scraped surface exchangers, 467
    - shell and coil, 467
    - vacuum, 467
  - solids
    - hydrocooling, 462, 464
    - surface contact, 465
    - tunnel, 465, 466
    - vacuum, 464, 465
- Cost of dryers, 410
  - applications, 414
  - coefficient, 413
  - and concentration, 413
  - manufacturers and suppliers, 413
- Counter-current spray dryer, 399
- Crateless retorts, 527, 528
- Crushing
  - advantages, grinding, 166
  - Bond theory, 170
  - breaking, 167, 168
  - DIN series, 166
  - disadvantages, grinding, 166
  - equipment
    - characteristics, 165
    - selection, 186
  - G, calculation of, 169
  - grindability, 166
  - and grinding equipment, 171–173, 185
  - grinding presumes stress, 167
  - Kick theory, 169–170
  - pan mills, 176–177
  - particle analysis, 166
  - particle size distribution, 171
  - Rittinger theory, 169
  - roll crushers, 173–174
  - roll mills, 174–176
  - sieving, 166
  - statistical lengths, 165
  - strainers/pulpers, 177–178
- Cryogenic liquids
  - advantages, 482
  - CO<sub>2</sub>, 481
  - disadvantages, 482
  - evaporation, 481
  - freezing equipment, 481
  - spirals, 480
  - straight-belt equipment, 480, 481
- Crystal growth rate, 598
- Crystallization, melt, 622–625
  - crystal growth, 625
  - fat fractionation
    - detergent, 627
    - dry, 626
    - solvent, 627
  - food applications, 625–626
  - freeze concentration, 624
  - ice
    - freezing point depression, 624
    - mechanism, 625
    - separation, 625
- Culinary (potable) steam, 537
- Curing
  - automation, 583
  - dry, 580
  - engineering estimations, 579
  - nitrate content, 580
  - soaking, 580
  - wet, 580
- Curved belts
  - advantages, 478
  - disadvantages, 478
  - types, 477

## Cutting

- advantages, 154
- band saws, 160
- cutters, 161, 163
- disadvantages, 154
- disintegrators, 182
- disk grinders, 180–182
- elements, 156–157
- equipment, selection, 164–165
- factors, 153
- food processing industries, 159
- force  $F$ , 154, 156
- hammer crushers, 180
- hammer mills, 178–180
- knives, 154
- meat mincers, 161
- portable tools, 158–159
- products, 153
- slicers/dicers, 160, 161
- tool and product, 154
- ultrasonic devices, 163
- water jet, 164

## Cyclone scrubbers, 591

## Cyclone separators

- efficiency, 271, 272
- flow pattern, 270, 271
- particle/air mixture enters, 271
- pressure drop, 272
- solids density, milk powder, 272

**D**

- Decimal reduction time, 505
- Defrosting, 437–438
- DeSmet extractor, 579
- Diaphragm pumps, 101
- Dicers, 161
- Direct heat exchangers
  - liquid food, 314
  - mixing, heating steam, 314
  - time-temperature, uperisation process, 315, 316
  - UHT sterilization, 314
  - uperization milk equipment, 314, 315
- Direct heating sterilizers, 537
- Disintegrators, 182
- Disk grinders, 180–182
- Dispersability, 191
- Distillation equipment
  - activity coefficients, 555
  - analytical methods, 562
  - bubble cap, 564
  - column efficiency, 563

- economic analysis, 562
- equilibrium stages, 557
- Murphree efficiency, 563
- reflux ratio, 561
- stripping/exhausting, 551
- trays, 563
- vapor/liquid equilibria, 551
  - activity coefficients and relative volatilities, 551–552
  - nonideal mixtures and azeotropes, 553
  - volatile food aromas, 555

## Distillation systems, 558

## Double-pipe heat exchangers, 304, 305, 312

## Double-wall design, 441

## Drum/roller dryers, 402

## Dry curing, 580

## Dryer design, industries

- capacity, 381
- cost-effective, 375
- energy efficiency, 381
- mechanical properties, 381
- modeling and simulation, 381
- selection
  - DRYERBASE, 383
  - DRYING, 383
  - fuzzy logic/expert system, 382
  - matrix structure, 382
  - pressure atmospheric/vacuum, 383
  - type and size, 382

## Drying agglomeration, 192

## Drying rates

- curves, 370, 371
- diffusion mechanism, 373
- flash/spray, 374
- food materials, 370
- moisture, 373
- ratio curve, 372
- semilog coordinates, 371
- water transport, 372

## DRYSEL, 382

## Dual media filters, 258

**E**

- ED *See* Electro dialysis (ED)
- Ejector-venturi scrubbers, 591
- Electrical thawing
  - belt transporting, 485
  - dielectric
    - heating, 484
    - properties, 484
  - electromagnetic energy, 484
  - MW, 484, 485

Electrical thawing (*cont.*)  
 properties, 484  
 rubber/plastic conveyor belt, 484, 485  
 Electric resistance heating, 323, 324  
 Electrodialysis (ED), 620–621  
 Elevators, 124–125  
 Energy-efficient dryers, 412  
 Energy-saving evaporation systems, 348–356  
 Energy savings, 410  
 Essence recovery unit, 565–568  
 Ethanol, 600  
 distillation, 565  
 alcoholic beverages, 564  
 fusel oils, 563  
 nonalcoholic wine, 569  
 stripping, aromas, 567  
 three-column distillation system, 565  
 traditional brass, 564  
 solutions, 557  
 Evaporation equipment  
 engineering design, 331  
 fruit and vegetable, 331  
 physical separation process, 331  
 pre-concentration process, 331  
 Evaporative condensers, 444  
 Evaporative crystallizers, 599  
 Evaporator components  
 bodies, 356  
 control system, 360  
 hygienic (sanitary) guidelines, 361  
 LTV, 356  
 plate evaporators, 357  
 testing and evaluation, 360  
 vapor/liquid separators, 357–358  
 Evaporators  
 bath and tube, 438, 439  
 baudelot, 441  
 blower, 434  
 classification, 433, 434, 436  
 double-pipe, 441  
 double-walled and structured plain  
 surfaces, 434, 435, 441  
 flooded type, 434, 435  
 food processing unit, 433  
 forced convection air coolers, 434–438  
 heat exchangers, 433  
 heat transfer, 442  
 shell  
 and coil, 440, 441  
 and tube, 439, 440  
 solids, 442  
 Explosion-puff drying, 407  
 Extruders, 220–223  
 Extrusion, 220, 221, 223, 225

**F**

Fabrication  
 chemical reactions, 61  
 installation, 64–66  
 mechanical stresses, 61  
 physical and internal stress, 61  
 sensitive and weak points, 63  
 silos (bins), 63  
 thermal stresses, 61  
 Falling film evaporators  
 coefficient, 336  
 condensing steam, 334  
 evaporation surface, 336  
 forced-circulation evaporator, 344  
 fruit juices, 338–339  
 heat transfer coefficient, 336, 338  
 material and energy balances, 341  
 minimum flow rate, 335  
 short-tube evaporator, 343  
 water films, 336  
 Fast curing, 580  
 Feedforward triple-effect evaporator, 362  
 Fenske equation, 562  
 Fenske–Underwood–Gilliland calculation  
 method, 562  
 Filling equipment, 670–672, 674–679  
 dosing  
 capacity, 671–672  
 carousel, 672  
 counting, 671  
 packages filling methods, 670  
 time-controlled filling, 671  
 volumetrics, 670  
 weight, 671  
 flowability, food, 668  
 hygienic conditions, 666  
 liquids, 668  
 output, 667  
 overflowing, food, 667  
 packaging materials, 669  
 product transfer systems, 673  
 valves  
 comminuted solids, 675  
 filling liquid, 674–676  
 weighing scales  
 computer techniques, 678, 679  
 continuous, 677  
 conveyors, 678  
 multihead, 678  
 multi-weight, 678  
 technical data, 679  
 Film evaporators, 334–337  
 Fixed adsorption bed, 593  
 Flame sterilizers, 534



- Flash 18 system, 534
- Flowability, 191
- Fluid bed dryers, 393, 394
- Fluid classification, solid particles, 247, 250, 251
  - air (*see* Air classifiers)
  - wet
    - hydrocyclones, 250, 251
    - sieving, 250
- Fluid flow and heat transfer, 516
- Fluid food transport equipment, 88, 91
  - food pumping and piping systems, 90
  - friction losses, 92–93
  - MEBE (*see* Mechanical energy balance equation (MEBE))
  - Newtonian and non-Newtonian materials, 88
  - Poiseuille equation, 89
  - rheological property, 88–90
- Fluid mixing equipment
  - agitated tanks, 214–216
  - factors, 214
  - food, 218
  - industrial, 216–218
  - power, 216
  - primary engineering, 214
  - selection, 218–219
- Fluidized bed agglomeration systems, 200
- Fluidized bed agglomerators (Wurster), 199, 201
- Fluidized bed method
  - advantages, 476
  - disadvantages, 476
  - equipment, 475
  - transport, 475
- Fluorocarbons
  - applications, 454
  - category, 453
  - chlorine-containing refrigerants, 453
  - hydrolysis, 454
- Foam-mat drying, 375, 408
- Food cleaning
  - dry, 290
  - equipments, 287
  - raw food, 288
  - wet, 288, 290
- Food containers, 540
  - blow-mold packages, 665, 666
  - cartons and cardboard packages, 659, 660
  - drum-type unscrambling equipment, 658
  - film-based packages, 658, 660
  - metal containers, 659
  - pouch method, 661, 664
  - prefabricated containers, 658
  - ready-to-fill packages, 657
  - thermoformed packages, 663–665
  - tube-type packages, 660–662
- Food cooling, 459–462
  - equipment (*see* Cooling equipment)
  - extended application, 460
  - fresh products, 459
  - function, 459
  - indicative values, 459, 460
  - Riedel diagrams, 460–462
  - storage technology, 459
  - types, 459, 460
- Food dehydration
  - diced potatoes, 376
  - drying processes and equipment, 367
  - fruits and vegetables, 374
  - hygienic and safety, 409–410
  - IMFs, 375
  - mathematical modeling and simulations, 379, 380
  - moisture diffusivity, 373
  - operations and equipment, 384
  - plant wastes, 367
  - pre-and post-drying operations, 375
  - water removal, 367
- Food and Drug Administration (FDA), 516
- Food evaporators
  - long residence-time evaporators, 341–344
  - material and energy balances, 340–341
- Food freezing, 474, 482
  - advantages, 473
  - calculations, 471, 472
  - cold front, 469
  - components, 468
  - consumption/thawing, 468
  - conventional methods, 470, 471
  - crystals, 470
  - disadvantages, 474
  - equipment (*see* Freezing equipment)
  - estimations, 472
  - factors, 470
  - fraction, 471
  - homogeneous, 471
  - mechanism, 468
  - Plank equation, 472, 473
  - preparation, 468
  - preservation method, 468
  - quality, frozen, 468
  - thawing equipment (*see* Thawing equipment)
  - variations, 473

- Food irradiation
    - applications, 630, 631
    - cost, 633–634
    - dosage regions, 630
    - electromagnetic radiation, 628, 631
    - gamma rays, 631–632
    - installations, 632, 633
    - ionizing radiations, 628, 629, 631
    - packaging materials, 629
    - penetration, radiation, 630
    - procedure, 632
    - requirements, 629
    - systematic research, 628, 629
  - Food packaging processes
    - attractive, 650
    - operations, 645, 646
  - Food pumps
    - hygienic requirements, 103
    - packings and mechanical seals, 103
    - plastic materials, 103
    - stainless steel, 103
  - Food quality considerations
    - aroma components, 340
    - heat transfer coefficients, 340
    - suspensions and pulps, 340
  - Food storage equipment
    - liquids, storage (*see* Storage of liquids)
    - solids, storage (*see* Storage of solids)
  - Forced-circulation evaporators, 342–344
  - Forklifts, 118
  - Forming equipment, 223–226
  - Formula method, 513–514
  - Fouling
    - in evaporators
      - capital cost, 333
      - empirical correlations, 334
      - film evaporators, 334–337
    - heat exchangers
      - CFD, 302
      - cleaning techniques, 302
      - engineering, 302
      - FR, 302, 303
      - and induction, 302
      - insulating solid layer, 302
      - PHE, 302
      - rate, 302
      - scheduling, 302
      - surfaces, 302
      - velocity and temperature, 302
  - Fourier equations, 294
  - Fractional distillation, 564
  - Free structure equipment
    - advantages, 191
    - disadvantages, 191
    - drying agglomeration, 192
    - factors, 191
    - instantized products, 191
    - mixing and rolling agglomeration, 192
    - water, 190
  - Freeze-drying, 375
  - Freezing equipment, 479
    - air, 474–478
    - cold surface, 478, 479
    - liquid (*see* Liquid freezing)
  - Freundlich equation, 592
  - Frozen pellets, 480
  - Fruit aroma, 565
  - Fryers, 318–319
- G**
- Gas absorption
    - cyclone, 591
    - and desorption
      - capacity, 594
      - dilute solutions, 589
      - equilibrium stages, 587
      - food processing, 586
      - gas phase, 587
      - HTU and HETP, 590
      - ion exchange equipment, 594
      - multistage columns and packed towers, 590
      - operating cycle, 595
      - packed towers, 588
      - tray columns, 587
      - ejector-venturi scrubbers, 591
  - Glass–ceramics, 60
  - Glass container closing machines, 522
  - Glass and flexible containers, 527–528
  - Glass and flexible packages, 534
  - Graetz (*Gz*) number, 298
  - Group packaging, 688–690
    - palletizing, 691–693
    - strapping equipment, 691
    - wrapping
      - plastic film, 688
      - shrink, 689, 690
      - stretch, 690
- H**
- Hammer crushers, 180
  - Hammer mills, 178–180
  - Handbook of Industrial Drying*, 374, 376
  - Heat exchangers, 306

- agitated kettles, 310–312
- baking and roasting ovens, 315–318
- CAD, 300
- coefficients, 300–301
- direct, 314, 315
- fouling, 302, 303
- fryers, 318–319
- heat load, 300
- hygienic requirements, 324
- microwave and dielectric heating, 321–323
- ohmic/electric resistance heating, 323
- PEF, 323
- PHE (*see* Plate heat exchangers (PHE))
- principles, 300
- radiation, 319–321
- refrigeration and freezing equipment, 300
- residence time distribution, 303
- SSHEs, 312, 313
- tubular, 304–306
- Heat/film transfer coefficient ( $h$ )
  - air and water, 298, 299
  - condensing vapors, 297
  - cooling equipment operates, 293
  - correlations, 296, 297
  - dimensionless numbers, 296, 297
  - exchangers and transfer equipment, 295
  - foods and engineering materials, 294, 295
  - food heat exchange systems, 296
  - FR, 295
  - Graetz ( $Gz$ ) number, 298
  - heat transfer factor, 299, 300
  - laminar flow, power-law fluids, 298
  - log mean diameter, 295
  - non-Newtonian fluids, 297
  - physical properties, food, 294
  - power-law model, 297
  - Reynolds number, 296
  - thermal conductivity and diffusivity, 294
  - tube diameter to tube length, 297
  - viscosity ratio, 297
- Heat and mass transport
  - air–moisture systems, 378
  - coefficients, 379
  - Colburn analogies, 378
  - drying rate, 376
  - factors, 379
  - interphase, 377
  - mass transfer coefficient, 377
  - Prandtl and Schmidt numbers, 379
  - Stanton numbers, 378
  - thermophysical and properties, 378
- Heat penetration curve, 510
- Heat pump dryer, 412
- Heat pump evaporators, 353
- Heat recovery, 411
- Heat sources, drying, 410–411
- Heat transfer
  - coefficients, 507
  - cooling curves, 510
  - heat penetration curve, 509
  - heating time parameter, 509
  - in-container sterilization, 511
  - principles, 507
  - process calculations, 511
  - thermal processing equipment, 508
  - unsteady-state heat transfer, 508, 509
- Heat transfer equipment, 293–296, 300–328
  - coefficient ( $h$ ) (*see* Heat/film transfer coefficient ( $h$ ))
  - exchangers (*see* Heat exchangers)
  - food processing, 293, 294
- Heat transfer in evaporators
  - coefficients, 333
  - material and energy balances, 332
  - physical properties, 332
  - thermophysical properties, 332
- Heated rotary dryer, 392
- Heating time factor, 509
- Heat-resistant enzymes, 543
- Helical (coiled) heat exchangers, 306, 307
- Herschel–Bulkley model, 88
- High-efficiency particulate air (HEPA), 275
- High-pressure processing (HPP)
  - applications, 634
  - batch sterilization, 634
  - foodborne pathogens, inactivation, 634
  - homogenization, 635
- High-speed closing machines, 522
- High-temperature short-time (HTST)
  - pasteurizer, 541
- Hilderbrand extractor, 578
- Hoists cranes, 124–125
- Holding tube (HT), 545
- Homogenization
  - application, 208
  - colloid mills, 212
  - emulsification, 207
  - high-pressure, 213
  - liquid foods, 207
  - physical properties and stability, 207
  - pressures, 208–212
  - rotor–stator homogenizers, 212–213
  - ultrasonic homogenizers, 213
- Horizontal rotating sterilizer, 532
- Hosokawa Bepex machines, 206
- Hot smoking, 585
- Hot water blanchers, 544
- Hydraulic conveyors
  - agricultural raw materials, 110
  - critical velocity ( $u_c$ ), 111

Hydraulic conveyors (*cont.*)  
 empirical equation, 111  
 stainless steel/cast iron, 111

Hydrocooling  
 advantages, 464  
 classification, 462  
 continuous method, 462  
 disadvantages, 464  
 equipment, types, 464  
 evaporative, 464  
 pumping system, 464  
 relative motion, 462  
 sensitive products, 462, 463  
 skin and fatty tissue, 464  
 water activity, 464

Hydroflow system, 534

Hydrostatic sterilizers, 529–531

Hygienic/sanitary design, 69–72  
 cleaning (*see* CIP systems)  
 engineering implications, 66  
 standards and regulations, 66–69

## I

Ice manufacturing  
 advantages, 493  
 air coolers, 496  
 applications, 493  
 assumptions, 497, 498  
 cold storage, 496  
 compressor, 499  
 cooling/cold storage, 493  
 external walls, 497  
 flakes, 494  
 geometrical forms, 494  
 hoist/crane system, 494  
 ice-block production, 493, 494  
 installations, 493  
 tube, 495  
 types, 493  
 vacuum chamber, 495

Impeller attritors, 184

Impingement dryers, 412

In-container pasteurizers, 540

In-container sterilizers  
 flame, 534  
 Flash 18, 534  
 track flow, 533–534  
 water and steam, 531–533

In-container sterilization

Bigelow, 511  
 commercial sterility, 514  
 formula method, 513

lethality, 512

Indirect heating

plate heat exchangers, 537

tubular heat exchangers, 537

Individual quick blanching (IQB)  
 system, 544

Industrial crystallizers, 599

Industrial filters, 253

cake (*see* Cake filtration)

dual media, 258

micro/ultrafiltration, 252

sand, 257

sterile, 258

Infrared (IR)

drying (IR), 407

radiators, 320, 321

Injection pumps, 102

Inverted heat penetration curve, 510

## J

Jacketed vessel evaporators, 342

Jacketed vessels, 467

Jet mills, 184–185

Joint Committee on Irradiation  
 of Foods, 629

## K

Kick theory, 169

Kneaders/Z-blade mixers, 220

Kremser equation, 574, 601

## L

Liquid food products, 539

Liquid freezers, 479–480

Liquid freezing

cryogenic, 480–482

freezers, 479–480

frozen pellets, 480

Liquid-phase volumetric mass  
 transfer, 593

Lobe pumps, 100

Long-tube vertical evaporators  
 (LTV), 344, 345

Lubricants, 458

additives, 459

function, 456

refrigerant

acid value, 458

requirements, 458

MO, 458

- PAG, 458
  - POE, 458
  - temperature, 458
  - requirements, 456, 457
  - types, 455
- M**
- Marination, 579
  - Martin diameter, 165
  - Mass transfer equipment, 551
    - distillation (*see* Distillation equipment)
    - food process industries, 549
    - mass transfer operations, 549
    - phase equilibria, 550
    - separation of components, 549
  - Mass transfer factor, 593
  - Materials construction, 55
    - corrosion, 55
    - hygienic (sanitary) materials, 55
    - nonferrous metals (*see* Metals)
    - properties, 54
    - resistance, 55
  - McCabe–Thiele diagram, 559, 561, 571, 572, 602
  - McCabe–Thiele method, 559
  - Meat mincers, 161
  - Mechanical conveyors
    - belt conveyors, 114–116
    - chain, 119–121
    - elevators, 124–125
    - hoists cranes, 124–125
    - hygienic considerations, 125
    - mobile transport systems, 124–125
    - motor-driven and gravity, 112, 113, 119, 123
    - robots, 125
    - roll and skate wheel, 118–119
    - screw, 122–123
    - segmented belt, 116–118
    - trays, 112
    - vibratory conveyors, 123–124
  - Mechanical energy balance equation (MEBE)
    - friction losses, 91
    - mechanical damage, 92
    - pipng system, 91
  - Mechanical expression, solid/liquid separation, 264–270
    - box and pot presses, 263, 264
    - continuous presses
      - belt, 265
      - fruit juice reamers, 266
      - roller, 265
      - screw, 264, 265
    - curb and cage presses, 264
    - equipment, fruit juice processing
      - apple and grape, 267, 268
      - citrus, 268–270
    - extraction, juices and oils, 262
    - pressure, 262
  - Mechanical separations, 233, 237–251, 270, 277–285, 287
    - animal products
      - blood, 280
      - cutting, 278, 279
      - de-hairing, 278
      - equipment, 277
      - mussel shells, 279
      - screening, 279, 280
      - skinning, 278
    - cleaning (*see* Food cleaning)
    - density, 235
    - differences, 233
    - equipment, 233
    - external and internal product parts removal, 287
    - in foods, 234
      - skinning: powders, 235
      - skinning: processing, 233
    - grading, 236, 237
    - liquid/liquid separations, 235
    - materials, 233
    - particle size distribution, 235
    - plant products, 285
      - breaking processes, 280
      - brushing/polishing, 282
      - coring and scooping, 283
      - cutting/slicing, 285
      - dehulling, 281, 282
      - destemming, 282
      - equipment, 280
      - peeling (*see* Peeling, plant products)
      - pitting, 283, 284
    - product-own parts removal, 276, 277
    - properties, 235
    - removal, food related parts, 277
    - solid/air (*see* Solid/air separators)
    - solid/liquid (*see* Solid/liquid separation)
    - solid/solid (*see* Solid/solid separation)
    - sorting
      - color, 240, 241
      - criteria, 237
      - dry, 239
      - eggs, weight sorters, 240
      - grains, dry sorters, 239
      - material size, 237
      - processing, 237
      - roller, 239

- Mechanical separations (*cont.*)
- screens, 237
  - shape, 237
  - size, 238
  - spiral separators, 239
- Mechanical transport equipment
- fluid (*see* Fluid food transport equipment)
  - hydraulic (*see* Hydraulic conveyors)
  - pneumatic (*see* Pneumatic conveyors)
- Membrane separation equipment
- ED, 620
  - MF, 616
  - NF, 611
  - pervaporation, 618, 619
  - RO, 611
  - UF, 613
- Membrane separation system
- ceramic modules, 609
  - commercial membrane modules, 609
  - feed and bleed operation, 609, 610
  - food processing industry, application, 606
  - fouling, 610
  - mass transfer considerations, 606–608
  - mechanical pressure, 606
  - polymeric membranes, 608
  - tubular modules, 609
  - ultrafiltration, 606
- Metals
- aluminum, 58
  - copper, 58–59
  - nickel and chromium, 59
  - stainless Steels, 57–58
  - steel, 56–57
- MF *See* Microfiltration (MF)
- Microfiltration (MF)
- bubble point method, 617
  - ceramic membranes, 618
  - food applications, 618
  - pore size, 617
  - spiral-wound modules, 617
- Microprocessor controllers, 518
- Microwave and dielectric heating, 321–323
- Mixed suspension mixed product removal (MSMPR), 598
- Mixing agglomeration equipment, 192
- drying, 201–202
  - fluidized bed-spray, 199–201
  - high-speed agitation, 196–199
- Mobile transport systems, 124–125
- Molecular distillation, 569
- Molecular weight cutoff (MWCO), 614
- Moving-bed (continuous) leaching equipment, 578
- Multiple-effect (ME) evaporation system, 348, 350
- MultPAX system, 532
- Muscle injection, 580–581
- MWCO *See* Molecular weight cutoff (MWCO)
- N**
- Nanofiltration (NF), 611
- Nanotechnology, 636
- Natural refrigerants
- ammonia R717 (NH<sub>3</sub>), 452
  - applications, 452
  - carbon dioxide R744 (CO<sub>2</sub>), 453
  - propane R290 (C<sub>3</sub>H<sub>8</sub>), 453
- Needle curing injection, 581
- Net Positive Suction Head (NPSH), 97, 98
- NF *See* Nanofiltration (NF)
- Nonthermal food preservation, 627, 628, 635, 636
- HPP (*see* High-pressure processing (HPP))
  - irradiation (*see* Food irradiation)
  - nanotechnology, 636, 637
  - pasteurization and sterilization, 627
  - PEF (*see* Pulsed electric field (PEF))
  - robotics (*see* Robotics, food industry)
- Novel food process
- advantage, 605
  - conventional food operations, 605
- NPSH *See* Net Positive Suction Head (NPSH)
- O**
- Ohmic heating, 323, 324, 538
- Orthogonal triangle diagram, 571
- OSHA regulation, 157
- Osmotic dehydration
- food preservation, 408
  - large-scale commercial application, 409
  - mass transfer, 408
  - pumping and heating, 409
- P**
- PA *See* Polyamide (PA)
- Packages and packaging materials, 651–653, 655–657
- cardboard, 654
  - carton, 654, 655
  - glass
    - caps and lids, 653
    - disadvantages, 652
    - external coating, 653

- metal
  - advantages, 651
  - aluminum food trays, 652
  - cans, 651
  - containers, 651
  - thin aluminum films, 652
  - tubes, 652
- nanomaterials, 651
- paper
  - coarse sulfate, 653
  - fine sulfite, 653
  - kraft, 653
- plastics
  - cellulose, 657
  - disadvantages, 655
  - PA, 657
  - PE, 655
  - PET, 656
  - PP, 656
  - properties, 655
  - PTFE, 657
  - PVdC, 656
  - types, 655
- Packaging equipment, 651, 657, 666
  - characteristics, 647, 648
  - choice, 648
  - containers (*see* Food containers)
  - ecological considerations, 650
  - economic factors, 650
  - filling technique, 645, 647 (*See also* Filling equipment)
  - grouped packages, 647
  - materials (*see* Packages and packaging materials)
  - media cleaning, 693, 694
  - monoblock equipment, 647
  - ready-to-fill packages, 645
  - safety aspects, 649
  - sealed packages, 647
  - sterilization, 646
  - technological considerations, 649, 650
- Packed tower systems, 576, 587–590
- PAG *See* Polyalkylene glycol (PAG)
- Pan dryer, 398
- Pan mills, 176–177
- Paste and dough mixing equipment, 219–220
- Pasteurization, 539
- Pasteurization process control, 542
- PE *See* Polyethylene (PE)
- Pelletizing agglomeration machines, 205
- Peristaltic pumps, 100, 101
- PET *See* Polyesters (PET)
- Phase equilibria, 5, 550, 553, 597, 622
- Piston pumps, 101
- Plastics–rubber
  - equipment/machines, 60
  - properties, 56, 59
  - thermoplastic and thermosetting materials, 59
- Plate evaporators, 345–346
- Plate heat exchangers (PHE), 466, 467
  - adjacent plates, 306, 307
  - assembly, 306, 307
  - design (sizing), 308
  - dimensions and capacities, 308
  - food industry, 306
  - fouling, modeling and simulation, 302
  - gaskets, 306, 308
  - geometry, 306
  - heat transfer coefficient ( $h$ ), 308
  - heat transfer factor ( $j_H$ ), 308, 310
  - heating/cooling application, liquid food, 308, 309
  - liquid flows, 308, 309
  - pasteurization, orange (OJ), 324–326
  - and pressure drop factor, 308, 309
- Pleeing, plant products
  - apple, 284
  - dry, 285
  - flame, 285
  - flash steam, 286
  - knives, 285
  - lye peelers, 285
  - pressure steam, 286, 287
- Pneumatic conveyors
  - air-pressure and vacuum system, 108, 109
  - bulk density, 109
  - design data, 109
  - empirical equations, 109
  - explosion hazards, 110
  - granular foods, 108
  - inorganic materials, 108
  - physical and mechanical properties, 108
  - pipng, 110
  - units, 110
- Pneumatic/flash dryers, 394, 396
- Pneumatic ring dryer, 396
- POE *See* Polyol ester (POE)
- Polyalkylene glycol (PAG), 458
- Polyamide (PA), 657
- Polyesters (PET), 656
- Polyethylene (PE), 655
- Polyol ester (POE), 458
- Polypropylene (PP), 656
- Polytetrafluorethylene (PTFE), 657
- Polyvinylidene chloride (PVdC), 655

- Ponchon–Savarit diagram, 561, 571, 573
- Positive displacement pumps (PDPs)
- cavity/eccentric screw, 99
  - diaphragm, 101
  - dosing applications, 100
  - lobe, 100
  - peristaltic, 100
  - piston, 101
  - rotary, 99
  - twin-screw, 99
  - vane, 100
- Power-law model, 297
- PP *See* Polypropylene (PP)
- Prandtl number, 300
- Process design, 2–6, 19–23, 27, 28, 34, 38, 39, 41, 43–46
- advanced food plants, 35–36
  - agencies, 29
  - capital cost, 42
  - chemical and plant design
    - economical, 2
    - flow sheets, 2, 3
    - gases and liquids, 2
    - industries, 2
    - material and energy balances, 4–5
    - plant layout buildings, 6
    - types, 3, 4
  - computer-aided food process
    - design, 28
  - consumption, 16
  - definition, 1
  - economic analysis
    - heat balances, 45, 46
    - material balances, 43–45
  - equipment, 33
  - estimation, 42
  - factories, 16
  - flexibility, 33
  - flow sheets, 22–23, 25, 26, 43
  - food plant economics
    - expenses, 41
    - investment, 38, 39
    - manufacturing process, 39
    - profitability, 38
  - food storage, 33
  - GMPs, 36, 37
  - heat application, 32
  - hygienic, 30, 33
  - industries, 30, 31, 42
  - investment, 17, 31
  - location, 32
  - manufacturing, 16, 29
  - marketing, 16, 17
  - material and energy balances
    - calculations, 27
    - complexity, 23
    - principles and techniques, 23
    - refractometers, 27
  - micro and macrostructures, 19
  - mobile food plants, 35
  - packaging materials, 42
  - plant expansion, 34, 35
  - plant improvement
    - buildings, 34
    - conveyance, 34
    - energy, 34
    - environment, 34
    - management, 34
    - production, 34
    - storage, 34
  - plant safety, 33
  - principles, 1, 15
  - product/process, 32, 33
  - production rate, 31
  - profitability, 43
  - quality, 16, 29
  - raw materials, 18
  - safety programs and HACCP, 37, 38
  - sanitation, 32
  - standardization, 32
  - storage, 29
  - technologies, 15
  - trade, 16
  - unit operations, 15
    - assembly, 20
    - categories, 20, 21
    - equipment, 19, 22
    - gases and liquids, 19
    - processes and testing, 22
    - quality, 20
    - separation processes, 19
- Propane R290 (C<sub>3</sub>H<sub>8</sub>), 453
- Psychrometrics
- adiabatic convective dryer, 368
  - air/water vapor mixtures, 368
  - chart, 369
  - computer calculations, 369
  - hygroscopic properties, 368
  - moisture content, 368
- PTFE *See* Polytetrafluorethylene (PTFE)
- Puff drying, 375
- Pulsed electric field (PEF), 323, 635
- Pump auxiliaries
- electric motors, 104–105



- mechanical seals, 105
  - piping, 105–106
  - valves, 106–107
  - PVdC *See* Polyvinylidene chloride (PVdC)
- R**
- Radiation heaters, 319–321
  - Raoult's law, 554
  - Reciprocating compressors
    - advantages, 431
    - characteristics, 427, 429, 430
    - disadvantages, 431
    - indicator diagram, 429, 430
    - selection, 430
    - types, 427, 428
  - Recirculating water blancher, 544
  - Refrigerants
    - absorption, 446
    - blends, 454, 455
    - chemical requirements, 452
    - chlorine-containing, 447
    - compression, 446
    - fluorocarbons, 453, 454
    - invention, 446
    - liquid, 446
    - Montreal protocol, 447–450
    - natural, 452, 453
    - properties, 447
    - requirements, 447
  - Refrigeration cycles
    - advantages, 427
    - disadvantages, 427
    - elements, 426
    - equipment, 426
    - evaporators, 422, 424, 426
    - pressure–enthalpy diagrams, 426
    - single-stage process, 425
    - variations, 422
  - Refrigeration equipment, 427, 433, 443
    - capacity control, 445, 446
    - classification, 422–424
    - compressors (*see* Compressors)
    - condensers (*see* Condensers)
    - cycles, 422, 424–427
    - evaporators (*see* Evaporators)
  - Regression analysis, 593
  - Residence time distribution, 303
  - Reverse osmosis (RO) systems
    - composite membrane, 612
    - concentration polarization, 612
    - evaporation, 355
    - food applications, 612, 613
    - skinned asymmetric membrane, 612
  - Reynolds number, 296, 299
  - Rising (climbing) film evaporators
    - liquid feed, 337
    - surface tension, 337
    - temperatures and pressure, 337
    - vapor to liquid velocities, 337
  - Rittinger theory, 169
  - RO *See* Reverse osmosis (RO) system
  - Robotics, food industry
    - advantage, 637
    - applications, 637
    - cartesian, 637, 638
    - cylindrical, 637
    - elements, 639
    - IP Code Standards, 640
    - technical restrictions, 639–641
    - types, 638, 639
  - Roll and skate wheel conveyors
    - advantages, 119
    - coaxial wheels, 118
    - cylindrical steel rolls, 118
    - disadvantages, 119
    - forklifts, 118
    - fruit and vegetable cleaning equipment, 118
  - Roll mills, 174–176
  - Rolling agglomeration, 191
    - rotating drums, 195
    - rotating pans, 193–195
  - Rosin–Rammler distribution, 171
  - Rotary compressors
    - advantages, 431
    - disadvantages, 431
    - refrigerant vapor, 431
  - Rotary convective dryer
    - air flow capacity, 415
    - by-products, 414
    - combustion water, 415
    - hot air/flue gases, 415
    - psychrometric chart, 414
  - Rotary cooker/coolers, 528, 529
  - Rotary dryers, 392
  - Rotary grinders, 183
  - Rotary positive displacement (PD) pumps, 536
  - Rotor–stator homogenizers, 212–213
- S**
- Sand filters, 257
  - Scraped surface exchangers, 467
  - Scraped surface heat exchangers (SSHEs), 538
    - double stacks, 313
    - heat transfer, 313
    - heating/cooling medium, 312
    - high-pressure drops, 313

- Scraped surface heat exchangers (SSHEs)  
(*cont.*)  
hydrodynamics, fluid food flow, 313  
mechanical construction, 313  
pipe diameters, 313  
positive displacement pump, 313  
thermal design, 313
- Screw compressors  
advantages, 433  
development, 432  
disadvantages, 433  
volumetric efficiency, 432
- Screw conveyors  
advantages, 122  
continuous ribbon, 122  
cylindrical vessel, 122  
disadvantages, 123  
emptying silos, 122
- Segmented belt conveyors  
belt structures/thickness, 117  
chains/cables, 116  
modular system, 117  
sprockets, 117  
steel plate belts, 116
- Selection of food processing equipment, 72–78  
construction characteristics  
automation, 74  
cleaning facility, 73  
dimensions/weight, 72–73  
firmness/durability, 74  
maintenance, 73  
quality of materials, 73  
spare parts standardization, 73  
operational characteristics  
accuracy, 78  
convenience, 75  
effectiveness, 77–78  
efficiency, 77  
environmental impact, 78  
ergonomics, 77  
instrumentation, 77  
reliability, 74  
safety, 75–76
- Separations and supercritical fluid (SCF), 605
- Separations of food materials *See* Mechanical separations
- Shaka equipment, 532
- Shell heat exchangers, 305, 327, 328
- Short-tube evaporators (calandria), 342
- Shugi agglomerator, 200
- Sil dryers, 387, 389
- Simple distillation tray, 565
- Single-belt (band) conveyor dryer, 391
- Single-drum dryer, 402
- Single screw extruder, 221
- Sinkability, 191
- Size enlargement  
agglomeration, 186–188  
besides water, 188  
food technology, 186  
no water, 188  
solid, 186  
van der Waals and electrostatic forces, 187
- Size reduction, 153–165  
application of forces, 150  
construction characteristics, 150  
cutting (*see* Cutting)  
disadvantages, 152  
final size of products, 150  
grindability, 150  
main forces, 150  
processes, 149  
reasons, 152
- Sizing and costing, equipment  
air-cooling unit, 52  
alloying metals, 54  
material and energy balances, 52  
metallic materials, 52  
off-the-shelf equipment, 52
- Slicers, 160
- Slow agitation equipment, 195–196
- Smoking, 583
- Soaking, 580
- Solar drying, 385, 386
- Solid/air separators, 270, 272–276  
cyclones (*see* Cyclone separators)  
design, 270  
filters  
bag, 272–274  
clean room technology, 274  
dry, 274  
electrical, 275, 276  
HEPA, 275  
industrial, 274  
technical characteristics, 275  
viscous, 274  
recovery, food particles, 270  
wet scrubbers/particle collectors, 276
- Solid foods, 442
- Solid/liquid separation, 252–269  
centrifuges  
filtering, 261  
milk separators, 261  
sedimentation, 258–260  
separators, 260  
food processing, 251

- industrial filters (*see* Industrial filters)
  - mechanical expression (*see* Mechanical expression, solid/liquid separation)
  - properties, 233
  - screening, 251
  - sedimentation, 251, 252
  - Solid mixing and encrusting equipment, 227–229
  - Solid/solid separations, 241–247
    - classification, fluid (*see* Fluid classification, solid particles)
    - screening, equipment, 244
    - screening/sieving
      - categories, 243
      - cloths, 245, 246
      - electrostatic separators, 246
      - flat, 245
      - flour, 246
      - grizzlies/belt, 244
      - magnetic separators, 246
      - particles, 241
      - rotating sifters, 245
      - sizes, 242
      - stainless steel, 243
      - stratification, 243
      - surface, 243
      - trommels, 244
    - sizes, 242
    - surface, 241
  - Solubility–temperature diagram, 597
  - Solvent extraction and leaching
    - equilibrium, 570, 573
    - liquid/liquid extraction, 570, 576
    - mass transfer considerations, 574
    - multistage equipment, 577
    - oil from oilseeds, 575
    - RTC, 576
    - solid/liquid equilibria, 571, 572
    - sugar beets, 575
  - Special food dryers
    - convective/contact heat transfer, 405
    - moisture permeability, 405
    - MW and RF, 405
    - pasta drying operations, 406
    - vacuum-and freeze-drying operations, 406
  - Spinning cone distillation column, 569
  - Spinning cone stripping column (SCSC), 568
  - Spiral-tube heat exchangers, 306
  - Spouted bed dryers, 394
  - Spray dryers, 399–402
  - Spray water tunnel, 540
  - Sprockets, 117
  - Static-bed system, 577
  - Steam blanching, 543
  - Steam economy (SE), 348, 349
  - Sterile filters, 258
  - Sterilization, 523
  - Still retorts, 525
  - Storage of liquids, 138–141
    - tanks, 141–146
    - vats (*see* Vats and vessels)
  - Storage of solids, 130–138
    - bags, 129–130
    - bins (*see* Bins and silos)
    - box pallets, 127–128
    - pallets, 126–127
  - Stork–Lagarde circulating steam sterilizer, 532
  - Stresses
    - impeller attritors, 184
    - jet mills, 184–185
    - rotary grinders, 183
  - Stripping line, 560
  - Sugar beets, 575
  - Sun drying, 385
  - Supercritical fluid (SCF) extraction
    - carbon dioxide solvent, rules, 622
    - critical properties, carbon dioxide and water, 621
    - food processing, 623
    - phase equilibrium, 622
    - processes and equipment, 622
    - transport properties, 621, 622
  - Superheated steam dryer, 412
  - Surface contact cooling, 465
- T**
- Tanks
    - advantages and disadvantages, 142
    - fermentation, 142–143
    - liquid foods and fruit/vegetable, 141
    - regulations, 144–146
    - trucks, 142
  - Tenderizing, 582
  - Testing of equipment
    - Newtonian fluids, 78
    - specifications, 79–82
  - Thawing equipment
    - contact, 483
    - convective methods, 482, 483
    - electrical, 484, 485
    - industrial process, 482
    - vacuum, 483
  - Thermal damage reactions, 507
  - Thermal inactivation
    - activation energies, 506

- Thermal inactivation (*cont.*)  
 decimal reduction time, 506  
 microorganisms and enzymes, 504  
 negative slope, 505  
 thermal damage, food components, 507  
 thermal death time curve, 505
- Thermal pasteurizers, 539–543  
 continuous, 541  
 in-container, 540
- Thermal process calculation diagram, 512
- Thermal process calculations  
 in-container sterilization, 511  
 microorganisms, 511
- Thermal processing equipment, 504  
 blanching, 520  
 can sizes, 523  
 canning, 503, 518  
 continuous flow thermal processes, 514  
 cutting, 521  
 damage in nutrition, 503  
 design, 504  
 exhausting, 522  
 filling, 521  
 food plants, 517  
 grading, 520  
 heating of foods, 503  
 heat transfer, 507  
 hygienic requirements, 544  
 in-container sterilizers, 517  
 industrial equipment, 517  
 inspection of product, 520  
 labeling/casing/warehousing, 523  
 peeling, fruits and vegetables, 521  
 raw materials, 518  
 receiving, 518  
 thermal inactivation (*see* Thermal inactivation)
- Thermal processing time, 515
- Thermophilic bacteria, 523
- Three-column distillation system, 565
- Tomato evaporators, 354
- Tower condenser, 444
- Tower dryers, 387–389
- Track flow sterilizer systems, 533
- Tray/cabinet dryers, 389
- Tray columns, 588
- Triple-effect evaporator  
 concentration, 361  
 engineering and construction, 362  
 orange juice, 362  
 pectic enzymes, 363  
 preliminary calculations, 361  
 vapor velocities, 363
- Tube heat exchanger, 327, 328
- Tubular Exchangers Manufacturers Association (TEMA), 305
- Tubular heat exchangers  
 active length, 306  
 co-current and counter-current, 328  
 and countercurrent shell, 305  
 design and applications, 305  
 dimensions, 305  
 double-pipe type, 304, 305  
 heating pulp-containing fruit juices, 304  
 helical (coiled), 306, 307  
 and shell, 305  
 spiral-tube heat exchangers, 306  
 TEMA, 305  
 temperature differences, 304
- Tumbling drum, 582
- Tumbling dryers, 407
- Tunnel cooling, 465, 466
- Tunnel dryers, 390
- Tunnel freezers  
 advantages, 475  
 continuous operation, 472, 474  
 disadvantages, 475  
 loading systems, 474
- Tunnel pasteurizers, 540
- Turbulent pipe flow, 299
- Twin-screw extruders, 221
- U**
- UF *See* Ultrafiltration (UF) membranes
- UHT sterilization processes, 535
- Ultrafiltration (UF) membranes  
 concentration polarization, 614, 615  
 diafiltration, 615  
 food applications, 615, 616  
 fouling, 614  
 modular forms, 614  
 MWCO, 614  
 separating capacity, 614
- Ultrahigh-temperature (UHT)  
 downstream system, 536  
 equipment, 535
- Ultrasonic cutting devices, 163
- V**
- Vacuum and freeze dryers  
 conventional (convective) methods, 403  
 pharmaceutical industry, 403  
 refrigeration, 405  
 semicontinuous vacuum, 404

- Vacuum application, 582
  - Vacuum cooling, 464, 465
  - Vacuum cooling equipment, 467
  - Vacuum maintaining system, 359
  - Vacuum thawing, 483
  - Vane pumps, 100
  - Vapor density, 600
  - Vapor recompression evaporators, 351, 352
  - Vats and vessels
    - advantages and disadvantage, 138, 139
    - AISI 304 stainless steel, 140
    - auxiliary equipment, 138
    - carbon steel /aluminum, 140
    - characteristics, 139
    - criteria, 138
    - cylindrical, 140
    - kneading equipment, 141
    - semiliquid products, 140
  - Vibration equipment, 196
  - Vibratory conveyors
    - advantages, 124
    - disadvantages, 124
    - gliding transport, 123
    - troughs/tubes, 123
  - Volatile aroma components, 567
  - Volumetric mass transfer rate, 592
- W**
- Warm drying, 585
  - Washing, 519
  - Waste-heat evaporators, 355–356
  - Water desalination, 355
  - Water jet cutting devices, 164
  - Water treatment
    - cation/anion exchange columns, 595
    - industrial enzymes, 596
    - ion exchange beds, 595
    - juices, 596
    - nucleation and mass transfer, 598
    - proteins, 596
    - solution equipment, 597
  - Wet cleaning
    - equipment, 288, 289
    - flotation, 290
    - raw fruits and vegetables, 288
    - rotary brush, 290
    - soaking, 288
    - spray, 288
  - Wet curing, 580
  - Wettability, 191
  - Wine and ethanol-fermented products, 556
  - Wood, 60