

Rattan Lal · Bal Ram Singh  
Dismas L. Mwaseba · David Kraybill  
David O. Hansen · Lars Olav Eik *Editors*

# Sustainable Intensification to Advance Food Security and Enhance Climate Resilience in Africa

Sustainable Intensification to Advance  
Food Security and Enhance Climate  
Resilience in Africa



Rattan Lal • Bal Ram Singh  
Dismas L. Mwaseba • David Kraybill  
David O. Hansen • Lars Olav Eik  
Editors

# Sustainable Intensification to Advance Food Security and Enhance Climate Resilience in Africa

 Springer

*Editors*

Rattan Lal  
Carbon Management and  
Sequestration Center  
Ohio State University OARDC  
Columbus, OH, USA

Bal Ram Singh  
Department of Environmental Sciences  
Norwegian University of Life Sciences  
Ås, Norway

Dismas L. Mwaseba  
Sokoine University of  
Agriculture  
Morogoro, Tanzania

David Kraybill  
AEDE/CFAES  
The Ohio State University  
Columbus, OH, USA

David O. Hansen  
IPA/CFAES  
The Ohio State University  
Columbus, OH, USA

Lars Olav Eik  
Department of International Environment and  
Development Studies/Noragric  
Norwegian University of Life Sciences (NMBU)  
Ås, Norway

ISBN 978-3-319-09359-8

ISBN 978-3-319-09360-4 (eBook)

DOI 10.1007/978-3-319-09360-4

Springer Cham Heidelberg New York Dordrecht London

Library of Congress Control Number: 2014952600

© Springer International Publishing Switzerland 2015

This work is subject to copyright. All rights are reserved by the Publisher, whether the whole or part of the material is concerned, specifically the rights of translation, reprinting, reuse of illustrations, recitation, broadcasting, reproduction on microfilms or in any other physical way, and transmission or information storage and retrieval, electronic adaptation, computer software, or by similar or dissimilar methodology now known or hereafter developed. Exempted from this legal reservation are brief excerpts in connection with reviews or scholarly analysis or material supplied specifically for the purpose of being entered and executed on a computer system, for exclusive use by the purchaser of the work. Duplication of this publication or parts thereof is permitted only under the provisions of the Copyright Law of the Publisher's location, in its current version, and permission for use must always be obtained from Springer. Permissions for use may be obtained through RightsLink at the Copyright Clearance Center. Violations are liable to prosecution under the respective Copyright Law.

The use of general descriptive names, registered names, trademarks, service marks, etc. in this publication does not imply, even in the absence of a specific statement, that such names are exempt from the relevant protective laws and regulations and therefore free for general use.

While the advice and information in this book are believed to be true and accurate at the date of publication, neither the authors nor the editors nor the publisher can accept any legal responsibility for any errors or omissions that may be made. The publisher makes no warranty, express or implied, with respect to the material contained herein.

Printed on acid-free paper

Springer is part of Springer Science+Business Media ([www.springer.com](http://www.springer.com))

# Preface

The Green Revolution of the 1960s and 1970s in South Asia and elsewhere did not happen in Sub-Saharan Africa (SSA). Indeed, agriculture in SSA either stagnated or regressed during the second half of the twentieth century and has lagged behind that of Asia and other parts of the developing world. Yet, a large part of the population of SSA is dependent on agriculture. It underpins the livelihoods of ~70 % of Africa's poor and under-privileged population. Agriculture in SSA is characterized by small farms of less than two 2 ha and subsistence farming which is typically characterized by the use of hand tools and manual labor and the absence of other inputs, including agrochemicals and irrigation.

That said, several regions of SSA have experienced substantial improvements in crop yields and growth in agricultural production since the beginning of the twenty-first century. Yet, no drastic increase in per capita food grain production has occurred, primarily because of rapid rates of population growth. And per capita food production has decreased in East Africa, Southern Africa and Central Africa. Thus, hunger, malnutrition and poverty remain endemic throughout SSA. Agriculture in SSA is vulnerable to harsh and uncertain climate variations. Resource-poor and small landholders are particularly susceptible to their negative impacts. SSA is one of the global hotspots for adverse effects of climate change on agricultural production and the environment. These include severe problems of soil degradation, nutrient and organic matter depletion, water contamination and eutrophication, and loss of biodiversity, especially the below-ground's diversity.

Despite encouraging signs of agronomic yield increases since 2000, major challenges remain in bringing about substantial agricultural improvements throughout SSA. Therefore, the strategy is to improve agricultural production while minimizing negative externalities and improving the environment.

It is in this context that sustainable intensification (SI) can play an important role in enhancing agricultural production while restoring degraded/desertified soils, mitigating global warming by sequestering atmospheric CO<sub>2</sub> in soils and vegetation (forests), adapting to climate change by using recommended management practices of the so-called climate-resilient or climate-strategic agriculture, improving farm

income, and empowering women and other under-privileged populations. SI is defined as the process of producing more from less while reducing negative externalities and restoring quality of soil and water resources.

An international conference that addressed SI as it relates to climate change and increased food security was held at the Sokoine University of Agriculture (SUA), Morogoro, Tanzania, from 13 to 15 November 2013. Major objectives of the conference were to describe the importance of SI in restoring soil quality and its organic carbon pool as a tool to off-set anthropogenic emissions; to deliberate the role of economic, social (gender), policy and cultural factors in adoption of RMPs by small landholders of SSA; and to identify priority research, development and training priorities that will facilitate SI in SSA.

This 32-chapter volume represents the core of several oral and poster presentations made at the conference. In addition to Introduction and Conclusion sections, the book is thematically divided into seven sections, namely, (1) Land Use and Farming Systems, (2) Effects of Climate Change on Crop Yield, (3) Soil Nutrient and Water Management for Carbon Sequestration, (4) Rehabilitation of Degraded Lands Through Forestry and Agroforestry, (5) Management of Animal Production for Greenhouse Gas Emissions, (6) Smallholder Adaptation to Climate Change, and (7) Economic, Social and Policy Issues.

The conference was attended by more than 100 participants from SSA countries as well as the USA and Norway. It was organized by a Steering Committee with representatives from SUA, the Ohio State University, and the Norwegian University of Animal and Life Sciences. The conference was funded by NORAD, USAID and SUA. Primary funding for the conference was channeled through several programs at SUA, namely the USAID-funded International Agricultural Research Initiative (iAGRI), the Climate Change Impacts, Adaptation and Mitigation (CCIAM) project, and the Enhancing Pro-poor Innovations in Natural Resources and Agricultural Value-Chains (EPINAV) project. In addition, the conference benefitted from contributions from Africa Rising, the International Food Policy Research Institute (IFPRI), the World Agroforestry Center (ICRAF), and the Carbon Management and Sequestration Center (C-MASC).

The editors thank all authors for their outstanding contributions to this volume. Thanks are also due to staff at Springer for their timely efforts in publishing this volume. Our special thanks are due to Laura Alexander (iAGRI), Samantha Alvis (Leland Congressional Fellow), Jennifer Donovan (C-MASC), Anthony Sangeda (iAGRI) and Ambonisye Haule (iAGRI).

1 May 2014

Editors

# Contents

## Part I Introduction

- 1 Sustainable Intensification for Adaptation and Mitigation of Climate Change and Advancement of Food Security in Africa . . . . . 3**  
Rattan Lal

## Part II Land Use and Farming System

- 2 Geopedological and Landscape Dynamic Controls on Productivity Potentials and Constraints in Selected Spatial Entities in Sub-Saharan Africa . . . . . 21**  
Yazidhi Bamutaze
- 3 Land Degradation and Soil Carbon Pool in Different Land Uses and Their Implication for Food Security in Southern Ethiopia . . . . . 45**  
Ambachew Demessie, Bal Ram Singh, and Rattan Lal
- 4 Land Use Impact on Soil Organic Carbon and Total Nitrogen Storage in a Typical Dry Land District in Tigray, Northern Ethiopia . . . . . 63**  
Aweke M. Gelaw, Bal Ram Singh, and Rattan Lal
- 5 Climate Risk Management Through Sustainable Land Management in Sub-Saharan Africa . . . . . 75**  
Ephraim Nkonya, Frank Place, Edward Kato, and Majaliwa Mwanjololo



<b>6</b>	<b>Effects of Land Cover Changes on Soil Organic Carbon and Total Nitrogen Stocks in the Eastern Mau Forest Reserve, Kenya . . . . .</b>	<b>113</b>
	Kennedy O. Were, Bal Ram Singh, and Øystein B. Dick	
<b>Part III Effects of Climate Change and Crop Yield</b>		
<b>7</b>	<b>Soil Erosion Hazard Under the Current and Potential Climate Change Induced Loss of Soil Organic Matter in the Upper Blue Nile (Abay) River Basin, Ethiopia . . . . .</b>	<b>137</b>
	Daniel Mengistu, Woldeamlak Bewket, and Rattan Lal	
<b>8</b>	<b>Climate Change and Crop Yield in Sub-Saharan Africa . . . . .</b>	<b>165</b>
	Charles K.K. Gachene, Anne N. Karuma, and Mary W. Baaru	
<b>9</b>	<b>Factors in Smallholder Farmers' Vulnerability to Climate Change Impacts in the Uluguru Mountains, Morogoro, Tanzania . . . . .</b>	<b>185</b>
	Amon Z. Mattee, K.R. Mussa, Dismas L. Mwaseba, C.P. Mahonge, and J.V. Nsenga	
<b>10</b>	<b>Using Climate and Crop Simulation Models for Assessing Climate Change Impacts on Agronomic Practices and Productivity . . . . .</b>	<b>201</b>
	Winfred B. Mbungu, Henry F. Mahoo, Siza D. Tumbo, Frederick C. Kahimba, Filbert B. Rwehumbiza, and Boniface P. Mbilinyi	
<b>Part IV Soil Nutrient and Water Management for Carbon Sequestration</b>		
<b>11</b>	<b>Microdosing of Mineral Fertilizer and Conservation Agriculture for Sustainable Agricultural Intensification in Sub-Saharan Africa . . . . .</b>	<b>223</b>
	Jens B. Aune and Adama Coulibaly	
<b>12</b>	<b>Approaches to Reinforce Crop Productivity Under Rain-fed Conditions in Sub-humid Environments in Sub-Saharan Africa . . . . .</b>	<b>235</b>
	Regis Chikowo, Shamie Zingore, Justice Nyamangara, Mateete Bekunda, Joseph Messina, and Sieglinde Snapp	
<b>13</b>	<b>Effect of In Situ Soil Water Harvesting Techniques and Local Plant Nutrient Sources on Grain Yield of Drought-Resistant Sorghum Varieties in Semi-arid Zone, Tanzania . . . . .</b>	<b>255</b>
	Method Kilasara, M.E. Boa, E.Y. Swai, K.P. Sibuga, Boniface H.J. Massawe, and E. Kisetu	

## **Part V Rehabilitation of Degraded Land Through Forestry and Agro-Forestry**

- 14 Restoration of Degraded Lands Affected by Salinization Process Under Climate Change Conditions: Impacts on Food Security in the Senegal River Valley** . . . . . 275  
Mateugue Diack, T. Diop, and R. Ndiaye
- 15 Tree Integration in Banana-Based Cropping Systems: A Case Study of Jinja, Uganda** . . . . . 289  
Lukman Nagaya Mulumba
- 16 Management Practices/Techniques Commonly Used in Niger Republic, West Africa** . . . . . 305  
Mohamadou Habibou Gabou and Abdou Maisharou
- 17 Soil Organic Carbon Stocks of the Kitonga Catchment Forest Reserve, Tanzania: Variation with Elevation** . . . . . 315  
H.B. Shelukindo, E. Semu, B.M. Msanya,  
Bal Ram Singh, and P.K.T. Munishi

## **Part VI Management of Animal Production for Greenhouse Gas Emissions**

- 18 Alternative Goat Kid-Rearing Systems for Improved Performance and Milk Sharing Between Humans and Offspring in Climate Change Mitigation** . . . . . 331  
Fanny C. Chigwa, Lars Olav Eik, G.C. Kifaro,  
V.C.M. Muhikambele, and Daniel E. Mushi
- 19 Reducing GHG Emissions from Traditional Livestock Systems to Mitigate Changing Climate and Biodiversity** . . . . . 343  
Daniel E. Mushi, Lars Olav Eik, A. Bernués, R. Ripoll-Bosch,  
F. Sundstøl, and M. Mo
- 20 Feeding Strategies for Improved Beef Productivity and Reduced GHG Emission in Tanzania: Effect of Type of Finish-Feeding on Carcass Yield and Meat Quality of Zebu Steers** . . . . . 367  
Ismail Saidi Selemani, Lars Olav Eik, Øystein Holand,  
Tormod Ådnøy, Ephraim J. Mtengeti, Daniel E. Mushi,  
and Sørheim Oddvin

## **Part VII Smallholder Adaptation to Climate Change**

- 21 Enhancing Resilience of Food Production Systems Under Changing Climate and Soil Degradation in Semi-arid and Highlands of Tanzania** . . . . . 385  
Nyambilila A. Amuri

<b>22</b>	<b>A Risk-Based Strategy for Climate Change Adaptation in Dryland Systems Based on an Understanding of Potential Production, Soil Resistance and Resilience, and Social Stability . . . . .</b>	<b>407</b>
	Jeffrey E. Herrick and Adam Beh	
<b>23</b>	<b>Use of Conservation Tillage and Cropping Systems to Sustain Crop Yields Under Drought Conditions in Zambia . . . . .</b>	<b>425</b>
	Obed I. Lungu	
<b>24</b>	<b>Sustainable Intensification of Maize and Rice in Smallholder Farming Systems Under Climate Change in Tanzania . . . . .</b>	<b>441</b>
	Ephraim J. Mtengeti, Frank Brentrup, Eva Mtengeti, Lars Olav Eik, and Ramadhani Chambuya	
<b>25</b>	<b>Smallholder Adaptation to Climate Change in Semi-arid Areas of Tanzania: Experiences from Iramba and Meatu Districts . . . . .</b>	<b>467</b>
	Gry Synnevåg, Samwel J. Kabote, Carolyn I. Nombo, Delphina Mamiro, and Amon Z. Mattee	
<b>Part VIII Economic, Social and Policy Issues</b>		
<b>26</b>	<b>Exploring the Meso-level of Agricultural Carbon Finance Projects . . . . .</b>	<b>489</b>
	Corinna Clements and Keith M. Moore	
<b>27</b>	<b>Community, Climate Change, and Sustainable Intensification: Why Gender Is Important . . . . .</b>	<b>515</b>
	Cornelia Butler Flora	
<b>28</b>	<b>Designing Environmental Instruments to Finance Agricultural Intensification Through the Clean Development Mechanism: Direct Cost Subsidy Versus Tax Cut Under Asymmetric Information . . . . .</b>	<b>533</b>
	Albert N. Honlonkou and Rashid M. Hassan	
<b>29</b>	<b>Farming Systems in Tanzania: Empirical Evidence of Changes in Livelihood Patterns and Poverty Among Smallholder Farmers . . . . .</b>	<b>555</b>
	Ntengua S.Y. Mdoe, Gilead I. Mlay, and Michael L. Kadigi	
<b>30</b>	<b>Carbon Market Impacts on Farm Management Practices on Mount Kilimanjaro . . . . .</b>	<b>573</b>
	Francis Mulangu and David Kraybill	

**31 Adaptation to Climate Change: Changing Gender Relations in the Meatu and Iramba Districts in Tanzania . . . . . 587**  
 C.I. Nombo, S.J. Kabote, D.P. Mamiro, G. Synnevåg,  
 A.Z. Mattee, J.K. Urassa, and L. Matata

**Part IX Conclusion**

**32 Forgotten Facts: Research and Development Priorities . . . . . 603**  
 Rattan Lal, B.R. Singh, Dismas L. Mwaseba, David Kraybill,  
 David O. Hansen, and Lars Olav Eik

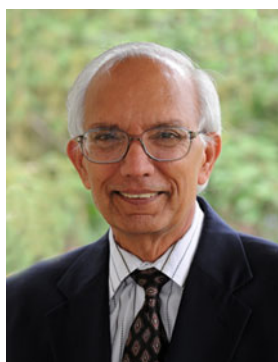
**Appendix: Working Group Recommendations . . . . . 617**

**Session Slides . . . . . 629**

**Index . . . . . 657**

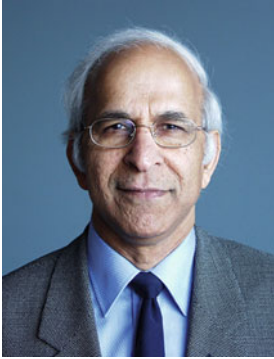


## Editors Biographies



**Dr. Rattan Lal, Ph.D.**, is a Distinguished University Professor of Soil Science and Director of the Carbon Management and Sequestration Center, The Ohio State University, and an Adjunct Professor of University of Iceland. He was Sr. Research Fellow with the University of Sydney, Australia (1968–1969), and Soil Physicist at IITA, Ibadan, Nigeria (1969–1987). He is a fellow of the American Society of Agronomy (ASA), Soil Science Society of America (SSSA), Third World Academy of Sciences, American Association for the Advancement of Sciences, Soil and Water Conservation Society (SWCS), and Indian Academy of Agricultural Sciences. He

received the Hugh Hammond Bennett Award of the SWCS, 2005 Borlaug Award, and Liebig Award (2006) of the International Union of Soil Sciences (IUSS), M.S. Swaminathan Award (India) of 2009, and COMLAND Award (Germany) of 2009. He received honorary degree of Doctor of Science from Punjab Agricultural University (2001), the Norwegian University of Life Sciences, Aas (2005), and Alecu Russo Balti State University, Moldova (2010). He was president of the World Association of the Soil and Water Conservation (1987–1990), the International Soil Tillage Research Organization (1988–1991), the SSSA (2005–2007), and President Elect and member of the Executive Committee of IUSS (2015–2020). He was a member of the Federal Advisory Committee on the Third National Assessment of Climate Change (2010–2014), member of the SERDP Scientific Advisory Board of the DOE (2011–), Senior Science Advisor to the Global Soil Forum of IASS, Potsdam, Germany (2010–), and a member of the Advisory Board of FACCE-JPI of the European Council (2013–). Professor Lal was a lead author of IPCC (1998–2000), and was awarded Nobel Peace Prize Certificate by IPCC in 2007, and Global Dry land Champion of UNCCD in 2013. He has mentored 100 graduate students and 52 postdoctoral researchers, and hosted more than 120 visiting scholars. He has authored/co-authored more than 1,700 research publications including 660 refereed journal articles, has written 14 and edited/co-edited 50 books.



**Dr. Bal Ram Singh, Ph.D.**, is a Professor in the Department of Environmental Sciences at the Norwegian University of Life Sciences (NMBU). He earned his M.Sc. degree from the Indian Agricultural Research Institute, New Delhi, and his Ph.D. degree from G.B. Pant University of Agriculture & Technology, Pantnagar, India. His program focuses on bioavailability and mobility of heavy metals in the soil and plant system, fertility management and agricultural sustainability in soils of the tropics and on carbon sequestration in soils and vegetation under different land uses. He has served as chairman of the program

board “Soils and Plants” of the Research Council of Norway and as Deputy Head of the Department. He has chaired or been a member of many national and international committees. He provides the current leadership of the Cost (European Cooperation in Science and Technology) Action FA0905 on “Mineral Improved Cop Production for Healthy Food and Feed”, in which >200 scientists from 31 countries are participating.

He has supervised 76 graduate students (Ph.D. and M.Sc.) and 16 visiting fellows/scientists from 20 countries. He has authored/coauthored 354 publications, of which 210 in peer-reviewed journals and books. He is serving on the editorial boards of 3 international journals and is a reviewer of 27 journals. Professor Singh has delivered lectures in more than 40 international conferences in 19 countries. Dr. Singh is a fellow of ASA (2004) and SSSA (2005) and recipient of International Award in Soil Science (SSSA) in 2011.



**Dr. Dismas L. Mwaseba** was born in 1958 in Kyela District in southwestern Tanzania. He completed his Bachelor of Science in Agriculture at Sokoine University of Agriculture in 1985 and a Master of Philosophy in Agricultural Extension and Rural Sociology at Obafemi Awolowo University, Ile-Ife, Nigeria in 1991. Ten years later, he joined the Department of International Environment and Development Studies, Noragric, at the Norwegian University of Life Sciences at Aas for a Ph.D., which he successfully completed in 2005. His research interests include agricultural innovation and impact assessment of R&D. Currently he is

an Associate Professor and Director, SUA Centre for Sustainable Rural Development.



**Dr. David Kraybill** currently serves as project director for the USAID-funded Innovative Agricultural Research Project in Tanzania. His primary research interest is economic development. His work focuses on regional and spatial development processes that interact with markets and national government policies to determine the economic and social wellbeing of individuals, households, and communities. Dr. Kraybill’s recent research includes studies of household poverty, household savings, governmental decentralization, primary and secondary education, and adaptation to climate change. Fluent in French and a Swahili speaker, he has lived in

Africa a total of 5 years, including a sabbatical year as Fulbright Scholar at Makerere University in Uganda. Kraybill has served as Associate Editor or member of editorial boards of seven academic journals. He has received research and advising awards at Ohio State, and received the International Award of Merit from the Gamma Sigma Delta honor society. He has been consultant advisor to World Bank, Rockefeller Foundation, Southeast Consortium for International Development, U.S. Department of Agriculture, and numerous governments and other organizations. He came to Ohio State in 1992.



**Dr. David O. Hansen** is currently employed by The Ohio State University to oversee several major USAID-funded higher education partnership projects in East Africa, including the International Agricultural Research Initiative (iAGRI) and the Trilateral Program for Food Security in Kenya. More recently he was a Senior Fellow with the Association for Public and Land-grant Universities (APLU), Washington, D.C. His responsibilities there included the Africa-U.S. Higher Education Initiative which promotes partnerships among U.S. and African Higher Education Institutions to build capacity in Africa. Many of them focus on

agriculture, climate change and related areas, such as water, range management and ecosystems services. He collaborates with USAID, World Bank, USDA, land-grant universities and NGO’s to help define the parameters of higher education capacity building within the context of the U.S. Government Feed the Future Initiative. He has dedicated his career to international development while at Ohio State University, having previously served as Associate Dean and Director of International Programs in Agriculture for over two decades. In this capacity he helped design and manage major institution building projects in Uganda, India, Swaziland, Mexico and the Dominican Republic. Early in his career he worked on long-term overseas assignments in Brazil where he served as Deputy Chief-of-Party and Chief-of-Party for institution building projects.





**Mr. Lars Olav Eik** works at University of Life Sciences (UMB) in Norway as coordinator for programs mainly in Tanzania in collaboration with Sokoine University of Agriculture. He has also worked in Ethiopia, Malawi and South Africa. His main area of teaching and research is production systems for small ruminants both in Norway and Tanzania. Eik often collaborates with private companies and farmers when experiments are undertaken. He has also supervised a number of Ph.D. students, particularly from East Africa.

# Abbreviations

ABMS	Activity Baseline and Monitoring Survey
ACER	Agricultural Credits of Emission Reduction
ADF	Acid detergent fiber
ADG	Average daily gain
AE	Agronomic efficiency
AECL	Associação Envirotrade Carbon Livelihoods Trust
AEZ	Agroecological zone
AF	Agroforestry
AFOLU	Agriculture, Forestry and Land Use
ANOVA	One-way analysis of variance
APSIM	Agricultural Production Systems sIMulator
ASDP	Agricultural Development Programme
ASDS	Agricultural Development Strategy
ATA	Agricultural Transformation Agenda
AWC	Available water capacity
BD	Soil bulk density
BF	Bamboo forests
BF2C	Cropland from bamboo forest
BMC	Microbial biomass carbon
BMPs	Best management practices
C	Carbon
CA	Conservation agriculture
Ca	Calcium
CAADP	Comprehensive Africa Agriculture Development Programme
CASL	Community Adaptation and Sustainable Livelihoods
CBA	Cost–benefit analysis
CC	Climate change
CCAFS	Climate Change, Agriculture and Food Security (a CGIAR research program)
CCB	Climate, Community, and Biodiversity Standards

CCBA	Climate, Community and Biodiversity Alliance
CCF	Community capitals framework
CD	Chest depth
CDM	Clean development mechanism
CEC	Cation exchange capacity
CEEPA	Center for Environmental Economics and Policy in Africa
CER	Certified Emission Reductions
CF	Conservation farming
CGCM	Coupled General Circulation Model
CGIAR	Consortium of International Agricultural Research Centers
CIESIN	Columbia University's Center for International Earth Science Information Network
CL	Carcass length
CNRM	Centre National de Recherches Météorologiques
COP15	Fifteenth Conference of Parties on Climate Change
CP	Crude protein
CRD	Completely randomized design
CRU	Climate Research Unit of the University of East Anglia
CT	Conservation tillage
DCS	Direct cost subsidy
DEM	Digital elevation model
DM	Dry matter
DOC	Dissolved organic carbon
DSSAT	Decision Support System for Agrotechnology Transfer
DUAT	<i>Direito de uso e aproveitamento da terra</i>
DUL	Dry upper limit
EC	Electrical conductivity
EE	Ether extract
EML	Envirotrade Mozambique Limitada
ENSO	El Niño Southern Oscillation
ES	Environmental Service
ES	Enterprise survey
ESP	Exchangeable sodium percentage
F	Crop field
FACE	Free-air carbon dioxide enrichment
FAO	Food and Agriculture Organization of the UN
FC	Flat cultivation
FDI	Foreign direct investment
FGDs	Focus group discussions
FMNR	Farmer Managed Natural Regeneration
FP	Farmers' practice
FS	Farming system
GAEZ	IIASA Global Agro-ecological Zones
GART	Golden Valley Agriculture Research Trust

GCMs	Global circulation models
GDP	Gross domestic product
GHG	Greenhouse gas
GIS	Geographic information systems
GRET	Professionals for Fair Development (French NGO)
GWP	Global warming potential
HARITA	Horn of Africa Risk Transfer Adoption
HC or Circ	Hind leg circumference
HH	Households
HL	Hind leg length
HSD	Tukey studentized test
IC	Initial contracting
ICP-AES	Inductively coupled plasma atomic emission spectroscopy
IETA	International Emissions Trading Association
IFPRI	International Food Policy Research Institute
IIED	International Institute for Environment and Development
INM	Integrated nutrient management
INVDMD	In vitro dry matter digestibility
INVOMD	In vitro organic matter digestibility
IPM	Integrated pest management
IPNM	Integrated plant nutrient management
IPSL	Institut Pierre Simon Laplace
IR	Infiltration rate
ISFM	Integrated soil fertility management
ITCZ	Inter-tropical convergence zone
K	Potassium
KACP	Kenya Agricultural Carbon Project
KFR	Kitonga Forest Reserve
KIIs	Key informant interviews
LandPKS	Land-Potential Knowledge System
LFS	Livestock farming systems
LGA	Local government area
LL	Lower limit
LPs	Livestock production systems
Lsmeans	Least square means
LUPRD	Land Use Planning and Regulatory Department (FAO)
MAAIF	Ministry of agriculture, animal industries and fisheries
MAHFP	Months of adequate household food provisioning
MAM	March-April-May season
MAM	March-April-May
MCLT	Mozambique Carbon Livelihoods Trust
MFI	Microfinance institutions
Mg	Magnesium
Mha	Million hectare

MT	Minimum tillage
N	Nitrogen
NAFCO	National Agriculture and Food Cooperation
NAP	National action plan
NAPA	National Action Programme For Adaptation
NASA	U.S. National Aeronautics and Space Administration
NBP	Net biome productivity
NDF	Neutral detergent fiber
NDVI	Normalized Difference Vegetation Index
NEMA	National Environmental Management Authority
NEP	Net ecosystem productivity
NEPAD	New Partnership for Africa's Development
NES	National Environmental Secretariat
NF	Natural forest
NF2C	Cropland from natural forest
NGO	Nongovernmental organizations
NK	Muriate of potash and ammonium nitrate
NLP	National Land Policy
NPKS	Compound fertilizer + ammonium nitrate
NPP	Net primary productivity
NPS	Single super phosphate + ammonium nitrate
NPV	Net present value
NRM	Natural resource management
NUE	Nutrient use efficiency
NVH	Norwegian College of Veterinary Sciences, Norway
OM	Organic matter
OND	October-November-December
OP	Open pasture
P	Phosphorus
PANTIL	Programme for Agricultural and Natural Resources Transformation for Improved Livelihoods (collaborative program between SUA/UMB/NVH)
PAW	Plant-available water
PDRT	Projet de Développement Rural de Tahoua
PES	Payments for environmental services
PF	Plantation forests
PF2C	Cropland from plantation forest
PI	Infiltration pit
PIK	Projet Intégré Keita
PKS	Single super phosphate + muriate of potash
PMA	Uganda's Plan for Modernization of Agriculture
RDS	Rural Development Strategy
RE	Recovery efficiencies

REDD	Reducing emissions from deforestation and forest degradation
REDD+	2010 update with new components for Reducing emissions from deforestation and forest degradation
RF	Rainfed cultivation
RMPs	Recommended management practices
RUSLE	Revised Universal Soil Loss Equation
SAGCOT	Southern Agricultural Growth Corridor of Tanzania
SALM	Sustainable Agricultural Land Management
SAP	Structural Adjustment Policy
SAS	Statistical Analysis System
SC	Soil conservation
SCC-ViA	Swedish Cooperative Centre – Vi Agro-forestry Program
SCRp	Soil Conservation Research Programme
SCS	Soil carbon sequestration
SDR	Sediment Delivery Ratio
SF	Stall feeding
SI	Sustainable intensification
SLM	Sustainable land management
SLWM	Sustainable land and water management
SOC	Soil organic carbon
SOM	Soil organic matter
SP	Silvopasture
SPSS	Statistical Package for the Social Sciences
SQI	Soil quality indexes
SSA	Sub-Saharan Africa
std	Standard deviation
STRM	Shuttle Radar Topography Mission
SUA	Sokoine University of Agriculture, Tanzania
SWC	Soil and water conservation
SWMRP	Soilwater Management Research Programme of SUA
SY	Sediment yield
TC	Total carbon concentration
TFP	Total factor productivity
TN	Total nitrogen
TOSCA	Tanzania Official Seed Certification Agency
TR	Tied-ridging
TZS	Tanzanian Shilling
UMB	University of Life Sciences, Norway
UNCCD	United Nations Convention to Combat Desertification
UNESCO	United Nations Educational, Scientific and Cultural Organization
UNFCCC	United Nations Framework Convention on Climate Change
URT	United Republic of Tanzania
VCR	Value–cost ratio
VCS	Verified carbon standard

VCU	Verified carbon unit
VER	Verified emission reductions
WBISPP	Woody Biomass Inventory and Strategic Planning Project
WBSF	Warner-Bratzler shear force machine
WGS 84	World Geodetic System
WSA	Water stable aggregation
YSS	Yara/Syngenta/SUA

**Part I**  
**Introduction**



# Chapter 1

## Sustainable Intensification for Adaptation and Mitigation of Climate Change and Advancement of Food Security in Africa

Rattan Lal

**Abstract** Africa is endowed with diverse eco-regions, climates, soils, landscapes and water resources. There were three regions of crop domestication in Africa. In addition to the Fertile Crescent in Mesopotamia, crop domestication also occurred in West Africa for yam and cassava, and in the Horn of Africa for teff, coffee, and the cucumber tree. With a land area of 30.2 million km<sup>2</sup> and population approaching one billion, Africa has a vast potential for agricultural and economic development. Africa's population has been increasing rapidly since the beginning of the twentieth century. The population (million) was 120 in 1900, 221 in 1950, 796 in 2000, 867 in 2010, and is projected to be 1,081 in 2020, 1,804 in 2050 and 2,255 in 2100. Thus, food security has been a major concern since 1970s, and the Green Revolution by-passed the resource-poor and small landholders of the continent. There were 240 million food-insecure people in Africa (approximately 1 in 4) in 2012, 223 million in Sub-Saharan Africa (SSA) in 2013, and the number is projected to increase by an additional 17 million (+6 %) by 2020. The problem is likely to be exacerbated by the changing and uncertain climate, because SSA is a vulnerable region, subject to the vagaries of projected climate change. Some project that as much as 65 % of the global total increase in climate-related hunger would occur in SSA. Climate change vulnerability in SSA is exacerbated by severe soil degradation, depletion of soil organic matter (SOM) and the negative soil nutrient balance of N, P, K at 40–50 kg/ha/year on continental scale. Soil degradation is the result of many factors, including wide spread use of extractive farming practices, poor structural stability and high erosion potential associated with harsh climates. Soils are highly prone to accelerated erosion by water and wind, crusting and hard setting, acidification and salinization. The rate of fertilizer input is low (~8 kg/ha) and less than 5 % of the potentially irrigable land is equipped for irrigation. Thus drought is a perpetual problem in SSA. A large yield gap exists between attainable and national average yield of most crops grown in the region. Recommended management practices (RMPs) for soils include conservation tillage, mulch

---

R. Lal (✉)

Carbon Management and Sequestration Center, Ohio State University OARDC,  
2021 Coffey Road, Columbus, OH 43210, USA  
e-mail: [lal.1@osu.edu](mailto:lal.1@osu.edu)

farming, cover cropping, using integrated nutrient management and manuring, growing nitrogen fixing legumes and trees, and applying bio-solids to enhance SOM reserves. Important among water management techniques are water harvesting and recycling, micro irrigation, recycling city water and grey water. The strategy is to create positive C and nutrient budgets and improve soil quality and its rhizospheric processes. A wide spread adoption of RMPs can improve soil quality, enhance input use efficiency, increase climate change resilience, narrow the yield gap and sustain agronomic production. Sequestration of C in soils and vegetation (trees) can also mitigate climate change by reducing net anthropogenic emissions. Payments to land managers for provision of ecosystem services, such as C sequestration, water quality improvement, and bio diversity enhancement, can create additional income streams and promote the adoption of RMPs. Sequestration of C in agro-ecosystems is a win-win situation. It will enhance agronomic production and sustain the use of soil and water resources while improving the capacity of smallholder agriculture to adapt to climate change and off set anthropogenic emissions.

**Keywords** Population • Food imbalance • Urbanization • Ecoregions of Africa • Soils of Africa • Domestication of crops in Africa • Soil degradation and political unrest • Sustainable soils management • Tradeoffs

## 1.1 Introduction

Africa is a large and highly diverse continent. Its land area is  $30.2 \times 10^6 \text{ km}^2$ , which is 3.15 times that of China, 3.08 times of USA, and 9.15 times of India. The population of Africa was 1.123 billion in 2010 compared to 1.343 in China, 1.205 million in India, and 313 million in the USA. After an extended period of economic and agronomic stagnation between 1960 and 2000, many countries in Africa have recently experienced rapid economic growth. The annual rate of economic growth in 2012 was 18 % in Sierra Leone, 12 % in Niger, 10 % in Ivory Coast, 9 % in Liberia, Ethiopia and Tanzania, and 7 % in Mozambique, Zambia, Ghana, and Tanzania. As a result of this growth, the proportion of the population in the region below the poverty line declined from 58 % in 1960 to 48 % in 2009, despite large increases in the national populations. Crop yields and agricultural production have also experienced significant increases in Zambia, Ghana, Malawi, Uganda, and other countries. However, major challenges lie ahead and the momentum in economic and agricultural growth since 2000 must be strengthened. These challenges are more daunting than ever before because of the warming earth, degrading soils, declining water availability, decreasing biodiversity, and increasing demands for food, feed, fiber, and fuel. Therefore, the objective of this article is to discuss strategies of sustainable intensification of smallholder agriculture for adaptation and mitigation of climate change while advancing food security and improving the environment.

## 1.2 Population and Food Imbalance

Food and nutritional insecurity have been major issues in Sub-Saharan Africa (SSA) since the 1970s. The number of inhabitants of this region that are vulnerable to food insecurity was estimated to be 240 million (or one in four) in 2010 (FAO 2012). Further, 79 million of them were estimated to be undernourished in East Africa, 47.6 in Central Africa, 33.3 in Southern Africa, 27.5 in West Africa and 24.9 in the Sahel (Lobell et al. 2008). The number of the food-insecure people for the entire region is likely to increase by an additional 17 million by 2020 (FAO 2011; USDA 2011). Rapid population growth (see Table 1.1) and rapid urbanization may exacerbate the food insecurity problem. Most cities in SSA are growing at a rate of 3–4.5 % per annum. The recent growth rate of Addis Ababa (Ethiopia) was ~12 % per annum (Table 1.2). There were 800 million people in sub-Saharan Africa in 2000 and this region is projected to have 1.1 billion inhabitants by 2020, 1.8 by 2050, 2.3 by 2100, and to stabilize at around 2.1 billion in 2150 (Table 1.1). Hot spots of hunger and malnutrition in SSA are the Sahel from Senegal to Chad, and the Horn of Africa which is comprised of Djibouti, Ethiopia, Kenya, and Somalia. Food insecurity is aggravated by civil strife and political instability.

**Table 1.1** Past and projected population growth trends – Africa

Year	Population (10 <sup>6</sup> )	Relative
1900	120	1.00
1950	221	1.84
2000	796	6.60
2010	867	7.23
2015	971	8.09
2020	1,081	9.00
2050	1,804	15.00
2100	2,255	18.79
2150	2,082	17.35
2200	2,009	16.74
2250	2,061	17.18
2300	2,112	17.60

Adapted from U.N. (2013)

**Table 1.2** Select urban population growth in Africa

City	Population (10 <sup>6</sup> )			Growth (% p.a.)
	1975	2007	2025	
Accra	0.7	2.1	3.4	2.93
Addis	0.9	3.1	6.2	11.78
Dar	0.6	2.9	5.7	4.39
Kinshasa	1.5	7.8	16.8	3.89
Lagos	1.9	9.5	15.8	4.44
Nairobi	0.7	3.0	5.9	3.87

UN Population St./ERS/SER.A/274 2008

Past trends in per capita food production in Africa have been negative. Between 1970 and 2007, per capita food production decreased by 30 % in eastern Africa, 20 % in southern Africa, 2 % in western Africa, and 40 % in central Africa (Shapouri et al. 2010). In comparison, per capita food production increased by 35 % in South Asia.

Underlying processes and causes of the historic decline in the per capita food production must be objectively and critically assessed if the problem is to be addressed. This assessment will need to focus on plant genetics and improved soil quality, particularly in regard to increasing availability of water and plant nutrients (Sinclair and Sinclair 2010), restoring soil organic carbon (SOC) concentration and stock, and improving soil structure. This conclusion was strongly supported by Norman Borlaug (1972) when he asserted that “chemical fertilizer is the fuel that has powered the Green Revolution’s forward thrust.” In SSA, major production constraints are poor soil quality and low availability of water and nutrients for site-specific cropping systems. In developing countries, it is the lack of availability of N and water that are considered to be the principal constraints (Sinclair and Rufty 2012).

The recent economic resurgence experienced in several countries of SSA cannot be sustained without addressing hunger, which affects a quarter of its population. It is a harsh paradox that hunger and malnutrition continue to be pervasive on a continent with an ample agricultural endowment. Unfortunately, it may become even more apparent due to rapid population increases and changing climate. Climate change may decrease crop yields for maize, rice, and wheat in irrigated areas by 40 %, 39 % and 24 % respectively. This compares with projected potential impacts of climate change on yields of these same crops under rain fed farming conditions of 15 %, 11 %, and 33 % respectively (WFP 2013; Lobell et al. 2011). Sub-Saharan Africa is the region that is most vulnerable to climate change. As much as 65 % of the global total increase in climate change induced hunger may occur in this region (WFP 2013).

### 1.3 Soil, Water and Biotic Resources

The ecoregion of Sub-Saharan Africa is generously endowed in soil resources (Table 1.3). The desert/arid climates of the Saharan and Namibian deserts make up 45 % of the total land area. Ecoregions in them that are suited for intensive agriculture include humid regions (13.7 %) and semi-arid regions (36.8 %). Semi-arid regions are the most suitable for cultivation of crops. Similar to biomes, sub-Saharan Africa is also endowed with diverse soil resources (Table 1.4) including Alfisols (10.3 %), Aridisols (25.9 %), Entisols (24.1 %), Inceptisols (7.6 %), Ultisols (6.1 %), Oxisols (14.1 %) and Vertisols (3.2 %). Minor soils include Histosols and Mollisols (Table 1.4).

Soil and climate diversity have led to domestication of several crops in SSA (Table 1.5). Thus, scarcity of soil, water and diverse biomes and climatic regimes are not major causes of low crop yields, or the poor agronomic production, and agrarian stagnation experienced since 1960s.

**Table 1.3** Major ecoregions of Africa

Biome	Area (10 <sup>6</sup> ha)	% of total
Arid-tropical	299.6	9.5
Arid-temperate	1,128.6	36.2
Mediterranean	113.2	3.6
Semi-arid tropical	1,093.9	35.2
Semi-arid temperate	52.4	1.7
Humid tropical	371.8	11.9
Humid temperate	55.0	1.8
<b>Total</b>	<b>3,114.5</b>	<b>100</b>

Adapted and recalculated from Eswaran et al. (1997)

**Table 1.4** Major soils of Africa

Order	Area (10 <sup>6</sup> ha)	% of total
Alfisols	320.0	10.28
Andisols	4.9	0.16
Aridsols	807.6	25.94
Entisols	750.6	24.11
Histosols	1.53	0.05
Inceptisols	237.8	7.64
Mollisols	7.0	0.22
Oxisols	438.9	14.09
Spodosols	3.07	0.10
Ultisols	190.6	6.12
Vertisols	99.0	3.18
Dune Sands	144.1	4.60
Rocks	32.4	1.04
Salt Flats	3.5	0.11
Inland Water	73.5	2.36
<b>Total</b>	<b>3,114.5</b>	<b>100</b>

Adapted and recalculated from Eswaran et al. (1997)

**Table 1.5** Domestication of some food crops in sub-Saharan Africa

Region	1,000 year BP	Crops domesticated
North Africa (Nile Delta)	9–14	Eincorn, Emmer, Barley, Vetch, Lentil, Pea
Horn of Africa	5–7	Teff, Coffee, Cucumber tree, Yehab nut
West Africa	4–5	Yam, Cassava

## 1.4 Predominant Cropping/Farming Systems

Most smallholder farmers in sub-Saharan Africa practice subsistence farming and are women. Farming practices typically do not include use of irrigation or other energy-based inputs, such as fertilizers, pesticides, and mechanized farm operations. These farms are characterized by low yields, nutrient mining, and reliance on rain fed agriculture. Soils associated with 200 Mha of croplands in 13 countries

have lost as much as 600 kg/ha of N, 75 kg/ha of P and 450 kg/ha of K from 1980 to 2010 (Lobo and Hewlett 2011). Losses by water and wind erosion are projected to increase by as much as 36 % in Africa between 1980 and 2090 due to climate change. Cultivated soils are also severely depleted of their soil organic matter (SOM) stocks. Long-term experiments conducted in Senegal indicate that SOM concentration declined from 2.8 to 0.8 % in the 0–10 cm layer, and 1.5 to 0.75 % in the 10–20 cm layer, by continuous cultivation over 90 years (Siband 1974; Pieri 1992). Depletion of the SOM is caused by erosion, rapid mineralization due to continuously high temperatures, removal of crop residues, and low or non-use of inputs such as chemical fertilizers. Because crop residues have other uses, such as fodder, household fuel, and construction material, they are also harvested and manures are not applied. Thus, soils have low microbiological activity and species diversity as that represented by earthworms, termites, and microbial biomass. Given that biotic activity is the bioengine for soils, those devoid of biotic activity are prone to degradation by physical, chemical, and biological processes.

Many plant nutrients are harvested in grains, stover, (Table 1.6) and tubers such as cassava, yams and sweet potatoes.

The problem of nutrient depletion is severely aggravated by low rates of fertilizer use in sub-Saharan Africa (Table 1.7). Fertilizer use has increased from 0.16 million Mg in 1961 to 2.11 million Mg in 2012, but is substantially below the increase in use in South Asia. In that region fertilizer use increased from 0.49

**Table 1.6** Plant nutrients harvested per Mg of corn grains and stover

Plant nutrient	Harvested (kg/ha)		
	Grains	Stover	Total
Nitrogen	36	15	51
Phosphorus	8	2	10
Potassium	9	37	46
<b>Total (all nutrients)</b>	<b>58.4</b>	<b>71.8</b>	<b>130.2</b>

Recalculated from Bundy (2012)

**Table 1.7** Fertilizer use trends in sub-Saharan Africa and South Asia

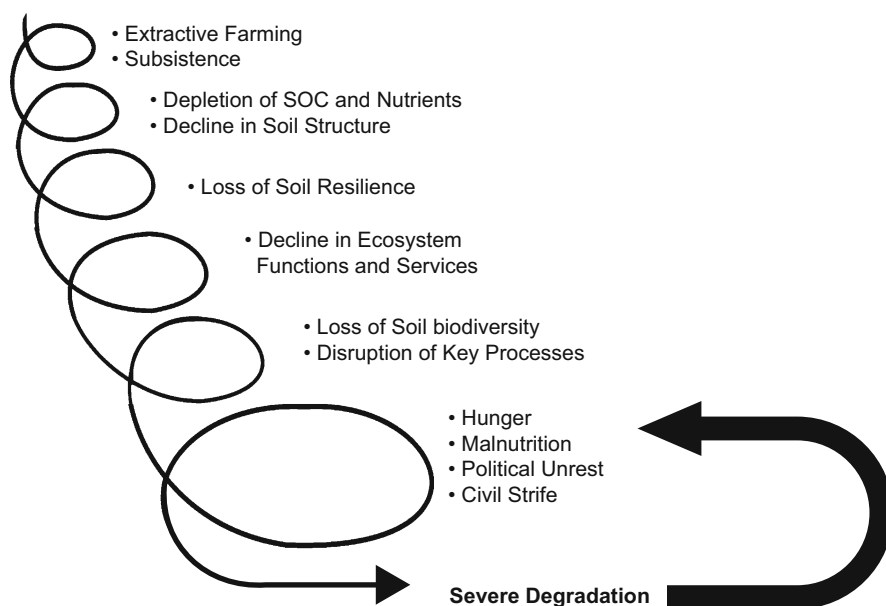
Year	Fertilizer use ( $10^6$ Mg)	
	South Asia	Sub-Saharan Africa
1961	0.49	0.16
1965	1.02	0.26
1970	2.83	0.44
1975	4.44	0.71
1980	7.37	0.96
1985	11.22	1.06
1990	15.21	1.25
1995	18.07	1.07
2002	21.03	1.38
2005	27.53	1.80
2010	35.84	1.20
2012	34.84	2.11

Adapted from IFDC (2013); FAO (2013)

**Table 1.8** Areas under irrigation by continent

Continent	Arable land (10 <sup>6</sup> ha)	Irrigated (10 <sup>6</sup> ha)	% irrigated
Australia	49.4	2.5	5.1
North and Central America	234.4	34.0	14.5
Europe	276.5	16.5	6.0
South America	130.8	13.63	10.4
Asia	495.0	180.7	36.5
Africa	177.3	12.4	7.0 (3.8 for SSA)

FAOstat (2014), Aquastat (2014)

**Fig. 1.1** Soil degradation processes set in motion by extractive farming practices and excessive grazing

million Mg in 1961 to 34.84 million Mg in 2012 (Table 1.7). The average rate of fertilizer use on croplands in sub-Saharan Africa is ~8 kg/ha/year compared to ~100 kg/ha/year in India and ~400 kg/ha/year in China (maximum of >600 kg/ha/year in some regions).

Despite severe recurring droughts in sub-Saharan Africa, the proportion of land that can be irrigated and the land that is equipped with irrigation facilities is rather low (Table 1.8). Drought is a perpetual problem in the region. Crop yields vary with the amount of rainfall received during the growing season and especially with the amount received at the critical flowering stage of crop development.

Extractive farming practices associated with low inputs is a primary cause for the widespread problem of soil and environmental degradation (Fig. 1.1), and the large gap between the attainable and actual crop yields (Table 1.9).

**Table 1.9** Gap in maize yield in sub-Saharan Africa

Region	Grain yield (Mg/ha)		
	Potential	Average	Gap
Mid-altitude	7.0	2.5	4.5
Sub-tropical			
Tropical lowland	4.5	0.7	3.8
Western Kenya	3.7	1.7	2.0

Recalculated from Lobell et al. (2009)

**Table 1.10** Climate change effects on crop yields in sub-Saharan Africa

Crop	Yield reduction (%)	
	Irrigated	Rain fed
Maize	40	15
Rice	28–39	9–11
Wheat	30–34	24–33

WFP (2009), Nelson et al. (2011)

## 1.5 Impacts of Climate Change on Agronomic Yield in Africa

Several notable sustainable intensification success stories exist for sub-Saharan Africa (Pretty et al. 2011). Ideally, they will be repeated elsewhere. Drought and unprecedented seasonal heat can exacerbate food insecurity (Battisti and Naylor 2009). Crop yields in Africa are likely to be adversely impacted by climate changes (Table 1.10), and Africa is more at risk from the envisioned variability in climate than other continents (WFP 2009; Nelson et al. 2011). Reductions in crop yields may occur in root crops as well as cereal crops. Srivastava et al. (2012) estimated that declines in yam yields will be from 18 to 33 % during the period 2041–2050. Adaptation to climate change and enhancing soil and ecosystem resilience are important to avoid such decreases in yields. Soil quality issues are important determinants of banana yield in Kenya (Okumu et al. 2011).

## 1.6 Strategies for Sustainable Soil Managers in Sub-Sahara Africa

While the global population grew from 3 to 6.8 billion between 1961 and 2007, agricultural production almost tripled. This occurred despite an increase in land area for that period of only 11 % (Pretty et al. 2011). Future demands for food may have to be met even under conditions of decreasing or stable amounts of land area under production, reduced water availability, and a warming climate. An increase in food production in sub-Saharan Africa will also be necessary, but on prevailing or reduced land areas. To do so will require restoration of degraded soils, increased



supplies and increased quality of fresh water resources, and environmental improvements. Negative externalizations must be reduced while production is increased and soil/environmental quality is restored. Problems of soil degradation and plant nutrient and SOM stock depletions are not temporary, so proposed strategies to address them must not be temporary either. Horizontal expansion of cropland through deforestation and conversion of natural into agricultural ecosystems are not feasible. Thus, the preferred strategy must be sustainable intensification which is defined by some to be “producing more food from the same area of land while reducing its environmental impact” (Royal Society 2009; Godfray et al. 2010). Pretty et al. (2011) defined sustainable intensification to be “producing more output from the same area of land while reducing the negative environmental impacts and at the same time increasing contributions to natural capital and the flow of environmental services.” Similar definitions have been proposed by the Royal Society (2009) and Conway and Waage (2010). The strategy is to reduce negative externalities, such as greenhouse gas emissions, soil degradation, water pollution, and biodiversity reduction by adopting best management practices (BMPs) for the specific soils type and ecoregion.

## 1.7 Technological Options for Sustainable Intensification

A wide range of technological options exist to reduce vulnerability and increase resilience. Rather than a silver bullet or a panacea, multiple paths must be followed in order to achieve this goal. It is important that policy makers and practitioners not be myopic or locked into a specific strategy, such as no-till, cover cropping, agroforestry, water harvesting and recycling, or integrated nutrient management etc. (Table 1.11). Multiple options need to be followed and appropriate choices made on the basis of site-specific biophysical, economic, and social conditions.

Conservation agriculture (CA) is considered to be an important option for smallholders in sub-Saharan Africa. It is suitable for specific soils and environments (Lal 2007). In addition to biophysical constraints, such as declining soil quality (Braimoh and Vlek 2006), other factors that can limit the adoption of CA include increased labor requirements, non-availability or lack of access to herbicides, gender shifts for laborious tasks done by women, and lack of mulch because of competing uses (Giller et al. 2009). Declining rates of and variable levels of soil fertility must be managed. Deficiencies of some micronutrients, such as Zn and Ca, are also major constraints (Tittonell et al. 2007), which must be addressed.

Despite numerous and promising technology options for sustainable intensification (Table 1.11), it is also important to identify potential synergies and trade-offs (Palm et al. 2010) in defining strategies and programs to achieve food security while adapting to climate change. Properly implemented, sustainable intensification practices can avoid deforestation, reduce greenhouse gas emissions, and open areas for reforestation and nature conservancy. Trade-offs between the short- and long-term

**Table 1.11** Climate change adaptation strategies in sub-Saharan Africa

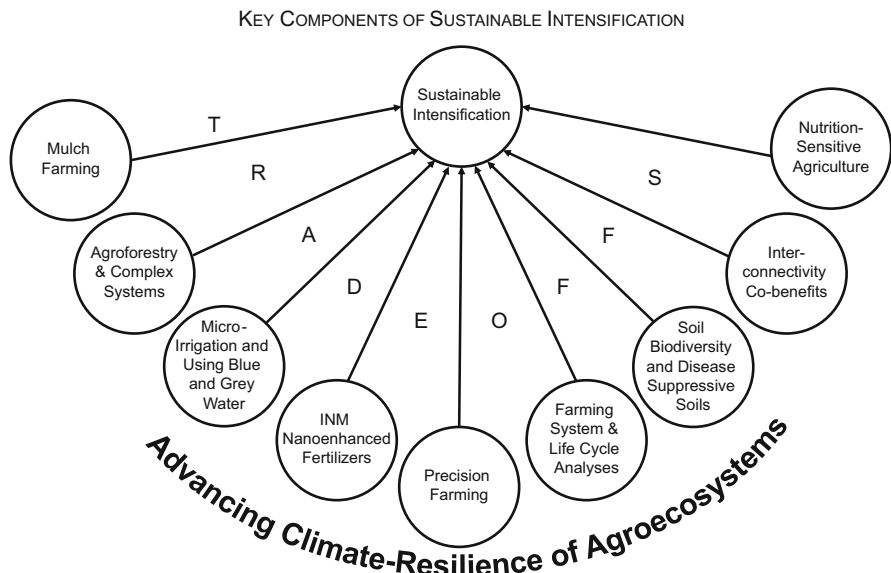
Option	Specific technology	Reference
1. Cropping systems and crop diversification	Multiple cropping systems, crop intensification and time of sowing	Waha et al. (2013) Mhango et al. (2013)
2. Conservation agriculture	Suitable for drylands and degraded soils	Bayala et al. (2012) Traoré and Zougmore (2008) Thiombiano and Meshack (2009)
3. Agroforestry, Fertilizer trees	Evergreen agriculture	Akinnifesi et al. (2010) Reij et al. (2005) Coghlan (2006) Garrity et al. (2010)
4. Integrated nutrient management, green manure	Soil fertility management	Pieri (1992) Tittonnell et al. (2007)
5. Soil organic matter management	Soil carbon sequestration	Soler et al. (2011) Doumbia et al. (2009) Bationo et al. (2007)

effects of technologies of sustainable intensification (Gentile et al. 2011), must also be duly considered.

All technologies have their specific merits and demerits, specific advantages and disadvantages, and specific pros and cons. There is no such thing as a free lunch (Commoner 1972). Thus, site-specific trade-offs of technologies (Fig. 1.2) must be objectively assessed.

## 1.8 Gaseous Emissions and Soil Carbon Sequestration

Rapid economic growth is accompanied by increases in gaseous emissions from fossil fuel combustion. In addition, emission increases are also a result of land use changes, deforestation, biomass burning, and soil cultivation. Expansion of agriculture to meet the growing food demand is accelerating gaseous emissions from land use conversion. Average total anthropogenic emissions in Africa for 2000–2005 were estimated to be 500 Tg C/year. They were estimated to be 260 Tg/year from the fossil fuel combustion and 240 Tg C/year from land use changes (Canadell et al. 2009). Ninety percent of all emissions in sub-Saharan Africa are attributed to



**Fig. 1.2** Recommended management practices are site-specific and have numerous trade-offs which must be critically and objectively assessed

fossil fuel combustion in 10 countries and land use changes in 15 countries, although large variations exist among them. Countries with large emissions from both fossil fuel and land use change included Nigeria, Angola, Zimbabwe, Sudan, Cameroon, and Ghana. Deforestation rates in Africa were higher than those in tropical Asia and equivalent to those of Latin America (Canadell et al. 2009). However, emissions from land use change per unit area are smaller for Africa than for Latin America, because deforestation in Africa is typically associated with dry forests that have lower biomass and lower soil organic carbon (SOC) stocks. Most cultivated soils of sub-Saharan Africa are severely depleted of their SOC stock, especially in the root zone (Sanchez and Jama 2002; Gentile et al. 2011; Pieri 1992). The SOC concentration in most cultivated soils is below the critical threshold of 1.1 % (Aune and Lal 1998). Therefore, restoration of SOC stock will be important in order to enhance soil physical properties, biotic activity, and nutrient dynamics and availability. Combined use of mineral fertilizers and organic manures is a form of integrated nutrient management (INM) and may be an appropriate strategy (Paul et al. 2013; Palm et al. 2001) to create positive soil C budgets. Popular myths regarding soil fertility management (Vanlauwe and Giller 2006; Vanlauwe et al. 2010) must be dispelled by credible scientific data from long-term experimentation.

Another important realm of food security is the nutrition security. In addition to calories, a healthy diet must also have adequate amount of protein and several essential micronutrients (e.g., Fe, I, P, Ca). Thus, agro-ecosystems must be nutrition-sensitive. Strategies of achieving nutrition-sensitive agroecosystems are outline in Fig. 1.3.



Fig. 1.3 Food and nutritional security by climate-resilient agriculture

## 1.9 Conclusions

Sub-Saharan Africa faces numerous food security challenges (The Montpellier Panel 2012). Interactive effects of biophysical constraints and socioeconomic limitations can be addressed by adopting BMPs of sustainable intensification. Despite numerous potential technology options, the choice of an appropriate technology must be made on the basis of site-specific factors, trade-offs, and bio-physical and socioeconomic considerations. Sustainable intensification of agricultural production can address environmental degradation and strengthen the resilience of smallholder farming with respect to climate change impacts. It can also narrow the yield gap, increase food production, advance food security, increase farm income, alleviate poverty, and enhance human wellbeing.

## References

- Akinnifesi FK, Ajayi OC, Sileshi G, Chirwa PW, Chianu J (2010) Fertilizer trees for sustainable food security in the maize-based production systems of East and Southern Africa. A review. *Agron Sustain Dev* 30(3):615–629
- Aquastat (2014) Irrigation water requirement and water withdrawal by country. [http://www.fao.org/nr/water/aquastat/water\\_use\\_agr/index.stm](http://www.fao.org/nr/water/aquastat/water_use_agr/index.stm)
- Aune JB, Lal R (1998) Agricultural productivity in the tropics and critical limits of properties of Oxisols, Ultisols and Alfisols. *Trop Agric* 74:96–103
- Bationo A, Kihara J, Vanlauwe B, Waswa B, Kimetu J (2007) Soil organic carbon dynamics, functions and management in West African agro-ecosystems. *Agric Syst* 94(1):13–25
- Battisti DS, Naylor RL (2009) Historical warnings of future food insecurity with unprecedented seasonal heat. *Science* 323(5911):240–244
- Bayala J, Sileshi GW, Coe R, Kalinganire A, Tchoundjeu Z, Sinclair F, Garrity D (2012) Cereal yield response to conservation agriculture practices in drylands of West Africa: a quantitative synthesis. *J Arid Environ* 78:13–25
- Borlaug NE (1972) The green revolution, peace and humanity, CIMMYT reprints and transaction series #3. International Maize and Wheat Improvement Center, Londres/Mexico
- Braimoh AK, Vlek PLG (2006) Soil quality and other factors influencing maize yield in northern Ghana. *Soil Use Manage* 22(2):165–171
- Bundy LG (2012) Corn fertilization. Cooperative extension University of Wisconsin, RP-08-2004. University of Wisconsin, Madison, pp 1–11
- Canadell JG, Raupach MR, Houghton RA (2009) Anthropogenic CO<sub>2</sub> emissions in Africa. *Biogeosciences* 6(3):463–468
- Coghlan A (2006) More crops for Africa as trees reclaim the desert. *New Sci* 192(2573):11
- Commoner B (1972) The closing circle: nature, man and technology. Alfred A. Knopf, New York, 326 pp
- Conway GR, Waage J (2010) Science and innovation for development. UKCDS, London
- Doumbia M, Jarju A, Sene M, Traore K, Yost R, Kablan R et al (2009) Sequestration of organic carbon in West African soils by Amenagement en Courbes de Niveau. *Agron Sustain Dev* 29(2):267–275
- Eswaran H, Almaraz R, van den Berg E, Reich P (1997) An assessment of the soil resources of Africa in relation to productivity. *Geoderma* 77(1):1–18
- FAO (2011) The state of food insecurity in the world 2011. FAO, Rome
- FAO (2012) The state of food insecurity in the world 2012. FAO, Rome
- FAO (2013) The state of food and agriculture 2013. FAO, Rome
- FAOstat (2014) Total area equipped for irrigation. <http://faostat3.fao.org/faostat-gateway/go/to/search/irrigation/E>
- Garrity DP, Akinnifesi FK, Ajayi OC, Weldesemayat SG, Mowo JG, Kalinganire A et al (2010) Evergreen agriculture: a robust approach to sustainable food security in Africa. *Food Security* 2(3):197–214
- Gentile R, Vanlauwe B, Chivenge P, Six J (2011) Trade-offs between the short- and long-term effects of residue quality on soil C and N dynamics. *Plant and Soil* 338(1–2):159–169
- Giller KE, Witter E, Corbeels M, Tittonell P (2009) Conservation agriculture and smallholder farming in Africa: the heretics' view. *Field Crop Res* 114(1):23–34
- Godfray HCJ, Beddington JR, Crute IR, Haddad L, Lawrence D, Muir JF et al (2010) Food security: the challenge of feeding 9 billion people. *Science* 327:812–818
- IFDC (2013) Fertilizer deep placement. International Fertilizer Development Center, Muscle Shoals
- Lal R (2007) Constraints to adopting no-till farming in developing countries. *Soil Tillage Res* 94:1–3
- Lobell DB, Burke MB, Tebaldi C, Mastrandrea MD, Falcon WP, Naylor LR (2008) Prioritizing climate change adaptation needs for food security in 2030. *Science* 319:607–610

- Lobell DB, Bala G, Mirin A, Phillips T, Maxwell R, Rotman D (2009) Regional differences in the influence of irrigation on climate. *J Climate* 22:2248–2255
- Lobell DB, Schlenker W, Costa-Roberts J (2011) Climate trends and global crop production since 1980. *Science* 333:616–620
- Lobo RE, Hewlett J (2011) Ag in uncertain times in English. <http://www.farmmanagement.org/aginuncertaintimesenglish/>
- Mhango WG, Snapp SS, Phiri GYK (2013) Opportunities and constraints to legume diversification for sustainable maize production on smallholder farms in Malawi. *Renew Agric Food Syst* 28(3):234–244
- Nelson NO, Agudelo SC, Yuan W, Gan J (2011) Nitrogen and phosphorus availability in biochar-amended soils. *Soil Sci* 176:218–226
- Okumu MO, van Asten PJA, Kahangi E, Okech SH, Jefwa J, Vanlauwe B (2011) Production gradients in smallholder banana (cv. Giant Cavendish) farms in Central Kenya. *Sci Hortic* 127(4):475–481
- Palm CA, Gachengo CN, Delve RJ, Cadisch G, Giller KE (2001) Organic inputs for soil fertility management in tropical agroecosystems: application of an organic resource database. *Agric Ecosyst Environ* 83(1–2):27–42
- Palm CA, Smukler SM, Sullivan CC, Mutuo PK, Nyadzi GI, Walsh MG (2010) Identifying potential synergies and trade-offs for meeting food security and climate change objectives in sub-Saharan Africa. *Proc Natl Acad Sci U S A* 107(46):19661–19666
- Paul BK, Vanlauwe B, Ayuke F, Gassner A, Hoogmoed M, Hurisso TT et al (2013) Medium-term impact of tillage and residue management on soil aggregate stability, soil carbon and crop productivity. *Agric Ecosyst Environ* 164:14–22
- Pieri CJMG (1992) Fertility of soils: a future for farming in the west African savannah. Springer, Berlin, 348 pp
- Pretty J, Toulmin C, Williams S (2011) Sustainable intensification in African agriculture. *Int J Agric Sustain* 9(1):5–24
- Reij C, Tappan G, Belemvire A (2005) Changing land management practices and vegetation on the Central Plateau of Burkina Faso (1968–2002). *J Arid Environ* 63(3):642–659
- Royal Society (2009) Reaping the benefits: science and the sustainable intensification of global agriculture. Royal Society, London
- Sanchez PA, Jama B (2002) Soil fertility replenishment takes off in East and Southern Africa. In: Vanlauwe B, Diels J, Sanginga N, Merckx R (eds) *Integrated plant nutrient management in Sub-Saharan Africa: from concept to practice*. CABI, Wallingford, pp 23–46
- Shapouri S, Rosen S, Peters M, Allen S (2010) Food security assessment, 2010–20. Report nr GFA-21. US Department of Agriculture, Washington, DC
- Siband P (1974) Evolution des caracteres et de la fertilite' d'un sol rouge de Casamance. *Agronomie tropicale* 29:1228–1248
- Sinclair TR, Rufty TW (2012) Nitrogen and water resources commonly limit crop yield increases, not necessarily plant genetics. *Glob Food Security* 1:94–98
- Sinclair TR, Sinclair CJ (2010) Bread, beer and the seeds of change: agriculture's imprint on world history. CAB International, Wallingford, 208 pp
- Soler CMT, Bado VB, Traore K, Bostick WM, Jones JW, Hoogenboom G (2011) Soil organic carbon dynamics and crop yield for different crop rotations in a degraded ferruginous tropical soil in a semi-arid region: a simulation approach. *J Agric Sci* 149:579–593
- Srivastava AK, Gaiser T, Paeth H, Ewert F (2012) The impact of climate change on Yam (*Dioscorea alata*) yield in the savanna zone of West Africa. *Agric Ecosyst Environ* 153:57–64
- The Montpellier Panel (2012) Growth with resilience: opportunities in African agriculture. Agriculture for Impact, London, p 32 pp
- Thiombiano L, Meshack M (2009) Scaling-up conservation agriculture in Africa: strategy and approaches. The FAO Subregional Office for Eastern Africa, Addis Ababa, 35 pp

- Tittonell P, Zingore S, van Wijk MT, Corbeels M, Giller KE (2007) Nutrient use efficiencies and crop responses to N, P and manure applications in Zimbabwean soils: exploring management strategies across soil fertility gradients. *Field Crop Res* 100(2–3):348–368
- Traoré K, Zougmore R (2008) Conservation agriculture in Africa: state of the art in Burkina Faso. INERA, Burkina Faso, 14 pp
- United Nations (2008) World population prospects the 2007 revision. United Nations, New York
- United Nations (2013) World population prospects: the 2012 revision, key finding and advance tables. Working paper #ESA/P/WP 227. United Nations, New York
- United States Department of Agriculture (2011) International food security assessment, 2011-21/GFA-22. Economic Research Service, USDA, Washington, DC, pp 1–64
- Vanlauwe B, Giller KE (2006) Popular myths around soil fertility management in sub-Saharan Africa. *Agric Ecosyst Environ* 116(1–2):34–46
- Vanlauwe B, Bationo A, Chianu J, Giller KE, Merckx R, Mokwunye U et al (2010) Integrated soil fertility management operational definition and consequences for implementation and dissemination. *Outlook Agric* 39(1):17–24
- Waha K, Muller C, Bondeau A, Dietrich JP, Kurukulasuriya P, Heinke J, Lotze-Campen H (2013) Adaptation to climate change through the choice of cropping system and sowing date in sub-Saharan Africa. *Glob Environ Change* 23(1):130–143
- World Food Programme (2009) Annual report. WFP, Rome, pp 1–56
- World Food Programme (2013) Climate impacts on food security and nutrition. WFP, Rome

**Part II**  
**Land Use and Farming System**



## Chapter 2

# Geopedological and Landscape Dynamic Controls on Productivity Potentials and Constraints in Selected Spatial Entities in Sub-Saharan Africa

Yazidhi Bamutaze

**Abstract** Soil-landscape relations play an important role in the agricultural production systems of Sub-Saharan Africa. As the demands on elevated agricultural productivity grows in the face of increasing demographic pressure and the adverse impacts of global environmental change, we must identify socio-ecological production landscapes that are resilient to environmental changes. This paper analyses a spectrum of spatial and non-spatial datasets covering soil, terrain, land use, and geology in a GIS environment to derive spatial entities that inform the production potentials and constraints of East Africa. Landscape analysis, premised on the geopedological and elevation constructs, culminated in a spatial coverage of lowlands (40 %), plateaux (46 %), highlands (11 %) and mountains (3 %) across the East African region. Regional-level analysis reveals spatially variable soil typologies dominated by Cambisols (24 %) and Ferralsols (13 %). In these geomorphic landscapes and soil types, there are two outstanding anthropogenic threats to productivity: soil erosion and land use/cover conversions and transformations. These must be delicately tackled with site-specific tailored interventions that not only recognize geopedological landscape sensitivity, but also the inherent social systems.

**Keywords** Geopedological • Geomorphology • Landscape dynamics • Productivity

---

Y. Bamutaze (✉)

Department of Geography, Geo-informatics and Climatic Sciences,  
Makerere University, PO Box 7062, Kampala, Uganda  
e-mail: [yazidhibamutaze@gmail.com](mailto:yazidhibamutaze@gmail.com)

## 2.1 Introduction

Sub-Saharan Africa (SSA) is one of the most dynamic, diverse, and heterogeneous biophysical landscapes in the world. The landscape's complexity manifests in the geomorphological, soil, and geological settings, posing a range of challenges and opportunities that underpin the continental development pathways from household to national levels. The central geomorphological feedback processes associated with its complex and dynamic socio-ecological landscape strongly influence production patterns. Therefore, understanding the inherent ecological fragility of this coupled landscape is fundamental to reduce the effects of geohazards, sustain ecological integrity, and secure people's livelihoods. The need for sustainable landscapes and livelihood systems is critical for SSA because of rapid demographic changes, increasing land degradation, stagnant or declining crop yields, and relatively new threats linked to the increasing variability and changes of the climate.

Sustainable land use practices recognizing a landscape's ecological sensitivities and maintain agricultural productivity are gathering attention. Soil resources are fundamental to fighting the traditional challenges of land degradation, as well as effectively buffering communities from the dangers of climate change. For example, the Comprehensive Africa Agriculture Development Programme (CAADP) has an ambitious annual agricultural growth target of 6 %, a harbinger of development transformation on the continent (Kolavalli et al. 2010). Due to the fundamental importance of quality geopedological resources for agricultural production, only sound landscape stewardship can achieve this goal. Although agricultural production in SSA relies on heavily inherent natural soil fertility, the general understanding of soil geomorphology systems remains dismally low compared to other continents.

It is impossible to underestimate the importance of healthy soil resources for sustainable livelihoods in SSA (Eswaran et al. 1997; Henao and Baanante 2006; Bationo et al. 2006). Because so many livelihoods in the region depend on natural resources, the relationships between soil quality, productivity, and poverty levels are strongly interdependent. However, despite their productive role in agricultural livelihoods, the importance of soils and the multitude of associated environmental services are not widely appreciated in Africa (Dewitte et al. 2013). Consequently, limited efforts have been undertaken to address a range of soil-related issues at a finer scale crucial to improve productivity. In most SSA countries, low crop yields indicate an abundance of poor quality soils (Sanginga and Woomeer 2009). Under these conditions, there is need to improve understanding of spatially explicit soil-geomorphic settings crucial for agricultural productivity.

A geopedological perspective embeds geomorphic and pedologic processes throughout the landscape, as well as recognizing biophysical feedback and socio-logical processes. Thus, this geographically-oriented soil-landscape nexus yields a better understanding of the production systems and ecosystem servicing crucial for the sustainable development of agriculture and biodiversity (Sayre et al. 2013; Griffiths et al. 2011). This paper helps correct the paucity of soil-based landscape studies by using geomorphic and pedologic analysis to present information on productivity potentials and constraints.

## 2.2 Geographical Settings

This study is confined to the East African region of SSA covering five countries: Uganda, Kenya, Tanzania, Rwanda and Burundi. The region is located approximately between 4°N and 12°S latitude and 29°E to 42°E longitude, as shown in Fig. 2.1.



Fig. 2.1 Location map of East Africa

**Table 2.1** Key socio-economic characteristics of the East African countries

Parameter	Uganda	Kenya	Tanzania	Rwanda	Burundi
Size (km <sup>2</sup> )	241,248	593,116	933,566	24,550	28,062
Population (millions)	35.6	42.7	47.7	11.3	8.7
Population density (persons/km <sup>2</sup> )	148	72	51	460	310
Human development index in 2012	0.456	0.519	0.476	0.434	0.355
Annual population growth rate (%)	3.3	2.7	3.0	2.8	3.2
Life expectancy at birth (years)	58	60	60	63	53
GDP per capita by 2012 (US\$)	547	943	609	620	251
Agricultural area in 2011 (km <sup>2</sup> )	168,874	284,696	392,098	19,149	24,133

The region exhibits a high level of ecological and social diversity in its geology, geomorphology, climate, and vegetation. It displays significant geomorphological features of the East African Rift valley, the Lake Victoria basin and a range of highland and mountainous landscapes. Climatic conditions of the region are diverse and variable. The climatic geography is a function of global, regional, and local factors, notably the Inter-Tropical Convergence Zone (ITCZ) and physiographic features, including topography, latitudinal position, and relative location from major drainage bodies such as Lake Victoria. Major mountain landscapes such as Mt. Kilimanjaro, Mt. Rwenzori, Mt. Elgon, and Mt. Kenya also significantly control the local and regional climatic conditions. Annual rainfall amounts vary from about 250 mm in semi-arid regions to over 2,500 mm in the highlands. The region has a distinctly uneven spatial and temporal rainfall distribution, exhibiting both unimodal and bimodal distribution structures. However, most crop production is confined to areas less than 2,500 m above sea level. The key socio-economic characteristics of the region are found in Table 2.1.

The region's population was estimated to be 142 million people in 2013. The highest and lowest population densities are 460 and 51 persons/km<sup>2</sup> in Rwanda and Tanzania respectively. Agriculture is essential to the East African economy and is dominated by small-scale farming which relies heavily on rainfall. Land degradation is a serious production constraint, principally because of soil erosion and nutrient depletion, a more variable and changing climate, increasing incidences of natural hazards and disasters, biodiversity loss, land use changes and conversions, and rapid population growth.

## 2.3 Data Sources and Analysis

The data sets used, their characteristics, and sources are given in Table 2.2. The data consist of both geospatial and non-spatial data, gathered from secondary and primary sources. Geospatial data were obtained from an array of sources in formats compatible with digital Geographical Information System (GIS).

The joint FAO and IIASA Global Agro-ecological Zones (GAEZ) portal supplied data on soil and terrain conditions which was used to assess the regional spatial variability of agricultural suitability. A digital soil data set grid from FAO was used to quantitatively analyse the predominant soil types at the national level. A Digital Elevation Model (DEM), based on Shuttle Radar Topography Mission (STRM) 90 m spatial resolution data, was obtained from the Makerere University archives and used for deriving and classifying landscapes. Geomorphic landscapes based on altitude thresholds were delineated as: mountains (>2,000 masl), highlands (1,500–2,000 masl), plateau (900–1,500 masl) and lowlands (<900 masl). The Makerere University archives also supplied a geology shapefile for Uganda to depict geology types spatially. Columbia University's Center for International Earth Science Information Network (CIESIN) provided digital gridded population data, projected for the year 2015. The data was used to map population density hotspots and relate them to landscape typologies. Because the sources of geospatial

**Table 2.2** Datasets used, sources and characteristics

No.	Variable	Source	Type	Spatial extent	Usage/ analysis
1	Soil type	FAO & IIASA ( <a href="http://webarchive.iiasa.ac.at/Research/LUC/GAEZv3.0/">http://webarchive.iiasa.ac.at/Research/LUC/GAEZv3.0/</a> )	Spatial	East Africa	Spatial typologies
2	Soil erosion	Field and published data	Spatial	Uganda	Magnitude and variability
3	Geology	Archives	Spatial	Uganda	Types and distribution
4	DEM	Archives	Spatial	East Africa	Landscape delineation
5	Suitability	FAO and IIASA ( <a href="http://webarchive.iiasa.ac.at/Research/LUC/GAEZv3.0/">http://webarchive.iiasa.ac.at/Research/LUC/GAEZv3.0/</a> )	Spatial	East Africa	Quantitative variability
6	Forest cover	World Bank ( <a href="http://data.worldbank.org/">http://data.worldbank.org/</a> )	Tabular	East Africa	Trend analysis
7	Arable land	World Bank ( <a href="http://data.worldbank.org/">http://data.worldbank.org/</a> )	Tabular	East Africa	Trend analysis
8	Population	CIESIN ( <a href="http://sedac.ciesin.columbia.edu/">http://sedac.ciesin.columbia.edu/</a> )	Spatial	East Africa	Hotspot sites
9	Erosion Risk	Derived using GLASSOD methodology	Spatial	Uganda	Hotspot landscapes
10	Production data	FAOSTAT ( <a href="http://faostat.fao.org/">http://faostat.fao.org/</a> )	Tabular	East Africa	Trend analysis

data were so diverse, I employed a range of data quality control measures and standardized all data sets to World Geodetic System (WGS 84) datum in a GIS environment to enable a spatial multiple overlay analysis. After standardizing the data, the East Africa region was clipped out of the continental and global datasets. Relevant tabular and statistical data were then extracted in a GIS and further plotted or statistically analysed in appropriate programmes. Geospatial analyses used ARCGIS 10 software from ESRI. Statistical and tabular data was obtained from the FAOSTAT and World Bank data portals and published data in literature. Data was subjected to an array of statistical analyses, including descriptive and inferential statistics. Descriptive statistical data used mean, standard deviation, coefficient of variation, and percentages. Inferential statistics included linear regression analysis for detecting temporal trends in forest cover change.

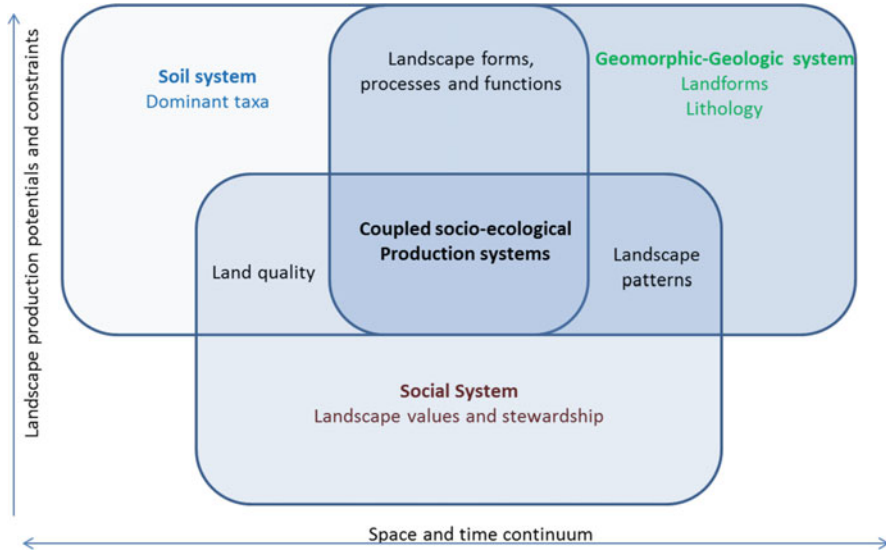
## **2.4 The Geopedological Construct**

Geopedology refers to the contribution of geomorphology to pedology, and the resulting feedback (Zinck 2013). It is premised on the fact that geomorphology and pedology constitute intricately inseparable landscape characteristics through geoforms and soils. The geopedological construct thus analyses prime biogeochemical processes to facilitate inferences of landscape constraints and opportunities for agricultural productivity. Thus, coherence and synergies of landscape elements that geomorphology and soils reveal are the most important land quality aspects regarding agricultural productivity. Current agricultural production in SSA is mostly low-input and heavily depends on soil quality. Lucid interfaces between soil-geomorphologic systems and the relevant social systems strongly influence production potentials and constraints. The geopedological construct, therefore, provides a holistic biophysical structure and coupling that represents a socio-ecological production system, as depicted in Fig. 2.2.

## **2.5 Landscape Dynamics and Agricultural Productivity**

### ***2.5.1 Geomorphological Landscape, Productivity Constraints, and Opportunities***

A landscape is the highest level in the geopedological hierarchy. The significance of geomorphic landscapes for agricultural productivity is well documented, particularly regarding crop types, production patterns, and yields. The landscapes' influence is largely manifested through moderation of climatic conditions, weathering, soil formation, soil quality, and ultimately soil resilience. From a geomorphological perspective, four landscape typologies based on altitudinal variability and

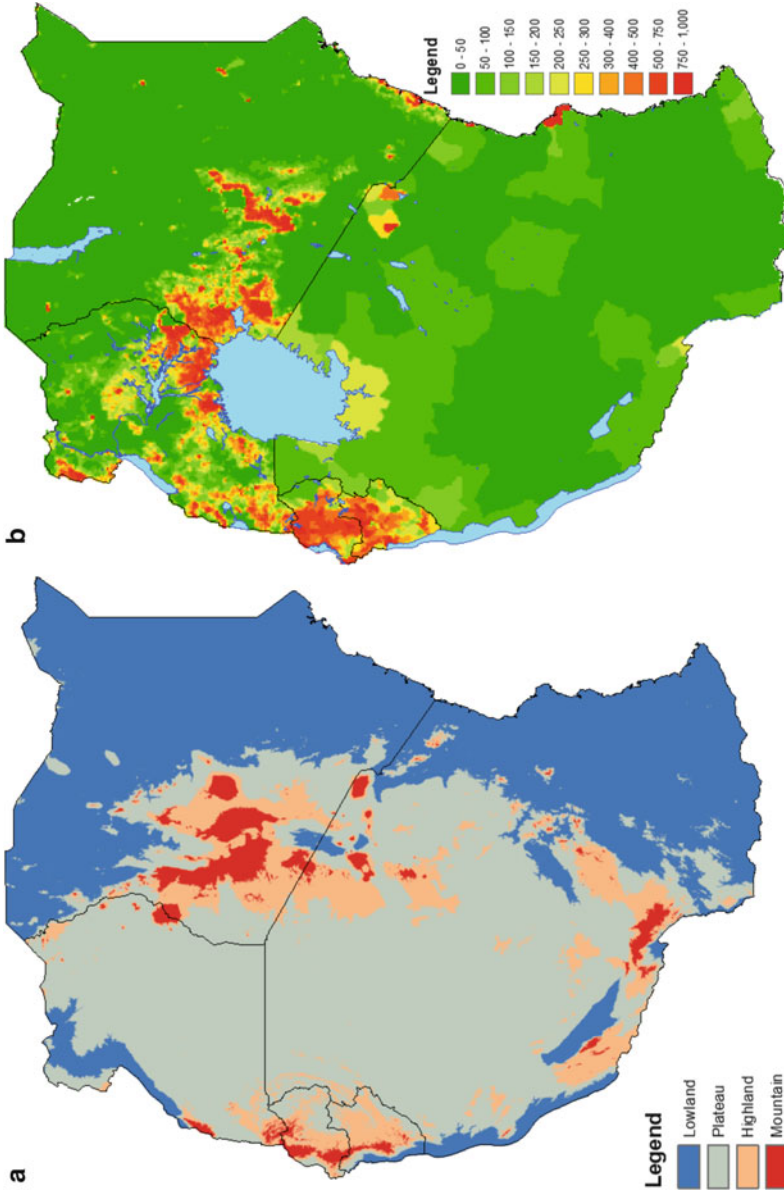


**Fig. 2.2** Schematized interfaces of elements influencing productivity dynamics in the geopedological construct

thresholds were delineated for East Africa: lowlands, plateau, highlands, and mountains. They are associated with diverse challenges and opportunities for agricultural productivity. The spatial distribution and major characteristics of East Africa's landscapes are shown in Fig. 2.3. These landscapes reflect a complex of past and current geomorphological processes, such as volcanicity, faulting, folding, weathering, and erosion. The diverse geographical operations of these processes have resulted in the current terrain configuration of East Africa.

Mountain landscapes are more than 2,000 m above sea level, the highest altitude landscape hierarchy. They cover about 3 % of the area of East Africa. Mountain landscapes are extremely diverse even at short distances. With the exception of urban centers, mountain landscapes have the highest population densities in the region (See Fig. 2.3b). They are attractive for settlement because of good conditions for crop production such as high levels of soil fertility and annual rainfall. The most important perennial crops, such as coffee and bananas, are productively grown in mountain landscapes in what is agro-ecologically classified as montane farming systems. However, mountain landscapes possess high erosive energy because their steep gradients encourage high runoff, which if not managed well greatly damages crops. Consequently, mountain landscapes are prone to a range of geohazards (Table 2.3).

Highland landscapes lie between 1,500 and 2,000 m above sea level, and represent approximately 11 % of the East African region. Over 60 % of Burundi and Rwanda can be categorized as either highland or mountainous. The steep slopes of highland environments and similar geohazards as mountain areas cause severe



**Fig. 2.3** Geomorphological landscape categories (a) and population density hotspots in East Africa (b)



**Table 2.3** Selected landscape characteristics in East Africa

Landscape	Altitude (masl)	Coverage	Productivity <sup>a</sup>	Major geohazards
Mountains	>2,000	3 %	High	Erosion, slope failure, land cover transformation
Highlands	1,500–2,000	11	High	Soil erosion, nutrient mining,
Plateau	900–1,500	46	Medium to high	Soil erosion, floods, nutrient mining
Lowlands	<900	40	Low to medium	Flooding, drought

<sup>a</sup>Productivity hinged on low input conditions (natural nutrient conditions)

agricultural production constraints. Geomorphologically, highland and mountain landscapes have high transportation capacities and stream densities that convey both runoff and sediment to the lower landscapes. Plateau landscapes range from 900 to 1,500 m above sea level and represent the largest part of the entire region. Agricultural productivity in the plateau landscape is highly varied and also depends in part on rainfall levels. The Lake Victoria Basin is the most attractive region of the plateau landscape in East Africa. Despite their relatively lower slope gradients, plateau landscapes also experience erosion and nutrient mining. Lowlands, which are below 900 m, constitute a north–south axis in the eastern part of the region parallel to the Indian Ocean. Lowlands occupy about 40 % of the region's landscape, including much of Kenya and a significant part of Tanzania. They are generally characterized by transport-limited slopes, and are prone to flood hazards. For lowland inland regions such as eastern Uganda, flooding is also strongly linked to the climatic and geomorphological conditions in the mountain landscapes that consequently supply runoff to the lower areas.

### 2.5.2 Soil and Terrain Influences on Agricultural Suitability

Agricultural systems in East Africa are typically rain-fed systems. Land suitability under rain-fed conditions depends on the ecological interfaces between climate, soil, and terrain which determine productivity levels and yield dynamics. The spatial extent of rain-fed agricultural suitability in Eastern Africa under low and high input conditions constrained by soil factors alone is found in Fig. 2.4, while that constrained by both soil and terrain conditions is depicted in Fig. 2.5.

Evidently, a change from the low input conditions of traditional subsistence land management and crop varieties, to high input conditions characterized by market-oriented land management practices would change landscape suitability and ultimately improve crop yields by about 24 %. This provides, in part, the rationale for the region's agricultural policy changes which Uganda's Plan for Modernization of

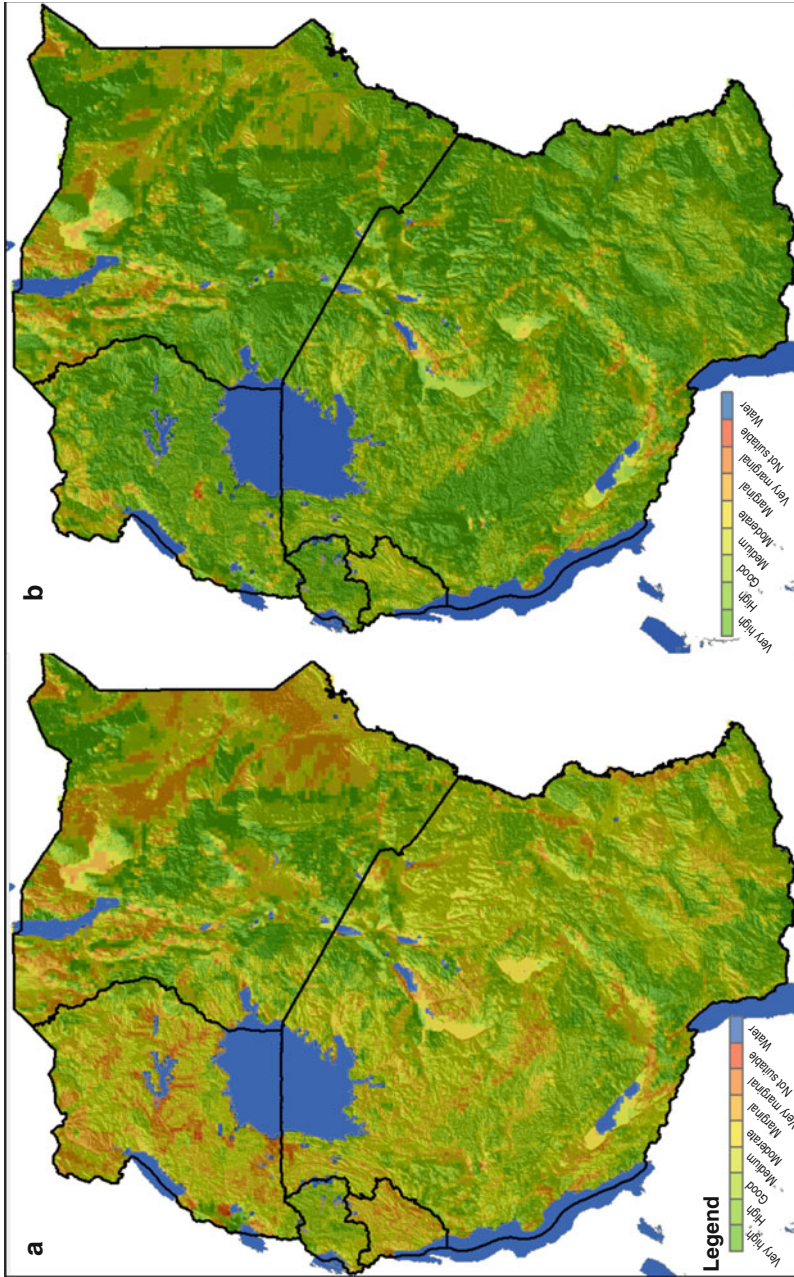


Fig. 2.4 Spatial variability of rain-fed agricultural suitability as constrained by soil under low (a) and high input (b) conditions

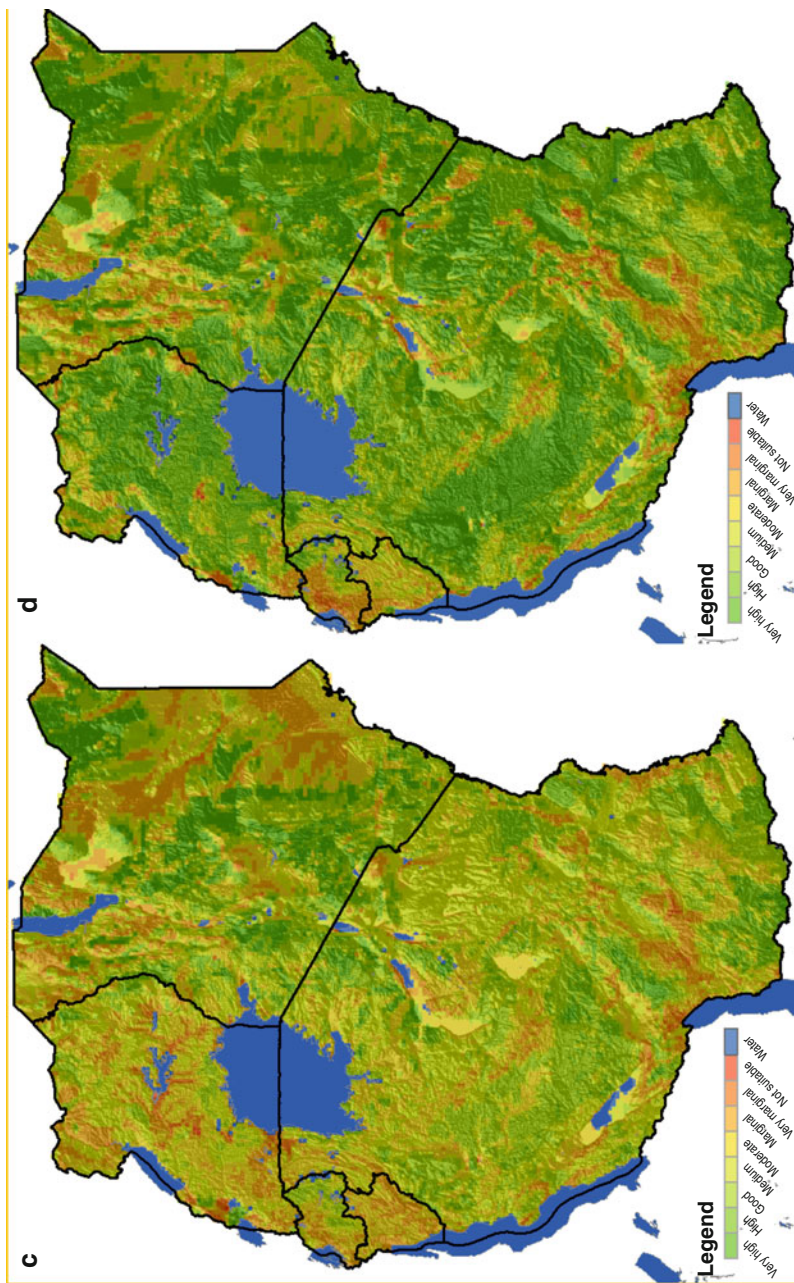


Fig. 2.5 Spatial variability of rain-fed agricultural suitability as constrained by soil and terrain factors under low (c) and high input (d) conditions

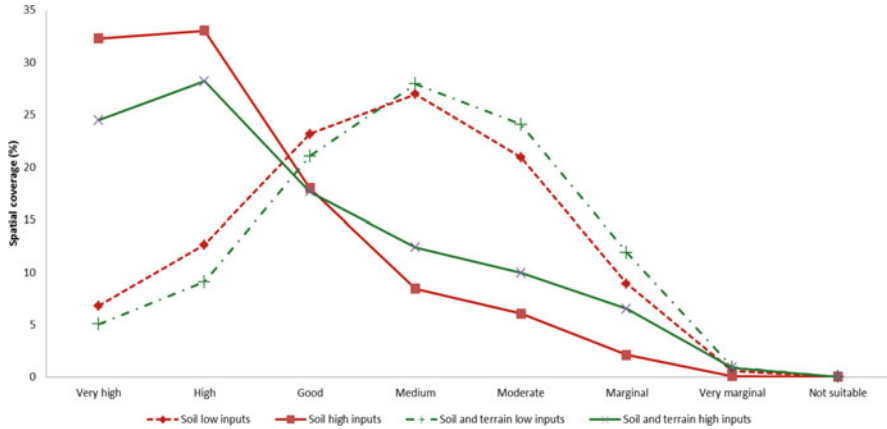


Fig. 2.6 Variation in suitability under low and high input conditions

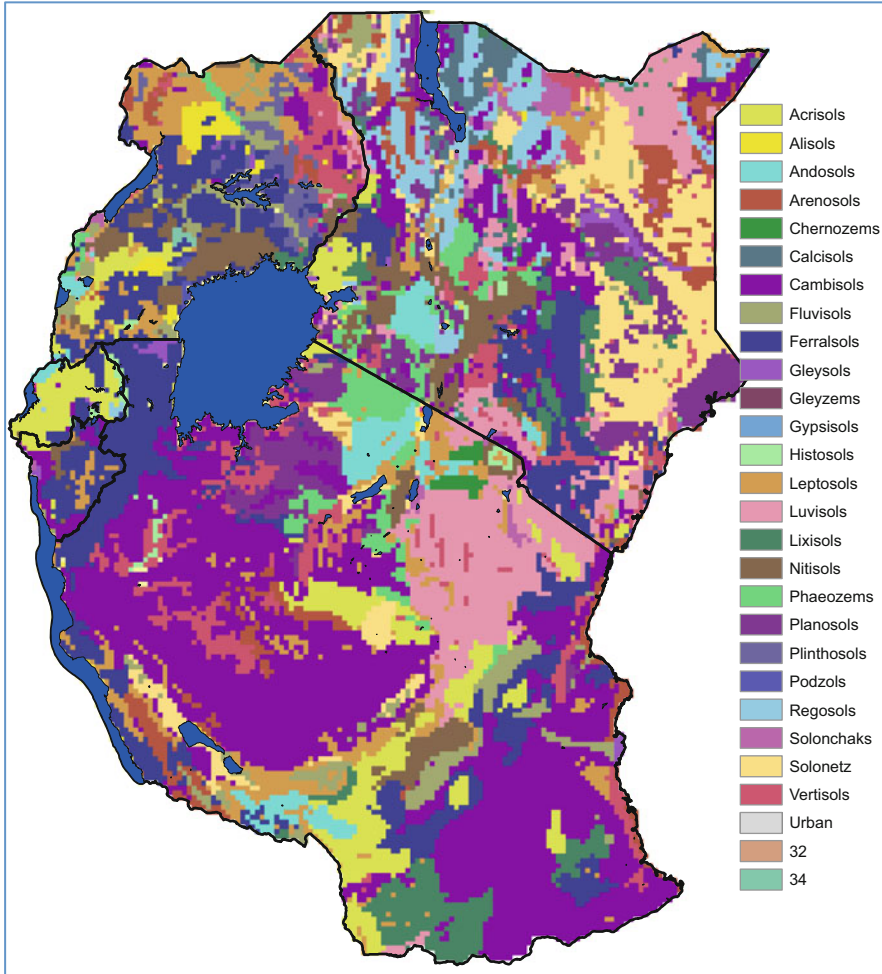
Agriculture (PMA) exemplifies. This plan focuses on market-oriented agriculture and sustainable management of land resources.

The percentage coverage of agriculturally suiland according to soil conditions alone is compared with that of the coupled soil and terrain conditions in Fig. 2.6. In general, the terrain factor, denoted largely by altitude and slope gradient, imposes more constraints on land's suitability for crop production. Therefore, it is not surprising that areas with proportionally higher highland and mountainous environments, like Rwanda and Burundi pale in suitability when compared to Kenya, Uganda, and Tanzania.

Under low input conditions, a suitability deviation of about 3 % is attributed to the terrain effect, while the deviation is as high as 9 % under high input conditions. In consonance with other studies (Akinci et al. 2013; Xu and Zhang 2013; Igue et al. 2004), high rates of water runoff, soil erosion, higher transportation capacities of water and nutrients, and difficulties with tillage and conservation practices are all evidence of terrain's effect on a landscape's agricultural suitability and productivity. Soil formation and development intimately depends on site topography and geomorphological characteristics, slope gradient having the greatest effect. In East Africa, FAO (2006) categorizes sites with slope gradients of more than 30 % as steeply dissected. For rain-fed agriculture, they are considered severely constrained for crop production. A spatial analysis by van Velthuisen (2007) reveals that areas with slope gradients of more than 30 % represent about 6 % of East Africa's total area and contain 9 % of the rural population.

### 2.5.3 Soil Quality and Soil Types

African soils are among the least fertile in the world, with about 80 % having inherent fertility limitations (Otter et al., 2007). Major soil limitations present huge obstacles to agricultural productivity. Some postulates to explain poor soils



**Fig. 2.7** Major soil types of East Africa based on the FAO classification system

implicate their having developed from Precambrian basement rocks as a major causal factor. SSA soils, in particular, are highly diverse and spatially variable (Voortman 2010). Despite providing livelihoods for millions of small scale farmers, the soils of Africa are poorly mapped and badly understood (Sanginga and Woomer 2009). A spatial distribution of East Africa's major soil types based on the FAO soil classification system is found in Fig. 2.7.

Figure 2.8 contains a quantitative analysis of the distribution of the region's respective soil types. The data identifies approximately 25 soil types with diverse production potentials and constraints, signifying a high level of soil diversity and heterogeneity. A recent soil mapping by Dewitte et al. (2013) identified 29 soil types for continental Africa, which is not surprising given the geomorphological, geological, and climatic complexity of the region. The most common soil types in

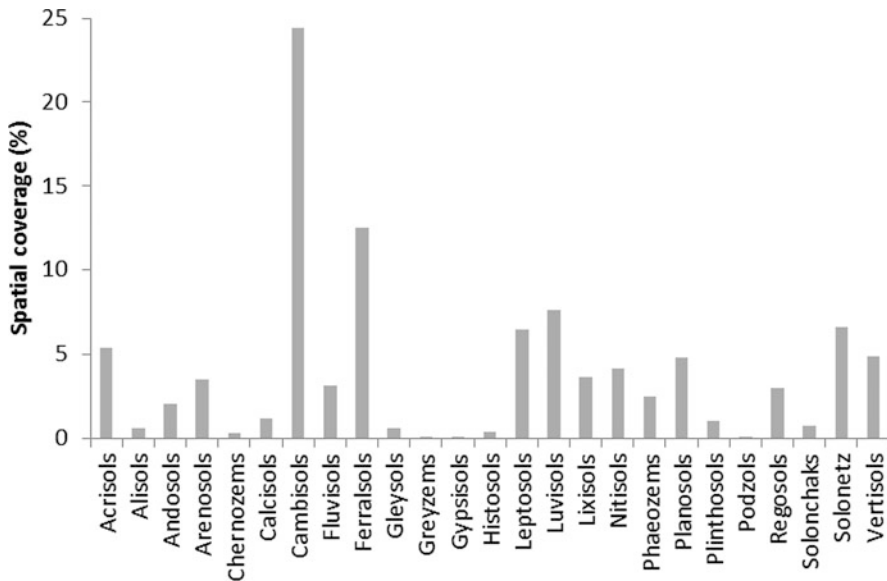


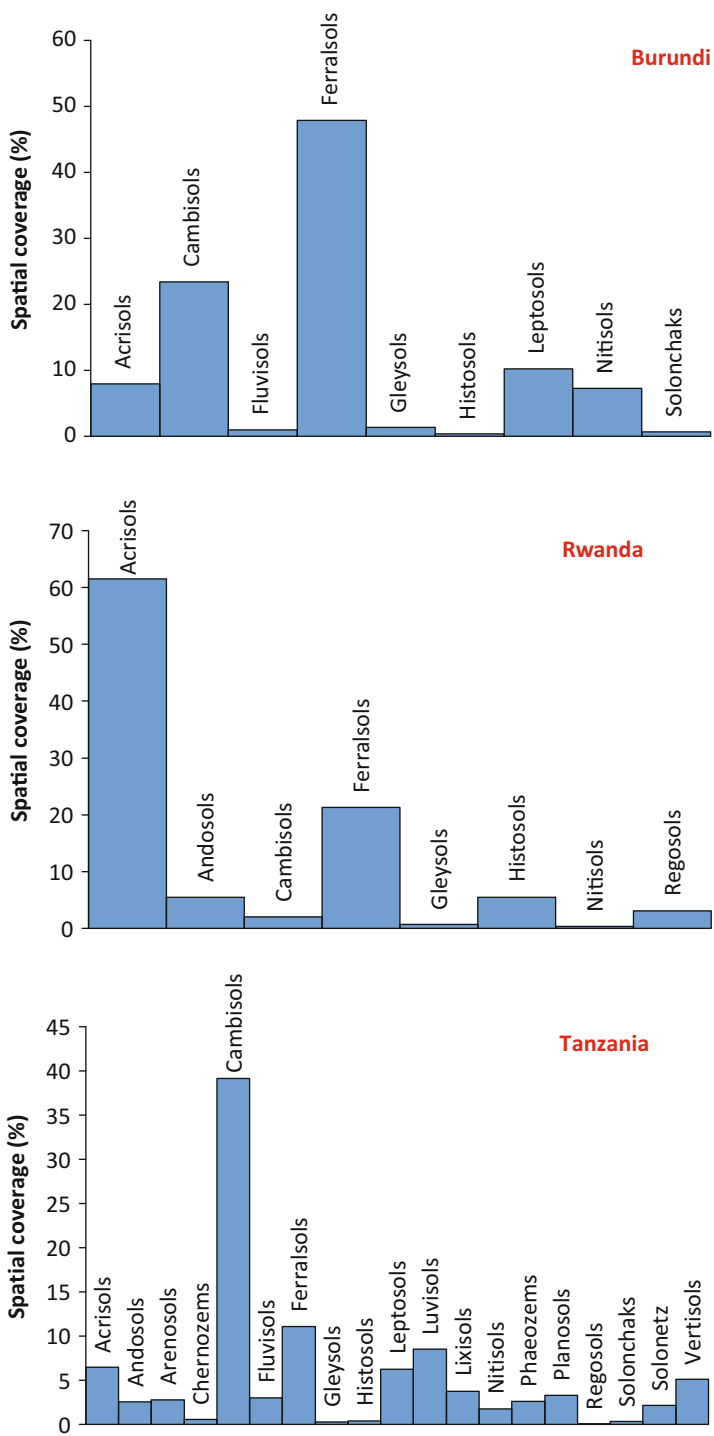
Fig. 2.8 Quantitative distribution of soil types in East Africa

East Africa are the Cambisols and Ferralsols which constitute about 24 % and 13 % respectively of soil. Other soil types with reasonable spatial distribution include Luvisols (8 %), Solonetz (7 %), Leptosols (6 %), Acrisols (5 %), Planosols (5 %), and Vertisols (5 %) as depicted in Fig. 2.8. A spatial analysis reveals that these eight soil types cover approximately 73 % of East Africa's land. The remaining 17 soil types cover only 27 % of the region, with the least common being the Gypsisols (<0.1). This means that many local factors control soil formation and development in the region. Increasing agricultural productivity requires targeted interventions and management strategies adjusted to each soil type.

The variability of soil types and their prevalence at national levels are depicted in Fig. 2.9. There are 22 soil types in Uganda, 23 in Kenya, 19 in Tanzania, 8 in Rwanda and 9 in Burundi. The Ferralsols (25 %) are the most dominant in Uganda, while Calsisols have the lowest coverage (<0.1 %). In Kenya, the Solonetz soils have highest coverage (16 %) and Gypsisols have the lowest. Cambisols dominate Tanzania, occupying 39 % of the land area, while Regosols have the lowest coverage (<0.1 %). Acrisols cover most of the land in Rwanda (62 %), while Nitisols only cover 0.3 %. In Burundi, Ferralsols cover the highest percentage of the land (48 %) while Histols cover the lowest amount (0.3 %).

## 2.6 Landscape Degrading Processes

Two major factors related to landscape degradation hinder agricultural productivity in SSA and specifically East Africa: soil erosion and land use cover transformations.



**Fig. 2.9** Spatial coverage of soil types in the East African countries

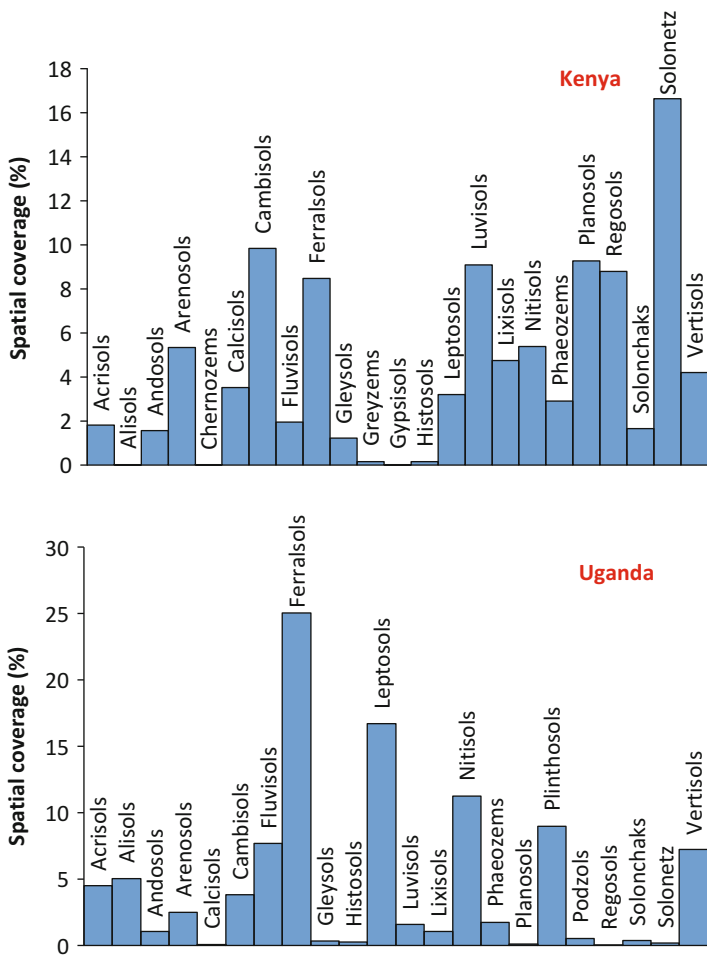


Fig. 2.9 (continued)

### 2.6.1 Soil Erosion

Soil erosion, particularly by water, is one of the most serious threats to agricultural productivity in SSA (Obalum et al. 2012). Soil erosion is omnipresent in the region and reported to be increasing, although comprehensive empirical studies of erosion rates for the entire East African region are scarce. However, scattered reports from both experimental runoff plots and spatial modelling verify its extent and magnitude. Results on annual soil erosion rates from diverse studies based on experimental runoff plots in major Ugandan landscapes are depicted in Table 2.4.



**Table 2.4** Measured mean annual soil losses from dominant land use system across landscape categories in Uganda

Author	Soil loss	Landscape category	Land use system
Bagoora (1998)	10–129 t/ha/year	Highland	Maize and beans
Bamutaze (2011)	10 t/ha/year	Mountain	Intercropped annual and perennial
Bamutaze (2005)	25–45 t/ha/year	Mountain	Maize, banana, coffee
De Meyer et al. (2011)	34–207 t/ha/year	Plateau	Footpaths and agricultural fields
Kizza et al. (2013)	10–320 kg/ha/year	Plateau	Forest
Majaliwa (1998)	40–45 t/ha/year	Plateau	Maize, maize-beans intercrop
Majaliwa (2005)	20–85 t/ha/year	Plateau	Coffee, banana, beans
Mulebeke (2004)	25–71 t/ha/year	Plateau	Banana, coffee, beans
Nadhomi et al. (2006)	9–48 t/ha/year	Plateau	Banana, coffee
Nakileza (1994)	3–7 t/ha/year	Mountain	Maize, beans, mixed cropping
Nakileza (2005)	20 t/ha/year	Plateau	Annual cropping
Semalulu et al. (2013)	1–39 t/ha/year	Mountain	Banana, coffee
Tukahirwa (1996)	1–38 t/ha/year	Highland	Sorghum

The spatial variability of Uganda's erosion rate using the GLASSOD methodology is found in Fig. 2.10a. Figure 2.10b is a geopedological map coupling the dominant soils, geology, and geomorphology.

As expected, highland and mountainous landscapes experience more degradation than lower elevations. In Uganda, these landscapes receive substantial annual rainfall. They are dominated by steep slopes of more than 30 % which are especially prone to soil erosion. The ownership of land is extremely fragmented in highland and mountainous landscapes, with land size per household predominantly at less than 1 ha.

In these landscapes, soil erosion is dominated by rill and interrill typologies, while gullies are confined to a few areas, particularly in western Uganda. High erosion rates are observed in the heavily populated and intensively cultivated plateau of the Lake Victoria Basin. These dangerous erosion rates are in the range of those observed in the South-western highland and Mt. Elgon in Eastern Uganda. A runoff and soil loss assessment at varied hill slope positions on the Mt. Elgon landscape under annual and perennial cropping (Bamutaze 2005) confirms high erosion across lower, middle, and upper hillslope segments, as Fig. 2.11 shows. Observed annual soil erosion rates from these hillslope segments are higher than the generally accepted tolerable limit of  $5 \text{ t ha}^{-1} \text{ year}^{-1}$ . This pattern has also been observed at sites in other SSA countries, such as the Ethiopian highlands,

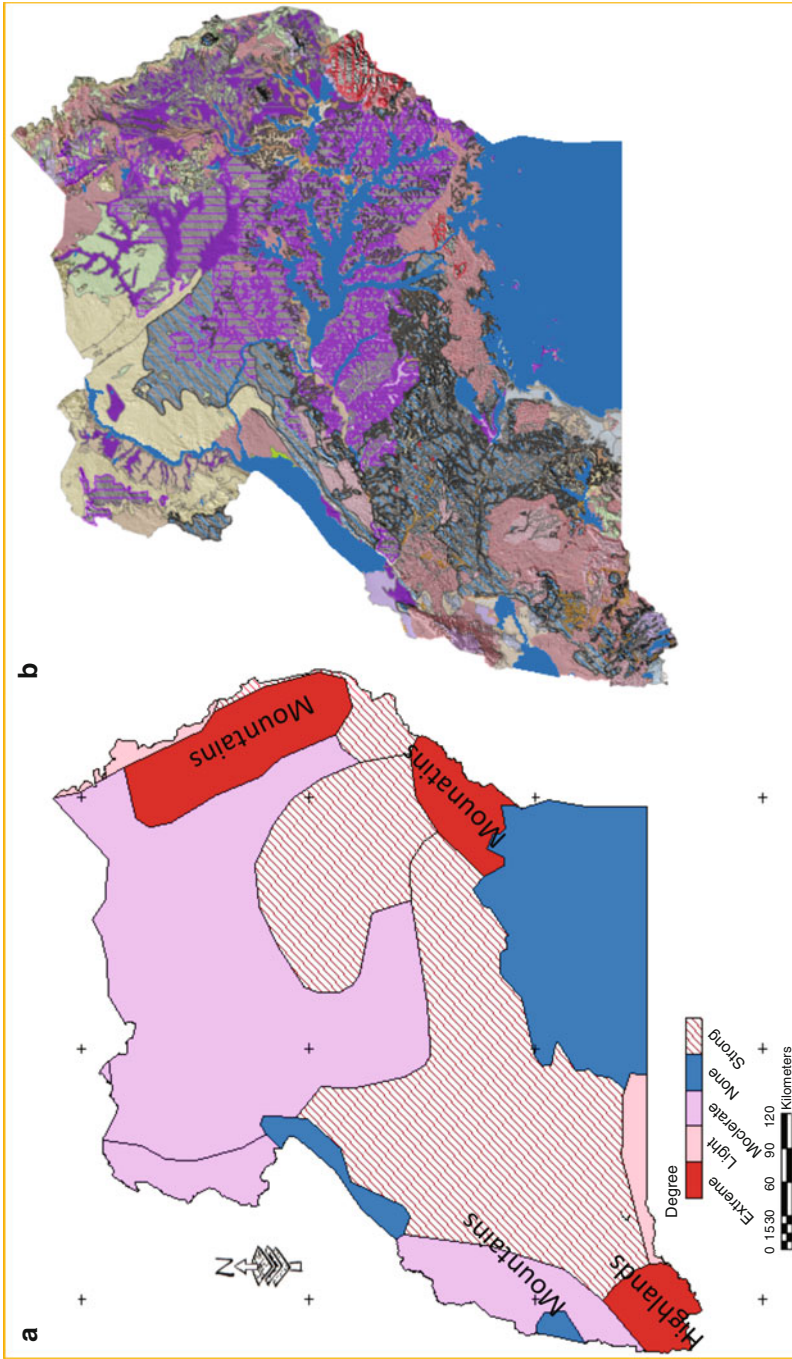
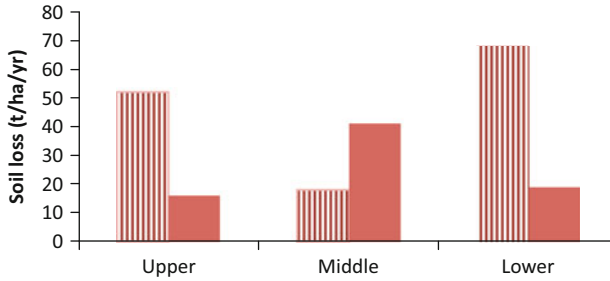


Fig. 2.10 Soil degradation status based on GLASSOD methodology (a) and geopedological entities of Uganda (b)



**Fig. 2.11** Variability of soil loss rates at diverse slope positions on Mt. Elgon (Source Bamutaze 2005)

(Munro et al. 2008; Nyssen et al. 2009) and Tanzania's Ulugulu mountains (Kimaro et al. 2008). While a mix of natural and anthropogenic factors contribute to these high soil erosion rates (Boardman 2006), poor landscape management is the dominant cause of soil erosion in SSA.

Recent comprehensive quantitative data on yield reductions from erosion in SSA are very limited. According to Lal (1995), erosion-related yield reductions in Africa generally vary from 2 to 40 % with a mean of 8.2 % for the continent and 6.2 % for SSA. These reductions are projected to rise to 16.5 % for the continent and 14.5 % for SSA by the year 2020 if erosion continues unabated (Lal et al. 2004; Obalum et al. 2012). As well, it is estimated that about 1.2 % of soil nutrients in Uganda are depleted annually, which contributes to poor harvest yields (NBI 2012).

### 2.6.2 Trends and Implications in Land Use and Coverage Change

Land use and soil coverage changes are significant terrestrial processes altering biogeochemical processes, ecological dynamics, and the sustainability of agricultural systems (Alkharabsheh et al. 2013). Conversions of forest cover into agricultural fields in East Africa are widespread and increasing. The change in East Africa's forest cover between 1990 and 2011 as a percentage of the total land area is shown in Fig. 2.12. Figure 2.13 displays trends in arable land for the same period.

A regression analysis shows that with the exception of Rwanda, all East African countries experienced a significant reduction in forest cover between 1990 and 2011 ( $p < 0.05$ ). Regional-level analysis shows that forest cover was reduced from about 30 % of the land area to 23 % for the same period. The highest reduction was observed in Burundi (-41 %) and lowest in Kenya (-7 %). Strikingly, all countries except Burundi at least experienced a significant increase in arable land. The observed declining trend in East Africa's forest cover corroborates observations made elsewhere in SSA (Brink and Eva 2009; Were et al. 2013; Gross et al. 2013;

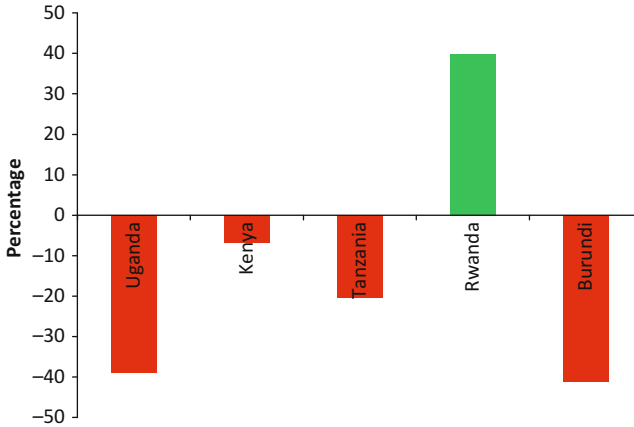


Fig. 2.12 Change in forest cover between 1990 and 2011 in Eastern Africa

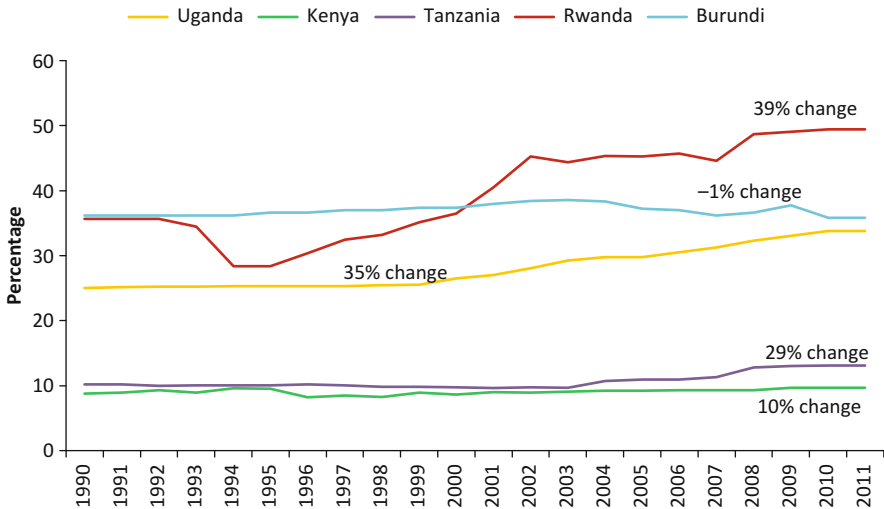


Fig. 2.13 Change in the proportional coverage of arable land in East Africa between 1990 and 2011

Brink et al. 2014). Interestingly, although Rwanda experienced the most rapid increase in arable land (39 %), its forest cover also increased between 1990 and 2011. The most plausible reason for this trend is that Rwanda has implemented environmental laws more firmly than other East African countries and begun a concerted re-forestation programme.



**Fig. 2.14** Naked or raped landscape on a ferralsol on Mt. Elgon due to improper land use

Although the relationship between land use change and soil erosion is generally non-linear in the long term (Dotterweich 2013), extensive studies (Defersha and Melesse 2012; Munro et al. 2008; Heckmann 2014; Mohammad and Adam 2010) of the East African region show that land use changes result in high levels of land degradation. In the same region, studies by Mugagga et al. (2011) suggest that these landscape transformations account for the exponential increase in slope failures. Land use and cover change are more pronounced in highland and mountainous landscapes, which is more evident on the Ugandan side of Mt. Elgon than the Kenyan side. Unsustainable conversions from forest cover to annual crops have culminated in a landscape described locally as “naked or raped” (See Fig. 2.14). High soil erosion rates and related sedimentation processes compromise the immediate and long term productivity of these sites.

## 2.7 Conclusions

The interplay between geomorphology and pedology in tandem with climate plays a significant role in SSA’s agricultural production systems. Regional landscape analyses indicate that terrain limitations prevent about 13 % of the region’s highland and mountain areas from suifood production. Soil quality in many parts of the region also constrains production. Delineated geopedological landscapes are characterized by a range of geohazards, but the most significant seem to be soil erosion and land use change, particularly conversions from forest cover to cropping activities. For the landscapes to sustain the rapidly increasing human populations occupying them today and in the future, deliberate attention toward socio-ecological sustainability is required.

## References

- Akinci H, Özalp AY, Turgut B (2013) Agricultural land use suitability analysis using GIS and AHP technique. *Comput Electron Agric* 97:71–82
- Alkharabsheh MM, Alexandridis TK, Bilas G, Misopolinos N, Silleos N (2013) Impact of land cover change on soil erosion hazard in Northern Jordan using remote sensing and GIS. *Procedia Environ Sci* 19:912–921
- Bagoora FDK (1998) Soil loss in Rukiga highlands in Eastern Kabale, Western Uganda. Ph.D, Makerere University, Kampala
- Bamutaze Y (2005) The impact of land use on runoff and soil loss in Wanale micro-catchment, Mt. Elgon. M.Sc, Makerere University, Kampala
- Bamutaze Y (2011) Patterns of water erosion and sediment loading on Mt. Elgon, Eastern Uganda. In: *Geography*. Makerere University, Kampala
- Bationo A, Hartemink A, Lungu O, Naimi M, Okoth PF, Smaling E, Thiombiano L (2006) African soils: their productivity and profitability of fertilizer use. Background paper prepared for the African Fertilizer Summit, Tropical Soil Biology and Fertility Institute of CIAT, Abuja, 9–13 June 2006, p 29
- Boardman J (2006) Soil erosion science: reflections on the limitations of current approaches. *CATENA* 68:73–86
- Brink AB, Eva HD (2009) Monitoring 25 years of land cover change dynamics in Africa: a sample based remote sensing approach. *Appl Geogr* 29:501–512
- Brink AB, Bodart C, Brodsky L, Defournay P, Ernst C, Donney F, Lupi A, Tuckova K (2014) Anthropogenic pressure in East Africa-Monitoring 20 years of land cover changes by means of medium resolution satellite data. *Int J Appl Earth Observ Geoinf* 28:60–69
- De Meyer A, Poesen J, Isabirye M, Deckers J, Raes D (2011) Soil erosion rates in tropical villages: a case study from Lake Victoria Basin, Uganda. *Catena* 84:89–98
- Defersha MB, Melesse AM (2012) Field-scale investigation of the effect of land use on sediment yield and runoff using runoff plot data and models in the Mara River basin, Kenya. *Catena* 89:54–64
- Dewitte O, Jones A, Spaargaren O, Breuning-Madsen H, Brossard M, Dampha A, Deckers J, Gallali T, Hallett S, Jones R (2013) Harmonisation of the soil map of Africa at the continental scale. *Geoderma* 211:138–153
- Dotterweich M (2013) The history of human-induced soil erosion: geomorphic legacies, early descriptions and research, and the development of soil conservation-A global synopsis. *Geomorphology* 201:1–34
- Eswaran H, Almaraz R, van den Berg E, Reich P (1997) An assessment of the soil resources of Africa in relation to productivity. *Geoderma* 77:1–18
- FAO (2006) Guidelines for soil description. FAO, Rome
- Griffiths JS, Smith MJ, Paron P (2011) Introduction to applied geomorphological mapping. In: Smith MJ (ed) *Geomorphological mapping: methods and applications: developments in earth surface processes*, vol 15, 1st edn. Elsevier, Amsterdam, p 3
- Gross D, Dubois G, Pekel JF, Mayaux P, Holmgren M, Prins HHT, Rondinini C, Boitani L (2013) Monitoring land cover changes in African protected areas in the 21st century. *Ecol Inform* 14:31–37
- Heckmann M (2014) Farmers, smelters and caravans: two thousand years of land use and soil erosion in North Pare, NE Tanzania. *Catena* 113:187–201
- Henao J, Baanante C (2006) Agricultural production and soil nutrient mining in Africa: implications for resource conservation and policy development. IFDC-International Center for Soil Fertility and Agricultural Development, Muscle Shoals
- Igue AM, Gaiser T, Stahr K (2004) A soil and terrain digital database (SOTER) for improved land use planning in Central Benin. *Eur J Agron* 21:41–52
- Kimaro DN, Poesen J, Msanya BM, Deckers JA (2008) Magnitude of soil erosion on the northern slope of the Uluguru Mountains, Tanzania: interrill and rill erosion. *Catena* 75:38–44

- Kizza CL, Majaliwa JGM, Nakileza B, Eilu G, Bahat I, Kansime F, Wilson J (2013) Soil and nutrient losses along the chronosequential forest recovery gradient in Mabira Forest Reserve, Uganda. *Afr J Agric Res* 8:77–85
- Kolavalli S, Flaherty K, Al-Hassan R, Baah KO (2010) Do Comprehensive Africa Agriculture Development Program (CAADP) processes make a difference to country commitments to develop agriculture? The case of Ghana. IFPRI discussion paper 01006, IFPRI
- Lal R (1995) Erosion-crop productivity relationships for soils of Africa. *Soil Sci Soc Am J* 59:661–667
- Lal R, Den Biggelaar C, Weibe K (2004) Measuring on-site and off-site effects of soil erosion on productivity and environment quality. OCDE, agricultural impacts on soil erosion and soil biodiversity: developing indicators for policy analysis, Paris. [www.oecd.org/tad/env/indicateurs](http://www.oecd.org/tad/env/indicateurs)
- Majaliwa JGM (1998) Soil loss from maize based cropping systems in the Lake Victoria crescent. Makerere University, Kampala
- Majaliwa JG (2005) Soil erosion from major agricultural land use types and associated pollution loading in selected Lake Victoria micro-catchments. Ph.D., Makerere University, Kampala
- Mohammad AG, Adam MA (2010) The impact of vegetative cover type on runoff and soil erosion under different land uses. *Catena* 81:97–103
- Mugagga F, Kakembo V, Buyinza M (2011) Land use changes on the slopes of Mount Elgon and the implications for the occurrence of landslides. *Catena* 90:39–46
- Mulebeke R (2004) Validation of a GIS-based USLE model in a banana-based microcatchment of the Lake Victoria basin. In: Soil science. Makerere University, Kampala
- Munro RN, Deckers J, Haile M, Grove AT, Poesen J, Nyssen J (2008) Soil landscapes, land cover change and erosion features of the Central Plateau region of Tigräi, Ethiopia: photo-monitoring with an interval of 30 years. *Catena* 75:55–64
- Nadhomi DL, Tenywa JS, Bagoora FDK (2006) Interactive effect of slope magnitude and land use on runoff and soil loss on a Luvisol in the Lake Victoria basin of Uganda. *Makerere Univ Res J* 1:49–62
- Nakileza B (1994) The influence of cropping systems and management practices on soil erosion on Mt. Elgon slopes. Makerere University, Kampala
- Nakileza B (2005) Soil degradation and associated sociological impacts in the drylands of Nakasongola district. PhD thesis, University of Capetown, Capetown
- NBI (2012) State of the river Nile Basin 2012. Nile Basin Initiative, Entebbe
- Nyssen J, Poesen J, Deckers J (2009) Land degradation and soil and water conservation in tropical highlands. *Soil Tillage Res* 103:197–202
- Obalum SE, Buri MM, Nwite JC, Watanabe Y, Igwe CA, Wakatsuki T (2012) Soil degradation-induced decline in productivity of sub-saharan African soils: the prospects of looking downwards the lowlands with the Sawah ecotechnology. *Appl Environ Soil Sci* 2012:1–10
- Sanginga N, Woomer PL (eds) (2009) Integrated soil fertility management in Africa: principles, practices and developmental process. Tropical Soil Biology and Fertility Institute of the International Centre for Tropical Agriculture, Nairobi, 263pp
- Sayre R, Comer P, Hak J, Josse C, Bow J, Warner H, Larwanou M, Kelbessa E, Bekele T, Kahl H, Amena R, Andriamasimanana R, Ba T, Benson L, Boucher T, Brown M, Cress J, Dassering O, Friesen B, Gachathi F, Houcine S, Keita M, Khamala E, Marangu D, Mokuu F, Morou B, Mucina L, Mugisha S, Mwavu E, Rutherford M, Sanou P, Syampungani S, Tomor B, Vall A, Vande Weghe J, Wangui E, Waruingi L (2013) A new map of standardized terrestrial ecosystems of Africa. Association of American Geographers, Washington, DC, 24pp
- Semalulu O, Kimaro D, Kasenge V, Isabirye M, Makhosi P (2013) Soil and nutrient losses in banana-based cropping systems of the Mount Elgon hillsides of Uganda: economic implications. *Int J Agric Sci* 2:256–262
- Tukahirwa JMB (1996) Measurement, prediction and social ecology of accelerated soil erosion in Kabale District, Southwest Uganda. Ph.D., Makerere University, Kampala

- van Velthuisen H (2007) Mapping biophysical factors that influence agricultural production and rural vulnerability. FAO, Rome
- Voortman R (2010) Explorations into African land resource ecology on the chemistry between soils, plants and fertilizers. Vrije Universiteit, Amsterdam
- Were KO, Dick AB, Singh BR (2013) Remotely sensing the spatial and temporal land cover changes in Eastern Mau forest reserve and Lake Nakuru drainage basin, Kenya. *Appl Geogr* 41:75–86
- Xu E, Zhang H (2013) Spatially-explicit sensitivity analysis for land suitability evaluation. *Appl Geogr* 45:1–9
- Zinck JA (2013) Geopedology: elements of geomorphology for soil and geohazard studies. ITC special lecture notes series: ISBN: 978-90-6164-352-4, 135



# Chapter 3

## Land Degradation and Soil Carbon Pool in Different Land Uses and Their Implication for Food Security in Southern Ethiopia

Ambachew Demessie, Bal Ram Singh, and Rattan Lal

**Abstract** This paper provides an overview of land degradation and a summary of carbon and nitrogen pooling under different land uses in Southern Ethiopia. The conversion of pristine vegetation to cultivated lands depletes soil organic matter (SOM). In this paper, we: (i) explore the extent of the land degradation in Ethiopia; (ii) assess changes in the stocks of soil organic carbon (SOC) and nitrogen (N) in soils under the chronosequences of 12–50 years of traditional agroforestry (AF) and crop fields (F); (iii) discover the effect of plantations on the state of SOC and N; (iv) consider the litter production and in situ decomposition rate under plantations; and (v) evaluate the effect of plantations on soil quality in Gambo District. The rates of soil erosion in Ethiopia hover around 16–300 Mg ha<sup>-1</sup> year<sup>-1</sup>. The SOM loss was estimated to be 1.17–78 Tg year<sup>-1</sup> from 78 M ha of cultivated and grazing lands. The SOC stock under the chronosequence of 12–50 years of AF and F land uses varied from 28.2 to 98.9 Mg ha<sup>-1</sup>, or 12–43 % of the stock, under the NF. The plantations accrued from 133.62 to 213.73 Mg ha<sup>-1</sup>, or 59.1–94.5 % SOC of that under the NF. Litter fall was higher under broad-leaved compared with the coniferous plantations. The soil quality index was high for NF and *Juniperous procera*. Plantations may represent the best option for mitigation of the increasing atmospheric CO<sub>2</sub> and sustenance of land productivity. Nevertheless, NF should be protected from further conversion to other land uses to maintain healthy ecosystem functions.

---

A. Demessie (✉)

School of Plant and Horticultural Science, College of Agriculture, Hawassa University,  
P.O. Box 5, Hawassa, Ethiopia  
e-mail: [dambachew@yahoo.com](mailto:dambachew@yahoo.com)

B.R. Singh

Department of Environmental Sciences, Norwegian University of Life Sciences,  
P.O. Box 5003, No-1432 Ås, Norway

R. Lal

Carbon Management and Sequestration Center, Ohio State University OARDC,  
2021 Coffey Road, Columbus, OH 43210, USA  
e-mail: [lal.1@osu.edu](mailto:lal.1@osu.edu)

**Keywords** Carbon sequestration • Deforestation • Litter fall • Natural forest • Plantation species • Soil organic carbon • Traditional agroforestry

### 3.1 Introduction

Growing populations have increased the demand for food and other goods in Ethiopia and elsewhere in Sub-Saharan Africa (SSA). Food productivity and the availability of agricultural-based products are at risk due to the degradation of the agricultural resource base and climate change. The total amount of severely degraded soils in SSA is approximately 3–5 million km<sup>2</sup>, or between 20 and 25 % of the total land area (Vagen et al. 2005). Deforestation and continuous cultivation deplete SOM and soil nutrient reserves by hastening decomposition, reducing replenishment through litter input, and increasing soil erosion, which together result in vegetation and soil degradation. Land that has economic and ecological functions (Vlek 2008) related to controlling global warming could act as a sink for many harmful chemicals. Land degradation is a manifestation of losses in certain intrinsic qualities or a decline in the land's capability to perform vital economic and ecological functions (Vlek 2008). In order for land to sustainably perform its vital functions, land use must be consistent with the land's ability to maintain its quality. Net land degradation is mainly due to the interactions between the land and its users [(natural degradation process + human interference) – (natural restoration process + human restoration management)]. Anthropogenic land degradation takes place at variable rates and to variable degrees, depending upon environmental conditions and management systems.

In the lexicon of agriculture, land degradation refers to declines in productivity and the quality and kind of land utility under normal weather and consistent inputs and management regimes (Vlek 2008). Land degradation is use-specific; thus, its quality may drastically decrease for one purpose and not for another (Johnson and Lewis 1995). The loss of land's intrinsic quality to perform its functions may be attributed to a mismatch between its use and its attributes. Once degradation sets in, the balance is upset; hence, soil, water, and vegetation are damaged. Land degradation can be classified as slight when persistent productivity losses are only 10–15 %. Under this scenario, the problem can be eased by adopting appropriate management practices. Moderate productivity losses over time (15–33 %) require ameliorative management at the farm level. When productivity losses are consistently high (50–66 %), land can be restored, but the cost is high (Oldeman 1988). Higher levels of consistent productivity losses make land reclamation economically and technically unviable. Such degraded lands will inadequately support the growth of plants that can absorb CO<sub>2</sub> to mitigate climate change (global warming), and they also threaten food security. In this paper, we assess the extent of land degradation and the turnover of SOC and N under different land uses in Ethiopia.

## 3.2 Land Degradation in Ethiopia

Ethiopia is a country whose topography is dominated by rugged mountains – which are cut by river valleys – deep gorges, flat-topped plateaus, undulating hills, and lowland plains (Yirdaw 2002). The highlands constitute more than 44 % of the total area of the country (FAO 1984). Montane forests are the main constituents of the natural vegetation, of which dry afro-montane forests form the largest part (Demel 2005). *Juniperus procera* and *Olea europaea* ssp. *cuspidata* are the typical dominant species in Ethiopia in the dry montane forests at altitudes from 1,500 to 2,700 m (Yirdaw 2002). As precipitation levels increase, the montane forests characteristically contain a mixture of *Podocarpus falcatus*, *Aningeria adolfi-friedericii*, and other broad-leaved species in the canopy (Friis 1992). The highlands of Ethiopia, in contrast to most mountain systems outside Africa, are very suitable for human habitation (Hawando 1997; Yirdaw 2002). As a result, 88 % of the population, 95 % of the cropped land (Hurni 1988), and 60 % of the livestock are concentrated in these highlands. This places the native forests under immense pressure.

Deforestation commenced as early as 2000 years ago in Ethiopia (Yirdaw 2002). “However, the rate of the disappearance of forests has drastically increased during the past 100 years.” The maximum rate of deforestation was reached in the 1950s and early 1960s (Pohjonen and Pukkala 1990). Remnant natural forests in the central and northern highlands only exist as isolated small patches at inaccessible locations and around the numerous churches and burial grounds (Yirdaw 2002; Wassie et al. 2003). It is estimated that open savannah-type woodlands dominated by *Acacia* species cover more than 20 million hectares (M ha). Nationally, a conservative estimate of the deforestation rates of natural forests is from 0.16 to 0.20 M ha year<sup>-1</sup>, and natural forest cover is believed to have decreased from 16 % in the 1950s to about 2.8 % in the 1980s (EFAP 1994). The ever-increasing population’s growing demand for grazing and arable land, fuel wood, and construction material is the major factor contributing to deforestation, and loss of soil fertility through erosion process in the Ethiopian highlands (Mekonnen 1999). The demand for forest products is still growing; as a result, the remnant forests are under high pressure of continued deforestation. Due to deforestation, much of the Ethiopian highlands are covered with wooded grasslands on which secondary tree species such as *Acacia abyssinica*, *Acacia negrii*, and *Acacia pilispina* are found (Friis 1992).

Poor land cover and traditional farming practices have increased levels of soil erosion and fertility loss in the country. Current documented rates of soil erosion in Ethiopia range from 16 to 300 Mg ha<sup>-1</sup> year<sup>-1</sup> (Hurni 1988). According to Hawando (1997), the SOM loss associated with the removal of surface soil ranges from 15 to 1,000 kg ha<sup>-1</sup> year<sup>-1</sup>, which amounts to 1.17–78 Tg of SOM year<sup>-1</sup> from 78 M ha of cultivated and grazing lands. The loss of soil nitrogen ranged from 0.39 to 5.07 Tg year<sup>-1</sup>, and that of phosphorus ranged from 1.17 to 11.7 Tg year<sup>-1</sup>. Fuel wood has become increasingly scarce for many Ethiopian households.

Therefore, rural people use dung and agricultural residues as alternative fuels, rather than returning them to the soil to increase crop yields. The burning of dung and crop residues for fuel, uncontrolled burning of range lands, conversion of forest into crop lands, cultivation of steep slopes, and poor farming practices (particularly in areas where cereal mono-culture farming systems predominate) increase the susceptibility of the land resources to erosion in dry sub-humid and semi-arid areas. This reduces the chances of achieving food security, alleviating poverty, and generating economic growth in Ethiopia (Mekonnen 1999).

### **3.3 Loss of Biodiversity**

Severe deforestation may result in the extinction of a wide range of Ethiopian flora (Tolera et al. 2008). Endemism is particularly high in the afro-alpine vegetation zone, the dry montane forests, and plateau grassland complexes (Tilahun et al. 1996). As a result of deforestation, Ethiopia's forests and woodlands have been declining both in size and species richness (Yirdaw 2002). Due to continuing human encroachment, fragmented forests in the highlands are much more impoverished in terms of floral diversity than the forests that once occupied the same site. The number of species and intra-species genetic diversity in fragmented forests will diminish over time after isolation owing to a variety of factors, such as inbreeding and genetic drift (Turner and Corlett 1996). Consequently, some of the remnant tree species in the northern and central highlands are endangered, since they are found isolated from one another. The problem of deforestation is continuous, as is the increased population pressure on the remnant forests that are located in the southwestern and southeastern highlands.

### **3.4 Soil Carbon and Nitrogen Turnover in Agricultural and Forest Soils**

The accrual and loss of SOM is a major factor in soil fertility and ecosystem functioning, reflecting whether soils are sinks or sources of carbon (C) in the global cycle (Feller and Beare 1997; Post and Kwon 2000). Much of the loss in SOC can be attributed to reduced inputs of organic matter, increased decomposability of crop residues, and tillage effects, which decrease the amount of physical protection against decomposition (Mann 1986; Post and Kwon 2000; Vesterdal et al. 2002). On the other hand, a change in land use from field crops to forests reflects a change from an annual cycle of cultivating and harvesting crops to a much longer forest cycle (Vesterdal et al. 2002). This enables the production of more biomass and reduces the level of soil disturbance. The residence time of SOM in less disturbed soils varies between 20 and 40 years in tropical regions and between 40 and

70 years in temperate regions, with some SOM pools highly labile (<1 year) and others more passive (>100 years) in deep horizons (Feller et al. 2001).

Highly productive woody crops will add substantial C to soil, both above and below ground. “However, with all other factors kept constant, this addition depends on the native vegetation types (Ovington and Heitkamp 1960; Lal 2005).” In turn, the vegetation types are influenced by geologic parent material or managed plantation forest species. In managed forests, within 2–3 years after plantation establishment, mulching by leaf litter and a lack of cultivation will slow decomposition and further help retain the SOC pool (Grigal and Berguson 1998). Decomposition accounts for the transformation of nearly as much C as does photosynthesis, and it is carried out primarily by bacteria and fungi (Berg and McLaugherty 2008). SOM decomposition is responsible for much of the CO<sub>2</sub> returned to the atmosphere. Decomposition is also responsible for the formation of humic substances that contribute to increased soil fertility and long storage of C. It is closely tied to nutrient cycling, and it is essential for the release of organically bound nutrients (Berg and McLaugherty 2008). A substantial fraction (often 30–50 % or more) of the energy and carbon annually fixed in forests is contributed to the forest floor as litter fall that mostly consists of leaves (Ovington and Heitkamp 1960). Because litter fall is generally related to the quantity of photosynthetic material in the system, it is an interesting index of ecosystem productivity (Olson 1963).

### 3.5 Factors Controlling the Dynamics of Soil Organic Matter

Land use, soil type, climate, and vegetation are the drivers of SOM dynamics (Feller and Beare 1997). Under similar conditions, land use management controls the ability of soils to be either a source or a sink of SOM and nutrients. For example, the conversion of natural vegetation to cultivated land results in rapid declines of SOM (Mann 1986; Post and Mann 1990; Davidson and Ackerman 1993). The amount of C in soil is usually greater than the amount in living vegetation. The SOM is represented by plant, animal, and microbial residues in all stages of decomposition (Oades 1988; Post and Kwon 2000). The C content of the soil depends upon both the rate of input of plant litter and its rate of decomposition. Nevertheless, the C sequestration occurs more slowly in soil than in biomass, but C stored in soils would be more resistant than C stored in biomass to sudden changes in forest management. Many organic compounds in the soil are intimately associated with inorganic soil particles (Post and Kwon 2000). The effects of different soil types on SOM turnover are most often ascribed directly to differences in soil clay content (Schjønning et al. 1999). Clay is assumed to protect OM against decomposition. Some of the mechanisms proposed to explain the stabilization of SOC are the adsorption of organics onto the surfaces of clays, which leads to the formation of organic-clay complexes (Oades 1988), and the entrapment of organic particles in

aggregates (Van Veen and Kuikman 1990). The formation of stable soil aggregates is influenced by mineralogy, texture, land use management, and the quality and quantity of organic matter inputs. The interaction of these factors determines the relationships between SOM content and water stable aggregation (WSA). The factors are highly dependent upon clay content (Feller and Beare 1997). Stable aggregates may enhance the physical protection of SOM against losses due either to mineralization or detachability and erosion (Feller and Beare 1997). Parent material with a high base status and/or the presence of a substantial amount of Al and Fe oxides has a positive influence on the stabilization of SOM. This includes soils with andic properties (Zunino et al. 1982; Percival et al. 2000). Base-rich materials contain more clay and SOM than soils formed under similar conditions from acidic materials (Oades 1988).

### **3.6 Soil Organic Carbon Pool in Different Land Uses in the Gambo District, Southern Ethiopia**

The Gambo District in southern Ethiopia features one of the country's few remaining natural forests. The district is experiencing extensive deforestation, overgrazing, and conversion into arable land (Ashagrie et al. 2005; Solomon et al. 2002; Lemenih and Itanna 2004). Trees that were deliberately left after the clearing of the woodland and natural forest are scattered across the agricultural lands, and they represent the local traditional parkland agroforestry system. The tree species that are deliberately maintained in traditional agroforestry systems are mostly endangered species that are prone to selective removal by encroachers from the adjacent natural forest. These conserved species supply litter that can enhance soil productivity through the maintenance of SOC. Additionally; they will likely serve as seed sources for the rehabilitation of their habitat.

Crops are grown during the rainy season in both traditional agroforestry and on farmlands without trees. After harvest, farmers remove crop residue by burning it or by transporting it to their homes for various uses.

#### ***3.6.1 Soil Organic Carbon and Nitrogen Stock Under AF and F Land Uses of Chronosequences***

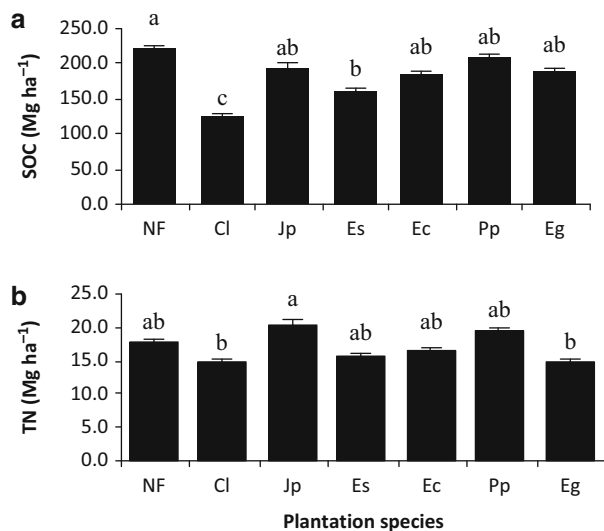
The SOC stock under land uses of all age chronosequences, with the exception of AF<sub>40</sub>, was low, compared with NF. The SOC stock under F, compared with AF, did not differ by time under cultivation. The type of land use did not affect the N stock; "however, the stock was higher under AF<sub>40</sub> than AF<sub>20</sub> (Demessie 2013). The SOC stocks decreased in the 12- to 30-year chronosequence in both AF and F land uses." When forest is cleared for new agricultural land, a considerable amount of C is lost

to the atmosphere because the decay rate of SOC is an order of magnitude higher under agriculture than under forest. “However, each soil has a C carrying capacity (i.e., an equilibrium C content, depending on the nature of vegetation and climatic conditions (Gupta and Rao 1994).” Land use change disturbs the equilibrium between C inflows and outflows in soil until a new equilibrium is eventually reached in the new system (Guo and Gifford 2002). Forest clearance and subsequent tillage affects the proper soil function of acting as a carbon sink. This results in: (i) a decreased supply of litter, which would compensate the amount decomposed; (ii) a reduced capacity of the soil to physically protect SOC from decomposition, due to the destruction of soil aggregates; and (iii) enhanced leaching and translocation reflected by dissolved organic carbon (DOC) or particulate organic carbon (POC) and accelerated erosion by water runoff or wind (Post and Kwon 2000; Lal 2002).

### 3.6.2 SOC, N Stocks and C Pool Under Short Rotation Plantations

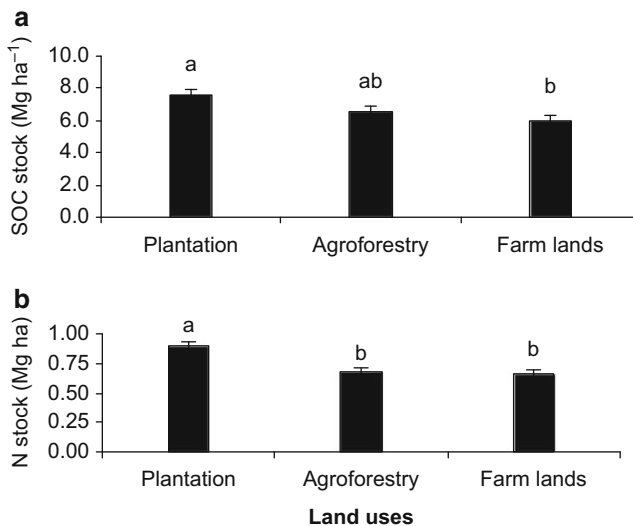
The data suggest that the C and N stocks under *P. patula* and natural forest was higher than that under *C. lusitanica* ( $p < 0.05$ ). The N stock under *J. procera* tended to be higher when compared to the other plantations and natural forests, but the difference was not statistically significant (Fig. 3.1). The lower SOC and N stock under *C. lusitanica* may be partly ascribed to the lower clay content in the uppermost layers of the soil profile, where more of the SOC and N stock commonly accumulate (Demessie et al. 2012a, b).

**Fig. 3.1** (a) Stocks of soil organic carbon (SOC) and (b) total nitrogen (N) under natural forest (NF), *J. procera* (Jp), *C. lusitanica* (Cl), *E. saligna* (Es), *E. camaldulensis* (Ec), *E. globulus* (Eg), and *P. patula* (Pp). Means followed by the same letter (s) are not significantly different ( $p < 0.05$ ) (Demessie et al. 2011)



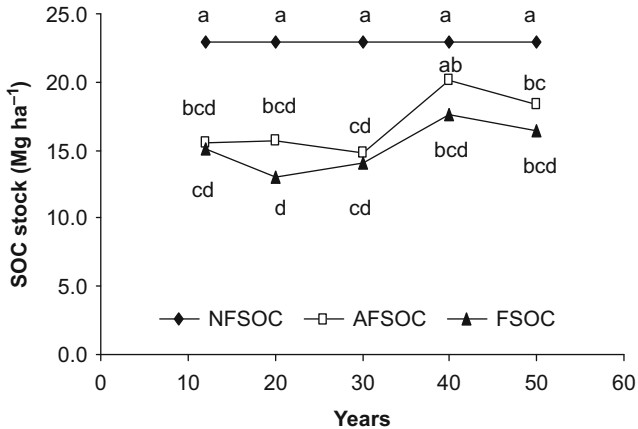
The *Cupressus* plantation was at the harvesting stage, which may have negatively influenced the quantity and quality of the stand's litter production capability. The latter was manifested in a lower detritus mass and correspondingly lower SOC and N concentrations along the depth. Hence, this condition and others, such as the topography and density of plant population, may have negatively influenced the SOC and N stocks under *C. lusitanica*, compared to the reference and the other plantation species. Despite the fact that no significant differences existed in the C and N stocks among plantations (excluding *C. lusitanica*), coniferous species (*P. patula* and *J. procera*) have a tendency to accrue more stocks, compared to the *Eucalyptus* species. The minor difference in the age of plantation and the mode of plantation establishment (on disturbed natural forest and previously cultivated lands) was not reflected in the accrual rates of C and N stocks. The interaction between the species category and land use history was not statistically significant; thus, any differences may be explained by the inherent characteristics of species, the site-to-site variability of soil physical and chemical properties, and differing management practices. These results are consistent with those reported by Vesterdal et al. (2002), who found that *Quercus robur* sequestered  $2 \text{ Mg C ha}^{-1}$ . They further found that *Picea abies* sequestered approximately  $9 \text{ Mg C ha}^{-1}$  in forest floors over 29 years, while the adjacent 200-year-old plantation sequestered  $81 \text{ Mg C ha}^{-1}$  after their establishment on arable lands. Generally, the establishment of plantations on either disturbed or previously cultivated lands reduced the tree and total biomass C and N, compared to the reference natural forest (Demessie et al. 2011).

Overall, in accordance with our expectations, plantations sequester a significantly higher C and N stock, compared to farmlands (Fig. 3.2). The higher accretion of SOC and N in plantations may be explained by a higher litter input and little or no soil disturbance, compared to farmlands.



**Fig. 3.2** Total soil carbon (a) and nitrogen (b) stock of 0–20 cm depth under plantations, agroforestry, and farmland uses ( $p < 0.05$ ) (Demessie 2009)





**Fig. 3.3** Total SOC stock of 1 m depth in the chronosequences of agroforestry (AF) and farm (F) land uses. Means followed by the same lower case letter(s) are not significantly different ( $p < 0.05$ ) (Demessie et al. 2013)

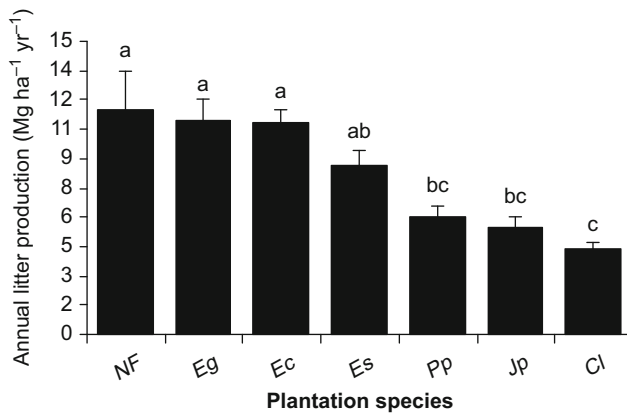
### 3.6.3 Rates of SOC and N Losses in Soils Under the Chronosequences of AF and F Land Uses

The conversion of natural forest into AF and F land uses resulted in declines in SOC stocks in all age chronosequences. The SOC stock under F and AF land uses of 12, 20, and 30 years of cultivation was 13.1–15.6 kg m<sup>-2</sup>, or 32–43 %, of that under the natural forest (Demessie et al. 2013). The maximum SOC loss of 9.9 kg m<sup>-2</sup>, or 43 %, was observed under F<sub>20</sub>, while the minimum was 2.8 kg m<sup>-2</sup>, or 12 %, under AF<sub>40</sub> (Demessie et al. 2013).

The rate of loss of SOC is high following the cutting of NF, and it stabilizes between 20 and 30 years of cultivation, with a small increase in the later chronosequences of 40–50 years. The rate of SOC loss was lower under AF (0.07–0.62 kg m<sup>-2</sup> year<sup>-1</sup>) than F (0.13–0.7 kg m<sup>-2</sup> year<sup>-1</sup>). The corresponding rates of loss for farmlands were 0.034 and 0.007 kg m<sup>-2</sup> year<sup>-1</sup>, respectively. Differences in the SOC stock among most of the age chronosequences of AF and F land uses were not significant. “However, the SOC levels under AF tended to be higher than those under corresponding F land uses (Fig. 3.3).”

### 3.6.4 Litter Fall and Annual Production in Short Rotation Plantations

The average annual litter fall for *Eucalyptus* species (*E. saligna*, *E. camaldulensis* and *E. globulus*) and natural forest (ranging from 8.7 to 11.5 Mg ha<sup>-1</sup> year<sup>-1</sup>) was significantly higher ( $p < 0.05$ ) than that for coniferous species (*C. lusitanica*, *J. procera* and *P. patula*), ranging from 4.4 to 6.0 Mg ha<sup>-1</sup> year<sup>-1</sup>.



**Fig. 3.4** Annual litter production under Natural Forest (NF), *Eucalyptus globules* (Eg), *Eucalyptus camaldulensis* (Ec), *Eucalyptus saligna* (Es), *Pinus patula* (Pp), *Juniperous procera* (Jp), and *Cupressus lusitanica* (Cl). Means followed by the same lower case letters are not significantly different ( $p < 0.05$ ) (Demessie et al. 2012b)

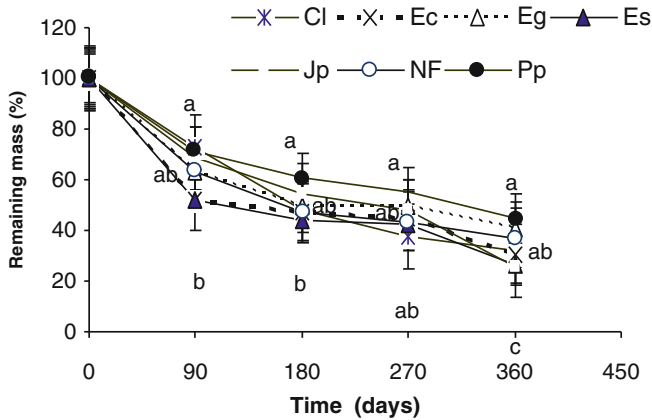
No such differences were observed within *Eucalyptus* or coniferous species (Fig. 3.4). According to Yang et al. (2004), the mean annual total litter fall varied from 5.47 Mg ha<sup>-1</sup> for *Cunninghamia lanceolata* to 11.01 Mg ha<sup>-1</sup> for natural forest at Fujian in subtropical China. These values are similar to those found in this study.

The integrated contribution of the diverse component species in natural forest may explain why the litter fall is higher than that for pure plantation stands. Plants differ in their ability to capture resources and in their influence on ecosystem processes (Russell et al. 2004). Hence, diverse natural vegetation and/or mixed plantation crops produce a higher annual litter mass than pure stand crops (Binkley et al. 1992; Lian and Zhang 1998; Parrotta 1999; Yang et al. 2004; Wang et al. 2007). Managed plantations, as mixed stands, could mimic the function of natural forest systems and produce higher litter mass and better nutrient recycling. For example, Wang et al. (2007) found that the mean annual litter production was significantly higher (24 %) in mixed stands than in monoculture for *Cunninghamia lanceolata*.

### 3.6.5 Litter Decomposition

In our litter decomposition experiment, the residual litter mass declined exponentially for all plantation species and natural forests. The remaining mass of litter varied between species and sampling times ( $p < 0.05$ ).

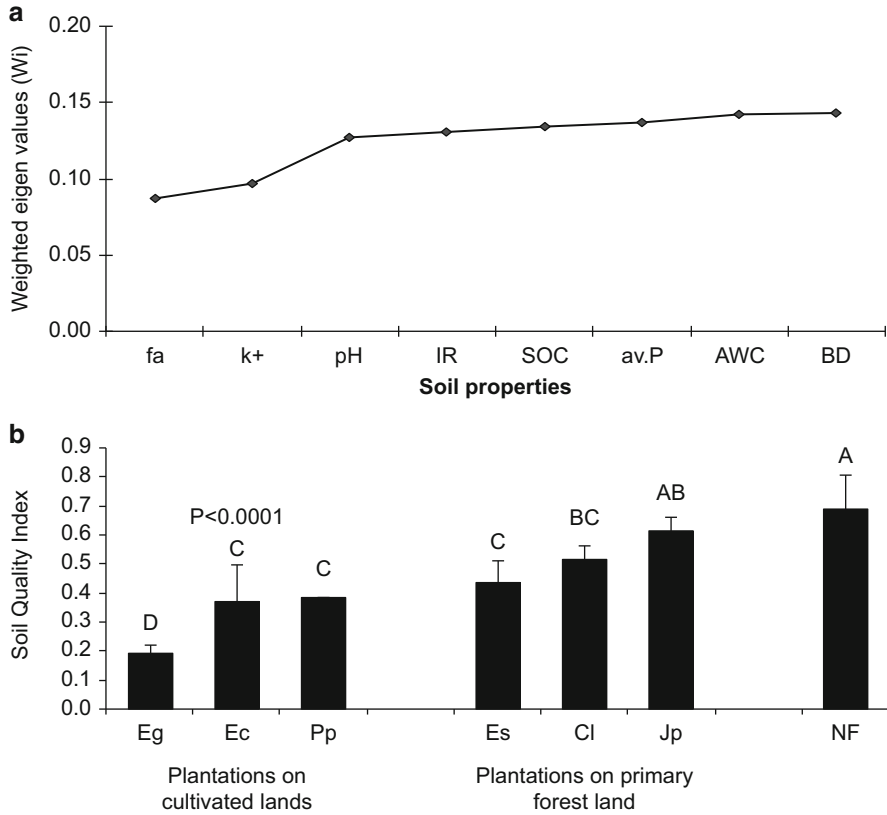
During the first 3 months, the remaining litter mass for *C. lusitanica* and *P. patula* was higher than that of *E. camaldulensis* and *E. saligna*. After 6 months,



**Fig. 3.5** Litter mass remaining in litter bags at various time intervals under *Cupressus lusitanica* (Cl), *Eucalyptus camaldulensis* (Ec), *Eucalyptus globules* (Eg), *Eucalyptus saligna* (Es), *Pinus patula* (Pp), *Juniperus procera* (Jp), and natural forest (NF) ( $p < 0.05$ ) (Demessie et al. 2012b)

the remaining litter mass of *E. saligna* was only lower than that of *P. patula*. After 9 months, the remaining litter mass of *C. lusitanica* was only lower than that of *P. patula* (Fig. 3.5). The remaining litter mass under *P. patula*, *E. globulus*, and natural forest was consistently higher when compared to other species investigated in the study. The single exponential model showed a good fit for all leaf litter of all plantation species (Demessie et al. 2012b).

The decay rate coefficient ( $k$ ) of all species ranged from  $0.07 \text{ month}^{-1}$  for *P. patula* to  $0.12 \text{ month}^{-1}$  for *E. saligna*, while the half-life decay period ranged from 6.0 to 9.7 months. The decomposition of *Eucalyptus* species generally tended to be faster than that of coniferous species. In addition to the variability of factors that control decomposition, such as moisture, temperature, etc., the initially fast and subsequently slower rates of decomposition at later time intervals could be due to a higher initial content of water soluble materials, simple substrate, and the breakdown of litter by decomposers, especially the micro-flora (Songwe et al. 1995), as well as the higher loss of these easily degradable and labile fractions during the early decomposition phase (Berg and Tamm 1991; Sundarapandian and Swamy 1999; Jamaludheen and Kumar 1999; Ribeiro et al. 2002; Yang et al. 2004; Huang et al. 2007). Nevertheless, the relatively slower decay rates at later stages may be due to the decrease in the substrate quality resulting from the removal of the labile C and the accumulation of recalcitrant matter in the residual litter mass (Berg and Tamm 1991; Ribeiro et al. 2002). These factors may explain the trend of decomposition observed in the present study. Slower decomposition in the 6 and 9 month intervals may be explained in part by drought conditions (Demessie et al. 2012b). “However, the data from this study may have been more easily interpreted if the decomposition process were measured using narrower time intervals, if the study period were extended, and if in situ site moisture and temperature data were collected and included as factors in the analysis.”



**Fig. 3.6** (a) Weighted vector  $i$  of soil quality factors, air volume (fa), Potassium (k+), soil acidity (pH), infiltration rate (IR), soil organic carbon (SOC), available P (av.P), available water capacity (AWC), and soil bulk density (BD); and (b) soil quality index (SQIs) under plantation land uses where *E. globulus* (Eg), *E. camaldulensis* (Ec), *P. patula* (Pp), *E. saligna* (Ec), *C. lusitanica* (Cl), *J. procera* (Jp) and natural forest (NF). Means followed by the same upper case letter do not differ significantly among species ( $p < 0.05$ ) (Demessie et al. 2012a)

### 3.6.6 Soil Quality

The iterated PCA analysis showed that the first three PCs with eigen values  $>1$  explain 79 % of the variability. The final PCA-based selection of soil property variables for soil quality indexes (SQIs) were: air volume at  $-10$  kPa matric potential (fa), exchangeable potassium ( $K^+$ ), pH, infiltration rate (IR), SOC, available phosphorus (av.P), AWC, and BD. The weighted eigen values of these soil property variables ranged from 0.09 to 0.14 (Fig. 3.6).

The SQI under all plantation species except *J. procera* (Jp) was significantly lower when compared to that under NF. The SQI of soil under *E. globulus* (Eg) was lower when compared with the other plantations species. Moreover, a significant

difference in SQI was observed on a species genera basis among the coniferous, *Eucalyptus*, and natural forest groups ( $p < 0.05$ ).

The SQI of soils under the *Eucalyptus* species was lower than those under coniferous plantations. This trend may be ascribed to the fast-growing nature of the *Eucalyptus* species, which may intensively absorb soil nutrients as well as a frequent harvest and transport of woody material out of the system (Demessie et al. 2012a). The entire tree harvest, combined with the short harvest cycles, often with leaves intact, results in a nutrient depletion that is far greater than conventional forest harvests (Heilman and Norby 1998). Within the *Eucalyptus* species, *E. globulus* and *E. camaldulensis* had a lower value of SQI than any of the other plantations. This trend may be attributed to their management, as coppice is harvested in short periods of time (usually every 7–10 years, depending on the required size of the woody material). Conversely, the higher value of SQI under *E. saligna*, compared to *E. globulus* and *E. camaldulensis*, could be attributed to differences in their mode of establishment and rotation period. *E. saligna* was established on undisturbed primary forest lands, and it was not harvested since its establishment.

Soil nutrients are accumulated and recycled through the addition of litter from the standing plantation crops. “However, the accrual of soil quality variables such as SOC via detritus material is a slow process.” One way of achieving accrual is by less intense harvests through prolonged rotation periods. The conversion of cropland to forest plantation land use means that the annual cycle of cultivating and harvesting crops is replaced by a much longer forest cycle (Six et al. 2000; Vesterdal et al. 2002). Such management has probably enabled the accumulation of more biomass under *E. saligna* established on the undisturbed soil and the prolonged rotation period, relative to the coppice management that the *E. globulus* and *E. camaldulensis* have endured. In cultivated lands, the soil nutrients were exhausted by crops, and so the disturbance of soil physical parameters could take longer to be restored, thus slowing the effect of *E. globulus* and *E. camaldulensis* (Post and Kwon 2000). Tillage, in addition to mixing and turning the soil, disrupts aggregates and exposes organo-mineral surfaces to decomposers (Post and Kwon 2000). Under such management, continuously cultivated lands depleted 80–96 % of the initial forest-derived SOC in sand, while depleting 73–85 % of the SOC from the silt fraction of Wushwush and Munessa, Ethiopia (Solomon et al. 2002).

### 3.7 Conclusions, Recommendations and Research Perspectives

Land degradation in Ethiopia is extremely high. Deforestation continues unabated. The extent of land degradation in Ethiopia warrants the rehabilitation of degraded lands and requires helping the farming community to practice soil conservation measures (both physical and biological methods) on their farmlands.

The conversion of natural forest to plantations, cultivated and traditional agroforestry land uses, and the subsequent residue management negatively influenced the SOC and N in the Gambo District in southern Ethiopia. The loss of SOC in both agroforestry and farmlands was much higher in the early chronosequence of 12 and 20 years than in the later chronosequences of 40 and 50 years. The relatively higher SOC stocks and the lower rate of SOC loss in agroforestry suggest that integrating more trees with proven multi-functionality and increasing the application of the crop residue input in all agricultural lands could lead to a higher potential for sequestering SOC.

Among plantations, *J. procera* (the native species) and *P. patula* sequestered a higher SOC than the *Eucalyptus* species. Nevertheless, the accretion of SOC and N stocks under *Eucalyptus* was not low, given the shorter rotation cycle.

The annual litter production (the main input for SOC sequestration) under broad-leaved *Eucalyptus* species was higher, compared with coniferous plantations and traditional agroforestry land uses. Hence, our findings suggest that the notion that *Eucalyptus* species lead to soil degradation by nutrient and water mining do not seem to hold true under the soil and climatic conditions of the study area.

The rate of decomposition, with the exception of *P. patula*, was fast for the plantation species and natural forest for the 1-year period that was investigated. The addition of nutrients to the soil through the decomposition of litter is crucial, especially where the application of fertilizers is limited to sustain soil productivity, as was the case in the study area. Hence, the higher litter production and the subsequently faster rate of decomposition (Demessie et al. 2012b) are qualities to consider during the selection of species for short-term rotation crops. The higher annual litter production under the *Eucalyptus* species, and the higher accretion rate of SOC under *P. patula* and *J. procera*, should be taken into account during species selection for plantation establishment. Thus, we recommend that *J. procera* and *P. patula* are good candidates for plantation establishment on cleared forest and degraded lands.

Overall, it is concluded that plantations are better than farmlands at sequestering C and N when the mitigation of the increasing atmospheric CO<sub>2</sub>, in combination with the sustenance of land productivity, is the main goal of land management. “However, since the SOC pools are highest in relic natural forests, the forests should be protected from further conversion to other land uses to maintain large SOC stocks and healthy ecosystem functions.” In general, the degraded soil’s physical and chemical properties under plantations established on cultivated lands did not return to their original state, and they were consistently inferior to those of soils under plantation stands established on undisturbed forest soils.

The value of soil quality below the baseline scoring function of soil properties under plantations established on previously cultivated lands indicate that the period required for the rehabilitation of the disturbed soil was not long enough (Demessie et al. 2012a). Plantations, especially *Eucalyptus* species, are managed as coppice harvested every 7–10 years. Such a short rotation period will not allow for the accumulation of SOC and other soil chemical nutrients to reach the level required to achieve high soil quality. Similarly, the sites under plantations established on

disturbed forest soils showed a lower SQI, compared to that under the natural forest. The same was true for plantations, except for *J. procera*, established on undisturbed forest soil. Thus, the data support the conclusion that proper selection and management of species, combined with prolonging the rotation period, would increase and sustain soil quality.

Nevertheless, the changes of SOC and total N due to changes in land use could not be related to yield parameters that may help farmers adopt best management practices (BMPs) for sustaining their farm productivity while sequestering carbon to offset carbon emissions. Therefore, it will be of paramount importance to carry out research through manipulative experiments on the application of crop residue, judicious fertilizer use, and plantation management practices. Such efforts will generate information that can be utilized for the improvement of farm management, helping to sustain and increase the productivity of the farms through the increased sequestration of SOC and N. Such a strategy could lead to increased soil and crop productivity, as well as the mitigation of climate change through biosequestration (soil and vegetation) of atmospheric CO<sub>2</sub>. The study for litter fall and decomposition only lasted for 1 year. To obtain more reliable information, future studies should be conducted for longer periods of time, and they should include more native species. In addition to the SOC and N turnover assessment in this study, future studies must also involve the dynamics of other nutrients, such as phosphorus, K<sup>+</sup> Ca<sup>+2</sup>, and Mg<sup>+2</sup> (essential components for both C sequestration and soil productivity). The experiment should be done simultaneously in controlled laboratory and field conditions to better understand the decomposition processes involved. Although the rate of SOC loss is calculated from the obtained data, it is a cumulative loss over a longer period of time, and may therefore not provide a true picture of the losses and gains that occur during short-time intervals, as changes are often nonlinear under field conditions.

## References

- Ashagrie Y, Zech W, Guggenberger G (2005) Transformation of a Podocarpus falcatus dominated natural forest into a monoculture eucalyptus globulus plantation at Munesa, Ethiopia: soil organic C, N and S dynamics in primary particle and aggregate-size fractions. *Agric Ecosyst Environ* 106:89–98
- Berg B, McClaugherty C (2008) *Plant litter: decomposition, humus formation, carbon sequestration*. Springer, Berlin/Heidelberg
- Berg B, Tamm CO (1991) Decomposition and nutrient dynamics of litter in long-term optimum nutrition experiments. *Scand J For Res* 6:305–321
- Binkley D, Dunkin KA, DeBell D, Ryan MG (1992) Production and nutrient cycling in mixed plantations of eucalyptus and albizia in Hawaii. *For Sci* 38:393–408
- Davidson EA, Ackerman IL (1993) Changes in soil carbon inventories following cultivation of previously untilled soils. *Biogeochemistry* 20:161–193
- Demel T (2005) Seed ecology and regeneration in dry afro-montane forests of Ethiopia. *Trop Ecol* 46:45–64

- Demessie A (2009) Effects of conservation of natural forests to plantations, traditional agroforestry and cultivated lands on carbon sequestration and maintenance of soil quality in Gambo District, southern Ethiopia. PhD thesis, Norwegian University of Life Science
- Demessie A, Singh BR, Lal R (2011) Soil carbon and nitrogen stocks under plantations in Gambo District, Southern Ethiopia. *J Sustain For* 30(6):496–517
- Demessie A, Singh BR, Lal R, Børresen T (2012a) Effects of eucalyptus and coniferous plantations on soil properties in Gambo District, southern Ethiopia. *Acta Agric Scand B Plant Soil Sci* 62:467–476
- Demessie A, Singh BR, Lal R, Børresen T (2012b) Leaf litter fall and litter decomposition under eucalyptus and coniferous plantations in Gambo District, southern Ethiopia. *Acta Agric Scand B Plant Soil Sci* 62:467–476
- Demessie A, Singh BR, Lal R (2013) Soil carbon and nitrogen stocks under chronosequence of farm and traditional agroforestry in Gambo district, Southern Ethiopia. *Nutr Cycl Agroecosyst* 95:365–375
- FAO (1984) Ethiopian highlands reclamation study (EHRS). Final report, vol 1–2, Rome
- Feller C, Beare MH (1997) Physical control of soil organic matter dynamics in the tropics. *Geoderma* 79:69–116
- Feller C, Albrecht A, Blanchart E, Cabidoche YM, Chevallier T, Hartmann C, Eschenbrenner V, Larrouy MC, Ndandou JF (2001) Soil organic carbon sequestration in tropical areas. General considerations and analysis of some edaphic determinants for Lesser Antilles soils. *Nutr Cycl Agroecosyst* 61:19–31
- Friis I (1992) Forests and forest trees of northeast tropical Africa: their natural habitats and distribution patterns in Ethiopia, Djibouti and Somalia. *Kew Bull Addit Ser* 15:1–396
- Grigal DF, Berguson WE (1998) Soil carbon changes associated with short-rotation systems. *Biomass and Bioenerg* 14:371–377
- Guo LB, Gifford RM (2002) Soil carbon stocks and land use change: a meta analysis. *Glob Chang Biol* 8:345–360
- Gupta RK, Rao DLN (1994) Potential of wastelands for sequestering carbon by reforestation. *Curr Sci* 65:378–380, Bangalore
- Hawando T (1997) Desertification in Ethiopian highlands, RALA report no. 200. Norwegian Church AID, Addis Ababa
- Heilman P, Norby RJ (1998) Nutrient cycling and fertility management in temperate short rotation forest systems. *Biomass Bioenerg* 14:361–370
- Huang J, Wang X, Yan E (2007) Leaf nutrient concentration, nutrient resorption and litter decomposition in an evergreen broad-leaved forest in eastern China. *For Ecol Manage* 239:150–158
- Hurni H (1988) Degradation and conservation of the resources in the Ethiopian highlands. *Mt Res Dev* 8:123–130
- Jamaludheen V, Kumar BM (1999) Litter of multipurpose trees in Kerala, India: variations in the amount, quality, decay rates and release of nutrients. *For Ecol Manage* 115:1–11
- Johnson DL, Lewis LA (1995) Land degradation: creation and destruction. Blackwell, Cambridge
- Lal R (2002) Soil carbon dynamics in cropland and rangeland. *Environ Pollut* 116:353–362
- Lal R (2005) Forest soils and carbon sequestration. *For Ecol Manage* 220:242–258
- Lemenih M, Itanna F (2004) Soil carbon stocks and turnovers in various vegetation types and arable lands along an elevation gradient in southern Ethiopia. *Geoderma* 123:177–188
- Lian Y, Zhang Q (1998) Conversion of a natural broad-leaved evergreen forest into pure and mixed plantation forests in a subtropical area: effects on nutrient cycling. *Can J For Res* 28:1518–1529
- Mann LK (1986) Changes in soil carbon storage after cultivation. *Soil Sci* 142:279
- Mekonnen A (1999) Rural household biomass fuel production and consumption in Ethiopia: a case study. *J For Econ* 5:69–97
- Ministry of National Resources Development and Environmental Protection (1994) Ethiopian forestry action plan, vols 1 and 2. Addis Ababa



- Oades JM (1988) The retention of organic matter in soils. *Biogeochemistry* 5:35–70
- Oldeman LR (1988) Global assessment of soil degradation. Guidelines for general assessment of status of human-induced soil degradation. International Soil Reference and Information Center, Wageningen
- Olson JS (1963) Energy storage and the balance of producers and decomposers in ecological systems. *Ecology* 44:322–331
- Ovington JD, Heitkamp D (1960) The accumulation of energy in forest plantations in Britain. *J Ecol* 48:639–646
- Parrotta JA (1999) Productivity, nutrient cycling, and succession in single-and mixed-species plantations of *Casuarina equisetifolia*, *Eucalyptus robusta*, and *Leucaena leucocephala* in Puerto Rico. *For Ecol Manage* 124:45–77
- Percival HJ, Parfitt RL, Scott NA (2000) Factors controlling soil carbon levels in New Zealand grasslands: is clay content important? *Soil Sci Soc Am J* 64:1623
- Pohjonen V, Pukkala T (1990) *Eucalyptus globulus* in Ethiopian forestry. *For Ecol Manage* 36:19–31
- Post WM, Kwon KC (2000) Soil carbon sequestration and land-use change: processes and potential. *Glob Chang Biol* 6:317–327
- Post WM, Mann LK (1990) Changes in soil organic carbon and nitrogen as a result of cultivation. In: Bouwman AF (ed) *Soils and the greenhouse effect*. Wiley, New York, pp 401–406
- Ribeiro C, Madeira M, Arajo MC (2002) Decomposition and nutrient release from leaf litter of *Eucalyptus globulus* grown under different water and nutrient regimes. *For Ecol Manage* 171:31–41
- Russell AE, Cambardella CA, Ewel JJ, Parkin TB (2004) Species, rotation, and life-form diversity effects on soil carbon in experimental tropical ecosystems. *Ecol Appl* 14:47–60
- Schjønning P, Thomsen IK, Mberg JP, de Jonge H, Kristensen K, Christensen BT (1999) Turnover of organic matter in differently textured soils I. Physical characteristics of structurally disturbed and intact soils. *Geoderma* 89:177–198
- Six J, Elliott ET, Paustian K (2000) Soil macroaggregate turnover and microaggregate formation: a mechanism for C sequestration under no-tillage agriculture. *Soil Biol Biochem* 32:2099–2103
- Solomon D, Fritzsche F, Tekalign M, Lehmann J, Zech W (2002) Soil organic matter composition in the subhumid Ethiopian highlands as influenced by deforestation and agricultural management 1415. *Soil Sci Soc Am J* 66:68–82
- Songwe NC, Okali DUU, Fasehun FE (1995) Litter decomposition and nutrient release in a tropical rainforest, Southern Bakundu Forest Reserve, Cameroon. *J Trop Ecol* 11:333–350
- Sundarapandian SM, Swamy PS (1999) Litter production and leaf-litter decomposition of selected tree species in tropical forests at Kodayar in the Western Ghats, India. *For Ecol Manage* 123:231–244
- Tilahun S, Edwards S, Egziabher TBG (eds) (1996) Important bird areas of Ethiopia. Ethiopian Wildlife and Natural History Society. Semayata Press, Addis Ababa
- Tolera M, Asfaw Z, Lemenih M, Karlton E (2008) Woody species diversity in a changing landscape in the south-central highlands of Ethiopia. *Agric Ecosyst Environ* 128:52–58
- Turner IM, Corlett T (1996) The conservation value of small, isolated fragments of lowland tropical rain forest. *Trends Ecol Evol* 11:330–333
- Vagen TG, Lal R, Singh BR (2005) Soil carbon sequestration in sub-Saharan Africa: a review. *Land Degrad Dev* 16:53–71
- Van Veen JA, Kuikman PJ (1990) Soil structural aspects of decomposition of organic matter by micro-organisms. *Biogeochemistry* 11:213–233
- Vesterdal L, Ritter E, Gundersen P (2002) Change in soil organic carbon following afforestation of former arable land. *For Ecol Manage* 169:137–147
- Vlek PLG (2008) The incipient threat of land degradation. *J Indian Soc Soil Sci* 56:1–13
- Wang Q, Wang S, Huang Y (2007) Comparisons of litterfall, litter decomposition and nutrient return in a monoculture *Cunninghamia lanceolata* and a mixed stand in southern China. *For Ecol Manage* 255:1210–1218

- Wassie A, Teketay D, Powell N (2003) Ethiopian church forests opportunities and challenges for restoration. PhD thesis, Wageningen University, Wageningen. ISBN: 978-90-8504-768-1
- Yang YS, Guo JF, Chen GS, Xie JS, Cai LP, Lin P (2004) Litterfall, nutrient return, and leaf-litter decomposition in four plantations compared with a natural forest in subtropical China. *Ann For Sci* 61:465–476
- Yirdaw E (2002) Restoration of the native woody-species diversity, using plantation species as foster trees, in the degraded highlands of Ethiopia. PhD thesis, University of Helsinki, Helsinki
- Zunino H, Borie F, Aguilera S, Martin JP, Haider K (1982) Decomposition of <sup>14</sup>C-labeled glucose, plant and microbial products and phenols in volcanic ash-derived soils of Chile. *Soil Biol Biochem* 14:37–43

## Chapter 4

# Land Use Impact on Soil Organic Carbon and Total Nitrogen Storage in a Typical Dry Land District in Tigray, Northern Ethiopia

Aweke M. Gelaw, Bal Ram Singh, and Rattan Lal

**Abstract** Soil serves to store and cycle soil organic carbon (SOC) and total nitrogen (TN), which are essential for functioning terrestrial ecosystems. We measured soil organic carbon (SOC) and total nitrogen (TN) concentrations and stocks in three soil depths (0–15, 15–30, and 30–50 cm) for four different land uses, namely, rainfed cultivation (RF), agroforestry (AF), open pasture (OP), and silvopasture (SP), with five replications within a watershed in Ethiopia. OP land use showed higher SOC concentration in the 0–15 cm layer. The highest SOC concentration ( $12.6 \text{ g kg}^{-1}$ ) in 0–15 cm depth was found in OP land use system. Except for SP ( $8.6 \text{ g kg}^{-1}$ ), it was significantly higher ( $p < 0.001$ ) than those in other land use systems. The concentration of TN across land uses in different depths followed a trend similar to that of SOC. Thus, the highest TN concentration in 0–15 cm layer in OP ( $1.1 \text{ g kg}^{-1}$ ) was significantly higher ( $p < 0.01$ ) than that in RF land use. OP also had significantly higher ( $P < 0.05$ ) SOC and TN stocks in the 0–50 cm depth than those in RF. The results of this study suggest that conversion of RF into grass and tree-based land uses has large technical potential for SOC and TN sequestration.

**Keywords** Soil organic carbon • Total nitrogen • Carbon sequestration • Land use • Ethiopia

---

A.M. Gelaw (✉) • B.R. Singh  
Department of Environmental Sciences, Norwegian University of Life Sciences,  
P.O. Box: 5003, No-1432 Ås, Norway  
e-mail: [aweke.gelaw@nmbu.no](mailto:aweke.gelaw@nmbu.no); [awekegelaw@gmail.com](mailto:awekegelaw@gmail.com); [aweke.gelaw@umb.no](mailto:aweke.gelaw@umb.no)

R. Lal  
Carbon Management and Sequestration Center, Ohio State University OARDC,  
2021 Coffey Road, Columbus, OH 43210, USA

## 4.1 Introduction

Climate change has the potential to modify existing ecosystem functions in diverse ways, including both the enhancement and reduction of crop yields and production. These impacts are potentially profound in the areas of the world that are the most vulnerable. Sub-Saharan Africa contains some of these vulnerable systems (Vagen et al. 2005; Tieszen et al. 2004). Africa's major role in the global carbon cycle can be attributed to the substantial release of carbon associated with land use conversions from forest or woodlands to agriculture (Smith 2008). Land management following conversion also impacts carbon status, soil fertility, and agricultural sustainability (Ringius 2002; Tieszen et al. 2004; Lal 2006). Soils often continue to lose carbon following land conversion to agriculture (Woomer et al. 2004; Tschakert et al. 2004; Liu et al. 2004). Further, carbon in soil is closely coupled to soil nitrogen and the continued mining of soil for crops or fuel without replenishment of nutrients results in decreased productivity and impacts food security (Lal 2004). However, carbon and nitrogen stocks can be replenished with combinations of residue retention, manure addition, nitrogen fertilization, agroforestry, and conservation practices (Lal 2006).

Several decades of massive deforestation of natural forests and extensive use of agricultural lands in Ethiopia have resulted in soil and environmental degradation (Ashagrie et al. 2005). In Tigray (northern Ethiopia) large parts of the area were once covered with acacia woodland (*Acacia etbaica* (Sch.) and *Faiderbhia albida* (Del.)) (Eweg et al. 1998). The early 1960s marked the disappearance of much woodland under pressure from the rapidly growing population (Eweg et al. 1998). Nowadays, farmers selectively take care of naturally growing *F. albida* trees in and around their farms and grazing lands in order to improve soil fertility and increase crop and pasture yields (Hadgu et al. 2009; Gelaw et al. 2013). Communal grazing lands are important land use systems in the region, as livestock is a vital source of livelihoods for poor farmers. Conversion of cropland to grassland is one of the most effective strategies for carbon sequestration (Lal et al. 1999; Smith et al. 2000). Soil retention of soil organic carbon (SOC) and total nitrogen (TN) can be characterized by short-term storage in macroaggregates or by long-term sequestration in microaggregates.

Land use type affects amount and quality of litter input, their rates of decomposition and processes of organic matter stabilization in soils (Römken et al. 1999). The role of land use in stabilizing CO<sub>2</sub> levels and increasing carbon (C) sink potentials of soils has attracted considerable scientific attention in the recent past (Kumar and Nair 2011; Murthy et al. 2013). In Ethiopia, very few studies have been conducted on SOC and TN storage capacities of soils with different land uses. Therefore, the principal objective of this study was to assess the effects of different land uses on soil organic carbon (SOC) and total nitrogen (TN) retention potentials of soils. In doing so, we determined the SOC and TN concentrations and stocks in soils under four different land uses, rainfed cultivation (RF), agroforestry (AF), open pasture (OP), and silvopasture (SP).

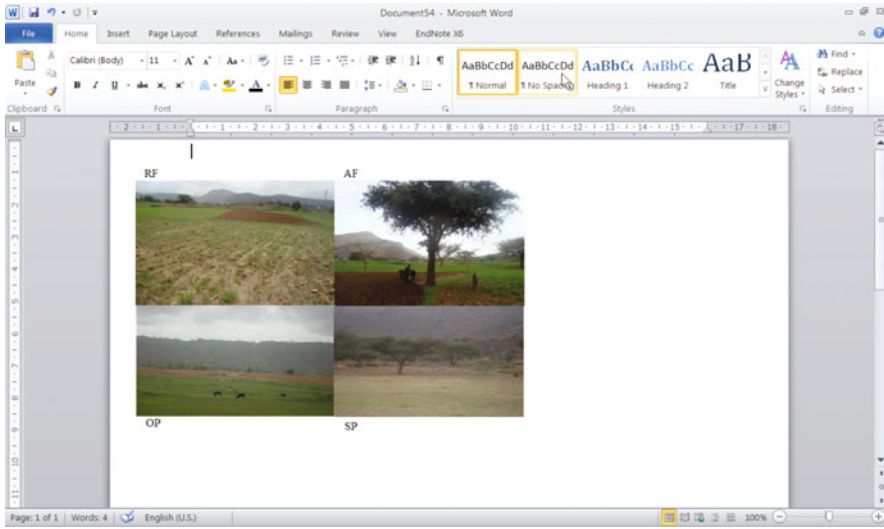
## 4.2 Materials and Methods

The study was conducted in the *Abraha-Atsbaha* district in eastern Tigray, northern Ethiopia. Geographically, it is located between 15°26'00 N to 15°32'00 N latitude and 55°00'00 E to 55°60'00 E longitude. The study covered an area of about 10 km<sup>2</sup> and is found at an elevation of 1960–2000 M.A.S.L. The average daily air temperature of the area ranges from around 15°C in winter to 30°C in summer. The mean annual rainfall of for this region is 558 mm, but the inter-annual variation is substantial. Soils in the watershed are classified as Arenosols and an association of Arenosols with Regosols, according to the World Reference Base for soil resources (WRB 2006). These soils developed from alluvial deposits and Adigrat sandstones. The texture of these soils are dominated by sand, loamy sand, and sandy loam fractions, and their pH ranges from 6.8 to 7.9 (Rabia et al. 2013). Major land uses in the watershed include *F. albida* based agroforestry (27.7 ha), rainfed crop production (11.9 ha), open pasture (23.2 ha), and *F. albida*-based silvopasture (11.7 ha). The most commonly practiced agricultural rotation in the agroforestry and rainfed cultivation land use systems is maize (*Zea mays*)-teff (*Eragrostis tef*)-field beans (*Vicia faba*)-finger millet (*Eleusine coracana*). Fallow is not practiced in the area due to population pressure and scarcity of farmlands. Use of chemical fertilizers is minimal and land is prepared for cultivation by using a wooden plow with oxen. Crop residues and manures are used for animal feed and fuel respectively. No pesticides and other agricultural chemicals are used in the area.

*Faidherbia albida* trees in and around farmlands and grazing lands are remnants from the original woodland in the region. These trees are selectively left by farmers to improve soil fertility and increase crop and pasture yields (Hadgu et al. 2009). Grazing lands/open pastures and silvopastures are commonly owned and managed by communities (Fig. 4.1). Trees are integrated into the pasture systems (silvopastures) on the peripheral marginal areas where soil fertility levels are estimated to be low, based on performance of grazing lands as perceived by farmers (personal communication with farmers). No external inputs such as fertilizer are used and no rotational grazing or other kinds of management are practiced in both the open pasture and silvopasture systems. However, grazing pressure will be higher in these systems only during cropping seasons which are from June to October. Otherwise animals graze freely all over the different land use systems. Mixed crop-livestock smallholder farming is a typical farming system of the region.

### 4.2.1 Soil Sampling and Analysis

A total of 60 composite soil samples were collected for SOC and TN measurements in three soil depths (0–15, 15–30, and 30–50 cm). Soil samples within each replicate were collected randomly from eight points within a 64 m<sup>2</sup> area at each sampling site/replicate and were well mixed and combined into a composite sample



**Fig. 4.1** Different land use systems in the district with tree-less rainfed crop production (RF), *F. albida* based agroforestry (AF), open communal grazing/pasture land (OP) and *F. albida* based silvopasture (SP)

by depth. Thus, a minimum of 40 point samples were represented in computing the average values of each soil parameter. Samples were air-dried, gently ground, and passed through a 2 mm sieve. Identifiable crop residues, root material, and stones were removed during sieving. Soil samples for carbon (C) and nitrogen (N) analyses were also pulverized using a ball-mill grinder.

Finally, SOC and TN (% w/w) concentrations in composite samples were determined by the dry combustion method (Nelson and Sommers 1996). Soil bulk density ( $\rho_b$ ) samples were taken for the same depth intervals as other soil samples for each replicate/plot using the core method (Blake and Hartge 1986). Core samples were collected from all depth intervals using 100 cm<sup>3</sup> volume stainless steel tubes (5 cm diameter and 5.1 cm height). The initial weight of soil core from each layer was measured in the laboratory immediately after collection. Simultaneously, soil moisture content was determined gravimetrically by oven drying the whole soil at 105°C for 24 h to calculate the dry  $\rho_b$ . No adjustment was made for rock volume because it was rather minimal. Soil  $\rho_b$  value was used to calculate the SOC and TN stocks (Mg ha<sup>-1</sup>) using the model by Ellert and Bettany (1995):

$$\text{SOC (or TN) Stock} = \text{Conc.} \cdot \rho_b \cdot T \cdot 10,000 \text{ m}^2 \text{ ha}^{-2} \cdot 0.001 \text{ Mg kg}^{-1}$$

where, SOC (or TN) stock = soil organic carbon or total nitrogen stock (Mg ha<sup>-1</sup>); Conc. = soil organic carbon or total nitrogen concentration (kg Mg<sup>-1</sup>);  $\rho_b$  = dry bulk density (Mg m<sup>-3</sup>), and T = thickness of soil layer (m).

The SOC (or TN) stock in the 50 cm depth for each land use was calculated by summing SOC (or TN) stocks in the 0–15, 15–30 and 30–50 cm depth intervals.

Accumulation of SOC (or TN) stock in the same soil depth (50 cm) for each land use was estimated by calculating the difference in SOC (or TN) stock between each one of the three land uses (AF, OP, and SP) and the control (RF) land use. Rate of accumulation of SOC (or TN) stock for 0–50 cm layer for each of the three land uses (AF, OP, and SP) was estimated by dividing accumulation values by the assumed duration of each land use (Puget and Lal 2005). Based on the survey of farmers conducted, an average duration of 50 years was taken as the age for OP, AF, and SP land use adoption since the early 1960s (Eweg et al. 1998).

### **4.2.2 Statistical Analysis**

The effects of different land use systems on SOC, TN, and WSA were subjected to one-way ANOVA. Differences between means of treatments were considered significant at  $p < 0.05$  in the Tukey studentized (HSD) test. The statistical analysis system (SAS) software package was used for statistical analyses (SAS 2007).

## **4.3 Results and Discussion**

### **4.3.1 Effects of Land Use on Soil Organic Carbon and Total Nitrogen Concentrations**

The highest SOC ( $12.6 \text{ g kg}^{-1}$ ) concentration in the 0–15 cm layer was measured in the OP land use system, and, except for SP, it was significantly higher ( $P < 0.001$ ) than that in other land use systems (Table 4.1). OP land use system also showed the highest TN concentration in the 0–15 cm layer, but it was significantly higher ( $P < 0.01$ ) than that in the RF land use system (Table 4.1). Furthermore, SOC and TN concentrations in the 0–50 cm were significantly higher ( $P < 0.05$ ) in OP than in RF. However, SOC and TN concentrations in 15–30 and 30–50 cm layers did not differ among land uses. These results indicated that SOC and TN concentrations in soils of the region can be increased by converting arable lands to grasslands and silvopastures or adopting no-till and reduced tillage practices, which is called conservation tillage. These conclusions are also in agreement with Lal (2002) who observed that with other factors remaining the same, grazing land soils have more SOC than cropland soils because of (1) low soil disturbance due to lack of plowing, (2) more root biomass and residue returned, and (3) return of cattle dung and manure. Moreover, concentrations of SOC and TN in AF were slightly higher than those in RF, indicating that the adoption of agroforestry systems could enhance SOC and TN concentrations. With adequate management of trees in arable and grazing lands, a significant fraction of the atmospheric  $\text{CO}_2$  could be captured and stored both in plant biomass and soils (Albrecht and Kandji 2003).

**Table 4.1** Soil Organic Carbon (SOC) and Total Nitrogen (TN) concentrations across different land uses

Land use	Soil organic carbon concentration (g kg <sup>-1</sup> )				Total nitrogen concentration (g kg <sup>-1</sup> )			
	0–15 cm	15–30 cm	30–50 cm	0–50 cm	0–15 cm	15–30 cm	30–50 cm	0–50 cm
RF	3.2(0.7) <sup>c</sup>	3.9(0.4)	4.1(0.4)	11.2(1.4) <sup>b</sup>	0.3(0.10) <sup>b</sup>	0.4(0.03)	0.4(0.01)	1.1(0.10) <sup>b</sup>
AF	6.4(0.3) <sup>bc</sup>	4.8(0.3)	3.8(0.3)	15.0(0.6) <sup>b</sup>	0.7(0.02) <sup>ab</sup>	0.5(0.03)	0.4(0.02)	1.6(0.06) <sup>ab</sup>
OP	12.6(1.2) <sup>a</sup>	8.8(2.7)	6.3(1.9)	27.7(5.2) <sup>a</sup>	1.1(0.14) <sup>a</sup>	0.9(0.3)	0.6(0.2)	2.6(0.6) <sup>a</sup>
SP	8.6(2.0) <sup>ab</sup>	6.6(2.3)	5.2(2.1)	20.5(6.3) <sup>ab</sup>	0.8(0.2) <sup>ab</sup>	0.5(0.2)	0.3(0.2)	1.6(0.6) <sup>ab</sup>
		NS	NS			NS	NS	

RF Dryland crop production, AF *Faidherbia albida* based agroforestry, OP communal open grazing/pasture, SP *Faidherbia albida* based silvopasture

±Column mean values followed by standard errors in the parentheses; values with different letters are significantly different. NS not significant (Tukey's test, P = 0.05)



Relatively higher concentrations of SOC and TN were measured in upper soil layers than in lower ones in all land uses except in RF (control), which was uniformly low across depths except a sign of slight increase with depth (Table 4.1) because of the tillage effect. Tillage practices can alter the depth distribution of SOC due to mixing (Beare et al. 1997; Chen et al. 2009). This agrees with the results of Trujillo et al. (1997), who observed that SOC generally diminishes with depth regardless of vegetation, soil texture, and clay size fraction. Haile et al. (2008) also observed a declining trend in SOC concentration with depth in silvopastoral systems in Florida. Higher concentrations of SOC and TN in upper soil layers in OP and SP land uses indicated there is a risk of a release of large amounts of CO<sub>2</sub> from the surface soil when these land uses are converted into an arable land use.

### ***4.3.2 Amount and Rates of Soil Organic Carbon and Total Nitrogen Accumulation Under Different Land Uses***

Total SOC stock in 0–50 cm depth under OP (64.2 Mg ha<sup>-1</sup>) was significantly higher ( $P < 0.05$ ) than that in RF (29.4 Mg ha<sup>-1</sup>). However, it did not differ from other land uses (Table 4.2). Similarly, TN stock in the same depth under OP land use (6.0 Mg ha<sup>-1</sup>) was significantly higher ( $P < 0.05$ ) than that in RF (2.8 Mg ha<sup>-1</sup>) land use. No significant difference in total TN stock was observed among other land uses (Table 4.2). The results were in agreement with the findings of Mekuria et al. (2009) who reported 36–50 % increase in mean SOC stock through conversion of degraded grazing lands to exclosures, areas closed from human and animal interference to promote natural regeneration of plants on formerly degraded communal grazing lands, in Tigray, Northern Ethiopia. Similarly, Omonode and Vyn (2006) reported higher TN and SOC stocks in grasslands than croplands in west-central Indiana, USA. Mclauchlan et al. (2006) also reported similar results, when agricultural lands of the northern Great Plains depleted in soil organic matter (SOM) by decades of cultivation were changed to grasslands through federal conservation programs.

Among the three grass- and tree-based land use systems (OP, SP, and AF), OP accumulated the highest SOC stock (34.8 Mg ha<sup>-1</sup>) followed by SP (20.0 Mg ha<sup>-1</sup>), and AF (7.2 Mg ha<sup>-1</sup>) land uses (Table 4.2). Similarly, the highest accumulation of TN stock was measured in OP (3.2 Mg ha<sup>-1</sup>) followed by those in AF (1.1 Mg ha<sup>-1</sup>) and SP (1.0 Mg ha<sup>-1</sup>) land uses. However, there were no statistically significant differences in SOC and TN stock accumulations among land uses (Table 4.2). Compared with open (treeless) pasture systems, silvopastoral agroforestry systems that integrate trees in to pasture production are likely to enhance SOC sequestration, especially in deeper soil layers (Haile et al. 2008). However, the results of the present study indicated that OP land use had higher SOC accumulation rates than the SP systems because those trees were integrated into the pasture system in the peripheral areas where fertility of the soil was low. These results are also in agreement with the findings of Puget and Lal (2005), who observed that pasture soil had more SOC stock than that in forest soils in the top layer of Mollisols in central Ohio, reflecting the larger grass root density in the layer.

**Table 4.2** Magnitude and rates of soil organic carbon and total nitrogen stocks accumulation in four different land uses in 0–50 cm depth in 50 years

Land use	SOC stock (Mg C ha <sup>-1</sup> )	SOC accumulation (Stock-RF) (Mg C ha <sup>-1</sup> )	Rate of SOC accumulation (Mg C ha <sup>-1</sup> year <sup>-1</sup> )	TN stock (Mg C ha <sup>-1</sup> )	TN accumulation (Stock-RF) (Mg C ha <sup>-1</sup> )	Rate of TN accumulation (Mg C ha <sup>-1</sup> year <sup>-1</sup> )
RF	29.4(3.5) <sup>b</sup>	–	–	2.8(0.2) <sup>b</sup>	–	–
AF	36.6(1.5) <sup>ab</sup>	7.2(4.7)	0.14(0.1)	3.9(0.2) <sup>ab</sup>	1.1(0.2)	0.02(0.00)
OP	64.2(11.8) <sup>a</sup>	34.8(11.0)	0.70(0.2)	6.0(1.5) <sup>a</sup>	3.2(1.4)	0.07(0.03)
SP	49.4(14.9) <sup>ab</sup>	20.0(14.0)	0.40(0.3)	3.8(1.3) <sup>ab</sup>	1.0(0.6)	0.02(0.03)
		NS	NS		NS	NS

RF Dryland crop production, AF *Faidherbia albida* based agroforestry, OP communal open grazing/pasture, SP *Faidherbia albida* based silvopasture

±Column mean values followed by standard errors in the parentheses; values with different letters are significantly different. NS not significant (Tukey's test, P = 0.05)

The highest rate of SOC stock accumulation was measured in OP land use ( $0.70 \text{ Mg C ha}^{-1} \text{ year}^{-1}$ ) followed by SP ( $0.40 \text{ Mg C ha}^{-1} \text{ year}^{-1}$ ). The lowest rate of SOC stock accumulation was measured in AF ( $0.14 \text{ Mg C ha}^{-1} \text{ year}^{-1}$ ) land use (Table 4.2). However, the effect of land use change on rate of SOC stock accumulation did not statistically differ among land uses (Table 4.2). Similarly, the highest rate of TN stock accumulation was also measured in OP land use ( $0.07 \text{ Mg N ha}^{-1} \text{ year}^{-1}$ ) followed by SP ( $0.02 \text{ Mg N ha}^{-1} \text{ year}^{-1}$ ) and AF ( $0.02 \text{ Mg N ha}^{-1} \text{ year}^{-1}$ ) land uses. However, no significant difference was observed in the rate of TN stock accumulation among land uses. The result of this study was comparable to the findings of Girmay et al. (2008). They estimated rates of soil carbon sequestration (SCS) potential in currently degraded soils in Ethiopia under rangeland, irrigation, and rain fed cropping land uses over the next 50 years if there is widespread adoption of soil-specific restoration measures in the order: 0.3–0.5, 0.06–0.2, and 0.06–0.15  $\text{Mg C ha}^{-1} \text{ year}^{-1}$ , respectively. On the other hand, the higher amounts of SOC stocks in soils under grasslands and silvopastures indicates a risk of large amounts of  $\text{CO}_2$  release if these land uses are converted to croplands. In agreement with this assertion, Fantaw et al. (2006) in their study on southeastern Ethiopia, indicated that on average 40–45 % of SOC stock in 1 m depth of mineral soils was held in the top 30 cm, indicating the risks of large amounts of  $\text{CO}_2$  release following deforestation and conversion into Agroecosystems.

## 4.4 Conclusion

Higher SOC and TN concentrations were measured in the top layers of soils under grass- and tree-based land use systems, OP, and SP. Furthermore, soils under these land use systems had higher SOC stocks and accumulations than that in RF in the 0–50 cm depth. This is an indication of that both OP and SP land use systems received more biomass inputs from grass and tree residues than the cultivated soils under AF and RF, as the amount of plant residues and the degree of SOM decomposition are vital factors in the formation and stabilization of organo-mineral complexes, which are called aggregates. Thus, the adoption of tree- and grass-based and other restorative land uses such as no-till farming and other recommended less intensive cultivation practices can result in carbon accumulation, stabilization, and sustainable use of soil resources in the region.

**Acknowledgements** Some laboratory facilities were provided by Mekelle University, Ethiopia. Practical laboratory work (soil particle fractionation and associated soil carbon C and N determinations) were done at the laboratory facility at the Carbon Management and Sequestration Center (C-MASC), Ohio State University (OSU), Columbus, Ohio, USA. Financial assistance from the Norwegian State Education Loan Fund for the first author is gratefully acknowledged. Last but not least, the anonymous reviewers are appreciated for their constructive comments.

## References

- Albrecht A, Kandji ST (2003) Carbon sequestration in tropical agroforestry systems: a review. *Agric Ecosyst Environ* 99:15–27
- Ashagrie Y, Zech W, Guggenberger G (2005) Transformation of a *Podocarpus falcatus* dominated natural forest into a monoculture *Eucalyptus globulus* plantation at Munesa, Ethiopia: soil organic C, N and S dynamics in primary particle and aggregate-size fractions. *Agric Ecosyst Environ* 106:89–98
- Beare MH, Hus S, Coleman DC, Hendrix RF (1997) Influences of mycelia fungi on aggregation and organic matter storage in conventional and no-tillage soils. *Appl Soil Ecol* 5:211–219
- Blake GR, Hartge KH (1986) Bulk density. In: Klute A (ed) *Methods of soil analysis. Part 1*, 2nd edn. American Society of Agronomy: Soil Science Society of America, Madison, pp 363–375
- Chen H, Marhan S, Billen N, Stahl K (2009) Soil organic carbon and total nitrogen stocks as affected by different land uses in Baden-Württemberg (southwest Germany). *J Plant Nutr Soil Sci* 172:32–42
- Ellert BH, Bettany ET (1995) Calculation of organic matter and nutrients stored in soils under contrasting management regimes. *Can J Soil Sci* 75:529–538
- Eweg HPA, van Lammeren R, Deurloo H, Woldu Z (1998) Analyzing degradation and rehabilitation for sustainable land management in the highlands of Ethiopia. *Land Degrad Dev* 9:529–542
- Fantaw Y, Ledin S, Abdu A (2006) Soil organic carbon and total nitrogen stocks as affected by topographic aspect and vegetation in the Bale Mountains, Ethiopia. *Geoderma* 135:335–344
- Gelaw AM, Singh BR, Lal R (2013) Organic carbon and nitrogen associated with soil aggregates and particle sizes under different land uses in Tigray, Northern Ethiopia. *Land Degrad Dev*. doi:10.1002/ldr.2261
- Girmay G, Singh BR, Mitiku H, Borresen T, Lal R (2008) Carbon stocks in Ethiopian soils in relation to land use and soil management. *Land Degrad Dev* 19:351–367
- Hadgu KM, Kooistra L, Rossing WAH, van Bruggen AH (2009) Assessing the effect of *Faidherbia albida* based land use systems on barley yield at field and regional scale in the highlands of Tigray, northern Ethiopia. *J Food Security* 1:337–350
- Haile GS, Nair PKR, Nair VD (2008) Carbon storage of different soil-size fractions in Florida silvopastoral systems. *J Environ Qual* 37:1789–1797
- Kumar BM, Nair PKR (2011) Carbon sequestration potential of agroforestry systems: opportunities and challenges. Springer, Dordrecht, The Netherlands, p 307
- Lal R (2002) Soil carbon dynamics in croplands and rangelands. *J Environ Pollut* 116:353–362
- Lal R (2004) Soil carbon sequestration impacts on global climate change and food security. *Science* 304:1623–1627
- Lal R (2006) Enhancing crop yields in the developing countries through restoration of the soil organic carbon pool in agricultural lands. *Land Degrad Dev* 17:197–209
- Lal R, Follett RF, Kimble JM, Cole CV (1999) Managing US crop land to sequester carbon in soil. *J Soil Water Conserv* 54:374–381
- Liu S, Kaire M, Wood E, Diallo O, Tieszen LL (2004) Impacts of land use and climate change on carbon dynamics in south-central Senegal. *J Arid Environ* 59:583–604
- Mclauchlan KK, Hobbie SE, Post WM (2006) Conversion from agriculture to grassland builds soil organic matter on decadal timescales. *Ecol Appl* 16:143–153
- Mekuria W, Veldkamp E, Haile M (2009) Carbon stock changes with relation to land use conversion in the lowlands of Tigray, Ethiopia. A paper presented at a conference on international research on food security, Natural Resource Management and Rural Development, University of Hamburg, 6–8 Oct 2009
- Murthy IK, Gupta M, Tomar S, Munsu M, Tiwari R, Hegde GT, Ravindranath NH (2013) Carbon sequestration potential of agroforestry systems in India. *J Earth Sci Clim Change*. <http://dx.doi.org/10.4172/2157-7617.1000131>. Accessed 28 Jan 2014

- Nelson DW, Sommers LE (1996) Total carbon, organic carbon and organic matter laboratory methods. In: Sparks DL et al (eds) *Methods of soil analysis, part 3*, SSSA book series 5. Soil Science Society of America: American Society of Agronomy, Madison, WI, USA, pp 961–1010
- Omonode RA, Vyn TJ (2006) Vertical distribution of soil organic carbon and nitrogen under warm-season native grasses relative to croplands in west-central Indiana, USA. *Agric Ecosyst Environ* 117:159–170
- Puget P, Lal R (2005) Soil organic carbon and nitrogen in a Mollisol in Central Ohio as affected by tillage and land use. *Soil Tillage Res* 80:201–213
- Rabia AH, Afifi RR, Gelaw AM et al (2013) Soil mapping and classification: a case study in the Tigray Region, Ethiopia. *J Agric Environ Int Dev* 7:7–99
- Ringius L (2002) Soil carbon sequestration and the CDM: opportunities and challenges for Africa. *Clim Change* 54:471–495
- Römken PF, van der Plicht J, Hassink J (1999) Soil organic matter dynamics after the conversion of arable land to pasture. *Biol Fertil Soils* 28:277–284
- SAS (2007) SAS system for Windows, version 9.2. SAS Institute Inc., Cary
- Smith P (2008) Soil organic carbon dynamics. In: Braimoh AK, Vick PLG (eds) *Land use and soil resources*. Springer, Dordrecht
- Smith P, Powlson DS, Smith JU, Falloon P, Coleman K (2000) Meeting Europe's climate change commitments: quantitative estimates of the potential for carbon mitigation by agriculture. *Glob Chang Biol* 6:525–539
- Tieszen LL, Tappan GG, Toure A (2004) Sequestration of carbon in soil organic matter in Senegal – an overview. *J Arid Environ* 59:409–425
- Trujillo W, Amezcua E, Fisher MJ, Lal R (1997) Soil organic carbon dynamics and land use in the Colombian Savannas: aggregate size distribution. In: Lal R, Kimble JM, Follett RF, Stewart BA (eds) *Soil processes and the carbon cycle*. CRC/Lewis Press, Boca Raton, pp 267–280
- Tschakert P, Khouma M, Sene M (2004) Biophysical potential for soil carbon sequestration in agricultural systems of the Old Peanut Basin of Senegal. *J Arid Environ* 3:511–533
- Vagen TG, Lal R, Singh BR (2005) Soil carbon sequestration in sub-Saharan Africa: a review. *Land Degrad Dev* 16:53–71
- Woomer PL, Tieszen LL, Tappan GG, Toure A, Sall M (2004) Land use change and terrestrial carbon stocks in Senegal. *J Arid Environ* 59:625–642
- WRB (2006) International Union of Soil Science working group, World soil resources reports no. 103. FAO, Rome

# Chapter 5

## Climate Risk Management Through Sustainable Land Management in Sub-Saharan Africa

Ephraim Nkonya, Frank Place, Edward Kato, and Majaliwa Mwanjololo

**Abstract** Empirical evidence has shown that farmers can adapt to climate change by using sustainable land and water management (SLWM) practices that provide local mitigation benefits, reducing or offsetting the negative effects of climate change at the level of the plot, the farm, or even the landscape. However, adaptation to climate change using SLWM practices in sub-Saharan Africa (SSA) remains low. This study was conducted to examine the impact of government policies on adaptation to climate change.

Kenya and Uganda in East Africa and Niger and Nigeria in West Africa were used as case studies. The selection ensured that the transboundary sites had comparable biophysical and livelihood characteristics and that the major difference between the sites across adjacent countries was the policies in each country. The study used a variety of data sources, including satellite imagery data, focus group discussions, and household- and plot-level survey data to determine how land users have responded to climate change and the effects of their responses on agricultural productivity, climate-related risks, and carbon stock.

Each of the four case study countries offers success stories that enhance adaptation strategies. While Kenya's policies have strongly supported agricultural research and development as well as an agricultural market environment that has offered incentives to farmers to adopt SLWM, neighboring Uganda has implemented government decentralization and a new land tenure policy, both of which have contributed to the rise of stronger local institutions that offer opportunities for improved community resource management. In West Africa, Nigeria has long supported irrigation development and recently focused on small-scale irrigation that has increased agricultural production and reduced production risks in the drier northern states. Even though such irrigation programs were not implemented

---

E. Nkonya (✉) • E. Kato  
International Food Policy Research Institute, Washington, DC, USA  
e-mail: [e.nkonya@cgiar.org](mailto:e.nkonya@cgiar.org)

F. Place  
World Agroforestry Center, Nairobi, Kenya

M. Mwanjololo  
Makerere University, Kampala, Uganda

as part of an adaptation to climate change, they have helped farmers to adapt well to climate change. Niger also offers a good example of tree planting and protection, which was successful due to a relaxation of the forest code and the passing of the Rural Code, which gave land users more rights to trees on their farms and thereby contributed to the greening of the Sahel. Hence, in all the countries, we see the influence of policies that have influenced the adoption of SLWM and the response to climate change in general, policies that show promise for scaling up.

Scaling up these success stories requires public investment to raise awareness and provide the technological support required for these often knowledge-intensive practices. The relative success of Kenya in promoting soil conservation and fertility measures suggests that large-scale extension programs can be effective but require long-term commitment, something that is absent in the common practice of project funding. The long-term extension project in Kenya was also supported by a large number of nongovernmental organizations (NGOs) active in land management. These organizations not only complement an extension program but also inject a degree of innovation that can lead to the generation of improved SLWM practices. Facilitating the linkages among all development organizations and with research organizations would serve to enhance the scaling-up process.

Some SLWM practices may require special attention. Specifically, irrigation is touted as an essential ingredient for increased productivity and for climate change adaptation in Africa by numerous organizations, including the New Partnership for Africa's Development (NEPAD). Irrigation faces many of the same challenges as other SLWM practices but given that irrigation development in SSA is the lowest in the world, there is greater need for capital investment (in water storage or distribution) to enhance more effective adaptation to climate change.

**Keywords** Climate change • Sustainable land and water management • Africa • Adaptation • Local institutions

## 5.1 Introduction

The dependence of poor farmers on rain-fed agriculture makes sub-Saharan Africa (SSA) economies the most vulnerable in the world to climatic changes (Barnichon and Peiris 2008; Conway and Waage 2010). There is significant evidence that both positive and negative effects of climate change have affected SSA agriculture. The positive effects include increased rainfall in the Sahel (the zone south of the Sahara desert), which has contributed to the greening of the region (Olsson et al. 2005) and increased rainfall in the Lake Victoria basin of East Africa (Christensen et al. 2007). However, global circulation models (GCMs) have predicted increases in temperature ranging from 0.7 to 1.5 °C by 2020 in both regions (Christensen et al. 2007). The severity and frequency of droughts, heat waves, and floods in most SSA countries are also expected to increase (Christensen et al. 2007; Cline 2007), resulting in significant effects on natural resources. These changes are not

uniformly distributed in any given region due to the diverse topographical features of the landscapes within each region.

An important policy question is the following: what can be done to enhance poor farmers' ability to adapt to and mitigate the local effects of climate change? Empirical evidence has shown that farmers can adapt to climate change by using sustainable land and water management (SLWM) practices that also provide local mitigation benefits, reducing or offsetting the negative effects of climate change at the level of the plot, the farm, or even the landscape (Smith et al. 2008; Cooper et al. 2009; Cooper and Coe 2011). However, there is limited evidence that farmers have used SLWM as an adaptation strategy. A study in Ethiopia found that 31 % of farmers adopted SLWM practices to address perceived changes in rainfall and only 4 % adopted water harvesting technologies (Yesuf et al. 2008). Benhin (2006) and Kabubo-Mariara and Karanja (2006) also found that farmers in South Africa and Kenya were using irrigation as an adaptation strategy. The low adoption of SLWM practices calls for action to design policies and strategies for increasing their adoption to take full advantage of their potential to adapt to climate change. This study was conducted with the broad objective of determining the effects of policies on farmer adaptation to climate change and to generate practical, context-specific recommendations for enhancing adaptation to climate change using SLWM. The study uses four countries—Kenya and Uganda in East Africa, and Niger and Nigeria in West Africa—as case studies. In the section below, we discuss the climate change in the two regions and the corresponding policies and strategies that the case study countries have taken to enhance mitigation of and adaptation to climate change.

## 5.2 Case Study Countries

The West African Sudano-Sahelian region and East Africa are priority regions for studying climate change and SLWM linkages because they are characterized by high levels of current climate variability and severe levels of land degradation. The risks of climate change differ between these regions. East Africa is strongly influenced by the El Niño Southern Oscillation (ENSO), and most GCMs predict that the climate in this region will become wetter, with increased risks of erosion and flooding (Christensen et al. 2007).

In contrast, the Sudano-Sahelian climate of West Africa is less predictable both interannually and in the long term, with some models predicting a wetter climate and some predicting a drier climate. In general, a more variable climate is expected. However, it is fairly certain that temperatures will increase throughout the region, and extreme weather events leading to droughts and flooding are predicted to increase (Boko et al. 2007). Information on the differing climate change patterns in the different agroecological and socioeconomic environments in the two regions can be used to inform current efforts.



### ***5.2.1 Current National, Regional, and International Efforts to Address the Negative Effects of Climate Change and Variability***

Each of the four case study countries has grappled with climatic shocks and long-term climate change and has designed various strategies to cope with and adapt to climate change. However, only Niger and Uganda have prepared a national action program for adaptation (NAPA). We discuss the strategies that each country has employed to promote adaptation to and mitigation of climate change.

#### **5.2.1.1 Kenya**

A number of floods, droughts, and other climate-induced catastrophes have induced a national debate on mitigation and adaptation and efforts to protect key water tower forest areas (for example, the Mau), and the Agriculture (Farm Forestry) Rules of 2009 stipulates that at least 10 % of farms should be planted with trees (Government of Kenya (GoK) 2009; Ng'endo et al. 2013).

In response to climate-induced catastrophes, Kenya established its National Disaster Operation Centre in 1998, and in 2009, the government drafted a new document, the National Policy for Disaster Management. The objective of the policy is to foster better planning and reaction to disasters and the implementation of programs to adapt to and mitigate climate change. In addition, Kenya formed a National Climate Change Secretariat housed in the Ministry of Environment. The secretariat has recently coordinated the development of the new National Climate Change Action Plan 2013–2017. These strategies and plans include all the relevant line ministries and the National Environmental Management Authority (NEMA), which manages several SLWM programs, including a forest and rangeland rehabilitation program. NEMA does not have a long-running program on climate change, but it does manage projects on climate change adaptation. Indeed, Kenya currently hosts numerous climate change adaptation research and development projects that focus on SLWM activities.

Kenya has invested significantly in promoting water harvesting and irrigation. Table 5.1 shows that nearly a third of the irrigable area has been irrigated. Among the four case study countries, Kenya's irrigated area as a share of the irrigable area is the largest. One of the reasons for this development is the large share of drylands in the country, which account for two-thirds of the country's land (Table 5.1). The development of high-value commercial agriculture in the country has also contributed significantly to the development of irrigation.

Kenya has long promoted important SLWM practices. A soil conservation program implemented through the extension system ran for about 20 years up through the 1990s and was deemed highly successful in terms of reach and adoption (Thompson and Pretty 1996). Compared with neighboring countries, Kenya's use of manure and mineral fertilizer is high. This is due to a number of factors,

**Table 5.1** Irrigation development in the case study countries

Country	Irrigated area (000 ha) <sup>a</sup>	Irrigated area as a % of irrigable land <sup>a</sup>	Value of irrigated output as a % of total output <sup>b</sup>	Drylands as a % of land area <sup>c</sup>
Kenya	103.203	29	9.5	68
Uganda	9.150	10	0.5	16
Niger	73.663	27	–	24
Nigeria	293.117	13	4.4	53

Sources: <sup>a</sup> Calculated from FAO (2007), <sup>b</sup> Bruinsma (2003), <sup>c</sup> WRI (2003)

Notes: Drylands include arid, semiarid, and dry subhumid areas (areas with aridity index of 0.05–0.65). Drylands exclude deserts (hyperarid areas with an aridity index of less than 0.05)

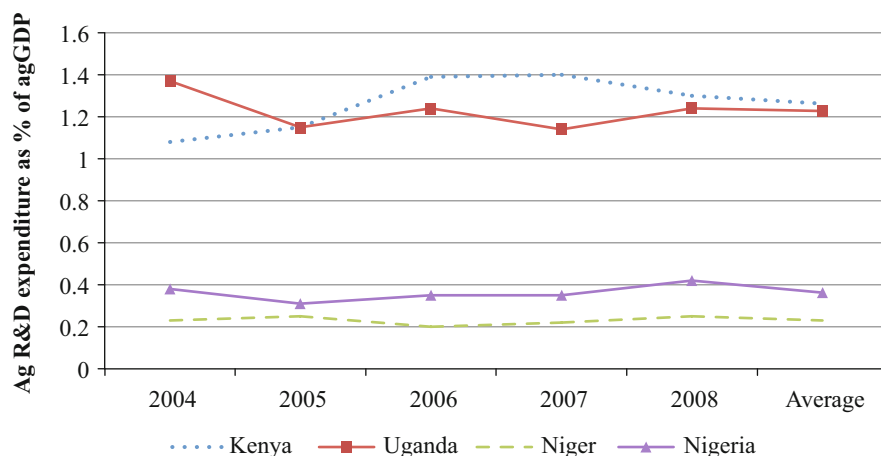
including the widespread production and marketing of high-value crops, the high adoption of intensive dairy farming and resulting manure availability (SDP 2006), significant extension efforts in fertilizer use, and efforts to improve efficiency in fertilizer value chains (Jayne et al. 2003). Similarly, tree planting campaigns on farms have been prolific in Kenya, perhaps best exemplified by the Green Belt Movement led by Nobel laureate Wangari Maathai and the recent law requiring farmers to plant trees on at least 10 % of their farm area (Ng'endo et al. 2013). The government has facilitated the efforts of its own extension staff and of many NGOs in terms of accessing tree germplasm and disseminating information. These successes are not uniform, however, and SLWM practices are more advanced in the areas with higher ecological and market potential, such as in central Kenya (Place et al. 2006).

Kenya has also invested significantly in agricultural research. The country is one of the eight countries that spent more than 1 % of its agricultural GDP on agricultural research and development (Fig. 5.1) and is one of the SSA “big eight countries”—i.e., countries that spent more than US\$50 million on R&D in 2008 (Beintema and Stads 2011). Kenya’s investment in agricultural R&D has been sustained for a long time, and this has led to Kenya having the highest adoption rate of improved seeds in SSA (Smale and Jayne 2008; Smale 2006). Additionally, Kenya has maintained a strong and steady growth of agricultural total factor productivity (TFP) since 1961. Kenya’s agricultural TFP increased by 78 % from 1961 to 2008, with an annual growth rate of 1.28 % (Fuglie and Rada 2012).<sup>1</sup>

One of the weaknesses in Kenya emanated from its centralized form of government. Due to the size and complexity of the central government, planning tended to be done in a highly sectoral manner. In 2013, however, a more decentralized government was operationalized with counties (formerly referred to as districts) controlling more programmatic allocations.<sup>2</sup> Among the aspects that changed was

<sup>1</sup> Only the following five other SSA countries experienced an annual TFP growth rate of exceeding one percent—with their annual TFP growth rates in parentheses: South Africa (1.63), Swaziland (1.8), Zambia (1.07), and Benin (1.01) (Fuglie and Rada 2011).

<sup>2</sup> Hereafter, we refer to the districts as stipulated in the old administrative structure.



**Fig. 5.1** Agricultural R&D expenditure as a percentage of the agricultural GDP of the selected countries (Source: Computed from Beintema and Stads 2011)

fiscal devolution, in which counties are given functional responsibility for managing at least 15 % of national revenues (Boex and Kelly 2011). However, there is still room for further improvement of the decentralization in Kenya. In addition, the number of ministries was reduced significantly, down to 18 ministries.<sup>3</sup> The management of natural resources such as land, water, and vegetation is a key area that suffered from the previous structure of government planning, and it is too early to tell whether the new structure will reduce fragmentation. Forest resource management was decentralized in 1983 when the “District Focus for Rural Development” system started and delegated most rural development management to local districts. However, policy making, planning, and funding decision making has remained centralized within the central government ministries (Coleman and Fleischman 2012). Agricultural objectives sometimes come into conflict with environmental objectives in terms of land use. There is conflicting advice on using irrigation from stream water and setting aside land near streams; on protecting indigenous trees and the planting of high-value exotic trees; and on protecting forested areas and finding land for the landless. There are good examples of integrated resource management at the landscape level, but they are often achieved through specific projects that have sufficient funding to create innovative governance mechanisms at the local level.

Kenya also ratified the United Nations Convention to Combat Desertification (UNCCD) in 1997 and prepared its national action plan (NAP) in 2002, in which the country planned to design policies and institutions for coordinating and supporting community participation in natural resource management and the provision of information on the control of desertification (National Environmental Secretariat

<sup>3</sup> See [www.kenya.go.ke](http://www.kenya.go.ke)

(NES 2002). The NAP also identified actions required to increase vegetation cover, the productivity of the agricultural and the pastoral sectors, and the protection of wildlife, 70 % of which is located in the drylands (NES 2002).

### 5.2.1.2 Uganda

The Uganda government has prepared its National Adaptation Programme of Action (NAPA), which spells out the strategies for enhancing adaptation to and mitigation of the negative effects of climate change and variability (Ministry of Water, Land and Environment (MWLE) 2007). The NAPA designed eight intervention strategies worth about \$39.8 million, including some related to SLWM.<sup>4</sup> The country is also a signatory of the United Nations Framework Convention on Climate Change (UNFCCC) and the UNCCD, both of which aim to coordinate international efforts to address climate change and the related problem of land degradation. However, policies and strategies for NAPA implementation are still weak and underdeveloped (Republic of Uganda (ROU) 2008), and this study provides information to aid that process.

Despite the abundance of wetlands, the Nile River, and other water resources, only 10 % of irrigable area in Uganda is irrigated, and the value of irrigated production as a share of the total value of crop production is only 0.5 %, the lowest among the four study countries (see Table 5.1). This shows the limited investment in irrigation by the government and by farmers. The limited development of irrigation reduces Uganda's ability to adapt to climate change, especially in the drier areas in the north. Water harvesting and irrigation are among the NAPA strategies to enhance adaptation (ROU 2008). The country has also developed water harvesting programs along the cattle corridor area. A total of 425 microdams have been constructed in the cattle corridor area, but these have been poorly constructed and managed so that their effectiveness is limited (Bashar et al. 2003).

NAPA and other government policies and strategies have also promoted SLWM practices aimed at addressing climate change as well as increasing agricultural productivity and the conservation of natural resources. The Ugandan NAP and the national development program both aim to develop SLWM practices aimed at enhancing land productivity by rehabilitating degraded lands and preventing degradation, increasing the availability of water resources, and integrating natural resource management (Ministry of Agriculture, Animal Industries and Fisheries (MAAIF) 1999; ROU 2010). The country has also enacted a number of policies and programs aimed at increasing agricultural productivity. However, the major weakness is the poor alignment of policies with investment. A recent study showed that the government contributes only 29 % of the public expenditures on SLWM, which

---

<sup>4</sup>The strategies are (1) community tree planting, (2) land degradation management, (3) strengthening meteorological stations, (4) community water sanitation, (5) irrigation, (6) climate change and development planning, (7) drought adaptation, and (8) indigenous knowledge.

raises questions about sustainability (World Bank 2008). As in Kenya, poor coordination among ministries and departments dealing with SLWM is also evident in Uganda (World Bank 2008).

Uganda's decentralization, which started in 1993, gave a mandate to local governments to pass bylaws and run local governments in accordance with the Local Government Act of 1997 and national policies. The Uganda government decentralization is well advanced. In a 31-country decentralization ranking by Ndegwa and Levy (2004), Uganda is ranked as the second most decentralized country in SSA—after South Africa. Both the National Environment Action Plan (NEAP) and the National Environmental Management Authority (NEMA) have taken advantage of decentralization and the development of local institutions to manage local natural resources and the environment. District and local environmental committees have been formed to enact and enforce environmental and natural resource ordinances and bylaws (Lind and Cappon 2001). A study by Nkonya et al. (2008) showed higher compliance with regulations enacted by local governments than with those enacted at higher administrative levels. This makes decentralization a key condition for achieving effective adaptation to climate change.

### 5.2.1.3 Niger

Responding to its arid climate, limited vegetation and water resources, and severe land degradation, Niger designed a NAPA in 2006 that identified 14 adaptation action strategies with the broad objectives of enhancing food security, sustainable resource management, and poverty reduction. The 14 strategic activities are achieved through the following broad activities: (1) pasture and rangeland improvement; (2) increasing livestock productivity by improving local livestock breeds; (3) the development and protection of water resources for domestic use, irrigation, and livestock; (4) the promotion of SLWM practices that enhance adaptation to climate change; (5) promoting peri-urban agriculture and nonfarm activities; (6) building the capacity and organizational skills of rural community development groups; (7) preventing and fighting climate-related pests and diseases; and (8) dissemination of climate information.

As is the case in other countries, however, the total budget set for Niger's NAPA is small, and donors contribute the largest share of NAPA activities. This reveals the weak political will of the government to put the NAPA into the sustainable and long-term operation required for effectiveness, which is currently limited. However, NAPA has spurred country-level policy awareness of climate change and the need to design policies and strategies to enhance adaptation and mitigation.

Tree planting and farmer-managed natural regeneration are among Niger's success stories. A large area of degraded land has been rehabilitated through the presidential program on land rehabilitation and several donor-funded projects. According to Adam et al. (2006), at least 250,000 ha of land have been rehabilitated using tree planting and SWC measures, while more than three million hectares have

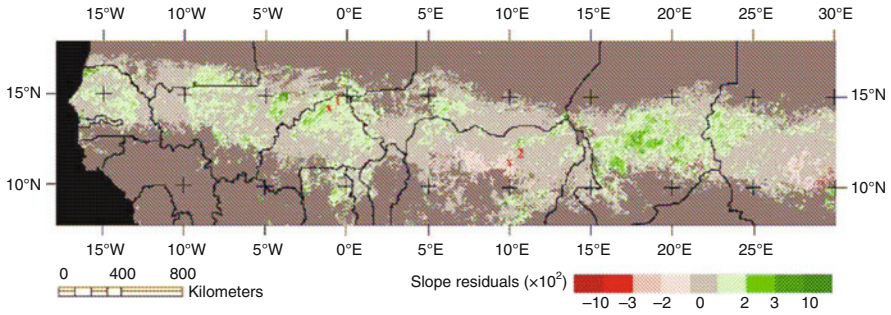


Fig. 5.2 Residual NDVI, 1982–2003 (Source: Herrmann et al. 2005)

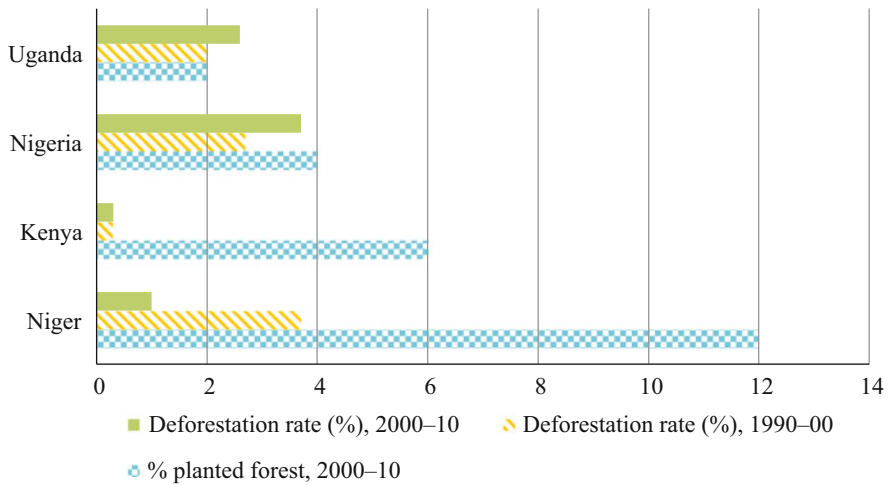


Fig. 5.3 Deforestation rate and planted forest as a share of the total forest area in selected countries (Source: Calculated from FAO 2011)

been reforested through farmer-managed natural regeneration since the mid-1980s (Reij et al. 2009). The greening area not being predicted by rainfall changes is centered in the area where one such project, *Projet Intégré Keita*, was implemented. For example, Mortimore et al. (2001) found that, despite (or perhaps because of) the decreasing availability of natural woodland in Maradi, tree densities on farms were increasing as a result of the widespread practice of farmer protection of valuable natural on-farm trees. Change in greenness—measured using the Normalized Difference Vegetation Index (NDVI)—in Northern Nigeria, with comparable or better climatic environment than southern Niger, was poorer, reflecting the heavy influence of policies on SLWM practices (Fig. 5.2). Niger also reported the largest share of forest area established through replanting than any of the four case study countries (Fig. 5.3).

The success of greening the Sahel in Niger could be explained by two major changes:

- Institutional changes and decentralization have shifted more ownership and authority for the management of natural resources to the local level. The government has embarked on strategies to promote vegetative technologies, which are supported by policy changes to replace the unwritten *right of axe* law by giving ownership rights to those who plant trees (Abdoulaye and Abasse 2005). Likewise, the 2004 forestry law also grants ownership rights to those who plant woodlots or protect forest resources on their private land. The government also decentralized the management of natural resources through the 2003 Rural Development Strategy (RDS). The RDS gives the local governments the responsibility for managing natural resources. These institutional changes have contributed to the regeneration of vegetation in Niger and to the significant decrease in the deforestation rate (Fig. 5.3). Enactment of the rural code—which was passed in 1993—provides tenure security and participatory management of land owned under customary land tenure systems (Yatich et al. 2014; World Bank 2009; Cotula 2006). These changes contributed to the sense of ownership and economic incentives that the communities needed to participate in protecting the forests. Sales of forest products also helped farmers cope with the country’s risky agricultural production. On decentralization, Niger is divided into eight regions, under which there are 36 departments and 265 municipalities (Diarra and Monimart 2006). The part of decentralization that significantly affects SLWM is the Rural Code (Principe d’Orientational du Code Rural Ordinance), passed in 1993. The Rural Code has been one of the policies that enhanced the greening of the Sahel. The Rural Code seeks to provide tenure security and participatory management of land owned under customary land tenure systems. The Rural Code integrates customary land tenure into the formal law by recognizing private land rights acquired through the customary law or written contracts, and it gives customary leaders the role of resolving land conflicts and enacting natural resource management (NRM) (Toulmin and Quan 2000; Lavigne Delville 2000). The National Committee of the Rural Code was set up with the mandate to set NRM regulations. As part of the implementation of the NAPA, the government started promoting sustainable pasture management, water harvesting, developing livestock markets, and other strategies. Despite these success stories, however, land degradation in Niger remains a major problem. Between 1990 and 2005, Niger lost nearly 26 % of its forest and woodland habitat (Butler 2006).

Irrigation in Niger has been developed to address the water constraints in the Sahelian region. A large share of Nigerian land area is in the Sahara desert (76 %), and the remainder is in the drylands (see Table 5.1). Table 5.1 shows that 27 % of the irrigable area is irrigated, the second largest share among the case study countries. However, a much larger investment is required given the unreliable rainfall in the country.

### 5.2.1.4 Nigeria

Like Kenya, Nigeria has not yet formulated a national adaptation program of action to coordinate adaptation to climate change. However, the country significantly invested in irrigation long before climate change became a major issue. Food security policies, which Nigeria has been implementing for more than four decades, are one of the key drivers of investment in irrigation. This demonstrates that, even though Nigeria has not prepared a NAPA, its existing policies and strategies address the common adaptation strategies identified by the 41 countries that have already prepared their NAPAs—water resource development and food security (Mutunga and Hardee 2009).

Irrigation investments in Nigeria were done as part of the country's efforts to address the drought problem in the northern part of the country. A total of 11 river basin rural irrigation authorities were formed in the 1970s to develop irrigation programs in the country, and a total of 162 dams were constructed (Olubode-Awosola et al. 2005; FAO 2005). About 70 % of the irrigated area is situated largely in floodplains (*fadama* areas). However, the effectiveness and performance of the large irrigation schemes was poor, and this prompted the government to invest in small-scale irrigation. Recent major projects promoting small irrigation include the Fadama II and III projects. The projects support the development of irrigation infrastructure and the construction of tube wells to lift water from shallow aquifers. Support for small-scale irrigation has helped to increase the development of irrigation in Nigeria. The country is among the six African countries where the irrigated area grew by at least three percent annually from 2000 to 2003 (Svendsen et al. 2009).<sup>5</sup>

Nigeria spends about 42 % of its federal agricultural budget to support fertilizer subsidies (Mogues et al. 2008). The new fertilizer policy, which is part of Nigeria's agricultural transformation agenda (ATA) focuses on subsidizing up to 50 % of major agricultural inputs, such as fertilizer and seeds, through an electronic distribution channel known as the e-wallet (Takeshima and Liverpool-Tasie 2013; Liverpool-Tasie and Takeshima 2013; Adesina 2011). The e-wallet scheme stipulates that farmers registered under the growth enhancement support (GES) are expected to pay 50 % of the cost of inputs, while the federal and state governments each pay 25 % (Adesina 2011). Despite the generous fertilizer subsidies, which Nigeria has implemented since the 1970s (Takeshima and Liverpool-Tasie 2013), the application rate of nitrogen in Nigeria is only about 5 kgN/ha, which is less than the average of 8 kgN/ha in SSA (FAOSTAT 2012).

Nigeria has invested significantly in agricultural research and development and is among the "big eight" SSA countries—i.e. countries that have invested more than US\$50 million in agricultural research in 2008 (Beintema and Stads 2011). These investments and other programs have made Nigeria one of the SSA countries with strong growth in total factor productivity (TFP) (Fuglie and Rada 2012). Nigeria's TFP grew by 58 % between 1980 and 2008 (Ibid.).

---

<sup>5</sup> The countries are the Central African Republic, Kenya, Mauritius, Nigeria, Senegal, and Zambia.



## 5.3 Methodology

This section discusses the site selection, data collection, and analytical methods.

### 5.3.1 Site Selection

The selection of the four case study countries was done to represent SSA regions' experience and common patterns of climate change. We selected countries sharing boundaries to capture the effect of policies on farmers' response to climate change. We used propensity score matching to select sites across neighboring countries that have comparable biophysical and livelihood characteristics and that the major difference between sites across the border from each other was the policies in the neighboring countries. The steps used in the site selection are described below:

1. Using monthly rainfall data from the Climate Research Unit (CRU) of the University of East Anglia, UK (1981–2001) and from the U.S. National Aeronautics and Space Administration (NASA, 2002–2007) for the four countries, we computed the mean and standard error of annual rainfall, year trend, and year squared trend regression coefficients for each pixel (0.5 degree pixel for CRU data and 1 degree pixel for NASA). The regression models also had month dummy variables and a dummy for the period from 2002 to 2007 to account for any shift due to using a different data source for this period. T-tests of the coefficients revealed a linear trend since the coefficients for the quadratic coefficients were not significant. Hence, the subsequent steps used only the linear trend model.
2. Using the nearest-neighbor matching procedure (Abadie and Imbens 2007; Abadie et al. 2004), we selected matching pixels in Niger and Nigeria (West Africa) and in Kenya and Uganda (East Africa). The selected matching sites were from areas having common support in terms of mean annual rainfall and corresponding standard error, the rainfall trend coefficient, and the standard error of the coefficient.<sup>6</sup> In some cases, one pixel from one country was the best match for more than one pixel from the other country. The matches with the minimum percentage difference in these statistics between the matching pixels were kept. In West Africa, a maximum cutoff point of a 10 % difference was set to ensure that only close matches were included in the matched sample. In East Africa, the matching pairs were fewer, so the cutoff point was 20 %.
3. In the case of East Africa, elevation was also included in the matching characteristics to take into account the large differences in topography.

---

<sup>6</sup> Common support is defined as the area in a propensity score distribution in which observations have comparable observable characteristics (e.g. rainfall variance). Propensity scores are calculated using a probit model, which seeks to determine the probability of being in a treatment group—in this case to be included in this study.

**Table 5.2** Agroclimatic zones and their representation in the selected zones

Zone	Area (000 km <sup>2</sup> )	% of SSA area	% of rural population in SSA	Rural population density (persons/km <sup>2</sup> )	Sites selected to represent the zone
Arid	8,327	37.3	5.3	1.7	–
Semi-arid	4,050	18.1	27.0	14.8	Moroto (Uganda); Illela (Sokoto, Nigeria); Niger; Samburu (Kenya)
Humid	4,137	18.5	28.0	15.0	–
Sub-humid	4,858	21.7	20.3	9.4	Kamuli (Uganda); Bondo (Kenya)
Highlands	990	4.4	19.4	44.2	Kapchorwa (Uganda); Bungoma (Kenya)
	22,362	100.0	100.0	10.7	

Source: Adapted from Jahnke (1982)

- To determine the effect of access to markets and technical support on farmers' responses to climate change, the matching pairs were further grouped according to market access and presence of SLWM projects.

The selected pixels were overlaid on the boundaries of administrative units [districts (counties) in Kenya<sup>7</sup> and Uganda, communes in Niger, and local government areas (LGAs) in Nigeria], and the pixel that best represented the administrative division was selected. In East Africa, sites from three different agroecological zones (AEZ) were selected.

The first was the semi-arid zone, where pastoral communities predominate. This zone represents 18 % of the land area in SSA (see Table 5.2). The matching sites selected were in the Samburu district in Kenya and the Moroto district in Uganda. In both districts, rainfall and population density are low, and the major livelihood is livestock production, although crop production is an emerging livelihood undertaken as a diversification strategy to adapt to climate change. Figure 5.4 shows the selected sites in West Africa. The matching sites are also shown (Fig. 5.5).

The second AEZ in East Africa was the sub-humid zone, receiving rainfall greater than 800 mm per year. In Kenya, the Bondo district in the Nyanza province, bordering Lake Victoria, was chosen. The sites matching Bondo in Uganda are located in the Kamuli district. The sub-humid zone represents about one-fifth of the SSA land area.

The third East African AEZ was the highlands, which accounts for 4.4 % of the SSA land area (Table 5.2). Though small in area, the highlands are important in East Africa in terms of population and agricultural production; in addition, land management in the highlands has important effects on the lowlands. Sites selected

<sup>7</sup>Former districts in Kenya have been converted into sub-counties in the new constitution (see [http://en.wikipedia.org/wiki/Counties\\_of\\_Kenya](http://en.wikipedia.org/wiki/Counties_of_Kenya)).



Fig. 5.4 Case study sites in West Africa

in Kenya were located in the Bungoma district in Kenya and the Kapchorwa district in Uganda. In each of the three zones, two villages with high access to markets—one with an SLWM project and another without an SLWM project—were selected. Similarly, two villages with low market access were selected, one with and one without an SLWM project.



**Fig. 5.5** Land area and human population by agroclimatic zone in East Africa and the sites selected matching each zone (Source: Authors)

A similar approach was used to select case study villages in West Africa. Eight villages were selected in the Tahoua region in Niger, and four matching villages were selected in the state of Sokoto in Nigeria. An additional four villages were selected from the state of Niger in Nigeria. To exploit synergies between this study and another on a cost–benefit analysis (CBA) of SLWM practices in Nigeria, all eight villages from Nigeria were located in or around the SLWM–CBA study sites that covered larger areas in the states of Sokoto and Niger.

### 5.3.2 Data Collection Methods

This study used five major sources of data, each achieving a specific purpose:

1. Satellite and secondary data were used to determine changes in land use and cover and the carbon density of the different types of land use and cover. These data were used to analyze changes in carbon stock at the landscape scale and the contributing influences of different livelihoods and management practices. These data were used in all sites, but for the sites in East Africa, additional carbon data were collected from communities and households to determine the carbon density and stock of different land use types.

**Table 5.3** Selected sites and household sample in each agroecological zone (AEZ) in each country

Households	Kenya <sup>a</sup>	Uganda	Niger <sup>b</sup>	Nigeria	Total
Sub-humid	62	69	–	–	131
Highlands	60	66	–	–	126
Semi-arid		63	245	120	428
Total	122	198	245	120	685
Communities	16	16	8	8	48
High market access, with SLWM project	3	3	2	2	10
High market access, no SLWM project	3	3	2	–	8
Low market access, SLWM project	3	3	2	–	8
Low market access, no SLWM project	3	3	2	2	10

Source: Authors' calculations

Notes: <sup>a</sup> Household surveys in the Samburu district were planned but could not be undertaken due to insecurity in the area in late 2009. <sup>b</sup> Four communities and 60 households from the state of Sokoto (Sudan savannah zone). *SLWM* indicates presence of a sustainable land and water management project in the community

2. Community resource mapping was used to determine biophysical changes and for ground truthing and updating the satellite imagery data.
3. Focus group discussion (FGD) was used to obtain community perceptions on biophysical and socioeconomic changes, the timeline of their occurrence, their drivers and effects, and community responses to these changes. Information gathered from FGDs was also used to design the questionnaire for the household survey.
4. Household-level data were collected and analyzed to understand the determinants of adaptation to climate change and the effects of SLWM practices on agricultural productivity. Table 5.3 reports the number of households and communities that participated in the study in each site.
5. Crop simulation models were done in the Nigerian sites that coincided with the SLWM–CBA study, which analyzed returns on SLWM practices.

### 5.3.2.1 Focus Group Discussions

A qualitative analysis of drivers and responses, including technological and institutional responses, as well as the impact of the responses, was done using focus group discussion and key informants. About 12–15 community members were purposively selected based on their age, gender, primary activity, knowledge of the community, and knowledge of major changes. Participants were required to be old enough to have good knowledge of major changes that had occurred in the village in the past 30 years. To ensure that women were well represented in the discussion, an equal gender mix was required. A guideline was used to discuss the following major topics: the timeline of major recent events and livelihood changes, resource management practices and changes, reasons for changes and

perceptions of drivers, responses to drivers, institutional responses, and the effects of responses.

When discussing drivers of change, care was taken not to lead the group toward specific responses. We were especially concerned that, if we mentioned the true emphasis of the project (perceptions of and responses to climate change), this would have biased the community's responses and given more importance to the issue compared to other possible drivers. Aspects specific to climate change were probed and pursued after communities identified climate change as one of the major changes in the past 30 years. All communities reported climate change as a major change.

### 5.3.2.2 Household Surveys

A common household and plot survey instrument was designed by the team for implementation in all countries. Some adjustments were made to adapt the instrument to suit the needs and circumstances in each country. The household survey captured data on household capital endowment; shocks to the household; climate change perceptions and responses; land holdings, tenure, and management; plot production, inputs, and outputs; livestock assets and production; access to rural services; expenditures on food; and nonfarm income. In Kenya and Uganda, plot-level soil samples were taken from each of the major land use types. Due to budget constraints, plot-level soil samples were not collected in Niger and Nigeria. Additionally, not all types of data were captured in each country since the instruments were altered to accommodate local characteristics. Consequently, the descriptive tables and regression coefficients have missing values for tables reporting results from all countries.

### 5.3.3 Analytical Methods

The qualitative information and data collected from the focus group discussions were compiled and summarized in tabular and graphical format to capture the commonality and divergence of responses across different sites.

The household surveys provided data for conducting an econometric analysis for understanding the effect of household characteristics on land management practices and adaptation to climate change. Drivers of response to climate change were estimated using a bivariate specification in equation  $i$  below.

$$y_i = \beta_0 + \beta_1 x_1 + \beta_2 x_2 + \beta_3 x_3 + \varepsilon_i$$

where  $y_i$  is the response to climate change.  $y_i|p = 1$  if a farmer has taken action to respond to climate change, and  $y_i|p = 0$  if otherwise.  $x_i$  is a vector of physical and socio-economic covariates,  $i = 1, 2, 3$ .  $x_1$  = household human capital endowment

(education, family, labor, etc.);  $x_2$  = household physical capital endowment (land area, livestock, value of farm equipment and irrigation infrastructure); and  $x_3$  = access to rural services (roads, extension services, climate information, etc.);  $\beta_i$  = coefficients associated with corresponding covariate; and  $\varepsilon_i$  = random error term with normal distribution.

At the plot level, the relationship between different SLWM practices and plot productivity profitability, variance of production, and soil carbon was analyzed. Plot productivity was measured by using the gross value of output per area as well as the net value per area (subtracting purchased inputs). Value was used because many plots had more than one commodity (for example, maize and beans), and there needed to be some basis for aggregation. The risk of production was estimated using the mean-variance method of Just and Pope (1979) to deal with cross-sectional data. We use the same variables as in equation i above to analyze the Just-Pope mean-variance model. To estimate the effect of a particular SLWM practice on risk, we divided the sample into those with and those without the SLWM practice. The mean productivity for the subsample was calculated, and then for each plot observation, a deviation about the mean or variance measure could be calculated. The hypothesis tested was that the SLWM practices would help to reduce the variance of production among those who had adopted the practices.

## 5.4 Results

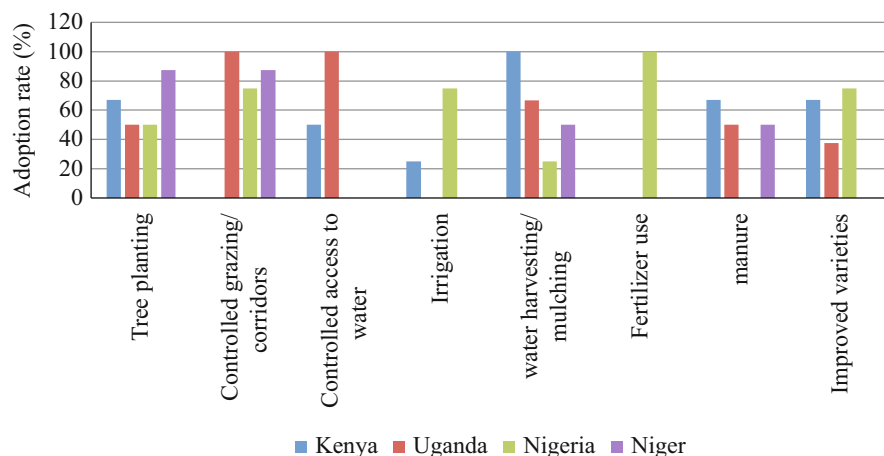
### 5.4.1 *Response to Climate Change*

Participants were asked during focus group discussions how they have responded to climate change. Households were also asked the same question in the household survey. Responses differed significantly by location, largely depending on the types of livelihood emphasized in each place. We first summarize the responses given during the focus group discussions. We then discuss the responses at the household level. Our discussion focuses on the SLWM practices used to adapt to climate change. As expected, the methods used to adapt to climate change across neighboring countries are different.

#### 5.4.1.1 Focus Group Discussions

##### 5.4.1.1.1 Protection and Planting of Trees

Almost all communities in Niger reported having planted or protected trees as an adaptation strategy, compared to only four out of eight communities in neighboring Nigeria (Fig. 5.6). In East Africa, more Kenyan communities reported tree planting and protection as an adaptation strategy than communities in Uganda, a country that



**Fig. 5.6** Adaptation strategies across countries—focus group discussion (Notes: Controlled grazing refers to only pastoral communities in all countries. Adaptation using fertilizer & improved varieties excludes pastoral areas in East Africa. Source: Focus group discussion)

has experienced significant deforestation in the past (Coleman and Fleischman 2012, Fig. 5.3). As discussed earlier, this is a reflection of the strong tree planting and protection in Niger and Kenya. Empirical evidence has also shown that increasing scarcity of fuelwood leads people to spend more time collecting fuelwood from communal woodlands or forests, and this provides an incentive to plant trees (Cooke et al. 2008; Arnold et al. 2003).

#### 5.4.1.1.2 Livestock and Rangeland Management

In the semiarid zones, controlled grazing was reported in all four communities in Uganda and in five of the eight communities in Niger. Pastoral communities in the semiarid zone in Kenya did not report controlled grazing but reported moving livestock to other areas in response to prolonged drought (Fig. 5.6). Controlled grazing among pastoral communities is contrary to the notion that rangelands used by transhumant communities are open-access commons with no management or improvement (Hoffman 2004). Participants explained that controlled grazing has been prompted by the decreasing pasture, which is partly due to climatic changes.

Communities also reported that decreasing pasture was due to increasing human and livestock population. Similarly, pastoral communities in Uganda reported controlled access to water resources, which is a result of drying rivers and other water sources. In Niger, seven of the eight villages had established livestock corridors to reduce conflicts between farmers and herders—a measure that is promoted by the Nigerien NAPA strategy.



#### 5.4.1.1.3 Irrigation, Water Harvesting, & Moisture Conservation

It was only in Nigeria that three of the eight communities reported using irrigation as an adaptation strategy to cope with climate change. One community in the sub-humid district in Kenya also reported using irrigation in response to drought, though on a modest scale. No community in Uganda or Niger reported having used irrigation as an adaptation strategy.

Four of the eight communities in Niger had increased use of *zai* pits, half-moon-shaped water basins, to trap rainwater. Three of the four communities in the highlands and two of the four communities in the sub-humid zones of Uganda also reported an increase in water management.

Mulching has been identified as one of the important SLWM practices for adaptation to climate change. For example, a study in semiarid areas in Kenya showed that mulching could increase the length of the growing season from 110 to 113 days (Cooper et al. 2009). Eight of the 12 communities in Uganda reported mulching as an adaptation strategy. In Kenya, all communities in the highlands also reported using more mulch than before. Two of the four communities in the state of Sokoto (Nigeria) also reported mulching, but no communities in Niger and Niger state in Nigeria reported mulching.

## 5.4.2 Early-Maturing Varieties

Improved crop varieties provide one of the key technologies for addressing climate change—especially in areas where rainfall is expected to be more erratic or to decrease (Lobell et al. 2008). Excluding communities in predominantly pastoral communities in East Africa (Fig. 5.6) shows that planting early-maturing varieties was mentioned in two of the three communities in the sub-humid zone of Kenya and in six of the eight communities in Nigeria but in none in Niger. In Uganda, three of the 12 communities in the highlands and sub-humid communities reported using early-maturing varieties to address climate change. The use of improved varieties as an adaptation strategy is comparable to the agricultural research and development of the four countries since crop breeding is a major agricultural research and development investment in SSA. Kenya and Nigeria have significantly invested more in agricultural R&D than neighboring Uganda and Niger, respectively (Beintema and Stads 2011).

### 5.4.2.1 Fertilizer and Manure Application

This analysis excludes the pastoral communities in Kenya and Uganda, where most communities did not mention soil fertility as a significant adaptation strategy. Nigeria and Niger communities reported different soil fertility management practices used for adaptation to climate change. As an apparent reflection of generous

fertilizer subsidies in Nigeria, communities in the country reported the use of inorganic fertilizer as a climate change adaptation strategy. In contrast, communities in Niger—where there is no large fertilizer subsidy program, communities reported the use of manure as a climate change adaptation strategy (Fig. 5.6). In East Africa, communities in both countries reported increased use of manure, but the increase in Kenya was greater than the case in Uganda. Inorganic fertilizer was not reported as a climate change adaptation strategy in both countries (Fig. 5.5).

#### **5.4.2.2 Livelihood Diversification and New Crops**

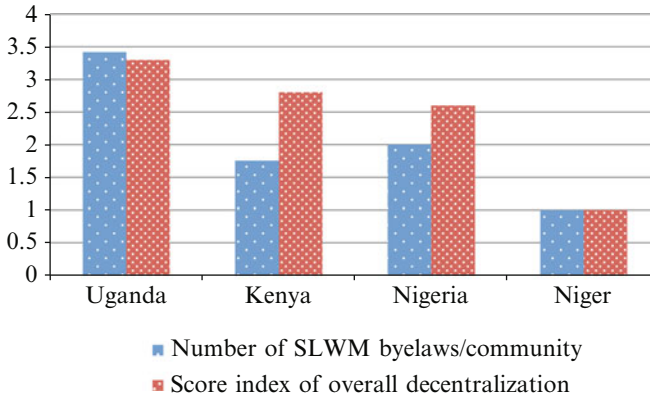
Contrary to Jones and Thornton (2009), who predicted that climate change would induce a shift from crop production to livestock production in the drylands, one of the three and two of the four pastoral communities in the semiarid areas of Kenya and Uganda, respectively, reported diversifying their livelihoods by planting crops. Major reasons given for planting crops was the decreasing livestock population due to prolonged drought and cattle rustling in Uganda. However, household-level results showed that all households interviewed reported having experienced 100 % crop failure due to severe drought. This underscores the riskiness of crop production, of which farmers are fully aware.

New crops were reported in all countries among predominantly crop farmers. Five of the eight communities in Niger had introduced new crops, while all four communities in the states of both Niger and Sokoto (Nigeria) reported having introduced new crops. Some communities in Kenya reported growing new crops.

#### **5.4.3 Institutional Responses to Climate Change: Opportunities and Challenges**

In focus group discussions, communities were asked to discuss the institutional responses to changes. Across all four countries, regulations have been introduced by the central government, local governments, and customary institutions. These regulations have also been introduced as a response to climate change and deforestation and in conjunction with environmental and agricultural programs aimed at protecting and rehabilitating natural resources.

The major regulations introduced in the past 30 years have been related to tree cutting, the prohibition of bush burning, access to water, and controlled grazing in semiarid zones. The effectiveness of local institutions to enact and enforce SLWM depends on the central government decentralization policies that enhance synergistic vertical interaction (Robinson and Berkes 2011). We compared the total number of SLWM regulations enacted in the past 30 years and the performance of decentralization to draw conclusions on how the vertical institutional linkage has affected collective adaptation to climate change. As expected, a comparison of the



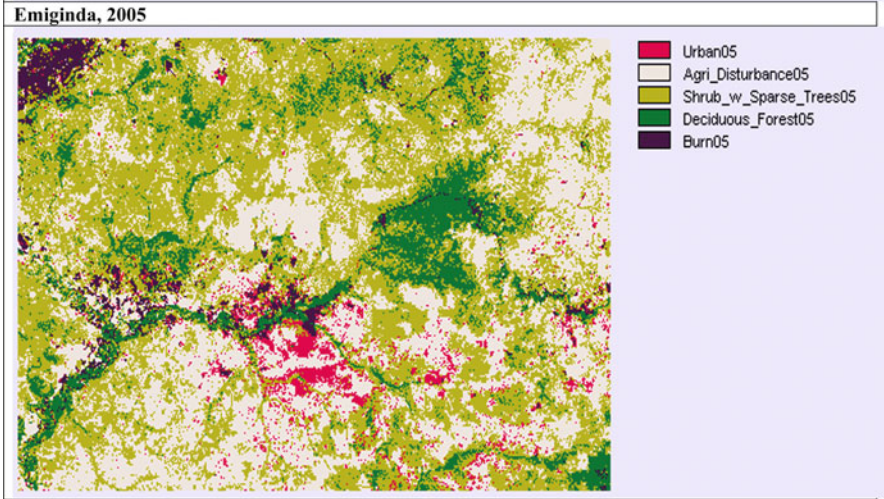
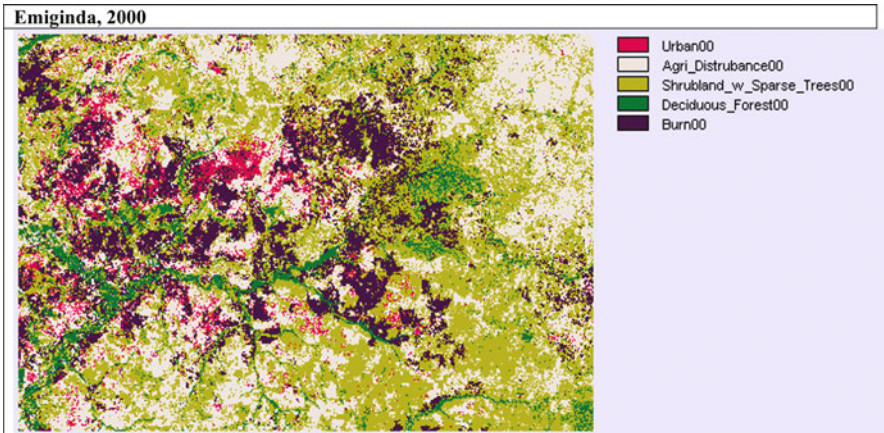
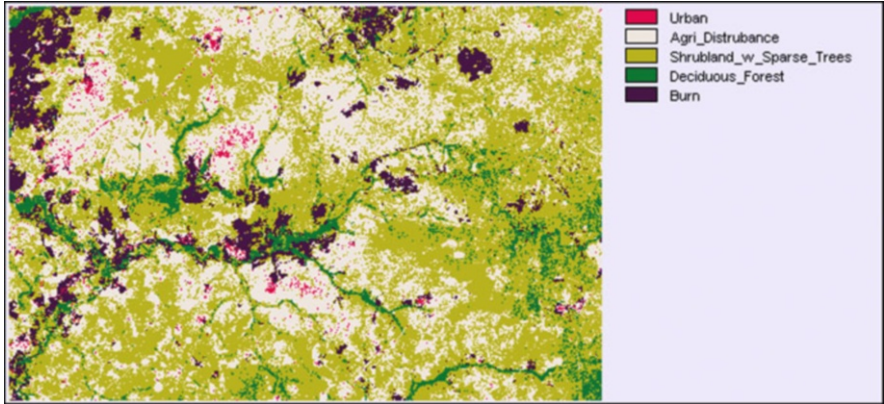
**Fig. 5.7** Relationship between the performance of decentralization and the number of SLWM bylaws enacted per community (Notes: SLWM: sustainable land and water management. Overall decentralization includes 12 performance and structural indicators of decentralization. The larger the index is, the greater the performance of decentralization is. Sources: Overall decentralization from Ndegwa and Levy 2004; SLWM bylaws: focus group discussion results)

performance of decentralization—a measure of how a central government has performed in transferring public authority, resources, and personnel from the national level to sub-national governments (Ndegwa and Levy 2004)—and the number of bylaws per community showed a greater number of bylaws per community in countries with better decentralization performance (Fig. 5.7). This underscores the effectiveness of the vertical linkage of the national and local governments in providing a mandate for local communities to take responsibility in managing their natural resources collectively through the enactment of bylaws.

A case study of Emigginda village in Nigeria demonstrates the effectiveness of the enactment of bylaws in adapting to climate change through the protection of above-ground and below-ground carbon. The community enacted bylaws prohibiting bush burning, which is a common practice in the Guinea savannah zone (Savadogo et al. 2007). The Emigginda village in the state of Niger experienced a serious bush fire in the late 1990s.

With dwindling forest and shrubland resources, Emigginda community passed the bylaw in 2000 after observing a severe reduction in vegetation. The community reported that it effectively enforced the bylaws, and as a result, there was a significant reduction in the burnt area. Satellite imagery data confirms that the burnt area had decreased by 53 % in 2005 from its level in 2000 (Fig. 5.8). The dramatic reduction of the burnt area underscores the effectiveness of locally enacted and enforced bylaws.

In summary, we find that communities have been taking collective action to address resource changes precipitated by climate change and other biophysical and socioeconomic changes. These initiatives provide an opportunity for the NAPA or other climate change programs to take advantage of community awareness of climate change; they also demonstrate the need to take action collectively and



**Fig. 5.8** Land use classification in the Emiginda village in the state of Niger, Nigeria (Source: Authors)

individually to address land and water resources. For example, we find that pastoral communities have voluntarily started enacting regulations on controlled grazing, something that was not effective when central governments attempted to restrict the mobility of transhumant communities (Mwangi and Ostrom 2009). The major impediment to these actions is the weak capacity of local institutions to enact and enforce these regulations. The household survey data analysis also shows that farmers' knowledge about climate change and the appropriate adaptation strategies is poor.

### 5.4.3.1 Household Survey Results

Table 5.4 summarizes the share of farmers who were aware of climate change but did not take an adaptive action. Only 22 % of farmers in Kenya who were aware of climate change did not take action. The corresponding percentages in Uganda, Niger, and Nigeria were 44 %, 2 %, and 71 %, respectively. The large share of farmers who did not respond to climate change in Nigeria could be explained by the way we framed the question. We asked farmers only to state actions taken in the past 30 years. This could have missed farmers who took action earlier than 30 years before. This is the case for many farmers in Northern Nigeria who have traditionally been using irrigation (Kimmage and Adams 1990). Almost all farmers aware of

**Table 5.4** Share of households that did not respond to climate change and their most important reason for not responding to climate change

Reason	Kenya <sup>a</sup>	Uganda <sup>a</sup>	Niger <sup>a</sup>	Nigeria <sup>a</sup>	All countries
<b>Percentage that did not respond to climate change</b>	22	44	2	71	30
Sub-humid	24	18	–	–	–
Highlands	19	50	–	–	–
Semiarid	–	65	–	–	–
<b>Reasons for not responding to climate change (% reporting)</b>					
No money	–	42	54	45	49
No inputs	26	12	21	7	18
No information on appropriate adaptations	13	33	2.1	15	15
No access to credit	8	4	18	27	13
No access to land	7	8	2.1	7	6
Shortage of labor	13	4	3.7	–	–
No water	33	–	–	–	–

Source: Household survey data

Note: <sup>a</sup> Includes households that reported having used an adaptation strategy but desiring to use other methods and were unable to do so. Non-response due to lack of money is not reported for Kenya because all farmers who did not respond effectively to climate change reported it

–Means that the corresponding statistic not collected or irrelevant in the country

climate change in Niger took adaptive measures to climate change. This was expected given the more serious effects of climate change in the country. In Uganda, however, more households in the humid zone and in the highlands adapted to climate change than those in the semiarid areas. This could be due to the limited crop production activities in the Moroto area.

The major reason given for not responding to climate change or for not more effectively responding was a lack of money (Table 5.4). This confirms the vulnerability of the poor and the high cost of some of the adaptation strategies used by farmers.

Lack of access to inputs was the second most frequently stated reason for not adapting to climate change. This suggests greater vulnerability for farmers in remote areas, where access to agricultural inputs such as early-maturing crop varieties is lower. Lack of information on appropriate adaptation strategies was the third most common reason for failing to adapt to climate change. This is to be expected given the level of uncertainty in predicted and perceived climate change and the lack of a coordinated and operational strategy on climate change adaptation in agriculture. This also underlines the failure of agricultural extension services to provide advice on adaptation to climate change, a problem that is common in SSA, where agricultural advisory services on climate change is still weak (Oladele 2013; Vogel and O'Brien 2006). For example, two studies conducted in Nigeria and Uganda asked agricultural extension agents to state the messages they provide to farmers. The studies found that none of the extension agents reported having advised farmers on climate change (Banful et al. 2010; Nkonya et al. 2011). This underscores the need to retrain extension service providers to equip them with new knowledge on climate change (Oladele 2013).

Other reasons for failing to adapt to climate change included lack of access to credit, land shortage, and labor shortage. Below, we show the results of a multivariate approach to analyzing the variables influencing the response to climate change. We analyzed the determinants of adaptation to long-term change in precipitation, variability of rainfall, and temperature. We also analyzed the drivers of adaptation to any of these three types of long-term climate change. For brevity, we combine all three types of climate change in our reporting of results.

#### ***5.4.4 Drivers of Response to Climate Change***

The regression results in Table 5.5 show that female-headed households in Niger were less likely to respond to climate change than male-headed households. The results underscore the vulnerability of female-headed households. In Kenya, Uganda, and Nigeria, however, the sex of the head of household did not have a significant effect. Primary and secondary education did not have a significant impact on adaptation to climate change in all countries. In Nigeria, however, having a postsecondary education had a negative influence on the likelihood of responding to climate change. This could be due to the lower degree of dependence on

**Table 5.5** Determinants of response to climate change

Variable (dependent variable responded to climate change? Yes = 1, no = 0)	Kenya	Uganda	Niger	Nigeria
<b>Marginal effects of probit model</b>				
<b>Household capital endowment</b>				
<i>Human capital</i>				
Ln (household size)	–	–0.149	–0.125	0.574
Female household head	0.590	–0.098	–0.078*	0.209
Ln (male household members)	–0.061	0.146	–0.044	–0.402
Ln (female household members)	–0.037	0.22	0.067	–0.123
Education of household head (cf. no formal education)				
Primary	0.479	0.033	0.344	–0.05
Secondary	0.776	–0.033	–0.012	0.081
Postsecondary	–	0.431***	–	–0.424***
Years of farming	0.039**		–	–
Nonfarm (cf crops)	–0.719**	–0.175*	–0.044	–0.420***
Livestock		0.528***		
<i>Physical capital</i>				
Ln (farm area, ha)	0.024	0.088**	0.009	0.129
Ln (value of farm equipment)	–	0.013	0.049***	–0.109**
Ln (value of livestock)	–	–0.005	–0.006	0.01
Irrigation	–	0.247**	–0.068*	–0.278*
<b>Access to rural services</b>				
Ln (distance to agricultural market, km)	0.182*	0.156***	0.054***	0.145*
Climate information	–	–0.056	–0.157***	–0.378***
Extension	0.435	–0.008	0.021	0.043
SLWM project		–0.100	0.086	0.266*
Borrowed from bank or microfinance inst.	0.052	–0.168	–0.001	0.077
Borrowed from nonformal sources		0.132**	–0.032	0.183
Belong to savings and credit group	0.499			
Belong to marketing group	–0.053			
Number of observations	109	325	244	58

Source: Household survey data

Notes: \*, \*\*, and \*\*\* indicate significance at  $p = 0.10$ ,  $p = 0.05$ , and  $p = 0.01$ , respectively. Fixed effects coefficients for each country (districts in Kenya and Uganda, villages in the state of Niger and Niger) are not reported

–Means that the corresponding statistic was not collected or irrelevant in the country

agriculture for households whose head has a postsecondary education. Contrary to this, having a post-secondary education in Uganda increased the probability of adapting to climate change. The contradicting results from the two countries demonstrate the context specificity of adaptation to climate change. In all countries, engaging in nonfarm activities reduced the likelihood of responding to climate

change. The result for nonfarm income suggests that households with significant nonfarm livelihoods may prefer to respond to the additional agricultural risks of climate change by emphasizing responses in nonagricultural areas.

In Kenya, a response to climate change was more likely among households that had been farming for long durations. This is sensible given that experienced farmers may be both more aware of climate change and its effects and more knowledgeable about how to respond, based on their long experience.

Distance to market in all countries was positively related to response to climate change, suggesting that those in remote areas are more likely to respond to climate change than those living closer to markets. These results are plausible, suggesting that households that are more remote from markets have fewer nonagricultural options and therefore may take more action in agriculture. This is consistent with the negative association of nonfarm activities with response to climate change discussed above.

Contrary to expectations, access to climate information was negatively associated with response to climate change in Nigeria. However, the major type of climate information that farmers received was current weather information, which may not be helpful in deciding on the response to long-term climate change.

Access to agricultural extension services did not have a significant impact on adaptation to climate change. This is a reflection of the weak capacity that extension services have to offer advisory services related to climate change. Advice on climate is currently not embedded in agricultural advisory services and takes place in isolation from the agricultural extension messages (Vogel and O'Brien 2006). This suggests a need to integrate climate change messages into the existing extension services.

Contrary to expectations and to the results implied in the descriptive statistics showing that lack of money was the major reason for failing to adapt to climate change, physical capital endowment—land area and livestock assets—did not have a significant effect on adaptation to climate change. The weak impact of the physical assets could be due to the small sample. As expected, access to irrigation in Uganda increased the likelihood of responding to climate change. Contrary to the focus group discussion results, however, farmers with access to irrigation were less likely to adapt to climate change in Niger and Nigeria. Again, this could be due to the way we asked the question, which missed farmers who could have undertaken adaptation strategies more than 30 years ago.

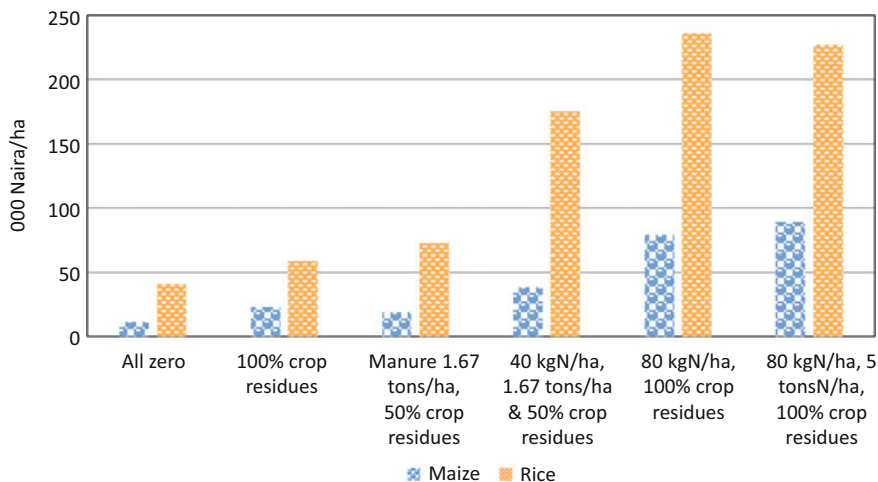
#### ***5.4.5 Returns on Land Management Practices***

To understand fully the incentives for adopting SLWM practices, we used crop simulation to determine the effects of SLWM practices on crop yield.<sup>8</sup> We then used these results to determine returns on SLWM investments. This topic is briefly discussed here and will be revisited in the section on local institutions below.

---

<sup>8</sup> For details of the methods used, see Nkonya et al. (2010).





**Fig. 5.9** Net benefit of land management practices over 30 years for maize and rice, Niger state, Nigeria (Source: Authors)

We use results from Nigeria only where crop simulation was done in a study on a cost–benefit analysis of SLWM (Nkonya et al. 2010). We analyzed the yield response to a combination of the following land management practices: fertilizer, manure, and crop residue. We used a baseline treatment to determine the change in yield when a farmer switches from the baseline land management practice to another practice. The baseline land management practice was no application of any form of organic or inorganic fertilizer but leaving 100 % of crop residues in the field. In this study, we discuss results for maize and rice and report only the returns to SLWM.<sup>9</sup> Figure 5.9 shows that a combination of crop residues, manure, and mineral fertilizer has the highest net benefit for rice and maize. The benefit–cost ratio was highest for land management practices that combined manure, crop residues, and mineral fertilizer. This is consistent with other socioeconomic studies that have shown that integrated soil fertility management (ISFM) practices—land management practices that strategically integrate organic and inorganic approaches to soil fertility (Vanlauwe and Giller 2006; Tittone et al. 2008)—are more profitable than practices using either fertilizer alone or organic soil fertility management practice alone (for example, Doraiswamy et al. 2007; Sauer and Tchale 2006).

As shown in Table 5.6, however, the adoption rate of ISFM practices is low in Nigeria, Uganda, and Niger and is relatively high only in Kenya.

Only 7.5 % of plots sampled in Nigeria and 2 % of plots in Uganda received both fertilizer and manure or compost. No plot sampled in Niger received such a combination. The adoption rate of ISFM was highest in Kenya, where a third of the plots received both treatments. The constraints leading to the low adoption of

<sup>9</sup> For details of crop simulation calibration, see Nkonya et al. (2010).

**Table 5.6** Adoption rate of land and water management practices which enhance adaptation to climate change

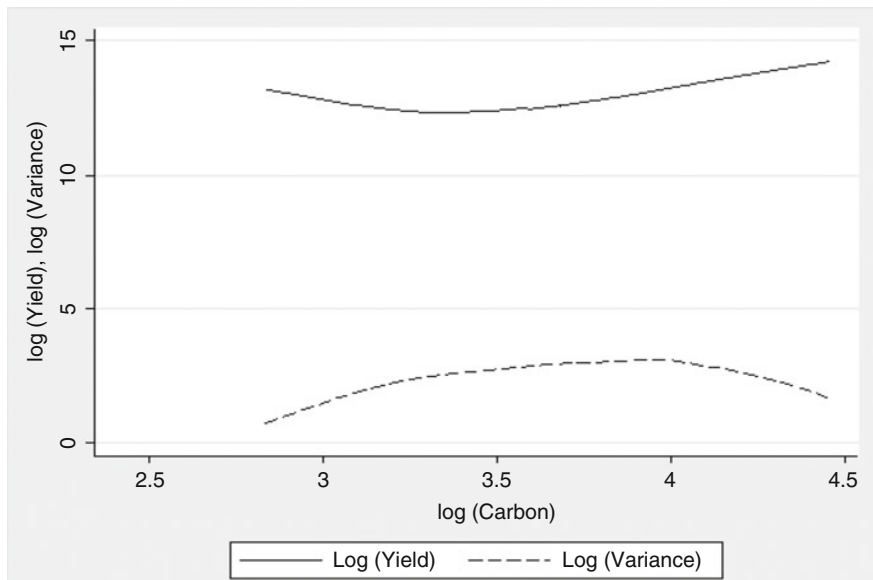
Variable	Kenya	Uganda	Niger	Nigeria
<b>% adoption of households</b>				
Irrigation	3.4	1.8	4.4	2.5
ISFM	33.00	2.0	0.0	7.5
Animal manure	67.95	11.9	1.0	12.1
Fertilizer	36.35	6.1	0.1	45.3
Crop residue incorporation	34.4	31.8	0.1	0.0
Mulching	35.2	22.2	6.4	0.9
Tree planting	37.6	19.6		0.0
Rotational grazing	7.45	1.8	0.4	0.6
Restricted grazing	7.4	1.8	0.4	0.6
Resting of grazing land	4.95	2.6	2.5	0.0
Water harvesting	18.00	0.5	0.8	0.6

Source: Authors

ISFM—despite its high returns—include lack of livestock (which both produces and transports manure), high labor intensity, poverty, and low capacity of extension services to promote ISFM (Benin et al. 2012; Banful et al. 2009).

#### **5.4.6 Impacts of SLWM Practices on Agricultural Productivity & Production Risks**

In the case of Uganda, we examined the influence of soil carbon stock on crop productivity. We found a U-shaped relationship between crop productivity and soil carbon stock (Fig. 5.10). These results are consistent with those of Marenja and Barrett (2009), who found a similar relationship in Kenya. The results suggest that carbon stock has a threshold that must be attained before it increases crop yield. It is possible that the quantities of carbon stored in the soil when using organic inputs does not attain the threshold required to increase crop productivity compared to other practices (e.g. the application of small doses of inorganic fertilizer only). The results suggest that SLWM practices that sequester a large quantity of soil carbon will simultaneously increase crop productivity and contribute to climate change mitigation. An analysis of yield variance revealed that greater carbon stock helps to reduce climate change–related production risks (Fig. 5.10). The study in Uganda also included soil carbon in the model, which shows an inverted U-shaped relationship with the variance of crop productivity. Overall, the results suggest that carbon stock increases yield and reduces yield variability above a minimum threshold level.



**Fig. 5.10** Relationship between soil carbon stock and crop mean yield and variance in Uganda (Source: Household survey data and lab analysis results of soil samples)

#### 5.4.6.1 Impact of Land Management Practices on the Mitigation of Climate-Related Production Risks

For all countries, we estimated the effect of land management practices on production risks using cross-sectional data. Overall, SLWM practices reduced climate-related risks that lead to yield variability. Of the 16 coefficients that were significant across all four countries, only three were positive, indicating that they increase yield variance and therefore production risks (Table 5.7). The rest (13 coefficients) were negative, suggesting that they reduce yield variance. The results are consistent with Fig. 5.10 and other biophysical studies, which have shown that organic soil fertility management practices increase moisture storage capacity, which in turn affects yield variability due to drought and other climate-related changes (Bationo et al. 2007; Bationo and Buerkert 2001).

## 5.5 Conclusions and Implications

This study shows that country-level policies play a key role in farmer adaptation to climate change. Long-term investment—whether in response to climate change or other factors is more important and help farmers to adapt better to climate change. In particular, we find that, while Kenya’s policies have strongly supported

**Table 5.7** Effect of SLWM on crop yield risks (deviation from conditional mean yield)

Variable	Kenya	Uganda	Niger	Nigeria
	Dependent variable = Log (variance of value of crop productivity/ha)			
Mulch and manure	–	–2.39	–	–
Mulch and crop residues	–	–3.385***	–	–
Fertilizer and manure	–		–	1.74
Fertilizer and compost	–		–	37.85**
Alley cropping	–		–0.132***	–
Improved mulching	–0.015	3.597***	–0.078	–
Improved crop rotation	0.444	–0.901*	–	–8.41**
Improved crop residue	0.714**	–1.167**	–	–
Compost	0.432		0.048	–33.45***
Inorganic fertilizer	–0.738**	–0.313	–	0.89
Improved fallow	–	–2.168*	–	14.95
Farm manure	0.473**	0.449	–	–2.1
Water harvesting	–0.264		–	–
Irrigation	–	0.394	–0.011	–32.23***
Tree planting	–0.097	0.076	–	–
Fanya chini/soil conservation	0.083	–4.024***	–0.043	–
Deep tillage	–	0.109	–	–
Fallow strips	–	0.392	–	–
Trash lines	–	1.443**	–	–
Soil carbon	–	4.174	–	–
Soil carbon squared	–	–0.569*	–	–
N (number of plots)	317	548	609	312

Source: Household survey data

Notes: \*, \*\*, and \*\*\* indicate significance at  $p = 0.10$ ,  $p = 0.05$ , and  $p = 0.01$ , respectively. We controlled for other variables but report only land management practices. Results for other variables included in the model are available upon request from the authors

–Means that no data were collected or there was a small number of observations in the corresponding country

agricultural research and development and an agricultural market environment that offers incentives to farmers to adapt to climate change, this has contributed to the relatively high adoption of several SLWM practices in Kenya in comparison to other countries. Neighboring Uganda has implemented government decentralization and a land tenure system that have been factors leading to stronger local institutions that offer opportunities for improved community resource management. In West Africa, Nigeria has long supported irrigation development and recently focused on small-scale irrigation that has increased agricultural production and reduced production risks in the drier northern states. Even though such irrigation schemes were not implemented as part of an adaptation to climate change, they have enhanced farmers' adaptation to climate change. Niger also offers a good example of tree planting and protection, which was successful due to a revised

Rural Code and relaxed enforcement of the Forest Code that gave land users rights to own the benefit from trees on their farms. This success contributed to the greening of the Sahel. The Niger success provides an important lesson for tree planting programs that can be used to help farmers adapt to climate change and enhance soil fertility if leguminous trees are promoted. Such efforts could also help avoid the major problem associated with the availability and bulkiness of animal manure.

Household survey results indicated that the major factors that drive response to climate change include the gender of the household head, level of education, access to rural services, and household capital endowment. Households that depend heavily on agriculture are more likely to respond to climate change than those that have alternative livelihoods, such as nonfarm activities, or those that have higher education or are closer to markets, where there are alternative livelihood options. However, a limited household capital endowment and access to rural services lead to nonresponse or to the limited effectiveness of responses to climate change. We also found that, in Niger, female-headed households, those with limited household capital endowment, or those with no access to informal credit sources were less likely to respond to climate change. The results confirm the vulnerability of poor households and those with limited access to rural services.

Additionally, we found that agricultural extension services did not have a significant influence on farmers' response to climate change, implying that they have limited capacity to provide advice on climate change. For example, the adoption rate of integrated soil fertility management (ISFM) practices—which are both more profitable and have greater potential to enhance adaptation to climate change than mineral fertilizer alone—is lower than that of mineral fertilizer. Again, this is due to lack of ISFM advisory services by extension agents. This underscores the need to retrain the existing extension service providers on climate change and to enhance the climate change curriculum in colleges that train extension service providers.

## References

- Abadie A, Imbens G (2007) Bias corrected matching estimators for average treatment effects, Harvard University Department of Economics working paper. National Bureau of Economic Research, Cambridge, MA
- Abadie A, Drukker D, Leber Herr J, Imbens G (2004) Implementing matching estimators for average treatment effects in stata. *Stata J* 4(3):290–311
- Abdoulaye T, Abasse T (2005) Assessment of joint forest management in Niger. Nigeria and Ghana executive final report, AFORNET GRANT No. 5 Dec 2003, Niamey
- Adam T, Reij C, Abdoulaye T, Larwanou M, Tappan G (2006) Impacts des investissements dans la gestion des ressources naturelles (GRN) au Niger: rapport de synthèse. Centre Régional d'Enseignement Spécialisé en Agriculture (CRESA), Niamey

- Adesina A (2011) Presidential brief: agricultural transformation agenda. Presentation made by the Honorable Minister of Agriculture to the Economic Management, Abuja, 9 Sept 2011
- Arnold M, Köhlin K, Persson R, Shepherd G (2003) Fuelwood revisited: what has changed in the last decade? Occasional paper 39. Center for International Forestry Research, Jakarta
- Banful B, Nkonya E, Oboh V (2009) Constraints to fertilizer use in Nigeria: perspectives and insights from the agricultural extension service, Nigeria Strategy Program Policy Brief #6. International Food Policy Research Institute (IFPRI), Abuja
- Banful B, Nkonya E, Oboh V (2010) Constraints to fertilizer use in Nigeria: insights from the Agricultural Extension Service. International Food Policy Research Institute (IFPRI) discussion paper #01010. IFPRI, Washington DC
- Barnichon R, Peiris S (2008) Sources of inflation in Sub-Saharan Africa. *J Afr Econ* 17(1):729–746
- Bashar K, Kizaa M, Chane B, Seleshi Y (2003) Assessment of existing micro dams in Ethiopia, Sudan and Uganda. Nile Basin Capacity Building Network for River Engineering, Cairo. [www.nbcbn.com/Project\\_Documents/prposals/phase%20I/River%20Structure/g1.pdf](http://www.nbcbn.com/Project_Documents/prposals/phase%20I/River%20Structure/g1.pdf). Accessed 12 Mar 2012
- Bationo A, Buerkert A (2001) Soil organic carbon management for sustainable land use in Sudano-Sahelian West Africa. *Nutr Cycl Agroecosyst* 61:131–142
- Bationo A, Waswa B, Kihara J, Kimetu J (eds) (2007) Advances in integrated soil fertility management in Sub-Saharan Africa: challenges and opportunities. Springer, Dordrecht
- Beintema N, Stads G (2011) African agricultural R&D in the new millennium. Progress for some, challenges for many. IFPRI Food Policy Report. Online at <http://www.ifpri.org/sites/default/files/publications/pr24.pdf>. Accessed 11 May 2014
- Benhin J (2006) Climate change and South African agriculture: impacts and adaptation options. CEEPA discussion paper no. 21. Centre for Environmental Economics and Policy in Africa (CEEPA), University of Pretoria, Pretoria
- Benin S, Nkonya E, Okecho G, Randriamamonjy J, Kato E, Lubadde G, Kyotalimye M, Byekwaso F (2012) Impact of Uganda's National Agricultural Advisory Services Program. IFPRI Research Monograph. Online at <http://www.ifpri.org/publication/impact-uganda-s-national-agricultural-advisory-services-program>. Accessed 11 May 2014
- Boex J, Kelly R (2011) Fiscal decentralization in Kenya: a small step or giant leap? International Development and Governance (IDG) policy brief. Publisher Center for International Development and Governance, Washington DC, pp 1–7
- Boko M, Niang I, Nyong A, Vogel C, Githeko A, Medany M, Osman-Elasha B et al (2007) Africa. In: Parry ML, Canziani OF, Palutikof JP, van der Linden PJ, Hanson CE (eds) Climate change 2007: impacts, adaptation and vulnerability, Contribution of working group II to the fourth assessment report of the Intergovernmental Panel on Climate Change. Cambridge University Press, Cambridge, pp 433–467
- Bruinsma J (2003) World agriculture: towards 2015/2030 – an FAO perspective. Earthscan/FAO, London/Rome
- Butler R (2006) Nigeria has worst deforestation rate, FAO revises figures. <http://news.mongabay.com/2005/1117-forests.html>
- Christensen JH, Hewitson B, Busuioc A, Chen A, Gao X, Held I, Jones R et al (2007) Regional climate projections. In: Solomon S, Qin D, Manning M, Chen Z, Marquis M, Averyt KB, Tignor M et al (eds) Climate change 2007: the physical science basis, Contribution of working group I to the fourth assessment report of the Intergovernmental Panel on Climate Change. Cambridge University Press, Cambridge, pp 847–940
- Cline W (2007) Country-level climate projections. Global warming and agriculture: impact estimates by country. Peterson Institute, Washington, DC
- Coleman E, Fleischman F (2012) Comparing forest decentralization and local institutional change in Bolivia, Kenya, Mexico, and Uganda. *World Dev* 40(4):836–849
- Conway G, Waage J (2010) Science and innovation for development. UK Collaborative on Development Sciences, London

- Cooke P, Köhlin G, Hyde W (2008) Fuelwood, forests and community management: evidence from household studies. *Environ Dev Econ* 13:103–135
- Cooper PJM, Coe R (2011) Assessing and addressing climate-induced risk in sub-Saharan rainfed agriculture: foreword to a special issue of experimental agriculture. *Exp Agric* 47(2):179–184
- Cooper PJM, Rao KPC, Singh P, Dimes J, Traore PS, Rao K, Dixit P, Twomlow SJ (2009) Farming with current and future climate risk: advancing a ‘hypothesis of hope’ for rainfed agriculture in the semi-arid tropics. *J SAT Agric Res* 7:1–19
- Cotula L (2006) Land and water rights in the Sahel: tenure challenges of improving access to water for agriculture. IIED issue paper 139. International Institute for Environment and Development (IIED), London. <http://pubs.iied.org/pdfs/12526IIED.pdf>. Accessed 11 May 2014
- Diarra M, Monimart M (2006) Landless women, hopeless women? Gender, land and decentralisation in Niger. IIED issue paper #143. International Institute for Environment and Development (IIED), London
- Doraiswamy P, McCarty G, Hunt E, Yost R, Doumbia M, Franzluebbers A (2007) Modeling soil carbon sequestration in agricultural lands of Mali. *Agric Syst* 94(1):63–74
- FAO (2005) Nigeria. [www.fao.org/nr/water/aquastat/countries/nigeria/index.stm](http://www.fao.org/nr/water/aquastat/countries/nigeria/index.stm)
- FAO (2007) AQUASTAT. [www.fao.org/nr/water/aquastat/data/query/index.html](http://www.fao.org/nr/water/aquastat/data/query/index.html). Accessed 21 Mar 2011
- FAO (2011) FAOSTAT. <http://faostat.fao.org/>. Accessed 28 Nov 2013.
- FAOSTAT (2012) Online data. <http://faostat.fao.org/>. Accessed 23 Mar 2014
- Fuglie KO, Rada N (2011) Policies and productivity growth in African agriculture. IFPRI/ASTI conference paper #19
- Fuglie K, Rada N (2012) Constraints to raising agricultural productivity in sub-Saharan Africa. In: Fuglie K (ed) *Productivity growth in agriculture: an international perspective*. CABI, Wallingford, pp 237–272
- GoK (Government of Kenya) (2009) *The agriculture (farm forestry) rules*. Government Printer, Nairobi
- Herrmann SM, Anyamba A, Tucker CJ (2005) Recent trends in vegetation dynamics in the African Sahel and their relationship to climate. *Glob Environ Chang* 15:394–404
- Hoffman I (2004) Access to land and water in the Zamfara reserve: a case study for the management of common property resources in pastoral areas of West Africa. *Hum Ecol* 32(1):77–105
- Jahnke HE (1982) *Livestock production systems and livestock development in tropical Africa*. Kieler Wissenschaftsverlag Vauk, Kiel
- Jayne T, Govereh J, Wanzala M, Demeke M (2003) Fertilizer market development: a comparative analysis of Ethiopia, Kenya and Zambia. *Food Policy* 28:293–316
- Jones P, Thornton P (2009) Croppers to livestock keepers: livelihood transitions to 2050 in Africa due to climate change. *Environ Sci Pol* 12:427–437
- Just RE, Pope RD (1979) Production function estimation and related risk considerations. *Am J Agric Econ* 61:276–284
- Kabubo-Mariara J, Karanja F (2006) The economic impact of climate change on Kenyan crop agriculture: a Ricardian approach. CEEPA discussion paper no. 12. Centre for Environmental Economics and Policy in Africa (CEEPA), University of Pretoria, Pretoria
- Kimmage K, Adams WM (1990) Small-scale farmer-managed irrigation in Northern Nigeria. *Geoforum* 21(4):435–443
- Lavigne Delville P (2000) Harmonising formal law and customary land rights in French-speaking West Africa. In: Toulmin J, Quan J (eds) *Evolving land rights, policy and tenure in Africa*. Department for International Development/International Institute for Environment and Development/Natural Resources Institute, London/Greenwich, pp 97–121
- Lind J, Cappon J (2001) Realities or rhetoric? Revisiting the decentralization of natural resource management in Uganda and Zambia. Acts Press, Nairobi
- Liverpool-Tasie LS, Takeshima H (2013) Input promotion within a complex subsector: fertilizer in Nigeria. *Agric Econ* 44:581–594

- Lobell D, Burke M, Tebaldi C, Mastrandrea M, Falcon W, Naylor R (2008) Prioritizing climate change adaptation needs for food security in 2030. *Science* 319(5863):607–610
- MAAIF (Ministry of Agriculture, Animal Industries and Fisheries) (1999) Framework for the national action programme to combat desertification and drought in Uganda: the way forward in implementing the United Nations Convention to Combat Desertification. MAAIF, Entebbe, Uganda. [www.unccd.int/actionprogrammes/africa/national/2000/uganda-eng.pdf](http://www.unccd.int/actionprogrammes/africa/national/2000/uganda-eng.pdf)
- Marenya P, Barrett C (2009) State-conditional fertilizer yield response on Western Kenyan farms. *Am J Agric Econ* 91(4):991–1006
- Mogues T, Morris M, Freinkman L, Adubi A, Ehui S (2008) Agricultural public spending in Nigeria. IFPRI Discussion Paper # 00789
- Mortimore M, Tiffen M, Boubacar Y, Nelson J (2001) Synthesis of long-term change in Maradi department, Niger, 1960–2000, Drylands research working paper no. 39e. Drylands Research, Crewkerne
- Mutunga C, Hardee K (2009) Population and reproductive health in national adaptation programmes of action (NAPAs) for climate change. In: Guzman JM, Martine G, McGranahan G, Schensul D, Tacoli C (eds) Population dynamics and climate change. United Nations Population Fund/International Institute for Environment and Development, New York/London, pp 176–191
- Mwangi E, Ostrom E (2009) Top-down solutions: looking up from East Africa's rangelands. *Environ: Sci Policy Sustain Dev* 51(1):34–45
- MWLE (Ministry of Water, Land and Environment) (2007) National adaptation programmes of action. Department of Meteorology, Government of Uganda, MWLE, Kampala
- Ndegwa S, Levy B (2004) The politics of decentralization in Africa: a comparative analysis. In: Levy B, Kpundel S (eds) Building state capacity in Africa: new approaches, emerging lessons. World Bank Institute, Washington, DC, pp 283–322
- NES (National Environmental Secretariat) (2002) National action programme: a framework for combating desertification in Kenya in the context of the United Nations Convention to Combat Desertification. NES, Nairobi. [www.unccd.int/actionprogrammes/africa/national/2002/kenya-eng.pdf](http://www.unccd.int/actionprogrammes/africa/national/2002/kenya-eng.pdf)
- Ng'endo M, Catacutan D, Kung'u J, Muriuki J, Kariuki J, Mowo J (2013) The policy environment of conservation agriculture with trees (CAWT) in Eastern Kenya: do small scale farmers benefit from existing policy incentives? *Afr J Agric Res* 8(23):2924–2939
- Nkonya E, Pender J, Kato E (2008) Who knows, who cares? The determinants of enactment, awareness, compliance with community natural resource management regulations in Uganda. *Environ Dev Econ* 13(1):79–101
- Nkonya E, Bisong F, Koo J, Xie H, Kato E, Izaurralde C, Traore PS et al (2010) SLM advisory services: key institutional, financing, economic elements for scaling up sustainable land management in Nigeria. Mimeo, International Food Policy Research Institute (IFPRI), Washington, DC
- Nkonya E, Afranaa kwapong N, Bashaasha B, Mangheni M, Kato E (2011) Is the provision of agricultural extension services better under decentralised than under centralised government systems? The case of Uganda. In: Tropentag proceedings 2011. Development on the margins, p 593. <http://www.tropentag.de/2011/proceedings/proceedings.pdf>
- Oladele OI (2013) Agricultural extension and rural advisory services: proactiveness or reactivity on climate change for food security in Africa. *Life Sci J* 10(3):593–597
- Olsson L, Eklundh L, Ardö J (2005) A recent greening of the Sahel: trends, patterns and potential causes. *J Arid Environ* 63(3):556–566
- Olubode-Awosola OO, Idowu EO, Van Schalkwyk HD (2005) Irrigation projects reform case studies: an assessment of projects' performance. In: Proceedings, river symposium. [www.riversymposium.com/2006/index.php?element=34](http://www.riversymposium.com/2006/index.php?element=34)



- Place F, Njuki J, Murithi F, Mugo F (2006) Agricultural enterprise and land management in the highlands of Kenya. In: Pender J, Place F, Ehui SJ (eds) Strategies for sustainable land management in the East African highlands. International Food Policy Research Institute (IFPRI), Washington, DC, pp 190–216
- Reij C, Tappan G, Smale M (2009) Re-greening the Sahel: farmer-led innovation in Burkina Faso and Niger. In: Spielman D, Pandya-Lorch R (eds) Millions fed. International Food Policy Research Institute, Washington, DC, pp 53–58
- Robinson LW, Berkes F (2011) Multi-level participation for building adaptive capacity: formal agency-community interactions in northern Kenya. *Glob Environ Chang* 21(4):1185–1194
- ROU (Republic of Uganda) (2008) Weather, climate and climate change in national development
- ROU (Republic of Uganda) (2010) National development program 2010/12–2014/15. Kampala
- Sauer J, Tchale H (2006) Alternative soil fertility management options in Malawi: an economic analysis. Paper presented at the International Association of Agricultural Economists conference, Gold Coast, 12–18 Aug
- Savadogo P, Sawadogo L, Tiveau D (2007) Effects of grazing intensity and prescribed fire on soil physical and hydrological properties and pasture yield in the Savanna woodlands of Burkina Faso. *Agric Ecosyst Environ* 118(1–4):80–92
- SDP (Smallholder Dairy Project) (2006) The uncertainty of cattle numbers in Kenya. SDP policy brief 10. International Livestock Research Institute, Nairobi
- Smale M (2006) Assessing the impact of crop genetic improvement in sub-Saharan Africa: research context and highlights. Genetic resource policies promising crop biotechnologies for smallholder farmers in East Africa: bananas and maize brief 19. IFPRI, Washington, DC
- Smale M, Jayne T (2008) Breeding an ‘amaizing’ crop: improved maize in Kenya, Malawi, Zambia, Zimbabwe. In: Spielman D, Pandya-Lorch R (eds) Millions fed. Proven successes in agricultural development. International Food Policy Research Institute, Washington, DC
- Smith P, Martino D, Cai Z, Gwary D, Janzen H, Kumar P, McCarl B, Ogle S, O’Mara F, Rice C, Scholes B, Sirotenko O, Howden M, McAllister T, Pan G, Romanenkov V, Schneider U, Towprayoon S, Wattenbach M, Smith J (2008) Greenhouse gas mitigation in agriculture. *Philos Trans R Soc* 363:789–813
- Svensden M, Ewing M, Msangi S (2009) Measuring irrigation performance in Africa, IFPRI discussion paper 00894. International Food Policy Research Institute, Washington, DC
- Takeshima H, Liverpool-Tasie LS (2013) Fertilizer subsidy, political influence and local food prices in sub-Saharan Africa: evidence from Nigeria. Selected paper prepared for presentation at the Agricultural & Applied Economics Association’s 2013 AAEA & CAES joint annual meeting, Washington, DC, 4–6 Aug 2013
- Thompson J, Pretty JN (1996) Sustainability indicators and soil conservation. A participatory impact study and self-evaluation of the catchment approach of the Ministry of Agriculture, Kenya. *J Soil Water Conserv* 51(4):265–273
- Tittonell P, Corbeels M, van Wijk M, Vanlauwe B, Giller K (2008) Combining organic and mineral fertilizers for integrated soil fertility management in smallholder farming systems of Kenya: explorations using the Crop–Soil Model FIELD. *Agron J* 100(5):1511–1526
- Toulmin C, Quan J (2000) Registering customary rights. In: Toulmin J, Quan J (eds) Evolving land rights, policy and tenure in Africa. Department for International Development/International Institute for Environment and Development/Natural Resources Institute, London/Greenwich, pp 207–228
- Vanlauwe B, Giller KE (2006) Popular myths around soil fertility management in sub-Saharan Africa. *Agric Ecosyst Environ* 116:34–46
- Vogel C, O’Brien K (2006) Who can eat information? Examining the effectiveness of seasonal climate forecasts and regional climate-risk management strategies. *Clim Res* 33:111–122
- World Bank (2008) World development report 2008: agriculture for development. World Bank, Washington, DC

- World Bank (2009) World development report 2010: development and climate change. World Bank, Washington, DC
- WRI (World Resource Institute) (2003) Forests, grasslands and drylands. [http://earthtrends.wri.org/select\\_action.php?theme=9](http://earthtrends.wri.org/select_action.php?theme=9)
- Yatich T, Kalinganire A, Weber J, Alinon K, Dakouo J, Samaké O, Sangaré S (2014) How do forestry codes affect access, use and management of protected indigenous tree species: evidence from West African Sahel, Occasional Paper No.15. World Agroforestry Centre, Nairobi
- Yesuf M, Di Falco S, Deressa T, Ringler C, Kohlin G (2008) The Impact of climate change and adaptation on food production in low-income countries: evidence from the Nile basin, Ethiopia, IFPRI discussion paper 828. International Food Policy Research Institute (IFPRI), Washington, DC

# Chapter 6

## Effects of Land Cover Changes on Soil Organic Carbon and Total Nitrogen Stocks in the Eastern Mau Forest Reserve, Kenya

Kennedy O. Were, Bal Ram Singh, and Øystein B. Dick

**Abstract** This study analysed the variations of soil organic carbon (SOC) and total nitrogen (TN) stocks under natural forests (NF), plantation forests (PF), bamboo forests (BF), and croplands that had been converted from such forests (i.e., NF2C, PF2C, and BF2C) in the Eastern Mau Forest Reserve using field, laboratory, spatial, and statistical techniques. The results displayed significant differences in SOC and TN stocks between NF and NF2C ( $p < 0.0001$ ), and between PF and PF2C ( $p < 0.0001$ ). For instance, the surface soils (0–15 cm) of NF had the highest SOC and TN stocks (71.6 and 7.1 Mg ha<sup>-1</sup>, respectively), while NF2C had the lowest (35.4 and 3.5 Mg ha<sup>-1</sup>). Similarly, the subsurface soils (15–30 cm) of NF had the highest stocks (55.7 and 5.6 Mg ha<sup>-1</sup>), while NF2C had the lowest (32.5 and 3.2 Mg ha<sup>-1</sup>). This reflects a decline in both SOC and TN stocks by about 51 % in the surface and about 42 % in the subsurface soils after NF conversion. There were also significant differences in SOC and TN stocks ( $p < 0.05$ ) between the surface and subsurface soils of different land cover types. The stocks decreased as soil depth increased. This trend suggests that (i) forest-to-cropland conversions are undermining the ecosystem's capacity for carbon sequestration, and (ii) subsurface soils have potential for carbon sequestration. SOC and TN losses in the croplands may be mitigated by adopting best management practices (BMPs), especially agro-forestry. These findings are useful for designing sustainable land management (SLM) and carbon sequestration projects.

---

K.O. Were (✉)

Department of Mathematical Sciences and Technology, Norwegian University of Life Sciences, P.O. Box 5003, NO-1432 Ås, Norway

Kenya Agricultural Research Institute, Kenya Soil Survey, P.O. Box 14733-00800, Nairobi, Kenya

e-mail: [kenwerez@yahoo.com](mailto:kenwerez@yahoo.com)

B.R. Singh

Department of Environmental Sciences, Norwegian University of Life Sciences, P.O. Box 5003, NO-1432 Ås, Norway

Ø.B. Dick

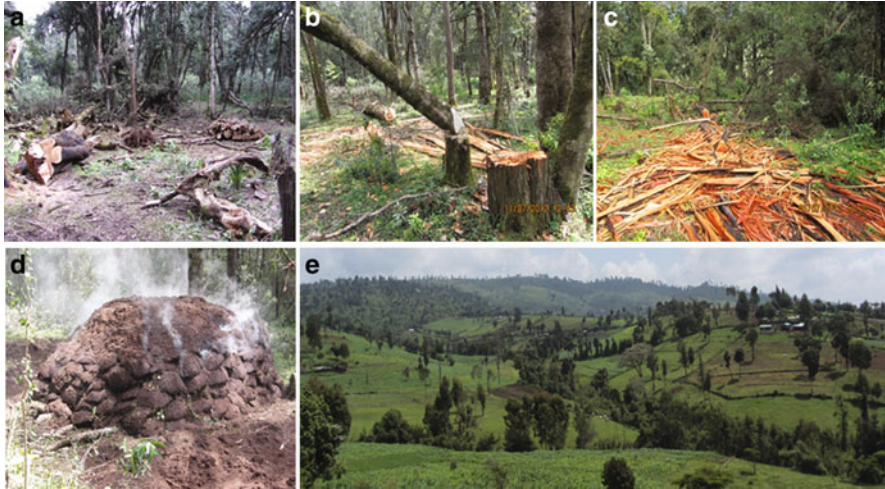
Department of Mathematical Sciences and Technology, Norwegian University of Life Sciences, P.O. Box 5003, NO-1432 Ås, Norway

**Keywords** Land cover changes • Soil organic carbon • Total nitrogen • Soil carbon sequestration • Eastern Mau

## 6.1 Introduction

Soil organic carbon (SOC) comprises organic compounds (i.e., plant, animal and microbial residues at all stages of decay) that are highly enriched in carbon (Lal 2008; Post and Kwon 2000; Solomon et al. 2000). SOC is a major determinant of the physical, chemical, and biological properties that are necessary for soil's proper functioning. For example, SOC ensures soil quality by supplying nutrients, enhancing cation exchange capacity (CEC), supporting biodiversity, and improving soil aggregation and water-holding capacity (Bationo et al. 2007). The quantity of SOC varies spatially and temporally because of climatic, edaphic, biotic (flora, fauna and humans), topographical, and lithological factors, which influence the balance between the gains and losses of soil carbon. However, the greatest carbon fluxes between the atmosphere and the Earth's surface are attributed to anthropogenic factors, including land use and land cover changes (IPCC 2013). Consequently, land cover change is a core theme of climate change research, which emphasizes the understanding of SOC responses to land cover dynamics. This is because the world's soils contain about 1,500 Pg C to 1 m depth (1 Pg =  $10^{15}$ g), while the atmosphere contains about 750 Pg C, and the biotic pool contains about 610 Pg C (Smith 2004, 2008; Lal 2004). Therefore, even slight changes in the SOC pool can significantly affect the global carbon cycle, climate, and soil properties (Powlson et al. 2011). This indicates that soil carbon sequestration is a potential strategy to mitigate climate change through reduction of CO<sub>2</sub> emissions as required by the United Nation Framework Convention for Climate Change (UNFCCC).

Many studies have reported that converting natural vegetation such as forests or grasslands to arable land impinges on soil carbon storage and fluxes (Demessie et al. 2013; Jafarian and Kavian 2013; Muñoz-Rojas et al. 2012; Biro et al. 2011; Don et al. 2011; Jiao et al. 2009; Awiti et al. 2008; Wang et al. 2008; Yimer et al. 2007; Evrendilek et al. 2004; Jing-Cheng et al. 2004; Powers 2004; Osher et al. 2003; Murty et al. 2002; Islam and Weil 2000; Solomon et al. 2000; Brown and Lugo 1990). Such conversions invariably result in SOC losses and CO<sub>2</sub> emissions because of the attendant changes in quality and quantity of biomass carbon inputs, accelerated decomposition of soil organic matter (SOM), leaching of dissolved organic carbon (DOC), and loss of particulates through mechanical clearing, water, and wind (Powlson et al. 2011; Detwiler 1986). However, the ultimate direction, magnitude, and rate of changes in SOC after land cover conversions depend on the initial carbon content of the soil, method of land clearance, terrain, soil type, climate, time since conversion, changes in the microbial community and nitrogen cycling, chemical properties of the litter, and land management practices (Vågen et al. 2005; Murty et al. 2002; Brown and Lugo 1990).



**Fig. 6.1** Human activities in the Eastern Mau Forest Reserve: (a, b, and c) illegal felling of trees; (d) charcoal burning; and (e) agricultural expansion and human settlement

In Kenya, human actions have brought dramatic changes to many crucial ecosystems; for example, the Eastern Mau Forest Reserve. It has experienced wanton destruction and degradation since the 1990s thanks to illegal logging, encroachments, and charcoal burning (Fig. 6.1), as well as ill-advised political decisions, particularly the excision of ~61,023 ha for human settlement in 2001 (Government of Kenya 2009; UNEP 2009). The Eastern Mau Forest Reserve is an important study site because it constitutes part of the largest closed-canopy indigenous montane forest in Eastern Africa, and is also one of Kenya's five key water catchment areas, which offers various ecosystem services, such as carbon sequestration, micro-climate regulation, ground water recharge, water storage, flood mitigation, etc. (UNEP 2009). Previous studies of land cover change in the area employed satellite remote sensing and GIS techniques (Were et al. 2013; Baldyga et al. 2007) to map the hotspots; that is, places where forests and shrublands had been converted to croplands. Although studies on the impacts on soil properties at such hotspots have been conducted globally, little attention has been paid to Eastern Africa. In particular, there is insufficient knowledge of how SOC has responded to deforestation and forest degradation in the Eastern Mau Forest Reserve. This study was designed to address these issues. The results will improve our understanding of SOC dynamics, the ecosystem's productivity and its role in climate change, as well as our capacity to monitor and predict carbon fluxes. This is essential to formulate realistic and effective policies for sustainable land management (SLM) and climate change mitigation.

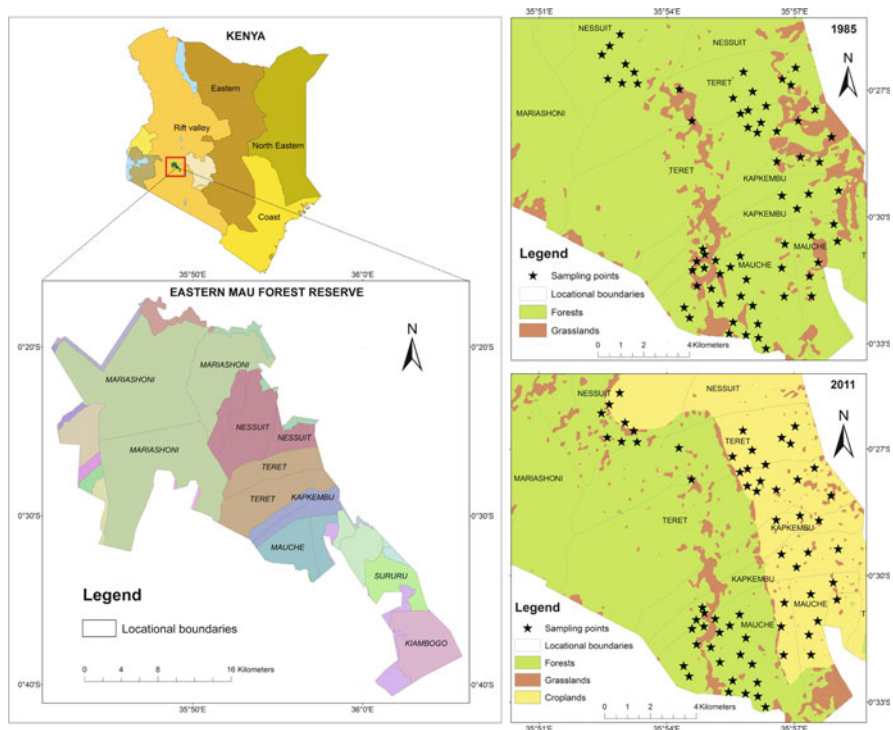
In this study, we analysed the effects of forest to cropland conversions on SOC, total nitrogen (TN), and bulk density (BD) in the Eastern Mau Forest Reserve. We then recommended the best management practices (BMPs) for SOC sequestration based on our results. We included TN in the study because of the intricate linkage

between soil C and N cycles. The study’s guiding hypothesis was that SOC, TN, and BD varied significantly between (i) forests and cropland establishments, and (ii) surface (0–15 cm) and subsurface soils (15–30 cm) of the land cover types.

## 6.2 Materials and Methods

### 6.2.1 Description of the Study Area

The study area covered Nessuiet, Teret, Kapkembu, and Mauche locations in the Eastern Mau Forest Reserve defined by the latitudes  $0^{\circ} 15' - 0^{\circ} 40'S$  and longitudes  $35^{\circ} 40' - 36^{\circ} 10'E$  (Fig. 6.2), and the altitudes ranging from 2,210 to 3,070 m above sea level. The climate is cool and humid, with the mean annual rainfall varying between 935 and 1,287 mm, and the mean annual temperature ranging from 9.8 to 17.5 °C (Jaetzold et al. 2010). The rainfall pattern is tri-modal with peaks in April, August, and November. The Njoro, Naishi, and Larmudiac Rivers drain the eastern



**Fig. 6.2** Geographical location of the study area and sampling points. The sampling points are superimposed on the land cover maps of 1985 and 2011 (on the *right*) that were derived from digital classification of Landsat TM imagery

slopes into Lake Nakuru, while the Nessuiet flows into Lake Bogoria, and the Rongai River into the Baringo. The area's physiography and lithology are characterized by major scarps and uplands comprising pyroclastic rocks, such as Pumice tuffs, of tertiary-quadernary volcanic age. These soft, light brown rocks have insets of yellow pumice and angular trachyte, which decompose into deep to very deep, dark reddish brown clayey soil aggregates (McCall 1967). The soils, classified as *Mollic Andosols*, are friable and smeary with humic topsoils (Jaetzold et al. 2010). The vegetation comprises indigenous trees, such as red stinkwood (*Prunus Africana*), bamboo (*Arundinaria alpina*), red cedar (*Juniperus procera*), African wild olive (*Olea europaea* ssp. *Africana*), East African olive (*Olea capensis* ssp. *hochstetteri*), broad-leaved yellowwood (*Podocarpus latifolius*), brittlewood (*Nuxia congesta*), clematis (*Clematis hirsuta*), schefflera (*Schefflera volkensii*), and forest dombeya (*Dombeya torrida*), exotic trees, such as pine (*Pinus patula*) and cypress (*Cupressus lusitanica*), as well as grasses like kikuyu grass (*Pennisetum clandestinum*). The major crops grown are maize (*Zea mays*), beans (*Phaseolus vulgaris*), wheat (*Triticum aestivum*), and potatoes (*Solanum tuberosum*).

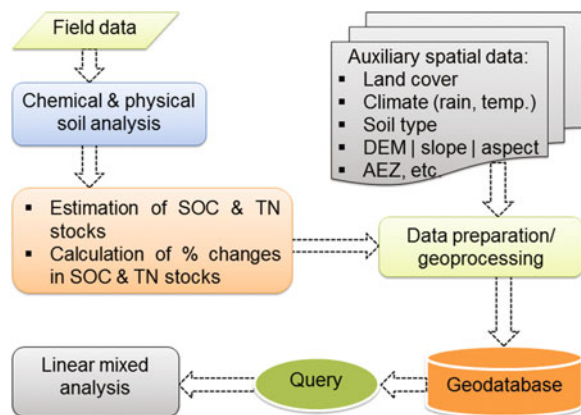
## 6.2.2 Data Sources, Processing and Analyses

The data and methods applied in this study are summarized in Fig. 6.3.

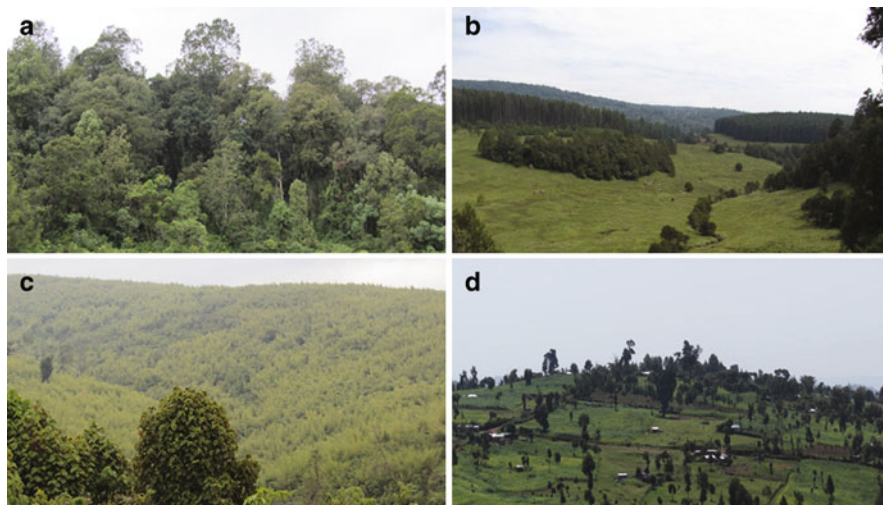
### 6.2.2.1 Field and Laboratory Methods

#### 6.2.2.1.1 Sampling Design and Soil Sampling

Fieldwork was conducted between June and August 2012. The sites were selected to minimize the variations in climate, soil type, and slope. Four to thirteen sampling



**Fig. 6.3** Schematic representation of the data and methods used in the study



**Fig. 6.4** Illustrations of the land cover types: (a) mixed natural forest; (b) pine and cypress plantation forest; (c) bamboo forest; and (d) croplands

plots ( $30 \times 30$  m) were laid out in a completely randomized design within the natural forests (NF), plantation forests (PF), bamboo forests (BF), and croplands that had been established on natural forests (NF2C), plantation forests (PF2C) and bamboo forests (BF2C) (Fig. 6.4). In each plot, an auger was used to collect soil samples from the centre and four corners of the plot at two depths, one at 0–15 cm and the other at 15–30 cm. The samples taken from corresponding depths were thoroughly mixed and bulked into one composite sample of about 500 g. To determine BD, a core sampler (5 cm in diameter and 5 cm in height) was used to collect one undisturbed sample per depth from each plot centre. Geographical position, elevation, vegetation, and land management practices at each plot were also recorded. A total of 120 soil samples were collected and transported to the National Agricultural Research Laboratories for chemical and physical analyses.

#### 6.2.2.1.2 Physical and Chemical Soil Analysis

At the laboratory, the soil samples were air-dried, ground and passed through a 2 mm mesh. SOC concentration was determined using Walkley-Black wet oxidation method (Nelson and Sommers 1982), while TN concentration was determined using Kjeldahl digestion method (Bremner and Mulvaney 1982). BD was estimated using the core method after oven-drying a specific volume of soil at  $105^\circ\text{C}$  for 48 h (Blake 1965). Particle size distribution was analysed using the hydrometer method after dispersing soil and eliminating organic matter (Day 1965). Potassium (K) was measured by a flame-photometer, calcium (Ca) and magnesium (Mg) by an atomic absorption spectrophotometer and pH (1:2.5 soil-water) by a pH meter (Okalebo



et al. 2002). Phosphorous (P) was analysed using the Mehlich method (Okalebo et al. 2002). The data on soil properties are found in Table 6.1.

### 6.2.2.1.3 Estimation of Soil Organic Carbon and Total Nitrogen Stocks

Stocks of SOC ( $\text{Mg C ha}^{-1}$ ) for each depth were calculated using Eq. 6.1:

$$\text{SOC}_{st} = \frac{\text{SOC}}{100} \times \text{BD} \times \text{D} \times 100 \quad (6.1)$$

where:  $\text{SOC}_{st}$  is the soil organic carbon stock ( $\text{Mg C ha}^{-1}$ ); SOC is the soil organic carbon concentration (%), which is then converted to  $\text{g C g}^{-1}$  soil; BD is the bulk density ( $\text{g cm}^{-3}$ ); D is the depth (cm); 100 is the multiplication factor to convert the SOC per unit area from  $\text{g C cm}^{-2}$  to  $\text{Mg C ha}^{-1}$ . Coarse particles were negligible due to the softness of the volcanic rocks; hence, Eq. 6.1 does not account for them. Similarly, TN mass per unit area ( $\text{TN}_{st}$ ;  $\text{Mg N ha}^{-1}$ ) for each depth was computed by substituting TN for SOC in Eq. 6.1. The percentage changes ( $\Delta$ ) in  $\text{SOC}_{st}$  (or  $\text{TN}_{st}$ ) following NF, PF or BF conversions were then estimated using Eq. 6.2:

$$\Delta(\%) = \frac{\text{SOC}_{st} \text{ (or TN}_{st}) \text{ under NF2C (PF2C or BF2C)} - \text{SOC}_{st} \text{ (or TN}_{st}) \text{ under NF (PF or BF)}}{\text{SOC}_{st} \text{ (or TN}_{st}) \text{ under NF (PF or BF)}} \times 100 \quad (6.2)$$

SOC and TN stocks in the surface (0–15 cm) and subsurface soils (15–30 cm) were summed up to obtain the total stocks in the soil from the surface to a depth 30 cm.

### 6.2.2.2 Remote Sensing and GIS Methods

Land cover maps (Fig. 6.2) produced through classification of terrain-corrected Landsat 5 TM images acquired in 1985 and 2011 were taken from Were et al. (2013). The images were atmospherically corrected, geometrically co-registered, and subsets made for classification using partitioning, hybrid classification, and spatial reclassification techniques. The subset for each date was further subdivided into spectrally distinct segments for separate classification. Depending on the degree of spatial heterogeneity, 15–30 spectral clusters were defined for each segment using an unsupervised classification procedure involving the ISODATA algorithm. The resultant clusters were assigned land cover labels (grassland, forest, or cropland) based on the analyst's knowledge of the area, as well as the ancillary and field data. In case of errors, supplementary spectral signatures were extracted, merged with the signatures of ISODATA clusters, and classified using the maximum likelihood algorithm. The land cover classes in each classified segment were recoded and, subsequently, the segments for each date were mosaicked. Finally, a majority filter was applied to reduce noise on the resultant seamless land cover

**Table 6.1** Some soil properties of the different land cover types (means and standard deviations)

Land cover	<i>n</i>	Depth	Soil properties									
			SOC (%)	TN (%)	P (ppm)	K (me %)	pH	BD (g cm <sup>-3</sup> )	Sand (%)	Silt (%)	Clay (%)	
NF	15	0-15	6.1 ± 1.3	0.6 ± 0.1	26.3 ± 6.5	0.9 ± 0.30	5.6 ± 0.3	0.8 ± 0.2	37.1 ± 6.5	31.5 ± 4.4	31.5 ± 7.2	
	15	15-30	4.2 ± 0.8	0.4 ± 0.1	22.9 ± 8.0	0.8 ± 0.47	5.5 ± 0.3	0.9 ± 0.1	33.3 ± 5.1	39.6 ± 3.6	27.1 ± 3.0	
NF2C	15	0-15	3.1 ± 0.8	0.3 ± 0.1	29.9 ± 8.6	1.2 ± 0.31	6.1 ± 0.5	0.8 ± 0.1	38.1 ± 6.7	39.5 ± 5.3	22.4 ± 4.7	
	15	15-30	2.4 ± 0.5	0.2 ± 0.1	26.1 ± 7.7	1.0 ± 0.26	6.0 ± 0.5	0.9 ± 0.1	31.7 ± 8.3	44.8 ± 6.3	23.5 ± 4.3	
PF	13	0-15	3.9 ± 0.5	0.4 ± 0.1	16.4 ± 4.7	0.5 ± 0.17	5.3 ± 0.3	0.9 ± 0.1	32.9 ± 4.1	38.6 ± 5.0	28.5 ± 4.6	
	13	15-30	3.5 ± 0.5	0.3 ± 0.1	14.9 ± 2.8	0.4 ± 0.11	5.0 ± 0.2	1.0 ± 0.1	34.0 ± 3.6	41.4 ± 5.3	24.6 ± 3.8	
PF2C	13	0-15	3.2 ± 0.8	0.3 ± 0.1	27.6 ± 8.0	1.0 ± 0.37	5.9 ± 0.2	0.8 ± 0.1	39.7 ± 4.8	38.9 ± 5.6	21.4 ± 5.4	
	13	15-30	2.3 ± 0.4	0.2 ± 0.1	25.8 ± 8.9	0.9 ± 0.29	6.0 ± 0.3	0.9 ± 0.1	34.2 ± 5.3	43.9 ± 5.4	22.0 ± 5.7	
BF	4	0-15	5.2 ± 2.3	0.5 ± 0.2	28.3 ± 7.0	1.3 ± 0.26	5.6 ± 0.2	0.8 ± 0.1	35.5 ± 3.4	30.0 ± 5.2	34.5 ± 6.0	
	4	15-30	3.3 ± 0.8	0.3 ± 0.1	25.0 ± 10.8	1.3 ± 0.36	5.6 ± 0.6	0.8 ± 0.1	36.0 ± 5.4	28.5 ± 5.0	35.5 ± 4.4	
BF2C	4	0-15	5.2 ± 2.2	0.5 ± 0.2	32.3 ± 10.6	1.5 ± 0.44	6.0 ± 0.5	0.8 ± 0.1	38.5 ± 8.5	31.5 ± 5.0	30.0 ± 9.8	
	4	15-30	2.7 ± 0.7	0.3 ± 0.1	26.3 ± 11.2	1.1 ± 0.29	5.6 ± 0.6	0.8 ± 0.1	34.0 ± 5.2	38.5 ± 4.1	27.5 ± 1.9	

Note: *NF* natural forest, *NF2C* natural forest converted to cropland, *PF* plantation forest, *PF2C* plantation forest converted to cropland, *BF* bamboo forest, and *BF2C* bamboo forest converted to cropland

maps. The quality of these maps was assessed using ancillary, temporally-invariant, and ground data. The overall accuracy of the 1985 and 2011 land cover maps were 95 % and 89 %, respectively.

Existing databases provided the auxiliary spatial data used to describe the topographical, climatic, agro-ecological, and pedological attributes of the area. Climate data (mean annual temperature and rainfall) were obtained from [www.worldclim.org](http://www.worldclim.org), soil data (soil type) from the Kenya Soil Survey, data on agro-ecological zonation from [www.ilri.org/gis](http://www.ilri.org/gis), and the digital elevation model (DEM) from <http://srtm.csi.cgiar.org>. Slope and aspect were extracted from the DEM. All these data were transformed to the Universal Transverse Mercator coordinate system (UTM WGS84 Zone 36S). The area of interest was clipped from each thematic layer, and all layers in vector format were rasterized. The datasets were then resampled to 100 m and a geodatabase was built. The field and laboratory data were also integrated into the geodatabase as points using the geographical coordinates that were recorded at each sampling plot. The attribute values from each raster dataset (e.g., slope, rainfall, soil type) were extracted to these points. This facilitated querying of the geodatabase to select only those points that met the criteria for statistical analyses. All geoprocessing and analyses were performed using ArcGIS® 10.1 and ERDAS IMAGINE® 2011.

### 6.2.2.3 Statistical Methods

Soil attributes of the point data in the geodatabase were summarized by land cover types and soil depths. Descriptive and correlation statistics were used to explore the distributions and relationships among various soil characteristics. Subsequently, linear mixed models were fitted to test the effects of land cover, soil depth, and sampling plot on SOC, SOC<sub>st</sub>, TN, TN<sub>st</sub> and BD for each category of forest to cropland conversion: NF vs. NF2C; PF vs. PF2C; and, BF vs. BF2C. Equation 6.3 shows the form of the statistical model (Montgomery 2006):

$$y_{ijkl} = \mu + \tau_i + \beta_j + \gamma_k + \epsilon_{ijkl} \quad (6.3)$$

where:  $\mu$  is the overall mean,  $\tau_i$  is the fixed effect of the  $i$ th land cover treatment,  $\beta_j$  is the fixed effect of the  $j$ th soil depth treatment,  $\gamma_k$  is the random effect of sampling plot, and  $\epsilon_{ijkl}$  is the normally and independently distributed random error with zero mean and constant variance. Pairwise comparisons between the types of land cover and soil depths were based on *post hoc* t-tests at a 5 % significance level. The  $p$ -values were adjusted by single-step method. Homoscedasticity was checked using residual plots and normality using normal probability plots. All analyses were carried out using package “nlme” and “lme4” in R version 3.0.1 (R Core Team 2013) and Microsoft Excel® 2010.

## 6.3 Results

### 6.3.1 *Basic Soil Properties Under Different Land Cover Types and Soil Depths*

The means and standard deviations of select physical and chemical soil properties of different land cover types are presented in Table 6.1. In the surface soils (0–15 cm), the highest BD was in PF and the lowest in NF2C, while in the subsurface soils (15–30 cm), the highest BD was in PF and the lowest in BF. At all sites, BD never exceeded  $1.0 \text{ g cm}^{-3}$  and was higher in the subsurface soils. Conversely, SOC and TN concentrations ranged from moderate to high and diminished as soil depth increased. In the surface soils, the highest SOC and TN concentrations were in NF (6.1 % and 0.6 %, respectively) and the lowest in NF2C (3.1 % and 0.3 %), while in the subsurface soils, the highest SOC and TN concentrations were in NF (4.2 % and 0.4 %) and the lowest in PF2C (2.3 % and 0.2 %). The proportions of soil separates ranged from 32 to 40 % for sand, 31–45 % for silt, and 21–32 % for clay. Sand content was generally higher in the surface soils, while silt content was higher in the subsurface soils. The soils were moderately acidic with the pH levels varying between 5.0 and 6.1. NF2C had the highest pH values, while PF had the lowest pH values in both soil depths. The lowest available phosphorus and potassium were both in the surface and subsurface soils of PF, while the highest was in the surface soils of BF2C. Correlation patterns in the matrix show that SOC concentration was positively correlated with TN concentration and clay content, but negatively with BD, silt, and sand content, both in the surface and subsurface soils (Table 6.2). The correlations of TN concentration with other soil properties showed similar trends to SOC concentration.

### 6.3.2 *Estimated SOC and TN Stocks Under Different Land Cover Types and Soil Depths*

According to Table 6.3, in the surface soils (0–15 cm), the highest SOC and TN stocks were in NF (71.6 and  $7.1 \text{ Mg ha}^{-1}$ , respectively) and the lowest in NF2C (35.4 and  $3.5 \text{ Mg ha}^{-1}$ ). In the subsurface soils (15–30 cm), the highest stocks were still in NF (55.7 and  $5.6 \text{ Mg ha}^{-1}$ ), but the lowest were in PF2C (32.3 and  $3.2 \text{ Mg ha}^{-1}$ ). Both SOC and TN stocks decreased as depth increased at all sites as shown in Figs. 6.5 and 6.6. The highest proportions of change in the stocks followed conversions from NF, while the lowest followed conversions from BF. In particular, cultivation of NF reduced both SOC and TN stocks by about 51 % in the surface soils, and about 42 % in the subsurface soils (Table 6.3; Figs. 6.7 and 6.8). Further, cultivation of PF reduced SOC and TN stocks by about 28 % each in the surface soils, and about 36 % each in the subsurface soils. However, cultivation of BF presented mixed results. In the surface soils, SOC stocks increased by 1 %, while TN stocks decreased by 0.6 %. In the subsurface soils, SOC and TN stocks were

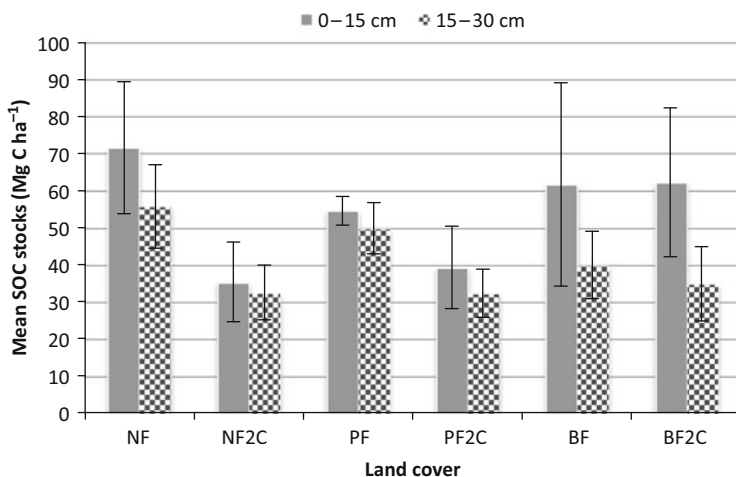
**Table 6.2** Pearson's correlation coefficients of the soil properties

Soil properties	Soil depth (0–15 cm)					Soil depth (15–30 cm)						
	TN	SOC	BD	Clay	Silt	Sand	TN	SOC	BD	Clay	Silt	Sand
	1.00						1.00					
SOC	0.99	1.00					0.99	1.00				
BD	-0.19	-0.19	1.00				-0.06	-0.05	1.00			
Clay	0.66	0.66	-0.14	1.00			0.23	0.21	-0.31	1.00		
Silt	-0.69	-0.69	0.26	-0.61	1.00		-0.50	-0.49	0.32	-0.53	1.00	
Sand	-0.09	-0.10	-0.10	-0.58	-0.29	1.00	0.35	0.35	-0.08	-0.32	-0.64	1.00

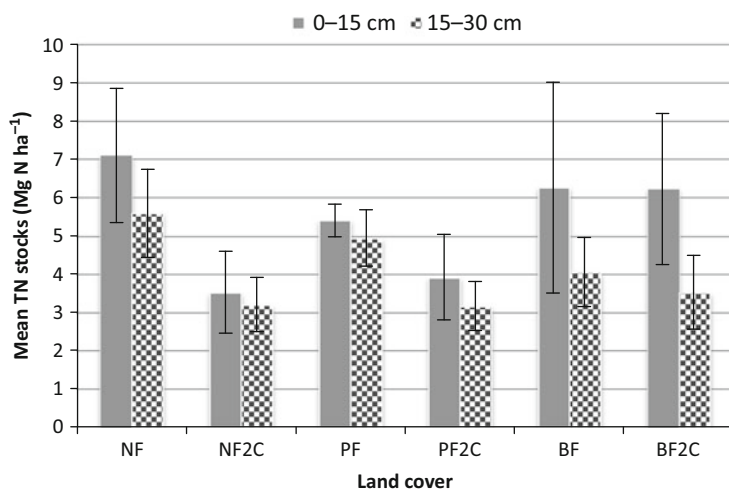
**Table 6.3** Soil organic carbon and total nitrogen stocks under different land cover types and soil depths (means and standard deviations)

Land cover	Soil depth (0–15 cm)			Soil depth (15–30 cm)			Soil depth (0–30 cm)		
	SOC <sub>st</sub> (Mg ha <sup>-1</sup> )	% change	TN <sub>st</sub> (Mg ha <sup>-1</sup> )	SOC <sub>st</sub> (Mg ha <sup>-1</sup> )	% change	TN <sub>st</sub> (Mg ha <sup>-1</sup> )	SOC <sub>st</sub> (Mg ha <sup>-1</sup> )	% change	TN <sub>st</sub> (Mg ha <sup>-1</sup> )
NF	71.6 ± 17.9		7.1 ± 1.8	55.7 ± 11.3		5.58 ± 1.2	127.3 ± 26.5		12.7 ± 2.6
NF2C	35.4 ± 10.8	-50.6	3.5 ± 1.1	32.5 ± 7.4	-41.8	3.20 ± 0.7	67.8 ± 15.5	-46.8	6.7 ± 1.6
PF	54.6 ± 3.9		5.4 ± 0.4	49.9 ± 7.0		4.94 ± 0.7	104.3 ± 8.9		10.3 ± 1.0
PF2C	39.3 ± 11.2	-28.0	3.9 ± 1.1	32.3 ± 6.5	-27.6	3.16 ± 0.6	71.5 ± 14.2	-31.48	7.1 ± 1.5
BF	61.6 ± 27.3		6.3 ± 2.8	39.9 ± 9.0		4.05 ± 0.9	101.5 ± 32.3		10.3 ± 3.3
BF2C	62.2 ± 20.1	1.0	6.2 ± 2.0	34.8 ± 10.2	-0.6	3.52 ± 1.0	97.0 ± 19.8	-4.48	9.7 ± 1.9

Note: *NF* natural forest, *NF2C* natural forest converted to cropland, *PF* plantation forest, *PF2C* plantation forest converted to cropland, *BF* bamboo forest, and *BF2C* bamboo forest converted to cropland

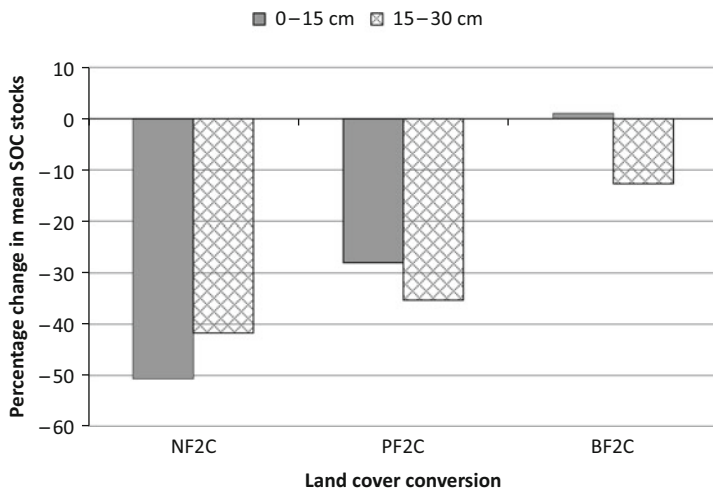


**Fig. 6.5** Soil organic carbon stocks under different land cover types and soil depths. *NF* natural forest, *NF2C* natural forest converted to cropland, *PF* plantation forest, *PF2C* plantation forest converted to cropland, *BF* bamboo forest, and *BF2C* bamboo forest converted to cropland

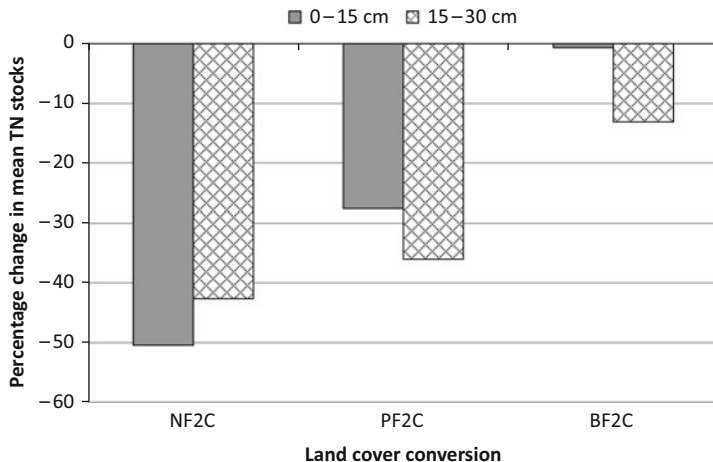


**Fig. 6.6** Total nitrogen stocks under different land cover types and soil depths. *NF* natural forest, *NF2C* natural forest converted to cropland, *PF* plantation forest, *PF2C* plantation forest converted to cropland, *BF* bamboo forest, and *BF2C* bamboo forest converted to cropland

about 13 % lower than at the surface. The same patterns were observed even when the entire topsoil (0–30 cm) was considered. The highest stocks of SOC amounting to 127 Mg ha<sup>-1</sup> were in *NF*, which cropland conversion reduced by 46.8 %. The lowest stocks of SOC amounting to 101.5 Mg ha<sup>-1</sup> were in *BF*, which cropland conversion reduced by 4.4 %. Similarly, the highest stocks of TN were in *NF* (12.7 Mg ha<sup>-1</sup>), which cropland conversion reduced by 47 %. The lowest stocks were in *BF* (10.3 Mg ha<sup>-1</sup>), which reduced by 5.4 % when converted to croplands.



**Fig. 6.7** Percentage change in SOC stocks following forest conversions. *NF2C* natural forest converted to cropland, *PF2C* plantation forest converted to cropland, and *BF2C* bamboo forest converted to cropland



**Fig. 6.8** Percentage change in TN stocks following forest conversion. *NF2C* natural forest converted to cropland, *PF2C* plantation forest converted to cropland, and *BF2C* bamboo forest converted to cropland



### 6.3.3 *Effects of Land Cover and Soil Depth on SOC, SOC<sub>st</sub>, TN, TN<sub>st</sub> and BD*

Table 6.4a shows a statistically significant land-cover effect on all the soil properties ( $p < 0.0001$ ) except for BD ( $p = 0.6648$ ) in the NF vs. NF2C category. SOC ( $p < 0.0001$ ), SOC<sub>st</sub> ( $p < 0.001$ ), TN ( $p < 0.0001$ ), and TN<sub>st</sub> ( $p < 0.001$ ) in NF differed from NF2C. However, BD were equal ( $p = 0.9450$ ). There was also a highly significant soil-depth effect on SOC ( $p < 0.0001$ ), SOC<sub>st</sub> ( $p = 0.0002$ ), TN ( $p < 0.0001$ ), TN<sub>st</sub> ( $p = 0.0002$ ), and BD ( $p < 0.0001$ ). SOC ( $p < 0.0001$ ), SOC<sub>st</sub> ( $p < 0.001$ ), TN ( $p < 0.0001$ ), TN<sub>st</sub> ( $p < 0.001$ ), and BD ( $p < 0.0001$ ) between soil depth 0–15 cm and 15–30 cm were significantly different.

Similarly, land cover had a highly significant effect on SOC ( $p = 0.0001$ ), SOC<sub>st</sub> ( $p = 0.0001$ ), TN ( $p = 0.0002$ ), TN<sub>st</sub> ( $p < 0.0001$ ), and BD ( $p = 0.0191$ ) in the PF vs. PF2C category (Table 6.4b). There were significant differences in SOC ( $p < 0.0001$ ), SOC<sub>st</sub> ( $p < 0.001$ ), TN ( $p < 0.0001$ ), TN<sub>st</sub> ( $p < 0.001$ ), and BD ( $p = 0.0320$ ) between PF and PF2C. Soil depth also had a highly significant effect on SOC ( $p < 0.0001$ ), SOC<sub>st</sub> ( $p = 0.0038$ ), TN ( $p < 0.0001$ ), TN<sub>st</sub> ( $p = 0.0026$ ), and BD ( $p = 0.0153$ ). SOC ( $p < 0.0001$ ), SOC<sub>st</sub> ( $p = 0.0041$ ), TN ( $p < 0.0001$ ), TN<sub>st</sub> ( $p = 0.0026$ ), and BD ( $p = 0.0255$ ) in soil depth 0–15 cm differed from soil depth 15–30 cm.

In contrast, land cover had no significant effect on SOC ( $p = 0.7894$ ), SOC<sub>st</sub> ( $p = 0.8217$ ), TN ( $p = 0.7460$ ), TN<sub>st</sub> ( $p = 0.7749$ ), and BD ( $p = 0.6992$ ) in the BF vs. BF2C category (Table 6.4c). SOC ( $p = 0.9825$ ), SOC<sub>st</sub> ( $p = 0.990$ ), TN ( $p = 0.9699$ ), TN<sub>st</sub> ( $p = 0.9794$ ), and BD ( $p = 0.9540$ ) in BF were similar to BF2C. However, soil depth had a significant effect on all the soil properties (SOC ( $p = 0.0284$ ), SOC<sub>st</sub> ( $p = 0.0206$ ), TN ( $p = 0.0279$ ), and TN<sub>st</sub> ( $p = 0.0204$ )) except for BD ( $p = 0.4545$ ). Pairwise comparisons revealed differences in SOC ( $p = 0.0157$ ), SOC<sub>st</sub> ( $p = 0.008$ ), TN ( $p = 0.0158$ ), and TN<sub>st</sub> ( $p = 0.008$ ), but similarities in BD ( $p = 0.7610$ ), between soil depths 0–15 and 15–30 cm.

## 6.4 Discussion

The empirical results suggest that forest-to-cropland conversions have reduced SOC and TN concentrations and stocks in the Eastern Mau Forest Reserve. The mean SOC and TN concentrations and stocks between forests and cropland establishments differed significantly as hypothesized (Table 6.4), and sometimes the difference was by as much as half (Table 6.3). This is consistent with the findings of previous studies in the tropics (Enanga et al. 2011; Walker and Desanker 2004; Lemenih et al. 2005; Bewketa and Stroosnijder 2003; Solomon et al. 2000; Detwiler 1986). In these studies, the rates and magnitude of decrease in SOC and TN stocks varied with soil type and time since conversion to cropland. The declining trend mostly persists until new steady states of carbon and nitrogen are reached

**Table 6.4** Statistical summary of land-cover and soil-depth effects on SOC, SOC<sub>st</sub>, TN, TN<sub>st</sub>, and BD

Source of variation	SOC		SOC <sub>st</sub>		TN		TN <sub>st</sub>		BD	
	F	P	F	P	F	P	F	P	F	P
(a) NF vs. NF2C										
Land cover	63.22	<0.0001	56.46	<0.0001	66.09	<0.0001	57.44	<0.0001	0.19	0.6648
Soil depth	72.51	<0.0001	18.02	0.0002	76.39	<0.0001	17.65	0.0002	32.01	<0.0001
Land cover × Soil depth	16.47	0.0004	8.61	0.0066	16.17	0.0004	7.42	0.0110	–	–
(b) PF vs. PF2C										
Land cover	22.17	0.0001	49.89	<0.0001	20.04	0.0002	44.92	<0.0001	6.32	0.0191
Soil depth	37.75	<0.0001	10.18	0.0038	40.00	<0.0001	11.15	0.0026	6.78	0.0153
(c) BF vs. BF2C										
Land cover	0.08	0.7894	0.06	0.8217	0.12	0.7460	0.09	0.7749	0.16	0.6992
Soil depth	7.57	0.0284	8.87	0.0206	7.65	0.0279	8.90	0.0204	0.62	0.4545

Note: The degree of freedom was 1 in all cases; *F* *F*-value, *NF* Natural forest, *NF2C* natural forest converted to cropland, *PF* plantation forest, *PF2C* plantation forest converted to cropland, *BF* bamboo forest, and *BF2C* bamboo forest converted to cropland

after years of continuous cultivation (Eaton et al. 2008; Lemenih et al. 2005; Evrendilek et al. 2004).

The decrease in SOC and TN stocks per se can be explained by the subsequent disruption of the balance between inputs and outputs of carbon and nitrogen in the soil system after forest conversion. Forest ecosystems usually have a higher net primary productivity (NPP) than agro-ecosystems; thus, their inputs of detritus to the soils are also higher (Eclesia et al. 2012; Smith 2008). In Eastern Mau, the NPP of forests and inputs of carbon and nitrogen to their soils is even higher because of the extremely fertile *Andosols* and high rainfall amounts. Despite the lower NPP of agro-ecosystems, the bulk of their biomass is usually removed from the crop fields after harvest for use as food or fuel. Only a small amount of readily decomposable residues remain on the fields to accumulate SOM. Removal of crop biomass after harvest also aggravates the erosion processes, which were initiated by clearance of forests, in the predominant uplands leading to SOC and TN losses. Additionally, frequent tillage and other perturbations disintegrate soil aggregates, redistribute crop residues, and alter soil aeration, moisture, and temperature. This accelerates microbial decomposition and oxidation of the soil's organic matter to CO<sub>2</sub>, which is ultimately emitted to the atmosphere (Wiesmeier et al. 2012; Batlle-Aguilar et al. 2011; Lal 2004; Powers 2004; Murty et al. 2002; Follett 2001). The reduction of SOC and TN stocks after forest conversions occurred regardless of the application of inorganic fertilizers in most croplands. This implies that supplementing fertilization by agro-forestry techniques, such as planting fast-growing, highly productive, deep-rooted, and nitrogen-fixing tree species within NF2C and PF2C, may be the optimal option to restore and enhance SOC and TN stocks.

In contrast, the mean SOC and TN concentrations and stocks between BF and BF2C were similar (Table 6.4c). This can be attributed to the establishment of croplands within BF less than 10 years ago. The sample sizes for BF and BF2C were also small ( $n=4$ ); hence, the data may not have fully represented the variations within these land cover treatments. Future studies should increase the sample sizes in these two land cover groups to reduce the relatively large standard deviations from the mean SOC and TN stocks.

Further, the results revealed that BD in the croplands had not significantly changed (Table 6.4) except for PF2C. This was unexpected because BD tends to increase as tillage breaks down soil aggregates. But as Walker and Desanker (2004) argued, the tillage of most croplands by hand may have only caused minimal disturbances to substantially increase the BD. This may have obviated the confounding influence of BD changes on estimating the changes in SOC and TN stocks after deforestation, as well as on analysing land-cover effect on these stocks. There was no confounding either in the PF vs. PF2C category because comparable results were obtained even when BD was included as a covariate in the statistical analyses.

Finally, SOC and TN concentrations and stocks decreased significantly as soil depth increased under all land cover treatments, which is in accordance with previous studies (Demessie et al. 2013; Li et al. 2013; Zhang et al. 2012, 2013; Fang et al. 2012; Girmay and Singh 2012; Han et al. 2010; Wang et al. 2010; Chen et al. 2009; Birch-Thomsen et al. 2007; Yimer et al. 2007; Brown and Lugo 1990).

The cause of this decline is that organic material inputs to forest soils (litter fall, exudates, leachates, dead roots, etc.) and agricultural soils (crop residues, manures, fertilizers, etc.) mostly reside in the upper layers, with only small amounts penetrating much deeper. High precipitation in the area may also instigate leaching of dissolved organic carbon and nitrogen compounds from the subsurface soils (15–30 cm) to deeper soils that were not sampled. The lower concentrations and stocks of SOC in the subsurface soils also help to explain the corresponding higher BD values. Other factors that may account for higher BD in the subsurface soils include reduced aggregation, root penetration, and soil micro-organism populations, as well as the compacting weight of surface soils (USDA 2008).

## 6.5 Conclusions and Recommendations

This study assessed the effects of forest to cropland conversions on SOC, TN, and BD in the Eastern Mau Forest Reserve. Based on the results, we conclude that (i) conversion of forests, particularly NF and PF, to croplands has led to a significant decline in the concentrations and stocks of SOC and TN, but no significant BD changes, and (ii) the surface soils contain significantly more concentrations and stocks of SOC and TN, while BD is significantly higher in the subsurface soils. This indicates that (i) transformation from natural to human-dominated landscape increases the risk of soil degradation and restricts the ecosystem's capacity to store carbon and nitrogen, and (ii) the subsurface soils have potential for carbon and nitrogen storage. Thus, intervention measures to enhance carbon and nitrogen storage should focus not only on surface soils, but also on subsurface soils. BMPs may reduce carbon and nitrogen losses in the croplands, especially agro-forestry practices that introduce fast-growing, highly productive, deep-rooted, and nitrogen-fixing trees. Long-term carbon and nitrogen storage in the forest soils depends on proper management and protection of the forests from further deforestation and degradation. Appropriate land use and land use change policies are needed to protect the soils.

The findings of this study improve our knowledge of the impacts of human activities on soil properties in the area. They also provide a basis to design sustainable land management and carbon sequestration strategies. In view of the ongoing soil degradation and requirements for sequestration of atmospheric CO<sub>2</sub>, future research should also employ remote sensing and GIS approaches to model and map the spatial patterns of carbon and nitrogen stocks. These approaches can afford holistic information and deeper understanding of carbon and nitrogen storage and fluxes throughout East Africa.

**Acknowledgements** This study was funded by the Research Council of Norway through the Norwegian University of Life Sciences. Special thanks go to Mr. P. Owenga for technical support during fieldwork, Mr. E. Thairu for excellent driving under difficult field conditions, and the two reviewers for improving the manuscript.

## References

- Awiti AO, Walsh MG, Kinyamario J (2008) Dynamics of topsoil carbon and nitrogen along a tropical forest–cropland chronosequence: evidence from stable isotope analysis and spectroscopy. *Agric Ecosyst Environ* 127:265–272
- Baldyga T, Miller SN, Driese KL, Gichaba CM (2007) Assessing land cover change in Kenya's Mau forest region using remotely-sensed data. *Afr J Ecol* 46:46–54
- Bationo A, Kihara J, Vanlauwe B, Waswa B, Kimetu J (2007) Soil organic carbon dynamics, functions and management in West African agro-ecosystems. *Agr Syst* 94:13–25
- Battle-Aguilar J, Brovelli A, Porporato A, Barry DA (2011) Modelling soil carbon and nitrogen cycles during land use change – a review. *Agron Sustain Dev* 31:251–274
- Bewketa W, Stroosnijder L (2003) Effects of agro-ecological land use succession on soil properties in Chemoga watershed, Blue Nile basin, Ethiopia. *Geoderma* 111:85–98
- Birch-Thomsen T, Elberling B, Fog B, Magid J (2007) Temporal and spatial trends in soil organic carbon stocks following maize cultivation in semi-arid Tanzania, East Africa. *Nutr Cycl Agroecosyst* 79:291–302
- Biro K, Pradhan B, Buchroithner M, Makeschin F (2011) Land use/land cover change analysis and its impact on soil properties in the northern part of Gadarif region, Sudan. *Land Degrad Dev* 24:90–102
- Blake GR (1965) Bulk density. In: Black CA (ed) *Methods of soil analysis, Part 1. Physical and mineralogical properties, including statistics of measurement and sampling*. American Society of Agronomy, Inc, Madison
- Bremner JM, Mulvaney CS (1982) Nitrogen – total. In: Page AL (ed) *Methods of soil analysis, Part 2. Chemical and microbiological properties, 2nd edn*. American Society of Agronomy, Inc, Madison
- Brown S, Lugo AE (1990) Effects of forest clearing and succession on the carbon and nitrogen content of soils in Puerto Rico and US Virgin Islands. *Plant Soil* 124:53–64
- Chen H, Marhan S, Billen N, Stahr K (2009) Soil organic carbon and total nitrogen stocks as affected by different land uses in Baden-Württemberg (southwest Germany). *J Plant Nutr Soil Sci* 172:32–42
- Day PR (1965) Particle fractionation and particle size analysis. In: Black CA (ed) *Methods of soil analysis, Part 1. Physical and mineralogical properties, including statistics of measurement and sampling*. American Society of Agronomy, Inc, Madison
- Demessie A, Singh BR, Lal R (2013) Soil carbon and nitrogen stocks under chronosequence of farm and traditional agro-forestry uses in Gambo district, southern Ethiopia. *Nutr Cycl Agroecosyst* 95:365–375
- Detwiler RP (1986) Land use change and the global carbon cycle: the role of tropical soils. *Biogeochemistry* 2:67–93
- Don A, Schumacher J, Freibauer A (2011) Impact of tropical land use change on soil organic carbon stocks – a meta-analysis. *Glob Chang Biol* 17:1658–1670
- Eaton JM, McGoff NM, Byrne KA, Leahy P, Kiely G (2008) Land cover change and soil organic carbon stocks in the Republic of Ireland 1851–2000. *Clim Change* 91:317–334
- Eclesia RP, Jobbagy EG, Jackson RB, Biganzoli F, Piñeiro G (2012) Shifts in soil organic carbon for plantation and pasture establishment in native forests and grasslands of South America. *Glob Chang Biol* 18:3237–3251
- Enanga EM, Shivoga WA, Maina-Gichaba C, Creed IF (2011) Observing changes in riparian buffer strip soil properties related to land use activities in the River Njoro watershed, Kenya. *Water Air Soil Pollut* 218:587–601
- Evrendilek F, Celik I, Kilic S (2004) Changes in soil organic carbon and other physical soil properties along adjacent Mediterranean forest, grassland, and cropland ecosystems in Turkey. *J Arid Environ* 59:743–752
- Fang X, Xue Z, Li B, An S (2012) Soil organic carbon distribution in relation to land use and its storage in a small watershed of the Loess Plateau, China. *Catena* 88:6–13

- Follett RF (2001) Soil management concepts and carbon sequestration in cropland soils. *Soil Tillage Res* 61:77–92
- Girmay G, Singh BR (2012) Changes in soil organic carbon stocks and soil quality: land use system effects in northern Ethiopia. *Acta Agric Scand Sect B Soil Plant Sci* 62(6):519–530
- Government of Kenya (2009) Report of the prime minister's task force on the conservation of the Mau forest complex [Online]. Available: <http://www.maurestoration.go.ke/>. Accessed 20 Dec 2012
- Han F, Hu H, Zheng J, Du F, Zhang X (2010) Estimating soil organic carbon storage and distribution in a catchment of Loess Plateau, China. *Geoderma* 154:261–266
- IPCC (2013) Summary for policymakers. In: Stocker TF, Qin D, Plattner GK, Tignor M, Allen SK, Boschung J, Nauels A, Xia Y, Bex V, Midgley PM (eds) *Climate change 2013: the physical science basis. Contribution of working group I to the fifth assessment report of the Intergovernmental Panel on Climate Change*. Cambridge University Press, Cambridge/New York
- Islam K, Weil RR (2000) Land use effects on soil quality in a tropical forest ecosystem of Bangladesh. *Agric Ecosyst Environ* 79:9–16
- Jaetzold R, Schmidt H, Hornetz B, Shisanya C (2010) *Farm management handbook of Kenya, Vol. II. Natural conditions and farm management information, 2nd edn, Part B Central Kenya, Subpart B1a Southern Rift Valley Province*. Ministry of Agriculture, Kenya and German Agency for Technical Cooperation (GTZ), Nairobi
- Jafarian Z, Kaviani A (2013) Effects of land use change on soil organic carbon and nitrogen. *Commun Soil Sci Plant Anal* 44(1–4):339–346
- Jiao Y, Xu Z, Zhao J (2009) Effects of grassland conversion to cropland and forest on soil organic carbon and dissolved organic carbon in the farming-pastoral ecotone of Inner Mongolia. *Acta Ecol Sin* 29:150–154
- Jing-cheng Y, Jian-hui H, Qing-min P, Jian-wei T, Xing-guo H (2004) Long-term impacts of land use change on dynamics of tropical soil carbon and nitrogen pools. *J Environ Sci* 16(2):256–261
- Lal R (2004) Soil carbon sequestration to mitigate climate change. *Geoderma* 123:1–22
- Lal R (2008) Carbon sequestration. *Phil Trans R Soc B* 363:815–830
- Lemenih M, Karlton E, Olsson M (2005) Assessing soil chemical and physical property responses to deforestation and subsequent cultivation in smallholders farming system in Ethiopia. *Agric Ecosyst Environ* 105:373–386
- Li M, Zhang X, Pang G, Han F (2013) The estimation of soil organic carbon distribution and storage in a small catchment area of the Loess Plateau. *Catena* 101:11–16
- McCall GJH (1967) *Geology of the Nakuru-Thomson's falls-Lake Hannington area: degree sheet No. 35, S.W. Quarter and 43 N.W. Quarter Report No. 78*. Government Printer, Nairobi
- Montgomery DC (2006) *Design and analysis of experiments*. Wiley, Hoboken
- Muñoz-Rojas M, Jordán A, Zavala LM, de la Rosa D, Abd-Elmabod SK, Anaya-Romero M (2012) Impact of land use and land cover changes on organic carbon stocks in Mediterranean soils (1956–2007). *Land Degrad Dev*. doi:10.1002/ldr.2194
- Murty D, Kirschbaum MFMM, McGilvray RE, H (2002) Does conversion of forest to agricultural land change soil carbon and nitrogen? A review of the literature. *Glob Chang Biol* 8:105–123
- Nelson DW, Sommers LE (1982) Total carbon, organic carbon and organic matter. In: Page AL (ed) *Methods of soil analysis, Part 2, Chemical and microbiological properties*, 2nd edn. American Society of Agronomy, Inc, Madison
- Okalebo JR, Gathna KW, Woomer PL (2002) *Laboratory methods for soil and plant analysis: a working manual, 2nd edn*. Tropical Soil Biology and Fertility Programme, Nairobi
- Osher LJ, Matson PA, Amundson R (2003) Effect of land use change on soil carbon in Hawaii. *Biogeochemistry* 65:213–232
- Post WM, Kwon KC (2000) Soil carbon sequestration and land use change: processes and potentials. *Glob Chang Biol* 6:317–327
- Powers JS (2004) Changes in soil carbon and nitrogen after contrasting land-use transitions in north-eastern Costa Rica. *Ecosystems* 7:134–146

- Powelson DS, Gregory PJ, Whalley WR, Quinton JN, Hopkins DW, Whitmore AP, Hirsch PR, Goulding KWT (2011) Soil management in relation to sustainable agriculture and ecosystem services. *Food Policy* 36:S72–S87
- R Core Team (2013) R: a language and environment for statistical computing. R Foundation for Statistical Computing, Vienna. ISBN 3-900051-07-0 URL <http://www.R-project.org/>
- Smith P (2004) Soils as carbon sinks: the global context. *Soil Use Manag* 20:212–218
- Smith P (2008) Land use change and soil organic carbon dynamics. *Nutr Cycl Agroecosyst* 81:169–178
- Solomon D, Lehmann J, Zech W (2000) Land use effects on soil organic matter properties of chromic luvisols in semi-arid northern Tanzania: carbon, nitrogen, lignin and carbohydrates. *Agric Ecosyst Environ* 78:203–213
- UNEP (2009) Kenya: atlas of our changing environment. Division of Early Warning and Assessment (DEWA), United Nations Environment Programme (UNEP) [Online]. Available: <http://www.unep.org/dewa/africa/kenyaatlas/>. Accessed 28 Aug 2013
- USDA (2008) Soil quality indicators: bulk density [Online]. Available: <http://soils.usda.gov/sqi/assessment/assessment.html>. Accessed 28 Aug 2013
- Vågen TG, Lal R, Singh BR (2005) Soil carbon sequestration in sub-Saharan Africa: a review. *Land Degrad Dev* 16:53–71
- Walker SM, Desanker PV (2004) The impact of land use on soil carbon in Miombo Woodlands of Malawi. *For Ecol Manage* 203:345–360
- Wang Z, Han X, Li L (2008) Effects of grassland conversion to croplands on soil organic carbon in the temperate Inner Mongolia. *J Environ Manage* 86:529–534
- Wang Y, Fu B, Lü Y, Song C, Luan Y (2010) Local-scale spatial variability of soil organic carbon and its stock in the hilly area of the Loess Plateau, China. *Quatern Res* 73:70–76
- Were KO, Dick ØB, Singh BR (2013) Remotely sensing the spatial and temporal land cover changes in Eastern Mau Forest Reserve and Lake Nakuru drainage basin, Kenya. *Appl Geogr* 41:75–86
- Wiesmeier M, Spörlein P, Geuß U, Hangen E, Haug S, Reischl A, Schilling B, von Lützw M, Kögel-Knabner I (2012) Soil organic carbon stocks in southeast Germany (Bavaria) as affected by land use, soil type and sampling depth. *Glob Chang Biol* 18:2233–2245
- Yimer F, Ledin S, Abdelkadir A (2007) Changes in soil organic carbon and total nitrogen contents in three adjacent land use types in the Bale Mountains, south-eastern highlands of Ethiopia. *For Ecol Manage* 242:337–342
- Zhang L, Xie Z, Zhao R, Wang Y (2012) The impact of land use change on soil organic carbon and labile organic carbon stocks in the Longzhong region of Loess Plateau. *J Arid Land* 4(3):241–250
- Zhang C, Liu G, Xue S, Sun C (2013) Soil organic carbon and total nitrogen storage as affected by land use in a small watershed of the Loess Plateau, China. *Eur J Soil Biol* 54:16–24

**Part III**  
**Effects of Climate Change**  
**and Crop Yield**



# Chapter 7

## Soil Erosion Hazard Under the Current and Potential Climate Change Induced Loss of Soil Organic Matter in the Upper Blue Nile (Abay) River Basin, Ethiopia

Daniel Mengistu, Woldeamlak Bewket, and Rattan Lal

**Abstract** This chapter assesses soil erosion hazard in the Upper Blue Nile (Abay) River Basin of Ethiopia, where the Grand Renaissance Dam is under construction, under the existing land resource use practices and climatic conditions as well as a scenario of future potential change in soil organic matter (SOM) concentration by the projected climate change. The Revised Universal Soil Loss Equation (RUSLE) model was used to estimate the soil loss rate. To capture potential effects of SOM loss by climate change on soil erodibility, specifically due to increase in temperatures, arbitrary scenarios of 20 % and 50 % reduction in SOM concentration were considered. The use of dekadal rainfall from 1,634 points representing a  $10 \times 10$  km spatial resolution is the key element of this study. Estimates show that the antecedent mean annual soil loss for the Basin was  $16 \text{ Mg ha}^{-1} \text{ year}^{-1}$ . Scenario analysis of SOM reduction by 20 % and 50 % resulted in mean annual soil erosion rates of  $17 \text{ Mg ha}^{-1} \text{ year}^{-1}$  and  $19 \text{ Mg ha}^{-1} \text{ year}^{-1}$ , respectively. The mean annual soil loss for the 50 % SOM reduction scenario exceeds the estimated maximum soil loss tolerance level of the country ( $18 \text{ Mg ha}^{-1} \text{ year}^{-1}$ ). Total soil loss from the Basin was estimated at  $280 \text{ Tg year}^{-1}$ , (Tg = teragram =  $10^{12} \text{ g} = 1 \text{ million Mg}$ ),

---

The senior author was a visiting scholar at the Carbon Management and Sequestration Center, The Ohio State University from June to December 2012.

D. Mengistu (✉)

Department of Geography and Environmental Studies, Addis Ababa University,  
Addis Ababa, Ethiopia

Carbon Management and Sequestration Center, The Ohio State University,  
Columbus, OH 43210, USA

e-mail: [dan952003@yahoo.com](mailto:dan952003@yahoo.com)

W. Bewket

Department of Geography and Environmental Studies, Addis Ababa University,  
Addis Ababa, Ethiopia

R. Lal

Carbon Management and Sequestration Center, Ohio State University OARDC,  
2021 Coffey Road, Columbus, OH 43210, USA

compared with 300 Tg year<sup>-1</sup> and 332 Tg year<sup>-1</sup> for the 20 % and 50 % SOM reduction, respectively. The northeastern, eastern and southern parts of the Basin (~25 % of the total area) are prone to very severe soil erosion risks (>30 Mg ha<sup>-1</sup> year<sup>-1</sup>). The lowest soil erosion rate (<10 Mg ha<sup>-1</sup> year<sup>-1</sup>) was observed in the southwestern, western and northwestern parts of the Basin. The sediment delivery ratio of the Basin was estimated at ~50 %. The sediments transported from the Basin are already affecting reservoirs and irrigation canals in the downstream countries of Sudan and Egypt, and will also adversely affect the Grand Ethiopian Renaissance Dam. Using the estimated soil erosion rates, the Basin was divided into priority categories for conservation intervention. Sub-basins prone to severe soil erosion risks are Beshilo, Welaka, North Gojjam, Jemma and Muger, and these need immediate attention for soil conservation and watershed management planning.

**Keywords** Soil erosion • Soil organic matter • Climate change • RUSLE • Blue Nile Basin • Ethiopia

## 7.1 Introduction

Soil erosion by water is one of the severe global challenges of the twenty-first century (Pimentel 2006). It has adverse on-site (soil quality and agronomic productivity) and off-site (siltation of reservoirs and dams, and non-point source pollution) effects (Pimentel et al. 1995; Lal 1999). Risks of soil erosion to food security are severe in developing countries because of their inappropriate agricultural practices, and low adaptive capacity to restore degraded soils and replace depleted nutrients (Erenstein 1999). These risks may be exacerbated by the projected climate change in the arid and semi-arid regions of developing countries (e.g., Horn of Africa).

In Ethiopia, soil erosion by water constitutes a severe threat to the national economy (Hurni 1993; Tamene 2005). Since more than 80 % of the population depends on agriculture, physical losses of top soil and removal of plant nutrients exacerbate food insecurity (FAO 1986; Hurni 1993). Hurni (1993) estimated that soil loss by water erosion in Ethiopia amounts to 1,493 Mg year<sup>-1</sup>. Of this about 42 Mg ha<sup>-1</sup> year<sup>-1</sup> or 4 mm of soil depth per annum is estimated for arable lands. This rate of soil loss exceeds the tolerable soil loss rate of 18 Mg ha<sup>-1</sup> year<sup>-1</sup> (Hurni 1985) and the soil formation rate of 3–7 Mg ha<sup>-1</sup> year<sup>-1</sup> (Hurni 1983) estimated for the country. Thus, about 50 % of the highlands of Ethiopia are already ‘significantly eroded’, 4 % is beyond reclamation, and erosion causes a severe decline in land productivity at the rate of about 2.2 % year<sup>-1</sup> (FAO 1986). At this rate, accelerated erosion can reduce the per capita income and render highland cultivation unsustainable. The economic cost of soil erosion has been estimated at ~ US\$ 1.0 billion year<sup>-1</sup> by Sonneveld (2002), and between 2 % and 3 % of the national agricultural GDP by MoARD and World Bank (2007).

Soil erosion from upstream areas of the Blue Nile (Abay) River Basin, hereafter called the Basin, and its subsequent sedimentation in downstream is a major threat to the existing and future water resources development. The suspended sediment load of the Blue Nile at El Deim is estimated at  $140 \text{ Tg year}^{-1}$  during the flood season (El Monshid et al. 1997). The deposition of large amounts of sediment in reservoirs reduces their lifetime and causes enormous dredging costs. Reservoirs on the Blue Nile in Sudan have experienced rapid sedimentation (Shahin 1993; Awulachew et al. 2009a). The Roseires reservoir of Sudan, which is about 120 km downstream from the Grand Renaissance Dam of Ethiopia, lost 38 % of its original capacity in 28 years (Awulachew et al. 2009a). The dam is currently being raised by 10 m to compensate for storage lost through sedimentation (Awulachew et al. 2009a). The Sennar dam (300 km south of Khartoum) lost 71 % of its original storage capacity ( $930 \text{ Million m}^3$ ) after 62 years of operation (Shahin 1993). Thus, Sennar reservoir is no longer used to store significant volumes of water; instead it generates a limited amount of hydropower ( $\sim 15 \text{ MW}$ ). More than 95 % of the sediments ( $120 \text{ Tg year}^{-1}$ , Teodoru et al. 2006) transported to the Aswan High Dam (AHD) of Egypt originate from Ethiopia. Of this, more than 70 % is from the Blue Nile (Abay) River Basin and 25 % from the Atbara (Tekeze) River Basin (El Monshid et al. 1997; NBCBN 2005). Since its construction (i.e., 1964), the AHD has lost  $\sim 11 \%$  of its storage capacity ( $\sim 0.3 \%$   $\text{year}^{-1}$ ) (Teodoru et al. 2006). Due to this high inflow of sediment, the lifetime of the AHD reservoir has been reduced by 50–265 years (Shahin 1993). Thus, sediments currently reaching the dams in Sudan and Egypt will be retained in the Grand Ethiopian Renaissance Dam.

Climate change may affect soil erosion through changes in rainfall erosivity, residue decomposition rate, evapotranspiration rate, soil erodibility, shifts in land use as adaptation to a new climate, and net primary productivity (NPP) (Favis-Mortlock and Guerra 1999; Nearing 2001; Pruski and Nearing 2002). However, the mechanisms by which temperature change affects SOM decomposition rates, and the attendant impacts on soil erosion, are complex (Pruski and Nearing 2002), and not well understood.

Increase in temperature, increases both the rate of NPP, which provides the input to soil organic carbon (SOC), and of SOM decomposition, which in turn determine the loss of SOC (Kirschbaum 1995, 2000). Concentration of SOC depends on the relative temperature sensitivities of NPP and SOM decomposition rates. Indeed, SOM decomposition is more sensitive to temperature than NPP, especially at low temperatures (Kirschbaum 1995, 2000; Bekku et al. 2003). Decomposition rates increase with increase in temperature (Jenkinson et al. 1991; Trumbore 1997; Burke et al. 2003; Davidson and Janssens 2006; Friedlingstein et al. 2006; Batjes 2011), approximately doubling with each  $10 \text{ }^\circ\text{C}$  rise in temperature (the Q10 of decomposition is two) (Kirschbaum 1995; Sanderman et al. 2003). Hence, warming reduces SOC concentration by stimulating SOM decomposition rates more than increasing NPP. Historical depletion of the global SOC pool is estimated at  $78 \pm 12 \text{ Pg}$  (Lal 1999, 2004). The depletion of SOC increases emission of  $\text{CO}_2$ , and causes a positive  $\text{CO}_2$  feedback to global warming (Kirschbaum 2000; Sanderman

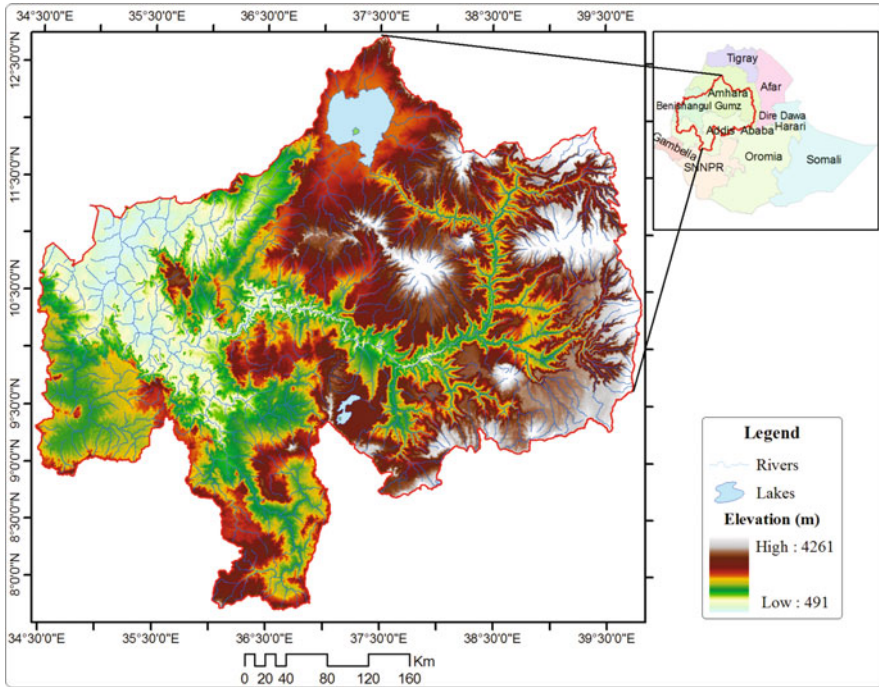
et al. 2003; Jones et al. 2005; Davidson and Janssens 2006; Allison et al. 2010). Soil respiration ( $60 \text{ Pg year}^{-1}$ ) is about six times the fossil fuel combustion of  $\sim 10 \text{ Pg year}^{-1}$  (Lal 2013). Despite large uncertainties, climate models have estimated that the potential loss of SOC under the future warming could be six times larger than that of the current soil C sink capacity (Reichstein 2008).

Depletion of SOM by increase in its rate of decomposition may lead to adverse impacts on ecosystem services and the environment (Lal 2004, 2013). Loss of SOM, for instance, reduces water infiltration capacity of soils, and increases water run-off and exacerbates soil erosion (Lal 2003). Accelerated soil erosion, in turn, reduces the SOM concentration by washing away the nutrient rich topsoil (Pimentel 2006). Despite its effects on the magnitude of soil–atmosphere  $\text{CO}_2$  exchange, little if any research has been done in the study area, specifically with regards to the potential effects of climate change on soil erosion. Moreover, as already narrated, most of the sediments which are presently reaching the reservoirs and dams of Sudan and Egypt will be retained in the Grand Ethiopian Renaissance Dam. Thus, sedimentation problem will seriously affect the storage capacity of the Grand Ethiopian Renaissance Dam, thereby jeopardizing its sustainability. To tackle the on- and off-site effects of soil erosion, appropriate erosion control and sediment management strategies are urgently needed. In order to plan and implement such strategies, understanding of the magnitude, factors responsible for and spatial pattern of soil erosion is crucial. The objective of this study is to assess soil erosion hazard under the current climate, and also of potential changes in SOM concentration by the projected climate change on soil erosion hazard in the Upper Blue Nile (Abay) River Basin. This study will provide empirical evidence of the magnitude of soil erosion hazard under the current and projected climate change, and its adverse effects on the sustainability of the reservoirs and dams in the Blue Nile (Abay) River Basin including the Grand Ethiopian Renaissance Dam and the downstream countries. The information generated will provide guidelines to policy makers and others concerned with identification of mitigation strategies.

## 7.2 Materials and Methods

### 7.2.1 Study Site Description

The Upper Blue Nile River Basin, known as the Abay in Ethiopia, covers an area of about  $176,000 \text{ km}^2$ , or 17 % of the total area of Ethiopia (Fig. 7.1). With a mean annual discharge of  $48.5 \text{ km}^3$  ( $1,536 \text{ m}^3\text{s}^{-1}$ ) (Conway 2000), it is the largest tributary of the Nile river. It accounts for  $\sim 40$  % of country's total surface water resources (World Bank 2006). The Blue Nile River flows from Lake Tana and crosses through the central Ethiopian highlands to the Sudanese border. It joins the White Nile at Khartoum, Sudan. The basin is characterized by a rugged topography. Mountainous highlands in the eastern and central parts of the Basin, with altitudes



**Fig. 7.1** Location map of the Upper Blue Nile (Abay) River Basin

ranging from 1,500 to 4,260 m asl and a slope of over 25 % (Fig. 7.1). The lowlands in the western parts of the Basin, with slopes less than 7 % are relatively flat (Fig. 7.1). The highlands are volcanic and Precambrian Basement Complex rocks, mainly basalts origin; while the lowlands are mainly covered by Basement Complex and metamorphic rocks, such as gneisses and marble (Awulachew et al. 2009a). The courses of the rivers and streams follow the drainage pattern radiating from volcanic rocky peaks. The valley of the Basin in some places is 1 km deep, and often difficult to cross. A number of tributaries join the Blue Nile (Abay) river. Most of which are perennial, though highly seasonal in their flow volumes.

The soils of the Basin are highly variable. However, four soil types (i.e., Nitisols, Leptosols, Luvisols and Vertisols) are dominant in the Basin. Nitisols (FAO/UNESCO soil classification system) are the dominant soils in the western part. The eastern part of the Basin is dominantly covered with Leptosols. Vertisols and Luvisols dominate the flat areas and the high rainfall areas around Lake Tana, respectively (Awulachew et al. 2009a).

The climate of the Basin varies from humid to semiarid. Most of the annual rainfall (i.e., 70 % of the rainfall) occurs in the wet season called *Kiremt* (June–September) (Conway 2000). Hence, more than 80 % of the annual flow from the Basin occurs from July to October, which flows to the downstream countries of Sudan and Egypt (Kim et al. 2008). The highlands receive the highest rainfall, often

ranges between  $>2,000 \text{ mm year}^{-1}$  in the southwest and  $1,000 \text{ mm year}^{-1}$  in the northeast (Conway 2000). The lowlands receive less than  $1,000 \text{ mm year}^{-1}$  (Conway 2000). The mean annual temperature of the Basin is  $\sim 18.5 \text{ }^\circ\text{C}$ . However, it varies in time and space. The average temperature of the Basin in the summer season (locally known as *Kiremt*) is  $17.7 \text{ }^\circ\text{C}$  but it rises to  $20.1 \text{ }^\circ\text{C}$  in the winter season (locally known as *Bega*) (Kim et al. 2008). The lowlands have the highest average temperatures ( $15\text{--}38 \text{ }^\circ\text{C}$ ) while the highlands have relatively lower average temperatures ( $-1 \text{ to } 20 \text{ }^\circ\text{C}$ ) (Merrey and Gebreselassie 2011). The mean annual potential evapotranspiration in the Basin is high, spatially variable and estimated to range from 1,000 to 1,800 mm per annum (Conway 2000).

The Basin is important nationally and regionally, and has immense potential for irrigation, hydroelectric power generation (Merrey and Gebreselassie 2011), crops and livestock production and ecotourism (Awulachew et al. 2009b). The Basin contributes 40 % of agricultural products of the country (Awulachew et al. 2009b). The wetlands in the Basin are habitat to many endemic birds. The Basin is known by its historical heritages including ancient monasteries, and cultural and archaeological sites. The Basin is also home to a large population that is growing rapidly. The total population in the 11 Nile Basin countries is 372 million ( $\sim 40 \%$  of Africa's population), of which 200 million (54 %) live within the Main Nile Basin (UNPD, 2005). A large majority of the population in the Basin still lives in rural areas, but the rate of urbanization is very high. The annual growth rate of the urban population in the Basin is 4–5% (UNPD 2005). The large rural population depends directly on the natural resource base for its food security and livelihood. It is a major factor responsible for a severe environmental degradation that in the Basin. Predominant land use in the Basin is arable (food crops). Croplands, woodlands, and grasslands/shrublands cover 60 %, 25 %, and 7 %, respectively, of the Basin (Kim et al. 2008). Principal land uses being rain-fed agriculture and grazing (Awulachew et al. 2009b). Thus, accelerated soil erosion is a major issue for the entire Basin.

### 7.2.2 Methods

The Revised Universal Soil Loss Equation (RUSLE), originally developed by Wischmeier and Smith (1978) and modified by Renard et al. (1997), was used to assess soil erosion hazard in the Basin (Eq. 7.1).

$$A = RKLSCP \quad (7.1)$$

Where, A is the annual soil loss ( $\text{Mg ha}^{-1} \text{ year}^{-1}$ ), R is the rainfall erosivity factor ( $\text{MJ mm ha}^{-1} \text{ h}^{-1} \text{ year}^{-1}$ ), K is the soil erodibility factor ( $\text{Mg h MJ}^{-1} \text{ mm}^{-1}$ ), L is the slope length factor (unitless terrain factor), S is the slope steepness factor (unitless terrain factor), C is the crop management or land cover factor (unitless vegetation cover factor) and P is a dimensionless erosion control practice factor.

Annual soil loss (A) was computed by overlaying five raster layers over the Upper Blue Nile River Basin using Eq. 7.1. The raster layers represented rainfall erosivity factor (R), soil erodibility factor (K), topographic factor (LS), cover management factor (C) and land management factor (P).

Field experimentation and modeling are two approaches which have been used to understand the potential impacts of climate change on soil erosion. Field experimentation is very expensive and difficult to extrapolate results to a basin scale. Thus, in this study, modeling approach was used. Arbitrary scenarios of 20 % and 50 % reduction in SOM concentration were considered to capture effects of potential reductions in SOM by climate change. These two values were selected based on the literature review from Trumbore (1997) and Lal (2004). Lal (2004) estimated the depletion of the SOC pool by as much as 60 % in soils of temperate regions and 75 % or more in cultivated soils of the tropics. The depletion may be exacerbated by projected global warming (Lal 2004).

Identification of erosion hotspot areas and prioritization of sub-basins is necessary and strategic for treatment with appropriate soil and water conservation measures. Therefore, the Basin was divided into 14 sub-basins based on the drainage systems delineated in the Basin's master plan. The magnitude of soil loss for each sub-basin was calculated (Table 7.7) using ArcGIS 10 spatial analyst zonal statistics extension. Finally, prioritization of sub-basins for soil and water conservation treatment was established on the basis of the amount of soil loss in each sub-basin. Methods and procedures used to generate each factor are outlined below.

### 7.3 Rainfall Erosivity Factor (R)

Rainfall erosivity is a climatic factor, which is estimated from the rainfall data. It is a measure of the kinetic energy ( $E$ ,  $\text{MJ m}^{-2}$ ) based on the 30 min maximum intensity of rainfall ( $I_{30}$ ,  $\text{mm h}^{-1}$ ) (Wischmeier and Smith 1978). Dekadal (10 days) rainfall data, reconstructed from observation stations and meteorological satellites data by the Ethiopian National Meteorological Agency in collaboration with the International Research Institute for Climate and Society, Columbia University, USA, were used for computing the erosivity index. The rainfall data were a  $10 \times 10$  km gridded data for 1983–2010. Computing  $EI_{30}$  required continuous rainfall intensity data. However, rainfall intensity data are not available for the study area. Therefore, alternative methods used include empirical equations to estimate local erosivity values from the available annual total rainfalls (Roose 1975, 1977; Morgan 1974, 2005; Millward and Mersey 1999). Hurni (1985) developed an empirical equation while adapting the USLE model to the Ethiopian highlands (Eq. 7.2):

$$R = -8.12 + 0.562P \quad (r^2 = 0.8) \quad (7.2)$$

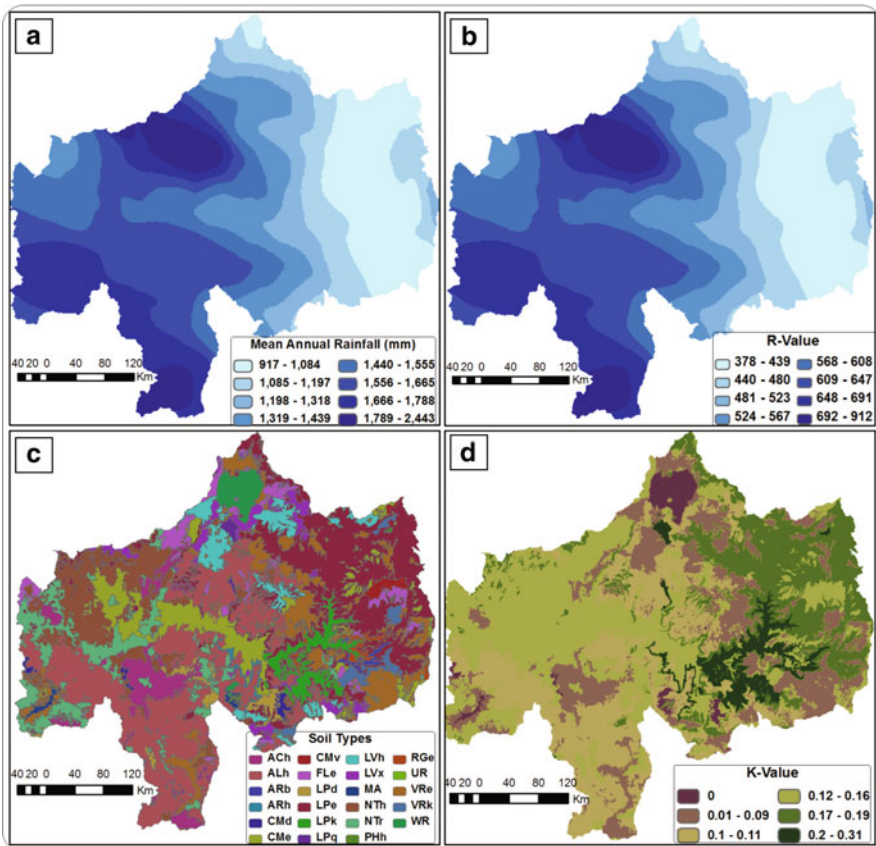
Where, R is the rainfall erosivity factor (in MJ mm ha<sup>-1</sup> h<sup>-1</sup> year<sup>-1</sup>), and P is the mean annual rainfall (mm).

Kaltenrieder (2007) developed another equation to estimate R factor from annual total rainfall amount (Eq. 7.3):

$$R = 0.36 X + 47.6 \tag{7.3}$$

Where, X is mean annual rainfall in mm.

The regression model (Eq. 7.2) developed by Hurni (1985) estimates higher R-factor than that by Eq. 7.3 (Kaltenrieder 2007). Thus, Kaltenrieder (2007) model, developed on a relatively large database, was used in the present study. The rainfall erosivity thus computed was used to prepare Isoerodent maps by using Ordinary Kriging interpolation method in Geostatistical Analysis extension of ArcGIS 10 software (Fig. 7.2).



**Fig. 7.2** Mean annual rainfall (a), rainfall erosivity (b), major soil types (c), and soil erodibility (d) in the Upper Blue Nile River Basin



Similar methods for determining R factor from total annual rainfall have been used in Ethiopia and many other countries (Morgan 1974, 2005 in Malaysia; Roose 1975 in Ivory Coast; Bols 1978 in Indonesia; Millward and Mersey 1999 in a mountainous tropical watershed; Cohen et al. 2005 in Western Kenya; Bewket and Teferi 2009 in Chemoga catchment, Ethiopia; Xin et al. 2010 in Loess Plateau, China; Shiferaw 2011 in Borena Woreda, Ethiopia; Meshesha et al. 2012 in Central Rift Valley of Ethiopia).

## 7.4 Soil Erodibility Factor (K)

The soil erodibility (K factor) indicates soil's susceptibility to detachment and transport by agents of erosion. K factor values were determined from the available soil data of the Basin (scale 1:250,000), which was obtained from the Ministry of Water and Energy (Fig. 7.2). Several methods have been developed to estimate the K-factor. However, the widely used nomograph method developed by Wischmeier et al. (1971) was used for this study (Eq. 7.4):

$$K_{\text{fact}} = (1.292) [2.1 * 10^{-6} f_p^{1.14} (12 - P_{\text{om}}) + 0.0325 (S_{\text{struc}} - 2) + 0.025 (f_{\text{perm}} - 3)]$$

$$f_p = P_{\text{silt}} (100 - P_{\text{clay}})$$
(7.4)

Where,  $f_p$  is the particle size parameter (unitless),  $P_{\text{om}}$  is the percent organic matter (unitless),  $S_{\text{struc}}$  is the soil structure index (unitless),  $f_{\text{perm}}$  is the profile-permeability class factor (unitless),  $P_{\text{silt}}$  is the percent silt (unitless) and  $P_{\text{clay}}$  is the percent clay (unitless).

The original model is expressed in imperial units. Thus, in Eq. 7.4, the factor (1.292) was used to convert  $K_{\text{fact}}$  from the imperial to the International System Units (i.e., SI metric units) (Streile et al. 1996). The soil structure index,  $S_{\text{struc}}$ , is 1 for very fine granular soil, 2 for fine granular soil, 3 for medium or coarse granular soil and 4 for blocky, platy, or massive soil (Wischmeier et al. 1971). The profile-permeability class factor,  $f_{\text{perm}}$ , is 1 for very slow infiltration, 2 for slow infiltration, 3 for slow to moderate infiltration, 4 for moderate infiltration, 5 for moderate to rapid infiltration and 6 for rapid infiltration (Wischmeier et al. 1971). Based on the K factor, soil erodibility data and map of the Basin are shown in Table 7.1 and Fig. 7.2, respectively.

## 7.5 Topographic Factors (LS)

Slope length (L) and slope steepness (S) factors were computed from a 90 m resolution Digital Elevation Model (DEM) of the Basin. Slope length (L) is a baseline for a horizontally projected slope length (hpsl) to the experimentally

Table 7.1 K value estimation from soil data of the Upper Blue Nile River Basin Topographic factors (LS)

FAO Class	Soil name	Texture	Pom	Pclay	Psilt	Sstruc	fperm	fp	K factor		
									Baseline	20 % SOM loss	50 % SOM loss
ACh	Haplic acrisols	C	6.98	46.40	30.10	4	1	1,614.47	0.081	0.098	0.124
ALh	Haplic alisols	C	5.57	44.26	31.37	4	1	1,748.56	0.106	0.121	0.144
ARb	Cambic arenosols	LS	1.87	8.50	11.68	4	6	1,068.72	0.259	0.262	0.266
ARh	Haplic arenosols	LS	1.87	8.50	11.68	4	6	1,068.72	0.259	0.262	0.266
CMd	Dystric cambisols	SiC	15.35	51.95	39.51	4	2	1,898.46	0.002	0.012	0.079
CMe	Eutric cambisols	SiC	4.20	47.07	28.29	4	2	1,497.39	0.140	0.149	0.164
CMv	Vertic cambisols	C	3.92	46.89	40.57	4	1	2,154.67	0.158	0.171	0.191
FLe	Eutric fluvisols	SiCL	3.92	61.95	32.18	4	2	1,224.45	0.124	0.131	0.142
LPd	Dystric leptosols	C	3.70	38.80	34.81	4	1	2,130.37	0.160	0.172	0.191
LPe	Eutric leptosols	CL-C	3.70	38.80	34.81	4	2	2,130.37	0.192	0.204	0.223
LPk	Rendzic leptosols	L	2.01	25.18	37.44	4	3	2,801.26	0.315	0.324	0.338
LPq	Lithic leptosols	L-CL	2.84	23.31	32.57	4	3	2,497.79	0.270	0.281	0.298
LVh	Haplic luvisols	C	5.54	54.37	30.70	4	1	1,400.84	0.087	0.099	0.116
LVx	Chromic luvisols	C	3.77	56.91	32.64	4	1	1,406.46	0.106	0.114	0.126
MA	Marsh								0	0	0
NTh	Haplic nitisols	Sic-C	3.65	56.97	28.86	4	2	1,241.85	0.128	0.135	0.145
NTr	Rhodic nitisols	CL-C	3.42	56.85	27.98	4	2	1,207.34	0.128	0.134	0.143
PHh	Haplic phaeozems	C	2.54	49.14	40.61	4	1	2065.42	0.174	0.182	0.194
RGe	Eutric regosols	C	3.30	42.65	29.49	4	1	1,691.25	0.132	0.141	0.154
UR	Urban, mining, etc.								0	0	0
VRe	Eutric vertisols	C	3.59	68.04	24.64	4	1	787.49	0.065	0.069	0.075
VRk	Calcic vertisols	C	3.32	72.89	22.03	4	1	597.23	0.054	0.056	0.060
WR	Water bodies								0	0	0

measured erosion for a 22.1 m (72.6 ft) reference slope length exponent (rsl) ( $m$ ) value that addresses the ratio of rill-to-inter-rill erosion (Eq. 7.5), (McCool et al. 1997; Renard et al. 1997):

$$L = \left( \frac{\lambda}{22.13} \right)^m \quad (7.5)$$

Where,  $L$  is the factor estimate,  $\lambda$  is the horizontally projected slope length in meter, and  $m$  is the slope length exponent.

It is also assumed that actual slope lengths are always longer than 4.6 m (15 ft) such that rilling is likely to be an active component of soil erosion. Hence, a single L-constituent algorithm may integrate with multiple exponents (McCool et al. 1987). Exponent ( $m$ ) depends on slope steepness, being 0.55 for slopes exceeding 5 %, 0.4 for 3–5 %, 0.3 for 1–3 %, and 0.2 for <1.0 %.

The slope steepness or S factor was calculated from the slope angle matrix using two equations (McCool et al. 1987; McCool et al. 1997) that are differentially applied according to the break point at the experimentally modeled 9 % gradient (Wischmeier and Smith 1978).

For slopes of less than 9 % gradient (Eq. 7.6):

$$S = 10.8 * \sin(\theta + 0.03) \quad (7.6)$$

For slopes of 9 % or steeper (Eq. 7.7):

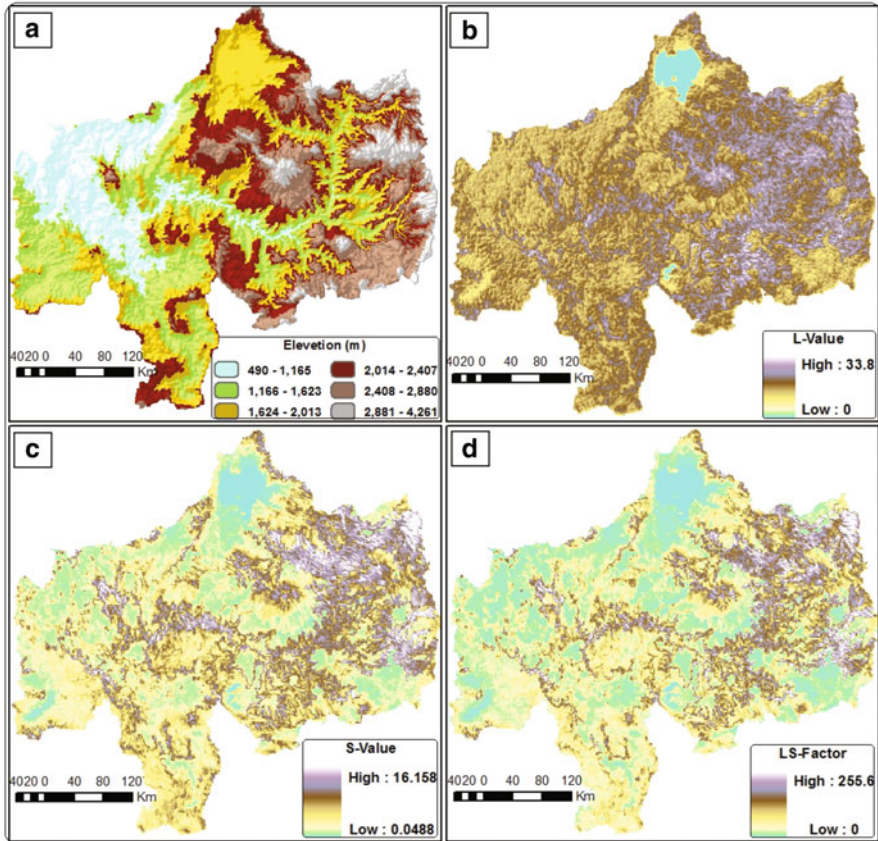
$$S = 16.8 * \sin(\theta - 0.05) \quad (7.7)$$

Where, S is the slope steepness and  $\theta$  is the angle of slope in degrees.

LS factor was estimated using an array-based executable C<sup>++</sup> program developed by Van Remortel et al. (2004). The executable program requires the input DEM in text format (ASCII). Hence, the DEM was converted in to ASCII format. Then, the executable program filled sinks in the DEM, calculated slope cutoff factors, flow direction, flow accumulation, and L and S constituents. Finally, LS factors were computed and the output files were converted back to a raster format using ArcGIS 10 software (Fig. 7.3).

## 7.6 Cover Management Factor (C)

The cover management factor (C) represents the effects of vegetation, management and erosion control practices on soil loss rates from 1.0 in completely bare land (no cover) to 0.0 in water body or completely covered land surface. The C-factor



**Fig. 7.3** Digital Elevation Model (*DEM*) (a), L constituent (b), S constituent (c) and LS factor (d) in the Upper Blue Nile River Basin

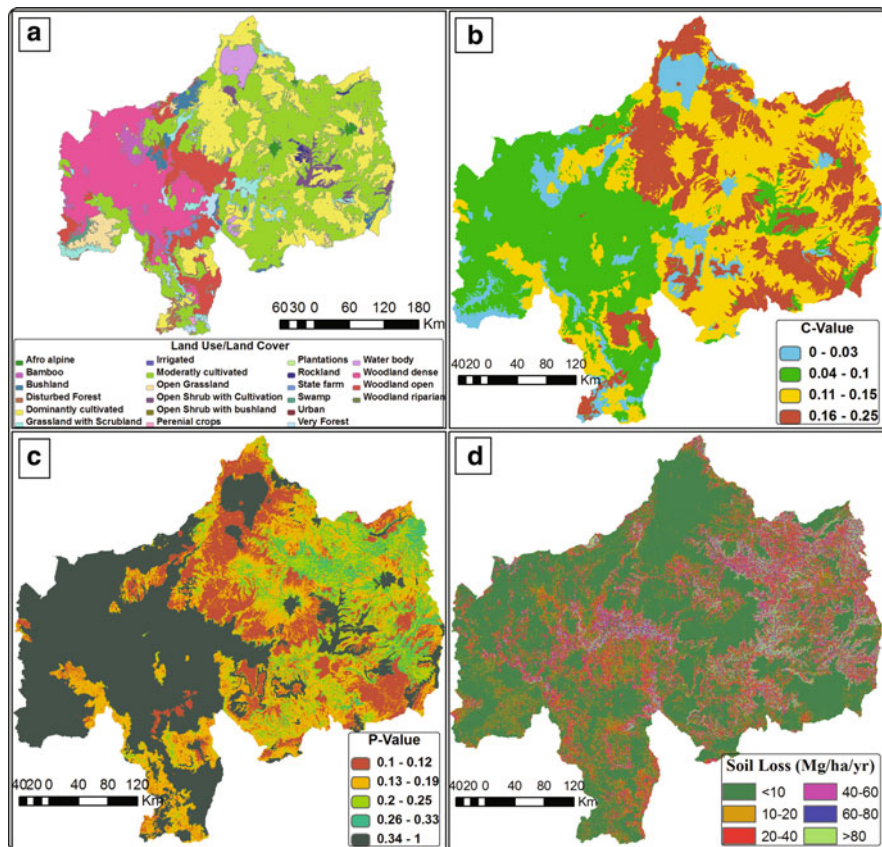
for the Basin was derived from the land use/land cover map of the Blue Nile River Basin master plan project (scale 1:250,000), which was obtained from the Ministry of Water and Energy (Fig. 7.4). The land use/land cover map of the Basin was prepared from Landsat images. Visual image interpretation and detailed field survey (429 field sites recorded) were performed to enhance the accuracy of the land use/land cover map prepared. Land cover classification was prepared using the Land Use Planning and Regulatory Department (LUPRD/FAO) and Woody Biomass Inventory and Strategic Planning Project (WBISPP) legends (BCEOM 1998), subjected to modification based on field experience. The legend contains 12 main classes, with sub-divisions in some cases and the total is 23 land use/land cover classes (Table 7.2 and Fig. 7.4).

**Table 7.2** Cropping and land-cover (C) factor values

ID	LULC Class	Description	C factor	Sources
1	Afro alpine	Vegetation grown above 3,200 m asl	0.010	BCEOM (1998)
2	Bushland	Dense	0.100	BCEOM (1998)
3	Bushland	Open	0.100	BCEOM (1998)
4	Bamboo	Bamboo trees	0.010	BCEOM (1998)
5	Dominantly cultivated	Rainfed	0.250	Brhane and Mekonen (2009), Hurni (1985)
6	Moderately cultivated	Rainfed	0.150	Brhane and Mekonen (2009), Hurni (1985)
7	Irrigated	Large irrigation farms	0.130	Brhane and Mekonen (2009)
8	Perennial crops	mainly coffee	0.001	Kaltenrieder (2007)
9	Disturbed forest	Forest	0.010	Hurni (1985)
10	Very disturbed forest	Forest	0.050	Hurni (1985)
11	Open grassland	Grassland	0.050	Hurni (1985)
12	Grassland with scrubland	Grassland	0.010	Eweg and van Lammeren (1996)
13	Water body	Wetland and water body	0.000	Ongsomwang and Thinley (2009)
14	Swamp	Perennial and seasonal Swamp/marsh	0.010	BCEOM (1998); Brhane and Mekonen (2009)
15	Plantations	Eucalyptus	0.130	Brhane and Mekonen (2009)
16	Rockland	Bare land (Badland hard)	0.050	Hurni (1985)
17	Open shrub with cultivation	Open scrubland	0.060	Eweg and van Lammeren (1996)
18	Open shrub with bushland	Dense scrubland	0.020	Krishna (2009)
19	State farm	Rainfed state farms	0.150	Hurni (1985)
20	Urban	Urban areas	0.000	Ongsomwang and Thinley (2009)
21	Woodland dense	Dense (>50 % canopy cover)	0.050	Eweg and van Lammeren (1996)
22	Woodland open	Open (<50 % canopy cover)	0.060	Eweg and van Lammeren (1996)
23	Woodland riparian	Riparian (along major rivers)	0.010	BCEOM (1998)

## 7.7 Conservation Practices Factor (P)

The conservation practices (P) account for control practices that reduce erosion potential of runoff with reference to the baseline without any conservation practices. The values depend on types of conservation measures implemented, and require mapping of conserved areas for it to be quantified. In the Basin, there are few experimental sites which have been treated with soil conservation practices



**Fig. 7.4** Land use/land cover types (a), the cover (C) factor (b), conservation practices (P) factor (c) and soil erosion hazard (d) in the Upper Blue Nile Basin

through the Soil Conservation Research Programme (SCRP) or other soil conservation programmes. However, these experimental sites do not occupy significant portion of the Basin. Hence, P factor values suggested by Wischmeier and Smith (1978), which considers two types of land uses (e.g., agricultural and other) and land slopes were used in this study (Table 7.3 and Fig. 7.4).

### 7.8 Sediment Yield (SY) and Sediment Delivery Ratio (SDR)

Total amount of soil eroded in the Basin was estimated using the RUSLE model. The sediment yield (SY) data are available for El Diem reservoir (the outlet of the Basin). Hence, sediment delivery ratio (SDR) was calculated by relating the annual sediment deposition to outlets with annual erosion from upslope catchments (Eq. 7.8):

**Table 7.3** The P factor values by land use types and slope categories suggested by Wischmeier and Smith (1978)

Land-use type	Slope (%)	P factor
Agricultural land	0–5	0.1
	5–10	0.12
	10–20	0.14
	20–30	0.19
	30–50	0.25
	50–100	0.33
Other land	All	100

$$\text{SDR} = \frac{\text{SY}}{\text{E}} \quad (7.8)$$

Where, SY = annual sediment deposition in a reservoir (outlet) and E = the annual soil loss from the corresponding catchment.

## 7.9 Prioritization for Soil and Water Conservation Measures

Identification of erosion hotspots and prioritization of sub-basins are necessary and strategic for treatment with appropriate soil and water conservation measures. Therefore, the Basin was divided into 14 sub-basins based on the drainage systems delineated in the Basin's master plan. Then, the amount of soil loss for each sub-basin was calculated (Tables 7.7, 7.8 and 7.9) using ArcGIS 10 Spatial Analyst Zonal Statistics extension. Finally, prioritization of sub-basins for soil and water conservation treatment was established based on the magnitude of soil loss that in each sub-basin.

## 7.10 Results and Discussion

### 7.10.1 Estimated Annual Soil Loss (A)

Mean annual soil loss for the Basin was estimated at 16 Mg ha<sup>-1</sup> year<sup>-1</sup>, reaching to maximum value of 1,511 Mg ha<sup>-1</sup> year<sup>-1</sup>. Scenario analysis of SOM reduction by 20 % and 50 % resulted in mean annual soil erosion rates of 17 Mg ha<sup>-1</sup> year<sup>-1</sup> and 19 Mg ha<sup>-1</sup> year<sup>-1</sup>, with corresponding maximum values of 1,555 and 1,622 Mg ha<sup>-1</sup> year<sup>-1</sup>, respectively (Tables 7.7, 7.8 and 7.9). The average soil loss rates estimated for the Basin exceed the soil loss tolerance level of 10 Mg ha<sup>-1</sup> year<sup>-1</sup> estimated for soils of the tropics by Morgan (1995). However, these rates are within

the soil loss tolerance range of 2–18 Mg ha<sup>-1</sup> year<sup>-1</sup> for shallow (sensitive soils) to deep soils estimated by Hurni (1985) for Ethiopia, except for the scenario of 50 % SOM reduction.

The estimated soil loss rates are comparable with the available field data and other studies conducted in the Basin. For instance, Bewket and Sterk (2003) assessed rill and inter-rill erosion at the field scale in Chemoga watershed in the Blue Nile Basin and estimated annual soil loss rates of 18–79 Mg ha<sup>-1</sup> year<sup>-1</sup>. Bewket and Teferi (2009) also estimated the average annual soil loss rate of 93 Mg ha<sup>-1</sup> year<sup>-1</sup> for the entire Chemoga watershed using the USLE model. Herweg and Ludi (1999) measured soil erosion from arable lands under traditional land-use practices in the Anjeni experimental watershed, South Gojjam sub-basin and reported annual soil loss ranged from 17 to 176 Mg ha<sup>-1</sup> year<sup>-1</sup>. Herweg and Stillhardt (1999) observed soil erosion rates as high as 130–170 Mg ha<sup>-1</sup> year<sup>-1</sup> in cultivated fields in the Anjeni catchment. Shiferaw (2011) estimated an average annual soil loss of 27 Mg ha<sup>-1</sup> year<sup>-1</sup> for the Welaka sub-basin in Borena woreda (district), Mekonnen and Melesse (2011) estimated annual soil loss of 18 Mg ha<sup>-1</sup> year<sup>-1</sup> for Debremawi watershed, North Gojjam sub-basin. FAO (1986) estimated average soil loss from croplands in the highlands as a whole at 100 Mg ha<sup>-1</sup> year<sup>-1</sup>. Hurni (1993) also reported that soil loss rates from test plots in the Ethiopian highlands ranged from 0 to 400 Mg ha<sup>-1</sup> year<sup>-1</sup>, with average of 42 Mg ha<sup>-1</sup> year<sup>-1</sup> for cropland and 70 Mg ha<sup>-1</sup> year<sup>-1</sup> from badlands.

Total magnitude of soil loss within the Basin was estimated at about 280 Tg year<sup>-1</sup> (Tg = teragram = 10<sup>12</sup> g = 1 million ton) for the baseline data. Awulachew et al. (2009a) and Abdel Aziz (2009) estimated the annual soil loss of 303 Tg year<sup>-1</sup> and 320 Tg year<sup>-1</sup> (for 202,994 km<sup>2</sup> area of the Basin), respectively. Thus, the present estimation is similar to those by Awulachew et al. (2009a) and Abdel Aziz (2009).

The potential soil loss for 20 % and 50 % SOM reduction scenario was estimated at about 300 Tg year<sup>-1</sup> and 332 Tg year<sup>-1</sup>, respectively. This implies that depletion of SOM will accelerate the soil loss rate in the Basin.

The extent and magnitude of soil erosion in the Basin are spatially variable. Severe to very severe soil erosion were predominantly observed in the northeast, east and southern parts of the Basin including Beshilo, Welaka, North Gojjam, Jemma and Muger sub-basins (Figs. 7.5, 7.6 and 7.7; Tables 7.7, 7.8 and 7.9). Moderate soil erosion is estimated for the northwest, southwest, and central parts of the Basin including South Gojjam, Wonbera, Anger and Guder sub-basins (Figs. 7.5, 7.6 and 7.7; Tables 7.7, 7.8 and 7.9). Lower soil erosion rate is estimated for the northwest, western and southwestern parts including Tana, Beles, Dabus, Didessa and Fincha sub-basins (Figs. 7.5, 7.6 and 7.7; Tables 7.7, 7.8 and 7.9). The transformation of Wonbera sub-basin from moderate to high and Beles and Didessa sub-basins from low to moderate soil erosion severity level for the 20 % SOM reduction, and Fincha sub-basin for the 50 % SOM reduction is manifestation of the adverse effect of SOM reduction on soil erodibility (Figs. 7.5, 7.6 and 7.7; Tables 7.7, 7.8 and 7.9). Spatial pattern of soil erosion, similar to those reported here, were also observed by BCEOM (1998), NBCBN (2005) and Awulachew



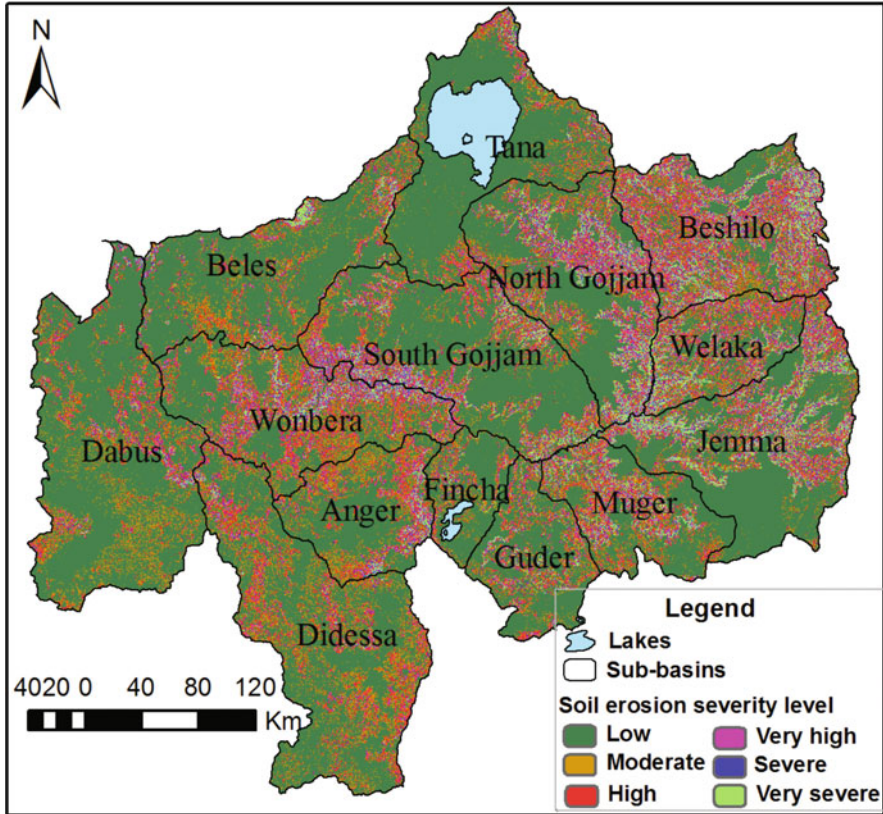
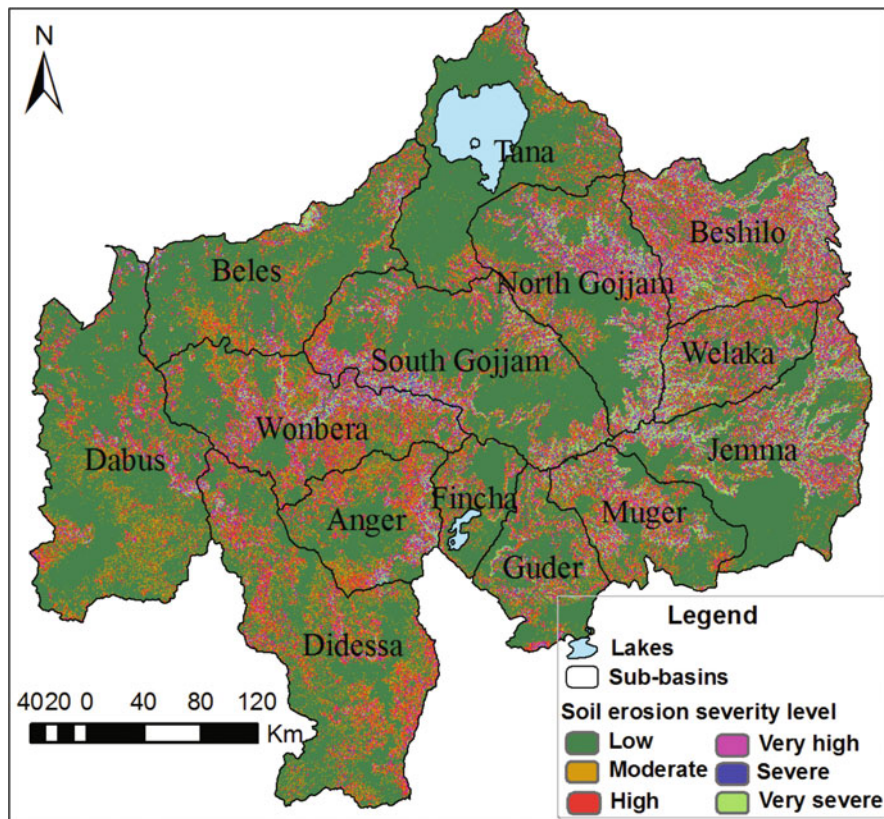


Fig. 7.5 Current soil erosion hazard in the Upper Blue Nile River Basin

et al. (2009a). The NBCBN (2005) attributed the severe degradation observed in the eastern and northeastern part of the Basin to steeper slopes, high cropping intensity, the crop type (i.e., *teff*) and marginal soils with shallow rooting depth. This area is unsustainable for cultivation because of high susceptibility to erosion caused by steep slopes and inadequate soil conservation measures (NBCBN 2005). However, the lowland parts of the Basin are currently relatively uneroded, because of the protection by the native vegetation cover (NBCBN 2005). Nonetheless, deforestation and expansion of cultivation may exacerbate the soil erosion hazard even in these lands. With respect to the Lake Tana sub-basin, 20 % (3,042 km<sup>2</sup>) of its area is covered by lake water (Lake Tana). This may contribute to the lowest soil erosion severity level observed in the sub-basin. The northern, eastern and southern parts of the sub-basin are equally affected by moderate to severe soil erosion like that of the other parts of the Basin. Thus, these parts of the sub-basin need attention.



**Fig. 7.6** Potential soil erosion hazard for 20 % SOM reduction in the Upper Blue Nile River Basin

### 7.10.2 Sediment Yield (SY) and Sediment Delivery Ratio (SDR)

The SDR was calculated for the Basin by relating the annual sediment yield (SY) data for El Diem reservoir (the outlet of the Basin) with the calculated amount of soil eroded in the Basin using Eq. 7.8. For baseline data,  $SDR = 140 \text{ Tg year}^{-1} / 280 \text{ Tg year}^{-1} = 50 \%$ . This value is close to the SDR estimated by Awulachew et al. (2009a) and Abdel-Aziz (2009) (i.e., 45 % and 44 %, respectively) for the Basin. Thus, sedimentation is a major threat for irrigation canals and hydroelectric power projects in the Basin and the downstream countries (Sudan and Egypt).

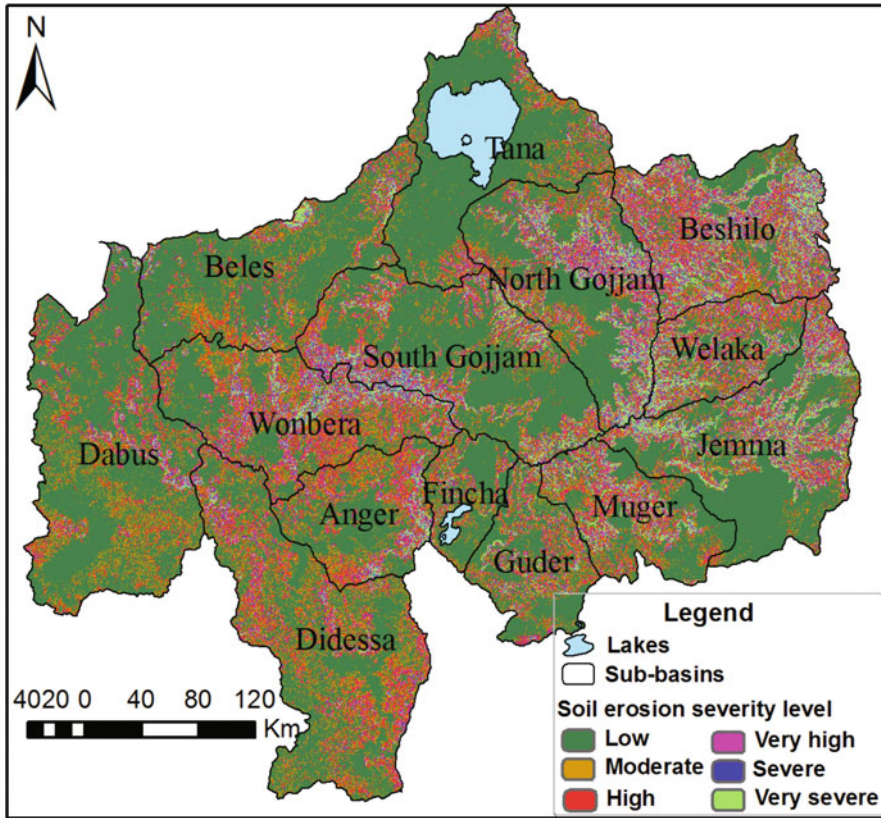


Fig. 7.7 Potential soil erosion hazard for 50 % SOM reduction in the Upper Blue Nile River Basin

### 7.10.3 Effect of Potential SOM Change Due to Climate Change

#### 7.10.3.1 Temperature Variability and Trends

The mean annual maximum and minimum temperatures indicate warming trends over the Basin at a rate of 0.1 °C/decade and 0.15 °C/decade, respectively for the period of 1981–2010 (Mengistu et al. 2013). The mean annual minimum and maximum temperatures in the Basin increased from 12.69 to 13.32 °C and 26.43–26.91 °C from 1981 to 2010, respectively (Mengistu et al. 2013). Similar warming trends have been reported by other studies at different spatial scales and time frames at the country level (NMA 2007; McSweeney et al. 2008; Jury and Funk 2012). The minimum temperatures increased at a higher rate than the maximum temperatures at the annual time scale and during winter, summer, autumn seasons (Mengistu

et al. 2013). McSweeney et al. (2008) attributed the difference between the minimum and the maximum temperatures to the increase in warmer nights on average by 137 days (an additional 37.5 %) and the decrease in cooler nights on average by 21 days (5.8 %) between 1960 and 2006. The rapid change in the minimum rather than the maximum temperature has serious adverse effects than just the increase in the maximum temperature due to its relation with plant respiration. This trend implies that the Basin is vulnerable to climate change induced environmental problems.

### 7.10.3.2 SOM Change Due to Climate Change

As reported in the Introduction section, climate induced warming will decrease SOM, which is a crucial component of soil quality. It serves as a reservoir of plant nutrients, enhances soil aggregation, increases nutrient exchange, retains moisture, reduces compaction, decreases surface crusting and soil erodibility, and increases water infiltration into soil (Lal et al. 1998). Depletion of SOM due to the increase in its rate of decomposition adversely impacts soil quality and the environment (Lal 2004). Thus, agronomic productivity, quality of the soils and environment of the Basin are vulnerable to climate change and severity of extreme events.

### 7.10.4 *Prioritization for Soil and Water Conservation Measures*

On the basis of the estimated annual soil loss rates, the Basin is classified into six erosion severity classes (Figs. 7.5, 7.6 and 7.7; Tables 7.4, 7.5 and 7.6). Accordingly, >60 % of the Basin comes under the low soil erosion severity class (Tables 7.4, 7.5 and 7.6). With decrease in SOM concentration, area of the Basin hitherto categorized under low soil erosion severity class is reduced from 63 % to

**Table 7.4** Current soil erosion severity level in the Upper Blue Nile River Basin

Soil loss Mg ha <sup>-1</sup> year <sup>-1</sup>	Severity level	Count	Area (10 <sup>6</sup> ha)	Percent of total
<10	Low	13,727,010	11.1	63.0
10–20	Moderate	2,735,124	2.2	12.6
20–40	High	2,297,452	1.9	10.5
40–60	Very high	1,114,542	0.9	5.1
60–80	Severe	626,812	0.5	2.9
>80	Very severe	1,287,928	1.0	5.9
Total		21,788,868	17.6	100.0

**Table 7.5** Potential soil erosion severity level for 20 % SOM decrease from the current level due to global warming in the Upper Blue Nile River Basin

Soil loss Mg ha <sup>-1</sup> year <sup>-1</sup>	Severity level	Count	Area (10 <sup>6</sup> ha)	Percent of total
<10	Low	13,337,413	10.8	61.2
10–20	Moderate	2,822,426	2.3	13.0
20–40	High	2,369,180	1.9	10.9
40–60	Very high	1,166,882	0.9	5.4
60–80	Severe	670,647	0.5	3.1
>80	Very severe	1,422,320	1.2	6.5
Total		21,788,868	17.6	100.0

**Table 7.6** Potential soil erosion severity level for 50 % SOM decrease from the current level due to global warming in the Upper Blue Nile River Basin

Soil loss Mg ha <sup>-1</sup> year <sup>-1</sup>	Severity level	Count	Area (10 <sup>6</sup> ha)	Percent of total
<10	Low	12,775,492	10.3	58.6
10–20	Moderate	2,938,814	2.4	13.5
20–40	High	2,475,933	2.0	11.4
40–60	Very high	1,237,989	1.0	5.7
60–80	Severe	733,091	0.6	3.4
>80	Very severe	1,627,549	1.3	7.5
Total		21,788,868	17.6	100.0

58.6 % (Table 7.4, 7.5 and 7.6). This trend clearly shows the adverse effect of SOM reduction on soil erosion severity level in the Basin. On the other hand, significant portion of the Basin (24 %, 26 % and 28 % for baseline, 20 % and 50 % SOM reduction, respectively) may be prone to high to very severe soil erosion hazard, far exceeding the soil loss tolerance level estimated for Ethiopia.

Implementation of strategic soil and water conservation measures necessitates identification of erosion hotspot areas and prioritization of sub-basins. Therefore, as shown in the soil erosion hazard maps (Figs. 7.5, 7.6 and 7.7; Tables 7.7, 7.8 and 7.9) the northeast, east and southern parts (including Beshilo, Welaka, North Gojjam, Jemma and Muger sub-basins) are severely eroded, thus are the first priority to implement soil and water conservation measures for a sustainable land use. Since the aforementioned sub-basins are severely eroded, and have shallow soils and steep slopes, it is difficult to adopt physical soil conservation measures (e.g., terraces). South Gojjam, Wonbera, Anger and Guder sub-basins in the northwest, southwest, and central parts of the Basin are prone to moderate soil erosion and thus have the second priority to implement soil and water conservation measures (Figs. 7.5 and 7.6; Tables 7.7, 7.8 and 7.9). Tana, Beles, Dabus, Didessa and Fincha sub-basins in the northwestern, western and southwestern parts of the Basin are prone to low soil erosion, and thus have the third priority to implement soil and water conservation treatments. Scenario analysis for 20 % and 50 % SOM

**Table 7.7** Current soil erosion severity level for sub-basins of Upper Blue Nile River Basin

Sub-basins	Area (10 <sup>3</sup> km <sup>2</sup> )	Soil loss (Mg ha <sup>-1</sup> year <sup>-1</sup> )				Severity Level
		Min	Min	Mean	STD	
Tana	15.0	0.0	581.9	4.9	16.7	Low
Beshilo	13.2	0.0	913.0	32.7	51.2	High
Beles	14.2	0.0	1,239.1	9.9	30.8	Low
North Gojjam	14.4	0.0	856.3	23.7	47.9	High
Dabus	21.0	0.0	298.6	7.0	15.5	Low
South Gojjam	16.8	0.0	1,133.0	15.6	38.3	Moderate
Jemma	15.8	0.0	1,027.5	24.0	55.9	High
Welaka	6.4	0.0	830.0	27.5	50.0	High
Wonbera	13.0	0.0	609.0	18.7	33.4	Moderate
Fincha	4.1	0.0	934.4	9.1	31.5	Low
Anger	7.9	0.0	783.1	13.7	29.0	Moderate
Muger	8.2	0.0	1,510.8	22.1	53.5	High
Didessa	19.6	0.0	394.1	9.2	16.2	Low
Guder	7.0	0.0	995.3	13.8	36.7	Moderate

**Table 7.8** Potential soil erosion severity level for 20 % SOM reduction scenario for sub-basins of Upper Blue Nile River Basin

Sub-basins	Area (10 <sup>3</sup> km <sup>2</sup> )	Soil loss (Mg ha <sup>-1</sup> year <sup>-1</sup> )				Severity Level
		Min	Max	Mean	STD	
Tana	15.0	0.0	619.8	5.3	18.0	Low
Beshilo	13.2	0.0	972.5	34.8	54.5	High
Beles	14.2	0.0	1,319.8	10.6	32.8	Moderate
North Gojjam	14.4	0.0	881.6	25.2	50.7	High
Dabus	21.0	0.0	318.1	7.7	16.9	Low
South Gojjam	16.8	0.0	1,166.5	16.7	40.9	Moderate
Jemma	15.8	0.0	1,051.9	25.3	58.8	High
Welaka	6.4	0.0	854.5	29.2	52.5	High
Wonbera	13.0	0.0	615.8	20.2	35.8	High
Fincha	4.1	0.0	944.8	9.7	32.6	Low
Anger	7.9	0.0	844.5	15.1	31.2	Moderate
Muger	8.2	0.0	1,555.4	23.2	55.7	High
Didessa	19.6	0.0	450.0	10.4	18.3	Moderate
Guder	7.0	0.0	1,006.3	14.8	38.5	Moderate

reduction shows that Wonbera sub-basin (for 20 % SOM reduction) will prone to high erosion risk, and Beles and Didessa (for 20 % SOM reduction) and Ficha (for 50 % SOM reduction) sub-basins will prone to moderate soil erosion risk. Thus, this should be considered during prioritization of the sub-basins for soil and water conservation measures.

**Table 7.9** Potential soil erosion severity level for 50 % SOM reduction scenario for sub-basins of Upper Blue Nile River Basin

Sub-basins	Area (10 <sup>3</sup> km <sup>2</sup> )	Soil loss (Mg ha <sup>-1</sup> year <sup>-1</sup> )				Severity Level
		Min	Max	Mean	STD	
Tana	15.0	0.0	676.7	5.9	19.9	Low
Beshilo	13.2	0.0	1,061.7	38.1	59.6	High
Beles	14.2	0.0	1,440.9	11.6	35.9	Moderate
North Gojjam	14.4	0.0	919.4	27.5	54.8	High
Dabus	21.0	0.0	361.7	8.7	19.0	Low
South Gojjam	16.8	0.0	1,216.6	18.5	44.7	Moderate
Jemma	15.8	0.0	1,097.1	27.3	63.1	High
Welaka	6.4	0.0	891.2	31.6	56.2	High
Wonbera	13.0	0.0	649.8	22.4	39.5	High
Fincha	4.1	0.0	960.4	10.7	34.4	Moderate
Anger	7.9	0.0	936.5	17.1	34.6	Moderate
Muger	8.2	0.0	1,622.3	24.8	59.1	High
Didessa	19.6	0.0	533.7	12.4	21.7	Moderate
Guder	7.0	0.0	1,022.9	16.9	41.4	Moderate

## 7.11 Conclusions

The data presented indicate a warming trend in the Basin. Mean maximum and minimum temperatures in the Basin have increased at a rate of 0.1 °C/decade and 0.15 °C/decade, respectively. The warming trend observed in the Basin may accelerate the SOM decomposition rate, severely deplete the SOM reserves and increase soil erodibility. Results from the soil erosion risk mapping show that about 280 Tg year<sup>-1</sup>, 300 Tg year<sup>-1</sup> and 332 Tg year<sup>-1</sup> of soils are eroded from the Basin for the baseline, 20 % and 50 % SOM reduction scenarios, respectively. The change in the magnitude of soil erosion risk with the reduction in SOM is a clear manifestation of the impact of warming on soil erosion risk. The soil erosion risk map shows that the risk is higher in the northeast, east and southern part of the Basin than in the central, northwest, western and southwestern parts. Therefore, sub-basins prone to high erosion risk have a high priority for soil conservation treatment.

The Blue Nile (Abay) River is a trans-boundary river; hence it has an off-site effect (siltation of reservoirs and dams) on the downstream countries of Sudan and Egypt. Therefore, coordinated efforts among the riparian countries are essential to implement effective conservation measures and to reduce the on- and off-site effects of accelerated erosion. Since most of the sediments are from the Ethiopian portion of the Nile River Basin, promoting implementation of strategic soil and water conservation technologies in Ethiopia would bring mutual benefits to Ethiopia and the downstream countries (Sudan and Egypt).

Obtaining credible estimates of soil loss, delineation of erosion-prone areas and estimation of the sediment load of the Basin are critical to prioritizing areas for

strategic/targeted conservation measures and to identify the types of conservation measures to be applied. The RUSLE together with geographical information systems (GIS) are useful tools to estimate erosion hazard over the Basin to facilitate adoption of sustainable land use and management. Ground truthing and field measurements are needed to validate these models.

**Acknowledgements** This study was made possible by a financial support to the first author by National Center of Competence in Research (NCCR) North-South (Switzerland). The first author is also grateful to the Robert S. McNamara Fellowships Program for supporting his stay at the Carbon Management and Sequestration Center, The Ohio State University.

## References

- Abdel Aziz TM (2009) Water and sediment management for the Blue Nile Basin. In: Thirteenth international water technology conference, IWTC 13 2009, Hurghada, Egypt
- Allison SD, Wallenstein MD, Bradford MA (2010) Soil-carbon response to warming dependent on microbial physiology. *Nat Geosci* 3:336–340
- Awulachew SB, McCartney M, Steenhuis TS, Ahmed AA (2009a) A review of hydrology, sediment and water resource use in the Blue Nile Basin, Working Paper: 131. International Water Management Institute, Colombo
- Awulachew SB, Erkossa T, Smakhtin V, Fernando A (Comp.) (2009b) Improved water and land management in the Ethiopian highlands: its impact on downstream stakeholders dependent on the Blue Nile. Intermediate results dissemination workshop held at the International Livestock Research Institute (ILRI), Addis Ababa, Ethiopia, 5–6 February 2009. Summary report, abstracts of papers with proceedings on CD-ROM. International Water Management Institute, Colombo, Sri Lanka. doi:[10.3910/2009.201](https://doi.org/10.3910/2009.201)
- Batjes NH (2011) Soil organic carbon stocks under native vegetation – revised estimates for use with the simple assessment option of the Carbon Benefits Project system. *Agric Ecosyst Environ* 142:365–373
- BCEOM (1998) Abay river basin integrated development master plan, main report. Ministry of Water Resources, Addis Ababa
- Bekku YS, Nakatsubo T, Kume A, Adachi M, Koizumi H (2003) Effect of warming on the temperature dependence of soil respiration rate in arctic, temperate and tropical soils. *Appl Soil Ecol* 22:205–210
- Bewket W, Sterk G (2003) Assessment of soil erosion in cultivated fields using a survey methodology for rills in the Chemoga watershed, Ethiopia. *Agric Ecosyst Environ* 97:81–93
- Bewket W, Teferi E (2009) Assessment of soil erosion hazard and prioritization for treatment at the watershed level: case study in the Chemoga watershed, Blue Nile Basin, Ethiopia. *Land Degrad Dev* 20:609–622, 2009
- Bols P (1978) The Iso-erodent map of Java and Madura. Belgian technical assistance project ATA 105. Soil Research Institute, Bogor
- Brhane G, Mekonen K (2009) Estimating soil loss using Universal Soil Loss Equation (USLE) for soil conservation planning at Medego Watershed, Northern Ethiopia. *J Am Sci* 5:58–69
- Burke I, Kaye J, Bird S, Hall S, McCulley R, Sommerville G (2003) Evaluating and testing models of terrestrial biogeochemistry: the role of temperature in controlling decomposition. In: Canham C, Cole J, Lauenroth W (eds) *Models in ecosystem science*. Princeton Univ. Press, NJ, pp 225–253
- Cohen MJ, Shepherd KD, Walsh MG (2005) Empirical reformulation of the universal soil loss equation for erosion risk assessment in the tropical watershed. *Geoderma* 124:235–252



- Conway D (2000) The climate and hydrology of the Upper Blue Nile. *Geogr J* 166:49–62
- Davidson EA, Janssens IA (2006) Temperature sensitivity of soil carbon decomposition and feedbacks to climate change. *Nature* 440:165–173
- El Monshid BEF, El Awad OMA, Ahmed SE (1997) Environmental effect of the Blue Nile Sediment on reservoirs and Irrigation Canals. In: International 5th Nile 2002 conference, Addis Ababa, Ethiopia
- Erenstein OCA (1999) The economics of soil conservation in developing countries: the case of crop residue mulching. Wageningen University, Wageningen
- Eweg HPA, van Lammeren R (1996) The application of geographic information system at the rehabilitation of degraded and degrading areas of Tigray, Ethiopia. Research report. Wageningen Agricultural University, Wageningen
- FAO (1986) Ethiopian highlands reclamation study, Ethiopia. Final Report. FAO, Rome
- Favis-Mortlock DT, Guerra AJT (1999) The implications of general circulation model estimates of rainfall for future erosion, a case study from Brazil. *Catena* 37:329–354
- Friedlingstein P, Cox P, Betts R, Bopp L, von Bloh W, Brovkin V, Cadule P, Doney S, Eby M, Fung I, Bala G, John J, Jones C, Joos F, Kato T, Kawamiya M, Knorr W, Lindsay K, Matthews HD, Raddatz T, Rayner P, Reick C, Roeckner E, Schnitzler KG, Schnur R, Strassmann K, Weaver AJ, Yoshikawa C, Zeng N (2006) Climate-carbon cycle feedback analysis: results from the C4MIP model intercomparison. *J Clim* 19:3337–3353
- Herweg K, Ludi E (1999) The performance of selected soil and water conservation measures-case studies from Ethiopia and Eritrea. *Catena* 36:99–114
- Herweg K, Stillhardt B (1999) The variability of soil erosion in the highlands of Ethiopia and Eritrea. Average and extreme erosion patterns. Research Report 33. University of Berne, Berne
- Hurni H (1983) Soil erosion and soil formation in agricultural ecosystems of Ethiopia and Northern Thailand. *Mt Res Dev* 3:131–142
- Hurni H (1985) Erosion–productivity–conservation systems in Ethiopia. Paper presented at the 4th international conference on soil conservation, 3–9 November 1985, Maracacy, Venezuela, pp 654–674
- Hurni H (1993) Land degradation, famine, and land resource scenarios in Ethiopia. In: Pimentel D (ed) *World soil erosion and conservation*. Cambridge University Press, Cambridge, pp 27–62
- Jenkinson DS, Adams DE, Wild A (1991) Model estimates of CO<sub>2</sub> emissions from soil in response to global warming. *Nature* 351:304–306
- Jones C, Mc-Connell C, Coleman K, Cox P, Falloon P, Jenkinson D, Powlson D (2005) Global climate change and soil carbon stocks; predictions from two contrasting models for the turnover of organic carbon in soil. *Glob Chang Biol* 11:154–166
- Jury MR, Funk C (2012) Climatic trends over Ethiopia: regional signals and drivers. *Int J Climatol* (in press). <http://onlinelibrary.wiley.com/doi/10.1002/joc.3560>
- Kaltenrieder J (2007) Adaptation and validation of the Universal Soil Loss Equation (USLE) for the Ethiopian-Eritrean Highlands. Unpublished thesis. University of Bern, Switzerland
- Kim U, Kaluarachchi J, Smakhtin V (2008) Climate change impacts on hydrology and water resources of the Upper Blue Nile River Basin, Ethiopia. International Water Management Institute (IWMI) Research Report 126
- Kirschbaum MUF (1995) The temperature dependence of soil organic matter decomposition and the effect of Global warming on soil organic C storage. *Soil Biol Biochem* 27:735–760
- Kirschbaum MUF (2000) Will changes in soil organic matter act as a positive or negative feedback on global warming? *Biogeochemistry* 48:21–51
- Krishna KC (2009) Mapping soil erosion susceptibility using remote sensing and GIS: a case of the Upper Nam Wa Watershed, Nan Province, Thailand. *Environ Geol* 57:695–705
- Lal R (1999) Erosion impact on soil quality in the tropics. In: Lal R (ed) *Soil quality and soil erosion*. CRC press, Boca Raton, pp 285–317
- Lal R (2003) Soil erosion and the global carbon budget. *Environ Int* 29:437–450
- Lal R (2004) Soil carbon sequestration impacts on global climate change and food security. *Science* 304:1623–1627

- Lal R (2013) Soil carbon management and climate change. *Carbon Manag* 4:439–462
- Lal R, Kimble JM, Follett RF, Stewart BA (1998) Soil processes and the carbon cycle. CRC Press, Boca Raton, p 609
- McCool DK, Brown LC, Foster GR, Mutchler CK, Meyer LD (1987) Revised slope steepness factor for the Universal Soil Loss Equation. *Trans ASCE* 30
- McCool DK, Foster GR, Weesies GA (1997) Slope length and slope steepness factors (LS). In: Renard KG, Foster GR, Weesies GA, McCool DK, Yoder DC (eds) *Predicting soil erosion by water: a guide to conservation planning with the Revised Universal Soil Loss Equation (RUSLE)*, Agriculture Handbook No. 703. US Department of Agriculture, Agricultural Research Service, Washington, DC, pp 101–141, 404pp
- McSweeney C, New M, Lizcano G (2008) UNDP climate change country profiles-Ethiopia. Available at: <http://country-profiles.geog.ox.ac.uk>
- Mekonnen M, Melesse AM (2011) Soil erosion mapping and hotspot area identification using GIS and remote sensing in Northwest Ethiopian Highlands, Near Lake Tana. In: Melesse AM (ed) *Nile River Basin: hydrology, climate and water use*. doi:10.1007/978-94-007-0689-7\_10, Springer Science+Business Media B.V. pp 207–224
- Mengistu D, Bewket W, Lal R (2013) Recent spatio-temporal temperature and rainfall variability and trends over the Upper Blue Nile River Basin, Ethiopia. *Int J Climatol* (in press)
- Merrey DJ, Gebreselassie T (2011) Promoting improved rainwater and land management in the Blue Nile (Abay) basin of Ethiopia. NBDC Technical Report 1. Nairobi, Kenya, ILRI
- Meshesha DT, Tsunekawa A, Tsubo M, Haregeweyn N (2012) Dynamics and hotspots of soil erosion and management scenarios of the Central Rift Valley of Ethiopia. *Int J Sediment Res* 27:84–99
- Millward AA, Mersey JE (1999) Adapting the RUSLE to model soil erosion potential in a mountainous tropical watershed. *Catena* 38:108–129
- Ministry of Agriculture and Rural Development (MoARD) and World Bank (2007) Ethiopia: thematic papers on land degradation in Ethiopia, (a product of TF052779). MoARD and World Bank Publication, Addis Ababa
- Morgan RPC (1974) Estimating regional variations in soil erosion hazard in Peninsular Malaysia. *Malay Nat J* 28:94–106
- Morgan RP (1995) *Soil erosion and conservation*, 2nd edn. Cranfield University, Silsoe College
- Morgan RPC (2005) *Soil erosion and conservation*, 3rd edn. Blackwell Publishing Limited, USA
- NBCBN (Nile Basin Capacity Building Network) (2005) Survey of literature and data inventory in watershed erosion and sediment transport. Nile Basin Capacity Building Network, Cairo
- Nearing MA (2001) Potential changes in rainfall erosivity in the U.S. with climate change during the 21st century. *J Soil Water Conserv* 56(3):229–232
- NMA (National Meteorological Agency, Ethiopia) (2007) Initial national communication of Ethiopia to the United Nations Framework Convention on Climate Change (UNFCCC). Addis Ababa
- Ongsomwang S, Thinley U (2009) Spatial modeling for soil erosion assessment in Upper Lam Phra Phloeng Watershed, Nakhon Ratchasima, Thailand. *Suranaree J Sci Technol* 16:253–262
- Pimentel D (2006) Soil erosion: a food and environmental threat. *Environ Dev Sustain* 8:119–137
- Pimentel D, Harvey C, Resosudarmo P, Sinclair K, Kurz D, McNair M, Crist S, Sphpritz L, Fitton L, Saffouri R, Blair R (1995) Environmental and economic costs of soil erosion and conservation benefits. *Science* 267:1117–1123
- Pruski FF, Nearing MA (2002) Climate-induced changes in erosion during the 21st century for eight U.S. locations. *Water Resour Res* 38:1298. doi:10.1029/2001WR000493
- Reichstein M (2008) Impacts of climate change on forest soil carbon: principles, factors, models, uncertainties. In: Freer-Smith PH, Broadmeadow MSJ, Linch JM (eds) *Forestry and climate change*. Wallingford, OECD, Forest Research, CABI Book, Wallingford, pp 127–135
- Renard KG, Foster GR, Weesies GA, McCool DK, Yoder DC (1997) *Predicting soil erosion by water: a guide to conservation planning with the Revised Universal Soil Loss Equation (RUSLE)*. USDA agricultural handbook 703, pp 126–131

- Roose EJ (1975) Erosion et ruissellement en Afrique de l'ouest: vingt années de mesures en petites parcelles expérimentales. ORSTOM, Adiopodoumé
- Roose EJ (1977) Application of the universal soil loss equation in West Africa. In: Greenland DJ, Lal R (eds) Soil conservation and management in the Humid Tropics. Wiley, UK, pp 177–188
- Sanderman J, Amundson RG, Baldocchi DD (2003) Application of eddy covariance measurements to the temperature dependence of soil organic matter mean residence time. *Global Biogeochem Cycles* 17:1061–1075. doi:[10.1029/2001GB001833](https://doi.org/10.1029/2001GB001833)
- Shahin M (1993) An overview of reservoir sedimentation in some African river basins. In: Proceedings of sediment problems: strategies for monitoring, prediction and control, Yokohama, July 1993, LAHS Publ. no. 217, pp 93–100
- Shiferaw A (2011) Estimating soil loss rates for soil conservation planning in the Borena woreda of South Wollo highlands, Ethiopia. *J Sustain Dev Afr* 13:87–106
- Sonneveld BGJS (2002) Land under pressure: the impact of water erosion on food production in Ethiopia. Shaker Publishing, Maastricht
- Streile GP, Shields KD, Stroth JL, Bagaasen LM, Whelan G, McDonald JP, Droppo JG, Buck JW (1996) The Multimedia Environmental Pollutant Assessment System (MEPAS): source-term release formulations. Pacific Northwest National Laboratory, Richland, PNNL-11248/UC-602, 630
- Tamene L (2005) Reservoir siltation in the drylands of northern Ethiopia: causes, source areas and management options. Ph.D. Thesis, Ecology and Development Series 30, Center for Development Research, University of Bonn
- Teodoru C, Wüest A, Wehrli B (2006) Independent review of the environmental impact assessment for the merowe dam project (Nile River, Sudan). Eawag aquatic research, Switzerland
- Trumbore SE (1997) Potential responses of soil organic carbon to global environmental change. *Proc Natl Acad Sci* 94:8284–8291
- United Nations Population Division (UNPD) (2005) Population prospects in the Nile Basin. Information products for Nile Basin Water Resources Management, GCP/INT/945/ITA. [www.fao.org/nr/water/faonile](http://www.fao.org/nr/water/faonile)
- Van Remortel RD, Maichle RW, Hickey RJ (2004) Computing the LS factor for the revised universal soil loss equation through array-based slope processing of digital elevation data using a C++ executable. *Comput Geosci* 30:1043–1053
- Wischmeier WH, Smith DD (1978) Predicting rainfall erosion losses—a guide to conservation, Agricultural Handbook no. 537. US Department of Agriculture, Washington, DC
- Wischmeier WH, Johnson CB, Cross BV (1971) A soil erodibility nomograph for farmland and construction sites. *J Soil Water Conserv* 26:189–192
- World Bank (2006) Ethiopia: managing water resources to maximize sustainable growth. World Bank Agriculture and Rural Development, Washington, DC
- Xin Z, Yu X, Li Q, Lu XX (2010) Spatiotemporal variation in rainfall erosivity on the Chinese Loess Plateau during the period 1956–2008. *Reg Environ Chang* 11:149–159

# Chapter 8

## Climate Change and Crop Yield in Sub-Saharan Africa

Charles K.K. Gachene, Anne N. Karuma, and Mary W. Baaru

**Abstract** Recent scientific evidence shows that crop yields in many Sub Saharan Africa (SSA) countries are likely to be severely affected by climate change. Reliance on rainfall in this region increases the vulnerability of cereal systems to climate change and variability. In large parts of SSA, maize (*Zea mays* L.) is the principal staple crop, covering a total of nearly 27 M ha, and yet maize yields remain the lowest in the world, stagnated at less than 2 Mg ha<sup>-1</sup>. Calculated and simulated analyses for SSA show that crop yields will decline by more than 10 % by 2055. The effect of climate change on crop yields is mainly attributed to: increased frequency of extreme events; effects of elevated CO<sub>2</sub> (where studies project crop yield increases of 5–20 % at 550 ppm CO<sub>2</sub>); interactions of elevated CO<sub>2</sub> with temperature and rainfall as well as with soil nutrients; and increased vulnerability to weed competition, insect pests, and diseases. However, several studies show that rainfall and water availability limit agricultural production more than temperature in SSA. The projected rainfall would increase by 2–4 % in Eastern Africa, but decrease by 5 % in Southern Africa during the main crop growing seasons. Temperatures are likely to increase throughout SSA by 2050, but the combination of increasing temperatures and low seasonal rainfall in Southern Africa suggest this region will be particularly vulnerable. Some of the crop models used for predicting the effect of climate change on yields are limited by their ability to predict effects of climatic events that lie outside the range of present-day variability. In addition, comparisons between models for the same setting have sometimes given differing results. This review paper shows that, for most of the SSA countries, the data required for assessing long-term effect of climate change on crop yield are lacking, that most of the models do not cater to assessment at the household level, and that no single approach can be considered as adequate. Therefore, a clear need exists for collaboration among different scientific disciplines for the development of agriculture in SSA in a changing climate.

---

C.K.K. Gachene (✉) • A.N. Karuma  
Department of Land Resource Management and Agricultural Technology,  
University of Nairobi, P.O. Box 29053, 00625 Nairobi, Kenya  
e-mail: [gachene@uonbi.ac.ke](mailto:gachene@uonbi.ac.ke); [gachenecharles@gmail.com](mailto:gachenecharles@gmail.com)

M.W. Baaru  
Kenyatta University, P.O. Box 43844, 00100 Nairobi, Kenya

**Keywords** Climate change • Crop yields • Sub-Saharan Africa

## 8.1 Introduction

Cereal production growth for a range of crops in Sub-Saharan Africa (SSA) is projected to decline by 3.2 % in 2050 as a result of climate change. Thus, the projected scenario is that of a continent whose people will be exposed to hardship economic livelihoods due to adverse direct effects, high agricultural dependence, and limited capacity to adapt to a changing climate (Nelson et al. 2009; Campbell et al. 2011; Ringler et al. 2010, 2011; Andersson et al. 2012). SSA relies almost entirely on maize (*Zea mays* L) as the principal staple crop; maize covers a total of nearly 27 million ha (M ha) (Table 8.1). This crop accounts for 30 % of the total area under cereal production in the region: 30.9 % is in West Africa, 8.8 % in Central Africa, 30.9 % in Eastern Africa, and 29.4 % in Southern Africa. In particular, the crop accounts for 62.1 % of the total area under cereal production in Central Africa (FAO 2010). Despite the importance of maize in SSA, its yields remain very low, having stagnated at less than 2 Mg ha<sup>-1</sup>, compared to yields of 6 Mg ha<sup>-1</sup> obtained in China and India (Shiferaw et al. 2011; Ray et al. 2012).

Low yields are largely associated with drought stress, inherent low soil fertility (coupled with continuous mining of plant nutrients without adequate replenishment), nutrient losses due to erosion, weeds, pests, diseases, low input availability, low input use, and lack of improved seed varieties. In addition, crop production is rainfed and this reliance on rainfall further increases the vulnerability of maize and other cereal systems to climate variability and change. Of equal importance, people have to pay more for their food in a changing climate (Table 8.2) and in this region, close to 198 million people are already considered as hungry (UN Hunger Task Force (2003) [www.developmenteducation.ie](http://www.developmenteducation.ie)). By 2050, prices of cereals will be more than 4 % higher while those of traditional crops such as cassava, sweet potato, and yam will be more than 20 % higher.

Ringler et al. (2011) and Oyiga et al. (2011) indicate that the largest negative yield impacts are projected for wheat—though the region grows very little of this crop—followed by sweet potatoes. The higher tolerance to higher temperatures and

**Table 8.1** Production area of major food crops in sub-Saharan Africa (FAO 2010)

	West Africa	Central	Eastern	Southern <sup>a</sup>	SSA
Cereals total area (M ha)	44.39	3.8	28.35	12.12	88.70
Maize ( <i>Zea mays</i> L.)	8.34	2.36	8.33	7.93	26.97
Sorghum ( <i>Sorghum bicolor</i> (L.) Moench)	11.32	0.75	9.43	3.10	24.60
Cassava ( <i>Manihot esculenta</i> Crantz)	5.10	2.51	1.57	2.79	11.97
Rice ( <i>Oryza glaberrima</i> )	5.23	0.58	0.96	2.10	8.87
Wheat ( <i>Triticum</i> spp.)	0.06	0	2.23	0.07	2.36
Maize yield kg/ha	1.41	1.70	2.49	1.29	1.71

<sup>a</sup>Excluding South Africa

**Table 8.2** Percent projected prices for some of the crops due to climate change (FAO 2003, [www.developmenteducation.ie](http://www.developmenteducation.ie))

Crop	Projected prices in 2050
Maize ( <i>Zea mays</i> L.)	4 % higher
Millet ( <i>Eleusine coracana</i> )	5 %
Sorghum ( <i>Sorghum bicolor</i> (L.) Moench)	5 %
Rice ( <i>Oryza glaberrima</i> )	7 %
Wheat ( <i>Triticum</i> spp.)	15 %
Cassava ( <i>Manihot esculenta</i> Crantz)	20 %
Sweet potato ( <i>Ipomea batatas</i> )	26 %
Yam ( <i>Dioscorea</i> spp.)	26 %

**Table 8.3** Climate change and related factors relevant to agricultural production and food security (Source: Iglesias 2006)

Climate factor	Direction of change	Consequences
Sea level rise	Increase	Sea level intrusion in coastal (agricultural) areas and salinization of water supply
Precipitation intensity/runoff	Intensified hydrological cycle	Changed patterns of erosion and accretion; changed storm impacts Changed occurrence of storm flooding and storm damage, water logging, increase in pests
Heat stress	Increase	Damage to grain formation, increase in some pests
Drought	Poorly known	Crop failure, yield decrease Competition for water
Atmospheric CO <sub>2</sub>	Increase	Increased crop productivity, but also increased weed productivity and therefore competition with crops

drought stress seen in millet and sorghum yields suggests that their projected yields will be slightly higher under climate change (Easterling et al. 2007; Ramirez et al. 2013). Thus, addressing crop yield decline in a changing climate in SSA is likely to involve adaptation strategies to climate change in maize and other cereal systems that include improved germplasm with tolerance to drought and heat stress and improved management practices (Ringler et al. 2010; Oseni and Masarirambi 2011). The impacts of climate change on agriculture are summarized in Table 8.3. Most of the climatic factors affecting crop growth and yield, such as heat stress and atmospheric CO<sub>2</sub>, are projected to increase.

## 8.2 Adapting to Climate Change in Sub Saharan Africa: The Role of Agricultural Research

Several areas of research are recognized in which agricultural and natural resource management and development can contribute to address the negative impact of climate change on crop yield. These adaptation measures include: improved crop

varieties, use of both organic and inorganic fertilizers to improve yields, soil water retention and soil structure, soil and water conservation, agroforestry, and the use of seasonal climate forecasting to strengthen agriculture. Some of these adaptation measures have been described in greater detail elsewhere in this book.

### ***8.2.1 Drought Mitigation Through Plant Breeding***

Drought has always been a great limiting factor to agricultural development in sub-Saharan Africa. However, many observers are now linking climate change to the increase in the frequency and intensity of drought events in recent years. The local and international research institutions have strived to develop and disseminate new crop varieties that are better adapted to the changing environment; these include maize varieties that are able to yield more than the currently available cultivars under conditions of limiting moisture, low fertility, and high disease/pest pressure, as well as pigeon pea, which is a drought-tolerant crop that can survive when crops like maize fail to reach maturity (Lobell et al. 2008; Thornton et al. 2009). However, the inability to access improved germplasm is a recurring problem for farmers in many SSA countries (Oseni and Masarirambi 2011). This limited access can be due to a lack of information, incentives (poor links to output markets), or means to purchase the germplasm. Thus, strategic partnerships between research institutions and their partners from private sector, national programs, NGOs, and community-based organizations are needed to increase this access. Training farmers so that they can produce high quality seeds and helping them enter into partnerships with seed companies are some ways of addressing this problem.

The average grain yield for maize in Sub Saharan Africa (SSA) has stagnated at around 1–2 Mg ha<sup>-1</sup>. In comparison, yields of more than 6 t ha<sup>-1</sup> are obtained in developed countries. The soils on which smallholder SSA farms are so dependent have been subjected to severe soil erosion and loss of organic matter, which leads to low crop productivity (Sanchez 2002). Recent studies in Rwanda by Ndayisaba et al. (2013) on highly weathered Ferralsols showed that application of fertilizer at the rate of 30 kg N, 30 kg P, and 30 kg K ha<sup>-1</sup> (supplied as N, P, NP, NK, PK, and NPK) significantly improved grain yields by 13.3–98 % across the study zone and cropping seasons. However, although a number of site-specific studies have shown positive effects of inorganic fertilizer and organic inputs on maize yield, information is lacking on the variation in yield risks with soils and climate in SSA. Sileshi et al. (2010) studied variation in maize yield gaps with plant nutrient inputs, soil type and climate and concluded that yield gaps and yield risks are closely associated with the sensitivity and resilience of soils, climate, and management (researcher vs. farmer). Yield gap was defined as the difference in grain yield between maize grown using a given nutrient input and without external nutrient inputs (i.e., control) under a specific study condition. Yield risk was defined as the probability of obtaining yields lower than or equal to the control across similar conditions.

Yield gaps with the recommended rate of inorganic fertilizer were significantly higher on farmers' fields than on research stations, while differences in organic inputs were smaller. The use of inorganic fertilizer increased the yield risks (up to 22 %) on Nitisols compared with Luvisols (<5 % risk).

### ***8.2.2 The Role of Rainwater Harvesting***

In many areas of SSA, a very small proportion of rainwater is used by crops; the remainder is lost through runoff and deep percolation (Rockström et al. 2001; Malesu et al. 2010). Of the total precipitation, green water accounts for 65 % while blue water accounts for 35 %. Climate change is likely to result in reduced or erratic rainfall over large areas of SSA; therefore, techniques are increasingly needed that can improve consumptive water use and rainwater infiltration or its storage for immediate or future use by crops or livestock.

Numerous technologies, such as deep tillage, manure application, terracing, soil bunds, and micro-catchments, are in use in many areas of SSA (Miriti et al. 2012; Karuma et al. 2011). These technologies significantly improve the water holding capacity of soils and mitigate the negative effects of agricultural drought (Njaimwe et al. 2013). The results obtained by Miriti et al. (2012) showed that tied-ridge tillage resulted in the greatest plant available water content while subsoiling-ripping tillage had the least in all seasons. Averaged across seasons and cropping systems, tillage had no significant effect on maize grain yield but it did have a significant positive effect on crop grain and dry matter water use efficiency. A study conducted in West Africa showed that soil water conservation strategies were mostly sited in the Sahelian region of Burkina and Niger as a strategy for reducing the effect of perceived rainfall decrease (Irénikatché et al. 2010).

### ***8.2.3 The Role of Seasonal Climate Forecasting***

Efforts for adaptation to climate variability combine strategies that minimize the negative impacts of extreme climatic events and those that take advantage of the good years. Climatic extremes such as droughts are expected to increase in frequency and intensity; therefore, predicting the inter-annual and inter-seasonal variation in rainfall will be paramount for short-term decision making (Chen et al. 2004). According to IPCC (2007), great uncertainty remains in projected changes in rainfall distribution patterns, as the outputs of climate models for future precipitation often do not agree on the direction of change for SSA. However, a general trend of increased precipitation appears to exist for East Africa, with decreased precipitation in Southern Africa (IPCC 2007). For West Africa, the projected changes in rainfall vary greatly, complicating any inference regarding future climate scenarios.



Results obtained by Oseni and Masarirambi (2011) showed significant differences on the effects of average rainfall and growing season rainfall on maize production. The rainfall trends in the Lowveld (severely drought prone area) tended to be declining whereas those of the Middleveld (moderately drought prone area) were somewhat stable. Reduced/or erratic rainfall during the years resulted in decreased maize production. These researchers concluded that vulnerability of maize production systems to climate change and variability in Swaziland depends on its time of occurrence relative to the growth stage of the crop.

### ***8.2.4 Weather-Proofing Agriculture: On-Farm Adaptation in a Changing Climate***

A very wide array of methods in crop husbandry have been developed to make the most of what climate offers as well as to minimize the adversity that it sometimes brings (Case 2006). The most relevant of these are methods designed to “weather-proof” agriculture and these can often be adapted to afford some protection against climate change. The following three categories are considered: (1) altered choice of crops, (2) altered tillage and crop management, and (3) altered inputs.

Farmers may address declining agricultural yields by re-evaluating longstanding choices about which crops to plant and at what time. In places where water scarcity is a problem, farmers may need to invest in drought resistant versions of traditional crops or shift cultivation to different plants altogether. In areas subject to intense rainfall or frequent flooding, farmers may have to shift to crops that can withstand periods of waterlogging. Dependence on livestock may no longer be a viable strategy in places where dry conditions and a lack of water and pasture are likely to worsen.

## **8.3 Approaches to the Assessment of the Impacts of Climate Change on Crop Yield**

Researchers have attempted to assess the impact of climate change on projected crop distribution, crop growth, and yield using different methods, such as:

- Agroclimatic indices and geographic information systems (GIS). For example, simple agroclimatic indices are used to analyze large-area shifts of cropping zones
- Statistical models and yield functions. Regression analyses allow the quantification of weather changes on crop yields in an actual cropping context. The few regression-based impact assessments of future climate change on crop yields in Africa are based on millet, cowpeas, and groundnut in Niger (Mohamed et al. 2002; Van Duivenbooden et al. 2002)
- Process-based models

A summary of the characteristics of the main agricultural models is given in Table 8.4.

Some of the above models have been used in SSA to project the impact of climate change on crop growth and yields. For instance, in Ghana, the impact of climate change on cereal production was assessed using the CERES model. CERES MAIZE and CERES MILLET models were used to predict the growth and yield of maize and millet, respectively. The future climate change scenarios generated indicated that both the maximum and minimum temperatures would increase over the years in all the agro-climatic zones of Ghana, but the increases were higher

**Table 8.4** Summary of the characteristics of the main agricultural models (Adapted from Parry et al. 2000)

Description and use	Weaknesses
Agro-climatic indices and GIS: effective for comparing across regions or crops	
Based on combinations of climate factors important for crops	Climate based only
Used in many agricultural planning studies	Lack management responses or consideration of carbon fertilization
Useful for general audiences	
Statistical models and yield functions: present-day crop and climatic variations are well described	
Based on the relationship between observed climate and crop responses (e.g., predicting crop yields on the basis of temperature, rainfall, sowing date, and fertilizer application)	Do not explain causal mechanisms
	Limited ability to predict effects of climatic events that lie outside the range of present-day variability
Used in yield prediction for famine early warning and commodity markets	May not capture future climate crop relationships or CO <sub>2</sub> fertilization
Process-based crop models: process based, widely calibrated, and validated. Useful for testing a broad range of adaptations. Test mitigation and adaptation strategies simultaneously. Available for most major crops	
Calculate crop responses to factors that affect growth and yield (i.e., climate, soils, and management)	Require detailed weather and management data for best results
Used by many agricultural scientists for research and development	
Economic tools: useful for incorporating financial considerations and market-based adaptations	
Calculate land values, commodity prices, and economic outcomes for farmers and consumers based on crop production data	Not all social systems, households, and individuals appropriately represented
	Climate-induced alterations in availability of land and water not always taken into account
	Models are complex and require a lot of data
Household and village models: useful in semi-commercial economies	
Description of coping strategies for current conditions by household and village as the unit of response	Not generalizable
	Do not capture future climate stresses, if different from current

Most of these models require detailed weather and management data for best results. One of the major problems in SSA is a lack of data that can be used to project the impact of climate change on crop yield. Table 8.5 highlights data requirements for some of the most commonly used models

**Table 8.5** Parameters used for some of the climate change crop models that are pertinent in SSA (Source: Adapted from Jones and Ritchie 1990)

Crop model	Parameters used
AFRCWHEAT ( <a href="http://www.unfccc.int">www.unfccc.int</a> )	Weather data such as daily values of maximum, minimum, dry and wet bulb temperature, solar radiation, sunshine hours, rainfall, wind, etc.
APSIM ( <a href="http://www.apsim.com">www.apsim.com</a> )	Crop factors – radiation use efficiency, biomass partitioning (root, shoot, leaves and grain), germination to emergence, emergence to juvenile stage, end of juvenile stage to floral initiation, floral initiation to appearance of flag leaf, appearance of flag leaf to start of grain filling, start of grain filling to end of grain filling, end of grain filling to physiological maturity, physiological maturity to harvest ripening, max LAI, max tillering rate, root extension parameters, crop lower limit for water extraction (each soil layer), grain filling parameters Soil – soil saturated flow, bulk density, air dry water content, lower limit water content, drained upper limit, saturation water content, plant lower limit water content, organic content, EC, pH, CEC, Ca, Cl, Mn, Al, B concentrations, sand, silt, clay, ET
BEANGRO ( <a href="http://www.unfccc.int">www.unfccc.int</a> )	The input data needed for the model are daily weather data, e.g., daily total radiation, minimum and maximum air temperature, and daily total rainfall, photoperiod, irrigation strategy, soil profile characteristics, and general management conditions, e.g. plant population and planting date The model BEANGRO is also sensitive to cultivar choice, planting date, row and plant spacing, and irrigation management regimes
CERES (Ritchie et al. 1989)	Management – cultivation parameters, planting date, plant population, fertilization and irrigation dates, rooting depth (cm) Climate – longitude and latitude, daily global radiation, daily max and min temps, precipitation Soil (by layer) – initial soil water content, 0.33 and 15 bar soil water content, soil texture and cation exchange capacity
CROPWAT ( <a href="http://www.fao.org">www.fao.org</a> )	Climatic and crop data (CLIMWAT database, included with the program) for calculations of crop water requirements and irrigation requirements Monthly, decade, and daily input of climatic data for calculation of reference evapotranspiration (ET <sub>o</sub> ) Decade and daily calculation of crop water requirements based on updated calculation algorithms including adjustment of crop-coefficient values Daily soil-water balance using various user-defined options for water supply and irrigation management conditions
EPIC (Williams et al. 1989)	Weather – max and min temp, precipitation, solar radiation, wind speed, relative humidity (for Penman/Monteith), monthly statistics (long run daily weather – mean, standard deviation, skew coefficient for daily precipitation, probability of a wet day after a wet day, probability of a wet day after a dry day, average rain days Soil (up to 10 soil layers) – soil albedo, hydrological soil group (A, B, C, D). For each soil layer: sand content (%), silt content (%), soil pH,

(continued)

**Table 8.5** (continued)

Crop model	Parameters used
	<p>OC (%), calcium carbonate content (%), bulk density of layer (moist), coarse fragment content (vol %)</p> <p>Topography – average field size (ha), slope length (m), slope steepness, elevation, longitude/latitude</p> <p>Crop rotation/management – date of planting, date, type and amount of fertilization (kg/ha), date and amount of irrigation (mm/ha), date and amount of pesticides (kg/ha of active ingredients), date of tillage operations (plough, harrow spike, field cultivator, thinning, date of harvesting (expected yield, grazing</p>
GAPS (Butler and Riha 1989)	Data on the site's soils, climate, and management
GOSSYM ( <a href="http://www.unfccc.int">www.unfccc.int</a> )	<p>Crop information: latitude of location, distance between rows, plant population per unit of planted row, date of emergence and cotton cultivar used (from the existing variety files), time and amount of irrigation and nitrogen fertilizer in various forms</p> <p>Soil information: initial (annually) soil files: initial soil water and fertility levels (NO<sub>3</sub>-N, NH<sub>4</sub>-N, organic matter) at 15 cm depth increments, taken at the beginning of each growing season. For the permanent soil hydrology files and for each horizon is required: the soil moisture characteristic curve, the saturated hydraulic conductivity and textural analysis and bulk density</p> <p>Weather information: daily air temperature (max. and min.), rainfall, solar radiation, and wind run</p>
PNUTGRO ( <a href="http://www.unfccc.int">www.unfccc.int</a> )	<p>Normally, experimental data are used as inputs for the model. The quality of these data depends on the quality of the experiment itself. For predictive purposes, the model only requires soil profile and weather information as inputs. It is up to the user to define the quantity of data used in these simulations. Shortfalls include the unavailability of solar radiation data, the unavailability of detailed soil profile information, and the unavailability of detailed experimental data to determine cultivar specific parameters</p> <p>Daily weather data (air temperature, precipitation, solar radiation). Soil physical conditions of the profile by layer. Soil chemical conditions of the profile by layer (nitrogen only)</p> <p>Crop management conditions (planting date, spacing, irrigation management). Predict weight of leaves, stems, roots, pods, shells, seeds, LAI, root</p>
RICEMOD ( <a href="http://www.unfccc.int">www.unfccc.int</a> )	Data intensive; requires soil, crop characteristics, and atmospheric data (rainfall, pan evaporation, radiation, minimum and maximum temperature, day length)
SORGF ( <a href="http://www.unfccc.int">www.unfccc.int</a> )	<p>This type of model generally requires soil data, daily weather data, variety information, and crop management information</p> <p>Detailed field measurements of interception of photosynthetically active radiation (PAR), leaf number and leaf area, soil water content, dry-matter production, and distribution in different components and phenology for different genotypes</p>

(continued)

**Table 8.5** (continued)

Crop model	Parameters used
SORKAM ( <a href="http://www.unfccc.int">www.unfccc.int</a> )	Weather (rainfall, max temp, min temp, max and min relative humidity, solar radiation, average wind speed, average vapor pressure)
	Plant parameters (leaf number, tiller coefficients, seed number coefficients, seed weight coefficients)
	Soil information – soil type, depth, soil albedo, field slope, soil water evaporation coefficients, thickness, bulk density, evapotranspiration
SOYGRO (Jones et al. 1989)	Site: latitude and longitude, elevation; average annual temperature; average annual amplitude in temperature, slope and aspect; major obstruction to the sun (e.g., nearby mountain); drainage (type, spacing, and depth); surface stones (coverage and size)
	Weather: daily global solar radiation, maximum and minimum air temperatures, precipitation
	Soil: classification using the local system and (to family level) the USDA-NRCS taxonomic system, basic profile characteristics by soil layer: in situ water release curve characteristics (saturated drained upper limit, lower limit); bulk density, organic carbon; pH; root growth factor; drainage coefficient
	Initial conditions: previous crop, root, and nodule amounts; numbers and effectiveness of rhizobia (nodulating crop), water, ammonium, and nitrate by soil layer
	Management: cultivar name and type, planting date, depth, and method; row spacing and direction; plant population, irrigation and water management, dates, methods, and amounts or depths, fertilizer (inorganic) and inoculant applications, residue (organic fertilizer) applications (material, depth of incorporation, amount and nutrient concentrations), tillage, environment (aerial) adjustments, harvest schedule
SOYMOD ( <a href="http://www.unfccc.int">www.unfccc.int</a> )	Solar radiation, minimum and maximum air temperatures, rainfall, wind, soil type, and sowing density
WOFOST ( <a href="http://www.unfccc.int">www.unfccc.int</a> )	WOFOST is designed to fit available regional data sets as input data
	Crop – crop cultivar choice and sowing date
	Soil and soil water data
	Weather: maximum temperature, minimum temperature, global radiation, wind speed, vapor pressure, evapotranspiration, and rainfall. The meteorological data are often measured on a daily basis
COTCROP ( <a href="http://www.unfccc.int">www.unfccc.int</a> )	Nutrient data
	Latitude and longitude,
	Daily weather data: minimum and maximum temperature, incoming global radiation,
COTTAM ( <a href="http://www.unfccc.int">www.unfccc.int</a> )	Genetic parameters: earliness, maximum weight of a single boll, first node on the main stem producing a fruit bearing branch,
	Management parameters; e.g., plant density
	Field and greenhouse data
COTTAM ( <a href="http://www.unfccc.int">www.unfccc.int</a> )	Daily weather data
	Plant data – maturity type, plant population, row spacing, water stress

in the Sudan Savanna zone where temperatures are normally the highest. The projected climate scenarios and the CERES model predicted that percentage decrease in maize yield in the Transition zone would range from 0.5 % in the year 2000 to 6.9 % in the year 2020. The yield of millet, however, was not affected by the projected climate change because millet is more drought tolerant and therefore less sensitive to temperature rise.

## 8.4 Impacts of Projected Climate Change on Crop Growth and Yield

Several studies have been conducted on the impact of climate change on crop yield (Cairns et al. 2013; Iglesias 2006; Thompson et al. 2010). Analysis of this work indicates a consistent prediction of decreased crop productivity. Some regions may improve their agricultural production whereas others will suffer from yield losses; therefore, a reorganization of the agricultural production areas may be required.

According to Fischer et al. (2005), the climate of large areas of Namibia, Botswana, South Africa, Lesotho, and smaller proportions of Swaziland and Zimbabwe is already unsuitable for crop production. Substantial decreases in the productivity of crop-suitable land in Namibia, Botswana, South Africa, and Zimbabwe are projected. Parts of Angola, Malawi, Mozambique, Zambia, and Madagascar are also projected to experience declines in crop production under climate change. However, substantial increases (over half of each country's area) are projected for Angola, Democratic Republic of Congo, Madagascar, Tanzania, and Zambia. A study of food-insecure countries in SSA yields similar results (Shiferaw et al. 2011). Using the HADCM3, CSIRO, and CGCM2 models, Fischer et al. (2002) showed the following: Sudan, Nigeria, Senegal, Mali, Burkina Faso, Somalia, Ethiopia, Zimbabwe, Chad, Sierra Leone, Angola, Mozambique, and Niger lose cereal production potential in the 2080s. In contrast, Zaire, Tanzania, Kenya, Uganda, Madagascar, Cote d'Ivoire, Benin, Togo, Ghana, and Guinea all gain cereal production potential in the 2080s.

The impact of projected climate change on crop yield can be either direct and or indirect.

### Direct Impacts

- Small increases in mean temperature of between 1 and 2 °C are projected to lead to a decrease in crop productivity. For example, the yield of rain-fed wheat grown at 450 ppm CO<sub>2</sub> was found to increase up to 0.8 °C warming, then declined beyond 1.5 °C warming. In such circumstances, additional irrigation will be needed to counterbalance these negative effects.
- Changes in temperature regimes could affect growing locations, the length of the growing season, crop yields, and planting and harvest dates. According to Campbell et al. (2011), high temperature during the critical flowering period

of a crop may lower otherwise positive CO<sub>2</sub> effects on yield by reducing grain number, size, and quality

- Increased need for irrigation in a region where existing water supply and quality is already negatively affected by other stressors. Increased temperatures during the growing period may also reduce CO<sub>2</sub> effects indirectly, by increasing water demand

#### Indirect Impacts

- Predicted higher temperatures are likely to have negative impacts on soil organic matter, thereby reducing soil nutrients. In a changing climate, a decline in N availability may be prevented by an increase in biological N<sub>2</sub> fixation under elevated atmospheric CO<sub>2</sub> concentrations
- Higher temperatures may favor the spread of significant pests and pathogens to a range of agricultural systems. Increasing frequency of crop loss due to pest attack and pre- and post-harvest losses events may mask any positive effects of moderate temperature increase and potential production increases due to increases in carbon dioxide concentrations

Several studies indicate that crop growth and yield will respond to increases in atmospheric CO<sub>2</sub> concentration, altered precipitation events and transpiration regimes, higher temperatures, and weed, pest and pathogen pressures (Kimball et al. 2002; Nowak et al. 2004; Intergovernmental Panel on Climate Change 2007).

## 8.5 Effects of Elevated CO<sub>2</sub>

Several studies conducted over the last 30 years have confirmed that crop biomass and yield tend to increase significantly as CO<sub>2</sub> concentrations increase above the current levels (Tubiello et al. 2007). However, these results are obtained from studies carried out under experimentally controlled conditions, such as in controlled environment closed chambers, greenhouses, and open and closed field top chambers, or using free-air carbon dioxide enrichment (FACE) (Tubiello et al. 2007). Elevated CO<sub>2</sub> concentrations stimulate photosynthesis, leading to increased crop productivity and modified water and nutrient cycles (Kimball et al. 2002; Nowak et al. 2004). Work conducted by Ainsworth and Long (2005) showed that across several species and under unstressed conditions, crop yields increased at 550 ppm CO<sub>2</sub> in the range of 10–20 % for C3 crops and 0–10 % for C4 crops when compared with the current atmospheric CO<sub>2</sub> concentrations of approximately 400 ppm. However the effects of elevated CO<sub>2</sub>, as measured in experimental settings, may nonetheless overestimate actual field and farm-level responses because of effects of many other limiting factors,(i.e. pests, weeds, nutrients, soil water) that are seldom taken into consideration when developing climate change projection models.

## 8.6 Interactions of Elevated CO<sub>2</sub> with Temperature and Precipitation

High temperature during the critical flowering period of a crop may lower otherwise positive CO<sub>2</sub> effects on yield by reducing grain number, size, and quality (Campbell et al. 2011). Increased temperatures during the growing period may also reduce CO<sub>2</sub> effects indirectly, by increasing water demand. For example, Xiao et al. (2007) showed that yield of rain-fed wheat grown at 450 ppm CO<sub>2</sub> increased up to 0.8 °C warming, and then declined beyond 1.5 °C warming; additional irrigation was needed to counterbalance these negative effects.

The key role of water in plant growth means that changes in precipitation will often shape both the direction and magnitude of the overall impacts of climate change (Tubiello et al. 2002). The expected reduction in yields due to climate change effects on temperature and precipitation in SSA will have catastrophic effects on smallholder rain fed agriculture in the absence of technological and breeding adaptations (Bancy 2000).

## 8.7 Interactions of Elevated CO<sub>2</sub> with Soil Nutrients

Some studies also consider the interaction of CO<sub>2</sub> with other crop environmental factors such as water stress or nutrients. FACE (free air carbon dioxide enrichment) experiments confirm that high N soil contents increase the relative response to elevated atmospheric CO<sub>2</sub> concentrations (Nowak et al. 2004). The yield response of a C3 grass to elevated atmospheric CO<sub>2</sub> concentration in a FACE experiment was not significant under low N supply, but increased over 10 years under high applications of N fertilizer (Schneider et al. 2004). This increase was caused by removing the N limitation to plant growth through the application of N fertilizer. A decline in N availability may be prevented by an increase in biological N<sub>2</sub> fixation under elevated atmospheric CO<sub>2</sub> concentrations (Teyssonneyre et al. 2002). Nevertheless, other nutrients, such as phosphorus, may act as the main limiting factors restricting legume growth responses to atmospheric CO<sub>2</sub> concentrations (Eilitta et al. 2004).

## 8.8 Increased Frequency of Extreme Events

Changes in the frequency and severity of extreme climate events, such as droughts and heavy precipitation, have the most serious consequences (Cairns et al. 2013). Short-term natural extremes such as storms and floods, interannual and decadal climate variations, and large-scale circulation changes such as the El Nino Southern Oscillation all have important effects on factors such as crop and ecosystem disturbance and major social dislocations. The SSA has seen the devastating effects



### **Box 8.1. The El Nino Menace in Kenya**

Kenya experienced heavy damage to the food crops and coffee industries. The livestock sector also underwent severe losses due to increased disease infection (especially Rift Valley Fever), drowning, damaged water facilities (dams, boreholes, water troughs), and disruptions in market infrastructure and road systems. The total losses in the agricultural sector were estimated at more than US\$230 million. Despite these massive losses, the abundant rainfall was beneficial in some areas. For instance, the tea sector outputs went up by about 20 % in 1997/98. Some agriculturally marginal areas of Eastern Province also had above average production of cereals, tubers, and root crops. In general, fodder and water stocks were improved in the arid and semiarid areas, leading to an improvement in livestock performance in those areas (Government of Kenya 2002).

of these extreme events such as flooding, which have resulted in massive human displacement and famine. For instance, the El Nino that occurred in Kenya resulted in massive crop failure and loss of life for both humans and livestock (Box 8.1). The recurrence of drought has led to the suffering of millions of people in the same country (Table 8.6). Most models do not incorporate these extreme events, so that projections of the impact of climate change on agricultural production may be far from the reality.

Modeling experiments suggest that increasing frequency of crop loss due to these types of extreme climate events may overcome any positive effects of moderate temperature increase (Easterling et al. 2007). Increases in the frequency of droughts and floods are projected to affect local crop production negatively, especially in subsistence sectors at low latitudes (IPCC 2007). Understanding the links between increased frequency of extreme climate events and ecosystem disturbance (such as fires, pest outbreaks, etc.) is particularly important for better quantitation of impacts. Only a few analyses have started to incorporate the effects of increased climate variability on plant production.

## **8.9 Impacts on Weed and Insect Pests, Diseases**

As climate changes, the severity of crop pest infestations and the emergence of new crop pests is perceived as changing among scientists. For instance, outbreaks of the African army worm moth (*Spodoptera exempta* Walk.) (Lepidoptera: Noctuidae) follow prolonged drought periods and the lifecycle of this pest depends on the prevailing temperature. The 2007 Kenya Economic Survey report indicates that cereal losses stand at 20.5 % due to post harvest losses. Yield losses are expected to

**Table 8.6** Recent history of natural disasters in Kenya (Source: Republic of Kenya 2004)

Year	Type disaster	Area of coverage	No. of people affected
2004	Drought	Widespread	3 Million
2002	Floods	Nyanza, Busia, Tana river basin	150,000
1999/00	Drought	Widespread	4.4 million
1997/98	El Nino flood	Widespread	1.5 million
1995/96	Drought	Widespread	1.41 million
1991/92	Drought	Arid and semi-Arid districts of NE, Rift Valley, Eastern and Coast	1.5 million
1985	Floods	Nyanza and Western	10,000
1983/84	Drought	Widespread	200,000
1982	Floods	Nyanza	4,000
1980	Drought	Widespread	40,000
1977	Drought	Widespread	20,000
1975	Drought	Widespread	16,000

be even higher when pre-harvest losses are taken into consideration. The importance of weed, insect pests, and disease interactions with climate change, including increasing CO<sub>2</sub> concentrations, is understood qualitatively, but quantitative knowledge is lacking. Most studies continue to investigate pest damage as a separate function of either CO<sub>2</sub> or climate, mostly temperature.

## 8.10 Conclusion

Despite the large body of literature on the impact of climate change on crop growth and yield, some gaps have been identified.

- Adaptation methods are not explicitly represented in the projection models. Instead, projection studies assume that adaption mechanisms adopted by farmers in the past will be employed in the future. This is despite the fact that most adaptation studies show that farmers are adopting strategies that include diversifying into early maturing or drought tolerant crops, adopting new farming practices like irrigation, tillage, terracing, mulching, and conservation agriculture. However, adaptation measures are likely to be compromised by a lack of suitable germplasm for the projected climatic conditions. Therefore, it is important to know how smallholder farming systems will adapt to a changing climate
- Most models predict expansion of areas under cultivation in order to meet projected food demands. In the process of expansion, other factors such as

topography may not be suitable for certain field crops. In particular, the targeted areas are currently in high altitude zones where crop growth will be severely limited due to the topography, especially with regard to mechanization. The same applies to areas that have problems with regard to certain soil conditions such as high salinity or acidity. Soil amendments need to be taken into consideration for future projections on climate change

- Local capacities and skills need strengthening for collective actions related to climate change. This applies to both scientists and local community. Apparently very few publications and research theses exist on the topic of modeling of climate change in SSA. Necessary facilities and software can be a contributory factor, as well lack of trained manpower to supervise this type of work. Results based on short term on-farm and on-station experiments are abundant, but most have examined the effects of fertilizer inputs on crop growth and soil properties. Few address the issue of soil and water management and modeling. Consequently, the projections are unlikely to be based on models developed for tropical conditions. Future research collaboration between the north and the south can be one of the strategies for addressing this gap in knowledge and exposure on modeling skills, as this will strengthen and enhance capacity building in research and graduate programs
- Statistical models are also difficult to apply to most of the SSA countries for projecting the impact of climate change on crop yield. Lack of long term experiments in SSA and lack or near absence of metrological data hinders these projections. Though regression-based predictions may be criticized for being based on statistical relationships between factors rather than on an understanding of the important causal mechanisms, they can provide a useful preliminary insight into climate change impacts
- Priorities are different. A small scale farmer places the first priority on having food on the table. Most of the developed countries are food secure, so their priorities may be different
- Research that links climate change to disease prevalence and incidence is limited. Models in general assume that weeds, diseases, and insect pests are controlled. Any gain obtained by CO<sub>2</sub> fertilization in a changing climate will be greatly affected by extreme changes in these factors
- Future agricultural responses to climate change are based on scenarios. It is crucial to understand that a large uncertainty exists in the climate scenarios used for these analyses. The scenarios are essential for evaluating possible futures but they do not represent conditions that will actually occur. Comparisons between models for the same climate and soil data sets have given results that sometimes differ. In addition, projections at the household level remain to be addressed. Nevertheless, the choice of crop, tillage, and time of operations, crop husbandry, irrigation, and water harvesting are some of the adaptation strategies that are currently practiced by the SSA farmers

## References

- Ainsworth EA, Long SP (2005) What have we learned from 15 years of free-air CO<sub>2</sub> enrichment (FACE)? A meta-analytic review of the responses of photosynthesis, canopy properties and plant production to rising CO<sub>2</sub>. *New Phytol* 165:351–372
- Andersson DA, Håkansson T, Hårsmar M et al (2012) Critical research issues for future sub-Saharan African agriculture. SLU, Framtidens lantbruk/Future Agriculture, Uppsala
- Bancy MM (2000) The influence of climate change on maize production in semi-humid and semi-arid areas of Kenya. *J Arid Environ* 46:333–334
- Butler IW, Riha SJ (1989) GAPS: a general purpose formulation model of the soil –plant – atmosphere system Version 1.1 user’s manual. Department of Agronomy Cornell University, Ithaca
- Cairns JE, Hellin J, Sonder K et al (2013) Adapting maize production to climate change in sub-Saharan Africa. *Food Sec.* doi:10.1007/s12571-013-0256-x
- Campbell B, Mann W, Meléndez-Ortiz R et al (2011) Agriculture and climate change. A scoping report. <http://www.climate-agriculture.org>. Accessed 12 May 2014
- Case M (2006) Climate change impacts on East Africa. A review of the scientific literature, World Wide Fund for Nature. Grand, Switzerland
- Chen CC, McCarl BA, Schimmelpfennig DE (2004) Yield variability as influenced by climate: a statistical investigation. *Clim Change* 66:239–261
- Easterling WE, Aggarwal PK, Batima P et al (2007) Food, fibre and forest products. In: Parry ML, Canziani OF, Palutikof JP et al (eds) *Climate change 2007: impacts adaptation and vulnerability. Contribution of working group II to the fourth assessment report of the intergovernmental panel on climate change*. Cambridge University Press, Cambridge, pp 273–313
- Eilitta M, Eteka A, Carsky RJ (2004) Integrating mucuna in the maize – based systems of Southern Benin. In: Eilitta M, Mureithi J, Derpsch R (eds) *Green manure/cover crops systems of smallholder farmers. Experiences from tropical and subtropical regions*. Kluwer Academic Publishers, Dordrecht, pp 237–262
- FAO (2003) *Global agro-ecological assessment for agriculture in the twenty-first century (CD-ROM)*. FAO land and water digital media series number 21. CD-ROM
- FAO (2010) FAO statistical database. Food and Agricultural Organization of the United Nations (FAO), Rome
- Fischer G, Shah M, van Velthuizen H (2002) Climate change and agricultural vulnerability, Special report to the UN World Summit on Sustainable Development. Johannesburg
- Fischer G, Shah M, Tubiello FN et al (2005) Socio-economic and climate change impacts on agriculture: an integrated assessment, 1990–2080. *Philos Trans R Soc Lond B Biol Sci* 360 (1463):2067–2083
- Food and Agriculture Organization (FAO) (2013) *Crop growth models*. Land and Water Division, Rome, [www.fao.org](http://www.fao.org)
- Government of Kenya (2002) Kenya’s initial national communication to the UNFCCC. Government of Kenya. 155 pp
- Iglesias A (2006) Climate change and agriculture. Universidad Politecnica de Madrid, Spain. CGE hands-on training workshop on V&A Assessment of the Asia and the Pacific Region. Jakarta. Accessed 20–24 Mar 2006
- Intergovernmental Panel on Climate Change (2007) *Climate change: impacts, adaptation and vulnerability, contribution of WG II to the fourth assessment report of the intergovernmental panel on climate change*. Cambridge University Press, Cambridge
- Irénikatché PB, Akponikpè PJ, Euloge KA (2010) Farmers’ perception of climate change and adaptation strategies in Sub-Saharan West-Africa. ICID+ 18 2nd International Conference: climate, sustainability and development in semi-arid regions, Fortaleza-Ceará, Brazil. Accessed 16–20 Aug 2010
- Jones JW, Ritchie JR (1990) Crop growth models. Management of farm irrigation systems. In: Hoffman GJ et al (eds). *American Society of Agricultural Engineers Monograph*, St. Joseph

- Jones JW, Boote KJ, Hoogenboom G et al (1989) SOYGRO V 5.42: soybean crop growth simulation model: user's guide. Department of Agricultural Engineering and Department of Agronomy, University of Florida, Gainesville
- Karuma A, Gachene CKK, Gicheru PT (2011) Effects of legume cover crops and subsoiling on soil properties and maize growth in Machakos District, Kenya. *J Trop Subtrop Agroecosyst* 14:237–243
- Kimball BA, Kobayashi K, Bind M (2002) Response of agricultural crops to free-air CO<sub>2</sub> enrichment. *Adv Agron* 77:293–368
- Lobell DB, Burke MB, Tebaldi C et al (2008) Prioritizing climate change adaptation and needs for food security in 2030. *Science* 319:607–610
- Malesu MA, Oduor K, Cherogony D et al (2010) Investing in rainwater harvesting to boost food security in East Africa. ICRAC HQs, Nairobi
- Miriti JM, Kironchi G, Esilaba AO et al (2012) Yield and water use efficiencies of maize and cowpea as affected by tillage and cropping systems in semi-arid Eastern Kenya. *Agr Water Manage* 115:148–155
- Mohamed AB, Van Duivenbooden V, Abdoussallam S (2002) Impact of climate change on agricultural production in the Sahel-Part 1: methodological approach and case study for groundnut and cowpea in Niger. *Clim Change* 54(3):327–348
- Ndayisaba PC, Kayumba J, Nabahungu LN (2013) Mineral fertilizers for improved productivity of climbing bean (*Phaseolus vulgaris L.*) in the South-eastern Rwanda. Paper presented during the ASSS and SSSEA, 20–25 Oct 2013, Nakuru
- Nelson GC, Rosegrant M, Koo J et al (2009) Climate change impact on agriculture and costs of adaptation. IFPRI, Washington, DC
- Njaimwe AN, Mkeni PNS, Muchaonyerwa P et al (2013) Tillage and crop rotation effects on structural properties of two sandy clay loam soils in Zanyokwe Irrigation Scheme, South Africa. Proceedings of the ASSS and SSSEA, Nakuru, Kenya. Accessed 20–25 Oct 2013
- Nowak RS, Ellsworth DS, Smith SD (2004) Functional responses of plants to elevated atmospheric CO<sub>2</sub> – Do photosynthetic and productivity data from FACE experiments support early predictions? *New Phytol* 162:253–280
- Oseni TO, Masarirambi MT (2011) Effect of climate change on maize (*Zea mays*) production and food security in Swaziland. *J Agric Environ Sci* 11(3):385–391
- Oyiga B, Mekbib H, Christine W (2011) Implications of climate change on crop yield and food accessibility in SSA. Interdisciplinary term paper, University of Bonn, 31 pp
- Parry LM, Rosenzweig C, Iglesias A (2000) Handbook of climate change: agriculture. UNEP/IVM Handbook, 47 pp
- Ramirez J, Jarvis A, Laderach P (2013) Empirical approaches for assessing the impacts of climate change on agricultural production: the EcoCrop model and a case study with sorghum (*Sorghum bicolor M.*). *Agric Forest Meteorol* 170:67–78
- Ray D, Ramankutty K, Mueller N et al (2012) Recent patterns of crop yield growth and stagnation. *Nat Commun* 3:1293
- Republic of Kenya (2004) National policy on disaster management (Revised Draft). Nairobi, p 4
- Ringler C, Zhu T, Cai X et al (2010) Climate change impacts on food security in Sub-Saharan Africa: insights from comprehensive climate change scenarios. IFPRI discussion paper no. 1042. International Food Policy Research Institute, Washington, DC
- Ringler C, Zhu T, Cai X (2011) Sub-Saharan Africa: insights from comprehensive climate change modeling. The impact of climate change on food outcomes. IFPRI Res Brief 15–20:1–2
- Ritchie JT, Singh U, Godwin D et al (1989) A user's guide to CERES – Maize V. 2.10. International Fertilizer Development Center, Muscle Shoals
- Rockström J, Barron JJ, Fox P (2001) Water productivity in rainfed agriculture: challenges and opportunities for smallholder farmers in drought-prone tropical agro-systems. IWMI Workshop, Colombo. Accessed 12–14 Nov 2001
- Sanchez PA (2002) Soil fertility and hunger in Africa. *Science* 295:2019–2020

- Schneider MK, Lüscher A, Richter M et al (2004) Ten years of free-air CO<sub>2</sub> enrichment altered the mobilization of N from soil in *Lolium perenne* L. swards. *Glob Chang Biol* 10:1377–1388
- Shiferaw B, Prasanna B, Hellin J et al (2011) Crops that feed the world. Past successes and future challenges to the role played by maize in global food security. *Food Secur* 3:307–327
- Sileshi G, Akinnifesi FK, Debusho LK et al (2010) Variation in maize yield gaps with plant nutrient inputs, soil type and climate across sub-Saharan Africa. *Field Crop Res* 116:1–13
- Teyssonneyre F, Picon-Cochard C, Falcimagne R et al (2002) Effects of elevated CO<sub>2</sub> and cutting frequency on plant community structure in a temperate grassland. *Glob Chang Biol* 8:1034–1046
- Thompson HE, Berrang-Ford L, Ford JD (2010) Climate change and food security in Sub-Saharan Africa: a systematic literature review. *Sustainability* 2:2719–2733
- Thornton PK, Jones PG, Alagarswamy G et al (2009) Spatial variation of crop yield response to climate change in East Africa. *Glob Environ Chang* 19:54–65
- Tubiello FN, Jagtap S, Rosenzweig C et al (2002) *Clim Res* 20:259–270
- Tubiello FN, Soussana JF, Howden SM (2007) Crop and pasture response to climate change. *Proc Natl Acad Sci U S A* 104:19686–19690
- UN Hunger Task Force (2003) Halving global hunger. Background paper of the task force 2 on hunger. UNDP, 89pp
- United Nations Framework Convention on Climate Change (UNFCCC). [www.unfccc.int](http://www.unfccc.int). Agriculture
- van der Linden PJ, Hanson CE (eds) (2007) *Climate change 2007: impacts, adaptation and vulnerability*, International Institute for applied systems analysis, Austria
- van Duivenbooden N, Abdoussallam S, Mohamed AB (2002) Impact of climate change on agricultural production in the Sahel-Part 2: methodological approach and case study for millet in Niger. *Clim Chang* 54(3):349–368
- Williams JR, Jones CA, Kiniry JR et al (1989) The EPIC growth model. *Trans Am Soc Agric Eng* 32(2):479–511
- Xiao G, Zhang O, Yao Y et al (2007) Effects of temperature increase on water use and crop yields in a pea–spring wheat–potato rotation. *Agr Water Manage* 91:86–91

# Chapter 9

## Factors in Smallholder Farmers' Vulnerability to Climate Change Impacts in the Uluguru Mountains, Morogoro, Tanzania

Amon Z. Mattee, K.R. Mussa, Dismas L. Mwaseba, C.P. Mahonge, and J.V. Nsenga

**Abstract** This study assessed factors in smallholder farmers' vulnerability to climate change impacts in the Uluguru Mountains in the Morogoro Region, Tanzania. To this end, the study first determined the smallholder farmers' awareness and perception of climate change and identified adaptation options preferred by the farmers. A combination of methods, including focus group discussions, key informants interviews, participant observations, and household surveys, were used for data collection. The results indicate that smallholder farmers had a poor understanding of climate change issues, but their knowledge was enhanced by a project that was implemented collaboratively by Sokoine University of Agriculture (SUA) and Professionals for Fair Development (GRET), a French non-governmental organization (NGO). The adaptation strategies preferred by smallholder farmers included terracing, planting fruit trees, the rehabilitation of micro-irrigation canals, and fish farming. However, a noticeable disparity in preference between men and women was observed. The results further revealed that smallholder farmers were vulnerable to climate change and variation due to their limited knowledge of climate change risks, low level of literacy, limited access to climate information, and absence of farmer-based organizations to facilitate better access to credit and market services. The study concludes that crucial factors for smallholder farmers' vulnerability to climate change in the Uluguru Mountains are access to information and resources, road and market infrastructure, and smallholder farmers' organization.

---

A.Z. Mattee (✉) • D.L. Mwaseba  
Department of Agricultural Education and Extension, Sokoine University of Agriculture,  
Morogoro, Tanzania  
e-mail: [mattee@iagri.org](mailto:mattee@iagri.org)

K.R. Mussa  
Department of Physical Sciences, Sokoine University of Agriculture, Morogoro, Tanzania

C.P. Mahonge • J.V. Nsenga  
SUA Centre for Sustainable Rural Development, Sokoine University of Agriculture,  
Morogoro, Tanzania

**Keywords** Vulnerability • Smallholder farmers • Climate change impacts

## 9.1 Introduction

### 9.1.1 Background Information

Climate change has a significant impact on rural inhabitants in developing countries, particularly among smallholder farmers, who have limited adaptive capacity. Smallholder farmers in many developing countries are predominantly dependent on rain-fed agriculture for their farming activities. They tend to have comparatively high exposure to extreme events, suffer from widespread poverty, and are highly marginalized. Studies (Harley et al. 2008; Gbetibouo and Ringler 2009; Lasco et al. 2011) indicate that smallholder farmers in sub-Saharan Africa, especially those in semi-arid areas, are particularly vulnerable to the effects of climate change. Based on knowledge generated from studies on the impact of and vulnerability to climate change and variability, the most vulnerable societies are usually those deprived of mechanisms and resources, including information to prepare for and adapt to climate change (Wongbusarakum and Loper 2011). Equally important, smallholder farmers are vulnerable to climate change because they face various socio-economic, demographic, and policy trends that limit their capacity to cope with climate change (Lasco et al. 2011). These farmers are characterized by complex, diverse, and risk prone environments and most have small farms and produce primarily for subsistence.

It is well documented (Mongi et al. 2010) that smallholder farmers in Tanzania are among the most vulnerable people to the projected changes in the climate system. Predictions show that areas with unimodal rainfall patterns will experience a 5–15 % decrease in rainfall while those with bimodal rainfall patterns will experience increased rainfall of 5–45 % (United Republic of Tanzania – URT 2005, 2007). Overall observations show that rains are increasingly declining in most parts of the country and cycles are detrimentally changing (Yanda et al. 2006; Mwandosya 2007; Mongi et al. 2010). Such changes in climatic variables are expected to alter the characteristics of the agro-ecological zones, leading to reduced yields of some crops, such as maize by 33 % nationally (URT 2007). This projection in crop yield reduction is in line with the prediction of the Global Climate Adaptation Partnership (GCAP) (2011) for maize, which showed that it will decrease by between 16 and 35 % by 2050.

Similarly, a study by the International Institute for Environment and Development (IIED) (2009) on the effects of climate change on agriculture in Tanzania found that rainfall patterns will become highly variable across the country, with an increase in the northern parts of 5–45 % and decreases of 5–15 % elsewhere. Wetter regions are at risk of more frequent and severe flooding. Accordingly, IIED (2009) suggested that the overall impact of climate change in Tanzania could be enormous, possibly shrinking the country's GDP by 0.6–1.0 % by 2030. Thus, it concluded that smallholder farmers will need to adapt to climate change impacts over the next 20 years to avoid catastrophic future costs. However, in order to do so, they will also need policy backing.



The effects of climate change and variability have been experienced in Tanzania. For example, it is reported that the severe droughts of 1994–1996 and 2005/2006, which hit most parts of Tanzania, led to acute food shortages, water scarcity, hunger, and acute shortage of hydropower (URT 2007). In economic terms, the 2005/2006 droughts are estimated to have cost the country at least 1 % of GDP (GCAP 2011).

In addition, the International Food Policy Research Institute (IFPRI 2007) estimated that by the 2080s, the world agricultural productivity could decline by 3–16 %, with the loss in Africa projected to be 17–28 %. Thus, it is apparent that the future of agricultural productivity in Tanzania is intertwined with climate change; hence, immediate adaptation measures are necessary.

### ***9.1.2 Factors Aggravating Vulnerability of Smallholder Farmers to Climate Change in Tanzania***

As with many other sub-Saharan African countries, the vulnerability of Tanzanian smallholder farmers to climate change is aggravated by several factors. The traditional farming systems used by about 90 % of smallholder farmers leave them highly vulnerable to climate change. As smallholder farmers, they are usually not well organized and not very well informed (URT 2003). In addition, smallholder farmers make little use of irrigation, improved seeds, or basic mechanization. Soil and water conservation techniques are not often applied, and these farmers have very limited market options.

URT (2003) and IFPRI (2007) reported that the choice of crops grown by smallholder farmers is influenced more by dietary preferences than by the suitability of the crop to particular agro-ecological conditions. Other vulnerability factors include (i) limited access to technology and delivery channels, with 60–75 % of households estimated to have no contact with research and extension services; (ii) limited access to financing for the uptake of technologies; (iii) high transaction costs due to the poor state or lack of infrastructure; (iv) under-investment in productivity enhancing technologies; and (v) unmanaged risks with significant exposure to variability in weather patterns and periodic droughts. The impact of these events is amplified by smallholder farmers' dependency on rain-fed agriculture and their limited capacity to manage land and water resources efficiently. In addition, weak capacity and coordination in the formulation and implementation of policy interventions among the various actors in the agricultural sector exacerbate smallholder farmers' vulnerability to climate change impacts (URT 2003; IFPRI 2007).

Although smallholder farmers have developed several adaptation options to climate change and variability, such adaptations are not sufficient for projected climate changes. Therefore, ensuring food security in a changing climate is one of the major development challenges facing Tanzania and many other developing countries (Kangalawe 2012). Consequently, if strong, more focused adaptation measures are not implemented, climate change may severely impact crop production and livelihoods in Tanzania.

Thus, enhancing smallholder farmers' adaptive capacity to the impacts of climate change will require concerted and long-term efforts by various stakeholders. However, a starting point is to understand their level of awareness and perception of climate change, its impact on their livelihood activities, and how they are adapting to it. Enhancing their adaptive capacity is thus a necessity. It includes understanding their vulnerability factors, and key barriers to adaptation. Furthermore, enhancing the adaptive capacities of smallholder farmers in Tanzania also includes support for their actual efforts to deal with the effects of climate change through innovation and complementarity.

In this paper, vulnerability factors and potential adaptation options available to smallholder farmers in the Uluguru Mountains are reviewed. Observations are based on activities that are being implemented to strengthen the resilience of the communities living on the slopes of the Uluguru Mountains. More specifically, the objectives of this paper are to: (a) assess smallholder farmers' levels of awareness and perception of climate change and variability; (b) analyze key challenges faced in adapting to climate change impacts in the Uluguru Mountains; (c) assess the vulnerability of smallholder farmers to climate change impacts; and (d) assess smallholder farmers' preferences with regard to adaptation practices introduced in the study area.

In the next section, the methodology adopted for the study is described. This is followed by a presentation and discussion of the study findings. The last section presents conclusions from the study.

## 9.2 Methodology

### 9.2.1 Description of the Study Area

The Uluguru Mountains lie immediately south of the town of Morogoro between latitudes 7° and 8° south and between longitudes 37° and 38° east and about 200 km from Dar es Salaam, the commercial city of Tanzania (Fig. 9.1). This study was carried out on the western slopes of the Uluguru Mountains. It covered three villages in the Luale Ward, namely, Luale, Londo, and Masalawe, in the Mvomero District, which is part of Morogoro Region.

Climatically, the eastern side of the Uluguru Mountains captures moisture moving inland from the Indian Ocean and is, therefore, wetter than the western side, with rainfall estimated at over 3,000 mm per year. Some rains fall in a sporadic fashion. According to Jens and Hansen (1993), the mean annual temperature in the Uluguru Mountains used to be 19.5 °C (with a maximum of 22 °C in December and a minimum of 17 °C in July). However, there has been a significant temperature increase and decline of rainfall and cloud cover (Mussa et al. 2012; Orhac 2013). By using the principal component analysis technique on rainfall and temperature data, Orhac (2013) found that the years 2003 and 2005 and 1978 and 1979 were highly correlated in terms of monthly maximum temperature average. Temperatures were low in 1978 and 1979 as compared to 2003 and 2005. Maximum temperatures were higher in the 2000s compared to the 1970s. In addition, Orhac

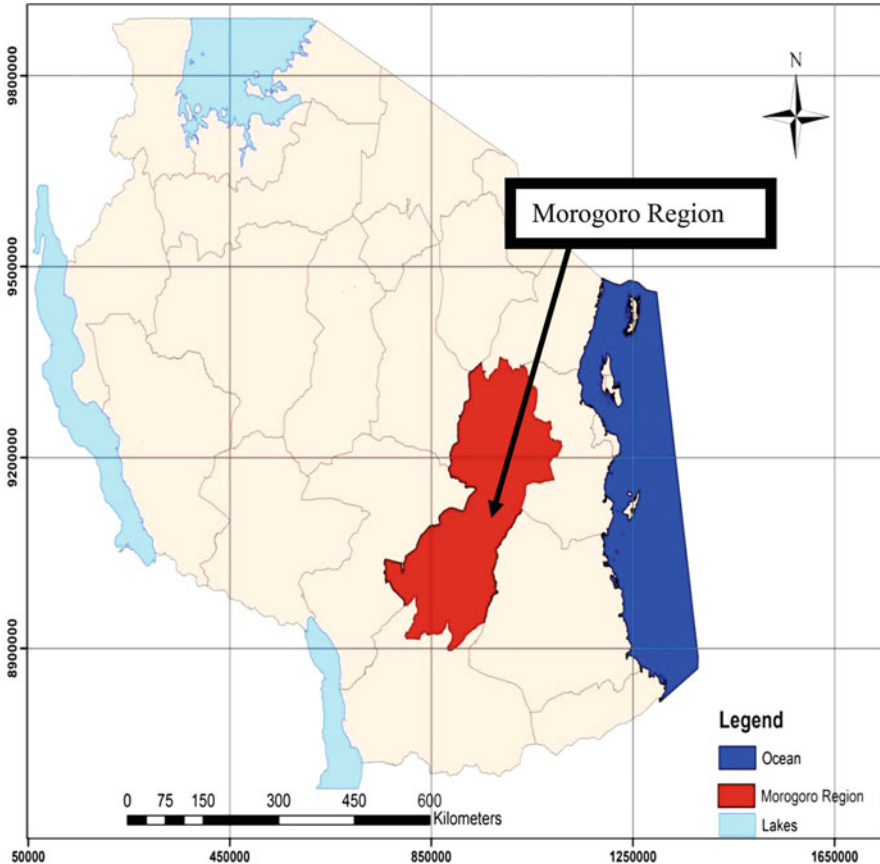


Fig. 9.1 Map of Tanzania showing the location of the Uluguru Mountains

(2013) found that rainfall amounts were higher in the 1970s than in the 2000s. This confirms the perception that there has been a significant change in the trends in key climatic variables (e.g. temperature and rainfall) in the Uluguru Mountains.

### 9.2.2 Data Collection Methodology

This study employed a combination of methods to collect relevant data, namely focus group discussions (FGDs), key informant interviews (KIIs), participant observation, a household survey, and a review of the literature. Three FGDs were held with smallholder farmers, women, and primary and secondary school pupils. Five KIIs were conducted involving agricultural extension and natural resources officers, primary and secondary school teachers, and village government officials.

FGDs and KIIs had two major objectives. First, they were designed to provide opportunities to clarify and supplement information collected from the literature and household survey regarding the vulnerability of smallholder farmers in Tanzania and in the Uluguru Mountains in particular. Second, they were designed to seek feedback from the aforementioned stakeholder groups regarding the potential of some of the proposed adaptation activities to build the resilience of local communities to climate change impacts.

The process of selecting individuals for interview (household survey) involved purposive and random sampling techniques. A purposive sampling technique was used to identify smallholder farmers who have been actively involved in project activities, with the specific consideration of having implemented at least one of the introduced climate change adaptation strategies. Thereafter, a simple random sampling technique was used to select 46 smallholder farmers for interview. A one-to-one interview method was used to administer the household questionnaire in the study area. Therefore, the sample size used in this study was more deterministic than probabilistic.

Adaptation challenges faced by smallholder farmers were assessed in terms of the following criteria:

- Access to climate information,
- Access to market,
- Attainment of formal education,
- Knowledge of climate risks,
- Presence of farmer-based organizations,
- Access to credit services,
- Condition of road infrastructure, and
- Conservation agriculture skills.

The impacts of climate change were assessed in terms of their effects on different human and natural systems linked to the livelihoods of smallholder farmers in the Uluguru Mountains. This involved using the concept of “vulnerability,” which was defined by Chambers (2009) as the degree to which a system is susceptible to or unable to cope with the adverse effects of climate change, including climate variability and extremes. Chambers (2009) added that vulnerability is a function of the character, magnitude, and rate of climate variation to which a system is exposed, its sensitivity, and its adaptive capacity.

Vulnerability was assessed based on resilience, marginality, susceptibility, adaptability, fragility, risk, and exposure of key livelihood resources to climate change impacts. The framework was used to describe socio-economic groups at risk, as well as those with insecure livelihoods on the margins of society because of climate change and variability in the Uluguru Mountains.

The vulnerability assessment framework developed for this study contains seven criteria to identify current and potential smallholder farmer vulnerabilities to climate change impacts. It points out how climate change impacts the resource base on which smallholder farmers draw their livelihoods. The first step in the vulnerability assessment was to identify key livelihood resources. Second, each resource was analyzed based on the seven key vulnerability criteria shown in Table 9.1.

**Table 9.1** Vulnerability assessment framework

S/N	Vulnerability criteria	Definition
1	Magnitude of impacts	<p>If the expected impacts are substantial, they are evaluated as key vulnerabilities in contrast with impacts with more limited effects. The magnitude of an impact is determined by:</p> <p>Its scale,</p> <p>The area affected,</p> <p>The number of people affected,</p> <p>The intensity, which implies the degree of damage caused</p>
2	Timing of impacts	A harmful impact is more likely to be considered key if it is expected to happen sooner rather than in the distant future
3	Persistence and reversibility of impacts	A harmful impact is more likely to be considered key if it is persistent and/or irreversible
4	Likelihood (estimates of uncertainty) of impacts and vulnerabilities	An impact characterized by high likelihood is more apt to be seen as key than the same impact with a lower likelihood of occurrence
5	Potential for adaptation	To assess vulnerability to climate change, the ability of individuals, groups, and communities to adapt to or ameliorate adverse impacts of climate change must be considered. The lower the availability and feasibility of effective adaptations, the more likely such impacts would be characterized as key vulnerabilities
6	Distributional aspects of impacts and vulnerabilities	Impacts that have significant distributional consequences are likely to have higher salience and therefore a greater chance of being considered key
7	Importance of the system(s) at risk	<p>A salient though subjective criterion for the identification of key vulnerabilities is the importance of the vulnerable system or system property</p> <p>If the livelihoods of many people depend on the functioning of a system, this system may be regarded as more important than a similar system in an isolated area</p>

Adapted from the Inter-governmental Panel on Climate Change (IPCC) (2007)

In order to analyze the preference of smallholder farmers to various adaptation strategies, farmers were asked to rank climate change adaptation activities that were being promoted by the project supported by the European Union and implemented in the Uluguru Mountains by Sokoine University of Agriculture in collaboration with GRET, a French non-governmental organization (NGO). A weighted ranking method was employed in which interviewees were asked to rank adaptation activities on a scale from one to four, with the most favored activity assigned a weight of four points, the second most favored a score of three points, and the third and fourth activities being assigned scores of two and one point, respectively. Scores were then

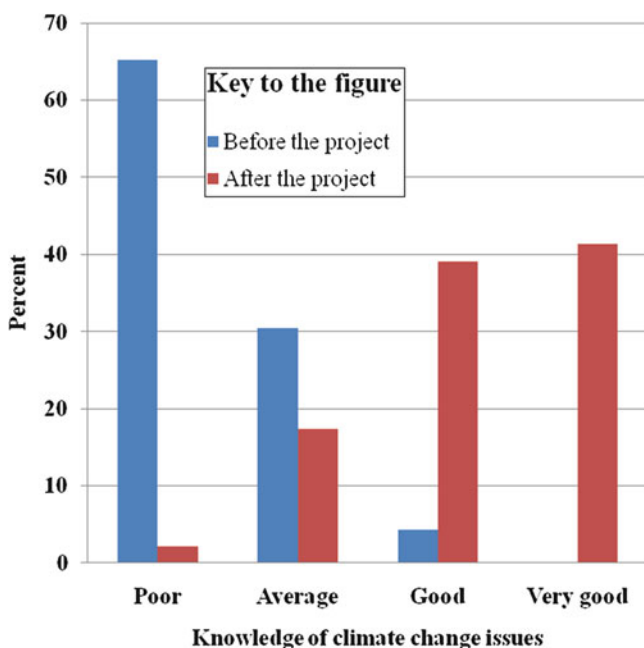
summed across all respondents, and total scores for each adaptation activity were used to define the most preferred adaptation activities by smallholder farmers in the Uluguru Mountains.

### 9.3 Study Findings

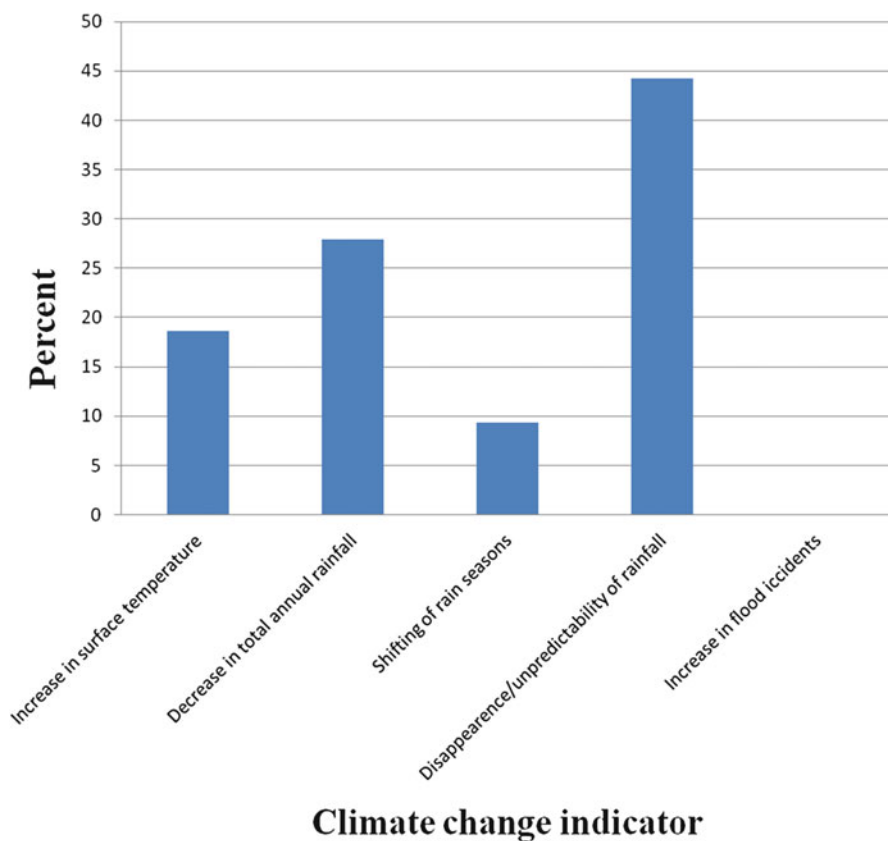
#### 9.3.1 *Smallholder Farmers' Awareness and Perception of Climate Change*

The SUA-GRET climate change project that has been in effect for the last 2.5 years has boosted the understanding of climate change issues of smallholder farmers in the Uluguru Mountains. This study found that before the project, 65 % of the 46 interviewed smallholder farmers had a poor understanding of climate change issues. Only 5 % reported that they had a good knowledge of climate change issues. None reported having had very good knowledge of climate change and variability (Fig. 9.2).

However, 2 years after the intervention by the climate change adaptation project, nearly 42 % of smallholder farmers in the Uluguru Mountains reported that they now have a very good understanding of climate change issues, and 39 % reported



**Fig. 9.2** Knowledge of climate change issues before and after the SUA-GRET climate change project in the Uluguru Mountains



**Fig. 9.3** Main indicators of climate change reported by smallholder farmers

having a good knowledge of those issues. The only source of this knowledge cited by respondents was the SUA-GRET climate change project.

When asked about the variable “rainfall” which they most commonly associate with climate change in their area, almost half (44.2 %) of smallholder farmers pointed to the unpredictable nature of seasonal rainfall. This was the principal indicator of the changing climate in the western slopes of the Uluguru Mountains. However, a decrease in the amount of rainfall received annually and an increase in surface air temperature were also cited as indicators of climate change in the area (see Figs. 9.3, 9.4 and 9.5).

### **9.3.2 Adaptation Challenges and Vulnerability of Smallholder Farmers in the Uluguru Mountains**

Although access to and control over the resources necessary for adaptation varies within communities and even within households, it is hugely influenced by external



**Fig. 9.4** A terraced land in the study area



**Fig. 9.5** One of the fishponds in the study area

factors, such as policies, institutions, and power structures (Chambers 2009). Notwithstanding, adaptive capacities vary over time based on changing conditions and may differ in relation to the prevailing climatic hazards. Nevertheless, Chambers (2009) has documented that the world's poorest people are the most vulnerable to climate change. This is often because they have limited access to the resources that would facilitate adaptation.



The vulnerability of smallholder farmers in the Uluguru Mountains was largely found to be a result of inadequate knowledge of climate risks and low literacy levels, as discussed elsewhere by Nkombe (2003), and most of the inhabitants of the Uluguru Mountains lack adequate formal education. They also lack conservation education. Since education raises awareness of the need for environmental conservation, most people in the Uluguru Mountains are unaware of the existing link between the surrounding forests and climate change.

Other factors that exacerbate vulnerability were identified using KIIs, FGDs, and participant observation. They include limited access to climate information and the absence of farmer-based producer organizations, which would facilitate better access to credit and marketing services. Another major factor is limited access to knowledge of climate change issues and climate information in general.

Nonetheless, the data indicate that the least-vulnerable villages in this study are Londo and Luale, and the most vulnerable village is Masalawe. It was further established that a common feature of the less vulnerable villages is that they have a higher percentage of inhabitants with primary level education and a relatively higher level of knowledge of climate risks. These villages have more organized farmer-based producer organizations, better access to credit services, and a better road infrastructure. Thus, it is easier for them to access health and marketing services. The most vulnerable village has less access to these services, since it is located in a more remote and inaccessible area.

The vulnerability assessment framework and household surveys were used to assess the vulnerability of smallholder farmers. These methods were used to estimate exposure to and the sensitivity of key livelihood resources. Based on this analysis, the discrepancy between knowledge of key conservation agricultural practices and the adoption of such practices was determined.

Key livelihood resources for smallholder farmers in the study area were found to be land and water for irrigation. Both land and water resources were found to be susceptible to destruction by extreme climate events, evinced by severe erosion and landslides, destruction of irrigation infrastructure, drying up of water sources, and irrigation water shortages. All of these events represent exposure of smallholder farmers to current and potential climate change impacts. Conway (1997) reported that mountainous areas are ecologically vulnerable and exacerbate the vulnerability of communities whose livelihoods largely depend on resources located in these fragile ecosystems. The ecological vulnerability reported by Conway (1997) extends to climatic vulnerability since, with limited rainfall, ecosystem goods and services, such as water, become highly limited, thus putting the livelihoods of mountainous communities at risk.

The magnitude of the impact on smallholder farmers was determined by assessing its scale; the area affected; the number of people already affected, i.e., those who disproportionately depend on land and water resources; and impact intensity, which refers to the level of damage inflicted on livelihood niches of smallholder farmers in the Uluguru Mountains. The magnitude of impact on both cropland and water resources and the ensuing consequences for smallholder farmers in the Uluguru Mountains are relatively high, as the two resources form the livelihood backbone of about 95 % of the communities in the study area.

**Table 9.2** Knowledge on conservation/climate-smart agriculture practices by smallholder farmers

Practice	Percentage aware	Percentage actually practicing
Agroforestry	33.3	20.0
Green manure residue or compost incorporation	66.7	46.7
Zero or minimum tillage	33.3	20.0

The timing of climate change impacts, their adaptation potential, and the likelihood of occurrence of these impacts were found to be key determinants of vulnerability of smallholder farmers to climate change impacts in the Uluguru Mountains. Impacts are already observed, and the capacity to adapt to both current and potential impacts is relatively limited.

Most smallholder farmers interviewed were found to be generally unaware of adaptation practices, and thus few had actually adopted them. For instance, only 33 % of the smallholder farmers reported awareness of agroforestry practices, and only 20 % of them actually practice agroforestry (Table 9.2). Lack of familiarity with the practices and not having sufficient resources to implement them were the key reasons for low adoption of these adaptation practices.

Climate change vulnerability is a function of system sensitivity to climate hazards and low adaptive capacity (Chambers 2009; IPCC 2007; Gbetibouo and Ringler 2009). Smallholder farmers in the Uluguru Mountains remain vulnerable to climate change impacts because of the sensitivity of the water sources and the cropland to climate changes.

However, the vulnerability of smallholder farmers in the Uluguru Mountains is not an isolated case. Conway (1997) reported that the majority of the world's poor live in areas that are resource poor, highly heterogeneous, and risk-prone. This scholar added that after semi-arid and arid zones, poverty is prevalent in mountainous areas that are ecologically vulnerable. The inhabitants of the Uluguru Mountains are a case in point.

### ***9.3.3 Adaptation Options and Preferences of Smallholder Farmers to Various Adaptation Activities in the Uluguru Mountains***

The ranking of alternative strategies are found in Table 9.3. Scores represent the number of individuals identifying the practice as first, second, third, or fourth preference multiplied by the relative weight for the preference from four (highest preference) to one (lowest preference).

Smallholder farmers in the western slopes of the Uluguru Mountains prefer terracing over other options as an adaptation strategy. This is followed by the planting of fruit trees, the rehabilitation of micro-irrigation canals, and fish farming.

**Table 9.3** Preferences for different adaptation options

Adaptation activity	Preference score				Total score	Overall rank
	1st	2nd	3rd	4th		
Terracing	72	42	14	7	135	1st
Planting of fruit trees	36	45	40	2	123	2nd
Rehabilitation of micro-irrigation canals	60	33	20	9	122	3rd
Fish farming	16	18	18	27	79	4th

**Table 9.4** Preference of adaptation activities by gender

	Terracing		Fruit trees		Irrigation canals		Fish farming	
	Percentage response by gender							
	Male	Female	Male	Female	Male	Female	Male	Female
1st option	26	58	15	26	48	11	11	5
2nd option	37	21	30	37	22	28	11	17
3rd option	19	11	48	37	11	39	22	17
4th option	18	10	7	0	19	22	56	61

Among these, 15 farmers indicated that canal rehabilitation was preferred as opposed to only nine who indicated the planting of fruit trees as preferred. Fish farming was viewed as the least favorable option. However, overall score shows that terracing is the preferred, while fish farming is the least preferred adaptation strategy (Table 9.3).

However, the data in Table 9.4 suggest men prefer fish farming and the rehabilitation of micro-irrigation canals to terracing and fruit trees. The laborious nature of fishpond construction and the rehabilitation of irrigation canals (as shown in Fig. 9.6) are possible reasons why women do not prefer these activities. Yet women rank terracing activity as the most preferred adaptation strategy despite it being a relatively labor-intensive undertaking. This is perhaps explained by the fact that terracing is usually associated with household food production (Fig. 9.7).

These results confirm a growing recognition of gender-based vulnerability to climate change and the need for gender-conscious interventions to climate change adaptation that is informed by the differences in needs, responsibilities, and unique contributions of both women and men in any social setting. As reported in Table 9.4, men and women indicated different preferences for adaptation strategies, with men preferring irrigation infrastructure and fish farming while more women preferred fruit trees and terracing.

## 9.4 Conclusion

Farmers in the Uluguru Mountains are aware of changes that have taken place with regard to the ability of the ecosystem to support their livelihoods. However, they have less understanding of the concept of climate change. Changes in rainfall patterns and



Fig. 9.6 Irrigation canal work in the study area is mainly attended by men



Fig. 9.7 One of the fruit tree nurseries in the study area

increases in temperature levels are the most perceptible indicators that things are not the same. Likewise, farmers have noted changes in the land and water, the two key livelihood resources, in terms of decreasing quality of the land due to increased soil erosion and landslides and decreased amounts of irrigation water. The level of smallholder farmers' awareness seems to have increased as a result of an intervention, which has enhanced awareness of the concept of climate change and promoted various adaptation measures in the form of climate-smart agricultural practices.

This study has also revealed that local communities in the Uluguru Mountains are generally vulnerable to climate change. Limited access to information about climate change issues and climate in general, poor road and market infrastructure, and the absence of effective local institutions are associated with the relatively high level of vulnerability of these communities. As such, there is a need to promote adaptive measures to reduce this vulnerability. Nonetheless, while promoting specific adaptation measures, it is crucial to consider gender differences in terms of the preferences for the various adaptation measures among different socio-cultural groups. Thus, climate change adaptation measures should be informed by differences in needs, responsibilities, and the unique contributions made by different gender groups in any social setting.

## References

- Chambers R (2009) Climate vulnerability and capacity analysis handbook, 1st edn. Care International, p 52
- Conway G (1997) The doubly green revolution. In: Food for all in the 21st century. Cornell University Press, Ithaca, pp 163–184
- Gbetibouo GA, Ringler C (2009) Mapping South African farming sector vulnerability to climate change and variability: a sub-national assessment, IFPRI discussion paper no. 885. International Food Policy Research Institute, Washington, DC
- GCAP (2011) The economics of climate change in the United Republic of Tanzania. <http://economics-of-cc-in-tanzania.org>
- Harley M, Horrocks L, Hodgson N, van Minnen J (2008) Climate change vulnerability and adaptation indicators. The European Topic Centre on Air and Climate Change (ETC/ACC) Technical Paper 2008, 9, p 37
- IFPRI (2007) In: Ringler C, Zhu T, Cai X, Coo J, Wang D (eds) Climate change impacts on food security in sub-Saharan Africa. Insights from comprehensive climate change scenarios. Cambridge University Press, Cambridge/New York
- IIED (2009) Cultivating success: the need to climate-proof Tanzanian agriculture. International Institute for Environment and Development Briefing, September 2009, p 2
- IPCC (2007) Climate change impacts, adaptation and vulnerability. Contribution of Working Group II to the fourth assessment report of the Intergovernmental Panel on Climate Change. Annex I, Parry ML, Canziani OF, Palutikof JP, van der Linden PJ, Hanson CE (eds), Cambridge University Press, Cambridge, 976pp
- Jens OS, Hansen LA (1993) Report on the biodiversity survey. Royal Society for the Bird Life, UK
- Kangalawe RYM (2012) Food security and health in the southern highlands of Tanzania: a multidisciplinary approach to evaluate the impact of climate change and other stress factors. *Afr J Environ Sci Technol* 6(1):50–66

- Lasco RD, Habito CM, Delfino RJP, Pulhin FB, Concepcion RN (2011) Climate change adaptation for smallholder farmers in Southeast Asia. World Agroforestry Centre (ICRAF), Laguna, p 69
- Mongi H, Majule A, Lyimo JG (2010) Vulnerability assessment of rain-fed agriculture to climate change and variability in semi-arid Tanzania. *Afr J Environ Sci Technol* 4(6):371–381
- Mussa KR, Mjemah IC, Malisa ET (2012) The role of development projects in strengthening community-based adaptation strategies: the case of Uluguru Mountains agricultural development project (UMADEP)-Morogoro-Tanzania. *Int J Agric Sci* 2(6):157–165
- Mwandosya MK (2007) Report to plenary session of the United Nations high level meeting on adaptation to climate change. Permanent Mission of the United Republic of Tanzania to the United Nations, Dar es Salaam
- Nkombe PM (2003) The future of Uluguru Mountains. A paper submitted to the XII World Agroforestry Congress, 2003, Quebec, Canada, p 8. <http://www.fao.org/docrep/article/wfc/xii/0863-a1.htm>, site visited on 30th August, 2013
- Orlhac M (2013) Local governance of water management in Luale ward, Uluguru Mountains, Tanzania: innovations and collective actions. Master's thesis report: final presentation for agronomy Systems Agricole et Agroalimentaires Durables au Sud (SAADS) engineer degree option, Development Agricole et Rural au Sud (DARS), p 108
- United Republic of Tanzania (2003) Agricultural sector development programme (ASDP) support through basket fund: government programme document. Dar es Salaam, 2003
- United Republic of Tanzania (2005) Initial national communication under the United Nations Framework Convention on Climate Change (UNFCCC). Vice President's Office, Dar es Salaam
- United Republic of Tanzania (2007) National Adaptation Programme of Action (NAPA). Vice President's Office, Division of Environment. Dar es Salaam
- Wongbusarakum S, Loper C (2011) Indicators to assess community-level social vulnerability to climate change: an addendum to SocMon and SEM-Pasifika regional socio-economic monitoring guidelines, p 41
- Yanda PZ, Kangalawe RYM, Sigalla RJ (2006) Climatic and socio-economic influences on malaria and cholera risks in the Lake Victoria region of Tanzania. *ICFAI J Environ Econ* 4(3):44–70

# Chapter 10

## Using Climate and Crop Simulation Models for Assessing Climate Change Impacts on Agronomic Practices and Productivity

Winfred B. Mbungu, Henry F. Mahoo, Siza D. Tumbo,  
Frederick C. Kahimba, Filbert B. Rwehumbiza, and Boniface P. Mbilinyi

**Abstract** Due to heavy dependence on rain-fed agriculture, most developing countries, particularly Sub-Saharan Africa including Tanzania, are likely to suffer negatively to the impacts of climate change. Future climate projections predict a 2–4 °C rise in temperature by 2100, and rainfall is expected to decrease especially in the interior regions. As a result, grain production is predicted to decrease, and particularly maize, which is the main cereal crop, will experience up to 33 % decrease in yield. To capture the impacts of climate change relevant to agronomic productivity, site-specific assessments are needed to inform adaptation options. This study investigated the impacts of climate change on maize production using outputs of Global Circulation Models (GCMs) and crop simulation models. Current conventional and recommended agronomic practices in Same District, Kilimanjaro region, Tanzania were simulated by Agricultural Production Systems sIMulator (APSIM) model using long-term and projected future climates. Four maize cultivars commonly used in the study area *Situka*, *Kito*, *Sc401*, and *TMV1* were used. Results show a yield decline of 13 % for cultivar *Situka*, and an increase of 10 % and 15 % for cultivars *Sc401* and *TMV1*, respectively, in the long rainy season (March–May) under the conventional practices. A yield increase of 10 % is projected for *Sc401* and *TMV1* and a decrease of 10 % for *Situka* and 45 % for *Kito* cultivars under recommended practices. The short rainy season (October–December) is projected to register yield increases of between 75 and 146 % for all cultivars under both conventional and recommended agronomic practices. Generally, the study has revealed that the yield of only some maize varieties are expected to decrease due to a 2 °C rise in temperature and only during the long rainy

---

W.B. Mbungu (✉) • H.F. Mahoo • S.D. Tumbo • F.C. Kahimba • B.P. Mbilinyi  
Department of Agricultural Engineering and Land Planning, Sokoine University  
of Agriculture, P.O. Box 3003, Morogoro, Tanzania  
e-mail: [winfredm@gmail.com](mailto:winfredm@gmail.com)

F.B. Rwehumbiza  
Department of Soil Science, Sokoine University of Agriculture,  
P.O. Box 3008, Morogoro, Tanzania

season. Therefore, there is a need for more site-specific climate change studies that evaluate several crop varieties grown in the area.

**Keywords** Climate change • Agronomic productivity • Maize yield • APSIM • Crop simulation model

### List of Acronyms and Abbreviations

APSIM	Agricultural Production Systems sIMulator
CGCM	Canadian Centre for Climate Modelling and Analysis
CNRM	Centre National de Recherches Météorologiques
DSSAT	Decision support system for agrotechnology transfer
DUL	Dry upper limit
ENSO	El Nino – southern oscillation
GCMs	Global circulation models
IPSL	Institut Pierre Simon Laplace
LL	Lower limit
MAM	March-April-May season
OND	October-November-December season
SOM	Self-organizing map
SSA	Sub-Saharan Africa
TOSCA	Tanzania Official Seed Certification Agency

## 10.1 Introduction

It is now generally agreed throughout the world that climate change and variability, caused by anthropogenic activities as well as some natural processes, is one of the challenging environmental issues in the modern era (IPCC 2007, 2013). Development of climate models has shown with certainty that global mean surface air temperatures over land and oceans have increased over the last 100 years (Cubasch et al. 2013). Climate change affects many sectors across the world and is considered to be one of the most serious threats to sustainable development, with adverse impacts on environment, human health, food security, natural resources, and physical infrastructure. Agriculture is among the sectors that will be most affected by the impacts of climate change and variability. Studies have confirmed that Africa, and in particular Sub-Saharan Africa, is one of the regions of the world that are most vulnerable to the impacts of climate variability and change because of multiple stresses such as widespread poverty, droughts, land policy, market fluctuation, plant diseases, and over-dependence on rain-fed agriculture compounded by its low adaptive capacity (Hulme 1996; IPCC 1998; Misselhorn 2005; O'Brien et al. 2004; Paavola 2008). Climate change will add burdens to those who are already poor (IPCC 2007).



Recurrent droughts and climate variability are the most common problems affecting crop production in the East Africa region (Misselhorn 2005; Paavola 2008), causing food insecurity. Changes in climate will aggravate the situation even more (Devereux and Edwards 2004; Rowhani et al. 2011). In Tanzania, subsistence agriculture, which is mainly rain-fed, is the main economic activity for over 80 % of the population (Tumbo et al. 2010). Furthermore, agriculture accounts for over 50 % of the Gross Domestic Product (GDP) and over approximately 80 % of the export earnings, making it an important economic activity in the country (Mary and Majule 2009; URT 2008a).

However, despite the country's high dependence on agriculture, currently only approximately 15 % of the total potential arable land is utilized with low use of chemical fertilizers (Rowhani et al. 2011), and crop yields are only 20–40 % of their potential (URT 2008b).

Agricultural production, including food security, is projected to be severely compromised by changes to climate in Tanzania, as it will in most of the East and Sub-Saharan countries in general. The Tanzania Plan of Action (NAPA: URT 2007) identified agriculture to be one of the sectors that will be highly affected by the impacts of climate change. Impacts of extreme events resulting from changes in climate are manifest in events such as droughts, floods, erratic rains, and diseases, and pests have already been common since the mid-1990s and have caused famine to many communities.

Based on outputs from a dozen Global Circulation Models (GCMs), temperatures are predicted to rise 2–4 °C by 2100, warming more during the dry season and in the interior regions of the country (Paavola 2008; Rowhani et al. 2011; Tumbo et al. 2010). Rainfall is expected to decrease up to 20 %, especially in the interior regions, and increase in regions around Lake Victoria with historical observations already showing prevalence of more extremes (Mbungu et al. 2012). Agricultural predictions indicate that Tanzania will suffer a loss of over 10 % of its grain production by the year 2080 (Parry et al. 1999). The cultivation of maize is going to be particularly hard hit. Estimates from the Crop Environment Resource Synthesis Model (CERES-Maize) (Jones and Kiniry 1986) show that the average yield decrease over the entire country would be about 33 %, and as high as 84 % in the central regions of Dodoma and Tabora.

Downscaled Global Climate Models (GCMs) for Same District, Kilimanjaro region, northern Tanzania, have indicated an increase in rainfall and temperature for the period 2046–2065 (Tumbo et al. 2010). The seasonal rainfall amounts have been projected to increase by 56 mm (23 % increase) during long rain seasons in March–April–May (MAM), and by 42 mm (26 % increase) during short rain seasons in October–November–December (OND). The air temperature is projected to increase by about 2 °C for both seasons (Tumbo et al. 2012). There is a growing concern that the length of the growing season and yield potential, particularly of smallholder farmers, are going to be heavily affected, exacerbating food insecurity and malnutrition. To prevent destructive impacts of climate change on food production and the livelihood of the majority of the population, adaptation is therefore critical (Lobell and Field 2007; Schlenker and Lobell 2010). Adaptation is one of

the policy options for reducing the negative impact of climate change (Adger et al. 2003). Adaptation to climate change includes adjustment in natural or human systems in response to actual or expected climate stimuli or their effects, which moderates harm or exploits beneficial opportunities (Griggs and Noguer 2002). Agronomic adaptation commonly includes the use of new crop varieties and livestock species that cope better to difficult conditions, irrigated farming, crop diversification, adoption of mixed cropping and livestock farming systems, and changing planting dates (Bradshaw et al. 2004; Deressa et al. 2009), as well as the use of recommended agronomic practices including tillage practices and use of weather forecasts for farm level decision making (Tumbo et al. 2012). Assessments of the possible impacts of climate change at landscape and farm level will help farmers and other stakeholders make informed decisions on their farm operations to curb the negative effects.

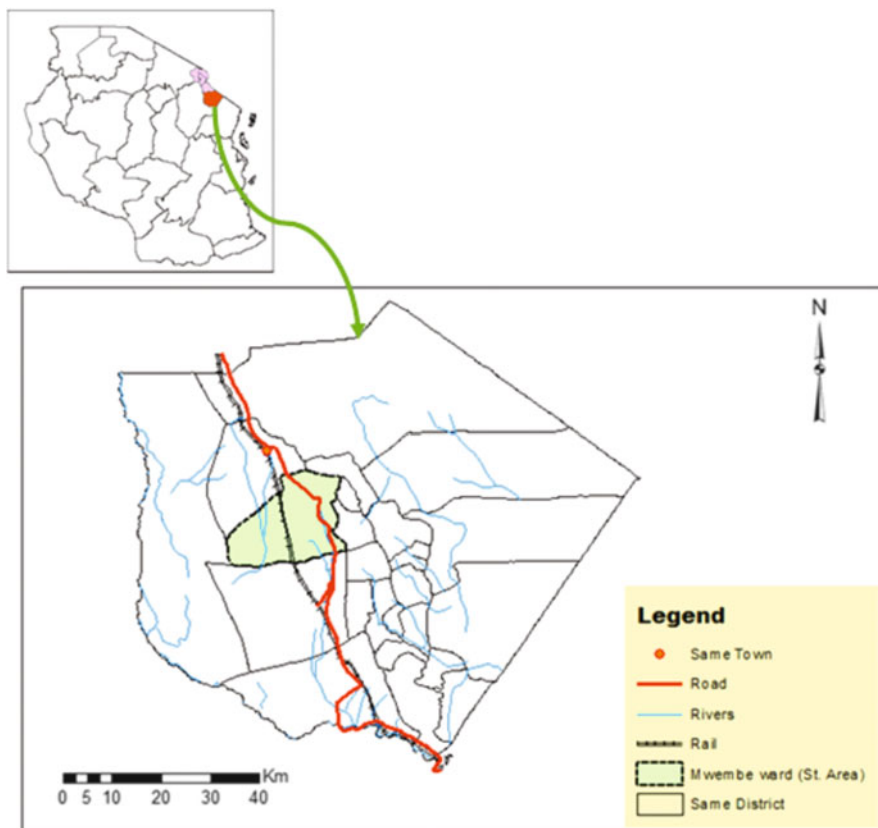
Understanding and measuring the impacts of the projected future climate at farm, landscape, and regional scales are therefore of critical importance. Farmers who are highly vulnerable have long used different approaches to cope with variability. On the other hand, extension personnel have recommended several agronomic practices such as use of fertilizers, mulching to conserve soil moisture, and use of recommended type of cultivars and livestock species.

The main objective of this study was to assess the impacts of climate change on agronomic productivity at a farm scale level by examining the current agronomic practices as adaptation options to cope with climate change using current and future climate data in Same District, Kilimanjaro, Tanzania. The study focused on measuring the impacts of agronomic practices on maize yield. Maize (*Zea mays*) is a staple food crop in Same District and in many parts of Tanzania. Same District is a semi-arid area with a bimodal rainfall experiencing a high variability with annual precipitation, averaging 562 mm with a standard deviation (std) of 193 mm (Enfors and Gordon 2008; Tumbo et al. 2010). The specific objectives of this study were to (i) predict yield of selected maize cultivars under the different agronomic management practices for the 1958–2006 (base) and 2046–2065 (future) periods, and (ii) recommend the most promising agronomic management practices to adapt to climate change.

## 10.2 Materials and Methods

### 10.2.1 Location of the Study Area

The study was conducted in Same District in the midlands and lowlands of the Western Pare Mountains of Tanzania (Fig. 10.1), during March 2005 to June 2009. The area is semi-arid with highly variable and unreliable rainfall, with farmers strongly attached to growing maize as their main food crop. Rainfall is bimodal with short rains running from October to December (OND), and long rains from



**Fig. 10.1** Location of Mwembe Ward (Study Area) in Same District, Kilimanjaro, Tanzania

March to May (MAM). The areas in the lowlands receive less than 500 mm per year and crop failure due to water deficit is common (Enfors and Gordon 2008). Various efforts to promote drought tolerant crops such as sorghum to ensure household food sufficiency in the district have received stern opposition in favor of maize.

The recurrent droughts resulting in seasonal soil moisture deficit are the major constraint to maize production. Various coping strategies have been proposed and used in the study area including use of water storage structures, in-situ rain water harvesting, and conservation technologies such as terraces to reduce runoff and increase infiltration of water. Dry planting is also a technique used in order to capture the first rains. Nevertheless, not all farmers have access to these technologies, and for those with access they hardly get the amount of water to suffice crop requirements (Enfors and Gordon 2007). On the other hand, the use of improved seeds and minerals as well as organic fertilizer, as recommended by agricultural extension officers, has also faced resistance, especially as farmers are afraid to take risks. Cooper et al. (2008) noted that farmers often over-estimate the frequency of negative impacts of climate variability and under-estimate the positive opportunities.

### ***10.2.2 Global Circulation Models (GCMs)***

Global Circulation Models represent physical processes in the atmosphere, ocean, cryosphere, and land surface. They are advanced tools currently available for simulating the response of the global climate system to increasing greenhouse gas concentrations (Kistler et al. 2001; Wilby et al. 2004). The GCMs are capable of simulating general circulation as well as inter-annual oscillations such as El Niño – Southern Oscillation (ENSO), and forecasting climate trends decades or hundreds of years in advance. Although simpler models have also been used to provide globally- or regionally-averaged estimates of the climate response, only GCMs, possibly in conjunction with nested regional models, have the potential to provide geographically and physically consistent estimates of regional climate change, which are required in impact studies (Houghton et al. 2001). GCMs depict the climate using a three-dimensional grid over the globe typically having a horizontal resolution of between 250 and 600 km, 10–20 vertical layers in the atmosphere, and sometimes as many as 30 layers in the oceans (Houghton et al. 2001). Therefore, to capture climate change impacts relevant for agricultural production, location-based assessments are needed to complement the broad impact assessments (Feenstra et al. 1998). Four downscaled GCMs for Same Region, Kilimanjaro, were used in this study. The methodology for the GCM downscaling is described in detail by Tumbo et al. (2010).

### ***10.2.3 Crop Simulation Models***

The use of crop simulation models that integrate the impact of variable weather with a range of soil, water, and crop management choices are useful for measuring effects of the changes. The models are usually driven by daily climatic data which can be used to predict the impact of climate variability on the probability of success of a range of crop, water, and soil and management strategies (Cooper et al. 2008).

According to Probert et al. (1998), models are the means of extrapolation of knowledge derived from experimentation to other situations, seasons, soils, and different management such as crop sequences, and tillage and residue management practices. The use of models provides a quicker and much less costly opportunity of ‘accelerated learning’ compared with the more traditional multi-location, multi-seasonal, and multi-factorial field experiments (Cooper et al. 2008). Crop simulation models such as APSIM, DSSAT, PARCHED-THIRST, AQUACROP and several others have been known for their capability to perform long-term simulations of different management strategies in a short period of time (Tumbo et al. 2012). Models have different capabilities and the choice of the model depends on the objective of the simulation. While a model such as PARCHED-THIRST has a module that handles different types of water diversion (water harvesting), APSIM and DSSAT have modules that handle fertilizer application. Moreover, APSIM can simulate various soil and water management practices, conservation tillage

practices, together with the growth and yield of a range of crops and cultivars amongst which maize, sorghum (Cooper et al. 2008), and rice are likely to generate interest in Tanzania.

#### ***10.2.4 The APSIM Model***

The Agricultural Production Systems sIMulator (APSIM) model was used in this study because of its ability to handle more modules relevant for simulating long-term yields in semi-arid areas. Cooper et al. (2008) reports on studies in Zimbabwe and Kenya that used the APSIM model to perform long term yield simulations. In Zimbabwe, simulation of 46 years of daily climatic data found that farmers' recommendation of using 17 kg N/ha on an annual basis was more appropriate compared to the recommended rate of 52 kg N/ha by agricultural extension system, with the exception of very bad years. In Kenya, the study found that climate variability has significant effect on yield, especially for rainfall below 200 mm. The simulation will assist in understanding the effect of future climate change, and allow further investigations and development of adaptation strategies.

#### ***10.2.5 Model Set Up and Simulation***

The model was calibrated using experiments that were conducted between March 2005 and June 2009 in Mwembe ward, Same District, Kilimanjaro. In the experiments, information on climatic data (daily rainfall, maximum and minimum temperature), soil, water, and yield were collected, monitored, and analysed. Data sources and analysis used in the simulation are described in the subsequent sections.

##### **10.2.5.1 Climate Data**

Historical climatic data (1958–2006) for daily rainfall and maximum and minimum temperature was obtained from Same meteorological station. Solar radiation data was estimated as described by Tumbo et al. (2012). The climate data (daily rainfall, and maximum and minimum temperature) representing future scenarios (2046–2065) for Same District were downscaled from four GCMs (CGCM, CNRM, IPSL and ECHAM) using a self-organizing map (SOM) technique (Tumbo et al. 2010).

##### **10.2.5.2 Parameters for Maize Varieties**

The study used maize cultivars recommended by the agricultural extension agency for the midlands in Same District, Kilimanjaro. The recommended cultivars include

*Kito*, *Situka*, *TMV1* and *Sc403*. It was realized that the crop simulation models do not carry all the crop varieties commonly found in Tanzania. To be able to run simulations in APSIM, *Sc401* (available in the maize module in APSIM), with similar genetic characteristics, was used to represent *Sc403*. Parameters for *TMV1* were taken from PARCHED-THIRST software, while *Kito* and *Situka* parameters were derived from Tanzania Official Seed Certification Agency (TOSCA) crop variety experimental data. Table 10.1 summarizes data from TOSCA crop variety experiments which were used to derive simulation parameters for *Kito* and *Situka*.

### 10.2.5.3 Soil and Water Parameters

Summary of important information on soil and water used for calibration, validation, and long-term simulation are given in Tables 10.2 and 10.3. Table 10.2 shows

**Table 10.1** Maize varieties used in the study and their characteristics

Stage description	Maize variety				
	<i>sc403</i>	<i>TMV1</i>	<i>Situka</i>	<i>Kito</i>	<i>Katumani</i>
Days to tasseling	Very early	50–65	–	40–45	36–43
Days to 50 % tasseling	Early	55–70	45–55	45–47	40–52
Days to silk emergence	Very early	60–75	–	45–52	40–50
50 % silk emergence	–	65–80	78	52–56	44–56
Days to maturity	–	110–115	100–110	90	90
Yield (t/ha)	–	4.0–4.5	4.0–6.0	2.0–3.0	3.0–3.5

Source: MAFSC (2009)

**Table 10.2** Soil profile horizon for APSIM model calibration

Horizon	Depth (cm)	Texture	Nutrient (mg kg <sup>-1</sup> )		OM (%)
			NH <sub>4</sub> -N	NO <sub>3</sub> -N	
1A	0–30	Loam	4.31	5.72	1.3
2A	30–48	Sandy clay loam	3.15	5.50	0.9
B	48–100+	Clay loam	–	–	–

**Table 10.3** Soil and water parameters for the APSIM software

Depth (cm)	Bulk density (g cm <sup>-3</sup> )	Saturation (m m <sup>-1</sup> )	DUL (m m <sup>-1</sup> )	LL15 (m m <sup>-1</sup> )	LL-Maize (m m <sup>-1</sup> )
0–15	1.38	0.24	0.22	0.11	0.13
15–30	1.40	0.24	0.22	0.11	0.13
30–60	1.40	0.24	0.22	0.11	0.15
60–90	1.41	0.23	0.21	0.12	0.15
90–120	1.41	0.23	0.21	0.12	0.17
120–150	1.41	0.23	0.21	0.12	0.17

**Table 10.4** Observed average yields (kg/ha) of *Kito* maize cultivar from 2005 to 2009

Statistics	Long rain season ( <i>Masika</i> )	Short rain season ( <i>Vuli</i> )
Mean	2,501	1,764
Standard deviation	688	842
Maximum	3,161	2,702
Minimum	1,392	855

soil depth, soil texture, organic matter, and  $\text{NH}_4\text{-N}$  and  $\text{NO}_3\text{-N}$ . Table 10.3 shows soil and water parameters (bulk density, saturation, dry upper limit (DUL) and lower limit at 15 bar (LL 15)) as obtained from experimental results. Also included is the lower limit for maize as given in the APSIM model software. Nutrients from soil analysis such as P, K, and Mg were also added in the model.

#### 10.2.5.4 Calibration of the Model

APSIM model was calibrated using *Kito* cultivar parameters and results from the experimental plots planted in five different short and long rainy seasons. The planting and replanting dates for short rainy seasons varied between October 2nd and November 12th, whereas for long rainy seasons varied between February 15th and April 4th. Table 10.4 presents average yields obtained from the experiment.

For calibration and yield estimation, planting dates for the simulation model were based on planting, germination, and replanting dates observed during field experimentation. The obtained simulated yields based on the three planting dates for each season were averaged to get estimated yields. After model calibration, long-term simulation from 1958 to 2006 for *Kito* variety was carried out, followed by a run involving the other varieties.

#### 10.2.6 Model Simulation

After the model had been calibrated and validated, a simulation to test three management options for the *Kito* cultivar were simulated. The management options include conventional tillage, conservation tillage, and the use of artificial fertilizer. In conventional tillage, common methods used by farmers in the area to till the land were applied and neither manure nor fertilizers were applied. For conservation tillage, a ripper with the aim of increasing water infiltration and reduce runoff was used for tillage and manure of 5 t/ha was applied. Additionally, as recommended by extension staff, artificial fertilizer of about 54 kg/ha Urea-N at planting and 66 kg/ha of  $\text{NH}_4\text{NO}_3\text{-N}$  as top dressing 35 days after planting were applied.

Furthermore, to measure the impact of climate change on maize production, projected future climate for 2046–2065 was simulated. The four maize cultivars and three agronomic management practices were used for the simulation. Agronomic

practices included conventional practice (tillage practices and farm operations commonly applied in the area) and recommended practices by the extension agents in the study area, where mineral fertilizer of about  $54 \text{ kg ha}^{-1}$  of urea-N at planting and  $66 \text{ kg ha}^{-1}$  of  $\text{NH}_4\text{NO}_3\text{-N}$  as top dressing 35 days after planting were applied. The calibrated model was also used to simulate maize yield of the four varieties using the agronomic practices for the base period, 1958–2006.

The planting period in APSIM software was kept flexible, between 1st October and 15th November for *short rainy* season and between 15th February and 25th March for *long rainy* season. These periods are the normal planting periods for short and long rainy season respectively in Same District. Due to variable and unreliable season starting dates, farmers will normally plant as soon as rains fall within those periods. In the case where rains start late, farmers apply dry planting. In the APSIM model, planting was done automatically after the model detected that at least 15 mm of rainfall was received and the amount of soil water was 20 mm accumulated within 5 days. However, if within those planting periods conditions were not met, planting was forced at the end of the window.

Soil water was set at 10 % of field capacity to ensure that no autocorrelation (dependency between successive terms in the time series) occurred due to carryover of unused soil water. Hence, any remaining autocorrelations achieved are a consequence of the historical climate data.

**Yield analysis** Yield frequency plots of each maize cultivar for the base period (1958–2006) and future period (2045–2065) were developed. Also, tabular comparisons of yields between cultivars and between base and future period were made based on conventional and recommended practices. This enabled easy visualization of trends and effects on climate change scenarios, varietal, and resilient attributes of recommended agronomic practices.

## 10.3 Results and Discussion

### 10.3.1 Model Calibration

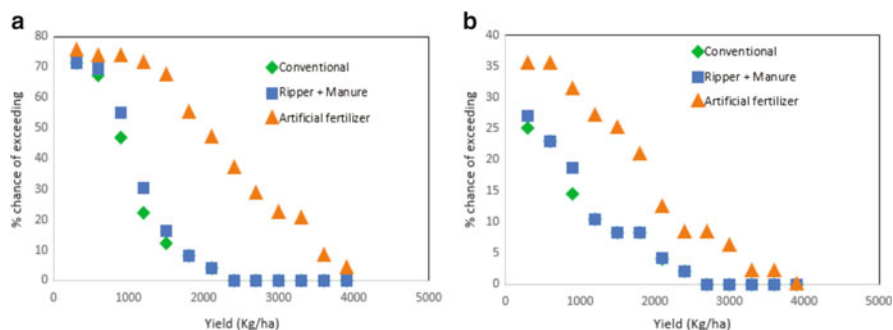
Calibration of APSIM software for yield simulation was challenging because the non-labile organic matter factor, which is one of the system parameters, had significant effect on yield and it had to be adjusted. Values of non-labile organic matter at 0–15 cm, 15–30 cm, 30–60 cm, 60–90 cm, 90–120 cm, and 120–150 cm depth that provided simulated yields comparable to observed yields, were 0.65, 0.75, 0.90, 0.75, 0.55, and 0.45, respectively. Table 10.5 shows simulated and observed yields of *Kito* maize cultivar. Observed yields have higher standard deviation compared to simulated yields. Also, the simulation under-predicted yields on a good season and over-predicted on a bad rainfall season. Overall, comparison between observed and simulated yields using two-sample t-test for unpaired data showed that the mean values were not statistically different ( $p < 0.05$ ) as indicated in Table 10.5.



**Table 10.5** Observed and simulated yields between 2005 and 2007

Season	Rainfall (mm)	Observed yields (kg/ha)		Simulated yields (kg/ha)		Two sample t-test for unpaired data
		Mean	std	Mean	std	
LRS 2005	165	233	247	417	723	NS
SRS 2005	95	0	0	96	167	NS
LRS 2006	326	2,501	688	2,433	130	NS
SRS 2006	549	1,764	842	1,646	141	NS

LRS long rainy season, SRS short rainy season, *std* standard deviation, NS not significant ( $p < 0.05$ )



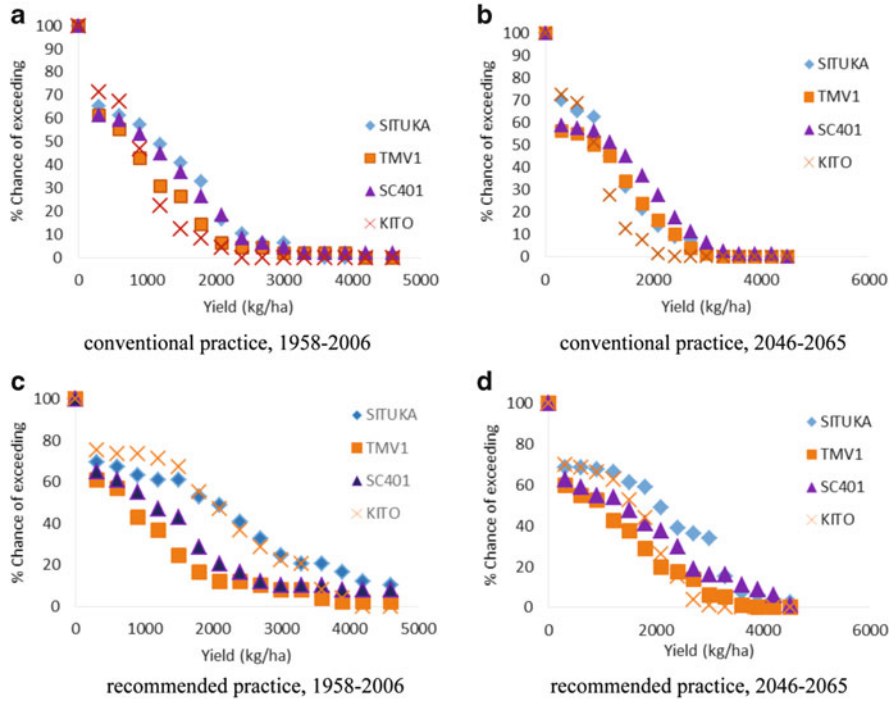
**Fig. 10.2** Long-term simulation of *Kito* variety under conventional, ripper + manure and artificial fertilizer (a) *Masika* probability of exceedance (b) *Vuli* probability of exceedance

### 10.3.2 *Kito* Variety Long Term Yield Simulation

Results of long term yield simulation (1958–2006) for *Kito* cultivar are shown in Fig. 10.2a, b. The option of using ripper and manure without artificial fertilizer seems to have the same outcome in *masika* as well as in *vuli* seasons. Probability of exceeding 1.5 t/ha stands at 70 % if fertilizer is used, whereas at the same yield it is about 10 % and 15 % for conventional and conservational agriculture respectively, for *masika* season. It can also be observed that for the *masika* season there is a 50 % chance of obtaining yields beyond 2 t/ha with the use of artificial fertilizer. There is no real advantage adopting either of the management strategies in *vuli* because the outcomes are very similar. Therefore, technique that uses minimum input should be given a higher priority, which in this case is conventional agriculture.

### 10.3.3 Climate Change Impact on the Long Rainy Season

Results generally indicate that under conventional practices, the change in climate will likely positively affect *Sc401* and *TMV1* maize varieties but negatively affect



**Fig. 10.3** Probability of exceeding a particular maize production threshold for conventional and recommended practices for base period (1958–2006) and future period (2046–2065) during long rainy season (March–May) season

cultivar *Situka*. Figure 10.3a–d shows simulation results of maize varieties based on conventional and recommended practices for 1958–2006 (base period) and 2046–2065 (future period). Figure 10.3a, b show that under conventional practice, the percent chance of exceeding 1 t/ha is about 50 % or higher for all varieties for the period 2046–2065. However, only two varieties (*Sc401* and *Situka*) had a chance of exceeding 1 t/ha in the base period. Given the fact that many farmers in SSA, including Same District, are mostly applying conventional practice, this implies that their current practice is not threatened by the projected change in climate. Essentially, farmers are assured of more options of maize cultivars because their chance of exceeding 1 t/ha is above 50 %.

The probability of exceeding 2 t/ha for *TMV1* increased from 10 % in the base period to 20 % in the future period (Fig. 10.3a, b). Similarly, maize yields for *Sc401* are projected to increase its probability of exceeding 2 t/ha from 20 % for the base period to around 30 % for the future period. *Kito* variety seems not to be affected in either way by the climate change, since its probability of exceeding 2 t/ha is almost zero in both periods. *Situka* seems to be negatively affected by the change in climate, especially with respect to the probability of exceeding 2 t/ha in which the probability decreased from 20 % in the base period to slightly below 20 %. This

implies that the variety of choice in the future for risk taker type farmers will likely to be *Sc401*, as there is 30 % chance of obtaining or exceeding 2 t/ha. However, farmers who are risk averse will likely stick to *Situka* cultivar as it guarantees them with some yields, even in a very poor season. The probability of exceeding maize yields beyond 3 t/ha seems to be similar for the base and future periods, which is close to zero.

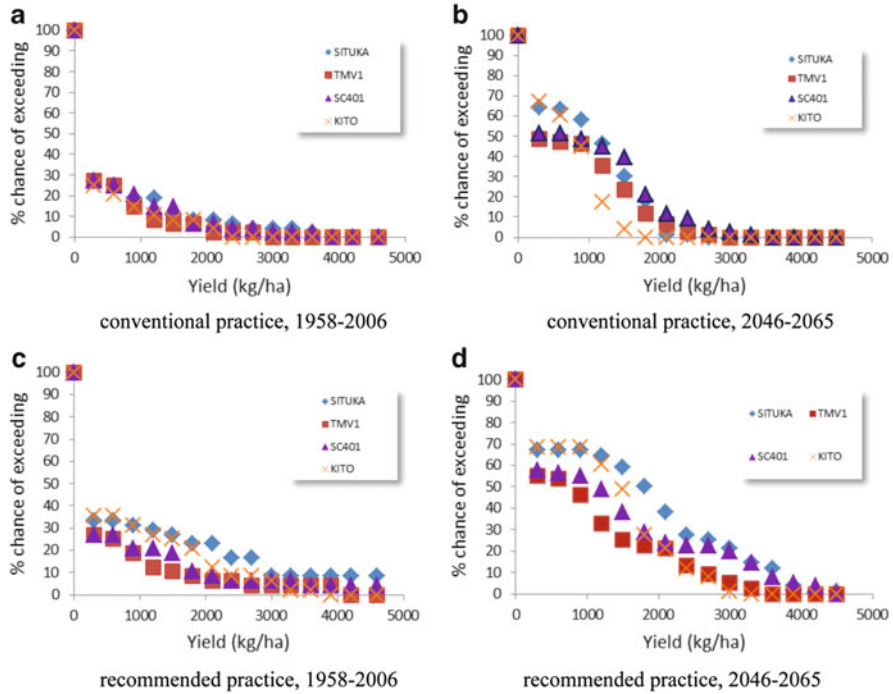
Under recommended practices, the probability of exceeding 1 t/ha decreases from 70 % to slightly below that value for the cultivar *Kito*, whereas for cultivars *Situka* and *TMV1* the probability increases from around 60 % to 68 % and from 40 % to 50 %, respectively (Fig. 10.3c, d). However, the probability of exceeding the same yield level seems to remain the same for *Sc401*. Generally, in the base period, recommended practice shows higher probability of exceeding a certain yield level compared with conventional practice. However, most farmers go for conventional practice because they have a risk averse attitude and low capital to invest in agricultural inputs. Also, the difference of chance of yield exceeding a certain threshold between the two practices is less than 10 % for *Situka* cultivar (Fig. 10.3a, c). It was noted through interviews with key informants that the majority of farmers prefer to plant *Situka* cultivar over other maize varieties.

The yield of *Kito* variety is highly affected by climate change, as its percent probabilities of exceeding 2 and 3 t/ha drop from 50 % to 30 % and from 20 % to almost 0 %, respectively. On the contrary, the probabilities of exceeding 2 t/ha for the two varieties *TMV1* and *Sc401* seems to increase, compared to base period, from 10 to 20 % for *TMV1* and from 20 to 40 % for *Sc401*. For cultivar *Situka*, the probability of exceeding 3 t/ha increased from 20 % for the base period to slightly above 30 % for the future period; the probability of exceeding 2 t/ha remained the same. Yields beyond 3 t/ha are negatively affected as the probabilities of exceeding that value seems to decrease or stagnate for the other three cultivars.

In general, *TMV1* is projected to have a slight gain in yield in response to future climate under both conventional and recommended practices. *Sc401* cultivar is projected to fair well under conventional practices, but poorly under the recommended practices, which is contrary to *Situka*, whose yield is projected to slightly decrease under conventional practices and increase under recommended practices. Therefore, this analysis has indicated that, for the long rainy season, farmers may not need to significantly change their maize varieties of choice. *Situka* and *Sc401* varieties stand a greater chance to adapt to climate change, at least by 2050 where temperature is projected to increase by 2 °C and rainfall to increase by 56 mm during the long rainy season (Tumbo et al. 2010). This does not take into account the yield increase that might be brought by carbon fertilization.

### 10.3.4 Climate Change Impact in the Short Rainy Season

Figures 10.4a–d shows the percent chance of exceeding a particular yield threshold during short rainy season for the base and future periods. Figure 10.3b, d indicate



**Fig. 10.4** Probability of exceeding a particular maize production threshold for conventional and recommended practices for base period (1958–2006) and future period (2046–2065) during *short rainy season* (October–December)

that for the future period the probability of exceeding a particular threshold is likely to improve with the climate change. For example, under conventional practice, the probability of exceeding 1 t/ha for all maize varieties from 10 to 20 %, whereas for the future period this will increase from 40 to 60 %. Cultivar *Situka* stands to benefit more from climate change compared to other cultivars. However, the benefits of climate change seem to significantly diminish beyond 1 t/ha. This is indicated by the probability of exceeding 2 t/ha, which has dropped to between 10 and 15 % for *TMV1*, *Situka* and *Sc401* and zero for *Kito*. Therefore, the yield gain in the future period is only expected just below 2 t/ha for almost all four maize varieties beyond. Also, the probability yield gain at 1 t/ha is quite significant in the short rainy season compared to that expected in the long rainy season, under conventional practice. Since the District of Same is in the bimodal rainfall zone, the increased yield probability in the future period implies a reduced risk of failure to farmers.

Under recommended practices (Fig. 10.3c, d) there is, again, a projected increase in the probability of exceeding 1 t/ha from between 20 and 30 % under the base period to between 45 and 67 % under the future period. Similarly, at 2 t/ha the probability of exceeding that yield threshold has doubled following an increase

**Table 10.6** Model predicted average maize variety yields (kg/ha) for conventional and recommended practices for long rainy season in Tanzania

GCMs and averages	Conventional				Recommended			
	<i>Situka</i>	<i>TMV1</i>	<i>Sc401</i>	<i>Kito</i>	<i>Situka</i>	<i>TMV1</i>	<i>Sc401</i>	<i>Kito</i>
CGCM	768	537	802	526	1,299	601	863	929
CRNM	1,063	916	1,214	670	1,960	1,039	1,436	1,397
IPSL	874	997	1,183	609	1,817	1,231	1,657	1,189
ECHAM	696	694	834	563	1,481	775	1,119	998
Future average	850	786	1,008	592	1,639	911	1,269	1,128
Base average	957	671	913	593	1,806	815	1,142	1,632
% change	-12.5	+14.7	+9.5	-0.1	-10.2	+10.6	+10.0	-44.7

*Situka*, *TMV1*, *Sc401*, and *Kito* are maize cultivars

GCMs Global Circulation Models

from between 10 % and 20 % to 20 % and 40 %. Also, there is an increase in the percent chance of exceeding a 3 t/ha yield threshold from 10 to 20 % for *Situka* and *Sc401*. Similar to results obtained in the long rainy season, the same two varieties *Situka* and *Sc401* showed improved performance in the future period based on the projected climate change in the short rainy season.

### 10.3.5 Mean Yield Comparison for the Long Rainy Seasons

Under conventional practices and during long rainy season, GCMs predict a 13 % decline in future maize yield for cultivar *Situka* (Table 10.7). Cultivars *Sc401* and *TMV1* are predicted to register 10 % and 15 % increases, respectively, in future yield compared to the current values. There will be no change for maize cultivar *Kito*. Under the recommended practices, *Kito* is projected to register about 45 % decline in yield compared to the base period (Table 10.6). A decline in future yield of 10 % is projected for cultivar *Situka* during long rainy season. The increase in future grain yield for cultivar *TMV1* and *SC401* is predicted at about 10 % based on the current values. All the same, the yield under recommended practices will still be much higher than base or future yield under conventional practices.

### 10.3.6 Mean Yield Comparison for the Short Rainy Seasons

All cultivars are projected to register more than 100 %, except *Situka* and *Kito* which will register about 75 %, increase in maize yield in the future during short rainy season under conventional practices (Table 10.7). *TMV1* and *Sc401* are predicted to have yields of 147 % and 136 %, respectively compared to base values, thus outperforming *Situka* and *Kito* (Table 10.7). By using improved practices, all

**Table 10.7** Model predicted average maize variety yields (kg ha<sup>-1</sup>) for conventional and recommended practices for short rainy season in Tanzania

GCMs	Conventional				Recommended			
	<i>Situka</i>	<i>TMV1</i>	<i>Sc401</i>	<i>Kito</i>	<i>Situka</i>	<i>TMV1</i>	<i>Sc401</i>	<i>Kito</i>
CGCM	757	622	761	449	1,274	715	960	923
CRNM	647	523	678	455	1,796	874	1,310	1,290
IPSL	855	688	921	539	1,611	943	1,297	1,108
ECHAM	784	595	876	522	1,192	597	991	930
Future average	761	607	809	491	1,468	782	1,140	1,063
Base average	374	246	342	235	829	365	506	606
% change	+103.2	+146.8	+136.3	+109.0	+77.1	+114.4	+125.3	+75.4

*Situka*, *TMV1*, *Sc401*, and *Kito* are maize cultivars

GCMs Global Circulation Models

cultivars are predicted to have yields 75 % greater than present levels. What is emerging is the fact that future short rainy seasons will be much better than the current situation in relation to maize production.

### ***10.3.7 Policies and Interventions Implications in View of the Projected Yield Decline***

Maize is a major staple food and sometimes a cash crop in Tanzania. It is mainly produced during the long rainy season. Any decline in maize production will have a major impact on many households and may force the Government to import the commodity. This will definitely have some bearing on the Government in terms of implementing its policies and programmes. Given these future scenarios, the Government needs to have in place policies and programmes that will address these future situations. For example, breeding programmes of maize cultivars that will cope with the future conditions need to be put in place.

## **10.4 Conclusion and Recommendations**

This study has demonstrated that tillage and other agronomic practices can result in different yield outputs for maize crops. Site-specific assessment provides more insight into the impacts of climate change than regional and global assessments. The assessments will help farmers and other decision makers to plan for coping and adaptation strategies. Using UK89 GCM model, Mwandosya et al. (1998) showed that under 2xCO<sub>2</sub> (doubling of greenhouse gases) scenario, which is expected to increase temperature to between 2.5 and 4 °C, maize average yield in Tanzania is expected to decrease by 33 %. Interpolating results of the same study for Same

District, maize yield is projected to decrease by 40 %. This study has shown that only some varieties are expected to decrease due to 2 °C rise in temperature and only during the long rainy season. Therefore, there is a strong need for more site-specific studies that evaluate several crop varieties grown in the area, several downscaled GCMs, the number of seasons, and agronomic management practiced by farmers in that area. Furthermore, the majority of crop varieties, including indigenous or local varieties in SSA, have yet to be modelled and entered into the major crop simulation software. This somehow limits the ability of climate change impact studies. Therefore, there is a strong need to parameterize these crops and crop varieties for computer models.

**Acknowledgement** The authors wish to acknowledge the Soilwater Management Research Programme (SWMRP) of SUA for financial and technical support during the implementation of this research work.

## References

- Adger WN, Huq S, Brown K, Conway D, Hulme M (2003) Adaptation to climate change in the developing world. *Prog Dev Stud* 3:179–195
- Bradshaw B, Dolan H, Smit B (2004) Farm-level adaptation to climatic variability and change: crop diversification in the Canadian Prairies. *Clim Change* 67:119–141
- Cooper PJM, Dimes J, Rao KPC, Shapiro B, Shiferaw B, Twomlow S (2008) Coping better with current climatic variability in the rain-fed farming systems of sub-Saharan Africa: an essential first step in adapting to future climate change? *Agric Ecosyst Environ* 126:24–35
- Cubasch U, Wuebbles D, Chen D, Facchini MC, Frame D, Mahowald N, Winther JG (2013) Introduction. In: Stocker TF, Qin D, Plattner GK, Tignor M, Allen SK, Boschung J, Nauels A, Xia Y, Bex V, Midgley PM (eds) *Climate change 2013: the physical science basis. Contribution of Working Group I to the fifth assessment report of the Intergovernmental Panel on Climate Change*. Cambridge University Press, Cambridge/New York
- Deressa TT, Hassan RM, Ringler C, Alemu T, Yesuf M (2009) Determinants of farmers' choice of adaptation methods to climate change in the Nile Basin of Ethiopia. *Glob Environ Change* 19:248–255
- Devereux S, Edwards J (2004) Climate change and food security. *IDS Bull* 35:22–30
- Enfors E, Gordon L (2007) Analyzing resilience in dryland agro-ecosystems. A case study of the Makanya catchment in Tanzania over the past 50 years. *Land Degrad Dev* 18:680–696
- Enfors EI, Gordon LJ (2008) Dealing with drought: the challenge of using water system technologies to break dryland poverty traps. *Glob Environ Change* 18:607–616
- Feenstra JF, Burton I, Smith JB, Tol RSJ (1998) *Handbook on methods for climate change impact assessment and adaptation strategies*. UNEP/Vrije Universiteit, Amsterdam
- Griggs DJ, Noguer M (2002) *Climate change 2001: the scientific basis. Contribution of Working Group I to the third assessment report of the Intergovernmental Panel on Climate Change*. *Weather* 57:267–269
- Houghton J, Ding YDJG, Griggs DJ, Noguer M, van der Linden PJ, Dai X, Maskell K, Johnson CA (2001) *Climate change 2001: the scientific basis*, vol 881. Cambridge University Press, Cambridge
- Hulme M (1996) *Climate change and Southern Africa: an exploration of some potential impacts and implications in the SADC region*. Climatic Research Unit and WWF, Norwich, p 104

- Intergovernmental Panel on Climate Change (IPCC) (1998) The regional impacts of climate change: an assessment of vulnerability. Special report of IPCC Working Group II [Watson RT, Zinyowera MC, Moss RH (eds)] Intergovernmental Panel on Climate Change, UK/New York, USA, p 517
- Intergovernmental Panel on Climate Change (IPCC) (2007) Climate change 2007: impacts, adaptation and vulnerability. Contribution of Working Group II to the fourth assessment report of the Intergovernmental Panel on Climate Change [Parry ML, Canziani OF, Palutikof JP, van der Linden PJ, Hanson CE (eds)] Intergovernmental Panel on Climate Change, Cambridge
- Intergovernmental Panel on Climate Change (IPCC) (2013) Climate change 2013: the physical science basis. Contribution of Working Group I to the fifth assessment report of the Intergovernmental Panel on Climate Change [Stocker TF, Qin D, Plattner G-K, Tignor M, Allen SK, Boschung J, Nauels A, Xia Y, Bex V, Midgley P (eds)] Intergovernmental Panel on Climate Change, Cambridge, pp 1535
- Jones CA, Kiniry JR (1986) CERES–Maize a simulation model of Maize growth and development. Texas A & M. University Press, College Station
- Kistler R, Kalnay E, Collins W, Saha S, White G, Woollen J, Chelliah M, Ebisuzaki W, Kanamitsu M, Kousky V, van den Dool H, Jenne R, Fiorino M (2001) The NCEP-NCAR 50-year reanalysis: monthly means CD-ROM and documentation. *Bull Am Meteorol Soc* 82(2):247–267
- Lobell DB, Field CB (2007) Global scale climate–crop yield relationships and the impacts of recent warming. *Environ Res Lett* 2:014002
- Mary AL, Majule AE (2009) Impacts of climate change, variability and adaptation strategies on agriculture in semi arid areas of Tanzania: the case of Manyoni District in Singida Region. *Afr J Environ Sci Technol* 3:206–218
- Mbungu W, Ntegeka V, Kahimba F, Taye M, Willems P (2012) Temporal and spatial variations in hydro-climatic extremes in the Lake Victoria basin. *Phys Chem Earth, Parts A/B/C* 50:24–33
- Ministry of Agriculture and Food Security (MAFC) (2009) Tanzania variety catalogue. Ministry of Agriculture, Food Security and Cooperatives. Access online from <http://www.kilimo.go.tz/publications/publications.html>. 25 Nov 2013
- Misselhorn AA (2005) What drives food insecurity in southern Africa? A meta-analysis of household economy studies. *Glob Environ Change* 15:33–43
- Mwandosya MJ, Nyenzi BS, Luhanga ML (1998) The assessment of vulnerability and adaptation to climate change impacts in Tanzania. The Centre for Energy, Environment, Science and Technology, Dar es Salaam
- O'Brien K, Leichenko R, Kelkar U, Venema H, Aandahl G, Tompkins H, Javed A, Bhadwal S, Barg S, Nygaard L, West J (2004) Mapping vulnerability to multiple stressors: climate change and globalization in India. *Glob Environ Change* 14:303–313
- Paavola J (2008) Livelihoods, vulnerability and adaptation to climate change in Morogoro, Tanzania. *Environ Sci Policy* 11:642–654
- Parry M, Rosenzweig C, Iglesias A, Fischer G, Livermore M (1999) Climate change and world food security: a new assessment. *Glob Environ Change* 9(Supplement 1):S51–S67
- Probert ME, Dimes JP, Keating BA, Dalal RC, Strong WM (1998) APSIM's water and nitrogen modules and simulation of the dynamics of water and nitrogen in fallow systems. *Agric Syst* 56(1):1–28
- Rowhani P, Lobell DB, Linderman M, Ramankutty N (2011) Climate variability and crop production in Tanzania. *Agr Forest Meteorol* 151:449–460
- Schlenker W, Lobell DB (2010) Robust negative impacts of climate change on African agriculture. *Environ Res Lett* 5(1):014010
- Tumbo SD, Mpeta E, Tadross M, Kahimba FC, Mbillinyi BP, Mahoo HF (2010) Application of self-organizing maps technique in downscaling GCMs climate change projections for Same, Tanzania. *Phys Chem Earth Parts A/B/C* 35:608–617



- Tumbo S, Kahimba F, Mbilinyi B, Rwehumbiza F, Mahoo H, Mbungu W, Enfors E (2012) Impact of projected climate change on agricultural production in semi-arid areas of Tanzania: a case of same district. *Afr Crop Sci J* 20:453–463
- United Republic of Tanzania (URT) (2007) National Adaptation Programme of Action (NAPA) Division of Environment, Vice President's Office, Dar es Salaam. Accessed from <http://www.adaptationlearning.net/tanzania-napa>. 23 Nov 2013
- United Republic of Tanzania (URT) (2008a) The economic survey 2007. The Ministry of Finance and Economic Affairs, Dar-es Salaam
- United Republic of Tanzania (URT) (2008b) Agriculture sector review and public expenditure review 2008/09. Ministry of Agriculture Food Security and Cooperatives, Dar Es Salaam
- Wilby RL, Charles SP, Zorita E, Timbal B, Whetton P, Mearns LO (2004) Guidelines for use of climate scenarios developed from statistical downscaling methods. Supporting material of the Intergovernmental Panel on Climate Change (IPCC), prepared on behalf of Task Group on Data and Scenario Support for Impacts and Climate Analysis (TGICA)

**Part IV**  
**Soil Nutrient and Water Management**  
**for Carbon Sequestration**

# Chapter 11

## Microdosing of Mineral Fertilizer and Conservation Agriculture for Sustainable Agricultural Intensification in Sub-Saharan Africa

Jens B. Aune and Adama Coulibaly

**Abstract** Microdosing of mineral fertilizer and conservation agriculture (CA) have been identified as promising approaches for sustainable agricultural intensification. Microdosing has been found to give a very good economic return for a small investment in fertilizer. Microdosing has created a demand for fertilizer in rural areas of Mali, and the local business community has responded by providing fertilizer in their shops. The agro-ecological advantages of microdosing are connected to adaption to climate change, highly efficient use of water, inhibition of the parasitic weed *Striga hermonthica* and earlier harvest. The possible problem that microdosing can lead to nutrient mining is exaggerated. The effect of CA on yield and soil properties is dependent on how it is practiced. Mulching has been identified as the key ecological component of CA, as it reduces soil surface temperature, improves water infiltration and helps control weeds. The major problem associated with mulching is the free roaming of animals in the dry season, which removes all the crop residues left on the soil surface. Grazing management must therefore go hand in hand with development of CA. It is concluded that microdosing and CA can be combined. Microdosing can give short-term benefits in terms of yield increase, while CA will build soil quality, which is of vital importance for the long-term sustainability of agricultural systems.

**Keywords** Precision farming • Striga • Fertilizer placement • Integrated plant nutrient management • Ard plow • Plant population density • Straw mulch • Basin tillage • Hoe cultivation

---

J.B. Aune (✉)

Department of International Environment and Development Studies, Norwegian University of Life Sciences, Ås, Norway  
e-mail: [jens.aune@nmbu.no](mailto:jens.aune@nmbu.no)

A. Coulibaly

Laboratoire Sol-Eau-Plantes, Institute d'Economie Rurale, Bamako, Mali  
e-mail: [adama\\_c@yahoo.fr](mailto:adama_c@yahoo.fr)

## 11.1 Introduction

Agriculture in Africa is still generally of a subsistence type, characterized by low yields, low use of inputs and corresponding high rates of nutrient mining. At the same time, there is an enormous potential to increase yields. There has been no lack of suggestions and initiatives as to how agricultural production might be increased. Suggested initiatives include alley cropping, and the use of *Tithonia diversifolia* and *Mucuna pruriens* for green manuring. These technologies were generally well documented in the scientific literature but failed to meet expectations when upscaled under real farming conditions. Key problems in the upscaling of alley cropping included lower farm cereal yields compared to those at research stations, high labor demand, low return on investment in the first years after planting and issues of security of land tenure (Carter 1995). The problem with upscaling the use of *Tithonia* was the poor availability of mulching material (Kamau 2007), whereas for *Mucuna* upscaling in Africa was limited by a lack of known uses for the *Mucuna* products (Versteeg et al. 1998).

Agricultural scientists are generally very quick to highlight success stories and opportunities, but they more seldom attempt to explain the reasons for failures. Researchers within social sciences gladly take on this task, resulting in well-written papers on the socio-economic causes for the failures, while the agronomic and ecological reasons are treated more superficially.

Current initiatives to increase productivity as defined by the Montpellier Panel Report (2013) include the microdosing of mineral fertilizer and conservation agriculture (CA). These initiatives are promoted as being low-cost and efficient ways to increase productivity. The benefits of these methods are comprehensively documented in the scientific literature, but this was also the case with the previous technologies mentioned. This paper discusses whether microdosing and conservation agriculture are likely to face the same destiny as previous technologies. Microdosing and CA are also subject to criticism. In the following, we discuss whether these approaches can possibly succeed under African farming conditions.

## 11.2 Microdosing and Sustainable Intensification

Microdosing can be described as the addition of small amounts of mineral fertilizer in the planting pocket/planting hill. The rates applied can vary from 0.3 g per pocket (Aune and Bationo 2008) to 6 g fertilizer per pocket (ICRISAT 2009). An application rate of 0.3 fertilizer per pocket corresponds to 3 kg fertilizer ha<sup>-1</sup> if there are 10,000 pockets ha<sup>-1</sup>.

Microdosing can be considered as a “low-hanging fruit” in agricultural intensification, as a small investment in fertilizer will give a high return. However, microdosing has been criticized on the basis that the return is too

low to make up for the cost of investing in fertilizer, and because it contributes to nutrient mining (<http://blogs.oxfam.org/es/node/5789>). There is ample evidence to refute the first claim. Microdosing is an economically attractive approach for farmers in the drylands of Africa, because productivity is increased at a low cost. Under dryland conditions, the value–cost ratio (VCR) should be greater than four in order to be economically attractive for farmers (Heerink 2005). A VCR of four implies that an investment of one money units will give four money units in return. Microdosing based on an application of 0.3 g fertilizer per planting hill has given a VCR well in excess of four in both Sudan and Mali (Aune et al. 2007; Aune and Ousman 2011). The VCR can be further increased if it is combined with seed priming, which consists of soaking millet and sorghum seeds for 8 h in water prior to sowing (Aune et al. 2012a, b; Aune and Ousman 2011). In on-farm experiments in Sudan, the VCR for sorghum and millet was 6.1 and 6.8 respectively for a treatment consisting of 0.3 g fertilizer per pocket and priming, compared to a control without fertilizer and seed priming (Aune and Ousman 2011). In the Mopti region of Mali a VCR of 32 was found with microdosing (0.3 g pocket) and seed priming in pearl millet. The gross margin could be doubled through the use of microdosing in Mali (Aune et al. 2012a). There is therefore ample evidence that this represents an economically attractive method for farmers. Previous recommendations based on broadcasting of fertilizer have not been taken up by farmers in the drylands of Africa, as such methods have a low VCR and involve high cash outlays. Farmers should start with forms of investment that provide the best possible return.

The criticism that microdosing can contribute to nutrient mining has more substance, but this effect may not necessarily be very strong. Microdosing trials in Mali and Sudan under dryland conditions showed that yield increases were typically of the order 100–400 kg ha<sup>-1</sup> (Aune et al. 2007; Aune and Ousman 2011). This is a very good response, given that only 0.3 g fertilizer is applied per planting hill. This rate corresponds to about 3 kg NPK fertilizer ha<sup>-1</sup> under a plant population density of 10,000 hills per hectare. The application of 3 kg NPK ha<sup>-1</sup> (17-17-17) corresponds to the application of 0.5 kg N and 0.5 kg P ha<sup>-1</sup>. A grain yield increase of 100 kg ha<sup>-1</sup> will remove about 2.4 kg N ha<sup>-1</sup> and 0.29 kg P ha<sup>-1</sup>, given that the grains have an average protein content of 15 % (Buerkert et al. 2001) and P concentration of 3.0 g kg<sup>-1</sup> (Muehlig-Versen et al. 2003). A typical grain yield increase of 200 kg ha<sup>-1</sup>, for example from 400 to 600 kg ha<sup>-1</sup>, will remove about 4.8 kg N ha and 0.58 kg P ha<sup>-1</sup>. Nevertheless, this removal rate is not alarming, as the phosphorous balance is close to zero. It is likely that the N removal is compensated by nitrogen fixation, since farmers typically intercrop millet with cowpea. Other mechanisms of nutrient loss, such as erosion, are low due to the sandy nature of the soils. The claim that microdosing will contribute to nutrient mining may seem exaggerated under these marginal conditions. It appears that up to a grain yield increase of 200 kg ha<sup>-1</sup>, the nutrient mining effect on phosphorus may not be significant. For Sudan, the optimum rate of NPK fertilizer was 0.6 g per pocket. This rate can make up for the phosphorous removal associated with a yield increase of 400 kg ha<sup>-1</sup>.

**Table 11.1** Positive and negative effects of microdosing

Positive effects of microdosing	Negative effects of microdosing
Increased yield at low cost	Limited quantities can be applied through microdosing: up to 1 g per pocket if seed is mixed with fertilizer
Highly efficient use of fertilizer	Nutrient mining if a small dose gives a high return
Earlier harvest	May increase labor demand if sowing and fertilizer application is undertaken in separate operations
Less risky than broadcasting of fertilizer	Depends on availability of mineral fertilizer
Can be mechanized	
Low-cost intensification	
Can stimulate the fertilizer market	
Less susceptible to parasitism by <i>Striga</i> species	
Possible entry point for agricultural intensification	

Microdosing also has some additional ecological merits (Table 11.1). The root biomass and straw production will both increase by approximately the same order as the grain yield. The root system contributes to the building of soil carbon, while the effect of increased straw production on soil organic carbon will depend on how the straw is used. The straw will either be grazed by cattle, used as a mulch or as building material. If the straw is grazed by cattle, the animals will spend longer time on the fields if the straw yields are higher, and thereby contribute to organic matter additions through defecation. There will be a particularly positive effect on soil quality if the increased straw production is used as a mulch. In a long term experiment (15 years) by ICRISAT in Niger, it was shown that soil organic carbon doubled by the annual addition of 4 ton mulch ha<sup>-1</sup> (Bationo and Buerkert 2001). Treatments with mineral fertilizer also contained more soil organic carbon than the control plot without fertilizer. In summary, it is likely that microdosing will add soil organic carbon, whereas the effect on soil organic carbon will depend on the use of the straw. These results show that it is possible to use mineral fertilizer strategically to increase soil organic carbon, but that this necessitates using the straw as a mulch.

Microdosing may also make the cropping system more resilient to climate change. Low quantities of phosphorous applied at rates similar to 0.3 g fertilizer per pocket were found to promote root development and stimulate early development of plants (Valluru et al. 2010). Improved root development is important to avoid early season drought and for more efficient use of water. Long-term experiments with fertilizer and mulching in Niger have shown that high yields can be achieved even in drought years if mulch is continuously applied (Bationo and Buerkert 2001); however, the production of sufficient mulch is dependent on the use of mineral fertilizer. Mulching reduces surface soil temperature and builds soil organic matter, thereby increasing the soil's water retention capacity. However, mulching in sub-Saharan Africa is difficult because free grazing is practiced. Mulching is not likely to succeed unless some form of controlled grazing is introduced. ICRISAT published the "hypothesis of hope" (Cooper

et al. 2009), which illustrates that, through appropriate agronomic interventions, it is possible to increase yield even as the climate gets harsher. Results from Niger show that fertilizer (preferably applied as microdosing) in combination with residue-management is important for building resilience to climate change. This conclusion is also in line with ICRISAT's "hypothesis of hope." One additional effect of microdosing, in relation to adaptation to climate change, is to produce an earlier harvest (Aune et al. 2007).

Microdosing can also alleviate problems associated with the parasitic weed *Striga hermonthica*. Sorghum plants growing in a low-nutrient soil will release strigolactones, which are signaling hormones that stimulate the germination of *S. hermonthica* (Jamil et al. 2012). Under field conditions in Mali, infection by *S. hermonthica* was reduced by 40–84 % when microdosing was applied (Jamil et al. 2012). Microdosing increased yield on *Striga*-infected land by 47–142 %. The effect here is that the improved nutrient status of the plant will contribute to less germination of *S. hermonthica*.

Microdosing contributes to a more efficient water use, which is a very important characteristic of a sustainable cropping system in the Sahel. Microdosing may be particularly useful because it kick-starts plant growth.

Supply of mineral fertilizer has been a serious constraint to the adoption of microdosing. However, in Mali it was observed that microdosing promoted the development of markets for mineral fertilizer even in smaller villages (Amponsah 2012). Microdosing created a local demand, and local shop owners responded by providing fertilizer through their outlets.

Mechanization of microdosing is under development in Mali (Fig. 11.1). This can ensure more uniform application rates and timelier sowing. There are more than a million sowing machines in Mali, and the disk in the sowing machine has been



Fig. 11.1 Microdosing can be mechanized in Mali

modified so that accurate quantities of fertilizer and seed are applied (Coulibaly et al. 2010). It has been shown in Mali that mechanization reduces the labour requirements for sowing by more than 90 % (Coulibaly et al. 2010). This is a very important benefit because very few days are available for sowing. Mechanization may greatly stimulate the use of microdosing because of its labor-saving advantages.

Microdosing in combination with seed priming has become popular in areas of Mali where it has been promoted. A study of uptake in three such districts showed that 68 % of farmers used microdosing while 51 % used microdosing (Amponsah 2012). The proportion of land under microdosing varied between the districts, from 6 to 41 %. The district with the least adoption was furthest from the fertilizer outlet, whereas the area with the highest adoption had a very good agronomic response to microdosing.

Microdosing can be considered as an entry point for agricultural intensification, as it is a method with good economic return and low risk for farmers (Aune et al. 2008). However, microdosing should be used in combination with seed priming and organic fertilizer such as manure.

### 11.3 Conservation Agriculture and Sustainable Intensification

Conservation Agriculture (CA) is another approach presented in the Montpellier Panel Report (2013) as a form of sustainable intensification. CA is based on the principles of minimum soil disturbance, permanent soil cover and crop diversification through intercropping or crop rotation (FAO 2013). If only the principle of minimum soil disturbance is practiced, it cannot be considered as a form of CA. CA is widely taken up in South America and in the USA (Derpich and Friedrich 2009). The advantages of CA are reduced soil erosion, increased soil water content, reduced soil surface temperatures and a reduction in consumption of fossil fuel by avoiding plowing (FAO 2013). However, in recent years CA has been criticized by Giller et al. (2009), who questioned the yield benefits in conservation agriculture, and raised concern with regard to the labor demand for weed control and the limited availability of mulching material and input. Giller et al. (2009) concluded that there is a need for further research to identify the ecological and socio-economic conditions under which CA may work. These critical comments on CA are not without substance, and this paper therefore presents results that give a more nuanced perspective of CA in sub-Saharan Africa. In the following, we will discuss the experiences from CA projects in Zambia, Malawi and Ethiopia.

The yield effects of CA vary according to how it is practiced. In Zambia, it has been observed that planting basins (30 cm long, 15 cm wide and 15–20 cm deep) can have a yield-increasing effect. Survey results have shown that yield increased from 1.8 ton ha<sup>-1</sup> in hoe cultivation to 5.2 tons ha<sup>-1</sup> in basin tillage. Experimental results confirm a yield-increasing effect of basin tillage (Umar et al. 2011). However, Umar et al. (2012) reported that the labor demand to prepare the basins (24 person days ha<sup>-1</sup>) is similar to that of general hoe cultivation (21 person days



ha<sup>-1</sup>). The major benefits of planting basins are water harvesting, and the effect that fertilizer is placed adjacent to the seeds, thereby increasing uptake of plant nutrients. The basins have a particularly marked increase on yields during dry years. Such basins have also been found to increase yield in Zimbabwe (Mazvimavi and Twomlow 2009). In Burkina Faso, the planting basins are called zais and are particularly used to rehabilitate degraded land (Sawadogo 2011). Another form of CA tillage in Zambia is ripping, which consist of opening a small furrow to a depth of 15–20 cm. However, in Zambia ripping was not found to increase yields compared to plowing (Umar et al. 2011). The advantage of this method is the speediness of the work, as it has a lower labor demand (0.8 person days ha<sup>-1</sup>) than plowing (3.8 labor days ha<sup>-1</sup>). Ripping is often combined with the use of herbicides to control weeds. Due to high grazing pressures, mulching is only practiced to a limited degree in Zambia.

In Malawi, there has been more emphasis on direct sowing. A planting stick is used to make a planting hole in the ground, into which seeds are placed. This method can be an alternative to the ridge-splitting method, which is the most common form of tillage in Malawi. Ridge-splitting is very laborious, and there is a clear reduction in labor use by introducing direct sowing (Ngwira et al. 2013). However, direct sowing alone does not increase productivity. In Malawi, it was found that the yield-increasing effect of CA only becomes apparent when direct sowing is combined with mulching and fertilizer. Fertilizer is necessary in order to produce sufficient mulch. Mulching has also reduced weed infestation in Malawi, and this effect is most likely due to the shading effect of the mulch. As in Zambia, it was found in Malawi that CA works particularly well under dry conditions (Ngwira et al. 2013). In Malawi, no reductions in yields was found following the introduction of CA, despite the effect that mulching introduces plant material with a high C/N ratio and might therefore immobilize nitrogen. Rather, under dry conditions there was a yield increase from the first year (Ngwira et al. 2013).

In Ethiopia, the traditional method of tillage employees an ard plow pulled by a pair of oxen (the *maresha*) (Aune et al. 2001). The ard does not turn the soil as does the moldboard plow, but loosens the soil and prepares a seed bed. From Ethiopia, it appears that minimum tillage can be an alternative to conventional tillage. As in Malawi, it has been observed that direct sowing without mulching will not give a positive yield effect (Sime 2014, unpublished paper). If CA is to work, it should give a positive yield effect in dry years as well as in humid areas. It has been observed in Zambia and Ethiopia that there has been a tendency for water logging in basins or in plots where zero tillage is combined with mulching (Aune et al. 2012b). However, this problem may only be apparent in the first years after changing to CA, because mulching may, in the long run, improve the infiltration capacity of the soil.

Studies on the yield effect of CA do not capture the effect that farmers may sow earlier as a result of CA, thereby reaping a yield benefit (Aune et al. 2012b). In areas where oxen plowing is the traditional tillage, farmers without oxen have to wait until the oxen owners have plowed their own land (Aune et al. 2001), and must therefore sow late with a resulting penalty on yield. By practicing direct sowing, it

will be possible to sow at the most appropriate time. Correct sowing time can, in many cases, have a stronger effect on yield than that of tillage. Renting oxen for land preparation is also expensive for farmers, and by practicing direct sowing this cost may be minimized. However, in Zambia it was observed that changing from hoe tillage to basins did not lead to earlier sowing (Aune et al. 2012b). Farmers were encouraged to prepare the basins in the dry season, but were reluctant to do so because at that time the soil is very hard and difficult to till. The labor demand in traditional hoe cultivation is also similar to that for basins (Umar et al. 2012). However, farmers practicing ripping, sow on average 10 days earlier than those practicing traditional plowing. The reason for this effect is probably the lower labor demand in ripping compared to traditional plowing.

Studies in Zambia reported no improvement in soil properties by changing from plowing to reduced tillage methods (Umar et al. 2011). In order to improve soil properties, it is important that crop residues are used as mulch. In Malawi, zero tillage in combination with mulching increased water infiltration and earthworm population in comparison with traditional tillage (Ngwira et al. 2013).

The importance of mulching was also shown in a long-term experiment in Niger. Mulched plots had consistently higher yield than non-mulched plots despite receiving the same amount of fertilizer (Bationo and Buerkert 2001). Even in years of low rainfall, the mulched plots produced a good yield.

Countries differ with regard to the ease of implementing mulching. In Malawi, the number of livestock is low and the cultivated areas smaller for each farmer, making it easier to practice mulching. CA with mulching is more challenging in Zambia and Ethiopia, as the livestock density is high in these countries. In the Sahel, mulching may be particularly difficult due to transhumance.

CA has not yet been fully embraced by farmers on the African continent. In Zambia and Malawi, there has been intensive promotion of CA, and in Zambia it was found that in project areas of the Conservation Farming Union about 71 % of farmers practiced CA. However, there is only a partial uptake of CA in Zambia, where only 26 % of the farmers' land was under CA while the rest was under conventional tillage (Aune et al. 2012b). For farmers practicing basins, land under basins is only 0.71 ha, while for farmers that have adopted ripping, the area under ripping was 1.21 ha. The average farm size is about 4 ha, which indicates that the major part of the land is still under traditional tillage. In Zambia, the amount of land under ripping has grown faster than that under basins. Ripping in combination with herbicides is expanding, as this method reduces labor demand. For farmers that previously utilized plowing, the practice of basin digging it is not an attractive solution; ripping is the feasible alternative for such farmers. However, limited access to rippers has constrained the uptake of ripping in Zambia. It is difficult to assess whether farmers in Zambia will continue to use CA in the long term, as there are other benefits that are associated with adhering to the CA project, such as improved access to seeds, fertilizer and extension services.

A survey in Malawi of areas where CA had been promoted showed that 18 % of farmers had adopted CA, and had allocated about 30 % of their land to CA (Ngwira et al. 2014). The area under CA has been gradually increasing since 2004. Lack of

information on CA is suggested to be the major reason for not adopting CA in Malawi (Ngwira et al. 2014).

Agricultural policies have also affected adoption of CA in the concerned countries; for example, both Zambia and Malawi have fertilizer subsidy programs. Subsidized fertilizer makes it easy for farmers to continue with their traditional system, because they always achieve some yield if they have access to fertilizer. On the other hand, as discussed previously, fertilizer is necessary in CA particularly for producing sufficient mulch. The increasing commercialization of agriculture may therefore favor CA, because inputs are needed if CA is to succeed.

It appears that many of the ecological benefits of CA are connected to the use of mulching, as it increases water infiltration, builds soil organic matter, promotes soil biological activity, and controls weeds. Free grazing of livestock in the dry season is the major obstacle to mulching. It is therefore strange that even in major programs on CA, such as that of the Conservation Farming Unit in Zambia, this aspect is ignored (Aune et al. 2012b). Livestock development should go hand in hand with CA development. There is a particular need to introduce stall feeding, controlled grazing systems and fodder production schemes.

## 11.4 Comparing Microdosing and Conservation Agriculture

It is difficult to predict whether these technologies will make a substantial contribution to sustainable intensification in Africa, because the uptake of a new technology is influenced by a range of factors. Fujisaka (1994) identified six reasons why farmers did not adopt innovations: (1) the innovation addresses the wrong problem or does not address the key problem; (2) the farmers' practice is equal to or better than the innovation; (3) the innovation does not work in practice, and creates other problems; (4) extension fails; (5) the innovation is too costly and the risk is too high; (6) social factors such as insecure land tenure and negative connotations associated with the technology. Agricultural policy may also have a strong bearing on adoption. Policy failure can be related to lack of awareness creation, limited economic incentives like credit and subsidies, limited infrastructure and markets and to unfavorable regulatory measures (Place and Dewees 1999). The problem is that all of these factors need to be favorable in order for a technology to be adopted. It does not help if the economic return on a technology is good, if it has negative social connotations. When assessing microdosing and CA against these criteria, it becomes clear that there are differences between technologies.

Microdosing has become popular in Mali because it does not require any major shift in the farming system, and because the method can be practiced without increasing the use of labor. Farmers also see the effect of microdosing in the first year. This is not always the case for the introduction of CA, particularly if mulch is not introduced. CA will require changes in equipment, the types of inputs and the

use of labor. CA will also not work unless farmers are properly trained in this method. To date, there is only partial uptake of CA. Farmers may have good reasons for this; for example, practicing both CA and traditional tillage methods reduces risks because CA may work well in a dry year whereas traditional tillage produces well in a humid year. By practicing both CA and traditional tillage, farmers spread the labor use over a longer period of time. CA is new to the African continent; it would therefore be surprising and highly risky if all farmers suddenly converted all of their land to practice CA. Few farmers have practiced CA for more than 10 years, and farmers need time in order to gain confidence in the technology. It is therefore not surprising that the adoption, so far, is limited.

## 11.5 Conclusion

Agricultural intensification can be described as climbing a ladder (Aune and Bationo 2008). Farmers should start with the lowest-cost technology and gradually move to more knowledge- and capital-intensive technologies as their resources increase. Agricultural intensification is, however, difficult in the drylands of West and East Africa, because it must take place under conditions characterized by a harsh climate, very poor farmers, limited infrastructure, weak extension systems and sometimes unfavorable agricultural policies. Farmers cannot afford to take risks under such conditions. New agricultural technologies must therefore be appropriate for the socio-economic conditions within which the farmers operate. Such new technologies may not necessarily be able to fulfill all the criteria for sustainable agricultural development.

It is possible to combine CA and microdosing. CA is important in order to build soil quality through its effect on soil organic matter, in which mulching can be particularly beneficial. Integrated plant nutrient management (IPNM) is important in order to produce sufficient mulch. Microdosing can be an important component of IPNM. Microdosing must be considered as one of the lowest-cost methods to increase biomass production under dryland conditions, and the VCR is generally very favorable. Microdosing will therefore provide short-term benefits while CA provides the longer-term benefits.

## References

- Amponsah E (2012) Farm households' adoption of ecofarm integrated agricultural technologies and potential economic effects on livelihoods in Segou, Mopti and Koulikoro regions of Mali. MSc thesis, Norwegian University of Life Sciences, 126 p
- Aune JB, Bationo A (2008) Agricultural intensification in the Sahel – the ladder approach. *Agric Syst* 98:119–125
- Aune JB, Ousman A (2011) Effect of seed priming and microdosing of fertilizers on sorghum and pearl millet in Western Sudan. *Exp Agric* 47:419–430

- Aune JB, Bussa MT, Asfaw FG, Ayele AA (2001) The ox-ploughing system in Ethiopia: can it be sustained. *Outlook Agric* 30:275–280
- Aune JB, Doumbia M, Berthe A (2007) Microfertilizing sorghum and pearl millet in Mali – agronomic, economic and social feasibility. *Outlook Agric* 36:199–203
- Aune JB, Traore CO, Mamadou S (2012a) Low-cost technologies for improved productivity of dryland farming in Mali. *Outlook Agric* 41:103–108
- Aune JB, Nyanga P, Johnsen FH (2012b) A monitoring and evaluation report of the Conservation Agriculture Project (CAP1) in Zambia. Noragric report no. 68, 34 p [Online]. Available from: <http://alturl.com/5av3w>. Accessed 10 Jan 2014
- Bationo A, Buerkert A (2001) Soil organic carbon management for sustainable land use in Sudano-Sahelian West Africa. *Nutr Cycl Agroecosyst* 61:131–142
- Buerkert A, Moser M, Kumar AK, Fürst P, Becker K (2001) Variation in grain quality of pearl millet from Sahelian West Africa. *Field Crop Res* 69:1–11
- Carter J (1995) Alley farming: have resource-poor farmers benefited? Natural resource perspectives no. 3. The Overseas Development Institute, London [Online]. Available from: <http://alturl.com/yiptd>. Accessed 10 Jan 2014
- Cooper P, Rao KC, Dimes J, Traore PS, Rao K, Dixit P, Twomlow SJ (2009) Farming with current and future climate risk: advancing a “hypothesis of hope” for rainfed agriculture in the semi-arid tropics. *SAT e-journal* 9 [Online]. Available from: <http://ejournal.icrisat.org/Volume7/Agroecosystems/AES701.pdf>. Accessed 10 Jan 2014
- Coulbaly A, Aune JB, Sissoko P (2010) Establishment of food crops in the Sahelian and Sudano-Sahelian region in Mali. Dryland Coordination Group Report no. 60 [Online]. Available from: <http://www.drylands-group.org/Articles/1933.html>. Accessed 10 Jan 2014
- Derpich R, Friedrich T (2009) Global overview of conservation agriculture adaptation. In: Lead papers. 4th World Congress on conservation agriculture, New Delhi, pp 429–438
- FAO (2013) Conservation agriculture [Online]. Available from: <http://www.fao.org/ag/ca/index.html>. Accessed 10 Jan 2014
- Fujisaka S (1994) Learning from six reasons why farmers do not adopt innovations intended to improve sustainability of upland agriculture. *Agric Syst* 46:409–425
- Giller KE, Witter E, Corbeels M, Tittonell P (2009) Conservation agriculture and smallholder farming in Africa: the heretics’ view. *Field Crop Res* 114:23–34
- Heerink H (2005) Soil fertility decline and economic policy reform in Sub-Saharan Africa. *Land Use Policy* 2:67–74
- ICRISAT (2009) Fertilizer microdosing. Boosting production on unproductive lands [Online]. Available from: <http://alturl.com/m2w75>. Accessed 10 Jan 2014
- Jamil M, van Mourik T, van Charnikhova T, Bouwmeester HJ (2012) Effect of diammonium phosphate application on strigolactone production and *Striga hermonthica* infection in three sorghum cultivars. *Weed Res* 53:121–130
- Kamau G (2007) Researching with farmers. A study of KARI participatory research practices in context. PhD thesis, Wageningen University, 272 p [Online]. Available from: <http://edepot.wur.nl/23841>. Accessed 10 Jan 2014
- Mazvimavi K, Twomlow S (2009) Socioeconomic and institutional factors influencing adoption of conservation farming by vulnerable households in Zimbabwe. *Agric Syst* 101:20–29
- Montpellier Panel Report (2013) Sustainable intensification: a new paradigm for African agriculture. Imperial College, London [Online]. Available from: <http://alturl.com/hxz4x>. Assessed 9 Sept 2014
- Muehlig-Versen B, Buerkert A, Bationo A, Roemheld V (2003) Phosphorous placement on acid arenosols of the West African Sahel. *Exp Agric* 39:307–325
- Ngwira AR, Thierfelder C, Lambert DM (2013) Conservation agriculture systems for Malawian smallholder farmers: long-term effects on crop productivity, profitability and soil quality. *Renew Agric Food Syst* 28:350–363
- Ngwira A, Johnsen FH, Aune JB, Mekuria M, Thierfelder C (2014) Adoption and extent of conservation agriculture practices among smallholder farmers in Malawi. *J Soil Water Conserv* 69:108–119

- Place F, Dewees P (1999) Policies and incentives for the adoption of improved fallows. *Agrofor Syst* 47:323–343
- Sawadogo H (2011) Using soil and water conservation techniques to rehabilitate degraded lands in northwestern Burkina Faso. *Int J Agric Sustain* 9:120–128
- Umar BW, Aune JB, Johnsen FH, Lungu OI (2011) Options for improving smallholder conservation agriculture in Zambia. *J Agric Sci* 3:50–62
- Umar BB, Aune JB, Johnsen FH, Lungu OI (2012) Are smallholder Zambian farmers economists? A dual-analysis of farmers' expenditure in conservation and conventional agriculture systems. *J Sustain Agric* 36:908–929
- Valluru R, Vadez V, Hash CT, Karanam P (2010) A minute P application contributes to a better establishment of pearl millet (*Pennisetum glaucum* (L.) R. Br.) seedling in P deficient soils. *Soil Use Manag* 26:36–43
- Versteeg MN, Amidji F, Etaka A, Gogan A, Koudokpon V (1998) Farmers' adoption of *Mucuna* fallowing and agroforestry technologies in the coastal savanna of Benin. *Agric Syst* 56:269–287

# Chapter 12

## Approaches to Reinforce Crop Productivity Under Rain-fed Conditions in Sub-humid Environments in Sub-Saharan Africa

Regis Chikowo, Shamie Zingore, Justice Nyamangara, Mateete Bekunda, Joseph Messina, and Sieglinde Snapp

**Abstract** Smallholder farming in much of Sub-Saharan Africa is rain-fed and thus exposed to rainfall variability. Among the climate variables, rainfall is projected to decline and have an overriding effect on crop productivity. With little opportunity for supplementary irrigation for the majority of farmers, a plausible strategy to maintain crop production under water-limited conditions includes balanced nutrient management for enhancing efficiency of use of limited soil water. Co-application of judicious rates of organic and mineral nutrient resources, particularly including the use of phosphorus (P) on P-limited soils, will facilitate development of an extensive crop rooting system for efficient exploration and capture of soil water, especially at a depth  $>0.8$  m. This chapter explores case studies across Eastern and Southern Africa where various soil water conservation and nutrient management

---

R. Chikowo (✉)

Plant Soil and Microbial Sciences Department, Michigan State University,  
East Lansing, MI 48824, USA

Crop Science Department, University of Zimbabwe, Box MP167, Harare, Zimbabwe  
e-mail: [regischikowo@yahoo.co.uk](mailto:regischikowo@yahoo.co.uk); [chikowor@msu.edu](mailto:chikowor@msu.edu)

S. Zingore

International Plant Nutrition Institute (IPNI), Africa Program, ICIPE Compound,  
Box 30772, Nairobi, Kenya

J. Nyamangara

International Crops Research Institute for the Semi-Arid Tropics (ICRISAT),  
P.O. Box 779, Bulawayo, Zimbabwe

M. Bekunda

International Institute of Tropical Agriculture (IITA), Arusha,  
P.O. Box 10, Duluti, Tanzania

J. Messina

Department of Geography, Michigan State University, East Lansing, MI 48824, USA

S. Snapp

Plant Soil and Microbial Sciences Department, Michigan State University,  
East Lansing, MI 48824, USA

approaches have been used to gain ‘extra miles’ with limited available soil water. Firstly, an approach is described that varies nitrogen (N) fertilizer application across growing seasons, by adjusting N application rates to match current season rainfall trends. The approach offers opportunities for farmers to increase crop productivity to  $>6 \text{ t ha}^{-1}$  in high agro-potential areas, compared to a ceiling of  $4.5 \text{ t ha}^{-1}$  for the fixed fertilization model, while minimizing economic losses due to investments in N fertilizer during drought years. Secondly, we deal with the subject of fertilization across nutrient gradients, where a poor agronomic N use efficiency of  $<18 \text{ kg grain kg}^{-1}$  of applied N is demonstrated for soils with  $<0.4 \%$  organic carbon, compared with  $>35 \text{ kg grain kg}^{-1}$  of N applied when soil organic carbon  $>0.5 \%$ . Thirdly, the conservation agriculture (CA)-nutrient management nexus is examined, where maize yields in farmers’ fields with CA alone were barely  $0.5 \text{ t ha}^{-1}$  compared to an average of  $2.5 \text{ t ha}^{-1}$  for CA combined with fertilizers. Fourthly, a novel system that involves intercropping two legumes with contrasting phenology for enhanced cropping system functioning is described. Finally, an approach that can be used for co-learning with farmers on soil fertility management principles for risk management is presented. The data lead to the conclusion that the ‘doubled-up’ legumes system results in reduced fertilizer requirements for cereal crops grown in sequence, which benefits yield stability over time. Variable use of N fertilizer according to season quality and more tailored targeting of nutrients are vital for profitable investments in fertilizers in Africa. The Africa RISING project in Eastern and Southern Africa is currently harnessing some of these principles as vehicles for intensification of smallholder farming systems.

**Keywords** Droughts • Nutrient use efficiency • Soil nutrients • Water productivity • Maize

## 12.1 Introduction

Poor agricultural productivity in much of Sub-Saharan Africa (SSA) is widely linked to soils that are inherently nutrient deficient, particularly for nitrogen (N) and phosphorus (P), and unreliable rainfall characterized by both droughts and flooding conditions (Mazvimavi 2010; IPCC 2007). Compared to other parts of the world where agricultural green revolutions have been stimulated by mechanization and high fertilizer use, SSA soil nutrient balances remain largely negative (Smaling et al. 1997). The capture and utilization of nutrients by crops has been poor, albeit applied in small doses, largely due to nutrient imbalances (Kho 2000).

Efficient nutrient recovery by crops is a function of a multitude of factors—ideally in a balanced state (Janssen 1998). Nitrogen fertilizers are easily lost through leaching in light textured soils during periods of high rainfall when residence times are short (Cadisch et al. 2004; Chikowo et al. 2004). Under water stress, movement of nutrients from the soil to the plant is curtailed such that any applied fertilizers are not used efficiently. Conversely, P availability is often acutely restricted by iron and aluminum oxides, which is common in highly weathered and





**Photo 12.1** Severe nutrient deficiencies on maize plants on a sandy soil, Murehwa district, Zimbabwe

acidic tropical soils (e.g., Vanlauwe et al. 2002; Sanchez et al. 1997). These are among the difficult scenarios that resource-constrained smallholder farmers in SSA must grapple with in their production systems.

Short-range spatial variability in soils commonly exists within and among farms due to localized differences in parent material and/or management (Tittonell et al. 2005; Mtambanengwe and Mapfumo 2005), with major implications for water and nutrient use efficiency. In most cases, fields that are poor in N and/or P will yield poor returns even when these nutrients are amply supplied through fertilizers, as nutrients other than N and P may limit production (Janssen 1998; Wopereis et al. 2006; Zingore et al. 2007). Therefore, any fertilization strategy that seeks to optimize resource use efficiencies by crops must recognize the important role of the inherent and distinct capacity of different soils to supply nutrients to the crops (Photos 12.1 and 12.2). In the face of limited external resources, the question of how to efficiently target the available nutrients on the farms in a continuum of conditions becomes critical (Giller et al. 2006).

A key objective of this chapter is to present nutrient management options in SSA agriculture and the associated nutrient use efficiencies—a vital step for identifying cropping systems or system components that offer opportunities for crop intensification under water-limited conditions. The performance of cropping systems in the different regions of SSA is illustrated using case studies for five pathways for crop production intensification and climatic risk management:

- I. Rainfall-responsive fertilization strategies
- II. Fertilization of spatially heterogeneous farms and nutrient use efficiencies
- III. Conservation agriculture and intensification



**Photo 12.2** Unfertilized (foreground), and fertilized (background) maize on a sandy soil, Murehwa district, Zimbabwe

- IV. Integration of double-up legumes—does that lead to more stable yields?
- V. Co-learning nutrient and risk management options with farmers

## **12.2 Approaches for Enhancing Crop Productivity on Smallholder Farms in SSA**

### ***12.2.1 A Flexible N Fertilization Strategy Responsive to Rainfall Season Quality***

The erratic and uneven distribution of rainfall makes use of fertilizers by smallholder farmers very risky. Farmers may be reluctant to apply full rates of fertilizers in good rainfall seasons because of the risk of crop failure, and they may apply more fertilizer than is justified by crop returns in drought years (Photo 12.3).

Nutrients such as P and K are usually applied 100 % at planting while N is partially applied at planting, and the remainder is applied as top-dressing. Most N top-dressing recommendations given to farmers are rigid and do not recognize the importance of soil–water interactions regarding N fertilizer use efficiency. Therefore, practical methods of applying proportioned doses of fertilizer dependent on the prevailing rainfall are required to optimize fertilizer use efficiency. To manage variable rainfall environments, Piha (1993) devised and successfully tested a flexible system of fertilization, in which theoretically optimum rates of the nutrients P, K, and S are applied based on yield potential in an average rainfall season, while nitrogen is applied as a series of portioned applications, adjusted



**Photo 12.3** Dry spells on soils with low water holding capacity is a major problem even for hardy sorghum, Wedza district, Zimbabwe. Such conditions reduce fertilizer use efficiency

during the season according to the degree of water stress observed. This system optimizes resource use efficiency during good rainfall seasons, while ensuring minimum wastage in case of drought due to the reduced fertilizer inputs. Piha (1993) compared two nutrient management strategies that involved either:

- I. A fixed N application rate for specific agro-ecologies, in line with recommendations normally given to farmers by the extension system, or
- II. Rainfall-varied N top-dressing that was a function of general agro-ecology as well as current rainfall season quality.

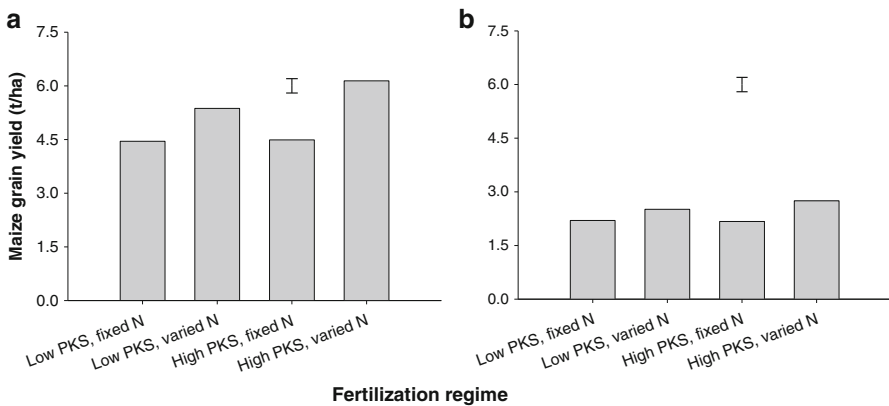
For both systems, maize was supplied with a low dose of N at planting, in the form of compound fertilizers that also contained P, K, and S. The fixed-N treatments received additional N as ammonium nitrate, in three equal portions at 4, 6 and 8 weeks after emergence to result in 50 kg N ha<sup>-1</sup> and 92 kg N ha<sup>-1</sup>, for high and low agro-potential areas, respectively. The rainfall-varied treatments received variable amounts of ammonium nitrate on the same dates (0, 17, 34 or 50 kg N ha<sup>-1</sup> for a high agro-potential area, or 0, 17, or 34 kg N ha<sup>-1</sup> for a low agro-potential area), resulting in variable top-dressing N being applied at 0–100 kg N ha<sup>-1</sup> for low potential areas and 0–150 kg N ha<sup>-1</sup> for high potential areas, respectively (Table 12.1).

This flexible system of fertilization, in which optimum rates of P, K, and S fertilizers are basally applied based on yield potential in an average rainfall season, while N is applied as a series of portioned applications and adjusted according to the evolving rainfall pattern in any one season, results in more efficient maize production (Fig. 12.1). Trials over a 5-year period on farmers' fields resulted in 25–42 % greater yield and 21–41 % more profit than a model based on existing fertilizer recommendations (Piha 1993). These results are significant in that they confirm that

**Table 12.1** Fertilizer rates (kg ha<sup>-1</sup>) used in maize field trials to evaluate a flexible system of N top dressing management in Zimbabwe

	Pre-planting				Top-dressing N
	N	P	K	S	
<i>High potential areas</i>					
Currently recommended rates	24	18	18	18	68
Theoretically optimum rates	24	26	26	26	0–150 <sup>a</sup>
<i>Low potential areas</i>					
Currently recommended rates	16	12	12	12	34
Theoretically optimum rates	16	17	17	17	0–150 <sup>a</sup>

<sup>a</sup>Variable N top dressing (see text for explanations)



**Fig. 12.1** Effects of N, P, K, and S application strategy on maize productivity for (a) a high agro-potential site and (b) a low agro-potential site in central Zimbabwe (synthesized based on data from Piha 1993). Vertical bars represent LSD

productive and profitable agriculture is possible on poor soils, and in semi-arid conditions, with the judicious use of inorganic fertilizers when strategically correct timing and quantities are followed. The fertilization strategy optimizes N use efficiency during good rainfall seasons, while ensuring minimum losses in case of drought as further N top-dressings are withheld under sub-optimal soil moisture.

### 12.2.2 Fertilization of Spatially Heterogeneous Farms and Nutrient Use Efficiencies

Many smallholder farms are known to be spatially heterogeneous in terms of soil quality; therefore, response to applied nutrients varies considerably across fields (Prudencio 1993; Manlay et al. 2002; Masvaya et al. 2010). However, fertilizer

recommendations currently accessed by smallholder farmers rarely reflect these circumstances and are based on an assumption of soil resource base homogeneity. For example, in Zimbabwe, fertilizer recommendations are linked to agro-ecological zones that are principally delineated based on rainfall, despite the short-range, wide variability known to exist in soils within the agro-ecological zones (Ncube et al. 2007; Zingore et al. 2007). Differences in nutrient resource management by farmers, which is usually a function of resource endowment and preferential application of nutrient inputs to fields close to the homesteads, has often accentuated variability in soil fertility, creating gradients of fertility across fields and farms (Mtambanengwe and Mapfumo 2005; Zingore et al. 2007; Tittone et al. 2013). Short range spatial variability in soils also exists within and across farms due to the inherent properties of soils. This spatial variability in soils on smallholder farming systems has largely been trivialized when designing technological interventions, yet it is widely asserted that variability of soil fertility within farms poses a major challenge for efficient use of resources for increased crop productivity (Wopereis et al. 2006; Zingore et al. 2007). Explicitly recognizing that farmers deal with a variable soil resource base is important for the formulation of nutrient management strategies that enhance efficient use of nutrient resources on farms (Janssen et al. 1990). Considering that fertilizer resources are scarce, it is critical that fertilization regimes be tailored to the biophysical environments and socio-economic status of farmers to optimize use efficiency. When robust soil fertility indicators are known, it is possible to use them to tailor fertilizer application strategies for different circumstances, allowing an informed approach that leads to improved farm system functioning (Janssen et al. 1990; Zingore et al. 2011; Nandwa 2001). In this study, soil organic carbon (SOC) is proposed to be a robust indicator for soil fertility status that can potentially be used to predict resource use efficiencies under a range of management regimes.

In order to better understand the influence of SOC on nutrient use efficiencies on granitic sands, 120 smallholder farms in Wedza district, Eastern Zimbabwe, were first surveyed for SOC content, resulting in categorization that recognized three distinct field types (domains):

- I. Field Type 1: fields with  $\leq 0.4$  % SOC—fields that have been poorly managed and have a history of poor yields
- II. Field Type 2: fields with  $>0.4$ – $0.6$  % SOC—fields that have received organic amendments intermittently
- III. Field Type 3: fields with  $>0.6$  % SOC—a small proportion of fields that have a history of good management, including use of organic manures and mineral fertilizers, with clay content generally  $>15$  %

Within each of the three Field Types (domains), field sites were identified for experimentation during two consecutive cropping seasons. All sites were strategically located within a 2 km radius to eliminate possible confounding effects due to differences in rainfall, because spatial variability in rainfall is known to be high (Table 12.2). The experimental treatments were formulated using widely available fertilizer resources as follows:

**Table 12.2** Physical and chemical characteristics of soils (0–20 cm) at establishment of field experiments in Eastern Zimbabwe

Site	Sand (%)	Clay (%)	SOC (%)	Available P (mg kg <sup>-1</sup> )	Soil pH (H <sub>2</sub> O)	Total N (%)	Ca	Mg	K
							cmol <sub>(+)</sub> kg <sup>-1</sup>		
Field type 1 ( $\leq 0.4$ % C)									
Chingwa	94	4	0.35	3.3	4.4	0.03	6.2	5.1	0.15
Muriva	94	5	0.40	5.5	5.0	0.03	7.1	6.3	0.23
Field type 2 ( $>0.4$ – $0.6$ % C)									
Makoni	94	4	0.46	5.1	4.9	0.05	12.2	4.2	0.42
Chinhengo	80	10	0.54	7.3	4.9	0.04	7.3	4.4	0.43
Field type 3 ( $>0.6$ % C)									
Mapiye	84	10	0.73	7.4	5.4	0.05	8.3	5.1	0.52
Muhwati	65	19	0.89	10.5	5.2	0.06	7.5	5.3	0.48

- (i) Control (no nutrients added)
- (ii) NK (muriate of potash and ammonium nitrate)
- (iii) NPS (single super phosphate + ammonium nitrate)
- (iv) PKS (single super phosphate + muriate of potash), and
- (v) NPKS (compound fertilizer + ammonium nitrate)

Across all sites, the target nutrient application rates for Year 1 were 40 kg ha<sup>-1</sup> P, 60 kg ha<sup>-1</sup> K, and 120 kg ha<sup>-1</sup> N. During Year 2, the target N application rate was maintained while only 20 kg P and 30 kg K were re-applied. Practically, N application was deemed a function of rainfall, with a mandatory initial application of 20 kg ha<sup>-1</sup> N at planting and two subsequent applications of 50 kg ha<sup>-1</sup> N, if soil moisture permitted. With this rule, only 70 kg ha<sup>-1</sup> was applied for both seasons, due to terminal season droughts that necessitated withholding the second N top dressing application of 50 kg ha<sup>-1</sup>. High nutrient application rates for P and K were used, compared with prevalent rates commonly used by farmers, to enable determination of attainable yields for the three soil fertility domains when all other variables were maintained the same, including rainfall. All the P, K, and S were applied at planting, as compound fertilizer, single super phosphate, or muriate of potash (KCl) fertilizer.

These experiments showed that N, P, and K agronomic use efficiencies were primarily influenced by treatment and SOC levels (Table 12.3A). Fertilization with NPKS and NPS produced the highest N agronomic efficiency (AE<sub>N</sub>) across sites, ranging from 16 to 37.8 kg grain kg<sup>-1</sup> N, whereas the NK treatment had an AE<sub>N</sub> range of 1.7–20 kg grain kg<sup>-1</sup> N applied across all sites. Agronomic efficiencies were always lowest for the Field Type 1 domain while AE<sub>N</sub> were larger but not significantly different between Field Types 2 and 3. The AE<sub>P</sub> for the NPS and NPKS treatments were also comparable for Field Types 2 and 3, ranging between 28 and 67 kg grain kg<sup>-1</sup> P for the NPS and NPKS treatments, compared to a paltry 0.5–14 kg grain kg<sup>-1</sup> P applied for the PKS treatment. Application of K had a very small impact on yield across all the field types with the largest AE<sub>K</sub> < 1 kg grain kg<sup>-1</sup> K applied (data not shown). Recovery efficiencies (RE) followed the same

**Table 12.3** Nitrogen and P agronomic efficiencies [A] and N and P recovery efficiencies [B] as influenced by nutrient management and soil resource base (site) in Dendenyore, Wedza district, Zimbabwe

[A]							
Site	Site % C	AE <sub>N</sub>			AE <sub>P</sub>		
		NK	NPS	NPKS	NPS	PKS	NPKS
		kg grain kg <sup>-1</sup> N applied			kg grain kg <sup>-1</sup> P applied		
Chingwa	0.35	1.7	16.0	17.0	28.0	0.5	29.3
Muriva	0.40	13.7	22.5	26.7	39.5	2.3	41.2
Makoni	0.46	10.3	27.0	31.2	47.5	7.5	50.4
Chinengo	0.54	20.0	32.0	34.8	56.0	2.2	56.3
Mapiye	0.73	17.7	35.8	36.4	62.7	8.7	64.1
Muhwati	0.89	18.5	37.1	37.8	65.0	14.0	67.0
LSD	NA		3.2			5.4	

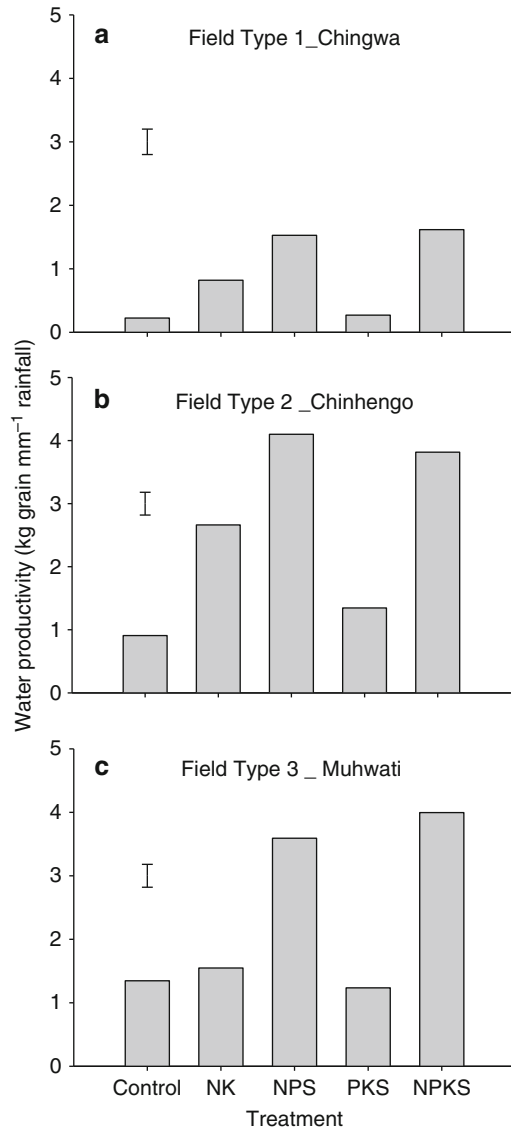
  

[B]							
Site	Site % C	RE <sub>N</sub>			RE <sub>P</sub>		
		NK	NPS	NPKS	NPS	PKS	NPKS
		Fraction N uptake (kg kg <sup>-1</sup> )			Fraction P uptake (kg kg <sup>-1</sup> )		
Chingwa	0.35	0.04	0.31	0.37	0.17	0.18	0.20
Muriva	0.40	0.32	0.47	0.60	0.25	0.10	0.27
Makoni	0.46	0.19	0.61	0.66	0.33	0.02	0.32
Chinhengo	0.54	0.40	0.67	0.73	0.32	0.01	0.33
Mapiye	0.73	0.14	0.75	0.77	0.26	0.03	0.27
Muhwati	0.89	0.44	0.83	0.84	0.30	0.08	0.31
LSD	NA		0.11			0.04	

trend, with a low RE<sub>N</sub> for Field Type 1 compared to Field Types 2 and 3 (Table 12.3B). In many cases, RE<sub>N</sub> at least doubled when P was co-applied. In one case, the RE<sub>P</sub> was as little as 1 % for the PKS treatment, increasing remarkably to 30 % when both N and P were applied. Again, the RE<sub>K</sub> were insignificant across all sites, and these results are not reported.

Yields for both NK and PKS treatments were poor across sites as indicated by low water productivity values for the three fields representing the three Field Types (Fig. 12.2), confirming these macronutrients as the most critical. In many cases, no differences existed in yields between the control and the PKS treatment, despite relatively high application rates of 40 kg ha<sup>-1</sup> P and 60 kg ha<sup>-1</sup> K. Yield response was only realized when N was added. These results represent a classic example of the law of the most limiting nutrient and crop growth and the indispensable need for balanced nutrient application. This is comparable to results from West Africa, where significant improvements in RE<sub>N</sub> were observed upon simultaneous application of N and P (Fofana et al. 2005). Often, smallholder farmers have managed to sustain low maize production levels by managing soil fertility through application of a combination of small quantities of livestock manure, compost and spreading nutrient-rich soils from anthills around the crop fields. Although the concentration

**Fig. 12.2** Water productivity (kg grain  $\text{mm}^{-1}$  rainfall) as influenced by nutrient management across three experimental sites belonging to different soil fertility domains, Dendenyore ward, Hwedza, Zimbabwe. *Bars* indicate least significant differences, LSDs between means



of nutrients in these resources is low, the few macro- and micronutrients that become available avert acute nutrient deficiencies, making production of base yields possible.

Response to fertilizers is a function of the current state of soil fertility, with acutely degraded fields responding poorly to nutrient additions (Kho 2000; Tittone et al. 2005; Zingore et al. 2007). The long-term lack of adequate mineral and organic nutrient resources has led to the expansion of fields that fall under Field Type 1, as farmers preferentially allocate the limited nutrient resources to a few

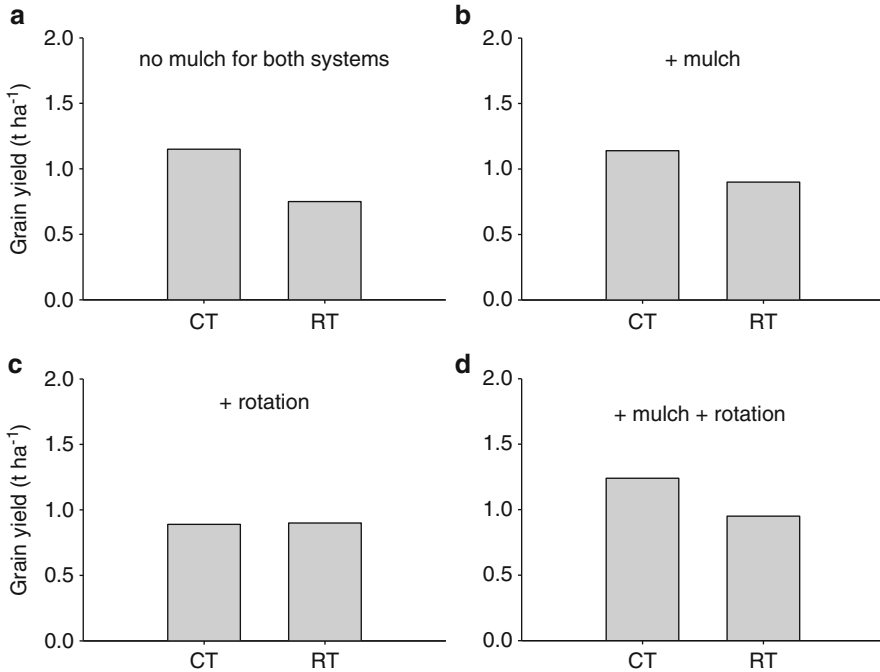


specific fields. The neglected fields are then cropped without any external nutrient inputs, gradually becoming exhausted of nutrients and concomitantly becoming acidic. Resuscitating these fields to profitable crop production becomes a challenge as they characteristically respond poorly to fertilizers when they become available. Giller et al. (2006) suggested that other nutrients critical to maize growth should be applied to enable greater responsiveness to N and P. Studies have shown that for degraded soils with poor response to fertilizer the process of soil rehabilitation can be kick-started with additions of livestock manure (Zingore et al. 2007). The feasibility of such interventions is, however, doubtful due to the resource constraints faced by smallholder farmers.

### ***12.2.3 Conservation Agriculture and Intensification***

Conservation agriculture (CA) has been widely promoted in SSA as a possible solution to control soil erosion and degradation in smallholder arable fields (Bayala et al. 2012; Haggblade and Tembo 2003; Marongwe et al. 2011; Umar et al. 2011), which is largely attributed to conventional tillage using the mouldboard plough. Conservation agriculture as defined by the Food and Agriculture Organization (FAO) consists of three principles: (i) minimal soil disturbance, (ii) maintenance of at least 30 % permanent organic mulch on the soil surface, and (iii) a diversified cropping system. Reduced tillage (RT) is by far the principle adopted by the largest number of smallholder farmers and practices range from hand-hoe dug planting basins to planting furrows opened using ox-drawn or tractor-drawn rippers (Nyamangara et al. 2013). The maintenance of at least 30 % permanent organic mulch on the soil surface is the least adopted principle, due to a combination of low crop yields (less than 1 t/ha) and competing claims to residue use on the farms, primarily for livestock feed during the dry season when grazing is limited and of poor quality (Giller et al. 2009).

Conservation agriculture has had dramatic effects in terms of reducing soil erosion and runoff but has been inconsistent in terms of increasing crop productivity largely due to inherent or declining soil fertility. Ndhlovu et al. (2013) reported 39 % more maize grain yield under conservation agriculture compared to conventional tillage in Zimbabwe, but noted that high labor and fertilizer demands in conservation agriculture present problems in adoption amongst resource-constrained farmers. In a compilation of 23 reports, Wall et al. (2013) reported >10 % higher crop yields under conservation agriculture compared with conventional tillage, but the role of fertilization was not clearly defined. Giller et al. (2009) noted that the empirical evidence is not clear and is inconsistent regarding the contribution of conservation agriculture to yield gains compared with conventional tillage. Nyagumbo (1999) reported that the performance of conservation agriculture relative to existing technologies is highly variable and dependent on site and farmer characteristics.



**Fig. 12.3** Maize grain yield under conventional tillage (CT) and reduced tillage (RT) during the 2011/2012 cropping season on a sandy soil at the Matopos Research Station, Zimbabwe. Bars present standard errors of the difference of the means

An experiment at the Matopos Research Station in a semi-arid part of Zimbabwe demonstrated that maize grain yields were significantly lower under reduced tillage only (RT), RT + mulch, and RT + mulch + rotation (all three CA principles) compared with conventional tillage (CT), but yields were similar between RT + rotation (no mulch) and CT (Fig. 12.3). Mineral fertilizer was applied to both RT and CT treatments. The studies appear to indicate the need to target conservation agriculture promotion according to access to nutrient resources, crop type, soil type and rainfall amount and distribution. It is also clear that benefits from reduced tillage will not be realized in the short term.

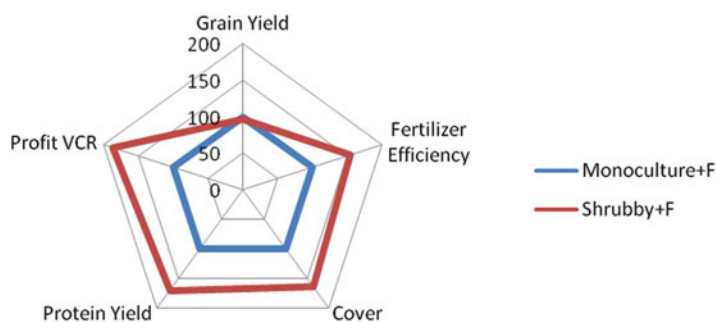
Appropriate use of fertilizer has been suggested as the fourth principle of conservation agriculture in SSA in order to increase the likelihood of benefits for smallholder farmers (Vanlauwe et al. 2014). On-farm survey results from Zimbabwe across several farms strongly suggest that appropriate fertilization is critical for benefits of conservation agriculture to be realized in soils that are already poor (Table 12.4). A meta-analysis of major long term conservation agriculture trials conducted worldwide indicated that grain yield was positive when mineral N fertilizer was applied at rates greater than 100 kg N ha<sup>-1</sup> (Rusinamhodzi et al. 2011). The performance of conservation agriculture under semi-arid conditions is enhanced by the addition of small amounts of N fertilizer and cattle

**Table 12.4** Effect of mineral fertilizer application on the yield of maize (kg ha<sup>-1</sup>) on 92 farms for maize monocropping and 65 farms for maize-legume rotation under CA in smallholder areas across semi-arid and sub-humid conditions in Zimbabwe

Fertilizer use	Maize monocrop (N = 92)	Maize-legume rotation (N = 65)
No fertilizer	520 ± 133	450 ± 61
N fertilizer (top-dressing)	1,760 ± 247	2,420 ± 493
NPKS fertilizer (basal and top-dressing)	2,560 ± 160	3,310 ± 482

Adapted from Nyamangara et al. (2013)

N number of farms



**Fig. 12.4** Doubled-up shrubby legumes offer multiple services in cropping systems as compared to monoculture practices, + F = with fertilizer (Modified from Snapp et al. 2010)

manure—the micro-dosing principle. These studies illustrate the pivotal role of optimal application of nutrients in enhancing crop yield under conservation agriculture as opposed to interpreting conservation agriculture as a silver bullet on its own.

### 12.2.4 Intercropping Legumes: The Doubled-Up Cropping System

Growing two or more crops simultaneously in the same space—known as inter-cropping—is a strategy employed to maximize beneficial interactions while minimizing competition. Where inter-specific competition for resources (nutrients, light, water) is minimal due to the companion crops occupying different ecological niches and thus growing in a complementary manner, intercropping is known to increase biodiversity, stability, and financial diversification on farms (Snapp et al. 2010; Fig. 12.4). The doubled-up legume cropping arrangement involves

intercropping two legume crops that have complementary plant architecture, and additional desirable traits such as different maturity dates. For example, groundnut and pigeonpea are ideal ‘doubled-up’ companion legume crops because groundnut can be grown as a shallow-rooted understory crop intercropped with pigeonpea (*Cajanus cajan L.*) Pigeonpea has a very slow early growth rate, developing into a bushy architecture when groundnut would be maturing. Thus, most of the resources (nutrients, water, light) used by pigeonpea during its late vegetative and reproductive phases are under conditions of ‘sole’ cropping. Pigeonpea develops a deep rooting system that facilitates capture of leached nutrients or soil moisture at depth at the end of the rainfall season. The resultant large leafy biomass eventually forms a layer of high quality litter on the soil surface—an important nutrient cycling pathway that stabilizes the yields of cereal crops grown in sequence even at reduced fertilizer use. This ‘doubled-up’ legume system ensures double benefits in form of improved soil fertility and grain harvests for two legume crops. Work with this system has consistently demonstrated superior land productivity compared to rotational systems.

### ***12.2.5 Co-learning Nutrient and Risk Management Options with Farmers***

Smallholder farmers in SSA have developed low risk farming management practices in an effort to ensure that their subsistence food needs are met. However, farmers’ practices are largely sub-optimal even under favourable climatic conditions, because they are faced with multiple biophysical and socio-economic stresses that are now exacerbated by increased rainfall variability. Evidence from empirical research indicates that it is possible for farmers to increase maize yields from the current  $<1 \text{ t ha}^{-1}$  to  $>3 \text{ t ha}^{-1}$  if appropriate technologies are adopted and rainfall is adequate. Recognizing that sustainable solutions should be embedded within the communities, it is hypothesized that vulnerability to food shortages could be partly addressed if a significant proportion of farmers in maize-based farming systems strategically tailored their practices. Among other elements, such practices should employ drought tolerant maize varieties, appropriate responses to rainfall season typologies by timely planting, and integrated soil fertility management (ISFM) to ensure production of high yields in favorable seasons and revert in future bad seasons to the surplus generated. Here, we present a co-learning approach that involves working with farmer groups and implementing adaptive field experiments anchored on the three essential components of ISFM: (1) use of mineral fertilizers (Photo 12.4) (2) use of locally available organic nutrient resources, and (3) use of improved maize germplasm. The approach is a knowledge-based empowerment process that aims to tailor crop production practices to each community and is closely related to farmer resource-endowment circumstances.



**Photo 12.4** Timely access to fertilizers is a key adaptation strategy for producing high crop yields during good rainfall seasons

A 3-year study was conducted with six smallholder farming communities in Eastern Zimbabwe to develop crop production strategies that ensure high agronomic efficiency and concurrently respond to the emerging challenges of increased climate variability. Agronomic practices were designed to provide answers to problems related to three rainfall season typologies that were readily identified by farmers:

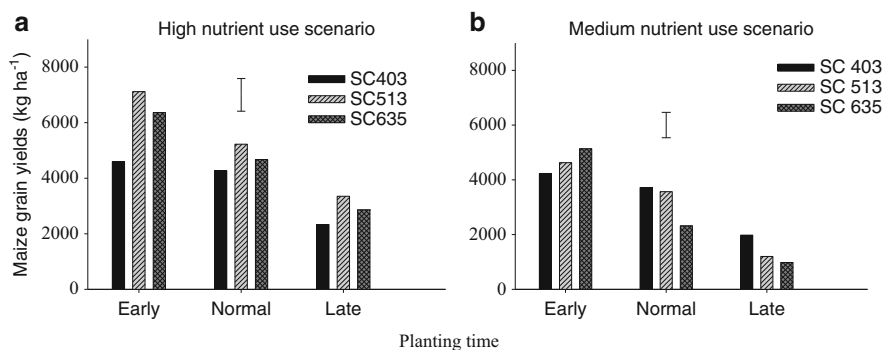
- I. Cropping seasons that are associated with crop yield losses due to delayed planting (late start of the rainfall season),
- II. Cropping seasons that experience excessive rains early in the season followed by drought, resulting in poor yields for early planted crops, and
- III. Cropping seasons with marked within-season dry spells, with prevailing conditions during the sensitive vegetative stages having the overriding effect on crop productivity.

Farmers prioritized combining inorganic fertilizers and locally available organic resources to improve soil productivity and 'trying out' different maize varieties and staggered planting dates for maize as options to increase maize productivity and simultaneously spread risk. Farmers in different resource endowment categories indicated their preferred rates of fertilizers and organic resources which best suited circumstances, a form of 'best fit—best bet' hybridization (Table 12.5; Mtambanengwe and Mapfumo 2005). Heterogeneity of farming households is an inherent component of smallholder communities, calling for better targeting of technologies, as farmers have different capacities to invest in soil fertility replenishment or maintenance (Giller et al. 2011). Staggered planting of each of three

**Table 12.5** Soil fertility management options targeted by different farmer resource groups during participatory field experimentation with farming communities in Eastern Zimbabwe

Fertilization rates and options	Farmer resource group <sup>a</sup>		
	RG1	RG2	RG3
Basal compound fertilizer (kg ha <sup>-1</sup> P)	26	21	14
Nitrogen fertilizer (kg ha <sup>-1</sup> N)	120	70	35
Cattle manure (t ha <sup>-1</sup> )	10	6	3
Woodland litter/compost (t ha <sup>-1</sup> )	Optional	3	2

<sup>a</sup>RG1 resource endowed farmers, RG2 intermediate resource group, RG3 resource constrained farmers



**Fig. 12.5** Mean maize grain yields across experimental sites with early, normal, and late planting of three maize varieties at (a) high nutrient use levels corresponding to resource endowed farmers, RG1 and (b) when medium nutrient application rates were used corresponding to intermediate farmer resource group RG 2. Vertical lines are LSDs

maize varieties was agreed upon as a viable strategy to spread and manage climate-related risk. During community workshops, farmers collectively defined planting windows as (i) early planting—before and up to 25 November, (ii) normal planting—26 November to 15 December, and (iii) late planting—16 December to 31 December. Planting beyond year-end was considered too late for maize in Southern Africa because the rainfall normally tails-off by mid April, making this too risky for maize varieties that require 4 months of development to physiological maturity. Actual planting dates depended on soil moisture availability within each of the planting windows, but successive planting events were at least 2 weeks apart.

The study revealed substantial variability in performance of maize varieties across seasons and sites due to excessive rains or prolonged dry spells experienced during the experimentation period. However, it is clear that use of combinations of locally available organic nutrient resources and external fertilizers provided an opportunity to produce yields ranging from 3 to 7 t ha<sup>-1</sup> when planting was completed during the early and normal planting windows (Fig. 12.5). Late planting was associated with large yield penalties, irrespective of the rate of nutrient application. Despite the increased climate variability, the analyses indicated that

it is feasible to stabilize food availability in a community if ISFM components are employed to increase production of food crops, especially during favorable seasons, creating safety-nets that buffer communities against future bad seasons. Development of crop and soil fertility management options based on rainfall season typologies identified by farmers is one of the strategies that could enhance the capacity of smallholders to increase crop productivity and ensure food self-sufficiency against a changing climate.

## 12.3 Conclusions

Cropping systems in much of SSA are functioning sub-optimally, but approaches exist that can help to reduce the yield gaps and ensure food security, even under variable rainfall environments. Appropriate targeting of nutrient resources to field types that vary widely in soil fertility can be employed by farmers to maintain niches of high crop productivity that buffer overall farm production in an uncertain environment. Nitrogen is one of the most limiting nutrients to cereal production, and its variable use in a manner responsive to rainfall season quality would ensure its profitable utilization and minimize losses during drought seasons. The field experience gained in this research also suggests that the 'doubled-up' legumes system results in reduced fertilizer requirements for cereal crops grown in sequence, and crop yield stability benefits over time.

**Acknowledgements** The authors gratefully acknowledge funding from USAID through the Africa RISING program being implemented by the International Institute of Tropical Agriculture (IITA). Data for case studies that constitute this chapter are a result of funding from the International Plant Nutrition Institute (IPNI), IDRC, ICRISAT, and the McKnight Foundation.

## References

- Bayala J, Sileshi GW, Coe R, Kalinganire A, Tchoundjeu Z, Sinclair FD, Garrity D (2012) Cereal yield response to conservation agriculture practices in drylands of West Africa: a quantitative synthesis. *J Arid Environ* 78:13–25
- Cadisch G, de Willigen P, Suprayogo D, Mobbs DC, van Noordwijk M, Rowe EC (2004) Catching and competing for mobile nutrients in soils. In: van Noordwijk M, Cadisch G, Ong CK (eds) *Below-ground interactions in tropical agroecosystems: concepts and models with multiple plant components*. CAB International, Wallingford, pp 171–191
- Chikowo R, Mapfumo P, Nyamugafata P, Giller KE (2004) Maize productivity and mineral N dynamics following different soil fertility management technologies on a depleted sandy soil in Zimbabwe. *Agric Ecosyst Environ* 102:119–131
- Fofana B, Tamelokpo A, Wopereis MC, Breman H, Dzotsi K, Carsky RJ (2005) Nitrogen use efficiency by maize as affected by a mucuna short fallow and P application in the coastal savanna of West Africa. *Nutr Cycl Agroecosyst* 71:227–237
- Giller KE, Rowe EC, de Ridder N, van Keulen H (2006) Resource use dynamics and interactions in the tropics: scaling up in space and time. *Agric Syst* 88:8–27

- Giller KE, Witter E, Corbeels M, Tittonell P (2009) Conservation agriculture and smallholder farming in Africa: the heretics' view. *Field Crop Res* 114:23–34
- Giller KE, Tittonell P, Rufino MC, Wijk MT et al (2011) Communicating complexity: integrated assessment of trade-offs concerning soil fertility management within African farming systems to support innovation and development. *Agric Syst* 104:191–203
- Haggblade S, Tembo G (2003) Development, diffusion and impact of conservation farming in Zambia, Working Paper No. 8. Food Security Research Project, Lusaka, Zambia, p 76
- IPCC (2007) Climate change: impacts, adaptation and vulnerability. Fourth Assessment Report (AR4) of the United Nations Intergovernmental Panel on Climate Change (IPCC). Cambridge University Press, Cambridge
- Janssen BH (1998) Efficient use of nutrients: an art of balancing. *Field Crop Res* 56:197–201
- Janssen BH, Guiking FC, van der Eijk D, Smaling EM, Wolf J, Van Reuler H (1990) A system for quantitative evaluation of tropical soils (QUEFTS). *Geoderma* 46:299–318
- Kho RM (2000) On crop production and the balance of available resources. *Agric Ecosyst Environ* 80:71–85
- Manlay RJ, Chotte JL, Masse D, Laurent JY, Feller C (2002) Carbon, nitrogen and phosphorus allocation in agro-ecosystems of a West African savanna. III. Plant and soil components under continuous cultivation. *Agric Ecosyst Environ* 88:249–269
- Marongwe LS, Kwazira K, Jenrich M, Thierfelder C, Kassam A, Friedrich T (2011) An African success: the case of conservation agriculture in Zimbabwe. *Int J Agric Sustain* 9:153–161
- Masvaya EN, Nyamangara J, Nyawasha RW, Zingore S, Delve RJ, Giller KE (2010) Effect of farmer management strategies on spatial variability of soil fertility and crop nutrient uptake in contrasting agro-ecological zones in Zimbabwe. *Nutr Cycl Agroecosyst* 88:111–120
- Mazvimavi D (2010) Investigating changes over time of annual rainfall in Zimbabwe. *Hydrol Earth Syst Sci* 14:2671–2679
- Mtambanengwe F, Mapfumo P (2005) Organic matter management as an underlying cause for soil fertility gradients on smallholder farms in Zimbabwe. *Nutr Cycl Agroecosyst* 73:227–233
- Nandwa SM (2001) Soil organic carbon (SOC) management for sustainable productivity of cropping and agro-forestry systems in Eastern and Southern Africa. *Nutr Cycl Agroecosyst* 61:143–158
- Ncube B, Dimes JP, Twomlow SJ, Mupangwa W, Giller KE (2007) Raising the productivity of smallholder farms under semi-arid conditions by use of small doses of manure and nitrogen: a case of participatory research. *Nutr Cycl Agroecosyst* 77:53–67
- Ndlovu PV, Mazvimavi K, An H, Murendo C (2013) Productivity and efficiency analysis of maize under conservation agriculture in Zimbabwe. *Agric Syst*. doi:10.1016/j.agsy.2013.10.004
- Nyagumbo I (1999) Conservation tillage for sustainable crop production systems – experiences from on-station and on-farm research in Zimbabwe (1997–1998). In: Kaumbutho PG, Simalenga TE (eds) Conservation tillage with animal traction. ATNESA, Harare
- Nyamangara J, Nyengerai K, Masvaya EN, Tirivavi R, Mashingaidze N, Mupangwa W, Dimes J, Hove L, Twomlow S (2013) Effect of conservation agriculture on maize yield in the semi-arid areas of Zimbabwe. *Exp Agric*. doi:10.1017/S0014479713000562
- Piha MI (1993) Optimizing fertilizer use and practical rainfall capture in a semi arid environment with variable rainfall. *Exp Agric* 29:405–415
- Prudencio CY (1993) Ring management of soils and crops in the West African semi-arid tropics: the case of the Mossi farming system in Burkina Faso. *Agric Ecosyst Environ* 47:237–264
- Rusinamhodzi L, Corbeels M, van Wijk MT, Rufino MC, Nyamangara J, Giller KE (2011) A meta-analysis of long-term effects of conservation agriculture practices on maize grain yield under rain-fed conditions: lessons from southern Africa. *Agron Sustain Dev* 31:1–17
- Sanchez PA, Sherperd KD, Soule MJ, Place FM, Buresh RJ, Izac AM, Mokunywe AU, Kwesiga FR, Ndiritu CG, Woome PL (1997) Soil fertility replenishment in Africa: an investment in natural resource capital. In: Buresh RJ, Sanchez PA, Calhoun F (eds) Replenishing soil fertility in Africa, SSSA Spec Publ 51. ASA/SSSA, Madison



- Smaling EMA, Nandwa SM, Janseen BH (1997) Soil fertility in Africa is at stake. In: Buresh RJ, Sanchez PA, Calhoun F (eds) Replenishing soil fertility in Africa, SSSA Spec Publ 51. ASA/SSSA, Madison, pp 47–61
- Snapp SS, Blackie MJ, Gilbert RA, Bezner-Kerr R, Kanyama-Phiri GY (2010) Biodiversity can support a greener revolution in Africa. *Proc Natl Acad Sci U S A* 107:20840–20845
- Tittonell P, Vanlauwe B, Leffelaar PA, Rowe EC, Giller KE (2005) Exploring diversity in soil fertility management of smallholder farms in Western Kenya. I. Heterogeneity of region and farm scale. *Agric Ecosyst Environ* 110:149–165
- Tittonell PA, Muriuki A, Klapwijk CJ, Shepherd KD, Coe R, Vanlauwe B (2013) Soil heterogeneity and soil fertility gradients in smallholder agricultural systems of the East African highlands. *Soil Sci Soc Am J* 77:525–538
- Umar BB, Aune JB, Johnsen FH, Lungu OI (2011) Options for improving smallholder conservation agriculture in Zambia. *J Agric Sci* 3:50–62
- Vanlauwe B, Diels J, Lyasse O, Aihou K, Iwuafor EN, Sanginga N, Deckers J (2002) Fertility status of soils of the derived savanna and northern Guinea savanna and response to major plant nutrients as influenced by soil type and land use management. *Nutr Cycl Agroecosyst* 62:139–150
- Vanlauwe B, Wendt J, Giller K et al (2014) A fourth principle is required to define conservation agriculture in Sub-Saharan Africa: the appropriate use of fertilizer to enhance crop productivity. *Field Crop Res* 155:10–13
- Wall PC, Thierfelder C, Ngwira A, Govaerts B, Nyagumbo I, Baudron F (2013) Conservation agriculture in Eastern and Southern Africa. In: Jat RA, Graziano de Silva J (eds) Conservation agriculture: global prospects and challenges. CABI, Wallingford
- Wopereis MC, Tamelokpo A, Ezui K, Gnakpenou D, Fofana B, Breman H (2006) Mineral fertilizer management of maize on farmer fields differing in organic inputs in the West African Savanna. *Field Crop Res* 96:355–362
- Zingore S, Murwira HK, Delve RJ, Giller KE (2007) Influence of nutrient management strategies on variability of soil fertility, crop yields and nutrient balances on smallholder farms in Zimbabwe. *Agric Ecosyst Environ* 119:112–126
- Zingore S, Tittonell P, Corbeels M, Wijk MT, Giller KE (2011) Managing soil fertility diversity to enhance resource use efficiencies in smallholder farming systems: a case from Murehwa District, Zimbabwe. *Nutr Cycl Agroecosyst* 90:87–103

# Chapter 13

## Effect of In Situ Soil Water Harvesting Techniques and Local Plant Nutrient Sources on Grain Yield of Drought-Resistant Sorghum Varieties in Semi-arid Zone, Tanzania

Method Kilasara, M.E. Boa, E.Y. Swai, K.P. Sibuga, Boniface H.J. Massawe, and E. Kisetu

**Abstract** Aridity is becoming a key threat to more than 500 million people who depend on agriculture for their livelihood in semi-arid areas worldwide. Climate change represents a significant threat to current agricultural production, and consequently to farmers' livelihoods in sub-Saharan Africa. The compounded effects of climate change, population pressure and change in dietary demands will further threaten fragile natural resources and accelerate land degradation processes. Poverty and hunger are still characteristics of sub-Saharan African countries in specific areas frequently hit by drought including the central zone of Tanzania. Typical characteristics of these areas are periodic to frequent dry spells that lead to crop failure, food shortage and lasting poverty. In Tanzania, the central regions of Dodoma and Singida are frequently threatened by drought that causes crop failure. In Dodoma, Singida and Tabora, 45–55 % of the households are food insecure. The purpose of this work was to investigate the effect of combining selected soil water harvesting techniques and locally available plant nutrient sources (FYM and urea-treated local phosphate rock, *Minjingu Mazao*) on the grain yield of early maturing and drought-resistant sorghum varieties (*Wahi* and *Hakika*). The trials were conducted at Mbande village, Kongwa

---

M. Kilasara (✉) • B.H.J. Massawe • E. Kisetu  
Department of Soil Science, Sokoine University of Agriculture,  
P.O. Box 3008, Chuo Kikuu, Morogoro, Tanzania  
e-mail: [mmkilasara@yahoo.com](mailto:mmkilasara@yahoo.com)

M.E. Boa  
Department of Animal Science and Production, Sokoine University of Agriculture,  
P.O. Box 3004, Chuo Kikuu, Morogoro, Tanzania

E.Y. Swai  
Agricultural Research Institute (ARI), P.O. Box 299, Dodoma, Tanzania

K.P. Sibuga  
Department of Crop Science and Production, Sokoine University of Agriculture,  
P.O. Box 3005, Chuo Kikuu, Morogoro, Tanzania

District and Ikhanoda village, Singida Rural District in Tanzania. A split-split plot design setup was used in this study. The main plots were tillage methods, which were infiltration pit (PI), tied-ridging (TR) and flat cultivation (FC). The sub-plots were the fertilizers, which were farmyard manure and *Minjingu Mazao*, and the sub-sub plots were the two sorghum (*Sorghum bicolor* L. Moench) varieties: *Wahi* and *Hakika*. Data were subjected to one-way analysis of variance. Treatment differences were separated using least significant differences (LSD) at  $p < 0.05$ ,  $p < 0.01$  and  $p < 0.001$ . At the Ikhanoda study site, when *Minjingu Mazao* was applied, the *Wahi* grain yield was significantly ( $p < 0.05$ ) higher in PI (2,414 kg ha<sup>-1</sup>) and FC (1,126 kg ha<sup>-1</sup>) than in TR treatment (648 kg ha<sup>-1</sup>). In contrast, with *Hakika*, TR significantly ( $p < 0.05$ ) outperformed other water harvesting methods with the highest grain yield (3,199 kg ha<sup>-1</sup>). The PI treatment recorded the highest grain yield (2,789 kg ha<sup>-1</sup> under *Wahi* and 3,223 kg ha<sup>-1</sup> under *Hakika*) when FYM was applied at 5 t ha<sup>-1</sup>. The grain yield of both varieties under FYM and all water harvesting techniques, including FC, did not differ significantly ( $p > 0.05$ ). However, *Hakika* under PI had the best yield (3,223 kg ha<sup>-1</sup>) while *Wahi* under FC registered the lowest yield (2,573 kg ha<sup>-1</sup>). In the absence of FYM or *Minjingu Mazao*, the grain yield showed the following trend: FC (1,660 kg ha<sup>-1</sup>, 1,863 kg ha<sup>-1</sup>) > PI (1,234 kg ha<sup>-1</sup>, 1,387 kg ha<sup>-1</sup>) > TR (875 kg ha<sup>-1</sup>, 930 kg ha<sup>-1</sup>) for *Wahi* and *Hakika*, respectively. At the Mbande site, the *Wahi* variety had a significantly higher grain yield ( $p < 0.05$ ) in the FC treatment (1058.6 kg ha<sup>-1</sup>) than TR (543 kg ha<sup>-1</sup>) and PI (320.3 kg ha<sup>-1</sup>) when FYM was applied. With the application of 5 tons ha<sup>-1</sup> FYM, the *Wahi* variety gave a significantly ( $p < 0.05$ ) higher grain yield (1320.2 kg ha<sup>-1</sup>) in the TR treatment but the lowest in the FC treatment (476.6 kg ha<sup>-1</sup>). With the *Hakika* variety, the grain yield was higher (1773.4 kg ha<sup>-1</sup>) in TR and FC than in PI (890.6 kg ha<sup>-1</sup>). The superiority of the FC treatment in the absence of external nutrient input is attributed to topsoil that is slightly richer in nutrients compared to the rest of the treatments in which the poorer subsoil is part of the root zone. External nutrient input might have compensated for nutrient deficiencies and thus attenuated the treatment differences. This study demonstrated that in the absence of external sources of plant nutrients such as FYM and *Minjingu Mazao*, FC performed better than PI and TR. With external nutrient input, the grain yield varied due to water harvesting practice and site. At Ikhanoda, PI was superior to the other treatments while at Mbande, TR outperformed the other treatments. The outcome of the use of rainwater harvesting technologies ought to be applied in well-characterized fields in terms of physical and bio-chemical soil characteristics for better results.

**Keywords** *Wahi* • *Hakika* • Sorghum varieties • In situ rainwater harvesting • Farmyard manure • *Minjingu Mazao* fertilizer • Central semi-arid Tanzania

### 13.1 Introduction

Arid and semi-arid areas are defined as areas that fall within the rainfall zones of 0–300 mm and 300–600 mm, respectively (Food and Agriculture Organization [FAO] 1987). Because of the short growing periods (1–74 and 75–119 growing

days, respectively), these areas are either not suitable or are only marginally suitable for cultivation. Rainfall patterns are unpredictable and are subject to great fluctuations. Inter-annual fluctuations range from 50 to 100 % in the arid zones to 20–50 % in the semi-arid zones (IISD 2006; Sutherland et al. 1991).

Worldwide, 868 million people continue to suffer from undernourishment, and the negative health consequences of micronutrient deficiencies continue to affect around two billion people (FAO et al. 2012). Further, more than 100 million children under the age of five are underweight, and therefore unable to realize their full socio-economic and human potential. Children malnutrition is the cause of death for more than 2.5 million children every year (FAO et al. 2012). Hunger and malnutrition can be a significant obstacle to economic growth (FAO 2010). In the Dodoma, Singida and Tabora regions in Tanzania, 45–55 % of the households are food (Sidahmed, 2000) insecure (World Food Programme [WFP] 2007).

In sub-Saharan Africa, agricultural production improved slightly, stagnated or has been declining for the last 50 years. This has caused a lot of food insecurity in the region as shown in Table 13.1. Problems associated with food insecurity are more pronounced in arid and semi-arid zones where the consequences of climate change are most severe (Salas et al. 2009). In sub-Saharan Africa, the majority of the countries are faced with a high level of malnutrition, frequently exceeding a quarter of the population; only a few countries have reversed the trend over the last two decades (Table 13.1). Countries dominated by arid and semi-arid subsistence agriculture are more vulnerable than those with better climatic conditions. Apart from the aridity, agriculture in these areas faces many challenges, including vulnerability to soil erosion, low soil fertility and reduced rainfall infiltration rate (Maestre et al. 2000), water-induced soil erosion (D'Odorico and Porporato 2006), scarce moisture reserves and low organic matter content (IISD 2006).

Better and efficient use of water resources is needed and soil fertility must be restored in arid and semi-arid zones through the application of affordable plant nutrient carriers and optimization of scarce rainfall through water harvesting. These actions would bring sustainable benefits to the target communities if appropriate crop varieties adapted to local conditions are considered.

Sorghum, millet and maize are the staple foods in Dodoma and Singida. However, most resource-poor farmers grow cereal crops that are not adapted to drought (Monyo et al. 2004). The *Striga* species (witchweed) is another limitation to food production in the marginal lands of the semi-arid zone of Tanzania (Monyo et al. 2004). *Striga* reduces up to 40 % of the sorghum yield in Tanzania (Ejeta et al. 1991). Recently, early maturing, drought and *Striga*-resistant sorghum varieties known as *Hakika* and *Wahi* were successfully introduced in Tanzania under the National Sorghum and Millet Improvement Program. However, farmers in Dodoma and Singida, and similar areas in Sub-Saharan Africa still depend on local landraces, though they are characterized low grain yield and are more prone to *Striga* (Dicko et al. 2006). The trend is attributed to many factors such as taste and preferences (Monyo et al. 2004), low ability of input markets to respond to farmers demands (Ahmed et al. 2000) and biotic and abiotic stresses to introduced varies in certain agro-ecological zones.

**Table 13.1** Prevalence of undernourishment in selected sub-Saharan Africa countries

	Number of people undernourished (10 <sup>6</sup> )					Proportion of undernourished in total population (%)					Change so far	
	1990–1992	1999–2001	2004–2006	2007–2009	2010–2012	Change so far	1990–1992	1999–2001	2004–2006	2007–2009		2010–2012
Angola	7	7	6	6	5	-21.0	63.9	47.5	35.1	30.7	27.4	-57.1
Benin	1	1	1	1	1	-33.7	22.4	16.4	13.1	10.8	8.1	-63.8
Botswana	<0.5	1	1	1	1	45.3	27.4	34.5	32.9	31.9	27.9	1.8
Burkina Faso	2	3	4	4	4	99.9	22.9	26.4	25.8	24.4	25.9	13.1
Burundi	3	4	5	6	6	124.4	49.0	63.0	67.9	72.4	73.4	49.8
Cameroon	5	5	3	3	3	-35.2	38.7	29.1	19.5	15.6	15.7	-59.4
Central Africa Rep.	1	2	2	1	1	-9.8	49.5	45.1	40.6	32.6	30.0	-39.4
Chad	4	3	4	4	4	1.7	61.1	41.0	37.3	36.4	33.4	-45.3
Congo	1	1	1	1	2	47.1	42.8	30.1	32.9	34.6	37.4	-12.6
Cote d'Ivoire	2	3	4	4	4	143.4	13.7	19.9	19.6	19.3	21.4	56.2
Eritrea	2	3	3	3	4	54.3	72.4	76.2	74.8	69.1	65.4	-9.7
Ethiopia	34	36	35	35	34	0.1	68.0	55.3	47.7	43.8	40.2	-40.9
Ghana	6	3	2	1	1	-87.0	40.5	16.6	9.5	5.8	<5	na
<b>SSA</b>	<b>170</b>	<b>200</b>	<b>205</b>	<b>216</b>	<b>234</b>	<b>37.8</b>	<b>32.8</b>	<b>30.0</b>	<b>27.2</b>	<b>26.5</b>	<b>26.8</b>	<b>-18.3</b>

Modified from FAO et al. (2012)

Integrated water management solutions in rain-fed agriculture can result in significant yield improvements (Hatibu et al. 2006). Research has shown that there are no agro-hydrological limitations to doubling or tripling on-farm stable food yields in rain-fed agriculture in a drought-prone environment. Different management techniques can contribute to improved water productivity, i.e., “more crop per drop” of rain. In arid and semi-arid regions, a large part of the rainfall is lost as unproductive evaporation and runoff. Approximately, 70–85 % of the rainfall (depending on land management conditions) from farmers’ fields (Dile et al. 2013). Thus, less than 15–30 % of rainfall is used for plant growth. Managing water and soil appropriately results in improved rainfall use efficiency and bridges intra-seasonal rainfall variability to double or even triple agricultural yield levels (Dile et al. 2013).

In Tanzania, the central regions of Dodoma and Singida and neighboring areas are semi-arid; moisture availability is the most limiting crop production factor (Hatibu et al. 2006). About 30–35 % of storm rainfall is lost as runoff (Hoogmodel et al. 1984). Rwehumbiza (1987) showed that the recharged root zone overperformed moisture-stressed treatments in terms of dry matter yield, maize kernel weight and total water use efficiency for dry matter and grain yield.

Water harvesting can play a larger role in achieving water productivity. Water harvesting practices are classified into three categories: macro-catchment systems, micro-catchments and in situ systems (Dile et al. 2013). Macro-catchment water harvesting systems are also called external water harvesting systems or ex situ. These systems collect water from a large area and have water collection catchment, conveyance and storage structures. Micro-catchment water harvesting systems collect water from a relatively small catchment area. The catchment and crop area are distinct but adjacent. In situ water harvesting systems are used where rainfall water is captured and stored where it falls. These techniques improve soil moisture by enhancing infiltration and reducing runoff and evaporation (Hatibu et al. 2006; Vohland and Barry 2009).

Field studies in Northern Ethiopia on in situ water harvesting systems such as tied-ridging, open ridging and sub-soiling improved the soil water content in the root zone during the cropping period compared to traditional tillage by 24 %, 15 % and 3 %, respectively (McHugh et al. 2007). Similarly, in the semi-arid region of Northern Ethiopia, tied-ridges improved the barley yield by 44 % compared to traditional tillage (Araya and Stroosnijder 2010).

Several in situ water harvesting techniques have proven effective in soil moisture conservation in semi-arid areas. Mwaliko (2001) noted a twice as large sorghum grain yield with the residual tied-ridge treatment compared to the no-till treatment. Working at Hombolo in Dodoma, Swai (1999) noted an increase in sorghum grain yield of 480–640 % and 79–320 % under annually made and residual tied-ridges over the no-till treatment when 30 t ha<sup>-1</sup> of FYM was applied.

Numerous studies show that high soil fertility methods such as the use of farmyard manure and enhanced soil moisture status reduce the adverse effects of *Striga* (Oswald 2005). The traditional tillage method (slash and burn) locally called *kuberega* dominates the sorghum-growing areas of the Dodoma and Singida regions. Studies conducted in the central zone of Tanzania showed that tied-ridging in combination with farmyard manure using *Striga*-resistant varieties *Hakika* and

*Wahi* gave higher grain yields compared to traditional tillage and research station trials.

However, recently a study on similar agro-ecological conditions revealed that in situ rainwater harvesting that involved ripping and deep ploughing techniques markedly increased sorghum productivity compared to tied-ridging (Swai 1999). Therefore, from these findings, integrating *Striga*-resistant varieties notably *Wahi* and *Hakika* and promising soil and water management technologies (tied-ridges, infiltration pit and ripping) are likely to significantly enhance sorghum grain yield in the drought-prone areas of Kongwa District, Dodoma Region and Singida Rural District, Singida Region, Tanzania. It is therefore assumed that combining these technologies will enhance sorghum grain yield and hence contribute to sustained household food security and poverty alleviation. That notwithstanding, there is ample evidence of existence of large gaps between on station crop yields and those actually attained at farmers' fields (van Ittersum et al. 2013; Lobell et al. 2009). This study was designed to minimize such discrepancies by making it on-farm and participatory.

The overall objective of this study was to investigate effect of combining selected soil water harvesting techniques and locally available plant nutrient sources, FYM and urea-treated local phosphate rock, *Minjingu Mazao*, on the grain yield of early maturing and drought-resistant sorghum varieties (*Wahi* and *Hakika*). The specific objective was to quantify the effects of tillage methods, tied-ridges and pit infiltration pits, compared with traditional flat cultivation on the grain yield of the *Wahi* and *Hakika* sorghum varieties.

## 13.2 Materials and Methods

### 13.2.1 Study Site

A participatory study was conducted at Mbande village in Kongwa District and Ikhanoda village in Singida Rural District, Tanzania, during the 2010–2011 cropping season. Mbande and Ikhanoda are located at 6° 6' 8" S and 36° 19' 25" E, 941.3 m.a.s.l., and 6° 38' 7" S and 34° 59' 2" E, 1,600 m.a.s.l., respectively.

### 13.2.2 Rainfall Characteristics of the Study Sites

Mbande and Ikhanoda are characterized by one rainy season that extends from November/December to April/May with an annual mean rainfall of 438.9 and 542.6 mm per annum, respectively. The areas are also characterized by wide inter-annual rainfall variation. For instance, data from the Kongwa Pasture Institute for a period of 24 years (1970–1993) show a range of 222.0–923.9 mm.

### 13.2.3 Soil Characteristics of the Study Sites

At each site, sampling was sampled from a soil profile that was dug close to the experimental trial area. Soil characteristics were determined for air-dried fine earth soil samples. Particle size distribution was estimated with Gee and Bauder's (1986) method. The pH (H<sub>2</sub>O) was measured following the procedure after Mclean (1982). Organic carbon was determined using the Black and Walkley wet combustion method (Nelson and Sommers 1982). Total nitrogen was determined with Bremner and Mulvaney's (1982) method. Extractable phosphorus was measured using Olsen and Sommers' (1982) procedure. CEC was determined using Thomas's (1982) method. The soil characteristics of the sites are shown in Table 13.2. Based on morphological and laboratory data, the soils were classified in accordance with the classification system developed by the Soil Survey Staff (2006) as Aridic Haplusteps at Kongwa and Dystric Haplusteps at Ikhanoda.

### 13.2.4 Experimental Design and Treatments

A split-split plot design experiment was laid down with three tillage treatments: traditional tillage or flat cultivation (FC), tied-ridges (TR) and infiltration pits (PI) as the main plots. The fertilizer types were no fertilizer (control), farmyard manure at 5 tons per ha and *Minjingu Mazao* at 30 kg per ha the subplots. In addition, two sorghum varieties, *Wahi* and *Hakika*, served as the sub-sub plots. The treatments were randomly replicated three times. Treatments were randomly allocated to a plot 10 m by 8 m (80 m<sup>2</sup>). Plant spacing of 0.8 m between rows and 0.3 m within rows with two plants per hill/hole was used. The seeds were top-dressed against head smut disease with a copper-based fungicide. Standard agronomic practices were applied that included two weedings at 3 and 6 weeks after germination.

### 13.2.5 Data Collection and Statistical Analysis

The weight of the grain yield of individual plots was obtained from mature plants in the inner three rows, shelled and dried to 14 % moisture content. The latter was converted to kg per hectare.

Data were analyzed with GenStat ( $p \leq 0.05$ ); trial data were subjected to analysis of variance appropriate for the experimental design. Treatment differences were separated using least significant differences (LSD) at  $p < 0.05$ ;  $p < 0.01$  and  $p < 0.001$ . The data were run using GenStatF stat (Wim et al. 2007) version 4.

The general statistical model is given by:  $Y_{ijk} = F + A_i + B_j + (AB)_{ij} + e_{ijk}$



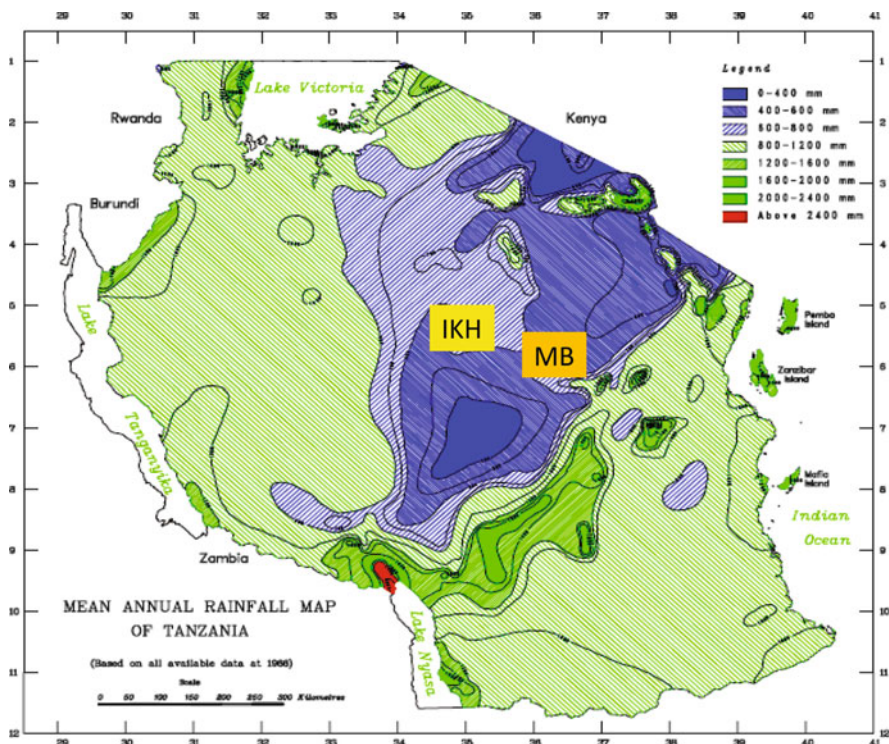
**Table 13.2** Selected soil characteristics of the Mbande and Ikhanoda sites

Site	Soil horizon	Soil texture	pH (H <sub>2</sub> O)	SOC (%)	Total N (%)	Extractable P (mg/kg)	CEC (cmol/kg soil)
Mbande	Ap	Loamy sand	6.1	0.6	0.06	2.5	21.8
	AB	Loamy sand	6.9	0.1	0.05	0.8	18
	BA	Loamy sand	6.6	0.4	0.04	0.6	22.6
	B	Loamy sand	7.8	0.4	0.03	0.8	10.8
	Mean ± stdev		6.9 ± 0.7	0.4 ± 0.2	0.05 ± 0.01	1.2 ± 0.9	18.3 ± 5.4
Ikhanoda	Ap	Sandy loam	5.7	0.3	0.05	9.9	13.8
	AB	Sandy loam	6.3	0.2	0.04	8.3	13.6
	BA	Sandy clay loam	5.8	0.3	0.02	0.6	13.2
	B	Sandy clay loam	6.6	0.2	0.03	0.2	13.6
	Mean ± stdev		6.1 ± 0.4	0.3 ± 0.1	0.04 ± 0.01	6.3 ± 5.0	13.6 ± 0.3

Where:

$Y_{ijk}$  = general mean common to all observations;  $A_i$  = effect of  $i$ th level of tillage methods;  $B_j$  = effects of varieties to be tested;  $[(AB)_{ij}]$  = interaction effects of three tillage methods and two varieties; and  $\epsilon_{ijk}$  = random error effect. One-way analysis of variance (one-way ANOVA) to evaluate productivity of two varieties (*Wahi* and *Hakika*) and three tillage methods (flat cultivation, infiltration pit and tied-ridges) were conducted.

In the second year of the study, the experiment was up-scaled by 10 farmers at Mbande and 25 farmers at Ikhanoda out of the 30 and 45 farmers, respectively, who were supplied with *Wahi* and *Hakika* seeds for the same purpose. The latter were randomly selected from the two villages from more than 100 farmers who took participated in the project initiation workshop held before the study started. The farmers invited to up-scale were those who had received training during the first year of the study and who were willing to raise the crop using their own resources and have their yield data recorded and be used by the project. Four farmers were randomly selected among the adopters at Ikhanoda to demonstrate crop performance under farmer management (Table 13.4).



**Fig. 13.1** Map showing rainfall zones of Tanzania and the location of the study sites Key: *IKH* Ikhanoda village, Singida Rural District, Singida Region. *MB* Mbande village, Kongwa District, Dodoma Region

## 13.3 Results and Discussion

### 13.3.1 Rainfall Distribution

The monthly rainfall for the 2010–2011 crop season is shown in Fig. 13.2. The rainy period started in November and ended in May 2011. However, good rainfall distribution was observed between December and March and then tapered in April and May 2011. The total precipitation for that year was typical for the arid regions of central Tanzania; the total rainfall was 542.6 mm and 434.9 mm for Ikhanoda (Singida Rural District) and Mbande (Kongwa District) villages, respectively. The annual rainfall data for the past 24 years from the Kongwa Pasture Research Centre agrees with the rainfall data for this crop year; the mean total annual rainfall data was 458.7 mm, with a maximum of 924.9 mm and a minimum of 222.0 mm (Figs. 13.3, 13.4, and 13.5).

### 13.3.2 Effect of Rainwater Harvesting on Grain Yield

At the Ikhanoda study site, when *Minjingu Maza* was applied, the grain yield of *Wahi* was significantly ( $p < 0.05$ ) higher in PI (2,414 kg ha<sup>-1</sup>) and FC (1,126 kg ha<sup>-1</sup>) than in the TR treatment (648 kg ha<sup>-1</sup>). In contrast, with *Hakika*, TR significantly ( $p < 0.05$ ) outperformed other water harvesting methods with the highest grain yield (3,199 kg ha<sup>-1</sup>). The PI treatment recorded the highest grain yield (2,789 kg ha<sup>-1</sup>) under *Wahi* and 3,223 kg ha<sup>-1</sup> under *Hakika*) when FYM was

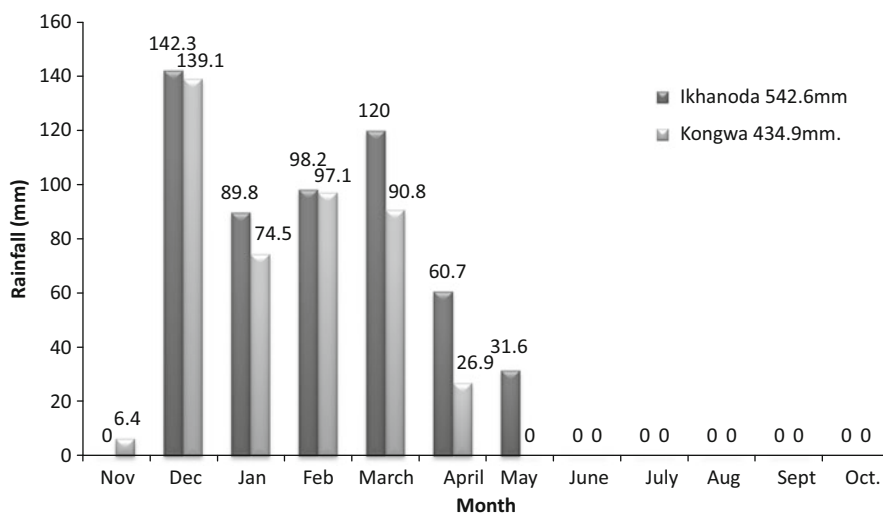


Fig. 13.2 Mean monthly rainfall at Ikhanoda and Mbande for 2010–2011 cropping season



Fig. 13.3 Land preparation at Ikhanoda village trial site, Singida Rural District



Fig. 13.4 Preparation of tie ridges (a) and application of FYM (b)

applied at  $5 \text{ t ha}^{-1}$ . The grain yield of both varieties under FYM all water harvesting techniques including FC, did not differ significantly ( $p > 0.05$ ) (Table 13.3).

*Hakika* under PI out-yielded the rest ( $3,223 \text{ kg ha}^{-1}$ ) while *Wahi* under FC registered the lowest yield ( $2,573 \text{ kg ha}^{-1}$ ). In the absence of FYM or *Minjingu Mazao*, the grain yield showed the following trend: FC ( $1,660 \text{ kg ha}^{-1}$ ,  $1,863 \text{ kg ha}^{-1}$ )  $>$  PI ( $1,234 \text{ kg ha}^{-1}$ ,  $1,387 \text{ kg ha}^{-1}$ )  $>$  TR ( $875 \text{ kg ha}^{-1}$ ,  $930 \text{ kg ha}^{-1}$ ) for *Wahi* and *Hakika*, respectively (Table 13.3).

At the Mbande site, the *Wahi* variety had a significantly higher yield ( $<0.05$ ) in the FC treatment ( $1058.6 \text{ kg ha}^{-1}$ ) than TR ( $543 \text{ kg ha}^{-1}$ ) and PI ( $320.3 \text{ kg ha}^{-1}$ ) when FYM was applied. With the application of  $5 \text{ t ha}^{-1}$  FYM, the *Wahi* variety



**Fig. 13.5** Wahi on tied ridges with FMY at Fatuma F. Tenanzo's farm, Ikhanoda village

gave a significantly ( $p < 0.05$ ) higher grain yield ( $1320.2 \text{ kg ha}^{-1}$ ) in the TR treatment but lowest in the FC treatment ( $476.6 \text{ kg ha}^{-1}$ ). With the *Hakika* variety, the grain yield was higher ( $1773.4 \text{ kg ha}^{-1}$ ) in TR and FC than in PI ( $890.6 \text{ kg ha}^{-1}$ ) (Tables 13.4 and 13.5).

## 13.4 Discussion and Conclusion

The superiority of the FC treatment in the absence of external nutrient input is presumably attributed to the topsoil that was slightly richer in nutrients that were easily accessed by plant roots through scavenging as opposed to TR and PI, in which the root biomass are exposed to the poorer subsoil. If there is no possibility of improving the soil with external nutrients, then farmers at the two sites and other places with similar soil and climatic conditions are advised to use FC. External nutrient input might have compensated for nutrient deficiencies and thus attenuated treatment differences.

In a similar observation to this study, Mwaliko (2001) observed a twice as large sorghum grain yield for residual tied-ridge treatment over the no-till treatment. In addition, working at Hombolo in Dodoma, Swai (1999) noted an increase in

**Table 13.3** Effect of in situ rainwater harvesting (tillage practices) and type of plant nutrient source on the grain yield of *Wahi* and *Hakika* sorghum varieties at the Ikhanoda village site

Treatments		Grain yield (kg ha <sup>-1</sup> )			
Variety	Tillage	No fertilizer	FYM	Minjingu Mazao	
Wahi	PI	1,234ab	2,789a	2,414b	<b>2,414b</b>
	TR	875a	2,605a	648a	<b>648a</b>
	FC	1,660ab	2,573a	1,126a	<b>1,126a</b>
Hakika	PI	1,387ab	3,223a	2,616b	<b>2,616b</b>
	TR	930a	2,836a	3,199b	<b>3,199b</b>
	FC	1,863b	2,859a	2,496b	<b>2,496b</b>
	SE±		422.9	642.8	<b>641.2</b>
	CV (%)		31.9	22.8	<b>30.8</b>
LSD <sub>0.05</sub>	Variety		368.0	559.3	<b>641.2</b>
	Tillage		450.7	685.1	<b>683.3</b>
	Interaction		637.4	968.8	<b>966.4</b>
F Stat	Variety		N.S.	N.S.	<b>***</b>
	Tillage		N.S.	N.S.	<b>N.S.</b>
	Interaction		**	N.S.	<b>**</b>

Means with a column followed by the same superscript are not significantly different according to LSD at a probability level of 0.05

PI Infiltration Pit, TR Tied-Ridging, F Flat cultivation

Key: Significant levels: N.S. =  $p > 0.05$ ; \*;  $p \leq 0.01$ ; \*\*,  $p \leq 0.01$ ; \*\*\*,  $p \leq 0.001$

**Table 13.4** Effect of in situ rainwater harvesting (tillage practices) and type of plant nutrient source on the grain yield of *Wahi* and *Hakika* sorghum varieties at the Mbande village site

Treatments		Grain yield (kg ha <sup>-1</sup> )	
Variety	Tillage	No fertilizer	Farm yard manure (FYM)
Wahi	PI	320.3a	523.4ab
	TR	543ab	1,320.3c
	FC	1,058.6c	476.6a
Hakika	PI	312.5a	890.6abc
	TR	335.9a	1,773.4d
	FC	617.2b	1,773.4d
	SE±	97.2	164.8
	CV (%)	18.3	16.7
LSD <sub>0.5%</sub>	Variety	144.3	244.6
	Tillage	176.8	299.6
	Interaction	250	423.7
F. Stat	Variety	*	N.S
	Tillage	**	***
	Interaction	N.S	N.S

Means with a column followed by the same superscript are not significantly different according to LSD at a probability level of 0.05

PI Infiltration Pit, TR Tied-Ridging, FC Flat Cultivation

Key: Significant levels: N.S.  $p > 0.05$ ; \*,  $p \leq 0.05$ ; \*\*,  $p \leq 0.01$ ; \*\*\*,  $p \leq 0.001$

**Table 13.5** Grain yield data for selected farmer fields at Ikhanoda village

S. no	Farmer's name	Variety	Practice adopted by the farmer	Yield (kg/ha)
1	Fatuma F. Tenanzo	Wahi	TR and FYM	7,777.8
2	Hawa O. Ramadhani	Wahi	TR and FYM	3,777.8
3	Halima Athumani	Wahi	TR	750.0
4	Salum Iddi	Wahi	TR and FYM	1,777.8

sorghum grain yield of 480–640 % and 79–320 % under annually made and residual tied-ridges over the no-till treatment when 30 t ha<sup>-1</sup> of FYM was applied. In the semi-arid area of Abergelle, Northern Ethiopia, the tillage main treatment effects, tied-ridging, increased grain yield by 5–10 % and up to 28 % for the stover yield of the sorghum variety compared to its effect on the *Woitozira* variety (Tefahunegn 2012). Field studies from Northern Ethiopia on in situ water harvesting systems such as tied-ridging, open ridging and sub-soiling improved soil water content in the root zone during the cropping period compared to traditional tillage systems by 25 %, 15 % and 3 %, respectively (McHugh et al. 2007).

A study conducted by Karrar et al. (2012) revealed that ridge tillage is very effective in conserving water in the root zone in semi-arid to sub-humid regions, particularly when the ridges have cross ties in the furrows. The ridges referred to included tied-ridging, furrow blocking or basin tillage. In addition, Botha et al. (2003) found that plant growth conditions were hampered by climatic factors such as low and erratic rainfall, low humidity levels and high temperature during the growing season, which is envisaged in arid and semi-arid regions. Karrar et al.'s (2012) findings suggest that the in situ water harvesting techniques improved the soil moisture stored within the root zone compared to conventional harrowing that uses a wide-level disc, resulting in increased sorghum dry matter and grain yield. Mmbaga and Lyamchai (2001) found a low yield in the bottom seed placement as a strategy for using water efficiently in the arid and semi-arid zones of Tanzania. Their results were related to the water logging in tied-ridging and by removing nutrients in the open ridges.

In another study, applying manure and compost on a half-moon soil and water conservation practice in a field trial in semi-arid Burkina Faso provided yields from 900 to 1,600 kg ha<sup>-1</sup> of sorghum grain, that is, 20–39 % of the yield obtained in the half moon treatment without added nutrients (Zougmore et al. 2006). Appropriate water and soil management results in improved rainfall use efficiency and bridges intra-seasonal rainfall variability to double or even triple agricultural yield levels (Dile et al. 2013).

The higher grain yield obtained under the flat cultivation treatment compared to the other treatments contradicts many findings that indicate tied-ridging or infiltration pits increase crop yield (Swai 1999; Zougmore et al. 2006). These results cannot be explained by the data collected. Mixing of the poorer subsoil in the PI and TR treatments might have created a condition with less to the root zone compared to the flat cultivation treatment. This may be explained as the decrease in evaporation by conservation tillage is not possible in dry land environments because of poor

ground cover by the crop especially during the early stage (Cooper et al. 1987). The other explanation could be that the ridges might be too high for water at the bottom of the ridges to reach root zones, especially during the early stages of plant growth coupled with the effect of evaporation on uncovered soils. More work, particularly detailed characterization of the topsoil and sub-soil of the studied sites, may provide a better understanding of these results.

The wider grain yield range observed among the farmers who up-scaled may be partly explained by farmer and land characteristics. Farmers differed in their ability and commitment to their experimental plots. The hard-working farmers got better yields than the rest. These farmers had better maintained fields. Nearly all higher-yielding fields were located close to the lower slope of the terrain or at the valley bottom with soils rich in the capacity to retain moisture. The farmers' fields on degraded land surfaces, which characteristically were located on upper slopes, gave poorer grain yields. The on-farm sorghum grain yields recorded in this study contrast with the average  $0.8 \text{ t ha}^{-1}$  values obtained in Sub Sahara Africa (FAO 1998). The results show the potential of the tested water harvesting technologies, even on soils with modest soil fertility, to change the food production status in the region and similar areas within and outside Tanzania. They provide the opportunity and means to fight hunger in the sub-Saharan region. In addition, the grain yield of the best farmers is close to the  $5,000\text{--}6,000 \text{ kg ha}^{-1}$  range, which has been reported in tropical regions with reliable rainfall and sufficient nutrient application under commercial agriculture (Dile et al. 2013). Therefore, with farmer education and sanitization, soil ripping, in situ water harvesting, the use of farmyard manure, proper plant spacing, timely thinning and weeding, the use of early maturing, drought- and *Striga*-resistant *Wahi* and *Hakika* varieties can contribute significantly in eradicating hunger in the climatically disadvantaged semi-arid areas in sub-Saharan Africa.

This research played a role in demonstrating that appropriate tillage with even modest nutrient input levels can result in high crop yields under good crop management. Even in less well-managed plots, infiltration pits or tied-ridges with low levels of FYM or *Minjingu Mazao* can double the sorghum grain yield.

In semi-arid zones similar to that of central Tanzania, the use of appropriate rainwater harvesting technologies, such as TR and PI, combined with external nutrient sources such as FYM and *Minjingu Mazao* is important to significantly increase sorghum (*Wahi* and *Hakika*) grain yield per hectare as observed in this study.

**Acknowledgements** The authors wish to acknowledge the financial support from the Tanzania Commission for Science and Technology (COSTECH) without which this study could not have been possible. We are grateful to the extension officers and farmers in Kongwa and Singida Rural Districts, who made it easy for the researchers to share local knowledge and farmers' experiences. The authors are also very thankful to the District Agricultural and Livestock Development Officers of the two districts for facilitating field activities. Last, thanks are due to the Sokoine University of Agriculture, for properly administering the research funds used to execute this study.



## References

- Ahmed MM, Sanders JH, Nell WTN (2000) New sorghum and millet cultivar introduction in Sub-Saharan Africa: impacts and research agenda. *Agric Syst* 64:55–65
- Araya A, Stroosnijder L (2010) Effects of tied ridges and mulch on barley (*Hordeum vulgare*) rain water use efficiency and production in Northern Ethiopia. *Agric Water Manag* 97:841–847
- Botha GA, Bristow CS, Porat N, Duller G, Armitage SJ, Roberts HM, Clarke BM, Kota M, Schoeman P (2003) Evidence for dune reactivation from GPR profiles on the Maputaland coastal plain, South Africa. In: Bristow CS, Jol HM (eds) Ground penetrating radar in sediments. The Geological Society, London, pp 29–46
- Bremner JM, Mulvaney CS (1982) Total nitrogen. In: Page AL, Miller RH, Keeney DR (eds) Methods of soil analysis part 2, 2nd edn, Monograph no 9. American Society of Agronomy, Soil Science Society of America, Madison, pp 149–158
- Cooper PTM, Gregory PJ, Tully D, Harris HC (1987) Improving water use efficiency in rain fed conditions in northern Syria. *Field Crops Res* 16:67–84
- Dicko MH, Gruppen H, Traore AS, Voragen AGJ, Berkel WJH (2006) Sorghum grain as human food in Africa: relevance of content of starch and amylase activities. *Afr J Biotechnol* 5(5):384–395
- Dile YT, Karberg L, Temesgen T, Rockstrom J (2013) The role of water harvesting to achieve sustainable agricultural intensification and resilience against water related shocks in sub-Saharan Africa. *Agric Ecosyst Environ* 181:69–79
- D’Odorico P, Porporato A (2006) Ecohydrology of arid and semiarid ecosystems: an introduction. In: D’Odorico P, Porporato A (eds) Dryland ecohydrology. Springer, Dordrecht, pp 1–10
- Ejeta G, Butler LG, Babiker AG (1991) New approaches to the control of Striga. Striga research at Purdue University. Research bulletin RB-991: 27. Purdue University, Agriculture Experiment Station, West Lafayette
- Food and Agriculture Organization of the United Nations (1987) Committee on agriculture (Ninth session). Improving productivity of dryland areas. FAO, Rome. <http://www.fao.org/docrep/meeting/027/z1908e.pdf>. Accessed Dec 2013
- Food and Agriculture Organization of the United Nations (1998) Agriculture database. FAO Committee on Commodity Problems, Rome
- Food and Agriculture Organization of the United Nations (2010) The state of food insecurity in the world. Addressing food security in protracted crises. FAO, Rome
- Food and Agriculture Organization of the United Nations, World Fund Programme, International Fund for Agricultural Development (2012) The state of food insecurity in the World 2012. Economic growth is necessary but not sufficient to accelerate reduction of hunger and malnutrition. FAO, Rome. <http://www.fao.org/docrep/016/i3027e/i3027e00.htm>. Accessed Feb 2014
- Gee GW, Bauder JW (1986) Particle size analysis. In: Page AL, Miller RH, Keeney DR (eds) Methods of soil analysis part 1, 2nd edn, Monograph no 9. American Society of Agronomy, Soil Science Society of America, Madison, pp 383–409
- Hatibu N, Mutabazi K, Senkondo E, Msangi A (2006) Economics of rain water harvesting for crop enterprises in Africa. *Agric Water Manag* 80:74–86
- Hoogmodel WB, Stroosnijder L, Hillel D (1984) Crust formation on sandy soils in the Sahel. *Soil Tillage Res* 4:5–23
- IISD (2006) Arid and semi-arid lands: characteristics and importance. <http://www.iisd.org/casl/asalprojectdetails/asal.htm>
- Karrar AB, Mohamed HI, Elramlwai HR, Saeed AB, Idris AE (2012) Effects of some in-situ water harvesting techniques on soil moisture and sorghum (*Sorghum bicolor* (L.) Moench) production in northern Gedaref state. *Glob J Plant Ecophysiol* 2:54–66
- Lobell DB, Cassman KG, Field CB (2009) Crop yield gaps: their importance, magnitudes and causes. *Annu Rev Environ Resour* 34:1–27. doi:10.1146/annurev.environ.041008.093740

- Maestre FT, Reynolds JF, Huber-Sannwald E, Herrick J, Stafford-Smith M (2000) Understanding global desertification: biophysical and socioeconomic dimensions of hydrology. Chapter 18. In: D'Odorico P, Porporato A (eds) *Dryland ecohydrology*. Springer, Dordrecht, pp 315–332
- McHugh OV, Steenhuis TS, Fernandes ECM (2007) Performance of in situ rain water conservation tillage techniques on dry spell mitigation and erosion control in the drought-prone North Wello zone of Ethiopian highlands. *Soil Tillage Res* 97:19–36
- McLean, EO (1982) Soil pH and lime requirement. In: Page et al (eds) *Methods of soil analysis part 2*, 2nd edn, Monograph no 9. ASA, SSSA, Madison, pp 199–224
- Mmbaga TE, Lyamchai CY (2001) Drought management options for maize production in Northern Tanzania. Selian Agriculture Research Institute, Arusha
- Monyo ES, Ngereza J, Mgonja MA, Rohrbach DD, Saadan HM, Ngowi P (2004) Adoption of improved sorghum and pearl millet technologies in Tanzania. International Crops Research Institute for the Semi Arid Tropics, Bulawayo, 28 pp. [http://www.icrisat.org/Publications/EBooksOnlinePublications/Publications-2004/2004\\_Adoption1.pdf](http://www.icrisat.org/Publications/EBooksOnlinePublications/Publications-2004/2004_Adoption1.pdf)
- Mwaliko RBM (2001) Effect of residual tie-ridging on soil physical factors and sorghum yield in semi-arid central Tanzania. Dissertation, Sokoine University of Agriculture
- Nelson DW, Sommers LE (1982) Total carbon, organic carbon and organic matter. In: Page AL, Miller RH, Keeney DR (eds) *Methods of soil analysis part 1*, 2nd edn, Monograph no 9. American Society of Agronomy, Soil Science Society of America, Madison, pp 561–1010
- Olsen SR, Sommers LE (1982) Phosphorus. In: Page AL, Miller RH, Keeney DR (eds) *Methods of soil analysis part 1*, 2nd edn, Monograph no 9. American Society of Agronomy, Soil Science Society of America, Madison, pp 403–430
- Oswald A (2005) Striga control—technologies and their dissemination. *Crop Prot* 24:333–342
- Rwehumbiza FBR (1987) Plant-water status and grain yield of maize (*Zea mays L.*) in relation to soil water status at Morogoro, Tanzania. Dissertation, Sokoine University of Agriculture
- Salas JC, König KW, Lo A (2009) Rainwater harvesting providing adaptation opportunities to climate change. In Barron J (ed) *Rainwater harvesting: a lifeline for human well-being*. A report prepared for UNEP by Stockholm Environment Institute York, UK/Stockholm Resilience Centre, Stockholm. ISBN: 978-92-807-3019-7. [http://www.unwater.org/downloads/Rainwater\\_Harvesting\\_090310b.pdf](http://www.unwater.org/downloads/Rainwater_Harvesting_090310b.pdf)
- Sidahmed AE (2000) The rangelands of arid/semiarid areas: challenges and hopes for the 2000s. <ftp://ftp.fao.org/docrep/nonfao/LEAD/X6189e/X6189e00.pdf>
- Soil Survey Staff (2006) *Keys to soil taxonomy*, 10th edn. U.S. Department of Agriculture Natural Resources Conservation Service, Washington, DC
- Sutherland RA, Bryan RB, Wijendes DO (1991) Analysis of the monthly and annual rainfall climate in a semi-arid environment, Kenya. *J Arid Environ* 20:257–275
- Swai EYA (1999) Effects of residual tie-ridging and farm yard manure application on soil water status and yield of sorghum in semi-arid areas: a case study in Hombolo, Dodoma-Tanzania. Dissertation, Sokoine University of Agriculture
- Tesfahunegn GB (2012) Effect of tillage and fertilizer practices on sorghum production in Abergelle area, Northern Ethiopia. *Momona Ethiop J Sci* 4:52–69
- Thomas GW (1982) Exchangeable cations. In: Page AL, Miller RH, Keeney DR (eds) *Methods of soil analysis part 1*, 2nd edn, Monograph no 9. American Society of Agronomy, Soil Science Society of America, Madison, pp 159–165
- van Ittersum MK, Cassman KG, Grassini P, Wolf J, Tittonell P, Hochman Z (2013) Yield gap analysis with local to global relevance—a review. *Field Crop Res* 144:4–17
- Vohland K, Barry B (2009) A review of in situ rainwater harvesting (RWH) practices modifying landscape functions in African dry lands. *Agric Ecosyst Environ* 131:119–127
- WFP (2007) Executive brief: Tanzania Comprehensive Food Security and Vulnerability Analysis. Available at: <http://documents.wfp.org/stellent/groups/public/documents/ena/wfp119800.pdf>. Accessed Mar 2014
- Wim B, Stern R, Coe R, Matere C (2007) *GenStat discovery for everyday use*, 4th edn. ICRAF, Nairobi, p 117
- Zougmore R, Zida Z, Kambou NF (2006) Role of nutrient amendments in the success of half-moon soil and water conservation practice in semiarid Burkina Faso. *Soil Tillage Res* 71:143–149

**Part V**  
**Rehabilitation of Degraded Land Through**  
**Forestry and Agro-Forestry**

# Chapter 14

## Restoration of Degraded Lands Affected by Salinization Process Under Climate Change Conditions: Impacts on Food Security in the Senegal River Valley

Mateugue Diack, T. Diop, and R. Ndiaye

**Abstract** With the progressive degradation of agricultural lands due to climate change, there is a need to document how land responds to management practices and their resilience to salinization processes. Salinization is a problem associated with agriculture and it constitutes a constraint which results in inappropriate practices. In addition, agriculture intensification and changes in temperature and precipitation patterns expected from climate change are likely to affect the salt-water balance of fragile ecosystems. Information on the relationship between climate change and salt-affected land salinization processes is scattered. Little has been done to highlight the most affected or vulnerable areas or to promote practices that can be used to adapt agricultural production in fragile areas to climate change. This study will contribute to food security and reducing the stress on ecosystems. This study relates land management practices to lands degraded and salinized due to climate change. Several land management practices have been used to evaluate the level of restoration of degraded lands. Changes in temperature, relative humidity, evaporation, solar radiation, and soil temperature combined with agricultural management practices driven by different cropping systems were used to evaluate the best and most adapted management practices for degraded lands that are dedicated to agriculture. Results suggest that regular seasonal cropping under irrigation might be recommended for degraded lands to assure sustainable food security.

**Keywords** Climate change • Agriculture • Degraded land • Salinization • Food security

---

M. Diack (✉)

UFR des Sciences Agronomiques, d'Aquaculture et de Technologies Alimentaires,  
Université Gaston Berger, Saint-Louis, Senegal  
e-mail: [mateugue.diack@ugb.edu.sn](mailto:mateugue.diack@ugb.edu.sn)

T. Diop

UFR des Sciences Economiques et de Gestion, Université Gaston Berger, Saint-Louis, Sénégal

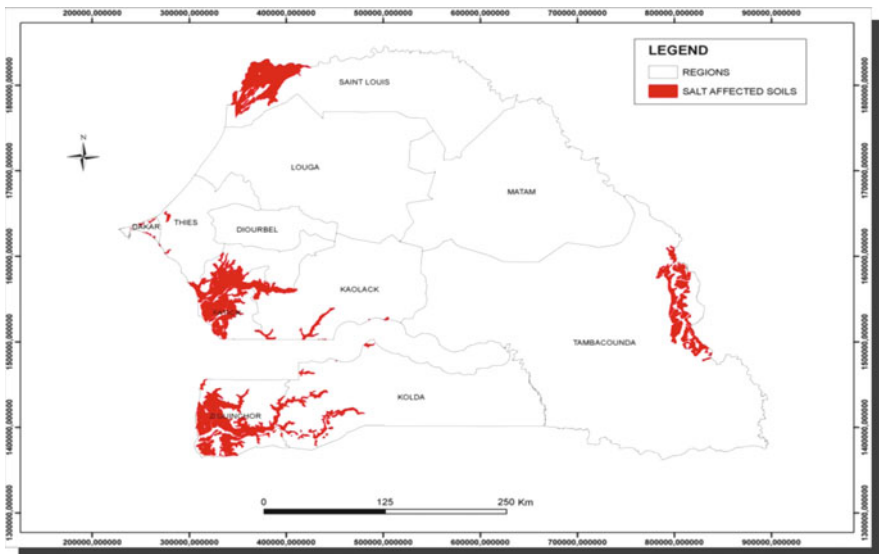
R. Ndiaye

Agricultural Research Institute of Senegal, Thies, Senegal

## 14.1 Introduction

Land degradation due to salinization has revealed negative interactions that have been developing for decades from an increase in population and a decrease of crop production in developing countries. This has aggravated inequalities in food production across regions (Parry et al. 2005). Moreover, food insecurity is likely to increase with climate change unless early warning systems and development programs are used more effectively (Brown and Funk 2008).

Developing countries in sub-Saharan Africa are more vulnerable because of the dominance of agriculture in their economies, the scarcity of capital for adaptation measures, warmer baseline climates, and heightened exposure to extreme events (Tubiello and Fischer 2007, 2013; Brown and Funk 2008). Soils affected by salinization processes have become a major environmental issue. Nearly 800 million hectares of land worldwide, more than 6 % of the total surface area of lands, are affected by salinization processes. In addition, climate changes aggravate losses of arable lands in the arid and semi-arid zones (Boivin and Le Brusq 1985). In Senegal, estimated total lands affected by salinization processes are 1,000,000 ha to 1,700,000 ha (Gobin et al. 2003; Sadio 1991). More recent studies conducted by the National Institute of Pedology in Senegal (2008) have estimated the total land affected by salinization processes at 996,950 ha (Fig. 14.1). The same studies underlined that the level of salinization requires setting up strategy control the phenomenon and determining the origin or the source of the salt within the considered soil. Those studies did not identify the arable surface area affected by



**Fig. 14.1** Distribution of the affected zones by salinization processes (Source: National Institute of Pedology 2008)



**Photo 14.1** Soil degradation due to salinization process (T. Diop)

the salinization process or indicate the sources of specific salinization processes for any surface area listed.

Salinization processes are near to irreversible in the case of heavy-textured soils with high levels of swelling clay (Marius 1995; Sadio 1986). The nature of the salt, the plant species, and even the individuality of the plant (e.g., structure and depth of the root system) determine the concentration of soil-salt levels at which a crop or plants will succumb (Photo 14.1). Consequently, there has been a progressive reduction of crop production regardless of whether it is for industrial or feeding purposes (Diop 2013). Therefore, improving and maintaining croplands to improve crop productivity are critical when techniques are adapted to restore lands affected by salinization processes (Marius 1985). Although a combination of efficient drainage and flushing of the soil by water is often used, the leaching of salts from the profile is rarely effective (Boivin et al. 1995, 1998). Because the reclamation, improvement, and management of salt affected soils necessitate complex and expensive technologies, all efforts must be taken for the efficient prevention of these harmful processes (Lal 2000).

Adequate soil and water conservation practices based on a comprehensive soil or land degradation assessment can become an early warning system that provides possibilities for efficient salinity (or alkalinity) control, the prevention of these environmental stresses, and their undesirable ecological, economic, and social consequences (Le Brusq and Loyer 1983). As adaptation practices refer to actual adjustments or changes in decision environments, which might ultimately enhance resilience or reduce vulnerability to observed or expected changes in climate, a changing climate will result in considerable changes in natural vegetation and in land use practices (Adger et al. 2007). These changes in turn result in a feedback effect on the climate, which considerably affects the field water cycle and soil formation/degradation processes (Lal and Stewart 1994; Lal et al. 1989; Várallyay 2007; Harnos and Csete 2008; Várallyay and Farkas 2008). The integral influence of climate, hydrology, and vegetation land use changes are reflected by the field

water balance and soil moisture regimen (Várallyay 1990, 1994, 2009; Farkas et al. 2008). Climate change and its hydrological consequences may result in the significant modification of soil conditions (Várallyay 2010). Changes in temperature, precipitation, natural vegetation, and land use practices will result in significant changes in crop production. In addition, climatic changes exacerbate the loss of woody lands in the arid and semi-arid regions (Zeng 2003). Soil salinity is also a serious problem in areas where the groundwater of high salt content is used for irrigation. The most serious salinity problems are faced by the irrigated arid and semi-arid regions of the world, and it is in these very dry regions that irrigation is essential to increase agricultural production to satisfy food requirements. The problem of soil degradation is a serious threat to the welfare of mankind. Although degradation of the land has always characterized man's systematic use of it, the process has accelerated in recent decades, precisely at a time when population growth and rising expectations have begun to demand enormous increases in food production. The issue is of overwhelming urgency. As the soil is subject to degradation, the cost of reclaiming it becomes higher, rising sharply until the threshold beyond which reclamation is no longer economically feasible is passed. Nearly 50 % of the irrigated land in the arid and semi-arid regions has some soil salinization problems. It is generally agreed that the future food needs of the increasing population will be met by directing the efforts of all concerned stakeholders (Le Gal 2001). D'aquino-Passouant (1995) studied the salinization process of the soils and noticed essentially two issues: the drainage of water and the rising of salt by capillarity. He revealed that the first process depended mostly on the nature and type of soil, as percolation of the vertisols and alfisols varied from 1 to 3 mm/day. Rising water by capillarity was due to the presence of shallow and high in salt groundwater that probably occurred during different periods of sea transgressions and regressions 2,000 years (before JC). This left a high quantity of soluble salt that remained at the fossil state in the soil of the delta, which explains the origin of the saline groundwater (Ceuppens and Wopereis 1999). Cropping systems are also responsible for rapid degradation of the soils of the delta as well as most of the abandoned private farms (Breman and Sissoko 1994; Dunia 1995). Loyer (1989) underlined that a converted system for irrigation without drainage and rice cultivation under permanent flooded conditions helps the desalinization process first for the soils and then for the groundwater. This induced and unexpected alkalization of these soils due to a rise in the groundwater in which movements are not well controlled. This raises the issue of evacuating drainage water. Sadio (1991) described a similar process with the tanns of Sine Saloum, which are characterized by a remarkable heterogeneity due to their morphology and physical and chemical properties. Their characteristics are closely related to topography, type of material, and hydrology (Sy 2008). Since 1971, their pedogenetic evolution has led to a severe drought all over the country, particularly in the fluviomarin fields (Michel 1973). This has led to dramatic consequences for the social and ecological environment (Enda 1986). Moreover, insufficient rainfall induced by the aridness of the climate has triggered and amplified salt concentration and acidification of the soils all over the area. This salt concentration, which was spread out a little bit few decades ago, has quickly reached all soils, from the terrace up to the linked

**Photo 14.2** A rice field under optimal management practices



colluviums. Data collected from the surveys conducted in several villages along the arm of the river showed that according to farmers, rice cultivation was the best management practice for restoring degraded salt affected lands because of its rooting system, its capacity to grow under flooded conditions, and its ability to be a salt tolerant crop (Photo 14.2).

However, irrigation is often costly and technically complex, and it requires skilled management. Failure to apply efficient principles of water management may result in the wastage of water through seepage; over-watering and inadequate drainage create waterlogging and salinity problems that reduce the soil productivity, eventually leading to loss of cultivable land. The problems of salt-affected soils are old, but their magnitude and their intensity have been increasing fast due to large-scale efforts to irrigate additional areas in recent decades. The problems have been made worse by scaling up the irrigation systems without adequate provision for drainage, and they are being aggravated by poor water management practices and unsound reclamation procedures. The general characteristics and basic principles involved in the identification, reclamation, and management of salt-affected soils are the same throughout the world. In the delta of the Senegal River where the study took place, the salinity of the soils is a real issue with an anthropic origin. This issue touches the low and middle delta of the River Valley. The objective of this study was to (1) analyze the dynamics of salinization process as related to climate change and (2) compare different management practices to remediate saline soils for rice cropping.

## 14.2 Materials and Methods

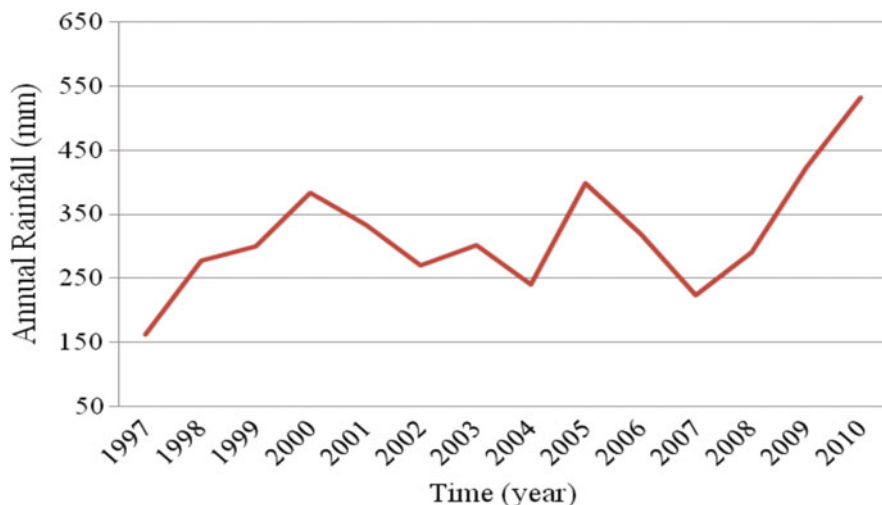
The site was located in the upper limit of the delta of the Senegal River Valley. Over 900 ha of land with different soil orders identified as Inceptisol (18 %), Vertisol (36 %), Alfisol (14 %), and Aridisol (30 %) were severely affected by the



salinization process (Soil Survey Staff 1992). To restore the degraded soils, different management practices were compared to determine the most efficient one that can be readily adopted by farmers. They consisted of (1) abandoning lands with no watering and no cropping (T1); (2) leaching followed by rice cropping (T2); (3) leaching followed by continuous rice cropping (T3); (4) leaching followed by crop rotation with rice, sugarcane, and fallow (T4); and (5) leaching followed by continuous rice cropping over years (T5). The leaching process consisted of watering the plots with an amount of water that dissolved the accumulated salts in the soil to make them move downward to the root zone or shallowly wash the soil from the salt. The leaching process was the same as for all management practices except for the “abandoned plot.” Plots receiving leaching treatments were arranged in bands of 0.7 ha separated by small flood banks. The dimensions of the bands differed from one plot to another. This way of turning plots into smaller bands ensured good coverage of the soil with a film of water and thus established the correct homogeneity of the plot. The watering by band consisted of having each band receive water up to a 40 cm height. In general, the frequency of watering was once every 25–30 days. After watering twice, the plot was dried out for 10 days before soil sampling at 0–20 and 20–30 cm for analysis in the laboratory. Once the soil sampling was done and the experimental design was set up, water was added to the plots. Each band was watered up to a 40 cm height. Watering was done while controlling the level of the water table with piezometers installed in the plots. This management could not proceed without knowing the physical and chemical characteristics of the soils. The idea was then to proceed with watering in a way that had one part of the salt percolate downward to be collected by the buried drains; the other part rose up by capillarity towards the shallow zone of the soil and was drained out towards the open drains. During leaching, water was sampled regularly from the plots, the buried drains, the open drains, and from irrigation. Changes in soil salinity concentration were measured by electrical conductivity (EC) at a 1:5 soil to water ratio. Likewise, soil acidity was measured by soil  $\text{pH}_{\text{water}}$  at a 1:5 soil to water ratio.

### 14.3 Results and Discussion

In the delta of the Senegal River, salinization of the lands is one of the biggest constraints farmers are facing. This salinization process results in two phases that are characteristic of the evolution of the environment during the Nouakchotian transgression and the drought periods of the 1970–1980. During that time, marine transgression polluted the groundwater of the delta. Afterward, these waters became highly concentrated due to the fossilization of the salt. Indeed, the weakness of the flow strongly penalized traditional farming in the flooding zones as well as breeding in the falling areas. Moreover, such process favored the rising of the salty water in the bed of the river in more than hundred kilometers from the mouth



**Fig. 14.2** Changes in mean annual rainfall over time (Source: CSS Weather Station 2011)

of the river (Guillaumie et al. 2005). This rising action led to the construction of the Diama dam in 1986 to stop the saline intrusion and develop cropping systems under irrigation. However, if water softening is a major factor in the delta, the dam is causing the reverse process in zones in the drainage basins and in certain agricultural racks where irrigation practices have no drainage systems and are not well conducted. In the delta, itinerant agriculture reduces the potential for tenure, mainly in the Boudoum zone and Lake Guiers. From a social point of view, this work will cause collective awakening of the impact of these techniques on the environment and therefore on the socio-economic activities of the populations living around the lake. Through this awakening, they should reach self-sufficiency in rice and vegetable cropping in the Dieri upland zone. The physical factors influencing the salinization processes are rainfall, temperature, relative humidity, wind speed, solar radiation, total evaporation, and population. Therefore, a monitoring process was set up and run from 1997 to 2010.

Figure 14.2 shows that the geographical location of the delta in the Sahelian region has two seasons with contrasting rainfall patterns in the range of 200–400 mm. There is a short rainy season of 2–3 months and a dry season of 9–10 months.

During the same period, mean annual temperatures were above 25 °C. There were extreme temperatures from 26.2 °C in 1999 to 29.1 °C in 2007 (Fig. 14.3). An analysis of these data revealed that temperatures were higher than that usually recorded. Maximum temperatures were above 34 °C, and the range was significant. During that period, temperatures ranged from 14.5 to 17 °C.

The relative humidity was strongly influenced by the continental location and marine bangs (Ciss 2002). Analysis of the data over the last 12 years showed high

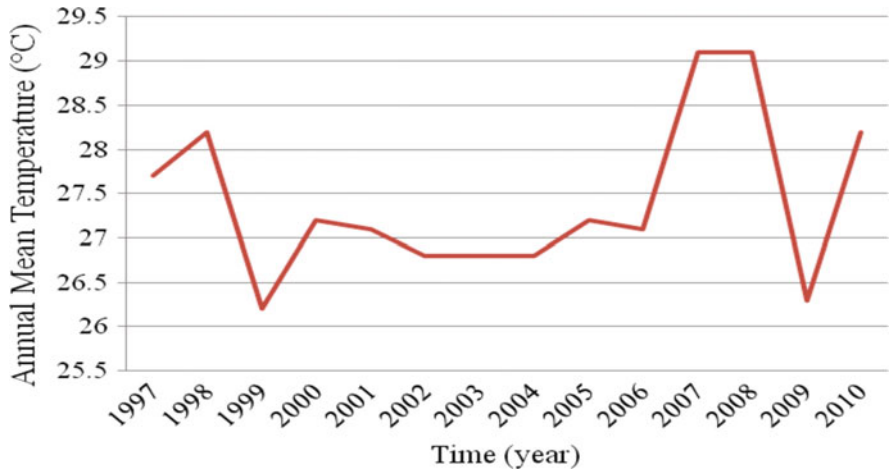


Fig. 14.3 Changes in annual mean temperature over time (Source: CSS Weather Station 2011)

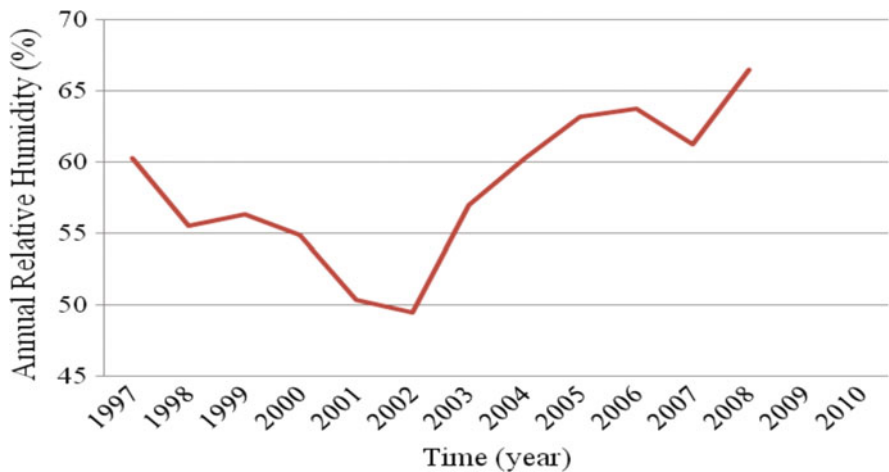


Fig. 14.4 Changes in relative humidity, 1997–2008 (Source: CSS Weather Station 2011)

humidity, from 49.45 % in 2002 to 66.54 % in 2008 (Fig. 14.4). The highest values were noted between 2004 and 2008.

Observations of all parameters seem to indicate that the period of sunshine determines evaporation. Indeed, the highest evaporation data were related to the maximum number of hours of sunshine, and this occurred during the years with high evaporation demand. This is the case for 2004 (Figs. 14.5 and 14.6). With less rainfall and high temperatures over the period between 2005 and 2010, these

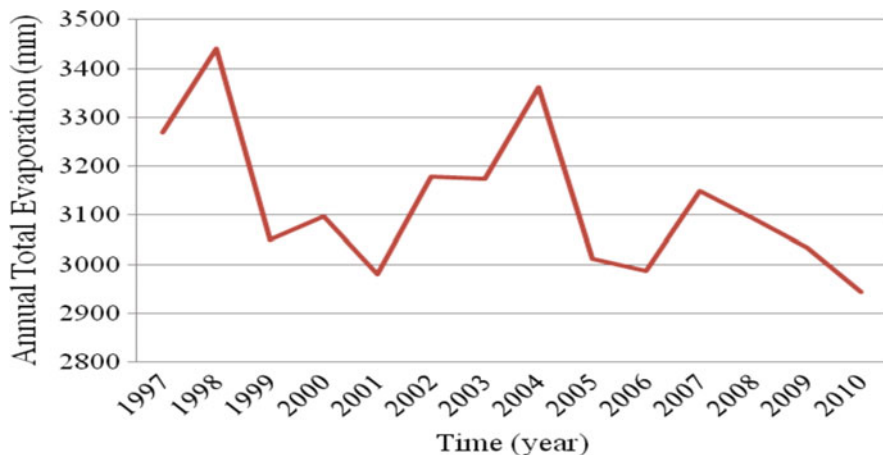


Fig. 14.5 Changes in total evaporation over time (Source: CSS Weather Station 2011)

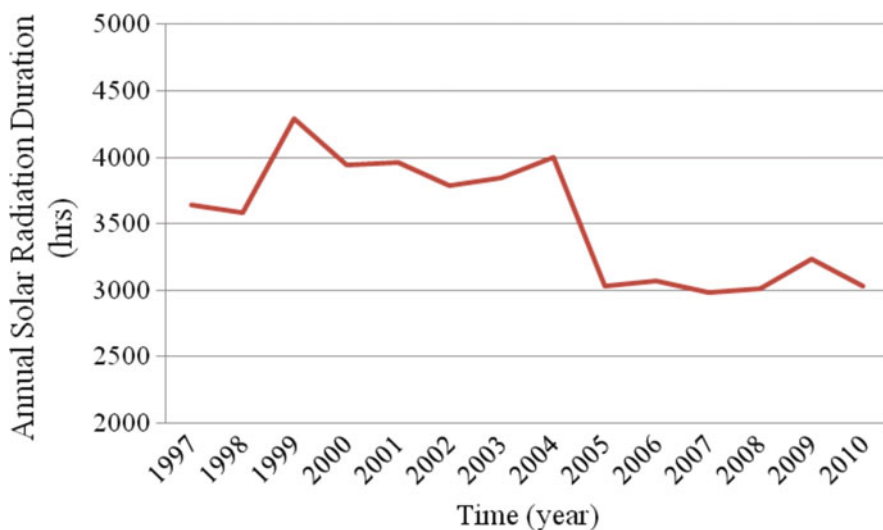


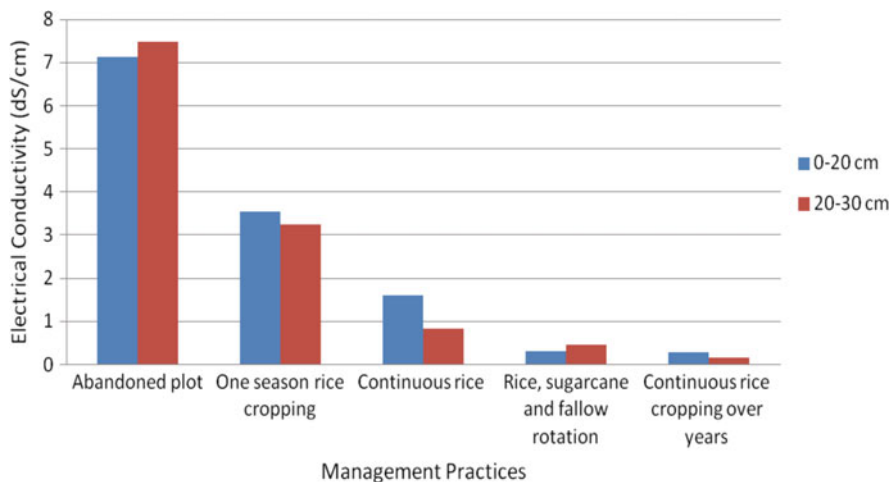
Fig. 14.6 Changes in annual solar radiation duration over time (Source: CSS Weather Station 2011)

temperatures were almost stable (close to 35 °C for  $T_{max}$ ), which is evidence of the climate change effect on the Sahelian zone. During this 6-year period, year 2008 recorded a shorter duration of sunshine, with 2,825 h.

Climatic parameters and geomorphology are among other biophysical factors that influence the salinization process in the field. Aridification of the soils from in the Sahelian zone, which took place in 1960, may result from a long climate

modification process, characterized by two big scourges in 1972–1973 and 1984–1985. Thus, changes in the sedimentary regimen in the climatic context of the Sahelian zone raised fossil salts through thermocapillarity. Such salinity levels may be favored by the shallow depth of the groundwater, which is usually in contact with the plant roots due to inadequate irrigation and a maladapted drainage system. The amount of water added to better leach a saline rooting zone depends mainly on the initial level of salinity of the soil, the soil texture, and the leaching technique used. Nevertheless, findings from the work done by Charollais and Weber (1994) did not agree with previous diagnoses. They indicated a significant decrease in the (EC) at the surface and at depths for the cultivated soil, without significant changes in exchangeable Sodium percentage (ESP). This decrease in EC is illustrated by the changes in chlorides and sodium in solutions. In conjunction with this, the level of exchangeable sodium did not change significantly, but a significant decrease of the exchangeable potassium was noticed. This decrease in EC was also observed in the delta of Senegal. Wopereis et al. (1999) confirmed that rice cultivation, whether it was drained or not, led to a desalination of the shallow layers. On irrigated rice, the presence of film water at the surface, with lower concentration, made a lateral evacuation of the salts possible along with the blocking the capillary increase in the saline in saline water and deep groundwater. In the fields alternating between cropping under dry conditions and rice cultivation, the crops grown for diversification, such as tomatoes or onions, were largely grown in irrigated fields for the villages or for private use, and most of these fields did not have a drainage system. The crops grown for diversification are mainly grown in the village's irrigated perimeters or in private perimeters, most of which do not have drainage systems. In spite of their filtering soils and unsuitability for rice cultivation-according to the extension agents and agents from development projects-farmers sometimes grow rice in these types of soils. This will allow for a leaching of the accumulated salts after few years of vegetable cropping. Before planting the crop, salt leaching was essentially done in the shallow water film and showed the effect of a flooding and evacuation cycle on changes in salinity of the surface horizon. Leaching by flooding showed that it was possible to obtain remarkable results. These results were encouraging and were obtained using a very rigorous soil and water management system for irrigation and drainage. By combining irrigation and cropping, convenient trends in the desalination process were obtained. The set of management practices used produced different results with an overall decrease in salinity levels. The abandoned plot treatment (Fig. 14.7) showed the highest salt content of 7.12 and 8.82 dS cm<sup>-1</sup> at the soil surface (0–20 cm) and at the subsoil level (20–30 cm), respectively. Non-cultivated soils have a salinity level with chlorine and are totally saturated with sodium at deeper levels and are equally split into sodium, calcium, and magnesium at the surface.

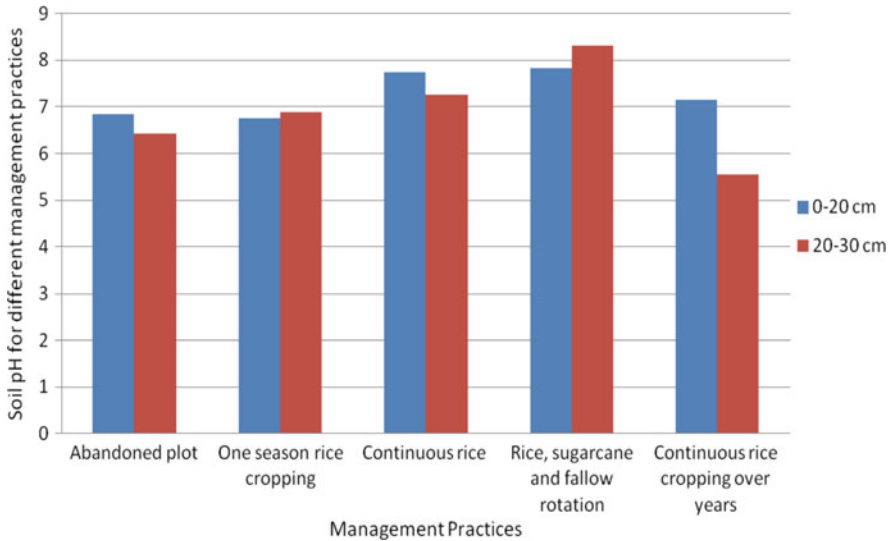
The first prospection (Poitevin 1993) showed an increase in the electric conductivity (EC) in the irrigated fields in the studied zone. With the other management practices where irrigation, leaching, and cropping are combined, a gradual but significant decrease in soil salinity content was noticed (Fig. 14.7). At the shallow



**Fig. 14.7** Changes in electrical conductivity between management practices

level (0–20 cm), the salinity level measured by  $EC_{1/5}$  showed a decrease from 3.54 to 0.17  $dS\ cm^{-1}$  in the four other management practices that went from leaching followed by rice cropping (T2) to rice cropping in the regular season (T5). The mean concentration of the salinity in the plots under leaching with different croppings varied from 0.28 to 3.54.00  $dS\ cm^{-1}$  for the 0–20 cm horizon (Fig. 14.7). For the 20–30 cm layer also, for all plots, a noticeable decrease in salt concentration was observed (3.24–0.17  $dS\ cm^{-1}$ ) except for the abandoned plot (T1) where there was a saline rise through capillarity and an increase in salt concentration due to intense evaporation. At the shallow soil depth, this decrease was estimated to be 47.26 % between T1 and T2, 45.48 % between T2 and T3, 81.37 % between T3 and T4, and 6.67 % between T4 and T5. A comparison of these results with those from previous studies showed a noticeable decrease in the level of salinity. At a greater depth, the soil salinity decrease was estimated to be 63.27 % between T1 and T2, 74.30 % between T2 and T3, 44.57 % between T3 and T4, and 84.78 % between T4 and T5. The study showed that it is possible to leach soluble salts initially present in saline profile up to 70 % by using an amount of water equivalent to 1/3 the thickness of the soil. This improves if the immersion continues with enough drainage water (Hoffman 1980). Data have showed that with rice cultivation over years and a good drainage system, desalinization of the land can be achieved.

Leaching combined with different cropping systems, such as management practices to restore degraded soils affected by salinization processes, showed that from the soil surface to a shallow depth, soil acidity was close to neutral with a pH range of 6.75–7.27 (Fig. 14.8). At a greater depth (20–30 cm), data showed acidic soil. At any rate, soil pH at both depth levels presented optimal conditions for cropping after leaching processes were conducted.



**Fig. 14.8** Changes in soil pH between management practices

## 14.4 Conclusion

Desalinization techniques used for 2 years showed convincing results not only for restoring degraded soils for better cropping but also for improving the socio-economic environment through an increase of agricultural land tenure for food security. The positive impact of leaching saline soils was noticed in the gradual increase in arable land and thus potential for crop production and improvement in soil quality. Once recovered from salinization, these lands can represent the most suitable zones for cropping compared to the uplands. Globally, desalinization through rice cultivation presents an economic and ecological cost, which should be taken into account when it comes to restoring degraded salty soils for crop production.

## References

- Adger WN, Agrawala S, Mirza MMQ, Conde C, O'Brien K, Pulhin J, Pulwarty R, Smit B, Takahashi K (2007) Assessment of adaptation practices, options, constraints and capacity. In: Parry ML, Canziani OF, Palutikof JP, van der Linden PJ, Hanson CE (eds) *Climate change 2007: impacts, adaptation and vulnerability. Contribution of Working Group II to the Fourth Assessment Report of the Intergovernmental Panel on Climate Change*. Cambridge University Press, Cambridge, pp 717–743
- Boivin P, Le Brusq JY (1985) Désertification et salinisation des terres au Sénégal: problèmes et remèdes. In: Séminaire national sur la désertification. ORSTOM, Dakar 5 p. multigr. Séminaire National sur la Désertification, Saint-Louis (SEN), 22–26 April 1985

- Boivin P, Brunet D, Gascuel C, Zante P, et Ndiaye JP (1995) Les sols argileux de la région de Nianga-Podor: répartition, caractéristiques, aptitude et risques de dégradation sous irrigation. In Nianga, laboratoire de l'agriculture irriguée dans la moyenne vallée du fleuve Sénégal, ORSTOM, coll. Colloques et Séminaires, Paris, France, pp 67–81
- Boivin P, Favre F, Maeght JL (1998) Les sols de la moyenne vallée du fleuve Sénégal: caractéristiques et évolution sous irrigation. *Etude et Gestion des Sols* 5:235–246
- Breman H, Sissoko K (1994) L'intensification agricole au Sahel. Karthala, Paris, p 975
- Brown ME, Funk C (2008) Food security under climate change. *Science* 319:580–581
- Ceuppens J, Wopereis MCS (1999) Impact of non-drained irrigated rice cropping on soil salinization in the Senegal River Delta. *Geoderma* 92:125–140
- Charollais M, Weber V (1994) Evolution des sols irrigués dans la moyenne vallée du fleuve Sénégal. Sodisation et alcalinisation. Mémoire de fin d'études EPFL, Département de Génie Rural, IATE, Option Pédologie, p. 46 et annexes
- Ciss AH (2002) Contribution à l'étude du bilan hydrique de la canne à sucre dans les périmètres irrigués de la CSS, mémoire de maîtrise. Université Gaston Berger, Saint-Louis
- D'Aquino P (1995) Etude de la salinité à Thiagar par l'utilisation d'un conductivimètre électronique. ISRA, Saint-Louis, p 29
- Deckers J, Raes D, Merckx R, Diallo AM (1994) The fate of salic and thionic fluvisols under irrigated rice in the Senegal river delta. *Pedologie* XLIII-3:389–401
- Diop T (2013) Les techniques de désalinisation des terres de la Compagnie Sucrière Sénégalaise: impact sur l'environnement. Mémoire de Master. Ecosystèmes et Environnement. Université Gaston Berger de Saint-Louis, Saint-Louis, Sénégal, p 85
- Dunia T (1995) Suivi de la salinisation dans les périmètres irrigués par télédétection et système d'information Géographique. p 136
- Enda (1986) Enjeux de l'après barrage vallée du Sénégal. p 632
- Farkas CS et al (2008) A chernozem soil water regime response to predicted climate change scenarios. *Soil Water Res* 3(Special Issue 1):558–567
- Gobin A, Jones R, Kirkby M, Campling P, Govers G, Kosmas C, Gentile AR (2003) Indicators for pan-European assessment and monitoring of soil erosion by water. *Environ Sci Policy* 7(1):25–38
- Guillaumie K et al (2005) La sécheresse au Sahel, un exemple de changement climatique. Atelier Changement Climatique ENPC-Département VET, p 40
- Harnos ZS, Cséte L (2008) Climate change: environment–risk–society. Research results. Szaktudás Kiadó Ház, Budapest, 380pp (In Hungarian)
- Hoffman GJ (1980) Guidelines for reclamation of salt-affected soils. In: Proceedings of the Inter-American Salinity and Water Management conference, Juarez, Mexico, 11–12 Dec 1980, pp 49–64
- Institut National de Pédologie (2008) Estimation des terres affectées par le processus de salinisation au Sénégal. Rapport annuel. p 38
- Lal R (2000) Soil management in the developing countries. *Soil Sci* 165:57–72 [27]
- Lal R, Stewart BA (1994) Soil processes and water quality. In: Lal R, Stewart BA (eds) *Soil processes and water quality*. Lewis Publishers, Boca Raton, 398 pp
- Lal R, Hall GF, Miller FP (1989) Soil degradation: I. Basic processes. *Land Degrad Rehabil* 1:51–69 [13]
- Le Brusq JY, et Loyer JY (1983) Evolution de la salinité des sols et des eaux en relation avec la riziculture submergée dans le delta du fleuve Sénégal (campagne 1981–1982). ORSTOM, Dakar, Sénégal, p 18
- Le Gal P-Y (2001) Gestion des systèmes de culture et organisation collective de la production: élaboration d'une démarche d'aide à la gestion des périmètres irrigués. ATP 10/98, p 14
- Loyer JY (1989) Dégradation saline des sols induite par l'irrigation en domaine sahelien. ORSTOM, Paris, pp 531–539



- Marius C (1985) Contribution à l'étude des mangroves du Sénégal et de Gambie. Ecologie-pédologie-géochimie. Mise en valeur et aménagement (Résumé de thèse), Thèse de doctorat en sciences—Ecologie de la Terre. Cahiers ORSTOM, Série Pédologie XXI, pp 12–131
- Marius C (1995) Effets de la sécheresse sur l'évolution des mangroves du Sénégal et de la Gambie. *Sécheresse* 6:123–125
- Michel P (1973) Les bassins des fleuves Sénégal et Gambie. Etude géographique. Mémoire de l'ORSTOM Paris, Tome 1. p 365
- Parry M, Rosenzweig C, Livermore M (2005) Climate change, global food supply and risk of hunger. *Philos Trans R Soc B* 360:2125–2138. doi:10.1098/rstb.2005.1751
- Poitevin F (1993) Etude d'impact des techniques culturales sur les aménagements hydro-agricoles dans la région de Podor (Sénégal), mémoire de quatrième année de l'ESAP, multigr. ORSTOM Dakar, p 53 et annexes
- Sadio S (1986) Etude pédologique des facteurs de mortalité des essences forestières introduites en milieux sales au Sénégal. In *Reboisement des Niayes et du Sine-Saloum*. ORSTOM, Dakar, Sénégal, p 105
- Sadio S (1991) Pédogénèse et potentialités forestières des sols sulfatés acides salés des tannes du Sine Saloum, Sénégal. ORSTOM, Bondy, p 269
- Soil Survey Staff (1992) Keys to soil taxonomy, 6th edn. United States Department of Agriculture, p 306
- Sy BA (2008) Dynamique Eolienne Actuelle Dans Le Delta Du Fleuve Sénégal. In: *Contribution A L'étude Géomorphologique Du Sénégal Septentrional*. Thèse De 3<sup>ème</sup> Cycle, Université Gaston Berger, Saint-Louis, Sénégal, p 251
- Tubiello FN, Fischer G (2007) Technological forecasting and social change, reducing climate change impacts on agriculture: global and regional effects of mitigation, 2000–2080, 74(7):1030–1056
- Tubiello FN, Fischer G (2013) Climate change impacts on global food security. *Science* 341(6145):508–513
- Várallyay G (1990) [Fertilizer - liquid manure - drinking water relationships] (H.e). *Egészseg-tudomány XXXIV*(2):126–137
- Várallyay G (1994) Climate change, soil salinity and alkalinity. In: Sounsevell MDA, Loveland RJ (eds) *Soil responses to climate change*, vol 23, NATO ASI series. Springer, London, pp 3–11
- Várallyay G (2007) Potential impacts of climate change on agro-ecosystems. *Agric Conspic Sci* 72(1):1–8
- Várallyay G (2009) The impact of climate change on soils and on their water management. Abstract Volume. Symposium and 3rd training course 'Climate change: challenge for training of applied plant scientist. Impact of climate change on crop production'. 'Agrisafe' (Martonvásár, 7–11 Sept, 2009). Agricultural Research Institute of HAS, Martonvásár, pp 6–15
- Várallyay G (2010) Soils as water reservoir and soil aridification. *Klíma* 21 Fuzetek (59):3–25
- Várallyay G, Farkas C (2008) Impact of climate change on soils in Hungary. In: Harnos Z, Csete L (eds) *Climate change: environment-risk-society*. Research results. Szaktudás Kiado Haz, Budapest, pp 91–129
- Wopereis MCS, Donvan C, Nebié B, Guindo D, Ndiaye MK (1999) Soil fertility management in irrigated rice systems in the Sahel and Savanna regions and West Africa. Part 1: agronomic analysis. *Field Crop Res* 61(2):125–145
- Zeng N (2003) Atmospheric science. Drought in the Sahel. *Science* 302:999–1000

## Chapter 15

# Tree Integration in Banana-Based Cropping Systems: A Case Study of Jinja, Uganda

Lukman Nagaya Mulumba

**Abstract** Bananas are a major staple crop and a source of livelihood for over seven million people in Uganda. However, productivity in many parts of the country has been declining over the past few years owing to low soil fertility as a result of nutrient mining among other causes. This has a negative effect on both household income and food security. Actual yields range from 10 to 25 Mg/ha/year compared to a potential yield of 70 Mg/ha. A study was conducted to assess the benefits and limitations of integrating trees in banana-based (*Musa* spp.) cropping systems in Uganda; 53 % of the farmers attributed the low yields to soil fertility decline, 25 % high fertilizer prices, and 49 % low availability of fertilizers.

The incorporation of coffee and *Ficus* trees in banana plantations was found to have several beneficial effects. The N content under the tree canopy (1,624 kg/ha) was significantly higher than outside the canopy (877 kg/ha) in the top soil. Similarly, the organic matter levels were found to be higher when trees were incorporated in the cropping systems. This was attributed to the high organic C levels under the tree crown (23.2 g/kg) compared to 16.2 g/kg outside the crown.

*Ficus* was found to have other beneficial effects. According to 85 % of respondents, these included its use as fodder. The shading effects of the trees helped to modify soil temperatures, which were found to be beneficial in the dry season. *Ficus* trees also provided shade for coffee trees hence modifying the microclimate. However, optimal spacing between the trees and the bananas needs to be determined in order to avoid unnecessary competition for nutrients and water.

This paper also discusses other shortcomings of the current land development strategies and identifies potential research needs. The active participation of the farmer in banana-based research is also highlighted for the sustainable use of the land resource.

**Keywords** *Ficus natalensis* • Banana • Nutrient mining • Nitisols • Shade tree • Agroforestry

---

L.N. Mulumba, Ph.D. (✉)

Department of Agricultural Production, Makerere University,

P.O. Box 7062, Kampala, Uganda

e-mail: [lmulumba@hotmail.com](mailto:lmulumba@hotmail.com)

## 15.1 Introduction

Uganda is the biggest producer of bananas (*Musa* spp.) in Africa and the second largest producer in the world—second only to India (Van Asten et al. 2008)—producing more than 10 million Mg of bananas per year. Bananas are grown across many different environments and farming systems in Uganda and form a stable food for more than seven million people in the country. Yields ranged from 10 to 25 Mg/ha/year as compared to a potential yield of 70 Mg/ha/year (Van Asten et al. 2005). However, yields have progressively declined over the years and threatened the livelihood of many people. Among the cited constraints is nutrient deficiency (INIBAP 2003) due to the subsistence nature of farming systems in which nutrients are rarely returned to the field. This is in agreement with Bekunda (1999), who observed that more than 75 % of the farmers in the Lake Victoria Crescent rarely use external inputs from the farm. The situation is made worse as a result of increased runoff and soil erosion. The rapid deterioration of soils in this farming system directly affects productivity and it perpetuates rural poverty. Similar constraints have been reported by Van Asten et al. (2008).

Limited use of agro inputs exists due to lack of capital, poor accessibility of agro inputs, and the belief that fertilizers damage soil quality and banana taste.

Based on these observations, a study was conducted with the objectives to:

- (i) Identify simple and affordable technologies geared at enhancing banana productivity in small holder banana-based farming systems, and
- (ii) Identify the constraints that could hinder the adoption of proven technologies.

## 15.2 Literature Review

### 15.2.1 Agroforestry

Agroforestry involves the integration of trees/shrubs with crops or livestock. Agroforestry systems can be advantageous over conventional agricultural and forest production methods. They can offer increased productivity, economic benefits, and more diversity in the ecological goods and services provided.

Batish et al. (2008) outlined some of the potential benefits of agroforestry as:

- Reducing poverty through increased production of wood and other tree products for home consumption and sale,
- Restoring soil fertility for food crops,
- Reduced nutrient losses and soil runoff,
- Reducing deforestation and pressure on woodlands by providing farm-grown fuel wood,
- Improving human nutrition through more diverse farm outputs, and
- Providing growing space for medicinal plants in situations where people have limited access to mainstream medicines.

Agroforestry makes use of the complementarity between trees and crops, so that the available resources can be more effectively exploited. Success of agroforestry is largely determined by the extent to which individual forest and agricultural components can be integrated to help rather than hinder each other. The choice of tree and crop species combinations is critically important when setting up systems. This then implies that care must be taken to ensure that the tree–mix does not compete but complement each other.

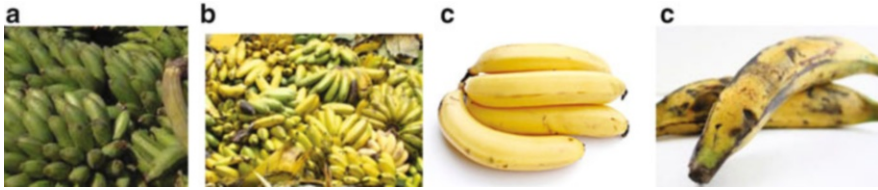
Through falling litter, atmospheric input, and nutrient extraction from deep soil layers, trees can contribute to soil fertility maintenance. Agroforestry systems improve soil fertility in various ways. Trees increase soil organic matter (SOM) through the turnover of decaying fine roots, which is an important source of nutrients. Several researchers have found significantly higher nutrient contents of N and P under various tree canopies compared to outside the tree canopies (Sierra et al. 2002; Chirwa et al. 2007; Gindaba et al. 2005; Rao et al. 2007).

Trees also protect the soil against erosion and reduce the rate of SOM decomposition (Young 1989). Trees may also improve soil biological activity and N mineralization through provision of shade, protection from erosion, and N fixation, and they improve soil fertility through the decomposition of biomass from tree root systems. These benefits can be exemplified by shade trees protecting heat-sensitive crops like coffee (*Coffea arabica*), cacao (*Theobroma cacao*), ginger (*Zingiber officinale*), and cardamom (*Ellattaria cardamomum*) from high temperatures. Additionally, they provide high wind breaks and shelter belts to slow down the wind speed, which reduces evaporation and physical damage to crops, mulch to reduce soil temperature, and various crop tree mixes to reduce erosion and maximize resource use efficiency (Rao et al. 2007).

### 15.2.2 *Banana-Based Cropping Systems*

In Uganda, various types of bananas are recognized based on their use (Fig. 15.1). These include the cooking type (*Musa* spp.), beer type, roasting type, and a dessert type (Cavendish group). Cooking bananas are eaten green, while the dessert bananas are eaten after ripening or roasting. Beer bananas—also known locally as Mbidde—are usually used for making banana beer. The pulp is bitter and astringent with sticky brown excretions. The banana growing regions are characterized by small farms and dynamic crop mixtures in order to cater to food needs and family income. Banana farming systems range from a simple monoculture to complex polycultures containing seven or more crops. Banana production is largely conducted by small scale farmers with an average acreage of 0.8 ha.

Bananas have been associated with different tree species with mixed results. In Iganga, while a progressive reduction in tree cover for the banana crop resulted in banana yield decline, shaded bananas were also found to produce low yields (Rubaihayo 1992). In other areas including Kamuli and Mukono, where bananas were interplanted with trees like *Ficus*, jack fruit (*Artocarpus heterophyllus*), and



**Fig. 15.1** Representations of the (a) cooking, (b) beer, and (c) dessert bananas



**Fig. 15.2** A typical banana–coffee–*Ficus* intercrop

pawpaws (*Carica papaya*), bananas under tree shade performed better and lived longer (Rubaihayo 1992). This clearly shows that not all trees give similar benefits. While some trees may enhance banana yields, others may lead to yield reduction. Figure 15.2 shows a typical banana–coffee–*Ficus* intercrop.

Generally, intensive monocultures have been associated with reduced soil fertility and increased soil parasite population levels; they have an adverse effect on the environment and sometimes on human health. Massive quantities of nutrients are extracted from the soil and rarely returned after harvest contributing to nutrient mining and consequently negative nutrient balances. Figure 15.3 shows harvested bananas ready for ferrying to urban centers.

### 15.2.2.1 Banana Nutrient Requirements

Bananas require well distributed rainfall of an average of 2,000–2,500 mm throughout the year and short dry seasons. Although bananas can be grown on a wide range of soils, deep well drained retentive loam soils, with high humus content are the best (Zake et al. 2000). Bananas extract significant amounts of nutrients from the soil, especially K, N, and P. Nutrient removal by banana plants is 30 Mg/ha amounting to 50–60 kg N, 15–20 kg P, 175–220 kg K, 10 kg Ca, and 25 kg Mg (Zake et al. 2000). These nutrients can either be supplied by fertile soils or by commercial fertilizers. Analysis of nutrient uptake by bananas has shown that the plant assimilates only about 50 % of applied fertilizers.



Fig. 15.3 Harvested bananas ready for the urban market (Photo by IITA 2008)

Without nutrient replenishment, banana yields reduce drastically owing to a poor crop stand. Badly nourished bananas are more susceptible to drought and diseases.

### 15.2.3 Coffee Agronomy

Shade has been found beneficial for coffee production especially in areas that experience high temperatures and moisture limitations. The prevention of over-bearing, suppression of weed growth, and reduction in the intensity of sunlight and temperature is essential. Shade also helps in the mitigation of drought effects. Adequate shade improves soil fertility by returning large amounts of leaf litter to the soil underneath, N fixation, and retention of soil moisture.

Shade trees have positive effects on the microclimate and soil biological properties, which are the key to long term sustainability of the coffee ecosystem. In a study to assess tree shade and coffee interactions, shade trees produced high coffee yields with a high positive correlation between the coffee yield and the size of the crown (Boffa et al. 2007).

### 15.2.4 *Ficus spp.*

*Ficus natalensis* grows widely in Uganda and is a common tree in banana-based cropping systems. Figure 15.4 shows a *Ficus* as the central tree growing in a banana-based cropping system. A member of the Moraceae family, it is one of the 750 species of the tropical genus *Ficus*. It occurs on a variety of soils but prefers light, dry, and well drained soils that are neutral-to-acidic. It is propagated by cuttings and seed dispersal by birds and animals.



**Fig. 15.4** A *Ficus* tree in a banana-based cropping system

*Ficus natalensis* has many uses including serving as a living fence, for shade, as a source of fodder for livestock, and for making bark cloth. It has been reported to have the ability to store water and conserve soil (Ndukwe et al. 2007).

While livestock is an important source of livelihoods for the farmers, productivity is being constrained by poor nutrition and low growth rates owing to the low protein and high fiber content of many of the native grasses and crop residues. Therefore, the introduction of suitable leguminous tree and shrub species could possibly remedy this situation. The food value of low quality agricultural residues and tropical grasses can be greatly improved by mixing them with foliage from leguminous trees and shrubs.

### 15.3 Materials and Methods

The study involved two major components—a socio-economic evaluation and bio-physical data collection. The socio-economic component involved the assessment of farmers' views on agroforestry, generally, and *Ficus* integration, specifically. Biophysical data collection focused on collecting soil samples from under and outside the canopy of *Ficus* trees in banana-based cropping systems.

#### 15.3.1 Site Characterization

The study was conducted in Namulesa, located 6 km from Jinja and 86 km from Kampala. The area is characterized by extensive undulating terrain, isolated hills, and pediments of approximately 115 m with linear and convex slopes between 2 and 8 %.

The largest part of the District is underlain by undifferentiated gneisses formerly seen as part of a basement complex. The soils in the area have been classified as Nitisols. They are generally deep with good physical properties and high clay content. This soil type is of relatively high to moderate fertility. They are permeable, with a stable structure and low erodibility.

The area experiences a bimodal type of rainfall with an average precipitation of 900–1,000 mm per annum with peaks in April to May and September to October. In the recent past, records indicate that the annual average rainfall has significantly declined compared to previous years (State of the Environment Report 2005).

The monthly average minimum temperature ranges from 18 to 28 °C. Relative humidity is low, averaging less than 10 % both in the morning and evening, hence, minimally influencing climatic modifications in the district.

The dominant land tenure system is the customary free-hold system in which pieces of land are owned in perpetuity, and hence, the owner is able to sell off any of his/her land if he/she so wishes. There has been a high level of land fragmentation, which has severely pressed limits on land productivity (State of the Environment Report 2005).

Many parts of the study area have experienced high levels of land degradation primarily as a result of erosion and nutrient mining. This has resulted in declined land productivity. Despite the rising concerns of land degradation on productivity, the available information on land degradation remains highly fragmented, incomplete, and often unreliable.

## **15.3.2 Data Collection**

### **15.3.2.1 Socio-economic Data**

Field visits were conducted to assess the agricultural practices in the area. This visit provided insight on the agroforestry systems and the traditional practices involving the use of *Ficus natalensis* as a component of the farming system. Additional information was collected informally by asking farmers about management, propagation, side effects, and constraints of using this species in association with crops and animals.

After the field visit, structured interviews were conducted at 45 households that incorporated *Ficus* as a component of their farms. These households were selected randomly from the list of the farmers who had propagated *Ficus natalensis* on their farms for at least 5 years. The interview focused on demographic information, predominant land uses, agricultural production trends, economic activities, general assessment of the status of the gardens, and constraints to adoption of recommended agricultural practices. The data were analyzed using the Statistical Package for the Social Sciences (SPSS). Chi-square tests were used at a significance level of 0.05 for all analyses.



### 15.3.2.2 Biophysical Data

Soil samples were collected around five randomly selected *Ficus natalensis* trees for laboratory analysis. For each tree, four locations were identified across a transect in proportion to the crown size, R. Samples were taken 1 m from the base of the tree, and at 0.5R, 1R, and 2R, where R is the crown radius. The soil samples were collected at 0–10 cm and 10–20 cm depths and were analyzed for soil pH, bulk density (BD), and total N, C, P, and K. Similarly, leaf samples were selected from ten mature trees and analyzed for total N, P, K, Ca, Mg, Na, Fe, Mn, Al, and S.

Soil pH was determined in a suspension in deionized water and in a 0.01 M CaCl<sub>2</sub> solution. Soil N was analyzed using the micro-Kjeldahl method as described by Landon (1984), while carbon content was determined using the Walkley and Black method (Okalebo et al. 2002).

Soil P was determined using the Olsen method of bicarbonate extraction (Landon 1984). K, Ca, Mg, Na were determined by extraction of air dried samples with 0.1 M NH<sub>4</sub>OAc at pH 7 followed by inductively coupled plasma atomic emission spectroscopy (ICP-AES) using the Perkin Elmer Optima 300 system, Massachusetts, USA.

### 15.3.2.3 Leaf Nutrient Content of *Ficus*

Leaves were collected from the mid canopy of six mature trees and oven dried at 70 °C for 24 h. Total N was determined using the Kjeldahl method. The leaf samples were extracted with a mixture of HClO<sub>4</sub> and HNO<sub>3</sub> to determine total P, K, Mg, Ca, Na, Mn, Al, S, and Fe using the Perkin Elmer Optima 3000 XL system, Massachusetts, USA.

## 15.3.3 Data Analysis

One way analysis of variance (ANOVA) was used to test for canopy effects across the crown radius on soil physical and chemical properties. Sample points at 1 m, 0.5R, and 1R were considered together as the ‘inside-canopy’ points while 2R was assigned to the ‘outside’ canopy. Pair-wise comparisons were performed on the depth profile data. Proximity means were separated using Student’s t-test at  $p = 0.05$ .

## 15.4 Results and Discussion

### 15.4.1 Socio-economic Analysis

A summary of the socio-economic data is shown in Table 15.1. The average family size was seven persons per household with a mean land area of 1.9 ha. While 53 % of the respondents reported a decline in soil fertility, there was an almost unanimous

**Table 15.1**  
Socio-economic data

Data category	Response	
	N = 45	Percent
1. Age structure (years)		
15–30	5	11
31–45	13	29
45–65	19	42
>65	8	18
2. Family size (number)		
1–5	13	28.9
6–10	29	64.5
>10	3	6.6
3. Educational status		
Illiterate	17	37.8
Primary education	13	28.9
Secondary	3	6.6
Post-secondary	12	26.7
4. Farm size (ha)		
0.25–1	5	11.1
1.0–2	21	46.7
2.0–3	19	42.2
5. Adequacy of land holding		
Adequate	16	35.6
Inadequate	29	64.4
6. Fertility status		
Decreasing	24	53.4
Increasing	20	44.4
Not changing	1	2.2
7. Existence of erosion		
Exists	44	98
Does not exist	1	2
8. Influence on tenure on planting		
Negative	14	31.1
Positive	31	68.9

consensus that erosion was a major problem (98 % of respondents). This conclusion is in agreement with that reported by Rubaihayo (1992) who observed declining soil fertility coupled with low soil pH as a major production constraint for highland bananas.

Despite a high desire expressed by 98 % of the respondents to plant *Ficus* trees in their gardens, 30 % of the respondents were constrained by the land tenure system. This underscored the fact that security of tenure is an important consideration for long term soil improvement programs.

Of the respondents, 19 % reported a decline in yield owing to the presence of *Ficus* while 65 % reported an increase. This apparent contradiction could be

attributed to competition for nutrients and water. In certain cases, shading has been known to reduce the yield of the associated crop (Rubaihayo 1992).

Livestock was found to be an important component of the farming system. The district had about 25,000 head of cattle, over 30,000 goats, and 300,000 chickens, which constituted the main forms of livestock in Jinja.

However, livestock rearing is constrained by the availability of fodder. A shortage of pasture was affirmed by 48 % of the respondents and 85 % of respondents were using *Ficus* as a major component of the feeding regime. The availability of browsing to animals, especially in the dry seasons, is essential when grass and herbaceous legume forages are scarce. The integration of *Ficus* could therefore play an important role in addressing this need. More importantly, it remains green most of the year and provides supplementary protein, vitamins, and minerals that are lacking in grassland pastures in the dry season (Tegbe et al. 2006).

Other benefits associated with *Ficus* included its use in making bark cloth, control of erosion, and as a source of fuel wood. Semalulu et al. (2012) found significantly lower soil loss under a banana—coffee regime ( $0.87 \text{ t ha}^{-1} \text{ year}^{-1}$ ) than under bananas alone ( $6.6 \text{ t ha}^{-1} \text{ year}^{-1}$ ).

Farmers mostly rely on resources internal to the farm in order to replenish soil fertility. The socio-economic survey revealed that farmers hardly used fertilizers. Table 15.2 show the relative magnitude of the various constraints to fertilizer use.

High fertilizer prices followed by low availability of fertilizers were sighted as the most predominant constraint to fertilizer use. The percentage of farmers who believe that fertilizers spoil the soil was also high. This implies that there is need to sensitive and train farmers on the benefits and the use of fertilizers.

#### 15.4.2 Soil Physical and Chemical Properties

A summary of the soil physical and chemical properties is shown in Table 15.3. Soil bulk density (BD) was not significantly different across the *Ficus* trees transect. However, BD was generally low, probably due to the extensive *Ficus* root system. Conversely, soil pH tended to have higher values outside the canopy as compared to the canopy area.

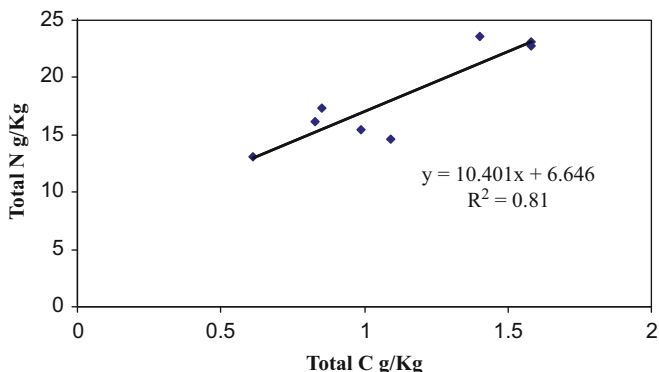
**Table 15.2** Constraints to the use of fertilizers

Constraint	Percentage of total respondents
1. High fertilizer prices	25
2. Low availability	24
3. 'Spoils' the soil	19
4. Labor intensive	11
5. Not available in appropriate packages	6
6. Others	15

**Table 15.3** Variation of selected soil properties with distance from *Ficus* trees

Distance from the tree	Depth (cm)	BD Mg/m <sup>3</sup>	pH (H <sub>2</sub> O)	Total N mg/g	Total P mg/g	K $\mu$ g/g	Total C g/kg
1 m	0-10	1.49(0.05)	6.96(0.09)	1.4(0.26)	0.94(0.09)	418(42)	23.6(2.87)
	10-20	1.47(0.05)	7.06(0.05)	0.85(0.12)	0.78(0.07)	322(30)	17.34(2.46)
0.5 R	0-10	1.49(0.12)	7.02(0.02)	1.58(0.22)	0.84(0.08)	474(32)	23.06(3.21)
	10-20	1.54(0.07)	7.08(0.05)	0.99(0.10)	0.65(0.09)	358(33)	15.39(1.09)
R	0-10	1.47(0.05)	6.98(0.02)	1.58(0.36)	0.85(0.13)	433(41)	22.77(4.76)
	10-20	1.40(0.09)	7.06(0.01)	1.09(0.29)	0.87(0.15)	398(35)	14.62(3.07)
2R	0-10	1.45(0.01)	7.08(0.09)	0.83(0.15)	0.81(0.07)	337(5)	16.14(1.59)
	10-20	1.44(0.01)	7.18(0.06)	0.61(0.06)	0.75(0.07)	312(16)	13.13(0.62)
P-values	0-10	>0.05	>0.05	>0.05	>0.05	>0.05	>0.05
	10-20	>0.05	>0.05	>0.05	>0.05	>0.05	>0.05

The values in brackets are standard errors



**Fig. 15.5** Variation of total N with total C

The mean total topsoil N was 1,624 kg/ha under the canopy and 877 kg/ha outside the tree canopy. The N content in the 10–20 cm soil depth was 1,032 kg/ha and 634 kg/ha, respectively, for under the canopy and outside the canopy. The higher total N accumulation under the canopy of the trees can be attributed to the high organic matter inputs from fine root degeneration and litter fall followed by microbial activities under the tree crowns (Table 15.3).

There was a strong positive correlation between soil N and total SOC (Fig. 15.5). The relationship is explained by regression Eq. 15.1:

$$Y = 10.4X + 6.65 \quad (P = 0.05) \quad (15.1)$$

where, Y is the level of N (g/kg) and X is the level of organic carbon expressed in g/kg.

The P content in the 0–10 cm soil depth was 0.88 and 0.81 g/kg, respectively, under the canopy and outside the canopy. At the 10–20 cm depth, the P concentration was 0.77 and 0.75 g/Kg, respectively, under and outside the canopy, showing a slight but not significant decrease with depth and distance away from the base of the tree. The average P concentration under the canopy was 12 % and 5 % higher than that outside the canopy in the 0–10 cm and 10–20 cm soil depths, respectively.

Total carbon concentration (TC) was significantly higher under the tree crown as compared to the area outside the crown. In both scenarios, TC decreased with depth. The mean TC concentration obtained in the 0–10 cm soil depth was 23.15 g/kg under the tree canopy and 16.15 g/kg outside the canopy. Concentrations of 15.79 g/kg and 13.13 g/kg of TC were found under the canopy and outside the canopy in the 10–20 cm soil depths, respectively. Under the *Ficus* canopy, the concentration of TC increased by an average of 47 % and 22 % in the 0–10 cm and 10–20 cm depths, respectively. The data indicate the importance of carbon inputs into the soil from litter and biomass under the canopy of *F. natalensis*.

Similarly, K content was higher under the crown, and it also decreased with an increase in depth for the same reasons.

The computed organic matter content in the soils under the *F. natalensis* canopy was 4 % in the 0–10 cm soil depth and 2.8 % in the 10–20 cm soil depth. SOM outside the canopy was 2.72 % and 2.3 %, respectively, for the 0–10 and 10–20 cm depths. SOM is an important source of plant nutrients in the soil. SOM also plays many other important roles in the soil, such as improving soil physical characteristics, increasing the soil moisture holding capacity, and providing a good habitat for soil micro- and macroorganisms. Therefore, it is very necessary to have adequate amounts of SOM in farm lands. A soil is considered to have high SOM content when it is 10 % or greater. SOM content below 2–3 % is considered to be very low and such soils are likely to respond positively to addition of organic materials.

Table 15.4 itemizes the nutritive value of *Ficus* leaves. The leaves were found to be highly nutritious; therefore, they are a good source of fodder especially during the dry season. The results obtained are in agreement with Akinnifesi et al. (2010) who noted that fertilizer trees can add more than 60 kg N ha<sup>-1</sup> per year through biological nitrogen fixation.

## 15.5 Conclusions and Recommendations

Trees can be used in association with crops and/or pasture considering spatial arrangements that can prevent negative outcomes. Indeed the nutrient contributions from *Ficus* tree biomass can significantly reduce the requirement for mineral N fertilizer. Despite the nutrient contribution owing to *Ficus* integration in the farming system, efforts must be made to remove barriers to fertilizer use if the banana industry is to be transformed from subsistence to commercial levels.

The shade provided by *Ficus* can play a vital role in maintaining long term banana and coffee productivity—for conserving soils, moisture and biodiversity, and improving crop quality. For successful adoption and sustainability, the technologies should integrate the various interests and strike a balance among ecological, economic, and social dimensions of the system. The active participation of the farm owner is necessary for identifying feasible solutions geared at increasing adaptation to climate change.

**Table 15.4** Leaf nutrient content of *Ficus*

Nutrients	N (mg/g)	P (mg/g)	K (mg/g)	Ca (mg/g)	Mg (mg/g)	Na (µg/g)	Mn (µg/g)	Al (µg/g)	Fe (µg/g)	S (mg/g)
Concentration	21.83 (1.24) <sup>a</sup>	2.05 (0.19)	9.10 (0.43)	18.05 (1.02)	3.57 (0.36)	166.4 (19.11)	34.3 (4.29)	191.1 (18.64)	258.3 (18.64)	1.59 (0.09)

<sup>a</sup>The values in brackets are standard errors

## References

- Akinnifesi FK, Ajayi OC, Sileshi G, Chirwa PW, Chianu J (2010) Fertiliser trees for sustainable food security in the maize-based production systems of East and Southern Africa. A review. *Agron Sustain Dev* 30:615–629
- Batish DR, Kohli RK, Jose S, Singh HP (2008) *Ecological basis of agroforestry*. CRC Press, New York
- Bekunda M (1999) Farmers' responses to soil fertility decline in banana-based cropping systems of Uganda. *Managing Africa's soils* no. 4, IIED Dryland Programme, London
- Boffa JM, Pinard F, Kagoro D, Ngendo M, Emmanuel R, Franzel S (2007) Tree shade and coffee interactions in the northern Lake Kivu region, Cooperative pour Promotion des Activités – Cafe (COOPAC), Gisenyi, Rwanda
- Chirwa PW, Black CR, Maghembe J, Ong CK (2007) Soil water dynamics in cropping systems containing *Gliricidia sepium*, pigeon pea and maize in southern Malawi. *Agrofor Syst* 69:29–43, Springer Science Business Media BV
- Gindaba J, Rozanov A, Negash L (2005) Trees on farms and their contribution to soil fertility parameters in Badessa, Eastern Ethiopia. *J Biol Fertil Soils* 42(1):66–71, Springer Berlin/Heidelberg International Symposium on Browsers in Africa
- IITA (2008) Growing bananas from seeds. <http://r4dreview.org/2008/09/growing-bananas-from-%E2%80%9Cseeds%E2%80%9D/>
- INIBAP (2003) Conservation through utilization of bananas and plantains in the Great Lakes region of East Africa—final report. INIBAP, Montpellier
- Landon JR (ed) (1984) *Booker tropical soil manual: a handbook for soil survey and agricultural land evaluation in the tropics and subtropics*. Longman Inc, New York
- Ndukwe IG, Bello AI, Habila JD, John C (2007) Phytochemical and antimicrobial screening of the crude petroleum spirits and methanol extracts of the stem bark, leaves and roots of *Ficus thonningii* (Blume). *Afr J Biotechnol* 6(23):2645–2649
- Semalulu Onesimas, Didas Kimaro, Valentine Kasenge, Moses Isabirye and Patrick Makhosi (2012) Soil and nutrient losses in banana-based cropping systems of Mount Elgon hillsides of Uganda: economic implications. *Int J Agric Sci* 2(9):256–262. ISSN: 2167-0447
- Okalebo JR, Gathua KW, Woomer PL (2002) *Laboratory methods for soil and plant analysis. A working manual*. TSBF-CIAT/SACRED Africa, Nairobi
- Rao KPC, Verchot LV, Laarman J (2007) *Adaptation to climatic change through sustainable management and development of agroforestry systems*. ICRISAT 4:1, World Agroforestry Center, Nairobi, Kenya
- Rubaihayo PR (1992) *Banana-based cropping system research: a report on a rapid rural appraisal survey of banana production*. Research bulletin no 2. Makerere University, Kampala
- Sierra J, Dulormne M, Desfontaines L (2002) Soil nitrogen as affected by *Gliricidia sepium* in a silvopastoral system in Guadeloupe, French Antilles. *Agrofor Syst* 54:87–97
- State of the Environment Report (2005) Jinja District, Uganda
- Tegbe TSB, Adeyinka IA, Alawa JP, Baye KD (2006) Evaluation of feeding graded levels of dried and milled *Ficus thonningii* leaves on growth performance, carcass characteristics and organs of Weaner rabbits. *Pak J Nutr* 5(6):548–550, Asian Network for Scientific Information
- Van Asten PJA, Gold CS, Wendt J, De Waele D, Okech SHO, Ssali H, Tushemereirwe WK (2005) The contribution of soil quality to yield and its relation with other banana yield loss factors in Uganda. In: Blomme G, Gold CS, Karamura E (eds) *Proceedings of a workshop held on farmer participatory testing of IPM options for sustainable banana production in Eastern Africa*. Seeta, Uganda, International Plant Genetic Resources Institute, Montpellier, France, 8–9 Dec 2003, pp 100–115
- Van Asten P, Wairegi L, Bagamba F, Drew C (2008) *Factors driving fertilizer adoption in banana systems in Uganda*. Unpublished report



- Young A (1989) *Agroforestry for soil conservation*. CABI International/BPCC and Wheatons Printers, Wallingford
- Zake YK, Bwaniki, DP, Nkwiine C (2000) Soil management requirements for banana production on the heavy soils around Lake Victoria in Uganda. In: Craenen K, Ortiz R, Karamura EB, Vuylsteke DR (eds) *Proceedings of the international conference on banana and plantain for Africa*. Acta Horticulturae no 540, International Society for Horticultural Science (ISHS), Leuven, Belgium, pp 285–292

# Chapter 16

## Management Practices/Techniques Commonly Used in Niger Republic, West Africa

Mohamadou Habibou Gabou and Abdou Maisharou

**Abstract** Niger republic, a Sahelian country with about 75 % of its area covered by the Sahara desert, continues to face high land degradation due to human activities and climate change. This land degradation, which is mainly manifested in the forms of soil crusts, gullies, sand dunes, siltation of water bodies such as River Niger, Lake Chad, and many other inland lakes, has many consequences including loss of productivity and biodiversity that lead to desertification and poverty. To reverse the trend of land degradation, Niger Republic, with the support of its partners, has undertaken many actions on land restoration. These have helped to rehabilitate more than 250,000 ha of degraded land and develop local knowledge and skills that can be used worldwide. Sustainable land management practices and agroforestry techniques used in Niger to rehabilitate these degraded lands include tree planting (shelter belt, living fence, urban planting) and construction of anti-erosive infrastructures using soil and water conservation techniques such as: rock dikes, half-moon, stabilization of gullies and river banks, sand dunes stabilization, and protection and promotion of natural regeneration. Benefits derived from these techniques include reduction of wind and water erosion, production of fuel wood and fodder, increased soil fertility, food security and carbon sequestration, recovery of wild species, improvement of local population revenues and livelihood, and local knowledge and skills in land restoration.

**Keywords** Land degradation • Ecological restoration • Agroforestry • Anthropogenic activities • Climate change • Niger

---

M.H. Gabou (✉)

General Directorate of Environment and Forestry, Ministry of Environment, Urban Sanitation and Sustainable Development, (B.P: 11436) Niamey, Niger  
e-mail: [habigabou@yahoo.fr](mailto:habigabou@yahoo.fr)

A. Maisharou

General Directorate of Environment and Forestry, Ministry of Environment, Urban Sanitation and Sustainable Development, (B.P: 578) Niamey, Niger

## 16.1 Introduction

Niger is a land locked Sahelian country with a population of 17,129,076 inhabitants, an annual growth rate of 3.9 % (INS 2013), and a total land area of 1,267,000 km<sup>2</sup>, of which 75 % is covered by the Sahara desert. The natural environment of Niger is harsh and characterized by high spatiotemporal variability of rainfall (Brooks 2004; République du Niger 2004; World Bank 2009), and very high temperatures (République du Niger 2004), heavy winds and storms (Reij et al. 2009), decreased land productivity and an increase in croplands area (Bender and Ousseïni 2000). In addition to the demographical and natural constraints, 83.8 % of the population of Niger live in rural areas and depend mainly on agriculture, animal rearing, and exploitation of natural resources (République du Niger 2004). Moreover, Niger is among the least developed countries of the world. Thus, 63 % of its population are poor and 86 % of these poor people live in rural areas (République du Niger 2004).

These unfavorable factors, combined with the effects of climate change, have contributed to increased land degradation in the country, which in turn leads to food insecurity and increased vulnerability of local people. Pimentel (1993) and Pimentel and Kounang (1998) observed that land degradation through erosion constitutes the principal handicap to the supply of food for an increasing population because it seriously threatens agriculture and the natural environment.

To reverse the trend of land degradation for the benefit of present and future generations, the Niger Government with the support of its partners has undertaken many actions to restore degraded land, mainly on the institutional, legal, political and technical frameworks. This chapter mainly focuses on some sustainable management practices and agroforestry techniques commonly used in Niger for rehabilitating degraded lands. It outlines notable achievements to date and the multiple benefits derived from the adoption of these practices and techniques. The chapter articulates mainly on the following parts: an overview of land degradation in Niger Republic, a brief description of some sustainable management practices and techniques locally adopted in Niger, their benefits, and lastly a short conclusion on the way forward.

In this chapter, technique refers to an orderly set of operations for production purposes which can be done without the farmer who implements it (Bayala et al. 2011); practices are the result of accumulated knowledge and know-how and are related to the environment, the perception of the farmer and their use (Bayala et al. 2011); measures are all institutional, technical, political, and legal actions taken to protect and to rehabilitate degraded lands; sustainable land management practices/techniques are practices and techniques used to protect and restore soil and to improve its fertility, productivity, and water holding capacity.

## 16.2 Overview on Land Degradation in Niger

Niger, like many other Sahelian countries, faced serious deterioration of its environment with loss of vegetation cover and decreases in the livelihood of local communities as a result of a series of droughts, most especially the droughts

of 1970 and 1980 (Batterbury and Warren 1999; Brooks 2004; CRESA 2006; Reij et al. 2009). Biophysical and socioeconomic factors are responsible for intensified erosion (Lal 1993) in the country. Land degradation, with its consequences on food security, human wellbeing, and environment equilibrium, highly threatens Niger ecosystems due to human activities and natural factors. It affects different regions of the country in different ways. In Niger land degradation occurs through water and wind erosion which lead to decreases in crop yield, sedimentation of water bodies (e.g. River Niger), and degradation of soils, ecosystems and other socio-economical infrastructures (World Bank 2009). Sahel region is much favorable to wind erosion, which potential rates range from 10 to 200 t/ha/year (Lal 1993). Deforestation and overexploitation of natural resources for crop production, fuel wood provision, or other uses lead to soil erosion which occurs throughout Niger in the forms of sand dunes, soil crusting, gullies and siltation of water bodies.

Gully erosion does not only affect mountainous areas, but also crusted and sandy soils (Valentin et al. 2005). It represents a major source of sediment, and therefore adversely affects land conditions (Poesen 2011). Sand dune movement is one of the principal problems of desertification and degradation of drylands, and threatens agricultural lands and other socio-economic infrastructures of most drylands of the world (Veste et al. 2001). In Niger, sand dunes encroachment is mainly affecting Zinder and Diffa regions in the Eastern parts of country.

About 80,000–100,000 ha of forest lands are lost per year in Niger through extension of agricultural land and inappropriate use of forest resources (CNEDD 2012). Warren et al. (2001a, b), estimated land degradation through erosion in south west Niger ranged from 26 to 46 ha/year over a 30 year period, which he considered to be highly above estimates for this part of Sahel (Warren et al. 2001b). Land degradation is very severe in the south-eastern populated zones of Niger. Thus, Maradi was the most degraded regions of the country between 1970 and 1980 due to its high population density (50–75 inhabitants/km<sup>2</sup>) and the use of 70 % of cultivable lands (CRESA 2006).

### **16.3 Descriptions of Some SLM Techniques and Practices Adopted in Niger**

Niger implemented several sustainable land management (SLM) programs with the financial support of many donors during the 1980s (CRESA 2006), with the aim to rehabilitate land and to improve the wellbeing of its population (World Bank 2009). Most of the SLM programs implemented in Niger have promoted various restoration and agroforestry practices to rehabilitate land for the provision of goods and services (World Bank 2009). These practices include tree planting, soil and water conservation techniques (SWC), stabilization of gullies and river banks, sand dunes stabilization, and protection and promotion of natural regeneration. Some of the most common techniques/practices used in Niger include sand dune stabilization, rock dikes, contour bund, half-moon, rock dams, tree planting, and farmer managed natural regeneration.

Successful results are obtained using practices/techniques to rehabilitated degraded land in the Sahel. There is excellent collaboration between government services, NGOs, and farmers in practices/techniques of rehabilitating degraded land (Reij et al. 2009) to reduce vulnerability (Serigne et al. 2006). This was obtained largely through diffusion of these proven techniques/practices in Burkina Faso and Niger (Reij et al. 2009). However, farmers are limited in the implementation of techniques/practices of rehabilitation of degraded land by constraints such as the labor-intensive nature of SWC techniques (Serigne et al. 2006; Barry et al. 2008; Reij et al. 2009), land tenure issues (Barry et al. 2008), the long term character of planting tree and agroforestry techniques, and seed availability to promote agroforestry (Serigne et al. 2006).

### 16.3.1 Sand Dune Stabilization

The technique comprises two components: mechanical and biological treatments. The mechanical treatment, which is the first step of the dune stabilization, consists of erecting wind barriers, called palisades, using millet stalks or any other available plant material for making hedges (left Photo, Fig. 16.1) (GIZ 2012). The distance between the hedges varies from 10 to 15 m. Once this mechanical treatment is complete, trees are planted inside the squares of the palisades. The most common tree species used in sand dunes stabilization are broom bush (*Leptadenia pyrotechnica*), balsam spurge (*Euphorbia balsamifera*), umbrella acacia (*Acacia raddiana*), gum Arabic acacia (*Acacia senegal*), desert date (*Balanites aegyptiaca*), and honey mesquite (*Prosopis juliflora*) (GIZ 2012). Apart from these trees species, grass and herbaceous species are also planted in strips in the fenced off area (GIZ 2012). Figure 16.1 presents sand dunes stabilization with hedges of *Euphorbia balsamifera* and with palisades of *Leptadenia pyrotechnica*.

The importance of this technique is to stop the blowing sand and to stabilize the soil, and therefore to prevent croplands and socioeconomic infrastructure from the invading sand dune (GIZ 2012). Vast areas of dunes have been stabilized using this



**Fig. 16.1** Sand dune stabilization with *Euphorbia balsamifera* hedges (left). With palisades of *Leptadenia pyrotechnica* (right) (Source: GIZ 2012)



**Fig. 16.2** Construction of rock dikes (*left*). A series of rock dikes in a field (*right*) (*Source: GIZ 2012*)

technique by many projects in Niger. For instance the “Projet de développement rural de Tahoua” (PDRT) in Niger stabilized 180 ha of sand dune to protect farmlands and infrastructures from its invasion (GIZ 2012).

### 16.3.2 Rock Dikes

Rock dikes are built along the contour lines on the valley bottoms (Spaan 2003), to dissipate the high amount of water flowing from the plateau and the slopes (GIZ 2012). Rock dikes are made with stones of different sizes. They have a foundation of 30 cm, and an elevation ranging from 40 to 60 cm (Spaan 2003). Permeable rock dikes help to reduce the water runoff and increase soil water infiltration (GIZ 2012). They can therefore, be used to restore degraded farmlands, forest, and rangelands (GIZ 2012). Figure 16.2 shows the construction of rock dikes and a series of rock dikes in a field. Rock dikes have contributed to the restoration of many degraded areas in Niger. For instance, the “Projet Intégré Keita” (PIK) has rehabilitated more than 20,000 ha of degraded land with the used of dikes and other SWC techniques (Bellefontaine et al. 2011).

### 16.3.3 Contour Bunds

Contour bunds are earthen banks with a length of 80 or 100 m and width of 10–15 m, constructed along the contour lines (Spaan 2003). They can be made with earth or stone or a combination of both (GIZ 2012), and have open ends facing uphill (GIZ 2012). Contour bunds are built in staggered rows (GIZ 2012). The width of the earthen bank is 2.5 m and the height 0.6 m (Spaan 2003). There is a distance of 10 m between bunds and 25 m between rows of bunds. Contour bunds are installed in plateaus to collect the water runoff, thereby preventing a heavy runoff in downstream areas (GIZ 2012). They increase water infiltration and deposition of fine particles favorable to vegetation growth. Therefore, contour



**Fig. 16.3** Construction of contour bunds (*left*). Rows of contour bunds (*right*) (Source: GIZ 2012)



**Fig. 16.4** Staggered agricultural half-moons (*left*). Rows of half-moons with millet growing in them (*right*) (Source: GIZ 2012)

bunds can be used to restore degraded agricultural lands, forest, and rangelands (GIZ 2012). Figure 16.3 presents the construction of contour bunds and rows of contour bunds in a field in Niger.

#### 16.3.4 Half-Moon

Half-moon is semi-circular earth construction (Spaan 2003) with an opening in the upward direction of the slope to catch runoff water, and arranged in staggered rows (GIZ 2012). The half-moon has a diameter of 4 m and dikes of 0.2 m (Spaan 2003). Often enriched with manure, half-moon can be used to grow cereals or to plant trees, shrubs, and/or grasses (GIZ 2012). Associated with animal manure or compost amendments, half-moon could improve the sorghum productivity from 600 to 1600 kg ha<sup>-1</sup> (Zougmoreé et al. 1999) or, 900 to 1600 kg ha<sup>-1</sup> (Zougmoreé et al. 2003), which is 20–39 times higher the sorghum yields obtained with half-moon without any amendment (Zougmoreé et al. 2003). Half-moon helps to slow down runoff by capturing it, and to trap the sediments (GIZ 2012). They are used to restore degraded sloping pediments and plateaus for crop production, forestry and rangelands (GIZ 2012). Figure 16.4 presents staggered agricultural half-moons and rows of half-moons with millet growing in them.



**Fig. 16.5** Closing-off of a gully with permeable rock dam (*left*). Treating a gully with gabion (*right*)

### **16.3.5 Permeable Rock Dams**

Permeable rock dams are anti-erosive structures built inside gullies with stones and rocks and sometimes with gabion to slow down the velocity and reduce the erosive force of runoff water (GIZ 2012). A blanket of gravel or small stones is used as filtering layer in the foundation, on the top of which medium to large sized stones and rocks are placed (GIZ 2012). Rock dams are used to treat severe gullies in farmlands, forests, and rangelands (GIZ 2012). Gully treatment with rock dams (mechanical) is often reinforced with tree planting on the gully banks (biological treatment). Figure 16.5 shows closing-off of gully with permeable rock dam and treatment of gully with gabion.

### **16.3.6 Trees Planting**

Local populations of Sahel planted 200 million trees between 1975 and 2003 (UNCCD 2011). Particularly in Niger, many trees were planted around this period with the development of many actions favorable to the management of the environmental policy. Thus, since 1984, the country has adopted a national policy for fighting desertification called “The Maradi Commitment” (Larwanou et al. 2006). With the implementation of this policy (which continues to date), 10 ha of land area is planted (bloc planting) in each city of Niger.

Apart from bloc plantations, many trees are also planted in Niger as shelter belts, living fences, and linear plantings for restoration of degraded land. These concern biological installation of 4,550 ha, linear planting of 1,500 km (windbreak and field borders), and plantations on restricted areas of 5,000 ha (Serigne et al. 2006).

The PIK alone planted about 17 million trees in the region of Tahoua (Bellefontaine et al. 2011). Trees are planted in Niger because of their many and varied functions. They provide fruits, fuel wood, medicine, and shade. They protect soil from wind and water erosion and contribute to carbon sequestration.



### **16.3.7 Farmer Managed Natural Regeneration**

In early 1980, farmers in Niger adopted a low cost and easy technology called “Farmer Managed Natural Regeneration” (FMNR) (Reij et al. 2009; World Vision International 2012). This technique, that allows trees and shrubs to grow together in farmlands for the production of food, fuel wood, and fodder, protected millions of trees (Reij et al. 2009; World Vision International 2012). This FMNR approach consists simply of selecting in the farm, three to five stems from each tree stump, based on their heights, shapes and usefulness, for protection while the rest are cut (Reij et al. 2009; Word Vision International 2012). The selected stems are periodically pruned by the farmer to enhance their growth and productivity and to reduce competition from weeds and other stems (Reij et al. 2009). This approach of associating crop production with trees (Reij et al. 2009) has helped farmers of Niger, particularly of the regions of Maradi and Zinder, to re-green their areas by keeping many trees in the farms and pasturelands. The areas affected by this re-greening were estimated to be about 5 million ha (Mha) (Reij et al. 2009; Pye-Smith 2013). This can be explained by the involvement of actors such as non-governmental organizations, donors, and governmental technical services (Environment and Forestry, Agriculture, Agricultural engineering) in the process of FMNR (Reij et al. 2009). A total carbon stock of 87.3 C/ha was estimated in a winter thorn (*Faidherbia albida*) Agroforestry parkland (Bayala et al. 2011).

## **16.4 Benefits of Techniques/Practices of Degraded Land Rehabilitation**

Techniques/practices used to rehabilitate degraded land in the Sahel present many benefits to rural communities. For example, soil and water conservation techniques help to reduce erosion and to improve soil fertility and rain water use efficiency (Spaan 2003). In Niger, some of the benefits obtained from these techniques include: reduction of soil erosion, production of fuel wood and fodder, increased soil fertility, food security and carbon sequestration, restoration of wild species, improvement of revenues and livelihood, and greater local knowledge and skills in land restoration. Important benefits have been realized by many farmers in the Sahel from FMNR (Pye-Smith 2013). These benefits include increase in revenues, food, high resilience to extreme events (e.g.: droughts), and peace (Word Vision International 2012). Moreover, FMNR practice can play an important role in climate change adaptation and mitigation (Word Vision International 2012).

With FMNR, the number of trees in many villages have increased 10 to 20-fold compared to 20 years ago (Reij et al. 2009). The high density of trees of different purposes in the area has many advantages to local communities, because trees have many benefits (Reij et al. 2009). Trees provide fuel wood for house use and for sale, and therefore represent a source of income generation to farmers. In addition, many tree species that provide fruits and other non-wood products are protected by

farmers in their farms (Pye-Smith 2013). This constitutes an additional source of revenue. With FMNR, farmers in the region of Maradi have additional revenue ranging from 17 to 23 million US dollars (Word Vision International 2012).

Furthermore, some tree species that fix nitrogen and hence improve soil fertility, such as *Faidherbia albida* (leguminous) (Reij et al. 2009; Pye-Smith 2013), also increase farm productivity. The increase of soil fertility by trees, particularly leguminous species, has led to an increase of 500,000 tons of cereals in Niger (Word Vision International 2012; Pye-Smith 2013).

## 16.5 Conclusions

Niger faced serious degradation of its environment with the droughts of 1970 and 1980, and the effects of climate change, which decreased farms productivity and exacerbated food insecurity in the country. The use of techniques and practices of rehabilitating degraded land were identified in early 1980s as appropriate measures for restoring the deteriorated environment of the country. Results from the use of these techniques/practices in Niger indicate a decrease in soil and water erosion, increase in soil fertility, increase in carbon sequestration, etc. Moreover, Niger is recognized by many scientists as a reference in the Sahel in matters related to FMNR. This practice helped the country to re-green more than 5 million ha in the area of Maradi and Zinder and increase farm production.

Despite the successes of Niger in the rehabilitation of degraded land, many things still need to be done to win the war against desertification and hunger. This can be achieved by strengthening the collaboration between all stakeholders concerned with management of natural resources. Such collaboration would include additional research on techniques/practices used in rehabilitating degraded lands in the country.

## References

- Barry B, Olaleye AO, Zougmore R, Fatondji D (2008) Rainwater harvesting technologies in the Sahelian zone of West Africa and the potential for outscaling. International Water Management Institute, Colombo
- Batterbury S, Warren A (1999) Land use and land degradation in South-Western Niger: change and continuity. ESRC Economic and Research Council, London
- Bayala J, Kalinganire A, Tchoundjeu Z, Sinclair F, Garrity D (2011) Conservation agriculture with trees in the West African Sahel: a review. World Agroforestry Centre, Nairobi
- Bellefontaine R, Bernoux M, Bonnet B, Cornet A, Cudennec C, D'Aquino P, Droy I, Jauffret S, Leroy M, Malagnoux M (2011) The African Great Green Wall project: what advice can scientists provide? A summary of published results. <http://www.csf-desertification.org/grande-muraille-verte>. Accessed on 08 Nov 2013
- Bender H, Ousseïni I (2000) Les bas-fonds aux Niger: transfert d'expériences. Université Abdou Moumouni de Niamey, Niger

- Brooks N (2004) Drought in the African Sahel: long term perspectives and future prospects. Tyndall Centre for Climate Change Research, Norwich, United Kingdom. Working paper 61
- CNEDD (Conseil National de l'Environnement pour un Développement Durable) (2012) Rapport National: conférence de RIO +20. Rapport National de synthèse de la République du Niger. Niamey, Niger, 50 p. <http://sustainabledevelopment.un.org/content/documents/597nigerreportnat.pdf>. Accessed on 10 Mar 2014
- CRESA (Centre Régional d'Enseignement Spécialisé en Agriculture) (2006) Impacts des investissements dans la gestion des ressources naturelles sur les systèmes de production au Niger. Rapport de synthèse. Niamey, Niger, 56 p
- GIZ (2012) Good practices in soil and water conservation. A contribution to adaptation and farmers' resilience towards climate change in the Sahel. <http://www.giz.de/Themen/en/.../giz2012-en-soil-water-conservation.pdf>. Accessed 06 Nov 2013
- INS (Institut National de la Statistique du Niger) (2013) Présentation des résultats préliminaires du quatrième recensement général de la population et de l'habitat (RGP/H) 2012. <http://www.stat-niger.org/statistique/file/rgh2012.pdf>. Accessed on 25 Oct 2013
- Lal R (1993) Soil erosion and conservation in West Africa. In: Pimentel D (ed) World soil erosion and conservation. Cambridge University Press, Cambridge
- Larwanou M, Abdoulaye A, Reij C (2006) La régénération Naturelle Assistée dans la région de Zinder (Niger), 39 p
- Pimentel D (1993) Overview. In: Pimentel D (ed) World soil erosion and conservation. Cambridge University Press, Cambridge
- Pimentel D, Kounang N (1998) Ecology of soil erosion in ecosystems. *Ecosystems* 1:416–426
- Poesen J (2011) Challenges in gully erosion research. *Landf Anal* 17:5–9
- Pye-Smith C (2013) The quiet revolution: how Niger's farmers are re-greening the parklands of the Sahel, ICRAF Trees for Change no. 12. World Agroforestry Centre, Nairobi
- Reij C, Tappan G, Smale M (2009) Re-greening the Sahel: farmer-led innovation in Burkina Faso and Niger. In: Agroenvironmental transformation in the Sahel: another kind of "Green Revolution". IFPRI Discussion Paper. International Food Policy Research Institute, Washington, DC
- République du Niger (2004) Stratégie Nationale de Développement Rural : Le secteur rural, principal moteur de la croissance économique. Cabinet du Premier Ministère, Niamey
- Serigne TK, Louis V, Jens M (2006) Climate change and variability in Sahel regions: impacts and adaptations strategies in the agricultural sector. UNEP and ICRAF Report, Nairobi
- Spaan W (2003) Consuming the savings: water conservation in a vegetation barrier system at the Central Plateau in Burkina Faso. PhD dissertation, Wageningen University and Research Centre
- UNCCD (2011) Désertification, une synthèse visuelle. Hori Y, Stuhlberger C, Simonett O (eds), UNCCD/Zoi Environment Network, Bresson
- Valentin C, Poesen J, Li Y (2005) Gully erosion: impacts, factors and control. *Catena* 63:132–153
- Veste M, Littmann T, Breckled S-W, Yair A (2001) The role of biological soil crusts on desert sand dunes in the North-western Negev, Israel. In: Veste M, Wucherer W (eds) Sustainable land-use in deserts. Springer, Heidelberg
- Warren A, Batterbury S, Osbahr H (2001a) Soil erosion in the West African Sahel: a review and an application of a "local political ecology" approach in South West Niger. *Glob Environ Chang* 11:79–95
- Warren A, Batterbury S, Osbahr H (2001b) Sustainability and Sahelian soils: evidence from Niger. *Geogr J* 167:324–341
- World Bank (2009) Republic of Niger: impacts of sustainable land management programs on land management and poverty in Niger. No. 48230- NE. Environmental and Natural Resources Management, Africa region. <https://Openknowledge.worldbank.org>. Accessed on 24 Mar 2013
- World Vision International (2012) Farmer manage natural regeneration: an effective approach to restoring and improving agricultural, forested and pasture lands. Integrated Ministry on behalf of World Vision International, Australia
- Zougmore R, Zida Z, Kambou N (1999) Réhabilitation des sols dégradés: rôles des amendements dans le succès des techniques de demi-lune et de zai au Sahel. *Bull Rés Érosion* 19:536–550
- Zougmore R, Zida Z, Kambou N (2003) Role of nutrient amendments in the success of half-moon soil and water conservation practice in semi arid Burkina Faso. *Soil Tillage Res* 71:143–149

## Chapter 17

# Soil Organic Carbon Stocks of the Kitonga Catchment Forest Reserve, Tanzania: Variation with Elevation

H.B. Shelukindo, E. Semu, B.M. Msanya, Bal Ram Singh, and P.K.T. Munishi

**Abstract** The carbon stored in forest soils has significant implications in global climate change processes. Few studies on soil organic carbon (SOC) have been reported from the Miombo woodlands. This study was conducted to assess SOC at different elevations in selected sites of the Miombo woodlands of the Kitonga Catchment Forest Reserve (KFR). Ten sampling points located at different elevations were selected and georeferenced. At each point, three randomly selected mini-soil pits were excavated for the collection of soil samples. The soil samples from different soil depths, up to 60 cm, were collected and composited from the mini-pits in three replicates. The SOC was analyzed using the wet oxidation method. The mean SOC stock increased from 15.2 to 26.7 Mg ha<sup>-1</sup> at 928 and 1,548 masl, respectively, for the Fluvisols, and from 11.3 to 44.9 Mg ha<sup>-1</sup> at 1,258 and 1,598 masl, respectively, in Cambisols. Conversely, SOC stocks decreased with elevation in Leptosols, and the trends were 28.9–12.5 Mg ha<sup>-1</sup> at 831 and 1,083 masl, respectively. The mean topsoil (0–15 cm) SOC stock was 26.3 ± 5.0 Mg ha<sup>-1</sup> in Fluvisols, 20.6 ± 7.0 Mg ha<sup>-1</sup> in Leptosols, and 19.4 ± 7.0 Mg ha<sup>-1</sup> in Cambisols. The SOC stocks in the 15–30 cm soil depth decreased by 57 %, 41 %, and 31 % compared to those of the top soils (0–15 cm) in Leptosols, Fluvisols, and Cambisols, respectively. The relatively higher amount of SOC stocks in the surface horizons justifies the need for conservation of the intact vegetation of the Miombo woodlands in the KFR.

---

H.B. Shelukindo (✉) • E. Semu • B.M. Msanya  
Department of Soil Science, Faculty of Agriculture, Sokoine University of Agriculture,  
P.O. Box 3008, Morogoro, Tanzania  
e-mail: [hbashelu@yahoo.com](mailto:hbashelu@yahoo.com)

B.R. Singh  
Department of Environmental Sciences, Norwegian University of Life Sciences,  
P.O. Box 5003, No-1432, Ås, Norway

P.K.T. Munishi  
Department of Forest Biology, Faculty of Forestry and Nature Conservation, Sokoine  
University of Agriculture, P.O. Box 3010, Morogoro, Tanzania

**Keywords** Altitude levels • Kitonga Forest Reserve • Miombo Woodlands • SOC stocks • Soil types • Soil depth • Tanzania

## 17.1 Introduction

Soils are the largest carbon (C) reservoirs in the terrestrial carbon cycle, and they play a role in the regulation of global warming and greenhouse gas effects (Vågen and Winowieck 2012; Woollen et al. 2012; Aticho 2013). According to Yuan et al. (2013), 40 % of the world's soil organic carbon (SOC) resides in forest ecosystems, with 11 % stored in forest soils (Yuan et al. 2013). In Tanzania, the Miombo woodlands are found, among other places, in the Kitonga Forest Reserve (KFR). However, few studies have been conducted on SOC stocks in soils of these woodlands. In view of the growing threats of global warming due to greenhouse gas (GHG) emissions, and the potential of SOC stocks for mitigation, an understanding of C storage in the soils of the Miombo woodlands in Tanzania is necessary. The Miombo woodlands, which cover 32 million ha, or 93 % of the total forested land area and approximately 40 % of the total land in Tanzania, provide diverse ecosystem services, including regulation of climate change and support for the livelihoods of the adjacent communities (Nshubemuki and Mbwambo 2007; FAO 2009; Woollen et al. 2012). In the context of global climate change, it is important to study the patterns of the SOC stocks of the Miombo woodlands.

The soils of the Miombo woodland forests show alarming deterioration rates due to disturbances that increase land degradation (Nshubemuki and Mbwambo 2007; FAO 2009), and it is important to predict the loss of SOC stock as a result of these disturbances. The SOC stocks across a landscape may vary among soil types, vegetation types, climate, topographical features, elevation, and soil depth. The objectives of the study reported herein were to determine the SOC stocks in the major soil types of the KFR, to determine the variations of SOC stocks along elevation gradients, and to determine changes of SOC stocks with soil depths. The working hypothesis of the study was that, '*SOC stocks of a given soil type are a function of elevation gradient and soil depth.*' The data obtained provide vital information about soil carbon stocks, which is helpful to stakeholders in designing interventions to reduce the extent of deforestation, soil degradation, and associated C emissions.

## 17.2 Materials and Methods

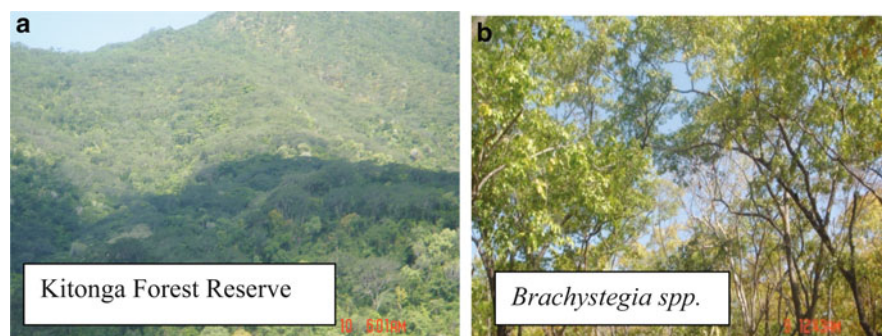
### 17.2.1 Description of the Study Site

The study site, the KFR, is located in the Kilolo district, Iringa region, Tanzania. Relevant information regarding the KFR is summarized in Table 17.1.

**Table 17.1** Site characteristics of the Kitonga Forest Reserve

Location	Kilolo district, Iringa region
Latitude/longitude	07°35'–07°43' S–37°07'–37°10' E
Altitude	660–1,880 masl
Annual rainfall	520–737 mm
Annual mean temp.	12.0–29.0 °C
<sup>a</sup> Soil types	Cambisols, Fluvisols, Leptosols
Dominant tree spps.	<i>Brachystegia</i> , <i>Julbernardia</i> , <i>Diplorhynchus</i> , and <i>Condylocarpon</i>
Dominant grasses	<i>Andropogon</i> , <i>Heteropogon</i>
Dominant shrub	<i>Fadogia</i> spp.
Dominant herb	<i>Commelina africana</i>

<sup>a</sup>FAO-WRB (2006) soil classification system



**Fig. 17.1** The Kitonga Forest Reserve (a) study site and (b) dominant *Brachystegia* spp.

From Table 17.1, the diversity of the study area from the viewpoints of altitude, annual rainfall, soil types, and vegetation are apparent. The section of the KFR where the studies were undertaken, and one prominent tree species, are presented in Fig. 17.1a, b respectively.

Figure 17.1a shows that the KFR is dense at a distance, although inside the forest sporadic deforestation occurs, for example, to make charcoal (Fig. 17.2).

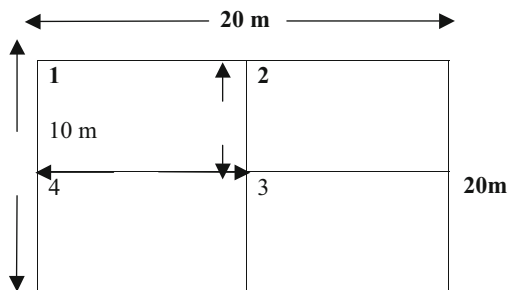
### 17.2.2 Field Methods

At each predetermined elevation, a 20 m × 20 m plot was demarcated and partitioned into four quadrants each of 10 m × 10 m in size (Fig. 17.3). One point in each quadrant was randomly selected from which the soil samples were collected. The soil samples from each point were collected from excavated mini-pits at the soil depths of 0–15, 15–30, and 30–60 cm. The soils from similar depths of the four sampled mini-pits from all four quadrants were mixed to obtain composite samples for the different soil depths.



**Fig. 17.2** Deforestation/charcoal making in the KFR

**Fig. 17.3** A 20 m × 20 m (0.04 ha) quadrant with four 10 m × 10 m subplots



Three different experimental plots, each of 20 m × 20 m in size, were demarcated to serve as replicates around each soil profile excavated, and soils were sampled as described. This procedure resulted in a total of 85 composite soil samples from all mini-pits. This number is less than the 90 samples expected to be obtained from the mini-pits because in five of the mini-pits the soils were only 30 cm deep. Sub-samples from each soil depth were mixed to make bulk samples of 2 kg which were used for laboratory analysis of the physical and chemical properties of the soils. At each sampling point, undisturbed core soil samples were collected from each soil depth (or thickness) for the determination of bulk density (BD).

For purposes of soil description, ten profiles were excavated and georeferenced to designated altitudes, namely 831, 928, 980, 1,083, 1,241, 1,258, 1,320, 1,377, 1,548, and 1,598 masl. To obtain the representative surface soil samples, three sampling points were selected randomly around each of the ten profiles and georeferenced for future follow up and monitoring. The coordinates of those points are presented in a study conducted by Shelukindo et al. (2014).

### 17.2.3 Laboratory Methods

In the laboratory, soil samples were air-dried to constant weight after which they were ground and sieved through a 2 mm wire mesh sieve to obtain the fine earth fraction

for laboratory analysis. The physical and chemical analyses were conducted as follows: the bulk density was determined using the core method (Black and Hartge 1986), and the texture was determined by the hydrometer method (Day 1965). The pH was measured in water and in 1 M CaCl<sub>2</sub> at the ratio of 1:2.5 soil:water or soil:CaCl<sub>2</sub>, respectively (McLean 1986). Organic carbon was determined by the wet oxidation method (Nelson and Sommers 1982). Total N was determined using the micro-Kjeldahl digestion – distillation method as described by Bremner and Mulvaney (1982). Extractable phosphorus was determined by the Bray and Kurtz-1 method (Bray and Kurtz 1945) and P was determined by a spectrophotometer (Watanabe and Olsen 1965). The exchangeable bases Ca<sup>2+</sup> and Mg<sup>2+</sup>, and Na<sup>+</sup> and K<sup>+</sup> were determined by an atomic absorption spectrophotometer and a flame photometer, respectively (Thomas 1982). The extractable micronutrients Fe, Mn, Zn, and Cu were extracted using buffered diethylenetriaminepentaacetic acid (DTPA), and the concentrations of Fe, Mn, Zn, and Cu in the DTPA extracts were determined by an atomic absorption spectrophotometer (AAS), (UNICAM 919 model) (Lindsay and Norvell 1978). The SOC stock was calculated based on the formula given by Spiotta and Sharma (2013):

$$\text{SOC}_{\text{st}} = \% \text{ SOC}/100 \times \text{BD} \times \text{D} \times 100$$

where SOC<sub>st</sub> is the soil organic carbon stock (Mg C ha<sup>-1</sup>), SOC is the soil organic carbon concentration in %, BD is the bulk density (g cm<sup>-3</sup>), D is the horizon thickness (cm), and 100 is the multiplication factor to convert the SOC from g cm<sup>-2</sup> to Mg C ha<sup>-1</sup>. The C stock in each dominant soil type was obtained by the summation of C stocks of each natural soil horizon to the soil depth of 60 cm.

#### ***17.2.4 Statistical Analysis***

The SOC data were subjected to a one-way analysis of variance (ANOVA) following a completely randomized design (CRD). The analyses were performed by using the statistical analysis system (SAS version 9.2). Descriptive statistics were used to summarize the data into variables such as means, standard deviation, standard error, minimum, and maximum values.

### **17.3 Results and Discussion**

#### ***17.3.1 Physical and Chemical Properties of the Major Soil Types in the Study Area***

The physical and chemical properties of the soils in the surface horizons of the major soil types are presented in Table 17.2. The soils were coarse in texture (loamy sandy,



**Table 17.2** Selected physico-chemical properties of the surface (0–15 cm depth) soils of the Kitonga Forest Reserve

Variable	No of observations	Minimum	Maximum	Mean	Standard deviation	Interpretation/rating <sup>a</sup>
Slope (%)	85	3	42	16.6	9.6	Gently sloping to steep
pH H <sub>2</sub> O	85	4.8	7	5.9	0.5	Medium acidic to neutral
Clay (%)	85	6.3	42.7	17.2	9.1	Coarse textured soils
Silt (%)	85	0.6	13	6	2.9	Coarse textured soils
Sand (%)	85	49.1	93.1	77	10.7	Coarse textured soils
Bulk density	85	1.0	1.31	1.17	0.08	Ideal for plant growth
OC (%)	85	0.1	4.4	1.0	0.9	Very low to very high
CEC (cmol (+)/kg)	85	2.4	24	8.4	4.1	Very low to medium
Total N (%)	85	0	0.3	0.1	0.1	Low to medium
Available P (mg/kg)	85	0.2	54.4	5.8	9.9	Very low to high
Ca (cmol (+)/kg)	85	0.3	10.7	2.2	2.1	Very low to very high
Mg (cmol (+)/kg)	85	0.2	24	1.5	2.6	Very low to very high
K (cmol (+)/kg)	85	0.1	0.6	0.2	0.1	Very low to medium
Na (cmol (+)/kg)	85	0.2	0.8	0.2	0.1	Low to high
Cu (mg/kg)	85	0.3	5.8	0.7	1.3	Deficient to adequate
Fe (mg/kg)	85	0.2	339.9	67.9	75.3	Adequate
Zn (mg/kg)	85	0	2.4	0.5	0.5	Deficient to adequate
Mn (mg/kg)	85	0	55.6	13.7	15	Deficient to adequate

<sup>a</sup>The interpretation column is based on the ratings compiled by Baize (1993), EUROCONSULT (1989), and Landon (1991)

sandy loam, sandy clay loam) with pH (water) ranging from 4.8 to 7.0, which is favorable for vegetation growth. According to Baize (1993), EUROCONSULT (1989), and Landon (1991), the soils had low mean OC (1 %) and cation exchange capacity (CEC) (NH<sub>4</sub>OA) (8.4 cmol(+)/kg). The values for different macro- and micronutrients varied from deficient, very low, or low to adequate, medium, high, or very high.

In the KFR, apart from the nature of the parent material that was subjected to *in situ* weathering (biotitic/quartz) and the mode of soil formation, which was a combination of colluvial/alluvial deposition and organic matter accumulation from forest vegetation, the low levels of most of the essential nutrient elements, especially in the surface soil horizons, may have resulted from deforestation, wild fires, grazing, and burning of charcoal in the Miombo woodlands. Such disturbances led to rapid decomposition of organic matter and losses of most mineral nutrients through subsequent soil erosion by water. Frost (1996) and Nshubemuki and Mbwambo (2007) observed similar trends in the soils of the Miombo woodlands in Tabora (Tanzania), which are also inherently poor in these essential nutrient elements.

### 17.3.2 Changes in SOC Stocks with Elevation

The SOC stocks of the major soil types, to the soil depth of up to 60 cm, at different elevations, are shown in Table 17.3. The overall mean SOC stocks increased from 15.2 Mg ha<sup>-1</sup> at 928 masl to 26.7 Mg ha<sup>-1</sup> at 1,548 masl in Fluvisols, and from 11.3 Mg ha<sup>-1</sup> at 1,258 masl to 44.9 Mg ha<sup>-1</sup> at 1,598 masl in Cambisols. In the Leptosols, however, the SOC stocks decreased with elevation, from 28.9 Mg ha<sup>-1</sup> at 831 to 12.5 Mg ha<sup>-1</sup> at 1,083 masl. The results of the present study demonstrated that within the Fluvisols and Cambisols occurring at different elevations, SOC stocks increased with elevation (Table 17.3).

Similar results were shown by Wang et al. (2012) whereby SOC increased as elevation increased. These authors attributed this trend to increased precipitation and reduced temperatures at the higher elevations. This, in turn, resulted in low rates of decomposition of organic matter at higher altitudes, with consequent SOC accumulation. However, in the current study, Leptosols showed a decreasing trend of SOC with increasing elevation. These soils occupy the areas which are highly degraded and disturbed, resulting in scanty trees, grasses, and shrubs, and show evidence of soil sedimentation at lower elevations due to soil eroded from the higher elevations. The eroded soils carried with them their constituent OC and deposited the OC at the lower altitudes, thereby resulting in higher SOC stocks in the lower elevations and lower SOC stocks at higher elevations.

Studies conducted by Wiesmeier et al. (2012), Liu et al. (2012), and Hoffmann et al. (2014) in Germany, China, and Canada, respectively, reported SOC stock variability to be influenced by the texture of the eroded and deposited sediments. The SOC stocks usually are higher at the bottom of slopes, in part because of wetter conditions at the bottom of slopes, promoting greater plant productivity. Consequently, the sedimentation and deposition which occurred in the locations occupied by the Leptosols may have contributed to increased soil moisture in the surface layer. Thereby, soil temperatures were reduced and the rate of residue decomposition was decreased, resulting in relatively more SOC at the lower elevations. However, the relatively higher amounts of SOC stocks in the surface horizons in all of the soils justify the need for conservation of intact vegetation of the Miombo woodlands to avoid disturbances and thereby increase SOC stocks at all elevations.

**Table 17.3** Variations of SOC stocks ( $\text{Mg ha}^{-1}$ ) to the depth of 60 cm as influenced by elevation

Elevation (masl)	Profile no.	Soil class FAO-WRB <sup>a</sup>	SOC stocks (Mg/ha)	Slope gradient	Natural horizons <sup>a</sup>	Horizon/soil thickness (cm)	SMR <sup>b</sup>	STR <sup>c</sup>
831	5	Leptosol	28.9	25	Ah	20	Ustic	Thermic
928	3	Fluvisol	15.2	15	Ah, BA, Bw	45	Aquic	Thermic
980	4	Leptosol	19.4	12	Ah	16	Ustic	Thermic
1,083	2	Leptosol	12.5	17	Ah, Bw	25	Ustic	Thermic
1,241	8	Fluvisol	24	10	Ah, Bw, 2Bgb <sub>1</sub>	60	Acquic	Mesic
1,258	9	Cambisol	11.3	10	Ah, Bw, BC	60	Ustic	Mesic
1,320	10	Cambisol	15.1	22	Ah, Bt	40	Ustic	Mesic
1,377	7	Cambisol	18.6	25	Ah, Bt	35	Ustic	Mesic
1,548	6	Fluvisol	26.7	10	Ah, BA, Bt <sub>1</sub> , Bt <sub>2</sub>	60	Ustic	Mesic
1,598	1	Cambisol	44.9	1	Ah, BA, Bw <sub>1</sub>	60	Ustic	Mesic

<sup>a</sup>FAO-WRB (2006) and FAO-UNESCO (2006)<sup>b</sup>SMR soil moisture regime<sup>c</sup>STR soil temperature regime

### 17.3.3 Changes in SOC Stocks with Soil Depth

Results of the changes in SOC stocks with soil depth, for each soil type, are presented in Fig. 17.4. The average SOC stocks decreased substantially from 28.9 Mg ha<sup>-1</sup> in the top 15 cm to 12.5 Mg ha<sup>-1</sup> (57 %) in the 15–30 cm soil layer in Leptosols.

In addition, SOC stocks decreased from 26.3 Mg ha<sup>-1</sup> in the top 15 cm to 15.6 Mg ha<sup>-1</sup> (41 %) at the 15–30 cm depth in Fluvisols. The SOC stocks decreased from 19.4 Mg ha<sup>-1</sup> in the top 15 cm to 13.3 Mg ha<sup>-1</sup> (31 %) at the 15–30 cm depth in Cambisols. The overall 0–30 cm depth has been cited here because the 0–15 and 15–30 cm soil depths are affected by soil management practices. Additionally, they constitute the depths of interest specified by the Kyoto SOC inventory guidelines (Hiederer 2009; Aticho 2013).

The decrease in SOC with an increase in soil depth has been reported in previous studies (Hiederer 2009; Wang et al. 2012; Yao et al. 2010; Salome et al. 2010; Grand and Lavkulich 2011; Rojas et al. 2012). The distribution of SOC with soil depth varied among the soils of the present study. Similar results were reported by Rojas et al. (2012) for the soils of southern Spain. On average, approximately 43 % of the SOC of the soils in this study was stored in the surface soil layers (0–15 cm), i.e., the layer which is most susceptible to disturbances and prone to land degradation.

Studies conducted by Hiederer (2009), Gruneberg et al. (2010), and Rojas et al. (2012) indicated that the SOC stocks in soils with shallow depths (e.g., Leptosols) decreased more rapidly with depth than in soils with greater depth (e.g., Cambisols). The Leptosols have limited soil development due to their shallow depth and accumulate their SOC stocks primarily in the surface layer (0–15 cm) as compared to Cambisols, which have carbon distributed across their thick soil layers. However, the relatively higher amounts of SOC stocks in the surface soils

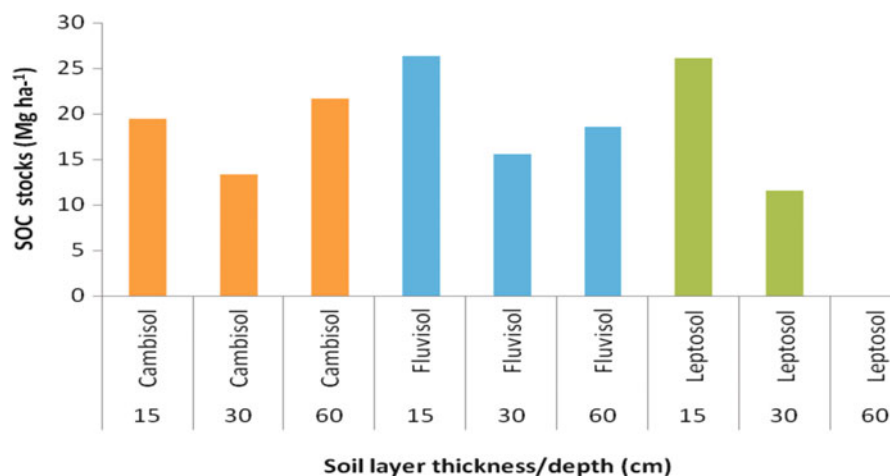


Fig. 17.4 The mean SOC stocks of the major soil types to the soil depth of 60 cm

of all soil types appeal for increased efforts at their conservation and avoidance of those actions that would deplete the SOC stocks.

The cumulative SOC levels to the soil depth of 60 cm were higher relative to those of the soil depth of 0–15 cm due to the contribution of the OC in 30–60 cm layer, which resulted in larger cumulative SOC stocks. A study conducted in Ethiopia by Aticho (2013) revealed cumulative soil sampling depth to be one of the important factors that affect SOC stocks. Aticho (2013) reported that as the sampling depth/layer of the soil increased the SOC stocks also increased.

The results of the present study are consistent with the findings obtained by other authors in previous studies of the same nature. For example, a study conducted by Cosel et al. (2011) in central Panama reported a mean SOC of  $28.1 \pm 3.9 \text{ Mg ha}^{-1}$  in the A horizon (top 10 cm), which dropped to  $22.7 \pm 1.6 \text{ Mg ha}^{-1}$  in the B horizon in an area of tropical moist forest vegetation. In Columbia, Usuga et al. (2010) reported a mean of  $33.4 \text{ Mg ha}^{-1}$  in the A horizon (top 25 cm), which dropped to  $14.7 \text{ Mg ha}^{-1}$  in the B horizon (25–50 cm) in a *Tectonia grandis* forest, and  $87.2 \text{ Mg ha}^{-1}$  (A horizon) that dropped to  $57.0 \text{ Mg ha}^{-1}$  (B horizon) in a *Pinus patula* forest of 26 years. Studies by Sheikh et al. (2009) determined that SOC levels for the soils of the Indian Himalayan zone decreased from  $24.3 \text{ g kg}^{-1}$  ( $\equiv 48.6 \text{ Mg ha}^{-1}$ ) in the A horizon (0–20 cm) to  $0.2 \text{ g kg}^{-1}$  ( $\equiv 0.4 \text{ Mg ha}^{-1}$ ) in the underlying layer (20–40 cm).

## 17.4 Conclusions and Recommendations

### 17.4.1 Conclusions

Spatial variations of SOC stocks were observed across elevations and soil depths. This is attributed to variations in soil types, physico-chemical properties of the soils, and topographical features. The study revealed that the quantities of SOC stored increased as elevation increased in Cambisols and Fluvisols but decreased as elevation increased in the Leptosols. The different trends observed among the soil types are affected by varying site characteristics, such as soil moisture regimes, variations in physico-chemical properties of the soils, and topographical features.

### 17.4.2 Recommendations

In view of the above, the following recommendations are proposed:

1. Due to the relatively high amounts of carbon stored in the surface horizons, it is recommended that the soils, and thus the SOC stocks in the Miombo woodlands in KFR, be conserved by avoiding fires, grazing, deforestation, and cultivation within the forest/woodlands.

2. Because the residents of communities adjacent to the Miombo woodlands are accustomed to destructive activities in the forest, it is hereby recommended that awareness be created among the communities regarding the need to strengthen forest conservation and to enforce conservation by-laws.
3. It is also recommended that these efforts should operate concurrently with the development of a policy supporting the use of alternative energy sources such as biogas, natural gas, and hydropower that will reduce deliberate deforestation and soil degradation as a prelude to reducing carbon emissions.

**Acknowledgements** The authors are thankful for the financial support provided to the senior author by the Climate Change Impacts Adaptation and Mitigation Measures (CCIAM) Project, at the Sokoine University of Agriculture (SUA), without which this study could have not been undertaken.

## References

- Aticho A (2013) Evaluating organic carbon storage capacity of forest soil: case study in Kafa Zone Bita District, south western Ethiopia. *Am Eurasian J Agric Environ Sci* 13(1):95–100
- Baize D (1993) *Soil science analysis, a guide to correct use*. Wiley, West Sussex
- Black GR, Hartge KH (1986) Bulk density. In: Klute A (ed) *Methods of soil analysis*. American Society of Agronomy and Soil Science Society of America, Madison, pp 364–376
- Bray RH, Kurtz LT (1945) Determination of total, organic and available forms of phosphorus in soils. *Soil Sci* 59:39–45
- Bremner JM, Mulvaney CS (1982) Total nitrogen. In: Page LA, Miller RH, Keeney DR (eds) *Methods of soil analysis*. American Society of Agronomy, Madison, pp 595–624
- Cosel CL, Zimmermann B, Hall JS, Breugel MV, Elsenbeer H (2011) Soil carbon dynamics under young tropical secondary forests on former pastures—a case study from Panama. *J For Ecol Manag* 261:1625–1633
- Day PR (1965) Particle fractionation and particle size analysis. In: Black CA, Evans DD, White JL, Ensminger LE, Clark FE (eds) *Methods of soil analysis, physical and mineralogical methods*. American Society of Agronomy, Madison, pp 545–566
- EUROCONSULT (1989) *Agricultural compendium for rural development in the tropics and sub tropics*, 3rd edn. Oxford University, New York
- FAO (2009) *State of world's forests. Adaptation to climate change in agriculture, forests and fisheries: perspectives, framework priorities*. Food and Agriculture Organization. [ftp://ftp.fao.org/docrep/fao/09/j9271e/j9271e.pdf](http://ftp.fao.org/docrep/fao/09/j9271e/j9271e.pdf). Accessed 18 Jul 2013
- FAO-UNESCO (2006) *Guidelines for soil description*, 4th edn. Food and Agriculture Organization, Rome
- FAO/WRB (2006) *World reference base for soil resource. A framework for international classification, correlation and communication*. World Soil Resources Report No. 103. Rome
- Frost P (1996) The ecology of Miombo woodlands. In: Campbell BM (ed) *The Miombo in transition. Woodlands and welfare in Africa*. Center for International Forestry Research, Bogor, pp 11–58
- Grand S, Lavkulich LM (2011) Depth distribution and predictors of soil organic carbon in Podzols of a forested watershed in south western Canada. *Soil Sci* 176(4):164–174
- Grüneberg E, Schönning I, Kalko EKV, Weisser WW (2010) Regional organic carbon stock variability: a comparison between depth increments and soil horizons. *Geoderma* 155:426–433

- Hiederer R (2009) Distribution of organic carbon in soil profile data. Office for Official Publications of the European Communities, Luxembourg
- Hoffmann U, Hoffmann T, Johnson EA, Kuhn NJ (2014) Assessment of variability and uncertainty of soil organic carbon in a mountainous boreal forest (Canadian rocky mountains, Alberta). *Catena* 113:107–112
- Landon JR (1991) Booker tropical soil manual. A handbook for soil survey and agricultural land evaluation in the tropics and subtropics. Longman Scientific and Technical Publishers, Essex
- Lindsay WL, Norvell WA (1978) Development of DTPA soil test for Zn, Fe, Mn and Cu. *Soil Sci Soc Am J* 42:421–428
- Liu W, Chen S, Qin X, Baumann F, Scholten T, Zhou Z, Sun W, Zhang T, Ren J, Qin D (2012) Storage patterns and control of soil organic carbon and nitrogen in the north-eastern margin of the Qinghai-Tibetan Plateau. <http://iopscience.iop.org/1748-9326/7/3/035401>. Accessed 10 Apr 2014
- McLean EO (1986) Soil pH and lime requirement. In: Page AL, Miller RH, Keeny DR (eds) *Methods of soil analysis*. American Society of Agronomy and Soil Science Society of America, Madison, pp 199–223
- Nelson DW, Sommers LE (1982) Total carbon, organic carbon and organic matter. In: Page AL, Miller RH, Keeny DR (eds) *Methods of soil analysis*. Chemical and microbiological properties. American Society of Agronomy and Soil Science Society of America, Madison, pp 539–579
- Nshubemuki L, Mbwambo L (2007) Trees to promote in the management of Miombo Woodlands in Tanzania: species, sizes and qualities. In: Varmola M, Valkonen S, Tapaninen S (eds) *Proceedings of the first MITMIOMBO project workshop management of indigenous tree species for ecosystem restoration and wood production in semi-arid Miombo Woodlands in eastern Africa*, 6–12 Feb 2007, Morogoro, pp 57–63
- Rojas MM, Jordan A, Zavala LM, Rosa DDL, Abd-Elmabod SK, Romero MA (2012) Organic carbon stocks in Mediterranean soil types under different land uses (Southern Spain). *Solid Earth* 3:375–386
- Salome C, Nunan N, Pouteau V, Lerch TZ, Chenu C (2010) Carbon dynamics in topsoil and in subsoil may be controlled by different regulatory mechanisms. *Glob Change Biol* 16:416–426
- Sheikh AM, Kumar M, Bussman R (2009) Altitudinal variation in soil organic carbon stock in coniferous subtropical and broadleaf temperate forests in Garhwal Himalaya. *Carbon Balance Manag* 4:1–6
- Shelukindo, HB, Semu E, Msanya BM, Mwangi SB, Singh BR, Munishi PKT (2014) Characterization of some typical soils of Miombo Woodlands ecosystem of Kitonga Forest Reserve, Iringa, Tanzania: physico-chemical properties and classification. *J Agric Sci Technol A B* 4:224–234
- Spiotta EM, Sharma S (2013) Carbon storage in successional and plantation forest soils: a tropical analysis. *Glob Ecol Biogeogr* 22:105–117
- Thomas GW (1982) Exchangeable cations. In: Page LA, Miller RH, Keeny DR (eds) *Methods of soil analysis, chemical and mineralogical properties*. American Society of Agronomy and Soil Science Society of America, Madison, pp 595–624
- Usuga JCL, Toro JAR, Alzate MVR, Tapias AJL (2010) Estimation of carbon stocks in plants, soil and forest floor in different tropical forests. *J For Ecol Manag* 260:1906–1913
- Vågen TG, Winowieck LA (2012) Mapping of soil organic carbon stocks for spatially explicit assessments of climate change mitigation potential. *Environ Res Lett* 8:9–10
- Wang Z, Liu GB, Xu MX, Zhang J, Wang Y, Tang L (2012) Temporal and spatial variations in soil organic carbon sequestration following re-vegetation in the hilly Loess Plateau, China. *Catena* 99:26–33
- Watanabe FS, Olsen SR (1965) Test of an ascorbic acid method for determining phosphorus in water and  $\text{NaHCO}_3$  extracts from soil. *Soil Sci Soc Am Pro* 29:677–678
- Wiesmeier M, Peter S, Uwe G, Edzard H, Stephan H, Arthur R, Bernd S, Margit VL, Kogel-Knabner I (2012) Soil organic carbon stocks in southeast Germany (Bavaria) as affected by land use, soil type and sampling depth. *Glob Change Biol* 10:1365–2486

- Woollen E, Casey MR, Mathew W (2012) Carbon stocks in an African woodland landscape: spatial distribution and scales of variation. *Ecosystems* 15:804–818
- Yao MK, Angui PKT, Konate S, Tondoh JE, Tano Y, Abbadie L, Benest D (2010) Effects of land use types on soil organic carbon and nitrogen dynamics in Mid-West Cote d'Ivoire. *Eur J Sci Res* 40(2):211–222
- Yuan Z, Antonio G, Fei L, Ji Y, Shuai S, Xugao W, Miao W, Zhanqing H (2013) Soil organic carbon in an old-growth temperate forest: spatial pattern, determinants and bias in its quantification. *Geoderma* 195(196):48–55



**Part VI**  
**Management of Animal Production**  
**for Greenhouse Gas Emissions**

# Chapter 18

## Alternative Goat Kid-Rearing Systems for Improved Performance and Milk Sharing Between Humans and Offspring in Climate Change Mitigation

Fanny C. Chigwa, Lars Olav Eik, G.C. Kifaro, V.C.M. Muhikambebe, and Daniel E. Mushi

**Abstract** Intensification of livestock production reduces the amount of land required to sustain a livestock unit and frees up the land necessary for carbon sequestration. Transforming the goat sector from meat only to a dual-purpose system with both milk and meat is reported to increase food production per unit of land. Dairy goats have been widely adopted among smallholders in Tanzania and are now gaining popularity in Malawi. High mortalities due to poor feeding of goat-kids have been identified as a major challenge and therefore kid rearing systems of different milking systems for dairy goats and use of different creep feeds and alternate rearing systems for meat goat on Likoma Island were evaluated.

In study I, the methods used were (a) suckling one teat twice daily and milking the other teat; (b) suckling in daytime only and morning-milking of dams, and (c) early weaning and bottle-rearing using goat's milk. In study II, three different types of locally available creep feed supplements were evaluated for animals grazed on unimproved rangeland. The third study qualitative differences in kid rearing systems for local goats, with or without milking, were evaluated on Likoma Island in Malawi using a semi-structured questionnaire. In study I, kid growth rates, ranging from 62 to 76 g/day did not significantly differ; one teat milking provided the most milk for human consumption and artificial rearing was found to be the most labor intensive and therefore not recommended under small-holder conditions. Goat farmers on Likoma Island preferred faster kid growth to more milk for

---

F.C. Chigwa (✉)

Department of Animal Science, Bunda College, Lilongwe University of Agricultural and Natural Resources, P.O. Box 219, Lilongwe, Malawi  
e-mail: [fanchigwa@yahoo.com](mailto:fanchigwa@yahoo.com)

L.O. Eik

Department of International Environment and Development Studies/Noragric, Norwegian University of Life Sciences (NMBU), P.O. Box 5003, No-1432 Ås, Norway

G.C. Kifaro • V.C.M. Muhikambebe • D.E. Mushi

Department of Animal Science, Sokoine University of Agriculture, P.O. Box 3004, Morogoro, Tanzania

human consumption. It is concluded that successful kid rearing systems should address farmer milk utilization and kid growth and evaluate locally available feeds for creep feeding and dam feeding.

**Keywords** Goat • Kids • Milking • Smallholder • Consumption • Teat • Suckling • Likoma

## 18.1 Introduction

Forest degradation in high-altitude water-catchment areas are seen as a threat to stable water supplies in Tanzania and Malawi. Traditional food crop production in steep terrain leads to massive soil erosion, land-degradation, loss of bio-diversity, and increased greenhouse-gas-emissions. Maintenance of more forest and grass-cover utilized by zero-grazed or tethered milking goats is seen as more environmental friendly, while still maintaining farmer's income and food-security (Mushi et al. 2014).

In Tanzania, the number of dairy goats and farmers keeping them has increased from almost none before start of the importation of dairy goats, which was initiated by Sokoine University of Agriculture (SUA) in 1983, to the present estimated number of 400,000 (Eik et al. 2008). Norwegian Land Race is the dominant breed. In a joint effort between the Lilongwe University of Agricultural and Natural Resources, SUA, and the University of Life Sciences (NMBU), the success story of dairy goats in Tanzania is now being replicated in Malawi.

Low birth weights and sub-optimum growth rates of kids resulting in high mortalities, particularly in early age, are identified as major challenges among dairy-goat farmers in Tanzania (Kiango 1996; Eik et al. 2008). In this study, a novel milk-sharing system introduced by Mgeta-farmers, i.e., suckling one teat and milking the other, was compared with the more conventional partly suckling and artificial milk rearing systems.

Although not well studied, anecdotal evidence suggests that high kid mortality and poor growth is a problem among local East African goats (Eik et al. 2008). Therefore creep-feeding of local goat-kids was included as a possible method for improving the performance of local goats.

Likoma Island is located in Lake Malawi in Malawi (called Lake Nyasa in Tanzania). While goats traditionally are not milked in East Africa, a tradition of milking local goats has developed on this island over a long period time. Therefore it was of interest to study this system and see how milk consumption was shared between goat kids and humans.

## 18.2 Material Methods

Two studies on alternative suckling methods were used: study I in Tanzania using Norwegian dairy goats, study II in Malawi comparing creep-feeding of kid with no separate feeding arrangement for suckling kids of local breed and study III where qualitative differences in rearing meat goat for milking and not milking household.

In study I, methods evaluated during the milk-rearing period from birth to 8 weeks of age were: (a) suckling one teat twice daily and milking the other teat; (b) suckling in daytime only and morning milking of dams, and (c) early weaning and bottle-rearing using goat's milk. Goat kids were kept indoors during the experimental period. Dams were stall-fed on a grass-hay mixture of *Penisetum*, *Hyperranea*, and *Panicum spp* garant grass, Dengu pori, Nsaam grasses, and crop residues of chick peas and bean pods. Metabolisable energy (MJ/kg) was 4.8 for garant grass, 8.9 for chickpea pods, 7.6 for Dengu pori, 8.0 for Nsaam, and 6.4 for bean pods. Calcium in the hay grasses was 1.1–1.6 g/kg and phosphorus was 3.2–4.4 g/kg. Goats were supplemented with 1.0 kg of concentrate mixture containing 16 % CP made of maize bran, sunflower cake, minerals, and salt. Twelve and 18 Norwegian goats were randomly allocated to the experimental treatments in first and second year, respectively.

In study II, does were randomly allocated to four treatments of *Urochloa mosambicensis*, Urocloa hay *Arachis hypogea*, groundnut haulms, a 16 % concentrate of crude protein, and no supplement for creep feeding 1 month after kidding for 2 months. Dams were housed with kids and separated at 08:00 h when does were let out to graze. Kids were confined as does and supplemented as dams were out grazing. Dams would return to suckle and water at 11:00 h and go back grazing at 13:00 h until 15:00 h. Dams grazed in natural pastures dominated by *Hyperrhenia* and *Pennisetum spp.*, woodland trees, and acacia trees in the dry season. Feed offer and refusal was weighed daily. Kids were weighed fortnightly in the creep feeding period (Figs. 18.1 and 18.2.).

Qualitative differences in kid rearing systems for local goats, with or without milking, were also evaluated on Likoma Island in Malawi using a semi-structured questionnaire. Thirty milking and 30 non-milking households were interviewed. Milking does and offspring were separated during the night and milking took place in the morning. Goats were tethered in maize fields and supplemented with tree leaves during the day time. Weaning of kids took place at approximately 4 months of age.



**Fig. 18.1** Pure Norwegian goats individually fed at Haydom in Tanzania



**Fig. 18.2** Kids of East African goats stimulating milk for milking but suckling after milking on Likoma Island in Malawi

Milking does from 30 households were tethered outside the homestead during the night separate from the kids. Kids were kept inside the house in the first month and later tethered away from the dam outside the house at night. During the day after 1 h of sunlight, dams were tethered in the fields and supplemented with tree leaves and watered at least twice a day while suckling the kid. Goats were milked once a day in the morning without completely emptying the udder and allowed to suckle after milking. Non-milking households tethered suckling dams outside the homestead at night and kept the kid in the house for 1 month but later tethered it outside with the doe overnight. During the day, suckling dams were tethered with the kid in the crop field and supplemented with tree leaves. Tree leaves used as supplements were *Protea welwitschii*, *Azalia quanzensis* (Msambafumu), *Cassia singueana* (Kathanyere), and *Mangifera indica* (mango leaves). Using a structured questionnaire, farmer demographic data, assets, income, and reasons for a preferred kid rearing system were obtained.

In studies 1 and II, data were analyzed using Minitab and SPSS was used for data in study III.

### 18.3 Result and Discussion

No significant differences were observed in the growth rate of the different milk-suckling systems, while twice daily milking and bottle-feeding kids resulted in significantly lower amounts of milk available for human consumption. These findings are in agreement with corresponding studies in Norway, indicating higher

total milk yield in combined suckling and milking systems, higher growth rate of kids, reduced workload, and no investment in equipment for milk-feeding (Chigwa 2011; Eik et al. 1998). It is therefore concluded that different types of partly suckling methods should be recommended for dairy goats in Malawi and Tanzania. Methods used may vary depending on local circumstances and the ratio chosen between the allocation of milk for household needs and goat kids.

Farmers practicing once milking of two teats, dam suckling, and one teat suckling are driven by farmer's traditional knowledge of the maternal instinct of milking goats to keep milk for their kids. Traditional knowledge agrees with the physiological work which showed that mother-offspring bond and maternal behavior inhibited oxytocin release but did not affect prolactin and cortisol production in goats (Hernandez et al. 2007). Milk withheld by the dam is then released when suckling her own kid.

It is also noted that the method developed by farmers to have one teat suckled and the other milked performed equally well as milking in morning and suckling during the day time. Particularly for the small flocks of two to five goats normally kept in Tanzania, it is advantageous to house kids and dams together. Dry matter of milk content is normally lower in partly suckling schemes (Chigwa 2011; Eik et al. 1998). In this study, facilities at the experimental farm did not allow for the measurement of the milk's content. It is possible that the DM content of milk for human intake was higher when one teat was milked and the other suckled. Therefore, it is recommended that a study comparing both milk yield and content should be undertaken. Frequent emptying of one teat and twice milking of the other may cause distress for the goats and could be examined in a new study.

Milk output was similar for all suckling regimes in first year, but it was significantly different in second year. Unlike experiment 1 of study I, which used a limited numbers of goats, experiment 2 of study I could bring out the differences in suckling and milking regimes on milk output. Milk output was higher for dams not suckling ( $P=0.001$ ) and was reduced by 32 % in once milking and kid suckling for the whole day and by 20 % in teat milking and one teat suckling twice a day. Twice milking and the artificial suckling of kids produced more milk and may therefore benefit farmers where kids are fed on milk replacers. In this study, kids on artificial suckling were fed on the dam's own milk at 300 ml/milking time. Therefore, milk available for farmers' use was significantly lower for twice milking and artificially suckled kids in both experiment one and two at ( $P=0.000$ ). In experiment 1 and in experiment 2, the artificial suckling of kids gave 2.5 times less milk compared to once milking and dam suckling, and it gave 2.8 times less milk compared to one teat milking and one teat suckling twice a day. Similar results were reported when working with Saanen goats (Diken et al. 2008). The kid suckling effect appears to explain the higher level of farmers' available milk due to high levels of oxytocin which is produced with the kid suckling effect (Marnet et al. 1999). Suckling does give more milk per day because galactopoietics hormones at suckling increases milk secretion compared to does involved in exclusive milking. In addition, mother-young contact appears to explain the higher milk yields than no dam contact; similar results were reported for milk yields of suckling

cows when compared to others milked by machines (Hernandez et al. 2007). Long-term results of suckling include enhanced mammary development, increase mammary proliferation, and the differentiation of mammary cells of goats (Peaker and Blatchford 1988).

Study I has shown a milk reduction of 32 % for once a day-milking and suckling whole day and 20 % for one teat milking and one teat suckling twice a day compared to twice milking two teats and not suckling. Similar results with 26–36 % reduction in milk output were reported for Saanen (Salama et al. 2003). A reduction of 18 % was also reported for Alpine goats milked once a day to in late lactation (Komara and Marnet 2009). The similarities in milk output observed in experiment 2 for once a day milking and one teat milking could be explained by the larger gland cistern size for goats (Peacker and Blatchford 1988) and that the average production of one teat could provide comparable amount of milk of 600 ml to feed a kid per day.

Study I has also shown that kid growth rate was not significantly different for different suckling systems in 2008 and 2009. Kid growth rates were similar because all kids were fed on dam's milk. Similar results were reported for Saanen kids suckling whole udder and those suckling the left lob of the udder (Diken et al. 2008). In this study, all goat kids were fed on own dam milk by suckling or bottle feeding soon after milking. Different results are reported where goat kids are fed milk replacers because of the lower digestibility of milk replacers compared to goat milk and because of the lack of growth promoters present in dam's milk (Sanz et al. 1990; Baumrucker and Blum 1993). The kid growth rate found in our study is higher than those reported by Mtenga et al. (1994). The differences could be explained by differences in the management of the goats (Tables 18.1 and 18.2).

The main results of the study with different supplements for suckling East African goat kids (study II) are presented in Table 18.3.

Kid growth rates were lower for the hay creep fed group. Hay creep fed kids grew 50 % less than kids on concentrate and no-creep feeding but at a similar rate to kids in the groundnut haulms group. Variation in the level of protein appears to exert a greater influence on growth in goats (Ogundola 1990). An increase in protein concentration in the diet increased growth rates, since the protein requirement is higher for growing animals. Kids creep fed with concentrate grew twice as

**Table 18.1** Chemical feed composition of creep feeding feeds

Feed	<i>Urochloa mosambicensis</i> hay	<i>Arachis hypogea</i> groundnut haulms	Concentrate
DM g/kg	927	916	909
CP g/kg DM	106	143	225
CF g/kg DM	607	182	113
Ash g/kg DM	107	84	44
NDF g/kg DM	835	811	518
ADF g/kg DM	536	428	402
TDN%	39	51	55

**Table 18.2** Kid growth and farmers available milk from Norwegian Dairy goats suckling kids through different methods in Tanzania

	Suckling method		
	Twice daily milking of one teat, suckling one teat	Two teat milking once a day and whole day suckling	Twice daily milking both teats and kid bottle feeding <sup>c</sup>
<u>Growth rate kids, 0–56 days (g/day)<sup>2</sup></u>			
1st year	73 ± 15	66 ± 24	62 ± 21
2nd year	58 ± 15	38 ± 23	51 ± 17
<u>Farmer's available milk (kg/day)<sup>2</sup></u>			
1st year	0.87 ± 15	0.73 ± 11	0.39 ± 18
2nd year	0.88 <sup>a</sup> ± 22	0.98 <sup>a</sup> ± 23	0.35 <sup>b</sup> ± 10

<sup>1</sup>0.5 kg of goat's milk allocated twice daily

<sup>2</sup>Means with different superscripts are significantly different at  $p < 0.05$

much as kids fed hay which had 50 % less protein as the concentrate because kids are monogastric until rumen develops. Kids on no-creep feeding grew faster because of frequent suckling. The longer suckling periods allowed the kids to nibble on creep feed and crude protein levels, and total digestible nutrients of the feeds determined the growth realized. The low intake of hay, which also had low total digestible nutrients, was reflected in the low growth rates compared to concentrate and groundnut haulms. Therefore, to increase the palatability of hay, farmers would need to combine hay and crop residues, such as groundnut haulms, which have high palatability, in the preferential forage supplement to kids as creep-feed.

The post creep feeding effect at 100 days indicated a 50 % drop in growth rate for kids on concentrate, although the growth rate was similar. BW at 9 months was also similar for all creep feeding regimes. The similarities obtained at 9 months may imply that farmers can benefit from kid creep feeding with hay supplementation despite the low nutritive value especially when environmental conditions in natural pastures increase the risk of infections for kids. The practice may be practical for farmers grazing on communal grazing lands where parasite and disease control require communal interventions.

The similar growth rates attained by different creep feeding feeds could also be explained by kid's birth weights, which were above 2 kg as reported by Hary (2002). Low birth weight limits growth and the survival of kids in the early stages of life (Sherman 1987). Low birth increases kid's vulnerability because they are weak and cannot ingest adequate amounts of colostrum and milk. In addition, animals of low birth weight have lower energy reserves and are unable to withstand harsh environmental conditions (Mtenga et al. 1994). Does mean daily milk yield was 152 ml; therefore, the amount of milk supplied by the dam is also critical along with birth weight (Hary 2002). But kids born with low birth weight to low milking does compensate for the restriction in milk availability by starting to graze on pasture at an early stage (Hary 2002). The type of feed in kid creep feeding



**Table 18.3** Effects of feeding different type of supplements (creep feeding) on performance of suckling East African goat kids and their dams

	Type of supplementation				SEM	P-value
	Urocloa hay	Groundnut haulms	Concentrate	None		
<b>BW dams (kg)</b>						
Initial weight	21.4 ± 5.0	21.9 ± 6.46	26.3 ± 8.53	21.1 ± 1.97	2.427	0.262
Feed intake (g/day)						
Intake at 60 days	67 ± 11	95 ± 38	85 ± 39	–	7.7353	0.082
<b>BW kids (kg)</b>						
Birth weight	1.9 ± 0.86	1.8.0 ± 0.71	2.1 ± 0.69	1.9 ± 0.51	0.0997	0.360
Start of creep feeding	4.2 <sup>a</sup> ± 1.2	3.2 <sup>a</sup> ± 1.37	4.2 <sup>a</sup> ± 2.13	2.9 <sup>b</sup> ± 0.74	0.4398	0.026
End of exp., 2 months old	5.13 ± 0.87	5.20 ± 1.98	6.62 ± 2.52	4.90 ± 0.89	0.494	0.024
Weight, 9 months	12.07 ± 3.72	10.30 ± 2.75	10.36 ± 4.01	11.34 ± 1.43	0.7142	0.892
<b>Growth rate, kids (g/day)</b>						
Start-2 months old	54 ± 8.9	60 ± 6.1	70 ± 3.3	54 ± 6.4	5.8380	0.0050, 350
2-3 months, post-suppl.	46 ± 1.9	34 ± 5.1	29 ± 10	42 ± 3.7	16.905	

Different superscripts denote significant differences at  $P < 0.05$

determines the rate of transformation from monogastrics to ruminants. In study II, we observed that earlier exposure to hay reduced the stress on kid growth when let out to graze. Kids on hay creep feed and on no creeping that were grazing outside with dams were not subjected to reduced growth rates as were observed for kids creep fed with concentrate. Furthermore, similarities relate to dry season kid rearing. Dry season kidding results in healthier kids due to a low incidence of disease agents compared to the wet season (Awemu et al. 1999). Differences in the performance of kids in dry season may reflect the yearly variations in seasons, management practices, and low milk yield by local goat yearlings with a mean of 152 ml/day. Similar pre-weaning kid growth rates of 53 g/day were observed by Karua (1989). Milk composition of local goats obtained in our study were similar to other studies of Malawi local goats (Banda 1992), the West African Dwarf goat (Akinsonyu 1977).

We managed to reduce kid mortality to 6 % in this study. Banda reported 62 % mortalities for local goats and 72 % mortalities for Saanen goats. The differences could be due to season, dam management prior to kidding, and management of goats during the experimental period. High mortalities are reported when does are not de-wormed in the rainy season and due to high parasite load and infections during kid rearing in the rainy season (Kamwanja et al. 1985). Better dam management and vaccination increased specific passive immunity and the survival of neonates (Kritas et al. 2003). In this study, goats were de-wormed before kidding; therefore, kids attained the necessary passive immunity from the does. Dry season kidding ensured that kids were exposed to the environment when the parasite and infection load was low, thus reducing incidences of diseases. High livestock mortalities occurring in the rainy season are due to the biological cycle of parasites (Huttner et al. 2001). The performance of kids with no-creep feed reflected the low parasite load in natural pasture. Van Niekerk and Pimental (2004) also attribute the high mortalities and disease incidences of the rainy season to poor hygiene and precarious housing conditions.

In study III, conducted at Likoma Island, farmers not milking their goats were asked why they did not adopt this practice. Out of the 34 households not milking goat, interviewed, 92 % did not milk the goats because they prioritized growth rate and survival of goat kids to milk for household purposes. Other reasons (3 % each) were dislike of the flavor of goat's milk, difficulty in milking goats, and a wish to be different from the older generation that milked goats. The findings clearly indicate that lack of feed was a main driver for not milking the goats.

The study found that milking local goats was common for survival in low-income households. Table 18.4 presents effects of milking goats on calculated family income.

Families at risk in terms of survival engage more in casual labor and the sale of dry fish. They milk local goats unlike well-to-do farmers who prefer the growth of the kids. Low income is the main driver to use available natural resources for livelihood. Farmers with low value assets engaged in casual labor and milked goats unlike farmers who could afford alternative sources of milk. This finding agrees with Hunter et al. (2011) who also reported a high dependence on natural resources by rural households.

**Table 18.4** Estimated monthly income levels of milking and none-milking households

Income sources, MWK <sup>a</sup>	Milking	Not-milking	P-value
Selling dry fish	17,772.00 ± 34,107	7,694.00 ± 15,643	0.013
Renting fishing gear	272 ± 1,420	2,500.00 ± 11,051	0.000
Working as a casual laborer	26,640.00 ± 56,618	14,450.00 ± 32,196	0.007

<sup>a</sup>Malawiina Kwacha (MWK), 1 USD = 0.0024 MWK

## 18.4 Conclusion

Different types of partly suckling systems should be recommended for dairy goats in Malawi and Tanzania. Methods used may vary depending on local circumstances and the ratio chosen between the allocation of milk for household needs and goat kids. For non-milking goats, creep-feeding with good quality hay could yield better results if used in combination with high energy and protein feeds. Goat milk remains useful for smallholder farmers, as demonstrated in traditional systems at Likoma Island. Improving living standards and having alternative income is likely to reduce goat milking and promote kid growth when rearing local goats for meat.

**Acknowledgements** Authors acknowledge the support of the Bunda College of Agriculture Capacity Building Programme, the Agricultural Research and Development Programme and staff of Likoma and Sakhulas Goat Research Station at Bunda College, and the Staff and management of Sokoine University of Agriculture for technical support through the PANTIL project.

## References

- Akinsonyu OA (1977) Studies on milk yield and composition of West African Dwarf goats. *J Dairy Res* 44:57–62
- Awemu EM, Nwakalor LN, Abubakar BY (1999) Environmental influences on preweaning mortality and reproductive performance of Red Sokoto does. *Small Rumin Res* 34:161–165
- Banda JW (1992) Genotypic and seasonal influences on milk yield and composition of sheep and goats in Malawi. PhD thesis, University of Giessen
- Baumrucker CR, Blum JR (1993) Secretion of insulin growth like factors in milk and their effect on neonates. *Livest Prod Sci* 35:49–72
- Chigwa FC (2011) Strategies for improving dairy goat rearing systems for milk and meat production in Norway, Tanzania and milk utilization in Malawi. Ph.D. thesis no 50, Norwegian University of Life Sciences, ISBN: 978-82575-1013-8
- Diken F, Ugur F, Tolu C, Akbulut MD (2008) Effect of suckling schedule on growth characteristics of Saanen kids. *Archiv Fur Tierzucht-Arch Anim Breed* 51(1):55–63
- Eik LO, Eknæs M, Havrevoll Ø, Garmo T, Raats J, Ådnøy T (1998) Partial suckling during the grazing period as a management tool for improving the annual patterns of goat milk in Norway. Sixth international symposium on the milking of small ruminants, Athens, Greece, September 26–October 1, pp 217–222
- Eik LO, Kifaro GC, Kiango SM, Nordhagen OM, Safari J, Mtenga LA (2008) Productivity of goats and their contribution to household food security in high potential areas of East Africa: a

- case of Mgeta, Tanzania. *Afr J Food Agric Nutr Dev* 8(3):278–290, <http://www.ajfand.net/Issue20/PDFs/Lars2275.pdf>. 13 Apr 2014
- Hary I (2002) Analysis of survival curves in seasonally mated pastoral goat herds in northern Kenya using logistic regression technique. *J Arid Environ* 50:621–640
- Hernandez H, Delgadillo JA, Flores JA, Rodrigues AD, Serafin N, Kann G, Marnet PG, Poindron P (2007) Effects of restricted nursing on milk production and collection, kid growth and plasma prolactin and growth hormone concentrations in dairy goats. *Anim Int J Anim Biosci* 1(2):233–240
- Hunter LM, Twine W, Johnson A (2011) Adult mortality and natural resources use in rural South Africa: evidence from the Agincourt health and demographic surveillance site. *Soc Nat Resour: Int J* 24(3):256–275
- Huttner K, Leidl K, Pfeiffer DU, Kasambara D, Jere FBD (2001) The effect of a community-based animal health service programme on livestock mortality, off-take and selected husbandry applications. A field study in northern Malawi. *Livest Prod Sci* 72:263–278
- Kamwanja LA, Ayoade JA, Makhambera TPE (1985) Characterisation of small ruminants in the Mitundu area, Lilongwe, Malawi. In: Wilson RT, Bourzat D (eds) *Small ruminants in African agriculture*. International Livestock Centre for Africa, Addis Ababa, pp 164–172
- Karua SA (1989) Some performance indicators of Malawi indigenous goats under village and ranch conditions. In: Wilson RT, Melaku A (eds) *African small ruminant research and development*. International Livestock Centre of Africa, Addis Ababa, pp 243–249
- Kiango SM (1996). Studies on factors affecting performance of dairy goats and socio-economic aspects of dairy goat production in Tchenzema and Dareda wards in Tanzania. M.Sc. dissertation, Sokoine University of Agriculture, Morogoro, Tanzania, p 184
- Komara M, Marnet PG (2009) Endocrine responses and milk emission characteristics in high yielding Alpine dairy goats under once milking management. *Small Rumin Res* 87:64–69
- Kritas SK, Burriel AR, Tzivara AH, Govaris A, Kyriakis SC, Karatzias H, Vlemmas J (2003) Prevention of scours in neonatal kids after modification of management and experimental vaccination against *Escherichia Coli*. *Small Rumin Res* 50:51–56
- Marnet PG, Negrao JA, Orgeur P, LeBellego L (1999) Effect of inhibition of maternal behaviour on the endocrine response to milking during the first days after parturition. In: Zervas N, Barillet F (eds) *Milking and milk production of dairy sheep and goats, 1995*. EAAP Publication, Wageningen Pers, Wageningen, pp 65–68
- Mtenga LA, Kifaro GC, Belay B (1994) Studies on factors affecting reproductive performance and mortality rates of small East African goats and their crosses. In: Lebbie SHB, Bey B, Irungu EK (eds) *Small ruminant research and development in Africa*. ILCA/ACTA, Addis Ababa, pp 69–74
- Mushi DE, Eik LO, Bernués A, Ripoll-Bosch R, Sundstøl F, Mo M (2014). Adapting traditional livestock systems to changing climate and preserving biodiversity (unpublished)
- Ogundola FI (1990) The effect of soybean meal and groundnut meal supplementation on the growth of West African Dwarf goat. *World Rev Anim Prod* 25:93–96
- Peaker M, Blatchford DR (1988) Distribution of milk in the goat mammary gland and its relation to the rate and control of milk secretion. *J Dairy Sci* 55:41–48
- Salama AAK, Such X, Caja G, Rovai M, Casals R, Albanell E, Marin MP, Marti A (2003) Effects of once versus twice daily milking throughout lactation on milk yield and milk composition in dairy goats. *J Dairy Sci* 86(5):1673–1680
- Sanz MR, Hernandez-Clua OD, Naranjo JA, Gil F, Boza J (1990) Utilization of goat milk vs milk replacer for Granadina goat kids. *Small Rumin Res* 3:37–46
- Sherman DM (1987) Causes of kid morbidity and mortality: an overview. In: *Proceedings of the IV international conference on goats, Brasilia*, vol. I, March 8–13 1987, pp 335–340
- Van Niekerk WA, Pimentel P (2004) Goat production in the smallholder section in the Boane district in Southern Mozambique. *S Afr J Anim Sci* 34:123–125

# Chapter 19

## Reducing GHG Emissions from Traditional Livestock Systems to Mitigate Changing Climate and Biodiversity

Daniel E. Mushi, Lars Olav Eik, A. Bernués, R. Ripoll-Bosch, F. Sundstøl, and M. Mo

**Abstract** Climate change (CC) directly impacts the economy, ecosystems, water resources, weather events, health issues, desertification, sea level rise, and even political and social stability. The effects of CC affect different groups of societies differently. In Tanzania, the effects of CC have even acquired a gender dimension, whereby women are viewed as more vulnerable than men because of socioeconomic and historic barriers. CC is largely caused by anthropogenic activities, including those that increase the concentrations of greenhouse gases (GHGs) in the atmosphere. Recent findings indicate that the livestock sector is responsible for 18 % of GHG emissions measured in the CO<sub>2</sub> equivalent. Moreover, some gases emitted by livestock have higher potential to warm the atmosphere than CO<sub>2</sub> and have a very long atmospheric lifetime. Methane (CH<sub>4</sub>) has 23 times the global warming potential (GWP) of CO<sub>2</sub>, whereas nitrous oxide (N<sub>2</sub>O) has 296 times the GWP of CO<sub>2</sub>. It is now estimated that the atmospheric concentrations of CH<sub>4</sub> and N<sub>2</sub>O are increasing at a rate of approximately 0.6 % and 0.25 % per year, respectively. Cattle may emit CH<sub>4</sub> from enteric fermentation equivalent to 2–12 % of the ingested energy, whereas produced manure can emit N<sub>2</sub>O up to 1.25 % of its weight. The estimated total CH<sub>4</sub> and N<sub>2</sub>O emissions from Tanzanian ruminants

---

D.E. Mushi (✉)

Department of Animal Science and Production, Sokoine University of Agriculture (SUA),  
P.O. Box 3004, Morogoro, Tanzania  
e-mail: [danielmushi@yahoo.com](mailto:danielmushi@yahoo.com)

L.O. Eik • F. Sundstøl

Department of International Environment and Development Studies/Noragric, Norwegian  
University of Life Sciences (NMBU), P.O. Box 5003, No-1432 Ås, Norway

A. Bernués • M. Mo

Department of Animal and Aquacultural Sciences, Norwegian University of Life Sciences  
(NMBU), P.O. Box 5003, No-1432 Ås, Norway

R. Ripoll-Bosch

Animal Production Systems Group, Wageningen University, P.O. Box 338, 6700 AH  
Wageningen, The Netherlands

stand at 26.17 Gg and 0.57 Gg, respectively. In this paper, we first very briefly review emissions of GHGs from different livestock production systems in Tanzania with the view of identifying the main hot spots. Then, we concentrate on the available adaptation options and the limitations on the adoption of such adaptation options in Tanzania. Emission of these GHGs per unit product varies with the level of intensification, the types of livestock kept, and manure management. Intensification of livestock production reduces the size of the land required to sustain a livestock unit and frees up the land necessary for carbon sequestration. In Tanzania, such intensification could take the form of the early harvesting and storing forage for dry-season feeding. The advantage of this intervention is twofold: young harvests have higher digestibility and emit less CH<sub>4</sub> when fed to ruminants than mature lignified forage; use of stored roughage in the dry season will reduce the desertification of rangeland and deforestation that occur when livestock search for pastureland. Dry-season supplementation of ruminants with energy and protein-rich diets will reduce CH<sub>4</sub> emission. The chemical treatment of crops byproducts will increase the crops' digestibility and reduce CH<sub>4</sub> emission from ruminants. Cross-breeds of indigenous and exotic breeds are more efficient converters of feed into products like meat and milk, with less GHG emitted per unit product. The use of manure for biogas production will reduce the emission of both CH<sub>4</sub> and N<sub>2</sub>O into the atmosphere. Shifting from liquid to solid manure management has the potential to reduce CH<sub>4</sub> emissions. Most of these interventions, however, are not cost neutral – enhancing awareness alone will not lead to their widespread adoption. In the absence of subsidies, the adoption of these interventions will depend on the relative cost of other options. Although some traditional livestock systems in Tanzania are already coping with the impact of CC, such efforts are handicapped by inadequate resources, poor coordination, and implementation of competing measures.

**Keywords** Livestock production • Global warming • Climate change • Adaptation strategies

## 19.1 Introduction

Tanzania has a large land resource base (88.6 M ha), most (60 M ha) of which is rangeland suitable for livestock production. The country also has a large livestock population currently estimated at 22.8 million cattle, 15.6 million goats, 7.0 million sheep, 2 million pigs, and 60 million poultry (MLDF 2013). This livestock population is an important resource that, if used efficiently, can contribute significantly to economic development and poverty alleviation. This resource, however, has the potential to contribute significantly to global warming through greenhouse emissions if not utilized properly. For instance, livestock manure can emit N<sub>2</sub>O up to 1.25 % of the weight of manure produced (Flessa et al. 2002), and cattle may emit CH<sub>4</sub> from enteric fermentation equivalent to 2–12 % of the ingested energy (Johnson and Johnson 1995). Currently, the contribution of the livestock sector to the Tanzanian gross domestic product is only 4.6 %, with beef cattle contributing

40 %, dairy cattle 30 %, and other livestock 30 % to this share (MLDF 2013). The largest proportion (95 %) of cattle in Tanzania is indigenous and in the hands of pastoral and agro-pastoral societies. These cattle are used mainly for beef production based on the free grazing on natural pasture. It is now known that beef production is the most inefficient production in terms of greenhouse gas (GHG) emissions produced per unit of product, especially compared to those of dairy cattle and monogastrics animals. Moreover, beef cattle production under extensive production systems leads to higher CH<sub>4</sub> emissions per animal, because these systems are characterized by lower feed quality and higher feed intake (FAO 2006; Pitesky et al. 2009). Given the large population of cattle in Tanzania and the extensive nature of production, the contribution of this sector to the GHG emissions is likely to be much larger than what is currently known.

The increase in the concentrations of GHG in the atmosphere results in global warming and ensuing CC. In Tanzania, the effects of CC have included the deterioration of water quality and quantity, the loss of biodiversity, a decline in agricultural productivity, and the loss of some means of livelihood (Shemsanga et al. 2010). The livelihood of pastoral communities has been among the worst hit by CC because of diminishing grazing and water resources, and the outbreak of climate-dependent livestock diseases. CC in the country has also been linked to the increasing problem of plants toxic to livestock and, potentially, to human beings (Shemsanga et al. 2010). Significant losses of livestock to drought in the recent past were linked to plant toxicity. The influx of young men from pastoral societies in Tanzania (Maasai, Nyaturu, and Barbaig) to urban areas is a manifestation of a failing means of making a living. Unfortunately, most efforts to mitigate the emission of GHGs have been directed toward the energy sector, because it accounts for about 75 % of the CO<sub>2</sub> emissions from human activities. Recent findings indicate that the global contribution of the livestock sector to the GHG emissions, measured in CO<sub>2</sub> equivalents, is estimated to be 18 % (FAO 2006; Pitesky et al. 2009; Rotz et al. 2010). There is, however, limited documentation on GHG emissions from livestock production in Africa. Current estimates of GHG emissions from Africa's agricultural sector rely on data collected in developed countries (Herrero et al. 2011). These estimates may not be applicable to Africa, given the different climatic conditions and production settings. Preliminary findings on GHG emissions and sinks in Tanzania, using default emissions factors, were reported by Mwandosya et al. (1996) and Mwandosya and Meena (1999). These reports show that CO<sub>2</sub> emissions from Tanzania amounted to 55,208 Gg. From these estimates, the contribution of CO<sub>2</sub>, CH<sub>4</sub>, and N<sub>2</sub>O emissions from Tanzania to the global warming potential was 55 %, 45 %, and 1 %, respectively. However, there is a need to establish country-specific emission factors, since emissions of GHG differ with production systems used, which is determined by climatic conditions, socioeconomics, traditions, and available resources. It is argued, notwithstanding, that developed countries are responsible for two-thirds of anthropogenic emissions (Mwandosya et al. 1996). At the same time, CC causes more casualties in developing countries than in developed countries because of the lack of resources to cope with its effects and the overdependence on natural resources that are already affected by CC. The limited ability of developing countries to adapt to CC necessitates effective collaboration with developed countries to forge concerted efforts to

mitigate GHG emissions and to build the capacity to adapt to the consequences of the emissions. Developing countries should, therefore, explore policy options and strategies that enhance the achievement of developmental objectives and of poverty alleviation while contributing to climate stabilization. In this paper, we briefly review: the impact of CC on traditional livestock systems; emissions of GHGs from different livestock production systems with the view of identifying the main GHGs emissions hot spots; the available mitigation and adaptation options; and the limitations on the adoption of such options in Tanzania.

## **19.2 The Effects of CC on the Performance of Traditional Livestock Systems and on Biodiversity in Tanzania**

Ongoing CC has affected livestock productivity (draught power, milk and meat production), survival, and distribution, through the reduced quantity and quality of range resources, and through the prevalence of vector-born livestock diseases (IPCC 2001; URT 2003). Consequently, milk and meat production is likely to be reduced following the stress on the grazing lands. This is more likely to happen in Tanzania, considering that the number of livestock already overwhelms the carrying capacity of many grazing grounds in the central and northwest zones, where droughts are common. Studies indicate that increased carbon dioxide reduces the protein available from vegetation and increases the eruption of diseases and new pests, for example, ticks, snails, and other pests (IPCC 2001; URT 2003). There are indications that the distribution of tsetse flies is shifting into northeast Tanzania and, thus, reduces land for human settlements, grazing ranges, and other developments (IPCC 2001). As a result, pastoralists have been forced to relocate to places where pasture and water are available (Shayo 2006). This mobility has already caused conflicts between different pastoral societies, on one hand, and farmers and pastoralists, on the other hand. Moreover, there are reported conflicts between livestock and wildlife. High livestock mortality linked to the lack of water and pastures has been recurring in Tanzania in recent years, hence, threatening the livelihood of pastoralists in the country. Pastoral societies have started to learn alternative livelihood support activities. Nonetheless, such adaptations are useful only for the short-term effects of CC (Shemsanga et al. 2010).

Despite Tanzania being among the richest countries in terms of biodiversity (UNEP 1998; URT 2007), Tanzania's forests are in major continuing danger of deforestation from both anthropogenic activities and CC. In 2002, it was estimated that the deforestation rate in the country was about 91,276 ha per year. Among the main anthropogenic activities responsible for deforestation are overgrazing, wild-fires, and clearing the land for agriculture and settlement. These anthropogenic activities have been contributing significant CO<sub>2</sub> emission while reducing carbon sinks (URT 2007). As in many other countries in Africa, the biodiversity of Tanzania is expected to change as different species try to adjust and cope with the impact of CC. CC may trigger the loss of some species and the migration of ecosystems. Because of increased ambient temperatures and decreasing



precipitation, many important forests are likely to be replaced by grasslands and woodlands (Shemsanga et al. 2010). Because invasive species tend to adapt better to changing climates than the desirable pasture species (Malcolm et al. 2002), pasturelands also are likely to be rendered a no-go area for animal grazing.

### 19.3 Livestock Production Systems and GHG Emissions

Livestock production can be classified into three main systems, based on the spatial characteristics (area requirement) and the economic objective (commercial or subsistence) of livestock keeping: extensive, semi-intensive, and intensive. Extensive systems are grassland based and require a large area (>5 ha) of rangeland to sustain a livestock unit for 1 year. In this system, livestock are mainly sustained by the free grazing of natural pastures whose quality and quantity vary with the season. Extensive systems may involve keeping livestock only (solely livestock), like pastoralism and commercial ranching, or keeping livestock combined with crop cultivation (mixed farming), like agro-pastoralism. Extensive systems are usually present on land considered unfit for growing crops, primarily semiarid or arid areas (FAO 2006; Pitesky et al. 2009). In Tanzania, this system is predominantly found in the central zone (Dodoma and Singida), the lake zone (Mwanza and Shinyanga), and the northeastern zone (Manyara and Arusha). In semi-intensive systems, livestock are allowed to graze during the day and are supplemented with improved feed upon their return from grazing. A good example of this system is the small-holder dairy production system. Intensive systems are high input–high output, with animals spending their lifetime in stalls (landless systems) and receiving improved feed; or, the animals spend time partly in the pasture and finish their eating via stall feeding (feedlot systems). Livestock production systems (LPs) used in any particular area are determined by the socioeconomic environment, tradition, and available resources.

To estimate the GHG “footprint” of livestock, the type of LP needs to be identified and characterized. The type of production system utilized (i.e., landless vs. grassland based) has a direct (from the animal) and an indirect (emissions associated with livestock) effect on livestock-based emissions. Globally, extensive LPs produce more GHG (5,000 vs. 2,100 Tg CO<sub>2</sub>-eq year<sup>-1</sup>) than intensive systems (FAO 2006; Pitesky et al. 2009), as poor livestock holders with extensive systems often extract marginal livelihoods from dwindling resources and lack the funds to invest in change. Most of these GHG emissions come from ruminants that produce more GHG than monogastrics, because of their greater biomass and unique metabolic function (ruminal fermentation). The high level of emissions from extensive systems is attributed to a high intake of poor-quality feed with a high retention time in the gastrointestinal tract, giving rise to a higher enteric emission of CH<sub>4</sub> per animal compared to that of a landless production system. Under grassland-based livestock management, livestock production is considered a net zero emitter of CO<sub>2</sub>. This occurs because the CO<sub>2</sub> from the respiration of livestock that had previously been absorbed via plants (FAO 2006). Thus, livestock-based CO<sub>2</sub>

emissions are components of a continuously cycling biological system, where plant matter that had once sequestered CO<sub>2</sub> is consumed by livestock and then released back into the atmosphere by respiration to be reabsorbed by plants (Kyoto Protocol 1997; FAO 2006). There is significant evidence from the literature that grassland more than offsets CO<sub>2</sub> emissions from livestock (Garnett 2009; Herrero et al. 2011). However, desertification caused by overgrazing of grassland during dry periods tends to make grassland-based livestock production a net emitter of CO<sub>2</sub> (Asner et al. 2003). In addition, extensive systems tend to contribute to deforestation, soil erosion, biodiversity loss, and water contamination caused by overgrazing (Eckard et al. 2010). Thus, the large population of ruminants in Tanzania in the hands of pastoral societies may be contributing more to global GHG emissions than the current estimates. For instance, with 22 million cattle, 15.6 million goats, and 7.0 million sheep, Tanzania may be a significant contributor to GHG emissions. However, as long as we do not have country-specific emission of GHG from livestock, we cannot demonize the ruminant population in the country as a causative agent of global warming. The current paucity of information on livestock-based emission levels from Tanzania and other African countries, in the face of increasing livestock population, calls for the commitment of research efforts and resources to generate badly needed emission indicators. The establishment of country-specific emission levels requires appropriate expertise and know-how, establishing networks for cooperation, sufficient funding for data collection, supportive policies, and the perceived application of information on emission levels (Brent et al. 2002; Udo de Haes 2004). In contrast to developed countries, developing countries may be facing challenges that need to be tackled before the environmental burdens of GHG emissions become a priority in their national policies (Arena 2001).

Intensification may be seen as a panacea for the problem of GHG emissions from livestock. However, caution should be exercised about this generalization. Intensive systems involving the heavy use of machinery for feed production and processing will contribute to the net emission of CO<sub>2</sub>. Cultivation of land for feed crop production will also contribute to the loss of soil organic carbon (SOC). The use of chemical nitrogen fertilizers to increase feed crop yield also contributes to increased N<sub>2</sub>O emission. Developed countries are the primary users of this system, with 54.6 % of total meat production produced in landless systems (FAO 2006). Globally, landless systems are used mainly for poultry and pig production (FAO 2006; Pitesky et al. 2009). Developing countries hardly use these systems for ruminant production, because these countries are still struggling with producing enough food for the human population.

## 19.4 Livestock-Based GHG Emission Hot Spots

Compared to other countries, the estimated contribution of Tanzania to the causes of CC is low, and it is mainly through large animal herds, overgrazing, deforestation, land use changes, and waste management (Shemsanga et al. 2010). In terms of

contribution by sector, land-use change in the country may contribute more to the GHG emission problem than fossil fuel emission, primarily because of the low level of industrialization.

The net emission of GHG from livestock production is best determined through a life cycle assessment (LCA) that includes all important emission sources and sinks within the production system as well as those associated with the production of resources used in the system (Weiske and Petersen 2006; Schils et al. 2007; Rotz et al. 2010; Gerber et al. 2013). The global contribution of livestock production to anthropogenic GHG emission varies a great deal, with the estimated contributions ranging from 8 to 18 % (Steinfeld et al. 2006; Weiske and Petersen 2006; Eckard et al. 2010; Herrero et al. 2011). This variation in estimates may reflect, *inter alia*, different methodological approaches used to measure the contribution of livestock to GHG emissions. Some of the methodologies used to estimate GHG emission per livestock product consider only edible outputs (FAO 2006; Weiske and Petersen 2006; Pitesky et al. 2009). When other non-food outputs of livestock production are considered, GHG emissions attributable to meat and dairy products will be much lower (Garnett 2009). For example, based on the economic value of leather, up to 7.7 % of GHG emission from livestock production is attributable to leather itself (Garnett 2009). This consideration would reduce GHG emissions per livestock product by 7.7 %, although overall livestock emissions will remain the same.

Despite efforts toward standardization, LCA methodology presents certain limitations and unresolved problems (Reap et al. 2008b; Finnveden et al. 2009), especially when applied to or adopted by developing countries (Arena 2001; Brent et al. 2002; Udo de Haes 2004). From the methodological point of view, several questions remain unsolved. The first methodological challenge deals with uncertainty, i.e., data gaps and uncertainties, methodological choices, and descriptions of the studied systems. First, data availability and quality in developing countries are common problems (Brent et al. 2002). To overcome this lack of data, databases included in commercial software packages are usually used. Hence, errors can occur because these databases rely on data from different countries or from regions with different practices, technologies, and regulations (Finnveden 2000; Brent et al. 2002). LCA is very data intensive, and the lack of data can restrict the conclusions that can be drawn from a specific study (Finnveden 2000). Second, regarding methodological choices, uncertainties arise in each of the LCA's four phases: (1) goal and scope definition; (2) life cycle inventory analysis; (3) life cycle impact assessment; and (4) life cycle interpretation. Such uncertainties can reduce the accuracy of the tool (Reap et al. 2008a, b). Generally, environmental impact categories have been performed in and for developed countries, without adjusting them for African conditions (Brent and Hietkamp 2003). Therefore, it may occur that impacts not considered important in developed countries are of major importance in developing ones (Brent et al. 2002). Furthermore, regional conditions should be well taken into account, clarifying the differences in conditions between industrialized and developing countries (Udo de Haes 2004). In general, livestock farming systems in developed countries are better defined, more homogeneous, and product oriented, and aim at optimizing animal

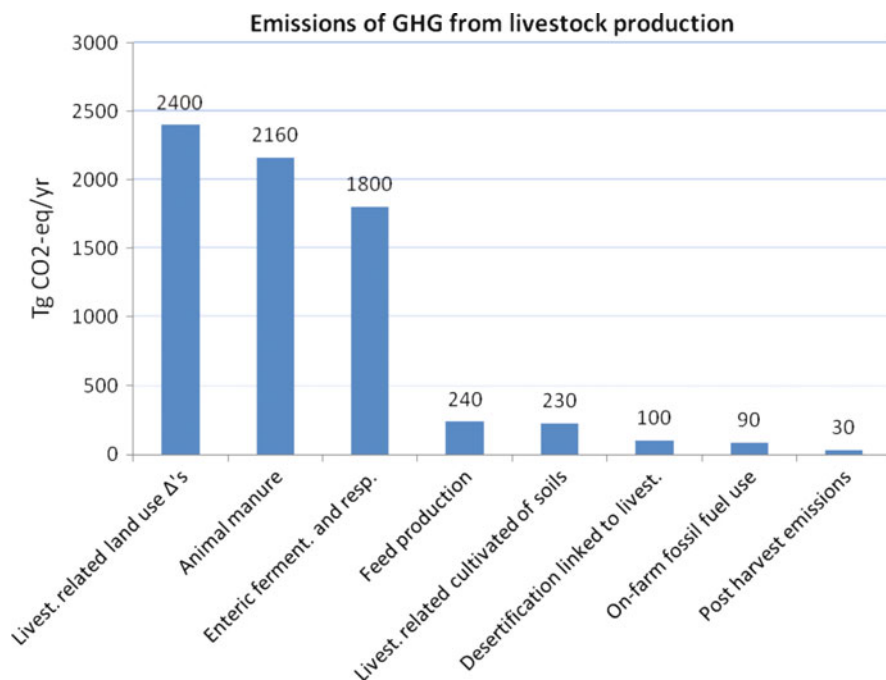
performances. However, livestock farming systems in developing countries are less studied, more heterogeneous, multifunctional, and aim at optimizing the farming system as a whole. This phenomenon is especially true for most livestock farming systems in developing countries, but this may also apply to pasture-based livestock systems in developed countries, mostly located in marginal land (Ripoll-Bosch et al. 2013). Moreover, in developing countries, enormous spatial variation applies, which refers to differences in geology, topography, land cover (both natural and anthropogenic), and meteorological conditions (Reap et al. 2008a).

The LCA “cradle-to-grave” approach, combined with its focus on products, results in environmental burdens allocated to such products. Therefore, the productivity of the system (especially commodities) becomes a key issue. This is a handicap for livestock farming systems in developing countries and in marginal lands in developed countries, since they are inherently associated with lower breeding efficiency and lower animal productivity (Gill et al. 2010). However, such livestock farming systems provide other functions that are generally omitted in LCA, i.e., the delivery of most non-food ecosystem services, the settlement of populations in remote areas, or capital assets. In this sense, other relevant issues are not tackled in the debate: Higher emissions are associated with meat from ruminant livestock than monogastrics (Williams et al. 2006; De Vries and De Boer 2010). However, it is worth considering the type of animal feed, as most diets for monogastrics are edible for humans, whereas the diets of pasture-based ruminant production are not (Gill et al. 2010; Wilkinson 2011). Pasture-based farming systems have the ability to valorize “natural and renewable resources” that do not compete with human nutrition and cannot be used for alternative purposes, such as human-edible products. However, this ability becomes a handicap from an LCA point of view, also because the emission of CH<sub>4</sub> decreases as feed quality (digestibility) increases (Beauchemin et al. 2008). Therefore, since intensive systems generally rely more on highly digestible concentrates, a decrease in CH<sub>4</sub> emissions with an increase in the intensification level should be expected (Gerber et al. 2011). Although monogastrics are more efficient in terms of total food resource use, accounting for the proportions of human-edible and inedible feeds would render a more realistic estimate of efficiency to compare with that of other systems (Wilkinson 2011).

In livestock production, particularly ruminants, the emission of GHG occurs during feed production, feed digestion, and the post-harvest handling of livestock product, with further emissions occurring during the handling of manure (FAO 2006; Rotz et al. 2010; Shortall and Barnes 2013). According to FAO (2006) and Pitesky et al. (2009), by disregarding post-harvest emissions, livestock account for 9 %, 37 %, and 65 % of the total global anthropogenic emission of CO<sub>2</sub>, CH<sub>4</sub>, and N<sub>2</sub>O, respectively. However, FAO (2006) considered three sources as the main GHG emission hot spots in livestock production: enteric fermentation (the main source of CH<sub>4</sub>); manure management (the main source of N<sub>2</sub>O); and land-use changes for grazing and feed production (the main source of CO<sub>2</sub>). Overall, beef production and cattle milk production account for most emissions, contributing, respectively, 41 % and 20 % of the sector’s emissions (Gerber et al. 2013). Pig meat

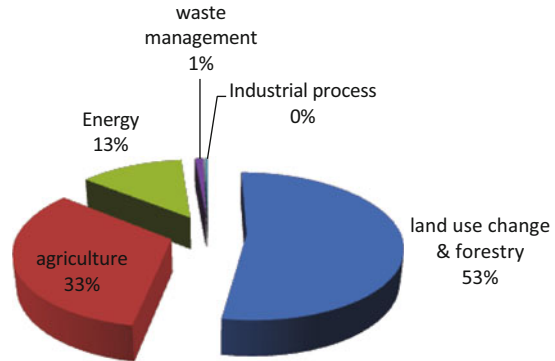
and poultry meat, and eggs contribute, respectively, 9 % and 8 % to the sector's emissions.

GHGs emissions from livestock can be divided into two types: direct and indirect emissions (FAO 2006; Pitesky et al. 2009; Rotz et al. 2010). Direct emissions are primarily produced by the livestock themselves, including CH<sub>4</sub> from enteric fermentation and manure, and N<sub>2</sub>O from excreted urine and manure. Given the large population of ruminants in Africa, and in Tanzania, in particular, the extensive nature of livestock production, poor manure handling practices, and direct emissions from livestock may constitute significant contributions to global GHG emissions. Indirect emissions stem from livestock feed production and the handling of livestock products (transportation, cold storage, and processing) as well as land-use changes for livestock production (Mosier et al. 1998; Pitesky et al. 2009). These include: CO<sub>2</sub> emission from the combustion of fuel in machinery used to produce feed, and to process and to transport livestock products; land-use changes to support livestock production, namely, the conversion of forests to pastures and cropland for livestock purposes; the degradation of above-ground vegetation from livestock grazing; and the loss of soil organic carbon from cultivated soils associated with livestock (Fig. 19.1). The study done in Tanzania in 1990 produced similar findings on the sectorial contribution to GHG emission (Fig. 19.2). The limited use of machinery in Tanzania for feed crop production,



**Fig. 19.1** Emission of GHG from livestock production (Derived from data provided by Pitesky et al. 2009)

**Fig. 19.2** Percentage contribution of different sectors to GHG emissions from Tanzania (Derived from data provided by Mwandosya and Meena 1999)



processing, and transportation of livestock may exempt the country from a significant contribution to CO<sub>2</sub> emission. However, the fast-growing population of livestock, which accelerates the rate of land-use changes to support livestock production, may imply that the livestock sector in Tanzania is still a significant contributor to global CO<sub>2</sub> emissions. Globally, feed production and processing, and enteric fermentation from ruminants are the two main sources of GHG (Fig. 19.1), representing, respectively, 45 % and 39 % of sector emissions (Gerber et al. 2013). The other main source is manure storage and processing, representing 10 %. The remainder is attributable to the processing and transportation of animal products. The consumption of fossil fuel along the sector supply chains accounts for about 20 % of sector emissions.

### 19.4.1 Emission of CH<sub>4</sub> from Livestock

Globally, livestock are the most important source of anthropogenic CH<sub>4</sub> emissions. Among domesticated livestock, ruminant animals (cattle, buffalo, sheep, goats, and camels) produce significant amounts of CH<sub>4</sub> as part of their normal digestive processes. Annual CH<sub>4</sub> emission (80 Tg) from ruminant livestock accounts for approximately 33 % of anthropogenic emissions globally (Beauchemin et al. 2008; Eckard et al. 2010). This emission stems from enteric fermentation in ruminant animals and manure disposals (Flessa et al. 2002; Mwandosya et al. 1996). Mwandosya and Meena (1999) estimated CH<sub>4</sub> emission from animals and manure in Tanzania to be 8 Gg.

#### 19.4.1.1 CH<sub>4</sub> from Enteric Fermentation

Ruminants are capable of converting marginal land into useful land by utilizing plants on such lands to produce valuable animal protein. At the same time, ruminant livestock are important contributors to CH<sub>4</sub> in the atmosphere. Because of the unique digestive system of ruminants, CH<sub>4</sub> production is part of the normal

**Table 19.1** Increasing emission of CH<sub>4</sub> with decreasing livestock productivity caused by increased stocking density

Stocking rate, ha/AUE	Grass used for maintenance, tones	Grass available for production, tones	Potential live weight gain, kg/year	Potential beef production, kg/year	Liter of CH <sub>4</sub> per kg beef produced
11.1	107	68	2,092	1,046	1,230
8.3	142	33	1,015	508	2,530
6.7	178	-3	-92	-46	∞
5.5	214	-39	-1,200	-600	∞

Source: Modified from Sundstøl (2007)

digestive process (Weiske and Petersen 2006; Rotz et al. 2010). The estimate of CH<sub>4</sub> emission from enteric fermentation is based on defining the type and the level of feeding, the number and the type of animal, animal size, livestock management systems, total energy intake, and production characteristics (Mwandosya et al. 1996; Jungbluth et al. 2001; Sun et al. 2008; Pitesky et al. 2009). Simplified relationships for the estimation of CH<sub>4</sub> emission are based on the estimation of the total energy intake by the animal and an estimate of the ratio of the feed energy converted to CH<sub>4</sub> (Mwandosya et al. 1996). Cattle may lose between 2 and 12 % of their ingested energy as eructated CH<sub>4</sub> (Johnson and Johnson 1995). Thus, the enteric emission of CH<sub>4</sub> in ruminants has two consequences: the loss of metabolizable energy and the contribution to GHG. Enteric CH<sub>4</sub> emissions per unit of production are highest when feed quality and level of production are low, see Table 19.1. Ruminants in the traditional sector in Tanzania and in many other African countries are mainly maintained on poor-quality feed and produce minimally. This natural combination of the type of feed available and the level of production may exacerbate the contribution of livestock in Tanzania to global GHG emissions. Holter and Young (1992) reported that CH<sub>4</sub> outputs range from 3.1 to 8.3 % of the gross energy intake for dry, non-lactating cows, and from 1.7 to 14.9 % of the gross energy intake for lactating cows. Overall, CH<sub>4</sub> emission from enteric fermentation accounts for 73 % of CH<sub>4</sub> from ruminants globally, making it the main source of this GHG from ruminants (Pitesky et al. 2009). The estimated level of enteric CH<sub>4</sub> emission amounts to approximately 1,800 Tg CO<sub>2</sub>-eq/yr. However, the definitive attribution of GHG emission to livestock production in developing countries awaits country-specific emission data.

#### 19.4.1.2 CH<sub>4</sub> from Manure Management

Methanogens require an anaerobic environment to function. This means that the amount of CH<sub>4</sub> produced is less when manure is handled aerobically. The amount of CH<sub>4</sub> produced depends on the manure's characteristics, especially the amount of volatile solids present in the manure and manure management (Mwandosya et al. 1996). Typically, when livestock manure is stored or treated in lagoons,

ponds, or tanks (anaerobic conditions), CH<sub>4</sub> emissions are produced in higher amounts than when manure is handled as a solid (stacks or drylot corrals) or deposited in a pasture where aerobic decomposition occurs, thereby reducing CH<sub>4</sub> emissions (Chadwick 2005; Pitesky et al. 2009). This understanding may indicate that intensive livestock systems produce more CH<sub>4</sub> than extensive systems, because liquid manure storage is common in intensive systems. In addition, semi-intensive livestock production systems may produce significant amounts of CH<sub>4</sub>, as compacted manure heaps (with an anaerobic core environment) are common in these systems. The use of manure to fertilize rice fields may contribute to the significant emission of CH<sub>4</sub> on account of the primarily anaerobic conditions of irrigated rice fields. However, the free-grazing systems practiced in the traditional livestock sector may emit less CH<sub>4</sub>, as free-grazing animals deposit manure directly onto the pasture, where manure fermentation proceeds aerobically. The use of straw as bedding material in a deep-litter system increases the aeration of manure and reduces CH<sub>4</sub> emission (Yamulki 2006). This method is one of the strategies that can easily be adopted in developing countries, given the abundance of such crop residues that otherwise would end up being burned in the field. Based on a number of assumptions, Mwandosya et al. (1996) estimated total CH<sub>4</sub> emission from ruminants in Tanzania at 26.17 Gg. This estimate, however, is based on default emission factors. There is a need, therefore, for researchers in Tanzania to establish emission factors specific to the country to give informed advice to the government for negotiating the implementation of various protocols and conventions related to CC.

#### ***19.4.2 Emission of N<sub>2</sub>O from Livestock***

Nitrous oxide is emitted in soils from applied manure and urine mainly through an anaerobic microbial process (denitrification) and, to a lesser extent, through an aerobic microbial process (nitrification) (Eckard et al. 2010). The denitrification process reduces nitrate to N<sub>2</sub>, with N<sub>2</sub>O as an obligatory intermediate, whereas the nitrification process oxidizes ammonium to nitrate, with N<sub>2</sub>O as a byproduct. Quantitatively, the rate of N<sub>2</sub>O emissions from soil is determined by the rate of fertilizer application (synthetic and manure), the presence of crop residues, the presence of N-fixing crops, the soil temperature, the soil anaerobicity, the soil pH, the soil nitrate content, and the tillage practices (Flessa et al. 2002; Eckard et al. 2010). A constant emission factor of 1.25 % for the amount of Nitrogen applied to agricultural land is currently recommended for calculating global and national emissions from fertilized soils (IPCC 1997; Flessa et al. 2002). The contribution of livestock production to anthropogenic N<sub>2</sub>O emissions is between 65 and 75 % (Flessa et al. 2002; Eckard et al. 2010). This contribution makes livestock production the main source of this GHG emission, with 296 times more global warming potential than CO<sub>2</sub>. The estimated N<sub>2</sub>O emission from manure management and fertilizer use in Tanzania is 0.57 Gg (Mwandosya and Meena 1999).



### ***19.4.3 Emission of CO<sub>2</sub> from Livestock***

As indicated previously, CO<sub>2</sub> produced by livestock through respiration does not contribute to net GHG emission, because this is part of CO<sub>2</sub> that had previously been sequestered by plants, is released back to the atmosphere by the livestock, and will be sequestered by plants. Consequently, the emitted and absorbed quantities are considered the equivalent of making livestock a net zero source of CO<sub>2</sub> (Garnett 2009; Herrero et al. 2011). However, land-use changes, including the deforestation and desertification of pasturelands that lead to a combination of vegetative loss and soil trampling, cause the loss of soil carbon and a net release of CO<sub>2</sub> (Garnett 2009; Pitesky et al. 2009). The traditional livestock sector may cause deforestation through the expansion of the grazing area into the forested area. With the ever-increasing livestock population in the traditional sector, the deforestation and desertification of pastureland are likely to persist for the next few decades until deliberate measures are taken to arrest the situation (Geist and Lambin 2002; Asner et al. 2003; Smith et al. 2007). Desertification caused by excessive grazing by livestock in Tanzania primarily occurs in arid, semiarid, and dry sub-humid grazing areas (pastures and rangeland), and causes a net loss of Carbon to the atmosphere, ultimately leading to land with reduced biological productivity. Since biomass is about 45 % carbon by weight, clearing forested areas by burning leads to the instantaneous release of CO<sub>2</sub> (Mwandosya et al. 1996). Bushfires associated with keeping migratory livestock are not uncommon in the tropics, including Tanzania.

## **19.5 Available Mitigation Options for Livestock-Based GHG Emissions**

It is now estimated that atmospheric concentrations of the GHGs CO<sub>2</sub>, CH<sub>4</sub>, and N<sub>2</sub>O are increasing at a rate of approximately 0.4 %, 0.6 %, and 0.25 % per year, respectively (IPCC 1997; Flessa et al. 2002). This phenomenon calls for mitigation strategies to keep down the levels of CH<sub>4</sub> and N<sub>2</sub>O emissions. This effort may involve improved animal management, including feeding and housing, improved management of grazing land, genetic improvement of ruminants for improved efficiency and improved manure management (Monteny et al. 2006; Garnett 2009).

### ***19.5.1 Mitigation of CH<sub>4</sub> Emission from Livestock Production***

#### **19.5.1.1 Improved Animal Feeding**

It is now clear that enteric fermentation is the main source of CH<sub>4</sub> from ruminants and that emission per animal and per unit of product is higher when the animal diet is poor. The intensification of livestock production that accompanies improved feed

quality has a potential to reduce CH<sub>4</sub> emissions from livestock production. Vlek et al. (2004) considered improved animal feed and feeding as important options to free up the land necessary for carbon sequestration. The increasing level of rapidly fermentable dietary carbohydrates (soluble carbohydrates and starch in concentrate feeds) promotes propionate production, subsequently reducing CH<sub>4</sub> formation (Monteny et al. 2006). In addition, improving dietary quality improves feed efficiency and economic benefits for producers (Pitesky et al. 2009). Supplementing ruminants on forage-based diets with high-energy concentrate feed increases starch and reduces fiber intake, reducing the rumen pH and favoring the production of propionate rather than acetate in the rumen (FAO 2006; McAllister and Newbold 2008; Eckard et al. 2010). This feeding intervention results in relatively higher animal productivity with less CH<sub>4</sub> emitted per unit of output (Johnson and Johnson 1995). Furthermore, concentrate supplementation reduces the time taken by meat-producing animals to attain market weight and, hence, reduces the total amount of GHG emitted by these livestock in their lifetime. This understanding should form the basis for promoting the feedlot finishing of beef cattle in the traditional sector in order to reduce the time taken to attain market weight from an average of 7 years to 2–3 years.

Feeding ruminants on less-mature pastures can reduce CH<sub>4</sub> production (Eckard et al. 2010; FAO 2006). This can be achieved through the early harvesting of forages before lignifications and storing them for dry-season feeding (Plate 19.1). To achieve this, harvesting should be done early in the rainy season to have good-quality hay (Sundstøl 2013). The CH<sub>4</sub> production per unit of cellulose digested is threefold higher than that of hemicelluloses; the fermentation of a unit of nonstructural carbohydrates yields far less CH<sub>4</sub> than that of cellulose and hemicellulose (FAO 2006; Eckard et al. 2010). Fewer fibrous forages promote higher voluntary intake and reduce the retention time in the rumen, energetically promoting more efficient post-ruminal digestion and reducing the proportion of dietary energy converted into CH<sub>4</sub>. Mixing legumes in pure pasture stand will reduce CH<sub>4</sub> emission from livestock, partly because of the lower fiber content, the faster rate of passage, and in some cases, the presence of condensed tannins that suppress



Pure stand of young *C. gayana* grass



Drying of young *C. gayana* grass on fences

**Plate 19.1** Young *Chloris gayana* grass before and after being harvested as hay (a) Pure stand of young *C. gayana* grass. (b) Drying of young *C. gayana* grass on fences

methanogens. The chemical treatment of crop residues, like wheat straw, will improve their digestibility and reduce CH<sub>4</sub> emitted per unit of meat or milk. Overall, improving diet quality can both improve animal productivity and reduce CH<sub>4</sub> production, but it can also improve efficiency by reducing CH<sub>4</sub> emissions per unit of animal product. The increase in production efficiency also leads to a drop in CH<sub>4</sub> emissions from a reduction in the size of the herd required to produce a given level of product. Small-scale farmers in Tanzania can improve the diets of the ruminant animals by better managing their grazing lands through rotational grazing (this can take the form of traditional deferred grazing systems, known as “Ngitiri”), planting improved species of pasture grasses, strategic applications of manure, and developing “fodder banks” of planted legumes and other forages. Concerted efforts, however, have to be directed toward overcoming the challenges that hinder the adoption of these simple mitigation options.

### 19.5.1.2 Work with the Right Number and Breed of Livestock

Another option to mitigate CH<sub>4</sub> emission from livestock in the traditional sector is by instituting measures for destocking cattle in pastoral and agro-pastoral societies (Table 19.1). This can be done by establishing bylaws for controlling overgrazing. Reducing the number of unproductive animals on a farm can potentially both improve profitability and reduce CH<sub>4</sub>. Better still, if a certain proportion of low-producing local breeds is replaced with higher-yielding, improved breeds, that method will contribute to the reduction in total emissions while maintaining or increasing livestock yields (Eckard et al. 2010). High-yielding beef breeds can be obtained from crossing local cows with genetically improved beef breeds to produce crossbred beef cattle that possess traits both for hardiness and higher meat yields, especially when combined with better fodder quality. However, caution should be exercised in implementing this option so as not to completely wipe out local breeds; some animals from the target breeds must be kept as a genetic resource base. Synchronizing breeding to have animals calving/kidding at the time of an ample feed supply will also reduce emission of CH<sub>4</sub> (Safari et al. 2012). Where possible, exchanging ruminant animals for monogastrics could also reduce total CH<sub>4</sub> emissions.

### 19.5.1.3 Improved Manure Management

Livestock manure is a mixed blessing. On one hand, manure contributes vital nutrients to the soil, but, on the other hand, manure emits N<sub>2</sub>O and CH<sub>4</sub> as it breaks down in the soil. As it is produced on a farm, the use of manure as fertilizer helps avoid the need to produce, transport, and use energy-intensive synthetic fertilizers. Controlled storage offers possibilities for the utilization of CH<sub>4</sub> produced (biogas). Other manure management strategies for the reduction of CH<sub>4</sub> emission may include solid disposal of manure (as opposed to liquid disposal, which increases

CH<sub>4</sub> emission), minimal compaction of manure heaps, and regular and complete removal of manure from animal barns (Arthur and Baidoo 2011; Monteny et al. 2006; Yamulki 2006). The use of crop residues as bedding will increase the Carbon to Nitrogen ratio of manure. Manure with a high nitrogen content will emit greater levels of methane than manure with a lower nitrogen content. The use of manure to generate biogas converts the treatment of livestock waste from a liability into a profit (Arthur and Baidoo 2011). The use of CH<sub>4</sub> to provide energy produces CO<sub>2</sub> that is less harmful to the environment than direct methane emission. This happens because CH<sub>4</sub> has 23 times more GWP than CO<sub>2</sub> within a span of 100 years (FAO 2006; Pitesky et al. 2009). The digested slurry from biogas chambers is the best fertilizer for farms in rural areas. This phenomenon makes use of manure for biogas production a win-win approach that enables the harnessing of energy in manure and produces slurry that has a limited emission of CH<sub>4</sub> to the atmosphere. With few exceptions, however, the dissemination of biogas technology in Tanzania has been relatively unsuccessful. This lack of success is partly attributable to the relatively high initial cost of installation that the rural poor cannot afford. In addition, African governments have given limited support to biogas technology through a focused energy policy. To overcome the financial component of biogas technology dissemination, governmental and non-governmental organizations in support of poor rural communities should introduce financial incentives, such as soft loans and subsidies at the initial stage of biogas acquisition, and design follow-up strategies to build the capacity for the regular maintenance of the biogas systems (Arthur and Baidoo 2011).

Aerobic conditions favor the production of CO<sub>2</sub> at the expense of CH<sub>4</sub> production (De Gryze et al. 2008). Thus, increasing the dry matter content and aerating the manure heap through the addition of straw have the potential to reduce CH<sub>4</sub> emission (Monteny et al. 2006; Yamulki 2006). The use of crop residues, like wheat straw as bedding material, is a workable solution in the traditional livestock sector. Most of these residues are either used for animal feeding or burned on crop fields before the next planting season. Governments can play an active role in reducing methane emission from manure by instituting regulatory frameworks for the better management of fresh manure and slurry.

### ***19.5.2 Mitigation of N<sub>2</sub>O Emission from Livestock Production***

A paradox exists on the impact of strategies used for to mitigate CH<sub>4</sub> and N<sub>2</sub>O. Strategies found to be effective in mitigating CH<sub>4</sub> emission tend increase N<sub>2</sub>O emission. For instance, the increased aeration of manure lowers CH<sub>4</sub> emissions but increases N<sub>2</sub>O emissions. For N<sub>2</sub>O emissions to occur, the waste must first be handled aerobically, allowing ammonia or organic nitrogen to be converted into nitrates and nitrites (nitrification). If manure is handled anaerobically, nitrates and nitrites are reduced to N<sub>2</sub>, with the intermediate production of N<sub>2</sub>O and nitric oxide

(NO) (denitrification). The use of manure for biogas production is the only strategy that mitigates both CH<sub>4</sub> and N<sub>2</sub>O emissions. This calls for the deployment of mitigation measures that take into account all GHGs to avoid instituting action to mitigate GHG emissions at one point in the production chain that may lead to higher emissions at a subsequent point (Weiske and Petersen 2006).

### 19.5.2.1 Dietary Improvement

Balancing the protein-to-energy ratios in the diets of ruminants will minimize N<sub>2</sub>O emission from excessive urinary nitrogen excretion. Eckard et al. (2010) reported that dairy cows fed diets with 14 % crude protein (CP) excreted 45 % less urinary nitrogen than dairy cows fed a 19 % CP diet. Optimizing proteins or amino acids in animal feed to match the exact requirements of individual animals or animal groups will reduce the nitrogen content of manure. Cows in the traditional sector have limited access to protein diets and may not excrete a significant amount of nitrogen in urine or in manure compared to what dairy cows excrete in intensive or semi-intensive systems. In addition, cattle in the traditional system graze or browse plants with a high content of condensed tannins (CT). CT form complexes with proteins in the rumen, protecting them from microbial digestion. This reaction results in the more efficient digestion of amino acids in the abomasum and lower intestine, causing less urinary nitrogen excretion (Eckard et al. 2010). Fecal nitrogen is mainly in an organic form and is, thus, less volatile, whereas urinary nitrogen is largely urea and is, therefore, more rapidly nitrified to NO<sub>3</sub><sup>-</sup>, with N<sub>2</sub>O as an important intermediate (Monteny et al. 2006). Further research is required to identify suitable and cost-effective high-tannin forages to which grazing ruminants should be given access.

### 19.5.2.2 Grazing Management

Improving the soil's physical conditions by drainage to reduce soil wetness, especially in grassland systems, may significantly reduce N<sub>2</sub>O emissions. Compacting soil by grazing livestock can increase the anaerobicity of the soil and enhance the conditions for denitrification. Denitrification is enhanced under conditions of low soil aeration. Oenema et al. (1997) reported that treading by cattle could increase emissions of N<sub>2</sub>O by a factor of two. Grazing livestock in one area for long time is very likely to happen around watering points, especially when such points are not evenly distributed in rangelands. This unequal distribution of livestock watering points is a common feature in rangelands grazed by livestock in the traditional systems in Tanzania.

Wet soils can be compacted easily by grazing animals. Reducing the waterlogging of grazing areas and/or restricting grazing on seasonally wet soils will reduce the potential for N<sub>2</sub>O emissions (Eckard et al. 2010). Waterlogging can be reduced by introducing surface or subsurface drains in seasonally waterlogged grazing areas. Dobbie and Smith (2003) demonstrated that water-filled pore space of more than 70 % results in significant N<sub>2</sub>O emissions from applied manure.

### 19.5.2.3 Improved Manure Management

Slurry from manure stored in biodigesters for biogas emits less  $N_2O$  than fresh manure applied directly to grassland (Lekule and Sarwatt 1997; Amon et al. 2006). This occurs because during storage and anaerobic digestion, readily available carbon, which could be used to fuel denitrification, is incorporated into the microbial biomass or is lost as  $CO_2$  or  $CH_4$ . As a result, there is less available carbon in the slurry to fuel denitrification when the slurry is applied to land (Eckard et al. 2010). Indeed, controlled anaerobic digestion is potentially a “win–win” management of animal manure, since  $CH_4$  emitted during storage (as a biogas) is used to produce heat and electricity, whereas  $N_2O$  emissions after digested slurry is spread are also reduced. The rate, timing, and placement of animal effluent applied to soils all affect potential  $N_2O$  emissions. Emission of  $N_2O$  from manure is higher when manure is applied to wet soil than when it is applied to drier soil; emission peaks generally occur within 24 h of application (Saggar et al. 2004; Eckard et al. 2010).

### 19.5.2.4 Breeding for Improved Feed Utilization

Breeding animals for higher protein utilization efficiency will lead to the lower excretion of nitrogen in urine, which is a substrate for emitted  $N_2O$  (Garnett 2009; Monteny et al. 2006). Crossbred animals are likely to have higher efficiency in utilizing dietary protein for large muscle tissue deposition than indigenous cattle. Eckard et al. (2010) reported that an improvement in the feed conversion efficiency of 0.01 could result in a 3.3 % reduction in nitrogen excretion. Therefore, breeding animals for more efficient feed conversion should produce animals that partition more of their intake into production and less into nitrogen excretion, thereby reducing potential  $N_2O$  loss.

## 19.6 Options for Adapting Traditional Livestock Systems to CC

CC adaptation measures in Tanzania will differ from community to community, depending on the geographical, sociological, and economical characteristics. There is evidence that some communities in the country are already coping with the effects of CC (Shayo 2006). These effects include rainwater harvesting for dry-season cattle use, the use of fuel-saving stoves, and the use of local skills to control livestock diseases. However, such adaptation mechanisms are handicapped by the severity and the speed of CC as well as the constraints on resources. Most local people find it hard to cope with CC by using modern technologies, such as high-input agriculture and biotechnology, and have, instead, relied on their

indigenous skills. Some adaptation and mitigation options, however, are closely interrelated. The rehabilitation of pastureland through the use of leguminous species and species limiting denitrification (e.g., *Bracharia spp.*) is both a mitigation and an adaptation option. Destocking herds of ruminants to adhere to herd sizes in keeping with the carrying capacity of grazing land will reduce desertification and the loss of biodiversity. Destocking will also enhance feeding the remaining animals better to improve their productivity, including attaining market weight earlier to reduce amount of GHG produced in a lifetime. This adaptive strategy should be tied to strengthening extension services. The repeated occurrence of climate disasters has forced some pastoralist societies in Tanzania to reduce the numbers of their herds as a coping mechanism.

Supporting the development of agricultural markets is a crucial way for increasing farmers' income and capacity for intensification of livestock and crop production and for increasing resilience to shocks (adaptation). Market development potentially encourages destocking as livestock owners are likely to sell their animals when given an incentive-producing price. Market development should be conducive to reducing GHG emissions from farming and to regulating the harvest of nature (biodiversity). Such development should be supported so that farmers have a fair share in the added value of their products. Market development should include mechanisms for absorbing some surpluses and for facing shortages generated by adverse climatic conditions (adaptation). Market development should go hand in hand with the development of rural infrastructures. The objective is to facilitate marketing inputs and outputs; harness natural resources for development; empower people and drive social organization; and monitor and mitigate risks. This effort should target rural and feeder roads, water storage and distribution, and storage of agricultural commodities.

Facilitating farmers' access to credit systems and developing crop and livestock insurance systems are other means for adapting the traditional livestock sector to CC. Livestock keepers consider the maximization of the number of livestock owned as a hedge against losses caused by natural calamities. It is hypothesized that if given some form of insurance to cover the losses of livestock in natural calamities, livestock keepers will reduce herd size to the carrying capacity of the grazing lands. In addition, national financial systems should better subsidize rural credit than input systems do. A credit worth system should address agricultural inputs with contribution from the inputs industry and wherever possible from the production-to-consumption chains through contractual farming agreements. The development of social safety nets to alleviate vulnerability in rural areas will enhance the adaptation of rural communities to CC. This can be through public support for employment of and giving income to vulnerable people; job creation at the community level; water-harvesting investment; tree development (cropped areas and watersheds); and energy generation as a substitute for wood fuel and charcoal.

Promoting and facilitating the recycling of livestock waste into crop systems are adaptive strategies. Recycling raw or composted animal wastes, and post-harvest residues, and processing residues provide valuable input for crops and reduce the use of chemical fertilizers whose production and application contribute to GHG emission.

Adapting to some local ways of predicting short- to long-term climatic changes, such as drought, is equally helpful. When a drought is predicted locally, a pastoralist can distribute livestock and/or shift the herd to safer places to reduce risk (Shemsanga et al. 2010). Pastoral societies like Barabaig and Masai have been particularly involved in transhumance. The Morogoro region has observed a huge influx of pastoralists with large herds of livestock (Paavola 2003). In addition, when a drought is likely, pastoralists in drought-prone regions should reserve pastureland for weak stocks, such as sick, young, and lactating animals. Such a method will enable them to survive during the drought season and reduce the deaths of weak individuals (Shayo 2006).

## 19.7 Conclusion

Introducing some form of intensification of livestock production in the traditional sector will provide opportunities for reducing GHG emissions and CC mitigation through improved feeding and feed utilization, manure management, and reduced deforestation. It is important to realize that with reasonable stocking intensity, ruminant production in the traditional sector can help tackle CC by making use of otherwise unproductive land. In addition, the ability of ruminant livestock to consume crop residues and byproducts that are inedible to humans is resource efficient and leads to GHG avoidance as long as there is controlled use of manure, such as biogas production. Some GHG emission abatement options have been identified in this review that can be implemented in animal production systems now and in the near future, many of which are likely to be cost effective in their own right. The adaptation option identified in this review should be closely tied to mitigation options to achieve greater impact. However, most of the options are not cost neutral and require economic incentives and institutional support for their adoption. A good example for this is the use of manure for biogas production in poor rural communities. Overall, livestock-related greenhouse gas reductions could be quickly achieved in the traditional sector by modifying production practices, such as keeping the right number and type of animals, switching to more nutritious pasture grasses, pasture harvesting and storage, supplementing diets with even small amounts of crop residues or grains, controlled manure disposal, restoring degraded grazing lands, and planting trees that both trap carbon and produce leaves that cows can eat. It is imperative to note that the current estimates of GHG emissions in livestock production in Africa rely heavily on data collected in developed countries that may not apply to Africa's climatic and environmental conditions. Obtaining country-specific GHG emission data from livestock production is critical to supporting "climate smart" agricultural practices that will help those in the traditional livestock sector protect their livelihood in face of CC. Although some traditional livestock systems in Tanzania are already coping with the impact of CC, such efforts are handicapped by inadequate resources, poor coordination, and implementation of competing measures.



## References

- Amon B, Kryvoruchko V, Amon T, Zechmeister-Boltenstern S (2006) Methane, nitrous oxide and ammonia emissions during storage and after application of dairy cattle slurry and influence of slurry treatment. *Agric Ecosyst Environ* 112(2–3):153–162
- Arena AP (2001) Spreading life-cycle assessment to developing countries: lessons from Argentina. *J Ind Ecol* 4(3):3–6
- Arthur R, Baidoo MF (2011) Harnessing methane generated from livestock manure in Ghana, Nigeria, Mali and Burkina Faso. *Biomass Bioenergy* 35(11):4648–4656
- Asner GP, Borghi CE, Ojeda RA (2003) Desertification in central Argentina: changes in ecosystem carbon and nitrogen from imaging spectroscopy. *Ecol Appl* 13:629–648
- Beauchemin KA, Kreuzer M, O'Mara F, McAllister TA (2008) Nutritional management for enteric methane abatement: a review. *Aust J Exp Agric* 48:21–27. doi:10.1071/EA07199
- Brent AC, Hietkamp S (2003) Comparative evaluation of life cycle impact assessment methods with a South African case study. *Int J Life Cycle Assess* 8(1):27–38
- Brent AC, Rohwer MB, Friedrich E, Von Blottnitz H (2002) Status of life cycle assessment and engineering research in South Africa. *Int J Life Cycle Assess* 7(3):167–172
- Chadwick DR (2005) Emissions of ammonia, nitrous oxide and methane from cattle manure heaps: effect of compaction and covering. *Atmos Environ* 39(4):787–799
- De Gryze S, Catala R, Howitt RE, Six J (2008) An integrated assessment of the biophysical and economic potential for greenhouse gas mitigation in California agricultural soils. California Energy Commission. PIER Energy-Related Environmental Research, California
- De Vries M, De Boer IJM (2010) Comparing environmental impacts for livestock products: a review of life cycle assessments. *Livest Sci* 128(1–3):1–11
- Dobbie KE, Smith KA (2003) Nitrous oxide emission factors for agricultural soils in Great Britain: the impact of soil water-filled pore space and other controlling variables. *Glob Chang Biol* 9:204–218
- Eckard RJ, Grainger C, de Klein CAM (2010) Options for the abatement of methane and nitrous oxide from ruminant production: a review. *Livest Sci* 130(1–3):47–56
- FAO (2006) Food and Agriculture Organization of the United Nations. Livestock's long shadow. In: Environmental issues and options. <http://ftp.fao.org/docrep/fao/010/a0701e/A0701E00.pdf>. Accessed 3 Nov 2013
- Finnveden G (2000) On the limitations of life cycle assessment and environmental systems analysis tools in general. *Int J Life Cycle Assess* 5(4):229–238
- Finnveden G, Hauschild MZ, Ekvall T, Guinée J, Heijungs R, Hellweg S, Koehler A, Pennington D, Suh S (2009) Recent developments in life cycle assessment. *J Environ Manag* 91:1–21
- Flessa H, Ruser R, Dorsch P, Kamp T, Jimenez MA, Munch JC, Beese F (2002) Integrated evaluation of greenhouse gas emissions (CO<sub>2</sub>, CH<sub>4</sub>, N<sub>2</sub>O) from two farming systems in southern Germany. *Agric Ecosyst Environ* 91(1–3):175–189
- Garnett T (2009) Livestock-related greenhouse gas emissions: impacts and options for policy makers. *Environ Sci Policy* 12(4):491–503
- Geist HJ, Lambin EF (2002) Proximated causes and underlying driving forces of tropical deforestation. *Bioscience* 52(2):143–150
- Gerber P, Vellinga TV, Opio C, Steinfeld H (2011) Productivity gains and greenhouse gas emissions intensity in dairy systems. *Livest Sci* 139:100–108
- Gerber PJ, Steinfeld H, Henderson B, Mottet A, Opio C, Dijkman J, Faluccci A, Tempio G (2013) Tackling climate change through livestock – a global assessment of emissions and mitigation opportunities. Food and Agriculture Organization of the United Nations (FAO), Rome
- Gill M, Smith P, Wilkinson JM (2010) Mitigating climate change: the role of domestic livestock. *Animal* 4(3):323–333
- Herrero M, Gerber P, Vellinga T, Garnett T, Leip A, Opio C, Westhoek HJ, Thornton PK, Olesen J, Hutchings N, Montgomery H, Soussana JF, Steinfeld H, McAllister TA (2011) Livestock and greenhouse gas emissions: the importance of getting the numbers right. *Anim Feed Sci Technol* 166–167:779–782

- Holter JB, Young AJ (1992) Methane prediction in dry and lactating Holstein cows. *J Dairy Sci* 75:2165–2175
- IPCC (1997) Intergovernmental panel on climate change/organization for economic cooperation and development: guidelines for national greenhouse gas inventories. IPCC, Paris. <http://www.ipcc-nggip.iges.or.jp/public/mtdocs/pdfiles/rockhamp.pdf>. Accessed 5 Nov 2013
- IPCC (2001) Climate change impacts, adaptation and vulnerability. In: Contribution of Working Group II to the Third Assessment Report of IPCC. Cambridge University Press, Cambridge
- Johnson K, Johnson D (1995) Methane emissions from cattle. *J Anim Sci* 73:2483–2492
- Jungbluth T, Hartung E, Brose G (2001) Greenhouse gas emissions from animal houses and manure stores. *Nutr Cycl Agroecosyst* 60:133–145
- Kyoto Protocol (1997) United Nations framework convention on climate change. Kyoto Protocol, Kyoto
- Lekule FP, Sarwatt SV (1997) Biogas production from animal waste. In: Proceedings of the 24th scientific conference of the Tanzania Society of Animal Production, Tanzania, vol 24, pp 1–8
- Malcolm JR, Markham A, Neilson RP, Garaci M (2002) Estimated migration rates under scenarios of global climate change. *J Biogeogr* 29:835–849
- McAllister TA, Newbold CJ (2008) Redirecting rumen fermentation to reduce methanogenesis. *Aust J Exp Agric* 48:7–13
- Ministry of Livestock Development and Fisheries (2013) Budget speech for 2013/2014. [www.parliament.go.tz/docs/83a5d-WIZARA-YA-MIFUGO-NA-UVUVI.pdf](http://www.parliament.go.tz/docs/83a5d-WIZARA-YA-MIFUGO-NA-UVUVI.pdf). Accessed 7 Nov 2013
- Monteny GJ, Bannink A, Chadwick D (2006) Greenhouse gas abatement strategies for animal husbandry. *Agric Ecosyst Environ* 112(2–3):163–170
- Mosier A, Kroeze C, Nevison C, Oenema O, Seitzinger S, Van Cleemput O (1998) Closing the global N<sub>2</sub>O budget: nitrous oxide emissions through the agricultural nitrogen cycle: OEDC/IPCC/IEA phase II development of IPCC guideline for national greenhouse gas methodology. *Nutr Cycl Agroecosyst* 52:225–248
- Mwandosya MJ, Meena HE (1999) Climate change mitigation study – Tanzania country study. Ministry of Energy and Mineral, Tanzania. ISBN 87-550-2428-9
- Mwandosya MJ, Victus P, Meena HE (1996) Green house gas emissions and mitigation studies in Tanzania: an overview. *Environ Prof* 18:15–24
- Oenema O, Velthof GL, Yamulki S, Jarvis SC, Smith K (1997) Nitrous oxide emissions from grazed grassland. Soils and the greenhouse effect. *Soil Use Manag* 13:288–295
- Paavola J (2003) Livelihoods, vulnerability and adaptation to climate change in the Morogoro region. Tanzania Centre for Social and Economic Research on the Global Environment, University of East Anglia, Norwich NR4 7TJ, UK Working Paper EDM
- Pitesky ME, Stackhouse KR, Mitloehner FM (2009) Clearing the air: livestock's contribution to climate change. *Adv Agron* 103:1–40
- Reap J, Roman F, Duncan S, Bras B (2008a) A survey of unresolved problems in life cycle assessment. Part 1: goal and scope and inventory analysis. *Int J Life Cycle Assess* 13:290–300
- Reap J, Roman F, Duncan S, Bras B (2008b) A survey of unresolved problems in life cycle assessment. Part 2: impact assessment and interpretation. *Int J Life Cycle Assess* 13:374–388
- Ripoll-Bosch R, de Boer IJM, Bernués A, Vellinga TV (2013) Accounting for multi-functionality of sheep farming in the carbon footprint of lamb: a comparison of three contrasting Mediterranean systems. *Agric Syst* 116:60–68
- Rotz CA, Montes F, Chianese DS (2010) The carbon footprint of dairy production systems through partial life cycle assessment. *J Dairy Sci* 93(3):1266–1282
- Safari J, Kifaro GC, Mushi DE, Mtenga LA, Adnøy T, Eik LO (2012) Influence of flushing and season of kidding on reproductive characteristics of Small East African goats (does) and growth performance of their kids in a semi arid area of Tanzania. *Afr J Agric Res* 7(35):4948–4955
- Saggar S, Andrew RM, Tate KR, Hedley CB, Rodda NJ, Townsend JA (2004) Modelling nitrous oxide emissions from dairy-grazed pastures. *Nutr Cycl Agroecosyst* 68:243–255
- Schils RLM, Olesen JE, del Prado A, Soussana JF (2007) A review of farm level modelling approaches for mitigating greenhouse gas emissions from ruminant livestock systems. *Livest Sci* 112(3):240–251

- Shayo CM (2006) Adaptation planning and implementation: agriculture and food security, UNFCCC African regional workshop on adaptation, Accra, Ghana, Vice President's Office, Dar es Salaam, 21–23 Sept 2006
- Shemsanga C, Omambia AN, Gu A (2010) The cost of climate change in Tanzania: impacts and adaptations. *J Am Sci* 6(3):182–196
- Shortall OK, Barnes AP (2013) Greenhouse gas emissions and the technical efficiency of dairy farmers. *Ecol Indic* 29:478–488
- Smith P, Martino D, Cai ZC, Gwary D, Janzen H, Kumar P, McCarl B, Ogle S, O'Mara F, Rice C, Scholes B, Sirotenko O (2007) Policy and technological constraints to implementation of greenhouse gas mitigation options in agriculture. *Agric Ecosyst Environ* 18:6–28
- Steinfeld H, Gerber P, Wassenaar T, Castel V, Rosales M, Haan CD (2006) Livestock's long shadow: environmental issues and options. Food and Agriculture Organization of the United Nations, Rome, p 390
- Sun H, Trabue SL, Scoggin K, Jackson WA, Pan Y, Zhao Y, Malkina IL, Koziel JA, Mitioehner FM (2008) Alcohol, volatile fatty acid, phenol, and methane emissions from dairy cows and fresh manure. *J Environ Qual* 37:615–622
- Sundstøl F (2007) Pasture productivity and some environmental aspects at varying stocking rates. Paper presented at a workshop on economic and ecological analysis of grazing systems, Centre for Economic Research and Department of Economics, Norwegian University of Science and Technology, Trondheim, 5–6 Jun 2007
- Sundstøl F (2013) East African farmers benefit from quality hay. *Approp Technol* 40(1):61–63, [www.appropriate-technology.com](http://www.appropriate-technology.com)
- Udo De Haes HA (2004) Life-cycle assessment and developing countries. *J Ind Ecol* 8(1–2):8–10
- United Nations Environment Programme (1998) Tanzania: country study on biological diversity. Office of the Vice President, Dar es Salaam
- United Republic of Tanzania (2003) Initial national communication under the United Nations framework convention on climate change (UNFCCC). Vice President's Office (VPO), Government Printers, Dar es Salaam
- United Republic of Tanzania (2007) National adaptation programme of action (NAPA). Vice President's Office, Division of Environment, Government Printers, Dar es Salaam
- Vlek PLG, Rodriguez-Kuhl G, Sommer R (2004) Energy use and CO<sub>2</sub> production in tropical agriculture and means and strategies for reduction or mitigation. *Environ Dev Sustain* 6(1–2):213–233
- Weiske A, Petersen SO (2006) Mitigation of greenhouse gas emissions from livestock production. *Agric Ecosyst Environ* 112(2–3):105–106
- Wilkinson JM (2011) Re-defining efficiency of feed use by livestock. *Animal* 5(7):1014–1022
- Williams AG, Audsley E, Sandars DL (2006) Determining the environmental burdens and resource use in the production of agricultural and horticultural commodities. Main Report. Defra Research Project IS0205. Bedford, UK, p 97
- Yamulki S (2006) Effect of straw addition on nitrous oxide and methane emissions from stored farmyard manures. *Agric Ecosyst Environ* 112(2–3):140–145

# Chapter 20

## Feeding Strategies for Improved Beef Productivity and Reduced GHG Emission in Tanzania: Effect of Type of Finish-Feeding on Carcass Yield and Meat Quality of Zebu Steers

Ismail Saidi Selemani, Lars Olav Eik, Øystein Holand, Tormod Ådnøy, Ephraim J. Mtengeti, Daniel E. Mushi, and Sørheim Oddvin

**Abstract** The study was conducted to elucidate the effects of grazing on natural pastures alone versus total stall feeding on growth performance, carcass characteristics, and meat quality of Tanzania Zebu steers. In this experiment, 27 steers were distributed into 2 dietary groups; stall feeding (SF) and natural pasture feeding (NP). Animals in SF were totally confined in the feedlot with free access to wheat straw as a basal diet and supplemented with concentrate mixture, while those in NP were freely grazed on natural pasture. Animals in SF displayed 500 g higher average daily gain (ADG) and four units higher dressing percentage than those in NP. The marbling scores, hind leg length (HL), and hind leg circumference (Circ.) was also statistically higher among animals in SF than among those in NP ( $P \leq 0.05$ ). Moreover, postmortem temperature was observed to decline more

---

I.S. Selemani (✉)

Department of Animal and Aquacultural Sciences, Norwegian University of Life Sciences, P.O. Box 5003, 1432 Ås, Norway

Department of Animal Science and Production, Sokoine University of Agriculture, P.O. Box 3004, Morogoro, Tanzania  
e-mail: [suma02seleman@yahoo.co.uk](mailto:suma02seleman@yahoo.co.uk)

L.O. Eik

Department of International Environment and Development Studies/Noragric, Norwegian University of Life Sciences (NMBU), P.O. Box 5003, No-1432 Ås, Norway

Ø. Holand • T. Ådnøy

Department of Animal and Aquacultural Sciences, Norwegian University of Life Sciences, P.O. Box 5003, 1432 Ås, Norway

E.J. Mtengeti • D.E. Mushi

Department of Animal Science and Production, Sokoine University of Agriculture, P.O. Box 3004, Morogoro, Tanzania

S. Oddvin

MATFORSK-Norwegian Food Research Institute, Osloveien 1, N-1430 Ås, Norway

rapidly among animals in NP than in SF. However, postmortem carcass pH, meat tenderness, meat color, meat chemical composition (moisture content, dry matter (DM), ash, Ether Extract (EE), and Crude Protein (CP)) were independent of concentrate supplementation ( $P > 0.05$ ). The high performance of the SF group in terms of ADG, dressing percentage, and intramuscular fat deposition was associated with utilization of high energy rich concentrate and improved utilization of wheat straw following concentrate supplementation. It was concluded that, in addition to the manipulation of the animals' body through nutrition, other factors such as reducing pre-slaughter stress and appropriate ageing of meat should be manipulated to improve the meat quality of indigenous Zebu cattle.

**Keywords** Concentrate • Pasture • Growth performance • Carcass • Meat quality

## 20.1 Background

Tanzania has a huge livestock resource base (NBS 2012). However, the productivity of this resource is lower than its potential mainly due to seasonality in the availability of feeds. Ruminant livestock production in the country depends largely on communal rangelands which are constrained by scarcity forage, particularly during the dry season. Animals undergo cycles of weight gain and loss in the wet and dry seasons, respectively (Kanuya et al. 2006); hence, it takes them a long time to reach the required live weights for slaughtering. Rubanza et al. (2003) confirmed that the available forages in the semi-arid rangelands of Tanzania are poor in quality and thus lead to severe weight losses in ruminants during the dry season.

The most promising approach to improve the quality of meat production from livestock ruminants and reducing greenhouse gas emission is through better nutrition. One of the basic principles is to increase digestibility of fibrous feedstuff through concentrate supplementation. McDonald et al. (2002) emphasized that to improve utilization of poor quality straws, provision of adequate supplies of high energy concentrates for the rumen microorganisms is crucial. High energy-rich concentrate provides sufficient fermentable nitrogen and carbohydrates, which enhance digestibility of poor quality roughage (Steinfeld et al. 2006).

The Hanang district in Manyara region comprises a larger proportion of semi-arid rangelands that are ideal for livestock production in the country (Mwilawa et al. 2008). The district is mainly occupied by the *Barabaig* semi-nomadic pastoralists with large herds of Zebu cattle. Previously, the *Barabaig* pastoral system was dependent on free movement of herders to utilize the most productive pastures (Lane 1994). Currently, these pastoralists are experiencing limited mobility due to diminishing grazing areas as a result of land alienation for the wheat production scheme. Since 1968, over 40,000 ha of productive grazing land has been declared by the government to the National Agriculture and Food Cooperation (NAFCO) for the wheat production scheme (Lane 1994). These farms yield a substantial amount of wheat straw—approximately 132,000 tonnes per annum

(Viggo 2008)—which can be used as potential sources of forage in the dry season. It can be argued that to sustain the livelihood of pastoral communities in the face of diminishing grazing resources, improved utilization of available crop residues is inevitable. Since wheat straws are low in nitrogen and high in lignocelluloses and hence have low digestibility and low voluntary intake (Forbes 2000), it is imperative to improve its utilization. In the last 10 years, these straws were considered to be too poor in nutritional value to be recommended for farm animals (McDonald et al. 2002). Although chemical treatment of straws may help to improve their utilization by increasing digestibility (Abebe et al. 2004), little effort has been made in Tanzania to increase the nutritional values of wheat straws through chemical treatment, partially due to the high cost of chemicals such as sodium hydroxide and ammonia. Moreover, the perceived risk of these chemicals as potential hazards to the environments limit their applications (Chaudhry 2000).

Despite the important role of crop residues as basal feed for ruminants, feeding animals with wheat straws alone is not adequate and cannot sustain high meat quality. Apart from chemical treatment, the nutritive value of crop residues can be improved by supplementation with other feedstuffs (Safari et al. 2011). According to Khandaker et al. (1998), wheat straw utilization could be improved by supplementation with high-energy feeds to provide sufficient fermentable nitrogen and carbohydrates. Nonetheless, the high cost of commercial concentrates coupled with poverty among Tanzanian pastoralists limit the use of concentrate feeds for meat production in the country. Moreover, there is paucity of information on how to improve production and quality of meat from Tanzanian Zebu steers found in semi-arid areas using locally available and cheap supplementary feeds. It is hypothesized that the absolute confinement of Zebu steers in the dry season with free access to wheat straw as basal diet and supplemented with locally made concentrate diet will improve growth performance and provide better meat quality than grazing them on natural pastures alone. Therefore, the current study seeks to elucidate the effects of dry season grazing alone vs. total confinement with free access to wheat straws and concentrate supplementation on growth performance, carcass characteristics, and meat quality of Tanzania Zebu steers.

## 20.2 Material and Methods

### 20.2.1 Study Area

The feeding trial was conducted in Haydom Farm and Development Ltd. in the Hanang district at Manyara region from November 2012 to February 2013. The climate in the study area is semi-arid characterized by two dry seasons—a long dry season, mainly from May to early November and a short dry season from December to February. The minimum and maximum temperatures range from 20 to 30 °C and the mean annual rainfall varies from 408 to 802 mm (Safari et al. 2011). The

vegetation type is mainly wooded grassland dominated by acacia species, such as red acacia (*Vachellia seyal*), umbrella thorn acacia (*Vachellia tortilis*), and fever trees (*Vachellia xanthopholea*) with a herbaceous layer covered mainly by Africa star grass (*Cynodon nlemfuensis*), creeping bluegrass (*Bothriocloa insculpta*), nut grass (*Cyperus rotundus*), devil's thorn (*Tribulus terrestris*), thatching grass (*Hyparrhenia rufa*), and buffel grass (*Cenchrus ciliaris*). The area is mainly inhabited by the *Barabaig* pastoralists and cattle is the main livestock species (Lane 1994). The East Africa Short Horn Zebu cattle (*Bos indicus*) is the main breed in this area (Sieff 1997).

### 20.2.2 Feeding and Animal Management

A feeding trial was conducted for 90 days with a preliminary period of 14 days. Twenty seven Zebu steers aged between 3 and 4 years were selected from livestock keepers around Haydom wheat farm for the feeding trial. The selection of animals was based on pastoralists' willingness to participate in the project to add market value to their animals. Hence, prior to the feeding trial, a village meeting was held in which the objectives of the project and importance of the feeding trial were discussed with livestock keepers. Five pastoralists were engaged in the project and some of their animals were used in the feeding trial.

All selected animals were treated with synthetic pyrethroids prior to beginning the trial to control tick-borne diseases and other external parasites. Animals were distributed into two dietary treatment groups: total stall feeding (SF) and natural pastures alone (NP) with average initial weights (kg) of  $250 \pm 11$  and  $210 \pm 13$ , respectively. Eleven animals were allowed to graze freely on NP during the day and 16 animals were totally confined with free access to wheat straw as a basal diet and supplemented with concentrate mixture (SF).

Stall feeding animals (SF), also referred to as feedlot animals, were offered a concentrate diet formulated from maize brain (70 %), sunflower seed cake (27 %), mineral mix (2 %), and salts (1 %), which are locally available and may be affordable to livestock keepers. Feedlot animals were group-fed with approximately 75 kg DM of concentrates per day. They were given concentrates in two lots, at 8:00 h and at 15:00 h. All feedlot animals were given wheat straw ad libitum and had free access to water. Both concentrates and wheat straw were weighed every day before feeding and residues were collected daily in the morning and weighed for estimation of feed intake.

The NP group was not given concentrate and grazed solely on natural pasture. The studied animals in this group were herded together and the group was released on pasture from 9:00 am to 5:00 pm every day. They were grazed on a grazing plot of 111.6 acres within the Haydom farm. The selected grazing plot was familiar to the studied animals and the vegetation composition was mainly herbaceous plants with scattered acacia woody species. The live weights of animals in both groups were recorded at the beginning of the feeding trial and after every 2 weeks until the

experiment ended. The weight gain (kg/day) of each animal was calculated by subtracting the initial body weight from final body weight and divided by the number of days when animals were undergoing the feeding trial.

### **20.2.3 Slaughtering Procedures**

Following the completion of the feeding trial, all 27 animals were transported to the Arusha Meat Company in Arusha town, approximately 280 km away, for slaughtering and chilling. All animals were fasted for approximately 12 h before slaughtering. They were rested in the waiting area (lairage) for approximately 12 h to recover from transportation stress. Final live weights were recorded before slaughtering, 1 day prior to slaughtering. The slaughtering and dressing followed the abattoir procedure, as given by Bourguet et al. (2011). Hot carcass weights were recorded immediately after slaughtering and the carcasses were split into two halves through the median plane. Dressed carcasses were obtained after removing skin, viscera, head from the occipito-atlantal joint, fore feet at the carpal-metacarpal joint, and hind feet at the tarsal-metatarsal joint, as described by Mapiye et al. (2009). Thereafter, 4 h post-slaughtering, dressed carcasses were taken into the chilling room (10 °C) for 20 h. The *Longissimus dorsi* (LD) samples were excised from the carcasses 24 h postmortem, vacuum packed, frozen, and transported chilled on ice to the Department of Animal Science and Production, Sokoine University of Agriculture (SUA) for physico-chemical analyses. The dressing out percentage was estimated as the ratio of hot carcass weight to slaughter live weight multiplied by 100.

### **20.2.4 Post Slaughter Measurements**

The temperature and pH of the remaining half carcasses were recorded at 45 min, 6, 12, and 24 h postmortem. The pH was measured by using a portable pH-meter (Portamess, Knick, Berlin, Germany) with a gel electrode (InLab, Mettler-Toledo, Greifensee, Switzerland) inserted in the geometric center of the LD muscle. Various linear measurements of carcasses were taken, such as carcass length (CL, from the lumbo-sacral joint to the cervical-thoracic joint), carcass depth (CD, from the dorsal to ventral edge of the carcass side along the ninth rib), and hind leg length (HL) and circumference (HC).

### **20.2.5 Chemical Composition of Feeds and Minced LD Samples**

The chemical composition of key forage species sampled from natural pastures and the feed ingredients constituting the concentrate mixture were analyzed following the



procedures of the AOAC (2002) for moisture content, dry matter (DM), ash, crude protein (CP), and Ether Extract (EE). Neutral and acid detergent fiber (NDF and ADF) were analyzed according to the method given by Van Soest and Robertson (1991). In vitro dry matter digestibility (INVDMD) and organic matter digestibility (INVOMD) were determined using the two-stage technique of Tilley and Terry (1963).

The LD samples were thawed and chemical analyses were conducted in the Department of Animal Science and Production, Sokoine University of Agriculture (SUA). The samples were minced homogeneously before chemical analyses. The chemical composition of meat was determined according to AOAC (2002). Dried matter and water content were estimated after the samples were dried for 48 h at 100 °C. Ash content was determined by subjecting dried samples at 550 °C in a muffle furnace for 3 h. Crude protein was determined following the Kjeldahl method.

### ***20.2.6 Determination of Meat Tenderness and Cooking Loss***

Meat tenderness was determined by measuring the amount of force required to shear across muscle fibers following the procedure described by Boccard et al. (1981). The Warner-Bratzler Shear Force (WBSF) machine (Zwick/Roell Z 2.5, Germany) installed in the Department of Animal Science and Production-SUA was used for this measurement. The LD steak samples from 27 animals were cooked at a core temperature of 70 °C in a water bath held at 80 °C. The internal temperature of the steaks was measured using a digital thermometer. The steaks were chilled at 4 °C overnight and cut parallel to the muscle fibers into 1 × 1 cm cubes. Meat tenderness was measured as the maximum force (N/cm<sup>2</sup>) required for shearing the cubes perpendicular to the muscles at a crosshead speed of 100 mm/min using the Warner-Bratzler shear force blade. The average peak shear forces of 12 cubes per muscle sample were taken as the force required to shear a particular animal's muscle.

The cooking loss was determined by measuring the weight change of meat samples after thawing, followed by vacuum packing and cooking in a water bath at 80 °C for 1 h. All samples were weighed before cooking (W1). Cooked samples were chilled in running water from the tap for approximately 2 min and transferred to the refrigerator set at 4 °C overnight, blotted dry, and weighed again (W2). Cooking loss was computed as the proportion of the weight of raw thawed steaks lost as a result of cooking, that is,  $\text{Cooking loss} = \frac{\text{Weight of raw steak after thawing (W1)} - \text{Weight of cooked steak (W2)}}{\text{Weight of raw steak after thawing (W1)}} \times 100$ .

### ***20.2.7 Color and Marbling Determination***

The color at the rib eye of LD muscles was assessed on chilled samples (after thawing) and scored against standard color chart references (Nickerson 1946).

A panel of three experienced assessors scored color using an 11 point scale: 1 = pale, 2 = light red, 3 = red, 4 = light dark red, 5 = very dark red, 6 = light brown, 7 = brown, 8 = very brown, 9 = slightly bleached, 10 = bleached, and 11 = highly bleached. The average scores from three assessors was considered the color of a particular muscle sample. Similarly, the amount of intra-muscular fat (marbling) was assessed using the standard marbling grading system (Shiranita et al. 2000). The marbling score chart used in this study has six point scales ranging from 1 = slight, 2 = small, 3 = modest, 4 = moderate, 5 = slightly abundant, and 6 = moderately abundant.

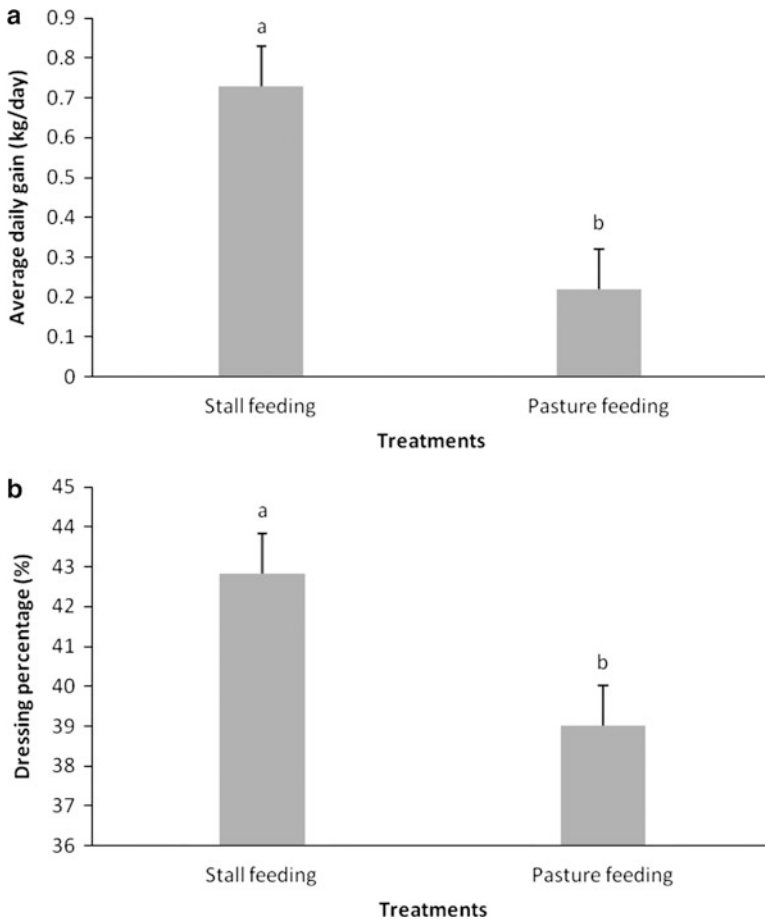
### 20.2.8 Statistical Analysis

Data were analyzed using the General Linear Model procedure of SAS (2004) for effects of dietary feeding treatment on weight gain, carcass characteristics, and meat quality. The dietary treatments were considered independent factors whereas live-weight gain, carcass characteristics, and meat quality were considered dependent factors. The initial weights of experimental animals were entered into the model as covariate. The Least Square Means (lsmeans) differences were tested using *t*-test. Similarly, the results for the chemical analyses of feed samples were subjected to GLM of SAS (2004).

## 20.3 Results

The daily dry matter intake for concentrate and wheat straw for stall-fed animals was 4.6 kg and 2.8 kg/head, respectively. Figure 20.1a, b present the least-square means for daily weight gain and dressing percentage, respectively. It is evident that SF animals displayed 500 g higher ADG and four units higher dressing percentage than NP animals with respective P values of 0.01 and 0.03. Table 20.1 presents the results for chemical analysis of forage samples collected from the grazing plot (natural pastures) and feed samples constituting the concentrate mixture. Higher variations were observed in the chemical composition of feed samples. Most key forage species from natural pastures displayed low values for CP content, high NDF and ADF, and reduced digestibility (INVDMD and INVOMD) as compared to the feed ingredients constituting the concentrate mixture.

Table 20.2 presented the lsmeans for chemical analyses of meat samples (DM, ash CP and EE), carcass linear measurements (CL, CD, HL, and Circ.), and meat quality parameters (meat color, marbling, tenderness and cooking loss). The lsmeans for chemical analyses were found to have no significant difference between SF and NP. In terms of carcass linear measurement, HL and Circ. were significantly higher in SF than NP. However, the values for CL and CD were not significantly different between SF and NP.



**Fig. 20.1** Daily weight gain (a) and dressing percentage (b) of steers under stall feeding and the pasture feeding trial

Dietary treatments were found to have significant impact on accumulation of intramuscular fat (Table 20.2). Further, SF steers were found to have higher lsmeans for marbling scores than NP ( $P = 0.01$ ). Nevertheless, dietary treatment was found to have no significant ( $P > 0.05$ ) effect on meat color, tenderness, and cooking loss.

Figure 20.2 presents the lsmeans values for pH and temperature measured at 45 min, 6 h, 12 h, and 24 h. The initial carcass temperature for NP was higher than SF but declined rapidly at 6 h, 12 h, and 24 h. Therefore, the lsmeans values of temperature for NP at 6 h, 12 h, and 24 h were significantly lower than SF. The pH values between SF and NP were not significantly different.

**Table 20.1** Chemical composition of key forage species and feed ingredients constituting concentrate mixture

Sample	DM	Ash	CP	NDF	ADF	INVDMD	INVOMD
Key forage species							
<i>Bothriochloa isculpta</i>	93.33b	14.59d	2.32h	72.16c	43.23d	34.41f	29.86h
<i>Cenchrus ciliaris</i>	92.59c	6.25g	6.37f	67.21d	46.26c	51.74c	53.47d
<i>Cynodon dactylon</i>	92.89c	5.44h	4.77g	73.67b	49.58b	28.37i	31.24g
<i>Cyperus rotundus</i>	90.37d	17.79c	8.53e	67.21d	39.34e	42.85e	41.60f
<i>Hyparrhenia rufa</i>	93.36b	7.62f	1.90j	86.24a	53.86a	31.94h	34.08
<i>Indigofera indica</i>	90.41d	21.62a	12.08c	49.87f	37.61f	60.36a	56.21c
<i>Tribulus terrestris</i>	90.55d	20.29b	14.20b	45.19	33.19g	33.39g	31.71g
Wheat straw	93.38b	11.45e	5.64	67.87d	37.61f	50.47d	50.09e
Concentrate mixture							
Maize bran	92.53c	4.40h	10.89d	35.58g	4.88h	60.81a	66.87a
Sunflower seed cake	93.84a	5.77g	19.96a	60.89e	42.69d	57.68b	60.98b
SE	1.36	6.59	5.68	15.06	13.41	12.56	13.66
* Mineral pre-mix	—	—	—	—	—	—	—

\*Composition of mineral pre-mix: 29.94 % Calcium, 0.4 % Sodium, 11.0 % Phosphorus, 27.0 % Chloride, 27.0 % Nitrate, 3.0 % Magnesium, 0.5 % Iron, 0.5 % Manganese, 0.5 % Zinc, and 0.16 % Copper

**Table 20.2** Chemical composition, carcass linear measurements, and meat quality parameters of steers fed with different diet compositions

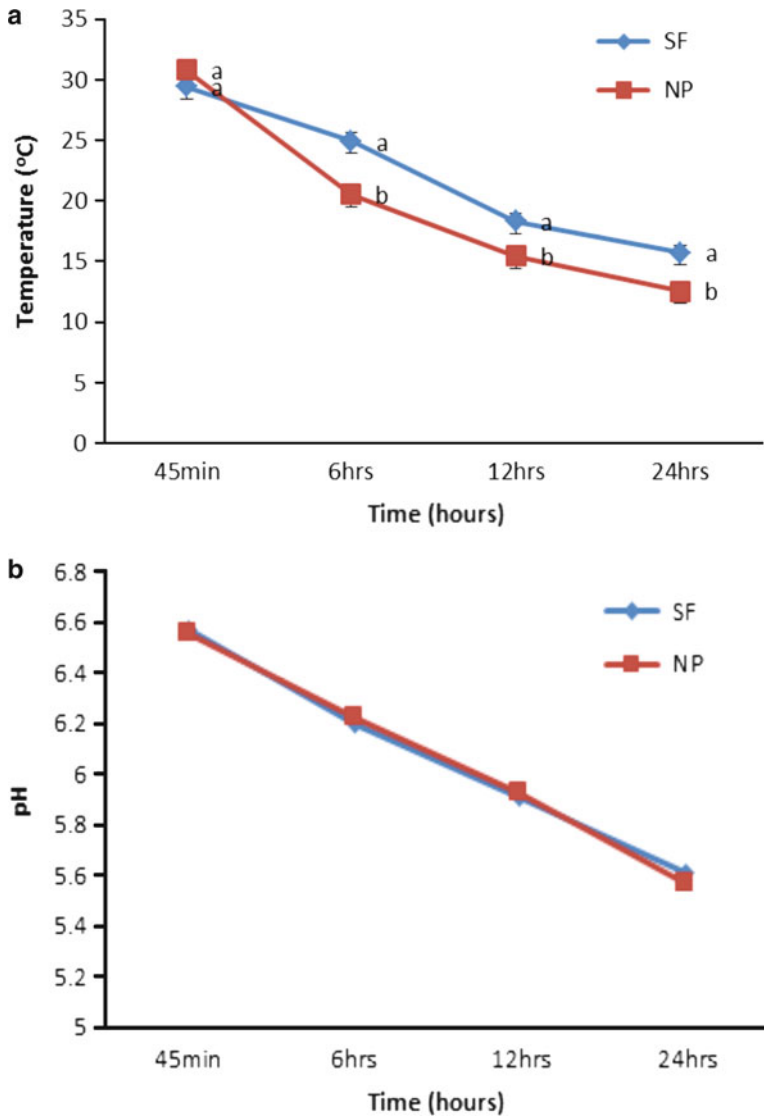
Variables	Treatments		
	Stall feeding (SF)	Natural pasture (NP)	Significance
Chemical analysis (%)			
Moisture content	73.62 ± 0.92	74.21 ± 1.14	0.70
Dry matter (DM)	26.37 ± 0.92	25.78 ± 1.14	0.70
Ash	17.86 ± 1.14	18.41 ± 1.41	0.77
Crude protein (CP)	22.43 ± 0.60	22.28 ± 0.73	0.87
Ether extract (EE)	1.64 ± 0.51	0.59 ± 0.42	0.13
Carcass linear measurement (cm)			
Carcass length (CL)	86.71 ± 1.09	84.60 ± 1.33	0.25
Chest depth (CD)	55.03 ± 2.06	53.80 ± 2.53	0.72
Hind leg length (HL)	88.18 ± 0.67	85.19 ± 0.82	0.01
Hind leg circumference (Circ.)	84.63 ± 0.97	79.63 ± 1.20	0.01
Meat quality parameters			
Color scores <sup>a</sup>	3.96 ± 0.47	3.24 ± 0.57	0.36
Marbling scores <sup>b</sup>	2.93 ± 0.17	2.10 ± 0.21	0.01
Tenderness (shear force N/cm <sup>2</sup> )	57.62 ± 4.54	60.49 ± 5.57	0.71
Cooking loss (%)	20.06 ± 1.68	21.14 ± 2.06	0.70

<sup>a</sup>Colour scores were based on the following scale: 1 = pale, 2 = light red, 3 = Red, 4 = light dark red, 5 = very dark red, 6 = light brown, 7 = brown, 8 = very brown, 9 = slightly bleached, 10 = bleached and 11 = highly bleached

<sup>b</sup>Marbling scores were based on the following scale: 1 = slight, 2 = small, 3 = modest, 4 = moderate, 5 = slightly abundant, 6 = moderately abundant

## 20.4 Discussion

The observed variation in weight gain between SF and NP is most likely a reflection of the impact of dietary treatments on growth performance. The reduced daily weight gain observed in the NP group might be associated with a decline in the quality of natural pasture in the dry season (Rubanza et al. 2003). Most of the key forage species collected from natural pasture were found to have low CP level, high cell wall contents (NDF and ADF), and reduced in vitro digestibility (INVDMD and INVOMD). Apart from chemical composition and digestibility of the pastures, the physical nature of the pasture probably contributed negatively to the feed intake for NP. McDonald et al. (2002) indicated that the physical structure and distribution of pasture are the main factors determining feed intake in grazing ruminants. Animals grazing in heterogeneous pastures spent substantial amount of time and energy in organizing the grazing process compared to feedlot animals. Therefore, reduced weight gain in animals grazed on natural pastures can also be explained by energy expenditure for muscular efforts such as walking. According to Lachica and Aguilera (2005), energy expenditure of grazing animals exceed those of confined animals.



**Fig. 20.2** (a) The post mortem temperature (°C) and (b) pH measured for carcasses from animals fed different diet

On the other hand, the increased daily weight gain in SF may be due to the supplement of high quality concentrate. The chemical composition of the ingredients constituting the concentrate mixture had relatively higher CP values and low NDF than the forage species from NP. Moreover, the digestibility of the concentrate mixture was relatively higher because of high concentration of rapid fermentable cell contents and low cell wall contents (NDF and ADF). Moreover, improved

weight gain in this group was probably due to the improved utilization of poor quality wheat straw following supplementation with concentrates. According to Khandaker et al. (1998), supplementing animals' diet with concentrate improves voluntary intake and digestibility of wheat straw. The degradation of feed in the rumen by microbes requires high concentration of N that increases digestibility and consequently voluntary intake of roughage (Rokomatu and Aregheore 2006). Morita et al. (1996) reported that the inclusion of concentrates in animals' feeds aids digestion of fiber in the rumen.

The relatively high values for dressing percentage observed in the feedlot animals compared to pasture grazed animals are in agreement with the findings of Moron-Fuenmayor and Clavero (1999). These variations might be associated with great fat deposition in the muscles of concentrate-fed animals. Cattle with higher fat deposition in the muscles usually produced higher dressing percentage (Van Koeveing et al. 1995). However, in this study, the values for dressing percentages of supplemented Zebu steers were relatively lower (42 %) than those of Nguni steers (53 %) (Mapiye et al. 2009), Angus steers (53.7 %), Bonsmara steers (56.9 %) (Muchenje et al. 2008), and crossbred steers (64–66 %) (Montgomery et al. 2009). These differences are most likely due to variation in breed types and the rearing husbandry systems, because the animals finished under this feeding trial were local breed grown on poor pastures.

Further, variation in carcass linear measurements implies a high growth rate in animals supplemented with concentrate diet than pasture grazed animals. These variations may have significant implication on meat quality traits, particularly meat tenderness. Rapidly growing animals tend to have tender meat due to increased protein turnover (French et al. 2001). However, the observed non-significant difference in meat tenderness between SF and NP was not correlated with their growth performance. These findings are in line with the report by Lowe et al. (2002) and Moloney et al. (2001) who found a poor correlation between pre-slaughter growth rate and meat tenderness. Therefore, meat tenderness may be influenced by other factors than growth performance. Gomes et al. (2012) found a positive correlation between meat tenderness of steers and their phenotypic traits rather than weight gain. According to Muchenje et al. (2009a), indigenous breeds—such as Nguni and Zebu—are considered to have tougher meat than exotic breeds. According to the authors, indigenous breeds have a high *calpastatin* activity that inhibits *calpains* activity, thereby leading to slower degradation of muscle postmortem. According to Gomes et al. (2012), the negative effect of tenderization in *B. indicus* is primarily associated with *calpain* system activity. Moreover, pre-slaughtering handling stresses can have a significant influence on the tenderization of meat. Devine et al. (2006) considered pre-slaughter stress due to transportation and handling as a major factor affecting meat tenderness. Stressed animals tend to release a high amount of catecholamines (Muchenje et al. 2009b) that influences depletion of glycogen and subsequently affects postmortem tenderization. In the present study, animals travelled 280 km for 20 h before slaughter. Therefore, to improve meat quality, several factors other than the manipulation of body weight should be considered, such as reducing pre-slaughter stress and adequate ageing of meat.

In line with increased carcass weight following concentrate supplementation, there was a significant increase in intra-muscular fat, as reflected by high lsmeans values for marbling scores in SF than NP. This concurred with Bruns et al.'s (2004) study, who found a positive correlation between increased carcass weight and intramuscular fat in finishing steers. Vestergaard et al. (2000) also found a markedly reduced intramuscular fat of the bulls raised on pasture than those finished on concentrate supplements. Increase in intramuscular fat is associated with increased tenderization of meat (Mushi et al. 2007). Muir et al. (1998) associated carcasses with high level of intramuscular fat with slow cooling that prolongs the postmortem proteolysis process which in turn increases meat tenderness. In the present study, a similar relationship was observed whereby concentrate-fed SF steers displayed slower postmortem temperature decline than NP. In addition to meat tenderness, marbling has also been associated with increased juiciness, flavor, and overall acceptability of meat by consumers (Muchenje et al. 2009a).

Meat color is an important factor affecting meat acceptability among consumers. Despite the variation in intramuscular fat between SF and NP animals, concentrate supplementation was found to have little effect on meat color. Although the higher amount of intramuscular fat was expected to increase the brightness of meat, there was only a weak relationship between marbling scores and meat color scores in this study. Lack of variation in meat color between pasture-fed and concentrate-fed animals contradict the findings reported by Baublits et al. (2004), which indicated the tendency of grass fed-animals to have darker meat than concentrate-fed animals. French et al. (2001) and Priolo et al. (2001) also found no significant difference in meat color between grass-fed animals and concentrate-fed ones.

## 20.5 Conclusion

The overall performance of feedlot animals was relatively better in terms of ADG, dressing percentage, and intramuscular fat deposition compared to pasture-fed animals. This has been associated with utilization of high energy-rich concentrates and improved utilization of wheat straw in feedlot animals following supplementation. On the contrary, the poor performance of pasture-fed animals is related to poor quality of forages, physical structure, distribution of forage resources, and energy expenditure for locomotion on the natural pasture. However, the concentrate feeding system in the present study had limited effects on meat tenderness. Therefore, other factors like pre-slaughter stress and postmortem carcass handling are likely to have overriding effects on meat tenderness compared to feeding.

**Acknowledgments** This research was financed by the Enhancing Pro-poor Innovation in Natural Resources and Agricultural Value Chains (EPINAV) program. Further, the authors are grateful to the management of the Haydom Farm and Development Ltd for their help in cattle handling within their farm.



## References

- Abebea G, Merkel RC, Animut G, Sahlu T, Goetsch AL (2004) Effects of ammoniation of wheat straw and supplementation with soybean meal or broiler litter on feed intake and digestion in yearling Spanish goat wethers. *Small Rumin Res* 51:37–46
- AOAC (2002) Official methods of analysis, 17th edn. Association of Official Analytical Chemists, Washington, DC
- Baublits RT, Brown AH Jr, Pohlman FW, Johnson ZB, Onks DO, Loveday HD, Morrow RE, Sandelin BA, Coblenz WK, Richards CJ et al (2004) Carcass and beef color characteristics of three biological types of cattle grazing cool-season forages supplemented with soyhulls. *Meat Sci* 68(2):297–303
- Boccard R, Buchter L, Casteels E, Cosentino E, Dransfield E, Hood DE, Joseph RL, MacDougall DB, Rhodes DN, Schön I et al (1981) Procedures for measuring meat quality characteristics in beef production experiments. Report of a working group in the commission of the European communities' (CEC) beef production research programme. *Livest Prod Sci* 8(5):385–397
- Bourguet C, Deiss V, Tannugi CC, Terlouw EMC (2011) Behavioural and physiological reactions of cattle in a commercial abattoir: relationships with organisational aspects of the abattoir and animal characteristics. *Meat Sci* 88(1):158–168
- Bruns KW, Pritchard RH, Boggs DL (2004) The relationships among body weight, body composition, and intramuscular fat content in steers. *J Anim Sci* 82:1315–1322
- Chaudhry AS (2000) Rumen degradation in sacco in sheep of wheat straw treated with calcium oxide, sodium hydroxide and sodium hydroxide plus hydrogen peroxide. *Anim Feed Sci Technol* 83(3–4):313–323
- Devine CE, Lowe TE, Wells RW, Edwards NJ, Edwards JEH, Starbuck TJ, Speck PA (2006) Pre-slaughter stress arising from on-farm handling and its interactions with electrical stimulation on tenderness of lambs. *Meat Sci* 73(2):304–312
- Forbes JM (2000) Physiological and metabolic aspects of feed intake. In: D'Mello JPF (ed) *Farm animal metabolism and nutrition*. CAB International, Wallingford, pp 317–319
- French P, O'Riordan EG, Monahan FJ, Caffrey PJ, Mooney MT, Troy DJ, Moloney AP (2001) The eating quality of meat of steers fed grass and/or concentrates. *Meat Sci* 57(4):379–386
- Gomes RC, Sainz RD, Silva SL, César MC, Bonin MN, Leme PR (2012) Feedlot performance, feed efficiency reranking, carcass traits, body composition, energy requirements, meat quality and calpain system activity in Nellore steers with low and high residual feed intake. *Livest Sci* 150(1–3):265–273
- Kanuya NL, Matiko MK, Nkya R, Bittegeko SBP, Mgasa MN, Reksen O, Ropstad E (2006) Seasonal changes in nutritional status and reproductive performance of Zebu cows kept under a traditional agro-pastoral system in Tanzania. *Trop Anim Health Prod* 38(6):511–519
- Khandaker ZH, Steingass H, Drochner W (1998) Supplementation of wheat straw with *Sesbania* on voluntary intake, digestibility and ruminal fermentation in sheep. *Small Rumin Res* 28(1):23–29
- Lachica M, Aguilera JF (2005) Energy expenditure of walk in grassland for small ruminants. *Small Rumin Res* 59:105–121
- Lane CR (1994) Pasture lost: alienation of Barabaig land in the context of land policy and legislation in Tanzania. *Nomad Peoples* 34(35):81–94
- Lowe TE, Peachey BM, Devine CE (2002) The effect of nutritional supplements on growth rate, stress responsiveness, muscle glycogen and meat tenderness in pastoral lambs. *Meat Sci* 62(4):391–397
- Mapiye C, Chimonyo M, Dzama K, Strydom PE, Muchenje V, Marufu MC (2009) Nutritional status, growth performance and carcass characteristics of Nguni steers supplemented with *Acacia* karroo leaf-meal. *Livest Sci* 126(1):206–214
- McDonald P, Edward RA, Greenhalgh JFD, Morgan CA (2002) *Animal nutrition*. Pearson Education, Harlow, p 693

- Moloney AP, Mooney MT, Kerry JP, Troy DJ (2001) Producing tender and flavoursome beef with enhanced nutritional characteristics. *Proc Nutr Soc* 60:221–229
- Montgomery JL, Krehbiel CR, Cranston JJ, Yates DA, Hutcheson JP, Nichols WT, Streeter MN, Bechtol DT, Johnson E, TerHune T et al (2009) Dietary zilpaterol hydrochloride. I. Feedlot performance and carcass traits of steers and heifers. *J Anim Sci* 87(4):1374–1383
- Morita S, Devir S, Ketelaar-De Lauwere CC, Smits AC, Hogeveen H, Metz JHM (1996) Effects of concentrate intake on subsequent roughage intake and eating behavior of cows in an automatic milking system. *J Dairy Sci* 79(9):1572–1580
- Moron-Fuenmayor OE, Clavero T (1999) The effect of feeding system on carcass characteristics, non-carcass components and retail cut percentages of lambs. *Small Rumin Res* 34(1):57–64
- Muchenje V, Dzama K, Chimonyo M, Raats JG, Strydom PE (2008) Meat quality of Nguni, Bonsmara and Aberdeen Angus steers raised on natural pasture in the Eastern Cape South Africa. *Meat Sci* 79(1):20–28
- Muchenje V, Dzama K, Chimonyo M, Strydom PE, Hugo A, Raats JG (2009a) Some biochemical aspects pertaining to beef eating quality and consumer health: a review. *Food Chem* 112(2):279–289
- Muchenje V, Dzama K, Chimonyo M, Strydom PE, Raats JG (2009b) Relationship between pre-slaughter stress responsiveness and beef quality in three cattle breeds. *Meat Sci* 81(4):653–657
- Muir PD, Deaker JM, Bown MD (1998) Effect of forage and grain based feeding system on beef quality: a review. *N Z J Agric Res* 41:623–635
- Mushi DE, Mtenga LA, Eika LO (2007) Some factors affecting the quality of meat from ruminants and their relevance to the Tanzanian meat industry-review. *Tanzan J Agric Sci* 8:173–192
- Mwilawa AJ, Komwihangilo DM, Kusekwa ML (2008) Conservation of forage resources for increasing livestock in traditional forage reserves in Tanzania. *Afr J Ecol* 46:85–89
- NBS (2012) National sample census of agriculture, small holder agriculture: livestock sector. National Bureau of Statistics, Dar es Salaam, 175 pp
- Nickerson D (1946) Colour measurement and its application to the grading of the agricultural products: a handbook on the methods of disk colorimetry. U.S. Department of Agriculture Misc. Publ. 580:62
- Priolo A, Micol D, Agabriel J (2001) Effects of grass feeding systems on ruminant meat colour and flavour. A review. *Anim Res* 50:185–200
- Rokomatu I, Aregheore EM (2006) Effects of supplementation on voluntary dry matter intake, growth and nutrient digestibility of the Fiji Fantastic sheep on a basal diet of Guinea grass (*Panicum maximum*). *Livest Sci* 100(2–3):132–141
- Rubanza CDK, Shem MN, Ostyina R, Ichinohe T, Fujihara T (2003) Nutritive evaluation of some browse tree legume foliages native to semi-arid areas in western Tanzania. *Asian Aust J Anim Sci* 16(10):1429–1437
- Safari, Mushi DE, Kifaro GC, Mtenga LA, Eik LO (2011) Seasonal variation in chemical composition of native forages, grazing behaviour and some blood metabolites of Small East African goats in a semi-arid area of Tanzania. *Anim Feed Sci Technol* 164(1–2):62–70
- SAS (2004) Statistical analysis software/stat. Users's guide. SAS Institute Inc., Cary
- Shiranita K, Hayashi K, Otsubo A, Tsuneharu M, Takiyama R (2000) Grading meat quality by image processing. *Pattern Recognit* 33(1):97–104
- Sieff DF (1997) Herding strategies of the Datoga pastoralists of Tanzania: is household labor a limiting factor. *Hum Ecol* 25:519–544
- Steinfeld H, Gerber P, Wassenaar T, Castel V, Rosales M, de Haan C (2006) Livestock long shadow: environmental issues and options. FAO, Rome
- Tilley MA, Terry RA (1963) A two-stage technique for the in vitro digestion of forage crops. *J Br Grassl Soc* 18:I04–I111
- Van Koevering MT, Gill DR, Owens FN, Dolezal HG, Strasia CA (1995) Effect of time on feed on performance of feedlot steers, carcass characteristics, and tenderness and composition of longissimus muscles. *J Anim Sci* 73:21–28

- Van Soest PJ, Robertson JB (1991) Methods for dietary fiber, neutral detergent fiber, and nonstarch polysaccharides in relation to animal nutrition. *J Dairy Sci* 55:1305–1307
- Vestergaard M, Therkildsen M, Henckel P, Jensen LR, Andersen HR, Sejrsen K (2000) Influence of feeding intensity, grazing and finishing feeding on meat and eating quality of young bulls and the relationship between muscle fibre characteristics, fibre fragmentation and meat tenderness. *Meat Sci* 54(2):187–195
- Viggo KPW (2008) Effect of straw treatment on dry matter intake and average daily gain in calves and the possibility to improve feed availability in dry season in Tanzania. Master's thesis, UMB. (<http://www.umb.no/library>). Accessed 10 Mar 2014

**Part VII**  
**Smallholder Adaptation**  
**to Climate Change**

# Chapter 21

## Enhancing Resilience of Food Production Systems Under Changing Climate and Soil Degradation in Semi-arid and Highlands of Tanzania

Nyambilila A. Amuri

**Abstract** Soil resources play a central role in food security as agriculture continues to depend on soil to feed the growing population. The objective of this paper is to review the status of food security, extent of soil degradation, and management options under changing climate to ensure food security in the semi-arid and highlands areas of Tanzania. Increased food production was realized over a 10-year period in the country, attributed to the increase in cultivated land at the rate of 0.38 million ha/year. Food productivity decreased at the rate of 0.04 t/ha/year despite higher average food production after (18.00 t) than before (13.75 t) introduction of fertilizer subsidy. Soil degradation due to soil loss of 9.2 Mg/ha/season accounted for 24 % yield reduction in semi-arid areas, and soil loss was 32–163 kg/ha/year in highlands. Poor residue and tillage practices contribute to low productivity even when inputs are used. Nutrient mining is widespread with 88 % of soils deficient in nitrogen, 71 % with low phosphorus, 29 % are low in potassium, and 67 % are deficient in Zn in semi-arid areas. In highlands, 92 % of soils are deficient in phosphorus while 24 % are deficient in zinc. Almost all soils in semi-arid and 58 % of soils from highlands had low soil organic carbon. Salinity increased in almost all irrigated areas in semi-arid regions without salinity management. Thus, climate smart agriculture to simultaneously conserve soil, harvest and conserve rainwater, and integrate nutrient management should be used to increase productivity and enhance agriculture resilience to changing climate.

**Keywords** Food security • Soil erosion • Nutrient management • Climate smart agriculture • Semi-arid • Highlands • Tanzania

---

N.A. Amuri (✉)

Department of Soil Science, Sokoine University of Agriculture, P.O. Box 3008, Morogoro, Tanzania

e-mail: [amurnyambilila@yahoo.com](mailto:amurnyambilila@yahoo.com); [nyambilila.amuri@gmail.com](mailto:nyambilila.amuri@gmail.com)

## 21.1 Introduction

Agriculture in Tanzania employs 77 % of the population and contributed 26.5 % to the GDP in 2007, a drop from 46 % in 2002 (United Republic of Tanzania (URT) 2009a). However, agriculture plays an indispensable role in food supply to meet human nutritional needs. Apart from economic and food security, agriculture is an important social and cultural activity that provides ecosystem services (Howden et al. 2007), especially in a country like Tanzania where the majority of people depend on agriculture. The major challenge in agriculture is to meet food requirements of a growing population, under changing climate, in a manner that does not degrade the environment. It is evident that as long as agriculture is the major food producing economic activity, and agriculture is soil-based, then sustainable food production can be achieved to a great extent through appropriate soil management (Gruhn et al. 2000).

Soil is an indispensable resource as far as agricultural food production is concerned. Soil is a multi-component and open system, exchanging energy and matter with the atmosphere, biosphere and hydrosphere (Sposito 2008). The multi-component soil resource consists of solid particles, water/moisture, gases, nutrients, and soil biology, which enable the soil to function properly. Thus for soil to be an efficient system and sustain provision of ecosystem services, the inputs and outputs to the system have to be conserved within a farm area scale. That is, for food production systems relying on soil resources to be sustainable, inputs and outputs to the soil resource have to be balanced. It is widely accepted that any disruption or imbalances of the soil components will lead to degradation that in turn negatively affects agricultural productivity in both the short and long run. Soil degradation is deterioration of the capability of soil to provide adequate crop and livestock productivity, and ecosystem services (Lal 2012). Soil degradation can be due to natural processes and/or human induced through poor soil management practices. The major causes of soil degradation are over exploitation of soil resources and poor management practices in crop and livestock production.

Apart from soil resource, agriculture largely depends on climate in terms of precipitation, temperature, and solar radiation, which determines the seasons and type of crops to be grown in a particular area. Climate is also an important factor in soil formation and determines the agro-ecological zones for crop and livestock production. Generally, Tanzania climate varies widely in terms of rainfall, temperature, landscape, and growing season due to proximity to ocean, inland lakes, altitude, and latitude (URT 2012). This wide difference in climate makes Tanzania agriculture capable of producing a wide range of crops, ranging from temperate to tropical crops. Variations in rainfall, temperature, and interaction with parent materials cause Tanzania to have diverse agroecological zones (AEZ). The most important AEZs in the country for food production are the semi-arid areas and highlands. Semi-arid areas, with annual rainfall <750 mm, occupy a large percent of Tanzania land (>50 %) (De Pauw 1984; DFID 2001). The Tanzania highlands are the most humid areas with annual rainfall of >800 mm and a long growing

season due to cooler temperatures caused by influence of relief. Thus, the highlands are highly dependable for food production in the country while semi-arid areas support a large population and are dependable for livestock keeping. Therefore, managing soil resources in these two AEZs is important for food production in Tanzania.

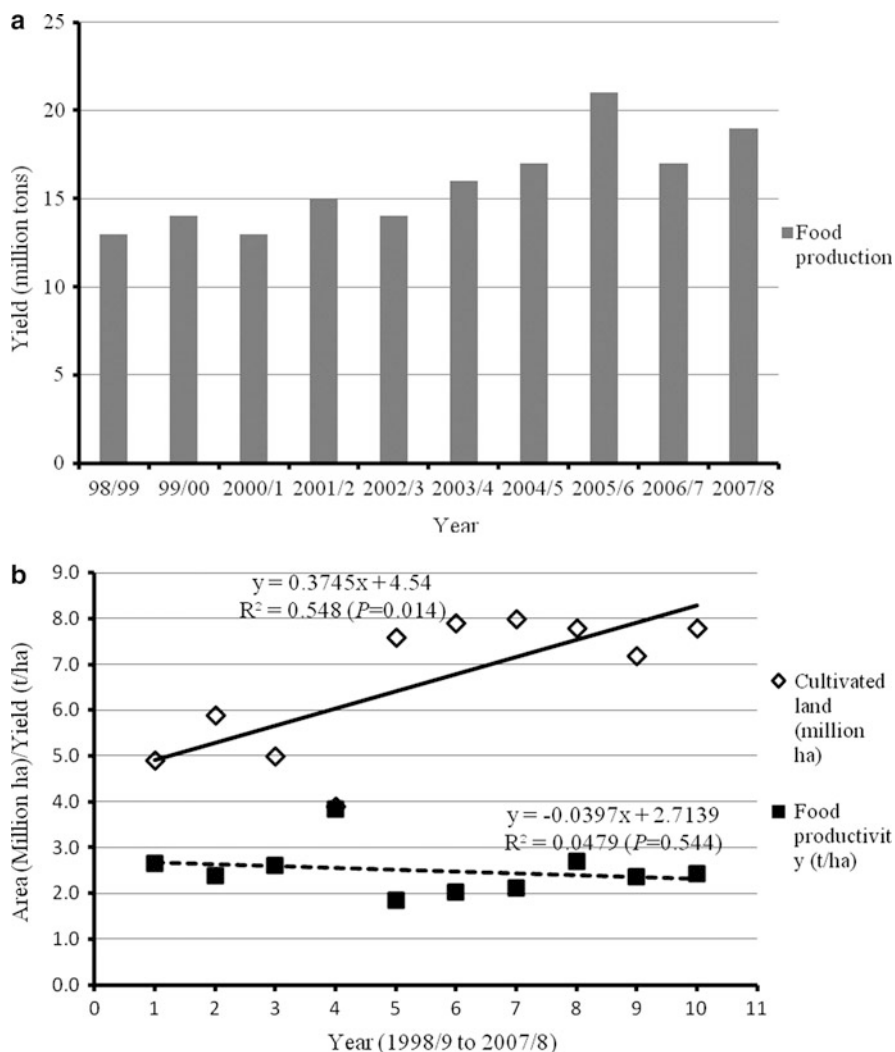
The dependence of agriculture on climate makes it highly vulnerable to the impacts of climate change and variability, and a risky enterprise (Howden et al. 2007; Parry and Carter 1989). Tanzania agriculture is no exception, as it has witnessed the impact of climate change due to rising temperatures, low and erratic rainfalls, and shortened growing seasons in many parts of the country (Mongi et al. 2010; Mwandosya et al. 1998; Paavola 2003; URT 2012). The future projections also predict an increase in temperature by 1.7 °C in North Eastern areas and by 2.5 °C in Western parts of Tanzania, with increased events of drought and floods (URT 2012). Tanzania agriculture, especially food crop and livestock, is mainly rain fed which makes it even more vulnerable to climate change. While managing climate is very limited, especially in field crop conditions, adapting to climate change is heavily relied upon for enhancing soil and crop productivity under changing climate. Thus, enhancing resilience of agriculture to changing climate is unavoidable.

Building resilient agriculture requires use of and generating knowledge to deal with unexpected events and stresses, and identifying sustainable ways to enhance agricultural productivity for food security in the face of climate change (Moberg and Simonsen 2011). Resilience of natural ecosystem is defined as the state of a natural system to withstand changes due to its ability to absorb a certain amount of disturbances (Gunderson 2000; Gallopín 2007). Resilience is further and recently referred to as the capacity of a system to recover, reorganize, and use shocks and disturbances to adapt and renew itself (Moberg and Simonsen 2014; Gallopín 2007). That is, enhancing the resilience of agriculture to climate change implies capacity to capitalize on opportunities and benefits of climate change. However, resilience recognizes the fact that dealing with stresses and disturbances has to be within the natural system's capacity. Thus, building resilience in agriculture should consider utilization of soil resources, management and prevention of soil degradation before it reaches an irreversible state, and enhancing agriculture capacity to withstand changing climate.

This paper presents an assessment of the current status of food security and agriculture, the extent of soil degradation, and management options to enhance resilience of agriculture under changing climate to ensure food security in the semi-arid and highlands areas of Tanzania.

## **21.2 State of Food Security and Sustainability in Tanzania**

Food security is attained when all people can access sufficient food to meet their dietary requirements and preferences by different means, be it physically, socially, and economically, at all times (FAO 2013; URT 2009a). The status



**Fig. 21.1** (a) Trend of food crop production (million tons), (b) food crop cultivated land (million ha) and food crop productivity in Tanzania (Source: Modified from URT 2009a)

of food security in the country, estimated as the ratio of food production to food requirement, showed a 6-years (2002–2008) average of 104 % (URT 2009a), and a 10-year increase in food production (Fig. 21.1a), which was viewed by the government as a success as far as food security is concerned (URT 2009a). During the same period, the area under cultivation showed a significant ( $P = 0.014$ ) increasing trend at the rate of 0.38 million ha/year, which is associated with the observed increase in food production (Fig. 21.1b).



Food production in the country is dominated by small scale farming, which has fed the growing population despite unfavorable and/or unreinforced policies to enable it to fight poverty. The expansion of cultivated land is not viewed as a problem by many policy makers, but as a potential to increase agriculture production (URT 2009a). This is because it is believed that Tanzania has ample land (44.5 million ha) which is not fully exploited for agriculture (URT 2009a). However, there is a warning that the unexploited land is not as ample as reported because most of the good land for agriculture is already under cultivation (SAGCOT 2013). This implies that the remaining uncultivated land may be marginal land or less suitable for agriculture. In addition, there is insufficient information to ascertain the suitability of Tanzania land for agriculture and other uses at the district, region, or country scale. Therefore, the current trend of agricultural land expansion to meet food requirement may not be sustainable.

One alarming trend in agricultural food crop production is the low productivity of major cereal crops of 2.0 t/ha for rice and 1.4 t/ha for maize, relative to a potential of 5 t/ha for common varieties for both crops (URT 2009b). The food crop productivity has not changed for the 10-year period from 1998 to 2008 and remained as low as averaging 2.5 t/ha (Fig. 21.1b), at 20–40 % of the potential yield. Furthermore, the food productivity trend, though not significant ( $P = 0.544$ ), showed a decreasing trend at the rate of 0.04 t/ha/year over the same 10-year period (Fig. 21.1b). A further analysis using cultivated land as covariate revealed a significant ( $P = 0.037$ ) higher food production (18.00 million tons), due to introduction of fertilizer subsidy from 2003/2004, than that from before subsidies (13.75 million tons) (data not shown). These results show the current trend in food production is not sustainable. Thus, more holistic approaches integrating appropriate use of agricultural inputs and climate information are needed to enhance productivity of agricultural land in Tanzania.

The livestock subsector is similarly reported to have low productivity, as it contributed only 2.5 % of the GDP in 2002 but uses about 68 % of total land in the country (Lugoe 2011). It is argued that pastoralist migrations have been a traditional strategy to avoid degradation by allowing the grazing land to regenerate and avoiding drought (Mung'ong'o and Mwamfupe 2003). However, such transhumance practice was possible and effective when there was large tracts of land and low population density. Reduced transhumance period and reliance on natural regeneration without appropriate land management have accelerated soil degradation in the grazing land (Lupindu 2007). The degradation of grazing land is now the major driver of current migrations (Niboye 2009). Furthermore, the extent of degradation of arable- and range-land that leads to migration of farming communities is yet to be quantified. It is evident that the current trend in agriculture (both crop and livestock production) will not be sustainable if appropriate soil management to increase productivity in agricultural land with potential is not addressed.

## **21.3 Extent of Soil Degradation and Implication to Agricultural Productivity**

### ***21.3.1 Soil Erosion***

Soil erosion is the number one soil degradation process in both semi-arid areas and highlands of Tanzania. The soils in semi-arid areas are susceptible to erosion because of little vegetation and plant residue cover due to low and short rains. Thus, in most of the time of the year the soils are bare, vulnerable to wind and water erosion. The farming system in semi-arid areas is dominated by extensive pastoralism and agro-pastoralism with low input and poor management (Schechambo et al. 1999). In most cases the size of the livestock head exceeds the carrying capacity of the land, making soil highly susceptible to erosion. In agro-pastoralism, the practice of grazing large numbers of animals in farm land and/or removal of crop residue (soil cover) causes compaction which reduces infiltration and increases runoff. Poor tillage practices in semi-arid areas contribute significantly to soil degradation by accelerating soil erosion, resulting in severe loss of fertile top soil. Christiansson (1981) estimated long term soil erosion rate in semi-arid areas of Dodoma to be 174–604 m<sup>3</sup>/km<sup>2</sup>/year. Bwana (2003) estimated that soil loss due to reduced tillage without crop residue cover is 9.2 Mg/ha in one season in area with slope of about 3.8 %, and is responsible for 24 % maize yield loss relative to conservation tillage.

In the highlands, soil erosion is exacerbated by land morphology consisting of landscape with steep slopes, and hence high rates of soil loss. The soil loss from agricultural land with slope >65 % in the Uluguru Mountains is reported to be 32–85 kg/ha/rainy season, which makes agriculture without soil and water conservation unsustainable in this area (Mulengera et al. 2009). Kimaro et al. (2008) reported soil loss ranging from 69 to 163 t/ha/year in steep slopes of 30–70 % in the Uluguru Mountains, of which rill erosion was responsible for greater soil loss than inter rill erosion. These steep slope lands are the major food producing areas, and in most cases farming is done without any soil conservation technologies. Soil erosion depletes both the top soil and nutrients, leaving the highlands susceptible for degradation due to both soil erosion and soil fertility depletion.

### ***21.3.2 Soil Erosion and Water Resource***

Water resources (natural and manmade) are important in agriculture and their management is closely linked to soil management and climate. However, depletion of water resources and its quality due to climate change is the major threat (IPCC 2007). Depletion of water reservoir due to soil degradation has been reported as early as over four decades ago. The lifespan of water reservoirs in Dodoma is threatened by soil erosion. It is reported that the lifespan of water reservoirs

constructed in 1970 is limited to 35–45 years (Christiansson 1981). Similarly, depletion of water sources in the highlands has been noted by farmers. A decrease in the volume of water flow in rivers and increased seasonality of river flow has been noted in Lushoto highlands, attributed to a decrease in the number and discharge of springs (Wickama et al. 2004), despite the presence of abundant water resources in the area (Meliyo et al. 2004). The decline in river flow, attributed to deforestation (Wickama et al. 2004) which increased soil erosion, reduces infiltration and recharge of aquifers. The low filling rate of water reservoirs in semi-arid areas has been reported to be due to low rainfall, resulting in water filling below the reservoir capacity in four out of 5 years in semi-arid areas of Dodoma (Christiansson 1981), and this is expected to be exacerbated under changing climate (Paavola 2003). The decrease in water resources in both semi-arid areas and the highlands comes at a time when the population has increased and coincides with the climate change threat in the country. The water scarcity has been reported to cause conflicts among water users in the Ruvu-Pangani River Basin, particularly among pastoralists, irrigation schemes, and hydroelectric power plants (Mbonile 2005).

### **21.3.3 Nutrient Mining**

Management practices that fail to ensure nutrient cycling for sustainable food production is the major cause of nutrient depletion in both areas. Depletion of plant nutrients in the soil is another soil degradation feature in semi-arid areas and the highlands of Tanzania. Semi-arid areas of Tanzania are formed by low nutrient parent materials (course grain granitic rocks). Agricultural soils under cultivation for a long time (10 to over 100 years) with no natural or management practices to replenish nutrients are usually low in N, P, and or K. A soil fertility survey in semi-arid areas farming maize and rice revealed that 88 % of soils had very low total nitrogen (N) (<0.2 % as per Landon 1991) with an average of 0.11 % (n = 24) (Table 21.1). Phosphorus, another important macronutrient, is also limited with 71 % of soils being low in available P (<15 mg/kg), while potassium (K) was low in 29 % of soils in the semi-arid areas. Solomon and Lehmann (2000) also reported a decrease in inorganic P (an available form of P) from 55 mg/kg in the native woodland to 18 mg/kg after 15 years of cultivation without replenishment in the semi-arid Masai plain, Northern Tanzania. Micronutrients are also becoming increasingly deficient in soils of semi-arid areas, which threatens the quality and mineral nutrition of humans. In the selected semi-arid soils under small scale farming, about 67 % of soils surveyed had low DTPA extractable Zn of less than 1.0 mg/kg (Table 21.1). It is generally believed that the yield limiting factor in semi-arid areas is moisture stress. However, these results show that low plant nutrients (macro and micronutrients) in soils contributes significantly to low productivity, even in irrigated fields. Thus, soil moisture conservation and fertility management have to be handled simultaneously to sustain productivity in semi-arid and other low rainfall areas.

**Table 21.1** Farm level fertility status of small scale farmers' fields in selected semi-arid areas under maize and rice production, Tanzania

District (source)	Village	Site	pH (H <sub>2</sub> O)	OC (%)	TN (%)	P (mg/kg)	K (cmol/kg)	Zn (mg/kg)
Same (Amur and Semu 2006)	Ndungu	Non-irrigated	6.33	1.20	0.11	23.90	1.31	1.37
		Irrigated	5.82	1.77	0.10	3.12	0.08	0.83
Uyui (Amuri et al. 2011)	Kigwa	Majengo	6.37	0.80	0.06	13.45	0.32	1.01
		Ng'ambo	5.66	0.65	0.05	5.96	0.19	0.19
		Kalofya	6.86	2.01	0.12	2.50	0.31	0.12
	Goweko	Mlimani shule	6.10	0.49	0.04	8.30	0.11	0.14
		Ufugajimi	5.81	0.65	0.13	1.21	0.13	0.09
		Ukonda	6.24	0.23	0.03	2.93	0.07	0.10
Gairo (Amuri et al. 2011)	Kwipipa	Mlimani	6.01	0.35	0.03	2.52	0.11	0.13
		Jumbadumwe	6.26	1.02	0.09	9.33	1.16	0.50
		Mkokani	8.11	2.08	0.15	4.00	2.26	0.23
		Kwipipa	6.49	0.57	0.07	4.74	0.71	0.28
		Melolo	5.64	0.88	0.12	2.93	0.81	0.31
		Chisiga	5.68	0.39	0.03	8.69	0.37	0.47
Kilosa (Amuri et al. 2011)	Mvumi	Mvumi A	6.65	2.99	0.21	32.68	0.41	2.81
		Mvumi B	6.47	3.25	0.22	50.42	0.92	2.64
		Mangumbuli	6.35	1.70	0.11	8.76	0.39	0.80
		Kibodiani	6.93	1.42	0.11	10.91	1.02	0.92
		Mandela A	6.54	1.76	0.13	52.00	1.12	1.34
		Mandela B	6.86	1.65	0.12	60.61	1.12	1.60
Morogoro (Semoka et al. 2011)	MkonoMara	6.40	0.82	0.11	23.90	1.31	1.37	
	Mikese	Station	6.50	2.42	0.20	30.50	2.32	2.17
	Gwata	Gwata	6.50	1.39	0.13	29.80	0.71	0.63
	Kiziwa	Kiziwa	6.10	1.09	0.22	4.70	0.41	1.65



**Table 21.2** Farm level fertility status of small scale farmers' fields in selected highland areas under maize and rice production, Tanzania

District (source)	Village	pH (H <sub>2</sub> O)	OC (%)	TN (%)	P (mg/kg)	K (cmol/kg)	Zn (mg/kg)
Njombe (Mligo 2013)	Ifominyi	5.2	5.60	0.44	1.06	11.20	nd
	Igagala	5.01	2.90	0.21	4.75	6.20	nd
Lushoto (Kinanda 2013)	Migambo	6.40	2.09	0.25	12.44	nd	5.19
(Kimaro and Amuri 2013)	Migambo2	6.11	4.19	nd	5.29	0.20	6.49
	Magamba	4.97	7.02	nd	3.74	0.10	0.40
Mbeya (Mhoro 2013)	Mkuyuni	5.09	4.38	0.15	6.62	1.14	1.41
	Mwanzazi	5.69	3.37	0.29	6.74	0.67	2.97
	Ifiga	5.51	2.45	0.18	8.54	1.24	4.17
	Makwenje	5.06	1.20	0.10	10.24	0.57	1.17
	Ndembela	5.94	1.50	0.16	4.33	1.69	0.98
Rungwe (Mhoro 2013)	Itula	5.55	4.93	0.37	7.60	0.99	0.36
	Ilima	5.19	1.01	0.09	0.90	0.28	0.38
Mbozi (Merumba 2004)	Sasanda	5.20	4.30	0.37	0.81	0.97	0.55
Critical levels (Landon 1991)		5.5–7.0	4.00	0.20	15.00	0.25	1.00
Mean		5.45	3.46	0.24	5.62	2.10	2.19
Maximum		6.40	7.02	0.44	12.44	11.20	6.49
Minimum		4.97	1.01	0.09	0.81	0.10	0.36
Standard deviation		0.46	1.82	0.12	3.59	3.29	2.18
Range		1.43	6.01	0.35	11.63	11.10	6.13
Coefficient of variation (%)		8.44	52.62	49.48	63.92	156.60	99.74
Number of observation (n)		13	13	11	13	12	11

OC organic carbon by Walkley-Black, TN total nitrogen by Kjeldahl digestion; extractable P by HCl-NH<sub>4</sub>F extraction (Bray 1) for soil pH <7 and NaHCO<sub>3</sub> extraction (Olsen) for soil pH >7, K exchangeable potassium by ammonium acetate, Zn extractable zinc by diethylenetriamine pentaacetic acid (DTPA)-CaCl<sub>2</sub> buffered at pH 7.3, nd not determined

Although highlands are rated fertile soils in Tanzania, soil fertility evaluation revealed low macro and some micronutrients (Table 21.2). Low nutrients in soils decreased productivity and justify reliance on expanded agricultural land to increase production. A study by Malley et al. (2009) revealed that soil fertility depletion coupled by low use of fertilizers is the major cause of low productivity. A soil fertility survey in the highlands (n = 12) showed that 92 % are deficient in available P, and 36 % cannot supply adequate Zn for plant growth (Table 21.2). The

lack of incentives for small scale farmers to invest in soil management practices to curb or prevent degradation, such as soil and water conservation and soil fertility management, is attributed to poor market and prices of agricultural products (Derksen-Schrock et al. 2011).

#### **21.3.4 Salinity**

Soil salinity is another chemical degradation that significantly reduced productivity of agricultural land in semi-arid areas and land under irrigation. It has been noted that the salt levels increase in the dry season or when the rains are too low to flush out salts from water reservoirs or fields in semi-arid areas of Dodoma (Kangalawe 2012; Isaka Hussein, personal communication, Nov 2013). Poor irrigation practices that apply too much water draw the water table close to the surface, bringing soluble salts with it. A study by Cronquist and Gustafsson (2002) shows low electrical conductivity (EC) in the top soil (0.2–0.55 dS/m) in both irrigated and unirrigated fields in Mgori dam, Singida, but higher exchangeable sodium percentage (ESP) of 10–34 % in irrigated fields than the 4–19 % ESP in the unirrigated fields. The changes in cation exchange due to irrigation shows a sodicity problem in the area. The increase in total salt of 1.47 kg/m<sup>2</sup>/year after consideration of salt inputs and outputs is also reported in Mgori dam (Cronquist and Gustafsson 2002). Lack of efficient drainage systems in irrigation schemes also contributes to salinity problems in Tanzania. In Northern Tanzania, about 65 % of 650 ha of Kileo and 360 ha of Kivulini irrigation schemes constructed by the Government of Tanzania in the 1970s and 2001, respectively, are affected by salinity (Kilimo Trust 2011). The salinity and sodicity problems in semi-arid areas pose a threat to sustainability of irrigation schemes in Tanzania, if salinity management is not taken into consideration.

#### **21.3.5 Loss of Soil Organic Matter**

Soil organic matter (SOM) plays a significant role in sustaining productivity of agricultural soils as a reservoir of nutrients, improving soil structure, enhancing water retention, and sorption and desorption of nutrients. Loss of soil organic matter due to continuous cultivation is common and is still a challenge in modern agricultural systems (Brye et al. 2004; Denison et al. 2004). Loss of SOM results not only in physical degradation, but also reduced responses of inorganic nutrient resources to crops (Johnston 2011), thereby reducing nutrient use efficiency (NUE). The increased NUE in soils with high SOM is attributed to good soil structure, which enables roots to grow rapidly and extensively, and absorb more nutrients (Johnston 2011). Cultivation and poor residue management result in rapid decomposition of organic materials and SOM, and release of C to the atmosphere in the form of CO<sub>2</sub> (Franzluebbers et al. 1998). The rate of loss of SOM in the soil is determined by temperature, moisture/precipitation, and the amount of organic materials input.

Most soils in semi-arid areas of Tanzania have low SOC of less than 4 % (Table 21.1), while in the highlands 58 % of soils studied have low SOC (Table 21.2). Warm temperatures and low precipitations (amount and duration of rainfall) result in an overall lower SOC in semi-arid soils than in humid areas of Tanzania. However, the low SOM in many soils of Tanzania is exacerbated by removal of crop residues for various uses, burning of crop residues, and low biomass produced under low nutrient soils.

## 21.4 Soil Management Options for Building Agriculture Resilience

The available knowledge in soil management can be organized and utilized in such a way that agricultural productivity can withstand the impact of climate change and prevent or reverse degradation. The adverse effects of climate change to agriculture include rising temperature, increased evapo-transpiration, frequent drought, and rainfall variability, (Mwandosya et al. 1998; NAPA 2007). Thus, agricultural resilience requires multiple and holistic approaches to enhance productivity and reverse soil degradation through measures detailed below:

### 21.4.1 Tillage Practices and Soil Moisture Conservation

Tillage is the mechanical manipulation of soil to obtain a good soil tilth that allows good root penetration, increase infiltration, nutrient cycling, and reduction of weeds. Excessive tillage is when the soil is manipulated by cultivating followed by harrowing several times to form a very fine seedbed. The limitation of excessive tillage includes soil structure disruption and rapid loss of SOM, which makes water infiltration a short term benefit and rapid loss of soil moisture under excessive tillage. Mechanization of agriculture using heavy machinery and turning the soil (burying top soil and exposing subsoil) leads to soil compaction and reduced fertility, respectively. Soil degradation problems, due to excessive tillage by mechanization, need further investigation and generation of tillage options that will sustain agricultural soil productivity in small holder agriculture. Tillage practices that provide adequate root and water penetration and efficient use of nutrients while preserving soil structure and SOM are preferred.

Generally, reduced tillage (ripping, small basins, *Chololo/Zai pits*) in combination with residue retention have great potential for small scale farmers in Tanzania. Tied-ridges tillage will provide more benefits in semi-arid areas with <5 % slopes as it acts as both an in situ water catchment (increasing infiltration), and to reduce run offs and hence soil erosion (Bwana 2003). Mkoga et al. (2010) demonstrated that a combination of surface residues and reduced tillage by ox-ripping reduced the



length of agricultural dry spell from 28 to 5 days, relative to ox-plough without surface residue cover in semi-arid areas of Mbeya, Tanzania. Enfors et al. (2011) questioned the ability of conservation tillage to harvest enough water to stabilize productivity in semi-arid soils of Same, Northern Tanzania, despite 17 % cumulative and a 41 % maximum yield increase under conservation tillage. Unreliability of conservation tillage to stabilize crop productivity is due to low nutrient content and reliance of manure as a source of nutrient, which could not supply enough P for higher grain yield even when rainfall was adequate.

### ***21.4.2 Carbon Sequestration***

Soils have the ability to store C and contribute to reduced greenhouse gases (GHG) and, more importantly, providing benefits of SOM in agricultural productivity. Soil organic matter mediates sorption and desorption of nutrients, and contributes to balanced ionic conditions in the soil solution for nutrient absorption by plant roots. Soil organic matter also increases soil aggregation and improves soil structure, and hence water infiltration and moisture retention. Increasing soil organic matter in agricultural systems is not an easy task due to the dynamics of organic matter. Most of the organic matter (OM) added in the soil is lost through aerobic soil microbial respiration. However, it is this process of OM decomposition that produces residue SOM that is essential in sustaining soil productivity. Therefore, deliberate efforts to increase SOM in agricultural fields should be employed through management practices that increase OM inputs, slow the decomposition rate, and reduce physical SOM losses if resilience of agricultural soils to changing climate is to be attained. Appropriate tillage in combination with crop residue addition or use of organic amendments suitable for a given farming system and soil conditions are available. Such practices as reduced tillage, no tillage, and tillage with residue incorporation can be used to increase SOM. Enfors et al. (2011) demonstrated that SOM can be increased under both ripping and hand hoe tillage with cover crops and manure application to about 17.8 and 17.1 kg/m<sup>2</sup>, respectively, compared to 15.9 kg/m<sup>2</sup> without organic inputs in semi-arid conditions of Same, Northern Tanzania. It is obvious that climate change will bring about more incidences of drought. Thus, increased SOM will help to minimize water stress to crops by increasing soil moisture holding capacity and infiltration.

### ***21.4.3 Soil Fertility and Plant Nutrient Management***

Soil fertility and nutrient management under variable climate is still a challenge in Tanzania. In the history of agricultural intensification and green revolution, soil fertility management and nutrient management were the major source of food surplus and defeat of hunger in Asia (Lal 2008). Tradeoffs of historical green

revolution, such as nutrient enrichment in water bodies in some areas due to over-application of both organic and inorganic fertilizers, erosion, and leaching, have been observed (Conway and Pretty 1991; Bumb and Baanante 1996). Other challenges include soil chemical degradation (acidity, salinity, SOM depletion, nutrient imbalances) and increased incidences of pests and diseases under continuous monocropping. In attempts to rescue agriculture from the green revolution tradeoffs, there have been movements to de-emphasize the benefits of green revolution stressing on reduced or no use of inorganic nutrient resources, stress of nutrient recycling using organic amendments, and legumes. However, sole dependence on these organic resources to sustain productivity is limited due to the lack of enough and quality organic amendments (Enfors et al. 2011; van Lauwe and Gillar 2006), and inherently low P in soils (Semoka and Kalumuna 2000) that limit N fixation by legumes. Therefore, timely supply of all essential plant nutrients is important for improved crop productivity and fighting hunger, malnutrition, and poverty in developing countries. To ensure the uptake of plant nutrients by plant roots, balanced concentration of the essential plant nutrients needs to be taken into account. To avoid nutrient mining and changes of chemical properties, use of various soil amendments (such as agricultural lime, elemental S, and organic amendments) in addition to fertilizers should be employed where necessary. Accurate and reliable soil testing services are critical to enable well-informed soil fertility management programs in small scale farming systems.

It is widely established that plants respond to stress and global changes in different ways including changes in absorption, partitioning, and accumulation of nutrients (Sardans and Penuelas 2012). Thus, understanding changes in plant physiology and elemental composition under changing climate is required in attempts to improve agricultural productivity through plant nutrient management. Studies reported that increase in CO<sub>2</sub> concentration in the atmosphere tends to increase photosynthesis, increase C:N and C:P ratios, and hence decrease N and P concentration in plant tissues (Sardans et al. 2012). However, the increased photosynthesis is expected to increase uptake of mineral nutrients from soil, which largely depends on the availability of these nutrients. In low fertile soils, the capacity of plants to increase growth due to increased photosynthesis is limited by reduction in root growth, hence reduced capacity to absorb nutrients (Johnson et al. 2006). Thus, more studies are needed to determine the changes in plant nutrients and their management under changing climate to enhance nutrient use efficiency and increase productivity.

#### **21.4.4 Irrigation**

One way of making agriculture cope with increased temperature and drought under climate change is irrigation. For irrigation to reduce the impact of climate change, it has to be used in a sustainable way. Availability of quality water with EC <0.7 dS/m, SAR <10, and Cl<sup>-</sup> <60 mg/kg (Landon 1991) is essential for

irrigation to be a sustainable coping strategy in a changing climate. The moderately suitable irrigation water, with range of EC 0.7–3 dS/m, SAR of 10–18, and  $\text{Cl}^-$  of 60–100 mg/kg, can also be used provided adequate drainage and leaching to remove salts, along with regular monitoring of EC and salinity management, is conducted. Levy and Sylvertsen (2004) warned that irrigation water with 200 mg  $\text{Cl}^-/\text{l}$  is enough to damage the soil to non-productive over a year, if 500 mm of water is applied per year. It has been observed that salt water is increasing in most ground water sources, which is a potential water source for irrigation and recharge of rivers in Tanzania. For moderately suitable water to be used, a reduced amount of water to irrigate is necessary. Monitoring of salinity should be an integral part of irrigation schemes. Also, considering water scarcity, the efficient use of irrigation is important to utilize low amounts of water, reduced evapo-transpiration and/or conserve soil moisture in the root zone to increase water productivity.

Flooded rice is the most irrigated crop in Tanzania, which requires an adjustment to increase water productivity. Lowland flooded rice is considered an adaptation strategy to soil degradation due to erosion (Obalum et al. 2012). However, to make lowland flooded rice resilient to climate change, irrigation and or flooding have to be controlled to ensure provision of water for other uses, the ecosystem, and minimizing greenhouse gases emissions. Khosa et al. (2011) showed that reducing the amount of irrigation water to a limit of 15 kpa resulted in up to 60 % reduction of  $\text{CH}_4$  emissions compared to continuous flooding, without decreasing rice yield in India. Mid-season drainage in rice fields in China has also been reported to have potential to decrease  $\text{CH}_4$  emissions by 34–62 % (Li et al. 2002). It can be seen that poor irrigation practices not only cause soil degradation but also increase GHG emissions. Therefore, efficient irrigation practices using good quality and low amount of water will prevent degradation and reduce GHG emissions and further enhance resilience of agriculture.

### ***21.4.5 Grazing Land Management and Livestock Keeping***

Grazing land management has the potential to contribute to food security and agricultural productivity via increased livestock yield and reduced land degradation. The feed quantity and quality from grazing land and established pasture is determined by weather and soil fertility. Adaptation of grazing land to climate change and prevention of soil degradation can be achieved through controlled grazing by stocking rate management, rotational grazing, and improved fallowing of grazing land (Branca et al. 2011; Howden et al. 2007; Smith et al. 2010). These grazing land management strategies will allow rejuvenation of grasses, ensure surface cover, and reduce erosion while increasing fodder productivity. Nutrient cycling to replenish soil nutrients to sustain the productivity of grazing land, by use of farm yard manure (FYM) is recommended. This is because FYM is readily available resource in livestock production system. Soil erosion control using cut off

drains and stone lines should be applied in semi-arid grazing land and pastures to reduce runoff and control soil erosion (Mati 2007).

Integration of livestock and crop farming through supply of organic nutrient sources (manure) for crop production is encouraged. Proper manure handling to reduce nutrient losses and excessive emissions of N-gases is required. Practices such as composting, storage of manure in shaded and none leaching sites, and utilization of manure for biogas and produced slurry are some of the proper manure handling practices. Improving pasture will indirectly help to improve agricultural land by reducing the demand for crop residue removal to feed livestock.

#### ***21.4.6 Climate Smart Agriculture***

Climate smart agriculture uses practices that enhance adaptation, increase the resilience of farming systems to climate impacts, and mitigate climate change (FAO 2010). Achieving CSA requires site specific interventions and requires knowledge and capacity investment (FAO 2013). Starting with soil as a central point to build resilience and sustain food production has great potential to successfully achieve CSA. Therefore, the right choice of crop varieties, grasses for pasture and range land, and tree species for agro-forestry that are more adaptive to drought, heat, and seasons under changing climate, are required along with soil management towards achieving CSA. In addition, crop diversification through crop rotation, intercropping, and crop cover should be logically considered. Integrated pest management for crops and livestock and use of resilient crop and livestock varieties is necessary to complement efforts in soil management for climate resilient agriculture. Therefore, a combination of soil, crop, livestock, and water resources management which are more adaptive to local agriculture system will enhance resilience and productivity of agriculture to ensure food security.

### **21.5 Transforming Small Scale Farming**

Making agriculture resilient using the available agricultural technologies necessitates transformation of small scale farming from extensive low input systems to intensive efficient input systems through adoption of available technologies. Lal (2008) emphasized that small-scale farmers in Africa will have to adopt improved soil management practices to meet the demand for food, fodder, and fuel from growing populations under changing climate. It is believed that low trust and use of scientific knowledge among African farmers to solve local problems in agriculture has hindered the realization of an African green revolution (Ejeta 2010), calling for locally developed relevant technology. However, it was also noted that there is scant data on the relationship between soils and crop productivity in Africa (Obalum et al. 2012) and management practices. Inadequate site-specific data may have

limited development of relevant technologies, their precision, and wide applicability to small scale farmers' environment. Kimaro et al. (2008) argued that efforts to control soil erosion in East African highland is hampered by a lack of adequate data and link between soil erosion processes and control measures. Lal (2008) explicitly stated that the problem of stagnation of SSA agriculture can be solved through the collective effort of scientists, farmers, policy-makers, and the public at large, to enhance, restore, and manage soil and water resources using site-specific relevant technologies. This further supports the need for increased commitment on soil-based research on soil erosion processes, nutrient management and fertilizer use efficiency, and soil and water conservation. These researches should be multi-disciplinary if reliable and sustainable soil-based technologies relevant to the current farming system dominated by small holder farmers are to be generated and adopted.

## 21.6 Conclusions

It is evident that although food production is increasing, the current trend of food production is not sustainable due to low and decreasing productivity. Soil degradation and the climate change impact are the major setbacks to increased agricultural productivity and agricultural sustainability. To enhance resilience of agriculture to changing climate there is a need to use the available technology holistically to simultaneously address multiple soil related productivity limiting factors i.e. moisture stress, low nutrient levels, depleted SOM, and low nutrient use efficiency. Thus, a change in agricultural practices, extension, research, and policy towards focusing on improving productivity and preventing or reversing degradation to enhance resilience of agriculture in a changing climate is highly needed in Tanzania.

## References

- Amur N, Semu E (2006) Fertility of rice-growing soils of Eastern Same district, Kilimanjaro region, Tanzania. I. Soil fertility status. *UNISWA J Agric* 14:52–61
- Amuri N, Massawe F, Ernest N, Moyo S (2011) The linkages between innovations and indigenous knowledge in soil fertility management. CDE-ESAPP project extension flier
- Branca G, McCarthy N, Lippe L, Jolejole MC (2011) Climate smart agriculture: a synthesis of empirical evidence of food security and mitigation benefits from improved cropland management. Mitigation of climate change in agriculture series 3, Food and Agriculture Organization of the United Nations (FAO), Rome, Dec, pp 1–36
- Brye KR, Gbur EE, Miller DM (2004) Relationship among soil C and physiochemical properties of a Typic Albaqualf as affected by years under cultivation. *Commun Soil Sci Plant Anal* 35:177–192
- Bumb B, Baanante C (1996) The role of fertilizer in sustaining food security and protecting the environment to 2020. 2020 Vision Discussion Paper 17. IFPRI, Washington, DC

- Bwana TN (2003) Assessment of in situ rainwater harvesting techniques for improving smallholder maize production in semi arid areas of Morogoro. M.Sc. dissertation, Sokoine University of Agriculture
- Christiansson C (1981) Soil erosion and sedimentation in semi-arid Tanzania. Studies of environmental change and ecological imbalance, Scandinavia Institute of African Studies, Uppsala; Department of Physical Geography, University of Stockholm, Uppsala, 208 p
- Conway GR, Pretty JN (1991) Unwelcome harvest: agriculture and pollution. Earthscan, London
- Cronquist I, Gustafsson M (2002) Salinization due to irrigation at Mgori dam Tanzania. M.Sc. degree thesis. Royal Institute of Technology (KTH), Stockholm, Sweden, 108 p
- De Pauw E (1984) Consultant's final report on the soils, physiography and agroecological zones of Tanzania. Ministry of Agriculture and Livestock Development, Dar es Salaam; FAO, Rome, 154 p
- Denison RF, Bryant DC, Kearney TE (2004) Crop yields over the first nine years of LTRAS, a long-term comparison of field crop systems in a Mediterranean climate. *Field Crop Res* 86:267–277
- Derksen-Schrock K, Anderson CL, Gugerty MK (2011) Tanzania: agricultural sector overview. EPAR Brief No. 133. Prepared for the Farmer Focus Advisory Group of the Bill & Melinda Gates Foundation. Evans School Policy Analysis and Research (EPAR) University of Washington
- DFID (The Department for International Development) (2001) Strategy for research on renewable natural resources, technical report for the DFID's Natural Resources Systems Programme – semi arid systems, UK Department for International Development (DFID)
- Ejeta G (2010) African green revolution needn't be a mirage. *Science* 327:831–832
- Enfors E, Barron J, Makurira H, Rockström J, Tumbo S (2011) Yield and soil system changes from conservation tillage in dryland farming: a case study from North Eastern Tanzania. *Agric Water Manag* 98:1687–1695
- FAO (Food and Agriculture Organization of the United Nations) (2010) Climate smart agriculture. Managing ecosystems for sustainable livelihood. [www.fao.org/docrep/015/an177e/an177e00.pdf](http://www.fao.org/docrep/015/an177e/an177e00.pdf). Accessed Dec 2013
- FAO (Food and Agriculture Organization of the United Nations) (2013) Climate smart agriculture sourcebook. Available at: [www.fao.org/docrep/018/i3325e/i3325e.pdf](http://www.fao.org/docrep/018/i3325e/i3325e.pdf). Accessed Dec 2013
- Franzluebbers AJ, Horns FM, Zuberer DA (1998) In situ and potential CO<sub>2</sub> evolution from a Fluventic Ustochrept in southcentral Texas as affected by tillage and cropping intensity. *Soil Tillage Res* 47:303–308
- Gallopín G (2007) Linkages between vulnerability, resilience, vulnerability, resilience, and adaptive capacity and adaptive capacity. A paper presented at workshop “formal approach to vulnerability”, Potsdam Institute for Climate Impact Research, Potsdam, 13–14 Sept 2007
- Gruhn P, Goletti F, Yudelman M (2000) Integrated nutrient management, soil fertility, and sustainable agriculture: current issues and future challenges. Food, Agriculture, and the Environment Discussion Paper 32. International Food Policy Research Institute, Washington, DC
- Gunderson LH (2000) Ecological resilience—in theory and application. *Annu Rev Ecol Syst* 31:425–439
- Howden SM, Soussana J-F, Tubiello FN, Chhetri N, Dunlop M, Meinke H (2007) Adapting agriculture to climate change. *PNAS* 104:19691–19696
- IPCC (2007) Climate change 2007: impacts, adaptation and vulnerability. Contribution of Working Group II to the fourth assessment report of the Intergovernmental Panel on Climate Change. Parry ML, Canziani OF, Palutikof JP, van der Linden PJ, Hanson CE (eds), Cambridge University Press, Cambridge, 976pp
- Johnson MG, Rygielwicz PT, Tingey DT, Phillips DL (2006) Elevated CO<sub>2</sub> and elevated temperature have no effect on Douglas-fir fine-root dynamics in nitrogen-poor soil. *New Phytol* 170:345–356
- Johnston J (2011) The essential role of soil organic matter in crop production and the efficient use of nitrogen and phosphorus. Soil organic matter part 2. *Better Crop* 95:9–11

- Kangalawe RYM (2012) Food security and health in the southern highlands of Tanzania: a multidisciplinary approach to evaluate the impact of climate change and other stress factors. *Afr J Environ Sci Technol* 6:50–66
- Khosa MK, Sidhu SD, Benbi DK (2011) Methane emission from rice fields in relation to management of irrigation water. *J Environ Biol* 32:169–172
- Kilimo Trust (2011) Increasing crop production on arid land. Reclaiming soils in Northern Tanzania. In: Making markets work to reduce poverty. Six years of Kilimo Trust in East Africa 2005–2006, Kilimo Trust, Kampala, Uganda, pp 68–69
- Kimaro DN, Amuri N (2013) Upscaling integrated soil fertility management for improved livelihood. A technical report. Association for Strengthening Agricultural Research in Eastern and Central Africa (ASARECA), Entebbe, Uganda
- Kimaro DN, Poesen J, Msanya BM, Deckers JA (2008) Magnitude of soil erosion on the northern slope of the Uluguru Mountains, Tanzania: interrill and rill erosion. *Catena* 75:38–44
- Kinanda R (2013) Chemical properties and sustainability of soils productivity in vegetable growing areas of Lushoto district. A special project, Department of Soil Science, Sokoine University of Agriculture
- Lal R (2008) Soils and food sufficiency. A review. *Agron Sustain Dev*. doi:10.1051/agro:2008044, INRA, EDP Sciences
- Lal R (2012) Climate change and soil degradation mitigation by sustainable management of soils and other natural resources. *Agric Res* 1:199–212
- Landon JL (1991) Booker tropical soil manual. A handbook for soil survey and agricultural land evaluation in the tropics and subtropics. Longman Group FE limited, New York, 185 pp
- Levy Y, Syvertsen J (2004) Irrigation water quality and salinity effects in citrus trees. *Hortic Rev* 30:37–82
- Li C, Qiu J, Frolking S, Xiao X, Salas W, Moore B III, Boles S, Huang Y, Sass R (2002) Reduced methane emissions from largescale changes in water management of China's rice paddies during 1980–2000. *Geophys Res Lett* 29(20):1–4
- Lugoe F (2011) Aligning and harmonizing the livestock and land policies of Tanzania. ESRF Discussion Paper No. 35. The Economic and Social Research Foundation (ESRF), Dar Es Salaam, Tanzania, pp 1–37
- Lupindu AM (2007) Pastoralists in Mbeya District of Tanzania and their perception of the national livestock policy. M.Sc. thesis, Wageningen University, Wageningen, 40 p
- Malley ZJU, Taeb M, Matsumoto T (2009) Agricultural productivity and environmental insecurity in the Usangu plain, Tanzania: policy implications for sustainability of agriculture. *Environ Dev Sustain* 11:175–195
- Mati B (2007) 100 ways to manage water for smallholder agriculture in Eastern Africa. SWIMNet Working Paper 13. A compendium of technologies and practices. IMEWASA, Nairobi, 52 p
- Mbonile MJ (2005) Migration and intensification of water conflicts in the Pangani Basin, Tanzania. *Habitat Int* 29:41–67
- Meliyo JL, Mansoor H, Masuki KFG, Mowo JG, Shemdoe R (2004) Socio and Biophysical profile of the Baga watershed. AHI – Lushoto, Lushoto
- Merumba MS (2004) Effect of phosphate rock placement methods and incorporation of organic residues on P availability and maize yield in two soils with P fixing capacities. M.Sc. dissertation, Sokoine University of Agriculture, Morogoro
- Mhoro L (2013) Levels of micronutrients in soils and crops from Mbeya, Tanzania, as reflection of nutritive value of crops. M.Sc. dissertation, Sokoine University of Agriculture, Morogoro
- Mkoga ZJ, Tumbo SD, Kihupi N, Semoka J (2010) Extrapolating effects of conservation tillage on yield, soil moisture, and dry spell mitigation using simulation modeling. *Phys Chem Earth* 35:686–689

- Mligo E (2013) Soil Fertility status evaluation for phosphate fertilizer sources recommendation in acid soils (Ferralsols and Andisols) of Njombe plateaus, Njombe District. A special project. Department of Soil Science, Sokoine University of Agriculture, Morogoro
- Moberg F, Simonsen SH (2011) What is resilience? An introduction to social-ecological research. Stockholm Resilience Centre, Stockholm
- Moberg F, Simonsen HS (2014) What is resilience? An introduction to social-ecological research. Stockholm Resilience Center (SCR), University of Stockholm, Stockholm
- Mongi H, Majule AE, Lyimo JG (2010) Vulnerability and adaptation of rain fed agriculture. *Afr J Environ Sci Technol* 4:371–381
- Mulengera MK, Lulandala LLL, Maliondo SMS (2009) Soil erosion and sediment yield from the degraded Mzinga river catchment in Uluguru Mountains, Tanzania. *Tanzan J For Nat Conserv* 79:47–57
- Mung'ong'o C, Mwamfupe D (2003) Poverty and changing livelihoods of migrant Maasai pastoralists in Morogoro and Kilosa district, Tanzania. Research report no. 03.5. Research on Poverty Alleviation (REPOA). Mkuki Nyota Publishers, Dar Es Salaam, 41 p
- Mwandosya MJ, Nyenzi BS, Luhanga ML (1998) The assessment of vulnerability and adaptation to climate change impacts in Tanzania. Centre for Energy, Environment, Science and Technology (CEEST), Dar es Salaam
- NAPA (2007) National adaptation program of action. United Republic of Tanzania, Vice President's Office. Division of Environment, Dar Es Salaam, Tanzania
- Niboye EP (2009) Impacts of changing pastoral strategies on environmental resources and livelihoods in Tanzania's Lake Victoria Basin. OSSREA Publications, Addis Ababa, Ethiopia
- Obalum SE, Buri MM, Nwite JC, Hermansah, Watanabe Y, Igwe CA, Wakatsuki T (2012) Soil degradation-induced decline in productivity of Sub-Saharan African soils: the prospects of looking downwards the lowlands with the Sawah ecotechnology. *Appl Environ Soil Sci* 2012:1–10
- Paavola J (2003) Vulnerability to climate change in Tanzania: sources, substance and solutions. Paper presented at the inaugural workshop of Southern Africa Vulnerability Initiative (SAVI). Maputo, Mozambique, 19–21 June
- Parry ML, Carter TR (1989) An assessment of the effects of climatic change on agriculture. *Clim Chang* 15:95–116
- SAGCOT, Southern Agricultural Growth Corridor of Tanzania (2013) Appendix III: land development. [http://www.sagcot.com/uploads/media/Appendix\\_III\\_Land\\_Development\\_04.pdf](http://www.sagcot.com/uploads/media/Appendix_III_Land_Development_04.pdf) Accessed Dec 2013
- Sardans J, Penuelas J (2012) The role of plants in the effects of global change on nutrient availability and stoichiometry in the plant-soil system. *Plant Physiol* 160:1741–1761
- Sardans J, Rivas-Ubach A, Peñuelas J (2012) The C:N:P stoichiometry of organisms and ecosystems in a changing world: a review and perspectives. *Perspect Plant Ecol Evol Syst* 14:33–47
- Semoka JMR, Kalumuna M (2000) Potential and constraints of using rock phosphate for crop production in Tanzania. Soil fertility initiative: background papers. Ministry of Agriculture and Cooperatives, Dar es Salaam; FAO, Rome
- Semoka JMR, Ikerra ST, Amuri N, Msuya-Bengesi C, Kullaya I (2011) Scaling up Minjingu phosphate utilization for balanced fertilization of crops in Tanzania. A technical report presented at Soil Health Conference of Alliance for Green Revolution in Africa (AGRA), Nairobi, Kenya
- Smith R, Panciera M, Probst A (2010) Using a grazing stick for pasture management. A collaborative publication of Berea College and the University of Kentucky Cooperative Extension Service, University of Kentucky College of Agriculture, Lexington, KY, 40546 AGR-191
- Solomon D, Lehmann J (2000) Loss of phosphorus from soil in semi-arid northern Tanzania as a result of cropping: evidence from sequential extraction and <sup>31</sup>P-NMR spectroscopy. *Eur J Soil Sci* 51:699–708



- Sosoveli, Schechambo, Kisanga D (1999) Rethinking natural resource degradation in semi-arid Sub-Saharan Africa: the case of semi-arid Tanzania. ODI, University of Dar Es Salaam, Tanzania, 58 p
- Sposito G (2008) The chemistry of soils, 2<sup>nd</sup> edn. Oxford University Press, New York, 329 p
- URT (United Republic of Tanzania) (2009a) Agriculture Sector review and public expenditure review 2008/09. Ministry of Agriculture Food Security and Cooperatives, Dar Es Salaam Tanzania, Nov 2008
- URT (United Republic of Tanzania) (2009b) Investment potential and opportunities in agriculture (Crop Sub-Sector). Ministry of Agriculture Food Security and Cooperatives, Dar Es Salaam Tanzania
- URT (United Republic of Tanzania) (2012). National climate change strategy. The Vice President Office, Division of Environment, Dar Es Salaam Tanzania, 91 p
- van Lauwe B, Gillar KE (2006) Popular myths around soil fertility management in Sub-Saharan Africa. *Agric Ecosyst Environ* 116:34–46
- Wickama J, Mathias S, Kiluvia V (2004) Community perception on resource degradation: the case of trees and water sources in Baga Watershed Lushoto District, 34 p

## Chapter 22

# A Risk-Based Strategy for Climate Change Adaptation in Dryland Systems Based on an Understanding of Potential Production, Soil Resistance and Resilience, and Social Stability

Jeffrey E. Herrick and Adam Beh

*Attention must be given to ensuring high productivity from stable soils, restoring and sustaining the productivity of resilient soils, and conserving fragile and marginal soils.*

(Greenland et al. 1994)

**Abstract** Climate change is expected to increase the intensity and temporal variability of storm events in many areas while reducing their frequency, resulting in increased runoff, and drought frequency and severity. Soil degradation can exacerbate these impacts by reducing both infiltration and plant-available water holding capacity. Therefore, an understanding of soil resistance and resilience to degradation is necessary to target climate change adaptation investments where they will have the largest impact. This paper (1) reviews key concepts necessary to understand the dynamic relationships between climate change adaptation, soil resistance and resilience, and social stability, and (2) provides a strategy for maximizing return on climate change adaptation investments in drylands based on an understanding of soil and ecosystem resilience. The strategy includes seven steps, which are completed for each landscape unit in the context of the surrounding landscape: (1) Determine current potential productivity based on soils, topography, and existing climate conditions. (2) Determine future potential productivity based on soil, topography, and climate change scenarios. (3) Rank landscape units based on predicted change in potential productivity. (4) Determine risk of land use change. (5) Determine degradation risk with and without land use change. (6) Rank each landscape unit based on

---

J.E. Herrick (✉)

ARS Jornada Experimental Range, USDA, Las Cruces, NM 88003, USA

e-mail: [jherrick@nmsu.edu](mailto:jherrick@nmsu.edu)

A. Beh

ARS Jornada Experimental Range, New Mexico State University,

Las Cruces, NM 88003, USA

e-mail: [abeh@nmsu.edu](mailto:abeh@nmsu.edu)

degradation risk with and without land use change. (7) Determine priorities for climate change and soil conservation investments. The strategy described here can be applied on multiple scales to address a wide variety of objectives. We conclude by suggesting that climate change adaptation resources allocation decisions include consideration of soil resistance and resilience.

**Keywords** Soil degradation • Social stability • Soil resistance and resilience • Discount rates • Livelihood security • Livestock migration • Conflict and soil degradation

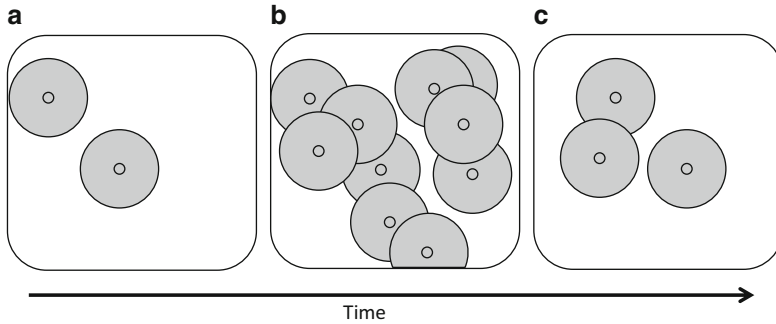
## 22.1 Introduction

Global population and per-capita food consumption are expected to continue to increase through at least 2050, with caloric intake increasing to over 3,100 kcal per day (Kearney 2010). Climate change is expected to negatively affect food security in many regions while soil degradation has already dramatically reduced food production and other ecosystem services (Lal 2001). Soil erosion is estimated to result in a US\$ 640 million annual loss to society, exceeding losses due to deforestation, over-fishing, and overuse of water resources (UNEP 2012). Research efforts dedicated to land degradation, however, lag significantly behind those allocated to climate change: the phrase “climate change” was used in more than 80,000 articles published in 2012, while only ~10,000 publications referred to “land degradation” or “soil degradation” (Herrick et al. 2013a). Research on soils and climate change has focused on mitigation, although improvement in soil quality is often cited as a co-benefit of carbon sequestration (Lal 2004) rather than adaptation. In this chapter, we argue that an understanding of soil resistance and resilience to degradation is necessary to target climate change adaptation investments where they will have the largest impact.

### 22.1.1 *Climate Change and Soil Degradation*

Soil degradation can exacerbate climate change impacts on food production. Climate change is expected to increase the intensity and temporal variability of storm events in many areas while reducing their frequency. Increased storm intensity further increases runoff from already degraded soils. Increased temporal variability increases the probability of extended periods with little or no precipitation, which increases the soil water storage requirements necessary to sustain plant production. At a minimum, this reduces plant production. In drylands, it can increase the frequency of crop failure. Crop failure risk is further increased by the cumulative effects of reduced water infiltration and storage in the rooting zone, together with increased evapotranspiration demand associated with higher temperatures.

In livestock production systems, which are the dominant production systems in global drylands, the impacts of soil degradation are more complex. Increased runoff



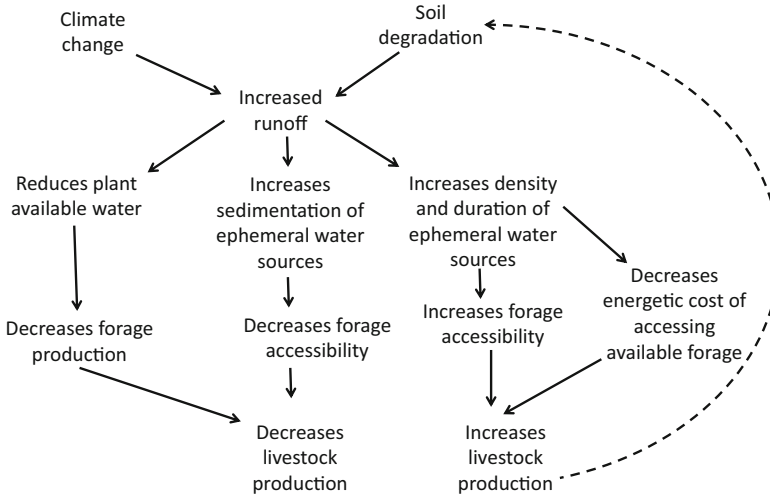
**Fig. 22.1** Soil degradation increases runoff, increasing the density of ephemeral water sources (a–b), but it also increases sedimentation, reducing storage capacity (b–c)

reduces forage production, but can increase the amount of forage that can be harvested by livestock by reducing distance to water. In many semi-arid rangelands, livestock depend on ephemeral water sources. The ability of grazing animals to exploit forage resources declines with increasing distance from water (Valentine 1947). Forage utilization by cattle can be predicted by distance from water (Ariapour et al. 2013), and is generally quite low at distances more than 3.2 km (Holechek et al. 2001). Depressions that naturally collect runoff increase the accessible area by decreasing distance to water. This also reduces the energy required to move between forage and water. Ranchers and pastoralists often construct small earthen dams to increase the density of ephemeral water sources. Increased runoff can increase the amount of water captured in both natural depressions and constructed structures (Fig. 22.1). However, because runoff increases erosion, it can also increase sedimentation, reducing the storage capacity of these structures. These complex interactions between soil degradation, climate change, forage production, and forage accessibility (Fig. 22.2) have received relatively little attention from the scientific community, despite obvious impacts on pastoralist livelihoods.

Soil nutrient limitations caused by soil degradation can also exacerbate climate change–induced plant water stress by limiting plant root growth, resulting in reductions in root length density. Reductions in root length density become more important during drought because unsaturated hydraulic conductivity declines. This means that even if there are plant-available nutrients in the soil, they become less accessible to the plant during periods of high evaporative demand. This creates a positive feedback loop with negative implications for biomass production.

### 22.1.2 Soil Degradation and Social Stability

Dryland systems cover close to 41 % of the global land surface, and are home to close to 2.5 billion people (Millennium Ecosystem Assessment 2005). The majority of these people living in dryland systems obtain their livelihoods from the animals



**Fig. 22.2** Complex interactions and feedbacks between climate change and soil degradation

they keep and the subsequent products these animals produce. Consequently, increasing soil degradation and other negative biophysical changes due to climate change in dryland regions is as much a humanitarian concern as an ecological one. Just as soil, water, and other biotic systems are at risk of climate change–driven degradation, so too are social systems. Past studies have documented functional and structural changes in social-ecological systems in response to climate change (Cowie et al. 2011; Reynolds et al. 2007). As climate change decreases soil resistance and resilience, negative feedbacks from related changes in social systems may lead to even more soil degradation, in turn leading to increased pressures on social systems. Soil resilience and human feedback mechanisms have been empirically linked across varied landscapes in Asia (Kiernan 2010; Muscolino 2011), Europe (Prazan and Dumbrovsky 2010), South America (Alscher 2011), and Africa (Oba et al. 2010; Gray 2011). Of primary concern are soil degradation impacts and feedback loops leading to, and driven by, changes in livelihoods, security, human migration patterns, and their ultimate contribution to an increase in violent conflict (see Table 22.1).

### 22.1.3 *Climate Change and Soil Resistance and Resilience*

By definition, soils that are resistant or resilient are less susceptible to long-term degradation than those that are not. Therefore, an understanding of how soil and ecosystem resilience varies at multiple spatial scales can help land managers and

**Table 22.1** Soil degradation and social stability linkages in Sub-Saharan Africa

Soil degradation—social stability linkage	Description of feedback loop
Livelihoods security	High population growth and fertility rates, coupled with poor soil quality and stagnant crop yields, result in continued reduction of carbon stock, increase erosion and sedimentation, and result in further degradation of natural resource base
	Farmers and pastoralists absorb financial loss due to crop failure, leading to an overall decrease in the rural economy
	Decrease in crop production leads to an overall decrease in household nutrition levels
	Decreased household income leads to an increased reliance on foreign food aid
	Increased dependency deteriorates existing social safety nets and contributes to reduced community resilience
Human and livestock migration	Soil degradation forces pastoralists to seek alternative pasture for livestock
	Pastoralists and farmers move in greater numbers (out-migration) to areas with better soil conditions (often in areas of marginal quality), escalating pressure on the capacity of the soil to absorb the impacts of increased grazing and farming
	As land tenure regimes trend toward private/group ownership from group ownership, access to these pastures is limited
Violent conflict	Pastoralists are forced to graze livestock on increasingly marginal lands with other tribal groups, increasing the chance of violent cattle raids
	Continued out-migration increases opportunity for violent conflict in other regions
	Compromised livelihoods, out-migration, and changing grazing patterns can weaken traditional governance mechanisms that historically have provided stability and diplomacy during times of conflict
	Continued violent conflict leads to increased soil degradation through the detritus of warfare

policymakers to design, spatially target, and prioritize investments in climate change adaptation. Maximizing food security returns on investment requires developing management strategies that sustainably maintain or increase agricultural production. Reducing the risk of long-term soil degradation must, therefore, be a key component of climate change adaptation. The objectives of this paper are to (1) review key concepts necessary to understand the dynamic relationships between climate change adaptation, soil resistance and resilience, and social stability, and (2) provide a strategy for maximizing return on climate change adaptation investments in drylands based on an understanding of soil and ecosystem resilience.

## 22.2 Definitions and Concepts

### 22.2.1 *Resilience*

The term “resilience” is not well-defined (Blum and Santelises 1994). Although it has been over 15 years since Lal (1997) highlighted the need to quantify soil resilience, there are still no standard methods for doing so. Nevertheless, it is a useful concept that is increasingly applied to guide policy and management. More and more, ecologists use it to refer to two distinct ecosystem properties: resistance to positive or negative change resulting from a disturbance, and potential recovery following disturbance (Scheffer et al. 2009). For example, many degraded lands are quite resilient to both further degradation and recovery. This definition of resilience focuses on the stability of the system. It ignores both the direction of change and whether stability is due to high resistance, or a tendency to recover, or return to the initial state, following a disturbance. Under this definition, both a paved asphalt surface or a concrete surface, and a field that has been cultivated for 50 years, would be resilient to tillage. The paved surface is highly resistant to perturbation by a tillage implement, while the structure of the historically cultivated soil will return to its previous state within a year.

Soil scientists generally argue that it is important to retain the distinction between resistance and resilience (Lal 1997; Seybold et al. 1999). This is similar to how the terms are used by engineers and physicists. The distinction is maintained for two reasons. First, soils may be resistant and resilient to one type of disturbance, while being only resistant, or resilient, to another. For example, relatively flat, deep soils, with uniform loamy fine sand texture throughout the profile, tend to be both resistant and resilient to water erosion. They are resistant due to both low slope and high infiltration capacity. They are resilient because the loss of several centimeters from the soil surface has little impact on relatively static soil properties; however, the loss may have a significant impact on dynamic properties such as soil organic matter content and nutrient availability. These same soils typically have low resistance to wind erosion due to their texture.

The second reason for maintaining the distinction between resistance and resilience is that the management and economic implications of resistance and resilience are quite different. The long-term costs of unsustainable land management practices are much higher in a system that is resistant but not resilient to degradation than in one that is resilient but not resistant. Ironically, however, agronomists have traditionally focused on degradation resistance rather than resilience. For example, a field that is losing 5 tons of soil per year is perceived to warrant more attention than one that is losing 10 tons, even if the 5 tons/year field is much more resilient than the 10 tons/year field. Economically, the net present value of conservation practices on the 5 tons/year field would likely exceed those on the 10 tons/year field.

A distinction is made between resistance and resilience in the following section. “Resilience” is defined as the rate and extent of recovery. Except where noted, we use the terms to refer to resistance and resilience to degradation.

## ***22.2.2 Climate Change Adaptation and Resilience***

Most climate change adaptation strategies are being designed to minimize or eliminate the negative impacts of climate change at the local level by changing the cultivar, crop, or management practice. Adaptation may also seek to compensate for production losses by exploiting positive impacts of climate change in areas of increased rainfall or longer growing seasons. Climate change adaptation strategies often include a resilience element. However, they are generally limited to considering the resilience of the system to changes in precipitation or temperature. They do not consider how these changes may be affected by current or potential future degradation resistance and resilience of the land itself.

### ***22.2.3 Degradation Risk, Discount Rates, and Net Present Value of Investments in Climate Change Adaptation***

Returns on investments in climate change adaptation are measured relative to a baseline of “no action.” This baseline is generally defined as decreasing, stable, or increasing production solely as a function of climate change. However, all changes in management practices also have the potential to result in a change in degradation risk. An increase in degradation risk reduces the anticipated return on investment by increasing the discount rate. This is because investors must “discount” the net present value of a climate change investment based on the risk that the investment may be negated by soil degradation. A similar logic applies to climate mitigation and carbon markets have often discounted the value of carbon sequestered in soil. Discounting is based on uncertainty about its persistence (Stavins 1999; Marland et al. 2001). Increasing soil resilience can increase the net present value of climate change adaptation investments by reducing degradation risks.

### ***22.2.4 Types of Risks***

Adaptation investments must consider risks directly associated with a change in climate, such as increased drought frequency or intensity. However, they must also consider the following: (a) future degradation risk based on projected climate change for current land use, (b) risk of land use change, and (c) degradation risk based on future resistance and resilience resulting from new land use.<sup>1</sup>

---

<sup>1</sup>This paper provides a strategy for increasing returns on climate change investments by considering the potential impact of each of these risks on sustainability.



### **22.2.5 Livelihood Security**

Overall birth and fertility rates continue to surge upwards while cereal production in Sub-Saharan Africa continues to stagnate due to land degradation, limited access to inputs, and declining capacities of natural resource governance structures. The World Research Institute reported that fertility rates in Sub-Saharan Africa are over five times the global replacement-level fertility rate (Searchinger et al. 2013). These rates put pressure on an already compromised land base to produce food and forages beyond its current capacity. Soil degradation reduces soil carbon stocks via runoff and erosion, decreased surface vegetation (spatially specific), and increased sedimentation. This reduction in soil carbon, and its resulting impact on soil quality, has obvious implications for crop yield. Demonstrated empirical links between soil degradation and direct pastoralist livelihood relationships are limited. However, existing studies reveal clear negative impacts on human nutrition (Searchinger et al. 2013) and household incomes (Scherr 2000), and an increased reliance on foreign food aid (Mafongoya et al. 2006; Millennium Ecosystem Assessment 2005), as a result of declining crop yields and livestock forage production. Moreover, these impacts and the dynamic feedbacks among them often weaken existing social safety nets that have been developed over time. These safety nets previously provided resistance to social change and human resilience to environmental shocks (Alinovi et al. 2007). Thus, climate-induced soil degradation can also intensify other dynamic feedback loops involving human and livestock migration patterns.

### **22.2.6 Human and Livestock Migration**

Soil degradation, when coupled with livestock production, forage accessibility, and plant-water availability impacts, can also force dryland pastoralists to search farther for available forage. Often, they must cross private and publicly held lands to do so. As a result, direct competition for resources in these land areas can lead to increased competition, which in turn results in violent conflicts. Some empirical debate exists about the direction of the relationship between natural resource degradation and violent conflict (Bergholt and Lujala 2012). Links have been established between soil degradation and increased human migration (Gray 2011), which can increase the occurrence of violent conflicts in specific areas (Mkutu 2001). As land tenure systems in global drylands continue to convert communal ownership to individual or select group ownership (Peters and Peters 2012), pastoralists are challenged to secure access to these lands prior to introducing their livestock to available pasture. In some cases, pastoralists may choose not to secure this access to private lands. Rather, they opt to move their livestock to safer, but often more marginal, pasture as a way to avoid violent conflict. These areas often include soil types with low degradation resistance, and the move may lead to irreversible damage.

Current estimates from the International Organization for Migration are that between 25 million and 1 billion people will be displaced by 2050 due to climate change and soil degradation (Laczko and Aghazarm 2009). As suggested above, the migration of pastoralists can also increase degradation in the areas where they settle. Importantly, a share of this migration occurs because many rural pastoralists must increase their incomes regardless of the reduced soil quality and environmental change this causes (Gray 2011). Nevertheless, as soil degradation intensifies in global drylands, there are increasing incentives for pastoralists to consider long-term migration as an effective strategy for adaptation. As noted above, while migration to fertile land may seem an effective adaptation to localized soil degradation, this practice often aggravates or initiates violent responses from the citizens of the host environment. This is especially true in areas dominated by the resource-dependent and often politically marginalized rural poor (Alscher 2011; Nie 2003).

### ***22.2.7 Violent Conflict***

Global crises reflected by violent conflict, human suffering, and civil war have often been described as being “wicked by design” (Nie 2003). Violent conflict is driven by a suite of biophysical and socioeconomic components (Fig. 22.3). The existence of conflict increases resource dependence and migration, thus resulting in more degradation. Contrary to popular development and conflict mitigation theories of the 1990s, Brunnschweiler and Bulte (2008, 2009) illustrate that there is no “resource curse” that condemns resource-rich nations to a legacy of internal conflict. Instead, it appears that the opposite is a more accurate picture, as revealed by their empirical test of the relationship between increased resource abundance and subsequent reduction of the likelihood of civil war. Thus, soil degradation can be defined as an obstacle to peace in dryland communities, and soil conservation may be heralded as a valid conflict mitigation strategy.

Soil degradation results in increases in food insecurity and changes in human and livestock migration patterns. These socio-political responses in turn weaken the structures of traditional governance among pastoralist communities and effectively reduce their capacity to manage future conflict. This weakness can be seen clearly in the Maasai land and culture struggles in the Laikipia plateau of north-central Kenya (Mkutu 2011). The changing and extended movements of people and their livestock were traditionally established through cooperation with neighboring communities. As the traditional governance structures among those communities deteriorate, conflicts that arise can go unchecked and unregulated, further weakening the governance structures responsible for managing peace (Berger 2003). Ultimately, the consequences of violent conflict and war further contribute to continued soil degradation and reduced environmental quality.

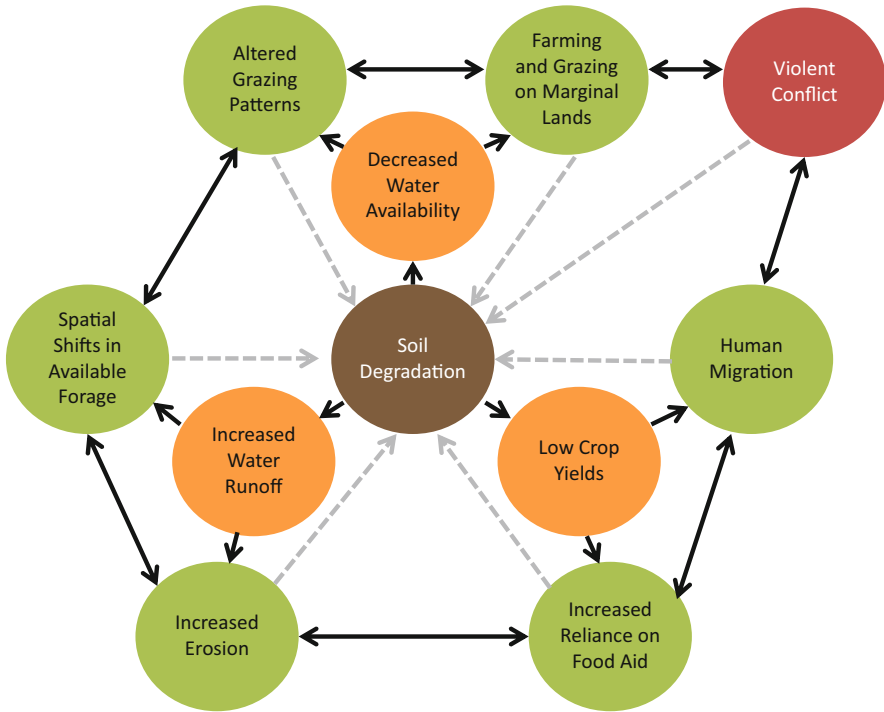


Fig. 22.3 Soil degradation and social stability feedbacks leading to potential violent conflict

### 22.3 A Strategy for Maximizing Return on Climate Change Adaptation Investments in Drylands Based on an Understanding of Soil and Ecosystem Resilience

This strategy includes seven steps, which are completed for each landscape unit in the context of the surrounding landscape:

1. Determine current potential productivity based on soils, topography, and existing climate conditions.
2. Determine future potential productivity based on soil, topography, and climate change scenarios.
3. Rank landscape units based on predicted change in potential productivity.
4. Determine risk of land use change.
5. Determine degradation risk with and without land use change.
6. Rank each landscape unit based on degradation risk with and without land use change.
7. Determine priorities for climate change and soil conservation investments.

Data needed to complete a quantitative analysis for this strategy are rarely available. However, qualitative analyses can be very useful for predicting the relative return on investment in climate change adaptation and soil conservation for different parts of a landscape, region, or nation. The subsections below describe each of the steps, followed by a case study of northern Namibia.

### ***22.3.1 Step 1. Determine Current Potential Productivity***

General predictions for a region can be obtained using the online Food and Agriculture Organization's Global Agro-ecological Zoning Tool (GAEZ) (FAO 2013). This tool is based on the land evaluation framework first published in 1976 and updated in 1996 (FAO 1996). It allows users to predict production for a wide variety of crops under low, medium, and high scenarios. It uses relatively coarse-scale soil, climate, and topographic layers. Consequently, while it is appropriate for general predictions for an area, it cannot be used at the field scale except in areas with exceptionally homogeneous soils and topography, such as lake plains.

A field-scale tool currently under development will allow users to predict potential production levels based on simple inputs to a mobile phone (Herrick et al. 2013b). This tool will initially use similar models to those used by the FAO GAEZ tool, but based on soil texture, color, and depth information provided by the user for the specific location of interest. Future versions will integrate local knowledge and production information gathered from the users themselves. It is being designed to complement the GAEZ tool, which down-scales global information by up-scaling local information and linking it with the global information provided by the GAEZ tool.

### ***22.3.2 Step 2. Determine Future Potential Productivity Based on Soils, Topography, and Climate Change Scenarios***

The GAEZ tool allows users to predict future production using down-scaled, pre-loaded climate change predictions generated under a variety of climate change scenarios. These climate change predictions can also be used to run field-scale models.

### ***22.3.3 Step 3. Rank Landscape Units Based on Predicted Change in Potential Productivity***

Where available, absolute values of potential productivity changes should be used.

#### ***22.3.4 Step 4. Determine Risk of Land Use Change***

The risk of land use change should be assessed for the individual landscape unit in the context of landscape to regional scale trends. It should take into account social and economic factors. In areas where the agricultural frontier is expanding onto increasingly less productive and resilient lands, it should consider the probability that an economic threshold will be reached prior to a degradation threshold (Fig. 22.4).

#### ***22.3.5 Step 5. Determine Degradation Risk with and Without Land Use Change***

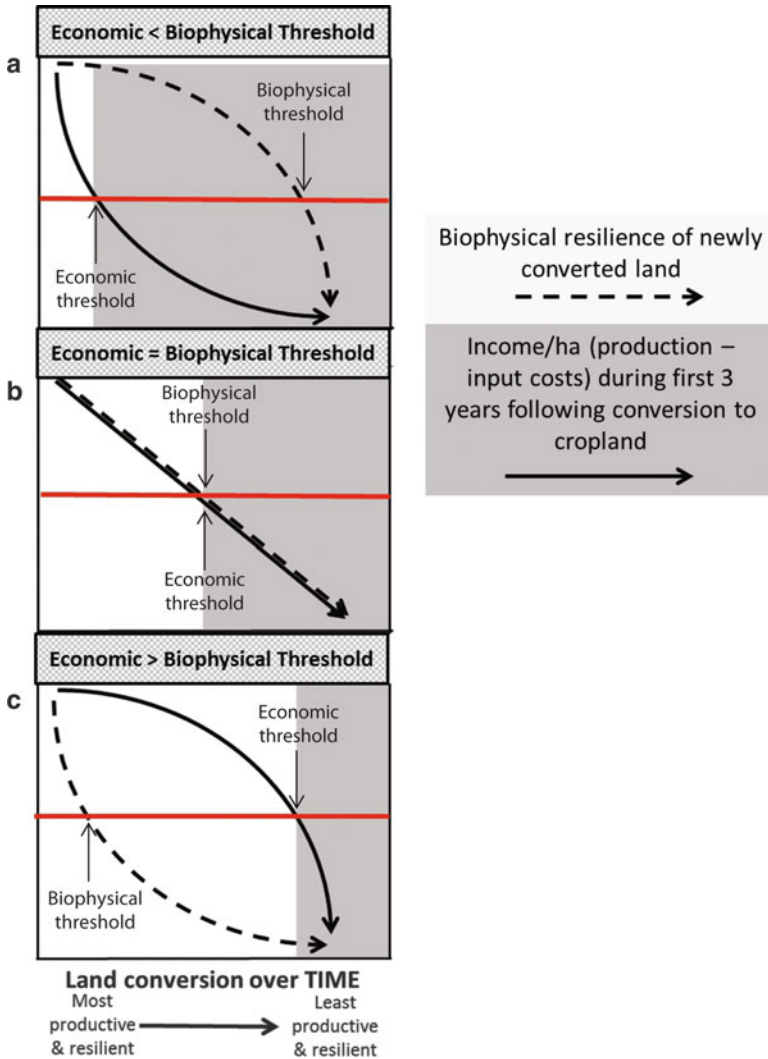
At a minimum, the risk of soil erosion should be evaluated. Soil erosion usually results in the loss of both soil nutrients and a reduction in soil water available to plants, which is associated with a reduction in infiltration capacity. Soil erosion may reduce or increase plant-available-water-holding capacity depending on soil profile characteristics, including texture and structure. Soil organic matter loss, soil compaction, salinization, drainage, and declines in soil nutrient availability are additional soil degradation processes that may also be evaluated.

#### ***22.3.6 Step 6. Rank Each Landscape Unit Based on Degradation Risk with and Without Land Use Change***

This is a necessarily subjective process due to the multiple types of degradation and uncertainty associated with each. Multiple experts, including local knowledge experts, should be consulted.

#### ***22.3.7 Step 7. Determine Priority for Climate Change and Soil Conservation Investments***

In addition to changes in potential production and degradation risks, this analysis should consider the degradation impact on potential production and whether or not it can be reversed. It should also consider uncertainty in the predictions. Application of the precautionary principle (Kriebel et al. 2001) must be balanced with the recognition of the reality that it is impossible to eliminate degradation risk from virtually any agro-ecosystem. Instead, the goal should be to minimize the risk of



**Fig. 22.4** Land conversion based on economic and biophysical thresholds. (a) When remaining (not yet cultivated) lands are beyond an economic threshold, but can be sustainably converted, land conversion will not occur for economic reasons. (b) When the economic and biophysical thresholds are equal, land conversion may occur for economic reasons before land (with high probability of crossing a biophysical threshold) is converted to cropland. (c) When the economic threshold is higher than the biophysical threshold, land conversion is likely to occur for economic reasons before land (with high probability of crossing a biophysical threshold) is converted to cropland (Modified from Herrick et al. 2012)

irreversible degradation of the most productive lands by intensifying production on the most productive and resilient soils, and targeting soil conservation interventions to highly productive, low resilience soils.

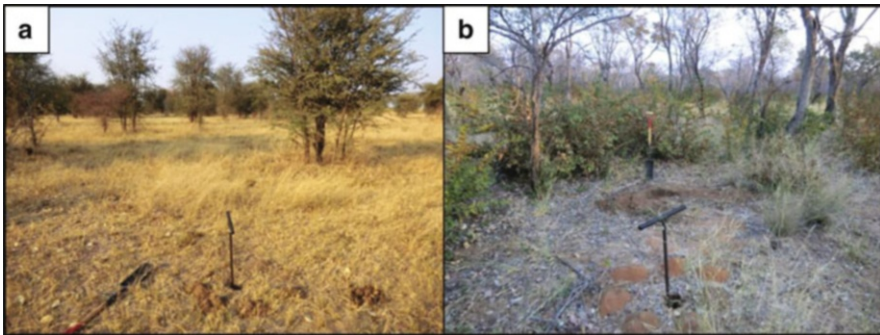
## 22.4 Case Study: Northeastern Namibia

### 22.4.1 *Biophysical Description*

Woodlands cover the majority of land in northern Namibia. Relatively small areas of deep loamy alluvial soils are interspersed in a matrix of deep eolian sands (Fig. 22.5; Table 22.2). Many of the fine-textured soils are associated with natural drainages, while others occur as isolated patches in upland landscape positions and associated ephemeral playas. These patches of relatively fine-textured soils are typically less than 100 ha in size and may be as little as 1 ha. They are clearly visible in satellite imagery. Annual rates of precipitation in the region average 500–600 mm, with most precipitation occurring during the November to March growing season. The mean temperature is 22 °C.

### 22.4.2 *Land Use*

Grazing is the dominant land use, and fires, both natural and anthropogenic, are relatively common. Small-scale subsistence agriculture is expanding. Loamy soils are highly preferred because they are more fertile, thus requiring fewer nutrient inputs, and because of their higher plant-available-water-holding capacity. Local farmers consider water-holding capacity a critical factor for determining whether or not a crop can be successfully produced during drought years.



**Fig. 22.5** Loamy (a) and sandy (b) soils in northeastern Namibia (see Table 22.1 for more information)

**Table 22.2** Namibia case study based on data from two locations approximately 120 km west of Rundu, Kavango, Namibia. Current land use is livestock grazing

Landscape unit and example locations (see Schrader et al. 2013 for additional site data)	Potential production			Degradation risk for current land use (rank)	Potential future land use	Probability of land use change in next 20 years	Degradation risk for potential future land use (rank)	Priority <sup>a</sup>	
	Current	Net change in potential production with climate change (rank)	Degradation risk for current land use (rank)					CC	SC
Flat loamy	High	1	2	Annual cropping	High	2 (high resistance, moderate resilience)	High	High	
17.7361°S									
18.4908°E									
Flat sandy	Low	2	1	Grazing with annual cropping during wet years	Moderate	1 (low resistance, high resilience)	Low	High	
17.76545°S									
18.48805°E									

<sup>a</sup>CC Climate Change, SC Soil Conservation



### ***22.4.3 Climate Change and Impacts on Potential Production***

Most climate change models predict that northern Namibia will become hotter and drier, and that rainfall events will become less frequent. This suggests that climate change adaptation must focus on increasing plant-available-water capture and storage, particularly for those lands that are undergoing conversion to cultivated agriculture.

### ***22.4.4 Interpretation***

Climate change adaptation should focus on more productive, loamy soils (Table 22.2). While potential productivity of all soils will be negatively affected by climate change, loamy soils are far more productive than sandy soils.

Soil conservation efforts, however, should be practiced on both types of soils. Northern Namibia's landscapes were formed by wind erosion and deposition interacting with alluvial processes that are part of the larger Okavango system. This system covers northwestern Botswana, southern Angola, and northeastern Namibia. The dominant soils in this system are classified as Ferralic Arenosols (Jones et al. 2013). Current studies are evaluating the risk that the cultivation of these landscapes may lead to regional destabilization.

## **22.5 Applications and Conclusions**

The strategy described here can be applied on multiple scales to address a wide variety of objectives. An individual landowner may use it to decide where to intensify production or which land areas should be prioritized for soil conservation. Governments and development organizations can use it to identify those parts of a country that are vulnerable to climate change and soil degradation, and where the processes are likely to reinforce each other. In particular, climate change adaptation funds are likely to increase over the coming years. We suggest that the allocation of funds be made with consideration to the issue of soil resistance and resilience.

## **22.6 A Footnote: Application of the Strategy to Test and Document Tools for Increasing Resilience**

The strategy presented for maximizing return on climate change adaptation investments in drylands is based on an understanding of soil and ecosystem resilience, and can be used to ensure that new systems for increasing resilience are rigorously tested and documented. Rigorous testing requires appropriate experimental

controls, and in many cases, it is impossible to randomize the selection of experimental treatments and controls, due to the nature of innovation and the dissemination and adoption of advanced production systems and management practices. This does not, however, preclude the use of experimental controls, which should be as close as possible to the treatments in their potential productivity based on soils, topography, and climate conditions. While this is best done by a trained soil scientist, the Land-Potential Knowledge System (LandPKS) currently under development will allow even individuals with limited knowledge of soils to select paired controls based on land potential (Herrick et al. 2013b).

**Acknowledgements** We are grateful to a large number of colleagues around the world with whom we have discussed these issues. This paper benefited particularly from conversations with Kevin Urama. We also thank Kara Shervanick for manuscript preparation assistance and editing, and David Hansen and an anonymous reviewer for their very helpful comments and suggestions.

## References

- Alinovi L, Hemrich G et al (2007) Addressing food insecurity in fragile states: case studies from the Democratic Republic of the Congo, Somalia and Sudan. FAO Agricultural Development Economics Division Working Paper No. 07-21. FAO, Rome, 26 pp
- Alscher S (2011) Environmental degradation and migration on Hispaniola Island. *Int Migr* 49: e164–e188
- Ariapour A, Hadid M et al (2013) Water resources suitability model by using GIS (case study: Borujerd Rangeland, Sarab Sefid). *J Rangel Sci* 3:177–187
- Berger R (2003) Conflict over natural resources among pastoralists in northern Kenya: a look at recent initiatives in conflict resolution. *J Int Dev* 15(2):245–257
- Bergholt D, Lujala P (2012) Climate-related natural disasters, economic growth, and armed civil conflict. *J Peace Res* 49(1):147–162
- Blum WEH, Santelises AA (1994) A concept of sustainability and resilience based on soil functions: the role of the International Society of Soil Science in promoting sustainable land use. In: Greenland DJ, Szabolos I (eds) Soil resilience and sustainable land use. CAB International, Wallingford, pp 535–542
- Brunnschweiler CN, Bulte EH (2008) Economics: linking natural resources to slow growth and more conflict. *Science* 320(5876):616–617
- Brunnschweiler CN, Bulte EH (2009) Natural resources and violent conflict: resource abundance, dependence, and the onset of civil wars. *Oxf Econ Pap* 61(4):651–674
- Cowie AL, Penman TD et al (2011) Towards sustainable land management in the drylands: scientific connections in monitoring and assessing dryland degradation, climate change and biodiversity. *Land Degrad Dev* 22:248–260
- FAO (1996) Agro-ecological zoning: guidelines. Food and Agriculture Organization of the United Nations Natural Resources and Environment. FAO, Rome
- FAO (2013) Global agro-ecological zones. Food and Agriculture Organization of the United Nations Natural Resources and Environment. FAO, Rome
- Gray CL (2011) Soil quality and human migration in Kenya and Uganda. *Glob Environ Chang* 21(2):421–430
- Greenland DJ, Bowen G et al (1994) Soil, water, and nutrient management research: a new agenda. International Board for Soil Research and Management Position Paper. IBSRAM, Bangkok
- Herrick J, Brown J et al (2012) Revolutionary land use change in the 21st century: is (rangeland) science relevant? *Rangel Ecol Manag* 65(6):590–598

- Herrick JE, Sala OE et al (2013a) Land degradation and climate change: a sin of omission? *Front Ecol Environ* 11(6):283–283
- Herrick JE, Urama KC et al (2013b) The global land-potential knowledge system (LandPKS) supporting evidence-based, site-specific land use and management through cloud computing, mobile applications, and crowdsourcing. *J Soil Water Conserv* 68(1):5A–12A
- Holechek JL, Pieper RD et al (2001) *Range management: principles and practices*, 4th edn. Prentice-Hall, Upper Saddle River
- Jones A, Breuning-Madsen H et al (2013) *Soil atlas of Africa*. European Commission, Brussels
- Kearney J (2010) Food consumption trends and drivers. *Phil Trans R Soc B* 365(1554):2793–2807
- Kiernan K (2010) Environmental degradation in karst areas of Cambodia: a legacy of war? *Land Degrad Dev* 21(6):503–519
- Kriebel D, Tickner J et al (2001) The precautionary principle in environmental science. *Environ Health Perspect* 109(9):871
- Laczko F, Aghazarm C (2009) *Migration, environment and climate change: assessing the evidence*. International Organization for Migration, Geneva, Switzerland
- Lal R (1997) Degradation and resilience of soils. *Phil Trans R Soc B* 352(1356):997–1008
- Lal R (2001) Soil degradation by erosion. *Land Degrad Dev* 12(6):519–539
- Lal R (2004) Soil carbon sequestration impacts on global climate change and food security. *Science* 304:1623–1627
- Mafongoya PL, Bationo A et al (2006) Appropriate technologies to replenish soil fertility in southern Africa. *Nutr Cycl Agroecosyst* 76(2–3):137–151
- Marland G, Fruit K et al (2001) Accounting for sequestered carbon: the question of permanence. *Environ Sci Policy* 4(6):259–268
- Millennium Ecosystem Assessment (2005) *Ecosystems and human well-being: desertification synthesis*. Island Press, Tucson
- Mkutu K (2001) *Pastoralism and conflict in the horn of Africa*. Saferworld Organisation, London, 44p
- Muscolino MS (2011) Violence against people and the land: the environment and refugee migration from China's Henan province, 1938–1945. *Environ Hist* 17(2):291–311
- Nie M (2003) Drivers of natural resource-based political conflict. *Policy Sci* 36(3–4):307–341
- Oba G, Weladji RB et al (2010) Scaling effects of proximate desertification drivers on soil nutrients in northeastern Tanzania. *J Arid Environ* 72(10):1820–1829
- Peters P, Peters PE (2012) *Conflicts over land and threats to customary tenure in Africa today*. Center for International Development Working Paper No. 247. Harvard University, Cambridge, MA, 25 pp
- Prazan J, Dumbrovsky M (2010) Soil conservation policies: conditions for their effectiveness in the Czech Republic. *Land Degrad Dev* 21:124–133
- Reynolds JF, Smith DMS et al (2007) Global desertification: building a science for dryland development. *Science* 316(5826):847–851
- Scheffer M, Bascompte J et al (2009) Early-warning signals for critical transitions. *Nature* 461:53–59
- Scherr SJ (2000) A downward spiral? Research evidence on the relationship between poverty and natural resource degradation. *Food Policy* 25(4):479–498
- Schrader S, Kapi U et al (2013) Namibia survey viewer. <http://landpotential.org/>. Accessed 5 May 2013
- Searchinger T, Hanson C et al (2013) *The great balancing act: working paper*. World Research Institute, Washington, DC
- Seybold CA, Herrick JE et al (1999) Soil resilience: a fundamental component of soil quality. *Soil Sci* 164(4):224–234
- Stavins RN (1999) The costs of carbon sequestration: a revealed-preference approach. *Am Econ Rev* 89(4):994–1009
- United Nations Environment Programme (UNEP) (2012) *2012 annual report*. UNEP, Nairobi
- Valentine KA (1947) Distance from water as a factor in grazing capacity of rangeland. *J For* 45:749–754

## Chapter 23

# Use of Conservation Tillage and Cropping Systems to Sustain Crop Yields Under Drought Conditions in Zambia

**Obed I. Lungu**

**Abstract** The adverse effects of climate change on agricultural productivity have been evident for several years. Factoring climate change risks into critical decision-making is crucial for ensuring food security. Zambia has adopted conservation agriculture in response to two real threats to food security: loss of animal draught power due to livestock disease, and poor yield and occasional total crop failure due to frequent drought. The main threats from climate change arise from the stresses and shocks caused by high temperature and erratic rainfall, such as shorter growing seasons and water deficit in the soil profile. Under these conditions, conventional tillage practices and a few of the current cropping systems have proved inappropriate and inadequate for sustaining high crop yields. For instance, the national long-term average yield of maize under conventional agricultural practices has declined by 40 %. In this paper, I discuss conservation tillage (CT), soil quality management, and crop and cultivar options for adapting to and mitigating the adverse effects of climate change with the aim of ensuring stable yields. In drought years, employing CT involving deep ripping (15–30 cm), leaving crop residues on the soil surface, and using an appropriate maturity cultivar have consistently resulted in yield increases of 30–70 % (with maize showing the highest yield increase) compared with conventional practices. Early planting is an important factor, and 45 % of the yield increment could be attributed to it. Both physical (plow pans) and chemical (subsoil acidity) impediments to soil depth can greatly restrict root growth into the subsoil and severely restrict the volume of soil exploited and, in turn, the quantities of nutrients and water available to the crop. This investigation shows that adopting a technology package of appropriate culture practices, and seed and crop management can potentially reduce the negative effects of drought and stabilize crop yields.

**Keywords** Crop adaptation • Drought mitigation • Subsoil acidity • Rooting depth • Tillage technology

---

O.I. Lungu (✉)

Department of Soil Science, School of Agricultural Sciences, University of Zambia, Lusaka, Zambia

e-mail: [olungu@unza.zm](mailto:olungu@unza.zm); [lunguio@gmail.com](mailto:lunguio@gmail.com)

### 23.1 Introduction

Drought and the consequent low crop yields or even total crop failure are realities to which we must adapt cropping systems and find methods to mitigate the effects of drought for ensuring food security. Erratic rainfall, high temperatures, and short growing seasons are all attributed to climate change effects. Zambia experienced drought in the 1972/73, 1983/84, 1990/91, 1992/93, and, very recently, in the 2001/2002 and 2004/5 growing seasons (Fig. 23.1). The crop damage recorded in these droughts is shown in Fig. 23.2. The association between drought and crop production is evident from the data shown in Fig. 23.3. Clear lessons have been learned from these droughts. The lessons have provided a solid basis for developing strategies that can help adapt to and mitigate the effects of drought on farming systems. Optimization of both soil and plant factors is crucial in these strategies (Lungu 2005).

Compared with Botswana and Namibia, which receive <500 mm rainfall annually in their wettest regions, Zambia is strictly not an arid country. In all three agro-ecological regions, the rainfall received is adequate for the successful growth of most crops, i.e., there is no meteorological drought (Fig. 23.1). Agricultural or technical drought is occasioned by erratic and poor rainfall distribution, as observed during the 2004/5 drought (Table 23.1).

Several proven cultural technologies can be used to mitigate the adverse effects of agricultural drought and ensure stable yields. This agricultural response to drought is anchored on three basic principles: capturing much of the available rainfall, storing the captured water, and preventing its loss due to evaporation. These principles are well espoused in the concepts of conservation farming (CF).

Conservation farming (CF) experiments were first conducted in the United States of America following the “Dust Bowl” phenomenon in the early 1930s.

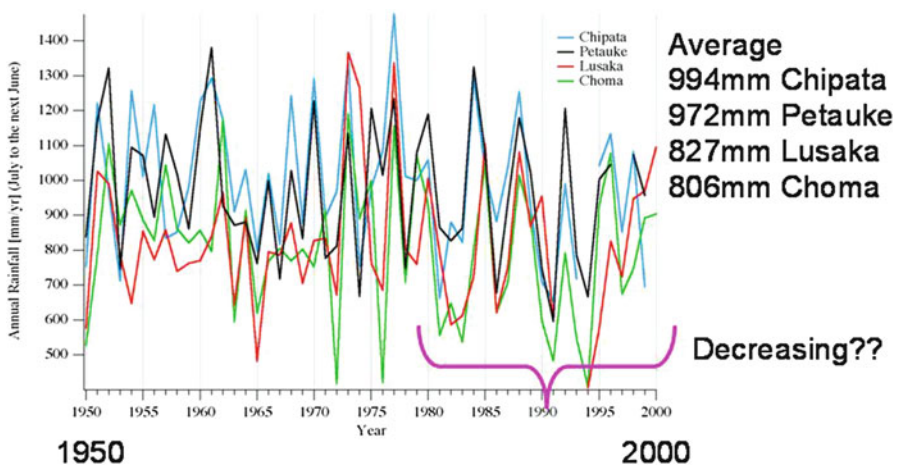
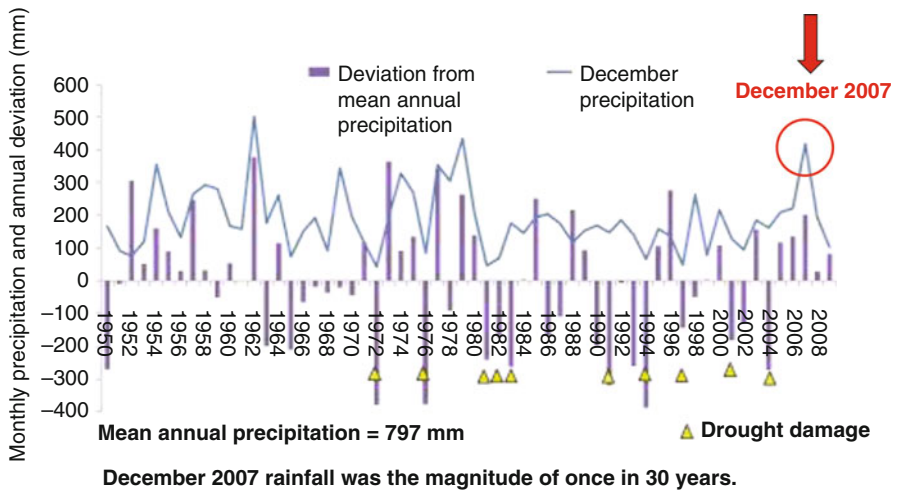
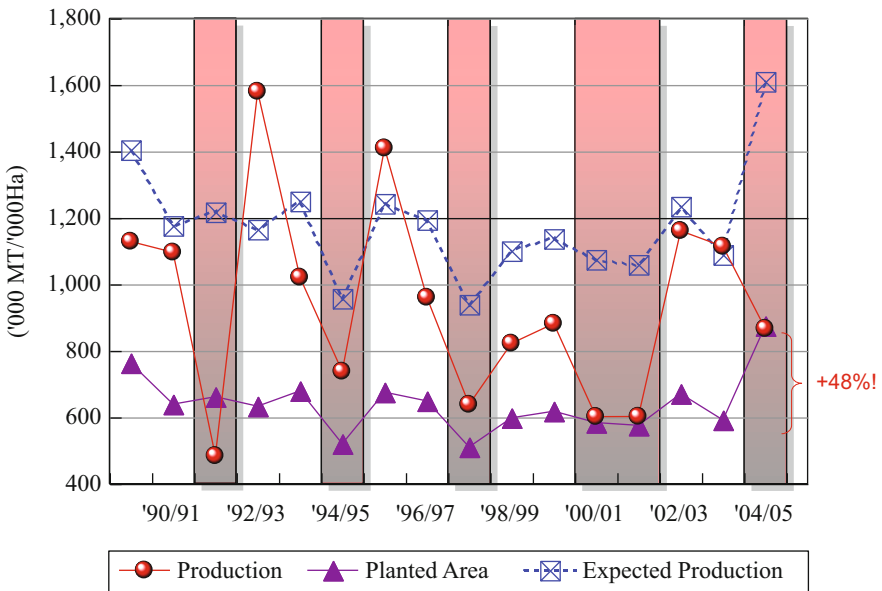


Fig. 23.1 Annual rainfall at four stations in Zambia and recent drought occurrences (Source: Moses Mwale (Zambia Agricultural Research Institute))



**Fig. 23.2** Rainfall shock on Southern Province of Zambia (1950–2009) (Source: Moses Mwale (Zambia Agricultural Research Institute))



**Fig. 23.3** Effect of agricultural drought on maize production in Zambia (Source: Moses Mwale (Zambia Agricultural Research Institute, ZARI))

**Table 23.1** Rainfall distribution at Golden Valley Agriculture Research Trust (GART) recommendation domain sites during 2004/05 drought (mm)

Month/year	Batoka	Chisamba	Magoye
October 2004	0	55.5	18.0
November 2004	18.7	85.5	85.0
December 2004	98.5	361.3	153.1
January 2005	220.7	174.2	150.6
February 2005	106.6	62.2	106.6
March 2005	14.8	52.3	14.8
April 2005	0	26.3	0
Seasonal total	459.3	817.0	528.1

Source: Lungu (2005)

This practice of land management has spread worldwide. The popularity of CF in Africa grew with the realization that tilling fragile soil in the conventional manner using a mould-board plow, as is common in Sub-Saharan Africa (SSA), can destroy soil structure and increase water loss from the soil profile. However, in SSA, CF has been implemented in different forms compared with the original concept (Montpellier Panel Report 2013).

As practiced in Zambia, conservation agriculture has four distinct and progressive stages: (1) Minimum tillage, which is practically zero-till but without residue retention (MT), (2) Conservation tillage (CT), which combines the practice in 1 with retention of crop residues as soil cover, (3) Conservation farming (CF), which involves crop rotation, preferably with legumes, in addition to MT and CT, and (4) Conservation agriculture (CA), wherein agro-forestry is integrated into the aspects of MT, CT, and CF. The often-voiced concern about little evidence for the widespread adoption of CA technology (Nebraska Declaration 2013) could partly be explained by a failure to recognize the fact that farmers seldom adopt all components of CA at once.

A technology package comprising appropriate cultural practices, and seed and crop management techniques can potentially reduce the negative effects of drought and stabilize crop yields. This paper explores CT, soil quality management, and crop and cultivar options as strategies for adapting to and mitigating the adverse effects of climate change to ensure stable yields.

## 23.2 Materials and Methods

### 23.2.1 *On-Station and On-Farm Trials*

CT, crop management, and liming trials were carried out both on farm and on station at three locations with varying soil and weather conditions in Zambia. The trials were part of a program on soil quality improvement conducted by the Golden Valley Agriculture Research Trust (GART) in the country. Soil quality parameters

such as soil reaction and exchangeable cations were monitored regularly in these trials. In addition, weather data at the three GART stations were recorded.

Different tillage practices were compared: direct planting, hand hoe planting basins, plowing (conventional practice), ripping up to at least 20 cm, and ridging. Maize was the test crop, both with and without a cover crop in between the planting furrows. The planting rows were spaced either 75 or 90 cm apart with an intra-row spacing of 25 or 30 cm, respectively, resulting in a plant population of 48,000 plants ha<sup>-1</sup>. The crop was grown to maturity, and the grain weight (12 % content) was measured.

In the liming trials, dolomitic lime was used, and in all cases, it was broadcast at the surface and lightly incorporated into the soil (conventional practice), but in the CT practice it was applied to the planting basins or to the ripped furrows.

Soil samples were obtained from two soil depths—0–20 and 20–40 cm—at the beginning of the trial (baseline) and after crop harvest. The samples were analyzed for various physical and chemical parameters such as soil organic carbon, bulk density, water holding capacity, and infiltration. Any changes in the soil properties between the two measurements were recorded.

## 23.3 Results and Discussion

### 23.3.1 *Effect of Tillage Practice on Water Storage in Soil Profile*

Physical soil impediments such as plow pans restrict the plant rooting depth and reduce moisture storage capacity of the soil, thus exacerbating drought stress and leading to low crop yields. The results summarized in Table 23.2 show the benefits of deep ripping of soil on crop yield. Deep ripping improves the soil structure,

**Table 23.2** Effect of tillage practice on pearl millet yield (*Pennisetum glaucum*) in Namibia

Farmer category Av.	Growing season	Tillage practice					
		Farmer traditional practice	Magoye ripper with manure	Magoye ripper with fertilizer	Tractor ripper/furrow no manure no fertilizer	Tractor ripper/furrow with manure	Tractor ripper/furrow with fertilizer
A	2005/06	463	476	664	1,023	1,959	–
	2006/07	643	1,341	1,730	1,410	1,717	1,791
B	2005/06	400	441	647	572	822	610
	2006/07	626	1,293	1,343	1,004	1,129	1,023
A and B	2005/06	432	459	656	789	1,391	1,369
	2006/07	635	1,317	1,537	1,207	1,423	1,407

Adapted from Davis (2009)



increases rainfall infiltration rate, and reduces soil erosion, thus increasing the water storage capacity of the soil (Lungu 2005). These results, especially those from the 2006/07 drought season confirm these assertions.

The trial was conducted on 20 smallholder farmers' fields, and the farmers were divided into two performance categories A and B. Fertilizers were applied as follows: monoammonium phosphate at a rate of 75–150 kg ha<sup>-1</sup> and manure at a rate of 5–10 ton ha<sup>-1</sup>. The yield data were computed as averages per category for each season as well as in the form of pooled data for the two categories.

Seasonal rainfall of 300 mm was effectively translated to 520 mm with deep ripping performed using a tractor ripper. Namibia faced drought in the 2006/07 season, and the resulting moisture stress was reflected in the lower crop yields than in the preceding season (2005/06). Even in the drought year, crop yields from the tractor ripper/furrow were at least 250 % greater than those from the farmers' traditional practice of shallow cultivation using a hand hoe. It was also interesting to note that tractor ripper/furrow alone without the application of manure or fertilizer resulted in doubling of the yield compared with the traditional farmers' method, thus confirming improved in-field rainwater harvesting owing to deep ripping.

The Magoye ripper is a Zambian invention which when used with strong oxen, proper implement adjustment, and slightly moist soils can open the soil down to 20–30 cm. The difference in crop yield between the tractor ripper and the Magoye ripper can be attributed to shallower ripping with the Magoye ripper.

Deep ripping has the effect of breaking the plow pan, resulting in deepening of the soil, which facilitates high water infiltration and easy root growth into the subsoil. Figures 23.4a–c show the effects of deep ripping compared with those of conventional soil inversion through plowing.

### ***23.3.2 Managing Subsoil Acidity and Associated Drought Stress***

Deep and well-drained soils with acidic profiles have high crop yield potential only if the roots penetrate and extract water and nutrients from the acidic subsoil. Acidic subsoil severely restricts root growth into the profile (Sumner 1994).

The harmful effects of soil acidity are usually manifested as drought stress. The low productivity of acid soils stems from the excessive soluble aluminum in the soil solutions and, thus leading to Al toxicity in plants. Below pH 5.2, Al dissolves in water and causes severe root pruning, which results in reduced water and nutrient uptake (Sumner 2001). Figure 23.5 shows the effect of soil acidity on root growth. Efficient subsoil water use requires inputs of lime and gypsum, which have been shown to increase yield (Sumner 1994).

The results summarized in Table 23.3 indicate the adverse effects of soil acidity and crop response to lime and fertilizer nitrogen. The data show that nitrogen



**Fig. 23.4** (a) Root restriction and ripping tillage to break the plough pan. (b) Comparison between conventional (*left*) and ripping tillage (*right*). (c) Deep ripping breaks plough pans that restrict water infiltration



**Fig. 23.5** Root pruning due to subsoil acidity (extreme *right*) and positive effect of lime on root growth (extreme *left*)

**Table 23.3** Effects of nitrogen and lime rates on acidification and maize yield in Oxisols from Kwazulu Natal, South Africa

Treatment		pH in water	Exchangeable bases (cmol/kg)		Yield (ton/ha)
Nitrogen <sup>a</sup> (kg/ha)	Dolomitic lime <sup>b</sup> (kg/ha)		Ca	Mg	
0	0	4.80	0.90	0.40	3.20
20	0	4.78	0.93	0.47	3.19
40	0	4.81	0.83	0.39	3.18
0	2,000	5.10	1.90	0.80	3.34
20	2,000	4.93	1.36	0.38	3.55
40	2,000	4.90	1.87	0.52	4.16
0	4,000	5.23	2.88	1.17	3.48
20	4,000	5.16	2.45	1.15	4.18
40	4,000	5.13	2.97	1.43	4.81

Adapted from Sumner (2001)

<sup>a</sup>Half the nitrogen was applied as ammonium nitrate at planting and other the half 1 month after emergence

<sup>b</sup>Dolomite was applied once

alone has no effect on crop yield in acidic soil, thus suggesting that the efficiency of nitrogen use is low in acidic soils. There was a definite response to lime, as indicated by the increase in soil pH and bases (Ca and Mg). With lime application

**Table 23.4** Effect of surface-applied lime on subsoil acidity at two GART-recommended domain sites in Batoka and Magoye (values are pH in CaCl<sub>2</sub>)

Soil depth (cm)	Treatment, dolomitic lime (kg ha <sup>-1</sup> )			
	0		2000	
	Batoka	Magoye	Batoka	Magoye
0–10	5.3	4.1	5.6	4.3
10–20	4.4	3.6	5.1	3.8
30–40	4.3	3.8	4.5	3.8

**Table 23.5** Effect of deep lime placement on maize yield at GART-recommended domain sites in Batoka and Magoye

Treatment <sup>a</sup> (nutrients applied, kg <sup>-1</sup> )			Dolomitic lime	Yield (ton ha <sup>-1</sup> )	
N	P <sub>2</sub> O <sub>5</sub>	K <sub>2</sub> O	Kg ha <sup>-1</sup>	Magoye	Batoka
10	20	10	0	4.5	3.5
10	20	10	2,000	4.8	5.0
66	40	20	0	4.8	5.2
66	40	20	2,000	5.7	7.0
122	60	30	0	5.9	6.8
122	60	30	2,000	6.4	6.2
172	80	40	0	7.0	8.0
172	80	40	2,000	5.8	7.8
234	100	50	0	6.8	6.5
234	100	50	2,000	7.6	7.2

<sup>a</sup>Nitrogen was applied as a compound fertilizer (10:20:10) during planting and as urea top dressing

at 2,000 kg/ha, there was an increase in yield, too, with an increase in the nitrogen level.

Enhancing root growth into the subsoil will greatly increase the volume of soil explored and the quantities of nutrients available to the crop, and this may prove critical toward crop yield stabilization under drought conditions. However, surface-applied lime seldom ameliorates subsoil acidity because lime is largely immobile in soil, as indicated by the data recorded in Zambia (Table 23.4).

Mechanical placement of lime into the subsoil, especially in the conventional tillage practice, adds an extra operation and cost, which many farmers will avoid. However, with CT, lime can be placed deeper in the ripped furrows than is possible with conventional plowing. This effect is apparent in the results listed in Table 23.5 for sites with known acidic soil in Zambia. Under these conditions, smallholder farmers using the traditional shallow cultivation method, which involves hand hoe use and no application of lime, achieved average maize yields of less than 1 ton/ha.

Application of gypsum CaSO<sub>4</sub>·2H<sub>2</sub>O to the surface soil for ameliorating subsoil acidity is now a common practice (McCray and Sumner 1990; Stainberg et al. 1989; Sumner 1993). In practice, lime is applied in combination with gypsum, and this has been shown to be effective in moving Ca to the subsoil and increasing crop yield in soils with subsoil acidity.

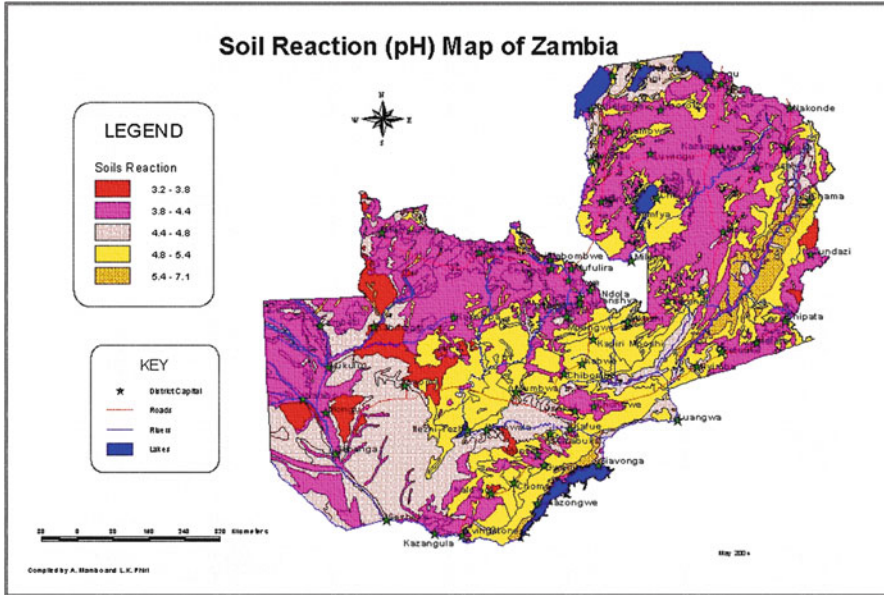


Fig. 23.6 Extent of soil acidity in Zambia

The above observations suggest that soil acidity can be mapped onto drought-prone areas. Globally, acidic soils are estimated to occupy  $3.7 \times 10^9$ – $3.9 \times 10^9$  ha of land or 30 % of all ice-free land (Eswaran et al. 1997; Von Uexkul and Mutert 1995). Therefore, we cannot afford to ignore the problem. In Zambia, soil acidity is quite widespread (Fig. 23.6) and is very often the cause of low crop productivity when lime is not used. Lime is not yet used widely compared with fertilizer by smallholder farmers in Zambia.

### 23.3.3 *Crop Management Strategies to Escape Drought and Stabilize Crop Yields*

Even in drought years, the total annual rainfall is usually above normal, as indicated by the data from the three GART sites (Table 23.1). The mid-season drought that was observed at these sites lasted for a maximum of 10 days. This period is not too long to allow the crop to escape the drought. Therefore, the soil profile should be so managed that it stores adequate amounts of water or the crop planting time should be synchronized with the rainfall pattern.

Water loss from the soil profile through evaporation can be reduced by covering the soil surface with a mulch of crop residues or with a cover crop. In Zambia, maize is planted in rows spaced at 75 and 90 cm, and legume cover crops are intercropped with maize using the interspaces, which has demonstrably increased

crop yields even during drought. Legume cover crops are promoted as a management practice that can provide multiple benefits to cereal production systems (Fig. 23.7).



**Fig. 23.7** (a) Maize-cowpea cover crop trial with ripping compared to farmer practice of monocropping with ploughing. (b) Potential of a maize-mucuna (*Mucuna pruriens*) rotation in Zambia

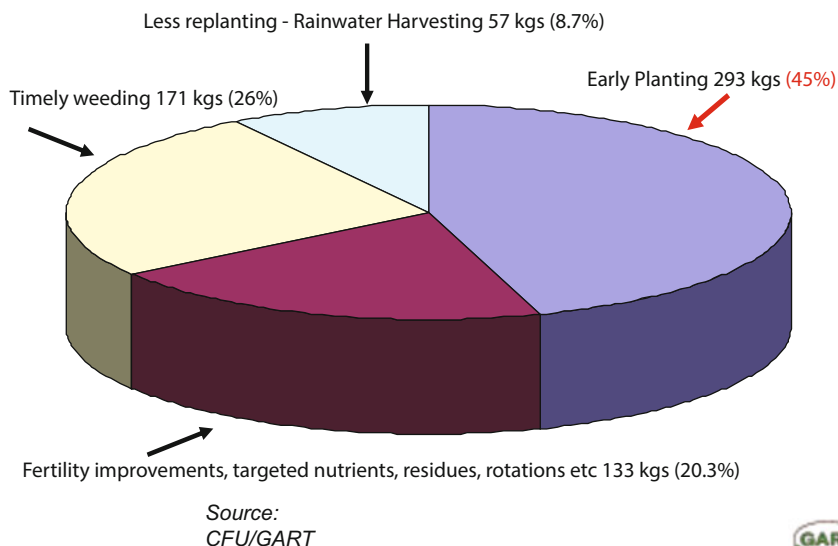


Fig. 23.7 (continued)

During a drought, a careful choice of crop cultivar and maturity date can mitigate the drought stress. When the rains are delayed beyond the optimal planting date for a crop, it is advisable to switch to an early- or medium-maturing variety instead of the long-maturing variety to effectively use the remainder of the season and to enable the crops to escape the midseason drought.

Farmers in Zambia have access to multiple seed options of different maturity dates to mitigate drought. All seed companies in the country sell maize seeds of four distinct maturity periods: early maturing (<130 days), early to medium (130–139 days), medium to late (140–149 days), and late maturing (>150 days).

An appropriate cropping package that integrates tillage practice, and seed and crop management in the field can potentially mitigate the adverse effects of drought and stabilize crop production. According to an analysis by Haggblade et al. (2010), most studies on CF (ripping and retention of crop residues) report substantially higher yields on CF plots, often double than those achieved under conventional tillage (shallow plowing and incorporating crop residues). Although these gains vary across locations and over time, Haggblade and Tembo (2003) estimated that 25 % of the observed gains under CF stem from higher input use, 25 % from early planting, and about 50 % of yield increment due to the combination of other CF cultural practices, including build up of soil organic matter, concentration of nutrients in planting basins or furrows, and water harvesting effects of basins and



**Fig. 23.8** Sources of benefits to crop growth in conservation farming

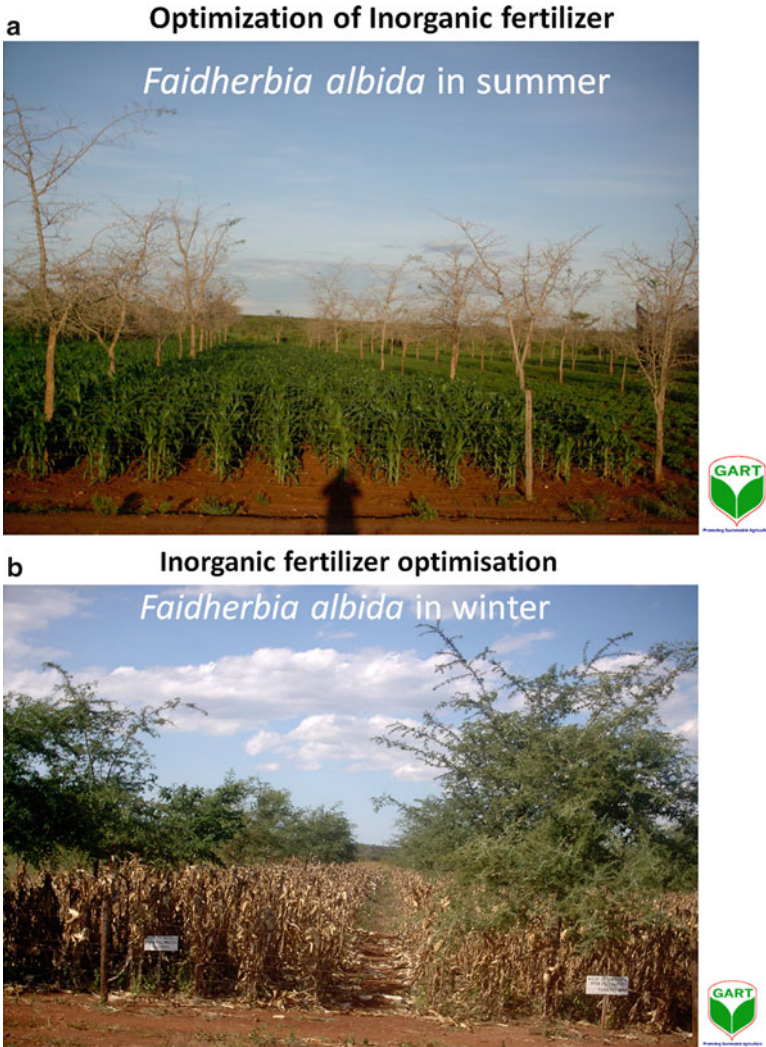
ripped furrows. The contributions of each of these effects are summarized in Fig. 23.8.

CA holds much promise in terms of improving soil productivity and stabilizing crop yields, even under drought conditions. In Zambia, CA involves integrating *Faidherbia albida* trees in croplands (100 trees/ha). Considerable benefit has been reported on crops grown under the canopy of trees that are older than 7 years. There is no shading of the crop, as the tree sheds its litter during crop growth (November–April) and is in full bloom for the rest of the year (Fig. 23.9a, b).

## 23.4 Conclusion

Drought has an adverse effect on food security. Climate change, which causes drought, dictates that production systems be adapted to the change for stabilizing crop yields. CF, which involves deep ripping, retaining crop residue on land, practicing crop rotations with legumes, liming acid soils, and adapting crop varieties to the length of the growing season, can potentially improve soil fertility and conserve water in the soil profile. The benefits of CF on crop yield are attributed to these improvements in soil quality.





**Fig. 23.9** (a) Optimization of inorganic fertilizer in combination with *Faidherbia albida* on maize growth. (b) Optimization of inorganic fertilizer in combination with *Faidherbia albida* on maize growth

**Acknowledgement** This work was funded by the Swedish International Development Agency (Sida) and the Norwegian Agency for Development (NORAD) through the Golden Valley Agricultural Research Trust (GART), Lusaka, Zambia. I thank the Director Dr. Stephen W. Muliokela for his constant interest in and support for this work.

## References

- Davis R (2009) Climate change, conservation agriculture, and the Namibian smallholder farmer. In: Golden Valley Agricultural Research Trust (GART) yearbook (ISSN 2071-95660). Golden Valley Agricultural Research Trust, Lusaka, pp 21–22
- Eswaran H, Reich P, Beinroth F (1997) Global distribution of soils with acidity. In: Moniz AC, Furlani AM, Schaffert RE, Fageria NK, Rosolem CA, Canttarella H (eds) Plant-soil interactions at low pH. Brazilian Society of Soil Science, Campinas, pp 159–164
- Haggblade S, Tembo G (2003) Conservation farming in Zambia, Environment and Production Technology Division Working Paper 108. International Food Policy Research Institute (IFPRI), Washington, DC
- Haggblade S, Kabwe S, Pleorhopes C (2010) Productivity impact of conservation farming on smallholder cotton farmers in Zambia. Food Security Research Project in Zambia, Ministry of Agriculture & Cooperatives, Agricultural Consultative Forum and Michigan State Un No. 43. <http://www.aec.msu.edu/agecon/fsz/zambian/index.htm>
- Lungu OI (2005) Drought management. In: Golden Valley Agricultural Research Trust (GART) yearbook (ISSN 2071- 95660) Golden valley agricultural research trust, Lusaka, pp 21–22
- McCray JM, Sumner ME (1990) Assessing and modifying calcium and aluminum levels in acid subsoils. *Adv Soil Sci* 14:45–75
- Montpellier Panel Report (2013) Sustainable intensification: a new paradigm for African agriculture. Agriculture for Impact, Imperial College, London
- Nebraska Declaration (2013) In: Output from the conservation agriculture workshop, University of Nebraska, Lincoln, 15–16 October 2012
- Stainberg I, Sumner ME, Miller WP, Farina MPW, Pavan MA, Fey MV (1989) Use of gypsum on soils: a review. *Adv Soil Sci* 9:1–11
- Sumner ME (1993) Gypsum and acid soils: the world scene. *Adv Agron* 51:11–32
- Sumner ME (1994) Amelioration of subsoil acidity with minimum disturbance. In: Jayawardene NS, Stewart BA (eds) Subsoil management technologies. Lewis Publishers, Boca Raton, pp 147–185
- Sumner ME (2001) Global extent, development and economic impact of acid soils. In: Farina M, de Villiers M, Barnard R, Walters M (eds) Plant-soil interactions at low pH Symposium: Integrated management and use of acid soils for sustainable production. Proceedings of the 5th international plant-soil interactions at low pH. Agricultural Research Council-Institute for Soil, Climate and Water, Pretoria, South Africa
- Von Uexkul HR, Mutert E (1995) Global extent, development and economic impact of acid soils. *Plant Soil* 171:1–15

## Chapter 24

# Sustainable Intensification of Maize and Rice in Smallholder Farming Systems Under Climate Change in Tanzania

Ephraim J. Mtengeti, Frank Brentrup, Eva Mtengeti, Lars Olav Eik, and Ramadhani Chambuya

**Abstract** Maize and rice are major staple food crops in Tanzania and constitute 31 % and 13 %, respectively, of total food production. The current productivity of the two crops (1.6 t/ha and 2.3 t/ha, respectively) will not match with the increasing demand for food created by population growth unless there is an expansion of cultivated land or intensification measures are imparted to smallholder farmers, who produce nearly 90 % of each crop in the country. Expansion of cropped areas is limited by increased land-use pressure. Under smallholder farming the same land is continuously cultivated without proper input to replenish the removal of nutrients with crop harvesting, which leads to a decline in the subsequent crop yield. The situation is exacerbated by the effects of climate change. The smallholder farmers lack agro-inputs, information and extension services, and are faced with erratic rainfall. Therefore, a public-private partnership comprising two public universities and two multinational companies dealing with fertilizer and crop protection was initiated in December 2010, aiming at demonstrating sustainable intensification of maize and rice production in smallholder farmers' fields. Five farms for maize and four for rice crops in different villages and districts were selected, and their soils were sampled for physical and chemical analysis. Two treatments were imposed on each farm. The treatments were farmers' practice (control) and improved practice, which includes the proper use of fertilizer, crop protection inputs and recommended crop seed variety. Generally, the soils of most farms were acidic with low phosphorus, potassium, magnesium, sulphur, copper and zinc values. On average, maize

---

E.J. Mtengeti (✉) • E. Mtengeti  
Sokoine University of Agriculture, P.O. Box 3004, Morogoro, Tanzania  
e-mail: [emtengeti@yahoo.co.uk](mailto:emtengeti@yahoo.co.uk)

F. Brentrup  
Research Centre Hanninghof, YARA International, Duelmen, Germany

L.O. Eik  
Department of International Environment and Development Studies/Noragric, Norwegian University of Life Sciences (NMBU), P.O. Box 5003, No-1432 Ås, Norway

R. Chambuya  
SYNGENTA International AG, Schwarzwaldalle e 215, CH-4058 Basel, Switzerland

and rice grain yield 14 % moisture content ranged from 2.5 to 5.4 t/ha in farmers' practice and 6.6–8.5 t/ha in improved practice. Maize and rice stover/straw biomass ranged from 5.33 to 15.4 t/ha for improved practice and 2.11–9.13 t/ha for farmers' practice. It can be concluded that improved agricultural practices, including plant nutrition, plant protection, improved seeds and conservation agriculture measures (e.g., crop residue recycling), enable sustainable intensification of smallholder crop production. Crop yields are improved, soil fertility is maintained, and family income is increased all at the same time. Therefore, public-private partnerships are needed to put this concept into practice and to make knowledge and technology available to smallholder farmers.

**Keywords** Fertilizer • Field days • Food crop • Nutrient removal • Public-private partnership

## 24.1 Introduction

### 24.1.1 *Importance of Maize and Rice in Tanzania*

Tanzania's economy is largely dependent on agriculture, which accounts for about 30 % of the GDP, provides 85 % of exports and employs about 80 % of the population. However, people active in the agricultural sector also represent the vast majority of the 12.5 million people living below the national poverty line (Ahmed et al. 2009). Maize and rice are the largest and most preferred food and cash crops in the country (RATES 2003; USDA 2012). Nearly 90 % of the production of these two cereal crops is done by small-scale farmers, with an average farm size ranging from 0.5 to 2 ha.

Maize crops are grown in nearly all agro-ecological zones of Tanzania. The primary maize-producing regions in the country include Arusha, Iringa, Manyara, Mbeya, Njombe, Rukwa and Ruvuma. Together, these seven regions have the capacity to supply at least 50 % of the national maize output, and the Iringa, Mbeya and Njombe regions in the southern highlands along the Southern Agricultural Growth Corridor of Tanzania (SAGCOT) may account for a quarter of the national maize production, producing on average more than 700,000 tons each year (Rowahni et al. 2011). Planted areas with maize crops increased from 2,570,147 ha in 2005/06 to 3,050,714 ha in the 2009/10 agricultural year with an average yield between 1.3 and 1.6 t/ha (MAFC 2010). Maize constitutes 75 % of the cereals consumed and 31 % of the total food production in the country (WEMA 2010). In general, the consumption of maize averages approximately 74.5 kg/person/year (PASS 2012).

Tanzania is the second-largest rice producer in Eastern, Southern and Central Africa. Rice is produced in the alluvial lowlands and coastal plains, along bottom valleys of mountains, and in land depressions as well as along river-valley basins. The main producing regions include Mwanza, Morogoro, Mbeya, Shinyanga and Tabora. On the other hand, Mbeya, Morogoro and Mwanza account

for >48 % of national production whereas the region with the highest yield of rice (Kilimanjaro with 3.6 tons/ha) represents less than 3 % of the national rice production (Rowahni et al. 2011). There are small irrigation farms averaging about 2–2.5 ha/farmer per irrigation scheme, and a few large-scale commercial rice irrigation schemes such as Madibira (3,000 ha), Kapunga (3,000 ha) and Mbarali (3,200 ha) in the Mbarali district (USAID/COMPETE 2010). Planted areas with rice increased from 702,000 ha in 2005/06 to 1,136,287 ha in the 2009/10 agricultural year while the yield increased from 1.5 to 2.3 t/ha within the same year (MAFC 2010). Rice accounts for 13 % of all cereals produced and is the second most important grain consumed, with per capita consumption of rice increasing from about 14.5 kg/person/year in 1999 to approximately 16.5 kg/person/year in 2010 (FAOSTAT 2012).

### ***24.1.2 Sustainable Intensification of Maize and Rice in Tanzania***

The cultivated areas of maize and rice and overall productivity by the year 2010 was three million ha at 1.5 t/ha and one million ha at 2.3 t/ha, respectively (MAFC 2010). This level of productivity could meet the demand of the two crops for 45 million people. It is expected, however, that the human population in the country will increase to 82 million by 2030 and reach 138 million by 2050. If it is assumed that there will be no diet changes and that it is projected that undernourishment will be reduced by half by 2030 and eliminated altogether by 2050 (based on the 2010 maize productivity), areas of maize cultivation should be expanded to approximately 6.38 million ha in 2030 and 12 million ha in 2050. If, however, maize productivity is increased to 5 t/ha, the required land will be 1.98 million ha in 2030 and 3.74 million ha in 2050.

Expansion of cropped areas is ultimately limited due to increased land-use pressure and is increasingly undesirable as it continues to degrade the environment under the current effects of climate change. The adverse impacts of climate change are already noticeable in the country, with frequent droughts, floods, and temperature increases, along with a dwindling supply of water (Rowahni et al. 2011). Total global greenhouse gas emissions are estimated at 49 billion t CO<sub>2</sub>eq, and agriculture contributes 26 % (IPCC 2007). There are large emissions due to land-use changes in agriculture. It is therefore undesirable to continuously expand arable land and thus to improve productivity within the same areas through intensification of agro-input use (e.g., fertilizer, pesticide, herbicides and better crop variety seed), as well as following up with improved agronomic practices. Smallholder farmers would like to increase maize and rice crop productivity but their efforts are hindered by a wide range of constraints. These include: (i) inadequate use of inputs such as fertilizer, improved seeds and crop protection. Indeed, the 2002/03 National Sample Census of Agriculture report indicated that the reasons for the low use of inputs were high prices (45 % of the farmers), lack of purchasing power (10.5 %),

and insufficient knowledge of the effects of inputs (7.9 %) and how to use them (7.8 %) (National Bureau of Statistics et al. 2006); (ii) inadequate access to information and extension services. Most farmers lack appropriate information about improved maize and rice varieties and agronomic practices due to the low levels of interaction with extension officers and other agricultural agents (WEMA 2010); (iii) erratic rainfall and frequent prolonged drought periods pose threats to maize and rice production (Rowahni et al. 2011).

### ***24.1.3 Sustainable Intensification Strategy for Maize and Rice Production in Tanzania***

Therefore the question is how to intensify agriculture on smallholder farms to provide more food for a growing population while conserving dwindling forests, wildlife and water. Opportunities for new and more sustainable agricultural investments and management choices that could also contribute to improved livelihoods and the reduction of poverty in rural communities are currently available through climate change mitigation and helping communities adapt to its impact. Opportunities for the increased use of inputs in Tanzania emanated from global food and inputs increases in 2008 that led the nation, with the assistance of the World Bank, to introduce the National Agricultural Inputs Voucher Scheme (NAIVS) (World Bank 2009). The NAIVS initially targeted the southern highlands regions, namely Iringa, Mbeya, Njombe, Ruvuma and Rukwa, which are seen as the “bread basket” of the country. The input vouchers included a 50 % subsidy to smallholder farmers for the prices of fertilizer and improved seeds estimated to be suitable for 0.5 ha of maize/rice crops. According to the World Bank (2009), a mixture of the fertilizers (32 kg N and 23.3 kg P<sub>2</sub>O<sub>5</sub>/ha) and improved seeds inputs were expected to raise the yields of maize and rice from 1.1 to 3.2 t/ha and 1.7–3.3 t/ha, respectively.

Faced with the aforementioned constraints of improving crop productivity and the increased demand for food by an increasing human population, intensification of agricultural production practices seems to be the proper way forward. Smallholder farmers therefore need a full amount of knowledge on how to improve maize/rice productivity (i.e., all inputs and how to use them appropriately). However, provision of discrete technological information on inputs and how to use them appropriately will not provide the sustainable profit margins necessary to motivate poor smallholder farmers to adopt new agricultural technologies (Foster and Rosenzweig 2010). Thus, an appropriate technological package to intensify crop production should strategically incorporate efficient agronomic practices such as soil and water management, weed and pest management, increased soil fertility exploitation and the use of improved crop seed varieties. These four agronomic practices, however, require skill and capital. A strong partnership between public technical advisory (both researchers and extensions) and agro-industries (both agro-input providers and agro-product processors) should therefore be the right vehicle to enhance crop productivity, especially of food crops, and thus reduce the vulnerability of rural communities, especially to the effects of climate

change. Such partnerships, especially of the Public–Private Partnership (PPP) model, are currently being encouraged by the Tanzanian government under its “Kilimo Kwanza” (*agriculture first*) strategy, and essentially within the recently launched Southern Agricultural Growth Corridor of Tanzania (SAGCOT).

This paper presents the results of a 3-year implementation of the public–private partnership model constituted by Sokoine University of Agriculture (SUA), Norwegian University of Life Sciences (UMB), Yara (an international fertilizer company) and Syngenta (an international plant protection inputs company) regarding smallholder maize and rice farmers in the Njombe, Mvomero, Morogoro and Kilombero districts. The partnership was initiated in December 2010, aimed at conducting research and demonstrating how to achieve sustainable intensification of maize and rice production among smallholder farmers in Tanzania, and specifically to show how to use appropriate agricultural inputs for increasing crop productivity, producing more food without expansions of agricultural land, and improving smallholder farmers’ household and income security.

## 24.2 Materials and Methods

### 24.2.1 *Description of the Study Area*

The study was conducted in the Morogoro, Mvomero and Kilombero districts in the eastern agricultural zone and in Njombe in the southern highlands zone (Table 24.1). Maize trials were established in the villages of Ibumila, Kichiwa, Welela and Matiganjola in the Njombe district and at the Sokoine University of Agriculture farm in the Morogoro Region. Typically, Njombe receives 1,200 mm of rainfall per year with a temperature range of 15–20 °C. The Sokoine University of Agriculture farm is located along the western part of the Uluguru Mountains and receives an average of 800 mm of rainfall per year with a temperature range of 20–33 °C. Rice trials were established in the Dihombo and Mkula villages, and the Dakawa Rice Research Institute farm. Dakawa and Dihombo are in the Mvomero district and Mkula is in the Kilombero district. The average annual rainfall in Dakawa, Dihombo and Mkula is 1,000 mm with a temperature range of 24–32 °C (Table 24.1).

### 24.2.2 *Reconnaissance Survey and Soil Sampling Before Planting*

Except for the two trials that were conducted at research stations (i.e., maize and rice plots at Sokoine University of Agriculture and Dakawa Rice Research Institute), all other demonstration plots were conducted within smallholder farmers’ fields. A reconnaissance survey and soil sampling was conducted on each farm before planting in order to establish baseline data of the soil’s

**Table 24.1** Locations and crops involved in demonstration trials

Region	District	Villages	Crops	Trials	Altitude (masl)
Morogoro	Mvomero	Dihombo	Rice	1	370
		Dakawa	Rice	1	370
		DRRI <sup>a</sup>	Rice	1	366
	Kilombero	Mkula	Rice	1	290
	Morogoro	SUA#	Maize	1	550
Njombe	Njombe	Ibumila	Maize	1	1,820
		Kichiwa	Maize	1	1,798
		Welela	Maize	1	1,793
		Matiganjola	Maize	1	1,791

<sup>a</sup>Dakawa Rice Research Institute; # Sokoine University of Agriculture

physical and chemical properties and to recommend the use of fertilizers according to plant nutrient deficiencies. Historical background of the farms was requested from the owners and recorded before soil sampling. The information recorded included how long the farm had been used, what types of crops were planted, if farm was irrigated or not, and if there was any fertilizer or plant protection input use. A free survey was conducted to discover the boundary and size of each farm. Important features of the farm such as landform, soil color and soil texture were observed in order to draw sampling units. At each sampling unit 10–15 points were selected in zigzag fashion, and at each point a pit of 60 × 60 cm was made and two soil samples were collected (one each in two sampling depths of 0–20 and 20–40 cm). Soils were air-dried, sieved through a 2 mm sieve, packed and sent to the soil laboratory at Yara International, Research Centre Hanninghof, Germany.

### 24.2.3 Treatments

Two treatments were included in each crop trial. These were: (i) farmers' practice (FP) and (ii) Yara/SUA/Syngenta (YSS) improved practices. The improved agricultural practices of the YSS included: (a) appropriate use of fertilizer, (b) crop protection through appropriate use of herbicides and pesticides, and (c) use of recommended improved maize/rice seed varieties for the locality. Fertilizers and plant protection application regimes for YSS and FP in maize and rice crop trials are shown in Tables 24.2, 24.3, 24.4 and 24.5.

### 24.2.4 Planting Patterns

Maize crops were planted at the beginning of the long rainy season in early December in Njombe and in early March in Morogoro for three consecutive years. Planting spaces were 90 cm by 30 cm for long maturity varieties





**Table 24.3** Plant protection application regimes for maize crops using YSS and Farmers' practices

Activity	Inputs		Time of application
	Yara/Syngenta/SUA (YSS)	Farmers' Practice (FP)	
Seed treatment	A seed treatment containing difenoconazole/thiamethoxam/metalaxyl-M at 10 g/4 kg seed	No seed treatment	Seed preparation during planting
Pre-emergence herbicide application	An atrazine/S-metalachlor mixture at 1.2 l/acre	No application. But 1st weeding 3rd week after planting with use of hand hoe	Just after planting
Insecticide application	Spray of lambda-cyhalothrin formulation to control stalk borers at 160 ml/acre	Spray of lambda-cyhalothrin formulation to control stalk borers @160 ml/acre	If symptoms of attack occur
Herbicide application	A paraquat formulation at 600 ml/acre	2nd weeding with use of hand hoe	10th week after planting

(120–150 days) and 75 cm by 30 cm for medium maturity varieties (90–110 days) at Njombe and Morogoro, respectively. Rice is usually grown twice per year at Dihombo and Mkula in August and March and harvested in December and June, respectively; at the Dakawa site, rice is grown once per year and is planted in March and harvested in July. Planting spaces for rice were 20 cm by 20 cm.

### 24.2.5 *Farmers' Field Days*

Farmers' field days were conducted before every crop harvest when the crops were just mature enough but not yet dry enough to harvest. All farmers, village leaders and extension staff in the villages were invited to the farmers' field days. The aim of the farmers' field days was to show how effective the improved crop production practices were compared with the normal farmers' practice methods. Usually on the farmers' field days the contact farmer in the presence of the researchers would explain step-by-step how she/he used improved crop production practices. Farmers' field days were chosen as the most cost-effective method of training agricultural technology since the invited farmers or communities could see the performance of the crops under improved agronomic practices. They were also used to encourage invited farmers to adopt technologies that had been adopted by fellow farmers.

### 24.2.6 *Harvesting the Crops*

During harvesting periods each treatment was demarcated into three sub-plots. Two sampling units were then fitted in each of the three sub-plots making a total of

**Table 24.4** Fertilizer application regimes for Yara/SUA/Syngenta (YSS) and Farmers' Practice (FP) in rice trials

Practice	Period of application	Kg/ha									
		Product	N	P <sub>2</sub> O <sub>5</sub> (P)	K <sub>2</sub> O	CaO	MgO	S	B	ZN	
YSS	Seedbed	Yara Mila Cereal	3.4	1.5	0.7	0	0	0.4	0	0	
YSS	Spray (4–6 leaves)	Yara Vita Tracel BZ	0.1	0.2	0.1	0	0.2	0.1	0.01	0.1	
	Tillering/booting	Yara Mila Java	54.3	14.8	30	0	0.4	7.0	0.5	0	
	Top dressing tillering/booting	Yara Liva Nitabor	9.5	0	0	15	0	0	0	0	
<b>Total</b>			102.3	31.5	39	15	0.9	12.1	1.0	0.6	
FP	Planting	None	0	0	0	0	0	0	0	0	
	Top dressing 12 days old	Urea	23 <sup>a</sup>	0	0	0	0	0	0	0	
<b>Total</b>			<b>23</b>	<b>0</b>	<b>0</b>	<b>0</b>	<b>0</b>	<b>0</b>	<b>0</b>	<b>0</b>	

<sup>a</sup>The rate for FP is tentative and may fluctuate depending on crop markets and/or readily available input subsidies

**Table 24.5** Plant protection application regimes for rice in YSS and Farmers' practices

Activity	Input application		Time of application
	YARA/SUA/SYNGENTA practice (YSS)	Farmers' Practice (FP)	
Seed treatment	A seed treatment containing difenoconazole/thiamethoxam/metalaxyl-M at 2.5 g/kg seed	No seed treatment	Seed preparation during planting
Herbicide application	A glyphosate formulation at 1 l/acre	No treatment	Clear weeds before cultivation
Herbicide application	A pyribenzoxim/pretilachlor mixture at 600 ml/acre	Hand weeding	2–3 weeks after transplanting
Insecticide application	A lambda-cyhalothrin/thiamethoxam mixture at 400 ml/acre	Application of Karate 5 EC @ 160 ml/acre	If symptoms of attack are noted
Fungicide application	A propiconazole/cyproconazole mixture at 200 ml/acre	No application of fungicide	If symptoms of attack are noted

six sampling units per treatment. Rice sampling units were just 1 m<sup>2</sup> while maize sampling units were lines 4 m long. The sampling units were placed in the middle of each sub-plot. After sampling, the farmers continued to harvest the rest of their crops. Two soil samples at 0–20 and 20–40 cm soil depth were collected in each crop sampling unit for physical and chemical analysis. In order to estimate nutrient removal, soils, crop grains and biomass samples were analyzed for Nitrogen, Phosphorus, Potassium and Sulphur. The parameters recorded for maize crops were: inter-row (between) and intra-row (within) spacing of the plants, number of plants per 4 m row (sampling unit), plant height, cob weight, cob length, grain yield (t/ha at 14 % MC), grain-specific weight (1,000 seed wt), stover biomass, (t DM/ha) and weed biomass/sampling areas. For the rice crops the parameters were: number of plants/m<sup>2</sup>, number of tillers/m<sup>2</sup>, tiller height, number of panicles/m<sup>2</sup>, grain yield (t/ha at 14 % MC), grain-specific weight (1,000 seed wt), and weed biomass/m<sup>2</sup>. However, in this article only grain and stover/straw biomass yield results will be discussed.

#### ***24.2.7 Fertilizer Rate Adjustment in Subsequent Season***

After the first crop harvest in 2011 the fertilizer rates were adjusted for the next season depending on crop removal. In the 2012 season the fertilizer rate was increased by 20 % at Kichiwa to compensate for the high removal of fertilizer through crop harvesting, while at Ibumila the rate was reduced by 20 % because the applied fertilizer in the previous season (2011) had low removal.

### **24.2.8 Management of Crop Residue**

After harvesting maize under farmers' practice, crop residues are fed to animals. In rice farms after threshing, rice straw is heaped in the fields and burnt to reduce bulk material that may interfere with cultivation in the next cropping season. Burning straw is also done to reduce or eradicate carriers of disease pathogens that may affect the next crop. At SUA and Dakawa, crop residues were incorporated in the soil after harvest.

### **24.2.9 Data Analysis**

The crop harvest data was handled and analyzed using Excel and a *t*-test was used to check if the difference between improved (YSS) and farmers' (FP) practices was significant. The soil's fertility status was interpreted using a handbook for soil survey and agricultural land evaluation in the tropics and subtropics by Landon (1991).

## **24.3 Results and Discussion**

### **24.3.1 Chemical Characteristics of Soils in the Study Sites**

Results of chemical characteristics of soils in **the** study sites are summarized in Table 24.6. In all Njombe sites, the soils had very low pH (<4.4 pH CaCl<sub>2</sub>), plant-available phosphorus (Bray 1 P) and mineralizable sulphur, while potassium, magnesium and micronutrients (boron, zinc and copper) were also at low levels (Landon 1991). Levels of total organic carbon and total nitrogen were also low (Landon 1991). These soils were depleted of plant nutrients and had a low capacity to hold nutrients. This was shown by very low soil pH and low organic carbon, a reddish color and a clayey texture. Soils in Njombe sites were therefore highly weathered, strongly acidic and inherently low-fertility sand clay and could benefit from the application of manure and incorporation of crop residue so as to improve soil structure and the recycling of plant nutrients (Bationo et al. 1998). Liming can also reduce exchangeable Al and Mn, which are likely to occur under waterlogging conditions in these soils. These soils require large amounts of fertilizer with major nutrients N, P and K plus moderate amounts of Ca, Mg, S and micronutrients in order to sustain high crop yields.

Soils at SUA were moderately acidic with very low plant-available P, low levels of S, Ca, Cu, B and Zn, and high levels of K and Mg (Table 24.6). Total N and organic carbon were at low levels (Landon 1991). The soil texture was clayey and reddish brown in color and could be rated as moderately fertile, but P-fertilization is crucial to maintaining a high crop yield.

**Table 24.6** Selected chemical properties of soils in the study sites before experiments

Site	Soil depth (cm)	pH (CaCl <sub>2</sub> )	Bray 1 P (mg/100 g)	K (mg/100 g)	Mg (mg/100 g)	Ca (mg/100 g)	N total (%)	N mineralized (kg/ha)	S mineralized (kg/ha)	Organic carbon (%)	Bo mg/kg	Zn mg/kg	Cu mg/kg
SUA	0-20	5.3	0.77	35.5	44.1	123.0	0.15	13.75	9.5	1.71	0.38	1.38	2.36
	20-40	5.2	0.54	25.8	43.1	120.79	0.13	10.78	9.37	1.49	0.32	0.98	2.45
Kichiwa	0-20	4.46	0.68	8.2	7.7	-	0.11	33.3	2.73	1.3	0.27	0.49	0.26
	20-40	4.33	0.33	6.4	6.5	-	0.07	29.1	3.05	0.92	0.18	0.13	0.13
1 bumila	0-20	4.14	0.64	6.4	2.05	-	0.08	31.6	4.7	1.0	0.14	0.33	0.24
	20-40	4.2	0.34	3.5	0.9	-	0.06	37.4	2.5	0.8	0.13	0.24	0.14
Welela	0-20	4.3	1.1	15.5	6.8	20.8	-	31.0	5.3	1.1	0.1	0.41	0.22
	20-40	4.4	0.3	13.0	6.0	16.5	-	16.5	5.1	0.8	0.1	0.01	0.12
Matiganjola	0-20	4.2	1.4	6.0	2.3	9.8	-	33.8	1.85	1.2	0.03	0.22	0.11
	20-40	4.3	0.6	4.8	2.0	9.5	-	15.0	2.33	0.8	0.03	0.01	0.09
Dakawa Research	0-20	5.3	1.3	13.4	50.5	164.6	-	20	26	1.4	0.18	0.8	4.2
	20-40	6.1	0.5	13.7	64.3	209.2	-	9	10	1.0	0.19	0.4	3.4
Dakawa	0-20	5.2	0.5	9.12	50	137.5	-	18	53	0.9	0.19	0.41	3.0
	20-40	7.1	0.3	5.7	65.2	164.77	-	9	40	0.2	0.32	0.13	2.1
Dihombo	0-20	7.67	1.19	3.54	27.28	-	-	20	6	1.75	0.2	1.36	3.24
	20-40	4.82	2.28	3.58	23.07	-	-	18	3	0.91	0.15	0.57	3.85
Mkula	0-20	4.4	0.28	3.30	49.84	98.5	0.21	28.85	38.6	-	-	-	-
	20-40	4.8	0.51	2.57	52.74	91.64	0.11	8.9	14.9	-	-	-	-

Soils at Dihombo and Mkula were slightly-to-moderately acidic with very low plant-available P and potassium. The soils of the two sites had moderate levels of mineralizable N and S and moderate levels of Mg and Ca. Generally, these soils can be rated as moderately fertile but need NPK fertilizers and good management of crop residue to sustain their production capacity.

Dakawa sites had moderately fertile soils. The top soils were slightly acidic while the sub-soils had pH ranging from neutral to slightly alkaline (Table 24.6). The higher acidity of top soils than sub-soils could possibly be due to (i) leaching of basic cations K, Ca and Mg because of frequent irrigation (sub-soils had higher levels of cations than top soils) and (ii) prolonged use of urea fertilizer, which has acidifying effects in soils. These soils had very low plant-available P and S and low levels of Zn while cations K, Mg and Ca were at sufficient levels.

Soils of rice fields were moderately fertile when compared to soils of maize fields in Njombe. Most soils in Njombe were found to have low levels of N, P and K, which could be associated with crop residue removal. Both maize and rice crop residues have high levels of N, P and K (Tables 24.14 and 24.16).

### 24.3.2 Maize Crop Performance

Total maize grain yields (t/ha at 14 % moisture content) including the rotten grain were persistently higher using YSS than FP treatment for all sites and years (Table 24.7). Higher grain yields under YSS than FP were explained by the quantity and quality of fertilizer used in YSS practice (Table 24.2). These fertilizers, composed of plant nutrients N, P, K, Ca, Mg, Cu and Zn, were applied according to the stage of plant development and plant demand. These gave balanced nutrients to the crop and maintained soils against degradation through the restoration of nutrients removed by crop harvest. The Ibumila village trial produced relatively lower amounts of grain in all treatments and years. In 2012 all sites except Ibumila produced nearly the same amount through YSS treatments, but in the following year Welela produced the highest amount of grain followed by Kichiwa. A higher yield of YSS than FP indicated that the soils were indeed poor in terms of available plant nutrients, and therefore farmers should know such important information and be trained on the

**Table 24.7** Mean maize grain yield (t/ha) at 14 % moisture content

Villages	2011		2012		2013	
	YSS	FP	YSS	FP	YSS	FP
Ibumila	3.81 <sup>a</sup>	0.85 <sup>b</sup>	2.9 <sup>a</sup>	2.54 <sup>a</sup>	4.29 <sup>a</sup>	1.11 <sup>b</sup>
Kichiwa	7.13 <sup>a</sup>	4.19 <sup>b</sup>	6.28	NR	7.90	6.21
Matiganjola	NR	NR	6.72 <sup>a</sup>	2.53 <sup>b</sup>	5.57 <sup>a</sup>	2.29 <sup>b</sup>
SUA	NR	NR	6.16 <sup>a</sup>	3.38 <sup>b</sup>	5.89 <sup>a</sup>	4.80 <sup>b</sup>
Welela	NR	NR	6.07 <sup>a</sup>	1.80 <sup>b</sup>	9.28 <sup>a</sup>	3.16 <sup>b</sup>

Means of YSS and FP in the same village and year with different superscripts are significantly different at  $P < 0.05$  according to *t*-test (two tails)

NR Not recorded

appropriate use of the required amounts of fertilizers in order to sustain their maize crop yields. The soils at the Ibumila site were strongly acidic, with low levels of plant nutrients and low cation-exchange capacity (CEC), which implied that the soil had low capacity to hold fertilizers. The situation in Ibumila could have been exacerbated by the release of exchangeable Mn (reduced from  $Mn^{4+}$  to  $Mn^{2+}$ ) and the release of toxic Aluminium ions ( $AlOH^{2+}$ ), processes that usually occur in strongly acidic soils under waterlogging conditions (Brady and Weil 2002), and which may have led to plant toxicity (Brady and Weil 2002) and thus less effectiveness of the fertilizer used, leading to low crop yields even under YSS treatment. The mean total yield of maize grain increased gradually with the years both in YSS and FP practices. This could be explained by the increased experience of farmers with the appropriate use of inputs. This was noted earlier in Zimbabwe as smallholder farmers gradually learn to adopt new farm practices (Mapiye et al. 2006).

Maize grain rotting was a major problem in most sites in the Njombe district, except in Welela village (Table 24.8). The village of Ibumila had the highest amount of grain rotting, especially in 2011 when the rotting reached 60 % of the produce in FP. However, in the following years rotting declined and by 2013 it was <10 % in Ibumila and just above 10 % in Kichiwa and Matiganjola. The cause of rotting could be due to maize variety and/or deficiency of certain plant nutrients that may have increased fungal attack in the maize grain; this needs further investigation.

After exclusion of the rotten grain, the grain yield showed a similar trend of higher yields in YSS than FP (Table 24.9). The yields under YSS in all sites and FP in some sites were higher than the national average of 1.5 ton/ha, implying that the cost of fertilizers was offset by the increased yield. If maize grain consumption in Tanzania is estimated at 74.5 kg/person/year (PASS 2012) then a family of six people will require about 0.5 t of maize grain per year. Therefore, the use of improved agronomic practices not only improves household food security but tremendously improves household income through sales of surplus grain, thus increasing the standard of life of the household. Regardless of village, mean grain production under both YSS and FP increased gradually from 2011 to 2013. The marketable maize grain of YSS increased by 112, 119 and 95 % over FP in 2011, 2012 and 2013, respectively. The overall mean of YSS for all 3 years is 5.4 t/ha, which could be produced by 3.6 ha using FP based on the mean national grain yield

**Table 24.8** Rotten maize grain (% of the total grain yield)

Villages	2011		2012		2013	
	YSS	FP	YSS	FP	YSS	FP
Ibumila	26b	61a	29	29	0.1 <sup>b</sup>	4a
Kichiwa	14a	5b	26	NR	4 <sup>b</sup>	11a
Matiganjola	NR	NR	7 <sup>b</sup>	10 <sup>a</sup>	4 <sup>b</sup>	13a
SUA	NR	NR	0	0	0	0
Welela	NR	NR	0	0	0	0

Means of YSS and FP in the same village and year with different superscripts are significantly different at  $P < 0.05$  according to t-test (two tails)

NR Not recorded



**Table 24.9** Marketable maize grain (t/ha at 14 % MC), excluding rotten grain

Villages	2011		2012		2013	
	YSS	FP	YSS	FP	YSS	FP
Ibumila	2.83 <sup>a</sup>	0.41 <sup>b</sup>	2.06 <sup>a</sup>	1.8 <sup>a</sup>	4.25 <sup>a</sup>	1.06 <sup>b</sup>
Kichiwa	6.1 <sup>a</sup>	3.98 <sup>b</sup>	4.67	NR	7.55 <sup>a</sup>	5.54 <sup>b</sup>
Matiganjola	NR	NR	6.34 <sup>a</sup>	2.27 <sup>b</sup>	5.37 <sup>a</sup>	1.99 <sup>b</sup>
SUA	NR	NR	6.16 <sup>a</sup>	3.38 <sup>b</sup>	5.89 <sup>a</sup>	4.8 <sup>b</sup>
Welela	NR	NR	6.07 <sup>a</sup>	1.8 <sup>b</sup>	9.28 <sup>a</sup>	3.16 <sup>b</sup>

Means of YSS and FP in the same village and year with different superscripts are significantly different at  $P < 0.05$  according to *t*-test (two tails)

NR Not recorded

**Table 24.10** Maize stover (without grain) (t/ha)

Villages	2011		2012		2013	
	YSS	FP	YSS	FP	YSS	FP
Ibumila	7.3 <sup>a</sup>	2.7 <sup>b</sup>	7.3 <sup>a</sup>	7.1 <sup>a</sup>	5.33 <sup>a</sup>	2.11 <sup>b</sup>
Kichiwa	10.9 <sup>a</sup>	7.7 <sup>b</sup>	15.4	NR	9.62 <sup>a</sup>	9.13 <sup>a</sup>
Matiganjola	NR	NR	14.2 <sup>a</sup>	4.84 <sup>b</sup>	6.8 <sup>a</sup>	3.25 <sup>b</sup>
SUA	NR	NR	11.63 <sup>a</sup>	6.2 <sup>b</sup>	7.80 <sup>a</sup>	5.92 <sup>b</sup>
Welela	NR	NR	11.16 <sup>a</sup>	3.0 <sup>b</sup>	10.86 <sup>a</sup>	6.91 <sup>b</sup>

Means of YSS and FP in the same village and year with different superscripts are significantly different at  $P < 0.05$  according to *t*-test (two tails)

NR Not recorded

of 1.5 t/ha. Thus, intensification of major staple food production can reduce the expansion of cultivatable areas and improve household food security.

Maize stover and cobs without grain are the most important grain yield components. The yields of these components were rather higher under YSS compared to FP in all trial sites (Table 24.10). The yields varied from 5.33 to 15.4 t/ha for YSS and 2.11–9.13 t/ha for FP. The variations could have been due to losses of over-dried maize leaves that might have been blown away by winds before harvest, or as a result of differences in seasonal, altitudinal and/or soil properties.

The results of the maize grain harvest index (HI) (i.e., the ratio of harvested grain to the total shoot dry matter yield) are summarized in Table 24.11. The HI values observed in this study in 2011 and 2012 at all sites were within the reported range of 0.4–0.6 by Linden et al. (2000). In 2013, the HI values were higher than those in preceding seasons. The higher the HI the better the yield.

### 24.3.3 Rice Crop Performance

Generally, regardless of season and site, the rice crop yields were higher under YSS than FP (Table 24.12). However, the difference between YSS and FP was not as high as for the maize crops. The small difference between YSS and FP in rice production

**Table 24.11** Maize harvest index = grain/total biomass

Villages	2011		2012		2013	
	FP	YSS	FP	YSS	FP	YSS
Ibumila	0.52 <sup>a</sup>	0.31 <sup>b</sup>	0.40	0.36	0.80 <sup>a</sup>	0.53 <sup>b</sup>
Kichiwa	0.65 <sup>a</sup>	0.54 <sup>b</sup>	0.41	NR	0.82 <sup>a</sup>	0.68 <sup>b</sup>
Matiganjola	NR	NR	0.47	0.52	0.82 <sup>a</sup>	0.71 <sup>b</sup>
SUA	NR	NR	0.53	0.55	0.76	0.81
Welela	NR	NR	0.54	0.60	0.85 <sup>a</sup>	0.46 <sup>b</sup>

Means of YSS and FP in the same village and year with different superscripts are significantly different at  $P < 0.05$  according to t-test

NR Not recorded

**Table 24.12** Rice grain yield (t/ha) at 14 % moisture content

Villages	2011		2012		2012		2013	
	Long rains		Short rains		Long rains		Long rains	
	YSS	FP	YSS	FP	YSS	FP	YSS	FP
Dihombo	8.23 <sup>a</sup>	7.76 <sup>a</sup>	8.9 <sup>a</sup>	8.87 <sup>a</sup>	7.64 <sup>a</sup>	6.14 <sup>a</sup>	7.00 <sup>a</sup>	6.68 <sup>a</sup>
Mkula	8.18 <sup>a</sup>	6.83 <sup>b</sup>	5.3 <sup>a</sup>	4.84 <sup>a</sup>	6.95 <sup>a</sup>	4.69 <sup>b</sup>	8.31 <sup>a</sup>	5.58 <sup>b</sup>
Dakawa	NR	NR	NR	NR	NR	NR	10.77 <sup>a</sup>	8.37 <sup>b</sup>
DRRI	NR	NR	NR	NR	7.32 <sup>a</sup>	5.33 <sup>b</sup>	8.30 <sup>a</sup>	7.73 <sup>a</sup>

Means of YSS and FP in the same village, season and year with different superscripts are significantly different at  $P < 0.05$  according to t-test (two tails)

NR Not recorded

could be due to the high paddy price it fetches: Tanzanian Shillings 800 per kg (0.51 US\$) compared to maize at Tanzanian Shillings 500/=per kg (0.32 US\$). The higher paddy price encouraged the farmers to apply fertilizers, thus lowering the difference between YSS and FP. Moreover, the rice sites were relatively naturally fertile compared to the maize sites (Table 24.6) and as a result showed little response to the fertilizers. The rice sites were located in lowlands and in flood plains with frequent flooding, therefore receiving fine fertile deposits from surrounding uplands; this explains the reason for high fertility in these sites. Both the YSS and FP mean grain yields were higher than the national mean rice production of 2.33 t/ha (MAFC 2010). The overall mean for YSS regardless of site and season was 7.8 t/ha, which would require 3.4 ha based on the national mean rice production. On average, the rice yield in Mkula was lower in both the short and long rainy seasons of 2012. This could be due to the incidence of plant diseases and pathogens; bacteria and fungi were noted in the area in 2012, but this was corrected in 2013.

The trend of rice straw yields (Table 24.13) followed that of grain yields. The highest straw yield was during the short rains of 2011 (16.27 t/ha) and the lowest was during the long rains of 2012 (6.63 t/ha). There was a rather small difference between YSS and FP in terms of rice straw yield.

**Table 24.13** Rice straw biomass (t/ha) at 14 % moisture content

Villages	2011		2012		2012		2013	
	Long rains		Short rains		Long rains		Long rains	
	YSS	FP	YSS	FP	YSS	FP	YSS	FP
Dihombo	16.27 <sup>a</sup>	13.05 <sup>b</sup>	11.14 <sup>a</sup>	10.48 <sup>a</sup>	13.72 <sup>a</sup>	9.48 <sup>b</sup>	8.02 <sup>a</sup>	7.26 <sup>a</sup>
Mkula	15.78 <sup>a</sup>	11.92 <sup>a</sup>	11.20 <sup>a</sup>	11.01 <sup>a</sup>	7.30 <sup>a</sup>	6.63 <sup>a</sup>	15.4 <sup>a</sup>	8.92 <sup>b</sup>
Dakawa	NR	NR	NR	NR	NR	NR	12.3 <sup>a</sup>	9.79 <sup>b</sup>
DRRI	NR	NR	NR	NR	10.93 <sup>a</sup>	7.14 <sup>b</sup>	8.79 <sup>a</sup>	7.49 <sup>a</sup>

Means of YSS and FP in the same village, season and year with different superscripts are significantly different at  $P < 0.05$  according to t-test (two tails)

NR Not recorded

### 24.3.4 Plant Nutrient Removal by Maize Grain and Stover

Nutrient balance did not account for the nutrient reserves in the soil and from roots after harvesting, but was based on the difference between nutrients applied and nutrients removed by shoots (grain and stover/straw). Since the amount of N applied in YSS practice was large (138 kg N/ha), high removals in these sites were associated with high grain yields. Most of the YSS-practice maize plots therefore had a negative N balance compared to FP practices (Table 24.14). The Ibumila site had no negative balance, which could be associated with limited plant nutrient uptake due to poor root growth caused by Mn toxicity. With respect to phosphorus balance, the results showed positive balance for YSS practice in all sites (Table 24.14), suggesting that the amount of P applied was sufficient. However, P balances under farmers' practice were negative at Kichiwa in 2011, Ibumila in 2012, Matiganjola in 2012 and SUA in 2012, showing depletion of soil reserves. The amount of P applied during planting under FP treatment in the form of DAP was only 5 kg P/ha at Njombe, and the amount was low in these strong acidic soils, whereby high amounts of applied P were retained in soils. This usually happens in such soils (Szilas 2002). In order to sustain high yields in such soils, elevated rates of P are required and the use of other soil amendments such as lime and manure improve P availability for the plants. Potassium balance was negative for both practices, and the higher the biomass the higher the removal of K (Table 24.14). More K is found in stover than in grain; therefore, K can be recycled into soils by incorporating crop residues into the soil. This practice should be encouraged because even where K was applied as fertilizer it was not sufficient for plant demand and thus most of it was taken up from soil reserves. These will ultimately lead to soil degradation through nutrient mining.

Nutrient removal by grain only (Table 24.15) showed positive nutrient balance for N, P and K. These results show that if crop residues are not removed from the fields' nutrient mining to a large extent, especially with respect to K (Table 24.15), will be reduced to a large extent. However, under farmers' practice or a low input system, even if the crop residues are recycled there still will be a negative nutrient

**Table 24.14** Nutrient balance (inorganic fertilizer inputs minus total removal) under the two practices in maize crops

Practice	N applied	N total removal	Balance	P applied	P total removal	Balance	K applied	K total removal	Balance	S applied	S total removal	Balance
Kichiwa 2011												
YSS	138	141.2	-3.2	30	24.2	5.8	28	134.6	-106.6	18	11	7
FP	69	97.3	-28.3	5	13.6	-8.6	0	119.0	-119	0	7.8	-7.8
Kichiwa 2012 (2011 + 20 % of previous rate)												
YSS	165.6	153	12.6	36	14.9	21.1	33.6	251	-217.4	21.6	12	9.6
FP	69	14.9	54.1	5	3.1	1.9	0	14.1	-14.1	0	1.3	-1.3
Ibumila 2012 (YSS Inputs (2011 – 20 % of previous rate))												
YSS	110.4	73.8	24	24	10.5	13.5	22.4	100.6	-78.2	14.4	8	6.4
FP	69	57.5	5	5	8.1	-3.5	0	94.9	-94.2	0	5.3	-5.4
Ibumila 2011 (Only stover)												
YSS	138	59.8	78.2	30	5.7	24.3	28	142	-114	18	6.5	11.5
FP	69	16.1	52.9	5	3.6	1.4	0	87	-87	0	4.1	-4.1
Welela 2012												
YSS	138	139.7	-1.7	30	15.7	14.3	28	265.5	-237.5	18	13.3	4.7
FP	69	28.7	40.3	5	2.3	2.7	0	59.6	-59.6	0	2.8	-2.8
Matiganjola 2012												
YSS	138	147.5	-9.5	30	15.1	14.9	28	207.7	-179.7	18	13.4	4.6
FP	69	51.8	17.2	5	6.1	-1.1	0	72.8	-72.8	0	4.9	-4.9
SUA 2012												
YSS	138	188	-50	30	18.1	11.9	28	260.8	-232.8	18	13.1	4.9
	0	75.3	-75.3	0	10.4	-10.4	0	106	-106	0	7.0	-7

Nutrient balance = Nutrients applied – Nutrient removed in maize shoot

**Table 24.15** Nutrient balance (fertilizer inputs minus grain removal) under the two practices in maize crops

Practice	N applied	N removal	Balance	P applied	P removal	Balance	K applied	K removal	Balance	S applied	S removal	Balance
Kichiwa 2011												
YSS	138	98.4	39.6	30	20.3	9.7	28	24.4	3.6	18	7.1	10.9
FP	69	97.3	-28.3	5	13.6	-8.6	0	119.0	-119	0	7.8	-7.8
Kichiwa 2012 (2011 + (20 % of previous rate))												
YSS	165.6	73.7	91.9	36	13.0	23.0	33.6	15.5	18.1	21.6	5.4	16.2
FP	69	9.45	59.55	5	1.92	3.08	0	2.0	-2.0	0	0.76	-0.76
Ibumila 2012 (YSS Inputs 2011 – 20 % of previous rate)												
YSS	110.4	32.0	78.0	24	5.6	18.4	22.4	7.5	14.9	14.4	8	6.4
FP	69	57.5	5	5	8.1	-3.5	0	8.7	-8.7	0	2.8	-2.8
Ibumila 2011 (Only stover)												
YSS	138	59.8	78.2	30	5.7	24.3	28	142	-114	18	6.5	11.5
FP	69	16.1	52.9	5	3.6	1.4	0	87	-87	0	4.1	-4.1
Welela 2012												
YSS	138	76.1	61.9	30	11.2	18.8	28	14.8	13.2	18	6.2	11.8
FP	69	15	54	5	1.6	3.4	0	2.4	-2.4	0	1.0	-1.0
Matiganjola 2012												
YSS	138	75.9	62.1	30	10.5	19.5	28	16.0	12.0	18.0	6.0	12.0
FP	69	25.8	43.2	5	4.1	0.9	0	6.3	-6.3	0	2.0	-2.0
SUA 2012												
YSS	138	94.1	43.9	30	12.8	7.2	28	14.6	13.4	18.0	6.6	11.4
	0	44.4	-44.4	0	7.3	-7.3	0	8.6	-8.6	0	3.5	-3.5

Nutrient balance = Nutrients applied – Nutrient removed in maize grain

balance. This is because even the residues under such practice have insufficient plant nutrients to restore positive balance in the field. These results therefore show that nutrient inputs are crucial not only for higher yields but also for preventing land degradation.

### ***24.3.5 Plant Nutrient Removal by Rice Grain and Straw***

Removal of nitrogen and phosphorus by both rice straw and grain resulted in negative balances at all sites for both YSS and farmers' practices (Table 24.16). These results implied that large rates of N (110 kg/ha), P (15 kg/ha) and K (32 kg/ha) applied under YSS practices were not satisfactory enough to offset negative nutrient balances. This could be due to high plant uptakes of nutrients through both the straw and grain. There is a possibility that some proportion of fertilizer applied to soil was not available to plants because of certain processes in soil, such as leaching, erosion and conversion to less soluble forms, especially phosphorus. Moreover, regular flooding in rice fields may lead to loss of fertilizer due to water flow, especially in irrigated fields. This is a big challenge for fertilizers and other inputs among irrigated rice. Actually, inefficient application of nitrogen fertilizers in rice production systems promotes the release of nitrous oxide, one of the most important greenhouse gases. The problem is currently being solved in DRRI by building strong sub-plot banks in order to control water flow.

However, positive nutrient balances for N and K under YSS practice were obtained when straw removal was not considered (Table 24.17), suggesting that if straw could be incorporated into soils it will restore nutrients in the field. Phosphorus balances were negative for both practices even if removal was through grain alone, showing that most of the P applied was not available to plants, though some of it was probably retained in the soils. Under farmers' practice the nutrients N, P and K had negative balances at all sites. These results indicate that planting crops without nutrient inputs leads to nutrient mining from soil reserves, which may lead to land degradation. In addition, smallholder rice farmers normally burn their rice crop straw after harvest, thus increasing K deficiency in their rice field soil. Moreover, burning crop residues such as straw contribute to greenhouse gas emission as rice cultivation is an important sequester of carbon dioxide from the atmosphere.

Reports have showed that continuous and intensive cropping without restoration of the soil fertility depletes the nutrient base of most soils (Zingore 2012). Therefore, any move to improve and sustain agricultural growth must depend upon improved soil productivity rather than on expansion of areas under cultivation. The soil fertility in intensified farming can only be maintained through integrated plant nutrient management with efficient recycling of organic materials such as crop residue, compost or manure in combination with mineral fertilizers. Furthermore, studies have shown positive interaction between fertilizer and

**Table 24.16** Nutrient balance (inorganic fertilizer inputs minus total removal) under the two practices in rice crops

Site	Practices	N applied	N total removal	N balance	P applied	P total removal	P balances	K applied	K total removal	K balances
Dakawa	YSS	110	132.4	-22.4	15	26.9	-11.9	32	232.9	-209
	FP	63	90.3	-27.3	0	20	-20.0	0	157.8	-157
Dihombo	YSS	110	142.9	-32.9	15	31.7	-16.7	32	233.2	-207.2
	FP	63	103.1	-40.1	0	24.6	-24.6	0	147	-147
Mkula (Nov. 2011)	YSS	110	164	-54	15	48.5	-33.5	32	272.4	-240.4
	FP	63	134.3	-61.3	0	40.1	-40.1	0	216.3	-216.3
Mkula (July 2012)	YSS	110	102.5	7.5	15	26.1	-11.1	32	119.4	-87
	YSS	63	87.1	-24.1	0	23	-23	0	145.4	-147

Nutrient balance = Nutrients applied – Nutrient removed in rice shoot

**Table 24.17** Nutrient balance (fertilizer inputs minus nutrient removal by grain) under the two practices in rice crops

Site	Practices	N applied	N removal	N balance	P applied	P removal	P balances	K applied	K removal	K balances
Dakawa	YSS	110	75.2	34.8	15	16.7	-1.7	32	20.6	11.4
	FP	63	50.8	12.2	0	11.8	-11.8	0	15.1	-15.1
Dihombo	YSS	110	76.7	33.3	15	17.9	-2.9	32	20.9	11.1
	FP	63	58.6	4.4	0	14.1	-14.1	0	16.9	-16.9
Mkula (Nov 2011)	YSS	110	85.15	24.85	15	21.11	-6.11	32	26.5	5.5
	FP	63	76.6	-13.6	0	19.5	-19.5	0	24.9	-24.9
Mkula (July 2012)	YSS	110	68.4	41.6	15	17.4	-2.4	32	17	15
	FP	63	46.2	38.8	0	12	-12	0	13.3	-13.3

Nutrient balance = Nutrients applied – Nutrient removed in rice grain



manure, with the benefits of manure increasing productivity while decreasing soil fertility (Zingore et al. 2008; Mtambanengwe and Mapfumo 2005).

Maintaining soil's organic matter through incorporation of crop residues or application of animal manure is a key component of sustainable land use management (Buresh et al. 1997). Organic matter acts as a source for plant nutrients. Other important benefits resulting from the maintenance of soil's organic matter in low-input agro-ecosystems include retention and storage of nutrients, increasing buffering capacity in low-activity clay soils, and increasing water-holding capacity.

## 24.4 Lessons Learned

Under farmers' practice, fertilizers are not applied adequately, and in some cases are not applied at all. When applied, the fertilizers used were composed of N and P in DAP and N only in urea, while other plant nutrients such as K, Ca, Mg, S, Zn, B and Mo were not applied. Plants obtained these nutrients from soil reserves. This practice produces very low yields and leads to nutrient mining, which in turn leads to soil deterioration and a reduced soil capacity to support good yields. The condition becomes worse if the crop residues are not incorporated into the soil to replenish some of the nutrients removed from the soil by crop harvesting. The results from this study as in other studies showed that crops remove large quantities of N, P, K and S (Zingore et al. 2008; Mtambanengwe and Mapfumo 2005). Using low input systems, in addition to small amounts of inorganic fertilizers, farmers should be encouraged to incorporate crop residues and, wherever possible, the use of animal manure. Furthermore, for acidic soils with low fertility, such as those in Njombe, incorporation of crop residue and manure is a prerequisite for good soil management and to improve carbon stock in soils, to replenish plant nutrients and to improve soil structure and sustain crop yields.

## 24.5 Conclusions and Recommendations

The results from this study have demonstrated that: (i) Smallholder farmers can increase productivity of maize and rice with optimal inputs; (ii) Improved agronomic practices can be designed to facilitate sustainable intensification of maize and rice (staple food crops for millions of people) and thus reduce expansion of cultivated land, leading to more conservation of natural resources under the effects of climate change; (iii) Farmers' livelihoods can be strengthened, enabling greater flexibility in cropping and ensuring more income expenditure in acquiring agricultural inputs; (iv) Since maize and rice crop residues have high levels of N, P and K, it is recommended that, with intensification, crop residues should be incorporated into the soil of the same field so as to avoid heavy soil mining of plant nutrients; (v) Njombe soils are strongly acidic and inherently low in fertility (sandy clay), so

the recommended management of these soils could be liming in order to reduce exchangeable Al and Mn, which are likely to occur under waterlogging conditions. Application of manure and incorporation of crop residues are highly recommended in order to improve soil structure and the recycling of plant nutrients. The results from this study suggest that there is a need to: (i) carry out further studies on the effects of intensification on the environment and biodiversity, and (ii) create workable plans to advance these results to wider parts of the country.

## References

- Ahmed SA, Diffenbaugh NS, Hertel TW, Lobell DB, Ramankutty N, Rios AR, Rowhani P (2009) Climate volatility and poverty vulnerability in Tanzania. Policy Research Working Paper 5117. World Bank, Washington, DC
- Bationo A, Lompo F, Koala S (1998) Nutrient balance as indicator of production and sustainability in Sub-Saharan African agriculture. *Agric Ecosyst Environ* 71:19–36
- Brady NC, Weil RR (2002) The nature and properties of soils, 13th edn. Prentice-Hall, 2012 Google, 960 pp
- Buresh RJ, Smithson PC, Hellums DT (1997) Building soil phosphorus capital in Africa. In: Buresh RJ, Sanchez PA, Calhoun F (eds) Replenishing soil fertility in Africa. *Soil Sci Soc Am; Spec Publ* 51:1–46
- FAOSTAT (2012) The Food and Agricultural Organization's statistical database. Land use area database. Available online at <http://faostat.fao.org/site/377/DesktopDefault.aspx?PageID=377#ancor>
- Foster AD, Rosenzweig MR (2010) Microeconomics of technology adoption. Center Discussion Paper No. 984. Economic Growth Center, Yale University, New Haven
- IPCC (2007) Climate change 2007: impacts, adaptation and vulnerability. Contribution of Working Group II to the fourth assessment report of the Intergovernmental Panel on Climate Change. Parry ML, Canziani OF, Palutikof JP, van der Linden PJ, Hanson CE (eds), Cambridge University Press, Cambridge, 976pp
- Landon JR (1991) Booker tropical soil manual: a handbook for soil survey and agricultural land evaluation in the tropics and subtropics. Wiley, New York, 474 pp
- Linden DR, Clapp, CE, Dowdy, RH (2000) USDA-ARS and Department of Soil, Water, and Climate, University of Minnesota, 439 Borlaug Hall, 1991 Upper Buford Circle, St. Paul, MN 55108, USA. Received 15 November 1999; received in revised form 17 April 2000; accepted 22 June 2000. Soil and Tillage research [www.elsevier.com/locate/still](http://www.elsevier.com/locate/still). Visited in October 2013
- MAFC (Ministry of Agriculture, Food and Cooperative) (2010) Overview of crop production in Tanzania, Government Printer, Dar es Salaam, Tanzania
- Mapiye C, Foti R, Chikumba N, Poshiwa X, Mwale M, Chivuraise C, Mupangwa JF (2006) Constraints to adoption of forage and browse legumes by smallholder dairy farmers in Zimbabwe. *Livest Res Rural Dev* 18(12). <http://www.lrrd.org/lrrd18/12/mapi18175.htm>
- Mtambanengwe F, Mapfumo P (2005) Organic matter management as an underlying cause for soil fertility gradient on smallholder farms in Zimbabwe. *Nutr Cycl Agroecosyst* 73:227–243
- National Bureau of Statistics, Ministry of Agriculture and Food Security, Ministry of Water and Livestock Department, Ministry of Cooperatives and Marketing & Presidents Office Regional Administration and Local Government Ministry of Finance and Economic Affairs – Zanzibar (2006) National sample census of agriculture 2002/2003, Government Printer, Dar es Salaam, Tanzania
- PASS (2012) Private agricultural sector support: investment potential in grain. <http://www.pass.ac.tz/investmentpotential.html>

- RATES (2003) Maize market assessment and baseline study for Tanzania. Regional Agricultural Trade Expansion Support Program (RATES), Nairobi
- Rowahni P, Lobell DB, Lindermanc M, Ramankuttya N (2011) Climate variability and crop production in Tanzania. *Agr Forest Meteorol* 151:449–460
- Szilas C (2002) The Tanzania Minjingu phosphate rock: possibilities and limitation for direct application. Thesis for award of PhD at Chemistry Department, Royal Veterinary and Agricultural University, Copenhagen, Denmark, pp 175
- USAID/COMPETE (2010) United States Agency for International Development (USAID) and the competitiveness and trade expansion program. Staple foods value chain analysis: country report: Tanzania. Prepared by Chemonics International Inc.
- USDA (2012) United States Agency for International Development review of policy constraints on competitive East Africa Community rice production. <http://agritrade.cta.int/en/layout/set/print/Agriculture/Commodities>. Visited 21 Oct 2013
- WEMA (2010) Mitigating the impact of drought in Tanzania: the WEMA intervention. Policy brief. Water efficient maize for Africa (WEMA). <http://www.aatf-africa.org/userfiles/WEMA-Tz-policy>. Visited 20 Oct 2013
- World Bank (2009) Accelerated food security program of the United Republic of Tanzania under the global food crisis response program. World Bank, Report No: 48549-Tanzania
- Zingore S (2012) Maize productivity and response to fertilizer use as affected by soil fertility variability, manure application and cropping system. Tropentag, Gottingen-Kassel/Witzenhansen, September 19–21, 2012. Resilience of Agricultural Systems Against Crises. <http://www.tropentag.de/2012/abstracts/link/zingore>. Visited 29 Dec 2013
- Zingore S, Nyamangara J, Delve RJ, Giller KE (2008) Multiple benefits of manure: the key to maintenance of soil fertility and restoration of depleted sandy soils on African smallholder farms gradients on African smallholder farms. *Nutr Cycl Agroecosyst* 80:267–282

## Chapter 25

# Smallholder Adaptation to Climate Change in Semi-arid Areas of Tanzania: Experiences from Iramba and Meatu Districts

Gry Synnevåg, Samwel J. Kabote, Carolyn I. Nombo, Delphina Mamiro, and Amon Z. Mattee

**Abstract** A study of the impact over the past 30 years of climate variability and change on smallholders' farming systems and adaptation strategies was conducted in three villages of Iramba and Meatu Districts, Tanzania. Both districts involved in the study lie within a semi-arid zone. Crop failure and food insecurity are common characteristics to all three villages in the study. Personal descriptions of climate change and meteorological data confirmed that rainfall patterns have become increasingly inconsistent and unpredictable and that the length of dry spells has increased. Crop growing seasons have been shortened by 1 month or more. The availability of ground water, particularly from rivers, has increasingly become seasonal, compared to the situation in the 1970s and 1980s. These results have all impacted negatively on rain-fed agriculture and livestock production systems and increased the vulnerability of smallholder livelihoods, because of their high dependency on natural resources. Almost 80 % of the households in both study areas were characterized as poor. Households are becoming increasingly vulnerable to multiple factors including drought, price fluctuations, increased population pressure, loss of soil fertility and decreased productivity, scarcity of farm and grazing land, water and fuel wood shortages, loss of 'ngitiri', increased conflicts over pastures, crop and livestock diseases, male out-migration, and increased labor burdens on women. Responses to climate change impacts varied by the socioeconomic condition of households and gender. Coping and adaptation mechanisms to which farmers have resorted include selling labor, land leasing, shifts in crop and livestock systems, use of early maturing, drought and disease resistant varieties, small scale irrigation systems, gardening, increased use of crop residues as animal feed, diversification to off farm activities, and petty trade.

---

G. Synnevåg (✉)

Department of International Environment and Development, Studies, Noragric,  
Norwegian University of Life Sciences, 1432 Ås, Norway  
e-mail: [gry.synnevag@nmbu.no](mailto:gry.synnevag@nmbu.no)

S.J. Kabote • C.I. Nombo • D. Mamiro • A.Z. Mattee  
Development Studies Institute, Sokoine University of Agriculture,  
P. O. Box 3024, Morogoro, Tanzania

**Keywords** Climate change impact and adaptation • Gender • Smallholder livelihoods

## 25.1 Introduction

One third of the land area in Tanzania is located in the semi-arid agro-ecological zone, in which mean annual rainfalls fluctuate between 400 and 900 mm. Semi-arid agro-ecological zones are characterized by erratic and low mean annual rainfall. Drought, inadequate soil moisture, soil infertility, higher day time temperatures, and evaporation rates that exceed precipitation rates are also common in these areas (Senkondo et al. 2004; Vette 2009; Mongi et al. 2010). Agriculture and agro-pastoralism are major farming systems, and 95 % of the agriculture is rain fed. According to IPCC (2007) and Sarr (2012), semi-arid areas are most affected by climate change.

Many studies on climate variability and climate change in Sub-Saharan Africa, and in Tanzania more specifically, have been undertaken (Galvin et al. 2001; Paavola 2008; Lema and Majule 2009; Mongi et al. 2010; Swai et al. 2012; Juana et al. 2013; Legesse et al. 2013). Lyimo and Kangalawe (2010) analyzed rainfall variability for the period between 1974 and 2005 in semi-arid areas of Shinyanga Rural District in Tanzania and reported no significant decrease over time. Lema and Majule (2009) reported decreasing measured rainfall and increasing temperature for the period between 1922 and 2007 in Manyoni, another semi-arid area in Tanzania.

Climate change is, however, not just an environmental issue. It is also a human issue because it impacts livelihoods and numerous communities are threatened by it. While the exact nature and extent of climate change impacts on temperature and rainfall distribution patterns remain uncertain, it is the poor and vulnerable who will be the most susceptible to them. This is especially true for households who rely largely or totally on rain-fed agriculture and natural resources for their livelihoods. Production uncertainty associated with between and within season rainfall variability remains a fundamental livelihood constraint for many communities, and climate change is likely to increase their vulnerability due to increases in rainfall variability and uncertainty.

Small scale farmers in semi-arid areas have developed coping and adaptation strategies to deal with climate variability and associated climatic extremes. These strategies introduce flexibility in agricultural practices and regimes for access to natural resources. They focus on diversity and draw upon social networks for implementation. Increasing climate risk is affecting those strategies and the effects are particularly dramatic when they are added to existing stresses on production systems, such as price volatility for inputs and commodities, population pressure, land scarcity, and social and political conflict. Social, economic, and environmental factors define the situation people confront. Thus, they affect vulnerability levels and capacity to adapt. Smallholder subsistence farming is predominantly a woman's task (FAO 1996) and rural women farmers are affected differently than male farmers.

They respond differently to climate change, depending on culture and socio economic group. The gender and socio economic dimensions of adaptation to climate change impacts and the capacity to adapt has, however, not been significantly addressed, and women are rarely involved as important agents and active participants in adaptation activities (Nombo et al. 2013).<sup>1</sup>

In this article we address relationships between farmers' perception of climate change over the last 30 years, related variables measured using meteorological data, the impact of the climate change on farming systems and food security, and small scale farmers' adaptation strategies. We conclude with some policy guidelines for adaptation to climate change in semi-arid areas of Tanzania based on our analyses.

## 25.2 Study Area

The study was conducted in Meatu District in Simiyu Region.<sup>2</sup> Mean annual rainfall in Meatu varies between 400 and 900 mm in the district southern and northern zones. Being farmers and agro-pastoralists, the Sukumas began migrating to and settling in the area in 1966. Meatu is regarded as the poorest district in Simiyu region. More than 40 % of the population live below the basic need poverty line. Eighty-seven percent of the Meatu population is employed in the agriculture sector. Two villages were selected for the study, namely, Mwamanimba located in the southern zone, and Mshwata located in the northern zone. In Mwamanimba, farmers pursue a sorghum/cotton crop production system. They also practice agro-pastoralism, and rely on income from livestock. Farmers in Mwashata, in the highest rainfall zone, are more dependent on agriculture and mainly on crop production. A maize/cotton crop production system predominates. The dominant ethnic group in both villages is Sukuma. Members of this group constitute 95 % of the Mwamanimba population and 75 % of the Mshwata population.

Iramba District, on the other hand, is divided into three major agro-ecological zones, namely, the Western Great East African Rift Valley, the Central highland, and the Eastern zone. The former zone is relatively drier (Iramba District Council 2009). Generally, the district receives a mean annual rainfall of between 500 and 850 mm. The village selected for the study, Kidaru, lies in the Western zone and the major crop production system is millet/sorghum. The main ethnic group in this region is Nyiramba.

---

<sup>1</sup> In this paper, we report on the research findings for a project entitled, "A gendered analysis of climate change impact and adaptation on dry-land farming systems and natural resources management" which began in 2011 as a part of the more comprehensive NORAD-funded program at Sokoine University of Agriculture. The main objective of this study was to determine gender differentiated impacts of climate change on rural livelihoods in semi-arid areas of Tanzania and small scale farmers' adaptation strategies.

<sup>2</sup> Before 2011/12 the district was part of (Shinyanga Region), and in Iramba District in Singida Region.

In both districts the rainfall regime is mainly unimodal, and 80 % of the population are agro-pastoralists depending on crop production and livestock as their main economic activity for food and income. The seasons are determined by rainfall, being divided into a 'wet/rainy' season that runs from November to May, with a dry spell in February and heavier rains falling from March to May, and a 'dry' season that runs generally June to October/November. Both districts involved in the study lie within a semi-arid zone, and climate variability and unpredictability have a major impact on people's livelihoods. Crop failure and food insecurity are common characteristics to all three villages in the study.

### 25.3 Methodology

Climate variability and change were assessed using quantitative data and qualitative information. Rainfall meteorological data from 1994 to 2011 was collected from Tanzania Meteorological Agency (TMA). In Iramba, the data were from Kiomboi administrative station, while in Meatu the data were an average from two stations, one situated at Mwandoya and the second one situated at Mwanhuzi. The analysis of meteorological data focused on trends of mean monthly rainfall within the November–April growing period. The study measured changes in rainfall patterns by comparing their deviation from the seasonal mean.

Farmers' perceptions were obtained through focus group discussions (FGDs) and key informant interviews were conducted. The composition of the sample for this study is found in Table 25.1.

Using a structured questionnaire, the study used a household survey to collect additional quantitative data on farmers' perception of climate variability and change. Systematic random sampling was used to select 388 households (HH) as shown in Table 25.2

**Table 25.1** Information on FGDs and participants involved

Village name	Number of FGDs conducted	Number of male participants	Number of female participants	Mean age (years)	Maximum age (years)	Minimum age (years)
Kidaru	3	6	9	44	60	25
Mwashata	2	10	14	42	63	29
Mwanimba	2	13	11	49	68	31
Total	7	29	34			

**Table 25.2** Households involved in the survey

Village name	Total number of households	Selected households	Selected households (%)	Women involved (%)
Kidaru	444	142	32	42
Mwashata	462	145	31	30
Mwanimba	315	101	32	43
Total	1,201	388	32	39

A 1–5 point scale was used to measure perception of climate variability and change. The variables measured were: (i) frequency of floods, (ii) rainfall unevenness, (iii) rainfall predictability, (iv) strength of winds, (v) daytime temperatures, and (vi) nighttime temperatures. Others were: (vii) frequency of droughts, (viii) prevalence of crop diseases, (ix) prevalence of livestock diseases, and (x) prevalence of crop insect pests. Farmers' perceptions and meteorological data on rainfall patterns and trends of bad years were compared.

Trends of bad years were assessed using a timeline approach. The variables of interest were change in rainfall pattern (onset and end), change in the February dry spell, change in length of the dry season, changes water levels of ponds, lakes, etc., change in amount of rainfall and trends of bad years. In addition historical timelines and resource mapping were accumulated based on interviews with groups consisting of different gender and age.

The household survey was used to collect data on the impact of climate change on farming systems, management of natural resources, household food and nutrition security, and small scale farmer coping and adaptation strategies. Although the main aim was to examine the influence of climate change on farming systems, other drivers for the changes were also explored.

The number of months of adequate household food provisioning (MAHFP) was used to measure the level of food security. MAHFP scores are a measure of the number of months during the previous year a household, or group of households, was able to obtain adequate food resources to maintain normal health and activity (Bilinsky 2010).

## 25.4 Results

### 25.4.1 *Climate Change in Meatu and Iramba Districts – Farmers' Perception*

During the focus group discussions, farmers explained that the rain stopped falling in February for 2–4 weeks even in a good year. They also noted that during other months of the year, rainfall would fluctuate consistently, but would never stop for longer than 1 week at a time.

Farmers' perceptions regarding changes in rainfall patterns from the 1970s to the present are found in Tables 25.3 and 25.4. Data in Table 25.3 suggest a change in the onset of rainfall from September/October to November/December, and the end of rainfall from May/June to April/May, shortening the growing period in the villages of Meatu by approximately 2 months.

Data in Table 25.4 suggest that the dry spell, occurring earlier in February, has expanded in each of the villages. According to the farmers, the length of the dry period in the 1970s lasted from June/July to September/October; now it lasts from May to November/December, indicating a longer dry season.



**Table 25.3** Change in onset and end of rainfall

Village	1970		2013	
	Onset	End	Onset	End
Kidaru	November/ December	May/June	November/ December/January	March/April/May
Mwashata	September/ October	May/July	November/December	April/May
Mwanimba	September/ October	May/June	December	April/May

**Table 25.4** Change in February dry spell and dry season

Village	Dry spell		Dry season	
	1970	2013	1970	2013
Kidaru	1 month	More than 1 month	June–October	May–December
Mwashata	8 days	2 weeks to 1 month	July–September	May–December
Mwanimba	8 days	1 month	June–October	May–November

The results from the household survey show that the frequency of droughts and rain fall unpredictability has greatly increased (Table 25.5). Respondents also confirmed that day and night temperatures have increased since the 1970s.

The results from the survey also indicated that the amount of rainfall has decreased, and frequency of bad years has increased, particularly since 2000. River flows of water have increasingly become seasonal.

### 25.4.2 Meteorological Data

Below, meteorological data are used to assess past and current rainfalls patterns for the two districts studied. Data for monthly rainfall 2009–2011 was only available for Meatu district. Data in Tables 25.6 and 25.7 represent monthly and seasonal means of mm rainfall measured from November to April for the period 1994–2011. The data do not show a clear trend of decreasing rainfall during the period, but indicate reduced rainfall in January compared to the past. The result was in line with people's perceptions, which suggested that the dry spell that used to occur in February had extended to January, and that the growing season had decreased. A study conducted by Mongi et al. (2010), which analyzed meteorological data at the regional level in Tabora,<sup>3</sup> Tanzania, for a 35-year period (1973–2008), also reports that the duration and frequency of the February dry spell has increased with implications for crop production and food security.

<sup>3</sup> This borders Singida and Shinyanga regions and some parts of the Tabora Region are found in semi-arid zone.

**Table 25.5** Perceived climate variability and change compared to the situation in the past 30 years in percentages (n = 388)

Perceived climate change variables	Percentage responses					Descriptive statistics
	Greatly decreased	Moderately decreased	No change	Moderately increased	Greatly increased	Median score
Frequency of flood	22	11	60	6	2	3
Rainfall unevenness	13	18	5	33	32	4
Rainfall unpredictability	10	12	4	28	47	4
Greater wind velocity	11	13	15	29	32	4
Higher day temperature	3	11	4	37	46	4
Higher night temperature	3	10	7	41	40	4
Crop disease prevalence	5	13	10	36	35	4
Livestock disease prevalence	8	16	11	39	27	4
Insect crop pests prevalence	8	16	8	37	31	4

Scores: Greatly decreased (1 score); Moderately decreased (2 scores); No change (3 scores); Moderately increased (4 scores); and Greatly increased (5 scores)

Meteorological data from Iramba shows that rainfall in December and April was declining during the period between 1994 and 2008 (Table 25.7). A decrease of rainfall in April implies early cessation compared to the situation in the past. Decrease of rainfall in December indicates that rainfall has become insufficient during a critical growing period.

Meteorological data for Meatu and Iramba indicate that standard deviations were high, implying that rainfall patterns were inconsistent in each month during growing seasons.

People's perceptions of a changing climate suggested that the amount of rainfall had decreased during growing seasons compared to the situation in the 1970s. In addition, there had been an increase in the frequency of droughts, expansion of the dry spell, shortening of the growing seasons by 1 month or more, as well as rainfall unpredictability. The meteorological data confirm people's perceptions (Kabote et al. 2013). The correlation between local views and meteorological climate trends is also documented in other studies (West et al. 2008; Gill 1991).

The shortening of the growing season implies that smallholder farmers must change crop and livestock production systems to address the impact. Insufficient and inconsistent rainfall patterns have serious implications on the decisions of farmers and agro-pastoralists regarding the cropping calendar and types of crop varieties to be adopted.

**Table 25.6** Measured rainfall variability during growing seasons in Meatu District

Period	November		December		January		February		March		April	
	Mean	Std.dev	Mean	Std.dev	Mean	Std.dev	Mean	Std.dev	Mean	Std.dev	Mean	Std.dev
1994–1998	132.9	90.9	141.0	106.5	168.4	113.1	124.1	88.4	102.1	42.8	130.5	23.2
1999–2003	64.6	31.5	77.6	15.1	108.9	46.3	74.9	34.9	138.2	62.1	88.5	69.6
2004–2008	108.4	83.5	135.0	42.1	101.2	53.2	102.1	48.0	133.3	92.5	84.3	43.5
2009–2011	62.5	20.2	175.0	16.8	48.0	36.4	139.9	49.1	136.0	23.8	96.3	76.9

**Table 25.7** Measured rainfall variability during growing seasons in Iramba District

Period	November		December		January		February		March		April	
	Mean	Std.dev	Mean	Std.dev	Mean	Std.dev	Mean	Std.dev	Mean	Std.dev	Mean	Std.dev
1994–1998	71.0	68.9	195.6	197.6	140.2	68.1	158.8	49.5	151.8	112.8	120.8	56.1
1999–2003	123.6	84.8	139.1	54.0	192.4	97.2	60.1	26.4	202.2	57.1	87.6	45.3
2004–2008	67.3	50.6	112.9	59.3	149.9	65.7	134.7	57.5	135.3	100.4	66.6	69.1
2009–2011	NA	NA	NA	NA	NA	NA	NA	NA	NA	NA	NA	NA

NA not available

### 25.4.3 Food Security and Wealth Status

Food insecurity in Meatu and Iramba districts is a serious problem. Food aid has been distributed to the villages by the district authorities every year since 2000. Food security update for Tanzania in May 2011, projected that the Shinyanga region would be in the ‘Stressed’ Acute Food Insecurity Phase in the months from May to September 2011. It also stated that food prices in 2011 had remained above the 5 year average due to insufficient rainfall affecting crop production, as well as high transportation costs of both inputs and outputs due to rising fuel prices (FEWS NET 2011).

Wealth inequalities affect access to resources and the ability to respond to changes brought about by climate change and other stresses. This study was designed to ensure that the concerns, with respect to climate change impacts and adaptations, of all community members from different socio-economic groups were taken into account.

Key informants used their local classification to define poor, less poor, and rich households in the three villages. Their definitions of the different wealth groups took into consideration issues such as a household food security, asset ownership (in particular livestock), land access, ability to hire labor, and quality of housing. Indicators were developed and the households included in the survey were defined accordingly. The association between livestock keeping and wealth status was significant ( $p < 0.05$ ). Most rich households had more livestock than poor and less poor households. Differences of income and poverty can be traced to differences in cattle ownership across households. Very few households kept cash as savings; rather cattle were the most important form of savings.

The percentage of households in the different wealth groups is shown in Table 25.8.

The study showed a high degree of poverty, less poor and poor households exceeded 80 % in all villages. The observed percentages of poor households were high when compared to levels reported for other rural areas of Tanzania. According to Tanzania Country Report on the Millennium Development Goals (2011), about 33.6 % of Tanzanians fall below the basic needs poverty line and 17 % below the food poverty line.

The respondents were asked to remember how many months of the past 12 the households had insufficient food access. The Monthly Adequate Household Food Provisioning (MAHFP) scores (Bilinsky and Swindale 2010) are presented in Table 25.9. The measurement ranges from 0 to 12. Households in Mwshata,

**Table 25.8** Wealth status of households (HH) in the study villages

Wealth status	Location		
	Mwamanimba	Mwashata	Kidaru
% Poor HH	59.7	43.0	48.4
% Less poor HH	22.8	49.6	36.6
% Rich HH	17.5	7.4	15.0

**Table 25.9** Months of adequate food provisioning (MAHFP)

MAHFP		
Wealth group	Agricultural production system	Agro-pastoral production system
	Mwshata	Mwamanimba
Poor	7.6	9.6
Medium	8.1	9.9
Rich	9.8	10.4
Average	8.5	10

depending mainly on crop production, were more food insecure than households in Mwamanimba, where livestock keeping was more widespread. Households practicing agro-pastoralism had on average, 1.5 months more adequate food provisioning than households mainly practicing agriculture. The poorest households showed the lowest number of months with adequate food provisioning, 7.6 months during the year. The rest of the months the households suffered from inadequate food provisioning. The most food insecure months are from December to March with a significant peak in January–February.

In the agro-pastoral village, Mwamanimba, all wealth groups had access to a varying and higher number of livestock, and were less dependent on crop production for ensuring food security. Owning livestock may signify increased adaptive capacity since cattle can be sold to purchase food during food insecure months. This might explain the higher food security score in the agro-pastoral production system despite frequent droughts.

#### 25.4.4 Crop and Livestock System Under Pressure

The main staple crops differed in the three villages studied, due to different farming systems and rainfall patterns in the villages, as shown in Table 25.10. The table indicates a strong association between types of crops grown and location. Kidaru and Mwamanimba had the lowest amount of rainfall (400–500 mm), and drought resistant crops, such as millet (*Pennisetum glaucum* L.) and sorghum (*Sorghum bicolor* L.), were the main staple crops. Mwshata received higher annual rainfall and maize (*Zea mays* L.) was the main staple crop in the village. However, farmers still cultivated a diverse range of crops and practiced intercropping. Traditional wild and cultivated vegetables were key food and/or medical crops. They were either consumed raw or dried depending on the season. Dried vegetables were combined in various ways, and stored dried vegetables were expected to last for an entire season of at least 6–7 months. Twenty-three important traditional, wild and modern vegetable species were identified as important components of the local diet (Ang and Synnevåg 2012). Wild vegetables included jute mallow (*Chorcorus olitorius* L.), wild amaranth (*Amaranthus* spp.), spider plant (*Cleome gynandra* L.) and wild traditional cucumber (*Cucumis anguria* L.), which are all resistant to

**Table 25.10** Percentage of farmers who produced major crops grown during the 2012/2013 growing season

Type of crop	Variable	Kidaru (n = 142)	Mwamanimba (n = 101)	Mwashata (n = 145)	Chi-square	P-value	Phi-value
Maize	Grown	37	85	96	135.934	0.000	0.592
	Not grown	63	15	4			
Sorghum	Grown	38	65	9	85.400	0.000	0.469
	Not grown	62	35	91			
Sweet potatoes	Grown	16	78	72	123.430	0.000	0.564
	Not grown	84	22	28			
Bulrush millet	Grown	74	4	3	214.359	0.000	0.743
	Not grown	26	96	97			
Cotton	Grown	4	93	69	218.394	0.000	0.750
	Not grown	96	7	31			
Sunflower	Grown	65	19	35	56.081	0.000	0.380
	Not grown	35	81	65			

drought and often used as famine crops. Sweet potato (*Ipomoea batatas L.*) was also mentioned to be an important crop during food shortage periods, normally occurring during February and March just before the harvesting period. Cotton (*Gossypium arboreum*) was the main cash crop in Mshwata and Mwamanimba, while sunflower (*Helianthus annuus*) was the main cash crop in Kidaru. Sunflower also became a cash crop in Mwashata and Mwamanimba between 2008 and 2010, due to price fluctuations and low market prices for cotton at that time.

Drought and irregular rainfall had a huge negative impact on harvest and household food security within and between years, and it was not surprising that this was the main challenge for adequate food access for all villages included in the study. Food security had, according to 70 % of farmers, decreased due to longer dry periods characterized by inadequate access to food and reduced and more irregular food intake. Several wild species, commonly used in the diet in the southern zone of Meatu, began to decline from the 1990s as rainfall patterns became more irregular. These plants were among the first to be harvested after the dry season, serving as important food inputs during the hunger gap. The increasing scarcity of wild food plants was a concern for the interviewed households. Also the increased time it took for women to gather the wild plants concerned the respondents. Decreasing ground-water and increased water scarcity were also reported, as rivers in the area had become increasingly seasonal since the 1970s, making irrigated farming and vegetable growing for improved income generation difficult.

Excessive droughts had also increased the distance, duration, and frequency of movement of animals since the 1970s, also with major implications for food security. Livestock keepers in the agro-pastoral village of Mwamanimba indicated that they had to move their herds to neighboring areas and even to far regions in search of pastures during the dry season. Although the practice has been commonly used for decades, the increased frequency of prolonged and excessive drought required that livestock keepers and herders, mainly men and boys, were away for longer periods to seek pasture and water. In the past, livestock keepers were away for between 1 and 2 months, returning when the rainy season began. Now they often moved for several months and sometimes did not return in the case of two consecutive dry seasons. This had major implications for women, children, and elders left behind in the village, as their working burden increased substantially. In Kidaru and Mwashata, where households were mostly dependent on agriculture, seasonal movement of animals occurred during the growing season to give room for crop production, from January to July. Growing populations and agricultural expansion were the main drivers for the seasonal movement of the animals. During the July–December dry season, animals returned to feed on agricultural residues.

During the dry seasons, the distressed sale of animals at very low prices is a common occurrence. Animal deaths have increased compared to the situation in the 1970s, mainly due to decreased pasture and increased livestock diseases. Lack of agro-vet shops in the villages has enhanced the problem. Insufficient knowledge about livestock diseases and pests among livestock keepers is also problematic.

Drought and irregular rainfall also had a negative impact on river flows becoming seasonal, thus increasing water scarcity for humans and animals, even during wet seasons. Since the 1980s, prolonged droughts had prompted agro-pastoralists to dig trenches in low lands and along the rivers in search of water for the animals. The depths of these watering trenches have increased over time.<sup>4</sup>

Lack of farm implements was also mentioned as a challenge. According to the FGDs, slight changes in the use of agricultural implements had occurred, and the use of oxen in land preparation was increasing. However, due to population growth, *insufficient land* was rated as a more important challenge than farming technologies. Population increase was associated with migration in search of land for both crop cultivation and animal pasturing. In the 1970s, the Sukuma tribe dominated both villages in Meatu district. However, as a consequence of migration, a number of ethnic groups are now found in the area. It was also observed that the farmers are currently cultivating more farm land than before due to declining soil fertility and low productivity. They were compensating for these factors by expanding the area cultivated rather than intensifying their production. Increased farm size has implications for the workload of women, as they perform important on-farm activities.

---

<sup>4</sup>Mattee and Shem (2006), also reported presence of water trenches for animals in semi-arid northern Tanzania.



Striga and birds were identified by interviewees as important problems. Participants in FGDs reported that the intensity of insects, diseases, and birds attacking farm crops had increased compared to the past. They also reported that disease identification and how to manage crop-related pests and diseases is a challenge.

Distance to markets and bad roads were also mentioned as a major challenge for selling their crops and for buying food and agricultural inputs, particularly during the rainy season. In order to increase food security, most crops were sold during the harvest period when the prices were low. During the December–April food shortage period, each year prices were higher causing households to sell their assets, including livestock, in order to purchase food stuffs.

### 25.4.5 Farmers' Adaptation Strategies

Because of the shorter growing period, combined with increased length of the February dry spell and higher unpredictability and irregularity of rainfall, small scale farmers had adopted crop varieties that could be harvested within a shorter growing period. Changes had occurred in terms of varieties cultivated now compared to the past. For instance in Kidaru, early sorghum and millet varieties were introduced in the village during 1990s following the failure of long-term sorghum varieties. Similarly, participants in Mwamanimba village reported a change from long-term sorghum varieties to short-term sorghum varieties. In Mshwata, a change from long-term to short-term maize varieties was reported. As indicated in Table 25.11, 66 % of the rich households had adopted improved maize varieties. Improved varieties of sorghum were not regarded as drought resistant and local varieties were preferred.

**Table 25.11** Percentage responses on adoption of improved varieties (n = 388)

Type of crop	Variable	Wealth status			Chi-square	P-value	Cramer's V – value
		Poor (n = 192)	Less poor (n = 152)	Rich (n = 44)			
Maize	Adopted	46	49	66	8.637	0.071	0.105
	Not adopted	24	24	25			
	Partly adopted	30	27	9			
Sorghum	Adopted	24	20	27	9.374	0.052	0.110
	Not adopted	46	53	64			
	Partly adopted	30	27	9			

Adopted: Improved seeds bought every year

Partly adopted: Improved seeds bought some of the years

Results from FGDs in Kidaru village showed that farmers were making use of both improved and local maize and sorghum varieties, and kept seeds for a range of varieties to ensure flexibility and enhance stability of yields. On average 25 % of the farmers had adopted improved seeds. Farmers usually procured seeds from other farmers. Farmers also procured seeds from the District Agricultural and Livestock Development Department and from private agro-dealers, mainly based at the district headquarters. Farmers indicated that the main reasons for not adopting improved seeds were unavailability and high price.

Farmers practiced intercropping to enhance effective utilization of labor and land, and to minimize risk of crop failure.

Small-scale irrigation farming systems and water harvesting had emerged as a way to overcome increased frequency of drought. The main water sources during the dry season were dry river canals. Holes were dug in river channels during the evening. Overnight water rose through the sand layers to the surface for collection in the morning. Water was used for personal as well as irrigation purposes. Women and girls were responsible for collecting water. Small scale rain water collection systems were developed by some farmers to harvest water in the wet season and also for tapping into groundwater sources. It was also reported that there were about 20 small water pumps in the villages. Results from the focus group discussions showed that a few farmers practiced gardening of modern vegetable crops, such as tomatoes and lady fingers for income generation, by using small-scale traditional irrigation mainly along River Ndurumo in Kidaru village and River Simiyu in Mwashata village. This strategy ensured food availability. Some farmers in Mwanimimba and Kidaru village had started practicing irrigated farming along the river valleys using generator driven water pumps. Examples of water and soil conservation strategies by mulching and ridges were reported.

Regarding agricultural technologies, focus group discussions showed that 75 % of the informants in Mwanimimba and Mwashata villages used the ox-plough for land tilling. The other 25 % probably use a hand hoe, axe, and bush knife. In Kidaru village, however, less than 25 % of the informants reported use of the ox-plough. Some changes were noted in comparing practices. In the 1970s, most farmers depended on a hand hoe, axe, and bush knife to till the land. An important labor exchange system was noted. Farmers without oxen provided labor to the farmers with oxen, in exchange for assistance in tilling their farm land using the ox-ploughs.

Climate change, human population growth and agricultural expansion had consequences for agro-pastoral livelihoods. In the 1970s, animals grazed anywhere in the village. Due to dwindling sizes of these grazing areas, the situation changed in the 1990s. Adaptation mechanisms included changes in increased duration of seasonal movement and migration of animals, purchase of grazing areas, and grazing crop residues in the household plots. Crop residues after harvesting have increasingly become an important source of feed. Currently, livestock keepers have to pay other farmers for animal feed in the form of crop residues (maize stove, sorghum and millet remains, and beans straws etc.).

Before the 1970s, the communities in Meatu District used to set aside a reserve land known as “ngitiri” for grazing which was used during the dry season as a

fodder/grazing reserve. Two types of *ngitri* existed, namely, enclosures owned by individuals or families, and communal enclosures owned and managed in common. Both were originally developed by the Sukuma people in response to acute animal feed shortages caused by droughts. The system is now facing a number of constraints, mainly declining land availability, increasing land insecurity, and resource use conflicts. They have weakened traditional adaptation strategies. Data suggest that it is no longer feasible to set aside areas for pasture as *ngitiris*, because the demand for agricultural land is too high in the villages of this study. Grazing lands also decreased due to the creation and expansion of the game reserves. Game reserve policies prohibit grazing in the Maswa Game Reserve. Thus, conflicts and killings have been reported between agro-pastoralists and conservation authorities in Mwanimba and Mwashata. One of the male FGD participants in Mwanimba described the situation as follows ‘...grazing animals in the Maswa Game Reserve is part of life...this will continue forever unless pasture and water scarcity problems are addressed...’

To reduce vulnerability, some farmers have searched for casual jobs to generate income to meet some of their needs. They have diversified their livelihood options to include off-farm activities and petty trade. Engagement in non-agricultural activities has become a popular way of coping with reduced agricultural production. Men have been engaged in brick making and selling of cash crops such as sunflower seeds. Women have reportedly been engaged in petty trade, such as selling food and vegetables from their own gardens, as well as fish, porridge, and local brew.

## 25.5 Summary and Conclusion

The three remote rural villages that we studied are located in Meatu and Iramba district in Northern Tanzania. They are in a semi-arid environment, characterized by irregular and unpredictable rainfall, and substantial household food insecurity. Small scale rain fed agriculture and agro-pastoralism were the main source of livelihoods. Flexibility and physical mobility were traditionally important strategies to overcome impact caused by climate variability in the villages. Small scale farmers developed local coping and adaptation strategies dependent on access to economic, social, and natural resources, the local context and culture. However, they are now confronted with growing competition for resources such as land, water and pasture, and local coping and adaptation strategies are weakened, thereby threatening livelihoods. Human population, land scarcity, related expansion of agricultural land, declining soil fertility, shrinking pastures, and increasing levels of land use conflicts were reported. Data were collected from focus group discussions with male and female farmers, household surveys, and secondary meteorological sources. Results of our analyses indicate that (1) the onset and end of rainfall during the growing period has become more erratic and unpredictable since the 1970s, (2) the February dry spell has become longer, and (3) that the growing season has been shortened by a month or two dependent on location. Droughts have

become more common. Farmers reported that the dry season is becoming more prolonged and that less water is available for domestic purposes, livestock, and irrigation. Farmers' perceptions of climate change are confirmed by secondary meteorological data. Climate change is causing additional pressure on crop and livestock production systems, threatening livelihoods of an already vulnerable and food insecure rural population.

Data from the study suggest that poverty and food insecurity are prevalent in all the three villages. In fact the percentage of less poor and poor households exceeded 80 % in all villages. Wealth differences were correlated to ownership of assets, in particular livestock, land, and ability to hire labor. The poorest households had adequate food provisioning for only 7.6 months during the year, and households depending mainly on crop production had a higher degree of food insecurity than agro-pastoral households. Drought and irregular rainfall had a huge negative impact on harvest and household food security within and between years. Seventy percent of the farmers reported a decline in household food security. Longer dry periods have resulted in reduced access to food and less and more irregular food intake. Several wild species, commonly used in the diet in the southern zone of Meatu, have begun to decline. These plants were among the first to be harvested after the dry season, serving as important food inputs during the hunger gap. The increasing scarcity of wild food plants was a concern for the interviewed households. Excessive droughts have also increased the distance, duration, and frequency of movement of animals compared to the 1970s. Increased seasonal and permanent migration has serious implications for women left with responsibilities for managing both household and farming activities. Their working burden has increased and gender roles are changing. Reductions in available pasture lands have resulted in increased grazing of livestock in a neighboring Game Reserve which has been a frequent source of conflict in villages in Meatu district. Loss of ngitiris, reserved land for grazing during the dry periods, were reported.

Adaptation strategies have included a clear shift to early varieties of maize, sorghum, and millet. Diversification of crops and varieties are practiced to promote flexibility. Small-scale irrigation systems and water harvesting have occurred and have resulted in increased access to water for crops and livestock as well as for domestic purposes. Diversification of crops, keeping a range of local and improved varieties, intercropping, and income generation from vegetable gardening along the riverbeds have become common practices, particularly among agricultural households. Adaptation mechanisms introduced by agro-pastoralists include changes in seasonal movement and migration of animals, and the purchase of grazing areas and paying for feeding livestock on crop residues from household plots. Crop residues after the harvesting period had increasingly become an important source of feed. Diversification to off-farm activities like petty trade has become an important strategy to reduce vulnerability. Wealth inequalities among households are directly related to access to resources and the ability to adapt to changes brought about by climate change and other stresses. Poor households have been most affected by the changes and have had less resources and adaptive capacity. Climate changes has affected men and women differently, and caused changes in gender roles and

responsibilities. Socio-economic and gender considerations must be taken into account when climate change and adaptation responses are planned and implemented at national and local levels.

## **25.6 Suggested Policy Recommendations for Adaptation to Climate Change in Semi-arid Areas**

- Climate change threatens livelihoods, food and water supplies by reducing the ecological base on which they depend. Integrated long term development plans, actions, and programs for semi-arid areas at a national and local level need to include actions for improved adaptation to climate change. Climate change adaptation must be mainstreamed into development programs.
- Integrating the views of the people most affected by droughts is crucial if we are to understand the impacts of climate change and their ability to adapt.
- Integrated adaptation and development programs must bring together activities to improve resilience, environmental sustainability, and food- and livelihood security
- Climate change has resulted in additional pressure being put on an already vulnerable rural population. Integrated adaptation and development programs need to consider population increases, agricultural expansion, land scarcity, competing land use, price fluctuations and policies, and access to infrastructure and markets.
- Adaptation processes need to be seen in a holistic manner. They need to consider local actors and local knowledge, climate risk, vulnerability and adaptive capacity, and take into account environmental, technological, cultural, institutional, and political considerations. Improved technology alone will not reduce the impact of climate change on farming systems and people's livelihoods.
- Access and rights to natural, economic, and social resources are crucial for successful adaptation to climate change impacts
- Poor small scale farmers have few adaptation options, and low adaptive capacity. To reduce vulnerability, it is important to build local adaptive capacity. There is a lack of institutional capacity and human capital needed to adapt to the changes.
- Actions for improved adaptation to climate change need to build on knowledge about the diversity and differences in and between local farming systems and natural resource management strategies.
- Social, economic, and environmental factors decide the situation people are in – and thus decide vulnerability and capacity to adapt. Vulnerability varies between socioeconomic groups and individuals.
- Climate change impacts are not gender neutral, and may influence male and female farmers differently depending on gender roles and responsibilities. Adaptation strategies to improve livelihoods must be gender sensitive. Gender considerations must be mainstreamed into adaptation and development strategies and actions.

## References

- Ang M, Synnevåg G (2012) Traditional vegetables of Meatu, Shinyanga, Tanzania. Noragric Report, UMB, 86 pp
- Bilinsky P, Swindale A (2010) Months of adequate household food provisioning (MAHFP) for measurement of household food access: indicator guide (v.4). Food and Nutrition Technical Assistance Project, AED, Washington, DC
- FAO (1996) The role of women in agriculture, 46pp
- FEWS NET (2011) Famine early warning systems network, East Africa. Food Security Outlook
- Galvin KA, Boone RB, Smith NM, Lynn SJ (2001) Impacts of climate variability on East African pastoralists: linking social science and remote sensing. *Climate Res* 19:161–172
- Gill GJ (1991) But how does it compare with real data? PRA notes, Issue 14, IIED London, pp 5–13
- Intergovernmental Panel on Climate Change (IPCC) (2007) Summary for policy makers. In: Parry ML, Canziani OF, Palutikof JP, Van der Linden PJ, Hanson CE (eds) *Climate change 2007: impacts, adaptation and vulnerability. Contribution of Working Group II to the fourth assessment report of the intergovernmental panel on climate change*. Cambridge University Press, Cambridge, pp 7–22
- Iramba District Council (2009) Iramba district socio-economic profile. Kiomboi/Singida, 10 pp
- Juana JS, Kahaka Z, Okurut FN (2013) Farmers' perceptions to climate change in Sub-Saharan Africa: a synthesis of empirical studies and implications for public policy in African agriculture. *J Agric Sci* 5(4):121–135
- Kabote SJ, Mamiro D, Mbwambo J, Synnevåg G, Matte AZ, Urassa KJ, Nombo CI, Masolwa LW (2013) Perceived and measured climate variability and change in Semi- Arid Tanzania: experiences from Iramba and Meatu Districts, Sokoine University of Agriculture (in press)
- Legesse B, Ayele Y, Bewket W (2013) Smallholder farmers' perceptions and adaptations to climate variability and climate change in Doba District, West Haraghe, Ethiopia. *Asian J Empirical Res* 3(3):251–265
- Lema MA, Majule AE (2009) Impacts of climate change, variability and adaptation strategies on agriculture in semi arid areas of Tanzania: the case of Manyoni District in Singida Region, Tanzania. *Afr J Environ Sci Technol* 3(8):206–218
- Lyimo JG, Kangalawe RYM (2010) Vulnerability and adaptive strategies to the impact of climate change and variability: the case of rural households in semi-arid Tanzania. *Environ Econ* 1(2):89–97
- Mongi H, Majule AE, Lyimo JG (2010) Vulnerability and adaptation of rain fed agriculture to climate change and variability in semi-arid Tanzania. *Afr J Environ Sci Technol* 4(6):371–381
- Nombo CI, Urassa JK, Mbwambo JS, Matte AZ, Mamiro DP, Kabote S, Matata L, Synnevåg G (2013) Gender and adaptation to climate change. Experiences from Meatu and Iramba districts Tanzania. *JCEC* 4(1):212–227
- Paavola J (2008) Livelihoods, vulnerability and adaptation to climate change in Morogoro, Tanzania. *Environ Sci Pol* 11:642–654
- Sarr B (2012) Present and future climate change in the semi-arid region of West Africa: a crucial input for practical adaptation in agriculture. *Atmos Sci Lett*. wileyonlinelibrary.com Accessed on 8/7/2013
- Senkondo EMM, Msangi K, Xavery P, Lazaro EA, Hatibu N (2004) Profitability of rainwater harvesting for agricultural production in selected semi-arid areas of Tanzania. *J Appl Irrig Sci* 39(1):65–81
- Swai OW, Mbwambo JS, Magayane FT (2012) Gender and adaptation practices to the effects of climate change in Bahi and Kondoa Districts, Dodoma Region, Tanzania. *J Sustain Dev* 5 (12):65–77
- Tanzania Country Report on the Millennium Development Goals (2011), 74 pp
- Vette S (2009) Drought, change and resilience in South Africa's arid and semi-arid rangelands. *S Afr J Sci* 105:29–33
- West CT, Roncoli C, Ouattara F (2008) Local perceptions and regional climate trends on the central plateau of Burkina Faso. *Land Degrad Dev* 19:289–304

**Part VIII**  
**Economic, Social and Policy Issues**

# Chapter 26

## Exploring the Meso-level of Agricultural Carbon Finance Projects

Corinna Clements and Keith M. Moore

**Abstract** Agricultural carbon schemes are intended to mitigate climate change and provide carbon revenues while facilitating sustainable development. This is accomplished through practices which simultaneously increase yields, improve resilience, and store carbon, such as agroforestry, reduced tillage, and grasslands management. Proper monitoring, reporting, and verification of these activities enable the generation and sale of carbon credits. However, this requires linking smallholder farmers at the micro-level with carbon credit buyers operating at the macro-level. These vastly distinct scales are bridged by intermediaries operating at the meso-level, which influence, incentivize, monitor, and aggregate production decisions made by smallholders. Multiple levels of intermediaries may be involved, often including external initiating agencies, such as non-governmental organizations, as well as local-level units, such as farmer groups or local governance associations. Here, we frame evaluation of agricultural carbon schemes with this three-tiered approach, and describe parameters for appraising participation and power, as well as assessing financial feasibility, verifications and market linkages. This is applied to two case studies: The Kenya Agricultural Carbon Project and The Sofala Community Carbon Project.

**Keywords** Local governance • Community organizations • Carbon markets • Intermediary organizations • Agricultural carbon • Carbon sequestration • Carbon credits • Climate change

### 26.1 Introduction

The impact of climate change on smallholder farmers in sub-Saharan Africa is expected to be severe, exacerbating problems of soil degradation, drought, and food insecurity (Waha et al. 2013; Nelson et al. 2009). Management of terrestrial carbon, which includes carbon sequestered in forest and agricultural soils, has significant mitigation potential; The Terrestrial Carbon Group argues that it can account for up

---

C. Clements (✉) • K.M. Moore  
Office of International Research, Education and Development (OIREd),  
Virginia Tech, Blacksburg, VA, USA  
e-mail: [corinc9@vt.edu](mailto:corinc9@vt.edu); [keithm@vt.edu](mailto:keithm@vt.edu)



to 25 % of the climate change solution. At the same time, co-benefits for terrestrial carbon management include increased resilience and biodiversity (The Terrestrial Carbon Group 2010).

Resilience co-benefits are particularly relevant for agricultural carbon sequestration, which focuses on practices that can improve soil fertility while storing carbon, such as minimal tillage, agroforestry, mulching, and grasslands management (Lal 2011, 2004; Conant et al. 2001; The Terrestrial Carbon Group 2008). The Intergovernmental Panel on Climate Change (IPCC) reports that in 2005, agriculture contributed 10–12 % of global greenhouse gas emissions (IPCC 2007). Consequently, the World Bank, the Food and Agriculture Organization (FAO) of the UN, and the Climate Change, Agriculture and Food Security (CCAFS) research program of the CGIAR consortium have promoted ‘Climate Smart Agriculture.’ This model is championed as a means to achieve food security and agricultural development goals in conjunction with climate change mitigation objectives, leading the World Bank to laud climate-smart agriculture as a ‘Triple Win’ (The World Bank 2011a, b; FAO 2013; Pye-Smith 2011).

Although smallholder farmers are simultaneously resource managers and beneficiaries of much of the terrestrial carbon rhetoric, the size of their landholdings is often less than 2 ha and severely limits their individual implementation potential. The sequestration capacity of many smallholders must be combined in order to be commercially significant. In order to better understand how this can occur, we will analyze these interactions through a framework of three levels: micro, meso, and macro (Reynolds 2012). This framework, based on Ostrom’s (2005) multiple levels of governance, recognizes the scalar disparity between smallholders (micro-level) and international carbon markets (macro-level). These vastly distinct scales are bridged by intermediary organizations at the meso-level, which facilitate interactions between smallholders and international carbon markets.

We apply this framework to assess agricultural carbon projects, emphasizing administrative, financial, and governance issues at the meso level. However, the discussion would not be complete without consideration of micro-level impacts and macro-level linkages. Indeed, the degree of interconnectedness prevents a discussion of any one level in isolation from an understanding of all three. Therefore, we present an overview of the macro-level context and address micro-level decision-making before shifting attention to the meso level. After thus framing our analysis, we describe parameters for appraising participation and power, and for evaluating financial feasibility, verification and market linkages.

These parameters are utilized to assess intermediaries in two case studies: The Kenya Agricultural Carbon Project and The Sofala Community Carbon Project. We are focusing on projects which incorporate carbon sequestration and finance mechanisms into program designed to transform agricultural practices. We selected these cases because they are located in sub-Saharan Africa, engage smallholder farmers, and have sufficiently detailed information available in order to contribute to our discussion. This analysis recognizes the nuances and ambiguities involved in evaluating these projects. Because it is based on project documents, theses, and a few external reviews and articles, the information is necessarily biased.

The assessment of these case studies represents an attempt to sift through the literature related to the projects in order to make some tentative conclusions about the institutional and economic dynamics of agricultural carbon finance, and to identify the kinds of questions that should be asked in designing and evaluating future projects.

## 26.2 Macro-level Context: Defining a Commodity

An examination of carbon markets and global institutions is critical to understand the context in which agricultural carbon projects operate. Macro-level institutions are shifting towards greater recognition and acceptance of agricultural carbon sequestration. However, this process is gradual, slowed by difficulties in measuring agricultural carbon storage.

There are two primary types of carbon markets: the compliance market and the voluntary market. The compliance market was created through the Kyoto Protocol, and includes the Clean Development Mechanism (CDM), Joint Implementation, and the EU Trading System (Seeberg-Elverfeldt 2010). Most agriculture, forestry, and other land use (AFOLU) projects are not eligible for these mechanisms. In order to be eligible, a project's methodology must be approved by the Executive Board of the CDM. However, there has been a push for greater inclusion of AFOLU initiatives, and certain afforestation/reforestation initiatives are now included in the CDM. Still, many AFOLU projects, agricultural projects in particular, are relegated to the voluntary carbon market (McKenzie and Childress 2011; Seeberg-Elverfeldt 2010). This represents a growing and increasingly important facet of global carbon finance. Credits produced from forestry and land management initiatives are increasingly traded, with demand driven by growing corporate responsibility (Peters-Stanley and Yin 2013). However, fluctuating or low carbon credit prices can decrease perceived profitability or financial feasibility, thus creating greater uncertainty for carbon sequestration initiatives and increased reliance on donor funds.

The AFOLU sector which has received the most attention and acceptance is REDD+, or reducing emissions from deforestation and forest degradation in developing countries. The "+" was added to recognize the role of conservation, sustainable management of forests, and enhancement of forest carbon stocks. The REDD agenda has built momentum for land-use change mitigation (Shames and Scherr 2010). The United Nations Framework Convention on Climate Change (UNFCCC) has recognized REDD's role in addressing climate change, and discussions of a mechanism to support REDD + action have continued. Meanwhile, REDD + projects have been implemented, and credits produced from REDD + activities have been sold on the voluntary carbon market (McKenzie and Childress 2011). While our focus is on agricultural land use changes rather than forestry-related changes, REDD + is relevant to our discussion. There has been increased recognition that the individuals implementing REDD + schemes are also

smallholder farmers. Some projects implement REDD + mitigation efforts alongside agricultural carbon sequestration endeavors.

Institutions have developed to support AFOLU mitigation initiatives in developing countries. One of these is the BioCarbon Fund of the World Bank (Seeberg-Elverfeldt 2010). The BioCarbon Fund is a public/private partnership which provides carbon finance for AFOLU projects on both the compliance and voluntary carbon markets (Seeberg-Elverfeldt 2010). Although 80 % of the BioCarbon Funds are dedicated to afforestation/reforestation efforts under the CDM (BioCarbon Fund 2013), the BioCarbon Fund also purchases carbon from REDD + initiatives (Reddy 2010). The Kenya Agricultural Carbon Project, the first of our case studies, is the first agricultural carbon project supported by the BioCarbon Fund.

The ability to turn any land-use change into a saleable commodity is based on the monitoring, reporting, and verification system utilized by the project. Verified emission reductions (VERs) refer to credits sold on the voluntary market that have been generated according to standards that were not created by a market mechanism related to the Kyoto protocol. Various organizations and systems independently verify and validate carbon credits. Some, such as the Verified Carbon Standard (VCS), focus on rigorous technical specifications for carbon sequestration, while others, such as the Climate, Community and Biodiversity Alliance (CCBA), include an emphasis on socio-economic and biodiversity impacts. A project's verification system impacts the marketability of its credits. For example, demand on the voluntary carbon market soared in 2012 for forestry initiatives certified by the VCS and the CCBA (Peters-Stanley and Yin 2013).

The Verified Carbon Standard (VCS) is “the most widely used voluntary Green House Gas reduction program.” (VCS 2013a). Founded in 2005 by The Climate Group, International Emissions Trading Association (IETA), and The World Economic Forum, the VCS improves quality assurance in voluntary carbon trading by establishing methodologies for measuring and estimating carbon storage. Carbon credits approved by the VCS are known as verified carbon units, or VCUs, and are well-regarded for their rigorous testing. The quality assurance principles (VCS 2013b) of the VCS require that projects are:

- Additional: Only reductions and mitigations that occur as a result of the project are counted.
- Real: The mitigation or reduction has actually occurred, rather than simply projected to occur over time.
- Conservative: Assumptions of carbon sequestration are expected to be conservative.
- Permanent: AFOLU projects must ensure that sequestered carbon is not released through fire or disease.
- Independently verified: A validation/verification body must be contracted to confirm that the project meets VCS requirement.
- Uniquely numbered and transparently listed.

Determining the amount of carbon stored in farmers' fields cannot be done directly, so various methodologies have been developed to estimate these levels. The adoption of a Sustainable Agricultural Land Management (SALM) methodology (VM0017), created in partnership with the Kenya Agricultural Carbon Project, was approved in 2011, and constituted the first agricultural land management methodology to be approved by the VCS. Like other VCS methodologies, SALM provides specific, technical details to estimate and monitor greenhouse-gas emission reductions. It relies on soil organic carbon (SOC) models. The baseline land-use scenario is evaluated at the beginning of the project through an Activity Baseline and Monitoring Survey (ABMS). This information is applied to an analytic model in order to estimate baseline SOC density. Use of the Roth C model<sup>1</sup> is assumed, though not required. The ABMS survey is meant to be conducted biannually or annually throughout the project. These data, after being analyzed in the Roth-C model, can be compared against the initial ABMS information in order to determine the amount of sequestration attributable to project activities. The methodology also requires monitoring of emissions related to project activities, deducting this amount from the quantity of carbon sequestered (VCS 2012).

The Climate, Community, and Biodiversity Standards (CCB Standards) from the Climate, Community, and Biodiversity Alliance (CCBA) is another international benchmark that complements technical methodologies by evaluating land management projects based on social and environmental impacts. According to their website (<http://www.climate-standards.org>) their standards include:

- Identifying projects that simultaneously address climate change, support local communities and smallholders, and conserve biodiversity
- Promoting excellence and innovation in project design and implementation
- Mitigating risk for investors and offset buyers and increasing funding opportunities for project developers

The CCBA certification follows a two-step process for validation and verification. Validation requires good project design, while verification involves rigorous independent evaluation of project implementation and delivery of multiple benefits. Certification allows a project to apply the 'CCB label' to the carbon credits that they produce (CCBA 2013). This label can be used in addition to approval from a monitoring standard in order to boost marketability of credits. The VCS and CCBA have even created an alliance to streamline dual certification of projects (VCS 2013c).

The Plan Vivo Foundation, a Scottish charity, is another example of an organization which validates and verifies VERs for sale on the voluntary carbon market. It has established step-by-step guidance for community-based projects which provide payments for afforestation and agroforestry, forest conservation, restoration, and avoided deforestation. Certification from Plan Vivo is intended to

---

<sup>1</sup> The Roth C model estimates soil organic carbon turnover in non-waterlogged topsoils based on a few data inputs (Coleman and Jenkinson 2008)

indicate community participation, livelihood improvement, and environmental benefit. While the Plan Vivo standard contains requirements for technical specifications, it does not provide an explicit methodology to implementers (Plan Vivo 2013). Unlike the VCS, these standards do not stipulate that carbon credits must be 'real.' Rather, it allows for the sale of credits calculated on the basis of 100 years of projected carbon sequestration. This time frame has led to doubts about the verification's rigor (Shames and Scherr 2010). The Sofala Community Carbon Project, one of our case studies, utilizes the Plan Vivo system, and is also verified by the CCBA.

### 26.3 Micro-level: Household Impacts and Decision-Making

Household and individual-level decision-making analysis constitutes an important dimension of project evaluation. A variety of factors influence farmer land use decision-making. These factors are reviewed in Moore et al. (in press). Context is the key to framing farmers' soil-management decisions. Soil type, farmer resources, production and livelihood risk, as well as beliefs and perceptions of soil fertility choices may all contribute. They also highlight how collective knowledge and innovation systems support individual farmer decision-making at the community level through social learning.

Projects often attempt to influence land use decision making through the provision of payments for environmental services (PES). PES are intended to modify the decision-making process by incentivizing certain behaviors (Bhatnagar 2008). PES is defined by Wunder (2005) as "a voluntary transaction where a well-defined ES [environmental service] (or a land-use likely to secure that service) is being 'bought' by a (minimum one) ES buyer from a (minimum one) ES provider if and only if the ES provider secures ES provision (conditionality)." In most terrestrial carbon schemes, a portion of carbon revenues is distributed to stakeholders. However, the perception of payments may vary depending on institutional dimensions and payment structure. Vatn (2010) distinguishes between payments as compensation and payments as incentive. While we do not apply this distinction, variety in payment language is clear in the differences between our case studies. The Kenya Agricultural Carbon Project justifies small payments by arguing that monetary benefits are not the primary motivation for participation. Rather, they are secondary to the intrinsic benefits of improved agricultural practices, not the primary motivation for participation. On the other hand, the Sofala Community Carbon Project emphasizes the livelihood benefits that results from payments for environmental services as key to the project's mission.

Many studies that examine the socio-economic impacts of a project focus on micro-level conditions, assessing the impacts of project activities and payments on household well-being, financial state and food security (see Tshakert 2003; Jindal 2004; Carter 2009; Kinuthia 2010). Tshakert (2003), for example, analyzed the individual decision-making process for a project in Senegal by developing budget

models based on the distribution of incentives and the costs of changing practices. These analyses also addressed farmer participation in the project. The term ‘participation’ in these analyses, however, is often used simplistically to denote adoption of the practices promoted by the project (Andersson and D’Souza 2013). Nevertheless, many studies of farmer adoption have emphasized the significance of participation in all phases of agricultural practice innovations, from design to sharing in collective output benefits (Chambers 1983; Pretty 1995; Narayan 1995; Moore et al. *in press*). Some studies have also examined farmers’ involvement and access to information about a project, and found that women and youth are most likely to be excluded because they are least likely to own land (Atela 2012; Jindal 2004). A more nuanced approach to studying stakeholder participation will be discussed in the section which outlines our analytic approach.

## 26.4 Meso-level: Embedded Intermediaries

Meso-level intermediaries influence, incentivize, monitor, and aggregate decisions made at the micro- level. By integrating a multitude of individual decisions into a standardized accounting system, the intermediaries transform individual production choices into a saleable commodity. Typically, this is initiated by an external agency such as a non-governmental organization (NGO) (Vatn 2010). This external initiating agency engages a variety of stakeholders and actors to achieve carbon storage and sale goals, often serving as the coordinating unit for the project. Multiple levels of intermediaries may be involved, filling roles in financing, providing inputs and information, monitoring carbon storage, and selling carbon credits (Shames and Scherr 2010; Shames et al. 2012b). These often include local units, such as farmer groups or local community associations.

Because of the sheer number of smallholders that must be aggregated, community-based carbon initiatives which target smallholders have the highest transaction costs of carbon storage initiative types (Shames et al. 2012b). These transaction costs result from training and monitoring large numbers of smallholders (Vatn 2010). Local-level intermediary organizations are critical to minimizing transaction costs in carbon finance markets. In the context of community-based agricultural carbon schemes, engagement of local-level intermediaries, such as farmer groups and community associations, has been found to further decrease transaction costs by consolidating smallholders (Dougill et al. 2012; Shames et al. 2012b; Jindal et al. 2008). As a result, the structure of community-based carbon finance schemes tends to include at least two levels of intermediary organization.

While the functional role of local-level intermediaries encourages local action, it does not necessarily allow for recognition of local frames of reference. Too often, vertical linkages between local and higher-level units are defined by a top-down relationship, in which knowledge and decision making flow only from higher to lower level institutions. A more collaborative relationship to facilitate co-production of knowledge and decision making will require two-way interaction

(Homsy and Warner 2013). Therefore, the quality of local intermediaries' engagement must be assessed in terms of vertical linkages and the existence of mechanisms for two-way communication.

## 26.5 Analytic Approach

### 26.5.1 *Participation and Power*

Carbon sequestration implies a long term commitment on the part of the resource manager. Since stakeholders' commitment to practices is correlated with their degree of participation in project design and implementation, Pretty (1995) developed a scale which describes seven participation types in order to measure stakeholder engagement and decision-making power. Prokopy and Floress (2011) formed a similar scale, with six participation types. Both have their strengths. Although these scales were originally developed to apply to individual participants, our analysis also applies them to local-level organizational units. Here, we have consolidated the two scales, and added an additional category, namely, reactive participation.

1. Manipulative participation is only a façade of participation, in which the presence of stakeholders is taken to imply their consent.
2. Passive participation consists of information dissemination. Stakeholders are told what has been decided without opportunity to respond to the decision.
3. Reactive participation describes circumstances in which stakeholders can have a voice and do exercise it, but this voice speaks in reaction to decisions that have been made by project implementers, rather than having a functional role in the planning process.
4. Consultative participation involves stakeholders by having them answer questions, such as through surveys. Although stakeholders are asked to provide input, all problem-defining and decision-making power still remains with the external agent. Reflective examination of the issues at hand is precluded.
5. Program participation is more active, but the stakeholder still does not possess independent decision-making power. People take part in programs that were organized by others, and involvement is motivated by concern with how they as an individual can benefit from participation.
6. Functional participation engages stakeholders by organizing groups to meet previously defined objectives, and granting some decision-making power in their achievement.
7. Interactive participation indicates stakeholders possess some decision-making power, and are involved in analysis and project plan development.
8. Self-mobilization consists of stakeholders taking initiatives independently of an external initiating agent. While contacts with external agencies are developed for resources and technical advice, the stakeholders maintain control over the resources.

The evaluation of levels and types of participation necessarily includes an analysis of the configuration and nature of power. While a review of participation is, fundamentally, an assessment of the role that stakeholders play in affecting a project's processes, power refers to the capacity to influence behaviors or achieve desired outcomes. It serves to rationalize particular participatory arrangements. This capacity is dependent on how power is derived. For example, the power of government officials and traditional local authorities is derived from the perceived legitimacy of the state and customary institutions they represent. Expert power, conversely, is dependent upon the individual's trust and acceptance of the credentials and superior knowledge of the organization or individual. This is often utilized in terrestrial carbon projects, when the external initiating agency makes claims based on specialized knowledge concerning carbon sequestration practices and market mechanisms (Morton 2011).

### ***26.5.2 Market Linkages and Carbon Revenues***

Agricultural carbon projects differ from other sustainable development initiatives because they engage in carbon finance, which entails monitoring, reporting and verification of carbon sequestration, selling carbon credits, and distribution of carbon revenues. The appeal of a carbon finance scheme over traditional development projects is that revenues generated through carbon market mechanisms provide funding for project implementation and a source of income for farmers. The ability of initiatives to acquire funding through market mechanisms implies that carbon finance schemes are more likely to be financially sustainable. However, this may be eroded by the costs of monitoring, reporting, and verification of carbon storage. Therefore, claims of financial practicality should be carefully evaluated, along with an analysis of market linkages.

As discussed above, monitoring, reporting, and verification of carbon sequestration determines the ability of a project to sell carbon credits. Rigorous carbon accounting procedures can be costly, but usually enhance the marketability of carbon credits, as do other verifications and endorsements. Similarly, a vigorous verification system can allow for recognition of the project by international institutions, such as the BioCarbon Fund, thus facilitating carbon credit purchase contracts. The following indicators will be used to determine the success of carbon finance efforts in attaching monetary value to carbon sequestration efforts:

- The monitoring and accounting methodology utilized
- Validations, verifications, and endorsements generated
- The prices received for carbon credits

The use of carbon revenues earned and their contribution to the financial feasibility of the project will be assessed along the following parameters:

- The distribution of revenues to smallholders and to project costs.
- The percentage of total project costs covered by carbon revenues that impose the necessity of and search for additional funding.



- Incentive distributions, the structure of the payment system, and the potential for incentives to impact stakeholders' livelihoods.

These parameters will characterize the impact of carbon finance on project implementation, financing, and stakeholder benefits. Combined with the indicators of power and participation, they structure the following case study analyses.

## 26.6 Case Studies

### 26.6.1 *The Kenya Agricultural Carbon Project (KACP)*

The Kenya Agricultural Carbon Project (KACP) focuses most exclusively on agricultural carbon storage, espousing the benefits of the 'triple win'. The project, located in the Kisumu and Kitale regions of Kenya, promotes agro-forestry, residue management, cover cropping, reduced tillage, and manure management (Atela 2012; Tennigkeit et al. 2012; Shames et al. 2012a). The project is sponsored by the World Bank's BioCarbon Fund as an 'early action project' meant to inform the debate on opportunities and challenges in agricultural carbon finance. In 2010, an Emission Reduction Purchase Agreement (ERPA) was signed, guaranteeing that the BioCarbon Fund would purchase carbon credits produced by the project (Atela 2012).

#### 26.6.1.1 External Intermediary Agencies

The project was initiated and developed by the BioCarbon Fund and the Swedish NGO the Swedish Cooperative Centre – Vi Agro-forestry Program (SCC-ViA), which is also referred to as Vi Agroforestry. The BioCarbon Fund had been seeking an agricultural land use activity in which to invest, and Vi Agroforestry offered a promising opportunity to demonstrate the 'Triple Win' (Shames et al. 2012a). Vi Agroforestry has an established presence in the region, having promoted agroforestry systems in East Africa for over 25 years. It also claims to take a holistic and participatory approach to development by engaging farmers groups and empowering farmers to take on decision-making roles (Tennigkeit et al. 2012).

#### 26.6.1.2 Project Implementation

The model promoted by Vi Agroforestry is based on two phases, namely, (a) 4-year phase of intensive organizational involvement in which a field officer recruits farming households and trains farmer groups, and (b) a second ongoing phase when Vi Agroforestry's direct support is reduced, and community-based extension services play a more prominent role. The regions in which the KACP is active are divided into 28 project areas, each of which is assigned a field officer whose goal

is to recruit 400–600 farming households per year during the intensive phase (Atela 2012). To accomplish this goal, the field officers diffuse information by holding field days and public meetings, and by using other communication channels, such as radio programs, newspapers, and leaflets. They are also charged with reinforcing the capacity of community groups (Shames et al. 2012a; Tennigkeit et al. 2012). Additionally, field officers train some local farmers to become community facilitators. They serve as locally-based extension agents and are the primary liaison between field officers and community groups. Community facilitators are paid a small fee to provide input and information services, and to monitor carbon storage (Shames et al. 2012a). It is difficult to determine the degree of connection between farmers and field officers because information is often passed through community groups. Atela (2012) found that only 10 % of farmers learned about the project through extension visits, while 24 % of farmers learned about the project through group meetings. Thus, community groups play a central role to knowledge diffusion.

Atela (2012) found that willingness of individual farmers to be a part of the project was not adequately pursued. His interviews revealed that some farmers only realized that they had been selected to participate in the baseline assessment when extension staff arrived to record land uses. Atela (2012) also found that farmers had minimal knowledge of the co-benefits of practices promoted by Vi Agroforestry.

Institutions of local governance mostly served as an introductory forum for Vi Agroforestry to share information on project goals and activities and legitimate their involvement. A primary example was that of Chiefs' Barazas, local administrative forums through which 36 % of the farmers interviewed learned about the KACP. According to Atela (2012):

Practices of introducing initiatives to farmers through local elites in fora such as the Chief's Barazas have evolved over time, but have commonly been deployed by new projects as an effective way to gain farmer acceptance of external projects and technological solutions. Farmers perceive Barazas as conduits for legitimizing information provided by the state and external actors. Consequently, farmers perceive 'participation' in barazas as a top-down process whereby local elites and contact farmers are the only entry points into the community, and they shape the nature and content of the engagement.

Atela (2012) identified these 'local elites' as community group leaders and elders. The influence of these more active participants is sought as a means to animate local farmers. Atela's (2012) analysis indicates that the majority of farmers were engaged in these forums only at the level of passive participation.

### 26.6.1.3 Roles of Lower-Level Intermediary Organizations

Community/farmer groups play a significant role in the organizational structure of the project.<sup>2</sup> They are the smallest unit of organization within the project and serve as the interface between project staff and individual farmers. Smallholder farmers

---

<sup>2</sup> Here the term community group will be used to denote either.

are aggregated by community group. The 60,000 farmer participants are organized into 3,000 pre-existing community groups, which are each contracted by Vi Agroforestry (Tennigkeit et al. 2012). These community groups are often part of umbrella groups, or coalitions of smaller groups, which are connected to the provision of information and input services, but play a less direct role in project implementation. Less information is available on their function (Shames et al. 2012a).

Community groups play a central role in project implementation. They are mobilized by community group leaders who use them to diffuse information, collect data for monitoring carbon storage, and distribute payments. This could be classified as functional participation, at least on the part of group leaders. Vi Agroforestry contracts community groups to take part in the project. Within the contracted group, farmers must fill out a 'farmer commitment form' stating their willingness to participate in the project. These forms are collected and signed by the group leader before being submitted to Vi Agroforestry. The community groups are also responsible for implementing the Activity Baseline and Monitoring Survey. Individual forms are filled out by farmers annually and collected by group leaders to be submitted to project offices. Using this information Vi Agroforestry allots carbon payments to group leaders, who in turn distribute the payment among individual farmers (Shames et al. 2012a; Tennigkeit et al. 2012). Although they play an essential role in project implementation, limited information exists about the motivation for involvement and the power of group leaders. Atela (2012) implied that group leaders possess more knowledge of the 'Triple Win' rationale than other farmers. This may have resulted from a Vi Agroforestry workshop at which attending community group leaders learned about project structure and agricultural practices.

Although local institutions, in the form of community groups, play a significant role in project implementation, they were not given decision-making power in project planning and design. The external initiating agency determined the practices to be implemented, monitoring methodology, and payment mechanisms (Atela 2012; Shames et al. 2012a), thus implying that individual farmers are only engaged at the level of program participation. Community groups, the central actors in project activities, sign contracts specifying pre-determined activities and payment mechanisms. Vertical collaboration is limited because there is an absence of an effective forum through which communication between lower-level and higher-level intermediaries may occur. In fact, community facilitators represent the primary linkage between community groups and Vi Agroforestry.

#### **26.6.1.4 Monitoring and Market Linkages**

The methodology employed by the project, Sustainable Agricultural Land Management (SALM), was put forth by the World Bank's BioCarbon fund and approved by the Verified Carbon Standard (VCS) in 2011. The BioCarbon Fund purchases the VCU (verified carbon units) produced by the project at a guaranteed

rate of \$4 USD/tCo<sub>2</sub> for 20 years. To determine carbon sequestered, the project uses an activity baseline and monitoring survey (ABMS), and estimates of soil organic carbon based on a Roth-C analysis of recorded SALM practices. Fifteen farmers were chosen to be the ABMS sample farmers. Monitoring of their practices helped to inform validation of credits (Atela 2012). Information was also gathered from forms that farmers filled out and turned in to the farmer group leader. The reliability of calculations based on this data is questionable. For example, farmers may over report land holdings in order to gain more carbon revenue. On the other hand, if farmers are trying to receive food aid or are concerned with having land taken from them, they may under report their land holdings and yields. This lack of confidence in reporting is used to justify a 60 % discount in carbon credits. While total earnings were projected to be US\$ 4,945,492, with the discount this amount is reduced to US\$ 1,978,197 (Shames et al. 2012a).

### **26.6.1.5 Distribution of Carbon Revenues**

Carbon revenues received by the project are significantly reduced by the 60 % discount. Twelve percent of the initial credits (30 % of discounted credits) are used to cover project operating costs, leaving 28 % of the initial credits as revenues for farmers, who will receive only \$23 per ton sequestered over the course of the 20 year project (Atela 2012; Sharma and Suppan 2011). The yearly contribution to household income, therefore, is nominal. However, the project justifies such small payments by arguing that the project's main intent, and the primary motivation for participating farmers, is to increase yields and improve resilience (Atela 2012; World Bank 2010). The 12 % of initial carbon revenues reserved as farmers' contribution to the project is expected to cover 30 % of project operational costs. The remaining project expenses are covered by the Swedish International Development Agency (38 %) and by Vi Agroforestry itself (32 %).

### **26.6.2 Sofala Community Carbon Project**

The Sofala Community Carbon Project was started in 2002 by Envirotrade, the University of Edinburgh, and the European Union (COTAP 2013). Located in the Sofala province of Mozambique, the project operates in three sites: Gorongosa, Zambezi Delta, and Quirimbas, promoting sustainable land use and rural development through agroforestry and other development activities, while working to increase farmer incomes with revenues from the sale of carbon credits. It is a Plan Vivo flagship project and engages in REDD + activities as well as agroforestry and other emission-reducing behaviors (Envirotrade 2013a). The project also contracted the University of Eduardo Mondlane to assist in monitoring forest and fire management activities.

### **26.6.2.1 External Initiating Agency; Higher-Level Intermediary**

Envirotrade Carbon Limited, a company that trades carbon offsets, can take credit for forming the project. The Mauritius-based organization provides Payments for Environmental Services to farmers in Mozambique and sells carbon offsets to businesses and individuals on the voluntary carbon market. The Envirotrade Mozambique Limitada (EML), the national subsidiary of Envirotrade, is described as the implementing organization for the project (Envirotrade 2010). It follows the Plan Vivo model for carbon storage and development activities (Envirotrade 2010).

### **26.6.2.2 Project Implementation**

Community members are employed by project staff as community technicians. They are essential for promotion and monitoring of carbon storage activities. They have been trained to carry out biomass surveys, and perform two monitoring checks on participating farmers each year. These visits are intended not only to monitor activities, but also to provide a forum in which community technicians can continue to train farmers, and to allow them to seek clarification about monitoring processes, their individual contracts, or carbon payments. This feedback is purely reactive participation. Contact with community technicians represents the primary connection that individual farmers have with the project and results in a limited degree of two-way vertical communication and collaboration (Envirotrade 2010).

The project is organized following the Plan Vivo system for a community-based carbon initiative. Individual farmers choose how to implement their participation using nine land-use system options. Each system is informed by a set of technical specifications, and its implementation is monitored in order for farmers to receive payment. Stakeholders can take on multiple contracts, which may allow them to spread out their incentive payments over time (Envirotrade 2010). In contrast to the KACP, monetary incentives are emphasized in the project, and the supplement to households' income is viewed as a key accomplishment of the project, indicating that participation is based on the provision of material incentives. However, the inherent benefits of these practices are expected to be sufficient motivation to maintain them after 7 years of carbon payments (Envirotrade 2013a).

Community meetings are utilized to foster vertical communication, to answer questions, and to announce the project in new sites. The 2009 Annual Report (Envirotrade 2009) includes meeting minutes from a 'consultation ceremony' in which stakeholder participation was simplistically summed up as: "The community of Gorra was happy to receive the project, and they asked for employment and help from the project." The 2011 Annual Report (Goodman 2012) provides a tabular summary of community meetings in the Gorongosa project site. It indicates a high degree of individual participation. Meetings are intended to provide farmers with the opportunity to be able to express concerns, make recommendations, and ask for clarification. One example in which farmers used the opportunity to speak out was a result of a delay in REDD payments. Although the meeting allowed the farmers to voice their frustration to project implementers, it did not represent a chance

for farmers to change project practices. Thus, it is also an example of reactive participation. Still, it represents a higher degree of farmer participation than that occurring at most meetings. Many meetings involved discussion among local administrative leaders (*Regulos*), community technicians, and project staff with the passive participation of other community members in attendance.

### 26.6.2.3 Roles of Lower-Level Intermediary Organizations

As the project has evolved, its structure has been transformed to allow local level intermediaries to take on more empowered roles. At the beginning of the project, the lack of institutional infrastructure, attributable to the civil war in the 1990s, represented a challenge to the project (Dougill et al. 2012). The Sofala pilot project was instrumental in applying for the communities' state-granted land rights (*direito de uso e aproveitamento da terra* or DUAT), which established community associations at the project sites (Envirotrade 2010). As newly established entities, the community associations played only minimal roles in the pilot phase of the project. Jindal (2004) noted that community associations were hardly functioning and that most project activities were overseen by project staff. He stressed the importance of active participation by community associations for the long-term sustainability of the project. Envirotrade apparently shares this view. The Project Design Document describes a plan to shift greater control to community associations, which have actually assumed a more active role as the project has progressed (Envirotrade 2010).

Community associations are the lowest-level intermediary organization in the institutional structure of the Sofala Community Carbon Project. Community associations are meant to "ensure the responsible use of communal natural resources" (Envirotrade 2010). They grant forestry licenses and resolve land tenure conflicts. Because the New Land Law of 1997 allows for communal ownership, community associations also serve to coordinate collective action. They are a mechanism for the delivery of community benefits necessary for the REDD activities in the project (Dougill et al. 2012). Most REDD activities are implemented on communally-owned land, and REDD financing is placed in community trust funds managed by the community associations (Envirotrade 2010). The community associations coordinate action for a collective good. For example, to support REDD financing, they sign contracts with individuals to patrol and make fire breaks in forest areas. Community associations appear to be instrumental in determining how community funds from carbon revenues are used. The community associations, as local governance units, have also invested carbon revenues in community institutions such as schools and a health facility. They have directed the building process by holding consultations, agreeing on sites and goals, and allocating resources (Envirotrade 2010). If associations are as active as project documents claim, their role is primarily one of functional participation.

Until 2010, community association's primary vertical linkage was through the Mozambique Carbon Livelihoods Trust (MCLT), which was established by Envirotrade in 2007. Initially, the mandate was to manage disbursement of carbon revenues. However, the intent was to increase its level of responsibility as the

project progressed. Representatives from each community association acted as members of the board of the MCLT, providing input on the use of carbon revenues, along with representatives from the Envirotrade Mozambique Limitada (EML), and the auditing firm Contabil. The EML was established as a Mozambican not-for-profit to manage the technical and administrative aspects of the project during the pilot phase (Envirotrade 2010). Although the EML hired many members of the community and worked closely with the MCLT, there is little evidence of local participation in the first phases of the project. Dougill et al. (2012) indicate that the absence of community institutions limited the project's ability to foster connections across institutional levels.

In 2010, the non-profit Associação Envirotrade Carbon Livelihoods Trust (AECL) was established to replace the Mozambique Carbon Livelihoods Trust (MCLT). According to the 2010 annual report, the AECL is more transparent and independent than the MCLT had been (Goodman 2010). However, the difference between the two is not clear aside from the AECL's preferable compliance with Mozambican corporate laws as a community non-profit association (Goodman 2010, 2012). Similar to the MCLT, AECL members are representatives from community associations, Envirotrade, and third-party stakeholders (Goodman 2010). The AECL claims to be more independent and transparent. The 2012 annual report (Goodman 2012) describes the AECL as the effective owner of the project, and as "the interface between the participating communities and the project developer."

In this way, the AECL provides a forum to link lower level and higher level intermediaries. It is the highest-level intermediary organization with direct interaction with local stakeholders. Membership in the AECL grants community associations decision-making power by involving them in planning and analysis. However, they may be subject to manipulative participation, especially when board members have minimal opportunities to influence decisions. Additionally, it is unclear what decisions the AECL is able to make, as the practices, project areas, and distribution system have already been established.

#### **26.6.2.4 Monitoring and Market Linkages**

The University of Edinburgh and Edinburgh Centre for Carbon Management researched and wrote the technical specifications for the project, which were approved by the Plan Vivo Foundation. Carbon accounting mechanisms are based on a variety of research findings for biomass and soil sequestration, and integrated into a carbon calculator, which is described in the project design document (Envirotrade 2010):

The carbon calculator is the summarized output of all the agro-forestry and agricultural soil carbon technical specifications and is used to determine the number of carbon credits generated based on the land use system, area planted and baseline. Area planted is determined by [a] mapping process... carried out by community technicians and then entered into the carbon calculator... By summing the total carbon in each contract with the farmers, it is possible to get a project wide summary of carbon produced and available for sale. Each contract has a carbon calculator attached derived from the technical specification in use at that time.

Monitoring reports are submitted annually to Plan Vivo, which verifies the credits before they are issued to buyers (Envirotrade 2010). Carbon credits are calculated as the average offsets per hectare over 100 years. However, farmers are contracted to be paid the entire amount over 7 years. The inherent benefits from implementing these activities are expected to be sufficient incentive for farmers to maintain them for 93 years after monetary incentives end, even though the livelihood benefits of these payments are emphasized (Envirotrade 2010). Despite this dubious assumption, a risk buffer of only 15 % is used to account for accidental carbon stock loss. Shames and Scherr (2010) indicate that, as a result, the use of Plan Vivo may make carbon credits less marketable, particularly when compared against more rigorous verification systems such as the VCS. However, the marketability of the credits is improved by validation from the Climate, Community and Biodiversity Alliance (CCBA). The project received Triple Gold status for 'exceptional benefits' in the evaluation areas of climate, community, and biodiversity. Unlike the KACP, the project does not have a large fund contracted to purchase its credits. Instead, the carbon credits are purchased by other companies, and individuals on the voluntary carbon market, exposing the project to the risk of fluctuating market prices. Expectations for carbon revenues were based on the assumption that \$15 would be earned per ton of carbon sequestered (Envirotrade 2013b). However, this selling price has not been achieved. In 2012, the average selling price was \$8.32 USD/tCO<sub>2</sub>.

### 26.6.2.5 Distribution of Carbon Revenues

The variability of the voluntary carbon market has proven challenging for Envirotrade's finances. According to Plan Vivo guidelines, one third of carbon revenues should go to the participating farmers, one third to local project operations (which include salaries of local staff), and another third to the operating company management team, overhead expenses, and return to investors (Envirotrade 2013b). Lower-than-projected carbon revenues, averaging \$8.32 USD/tCO<sub>2</sub> in 2012, have meant that payments to farmers, which are fixed at a rate \$4.00 per ton sequestered, constituted over half of the average price received for each carbon credit. As a result, expenditures on farmer incentives and local project operations have consistently exceeded carbon revenues, with nothing left over for the company management team, overhead expenses, and return to investors. Nevertheless, from 2009–2012, 70–77 % of expenses from local project operations were covered by carbon revenues (Goodman 2010, 2012; Envirotrade 2009, 2013b). The remainder, as well as the company management team and overhead expenses, was financed by Envirotrade. However, figures are available for only certain years of implementation. Since payments to farmers are front-loaded, it is likely that more carbon revenues were allocated to project expenses in these later years of the project.

Payments to farmers include contributions to a community fund for communally-owned land, which mostly applies to REDD + activities, and payments to individuals for individually-owned land (Envirotrade 2010). The payment



structure protects farmers from price fluctuations, as they are contracted to receive US\$ 4.70 per ton sequestered regardless of market price (Envirotrade 2013b). Assuming individual land holdings of one hectare, Jindal (2004) estimates that a household would receive US\$ 242.60 over the course of 7 years. The contracts specify that farmers will receive 35 % of the payment in the first year. It is expected that project activities will be self-sustaining after 7 years with no additional financial incentives.

The payment structure for REDD activities is different. Most REDD activities take place on communally-owned land, and revenues are allocated to a community fund. They are invested in community infrastructure in the form of schools and health services (Envirotrade 2010). Jindal (2004) estimated that each hectare of communally-owned land will generate a total of US\$ 40.50 in carbon revenues over the course of 10 years. In 2010 Envirotrade anticipated that the project will receive a total of over ten million dollars in carbon revenues (Envirotrade 2010). It is not clear if fluctuating prices will allow them to reach this number.

### ***26.6.3 Comparison of Case Studies***

The KACP and Sofala Community Carbon case studies constitute successfully managed agricultural carbon projects. They have generated and sold carbon credits from sequestration activities implemented by smallholders. A comparison of these case studies reveals common challenges; their dissimilarities indicate distinct motivations and orientations on the part of the project implementers.

Both projects were initiated by an external agency. The KACP was initiated by the BioCarbon Fund of the World Bank and implemented by Vi Agroforestry, a foreign NGO with 25 years of experience working in the region (Shames et al. 2012a). The Sofala Community Carbon Project, on the other hand, was initiated by Envirotrade Carbon Limited, a company without previous experience in the region.

Both projects engaged local-level intermediaries to serve some functions in implementation. The KACP engaged pre-existing community groups to inform members about the project, monitor farmer implementation of project activities, and distribute incentive payments. By contrast, the Sofala Community Carbon Project did not have the option of engaging pre-existing groups because of the civil war in Mozambique. Instead, Envirotrade was able to create community associations. Although they derive their land-management authority through national laws, they had no previous land-use governance experience. An additional level of intermediary organization is present in the Sofala project, in the form of the AECL, which serves as an interface between representatives of community-level intermediaries and representatives from Envirotrade. The KACP does not have a parallel structure for vertical linkages.

Hired extension agents play vital roles in monitoring and information diffusion for both projects. Extension agents in the KACP focus on disseminating

information to large numbers of farmers while strengthening the capacity of community groups to take part in monitoring and knowledge diffusion (Shames et al. 2012a). Field officers, who are extension agents paid by Vi Agroforestry, work to recruit 400–600 farmers per year. They also train community facilitators to act as liaisons with community groups (Atela 2012). In the Sofala project community technicians are hired by Envirotrade and trained by project staff to monitor agroforestry activities and to work closely with individual farmers. Each community technician works with 100 farming households and visits farms twice a year as a monitoring activity. These visits are also intended to serve as an opportunity for the technicians to educate and train farmers, while allowing farmers to ask questions about practices, payments, or their contract (Envirotrade 2010). Thus, these visits serve as farmers' primary interface with Envirotrade, while in the KACP farmers' participation in the project is brokered by the group leader.

A key difference, however, is that the KACP signed contracts with community groups, while the Sofala project contracted with individual farmers. This has an impact on the distribution of carbon revenues. In the KACP, carbon revenues are distributed to community group leaders who in turn disburse them to group members. In the Sofala project, individuals receive payments directly for the land-management plans implemented on their farms, and community associations receive and manage funds for practices on communal lands.

The pattern of stakeholder participation, however, is quite similar. Both projects began with intensive involvement of their respective external initiating agency. Nevertheless, each established a plan to allow local organizations to take a greater role in project implementation. The KACP adapted Vi Agroforestry's approach which emphasized initial efforts to train communities to take on greater responsibility for project activities in later stages (Tennigkeit et al. 2012). The difference in stakeholder engagement between earlier and later stages of the project is more pronounced in the Sofala Community Carbon project, partly as a result of an initial absence of functional local institutions. After their project-initiated establishment, community associations took on an increasingly significant role.

Neither project apparently had strong stakeholder input in project planning and design. Community members and community-level institutions possess some decision-making power about how to achieve project goals. However, project goals were not informed by local frames of reference. Stakeholders did not take part in decisions about which agricultural practices to implement, the structure of incentive disbursements, monitoring practices, or the choice of certification system. Even if all authority were to eventually be transferred to local leaders, they have only been handed a pre-made package designed by an external agency.

Each of these projects is characterized by the narrative adopted in their rationale. The KACP, as an initiative of the BioCarbon Fund, adheres to the logic put forth by powerful international institutions such as the FAO and World Bank. Thus, the project is guided by the logic of 'Climate Smart Agriculture' and 'The Triple Win.' As a result, improved resilience and increased yields are emphasized over livelihood benefits from carbon payments (Atela 2012). The Sofala Community Carbon project, on the other hand, is not linked to such a powerful international institution,

but reflects a private enterprise orientation. As a Plan Vivo flagship project, it is characterized by the Plan Vivo standards, a certification system for community-based payments for environmental services. The standards seek to ensure that projects validated through Plan Vivo “benefit livelihoods, enhance ecosystems and protect biodiversity” (Plan Vivo 2013). Thus, the Sofala project is more closely associated with market principles.

Because the KACP is linked to the BioCarbon Fund, it must adhere to strict international standards. Its credits are verified through the VCS, which requires a 60 % discount. This allows the VCS to maintain its reputation for rigorous standards when verifying agricultural carbon sequestration as this approach is more experimental and indeterminate when compared with other methods of carbon sequestration. The Sofala Community Carbon Project does not adhere to such strict standards. The methodology utilized by Sofala only requires a 15 % discount, although the system for calculating credits is more dubious, as it is based on the average amount of carbon expected to be sequestered over 100 years of implementing the land-use change promoted by the project. In contrast, the VCS requires that carbon credits can only be generated from carbon that has already been sequestered, making the carbon sequestration efforts of the KACP more realistic.

Although the Kenya Agricultural Carbon Project adhered to more rigorous standards, its fixed price of \$4 USD/tCO<sub>2</sub> (Atela 2012) is less than half the average amount received by the Sofala Community Carbon project on the voluntary market in 2012.<sup>3</sup> At the same time, the KACP was obligated to discount 60 % of its carbon credits in order to adhere to its robust standards, while the Sofala project discounted only 15 %. The KACP is buffered from market risks as its credits are guaranteed to be purchased by the BioCarbon Fund at a guaranteed rate. Conversely, the Sofala project must market and sell credits to individuals, companies, and carbon resellers, thus exposing itself to market risks. The external agency (Envirotrade) absorbs this risk, however, protecting farmers from fluctuating markets by contracting them at a fixed price. While this has the potential to disadvantage farmers if the carbon credits are sold at prices well above the rate they receive, it has actually served to buffer farmers from lower-than-expected market rates.

Table 26.1 provides detailed comparative figures. In both instances, a proportion of project costs was covered by carbon revenues. The KACP expects to cover 30 % of total project costs with revenues. It is difficult to compare this to the Sofala Community Carbon project, which distinguishes local project costs from overhead expenses and management team operational costs. While 70–77 % of local project costs were covered by carbon revenues in years 2009–2012, it is impossible to determine the percentage of total costs covered. In both cases, carbon revenues were far from sufficient to pay all project expenses.

---

<sup>3</sup> It received an average amount of \$8.32 USD/tCO<sub>2</sub> (Envirotrade 2013a, b).

**Table 26.1** Comparison of carbon revenues and their distribution

Project	Payment to project for sale of carbon credits	Percent discounted	Payment to farmers per ton sequestered	Proportion of project expenses covered by carbon revenues
The KACP	\$4.00	60 %	\$0.96	30 %
Sofala Community Carbon	\$8.32 <sup>a</sup>	15 %	\$4.70	70–77 % <sup>b</sup>

Figures from Atela (2012), Goodman (2010, 2012), Envirotrade (2009, Envirotrade 2013b)

<sup>a</sup>Average in year 2012

<sup>b</sup>Calculated percentage of *local expenses* covered by carbon revenues in years 2009–2012, based on figures in the 2009–2012 annual reports. The proportion of total costs covered by the project, including overhead expenses and costs of operating Envirotrade, is unknown, limiting our ability to compare the KACP and Sofala Project

## 26.7 Considerations for Development of Agricultural Carbon Projects

These initiatives are similar in many ways to other agricultural development projects. Nevertheless, they set themselves apart by generating carbon credits, which provide a source of income and represent attempts to mitigate climate change. Each case study conveys a different narrative of this process. The KACP reflects the goals and principles of multi-national institutions, emphasizing conservation practices as a form of climate change mitigation and adaptation. Conversely, the Sofala project is market-oriented, highlighting the capacity for carbon credits to provide a source of income to farmers, the project and communities.

Whether agricultural carbon projects are ‘practice’ or ‘market’ oriented, the advantages of carbon credit generation still face practical challenges. The costs of agricultural carbon projects are likely to exceed carbon revenues, particularly as monitoring, reporting, and verification can be complicated and expensive. Additionally, the goal of climate change mitigation necessitates enduring land-use change. This leads us to the question:

### **To what extent can agricultural carbon finance initiatives become self-sustaining?**

This question should guide future discussion of the value of agricultural carbon initiatives, and can be addressed along two dimensions, namely, financial and farmer commitment. The inability of our two case studies to operate solely, or even primarily, on carbon revenues casts doubt on the value of this market mechanism for supporting community-based agricultural carbon initiatives. If carbon finance schemes cannot be self-sustaining financially, we must ask whether they would function more efficiently and effectively as conventional development projects, without any connection to carbon markets. Therefore, project implementers should ask:

### **Do carbon revenues justify efforts to monitor, report, and verify sequestered carbon?**

This issue may be partially addressed at the macro level. Greater acceptance of land-use change as a method of carbon sequestration would allow these initiatives to sell credits on the compliance market, reducing uncertainty and potentially improving revenues.

In order to be truly significant for climate change mitigation, sustainable land use practices should be maintained in the long-term, beyond the life of the project and the provision of incentives. This will be determined by motivation and commitment on the part of the farmers implementing these practices. Evaluation of this commitment is complicated by the provision of direct material incentives. Farmers in the KACP are engaged by emphasizing co-benefits over material incentives, increasing the likelihood that they will maintain project activities, while in the Sofala project farmers appear to be motivated primarily by carbon payments. However, farmer commitment to project activities is not only a function of material incentives. The level and quality of participation can also influence commitment to project goals. A higher degree of local stakeholder participation allows the project to be shaped by local knowledge and interests, resulting in projects which are more relevant to farmer priorities and concerns. Thus, project implementers should ask:

### **What role do stakeholders have in determining the following facets of the project?**

- (a) Finance mechanism (open market, BioCarbon Fund, other)
- (b) Practices to be implemented
- (c) Verification methodology
- (d) Contract arrangements
- (e) Payment Structure

In our case studies, local stakeholders do not appear to be engaged in project planning, precluding their meaningful participation in decision-making. Rather, the interests of the external agency, as informed by the macro-level narratives, are being executed by micro-level agents. To become truly sustainable, these narratives will need to evolve as carbon credit generation through land-use change becomes increasingly incorporated into local discourse. Meanwhile, greater acceptance of carbon credits in international institutions will increase the leverage and the revenue-earning potential of agricultural carbon initiatives. For local and international narratives to be mutually beneficial, agents at the meso level must serve as true intermediaries by negotiating micro-level interests on macro-level markets and institutions.

## **References**

- Andersson JA, D'Souza S (2013) From adoption claims to understanding farmers and contexts: a literature review of Conservation Agriculture (CA) adoption among smallholder farmers in southern Africa. *Agric Ecosyst Environ* 87:116–132

- Atela JO (2012) The politics of agricultural carbon finance: the case of the Kenya agricultural carbon project, STEPS Working Paper 49. STEPS Centre, Brighton
- Bhatnagar M (2008) Payment for environmental services: an introduction. In: Bhatnagar M (ed) Payment for environmental services: some concepts and experiences. The ICFAI University Press, Hyderabad
- Carter S (2009) Socio-economic benefits in Plan Vivo projects: trees for global benefits, Uganda. Plan Vivo Foundation and Ecotrust Uganda. Available via <http://www.geos.ed.ac.uk/homes/scarter/Uganda1v2.pdf>
- CCBA (2013) CCB standards [Online] <http://www.climate-standards.org/ccb-standards/> Accessed 2 Dec 2013
- Chambers R (1983) Rural development: putting the last first. Longman, London
- Coleman K, Jenkinson DS (2008) RothC-26.3 a model for the turnover of carbon in soil: model description and windows users guide. Rothamsted Research, Harpenden
- Conant TR, Paustian K, Elliott ET (2001) Grassland management and conversion into grassland: effects on soil carbon. *Ecol Appl* 11(2):343–355
- COTAP: Carbon offsets to alleviate poverty (2013) Sofala, Mozambique. <http://cotap.org/projects/sofala/> Accessed 4 Nov 2013
- Dougill AJ, Stringer LC, Leventon J, Riddell M, Rueff H, Spracklen DV, Butt E (2012) Lessons from community-based payment for ecosystem service schemes: from forests to rangelands. *Philos Trans R Soc B* 367:3178–3190
- Envirotrade (2009) Sofala community carbon project 2009 Plan Vivo annual report. Available via [http://www.planvivo.org/wp-content/uploads/Sofala\\_Community\\_Carbon\\_AR2009.pdf](http://www.planvivo.org/wp-content/uploads/Sofala_Community_Carbon_AR2009.pdf). Accessed 14 Oct 2013
- Envirotrade (2010) Sofala community carbon project design document according to CCB and Plan Vivo standards. Available via [http://www.planvivo.org/wp-content/uploads/2010-19-08-PDD-CCBA\\_PV-Sofala-post-audit.pdf](http://www.planvivo.org/wp-content/uploads/2010-19-08-PDD-CCBA_PV-Sofala-post-audit.pdf). Accessed 14 Oct 2013
- Envirotrade (2013a) Envirotrade carbon livelihoods projects. <http://www.envirotrade.co.uk/html/projects.php>. Accessed 4 Nov 2013
- Envirotrade (2013b) Sofala Community carbon project: 2012 annual report. Available via [http://www.planvivo.org/wp-content/uploads/2012-Sofala-Plan-Vivo-Annual-Report\\_published.pdf](http://www.planvivo.org/wp-content/uploads/2012-Sofala-Plan-Vivo-Annual-Report_published.pdf). Accessed 15 Oct 2013
- FAO (2013) Climate-smart agriculture sourcebook. Available via <http://www.fao.org/docrep/018/i3325e/i3325e.pdf>. Accessed 23 Oct 2013
- Goodman L (2010) Plan Vivo Annual Report Sofala Community Carbon Project: 2010. Available via [http://www.planvivo.org/wp-content/uploads/2010\\_annual-report\\_Sofala-community-carbon-Markit1.pdf](http://www.planvivo.org/wp-content/uploads/2010_annual-report_Sofala-community-carbon-Markit1.pdf). Accessed 15 Oct 2013
- Goodman L (2012) Sofala Community Carbon Project 2011 Annual Report. Available via [http://www.planvivo.org/wp-content/uploads/2011\\_Plan-Vivo-Annual-Report-final\\_website.pdf](http://www.planvivo.org/wp-content/uploads/2011_Plan-Vivo-Annual-Report-final_website.pdf). Accessed 15 Oct 2013
- Homsy GC, Warner ME (2013) Climate change and the co-production of knowledge and policy in rural USA communities. *Sociol Rural* 53(3):291–310
- IPCC (2007) Climate change 2007: synthesis report. In: Contribution of Working Groups I, II and III to the Fourth Assessment Report of the Intergovernmental Panel on Climate Change [Core Writing Team, Pachauri RK, Reisinger A (eds)]. IPCC, Geneva
- Jindal R (2004) Measuring the socio-economic impact of carbon sequestration on local communities: An assessment study with specific reference to the Nhambita pilot project in Mozambique. Master's dissertation, University of Edinburgh, Edinburgh
- Jindal R, Swallow B, Kerr J (2008) Forestry-based carbon sequestration projects in Africa: potential benefits and challenges. *Nat Res Forum* 32:116–130
- Kinuthia EK (2010) The effects of the international smallgroup and tree planting program on household income in Nyeri district, Kenya. Master's thesis, Egerton University, Nakuru
- Lal R (2004) Soil carbon sequestration to mitigate climate change. *Geoderma* 123:1–22
- Lal R (2011) Sequestering carbon in soils of agro-ecosystems. *Food Policy* 36:S33–S39

- McKenzie F, Childress A (2011) A 'state of play' assessment of land use in the international policy response to climate change. The Terrestrial Carbon Group. Available via [http://www.terrestrialcarbon.org/Terrestrial\\_Carbon\\_Group\\_soil\\_%26\\_vegetation\\_in\\_climate\\_solution/Policy\\_Briefs\\_files/Terrestrial%20Carbon%20State%20of%20Play.pdf](http://www.terrestrialcarbon.org/Terrestrial_Carbon_Group_soil_%26_vegetation_in_climate_solution/Policy_Briefs_files/Terrestrial%20Carbon%20State%20of%20Play.pdf)
- Moore KM, Myers J, Clements C (in press) Small farmer choice and decision making for sustainable soil management. In: Lal R, Stewart BA (eds) *Managing the soils of smallholder agriculture*. Taylor & Francis
- Morton LW (2011) Relationships, connections, influence, and power. In: Morton LW, Brown SS (eds) *Pathways for getting to better water quality: the citizen effect*. Springer, New York, Available online at <http://link.springer.com/book/10.1007%2F978-1-4419-7282-8>. Accessed 1 Oct 2013
- Narayan D (1995) Focus on participation: evidence from 121 rural water supply projects. Environmentally sustainable development occasional paper series no. I. The World Bank, Washington, DC
- Nelson GC, Rosegrant MW, Koo J, Robertson R, Sulser T (2009) *Climate change: impact on agriculture and costs of adaptation*. International Food Policy Research Institute (IFPRI), Washington, DC
- Ostrom E (2005) *Understanding institutional diversity*. Princeton University Press, Princeton
- Peters-Stanley M, Yin D (2013) Maneuvering the mosaic: state of the voluntary carbon markets 2013. Available via [http://www.forest-trends.org/documents/files/doc\\_3846.pdf](http://www.forest-trends.org/documents/files/doc_3846.pdf). Accessed 16 Jan 2014
- Plan Vivo (2013) The Plan Vivo standard for community payments for ecosystem services programmes. Available via <http://www.planvivo.org/wp-content/uploads/Plan-Vivo-Standard-2013.pdf>. Accessed 8 Jan 2014
- Pretty J (1995) Participatory learning for sustainable agriculture. *World Dev* 23(8):1247–1263
- Prokopy LS, Floress K (2011) Measuring the citizen effect: what does good citizen involvement look like? In: Morton LW, Brown SS (eds) *Pathways for getting to better water quality: the citizen effect*. Springer, New York, Available via <http://link.springer.com/book/10.1007%2F978-1-4419-7282-8>. Accessed 1 Oct 2013
- Pye-Smith C (2011) Farming's climate-smart future: placing agriculture at the heart of climate-change policy. *Climate Change, Agriculture and Food Security (CCAFS)*. Available via <https://cgispace.cgiar.org/bitstream/handle/10568/25164/FarmingsClimate-smartFuture.pdf?sequence=1>
- Reddy RC (2010) BioCarbon fund in agriculture. Presented at the workshop on climate change mitigation in agriculture in Latin America and the Caribbean: investments and actions, Rome, 19–20 April 2010
- Reynolds TW (2012) Institutional determinants of success among forestry-based carbon sequestration projects in sub-Saharan Africa. *World Dev* 40(3):542–554
- Seeberg-Elverfeldt C (2010) Carbon finance possibilities for agriculture, forestry and other land use projects in a smallholder context. Food and Agriculture Organization (FAO), Rome
- Shames S, Scherr SJ (2010) Institutional models for carbon finance to mobilize sustainable agricultural development in Africa. USAID. Available via [www.ccafs.cgiar.org](http://www.ccafs.cgiar.org). Accessed 4 Nov 2013
- Shames S, Wekesa A, Wachiye E (2012a) Case study: Western Kenya smallholder agriculture carbon finance project: Vi Agroforestry. In: Shames S, Wollenberg E, Buck LE, Kristjanson P, Masiga M, Biryahaho B (eds) *Institutional innovations in African smallholder carbon projects*. CCAFS Report no. 8. CGIAR Research Program on Climate Change, Agriculture and Food Security (CCAFS), Copenhagen. Available via [www.ccafs.cgiar.org](http://www.ccafs.cgiar.org). Accessed 4 Nov 2013
- Shames S, Wollenberg E, Buck LE, Kristjanson P, Masiga M, Biryahaho B (2012b) *Institutional innovations in African smallholder carbon projects*. CCAFS Report no. 8. CGIAR Research Program on Climate Change, Agriculture and Food Security (CCAFS), Copenhagen. Available via [www.ccafs.cgiar.org](http://www.ccafs.cgiar.org). Accessed 4 Nov 2013

- Sharma S, Suppan S (2011) Elusive promises of the Kenya agricultural carbon project. Institute for Agriculture and Trade Policy (IATP) Available via <http://www.iatp.org/documents/elusive-promises-of-the-kenya-agricultural-carbon-project>
- Tennigkeit T, Solymosi K, Seebauer M, Lager B (2012) Carbon intensification and poverty reduction in Kenya: lessons from the Kenya agricultural carbon project. Field Actions Science Reports 7. Available via <http://factsreports.revues.org/2600>. Accessed 9 Oct 2013
- The BioCarbon Fund (2013) About the BioCarbon Fund (BIOCF) Available via <https://wbcarbonfinance.org/Router.cfm?Page=BioCF&FID=9708&ItemID=9708&ft>About>. Accessed 11 Dec 2013
- The Terrestrial Carbon Group (2008) How to include terrestrial carbon in developing nations in the overall climate change solution. Available via [www.terrestrialcarbon.org](http://www.terrestrialcarbon.org) Accessed 23 Aug 2013
- The Terrestrial Carbon Group (2010) Roadmap for terrestrial carbon science: research needs for carbon management in agriculture, forestry and other land uses. Available online at [www.terrestrialcarbon.org](http://www.terrestrialcarbon.org) Accessed 10 Oct 2013
- The World Bank (2010) Project information document (PID): appraisal stage. Report no: 53088. Available via <http://documents.worldbank.org/curated/en/2010/02/11807801/kenya-agricultural-carbon-project>. Accessed 9 Oct 2013
- The World Bank (2011a) Climate-smart agriculture: a triple win [Video]. [http://www.youtube.com/watch?feature=player\\_embedded&v=rs-pA1Ee02U](http://www.youtube.com/watch?feature=player_embedded&v=rs-pA1Ee02U). Accessed 6 Jan 2014
- The World Bank (2011b) Climate-smart agriculture: a call to action. Available via [http://www.worldbank.org/content/dam/Worldbank/document/CSA\\_Brochure\\_web\\_WB.pdf](http://www.worldbank.org/content/dam/Worldbank/document/CSA_Brochure_web_WB.pdf). Accessed 7 Jan 2014
- Tshakert P (2003) Soil carbon sequestration in small-scale farming systems: a case study from the old peanut basin in Senegal. Ph.D. dissertation, The University of Michigan, Ann Arbor
- Vatn A (2010) An institutional analysis of payments for environmental services. *Ecol Econ* 69:1245–1252
- VCS (2012) Methodology VM0017: adoption of sustainable agricultural land management. Available via <http://www.v-c-s.org/methodologies/>. VM0017 Accessed 8 Oct 2013
- VCS (2013a) VCS quality assurance principles. <http://www.v-c-s.org/quality-assurance-principles> Accessed 18 Dec 2013
- VCS (2013b) Why VCS? <http://www.v-c-s.org/how-it-works/why-vcs> Accessed 12 Dec 2013
- VCS (2013c) Who we are. <http://www.v-c-s.org/who-we-are>. Accessed 11 Dec 2013
- Waha K, Müller C, Rolinski S (2013) Separate and combined effects of temperature and precipitation change on maize yields in sub-Saharan Africa for mid- to late-21st century. *Glob Planet Chang* 106:1–12
- Wunder S (2005) Payments for environmental services: some nuts and bolts. CIFOR Occasional Paper, vol 42. Center for International Forestry Research, Bogor



# Chapter 27

## Community, Climate Change, and Sustainable Intensification: Why Gender Is Important

Cornelia Butler Flora

**Abstract** Adaptation to climate change is greatly enhanced when it occurs across a landscape. Agricultural and herding communities are important loci of adaptation. Women's knowledge and practices can help in determining new community livelihood strategies. Community adaptation is hindered when land grabs limit access to land for crops and animals. New forms of public-private partnerships that are often designated as foreign direct investment further complicate adaptation. Using the community capitals framework, community-based adaptation strategies that take gender into account are identified.

**Keywords** Adaptive capacity • Bonding social capital • Bridging social capital • Capacity • Capitals • Adaptation • Coping • Vulnerability

### 27.1 Introduction

Small producers, their livelihoods, and the land associated with both are threatened by changes in climate. They are among vulnerable populations, in that their natural and social systems are susceptible to damage from climate change (IPCC 2012). Their adaptive capacity, which is the degree to which adjustments in practices, processes, or structures can moderate or offset the potential for damage or take advantage of opportunities created by a given change in climate (IPCC 2012), is often limited by the political economy that determines the access to and control of the land.

Social science distinguishes two kinds of responses to climate change: adaptation and coping. Adaptation involves anticipating, planning, and acting to decrease vulnerability to climate change. Coping is the use of available skills, resources, and opportunities to address, manage and overcome adverse conditions with the aim of

---

C.B. Flora (✉)  
Iowa State University, Ames, IA, USA

Kansas State University, Manhattan, KS, USA  
e-mail: [cflora@iastate.edu](mailto:cflora@iastate.edu)

achieving basic functioning in the short to medium terms. In some cases, coping can increase long-term vulnerability.

While individuals cope or adapt to climate changes, community adaptation is often more effective in preserving both soils and the dignity of the small producers. Community adaptation is most effective when women are included, particularly in Africa, where women produce subsistence food crops and small animals for local markets (Gladwin 2002).

Structural adjustment in the 1980s and 1990s had major negative impacts on farming communities, particularly on women (MacKenzie 1993; Meena 1991; Due and Gladwin 1991). Governments dismantled and privatized extension systems that distributed agricultural inputs and technical assistance. As government spending on health and education decreased, fees for these services increased dramatically. Wage freezes meant a large reduction in remittances from fathers and sons with urban employment. Farming systems designed for subsidized inputs were no longer affordable (Tchingulou et al. 2013; Hassan et al. 2013). National emphasis on export crop production in order to generate foreign exchange often led to monocultures and increasing land concentration (Gladwin 1991).

The twenty-first century brought a new development model, where public-private partnerships brought new sources of foreign exchange to governments in the form of foreign direct investment (FDI). Under the right circumstances, when FDI invests in roads, ports, railways, electricity, and water, for example, it can contribute to international integrations and encourage transfer of technology between countries, and under the right policy environment, FDI can be an important vehicle for development (OECD 2012a). However, land-based investment often is purely extractive. Most FDI studies look at it as a totality, and their analyses combine FDI in industry and infrastructure with FDI in land, finding that it is not extremely negative (Xu and Sheng 2011). Thus, it is difficult to systematically address its impacts in different contexts.

In many parts of the world, the government holds title to communal lands, which is a primary resource for small holders and pastoralists. When this land is leased to foreign interests (often with a national partner within or close to the national government), the money goes to the government, and the new investors can extract what they please from the land and people. Although some countries have used portions of these payments to provide stipends to the poor, such poverty reduction does not produce local development nor is it sustainable once the resource of land, minerals, and/or water are depleted.

De Schutter (2011) is extremely cautious about FDI in land. He points out that giving land away to investors who have better access to capital to “develop” implies huge opportunity costs. As a result, a type of farming is brought in that has much less powerful poverty-reducing impacts than if access to land and water were improved for the local farming communities. This type of FDI farming directs agriculture toward crops for export markets, increasing the vulnerability to price shocks of the target countries. Even where titling schemes seek to protect land users from eviction, individual titling accelerates the development of a market for land rights with potentially destructive effects on the livelihoods of the current land users

that will face increased commercial pressure on land and on groups that depend on the commons – grazing and fishing grounds and forests.

Africa is faced with continuing mean temperature increases. Rising temperatures impact the water cycle, with more extreme storms and longer periods between rains. While total precipitation remains the same, local men and women perceive that there is a decline in rainfall. Rises in temperature result in more rapid rates of evapotranspiration, which makes the water seem scarcer despite systematic measurements showing no change in total precipitation (Kassie et al. 2013). Other significant extreme weather events include droughts, floods, freezes, and hail, all of which can damage crops, animals, and soils. They also result in an increased number of bacteria and pests. These changes are particularly felt by small holders and pastoralists, and in these groups, the most vulnerable are women and children.

## 27.2 Community Capitals and Climate Change

The community capitals framework (CCF) is a useful tool in analyzing the context and process of social change, and it has been used in the context of development in the United States and Latin America (Flora and Flora 2013; Ashwill et al. 2011; Pigg et al. 2013; Gasteyer and Araj 2009; Siles et al. 2013; Cepeda Gomez et al. 2008; Flora and Bregendahl 2012; Flora and Delaney 2012). The CCF defines *capital* as resources invested to create new resources over a long time frame. It was developed to show that many resources are needed to achieve a healthy ecosystem, social inclusion, and economic security for all people (See Fig. 27.1).

Forms of capital in this framework are viewed as collective resources, not just individual property. The types of capital are shown in a particular order, with natural capital, the natural environment, being the first and the basis for all the others. Next is cultural capital, which is the belief systems that link people to their

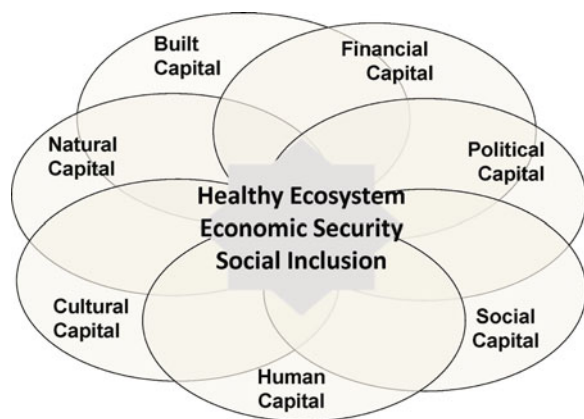


Fig. 27.1 Community capital diagram

environment and each other by connecting the seen and the unseen. Human capital is the attributes of human beings, including education, abilities, health, and self-esteem. These attributes are determined by structural factors but are part of each human actor. Social capital is the relationships that link people to each other through groups. Social capital can be ties of trust and reciprocity within a group or community (bonding social capital) and with other groups and communities (bridging social capital). Political capital is the ability of a group to turn its values and norms into the standards for the society (such as universal education, access to clean water, etc.) that are implemented through enforced rules and regulations. It involves voice and power. Financial capital is the financial instruments, including but not limited to money, that can be easily traded and monetized. There is a tendency to put all the other forms of capital in terms of financial capital. While the role of the state (political capital) under capitalism is to make it profitable to do what is for the common good, increasingly anything that is profitable, even if that profit is only for a few, is assumed to be for the common good. Built capital is the physical infrastructure, buildings, roads, dams, sewer systems, railroads, and electronic technology that can make other types of capital more efficient – or destroy them.

### **27.2.1 Natural Capital**

Natural capital includes air quality and the quality and quantity of water and soil, biodiversity, and the landscape. It can be viewed as a set of resources to be extracted or as a source of life that needs to be tended and cared for, depending on a group's cultural capital.

Soil security is key to food security. Moreover, community action is often the best way to increase both through sustainable intensification. For many agriculturalists, the community is where the norms and values, as well as the appropriate cultural and agricultural practices, are embedded. Communities can create healthy ecosystems, economic security, and social inclusion by investing their multiple resources to create new resources, or they can exhaust those resources by consuming them for immediate benefit. When resources are invested to create new resources, they can be referred to as *capital*. Soil security, and thus food security, depends on how each community invests its natural, cultural, human, social, political, financial, and built capitals. Women are critical in achieving soil security, food security, and sustainable intensification (Gladwin et al. 2002).

Climate change creates new environmental conditions that stress all community resources, although the most obvious is the impact on natural capital. The stress is felt unequally across communities and within communities, based on access and control of resources. Both gender and ethnicity can limit access to and control of different community capital stocks, making it particularly difficult for women and ethnic minorities to adapt to the climate-induced changes.

Understanding that context and how different actors in the community truly understand the soil as a resource that they feel capable of improving is critically

important if sustainable intensification is to occur. This is particularly so when confronted with climate change. A gender-aware perspective that acknowledges the influences of social relations, cultures, beliefs, values, and attitudes on our understanding, experience, and perceptions of the risks of climate change could contribute to a more balanced, nuanced approach to the problem that can consider these multiple understandings (Skinner 2011).

Women in vulnerable communities adapt to changes in the environment caused by climate and other forces. Many need to venture further to get wood and water. They save seed from diverse sources, plant different varieties or species depending on when it rains, have complex and diverse agricultural systems to minimize risk, access a variety of wild foods, closely observe changes in flora and fauna, and adapt their livelihood strategies to them. Access to and control of natural capital is often contested (Allen 2003).

Technologies to improve natural capital often work at the community level. Putting in small dikes and putting on more organic matter to retain moisture may lead to the improvement of soil. Kassie et al. (2013) found that to be the case in Ethiopia. Increasing organic matter in the soil increased its water holding capacity. This was far easier for local communities to understand than an abstract notion of soil organic matter as an end in itself. As natural capital is extremely heterogeneous, attention to place is critical for adaptation strategies.

Women and men in the same community tend to grow different crops; the specific crop varies by place and gender (Doss 2002). Generally women grow for home consumption and local markets, while men are tied into longer value chains (Gladwin et al. 2001). As pressure on land has increased, the crops that women grow have become more diverse in southern Cameroon. There is more frequent and more intensive cultivation of the women's crops, which increasingly provide family sustenance. That diversification means changes in land use, including amount of lands cleared for cultivation, planting of different crops, different crop densities, and different fallow periods. Gender and changes in the community shape agro-ecological practices (Guyer 1986).

Climate change has an immediate impact on natural resources. Farm communities and individual farmers have a long record of adapting to changes in rainfall and temperature over time (OECD 2012b). However, current changes and the increasing number of extreme events makes the use of natural capital even more problematic than before, impacting farm management practices, land use, what is produced and where it is produced.

Small holders around the world are turning to indigenous roots and grains for their basic food supply. Colonial regimes introduced exotic grains into soils which had not co-evolved with them. Examples are wheat and soybeans into the Americas and corn and soybeans into Africa. These crops have quickly depleted soils of their organic matter and nutrients and have proved ever-more dependent on external inputs, generally purchased at a highly subsidized rate as the national diet shifted to these new crops. Others are turning to locally-produced sources of nutrients such as the *Faidherbia* tree, which improves micro-climates, soil organic matter and

nutrients, and provides fodder for livestock at no external cost (Garrity 2013). However, for them to be successfully introduced, the community must agree to protect the new shoots from livestock in order for the trees to generate properly.

### ***27.2.2 Cultural Capital***

Cultural capital determines how communities and groups within communities see the world, how they connect the seen and the unseen, what they take for granted and what they think is possible to change. Cultural capital is often highly determined by and determines natural capital. Like natural capital, cultural capital is heterogeneous and gendered. Women's cultural capital often includes understanding what to plant under what conditions and where to take animals as pastures become dry. Community culture gives meaning to animals beyond their market value, and food often has specific ritual meanings. Rituals of respect are important for linking community members to each other and to the land. When one group's cultural capital predominates and devalues other ways of seeing and knowing, it is called hegemony.

Cultural capital determines what women are supposed to do and what men are supposed to do. In much of the world, women are to raise crops and animals for household use, while men produce them for sale. Women search for and haul wood and water for household use, while men undertake the same tasks in order to sell into a larger market (Nombo et al. 2013).

In much of Africa, farming for food is a critical part of gender identity (Gladwin 2002). At one point, this led to gender complementarity between male and female roles, but that changed with increasing globalization (Flora 1985). Today, men's tasks are often privileged in the distribution of resources within the household, community and state.

### ***27.2.3 Human Capital***

Human capital represents the skills, abilities, and knowledge that each human being possesses in a community. Gender in part determines which skills are taught by grandmothers and mothers to daughters and by grandfathers and fathers to sons. Formal education can be limited by whether a child is a boy or a girl, particularly when the daily work of girls in agricultural production or boys in herding keeps them from school. Norms that stem from cultural capital can define what is appropriate for boys and for girls to change, with many communities seeing the value of girls' education. When males seek work by migrating as part of a household strategy to adapt to climate change, women take over many productive activities traditionally performed by males.

In cases of drought, household food consumption is often cut back as a way of coping. This generally means that women wind up eating less while men and children get a little more to eat, although all remain hungry.

Often bridging social capital can help women's groups in an agricultural community increase human capital by learning skills from other communities that have adapted successfully or from nongovernmental organizations (NGOs) that build individual capacity in the context of the community.

#### ***27.2.4 Social Capital***

Social capital consists of interactions among people and groups for mutual support. It involves trust, shared norms, reciprocity, and working together. Social capital has two dimensions: bridging and bonding. Bridging social capital is the linking of local groups or institutions to resources and external partners with similar goals, while bonding social capital is the strengthening of internal organization and the capacity to take collective action based on the common backgrounds and experiences of the individuals or groups involved. In traditional societies, interactions are often determined by gender and age, which determine what groups are appropriate for which kinds of people. Often cultural and political capital limits both their bonding and bridging social capital. Capacity is the ability of individuals and organizations or organizational units to perform functions effectively, efficiently, and sustainably (UNDP 1998).

Women's social capital in many traditional societies is bonding, and there are barriers to women forming bridging social capital. Increasingly, women use bonding social capital to form women's associations and mothers' clubs. Through these community groups, they create bridging social capital with technical assistance providers.

Local bridging and bonding networks are key for community adaptation (Skinner 2011). Since women's networks are frequently informal, they are often ignored when outsiders come in to facilitate adaptation. Many times external projects are subject to elite capture (taken over by those who have most resources), and these elites are almost always male. Women's groups often create internal mechanisms to protect the assets they generate in their groups for family use.

#### ***27.2.5 Political Capital***

Political capital refers to the codification of community's norms and values into standards that are supported by rules and regulations, which are enforced equally. Policy incentives can hurt or hinder adaptation to climate change. Very often insurance schemes reward producers for doing what they previously have done

(as that makes it easier to determine the value of the loss), rather than encouraging innovative adaptations to changing climatic conditions.

Traditional agricultural communities, particularly women in those communities, are not able to get larger political entities to recognize their norms and values, particularly those related to common land use, so they have little ability to influence the distribution of resources at the family, community, or regional level. Women's organizations are often not officially recognized. Women's strategic interests regarding access and control of land, pasture, water, and fuel are often not recognized in official adaptation strategies. Skinner (2011) has documented how women are not equal partners in decision-making on climate-change responses.

An African example of efforts of women's groups to mitigate climate change through controlling large polluters is found in the Niger Delta Region of Nigeria (Odigie-Emmanuel 2010b).

Climate change is often related to increased political conflict among and within communities. Adaptation itself is a political process, as adjustments made to livelihoods have uneven outcomes (Eriksen and Lind 2009). Power relations and their related effects on social interactions within and between communities are often challenged by change (Allen 2003).

Collective decisions regarding local adjustments are hotly contested. In dry land Kenya, Eriksen and Lind (2009) document how alliances are formed between different groups of villagers and communities of pastoralists, politicians, clan elders, chiefs, and groups such as youth and women's community-based organizations. As they build these alliances, they rely on the values of the other capitals to demonstrate their spatial primacy when productive land and water is scarce due to drought. When pastoralists and villagers peacefully negotiate drought adjustments, these are often challenged by entrenched elites who see their control threatened by community-level action.

### **27.2.6 *Financial Capital***

Financial capital is often privileged in development schemes that are built around increasing market participation, including export. In many communities, there are men's crops and women's crops. Moreover, when they do grow the same crop, they have different value chains. For example, when women gather firewood, it is generally for domestic use. Men gather it to sell.

Because women have less access to financial capital, they are limited in the degree to which they can take advantage of the input responsive crop varieties and animal species recommended by outside experts seeking to increase productivity (Uttaro 2002). Fortunately, there is research underway in Africa to enhance women's capacity to increase the productivity of traditional varieties and species through mixed cropping and fodder systems.



### **27.2.7 Built Capital**

Built capital refers to technology, infrastructure, tools, and machinery. While an individual can accumulate tools and machinery, collective goods such as roads, water systems, school buildings, and community centers are generally best generated by a community working together. Often built capital is biased toward the wealthy and toward males, with little investment in infrastructure that reduces women's work for the market or the home.

Of increasing concern are large projects such as monoculture plantations using large machinery and specialized seed, dams, mines, and petroleum exploration that drastically limit the adaptive possibilities for small holders and herders. Further, the land uses from these types of built capital provide few positive livelihood strengthening impacts (De Schutter 2011).

## **27.3 Adaptation and Coping**

Globalization leads to changes in land use, including land grabs, changes in political regimes, and increasing inequality in wealth and income, which compounds the impacts of climate change. Predictability, never high, becomes even lower. Yet agriculturalists persist, often doing the same thing they have always done, because they are not in a position to consider alternatives. There are two responses to climate change: coping and adaptation. Coping tends to mine the soil of carbon, whereas adaptation has the possibility of renewing it.

### **27.3.1 Coping**

Coping approaches impose agricultural systems adapted to one context on a totally different context. Coping approaches clear land for industrial input crops: palm oil, soybeans, and corn, among others. Land grabs can be seen as a way of responding to declining soil quality and water availability in one area to capture that soil and water, often through crop production and export (Woodhouse 2012). Coping utilizes immediate market responses over long-term ecological responses. These coping approaches disadvantage small holders, biodiversity, and soil quality.

Coping is generally individual and reactionary and does not involve planning, sometimes leading to actions that can exacerbate community vulnerability to climate change. That is called "erosive coping" (Van der Geest and Dietz 2004; Warner et al. 2012). Warner and colleagues illustrate this in the Budalangi Division in Kenya, where coping in response to a devastating flood caused temporary relocation, which took children out of schools, resulting in the loss of social capital. Households sold their traction animals to buy food, reducing the amount of land they could farm in subsequent years.

### 27.3.2 *Adaptation*

Communities and households that adapt see change as constant. They build on internal capitals first in order to change farming systems and diversify their livelihood strategies. They are mindful of changes and what is happening with their soil, often by taste or smell or feel. In addition, they seek alliances with market, state, and civil society actors to constantly innovate. Warner et al. (2013) see national governments and national market institutions joining forces to provide resilience-producing insurance schemes in order to share risk, particularly if they provide *ex ante* mechanisms to reduce vulnerability and prevent risk.

Communities and households that cope view extreme events and warmer weather as temporary. They look to infrastructure and technological solutions (built capital). They keep doing what they have been doing, only more so – use more pesticides, cultivate the land more often and put marginal land into cash crops. Coping is often supported by state policies that subsidize inputs and offer a high level of crop insurance for a limited number of crops planted by certain times. Even those “copers” who acknowledge that climate change is occurring are convinced that technology will solve the problem – better engineered seeds, better “chemistry” to put on the crop, more extensive use of ground water for irrigation. Sociologists refer to this as *ecological modernization* (Mol 2001; Horlings and Marsden 2011).

### 27.3.3 *Types of Adaptation*

Adaptation has several dimensions as illustrated in Table 27.1. It can take place at the individual level or the household level, or it can take place at the community level. Adaptation is not only undertaken by individuals, such as agriculturalists. State agencies and institutions either cope or adapt as well, and when they adapt, it can be through increased assistance to individuals or through working with communities to make innovative adaptation possible. Agrawal and Perrin (2008) have identified five types of adaptation: mobility, storage, diversification, communal pool, and market exchange. To these five, I would add a sixth: political mobilization. Work with agricultural communities suggests that these adaptations can be individual or collective. Further, it is important to understand that outside entities, including governments and NGOs, facilitate or impede implementing a particular adaptation. Often such outside incentives and policy mechanisms are focused on individual producers (generally male) and not the community (Ashwill et al. 2011).

It is imperative that adaptation occurs at more than the individual and community level. Possible avenues for adaptation must include dealing with drought, floods, high temperatures, waterlogging, new and increasing incidences of plant pests and diseases, a shorter growing season, and associated human health concerns, such as malaria and sleeping sickness in the Sahel due to wetter conditions favorable to mosquitoes and the tsetse fly (Jalloh et al. 2013).

**Table 27.1** Adaptation practices corresponding to basic types of adaptation

Type of adaptation	Community level		Agency level	
	Individually undertaken	Collectively undertaken	Individual	Community
Mobility	Wage labor migration, remittances (together with market exchange)	Agropastoral migration, wage labor migration, involuntary migration, remittances (together with market exchange)	Relocation expenses to less vulnerable area	Aid to a community to relocate together
Storage	Water storage, food storage, live animal storage	Water storage, food storage (crops, seeds, forest products), animal/live storage, dikes, embankments	Distribution to individuals of containers for water or for seed	Aid in building storage facilities and small reservoirs, crop intensification programs
Diversification	Asset portfolio diversification, skills and occupational training, diversify crop choices, production technologies, consumption choices, agro-forestry	Community animal breeding programs, collective enterprises	Offer individual courses	Provide community capacity for new collective enterprises, including agroforestry
Communal pooling		Forestry, infrastructure development, information gathering, disaster preparation	Build water capturing infrastructure for individual households	Support building water capturing infrastructure
Market exchange	Product sales, sell property, sell labor	Improved market access; seeds, animal, and other input purchases; remittances (in conjunction with mobility)	Insurance provision	Insurance provision, social safety nets, transfer payments
Mobilization	Refusal to move	Collective petition to government		Link to international movements with similar concerns

Adapted from Agrawal and Perrin (2008)

### 27.3.4 *Mobility*

As in many cultures, around Lake Chad in Nigeria, men migrate to the city to seek jobs as laborers in response to climate change disruption of their livelihoods. Women stay home because of lack of urban employment opportunities and the

need to care for their children and elders (Odigie-Emmanuel 2010a). While this occurs in the community, these are individual decisions and no structures exist for the women who remain to deal with the increased work caused by fewer workers, disrupted agricultural cycles, and longer distances to go for wood and water. In other areas of Africa, young single women without children migrate to nearby countries such as Sudan, Dubai, and Saudi Arabia (Kassie et al. 2013).

Mobility is often forced by outside interventions such as land acquisition by mining, oil companies, and plantation agriculture investors. Even tourism and nature preservation can force communities to leave their ancestral lands. Although the causes cited for migration are not directly climate related, the impacts of migration are often the same. Migration can be hugely disruptive of cultural, human, and social capital, even if there are short-term gains for a few in terms of financial capital (Chansinga et al. 2013). With some FDI, land is acquired and the people are removed, which is referred to as a *new enclosure movement* (McMichael 2012). In Tanzania, Kusiluka et al. (2011) found that migration resulted in loss of land, loss of means of livelihood, disruption of economic activities, persistent land-related conflicts, relocations to poorly developed areas, inadequate and late compensation, and environmental degradation. Geographic mobility is often exacerbated by climate change, particularly when the relocation is to arid areas.

### **27.3.5 Storage**

Communities can work together to build stores of basic food to be shared for emergencies, although this more often takes place at a household level. Women's groups within communities often take on the responsibilities for storage of emergency supplies and distributing them when needed.

Water storage is often best done on a community level, as there has to be agreement on provision and access to the collective water source. Water can be stored in the soil when there is good organic matter available. Storage can occur by returning nutrients and organic matter to the soil through such activities as using mulch and compost (Goldman and Hendenbrand 2002), although often not at a level to improve soil fertility.

### **27.3.6 Diversification**

Women commonly respond to climate change by adapting what is planted to precipitation and temperature changes. This can be done collectively at the community level, where seeds and knowledge are interchanged in order to increase everyone's potential return, or it can be done individually. Unfortunately, most institutional input focuses on monoculture rather than diversification. There is often

institutional assistance in getting irrigation through boreholes, but often women have difficulty accessing these new sources of water (Vincent et al. 2010).

One of the goals of structural adjustment was to get small holders to diversify from farming to wage labor and craft sales, through an emphasis on commodification, specialization, and standardization. This has led to the accumulation of resources in high-potential areas with higher and more reliable rainfall, on farmers with more resources vs. farmers with fewer resources, and on men rather than women, increasing inequalities (Bernstein 1990).

### ***27.3.7 Communal Pooling***

Women's groups have mobilized around advocacy and sharing of the domestic tasks of hauling water and wood (community response). However, more often, it is males who mechanize the process and sell the water and wood, with little alleviation of the women's tasks, turning traditional women's work into male market exchange.

### ***27.3.8 Market Exchange***

Government transfers to households whose livelihood strategies have been disrupted represent a form of market adaptation. In Limpopo Province, South African women who live with elderly relatives with a monthly social pension manage the insecurities of climate change with cash. Remittances from relatives in the city also help (part of the mobility response). These are agency solutions for individuals (Vincent et al. 2010).

Sharing and transferring risk through insurance can be an adaptation, when it does not reward behavior that ignores climate-change realities. Increasingly, insurance policies, some with state underwriting, are offered to individuals to reimburse them for losses due to extreme events such as floods, drought, hurricanes, and hail (Warner et al. 2013). These policies are normally offered to individuals and purchased, as in the Ghana Agricultural Insurance Program.

Community-level insurance schemes are possible but not common. In Nigeria, an index-based livestock insurance program was introduced. Payouts were based on areal statistical models, involving all community pastoralists that had purchased insurance. Most of the small holders and pastoralists in Africa are uninsured. Ethiopia has instituted the Horn of Africa Risk Transfer Adoption (HARITA) program, which takes a holistic approach by linking insurance with risk reduction measures (Warner et al. 2013). Such schemes require public-private partnerships between insurance companies and governments. When there are multigovernment or regional agreements, multicountry programs such as African Risk Capacity

further share the risks. Women farmers and pastoralists need access to such resources, as well as their male counterparts.

Often in the face of climate change or by pressure from large-scale land buyers, communities with customary land access sell their land – or it is sold for them by the government. The land, previously a crucial asset for the rural poor, is now lost to them. German et al. (2013) documented such cases in Ghana, Mozambique, Tanzania, and Zambia. These break up communities and particularly disadvantage women.

### **27.3.9 Mobilization**

Responses to climate change are limited by access to all types of capital, including natural capital, such as land. A number of social movements have arisen in and across agricultural communities as access to land and water are increasingly constrained (McKeon 2013).

## **27.4 Conclusions**

Many of the proposed adaptations from international agencies address developing new technologies, educating individuals, and changing traditional farming patterns (Jalloh et al. 2013). These strategies would be strengthened by locating them within agricultural communities and taking into account gendered access and control of potential resources within communities. Women are particularly vulnerable to climate change, as their lack of access and control over the resources, particularly political, financial, and built capital and their responsibilities for the day-to-day upkeep of their families (human and cultural capital), give them fewer alternatives for adaptation (Arora-Jonsson 2011). Yet, when women organize within their communities and across communities, they can be powerful actors to influence adaptation to climate change (Odigie-Emmanuel 2010b).

Traditional communities, especially the women of these communities, are very vulnerable to climate change and globalization. Women's cultural capital, combined with bridging and bonding social capital, result in adaptation in areas where there has not been a strong presence of global resource extraction. The ability of women to adapt to climate change is greatly reduced where there are areas of large-scale land acquisition, including petroleum extraction, large-scale mining, and industrial agriculture. These activities destabilize communities and greatly marginalize women.

While it is easy to fault vulnerable communities for not adapting to climate change, government and donor programs, combined with market incentives that encourage risky livelihood strategies, provide perverse incentives to vulnerable communities not to adapt, further disadvantaging women. Enhancing and building

upon women's capital in the context of their communities is an effective approach to help them adapt to climate change. It can result in increasing soil quality and enhanced agricultural intensification for food security.

## References

- Agrawal A, Perrin N (2008) Climate adaptation, local institutions, and rural livelihoods. IFRI (International Forestry Resources and Institutions Program) working paper #W08I-6
- Allen J (2003) *Lost geographies of power*. Blackwell, Malden
- Arora-Jonsson S (2011) Virtue and vulnerability: discourses on women, gender and climate change. *Glob Environ Chang* 21:744–751
- Ashwill M, Flora CB, Flora JL (2011) *Building community resilience to climate change: testing the adaptation coalition framework in Latin America*. World Bank, Washington, DC
- Bernstein H (1990) Agricultural 'modernization' and the era of structural adjustment: observations on sub-Saharan Africa. *J Peasant Stud* 18:3–35
- Cepeda Gómez C, Gutiérrez-Montes I, Imbach A, Alpizar F, Windevoxhel N (2008) Tiburón ballena y bienestar comunitario en Holbox, Quintana Roo, México. *Recursos Naturales y Ambiente* 55:109–117
- Chansinga B, Chasukwa M, Zuka SP (2013) The political economy of land grabs in Malawi: investigating the contribution of Limphasa Sugar Corporation to rural development. *J Agric Environ Ethics* 26:1064–1084
- De Schutter O (2011) How not to think of land-grabbing: three critiques of large-scale investments in farmland. *J Peasant Stud* 38:249–279
- Doss CR (2002) Men's crops? Women's crops? The gender patterns in Ghana. *World Dev* 30:1987–2000
- Due JM, Gladwin CH (1991) Impacts of structural adjustment programs on Africa women farmers and female-headed households. *Am J Agric Econ* 73:1431–1439
- Eriksen S, Lind J (2009) Adaptation as a political process: adjusting to drought and conflict in Kenya's drylands. *Environ Manage* 43:817–835
- Flora CB (1985) Women and agriculture. *Agric Hum Values* 2:5–12
- Flora CB, Bregendahl C (2012) Collaborative community-supported agriculture: balancing community capitals for producers and consumers. *Int J Sociol Agric Food* 19:329–346
- Flora CB, Delaney M (2012) Mobilizing civil society for environmental protection in a context dominated by industrial agriculture: avoiding projects. In: Sjöblom IS, Andersson K, Marsden T, Skerratt S (eds) *Sustainability and short-term policies: improving governance in spatial policy interventions*. Ashgate, Burlington, pp 201–213
- Flora CB, Flora JL (2013) *Rural communities: legacy and change*, 4th edn. Westview Press, Boulder
- Garrity D (2013) Transformational opportunities in regreening to create an evergreen agriculture. Presentation at climate change, sustainable intensification and food security in Sub-Saharan Africa iAGRI conference, Morogoro, Tanzania, 13–15 November 2013
- Gasteyer S, Araj T (2009) Empowering Palestinian community water management capacity: understanding the intersection of community cultural, political, social and natural capitals. *Community Dev: J Community Dev Soc* 40:163–184
- German L, Schoneveld G, Mwangi E (2013) Contemporary processes of large-scale land acquisition in Sub-Saharan Africa: legal deficiency or elite capture of the rule of law? *World Dev* 48:1–18
- Gladwin CH (1991) *Structural adjustment and African women farmers*. University of Florida Press, Gainesville

- Gladwin CH (2002) Introduction to gender and soil fertility in Africa. *Gend Soil Fertil Afr Spec Issue Afr Stud Q* 6(1,2):1–26
- Gladwin CH, Thomson AM, Peterson JS, Anderson AS (2001) Addressing food security in Africa via multiple livelihood strategies of women farmers. *Food Policy* 26:177–207
- Gladwin CH, Cassidy L, Hoon PN (eds) (2002) Gender and soil fertility in Africa. Special issue of *African Studies Quarterly* 6(1,2):177–207
- Goldman A, Hendenbrand K (2002) Gender and soil fertility management in Mbale district, southeastern Uganda. *Gend Soil Fertil Afr Spec Issue Afr Stud Q* 6(1,2):45–76
- Guyer JI (1986) Intra-household processes and farming systems research: perspectives from anthropology. In: Moock JL (ed) *Understanding Africa's rural households and farming systems*. Westview Press, Boulder, pp 92–104
- Hassan SM, Ikuenobe CE, Jalloh S, Nelson GC, Thomas TS (2013) In: Jalloh A, Nelson GC, Thomas TS, Zougmore R, Roy-Macauley H (eds) *West African agriculture and climate change*. International Food Policy Research Institute, Washington, DC, pp 29–290
- Horlings LG, Marsden TK (2011) Towards the real green revolution? Exploring the conceptual dimensions of a new ecological modernization of agriculture that could “feed the world”. *Glob Environ Chang* 21:441–452
- IPCC (Intergovernmental Panel on Climate Change) (2012) *Managing the risks of extreme events and disasters to advance climate change adaptation*. Cambridge University Press, Cambridge
- Jalloh A, Nelson GC, Thomas TS, Zougmore R, Roy-Macauley H (2013) *West African agriculture and climate change*. International Food Policy Research Institute, Washington, DC
- Kassie BT, Hengsdijk H, Rötter R, Kahiluotot H, Asseng S, Van Ittersum M (2013) Adapting to climate variability and change: experiences from cereal-based farming in the Central Rift and Kobo Valleys, Ethiopia. *Environ Manage*. doi:10.1007/s00267-013-0145-2
- Kusiluka MM, Kongela S, Kusiluka MA, Karimuribo ED, Kusiluka LJM (2011) The negative impact of land acquisition on indigenous communities' livelihood and environment in Tanzania. *Habitat Int* 35:66–73
- MacKenzie F (1993) Exploring the connections: structural adjustment, gender and the environment. *Geoforum* 24:71–87
- McKeon N (2013) One does not sell the land upon which people walk: land grabbing, transnational rural social movements, and global governance. *Globalizations* 10:105–222
- McMichael P (2012) The land grab and corporate food regime restructuring. *J Peasant Stud* 39:681–701
- Meena R (1991) The impact of structural adjustment programs on rural women in Tanzania. In: Gladwin CH (ed) *Structural adjustment and African women farmers*. University of Florida Press, Gainesville, pp 169–190
- Mol A (2001) *Globalization and environmental reform: the ecological modernisation of the global economy*. MIT Press, London
- Nombo CI, Kabote SJ, Mamiro DP, Synneåg G, Mattee AZ, Urassa JK, Matata LM (2013) Adaptation to climate change effects: changing gender relations. Presentation at the climate change, sustainable intensification and food security in Sub-Saharan Africa iAGRI conference, Morogoro, Tanzania, 13–15 November 2013
- Odigie-Emmanuel O (2010a) The gender impact of climate change in Nigeria. In: Dankleman I (ed) *Gender and climate change: an introduction*. Earthscan, Sterling, pp 123–129
- Odigie-Emmanuel O (2010b) Women and the environmental justice movement in the Niger Delta region of Nigeria. In: Dankleman I (ed) *Gender and climate change: an introduction*. Earthscan, Sterling, pp 247–248
- OECD (2012a) OECD factbook 2012. <http://www.oecd-ilibrary.org/sites/factbook-2013-en/04/02/01/index.html?itemId=/content/chapter/factbook-2013-34-en>. Accessed 31 Jan 2014
- OECD (2012b) Farmer behaviour, agricultural management and climate change. OECD Publishing. <http://dx.doi.org/10.1787/9789264167650-en>. Accessed 31 Jan 2014



- Pigg K, Gasteyer S, Martin K, Apaliya G, Keating K (2013) The community capitals framework: an empirical examination of internal relationships. *Community Dev: J Community Dev Soc* 44 (4):492–502
- Siles CJ, Gutiérrez I, Flora CB (2013) Acción colectiva de consorcios locales para la gobernanza ambiental: un análisis a partir de los capitales de la comunidad. *Biocenosis* 27:94–105
- Skinner E (2011) Gender and climate change: overview report. Institute for Development Studies, London
- Tchingulou A, Jalloh A, Thomas TS, Nelson GC (2013) In: Jalloh A, Nelson GC, Thomas TS, Zougmore R, Roy-Macauley H (eds) West African agriculture and climate change. International Food Policy Research Institute, Washington, DC, pp 353–382
- UNDP (1998) Capacity assessment and development. Technical advisory paper no. 3. <http://www.cbd.int/doc/pa/tools/Capacity%20assessment%20and%20development.pdf>
- Uttaro RP (2002) Diminishing choices: gender, small bags of fertilizer, and household food security decisions in Malawi. In: Gladwin CH, Cassidy L, Hoon PN (eds) Gender and soil fertility in Africa. Special issue of *African Studies Quarterly* 6(1,2):77–110
- Van der Geest K, Dietz T (2004) A literature survey about risk and vulnerability in drylands, with a focus on the Sahel. In: Dietz T, Rueben R, Verhagen J (eds) The impact of climate change on drylands. Kluwer, Dordrecht, pp 117–146
- Vincent K, Cull T, Archer ERM (2010) Gendered vulnerability to climate change in Limpopo Province, South Africa. In: Dankleman I (ed) Gender and climate change: an introduction. Earthscan, Sterling, pp 130–137
- Warner K, Van de Geest K, Kreft S, Huq S, Harmeling S, Kusters K, de Sherbinin A (2012) Evidence from the frontlines of climate change: loss and damage to communities despite coping and adaptation. Report no. 9. United Nations University Institute for Environment and Human Security (UNU-EHS), Bonn
- Warner K, Yuzva K, Zissener M, Gille S, Voss J, Wanczeck S (2013) Innovative insurance solutions for climate change: how to integrate climate risk insurance into a comprehensive climate risk management approach. Report no. 12. United Nations University Institute for Environment and Human Security (UNU-EHS), Bonn
- Woodhouse P (2012) New investment, old challenges: land deals and the water constraint in African agriculture. *J Peasant Stud* 39:777–794
- Xu X, Sheng Y (2011) Productivity spillovers from foreign direct investment: firm level evidence from China. *World Dev* 40:62–74

# Chapter 28

## Designing Environmental Instruments to Finance Agricultural Intensification Through the Clean Development Mechanism: Direct Cost Subsidy Versus Tax Cut Under Asymmetric Information

Albert N. Honlonkou and Rashid M. Hassan

**Abstract** Various agreements addressing climate change plead for the adoption of innovative green technologies to reduce production of greenhouse gases responsible for global warming. Yet, the most successful instrument so far, the Clean Development Mechanism (CDM) is at pains to succeed in small, developing countries facing sustainable development problems like food security. Worse, while the CDM succeeded in financing agricultural projects, few are funded in small, developing countries.

A tax cut is one innovative financial scheme that many countries enact in their investment code to promote environmentally sound technologies. Tax cuts return a portion of investment costs to firms that implement green innovations, which ultimately reduces investment costs and so adds to their net benefits. We compare this scheme to a direct cost subsidy designed to offer firms access to capital at a lower interest, for their capacities to boost the use of CDM in agriculture. This paper shows that the narrow scope of tax cuts compared to direct cost subsidies make corporate tax relief inadequate for the needs of developing countries. We also show that while both schemes are equally efficient under perfect conditions and asymmetric information, the direct cost subsidy is more appropriate to further environmental and sustainability goals like food security in developing countries where informational problems are pervasive. Empirical results support these results (JEL: D61, D82, G21, O13, Q01, Q54, Q55.)

---

A.N. Honlonkou (✉)

Ecole Nationale d'Economie Appliquée et de Management, University of Abomey-Calavi,  
Cotonou, Republic of Benin

e-mail: [meintoh@yahoo.fr](mailto:meintoh@yahoo.fr)

R.M. Hassan

Center for Environmental Economics and Policy in Africa (CEEPA), University of Pretoria,  
Pretoria, Republic of South Africa

e-mail: [rashid.hassan@up.ac.za](mailto:rashid.hassan@up.ac.za)

**Keywords** Climate change • Tax cut • Direct cost subsidy • Asymmetric information • Agriculture • Developing countries

## 28.1 Introduction

There are many instruments to finance the mitigation of climate change. With finance in mind, the Copenhagen Summit, the fifteenth Conference of Parties (COP15) on Climate Change, made the recommendation that a common fund of US\$100 billion per year over the post-Kyoto period (2013–2020) be created to help poor and emerging countries adopt costly, but eco-friendly technologies (Article 8 of the Treaty) (UNFCCC 2009). These technologies are aimed at reducing the production of greenhouse gases (GHG) responsible for global warming.

To be sure, innovative instruments to support eco-friendly technologies already exist. One such instrument is the well-known Clean Development Mechanism (CDM) designed to finance climate mitigation efforts. The CDM was created within the framework of the Kyoto Protocol to promote low-carbon projects and reduce harmful gas emissions. It is one of three market-based instruments of the Kyoto Protocol beside the Joint Implementation and Emission Trading instruments designed for developed countries (UNFCCC 2008; Olawuyi 2009; Zhang and Wang 2011).

The CDM was designed to provide an incentive for governments and companies in industrialized countries to invest in GHG reduction projects in developing countries and be credited by issuance of marketable Certified Emission Reductions (CER). However, records show that small, developing countries rarely use CDM. From the start of the Protocol in 2005–2012, the entire continent of Africa accounted for only 3.6 % of the 2,386,899 kiloCERs produced compared to the five CDM giant countries, China, India, South Korea, Brazil, and Mexico, which account for more than 80 % of the total production. As well, China, Brazil, India, Mexico, and Malaysia account for 79 % of agricultural projects. For instance, out of 8,868 CDM-financed projects, only 259 are in Africa, of which 74 are in South Africa (UNEP RISOE Centre, CDMpipeline.org, June 2013). In total, 122 of the 150 eligible non-annex I countries hosted CDM projects by 2012 (see also Winkelman and Moore 2011). Agricultural land-use projects are particularly scarce under the CDM, even though such projects sequester carbon in soils, and can boost fertility, agricultural productivity, food security, and alleviate poverty in developing countries (Larson et al. 2011). Mitigation opportunities in agriculture are numerous, including agricultural residue management, manure, composting, crop management, integrated pest management, integrated management of wastes in livestock production, agroforestry, land use, irrigation, and mangroves. In addition, agriculture accounted for roughly 12 % of anthropogenic GHG emissions, a significant sector. However, by 2012, the mitigation impact in agriculture is only 8 % of the total (Larson et al. 2011; Godfray et al. 2010). Authors often attribute the low reach of CDM to factors linked to high transaction costs of investing in projects in small, developing countries (Michaelowa and Jotzo 2003; Ahonen and Hamekoski 2005; Olawuyi 2009; Larson et al. 2011).

So lowering the carbon mitigation cost expected from an annex I country investing in a developing country may not be sufficient to attract carbon investors. The problem is therefore how to design environmental instruments that mitigate the effects of transaction costs and encourage environmental innovations with a broad reach for application in specific contexts in developing countries. This question is especially important for agricultural land-use projects that are complex and costly to implement, mainly due to uncertainties about net emission outcomes and the permanence of sequestration. These uncertainties lead to steeper monitoring, measurement, and implementation costs, all of which make agricultural land use projects less attractive to investors (Larson et al. 2011). Nonetheless, agricultural mitigation interventions are a key element of adaptation because climate change is expected to have adverse effect on food security, especially in sub-Saharan Africa (Schmidhuber and Tubiello 2007).

One solution to promote low carbon projects is to reduce the costs of green technological change that CDM investors incur in small, developing countries. The financial instruments available for this purpose include subsidizing investments through reduction of capital costs, such as reducing interest rates, and tax cuts.

We propose the interest rate bonus as a direct cost subsidy scheme because the informal economies of developing countries offer huge numbers of eligible firms. In West Africa, for instance, banks and microfinance institutions (MFI) come into contact with hundreds of thousands of small- and medium-sized enterprises. Their reach as a proportion of population served in 2003 was 25 % for MFIs and 8 % for banks (PASMEC 2005). Thus, finance is a suitable channel to finance green projects. Moreover, pairing microfinance and climate mitigation is an efficient way to establish a virtuous link between poverty alleviation and environmental protection. Studies abound confirming that microfinance enables the poor, who are excluded from classical financing systems, to access funding and improve their well-being (Woller and Woodworth 2001; Paxton 2002; Ruben and Clercx 2003; Khandker and Faruque 2003; Shaw 2004).

One version of the tax cut instrument consists of deducting a fraction of the costs of a new investment from a firm's benefit tax for a given period of time, which would reduce its investment costs through savings on corporate taxes (Hall and Jorgenson 1967; Muet and Ayouvi-Dovi 1987). Tax cuts are widely used to promote green investments. In Benin, for example, the investment code and its implementation agency, the "Centre de Promotion des Investissements" directs a tax cut policy for new investment projects.<sup>1</sup> This Code excludes any activity having negative effects on the environment and health of populations from receiving a fiscal discount. Benin is not unique, as many developing countries authorize tax cuts or subsidies in their investment code to promote the adoption of eco-friendly technologies. The list includes Algeria, Burkina Faso, Cameroon, The Central

---

<sup>1</sup> Law n° 90-002 of May 9th, 1990, in the Investments Code, modified by law 90-033 of December 24th, 1990.

African Republic, Congo, Côte d'Ivoire, Gabon, Mali, Morocco, Nigeria, Democratic Republic of Congo, Senegal, South Africa, Tunisia, and Uganda.

This paper compares direct cost subsidies through interest rate reduction and corporate tax cuts with respect to their reach and efficiency under asymmetric information. Specifically, it aims to examine whether we can construct a direct cost subsidy scheme that is equally efficient as the tax cut scheme.

Environmental economists evaluate environmental policies using criteria such as cost effectiveness or efficiency, incentive compatibility, ethics, breadth of distribution, equity and broader economic stabilization concerns, and administrative feasibility and flexibility (Bohm and Russell 1985; Xepapadeas 1991; Baumol and Oates 1993; Sterner 2003).

An environmental instrument is cost-effective if it achieves a set of environmental goals at the least cost. Such effectiveness represents a type of static efficiency based on fixed technology and discharge location (Bohm and Russell 1985). An instrument is dynamically efficient if, in the long run, it does not impede adaptation and innovation of complying agents to an evolving world. The instrument must be adapted to the national and local economy and should provide incentives for those who comply with it to give their maximum effort. Direct cost subsidies and tax cuts fulfill one aspect of dynamic efficiency: they make relatively few informational demands on an environmental authority, thereby allowing firms to make private decisions regarding the choice of the best technology to curb emissions or to produce a public good (Baumol and Oates 1993).

An instrument is incentive-compatible if the agents involved (e.g., polluters, victims, regulators) have an incentive to disclose information and act as intended. Indeed, implementing an instrument requires data and predictive modeling skills. Because the information on cost and corporate benefit necessary to implement our two schemes are private and may be manipulated by firms, we choose to compare them in an asymmetric information setting. This choice is particularly important for developing countries where there are often considerable information asymmetries, high transaction costs, considerably complex project evaluation procedures, and a lack of local experience with such work (Kirsten and Karaan 2005; Stiglitz 1985; Furubotn and Richter 2005; Williamson 2005; Miller 2005). In such contexts, institutions are reluctant to engage in innovative projects.

An instrument satisfies equity concerns if the parties involved perceive the distribution of costs and benefits as fair. The ethical aspects of such financial instruments emerge from the choice between two views: seeing environmental damage as a crime against nature or other persons, versus seeing environmental damage as a good that can be bought (Bohm and Russell 1985). For our instruments, we must take the second view.

Economic stabilization concerns relate to the use of environmental instruments to further employment, growth, and trade. Finally, regarding administrative feasibility and flexibility, an instrument must be practical and incur no excessive monetary or informational costs in its operation. In other words, the institution implementing the instrument should minimize transaction costs in management and monitoring. An instrument is flexible if it gives the polluter a broad set of choices to achieve its environmental goal.

To be sure, these criteria are related, and what criterion is advanced depends on the instrument and the stakeholders involved. For instance, once a goal is set, difference between efficiency in execution and cost effectiveness disappears. Functions that a planner maximizes to achieve efficiency may directly include distributional and equity issues. In a decentralized economy, the criterion of incentive compatibility is achieved by leaving some rent to more informed stakeholders, i.e., by sacrificing some efficiency (Laffont and Martimort 2002).

Existing literature offers analytical frameworks to compare environmental instruments. Weitzman (1974) created a framework to compare taxes and quotas as instruments to control the production of goods under imperfect information or uncertainty. He preferred the quota as a planning instrument if and only if its benefit function exhibits more curvature than the cost function around the optimal output level, i.e. uncertainty on the (steeper) marginal benefit function has greater effect on profit than uncertainty on the (flatter) marginal cost function. Anyanga (2010) compared foreign direct investment (FDI) and debt financing to develop environmentally sound technologies. He found that debt financing fares better than FDI because it requires coping only with adverse selection concerning the firm's own productivity. FDI, however, not only shares this hidden information problem, but also the moral hazard problem concerning an outside investor's control of a local project. As communication channels for information proliferate, more informational rents must be given away.

This study employs the principal-agent analytical framework to understand the relative reach and efficiency of direct cost subsidies and tax cuts. We present this framework in Sect. 28.2, and use it in Sects. 28.3 and 28.4 to evaluate the instruments' comparative reach and efficiency under perfect and imperfect information. Our results show that under asymmetric information, we can construct a direct cost subsidy scheme equally efficient as a tax cut scheme, but with a broader reach through the informal economies of developing countries. Section 28.5 presents empirical results that show how the pervasiveness of information asymmetry (i.e. the presence of informal sector as a major constraint) may impede the production of agricultural CERs through CDM. Section 28.6 offers concluding remarks.

## 28.2 Analytical Framework and Model

### 28.2.1 Notation

We use the following notation throughout the paper:

$e$  = quantity of the environmental good (e-good); for example, emission reductions produced along with an ordinary or dirty good (d-good) taken as the numeraire (price = 1).

$\theta$  = coefficient of pollution of the dirty good.

$\alpha$  = cost efficiency parameter for the production of the e-good;  $\alpha$  is private information to the firm. We assume that the firm can be of two types: a low-cost type ( $\alpha_1$ ) with probability  $q$ , or a high-cost type ( $\alpha_2$ ) with probability of  $(1 - q)$  and  $\alpha_1 > \alpha_2$ . A type- $\alpha_1$  firm is more efficient in producing the environmental good than a type- $\alpha_2$  firm.

$r$  = the unit cost of investment capital, including transaction costs.

$b$  = the interest rate discount. If  $r = b$ , the whole interest is subsidized.

$m$  = the tax cut rate for new investment.

$t$  = the tax rate on corporate profits.

$f$  = the per-unit gain from selling the e-good by the Principal, such as through an emissions reduction market. It may also be interpreted as the social value of the e-good for the Principal. The value of  $f$  is net of administrative costs.

$v$  = price per unit of the e-good paid by the Principal to the Agent. One obvious assumption is that  $f > v$ .

$c(e)$  = the production cost of the green good,  $e$ , such as the cost of using a depollution technique (operating + abatement cost). It has the following regular properties. The first and the second derivatives of  $c(\cdot)$  with respect to  $e$  are positive:  $c_e(\cdot) > 0$ ,  $c_{ee}(\cdot) > 0$ ; moreover,  $c(0, b; r) = c_e(0, b; r) = 0$ ;  $c(\cdot)$  is a negative function of  $b(c_b(\cdot) > 0)$ .

$K$  = fixed initial investment cost of acquiring and installing the new technology. We assume  $K$  is public information. This is a reasonable assumption because green technology is usually imported into developing countries and thus the investor country or the government knows its price. We assume that the Principal provides the green technology. He is then concerned with the type of firm with which he contracts, hence the necessity to consider a setting of asymmetric information.

Thus, the total cost of using the new green technology is:  $K + (1 + r - b)c(e)\alpha$ , private information to the firm. We assume that the firm either borrows or draws on internal funds to finance the new technology's operation. The firm claims opportunity cost for internal funds.

## 28.2.2 Setting

We consider a setting with two agents: a climate fund manager or a climate investor (an environmental protection agency, regulator or private investor) designated P (Principal), and a firm designated A (Agent). P, possessing all of the bargaining power, has three instruments available to implement its goals: one main instrument IC, (initial contracting) and two complementary instruments, DCS (Direct Cost Subsidy) and TC (Tax Cut).

1. *Initial Contracting (IC)*: P provides the A with the new technology, A produces the environmental good (e-good), and sells the quantity of e-good produced to P at the price  $v$ ;

2. *Direct Cost Subsidy (DCS)*: P supports access to capital at a lower interest rate or capital cost;
3. *Tax Cut (TC)*: firms that implement green innovations are returned a proportion  $m$  of their investment costs, which adds to their net benefits.

In practice, IC, DCS, and TC work similarly to a subsidy to further environmental goals. As well as an ordinary, dirty good (d-good) sold in markets, all firms produce an environmental good (e-good), that is costly for firms but is a positive argument for the utility function of P. There are many ways to understand the quantity  $e$  of the environmental good. We assume it to be a separable, non-joint product from an allocable factor (Beattie and Taylor 1993), supplied by firms which, in producing it, incur abatement and operating costs measured in terms of a quantity of their ordinary product (the numeraire). Examples of e-good production include the greening of a production process, acquiring environmental protection devices, or afforestation projects, such as building a carbon sink to compensate for a separate firm's pollution. This example has relevance to Benin, for example, where the largest contributors to greenhouse gas emissions are land and forest allocations (73 %) and agriculture (21 %) (FEM 2008).

We assume that firms receive no direct earnings from environmental productions but bear costs in the form of implementation, administration, and transaction costs, as well as forgone benefits from alternative land uses such as crop and livestock production. Therefore, an environmental agency or investor may encourage e-good production by compensating firms through payment for the e-good produced at price  $v$ . That is why direct cost subsidies and tax cuts are seen as complementary instruments to boost e-good production.

Because of separability assumptions, we will concentrate only on e-good production and ignore the d-good sector. P's problem is that the operating cost of the green technology by each firm is private information in such a way that a more efficient type- $\alpha_1$  firm can present itself as a less efficient type- $\alpha_2$  firm and obtain the latter's contract. This is rational from the firm's standpoint because if it succeeds in getting the contract it desires, it will bear only the cost  $\alpha_1 c(e_2)$  of producing  $e_2$  while receiving compensation for  $\alpha_2 c(e_2)$ . This is an instance of hidden information commonly known as adverse selection. The environmental agency must discriminate between the two types of firms so that each receives the appropriate type of contract among our three financing instruments. We account for the moral hazard problem that may occur if A accepts the contract but does not fulfill or partially fulfills its share of the agreement (Salanié 1994; Furubotn and Richter 2005; Laffont and Martimort 2002). The events are timed as follows:

1. The polluting firm learns its type,  $\alpha \in \{\alpha_1, \alpha_2\}$ ;
2. P proposes a menu of IC with complementary contracts  $[e(\alpha), b(\alpha)]$  for direct cost subsidy or a menu of IC with  $[e(\alpha), m(\alpha)]$  for tax cut;
3. The polluting firm accepts one contract or rejects them all;
4. Nature intervenes;
5. The polluting firm and P realize their payoff.



### 28.2.3 Theoretical Model

From the IC, a firm of type  $i$  obtains a first-period profit (net of taxes) given by the following equation:

$$\Pi_i(\alpha_i) = (1 - t)[ve_i - (1 + r)\alpha_i c(e_i)] \quad (28.1)$$

P (the environmental investor) obtains the following payoff from this type:

$$U_P(\alpha_i) = fe_i + t[ve_i - (1 + r)\alpha_i c(e_i)] - K \quad (28.2)$$

For a private investor, the tax revenue does not enter the objective function of P.

We assume that the investment lasts for only one time period per investor. In many African investment codes, tax cuts are actually a one-time return on imported goods. Since  $K$  is constant for an assumed standard investment, it will not affect the optimal values. So we ignore it in the subsequent development.

If agent  $i$  benefits from both complementary instruments ( $b, m > 0$ ), his payoff  $\Pi_i(\cdot)$  is given by the following equation:

$$\begin{aligned} \Pi_i(e_i; m, b, \alpha_i) &= [ve_i - (1 + r - b)\alpha_i c(e_i)] - t[ve_i - (1 + r - b)\alpha_i c(e_i)] \\ &\quad + m(1 + r - b)\alpha_i c(e_i) \end{aligned}$$

The payoff is collected as follows:

$$\Pi_i(e_i; m, b, \alpha_i) = (1 - t)[ve_i - (1 + r - b)\alpha_i c(e_i)] + m(1 + r - b)\alpha_i c(e_i) \quad (28.3)$$

The net gain that P extracts from the contracts is given by this equation:

$$U_P(\cdot) = \underbrace{fe_i}_{(i)} + \underbrace{t[ve_i - (1 + r - b)\alpha_i c(e_i)]}_{(ii)} - \underbrace{ve_i}_{(iii)} - \underbrace{b\alpha_i c(e_i)}_{(iv)} - \underbrace{m(1 + r - b)\alpha_i c(e_i)}_{(v)}$$

$U_P(\cdot)$  consists of five terms: (i) the revenue from sales of the e-good, (ii) corporate tax revenue, (iii) less the payment for the e-good, (iv) the cost of the tax cut, and (v) the direct subsidy cost.

$U_P(\cdot)$  is collected as follows:

$$U_P(\cdot) = fe_i - v(1 - t)e_i - [(1 + r - b)(t + m) + b]\alpha_i c(e_i) \quad (28.4)$$

We use specific functional forms for the increasing marginal cost function to obtain conclusive and clear results. Thus, we use the cost function (28.5):

$$c(e_i) = \frac{1}{2} \left( \frac{e_i}{\theta} \right)^2 \quad (28.5)$$

We interpret  $\theta$  as a parameter reflecting the firm's size and the polluting capacity. As is often assumed in environmental literature, decreases in marginal cost for target emissions are embodied in  $\theta$ .<sup>2</sup> With specification (28.5), (28.3) and (28.4) become

$$\Pi_i(\cdot) = (1 - t) \left[ ve_i - \frac{1}{2}(1 + r - b)\alpha_i \left(\frac{e_i}{\theta}\right)^2 \right] + \frac{1}{2}m(1 + r - b)\alpha_i \left(\frac{e_i}{\theta}\right)^2 \quad (28.3')$$

$$U_P(\cdot) = fe_i - v(1 - t)e_i - \frac{1}{2}[(1 + r - b)(t + m) + b]\alpha_i \left(\frac{e_i}{\theta}\right)^2 \quad (28.4')$$

Payoffs (28.3') and (28.4') accommodate the situation whereby the project holder benefits simultaneously from a tax cut and a direct cost subsidy. A general framework may consider the situation where the second instrument, if available, magnifies the effects of the operational instrument in which any project holder may be involved. In case of this twin implementation, one instrument can function as a parameter for comparative static analysis. Nevertheless, we chose to analyze the two instruments separately to sharpen their comparison.

The following definitions,  $(e_b, b)$  and  $(e_m, m)$ , complete the analytical framework to compare contracts. The variables  $e_b$  and  $e_m$  are, respectively, the quantity of the e-good produced under the direct cost subsidy and the tax cut schemes.

*Definitions* (R) Instrument 1 has more reach for P than instrument 2 if its constraint-delimited implementation space is broader than 2's.

(E) Instrument 1 is more efficient for P than instrument 2 if the payoff to P is greater under 1 than under 2.

Under this framework, we can now analyze the problem of the environmental investor, which consists of comparing the reach and efficiency of the two instruments. We begin by analyzing their performance under a scenario of perfect information as a benchmark.

### 28.3 Comparative Performance of the Two Instruments Under Perfect Information

In the direct cost subsidy scheme only ( $b > 0$  and  $m = 0$ ), the problem of the environmental investor under perfect information is given by:

$$\text{Max}_{e, b \geq 0} \left\{ fe_i - v(1 - t)e_i - \frac{1}{2}[(1 + r - b)t + b]\alpha_i \left(\frac{e_i}{\theta}\right)^2 \right\} \quad (28.6)$$

<sup>2</sup> While the functional form of the production technology of the e-good retains the essential properties that such a function might have, things can be more complicated depending on the available depollution technique, the quota of emissions authorized and the production progress of the d-good (see Dasgupta and Heal 1979, for some hints).

subject to

$$ve_i - \frac{1}{2}(1+r-b)\alpha_i\left(\frac{e_i}{\theta}\right)^2 \geq 0 \quad (28.7)$$

In the tax cut scheme only ( $b=0$  and  $m>0$ ), the problem of the environmental investor under perfect information is given by:

$$\text{Max}_{e, m \geq 0} \left\{ fe_i - v(1-t)e_i - \frac{1}{2}(1+r)(t+m)\alpha_i\left(\frac{e_i}{\theta}\right)^2 \right\} \quad (28.8)$$

subject to

$$ve_i - \frac{1}{2}(1+r)\alpha_i\left(\frac{e_i}{\theta}\right)^2 \geq 0 \quad (28.9)$$

Constraints (28.7) and (28.9) are conditions for the participation of firm  $i$  in the environmental contract. The value of any external option is normalized to 0. In the programs, the environmental investor chooses the optimal level of both the e-good and the instrument. So an increase in the level of the instrument has the advantage of broadening the feasibility space and possibly the optimum quantity of the e-good for DCS. But it narrows the feasibility space of the TC scheme. In any case, this increase is costly for the environmental investor, whence the necessity to choose the instrument's optimal level.

Constraint (28.9) needs more detailed explanation. The TC scheme is applicable only if the firm's corporate benefit is known and positive. This has implications for the relative reach of both schemes.

Define:

$B^*$  = set of  $e$  such that (28.7) holds

$M^*$  = set of  $e$  such that (28.9) holds

*Proposition 1*  $B^*$  contains  $M^*$  ( $B^* \supset M^*$ ); that is, DCS has more reach than TC under perfect information.

Proposition 1 is easily proved by noticing that if constraint (28.9) holds, we have:

$$0 \leq ve_i - \frac{1}{2}(1+r)\alpha_i\left(\frac{e_i}{\theta}\right)^2 < ve_i - \frac{1}{2}(1+r-b)\alpha_i\left(\frac{e_i}{\theta}\right)^2$$

Proposition 1 asserts that the number of firms eligible for the DCS scheme is greater than the number of firms eligible for the TC scheme. In Benin, for example, the limited effects of the national investment code's incentives are noticeable by the small number of projects that benefit from TC. Since 1991, an average of only nine projects per year have benefited from the implementation of the code (authors' data). Furthermore, the TC scheme is only available for firms that are subject to corporate tax in the first place. This instrument is inaccessible to informal

**Table 28.1** Optimal levels of e-good and compensation under perfect information

Variable	Direct cost subsidy (DCS)	Tax cut (TC)
Production of the e-good ( $e^*$ )	$e_b^* = \frac{\theta^2 [2f - v(1-t)]}{2(1+r)\alpha_i}$	$e_m^* = \frac{\theta^2 (2f - v(1-t))}{2(1+r)\alpha_i}$
Discount	$b^* = (1+r) \left[ 1 - \frac{2v}{2f - v(1-t)} \right]$	$m^* = (1-t) \left[ 1 - \frac{2v}{2f - (1-t)v} \right]$
Payoff for the principal	A	B (=A)

firms lacking adequate accounting systems, thus resulting in its low reach. Large and formally organized firms pay such taxes, but the bulk of firms, comprised of small and micro-enterprises, are liable only for a formula tax.<sup>3</sup>

The number of participating firms affects the environmental investor’s total revenue, and is thus likely to have global efficiency impacts. One may ask if, for any individual firm that contracts with the environmental investor, there is an efficiency difference in using DCS versus TC. The solutions to the problems of the moral hazard scenario are summarized in Table 28.1.

*Proposition 2* If both are feasible, DCS is equivalent to TC for P under perfect information.

The proof of this proposition is straightforward. Replacing  $e$ ,  $b$ , and  $m$  with their optimal values in P’s payoff function for both DCS and TC attains the same payoff. One way to obtain this result is to observe the structure of the two payoffs. For P’s payoffs, we have:

$$A = U_P(e^*, b^*) = fe_i - v(1-t)e_i - \frac{1}{2}[(1+r-b)t + b]\alpha_i \left(\frac{e_i}{\theta}\right)^2 \text{ and}$$

$$B = U_P(e^*, m^*) = fe_i - v(1-t)e_i - \frac{1}{2}(1+r)f(t+m)\alpha_i \left(\frac{e_i}{\theta}\right)^2$$

Since  $e_b^* = e_m^*$ , we obtain  $A = B$  by proving that  $(1+r-b)t + b = (1+r)(t+m)$  or that  $b(1-t) = (1+r)m$ .

This proposition basically states that the optimal use of DCS and TC under perfect information yields the same static efficiency for P. Moreover, they lead to the same quantity of the e-good. Thus, wherever and whenever TC cannot be applied, such as an informal economy, DCS can attain the same environmental goal.

The following section explores whether these results hold in scenarios of asymmetric information.

<sup>3</sup> In Benin, the informal sector provides 40 % of GDP and 90 % of employment (Charmes 1999).

## 28.4 Comparative Performance of the Instruments Under Adverse Selection

Recall that, under adverse selection, we assume that firms can be of two types, type- $\alpha_1$  with probability  $q$ , and type- $\alpha_2$  with probability  $(1 - q)$ . Table 28.1 shows how the optimum quantity of the e-good depends on  $\alpha_i$ . More efficient firms produce a larger quantity of the e-good. Thus, the environmental investor must have a mechanism that offers the appropriate contract,  $(e_i, b_i)$  or  $(e_i, m_i)$ , to each type of firm based on the cost incurred from using green technology and producing environmental goods.

The payoff for a type- $\alpha_1$  firm takes the following form<sup>4</sup>:

$$\Pi(\alpha_i) = (1 - t) \left[ ve_i - \frac{1}{2}(1 + r - b)\alpha_i \left(\frac{e_i}{\theta}\right)^2 \right] + \frac{1}{2}m(1 + r - b)\alpha_i \left(\frac{e_i}{\theta}\right)^2 \quad (28.10)$$

and the corresponding payoff for the environmental investor is:

$$U(\alpha_i) = fe_i - v(1 - t)e_i - \frac{1}{2}[(1 + r - b)(t + m) + b]\alpha_i \left(\frac{e_i}{\theta}\right)^2 \quad (28.11)$$

The investor has a prior distribution on the values of  $\alpha$  and selects the contract that maximizes his expected payoff  $E(U(\alpha)) = qU(\alpha_1) + (1 - q)U(\alpha_2)$ .

For notational simplicity, let  $e(\alpha_i) = e_i$ ,  $b(\alpha_i) = b_i$  and  $m(\alpha_i) = m_i$  for  $i = 1, 2$ .

The general problem of the risk-neutral<sup>5</sup> environmental investor is given by

$$\text{Max}_{e_1, e_2, b_1, m_1 \geq 0} \{qU_1(e_1, b_1, m_1) + (1 - q)U_2(e_2, b_2, m_2)\} \quad (28.12)$$

subject to

$$\Pi_1(e_1, b_1) \geq 0 \quad (28.13)$$

$$\Pi_2(e_2, b_2) \geq 0 \quad (28.14)$$

$$\Pi_1(e_1, b_1, m_1) \geq \Pi_1(e_2, b_2, m_2) \quad (28.15)$$

$$\Pi_2(e_2, b_2, m_2) \geq \Pi_2(e_1, b_1, m_1) \quad (28.16)$$

For the maximization problem, constraints (28.13) and (28.14) are individual participation constraints: no firm will accept participation in an environmental program that offers no opportunity for profit. Constraints (28.15) and (28.16) regard

<sup>4</sup>The subscript  $y$  is omitted because  $y$  is not a choice variable (see the separability assumptions in Sect. 28.3).

<sup>5</sup>One can assume that an agency acting on behalf of a number of people is risk neutral given its capacity to disperse risk among numerous stakeholders (Arrow and Lind 1970).

incentive compatibility: no firm of a given type can gain by presenting itself as another type – lying. Incentive compatibility constraints derive from the revelation principle, which states that instead of using complicated messages, forcing the firms to reveal their true nature causes no loss of generality (Dasgupta et al. 1979). However, we have associated with this a cost referred to as an “information rent”. Such an optimization problem is usually solved by recognizing that some constraints should be held strictly (Laffont and Martimort 2002; Cornes and Sandler 1996; Salanié 1994).

First, given the parameters of the problem, we can produce the following equations from 28.14 and 28.15:

$$\Pi_1(e_1, b_1, m_1) \geq \Pi_1(e_2, b_2, m_2) > \Pi_2(e_2, b_2) \geq 0 \quad (28.17)$$

Equation 28.14 should hold equally at the optimum level because we will otherwise be able to increase  $e_1$  and  $e_2$  by a sufficiently small constant amount without violating any constraints. If this is possible, it contradicts the fact that we are at the optimum. Because constraint (28.14) binds at the optimum, we can ignore constraint (28.13), which according to condition (28.17) should hold strictly.

Because constraint (28.13) is not binding, the more efficient firms (associated with cost parameter  $\alpha_1$ ) obtain a strictly positive rent, while the less efficient firms (associated with cost parameter  $\alpha_2$ ) have a rent of 0. This is the informational rent that the environmental investor is forced to pay to the most efficient type of firm to eliminate possible incentives to receive additional subsidies by misrepresenting itself as less efficient ( $m_2$  and  $b_2$  to produce  $e_2$ , instead of  $m_1$  and  $b_1$  to produce  $e_1$ ). The environmental investor realizes this by imposing constraint (28.15) at the optimum level: the more efficient firm achieves nothing by lying.

Second, (28.15) cannot be non-binding; that is, we cannot have

$$\Pi_1(e_1, b_1, m_1) > \Pi_1(e_2, b_2, m_2) > \Pi_2(e_2, b_2) = 0 \quad (28.18)$$

In fact, if (28.18) holds, we can allow a small increase in  $e_1$  without violating any constraints but with the possibility of increasing P’s optimal value, which indicates that we were not previously at the optimum. Thus, Eq. 28.15 should be binding.

Third, from (28.14) and (28.18), we establish Eqs. 28.19 and 28.18 holds strictly:

$$\Pi_2(e_2, b_2, m_2) = 0 > \Pi_2(e_1, b_1, m_1) \quad (28.19)$$

Equation 28.19 states that the higher-cost firm will never misrepresent itself as a low-cost firm. If it were to try, a negative payoff would result. Thus, the threat of misrepresentation comes only from the low-cost firm, which then requires an incentive like a strictly positive rent, to keep it from lying.

We therefore rewrite the problem of the environmental investor as follows:

$$\text{Max}_{e_1, e_2 \geq 0} \{qU_1(e_1, b_1, m_1) + (1 - q)U_2(e_2, b_2, m_2)\} \quad (28.12')$$

$$\pi_2(e_2, b_2) = 0 \quad (28.14')$$

$$\pi_1(e_1, b_1, m_1) = \pi_1(e_2, b_2, m_2) \quad (28.15')$$

The solutions to the problem under imperfect information may be obtained by request from the authors. The results lead to proposition 3.

*Proposition 3* Under asymmetric information, DCS and TC are equivalent and are equally less profitable for the environmental investor than their uses under perfect information.

The mathematical expression of the informational rent is too complex to display here. However, when available, the two instruments are again equivalent regarding efficiency when technological cost carries information asymmetry. The presence of informational rent means that information asymmetry controls P's bargaining power.

An efficient firm receives more compensation while continuing to produce the same perfect information level of e-good. An inefficient firm's production and compensation are distorted away from perfect information levels. Interestingly, the loss P incurs due to information asymmetry is the same whether he uses DCS or TC.

## 28.5 An Empirical Test of the Model

### 28.5.1 Empirical Model

We shall use a structural approach to analyze empirically information asymmetry's effect on the production of CER and agricultural credits of emission reduction (ACER). It aims at testing the effectiveness of the constraints imposed by the informality of the developing countries' economies on the production of CER and ACER that necessitates subsidy schemes to encourage environmental investors.

We derive the econometric model for observed ACER directly from the underlying theoretical model. The previous theoretical analyses show that conditions of identifying green projects ( $q$ ) are major determinants of the production of green goods in developing countries. We build an empirical econometric model to test this. Our identification strategy controls for confounding variables that are correlated with both ACER and the causal variable, which are the conditions of identifying a project.

The process of producing ACER under the CDM includes an expression of intent, contracting, producing, evaluation, and certification by an independent third party. We may assume that there is a continuum of countries based on their unobservable production of ACER. Among these countries, we can distinguish:

- countries that have already produced some quantity of ACER,
- countries that have projects in the pipeline but do not as yet receive any ACER,

- countries that seriously consider entering the ACER production process, and
- countries that do not even think about starting the process.

Thus the supply of agricultural green projects and each country's degree of interest in CDM that we name  $ACER_i^*$  is an unobservable latent variable. We accordingly specify the empirical model to be estimated as:

$$ACER_i^* = \alpha + \rho q_i + \delta' X_i + u_i \quad (28.20)$$

Where:

$i$  refers to countries,  $ACER_i^*$  is the desired certified emissions credits produced by country  $i$ ,  $q$  is quality of proposed projects,  $X_i$  is vector of control variables,  $\alpha$ ,  $\rho$ ,  $\delta$  are parameters, and  $u$  the error term.

Since  $ACER_i^*$  is not observable, we cannot estimate the empirical model (28.20). However, the actual certified quantity of  $ACER$  is observed. So the model to be estimated becomes:

$$\begin{cases} ACER_i = \alpha + \rho q_i + \delta' X_i + u_i & \text{if } ACER_i^* > 0 \\ ACER_i = 0 & \text{if } ACER_i^* \leq 0 \end{cases} \quad (28.21)$$

Since many countries with  $ACER_i^* > 0$  supply no  $ACER$ , the dependent variable is censored at zero, so the empirical model requires a censored regression such as the Tobit model. Furthermore, because  $q$  enters nonlinearly in the optimal production level of greed good, we use a functional log-linear form for the empirical model.

## 28.5.2 Data

### 28.5.2.1 Data Sources

Data to estimate empirical model (28.21) came from databases compiled by UNFCC and the World Bank. The World Bank database is built from the Enterprise Survey (ES) on a World Bank Group website ([www.enterprisesurveys.org](http://www.enterprisesurveys.org)). The ES data contain indicators computed from a firm-level annual survey of representative samples of an economy's private sector business owners or top managers. The transaction cost indicators measure the quality of the business climate, defined as the collective set of incentives which establish the 'rules of the game' to which economic actors must adhere. As such, they measure actual transaction costs and the quality of the business environment that existing firms experience. ES data covers bribery, licensing, infrastructure, trade, land and permits, taxation, informality, access to finance, costs of inputs/labor, corruption, business-government relations, and innovation and technology.

UNFCCC website ([www.unfccc.org](http://www.unfccc.org)) contains data on CER and carbon stocks. We compute agricultural CER from the paper by Larson et al. (2011).



### 28.5.2.2 Measurement of ACER

We use *ACER* for the year 2010. We recovered these series in the paper by Larson et al. (2011) who follows the United Nations' Food and Agriculture Organization (FAO) in defining an agricultural project as a project that uses agricultural residuals, outputs, or agricultural processes to directly or indirectly reduce greenhouse gas emissions.

### 28.5.2.3 Measurement of Asymmetric Information Variable $q$

The probability that the proposed project variable  $q$  will select the efficient firm can be measured by the percentage of abandoned or rejected projects in each country. Since such data are not available, we use INFORMC, the percentage of firms that identify competitors' informal sector practices as a major constraint.

### 28.5.2.4 Control Variables $X$

Our control variables' vector  $X$  contains only one variable: total CO<sub>2</sub> emission in 2004. Following the literature on the Kuznets curve for environmental pollution, gross domestic product could have been another control variable. But GDP turned out to be highly correlated with CO<sub>2</sub> emissions. Indeed, multicollinearity is common in data on investment climate because macroeconomic trade policy, microeconomic framework, and enabling infrastructure variables are closely interdependent (Olawuyi 2009). GDP is then abandoned as control variable to avoid multicollinearity.

Another control variable is transaction cost, for which there can be many proxies. Following Antinori and Sathaye (2007), we distinguish four factors that may affect the transaction costs defined in the Coasian sense as costs of exchange: (1) Individual characteristics, such as each firm's opportunity costs, experience, skills, and personal networks; (2) Characteristics of the good traded; (3) Form of exchange, such as a formal or informal market, pecuniary or barter exchange, specific contract clauses and terms for a trade; and (4) Institutional setting, the social and legal environments of a given country. Because the certified *CER* is a standardized good and the exchange is formal, such as on the CDM market, we chose a transaction cost variable based on the first and the fourth factors they list, which is measured by the ES variable bribery in infrastructure on the Incidence of GRAFT index. This index is the proportion of instances in which firms were either expected or requested to supply a gift or informal payment when applying for six different public services (electrical connection, water connection, phone connection, construction permit, import license, operating license).

### 28.5.2.5 Sample of Countries Covered

Since the sample of countries covered each year is different for the ES database, our selection of a sample of countries is a trade-off decision between sample size and year. Unfortunately, the number of countries covered per year is often small. To increase the size of the sample, we average the different variables over the periods 2003–2007 and 2009–2010. We exclude the year 2008 because of a methodological heterogeneity used then, compared to other years. We end up with a sample of countries that covers 100 non-annex I countries of the Kyoto Protocol: 41 African, 20 American, 28 Asian, 6 European and 5 Oceanic.

### 28.5.2.6 Description of the Data

Figure 28.1 depicts percentages of global average levels of CER and ACER, and Table 28.1 gives the descriptive statistics on the model variables for the five continents. Asia produces CERs better than any other continent, certainly due to its major nations being the major producers of CO<sub>2</sub> among developing countries. This suggests that CO<sub>2</sub> emission level is a major determinant of CER production.

Average figures show that Africa strives to surpass Asia to improve the quality of business environment as measured by bribes (GRAFT).<sup>6</sup> Data show that despite some European and Oceanic countries being closer to potential CDM host countries located in these continents, access to CDM appears a competition between African, American, and Asian countries. We therefore reduce the estimate of the empirical

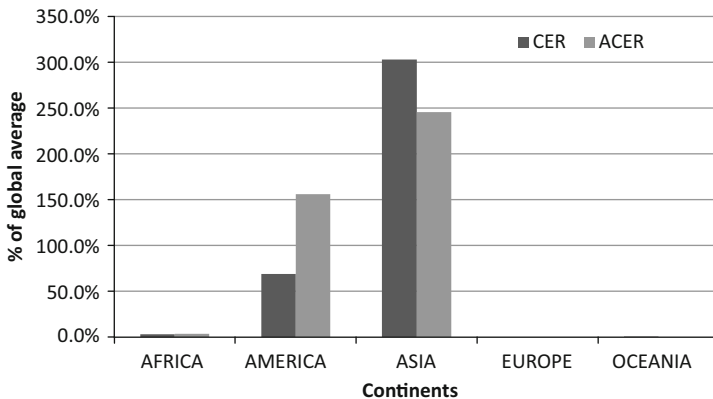


Fig. 28.1 Average production of CER and ACER per continent as percentages of global averages

<sup>6</sup> We recall that as concerning the interpretation of the variables, more means heavier constraint for GRAFT.

model to the sample including only African, American, and Asian countries. Figure 28.1 shows that productions of CERs et ACERs are mostly located in Asia and America.

### 28.5.3 Empirical Econometric Results

Table 28.2 shows the results of the econometric empirical estimates of model (28.21). The likelihood ratio and F tests show that both models are highly significant (1 %), meaning that the variables the models include explain a significant proportion of the variations in the dependent variable (CER).

The coefficient of GRAFT is significantly different from 0 with the expected negative signs. This suggests that infrastructural bribery (GRAFT) is a major obstacle to CER production in developing countries. The coefficient of INFORMC is negative but insignificant meaning that the informality/asymmetric information is not a major constraint for agricultural CER production. Well, the coefficient of INFORMC is negative and significant for the model of total CER meaning that the informality of the economy is a major constraint to the utilization of CDM by the host countries.

Another important result is the grandfathering effect. Results show that countries with an initially high stock of CO<sub>2</sub> or high mitigation potential before CDM inception benefit more from the mechanism than less polluted countries. This result may be explained by the fact that it is easier and cheaper for developed countries, designated operating entities, and host developing countries to produce CER in countries where the CO<sub>2</sub> stock is already abundant (Michaelowa et al. 2003). Indeed, developed countries decide which developing countries are least costly and risky to cooperate with in producing emission reduction credits. Results show that their strategy considers developing countries with high mitigation potentials because of high initial CO<sub>2</sub> emissions as low-risk investments (Olawuyi 2009).

**Table 28.2** Empirical econometric results (N = 81)

Log of independent variables	Dependent variable: logarithm of the quantity of ACER (LnACER)	
	CER	ACER
GRAFT	-5.62 (1.60)***	-6.61 (2.16)***
INFORMC	-0.16 (0.10)*	-1.31 (3.47)
CO2	3.35 (0.70)***	3.09 (0.91)***
CONSTANT	-11.79 (8.03)	-9.70 (15.57)
Likelihood ratio	41.70***	26.46***
Pseudo R <sup>2</sup> /adjusted R <sup>2</sup>	0.14	0.09

Standard errors are in *parentheses*

\*, \*\*, \*\*\* indicate statistical significance at 10 %, 5 % and 1 % levels, respectively

These results appeal for special strategies to encourage CER production and agricultural CER in smaller countries across the developing world. Key among these strategies are measures to improve information about and proliferation of efficient technologies, improve the investment climate, reduce transaction costs, promote effective legal mechanisms to curb corruption, and improve the quality of CDM projects.

## 28.6 Conclusions

We have shown that there is, in principle, no difference in efficiency between a direct cost subsidy and a tax cut to finance green projects. Under asymmetric information conditions, however, the environmental investor's bargaining power is decreased because he must leave some rents to better-informed firms. The results suggest that direct cost subsidies are more suitable for informal developing economies.

Our empirical results confirmed that the informality of the developing countries' economy is a serious obstacle to the production of CER. Using CDM to address agricultural intensification and combat food insecurity, a direct cost subsidy scheme is well-suited to contexts where the economy is largely informal and the reach of a tax cut scheme will be relatively low. In contrast, tax cut schemes may be the better of the two options in largely formal economies, due to the lack of additional transaction costs. Thus, a good environmental action plan should propose a range of schemes among which each firm can choose according to its circumstances.

## References

- Ahonen H-M, Hamekoski K (2005) Transaction costs under the Finnish CDM/JI Pilot Programme; Department of Economics and Management, University of Helsinki and Finnish CDM/JI Pilot Programme, Finnish Environment Institute (SYKE), Helsinki. <http://www.helsinki.fi/taloustiede/Abs/>. Accessed 12 July 2012
- Antinori C, Sathaye J (2007) Assessing transaction costs of project-based greenhouse gas emissions trading; Environmental energy technologies division; Ernest Orlando Lawrence Berkeley National Laboratory
- Anyanga JO (2010) Financing investment in environmentally sound technologies: foreign direct investment versus foreign debt finance. *Resour Energy Econ* 32:456–475
- Arrow KJ, Lind RC (1970) Uncertainty and the evaluation of public investment decisions. *Am Econ Rev* 60(3):364–378
- Baumol JB, Oates WE (1993) Economics, environmental policy, and the quality of life. Gregg Revivals, England
- Beattie BR, Taylor CR (1993) The economics of production. Krieger Publishing Company, Malabar
- Bohm P, Russell CS (1985) Comparative analysis of alternative policy instruments, handbook of natural resource and energy economics, vol I. In: Kneese AV, Sweeney JL (eds) North-Holland, Amsterdam

- Charmes J (1999) Gender and informal sector. ILO, Geneva
- Cornes R, Sandler T (1996) The theory of externalities, public good and club goods. Cambridge University Press, Cambridge
- Dasgupta PS, Heal GM (1979) Economic theory and exhaustible resources. Cambridge economic handbooks
- Dasgupta P, Hammond P, Maskin E (1979) The Implementation of social choice rules: some general results on incentive compatibility. *Rev Econ Stud* 46(2):185–216
- FEM-Fonds pour l'Environnement Mondial (2008) Examen de portefeuilles-pays du FEM: Bénin (1991–2007), Bureau de l'évaluation du FEM
- Furubotn EG, Richter R (2005) Institutions and economic theory: the contribution of the new institutional economics. University of Michigan Press, Ann Arbor
- Godfray HCJ et al (2010) People food security: the challenge of feeding 9 billion. *Science* 327:812–818
- Hall RE, Jorgenson DW (1967) Tax policy and investment behavior. *Am Econ Rev* 57(3):391–414
- Khandker SR, Faruquee RR (2003) The impact of farm credit in Pakistan. *Agric Econ* 28 (3):197–213
- Kirsten J, Karaan M (2005) The economics of institutions: a review. In: *The economics of institutions: theory and applications to African agriculture*, University of Pretoria, pp 24–61
- Laffont J-J, Martimort D (2002) The theory of incentives: the principal-agent model Princeton. Princeton University Press, Princeton
- Larson DF, Dinar A, Frisbie JA (2011) Agriculture and the clean development mechanism. Policy research working paper 5621. The World Bank Development Research Group Agriculture and Rural Development Team
- Michaelowa A, Jotzo F (2003) Impacts of transaction costs and institutional rigidities on the share of the clean development mechanism in the global greenhouse gas market. <http://www.uni-regensburg.de/Fakultaeten/WiWi/buchholz/forschung/AVR/Rostock/VortragRostock/>. Accessed 11 July 2012
- Michaelowa A, Stronzik M, Eckermann F, Hunt A (2003) Transaction costs of the Kyoto mechanisms. *Climate Policy* 3:261–278
- Miller GJ (2005) Solutions to principal-agent problems in firms. In: Menard C, Shirley MM (eds) *Handbook of new institutional economics*. Springer, Dordrecht, The Netherlands, pp 349–370
- Muet P-A, Avouyi-Dovi S (1987) L'effet des incitations fiscales sur l'investissement. *Revue de L'OFCE* 18:149–174
- Olawuyi DS (2009) Achieving sustainable development through the clean development mechanism: legal and institutional issues considered. *Afr J Int Com Law* 17(2):270–301
- PASMEC (Programme d'appui aux structures mutualistes d'épargne et de crédit, BCEAO) (2005) *Observatory 2003*, Dakar, Sénégal
- Paxton J (2002) Depth of outreach and its relation to the sustainability of MFIs. *Saving Dev* 26 (1):65–85
- Ruben R, Clercx L (2003) Rural finance, poverty alleviation, and sustainable land use. *J Microfinance* 5(2):77–100
- Salanié B (1994) *Théorie des contrats*, collection "Economie et Statistiques Avancées". Economica, Paris
- Schmidhuber J, Tubiello FN (2007) Global food security under climate change. *PNAS* 104 (50):19703–19708
- Shaw J (2004) Microenterprise occupation and poverty reduction in microfinance programs: evidence from Sri Lanka. *World Dev* 32(7):1247–1264
- Sterner T (2003) Policy instruments for environmental and natural resource management; resources for the future. The World Bank, Swedish International Development Cooperation Agency, Washington, DC
- Stiglitz J (1985) Information and economic analysis: a perspective. *Econ J supplement* 95:21–41
- UNFCCC- United Nations Framework Convention on Climate Change (2008) Clean development mechanism in brief. UNFCCC.ORG

- UNFCCC (2009) Accord de Copenhague. Copenhague, Danemark. <http://unfccc.int/resource/docs/2009/cop15/fre/>. Accessed 12 July 2012
- Weitzman ML (1974) Prices vs quantities. *Rev Econ Stud* 41(4):477–491
- Williamson O (2005) Transaction cost economics. In: Menard C, Shirley MM (eds) *Handbook of new institutional economics*. Springer, Dordrecht, The Netherlands, pp 41–68
- Winkelman AG, Moore MR (2011) Explaining the differential distribution of clean development mechanism projects across host countries. *Energy Policy* 39:1132–1143
- Woller G, Woodworth W (2001) Microcredit as a grass-roots policy for international development. *Policy Stud J* 29:267–282
- Xepapadeas AP (1991) Environmental policy under imperfect information: incentives and moral hazard. *J Environ Econ Manag* 20:113–126
- Zhang J, Wang C (2011) Co-benefits and additionality of the clean development mechanism: an empirical analysis. *J Environ Econ Manage* 62(2):140–154

## Chapter 29

# Farming Systems in Tanzania: Empirical Evidence of Changes in Livelihood Patterns and Poverty Among Smallholder Farmers

Ntengua S.Y. Mdoe, Gilead I. Mlay, and Michael L. Kadigi

**Abstract** In this paper, the major farming systems in Tanzania are described and evidence regarding the recent changes in livelihood patterns across the farming systems and their effect on poverty among smallholder farmers is provided. Evidence from the literature shows that the six major farming systems in Tanzania are characterized by diverse livelihood activities, with agriculture-based livelihood activities being dominant across all of the systems. The contribution of agriculture-based livelihood activities to total household income varies from 53 % in the coffee/banana/horticulture system to 65 % in the wet rice/sugarcane system. These activities have been affected by changes in both climate- and non-climate-related factors; however, climate-related factors significantly influence these changes. Furthermore, the evidence shows that the magnitude of the effect of changes in livelihood patterns on poverty among smallholder farmers varies across the farming systems – smallholder farmers in farming systems with more diverse sources of livelihood are less affected than those with limited sources of livelihood. The proportion of households that were categorized as being poor varies from 46 % in the coffee/banana/horticulture system to 72 % in the cassava/cashew/coconut system. Given differences in resources, livelihood patterns, and constraints among the farming systems, farming system-specific rather than countrywide policy interventions will be required to improve agricultural productivity, enhance livelihoods, and reduce poverty levels in rural Tanzania. The differential impact of climate- and non-climate-related factors on the farming systems implies that coping strategies should take into account the differences in these systems' vulnerabilities to such changes.

**Keywords** Tanzania • Farming systems • Climate change • Livelihood • Poverty

---

N.S.Y. Mdoe (✉) • G.I. Mlay • M.L. Kadigi  
Department of Agricultural Economics and Agribusiness,  
Sokoine University of Agriculture, Morogoro, Tanzania  
e-mail: [selemanimdoe@yahoo.com](mailto:selemanimdoe@yahoo.com)

## 29.1 Introduction

The majority of the poor in Sub-Saharan Africa live in rural areas and depend largely on agriculture for their livelihood. On average, in 2007, agriculture in Sub-Saharan Africa employed 62 % of the population and generated 27 % of the GDP of these countries (Staatz and Dembele 2008). Cross-country estimates show that GDP growth originating in agriculture is at least twice as effective in reducing poverty as GDP growth originating outside of agriculture (Livingston et al. 2011). Thus, improving agriculture, particularly smallholder farming, is fundamental to overcoming the seemingly intractable problem of African poverty. The Comprehensive Africa Agriculture Development Programme (CAADP), developed by the African Union's New Partnership for Africa's Development, provides a framework for agricultural development in Africa, emphasizing that agriculture lies at the heart of any resolution of the rural development crises. According to CAADP (2011), the challenge is to identify specific agricultural and rural development needs and opportunities, and to focus investment in areas where the greatest impact on poverty will be achieved. This identification and resource allocation process can be facilitated by analyzing farming systems<sup>1</sup> to identify, quantify, and integrate the driving forces and interactions that shape and constrain them. In the course of this effort, it is helpful to use the farming systems' framework to aggregate locations with similar constraints and investment opportunities, identify common natural resource management issues, and provide options for managing risk and enhancing productivity.

In Tanzania, agriculture plays an important role in terms of its contribution to the country's GDP, export earnings, employment, and income generation to the majority of the population. It contributes about 26 % to GDP (URT 2011) and about 34 % to the country's export earnings. Over 80 % of the nation's population relies on agriculture for its livelihood. Thus, the country's success in achieving its development goals for growth and poverty reduction largely depends on the performance of the agricultural sector. Unfortunately, the performance of the sector has not been impressive despite several efforts made by the government and development partners to transform it. These efforts include development policies, strategies and programs, such as the Agricultural and Livestock Policy of 1979, the Structural Adjustment Programs of the 1980s, National Land Policy, Agricultural Development Strategy (ASDS), Agricultural Development Programme (ASDP), Local Government Reform Programme, Agricultural Marketing Policy, and recent initiatives, including ASDP inputs vouchers, the warehouse receipt system, the Kilimo Kwanza resolution to rapidly transform Tanzania's agriculture, and the Agricultural Growth Corridors concept, which started with the development of the Southern Agricultural Growth Corridor of Tanzania (SAGCOT).

---

<sup>1</sup> A farming system is defined as a population of individual farm systems that have broadly similar resource bases, enterprise patterns, household livelihoods, and constraints, and for which similar development strategies and interventions would be appropriate (Byerlee et al. 1982; Collinson 1982; Norman et al. 1986; Shaner et al. 1982; Anandajayasekaram 1996).



Despite these efforts, the sector still experiences low productivity, and consequently, high levels of poverty and food insecurity in rural households, which depend on agriculture. A low level of agricultural technology, recurrent droughts, limited fertilizer use, weak support services (extension and research), low labor productivity, and deficient transportation and market infrastructure are among the major constraints leading to poor performance in the agricultural sector (Limbu 1995; World Bank 2000; URT 2001, 2006, 2008; Ngaiza 2012). However, because Tanzania is a large country, the effects of these factors on the performance of the agricultural sector are expected to vary across the country due to differences in climate, resource base, infrastructure, and services. Thus, generic or countrywide policy interventions geared towards improving agricultural performance will usually be inappropriate and ineffective in some parts of the country. To avoid this, interventions should be specific to each farming system, taking into account factors constraining a particular farming system.

Tanzania is divided into seven major agro-ecological zones in which diverse crop and livestock enterprises are undertaken in different farming systems. These agro-ecological zones are coastal, arid land, semi-arid land, plateaus, southern and western highlands, northern highlands, and alluvial plains (de Puaw 1984). Annual rainfall varies from less than 600 mm per year in the semi-arid zone (500–1,800 m above sea level) to about 1,400 mm per year in the northern, southern, and southwestern zones (1,200–2,300 m above sea level).

Due to differences in enterprise patterns, household livelihood opportunities, and constraints, the poverty levels in Tanzania vary across the major farming systems. Based on a combination of published and grey literature, this paper provides empirical evidence of recent changes in patterns of livelihood and poverty across these systems. The specific objectives of the paper are to: (i) describe the major farming systems in Tanzania, (ii) analyze patterns of livelihoods and poverty levels in relation to the farming systems, and (iii) determine the factors that have led to recent changes in the patterns of livelihood and poverty levels among smallholder farmers in the farming systems.

The paper is structured as follows: Sect. 29.2 describes the major farming systems in Tanzania. Section 29.3 describes the livelihood patterns and poverty levels in these farming systems. Section 29.4 discusses the changes in livelihood patterns and poverty among smallholder farmers in these farming systems, while conclusions and policy implications are presented in Sect. 29.5.

## 29.2 The Major Farming Systems in Tanzania

Two major criteria have been used to delineate farming systems in different parts of the world (Ruthenberg 1980; Dixon et al. 2001). The first criterion is the available natural resource base (water, land, grazing area, and forest) and climate. The second criterion is the dominant pattern of farm activities and household livelihoods. The livelihoods include field crops, livestock, trees, aquaculture, hunting and gathering,

processing, and off-farm activities. Technologies used in the livelihoods are taken into account, as they determine the intensity of production and integration of crops, livestock, and other activities. Based on these criteria, Ruthenberg (1980), the Food Studies Group (1992), and the World Bank (1994) have delineated the farming systems of Tanzania<sup>2</sup> that provide a framework for implementing agricultural development strategies. The present study adopted the Food Studies Group's classification of six broad categories of farming systems (FSs) that are recognized in Tanzania's agriculture. These are banana/coffee/horticulture, maize/legume, cassava/cashew/coconut, wet rice/sugarcane, livestock/sorghum/bulrush millet, and the pastoral and agro-pastoral systems.

Table 29.1 summarizes the distribution of these FSs in the country and their major characteristics, while Fig. 29.1 shows photographs of the FSs. Table 29.1 indicates that more than one FS can be found in one district/region and one FS may extend to more than one district/region.

### 29.3 Livelihood Patterns and Poverty Levels in the Major Farming Systems of Tanzania

According to Chambers and Conway (1991), livelihood comprises the capabilities, assets (including both material and social resources), and activities required to support an individual or a household. A livelihood is sustainable when it can cope with and recover from stress and shocks and maintain or enhance its capabilities and assets, both now and in the future, without undermining the natural resource base. Table 29.2 shows the livelihood activities and poverty levels among smallholder farmers in the major FSs of Tanzania. The table reveals three main features. First, all farming systems are characterized by diversity of livelihood activities. This feature is in agreement with empirical evidence from a variety of locations, which suggests that individuals and households in rural areas in developing countries make a living by engaging in diverse livelihood activities and rely on diversified income portfolios (Ellis 1998, 2000; Ellis and Freeman 2004). According to Ellis (2008), the reasons that individuals and households pursue diversification as a livelihood strategy can be divided into two categories: necessity and choice. Necessity refers to involuntary and desperation reasons for diversification due to factors such as land fragmentation, environmental deterioration leading to declining yields for crops, and natural disasters like drought and floods. Choice refers to voluntary and proactive reasons for diversification, which include a deliberate effort to save money to invest in non-farm businesses and efforts to educate children to improve their prospects of obtaining non-farm jobs (Ellis 2008).

---

<sup>2</sup> Delineation of FSs into broader categories avoids the complexity of discrete, micro-level FSs but still provides a useful framework within which appropriate agricultural development strategies and interventions can be determined.

**Table 29.1** Farming systems and their main features

Farming system	Districts and regions in which the farming system (FS) is found	Main features
Coffee/banana horticulture	Hai, Moshi rural and Mwanza in Kilimanjaro; Arumeru in Arusha; Lushoto in Tanga; Kasulu and Kibondo in Kigoma; Bukoba, Ngara, Karagwe, and Muleba in Kagera; Rungwe and Ileje in Mbeya; Mbinga in Ruvuma	Predominantly located in volcanic uplands with highly fertile soils derived from volcanic lava and ash. There is a scarcity of land and high population density in some areas. The rainfall pattern is bimodal, reliable in the highlands, and the rainfall amount is fairly high. Farming is predominantly done by smallholder farmers
Maize/legume system	Sumbawanga and Nkasi in Rukwa; Mpanda in Katavi; Songea in Ruvuma; Mbulu in Arusha; Hanang, Kiteto, and Babati in Manyara; Kilosa and Ilonga in Morogoro; Kahama in Shinyanga; Biharamulo in Kagera; Mbeya and Mbozi in Mbeya; Kibondo and Kasulu in Kigoma; Iringa and Mufindi in Iringa; Njombe, Makete, and Ludewa in Njombe; Urambo in Tabora; Korogwe, Handeni, and Muheza in Tanga	Generally located at an altitude between 800 and 1,500 m above sea level. Loam-clay of moderate fertility is found in the south, whereas in the north, infertile sandy soils are predominant. There is abundant land, and rainfall is largely unimodal and reliable. There is shifting cultivation, poor farming technologies, and mechanization is limited, although the use of draught power is increasing
Cassava/cashew/coconut	Bagamoyo, Mafia, Kibaha, and Kisarawe in Coast region; Kilwa, Lindi, and Liwale in Lindi; Mtwara, Masasi, Nachingwea, and Newala in Mtwara; Mwanza, Sengerema, and Ukerewe in Mwanza; Kigoma in Kigoma; Mara, Musoma, and Tarime in Mara; Tunduru in Ruvuma; Tanga, Muheza, and Pangani in Tanga	Much of this FS lies at an altitude of less than 300 m above sea level. It is characterized by infertile sandy soil, although there are some areas of fertile clay in raised areas and river flood plains. The rainfall pattern is usually unimodal, varying between 800 mm and 1,200 mm per year, and usually unreliable. There is a poor resource base, shifting cultivation, and low technology
Wet rice/sugarcane	Kilombero in Morogoro; Kyela and Mbarali in Mbeya; Rufiji in the Coastal region	Practiced in river valleys and alluvial plains with permanent water supplies, and good and reliable rainfall. Salinity limits water and land use in some areas. There are poor agricultural technologies; furrow irrigation is the predominant water supply technique. Although large-scale farming exists, the FS is generally dominated by smallholder farmers

(continued)

**Table 29.1** (continued)

Farming system	Districts and regions in which the farming system (FS) is found	Main features
Livestock/sorghum/bulrush millet/upland paddy rice	Maswa, Bariadi, and Shinmyanga in Shinyanga; Meatu in Simiyu; Kwimba and Magu in Mwanza; Geita in Geita; Nzega in Tabora	This FS lies at an altitude between 1,000 and 1,500 m above sea level, and has gently undulating plains with some rocky hills and escarpments. In the uplands, the soils are well drained; in the lowlands, there are areas of black, alluvial soils with moderate fertility. Rainfall is bimodal and low, with a mean annual rainfall ranging between 800 and 900 mm. There is low population density, poor farming technology, and the widespread use of oxen
Pastoralist and agro-pastoralist systems	Kondoa, Dodoma and Mpwapwa in Dodoma; Singida, Manyoni, and Iramba in Singida; Serengeti in Mara; Monduli and Ngorongoro in Arusha; Chunya in Mbeya; Igunga in the Tabora region	Typically made up of an undulating plain with rocky hills and escarpments. Altitude ranges from 1,000 to 1,500 m above sea level. In the plains, the soils are sandy loams, well-drained but with low fertility. Rainfall is highly unreliable and almost all areas are prone to drought; rainfall is unimodal, varying from 500 to 800 mm. There is a limited resource base, moderate population density (30 per sq. km), and shifting cultivation of sorghum and millet

Source: Food Studies Group (1992)

Second, the table shows that agriculture-based livelihood activities are dominant in the FSs of Tanzania, which is supported by the 2002–2003 Agricultural Sample Census data on the sources of household cash income presented in Table 29.3. The table reveals that the contribution of agricultural-based livelihood activities to total household cash income varies from 53 % in the coffee/banana/horticulture system to 65 % in the wet rice/sugarcane system. According to Table 29.3, the cash income contribution from non-farm sources varied from 34 % in the pastoral/agro-pastoral system to 47 % in the coffee/banana/horticulture system.

Third, Table 29.2 shows that poverty levels expressed as proportion of households categorized as being poor varied substantially across the six FSs. The proportion of households that were categorized as being poor varied from 46 % in the coffee/banana/horticulture system to 72 % in the cassava/cashew/coconut system.

Apart from the empirical evidence that rural households in developing countries make their living by engaging in diverse livelihood activities, there is empirical



**Fig. 29.1** Major farming systems of Tanzania

evidence that reliance on agriculture-based livelihoods in Sub-Saharan Africa diminishes as income level rises (Ellis 2008). This evidence is not supported by the data on proportion of households categorized as being poor in Table 29.2 nor that on the proportion of households deriving cash income from agriculture-based livelihood activities in Table 29.3. For example, the cassava/cashew/coconut system with the highest proportion (72 %) of households categorized as being poor had a lower proportion (55 %) of households that derived their cash income from agriculture-based livelihoods than the wet rice/sugarcane system, with 50 % categorized as being poor but with 65 % of the households deriving cash income from agriculture-based livelihood activities. However, this evidence is supported by data from the maize/legume FS in Morogoro, which shows that reliance on farm-based livelihood activities diminishes as income increases (Table 29.4). The table

**Table 29.2** Livelihood activities and poverty levels among smallholder farmers in the major farming systems of Tanzania

Farming system	Livelihood activities <sup>a</sup>	Proportion of households categorized as being poor (%) <sup>b</sup>
Coffee/banana/horticulture	Crop-based activities: production of banana, coffee, and horticultural crops. Maize, beans, and sunflower are minor crops	46
	Livestock-based activities: cattle, particularly dairy, small ruminants, and keeping poultry	
	Non-farm activities: businesses, wage employment, sale of forest products, local brewing, carpentry, and masonry	
Maize/legume	Crop-based activities: production of maize, legumes, potatoes, tea, tobacco, and pyrethrum	63
	Livestock-based activities: cattle, small ruminants, and poultry	
	Non-farm activities: wage employment, small businesses, sale of forest products, local brewing, carpentry, knitting, and pottery	
Cassava/cashew/coconut	Crop-based activities: cashew, coconut, cassava, paddy, and maize	72
	Livestock-based activities: fishing, cattle, small ruminants, and poultry	
	Non-farm activities: weaving, knitting, pottery, local brewing, small businesses, sale of forest products, and wage employment	
Rice/sugarcane	Crop-based activities: production of rice, sugarcane in flood plains and valley bottoms, and production of maize, cotton, and cassava in upland areas	50
	Livestock-based activities: fishing and cattle, small ruminants, and poultry	
	Non-farm activities: wage employment, small businesses, local brewing, weaving, knitting, and pottery	
Livestock/sorghum/bulrush millet/upland rice	Crop-based activities: production of sorghum, millet, upland rice, cotton, maize, cassava, groundnuts, and sweet potatoes	69
	Livestock-based activities: keeping cattle, goats, sheep, poultry, and fishing	
	Non-farm activities: wage employment, small businesses, sale of forest products, local brewing, carpentry, knitting, and pottery	

(continued)

**Table 29.2** (continued)

Farming system	Livelihood activities <sup>a</sup>	Proportion of households categorized as being poor (%) <sup>b</sup>
Pastoral and agro-pastoral	Livestock based activities: keeping cattle, goats, and sheep	66
	Crop-based activities: sorghum, finger millet, groundnuts, bambara nuts, cassava, and grapes	
	Non-farm activities: sale of forest products, weaving, knitting, pottery, small businesses, and wage employment	

Source: <sup>a</sup>Food Studies Group (1992)<sup>b</sup>Mnenwa and Maliti (2010)**Table 29.3** Main sources of household cash income by farming system (% of households)

Source of income	Farming system					
	CBH	ML	CCC	PRS	LSM	PSAPS
Crops	49.0	58.0	48.0	60.0	56.0	56.0
Livestock	4.0	4.0	7.0	5.0	2.0	10.0
Sub-total: farm	53.0	62.0	55.0	65.0	58.0	66.0
Forest products	4.6	3.9	6.3	2.1	11.4	3.0
Business	12.3	9.4	12.3	9.3	8.9	9.1
Employment	5.3	4.5	2.7	4.1	3.8	4.1
Casual labor	15.6	12.7	18.3	14.5	11.3	11.6
Fishing	4.9	3.9	4.1	3.0	4.3	3.6
Others	4.5	3.1	2.3	2.4	2.3	2.3
Sub-total: non-farm	47.0	38.0	45.0	35.0	42.0	34.0
Total	100.0	100.0	100.0	100.0	100.0	100.0

*CBH* Coffee/banana/horticulture, *ML* Maize/legume, *CCC* Cassava/cashew/coconut, *PRS* Paddy rice/sugarcane, *LSM* Livestock/sorghum/millet, *PSAPS* Pastoral and Agro-pastoral

Source: Mnenwa and Maliti (2010)

**Table 29.4** Maize/legume farming system in Morogoro: composition of household income (%) by income group

Income source	Income group				Total
	I n = 87	II n = 88	III n = 88	IV n = 81	
Maize	27.1	21.5	15.1	7.9	12.4
Rice	12.3	14.2	10.3	8.8	10.0
Other crops	23.3	19.9	23.8	11.8	16.3
Livestock	5.0	7.7	6.5	14.1	11.0
Sub-total agriculture	67.7	63.3	55.9	42.6	49.7
Wages	14.6	8.9	9.3	11.0	10.5
Non-farm self-employment	11.5	23.7	29.3	44.0	36.1
Transfers	6.3	4.2	5.7	2.5	3.7
Total	100.0	100.0	100.0	100.0	100.0

Source: Ellis and Mdoe (2003)

shows that dependency on agriculture-based sources of income declines from 67.7 % in the lowest income group to 43.6 % in the highest income group. The most striking feature of Table 29.4 is the sharp rise in non-farm self-employment from 11.5 % in the lowest income group to 44 % in the highest income group. This implies that becoming less reliant on agriculture is part of the process of getting out of poverty in rural areas of Tanzania.

## **29.4 Changes in Livelihood Patterns and Poverty Among Smallholder Farmers in the Major Farm Systems of Tanzania**

Over the past three decades, several factors have influenced the livelihood patterns among smallholder farmers in the FSs of developing countries, including Tanzania. These can be categorized into climate- and non-climate-related factors, as described below. These changes in livelihood patterns have been found to impact the income and welfare of rural households (Reardon 1997; Ellis 1998, 2000; Reardon et al. 2000; Block and Webb 2001; Canagarajah et al. 2001; Damite and Negatu 2004; Niehof 2004; Khatum and Roy 2012).

### ***29.4.1 Non-climate Related Factors***

The non-climate related factors can be grouped into four categories: government policies, economic factors, population growth, and changes in land tenure arrangements (Olson et al. 2004). The Structural Adjustment Policies (SAPs) are among the policy initiatives that led to changes in the livelihood patterns of most FSs in Tanzania. Studies on the impact of the SAPs show that while the number of private traders providing competitive market outlets and incentives for agricultural production increased with market liberalization, their uneven distribution in the country, high input prices, and poor input supply have compelled smallholder farmers to abandon and/or replace some crops with others (Narayan 1997; Madulu 1998; Mung'ong'o 1998; Mwakalobo and Kashuliza 1999; Hawassi et al. 1998; Ponte 2001, 2002). According to Madulu (1998), the collapse of public services at village level associated with SAP cutbacks have compelled some farmers in the Kwimba District of Tanzania to abandon farming in favor of non-farm activities.

The economic factors that influence smallholder farmers' decisions on how to use land include relative prices of agricultural products, input prices, marketability of commodities, availability of inputs, and technologies. Farmers have responded to changes in market conditions and relative prices by switching their choice of crop and livestock enterprises. For example, farmers in the coffee/banana/horticulture system have responded to declining coffee prices by replacing coffee with



horticultural crops and fodder for dairy cattle (Mdoe and Wiggins 1997; Temu et al. 2001; Soini 2005; Mdoe 2009; Shilinde and Bee 2013). In the maize/legume system of the southern highlands of Tanzania, Skarstein (2005) found that vagaries of the market, including the declining ratio of crop prices to input costs, increasingly led to smallholder farmers reducing maize production to levels that meet only their subsistence requirements. On the other hand, farmers seek non-farm sources of cash income, such as small businesses and local beer brewing. A recent study on the same FS by Mpogole et al. (2012) found that the increasing profitability of round potatoes, due to increased demand for potato chips and crisps, compelled some smallholder farmers to reduce maize acreage in favor of round potato production. In the pastoral/agro-pastoral system, high veterinary input prices compelled farmers to diversify their livelihood activities by increasing the proportion of small ruminants (goats and sheep) that are more disease resistant than cattle, and engage in more crop-related livelihood activities (Roger 1999; Olson et al. 2004; Mashingo 2010).

Increase in population generally leads to expansion in cultivated areas, and in many cases, causes conflicts between the different users of land and water resources. Further population increase tends to lead to intensification of the FS once fertile land is exhausted. The effect of high population density is more pronounced in farming systems that are characterized by scarcity of land, as in the coffee/banana/horticulture system. In the coffee/banana/horticulture system on the slopes of Mt. Kilimanjaro, farmers have adopted more intensified and diversified production and off-farm activities in response to land scarcity (Soini 2005).

### ***29.4.2 Climate-Related Factors***

There is strong empirical evidence to show that the livelihood activities and welfare of smallholder farmers in the different FSs of Tanzania have also been influenced by climate change and vulnerability. The available literature indicates a broad consensus among scientists and the public that climate change has occurred, but disagreement exists on whether it is caused by human activities or by natural factors. Proponents of the former argue that increasing human activities, such as the use of fossil fuels, unsustainable agriculture, deforestation, and forest fires, have added millions of tonnes of greenhouse gases, such as carbon dioxide, methane, and nitrous oxide, that are responsible for global warming (Antilla 2005; Watson et al. 2006; Mwandosya 2006; IPCC 2007). Opponents on the other hand, believe that human activities have nothing to do with global warming, but that it is a result of natural changes that have occurred on the earth over a long period of time (Kaser et al. 2004; Schmundt 2006). According to the ECA (2009), climate change affects livelihood patterns and impacts incomes and poverty among farmers in different FSs through: (i) drought that causes crop failure, reduction in grazing lands, and stock loss; (ii) increased rainfall and shifts in seasonality that cause elevated erosion, land degradation, and crop loss, (iii) high temperatures that lead to high

**Table 29.5** Major droughts and flood disasters between 1980 and 2010

Serial no.	Years of drought	Years of floods
1	1984	1989
2	1988	1990
3	1991	1993
4	1996	1996
5	2003	1997
6	2004	1998
7	2006	2002
8	2009	2007
9		2010
10		2011
11		2012

Source: EM-DAT: the OFDA/CRED International Disaster Database, [www.em-dat.net](http://www.em-dat.net)

evaporation and water losses, reduction in areas suitable for temperate crops, poor grain formation, and increased incidence of certain pests, and (iv) rising sea level with potential impact on marine coastal fisheries.

Tanzania has experienced several drought and flood disasters. According to Hatibu et al. (2000), more than 33 % of climate shocks in Tanzania over the past 100-year period have been related to drought, which is a major pre-cursor of hydrological problems in semi-arid areas. Studies on drought patterns in East Africa (Tanzania, Kenya, and Uganda) and their potential impacts on the economy show that the whole of East Africa was drought-free in 21 out of 100 years (Ininda 1984; Ogallo 1989; Mhita 1990; Ogallo and Ambenje 1996; URT 1998; Madaka 2007; Chang'a et al. 2010).

Table 29.5 shows the major drought and flood disasters that occurred in Tanzania between 1980 and 2012. During this period, floods were more frequent than drought disasters. Drought and flood occurrences have played a significant role in influencing household livelihood choices and strategies in different FSs in the country. According to Fischer et al. (2001), farming systems in arid and dry humid areas are likely to be most affected by an increase in global warming, while farming systems in high rainfall areas might benefit from the reduction of excessive moisture. In general, droughts are said to have more adverse effects on the livelihoods of farmers in FSs that depend entirely on rainfall than in FSs where crops are irrigated. For FSs depending entirely on rainfall, drought has fewer adverse effects on farmers' livelihoods when the FS has drought resistant crops, such as sorghum and millet, compared to FSs without such crops. Dry spells influence farmers in crop-based FSs to grow drought resistant and early maturing crop varieties (Ngana 1983; Meena et al. 2006; Gwambene 2007; Mongi et al. 2010). Paavola (2008) indicates how farmers in the maize/legume FS in the Morogoro region have responded to drought by switching to drought resistant crops like sorghum and millet and engaging in wage employment or in charcoal, timber, and brick making. In the semi-arid areas of central Tanzania, Lema and Majule (2009)

found that farmers used a combination of strategies to adapt to drought, such as crop diversification and involvement in non-farm activities. Besides influencing changes in livelihood patterns, prolonged droughts have been reported to cause failure and damage to crops, leading to chronic food shortages and poverty among crop growers in the country (Kangalawe and Liwenga 2005).

In livestock-based FSs, prolonged droughts have affected pastoral grazing land and decreased water availability for livestock. They have resulted in an increase in livestock mobility by pastoralists and agro-pastoralists in search of pastures and water, thus leading to conflicts with crop farmers (Morris et al. 2003; Mashingo 2010). In most cases, distance to grazing and water sources have tended to increase with the magnitude of the drought (Tumbo et al. 2011). In drought periods, the price of cattle may fall drastically, and sometimes, animals die before being sold. For example, the drought in the northern part of Tanzania in 2006 caused the death of 143,787 animals in the districts of Loliondo, Ngorongoro, Simanjiro, Kiteto, and Mwanza (Mashingo 2010). Various strategies are used by pastoralists and agro-pastoralists to mitigate the effects of drought; these include temporary and permanent migration and the keeping of different types of livestock – cattle, goats, and sheep (Obando et al. 2010). In most cases, goats and sheep are more preferred than cattle as they adapt more readily to drought. They can remain alive longer without water and they can browse on shrubs and trees.

Similarly, excessive rains in different parts of the country have led to changes in livelihood patterns (Meena et al. 2006). Flood areas in crop-based FSs favor crops with high water requirements. Coffee, for instance, will most likely be grown where rainfall is excessive, while cotton cannot be successfully grown under such conditions (Paavola 2008). In livestock-based farming systems, the excessive rains that occurred in 2005–2006 affected animals in the rangelands, including the drowning of some animals, destruction of livestock feeds, and outbreaks of Rift Valley Fever (Tumbo et al. 2011). In 1997, floods and high rainfall triggered by an El Niño event in East Africa resulted in the rise of the water level in Lake Victoria by 1.7 m, disrupting agricultural production and pastoral systems (Lovvet et al. 2005).

## 29.5 Conclusions and Policy Implications

The six major FSs of Tanzania are characterized by diverse livelihood activities, with agriculture-based livelihood activities being dominant across all FSs. Empirical evidence from the literature shows the existence of poverty in all the FSs; however, the levels of poverty among households vary across the FSs. For example, poverty levels among households in the cassava/cashew/coconut system are significantly higher than poverty levels among households in the coffee/banana/horticulture system. This implies that generic or countrywide policy assessments and interventions geared towards increasing the impact of agriculture on poverty reduction will be ineffective. Farming system-specific policy interventions would be required to improve agricultural productivity, enhance livelihoods, and reduce the poverty level in rural Tanzania.

Furthermore, empirical evidence from the literature shows that the livelihood patterns in the FSs in Tanzania have been changing in the past three decades due to climate- and non-climate-related factors. Non-climatic factors include population growth, changes in technology, trade liberalization and market development, policies, and institutions. These changes have involved replacement of certain agriculture-based livelihoods with other agriculture-based livelihoods of a different nature or with non-farm-based livelihoods. The changes in livelihood patterns have either increased or reduced poverty among smallholder farmers in the affected FS. Overall, the effect of these factors on livelihoods and poverty varies across the FSs. Some FSs have suffered more than others. Thus, strategies to cope with changes in the climatic- and non-climatic factors should take into account the differences in their vulnerability to these changes. In each FS, strategies to cope with climate change should promote indigenous knowledge in climate change adaptation.

Although we cannot wholly blame climate change, climatic extremes such as high temperatures, droughts, and floods have greatly contributed to changes in livelihood patterns and poverty among smallholder farmers in the different FSs in Tanzania. This calls for interventions to strengthen climate information and early warning systems for all types of climate change extremes.

## References

- Anandajayasekeram P (1996) Farming systems research: concepts, procedures and challenges. Keynote paper presented at the fourth regional conference of SAA – FSR-E, Harare, Zimbabwe, 2–4 October 1996
- Antilla L (2005) Climate skepticism: US newspaper coverage of the science of climate change. *Glob Environ Chang* 15:338–352
- Block S, Webb P (2001) The dynamics of livelihood diversification in post-famine Ethiopia. *Food Policy* 26(4):333–350
- Byerlee DL, Harrington L, Winkelmann D (1982) Farming systems research: issues in research strategy and technology design. *Am J Agric Econ* 64:897–904
- CAADP (2011) A framework for agricultural development. Comprehensive Africa Agriculture Development Programme, Johannesburg, South Africa
- Canagarajah S, Newman C, Bhattamishra R (2001) Non-farm income, gender and inequality: evidence from rural China and Uganda. *Food Policy* 26(4):405–420
- Chambers R, Conway GR (1991) Sustainable rural livelihoods: practical concepts for the 21st century. Institute of Development Studies discussion paper 296, University of Sussex, Brighton, December 1991
- Chang'a LB, Yanda PZ, Ngana J (2010) Spatial and temporal analysis of recent climatological data in Tanzania. *J Geogr Reg Plan* 3(3):44–65
- Collinson M (1982) Farming systems research in eastern Africa: the experience of CIMMYT and some national agricultural research services, 1976–81. MSU International development paper, no. 3 Michigan State University, Department of Agricultural Economics, East Lansing
- Damite D, Negatu W (2004) Determinants of rural livelihood diversification: evidence from South Ethiopia. *Q J Int Agric* 43(3):267–288
- De Puaw W (1984) Soils, physiograph and agro-ecological zones of Tanzania. Ministry of Agriculture, Dar es Salaam, Tanzania/FAO, Rome, Italy

- Dixon J, Gulliver A, Gibbon D (2001) Farming systems and poverty: improving farmers' livelihoods in a changing world. FAO/World Bank, Rome/Washington, DC
- ECA (2009) Shaping climate resilient development: a framework for decision making. Economics of Climate Change Adaptation Working Group (Climate Works Foundation, GFF, European Commission, Rockefeller Foundation, McKinsey and Co, Standard Chartered Bank, Swiss Re)
- Ellis F (1998) Survey article: household strategies and rural livelihood diversification. *J Dev Stud* 35(1):1–38
- Ellis F (2000) Rural livelihood diversity in developing countries. Oxford University Press, Oxford, UK
- Ellis F (2008) The determinants of rural livelihood diversification in developing countries. *J Agric Econ* 51(2):289–301
- Ellis F, Freeman HA (2004) Rural livelihoods and poverty reduction strategies in four African countries. *J Dev Stud* 40(4):1–30
- Ellis F, Mdoe N (2003) Livelihoods and rural poverty reduction in Tanzania. *World Dev* 31(8):1367–1384
- Fischer G, Shah M, van Velthuisen H et al (2001) Global agro-ecological assessment for agriculture in the 21st century. IIASA research report 02-02, International Institute for applied systems analysis, Laxenburg, Austria
- Food Studies Group (1992) Agricultural diversification and intensification study: final report—volume II, farming systems: characteristics and trends. Food Studies Group (FSG), International Development Centre, University of Oxford, Oxford, UK
- Gwambene B (2007) Climate change and variability adaptation strategies and their implications for land resource in Rungwe district, Tanzania. M.Sc. dissertation, Institute of Resource Assessment, University of Dar es Salaam, Dar es Salaam, Tanzania
- Hatibu N, Mahoo HF, Kajiru, GJ (2000) The role of rain water harvesting in agriculture and natural resource management: from mitigating drought to preventing floods. In: Hatibu N and Mahoo HF (eds) Rain water harvesting for natural resource management: a planning guide for Tanzania, Technical handbook no. 22, FRELMA/Sida
- Hawassi FGH, Mdoe SY, Turuka FM et al (1998) Efficiency in fertilizer use in the southern highlands of Tanzania and implications for development policies. *Q J Int Agric* 37(3):222–237
- Ininda J (1984) Spatial and temporal characteristics of drought in eastern and southern Africa. M. Sc. Thesis, University of Nairobi, Nairobi, Kenya
- Intergovernmental Panel on Climate Change (IPCC) (2007) Climate change 2007: synthesis report summary for policy makers. Workgroup Contribution to the Fourth Assessment Report at IPCC Plenary, Valencia, Spain 22:12–17
- Kangalawe RYM, Liwenga ET (2005) Livelihoods in the wetlands of Kilombero Valley in Tanzania: opportunities and challenges to integrated water resource management. *Phys Chem Earth* 30:968–975
- Kaser G, Hardy DR, Molg T et al (2004) Modern glacial retreat on Kilimanjaro as evidence of climate change: observations and facts. *Int J Climatol* 24:329–339
- Khatum D, Roy BC (2012) Rural livelihood diversification in west Bengal: determinants and constraints. *Agric Econ Res Rev* 25(1):115–124
- Lema AM, Majule AE (2009) Impacts of climate change, variability and adaptation strategies on agriculture in semi-arid areas of Tanzania: the case of Manyoni district in Singida region. *Tanzania J Environ Sci Technol* 3(8):206–218
- Limbu F (1995) Agriculture and rural development in Tanzania: a survey of the 1980–1995 literature. ESRF discussion paper series no. 007, Economic and Social Research Foundation, Dar es Salaam
- Livingston G, Schonberger S, Delaney S (2011) Sub-Saharan Africa: the state of smallholder agriculture. Paper presented at the IFAD conference on new direction for smallholder agriculture, Rome, Italy, 24–25 January 2011
- Lovvett JC, Midgely GF, Barnard PB (2005) Climate change and ecology in Africa. *Afr J Ecol* 43:279–281

- Madaka T (2007) Community vulnerability and adaptation to the impacts of climate variability and extremes in the wetlands, Lake Victoria Basin, Tanzania. M.Sc. dissertation, University of Dar es Salaam, Dar es Salaam, Tanzania
- Madulu NF (1998) Changing lifestyles in farming societies of Sukuma land, Kwimba district, Tanzani. ASC working paper 27, African Studies Centrum, Leiden
- Mashingo MSH (2010) Vulnerability assessment on pastoral livestock and pasture development to the extreme climatic events in Tanzania. Paper presented under the study on economics of climate change in Tanzania Phase 3, at the Stakeholder Inception Round Table Meeting held at the Peacock Hotel, Dar es Salaam, Tanzania, 26 March 2010
- Mdoe N (2009) Coffee and dairying in Kilimanjaro: historical development, income diversification and changes in the livelihoods of the Chagga. In: Clack TAA (ed) Culture, history and identity landscapes of inhabitation in Mount Kilimanjaro area, Tanzania: essays in honour of Paramount Chief Thomas Lenana Mlangi Marealle II (1915–2007). British Archaeological Reports (BAR) International Series 1966, Gordon House, Oxford, England
- Mdoe N, Wiggins S (1997) Returns to smallholder dairying in the Kilimanjaro region. *Tanzania Agric Econ* 17(1):75–87
- Meena HS, Kumar J, Deshmukh PS (2006) Genetic variability and correlation studies for traits related to drought tolerance in chickpea. *Indian J Genet Plant Breed* 66(2):140–142
- Mhita MS (1990) The analysis of rainfall data for agriculture in Tanzania. TMRP research report no. 2/90, Directorate of Meteorology, Dar es Salaam
- Mnenwa R, Maliti E (2010) A comparative analysis of poverty incidence in farming systems of Tanzania. REPOA special paper 10/4, Research on Poverty Alleviation, Dar es Salaam, Tanzania
- Mongi H, Majule AE, Lyimo JG (2010) Vulnerability and adaptation of rainfed agriculture to climate change and variability in semi-arid Tanzania. *Afr J Environ Sci Technol* 4(6):371–381
- Morris M, Butherworth J, Lambo R et al (2003) Understanding household coping strategies in semi-arid Tanzania. Technical report for the DFID's Natural Resources Systems Programme, Natural Resources Institute, UK
- Mpogole H, Mlambiti ME, Kadigi RMJ (2012) Round potato (*Solanum tuberosum*) production in the southern highlands of Tanzania: are smallholder farmers becoming commercial? *J Ext Rural Dev* 4(4):385–391
- Mung'ong'o CG (1998) Coming full circle: agriculture, non-farm activities and the resurgence of out-migration in Njombe district, Tanzania. ASC working paper 26, African Studies Centre, Leiden
- Mwakalobo A, Kashuliza A (1999) Smallholder farming systems in a liberalized market environment in Tanzania: empirical evidence from Mbeya region, Tanzania. Agricultural Economics Society of Tanzania (AGREST) conference proceedings series, vol 2
- Mwandosya MJ (2006) Mainstreaming environment and climate change concerns in natural resource planning in Tanzania. Paper presented at a development and climate change workshop integrated development and climate policies: how to realize benefits at national and international levels? Paris, France, 14–16 June 2006
- Narayan D (1997) Voices of the poor: poverty and social capital in Tanzania. Environmentally and socially sustainable development studies monograph series 20, World Bank, Washington, DC
- Ngaiza RS (2012) Kilimo Kwanza: the declaration of Tanzania's agricultural transformation. Paper presented at FAO Regional workshop on an integrated policy approach to commercializing smallholder maize production, Norfolk Hotel, Nairobi, Kenya, 6–7 June 2012
- Ngana JO (1983) Rainfall and agriculture, drought and famine in Dodoma district. Research report No. 60, new series, Institute of Resource Assessment, University of Dar es Salaam, Dar es Salaam, Tanzania
- Niehof A (2004) The significance of diversification for rural livelihood systems. *Food Policy* 29:321–338
- Norman DW, Simmons EB, Hays HM (1986) Farming systems in the Nigerian savanna: research and strategies for development. Westview Press, Boulder
- Obando J, Ogundo H, Otieno W et al (2010) Reducing vulnerability of pastoralists to climate change and vulnerability in northern Kenya. Paper presented at the international conference on

- climate, sustainability and development in semi-arid regions (ICID), Fortaleza-ceara, Brazil, 16–20 August 2010
- Ogallo IJ (1989) The spatial and temporal patterns of the east African seasonal rainfall derived from principal component analysis. *Int J Climatol* 9:145–167
- Ogallo IJ, Ambenje PG (1996) Monitoring drought in eastern Africa. WMO/TD No. 753, World Meteorological Organization, Geneva
- Olson JM, Misana S, Campbell DJ et al (2004) Spatial patterns and root causes of land use change in east Africa. Land use change, impacts and dynamics project working paper no. 47, International Livestock Research Institute, Nairobi, Kenya
- Paavola J (2008) Livelihoods, vulnerability and adaptation to climate change: lessons from Morogoro. *Tanzania Environ Sci Policy* 11:642–654
- Ponte S (2001) Policy reforms, market failures and input use in African smallholder agriculture. *Eur J Dev Res* 13(2):1–29
- Ponte S (2002) *Farmers and markets in Tanzania*. James Curry, Oxford
- Reardon T (1997) Using evidence of household income diversification to inform study of the rural non-farm labor market in Africa. *World Dev* 25(5):735–748
- Reardon T, Taylor JE, Stamoulis K et al (2000) Effects of non-farm employment on rural income inequality in developing countries: an investment perspective. *J Agric Econ* 51(2):266–288
- Roger PJ (1999) Pastoral resource management institutions in northern Tanzania. Paper prepared for the conference of the International Association for the study of common property, Washington, DC, USA, 17–20 September 1999
- Ruthenberg H (1980) *Farming systems in the tropics*. Clarendon, Oxford, UK
- Schmundt H (2006) Climate research in the death zone: why is Mt. Kilimanjaro melting? Spiegel Online International. <http://www.Spiegel.de/international/Spiegel/0,1518,403034-2,00.html>. Accessed 29 Nov 2013
- Shaner WW, Phillip PF, Schmehl WR (1982) *Farming systems research in development: guidelines for developing countries*. Westview Press, Boulder
- Shilinde JSM, Bee FK (2013) Does domestic trade policy change matter for international price volatility? Empirical evidence from coffee price in Tanzania. *Eur J Bus Manag* 5(25):40–51
- Skarstein R (2005) Economic liberalization and smallholder productivity in Tanzania: from promised success to real future, 1985–1998. *J Agrar Chang* 5(3):334–362
- Soini E (2005) Changing livelihoods on the slopes of Mt. Kilimanjaro, Tanzania: challenges and opportunities in the Chagga home garden system. *Agroforest Syst* 64:157–167
- Staatz JM, Dembele NN (2008) *Agriculture for development in Sub-Saharan Africa*. Background paper for the world development report 2008. World Bank, Washington, DC
- Temu A, Nelson AW, Gaveia P (2001) Market liberalization, vertical integration and price behaviour in Tanzania coffee auction. *Dev Policy Rev* 19:205–222
- Tumbo S, Mutabazi K, Kimambo A et al (2011) Costing and planning of adaptation to climate change in animal agriculture. Tanzania country report submitted to International Institute for Environment and Development (IIED), London, UK
- URT (1998) Tabora region socio-economic profiles. Planning Commission, Dar es Salaam
- URT (2001) *Agricultural Sector Development Strategy (ASDS)*. Government Printer, Dar-es-Salaam
- URT (2006) *Agricultural Sector Development Programme (ASDP)*. Government Printer, Dar-es-Salaam
- URT (2008) *Agricultural marketing policy*. Government Printer, Dar-es-Salaam
- URT (2011) *Tanzania agriculture and food security investment plan (TAFSIP) 2011/12-2020/21*. Final working paper no. 2, Ministry of Agriculture and Food Security, Oct 2011
- Watson RT, Zinyowera MC, Moss RH et al (2006) The regional impacts of climate change: an assessment of vulnerability. IPCC special report. <http://www.grida.no/climate/ipcc/regional/index.html>. Accessed 23 Nov 2013
- World Bank (1994) *Tanzania agricultural sector memorandum volume II: main report*, 29 July 1994
- World Bank (2000) *Agriculture in Tanzania since 1986: follower or leader of growth? A World Bank country study*. World Bank, Washington, DC

# Chapter 30

## Carbon Market Impacts on Farm Management Practices on Mount Kilimanjaro

Francis Mulangu and David Kraybill

**Abstract** Soil carbon sequestration projects have been promoted as a win-win strategy for agriculture in Africa to curb the global emission of greenhouse gases (GHG). Agriculture accounts for an estimated 10–14 % of total GHG emissions, so it has the potential of playing an important role in mitigating global warming. The large gap between soil maximum carbon sink capacity and current carbon stock levels could allow carbon sequestration projects to sequester more carbon while rapidly improving agricultural productivity and food security. This paper approximates the marginal cost of soil carbon sequestration and analyzes its implications for food security using the case of Mt. Kilimanjaro in Tanzania. We develop and calibrate a dynamic optimization model that maximizes the Net Present Value (NPV) of farm profit by allowing the farmer to choose optimal farm management practices subject to crop yield, soil carbon stock, and carbon price. The model is then simulated using various carbon prices to measure their impact on farm management choices. The results show farmer responsiveness to carbon prices but the resulting change in farm productivity is relatively modest.

**Keywords** Soil carbon market • Land tenure • Mount Kilimanjaro • Modeling • CMD • Cost-benefit analysis • Century model • Net present value

### 30.1 Introduction

Agricultural GDP growth in sub-Saharan Africa (SSA) averaged from 2.3 % per year in the 1980s, lower than the average annual population growth rate, to 3.8 % per year from 2000 to 2005, but this growth has been based mostly on area expansion (World Bank 2008). As land becomes scarcer as the population grows, many countries face limits to further expansion. Land degradation, low and

---

F. Mulangu (✉)

African Center for Economic Transformation, Accra, Ghana

e-mail: [mulangu@gmail.com](mailto:mulangu@gmail.com)

D. Kraybill

AEDE/CFAES, The Ohio State University, Columbus, OH, USA



declining agricultural productivity, and poverty are pressing problems in much of SSA especially given that 98 % of Africa's calories come directly from land (Jones et al. 2013). In this context, efficient and sustainable land management (SLM) practices such as conservation agriculture (CA) have been proposed as solutions for addressing poverty in the presence of limited resources (World Bank 2006).

Land degradation is a cause and consequence of rural poverty in Africa, requiring both public and private investments to reverse the downward trend in soil fertility and to avoid a downward spiral of living standards. Public spending on agriculture, if appropriately directed, can help reduce land degradation. Historically, public agricultural spending in Africa has been very low compared with that of other developing regions. Agricultural expenditure in Africa constituted only 5 % of government expenditure in 2004, despite the fact that it increased by an annual rate of 3.4 % between 1980 and 2004. During that same period, the rural population grew by about 1 % per year and agricultural GDP by 4.2 % annually (Fan et al. 2009). As a result, agricultural expenditure per rural household increased only slightly, while expenditure per unit of agricultural GDP decreased. In 2003, the initiators of the Comprehensive Africa Agriculture Development Program (CAADP) understood this trend and sought to address it by getting SSA countries to pledge to increase government support to agriculture in order to achieve the goal of 6 % annual agricultural growth. To expedite the attainment of this goal, African heads of state were urged to increase public agricultural spending to at least 10 % of national budgets.

African governments operate in an environment of scarce public resources and, so far, only Burkina Faso, Ethiopia, Mali, and Malawi have met these growth and spending targets. Limited budgets, which are in part externally supported, make it difficult for SSA governments to meet the CAADP targets. While the growing land constraint is putting more pressure on policy makers to invest to improve land productivity, tighter budgets are preventing them from allocating the financial resources required to address food security—effectively, a dual constraint.

The emerging market for environmental services has given SSA countries a rare opportunity to finance their agricultural growth agenda in a way that incentivizes smallholder farmers to adopt conservation agriculture. This approach to agriculture can contribute to solving the dual constraint problem. It facilitates soil restoration, improves productivity and food security, and generates “green” revenue by trading the resulting sequestered soil carbon (Lal 2004). However, this strategy, as good as it may sound, is faced with technical and financial challenges. This chapter discusses these challenges with the goal of proposing effective policy recommendations using the case of Mt Kilimanjaro.

We have three objectives. First, we seek to determine the extent to which Mt. Kilimanjaro's smallholder farmers would respond to the introduction of a carbon market. Second, we identify the optimal per-ton and per-hectare price that would encourage farmers to switch to CA. Third, we determine the impact of improved soil carbon levels on food security, measured by change in average agricultural yields. To address these objectives, we combine soil biophysical and farm level economic inputs and outputs to develop a dynamic model of agricultural

carbon sequestration. Considering the fact that farmers are forward looking and the complexity of the farm profit function, we use a Markov decision model where the farmer maximizes the non-linear net present value (NPV) of per-hectare farm profit by choosing optimal farm management practices, subject to crop yield, soil carbon stock, and carbon price. The results show that a carbon market is viable on Mt. Kilimanjaro, and carbon accumulation resulting from higher carbon prices will modestly enhance food security.

## 30.2 Literature Review

Seeking to determine whether traditional smallholder farmers have the capacity to sequester carbon efficiently enough to participate in CDM carbon projects, González-Estrada et al. (2008) simulated 48 different farm management systems over a period of 20 years in Northern Ghana. The researchers focused on two crops: maize and groundnuts. They simulated the potential carbon sequestration of each management practice using a bio-geochemical model called Century. Later, to determine whether smallholders are able to carry out CA without jeopardizing other economic activities, the authors estimated the NPV of farm revenues, including the cost of each farm management practice.

Tschakert (2004) presents a ‘farmer centered’ ex ante cost-benefit analysis of 15 farm management and land use options combined with a household budget model to assess the economic feasibility of CA practices for Old Peanut Basin farmers in Senegal. Unlike the study of González-Estrada et al. (2008), Tschakert’s analysis includes detailed land use practices and all of the crop types grown in the Old Peanut Basin. Tschakert (2004) simulates the various farm management practices over a period of 25 years using the Century model and later simulates the NPV of the different farm management practices to make inferences about their profitability.

Unlike the previous two articles discussed above, Graff-Zivin and Lipper (2008) derive comparative static results for equilibrium soil carbon levels as a function of the price of carbon, the price of agricultural output, the discount rate, the coefficient of risk aversion, and land quality, respectively. They first developed a Hamiltonian model that describes the expected utility of the farmer from engaging in both agricultural production and soil carbon sequestration. The Hamiltonian model is composed of a farm revenue function, a risk variable, carbon payment, and a conservation agriculture cost variable. The model assumes that the objective of the farmer is to choose optimal carbon sequestration activities to maximize expected utility, subject to the equation of motion for soil carbon growth.

Unlike previous studies, the present study introduces a carbon payment option to derive explicit policy implications for agriculture on Mt. Kilimanjaro. This valuation approach can help policy makers to effectively evaluate the cost of climate change mitigation. Choi and Sohngen (2010) also introduce a carbon payment option in a dynamic model of agricultural soil carbon sequestration using the case

of three US Midwestern States (Illinois, Indiana, and Ohio). Their model simulates farmers' crop choices, residue management choices, and fertilizer input choices. Instead of simulating each of the decisions farmers make, the present study combines all farming decisions into an agronomic index that ranks farm management practices based on their combined ability to sequester carbon. This general approach makes the study easily replicable and the results easily comparable anywhere there is high heterogeneity in the farm management practices used by farmers, as is the case in Africa. This study presents evidence of the relationship between soil carbon levels and food security. We show how carbon incentives could be used to change farm management decisions that improve soil quality and crop yields.

### 30.3 Implementation Challenges

Despite the various opportunities associated with CA as illustrated by the empirical evidence, translating them into reality can be very challenging in the African context. This sub-section summarizes some of these challenges.

- **Lack of Formal Soil Carbon Market** Soil carbon is traded in voluntary markets where its price is uncertain and the sustainability of the market is questionable. The Clean Development Mechanism (CDM) has not yet allowed carbon sequestered from agricultural activities in its protocols, making it difficult for African farmers to participate in the trading of soil carbon. There is a volunteer market funded by a World Bank fund. However, that fund and all other existing soil carbon compensation arrangements offer farmers low payments.
- **Insecure Land Tenure** Access to land is often cited as one of the key constraints to green growth. The situation varies by country depending on local land policies but may involve protracted negotiation with local traditional leaders, who may or may not represent local community interests. More often, large land transactions are mediated through government agencies using non-transparent processes that neglect local rights and enable corruption. Consequently, large-scale agricultural investments in Africa have too often failed and damaged communities and the environment (World Bank 2013). At the smallholder level, it is often argued that outdated and dysfunctional land tenure systems discourage farmers from investing in their land. As land is regarded as a public good in some communities, problems associated with the provision of public goods become prevalent and undermine the potential value land could generate.
- **Low CA Adoption Rate by Smallholder Farmers** In general, farmers' rates of adoption of soil and water conservation in Africa are low (Ajayi 2007). Though national land-use policies, agricultural research, and extension programs can influence adoption of soil and water conservation indirectly, the main deterrent to adoption of conservation is a set of economic and social constraints that cannot readily be eliminated by law and regulations. Therefore it is important

to understand these constraints and how they can be influenced to facilitate adoption. One of the most important constraints is that the yield benefits of CA may not be visible in the first few years of adoption. This is because it takes time for organic matter to build up in the soil.

- **Increased Vulnerability of Agriculture Due to Climate Change** As explained earlier on, climate change threatens to hinder the growth and development of agriculture. Further increases in global temperature are likely to have a detrimental effect on the productivity of crop agriculture in SSA, and this effect is compounded by widespread poverty which limits farmers' resilience to climate change. The increasing weather uncertainties could make agriculture impractical in some places in SSA as rainfall becomes more erratic and unpredictable. Areas with advanced degradation will become even less conducive for agriculture and, therefore, practicing CA in some of those areas may not be feasible. For example, Mulangu and Kraybill (2013) found that coffee and plantain production on the slopes of Mount Kilimanjaro is becoming less attractive.

### 30.4 Agriculture on Mt. Kilimanjaro

Seasonal rainfall distribution influences agricultural practices on Mt. Kilimanjaro. In the Kilimanjaro region, the year can be divided into four seasons. There are two rainy seasons, a long one March through May and a short one October through December; and two dry seasons, a short one in January and February and a long one June through September. There is marked variation in the amount of rainfall according to the altitude and the direction of the slope in mountainous areas. The mean annual rainfall varies from 500 mm in the lowlands to over 2,000 mm in the mountainous areas (over 1,600 m above sea level). Temperatures are closely related to altitude. During the rains, clouds and evaporative cooling tend to reduce maximum temperatures. The hot season lasts from October through March with high humidity and temperatures as high as 40 °C in the lowlands. In the mountainous areas, temperatures range from about 15 through 30 °C (URT 1998, 2002).

In general, home parcels of Mt. Kilimanjaro farmers are characterized by an intensive integration of numerous multipurpose trees and shrubs with food crops, cash crops, and animals simultaneously on the same unit of land. This farming system enables farmers to obtain sustained production with minimum external inputs. The multipurpose trees are used for shade, for coffee, fences for parcels, fodder, and mulching from leaves. The main food crops produced are bananas, beans, maize, cowpeas, sweet potatoes, and tomatoes. The main cash crop is Arabica coffee. The land fertility level is enhanced by volcanic soil, which contains a high base saturation and cation exchange capacity (Fernandes et al. 1985). The steep slopes require intense erosion control to reduce soil loss from torrential rains. Farmers have adopted multiple strategies to improve soil productivity and control erosion. Our survey conducted in the region revealed that 46 % of farmers practiced contour bunding, 28 % practiced terracing, and 57 % practiced mulching on their home parcels.

Irrigation is an important part of Mt. Kilimanjaro’s agriculture. Most, though not all, farm households have access to irrigation water. Other sources of water for agriculture are rainfall and run-off from the forest reserve above the zone of human habitation on the mountain. According to our survey, 44 % of home parcels on the southern and eastern slopes are connected to a network of traditional irrigation canals that lace the mountain. Most of these parcels are located on the southern slope of the mountain.

### 30.5 Modeling Procedures

We develop a model of soil carbon sequestration where the farmer chooses optimal farm management to maximize per-hectare farm profit. Let agricultural yield per hectare at a given period be:

$$y_t = f(x_{it}) + h(x_{it}, s_t) \tag{30.1}$$

where  $x_{it}$  is a discrete variable representing a farm management choice in period  $t$ , and  $s_t$  is the stock of carbon in the soil in period  $t$ . Farm management choices include  $i$  such that  $i \in \{1, \dots, I\}$ , where CA is considered an improved farm management practice. Expected yield,  $f(x_{it})$ , is non-linear and assumed to be increasing at a decreasing rate in  $x_{it}$ . Yield vulnerability to weather,  $h(x_{it}, s_t)$ , is also non-linear and assumed to be decreasing in  $x_{it}$  and  $s_t$ . For an agricultural price of  $p_y$ , per hectare profit is expressed as:

$$\prod_t = p_y y_t - c(x_{it}) - K \tag{30.2}$$

where  $c(x_{it})$  is the cost of activity  $i$  per hectare in period  $t$ , and  $K$  is a fixed land rental rate per hectare. We assume that  $c(x_{it})$  follows a quadratic functional form such that  $c(x_{it}) = \rho_1 x_{it} + \rho_2 x_{it}^2$ . Every period, the farmer chooses the optimal level of  $x_{it}$  given previous period soil carbon stock,  $s_{t-1}$ , and farm yield,  $y_{t-1}$ . The carbon accumulation rate function is such that:

$$\dot{s} = g(x_{it}, \bar{s}) \tag{30.3}$$

The carbon accumulation rate function is dependent on a farmer’s choice of  $x_{it}$  and initial carbon stock  $\bar{s}$ . The value of the farm in period  $t$ , given soil organic carbon  $s_t$  and farm yield  $y_t$ , satisfies the Bellman equation such that:

$$V_t(s_t, y_t) = \max_{x_{it}} \{ \Pi_t + \delta EV_{t+1}(g(x_{it}, \bar{s}), y_t) \} \tag{30.4}$$

$V_t(s_t, y_t)$  denotes the maximum attainable sum of current and expected future farm profits, given that the economic process is in states  $s_t$  and  $y_t$  in period  $t$ , and

discount rate  $\delta$ . The state variables are stock of carbon in the soil and farm yield while the action variable is  $x_{it}$ , where the latter represents discrete farm management choices.

We assume that  $g(x_{it}, \bar{s})$  represents a diminishing marginal accumulation rate regime. In other words, at time  $T$ , the soil carbon stock reaches a new level, referred to as the “attainable maximum” by Ingram and Fernandes (2001), at which the level of soil carbon stabilizes until further changes in  $x_{it}$  occur. In mathematical terms,  $g(x_{it}, \bar{s})$  follows a logistic functional form, implying that as more carbon is sequestered in a particular soil, the less the soil becomes able to absorb additional carbon (Antle et al. 2003).

To propose effective policy recommendations, we numerically approximate a solution to the Bellman equation presented in Eq. (30.4) at various exogenous carbon price levels using the method of collocation. This is achieved by writing the value function approximant as a linear combination of  $n$  known basis functions whose coefficients are to be determined. Then, we fix the basis function coefficients by requiring that the value function approximant satisfy the Bellman equation (30.4). This will not happen at all of the possible states, but rather, at the  $n$  collocation nodes (Miranda and Fackler 2002). A detailed discussion of the collocation method is provided in the annex. Once the collocation equation has been solved, residuals from the collocation equation are used to verify that the approximation errors are minimal across the entire domain of the value function.

To acquire the parameters to calibrate the production function presented in Eq. (30.1), an empirical production function is estimated. A Cobb-Douglas functional form is used to estimate the coefficient representing the marginal effect of carbon stock on crop yield, following Kasozi et al. (2005). Conceptually, the Cobb-Douglas model is specified as follows:

$$y = AC^\alpha [I^\beta]^\alpha \quad (30.5)$$

where

$y$  = cereal yield in kg/ha

$C$  = organic soil carbon in metric tons

$A$  = technology parameter

$I$  = vector of other production inputs

$\alpha$  and  $\beta$  are coefficients to be estimated.

The above production function is estimated using a weighted sum of cereal yield. The rest of the inputs used to calibrate Eq. (30.4) were taken from a survey conducted by the authors on Mt. Kilimanjaro. The Kilimanjaro Livelihood and Climate Survey (KLCS) project was funded by the Ohio State University Climate, Water, and Carbon (CWC) program. It started in September of 2008 and ended in November 2010. The project collected household level data on agricultural production, household socio-economic characteristics, and geographical

**Table 30.1** Management systems that affect soil organic matter levels from most ameliorative (assigned a value of 100) to the most degraded (assigned a value of 10)

Value	Farm management description
100	Improved permanent pastures with animal grazing
90	No-tillage rotation with row crops alternating with legumes and soil treated with manure
80	No-tillage with continuous row crops and manure additions
70	Conservation tillage with long rotation sequences that include green manures and animal manures
60	Plough tillage with rotation sequences that include green manures and animal manures
50	No-tillage with grains and residue harvested
40	Conservation tillage with continuous row crops
30	Intensive tillage with continuous row crops
20	Intensive tillage with continuous row crops on sloping lands
10	Intensive tillage with fallow in alternate years with little nutrient input

Source: Dick and Gregorich (2004)

coordinates of each household's location. The project also collected village level climatic and biophysical data such as rainfall and soil samples. Specifically, the project surveyed 15 villages where 15 households were randomly chosen in each village to make up a sample size of 225 respondents.

Farm management choices summarized by Dick and Gregorich (2004) are presented in Table 30.1. Using agronomic evidence, the table ranks the various farm management practices by their ability to aggregate soil organic matter. For this exercise, we consider values below 50 conventional farm management practices and values of 50 and above we consider CA practices.

The model used here is a discrete choice one where the farmer can choose any of the ten possible farm management practices such that the higher value options are considered CA practices. The farmer's choice of any of the above mentioned farm management practices will affect the rate of carbon accumulation in the soil. Improved farm management practices have the potential of sequestering relatively higher quantities of carbon. The difference in carbon accumulation rate of the various farm management practices is assumed to be uniform across farm management practices. The model is designed to take account of the above assumptions and to restrict the farmer's choice to be bounded between 10 and 100. This generalization allows the model to present a relative assessment as opposed to an absolute assessment of a farmer's responsiveness to the various carbon price incentives by changing their farm management practices. Maximum carbon sink capacity, which is the carbon soil stock under natural vegetation condition, is assumed to be around 250 Mg ha<sup>-1</sup> and is close to the maximum sink capacity in East Africa, as estimated by Lemenih and Itanna (2004).

## 30.6 Results

We first estimated a benchmark model where the farmer maximizes per hectare farm profit by choosing optimal farm management practices based on the choices presented in Table 30.1. By simulating accumulated carbon stock over a 30-year time horizon, we established a farmer's benchmark carbon level. The farm management choice made by the farmer in the benchmark is  $x_{it} = 10$ , where the farmer implements a system of intensive tillage with fallow in alternate years with little nutrient input.

A carbon contract is then introduced, such that farmers are paid for maintaining carbon stocks above the benchmark steady state carbon level,  $\hat{s}$ , and get the carbon level closer to maximum economic sink capacity. Carbon prices of \$2, \$5, \$10, \$20, \$30, and \$40 per metric ton are arbitrarily chosen to approximate accumulated soil carbon stock, given a 30 year time horizon. The goal is to identify the carbon price that will encourage the farmer to switch to CA, where  $x_{it} \geq 50$ . By letting  $p_c$  be carbon price, Eq. 30.2 becomes:

$$\Pi = p_y y_t - c(x_{it}) + p_c * \max(s_t - \hat{s}, 0) - K \quad (30.6)$$

At a price of \$2 per metric ton of carbon, the farm management decision does not change due to the insufficient payment incentive. The optimal farm management practice stays the same at  $x_{it} = 10$ . Farmers on Mt. Kilimanjaro and elsewhere in Africa have been reluctant to adopt CA because of insufficient incentives as shown here for the case of \$2 (Kraybill 2010). Therefore, it is important to get the carbon price right because low carbon prices may bring about negligible changes in farm management practices, though the payment may be enough to influence the rate of accumulated carbon stock. The latter may change because of marginal reduction of soil disturbance caused by the fencing of the parcel with the extra cash received. This involves no change in farm management practice, but an investment that will indirectly affect carbon accumulation rate. As carbon price increases to \$5 per metric tons of carbon, the optimal farm management practice becomes  $x_{it} = 20$ , which is an implementation of intensive tillage with continuous row crops on sloping lands.

At a price of \$10 per metric ton of carbon, the optimal farm management decision changes to  $x_{it} = 30$ , where the farmer implements intensive tillage with continuous row crops with terracing to preserve the topsoil. Although the farmer has applied some conservation practices at this point, the implementation of heavy tillage still makes  $x_{it} = 30$  a non-CA management practice. At a price of \$20 per metric tons of carbon, the optimal farm management becomes  $x_{it} = 50$ , which is a system of no-tillage with grains and residue harvested. At  $x_{it} = 30$  and above, the farm management choices are considered CA because tillage intensity is the farm management activity that affects soil organic matter levels the most. However, farmers are reluctant to adopt it at lower carbon price because absence of tillage reduces yields in the first few years after its adoption, such that it will require a larger payment to incentivise farmers to adopt it.



At a price of \$30 per metric ton of carbon, the optimal farm management becomes  $x_{it} = 70$ , a system that includes conservation tillage with long rotation sequences that include green manures and animal manures. An important contribution of green leguminous manure to an agricultural field is nitrogen fixing, which increases nitrogen accumulation in the soil. Green manure crops are also useful for erosion prevention and reduction of insect pests and diseases. In addition, the deep rooting properties of many green manure crops make them efficient at suppressing weeds. This low cost, high maintenance strategy increases crop yields because of its dual role as fertilizer and pesticide. Finally, at a price of \$40 per metric ton of carbon, the farmer will optimally choose  $x_{it} = 90$ , which is no-tillage rotation with row crops alternating with legumes and soil treated with manure. Beyond a price of \$40, the optimal farm management is  $x_{it} = 100$ , where farmers will implement improved permanent pastures with animal grazing. However, carbon will be accumulated at the same rate regardless of the carbon price because the maximum economic sink capacity has already been attained.

The results reveal the optimal farm management practices that simultaneously maximize farm profit and soil carbon sequestration at various exogenous carbon prices. The results can be used to ascertain the feasibility of carbon sequestration contracts for Mt. Kilimanjaro. This is demonstrated by the difference in steady-state carbon accumulation rates at the various carbon prices. Table 30.2 below presents the marginal cost of sequestering carbon and the cumulative carbon gain by 2040 at various carbon prices.

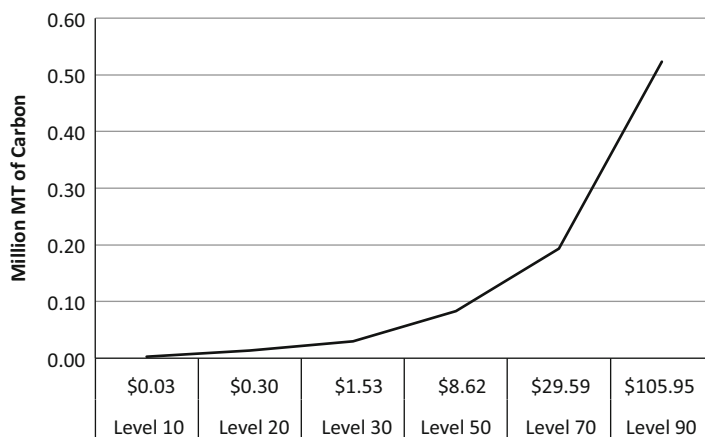
With an average of 1.5 ha of farmland per household, we calculated the potential soil carbon gain at the various carbon prices on Mt. Kilimanjaro. The results presented in Table 30.2 imply that Mt. Kilimanjaro can sequester between 0.002 (=0.08/30 years) and 0.5 (=15.72/30 years) million metric tons of carbon per year at a carbon price varying between \$2 and \$40 per metric ton.

The analysis above revealed that at a price of \$20 per metric ton of carbon, Mt. Kilimanjaro farmers would switch from the conventional agricultural system to CA. To identify the per-hectare price that will incentivize farmers to convert to  $x_{it} = 50$  we multiplied the per-year accumulated carbon stock by \$20 and divided it by the total agricultural area of Mt. Kilimanjaro. Presented in Fig. 30.1, at \$8.62 per hectare, 85,000 metric tons of carbon could be sequestered per year. This carbon

**Table 30.2** Carbon gains and cost estimates for Mt. Kilimanjaro

Carbon price (\$/t C)	Marginal cost (\$/t hectare)	Cumulative C gain by 2040 (millions of t C)	Farm management category
\$2	\$0.03	0.08	10
\$5	\$0.30	0.4	20
\$10	\$1.53	0.9	30
\$20	\$8.62	2.5	50
\$30	\$29.59	5.8	70
\$40	\$105.95	15.7	90

Source: Authors' estimates



**Fig. 30.1** The marginal cost curve of sequestering organic soil carbon on Mt. Kilimanjaro. Source: Authors' estimates. On the y-axis, we have average annual C gained in millions of tons, and on the x-axis, optimal farm management choice associated with the marginal cost

**Table 30.3** Carbon sequestration and food security

Carbon price	Farm management category	Change in yield (%)
\$2	10	+0.03
\$5	20	+0.12
\$10	30	+0.33
\$20	50	+0.95
\$30	70	+2.21
\$40	90	+5.93

Source: Authors' estimates

sequestration would come about because farmers would find it optimal to practice no-tillage with grains and residues harvested. At \$8.62 per hectare, Mt. Kilimanjaro farmers could receive about \$1.7 million (total acreage times \$8.62) per year for their provision of environmental services.

Improving food security is one of the reasons why smallholder farmers are encouraged to adopt CA. This improvement will occur because higher carbon levels ameliorate soil structure, enrich it, and subsequently increase yields. To measure the impact of the change in carbon levels on food security, we calibrated Eq. 30.2 with the new steady state carbon levels at various prices and compared it to the benchmark. The results, presented in Table 30.3, show that an increase in carbon levels will improve yields. Specifically, a \$2, \$5, \$10, \$20, \$30, and \$40 carbon price will increase yields by 0.03 %, 0.12 %, 0.33 %, 0.95 %, 2.21 %, and 5.93 %, respectively.

## 30.7 Conclusion

This chapter developed a dynamic carbon sequestration model for Mt. Kilimanjaro farmers. The model used farm management practices as the action variable and farm yield and soil carbon stock as the state variables to identify optimal farm management practices associated with various carbon prices. The model is solved using a collocation method which includes a numerical approximation approach that solves the model using the Newton method.

The study produced three important policy-relevant results. We first ascertained the potential for economically viable soil carbon sequestration contracts on Mt. Kilimanjaro. This was demonstrated by showing how carbon sink capacity changes at various carbon prices. Second, we estimated the marginal cost of sequestering carbon on Mt. Kilimanjaro. This was done by comparing carbon sink capacity of various prices to the benchmark economic carbon sink capacity using a 30-year simulation. We conclude that Mt. Kilimanjaro's farmers would adopt CA at a carbon price of around \$20 per metric ton (\$8.62 per hectare). Last, we showed how these incentives can improve food security by drawing upon the relationship between crop yield and soil carbon level and found that the food security impact of CA is positive but modest.

The success of CA in Africa is related to household socioeconomic factors (Kraybill 2010). For example, promoting higher soil residue cover must take into account that this recommendation may push low-income farmers to reallocate the residues away from animal feed to soil cover. Not accounting for this and other trade-off decisions that implementation of CA will lead farmers to make may undermine the effectiveness of CA. In addition, although the prescribed CA may be effective in sequestering carbon, it is important to insure the existence of proper land tenure laws as they are major determinants of farmers' land investment decisions. Adoption of CA is influenced by land tenure laws, gender relations within the household, availability of credit, and other institutional factors.

For future research, we intend to improve the biological aspects of the modeling by combining an economic model of farm profitability with a model of soil organic matter. This combination will provide a sounder basis for assumptions concerning the carbon rate of growth. Second, introducing a stochastic weather variable could further help us determine the extent to which climate change could affect the effectiveness of any CA strategies. Third, the cost figures discussed in this paper apply to Mt. Kilimanjaro but may not be relevant for other regions. Expanding the analysis to various agro-ecological zones in different regions of Africa would further the policy debate related to the cost of soil carbon sequestration.

## Annex: The Collocation Method

The dynamic model is estimated using the collocation method which we will derive here in three steps. First, after specifying reward and transition functions  $f(c_1, \dots, c_n; s_1, \dots, s_n)$  and  $g(c_1, \dots, c_n; s_1, \dots, s_n; \epsilon_t)$ , we approximate the value function (30.A1) as a linear combination of cubic spline basis functions,  $\phi_1, \dots, \phi_n$ , whose coefficients,  $x_1, \dots, x_n$ , will be determined:

$$V(s) = \max_{\{c_1, \dots, c_n\} \in X(s)} \left\{ f(c_1, \dots, c_n; s_1, \dots, s_n) + \delta EV(g(c_1, \dots, c_n; s_1, \dots, s_n)) \right\} \quad (30.A1)$$

where  $c_1, \dots, c_n$  are action variables and  $s_1, \dots, s_n$  are exogenous state variables.

$$V(s) \approx \sum_{j=1}^n x_j \phi_j(s) \quad (30.A2)$$

Second, we fix the coefficients  $x_1, \dots, x_n$  of the approximant by requiring them to satisfy the value function  $V(s)$ , not at all possible states but at some judiciously chosen state nodes. The collocation method replaces the Bellman functional Eq. (30.A1) with a system of  $n$  nonlinear equations with  $n$  unknowns, shown in Eq. (30.A3).

$$\sum_{j=1}^n x_j \phi_j(s_i) = \max_{\{c_1, \dots, c_n\} \in C(s)} \left\{ f(c_1, \dots, c_n; s_1, \dots, s_n) + \delta E \sum_{j=1}^n x_j \phi_j(g(c_1, \dots, c_n; s_1, \dots, s_n)) \right\} \quad (30.A3)$$

Third, the initial two steps allow us to replace the initially hard-to-solve Bellman equation (30.4) with a collocation Eq. (30.A3) that can be solved easily using numerical methods such as the Newton method for solving non-linear systems equations.

## References

- Ajayi OC (2007) User acceptability of soil fertility management technologies: lessons from farmers' knowledge, attitude and practices in southern Africa. *J Sustain Agric* 30(3):21–40
- Antle JM, Capalbo SM, Mooney S, Elliott ET, Paustian KH (2003) Spatial heterogeneity, contract design, and the efficiency of carbon sequestration policies for agriculture. *J Environ Econ Manag* 46:231–250
- Choi SW, Sohngen B (2010) The optimal choice of residue management, crop rotations, and cost of carbon sequestration: empirical results in the Midwest US. *Clim Change* 99(1–2):279–294

- Dick WA, Gregorich EG (2004) Developing and maintaining soil organic matter levels. In: Schjonning P, Elmholt S, Christensen BT (eds) *Managing soil quality: challenges in modern agriculture*. CABI Publishing, Cambridge
- Fan S, Mogues, Benin S (2009) Setting priorities for public spending for agricultural and rural development in Africa. International Food Policy Research Institute, Washington, DC, [Policy Brief No. 12](#)
- Fernandes EC, Oktingati A, Maghembe J (1985) The Chagga homegardens: a multistoried agroforestry cropping system in Mt Kilimanjaro (Northern Tanzania). *Agrofor Syst* 2:73–86
- González-Estrada E, Rodríguez LC, Walen VK, Naab JB, Koo J, Jones JW, Herrero M, Thornton PK (2008) Carbon sequestration and farm income in West Africa: identifying best management practices for smallholder agricultural systems in Northern Ghana. *Ecol Econ* 67:492–502
- Graff-Zivin J, Lipper L (2008) Poverty, risk, and the supply of soil carbon sequestration. *Environ Dev Econ* 13:353–373
- Ingram JSI, Fernandes ECM (2001) Managing carbon sequestration in soils: concepts and terminologies. *Agric Ecosyst Environ* 87:111–117
- Jones A, Breuning-Madsen H, Brossard M, Dampha A, Deckers J, Dewitte O et al (2013) *Soil Atlas of Africa*. European Commission, Publications Office of the European Union, Luxembourg
- Kasozi SM, Bashaasha B, Ochwoh V (2005) Economics of sorghum production and soil fertility management in Kabale highlands, Uganda. *J Food Agric Environ* 3(3&4):105–109
- Kraybill DS (2010) Climate change and natural resources management in Sub-Saharan Africa. In: Napier T (ed) *Human dimensions of soil and water conservation: a global perspective*. Nova Science Publishers, Hauppauge, pp 275–286
- Lal R (2004) Soil carbon sequestration impacts on global climate change and food security. *Science* 304:1623–1627
- Lemenih M, Itanna F (2004) Soil carbon stocks and turnovers in various vegetation types and arable lands along an elevation gradient in southern Ethiopia. *Geoderma* 123:177–188
- Miranda MJ, Fackler PL (2002) *Applied computational economics and finance*. MIT Press, Cambridge, MA
- Mulangu F, Kraybill D (2013) Climate change and the future of mountain farming on Mt. Kilimanjaro. In: Mann S (ed) *The future of mountain agriculture*. Springer, Berlin
- Tschakert P (2004) The costs of soil carbon sequestration: an economic analysis for small-scale farming systems in Senegal. *Agr Syst* 81:227–253
- United Republic of Tanzania (URT) Planning Commission (1998) *Kilimanjaro region socio-economic profile*. Government Printers, Dar es Salaam
- United Republic of Tanzania (URT) Planning Commission (2002) *Kilimanjaro region socio-economic profile*. Government Printers, Dar es Salaam
- World Bank (2006) *Sustainable land management: challenges, opportunities, and trade-offs*. World Bank, Washington, DC
- World Bank (2008) *World development report 2008: agriculture for development*. World Bank, Washington, DC
- World Bank (2013) *Growing Africa: unlocking the potential of agribusiness*. World Bank, Washington, DC

# Chapter 31

## Adaptation to Climate Change: Changing Gender Relations in the Meatu and Iramba Districts in Tanzania

C.I. Nombo, S.J. Kabote, D.P. Mamiro, G. Synnevåg, A.Z. Mattee, J.K. Urassa, and L. Matata

**Abstract** Neither the impacts of climate change on people nor the ways in which people respond to climate change are gender neutral. Important gender differences exist regarding the implications of climate change for the lives of females and males of all ages. Gender inequalities and gender roles play a key role in determining the choice of adaptation strategies of both men and women. They may ultimately lead to changing gender relations. The amount of research and documentation on existing coping and adaptation strategies has increased, but rarely are these findings differentiated along gender lines, and they frequently fail to describe how adaptive strategies cause changes in gender relations. Using qualitative data from the Meatu and Iramba Districts in Tanzania, this study examined changes in gender relations in response to climate change. Findings show that men and women react differently to climate change, leading to changes in gender roles and relations to accommodate the impact of the phenomenon. The impacts of climate change are changing gender relations, which can be to the advantage or disadvantage of either gender category. However, it was found that changes in gender relations had more disadvantages for women than for men. Adaptation strategies utilized by both men and women have positive and negative outcomes, which either challenge or reinforce existing gender inequality.

**Keywords** Climate change • Adaptation • Gender relations

---

C.I. Nombo (✉) • S.J. Kabote • A.Z. Mattee • J.K. Urassa  
Sokoine University of Agriculture, Development Studies Institute, P. O. Box 3024,  
Morogoro, Tanzania  
e-mail: [cnombo@suanet.ac.tz](mailto:cnombo@suanet.ac.tz); [cnombo@yahoo.com](mailto:cnombo@yahoo.com); [nombo@iagri.org](mailto:nombo@iagri.org)

D.P. Mamiro  
Department of Crop Science and Production, Sokoine University of Agriculture,  
P. O. Box 3005, Morogoro, Tanzania

G. Synnevåg  
Department of International Environment and Development Studies/Noragric, Norwegian  
University of Life Sciences, Noragric, P. O. Box 5003 NO-1432, As, Norway

L. Matata  
Tumbi Agricultural Research Institute, P. O. Box 306, Tumbi, Tabora, Tanzania

## 31.1 Introduction

Climate change impacts and adaptation are not happening in a vacuum. Rather, they are contextual (Terry 2009). Climate change and adaptation are frequently viewed as purely scientific and technical phenomena, and yet climate change is also a social, economic, and political phenomenon with profound implications for social justice and gender equality (Skinner 2011). Neither the impacts of climate change on people nor the ways in which people respond to climate change are gender neutral. Gender inequalities and different gender roles, needs, and preferences vary over space and over time. They influence the ways in which young, adult, and elderly males and females experience the impacts of climate change and develop adaptation strategies or mitigation. Across Africa and worldwide, the recognition that men and women experience differential vulnerabilities—and what this means for effective climate change adaptation interventions—has been widely documented (FAO 2009; UNDP 2009; World Bank, FAO, and IFAD 2009).

Adaptation can be defined as adjustments in natural or human systems in response to actual or expected climatic stimuli or their effects and in order to reduce harmful consequences or to exploit beneficial opportunities. Various types of adaptation can be identified, including anticipatory, autonomous, and planned adaptations (IPCC 2007). Adapting to the weather and climate is a characteristic of all human societies, but climate change is presenting new and increasing challenges. Tanzania, in its National Adaptation Programme of Action (NAPA) of 2007, identifies climate change and variability as one of the pressing issues threatening everyone and national development in general (URT 2007). Nonetheless, different socioeconomic groups including women are impacted differently by the phenomenon. Women constitute 70–80 % of the world's farmers and those living below the poverty line (FAO 2007). Therefore, women and other vulnerable groups are most likely to bear the heaviest burdens of climate change impacts and are often the first to suffer whenever there is an external shock that affects livelihoods (Brody et al. 2008). Women and men in rural areas in developing countries, who are highly dependent on local natural resources for their livelihoods, are especially vulnerable. Women responsible for securing water, food, and fuel for cooking and heating face the greatest challenges. When rural women have unequal access to resources and to decision-making processes as well as limited mobility, they are disproportionately affected by climate change (Terry 2009; Otzelberger 2011). Therefore, climate change tends to exacerbate preexisting gender inequalities, especially those related to women's access to and control of resources and decision-making power. This makes poor women particularly more vulnerable to its effects and prevents them from participating equally in solutions to the problem.

Climate change primary impacts are being experienced as changes of weather patterns. Thus, farmers and rural dwellers, many of whom are women, are searching for new ways to respond to the impacts. Although women and men are victims of climate change, they can also be effective agents of change in relation to both mitigation and adaptation. According to WEDO (2007), women can be key agents

of adaptation to and mitigation of climate change. Their responsibilities within households and communities and as stewards of natural resources provide them a stronger impetus to develop adaptation strategies to the changing environmental realities. However, several dynamics make adaptation more difficult for some women. They include a lack of access to formal education, economic poverty, discrimination in food distribution, food insecurity, limited access to resources, exclusion from policy and decision-making institutions and processes, and other forms of social marginalization (Angula 2010; Wendy undated). These dynamics put women at a distinct disadvantage and limit their ability to adapt to changes. A gender-sensitive response requires more than a set of disaggregated data showing that climate change has differential impacts on women and men. It requires an understanding of existing inequalities between women and men and of the ways in which climate change can exacerbate these inequalities (Otzelberger 2011). It also requires an understanding of the ways in which these inequalities can intensify the impacts of climate change for all individuals and communities. Both the broader body of knowledge on gender and the environment and most of the more recent research on specific climate gender impacts have been more or less limited to a focus on women. However, recent research demonstrates increasing awareness of the need to take a gender-responsive approach. It is based on an understanding of socially constructed roles and opportunities associated with being a man or a woman and the interactions and often unequal social relations between men and women (UNDP 2009).

Already farmers in developing countries are using their existing experience, knowledge, and resources to manage climate risks on their own account. These actions are not easily distinguished from a range of other social, demographic, and economic factors that influence livelihood decisions and development trajectories (Adger et al. 2003). However, progressive climate change is likely to require substantive responses, such as major changes in farming systems, livelihood diversification, and migration (Lamboll et al. 2011; Nombo et al. 2013). Adaptation involves a range of activities to reduce vulnerability and build resilience. The key development sectors within which women are adapting to climate change are agriculture, water, food security, forests, health, and the economy. Most women have traditionally worked in these sectors in most communities. In fact, women have been very active and innovative in these areas so as to guarantee the survival of their families and communities.

An increasing amount of research and documentation has focused on prevalent coping and adaptation strategies followed by men and women (Osman-Elasha 2008; UNFPA 2009; Nelson and Stathers 2009; UNDP 2010; Ribeiro and Chaúque 2010). But most of these studies did not give sufficient attention to how these impacts and strategies vary by gender or how they are differentiated among other social groups. They also did not give much attention to changes that these adaptive strategies cause on gender relations. In this paper, we assess how gendered households coping/adaptive strategies influence changes in gender relations and their long-term implications for women's vulnerability to climate change.



## 31.2 Location and Characteristics of the Study Areas

This paper is based on qualitative data that were collected in the Meatu and Iramba districts located in the Simiyu and Singida regions, respectively. Meatu has a mean annual rainfall that varies between 400 and 900 mm in its southern and northern areas, respectively. The rainfall regime is unimodal. Iramba, on the other hand, has a mean annual rainfall of between 500 and 850 mm. Surface temperature in the district ranges between 15 °C in July and 30 °C in October (Iramba District Council 2009). The agricultural production system in both districts is mainly rain fed and dominated by the hand hoe. In addition, the Meatu district is characterized by numerous agro-pastoralists who are mainly from the Sukuma ethnic group. In contrast, the Iramba district is dominated by the Nyiramba ethnic group. The landscape in Meatu is largely flat terrain with highly scattered or clustered vegetations (shrubs). In Iramba, on the other hand, the vegetation is mainly miombo woodland found on the hills near the Great East African Rift Valley. The two districts are classified as semi-arid (NRI 1991). Gender inequalities and gender roles determine the choice of adaptation strategies of both men and women in semi-arid areas. Barrow et al. (2003) argue that semi-arid conditions and the agro-pastoral land-use system as in Fig. 31.1 exacerbate challenges faced by households in such agricultural production systems, consequently threatening the areas' ability to sustain future livelihoods.



**Fig. 31.1** Cattle grazing on the farm after harvest in Meatu (Photo: Loti 2013)

### 31.3 Selection of the Villages

This study was conducted in the villages of Kidaru in the Iramba district, Singida region and Mwashata and Mwamanimba in the Meatu district, Simiyu region. The study villages were purposively selected because they are in districts that possess semi-arid agro-ecological zones in which rainfall is already uncertain even without climate change. The Mwashata and Mwamanimba villages in the Meatu district are more deforested, while the Kidaru village in the Iramba district is located along the Great East African Rift Valley. Rainfall is highly variable in the districts, and the mean temperature is relatively high in Kidaru village. In addition, the villages experience frequent drought and hunger. They frequently receive food aid from their respective district authorities and from non-governmental organizations, including World Vision Tanzania. Frequent hunger and frequency of receiving food aid are associated with crop failures associated with climate change.

### 31.4 Data Collection Methods

Data collection took place between 2012 and 2013. The study mainly used a qualitative research approach to collect in-depth information on people's experiences with climate change adaptation and gender relations (Creswell et al. 2007). Qualitative information was collected on the different roles of women and men, relationships and inequalities between them, their different experiences with the consequences of climate change, different adaptation strategies and constraints, and changes in gender relations in relation to specific adaptation strategies. Using a checklist of topics, interviews were conducted with key informants such as village leaders, village elders, and other influential persons. Two key informants, one male and one female aged 60 years and above, were involved in the study from each village. The choice of old-aged informants was based on the fact that they have vast knowledge and experience on climate change and also about adaptation practices in the farming systems. Issues that were explored during key informant interviews included perception on climate change, access and control over resources between men and women, equality with respect to men and women in the study areas, specific adaptation strategies, and effects of these strategies on men and women. Six separate focused group discussions (FGDs) were also held with groups of men and women in the three study villages. FGDs were held separately for men and women, so they don't influence each other, also giving the freedom to women to express themselves. Given that the participants needed to have specific characteristics, purposive sampling was used to select participants for the FGDs. This was done to make sure that different social groups composed of men and women were represented. Each group comprised 8–12 participants with different age and socioeconomic status. Information was collected on the impacts of climate change on households, adaptation strategies, changes in gender roles, and resource

access and control as a result of a given adaptation strategy on men and women and girls and boys. These data were subjected to content analysis in which field notes were categorized into themes, which were later sorted to identify similar phrases, patterns, relationships, or disparities in relation to the study objectives.

## **31.5 Presentation and Analysis of the Findings**

### ***31.5.1 Climate Change, Gender, and Food Insecurity***

Rural women and men play complementary roles in ensuring food security. However, women tend to play a greater role in natural resource management and in ensuring nutrition security (FAO 2003). Women often grow, process, manage, and market food crops. They are often responsible for raising small livestock, managing vegetable gardens, and collecting fuel wood and water. The findings of the study show that unpredictable rainfall, declining soil fertility, and increased incidence of some pests and diseases are leading to more frequent crop failure and increased yield variability. As a result of these changes, farmers are being forced to cultivate larger areas of land to obtain sufficient food. According to farmers, in the past two decades, farmers were able to produce sufficient food from 1 to 2 ac. However, today households have to cultivate more than 3 ac to produce sufficient food to feed their households. Farm area expansion has become necessary to compensate for declining soil fertility (hence productivity) and the use of low-yielding local varieties. Larger areas are also cultivated in order to mitigate droughts. Nonetheless, increased farm size has implications for women's workloads. Women perform more farm activities than men. Moreover, households are forced to use ox ploughs, which are mainly operated by men, to be able to cultivate large areas. Large field areas increase the demand for labor for other farm operations, such as weeding and post-harvest activities. Both men and women reported increased farm labor demands to cope with decreased yields. A study of routine daily activities indicated that both men and women had a reduced number of rest hours compared to the past because of the additional time required to cultivate larger plots of land.

In the Meatu district, sweet potatoes used to be cultivated by women only as a food reserve. Increasingly, men are now growing them due to their rising importance as a cash crop. Plots formerly cultivated by women to produce potatoes have been taken over by men for commercial production. Hence, women are losing access and control over food they used to produce for lean periods. Thus, food security at the household level is threatened, and women suffer the most.

Sunflower is a crop that is adapted to low rainfall levels. Its increased production in the Iramba district has led to higher household incomes and, hence, to increased food purchasing power. This income is not always equitably shared between women and men, although this crop has led to more weeding and processing work for women.

The search for casual employment to earn income and meet short-term food needs was reported to be another mechanism to cope with food shortages. Both men and women members indicated during focus group discussions that selling labor is the most common strategy used by both men and women to overcome food and income shortages. Those in need are usually hired by well-to do farmers in the village at a wage of TZS 5,000 per acre, which is insufficient to meet their food needs. During food shortage periods, as reported in all the studied villages, households may reduce the number of meals taken, and they may have no meals at all in extreme cases.

Women were reported to be highly affected by food shortages in the household, as they forego their meals for the sake of other household members, including men and children. Women, by virtue of their identity as mothers and wives, tend to devote a significant proportion of their resources to the family. They are expected to sacrifice for other family members. This is similar to the situation in India where girls' nutrition suffers most during periods of low consumption and rising food prices and where rainfall shortages are more strongly associated with deaths among girls than boys (UNDP 2007). Most children miss or drop out of school during these periods, which has an obvious negative impact on their future career. To ensure household food security, women have diversified to non-farm activities, especially petty businesses such as selling food (*Mama lishe*) and vegetables from their own gardens and selling fish, porridge, and local brew to generate cash income. Women are also selling charcoal and fuel wood to get extra income as shown in Fig. 31.2. Women in the study areas have somehow been able to decide on how to spend the cash earned, and this has shifted the power relations in the household and in the community. Women are increasingly gaining independence and power to make decisions over income and other resources. Currently, women do not entirely



**Fig. 31.2** A woman selling charcoal and fuel wood for income in Kidaru Village (Photo: Loti 2013)

depend on men for family needs as they have other sources of generating income as reported by one woman in the FGD:

These days even if my husband will not provide me with any cash for the family needs, I can still cater for such expenses from the income I get from my buns business. I am much free to use my own money than that provided by my husband.

Voluntary migration in response to seasonal changes is a commonly practiced response in the studied communities. The rate of outmigration is increasing with climate change. Male outmigration in search of casual employment or food is another strategy households use to cope with food shortages. Women in the focus group discussions reported an increased workload for those left behind, who are mainly women and girls. They become *de facto* heads of households and must take on men's farming roles in addition to their existing agricultural and domestic responsibilities. This may lead to changes in gender roles because women have more opportunities to make decisions and they exercise greater control over household resources, such as land and cash. In this case, male outmigration can have positive outcomes for women because existing gender inequalities are being challenged. Although the expectation is that those who migrate will send remittances, it was reported to us that many don't send remittances. Hence, women experience difficulties in making ends meet on their own. Furthermore, as reported in the women's FGD in the Kidaru village, migration leads to family member separation, which undermines family relations and exposes members to HIV infections. Women can become more vulnerable to infections while tending to the sick.

Women have formed self-help groups as a way to help members cope with life difficulties induced by climate change. Historically, women could not attend meetings because of their domestic responsibilities and the prohibition from their husbands. With the support of these groups and networks, such gender norms are challenged and women are actively involved in climate change adaptations through these groups. It was also noted during the focus group discussion with women in the Mwashata village that some men experience anxiety and are likely to be aggressive toward their wives when their livelihoods are undermined or when they are no longer able to fulfill their socially expected roles as providers as a result of climate change.

### ***31.5.2 Climate Change, Gender, and Water Shortages***

Water is a major resource threatened by climate change. Decreasing availability, declining quality, and growing demand for water are creating significant challenges for both men and women in semi-arid areas. Access to water has clear gender dimensions because women are often responsible for its collection. Climate change often means that they have to travel further to gain access to it because of increasing scarcity. Three types of water sources were mentioned in the study villages, namely water taps, wells, and rivers. In Meatu villages, water levels in these sources drop

**Fig. 31.3** A man fetching water from the shallow well dug on the river course  
(Photo: Loti 2013)



during the dry season from August to October every year. The water shortage is a serious problem for both humans and livestock. Women are often forced to dig wells in river beds along seasonal river courses to get water for domestic use. In addition, women and girls must often walk longer distances in search for water for domestic consumption. Some men also collect water (Fig. 31.3) using oxcarts and sell a water bucket of 20 l at TZS 500. The majority of women in the Meatu district cannot afford such high prices because their incomes are relatively low (Fig. 31.3).

Men and boys search for water for the livestock, trekking far from their villages, at times moving to other districts or regions for up to 5 months. In the Mwashata village, it was reported that only cattle were moved to the nearby areas in search of drinking water in the past. However, in recent times, bigger herds of goats and sheep are also involved. Movements of animals in search of water contribute to male migration and lack of milk for women, elders, and children who are rarely involved in seasonal movements of the animals. The nutrition and health of children and women are at risk because they lack important nutrients associated with milk consumption. The seasonal migration of men and boys results in increased workloads for the women and children who remain behind.

### ***31.5.3 Climate Change, Gender, and Reduced Grazing Land***

Livestock keeping is an important livelihood activity in the study areas. Grazing lands have been affected by climate change. Drought has resulted in the loss of pasture for livestock. Village inhabitants indicated that since year 2000, the seasonal movements of animals have become more complicated due to serious

drought. Some agro-pastoralists, who are mainly boys and men, have been permanently separated from their families because of the need for them to stay away with the animals searching for water and pastures for long periods. During the men's FGD in the Mwamanimba village, it was reported that animals grazed anywhere in the village in the 1970s, but the situation has recently changed because of dwindling grazing areas. Informants in all three villages reported that it was not feasible to set aside areas for pasture because demand for land was very high. In Meatu, the seasonal movement of animals is locally known as *lubaga*. Focus group informants pointed out that, in the past, *lubaga* areas were readily available in neighboring villages, which made it possible for wives to visit their husbands with some frequency. Currently, women are unable to visit their spouses because *lubaga* implies that they migrate far away from their homes. In some cases, men who migrate stay away permanently. As men and boys move away from their villages, women and children who are left behind face a number of problems in making ends meet. Animal deaths and the lack of pastures sometimes require that men who own animals must sell them at low prices during the dry season to make ends meet. This strategy destabilizes household savings because wealth is often invested in livestock, such as sheep, goats, and cattle. Men are typically the owners of livestock, and they are the most affected because the sale of livestock reflects their inability to invest for the long term. This makes them more vulnerable to other stresses and climate change impacts.

### ***31.5.4 Climate Change, Gender, and Fuelwood Shortage***

Women and girls are responsible for fuelwood collection in most communities in developing countries. In all three study villages, FGD participants reported that changes in vegetation and forest cover have caused women and girls to spend more time fetching fuelwood than in the past. In the 1990s, women used to collect fuelwood within 1.05–2 h walking distance from their homes. As a result of climate changes, they now spend up to 10 h walking in search of fuelwood. Thus, they have less time to fulfill their other domestic responsibilities, earn money, and engage in community or social activities. Girls are sometimes kept home from school in order to help gather fuelwood. This serves to perpetuate the cycle of disempowerment.

Energy-saving stoves have been introduced to cope with the fuelwood shortages. Women in Meatu were trained to make energy-saving stoves (*Majiko banifu*) using clay during the 1990s. They are able to preserve heat and use less firewood. This technology reduces the amount of fuelwood required and the time women need to spend on cooking.

In the women's focus group discussion in the Kidaru village, it was reported that some women have been sexually harassed and assaulted while searching for fuelwood. This has made them more vulnerable to HIV and other sexually transmitted diseases.

During the September to October dry season, households collect fuelwood to be used in the coming wet season. Given the long traveling distance and the amount of fuelwood to be carried, oxcarts are often used to transport the fuelwood at the cost of TZS 10, 000 per trip. The amount to be paid per trip is relatively high for most of the women in the villages, though for some, oxcarts have reduced their workload. Most women and girls are not able to afford this price and are more vulnerable to injuries resulting from walking long distances carrying heavy loads. The use of oxcarts has also motivated men to engage in fuelwood collection but for different reasons. In most cases, fuelwood collected by women is for domestic use, while men collect the fuelwood for sale. Men's involvement in fuelwood collection is likely to lead to an excessive exploitation of forest tree resources, which may further exacerbate climate change. However, this has also changed the community norms on the role of men as they have become engaged in fuelwood collection.

### **31.6 Conclusions and Recommendations**

This study has focused on changes in gender relations in response to climate change in farming and livestock-keeping systems in semi-arid areas. The paper has highlighted that a gendered approach to climate change should not simply be about women. Men and boys are also vulnerable to the impacts of climate change but often in different ways. Both men and women have reacted to climate changes and the corresponding changes that have occurred in gender roles and relations to accommodate socioeconomic and environmental changes. Interestingly, changes in the farming systems and other activities that are fundamental for the livelihoods in the Meatu and Iramba districts have had gender implications. The study findings have shown that both men and women are striving to adapt to different climate-related changes and that men and women have adopted different strategies due to their inherent roles and responsibilities in the household. Women often have to walk far away to find fuelwood and water. Thus, women and girls find themselves with less time for education, income-generating activities, and participation in community decision-making processes. This exacerbates unequal gender relations. However, men's involvement in fuelwood and water collection has changed the community norms on the gender roles of men and women. On the other hand, women are trying hard to find income-generating activities that could compensate for their reduction of food and income as a result of climate change, and this has enabled them to maintain some degree of financial independence from their husbands.

Increased food shortages were reported to be affecting the health of women because they were eating fewer and poorer quality meals per day. It would appear that, in many ways, existing inequalities created as they are by social norms and inequitable power relations are being compounded by increased climate change and variability.

Data from this study indicate that climate change is a driver of changes in gender roles and relations as the impacts of climate change become more apparent and



households are increasingly required to adapt to these changes by shifting from their traditional livelihood strategies and practices. These changes in turn lead to changes in gender roles and relations. There is some evidence that this is already occurring in the Meatu and Iramba districts, with men contributing more to previously female-dominated tasks, such as collection of water and fuelwood, and women more actively engaging in making decisions and control over some resources, including cash. Community social structures are also changing, notably the involvement of women in local groups for self-help. These changes have the potential to contribute to women's empowerment as women are able to earn incomes that contribute to the household economy. However, there are negative implications as well, such as an increased workload for women as they take on more responsibilities.

The impacts of climate change are changing gender relations, with both advantages and disadvantages for both gender categories. However, as discussed earlier on, regardless of whether or not they reduce vulnerability at the household level, adaptation strategies have altered intra-household gender relations, mostly to the disadvantage of women. Adaptation strategies utilized by both men and women have both positive and negative outcomes that may either challenge or reinforce existing gender inequalities. Therefore, adaptation efforts must take these ongoing changes in gender roles and relations into account and facilitate dialogue and negotiations within communities in order to enable more transformative and positive change for women and other marginalized groups.

## References

- Adger WN, Huq S, Brown K, Conway D, Hulme M (2003) Adaptation to climate change in the developing world. *Prog Dev Stud* 3(3):79–195
- Angula M (2010) Gender and climate change: Namibia case study. Heinrich BöllStiftung Publisher, Cape Town, p 50
- Barrow E, Kaale B, W (2003) Forest landscape restoration in Shinyanga, the United Republic of Tanzania. [www.fao.org/DOCREP/ARTICLE/WFC/XII/0164-B3.HTM](http://www.fao.org/DOCREP/ARTICLE/WFC/XII/0164-B3.HTM) [12/12/2013]
- Brody A, Demetriades J, Esplen E (2008) Gender and climate change: mapping the linkages. A scoping study on knowledge and gaps. Institute of Development Studies UK, Sussex, p 22
- Creswell JW, Hanson WE, Plano VLC, Morales A (2007) Qualitative research designs: selection and implementation. *Couns Psychol* 35(2):236–264
- FAO (2003) Gender-disaggregated data for agriculture and rural development – guide for facilitators. Socioeconomic and gender analysis programme. Food and Agriculture Organization of the UN, Rome, p 196
- FAO (2007) People-centred climate change adaptation: integrating gender issues. [ftp://ftp.fao.org/docrep/fao/010/a1395e/a1395e00.pdf](http://ftp.fao.org/docrep/fao/010/a1395e/a1395e00.pdf) [20/12/2013]
- FAO (2009) Bridging the gap. FAO's programme for gender equality in agriculture and rural development. Food and Agriculture Organization of the United Nations, Rome
- IPCC (2007) Climate change 2007 – impacts, adaptation and vulnerability. Contribution of working group II to the fourth assessment report of the IPCC. Cambridge University Press, Cambridge, p 976

- Iramba District Council (2009) Iramba district socio-economic profile. Iramba District Council, Kiomboi, p 100
- Lamboll R, Nelson V, Nathaniels N (2011) Emerging approaches for responding to climate change in African agricultural advisory services: challenges, opportunities and recommendations for an AFAAS climate change response strategy. AFAAS, Kampala, Uganda and FARA, Accra, Ghana, p 160
- Nelson V, Stathers T (2009) Resilience, power, culture, and climate: a case study from semi-arid Tanzania, and new research directions. *Gen Dev* 17(1):81–94
- Nombo CI, Urassa JK, Mbwambo JS, Mattee AZ, Mamiro DP, Kabote SJ, Matata L, Synnevåg G (2013) A gendered analysis of climate change impacts and adaptations in semi arid area farming systems of Tanzania. *J Contin Educ Ext* 4(1):212–227
- NRI (1991) Tanzania: profile of Agricultural Potential. Natural Resources Institute, Chatham, p 26
- Otzelberger A (2011) Gender-responsive strategies on climate change: progress and ways forward for donors. Institute of Development Studies UK, Sussex, p 58
- Ribeiro N, Chauque A (2010) Gender and climate change: Mozambique case study. Heinrich BöllStiftung Publisher, Cape Town, p 42
- Skinner E (2011) Gender and climate change overview report. Institute of Development Studies UK, Sussex, p 91
- Terry G (2009) No climate justice without gender justice: an overview of the issues. *Gen Dev* 17(1):5–18
- UNDP (2007) Human development report (2007/2008) fighting climate change: human solidarity in a divided world. Palgrave Macmillan, New York, 31
- UNDP (2009) Resource guide on gender and climate change. United Nations Development Programme, New York, p 151
- UNDP (2010) Gender, climate change and community-based adaptation. United Nations Development Programme, New York, p 80
- UNFPA (2009) State of world population report. Facing a changing world: women, population and climate. The United Nations Environment Programme, World Watch Institute. p 104
- URT (2007) National Adaptation Programme of Action (NAPA). Vice President's Office, Division of Environment. Dar es Salaam, p 52
- WEDO (2007) Changing the climate: why women's perspectives matter? Available on-line in <http://www.wedo.org/files/climatechange-org2ebook.pdf> [01/12/2013]
- Wendy A (Undated) Gender and climate change adaptation. Lessons learned from the community based adaptation in Africa (CBAA). Indigo development and change Nieuwoudtville, South Africa. Lessons learnt from the community based adaptation in Africa. <http://www.indigo-dc.org/documents/Adaptationandbeyond04small.pdf> (12/12/2013)
- World Bank, FAO, and IFAD (2009) Gender in agriculture: sourcebook. The World Bank, Washington, DC, p 791

# **Part IX**

## **Conclusion**

## Chapter 32

# Forgotten Facts: Research and Development Priorities

**Rattan Lal, B.R. Singh, Dismas L. Mwaseba, David Kraybill,  
David O. Hansen, and Lars Olav Eik**

**Abstract** Some high priority issues for research and development, and those which were not discussed included the followings: (1) Realizing the difference between climate and weather so that the confusion in short-term changes rather than the long-term trends can be minimized, and any opportunities emerging from changing climate are harnessed, (2) Evaluating water resources in terms of green vis-à-vis blue and grey water with the objective to enhancing the green water supply by conservation of blue water in the root zone and recycling of the grey water, along with the judicious use of virtual water through international trade, (3) Understanding sequestration of carbon in soils as secondary carbonates along with that as humus in the soil and the biomass-C in trees and other biota, (4) Assessing additional requirements of water and nutrients (N, P, S) for plantation and trees, and conversion of biomass-C(with low N, P, S) into humus, (5) Alleviating constraints(biophysical and socioeconomic) to adoption of recommended management practices by smallholder and resource-poor farmers, (6) Differentiating between genuine investments by overseas companies and the land grabs, (7) Developing nutrition-sensitive agriculture on the basis of the principle that healthy soils are essential to healthy plants, animals and people, (8) Making payments to farmers for provisioning of numerous ecosystem services for promoting adoption of best management practices, and

---

R. Lal (✉)

Carbon Management and Sequestration Center, Ohio State University OARDC,  
2021 Coffey Road, Columbus, OH 43210, USA  
e-mail: [lal.1@osu.edu](mailto:lal.1@osu.edu)

B.R. Singh

Department of Environmental Science, Norwegian University of Life Sciences,  
P.O. Box: 5003, No-1432 Ås, Norway

D.L. Mwaseba

Sokoine University of Agriculture, Morogoro, Tanzania

D. Kraybill

AEDE/CFAES, The Ohio State University, Columbus, OH, USA

D.O. Hansen

IPA/CFAES, The Ohio State University, Columbus, OH, USA

L.O. Eik

Department of International Environment and Development Studies/Noragric, Norwegian  
University of Life Sciences (NMBU), P.O. Box 5003, No-1432 Ås, Norway

creating another income stream towards alleviating poverty, (9) Addressing gender and other issues which affect agronomic productivity and wellbeing of under-privileged and minorities, and (10) Realizing the importance of interconnectivity and the nexus-approach to harness the benefits of a holistic approach to sustainable management of natural resources and for realizing the goals to sustainable intensification for advancing food security and developing climate-resilient agro ecosystems.

**Keywords** Functions of soil organic matter • Types of water • Types of drought • Terrestrial carbon reserves • Secondary carbonates • Adoption vs. adaptation • Payments for ecosystem services • Land grabs • Researchable priorities

## 32.1 Introduction

Soil organic matter (SOM) has been the key to managing soil fertility and improving agronomic productivity since the dawn of human civilization. Soil organic Carbon (SOC) represents about 58 % of this matter. The words “human” and “humus” are intricately linked and SOM has been considered by ancient civilizations to be an “elixir” of life. Yet, the beneficial effects of SOM on soil quality, such as net primary productivity (NPP) and agronomic yields, are hidden or intangible and are either overlooked or taken for granted. The development of nitrogenous and other fertilizers since World War II has further masked the beneficial effects of SOM as a storehouse of plant nutrients, just as the use of irrigation has masked its role as a reservoir of plant-available water (PAW). Nonetheless, the use efficiency of fertilizers and water decreases concentrations of SOC to levels below the threshold for specific soil types. The threshold level of SOC in the root zone for most soils of the tropics and that of sub-Saharan Africa (SSA) is ~1.1 % (Aune and Lal 1997). Shifting cultivation has been widely practiced in SSA for millennia. Lengths of cultivation periods and fallow cycles under this mode of farming depend on the quantity and quality of SOC reservoirs in soil (Nye and Greenland 1958.) In this chapter we highlight research and development priorities in the context of conference objectives and achievements.

## 32.2 Conference Rationale and Objectives

A strategic objective of the conference was to document how low agronomic yields and related impacts of changing and variable climate on productivity and prevailing poverty and hunger in SSA are mainly attributable to degraded soils which are severely depleted of their SOC and nutrient (N, P, K) reserves. Poverty and hunger persist in SSA. They result in high levels of child mortality and diseases and are exacerbated by a changing and uncertain climate. Adapting to climate change by using recommended management practices (RMPs) is essential. They enhance soil quality and restore SOC pool and, thus, improve agricultural production, alleviate hunger and poverty, and improve the environment.

Carbon (C) sequestration in soils, vegetation, and wetlands can play a critical role in improving positive functions of agro-ecosystems. And the quality of

depleted/degraded soils can be enhanced through sustainable intensification (SI) of agriculture. SI will help bridge the yield gap, advance food security and nutrition, avoid deforestation and save land for nature conservancy.

Consistent with this logic, the principal objectives of the conference were to:

1. Describe the importance of soil/terrestrial C pools in soils of SSA for adaptation to and mitigation of climate change;
2. Deliberate the role of land use, soil and crop/animal/tree management systems on SOC pool and flux, soil quality and productivity;
3. Debate the importance of economic, social (gender), policy and cultural factors on adaption of RMPs by smallholders in SSA;
4. Explain relationships between terrestrial C pool and ecosystem services;
5. Create a network of researchers committed to addressing how to improve soil C management for adaptation/mitigation of climate change;
6. Collate and synthesize state-of-the-knowledge on soil/terrestrial C in SSA; and
7. Identify research, development, and training priorities for SSA.

Conference deliberations described the importance of SOC pool in sustainability of smallholder agriculture, explained the significance of SI as a way forward, and identified knowledge gaps and researchable priorities.

### 32.3 Functions of Soil Organic Matter in Smallholder Agriculture in Sub-Saharan Africa

Chapters 1, 3, 4, and 17 amply highlight the critical role that SOM plays in smallholder agriculture throughout SSA. It sustains high agronomic productivity (Allison 1973), and adaptation to a changing and uncertain climate characterized by extreme events such as droughts and heat waves. Being the largest terrestrial reservoir of C, SOC plays crucial roles in key ecological functions outlined in

**Table 32.1** Ecological functions of soil organic matter

Ecosphere	Functions
1. Atmosphere	(i) Moderates gaseous composition of the atmosphere
	(ii) Influences gaseous emissions from soil
	(iii) Sequesters atmospheric CO <sub>2</sub> as secondary carbonates and as humus
	(iv) Oxidizes methane
2. Hydrosphere	(i) Affects components of the hydrologic cycle (e.g., surface runoff, soil water storage)
	(ii) Moderates quality of natural waters
	(iii) Denatures pollutants
3. Biosphere	(i) Stores plant available nutrients (N, P, S)
	(ii) Provides energy to soil biota
	(iii) Enhances below-ground biodiversity
4. Lithosphere	(i) Influences the rate of weathering
	(ii) Transforms elements (biogeochemical)
	(iii) Links lithosphere to pedosphere, atmosphere, hydrosphere and biosphere

Table 32.1. In the context of atmospheric chemistry, SOC pool moderates gaseous composition, influences gaseous emissions from soil, sequesters atmospheric CO<sub>2</sub> and oxidizes CH<sub>4</sub>. In the context of hydrosphere, SOC pool affects some key components of the hydrologic cycle such as surface runoff and soil water storage. It also moderates the quality of natural waters through non-point source pollution, eutrophication, etc., and denatures pollutants such as herbicides and pesticides. The SOC pool is important for converting blue water (such as rainfall, runoff, groundwater and stream flow) into green water, such as PAW used in evapotranspiration. It also reduces the adverse impacts of prolonged droughts and heat waves. In the context of biosphere, SOC is a storehouse of essential macro and micro plant nutrients. It is a source of energy for macro and micro fauna in soils and is a major determinant of belowground flora and fauna activity and species diversity. In the context of lithosphere, SOC pool affects the rate of weathering and of new soil formation through biogeochemical transformations and cycling, and by linking pedosphere and lithosphere with atmosphere, hydrosphere and the biosphere.

Several chapters (Chaps. 1, 2, and 22) have also highlighted the pedological functions of SOM. In the context of physical properties, SOC concentration plays a critical role in (a) the formation of structure and tilth by influencing aggregation and aggregate stability; (b) water retention (PAW) and transmission through infiltration, percolation, interflow, hydraulic conductivity; (c) temperature regime through its strong impact on heat capacity and thermal conductivity; and (d) reactivity by affecting the surface area of soil. In the context of chemical properties, SOC (a) moderates charge properties and the exchange complex including ion (cation and anion) exchange capacity; (b) buffers against sudden fluctuations in soil reaction (pH); (c) influences elemental/nutrient transformations; and (d) affects chemical composition of soil air (e.g., gaseous concentration of O<sub>2</sub>, CO<sub>2</sub>, CH<sub>4</sub>, N<sub>2</sub>O). In the context of biological properties, SOC pool (a) is a source of food and habitat for micro-organisms and affects the microbial biomass carbon (BMC); (b) moderates biological transformations, such as oxidation, methanogenesis, nitrification and denitrification; and (c) imparts disease-suppressive attributes to soils of the root zone (Table 32.2).

**Table 32.2** Pedological functions of soil organic matter

Properties	Functions
1. Physical	(i) Aggregation and aggregate stabilization
	(ii) Water retention and transmission
	(iii) Thermal properties (e.g., heat capacity, thermal conductivity)
	(iv) Surface area
2. Chemical	(i) Charge properties and cation exchange capacity
	(ii) Buffer against changes in pH
	(iii) Nutrient/elemental transformation
	(iv) Composition of soil air
3. Biological	(i) Food and habitat for soil biota
	(ii) Below-ground biodiversity
	(iii) Biological transformations
	(iv) Enhancing disease-suppressive properties

**Table 32.3** Agro-economic functions of soil organic matter

Factor	Influence/function
1. Net primary productivity (NPP)	(i) Enhances net, ecosystem and biome productivity
	(ii) Impacts biomass partitioning
	(iii) Moderates elemental biomass composition
2. Use efficiency of inputs	(i) Decreases losses of inherent and applied nutrients by runoffs, leaching and volatilization
	(ii) Increases use efficiency of fertilizers, water and energy
	(iii) Moderates effectiveness of pesticides
3. Sustainability	(i) Reduces variability in agronomic yield
	(ii) Ensures minimum productivity
	(iii) Improves long-term sustainability
4. Resilience	(i) Increases resilience of crops/pastures/trees against extremes
	(ii) Enhances soil resilience against degradation processes
	(iii) Improves soil's ability to restore itself
	(iv) Increases biological stability through biochemical recalcitrance

Above all, the quality and quantity of the SOC pool are strong determinants of agronomic productivity and economic profitability. In the context of net primary productivity (NPP), SOC pool (a) affects net ecosystem productivity (NEP) and net biome productivity (NBP); (b) impacts biomass partitioning into root and shoot, grains and stover; and (c) moderates elemental composition of the grains and stover through supply of plant nutrients. In the context of the use efficiency of inherent and applied inputs, such as nutrients and water, SOC pool (a) affects losses by leaching, runoff and volatilization; (b) moderates use efficiency of nutrients, water and energy; and (c) regulates effectiveness of pesticides and herbicides. In the context of agronomic sustainability, SOC pool (a) affects seasonal/annual variability in agronomic productivity; (b) determines the minimum assured yields in bad growing seasons; and (c) enhances long-term sustainability and farm income. Resilience of agro ecosystems to abiotic stresses, including extreme climate events such as drought, heat waves and floods, and biotic constraints, including the incidence of weed infestation and severity of other pests and pathogens is enhanced by SOC pool. It enhances recoverability and restorability of critical soil functions and improves soil's biological and biochemical resilience. This pool also increases the ability of agro ecosystems to recover from drastic perturbations and the associated stresses (Table 32.3).

## 32.4 Sustainable Intensification

Natural resources, including soil, water, nutrients and energy, are finite and unequally distributed over the landscape and across geographical regions or biomes. They are prone to depletion and degradation by misuse and mismanagement. Extensive land use through extractive farming is based on low inputs and characterized by subsistence farming and a marginal life style. It is not the best approach to production.



**Table 32.4** Successful agro ecological management practices for agricultural intensification

Management practices	Function
Contour plowing, rock and vegetative bunds and terraces	Soil and water conservation and management
Integrated production of crops and livestock composting of manure and other organic materials, incorporation of crop residue and weeds in soil, use of nitrogen fixing crops	Nutrient supply and recycling, soil fertility building
Hoing, crop rotation, intercropping within fields, undersown crops and catch crops to deter weeds	Weed control management
Alley cropping, vegetative strips, live fences	Fuel fodder, timber, reduction of runoff and nutrient pumping and cycling

Extracted from Holm-Gimenes (2002), Tengo and Belfrage (2004), and Lin et al. (2008)

Rather, a better strategy is to use the best soil, land, water and save the rest for nature conservancy and other ecosystem functions and services.

SI was emphasized in Chaps. 1, 21, and 24. Several important components of SI are: (a) germ plasm improvement including genetically modified organisms or GMOs and plant and animal species improvements that increase the capacity to adapt to changing and uncertain climates; (b) use of integrated nutrient management (INM) practices that are based on a judicious combination of inorganic fertilizers and organic amendments, such as compost, manure, biological N fixation, and mycorrhizal inoculation, and integrated pest management (IPM); (c) adoption of no-till (NT) or conservation tillage (CT) in conjunction with crop residue mulch and cover cropping; (d) agroforestry systems involving judicious combinations of trees and livestock with crops (Gelaw et al. 2014); and (e) precision or soil specific farming. SI implies adoption of a holistic approach; there is no silver bullet. Generic technologies must be fine-tuned under site-specific situations to address local bio-physical, social, economic and cultural/gender factors.

Agricultural adaptation to climate change has generally focused on the genetic modification of crops (Orindi and Ochieng 2005) and on the development of models for climate forecasting (Hansen 2005). Less commonly recognized is that management practices can contribute to significantly to options available for adaptation to climate change (Holme-Grimenez 2002; Tengo and Belfrage 2004). Some of the most important options are presented below in Table 32.4.

The practices suggest that intensive agricultural systems may have lower resistance and higher vulnerability to extreme climate events, potentially affecting the long-term sustainability of crop production under global climate change (Gliessman 1998).

## 32.5 Forgotten Facts

While a wide range of thematic issues pertinent to smallholders in SSA were illustrated throughout this volume, several key issues were either omitted or discussed in passing. Some of these issues are outlined in Fig. 32.1 and described below.

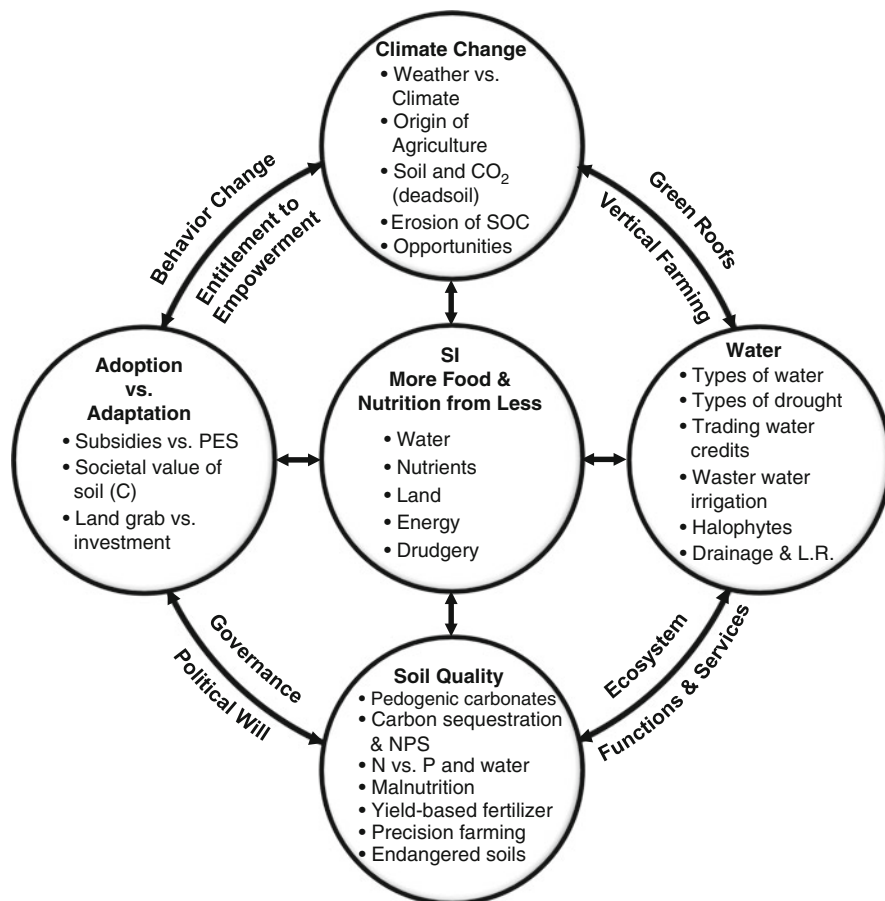


Fig. 32.1 Forgotten facts which need to be addressed

Climate Change – Concerns about the changing climate were addressed in Chaps. 1, 7, 8, 9, 10, and 11. However, confusion between “climate” and “weather” confounded some discussions. Climate refers to a time period of more than 30 years and weather to seasonal and annual variations. This difference must be recognized in order to objectively address these concerns. In general, climate change is considered to have adverse effects on agronomic production. This is particularly true for resource-poor smallholder farmers of SSA who are most vulnerable to the harsh climate. Yet, the climate change must also benefit soil/site-specific areas. They need to be identified and opportunistically harnessed. Settled agriculture evolved 12–15 millennia ago because of climate change.

It is also widely held that CO<sub>2</sub> emissions from soil must be reduced. In fact, the goal is not to decrease CO<sub>2</sub> emissions from soil per se because they are indicative of the activity and diversity of MBC and other biota which are essential to soil functions. Rather it is to increase the input of biomass-C into the soil at a rate that exceeds the respiration output of biota and that creates a positive soil and ecosystem C budget.

The importance of accelerated erosion on CO<sub>2</sub> emissions was not discussed at the conference. The preferential removal of SOC by water and wind erosion, as evidenced by the enrichment ratio of sediments being >1 for SOC, and the breakdown of aggregates, exacerbates the susceptibility of SOC to microbial processes. And the importance of adopting conservation-effective measures to reduce erosion-induced emissions of CO<sub>2</sub>, CH<sub>4</sub> and N<sub>2</sub>O was also not adequately discussed at the conference.

Changes in temperature and rainfall regime may have considerable impacts on agricultural productivity and on ecosystem services provided by forests and agroforestry. Yet data about the impact of climate change on biodiversity and its subsequent effects on productivity in forestry and agroforestry systems are limited.

Water – Drought risks were discussed in Chaps. 1, 12, 13, and 14. Yet, types of drought, such as meteorological, hydrological, pedological, agronomical, ecological and social, were not. Drought type identification is critical to determine appropriate adoption strategies. Similarly, water classifications, such as blue, green, grey, black and virtual, were not deliberated. As for drought types, such classifications are important in order to identify appropriate strategies and management options, such as conversion of blue and grey water into green water, and to enable trading of water credits. Irrigation was discussed in Chaps. 11, 12, and 13, but drainage requirements were not. The absence of adequate drainage actually increases risks of secondary salinization as mentioned in Chap. 14. The West African Sahel and other arid regions suffer from a scarcity of renewable fresh water; however they have ample brackish aquifers. The potential of using brackish water for irrigation and growing halophytes for fodder, biofuels, industrial and pharmaceutical uses were not considered. Sustainable management of water resources in a changing climate merits further investigation.

Climate shifts in the last few decades have already been linked to changes in the large scale hydrological cycle. The negative impacts of climate change on freshwater ecosystems are expected to outweigh the benefits of overall increases in global precipitation due to a warming planet. By 2050, more than half of the world's population will live in countries with several water constraints, including China, Egypt, Ethiopia, India, Iraq and Pakistan (Rockstrom et al. 2009).

Carbon Sequestration and Soil Quality – C pool and flux in soils, forest and livestock ecosystems were discussed in Chaps. 1, 17, 18, 19, and 20. However, principles and practices of SOC sequestration in relation to nutrients (N, P, S, etc.) and water requirements and trade offs were not (Lal 2009; Chabbi and Rumpel 2009). The need to trade water for C is widely recognized. Jackson et al. (2005) observed that forest plantations decreased stream flow by 227 mm/year globally, with 13 % stream drying completely for 1 year. Besides the need to apply biomass-C to soils as residues, manure, compost, etc., additional inputs of essential nutrients, such as N, P and S, are needed to enhance humification (Himes 1998). A major trade off exists between C and water. Increasing C sequestration reduces availability of renewable water reserves. Physical controls of SOM must be identified (Feller and Beare 1997), and the conversion factor for computing SOM from SOC and vice versa credibly determined (Pribyl 2010).

Other important forms of C sequestration exist. Among them are sequestration of C into humus and other organic compounds, the formation of secondary carbonates and the leaching of biocarbonates into the ground water in irrigated ecosystems (Lal et al. 2000).

The importance of secondary carbonates in the C cycle for soils of arid and semi-arid ecosystems of SSA, was not discussed and must be assessed (Fig. 32.2). Detailed assessment of the C pool in all components of the ecosystem must be credibly assessed.

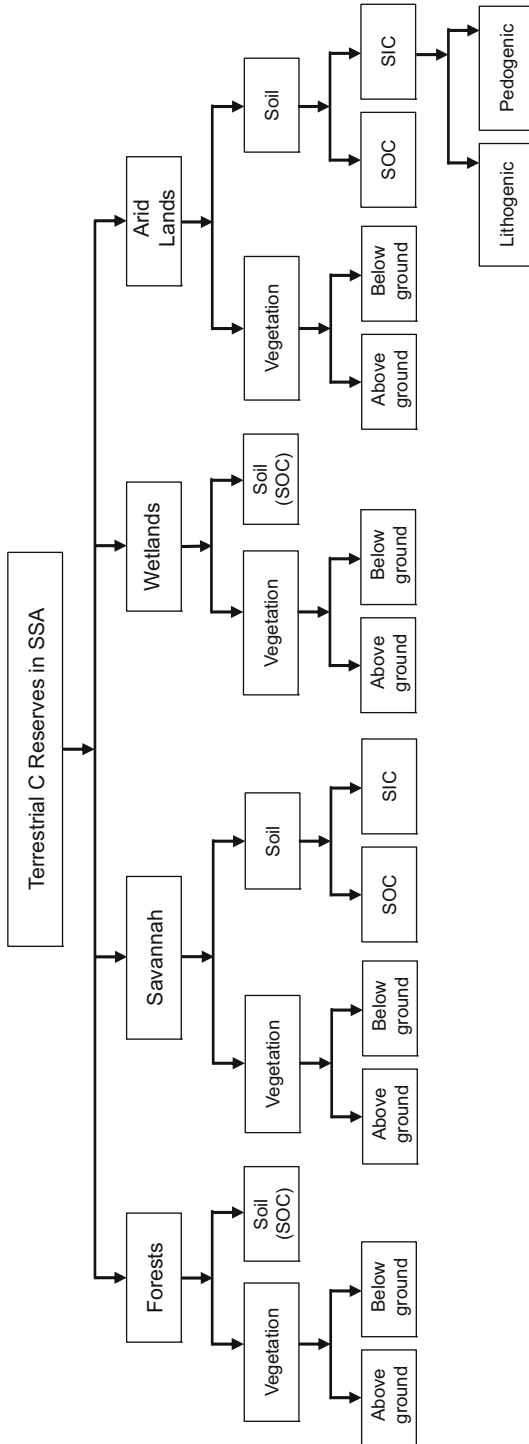
Other important management of soil quality issues and SI are related to precision agriculture which is soil-specific farming. Precision agriculture, although not practiced in SSA, is important for proper implementation of SI strategies related to the efficient use of fertilizers, irrigation and pesticides. Attention to soil-specific farming is also important for guiding farm machinery traffic in order to minimize risks of soil compaction, and seeding arrangements (clump planting) and row orientation to suit the micro-climatic environments.

Problems of soil degradation were discussed in Chaps. 3, 7, and 14. Major hotspots of soil degradation in SSA were identified, namely Sahel, East Africa, Highlands, Horn of Africa, and Southern Africa. Yet, the concept of endangered soils, which are at risk of irreversible degradation, was not mentioned nor discussed. Shallow soils with plinthite or rocks in the sub-soil horizons and soils prone to accelerated erosion are endangered soils. They should remain undisturbed and under natural vegetation cover for nature conservancy.

Adoption vs. Adaptation – RMPs that promote the SI of smallholder agriculture are needed. Several were discussed in Chaps. 21, 22, 23, 24, 25, 26, and 27, but not in the context of policy interventions to promote their adoption by resource-poor farmers. Adoption of RMPs normally requires behavioral changes. Rather than subsidizing fertilizers, pesticides, improved seeds, etc., it is important to compensate farmers through payments for ecosystem services (PES) such as C sequestration, biodiversity preservation and water quality maintenance that result from the adoption of RMPs. The goal of PESs is to transform entitlements to empowerments through a just, fair and transparent system that looks beyond the myopic economics of short-term profit to long-term sustainability. Prudent governance and strong political will are essential to ensure adoption of RMPs. To be effective, PESs must be based on prevailing values attributed to specific commodities such as soil C. Trading C credits, discussed in Chaps. 26, 27, 28, 29, and 30, can be effective if there is a fair price and the process is transparent and just.

“Land grabs” were discussed in Chap. 27. This is a complex process and requires an objective that direct investments be distinguished from land grabs. While direct investments need to be encouraged, there is no place for land grabs in SSA or elsewhere.

In addition to direct adoption, RMPs must also be fine-tuned to site-specific conditions (biophysical, social, cultural). Important biophysical factors related to adaptation to climate change are associated uncertainties about rainfall, length of the growing season and time of sowing/planting and harvesting, probability of rainless periods during the growing season, and increases in the incidence of pests and pathogens.



**Fig. 32.2** Components of terrestrial C reserves in Sub-Saharan Africa which must be credibly assessed (SOC soil organic carbon, SIC soil inorganic carbon, SSA Sub-Saharan Africa)

Nitrogen Management – Fertilizer nitrogen management practices significantly affect the emissions of N<sub>2</sub>O in agriculture. These practices are fertilizer type, timing, placement and rate of fertilizer, as well as coordinating the time of application with irrigation and rainfall events. Snyder et al. (2007) demonstrated that slow release and stabilized N fertilizer can enhance crop productivity and mitigate N<sub>2</sub>O emissions. Hultgreen and Leduc (2003) found that N<sub>2</sub>O emissions were lower for spring N fertilizer application than for autumn application.

Biochar for Carbon Sequestration – Biochar can be used to improve agriculture and the environment due to its stability in soil and superior nutrient retention capacity. Biochar acts as a soil conditioner. It enhances plant growth, retains nutrients, and improves soil properties (Lehmann et al. 2006), especially in tropical with poor chemical properties (Oxisols and Ultisols). This novel approach to sequester C in terrestrial ecosystems creates environmental benefits, but was not discussed at the conference.

## 32.6 The Human Factor in Addressing Climate Change

An overwhelming consensus exists that climate change is anthropogenic (Cook et al. 2013). Substantial attention has been given by social scientists to the role that society, communities, groups and individuals play in responding to climate change and its impacts. Papers presented at the conference addressed several key points for SSA, including the role of gender, community and individual responses, the role of external entities, such as non-governmental organizations (NGOs) and extension agencies, and the role of development assistance agencies. They have also clearly documented that smallholder farmers in SSA are the most vulnerable to climate change.<sup>1</sup>

Much variability exists among smallholder communities in SSA. Additional research needs to be conducted on how households in different regions and with different cultures secure their immediate needs when manifestations of climate change occur (Morton 2007). These can include informal exchanges, and other similar practices which are part of daily livelihoods in communities. Other short-term coping strategies also need to be documented, including selective changes in diets by gender and age and their impacts on human health.

Other immediate forms of responding to short-term weather disturbances need to be researched. They include different forms of crop diversification. At this conference, clear shifts to early varieties of maize, sorghum and millet in response to changes in rainy seasons in select Tanzanian districts was reported (See Chap. 25). Also evident was incorporation of a greater diversity of local and improved crops varieties, new regimes of intercropping and increased vegetable gardening as a

---

<sup>1</sup> See especially Chaps. 9, 27, and 31.

source of income. Other studies have discovered other individual forms of adaptation using traditional knowledge in the process (Thomas et al. 2005).

Collective or community forms of adaptation also need to be researched in different geographical and cultural contexts in SSA. Thomas et al. (2005) provide a useful categorization of these responses for future research, including (a) social capital which involves the building of social networks of mutual support, such as cooperatives and farmer associations and women's groups; (b) commercialization which involves investments in small scale livestock for sale, vegetable crops, perhaps through small scale gardens run by women, etc.; and (c) increased off-farm labor, such as migration to mining areas and cities. All of these forms of adaptation imply changing gender roles and relations as women become more empowered to direct new-found resources at their disposal and/or to assume decision making roles vacated by their male counterparts. The impact of these changing roles on family structures and communities needs also need to be researched.

Proper management of SOC is important to mitigate the impacts of climate change as well as to contribute to SI. Eco-systems services are one way for farmers, including smallholders, to adapt to climate change as well as to mitigate its impacts. Research is needed on the organization, management and payment for SOC sequestration as well as forest C sequestration. Examples of these projects were given at the conference in Chap. 26. These projects monetarily benefit farmers for adopting practices that increase C stocks in soils. However, they require substantial commitment and continued inputs from intermediary organizations, local community organizations and their members in order to be effective and sustainable.

Social science researchers need to direct more of their efforts to understanding how adaptation to climate change can be facilitated, thus enhancing smallholder resilience to it. Priority areas include research on the formation of farmer and related associations and education efforts by governmental and non-governmental extension workers. Research is also needed about how to initiate and support village communication networks that facilitate introduction of alternative strategies through bridging to external organizations and similar communities.

### **32.7 Livestock Sustainable Intensification to Mitigate Climate Changes and Increase Food Production**

The agricultural sector in *Sub Saharan Africa (SSA) including Tanzania is faced with the daunting task of providing enough quality food for a growing population.* Intake of animal protein in African countries is generally low and livestock products provide high-value protein and are important sources of a wide range of essential micronutrients such as iron and zinc, and vitamins such as vitamin A. For the large majority of people in the world, livestock products remain a desired food for nutritional value and taste. In addition to milk and meat, manure is an important by-product, particularly for small-scale farmers.

*Livestock is also a significant contributor to GHG emissions. Therefore it is important to increase production while at the same time minimizing GHG emissions per unit of food produced.* Intensification of livestock production reduces the size of land required to sustain a livestock unit and frees up the land necessary for carbon sequestration and preservation of biological diversity.

Livestock ruminant production in SSA-countries depends largely on communal rangelands which are constrained forage scarcities, especially during dry seasons. Animals go through cycles of weight gains and losses in wet and dry seasons thereby taking a long time to reach the required live weights for slaughtering.

As discussed in Chap. 20, the most promising approach to improve the meat production from livestock ruminants and to reduce GHG emission is improved nutrition using supplementary feeding during periods of feed-shortages. Examples are early harvested hay, treated crop by-products and concentrate supplementation.

A transformation of the goat sector from meat only to a dual purpose system with both milk and meat increases food production per unit of land as discussed in Chap. 18. Dairy goats have been widely adopted among smallholders in Tanzania and are now gaining popularity in Malawi. Forest degradation in high-altitude water-catchment areas is seen as a threat to stable water supplies. Traditional food crop production in steep terrain leads to massive soil erosion, land-degradation, loss of bio-diversity and increased GHG emissions. Maintenance of more forest and grass-cover utilized by zero-grazed or tethered milking goats is more environmental friendly, while still maintaining farmer's income and food-security.

The SI of livestock farming systems (LFS) is not an easy task. There are increased societal concerns about the global impacts on the environment (GHG emissions, biodiversity, water, and soil fertility) and also ethical considerations due to the fact that industrial LFS are based on resources that directly compete with food for humans. Other pillars of sustainability are also of great importance, particularly land rights for pastoralists and income for the small-scale farmers whose livelihoods totally depend on farming. Therefore, SI needs to address broad terms that include aspects of biological efficiency, long-term sustainability and social responsibility.

## References

- Allison FE (1973) Soil organic matter and its role in crop production. Elsevier, Amsterdam, 640 pp
- Aune J, Lal R (1997) Agricultural productivity in the tropics and critical limits of properties of Oxisols, Ultisols and Alfisols. *Trop Agric (Trinidad)* 74:96–103
- Chabbi A, Rumpel C (2009) Organic matter dynamics in agro-ecosystems – the knowledge gaps. *Eur J Soil Sci* 60:153–157
- Cook J, Nuccitelli C, Green SA, Richardson M, Winkler B, Painting R, Way R, Jacobs P, Skuce A (2013) Quantifying the consensus on anthropogenic global warming in the scientific literature. *Environ Res Lett* 8(2)



- Feller C, Beare M (1997) Physical control of soil organic matter in the tropics. *Geoderma* 79:69–116
- Gelaw AM, Singh BR, Lal R (2014) Soil quality assessment for smallholder agroforestry and irrigation based agricultural land use systems in a semi-arid watershed in Tigray, northern Ethiopia. *Agroforestry systems* (Submitted)
- Gliesman SR (1998) Agroecology: researching the ecological processes in sustainable agriculture. In: Chou CH, Shan KT (eds) *Biology: the challenge of biodiversity, biotechnology and sustainable agriculture*. Academia Sinica, Taipei, pp 173–186
- Hansen JW (2005) Integrating seasonal climate prediction and agricultural models for insights into agricultural practices. *Philos Trans R Soc B* 360:2037–2047
- Himes FL (1998) Chapter 21: Nitrogen, sulfur and phosphorous and the sequestering of carbon. In: Lal R, Kimble JM, Follett RF, Stewart BA (eds) *Soil processes and the carbon cycle*. CRC Press, Boca Raton, pp 315–319
- Holt-Gimenez E (2002) Measuring farmer agricultural resilience after hurricane Mitch in Nicaragua. A case study in participatory, sustainable land management impact monitoring. *Agric Ecosyst Environ* 93:87–105
- Hultgreen G, Leduc P (2003) The effect of nitrogen fertilizer placement, formulation, timing, and rate on greenhouse gas emissions and agronomic performance. Saskatchewan Department of Agriculture and Food, Regina. Final report project no. 5300G
- Jackson RB, Jobbagy EG, Avissar P, Roy SB, Barrett DJ, Cook CW, Farley KA, le Maitre DC, McCarl BA, Murray BC (2005) Trading water for carbon with biological carbon sequestration. *Science* 310:1944–1947
- Lal R (2009) Challenges and opportunities in soil organic matter research. *Eur J Soil Sci* 60:158–169
- Lal R, Kimble JM, Eswaran H, Stewart BA (eds) (2000) *Global climate change and pedogenic carbonates*. Lewis Publishers, Boca Raton, 305 pp
- Lehmann, Gaunt JJ, Rondon M (2006) Biochar sequestration in terrestrial ecosystems – a review. *Mitig Adapt Strateg Glob Chang* 11:403–427. doi:[10.1007/s1027-005-9006-5](https://doi.org/10.1007/s1027-005-9006-5)
- Lin B, Perfecto I, Vandermeer J (2008) Synergies between agricultural intensification and climate change could create surprising vulnerabilities for crops. *Bioscience* 58:847–854
- Morton J (2007) The impact of climate change on smallholder and subsistence agriculture. *Proc Natl Acad Sci* 104:19680–19685
- Nye PH, Greenland DJ (1958) *The soil under shifting cultivation*. CAB, Harpenden, 156 pp
- Orindi VA, Ochieng A (2005) Case study 5: Kenya-ses fair as a drought recovery strategy in Kenya. *IDS Bull* 36:87–90
- Pribyl DW (2010) A critical review of the conventional SOC to SOM conversion factor. *Geoderma* 156:75–83
- Rockström J, Falkenmark M, Karlberg L, Hoff H, Rost S, Gerten D (2009) Future water availability for global food production: the potential of green water for increasing resilience to global change. *Water Resour Res* 45. doi:[10.1029/2007WR006767](https://doi.org/10.1029/2007WR006767)
- Snyder CS, Bruulsema TW, Jensen JL (2007) Greenhouse gas emissions from cropping systems and the influences of fertilizer management – a literature review. International Plant Nutrition Institute, Norcross
- Tengo M, Belfrage K (2004) Local management practices for dealing with change and uncertainty: a cross-scale comparison of cases in Sweden and Tanzania. *Ecol Soc* 9:4
- Thomas D, Osbahr H, Twyman C, Adger N, Hewilson B (2005) Adaptation of climate change amongst natural resource-dependant societies in the developing world: across the Southern African climate gradient. Tyndall Centre for Climate Change Research. Technical report 35, November

# Appendix: Working Group Recommendations

## Session No. 1 (Recorder Filbert Rwehumbiza)

**SESSION THEME:** CHANGING CLIMATE, SOIL DEGRADATION AND FOOD SECURITY IN SUB-SAHARAN AFRICA

### MAIN HIGHLIGHTS FROM PRESENTATIONS:

#### Characteristics of SSA:

- Africa is a large continent: Larger than combined area of USA, Europe, China and South East Asia
- Relatively lower population compared to those of China or India (>1 billion)
- More than 48 % of population living below poverty line
- 25 % percent of population food insecure and still increasing

#### Huge unexploited potential:

- Large and suitable agricultural area not yet exploited
- Very diverse eco-regions – can support various crops / agric activities
- Very small area currently under irrigation (3.8 % of potential)
- Low use of fertilizer in production
- Huge amounts of organic wastes in cities could sustainably support urban agriculture

#### Challenges:

- Land degradation rate highest in the world at >x2 global average
- Very high rates of population increase
- Undernourishment wide spread
- Climate change amplifying exiting stresses:
  - Declining yield
  - SSA to account for 65 % of projected global related hunger related crisis

- SOC decreasing while erosion increasing (Bio-engine of Earth/soil declining)
- Biodiversity declining
- Negative (-ve) soil nutrient budget
- Economic, Social and Political Forces affecting Soil Management Policy

### **Way forward:**

- Produce more using less of available resources
- Multi-Path strategy required for sustainable intensification to achieve climate resilient agriculture incorporating but not limited to:
  - Conservation Agriculture
  - Agroforestry
  - Micro-irrigation
  - Balanced and Integrated Nutrient Management
  - Precision Farming
  - Use of GMOs

## **Session No. 2 (Jennifer Olsen)**

### **SESSION THEME: ECOREGIONS/BIOMES OF SUB-SAHARAN AFRICA**

#### **MAIN HIGHLIGHTS FROM PRESENTATIONS:**

##### **Common Points:**

- Big gap between current and projected future food production, and current and future food needs.
- Current low soil productivity is a big barrier to increased production. Climate change will exasperate soil degradation, yet resilience to drought and hunger depends on high SOM. Need to change how we manage our soils.
- However, high spatial heterogeneity in soils, landscapes, human land use, etc. in SSA. Need to target interventions to local situation.

##### **How can we best increase productivity?**

- Add Nitrogen fertilizer (lots). But, we need to consider cost and many other factors. Or,
- Identify locations of high risk of soil degradation, and work there. But, need to use best available data, and need to integrate physical/social information, to be useful. Or,
- Reduce nutrient depletion through use of emerging nano- and bio-technologies. But, how can this technology reach small scale farmers?

## Lessons Learned

- Soil productivity is the key to increased production.
- The gap between current and potential yields, and the gap between actual and needed yields to feed people, can be breached with better soil management.
- This will become more difficult, and even more important, with the effects of climate change.
- A combination of “traditional” (SWC, chem. fertilizer, manure) and new technologies need to be applied in high-risk zones. Requires supportive policy, economic, infrastructure, etc. environment.

## Session No. 3 (Didas N. Kimaro)

### SESSION THEME:

### MAIN HIGHLIGHTS FROM PRESENTATIONS:

#### Specific Issues

- LandPKS
  - Knowledge Engine supported by global databases and models including use of Internet and mobile phones to tap the land potential opportunities (increase production and eliminate degradation)
- Effects of land cover changes on soil organic carbon and nitrogen stocks
  - Formulate realistic and effective policies for sustainable land management and climate change mitigation
  - Design and implement pertinent location-specific and sustainable land management and C sequestration policies

#### The paper on Farming Systems in Tanzania

- Calls for the need to re-categorize the farming systems in the context of dynamic livelihood options at fine scale

#### Conservation Agriculture, Climate-Smart Agriculture, Organic Farming

- Observed that potential adoption of CA by small holder farmers in the SSA is limited despite its benefits
- CA seems to have a better potential to feed the African mass if adoption by smallholder farmers is improved by adapting local practices coupled with formation of agricultural innovation platforms that involve the Public Private Partnerships (PPP model)

#### Commonality

- The papers emphasised on identification and access to local and scientific knowledge and information about land potential with respect to knowledge

and information relevant to each type of land/soil with full participation of stakeholders (multi-stakeholder approach) i.e. people with similar types of lands and challenges (landscape approach), public and private sector (formation of innovation platforms) etc.

**The presented papers calls for:**

- Research on management systems associated with specific types of land, current soil conditions, and climate for guiding grazing management, crop inputs, biodiversity conservation; restoration of degraded lands, land use planning and Management and provision of subsidy/incentives
- Formulation of realistic and effective policies for sustainable land management and climate change adaptation/mitigation at fine scale

**Session No. 4 (K. Mutabazi and T. Siza)**

**SESSION THEME: MEASURING THE IMPACT OF CLIMATE CHANGE ON AGRONOMIC PRODUCTIVITY**

**MAIN HIGHLIGHTS FROM PRESENTATIONS:**

**Introduction**

- Three deliberations were made – a keynote and two panel presentations
- Keynote speaker addressed:
  - Methods of assessing CC impacts on crop productivity
  - Application of integrated assessments to estimate impacts in the East Africa
- First panel ppt covered site-specific prediction of CC impacts on maize using downscaled GCMs and crop models
- Second panel ppt addressed approaches to reinforce crop productivity under water-limited conditions in sub-humid environments

**Similarities**

- Empirical assessments of climate impacts in agriculture are complex across scales: global, regional, national, sub-national and local
  - Prediction uncertainties underlying models
  - Dynamics of climate, social and biophysical systems
  - Modeling knowledge required
- Estimated impacts of climate change on rainfed crop agriculture vary depending on scale of analysis over space and through time
- Integrated assessments combining models and agronomic approaches are critical

### **Synthesized take away messages**

- Integrated assessment approach is critical in assessment complex climate change impacts
- Higher-level modeling has to be downscaled to inform site-specific impacts and responses
- Assessment of impacts have to be extended beyond the biophysical spheres to bring into the picture the “people”: livelihoods and human complex decision processes

### **Session No. 5 (Daniel Mushi)**

**SESSION THEME: INTENSIFICATION OF LIVESTOCK PRODUCTION PROVIDES LARGE OPPORTUNITIES FOR CC MITIGATION AND CAN REDUCE GHG EMISSIONS FROM DEFORESTATION.**

#### **MAIN HIGHLIGHTS FROM PRESENTATIONS:**

##### **Key Points**

- Overgrazing (desertification) causes vegetative loss and soil trampling and lead to loss of biodiversity and net emission of CO<sub>2</sub>
- Land-use changes, including expansion of pasture and arable land for feed crops gives rise to CO<sub>2</sub> emission Important with quality roughages and conservation of feed for dry season use
- Focus for ruminant systems should be on the utilization of feed resources not competing with man or monogastric animals.

##### **Strategies for improved productivity of beef in Tanzania**

- Traditional coping strategies, set aside area ngitili on communal land did not improve range productivity compared with continuous grazing while ngitili on private ground had a positive effect.
- Supplementary feeding of grazing cattle using concentrate or wheat straw did improve growth rate, meat quality and reduced time spent searching for feed on pasture.

##### **Multifunctional livestock systems and carbon footprint of lambs meat based on research work in Spain**

- When calculated solely per unit of meat, GHG emission decreased with increasing intensity of production.
- However when deliveries of public goods and biodiversity were taken into account, the more extensive systems came out favourably.
- This presentation also gave an insight in choice modelling as a tool for valuating public services from different production systems.

### **Last presentation by Fanny Chigwa was given by Lars Olav Eik**

- Various suckling systems and supplementary feeding of goat kids were compared.
- The distribution of milk between goat kids and human consumption depends on system of goat rearing practiced.
- Dairy goat keeping has become particularly important in Tanzania and is seen as a sustainable intensification compared with traditional meat goats.

## **Session No. 6**

### **SESSION THEME: RECOMMENDATIONS FOR FUTURE RESEARCH AND THIS CONFERENCE**

#### **MAIN HIGHLIGHTS FROM PRESENTATIONS:**

##### **Future research needs**

- More evidence-based research that makes convincing recommendations
- Better documentation of results
- Capacity building in research: including training of scientists
- More investments: laboratory/field equipment
- Improved quality of research, better methodology
- We need both basic (to understand processes better) and applied (to better implement knowledge) research
- Need for more long-term research, permanent plots: require secured funding
- Better involvement of farmers: Enable them to make rational decisions (farmer must be involved in the research process).
- Establishment of a coordinated research network on food security and CC
- Involve African Union in research, like EU is involved in research in Europe

##### **More knowledge needed**

- Synthesis of research-based knowledge, to create a platform for future research directions
- Improved knowledge on balanced plant nutrient management, nutrient efficiency, soil water management, under changing climate (particular precipitation).
- Better understanding of effects of changing conditions that are different from the conditions that current knowledge is based on (e.g. changes in precipitation, pests, need for new crop species)
- Improved understanding on efficiency and consequences of integrated agriculture, involving, crops, livestock and agroforestry
- Need for more truly inter-disciplinary research and knowledge: social sciences, gender issues, implementation of improved agricultural practices on farm, adaptation to change.
- More monitoring of changes (e.g. satellite images) other than forest cover (e.g. soil organic carbon)

## Conference

- Need to be continued and arranged on a regular basis
- Can contribute to establish a regional climate change-impact/food security research network
  - Country-based coordinators: identify research gaps, make research priorities that are relevant to region
    - Can spur a concerted action towards knowledge needs
  - Raise awareness among policy makers, disseminate knowledge (also in local language)
  - Promote attendance and visibility on international and regional conferences
  - Recommend to host conference where all participants stay together + excursion in order to improve communication and socio-scientific interactions

## Session No. 7

### SESSION THEME: NUTRIENT AND WATER MANAGEMENT FOR SOIL CARBON SEQUESTRATION

#### MAIN HIGHLIGHTS FROM PRESENTATIONS:

##### Key Note Speech

- Nutrient supply (N fertilization, manure) in combination with conservation tillage (no-tillage, crop residue) are key to SOC sequestration
- The magnitude would vary depending on the type of fertilization, tillage, and climate . . .
- Water harvesting and irrigation are also key to SOC sequestration
- SOC sequestration is just a short term strategy to climate change mitigation

##### Nutrient and water management for SOC sequestration

- Like the keynote speech, recommended nutrient and water management practices for SOC sequestration were advocated
- But here, site-specific RMPs and international collaboration efforts emphasized

##### Quantitative approaches for mapping the prevalence of land degradation and soil conditions in EA

- Landscape assessment is effective for understanding the complexity of ecosystem and soil health:



- This was illustrated by soil degradation (erosion) and properties (SOC, pH, sand content) maps for EA that were extracted using a combination of machine learning and ensemble techniques, soil spectroscopy, remote sensing imagery (Landsat, MODIS) and limited soil data

### **Development of SOC map based on NAFORMA and non-NAFORMA datasets for Tanzania**

- Another approach for understanding soil health (Different from Tor-Gunnar's approach)
- . . . That spatial distribution of SOC can be mapped at unvisited locations using a combination of environmental data, regression-kriging (geostatistics), limited soil survey data and FOSS
- Unlike Tor-Gunnar, Kaaya's presentation covered Tanzania only with high sampling density
- Application of such methods at national scale need concerted/collaborative efforts

### **SOC and TN contents and dynamics under different land uses in semi-arid watershed in northern Ethiopia**

- Since SOC and TN were higher in the topsoils, land use change in favour of cultivation NOT advisable in Tigray
- SOC and TN can be increased using RMPs, and land use change in favour of open pastures or silvo-pastures in Tigray

## **Session No. 8**

### **SESSION THEME:**

### **MAIN HIGHLIGHTS FROM PRESENTATIONS:**

#### **Common Themes**

- The significance of small holder vulnerability:
  - The ability to cope
- Identifying and implementing adaptation strategies
- Strengthening adaptive capacity:
  - Supporting partners and infrastructure
  - Providing technology transfer, education and training

#### **Differences**

- Most of the presenters identified broad strategies
- Only one focused on specific on-farm soil and water conservation technologies for sorghum and pearl millet

- Responses to climate change could be initiated at the global, national, community or household levels
- Not every one focused on climate change and its perception by scientists and farmers
- Recognition of increasing external dependence of adapting production systems

### **Take Aways**

- The importance of political will to achieve a small holder Green Revolution
- We all need knowledge based in social science to address climate change and small holder vulnerability
- The supporting infrastructure: input systems, output markets, scientific information, micro-finance
- Sustainable Intensification includes: Genetic; Ecological; and Socio-Economic dimensions
- The importance of seasonality for household roles in production system dynamics

## **Session No. 9**

**SESSION THEME: HUMAN DIMENSION OF TERRESTRIAL CARBON MANAGEMENT: GENDER, SOCIO-ECONOMIC FACTORS**

### **MAIN HIGHLIGHTS FROM PRESENTATIONS:**

#### **Common Themes**

- Humans activities aggravate the problem of TC
- Humans are affected by impacts of TC;
- Humans are adapting as affected; gender dynamics of adaptation; the role of markets for adaption and adoption
- Need to broaden and deepen gender analysis frameworks on impacts and outcome of proposed solutions
- Participation in seeking and implementing solutions happening; but marginal as solutions become complex conceptually
- Inclusion and clear gains enhance adoption
- Need to more efforts to institutionalize inclusion at various levels, and clarify gains at local level

#### **Differences**

- Different levels of analysis; case studies, analytical models, Assumptions
- Difference in taking local impacts into national and global analytical frameworks and proposed solutions

### Take Home Messages

- Inclusion is important
- As we take solutions down to local level;
- Keep it simple with clear tangible benefits

## Session No. 10

### SESSION THEME: REHABILITATION OF DEGRADED LANDS THROUGH FORESTRY AND AGROFORESTRY

#### MAIN HIGHLIGHTS FROM PRESENTATIONS:

##### Abstract

- The global debate to articulate the post 2015 Sustainable Development Goals has brought to the fore the critical role of land regeneration as the foundation to:
  - Achieving food security for the poorest
  - Build more sustainable
  - Resilient farming systems
- Based on agroecological principles
- EverGreen Agriculture is now emerging as an affordable and accessible science-based solution to:
  - Regenerate the land on small-scale farms
  - Increasing family food production
  - Increasing family cash income
- It is a form of more intensive farming that integrates trees into crop and livestock systems at the field, farm, and landscape levels
- EverGreen farming systems feature both perennial and annual species (food crops with trees)
- Millions of women and men farmers in various countries in Africa (i.e. Burkina Faso, Mali, Niger, Zambia etc.) are already practicing Ever-Green Agriculture
- In Niger, *Faidherbia* – dominate Agroforestry trees on croplands have recently spread via farmer-to-farmer diffusion, to over five million hectares, and in Mali, such regenerating parklands have recently been mapped to cover over 450,000 ha. There is evidence that they are now covering millions more hectares in other countries.
- The Malawi Agroforestry Food Security Programme is integrating a portfolio of trees for:
  - Fertilizer,
  - Fodder,

- Fruit,
- Fuelwood, and
- Timber production
- With food crops on small farms at a national scale, having reached 200,000 farm families during its first 5 years. Farmers' maize yields increased from 1.5 to 3.1 tons $\text{ha}^{-1}$
- Seventeen African countries are now either implementing or developing national EverGreen Agriculture scaling-up initiatives, along with India and Sri Lanka in South Asia.
- A Partnership to Create an EverGreen Agriculture, has emerged as a broad alliance of :
  - Governments,
  - International organizations
  - Research institutions
  - International and local development NGO partners
- To support the information needs, capacity building, and knowledge generation to further accelerate the scaling-up of EverGreen Agriculture throughout Africa and Asia

**1. Presenter: Birger Solberg, Department of Ecology and Natural Resource Management, Norwegian University of Life Sciences, Norway.**

Title of paper: Rehabilitation of Degraded Lands through Forestry and Agroforestry – Can Forest Economic contribute?

- The paper noted that Forestry and Agroforestry were of high interest in rehabilitation of degraded land – noting that the silvicultural and ecological aspects have been the main concern in such rehabilitation
- Wondered whether including economic analysis would be of interest in the work, focusing on:
  - What resource economics potentially can contribute
  - The choice between various rehabilitation regimes

**2. Presenter: Mateugue Diack, Soil Scientist, University Gaston Berger, Saint Louis, Senegal**

Paper title: Climate change and restoration of Salinized Lands: Impacts on Food Security in the River Valley, Senegal

- Looked at the effects of management practices in fragile areas to climate change by varying temperatures, relative humidity, solar radiation, soil temperature Etc
- Results indicated regular seasonal cropping under irrigation, assured sustainable food security

**3. Presenter: Habibou, M.G. Mohamadou, Niger**

Paper title: Rehabilitation of degraded Lands in Niger through Forestry and Agroforestry

- About 75 % of Niger is covered by dessert
- Continues to face high land degradation due to human activities and climate change
- Forms of degradation include gullying, sand dunes, siltation of water leading to
  - Loss in productivity and biodiversity
  - Desertification
  - Poverty
- Interventions through Agroforestry to stabilize and fix sand dunes, gully banks, protection and promotion of natural regeneration
- Have
  - Recovered back >250,000
  - Provided local knowledge and skills
- Results include reduction in soil erosion, increased production of fuel wood, fodder, increased fertility, improvement in the livelihood of the local people in general

# Session Slides

Session 2: Jennifer Olsen

## Session II Ecoregions/ Biomes of Sub-Saharan Africa

Abe Goldman  
Method Kilasara  
Daniel Mengistu  
Yazidhi Bamutaze

## Common Points

- Big gap between current and projected future food production, and current and future food needs.
- Current low soil productivity is a big barrier to increased production. Climate change will exasperate soil degradation, yet resilience to drought and hunger depends on high SOM. Need to change how we manage our soils.
- However, high spatial heterogeneity in soils, landscapes, human land use, etc. in SSA. Need to target interventions to local situation.

## Differences between Presenters

How can we best increase productivity?

- Add Nitrogen fertilizer (lots). But, we need to consider cost and many other factors. Or,
- Identify locations of high risk of soil degradation, and work there. But, need to use best available data, and need to integrate physical/social information, to be useful. Or,
- Reduce nutrient depletion through use of emerging nano- and bio-technologies. But, how can this technology reach small scale farmers?

## Therefore, lessons learned

- Soil productivity is the key to increased production.
- The gap between current and potential yields, and the gap between actual and needed yields to feed people, can be breached with better soil management.
- This will become more difficult, and even more important, with the effects of climate change.
- A combination of “traditional” (SWC, chem. fertilizer, manure) and new technologies need to be applied in high-risk zones. Requires supportive policy, economic, infrastructure, etc. environment.

## **Session 3: Didas N. Kimaro**

# **SUMMARY OF PRESENTATIONS SESSION III**

## **RECORDER: DIDAS N. KIMARO**

**Climate Change, Sustainable Intensification and Food Security in Sub-Saharan Africa Conference, Nashera Hotel, Morogoro, Tanzania, 13-15 Nov 2013**

### **Specific Issues**

#### **LandPKS**

❖ Knowledge Engine supported by global databases & models including use of Internet and mobile phones to tap the land potential opportunities (increase production and eliminate degradation)

#### **Effects of land cover changes on soil organic carbon and nitrogen stocks**

The need to:

❖ formulate realistic and effective policies for sustainable land management and climate change mitigation

❖ design and implement pertinent location-specific and sustainable land management and C sequestration policies



**The paper on Farming Systems in Tanzania**

❖ Calls for the need to re-categorize the farming systems in the context of dynamic livelihood options at fine scale

**Conservation Agriculture, Climate-Smart Agriculture, Organic Farming**

❖ Observed that potential adoption of CA by small holder farmers in the SSA is limited despite its benefits

❖ CA seems to have a better potential to feed the African mass if adoption by smallholder farmers is improved by adapting local practices coupled with formation of agricultural innovation platforms that involve the Public Private Partnerships (PPP model)

**Commonality**

The papers emphasised on identification and access to local and scientific knowledge and information about land potential with respect to knowledge and information relevant to each type of land/soil with full participation of stakeholders (multi-stakeholder approach) i.e. people with similar types of lands and challenges (landscape approach), public and private sector (formation of innovation platforms) etc.

**The presented papers calls for:**

- ❖ Research on management systems associated with specific types of land, current soil conditions, and climate for guiding grazing management, crop inputs, biodiversity conservation; restoration of degraded lands, land use planning & Management and provision of subsidy/incentives
  
- ❖ Formulation of realistic and effective policies for sustainable land management and climate change adaptation/mitigation at fine scale

**Session 5: Summary****Session 5, Summary**

Main speaker, Daniel Mushi from SUA gave a good overview over the potential for reduced emission from the Tanzanian livestock sector.

His main message was: **Intensification of livestock production provides large opportunities for CC mitigation and can reduce GHG emissions from deforestation.**

Other important key points were:

- Overgrazing (desertification) causes vegetative loss and soil trampling and lead to loss of biodiversity and net emission of CO<sub>2</sub>
- Land-use changes, including expansion of pasture and arable land for feed crops gives rise to CO<sub>2</sub> emission Important with quality roughages and conservation of feed for dry season use
- Focus for ruminant systems should be on the utilization of feed resources not competing with man or monogastric animals.

First panel presenter, Ismail Selemani, underlined the message from Mushi giving examples from recent studies he had undertaken on strategies for improved productivity of beef in Tanzania. Main findings were:

Traditional coping strategies, set aside area ngitili on communal land did not improve range productivity compared with continuous grazing while ngitili on private ground had a positive effect.

Supplementary feeding of grazing cattle using concentrate or wheat straw did improve growth rate, meat quality and reduced time spent searching for feed on pasture.

Second panel presenter, Alberto Bernues' focused on multifunctional livestock systems and carbon footprint of lamb meat based on research work in Spain. When calculated solely per unit of meat, GHG emission decreased with increasing intensity of production. However when deliveries of public goods and biodiversity were taken into account, the more extensive systems came out favourably. This presentation also gave an insight in choice modelling as a tool for valuating public services from different production systems.

The last presentation by Fanny Chigwa was given by Lars Olav Eik. Various suckling systems and supplementary feeding of goat kids were compared. The distribution of milk between goat kids and human consumption depends on system of goat rearing practiced. Dairy goat keeping has become particularly important in Tanzania and is seen as a sustainable intensification compared with traditional meat goats.

## Session 7: Kennedy Were

# SESSION VII: NUTRIENT AND WATER MANAGEMENT FOR SOIL CARBON SEQUESTRATION

## KEY NOTE SPEECH (BR Singh)

- Nutrient supply (N fertilization, manure) in combination with conservation tillage (no-tillage, crop residue) are key to SOC sequestration
- The magnitude would vary depending on the type of fertilization, tillage, and climate ...
- Water harvesting and irrigation are also key to SOC sequestration
- SOC sequestration is just a short term strategy to climate change mitigation

### Nutrient and water management for SOC sequestration (Patrick Aina)

- Like the keynote speech, recommended nutrient and water management practices for SOC sequestration were advocated
- But here, **site-specific** RMPs and international collaboration efforts emphasized

### Quantitative approaches for mapping the prevalence of land degradation and soil conditions in EA (Tor-Gunnar Vågen)

- Landscape assessment is effective for understanding the complexity of ecosystem & soil health:
  - This was illustrated by soil degradation (erosion) & properties (SOC, pH, sand content) maps for EA that were extracted using a combination of machine learning & ensemble techniques, soil spectroscopy, remote sensing imagery (Landsat, MODIS) and limited soil data

### Development of SOC map based on NAFORMA and non-NAFORMA datasets for Tanzania (Abel Kaaya)

- Another approach for understanding soil health (Different from Tor-Gunnar's approach)
- ... That spatial distribution of SOC can be mapped at unvisited locations using a combination of environmental data, regression-kriging (geostatistics), limited soil survey data & FOSS
- Unlike Tor-Gunnar, Kaaya's presentation covered Tanzania only with high sampling density
- Application of such methods at national scale need concerted/ collaborative efforts ...

### SOC and TN contents and dynamics under different land uses in semi-arid watershed in northern Ethiopia (Aweke Gelaw)

- Since SOC and TN were higher in the topsoils, land use change in favour of cultivation NOT advisable in Tigray
- SOC and TN can be increased using RMPs, and land use change in favour of open pastures or silvo-pastures in Tigray

**Session 9: Aida****Session IX****Human dimension of Terrestrial  
Carbon Management: Gender,  
socio-economic Factors****Common Themes**

- Humans activities aggravate the problem of TC
- Humans are affected by impacts of TC;
- Humans are adapting as affected; gender dynamics of adaptation; the role of markets for adaption and adoption
- Need to broaden and deepen gender analysis frameworks on impacts & outcome of proposed solutions
- Participation in seeking and implementing solutions happening; but marginal as solutions become complex conceptually
- Inclusion & clear gains enhance adoption
- Need to more efforts to institutionalize inclusion at various levels, and clarify gains at local level

**Differences**

- different levels of analysis; case studies, analytical models, Assumptions
- Difference in taking local impacts into national & global analytical frameworks and proposed solutions

**Take home messages**

- Inclusion is important
- As we take solutions down to local level;  
**KEEP IT SIMPLE WITH CLEAR TANGIBLE BENEFITS**

## Session Recaps

### Climate change, sustainable Intensification & Food Security in SSA

Session 1 report  
CHANGING CLIMATE, SOIL  
DEGRADATION AND FOOD SECURITY IN  
SUB-SAHARAN AFRICA

## MAIN HIGHLIGHTS FROM PRESENTATIONS

- **Characteristics of SSA:**
  - Africa is a large continent: Larger than combined area of USA, Europe, China and South East Asia
  - Relatively lower population compared to those of China or India (>1 billion)
  - More than 48% of population living below poverty line
  - 25% percent of population food insecure and still increasing
- **Huge unexploited potential:**
  - Large and suitable agricultural area not yet exploited
  - Very diverse eco-regions- can support various crops / agric activities
  - Very small area currently under irrigation (3.8% of potential)
  - Low use of fertilizer in production
  - Huge amounts of organic wastes in cities could sustainably support urban agriculture



## Challenges:

- Land degradation rate highest in the world at > x2 global average
- Very high rates of population increase
- Undernourishment wide spread
- Economic, Social and Political Forces affecting Soil Management Policy
  
- Climate change amplifying exiting stresses:
  - Declining yield
  - SSA to account for 65% of projected global related hunger related crisis
  - SOC decreasing while erosion increasing (Bio-engine of Earth/ soil declining)
  - Biodiversity declining
  - Negative (-ve) soil nutrient budget
  
- **Way forward:**
- Produce more using less of available resources
- Multi-Path strategy required for sustainable intensification to achieve climate resilient agriculture incorporating but not limited to:
  - Conservation Agriculture
  - Agroforestry
  - Micro-irrigation
  - Balanced and Integrated Nutrient Management
  - Precision Farming
  - Use of GMOs

## Session II Ecoregions/ Biomes of Sub-Saharan Africa

Abe Goldman  
Method Kilasara  
Daniel Mengistu  
Yazidhi Bamutaze

### Common Points

- Big gap between current and projected future food production, and current and future food needs.
- Current low soil productivity is a big barrier to increased production. Climate change will exasperate soil degradation, yet resilience to drought and hunger depends on high SOM. Need to change how we manage our soils.
- However, high spatial heterogeneity in soils, landscapes, human land use, etc. in SSA. Need to target interventions to local situation.

### Differences between Presenters

How can we best increase productivity?

- Add Nitrogen fertilizer (lots). But, we need to consider cost and many other factors. Or,
- Identify locations of high risk of soil degradation, and work there. But, need to use best available data, and need to integrate physical/social information, to be useful. Or,
- Reduce nutrient depletion through use of emerging nano- and bio-technologies. But, how can this technology reach small scale farmers?

## Therefore, lessons learned

- Soil productivity is the key to increased production.
- The gap between current and potential yields, and the gap between actual and needed yields to feed people, can be breached with better soil management.
- This will become more difficult, and even more important, with the effects of climate change.
- A combination of “traditional” (SWC, chem. fertilizer, manure) and new technologies need to be applied in high-risk zones. Requires supportive policy, economic, infrastructure, etc. environment.

### **SUMMARY OF PRESENTATIONS SESSION III**

**RECORDER: DIDAS N. KIMARO**

**Climate Change, Sustainable Intensification and  
Food Security in Sub-Saharan Africa Conference,  
Nashera Hotel, Morogoro, Tanzania, 13-15 Nov  
2013**

## Specific Issues

### LandPKS

❖ Knowledge Engine supported by global databases & models including use of Internet and mobile phones to tap the land potential opportunities (increase production and eliminate degradation)

### Effects of land cover changes on soil organic carbon and nitrogen stocks

The need to:

- ❖ formulate realistic and effective policies for sustainable land management and climate change mitigation
- ❖ design and implement pertinent location-specific and sustainable land management and C sequestration policies

### The paper on Farming Systems in Tanzania

❖ Calls for the need to re-categorize the farming systems in the context of dynamic livelihood options at fine scale

### Conservation Agriculture, Climate-Smart Agriculture, Organic Farming

❖ Observed that potential adoption of CA by small holder farmers in the SSA is limited despite its benefits

❖ CA seems to have a better potential to feed the African mass if adoption by smallholder farmers is improved by adapting local practices coupled with formation of agricultural innovation platforms that involve the Public Private Partnerships (PPP model)

## **Commonality**

The papers emphasised on identification and access to local and scientific knowledge and information about land potential with respect to knowledge and information relevant to each type of land/soil with full participation of stakeholders (multi-stakeholder approach) i.e. people with similar types of lands and challenges (landscape approach), public and private sector (formation of innovation platforms) etc.

### **The presented papers calls for:**

- ❖ Research on management systems associated with specific types of land, current soil conditions, and climate for guiding grazing management, crop inputs, biodiversity conservation; restoration of degraded lands, land use planning & Management and provision of subsidy/incentives
  
- ❖ Formulation of realistic and effective policies for sustainable land management and climate change adaptation/mitigation at fine scale

# Measuring the impact of climate change on agronomic productivity

Session IV

Session summary report

Mutabazi, K. and Tumbo Siza

## Outline

- A brief introduction
- Key messages – similarities
- Key messages – differences
- Synthesized take away messages

## A brief introduction

- Three deliberations were made – a keynote and 2 panel presentations
- Keynote speaker addressed:
  - Methods of assessing CC impacts on crop productivity
  - Application of integrated assessments to estimate impacts in the East Africa
- First panel ppt covered site-specific prediction of CC impacts on maize using downscaled GCMs and crop models
- Second panel ppt addressed approaches to reinforce crop productivity under water-limited conditions in sub-humid environments

## Key messages – similarities

- Empirical assessments of climate impacts in agriculture are complex across scales: global, regional, national, sub-national and local
  - Prediction uncertainties underlying models
  - Dynamics of climate, social and biophysical systems
  - Modeling knowledge required
- Estimated impacts of climate change on rainfed crop agriculture vary depending on scale of analysis over space and through time
- Integrated assessments combining models and agronomic approaches are critical

## Synthesized take away messages

- Integrated assessment approach is critical in assessment complex climate change impacts
- Higher-level modeling has to be downscaled to inform site-specific impacts and responses
- Assessment of impacts have to be extended beyond the biophysical spheres to bring into the picture the “people”: livelihoods and human complex decision processes

Thank you  
Asante sana

## Session 5, Summary

Main speaker, Daniel Mushi from SUA gave a good overview over the potential for reduced emission from the Tanzanian livestock sector.

His main message was: **Intensification of livestock production provides large opportunities for CC mitigation and can reduce GHG emissions from deforestation.**

Other important key points were:

- Overgrazing (desertification) causes vegetative loss and soil trampling and lead to loss of biodiversity and net emission of CO<sub>2</sub>
- Land-use changes, including expansion of pasture and arable land for feed crops gives rise to CO<sub>2</sub> emission Important with quality roughages and conservation of feed for dry season use
- Focus for ruminant systems should be on the utilization of feed resources not competing with man or monogastric animals.

First panel presenter, Ismail Selemani, underlined the message from Mushi giving examples from recent studies he had undertaken on strategies for improved productivity of beef in Tanzania. Main findings were:

Traditional coping strategies, set aside area ngitili on communal land did nor improve range productivity compared with continuous grazing while ngitili on private ground had a positive effect.

Supplementary feeding of grazing cattle using concentrate or wheat straw did improve growth rate, meat quality and reduced time spent searching for feed on pasture.

Second panel presenter, Alberto Bernues' focused on multifunctional livestock systems and carbon footprint of lambs meat based on research work in Spain. When calculated solely per unit of meat, GHG emission decreased with increasing intensity of production. However when deliveries of public goods and biodiversity were taken into account, the more extensive systems came out favourably. This presentation also gave an insight in choice modelling as a tool for valuating public services from different production systems.



The last presentation by Fanny Chigwa was given by Lars Olav Eik. Various suckling systems and supplementary feeding of goat kids were compared. The distribution of milk between goat kids and human consumption depends on system of goat rearing practiced. Dairy goat keeping has become particularly important in Tanzania and is seen as a sustainable intensification compared with traditional meat goats.

## **SESSION VII: NUTRIENT AND WATER MANAGEMENT FOR SOIL CARBON SEQUESTRATION**

### **KEY NOTE SPEECH (BR Singh)**

- Nutrient supply (N fertilization, manure) in combination with conservation tillage (no-tillage, crop residue) are key to SOC sequestration
- The magnitude would vary depending on the type of fertilization, tillage, and climate ...
- Water harvesting and irrigation are also key to SOC sequestration
- SOC sequestration is just a short term strategy to climate change mitigation

**Nutrient and water management for SOC sequestration  
(Patrick Aina)**

- Like the keynote speech, recommended nutrient and water management practices for SOC sequestration were advocated
- But here, **site-specific** RMPs and international collaboration efforts emphasized

**Quantitative approaches for mapping the prevalence of land degradation and soil conditions in EA  
(Tor-Gunnar Vågen)**

- Landscape assessment is effective for understanding the complexity of ecosystem & soil health:
  - This was illustrated by soil degradation (erosion) & properties (SOC, pH, sand content) maps for EA that were extracted using a combination of machine learning & ensemble techniques, soil spectroscopy, remote sensing imagery (Landsat, MODIS) and limited soil data

**Development of SOC map based on NAFORMA and non-NAFORMA datasets for Tanzania  
(Abel Kaaya)**

- Another approach for understanding soil health (Different from Tor-Gunnar's approach)
- ... That spatial distribution of SOC can be mapped at unvisited locations using a combination of environmental data, regression-kriging (geostatistics), limited soil survey data & FOSS
- Unlike Tor-Gunnar, Kaaya's presentation covered Tanzania only with high sampling density
- Application of such methods at national scale need concerted/ collaborative efforts ...

**SOC and TN contents and dynamics under different land uses in semi-arid watershed in northern Ethiopia  
(Aweke Gelaw)**

- Since SOC and TN were higher in the topsoils, land use change in favour of cultivation NOT advisable in Tigray
  
- SOC and TN can be increased using RMPs, and land use change in favour of open pastures or silvo-pastures in Tigray

## Common Themes

- The significance of small holder **vulnerability**:
  - **the ability to cope**
- Identifying and implementing **adaptation strategies**
- Strengthening **adaptive capacity**:
  - supporting **partners and infrastructure**
  - providing **technology transfer, education and training**

## Differences

- Most of the presenters identified broad strategies
- Only one focused on specific on-farm soil and water conservation technologies for sorghum and pearl millet
- Responses to climate change could be initiated at the global, national, community or household levels
- Not every one focused on climate change and its perception by scientists and farmers
- Recognition of increasing external dependence of adapting production systems

## Take Aways

- The importance of political will to achieve a small holder Green Revolution
- We all need knowledge based in social science to address climate change and small holder vulnerability
- The supporting infrastructure: input systems, output markets, scientific information, micro-finance
- Sustainable Intensification includes: Genetic; Ecological; and Socio-Economic dimensions
- The importance of seasonality for household roles in production system dynamics

## Session IX

### Human dimension of Terrestrial Carbon Management: Gender, socio-economic Factors

## Common Themes

- Humans activities aggravate the problem of TC
- Humans are affected by impacts of TC;
- Humans are adapting as affected; gender dynamics of adaptation; the role of markets for adaption and adoption
- Need to broaden and deepen gender analysis frameworks on impacts & outcome of proposed solutions
- Participation in seeking and implementing solutions happening; but marginal as solutions become complex conceptually
- Inclusion & clear gains enhance adoption
- Need to more efforts to institutionalize inclusion at various levels, and clarify gains at local level

## Differences

- different levels of analysis; case studies, analytical models, Assumptions
- Difference in taking local impacts into national & global analytical frameworks and proposed solutions

## Take home messages

- Inclusion is important
  - As we take solutions down to local level;
- KEEP IT SIMPLE WITH CLEAR TANGIBLE BENEFITS

## SESSION X: Rehabilitation of Degraded Lands through Forestry and Agroforestry

### Abstract

The global debate to articulate the post 2015 Sustainable Development Goals has brought to the fore the critical role of land regeneration as the foundation to:

- Achieving food security for the poorest
- Build more sustainable
- Resilient farming systems

Based on agroecological principles EverGreen Agriculture is now emerging as an affordable and accessible science-based solution to:

- Regenerate the land on small-scale farms
- Increasing family food production
- Increasing family cash income

It is a form of more intensive farming that integrates trees into crop and livestock systems at the field, farm, and landscape levels.

EverGreen farming systems feature both perennial and annual species (food crops with trees) Millions of women and men farmers in various countries in Africa (i.e. Burkina Faso, Mali, Niger, Zambia etc.) are already practicing EverGreen Agriculture

In Niger, Faidherbia –dominate Agroforestry trees on croplands have recently spread via farmer-to-farmer diffusion, to over 5 million hectares, and in Mali, such regenerating parklands have recently been mapped to cover over 450,000 hectares. There is evidence that they are now covering millions more hectares in other countries.

The Malawi Agroforestry Food Security Programme is integrating a portfolio of trees for:

- fertilizer,
- fodder,
- fruit,
- fuelwood, and
- timber production

with food crops on small farms at a national scale, having reached 200,000 farm families during its first 5 years. Farmers' maize yields increased from 1.5 to 3.1 tons/ha<sup>-1</sup>

Seventeen African countries are now either implementing or developing national EverGreen Agriculture scaling-up initiatives, along with India and Sri Lanka in South Asia.

A Partnership to Create an EverGreen Agriculture, has emerged as a broad alliance of :

- Governments,
- International organizations
- Research institutions
- International and local development NGO partners

to support the information needs, capacity building, and knowledge generation to further accelerate the scaling-up of EverGreen Agriculture throughout Africa and Asia

The KeyNote presentation was followed by other three panel presentations as follows:

**1 Presenter:** Birger Solberg, Department of Ecology and Natural Resource Management, Norwegian University of Life Sciences, Norway.

**Title of paper:** Rehabilitation of Degraded Lands through Forestry and Agroforestry – Can Forest Economic contribute?

The paper noted that Forestry and Agroforestry were of high interest in rehabilitation of degraded land – noting that the silvicultural and ecological aspects have been the main concern in such rehabilitation

Wondered whether including economic analysis would be of interest in the work, focusing on: what resource economics potentially can contribute

The choice between various rehabilitation regimes

## **2 Presenter:** Mateugue Diack, Soil Scientist, University Gaston Berger, Saint Louis, Senegal

**Paper title:** Climate change and restoration of Salinized Lands: Impacts on Food Security in the River Valley, Senegal

Looked at the effects of management practices in fragile areas to climate change by varying temperatures, relative humidity, solar radiation, soil temperature, Etc

Results indicated regular seasonal cropping under irrigation, assured sustainable food security

**3 Presenter:** Habibou, M.G. Mohamadou, Niger

**Paper title:** Rehabilitation of degraded Lands in Niger through Forestry and Agroforestry

About 75% of Niger is covered by dessert

Continues to face high land degradation due to human activities and climate change

Forms of degradation include gullyng, sand dunes, siltation of water leading to

Loss in productivity and biodiversity

Dessertification

Poverty

Interventions through Agroforestry to stabilize and fix sand dunes, gulley banks, protection and promotion of natural regeneration

have

Recovered back > 250,000

Provided local knowledge and skills

Results include reduction in soil erosion, increased production of fuel wood, fodder, increased fertility, improvement in the livelihood of the local people in general



# Index

## A

- Abdel Aziz, T.M., 152, 154  
Adam, T., 82  
Adaptation, 3–14, 77, 78, 81, 82, 85,  
90–95, 98–101, 103–106, 139,  
167–171, 177, 179, 187, 188,  
190–197, 199, 203, 204, 276,  
277, 301, 312, 321, 346, 360–362,  
399, 400, 407–423, 467–484,  
509, 515, 516, 521–528, 535,  
536, 568, 587–598, 605, 608,  
614, 620, 622, 625  
Adaptation strategies, 12, 85, 93, 98, 99,  
101, 167, 171, 180, 185, 190,  
197, 207, 216, 413, 467, 469,  
471, 480–484, 519, 522,  
587–591, 598, 624  
Adaptive capacity, 138, 186, 188, 190, 196,  
202, 483, 484, 515  
Ådnøy, T., 367–379  
Africa, 3, 21, 46, 64, 75, 115, 138, 165,  
186, 202, 223, 235, 257, 276,  
290, 305, 317, 332, 335, 370,  
400, 410, 428, 442, 468,  
489, 516, 534, 556, 573,  
588, 604  
Agrawal, A., 524, 525  
Agricultural carbon, 489–510  
Agricultural Production Systems sIMulator  
(APSIM), 172, 206–210  
Agriculture, 4, 22, 46, 64, 76, 138, 167,  
186, 202, 223, 236, 256, 276,  
306, 332, 346, 368, 386, 417,  
428, 442, 468, 490, 516, 534,  
556, 574, 589, 604  
Agroforestry, 11, 12, 50, 52, 53, 58, 64–70,  
168, 196, 290–291, 294, 295,  
306–308, 312, 490, 493, 498–501,  
506, 507, 525, 534, 608, 610, 618,  
622, 626–628  
Agronomic productivity, 156, 204,  
604–606, 620  
Aguilera, J.F., 376  
Ainsworth, E.A., 176  
Akinifesi (2009), 301  
Akinnifesi, F.K., 12  
Altitude levels, 559, 560  
Amuri, N.A., 385–401  
Anthropogenic activities, 202, 346  
Antinori, C., 548  
Anyanga, J.O., 537  
APSIM. *See* Agricultural Production Systems  
sIMulator (APSIM)  
Ard plow, 229  
Asymmetric information, 533–551  
Atela, J.O., 499, 509  
Aticho, A., 324  
Aune, J.B., 223–232  
Awulachew, S.B., 152–154
- ## B
- Baaru, M.W., 165–180  
Bagoora, F.D.K., 37  
Baize, D., 320  
Bamutaze, Y., 21–41  
Banana, 10, 27, 37, 290–293, 297, 298, 301,  
558–560, 562, 564, 565, 567, 577  
Barrett, C., 103  
Barrow, E., 590

- Basin tillage, 228, 268  
 Bationo, A., 12  
 Baublits, R.T., 379  
 Bauder, J.W., 261  
 Bayala, J., 12  
 Beh, A., 407–423  
 Bekunda, M., 235–251, 290  
 Benhin, J., 77  
 Bernués, A., 343–363  
 Bettany, E.T., 66  
 Bewket, W., 137–160  
 Blue Nile Basin, 150, 152  
 Boa, M.E., 255–269  
 Boccard, R., 372  
 Bonding social capital, 518, 521, 528  
 Borlaug, N.E., 6  
 Botha, G.A., 268  
 Bourguet, C., 371  
 Bremner, J.M., 319  
 Brentrup, F., 441–464  
 Brhane, G., 149  
 Bridging social capital, 521  
 Bruns, K.W., 379  
 Bundy, L.G., 8  
 Bwana, T.N., 390
- C**
- Campbell, B., 175  
 Capacity, 4, 51, 56, 82, 98, 101, 103, 104, 106, 114, 115, 130, 138–140, 166, 169, 172, 180, 186–188, 190, 196, 202, 210, 226, 229, 237, 239, 251, 269, 279, 301, 306, 320, 346, 358, 361, 387, 390, 391, 397, 398, 400, 407, 409, 411, 412, 414, 415, 418, 420, 429, 430, 442, 451, 453, 454, 463, 468, 469, 477, 483, 484, 490, 497, 499, 507, 509, 515, 519, 521, 522, 525, 527, 541, 544, 575, 577, 580–582, 584, 606, 608, 613, 622, 624, 627  
 Capitals, 11, 76, 91, 92, 100, 101, 106, 213, 232, 276, 290, 350, 387, 444, 484, 516–524, 526, 528, 529, 535, 538, 539, 614  
 Carbon credits, 489, 491–495, 497, 498, 501, 504–506, 508–510  
 Carbon market, 413, 490–493, 497, 502, 505, 509, 573–585  
 Carbon sequestration, 12–14, 64, 71, 114, 130, 311–313, 344, 356, 397, 408, 490–492, 494, 496, 497, 508, 510, 575, 578, 582–585, 610, 613, 623
- Carcass, 367–379  
 CBA. *See* Cost–benefit analysis (CBA)  
 Central semi-arid Tanzania, 259  
 Century model, 575  
 Chambers, R., 190, 194, 558  
 Chambuya, R., 441–464  
 Charollais, M., 284  
 Chigwa, F.C., 331–340  
 Chikowo, R., 235–251  
 Choi, S.W., 575  
 Christiansson, C., 390  
 Clavero, T., 378  
 Clements, C., 489–510  
 Climate change, 3, 22, 46, 64, 76, 114, 137, 165, 185, 201, 226, 257, 276, 301, 305, 316, 343, 387, 407, 426, 441, 467, 489, 515, 534, 565, 577, 587, 604  
 Climate change impact and adaptation, 196, 469, 476, 484  
 Climate change impacts, 14, 180, 185–199, 201–217, 401, 408, 468, 469, 476, 484, 588, 596, 623  
 Climate smart agriculture, 196, 400, 490, 507, 619  
 CMD, 146  
 Coghlan, A., 12  
 Community organizations, 521, 522, 553, 614  
 Concentrate, 47, 280, 333, 336–339, 344, 350, 356, 368–371, 373, 375, 377–379, 539, 615, 621  
 Conflict and soil degradation, 414, 415  
 Consumption, 228, 290, 332, 334, 352, 361, 408, 442, 443, 454, 519, 521, 525, 595, 622  
 Conway, G.R., 11, 195, 196, 558  
 Cooper, P. J. M., 207  
 Coping, 171, 205, 216, 360–362, 399, 468, 471, 482, 515, 516, 521, 523, 524, 537, 589, 613, 621  
 Cooper et al. (2008), 205  
 Cosel, C.L., 324  
 Cost–benefit analysis (CBA), 89, 90, 102, 575  
 Coulibaly, A., 223–232  
 Cronquist, I., 394  
 Crop  
   adaptation, 426  
   simulation model, 90, 201–217  
   yields, 4, 6, 9, 10, 22, 29, 48, 64, 101, 103, 105, 165–180, 186, 203, 245, 247, 249, 251, 260, 268, 269, 307, 348, 411, 414, 425–438, 442, 451, 454, 455, 463, 556, 575, 579, 582, 584

**D**

- Davis, R., 429  
 De Meyer, A., 37  
 De Schutter, O., 516  
 Deforestation, 11–13, 46–48, 50, 57, 64, 71, 83,  
   84, 93, 115, 129, 130, 153, 290, 307,  
   316–318, 321, 324, 325, 344, 346,  
   348, 355, 362, 391, 408, 491, 493,  
   565, 605, 621  
 Degraded land, 46, 58, 81, 82, 229, 269,  
   275–286, 306, 308, 309,  
   311–313, 412, 620, 626–628  
 Demessie, A., 45–59  
 Desanker, P.V., 129  
 Developing countries, 6, 138, 186, 276, 345,  
   346, 348–350, 353, 354, 398, 491,  
   492, 534–538, 546, 549–551, 560,  
   564, 588, 589, 596  
 Devine, C.E., 378  
 Dewitte, O., 33  
 Diack, M., 275–286  
 Dick, Ø.B., 113–130  
 Dick, W.A., 580  
 Diop, T., 275–286  
 Direct cost subsidy, 533–551  
 Discount rates, 413, 575, 579  
 Dobbie, K.E., 359  
 Domestication of crops in Africa, 6, 7  
 Dougill, A.J., 504  
 Doumbia, M., 12  
 Drought mitigation, 168–169  
 Droughts, 8–10, 29, 55, 76–78, 81, 85, 93–95,  
   104, 166–170, 175, 177–179, 187,  
   202, 203, 205, 226, 236, 238–240,  
   242, 248, 249, 251, 257, 259, 278,  
   280, 293, 306, 312, 313, 335, 346,  
   362, 387, 389, 396–398, 400, 407,  
   409, 413, 420, 425–438, 443, 444,  
   468, 471–473, 477–484, 489, 517,  
   521, 522, 524, 527, 557, 558, 560,  
   565–568, 591, 592, 595, 596,  
   605–607, 610, 618

**E**

- Eastern Mau, 113–130  
 Eckard, R.J., 359, 360  
 Ecological restoration, 309, 311, 312  
 Ecoregions of Africa, 7, 618  
 Eik, L.O., 331–340, 343–363, 367–379,  
   441–464, 603–615  
 Ellert, B.H., 66  
 Ellis, F., 558  
 Enfors, E., 397  
 Eswaran, H., 7

- Ethiopia, 4, 5, 37, 45–59, 63–71, 77, 137–160,  
   228–230, 258, 259, 268, 324, 519,  
   527, 574, 610, 624  
 Eweg, H.P.A., 149

**F**

- Fantaw, Y., 71  
 Farming systems, 7–10, 48, 65, 179, 187, 204,  
   231, 241, 248, 290, 291, 295, 298,  
   301, 349, 350, 390, 397, 398, 400,  
   401, 441–464, 468, 469, 471, 481,  
   484, 516, 524, 555–568, 577, 589,  
   591, 597, 615, 619, 626  
 Farmyard manure, 259–261, 269  
 Fernandes, E.C.M., 579  
 Fertilizer, 6–9, 12, 13, 58, 59, 65, 78, 79,  
   85, 93–95, 102, 103, 105, 106,  
   129, 130, 168, 169, 171, 173,  
   174, 177, 180, 203–206, 209–211,  
   223–232, 236–242, 244–251, 256,  
   261, 267, 290, 292, 298, 301, 348,  
   354, 357, 358, 361, 389, 394, 398,  
   401, 429, 430, 433, 434, 438,  
   443–447, 449–451, 453, 454,  
   456–463, 557, 576, 582, 604,  
   607, 611, 613, 617–619, 626  
 Fertilizer placement, 224, 225, 229  
*Ficus natalensis*, 293–296  
 Field days, 448, 499  
 Fischer, G., 175, 566  
 Flora, C.B., 515–529  
 Floress, K., 496  
 Food  
   crop, 7, 142, 166, 178, 204, 251, 290,  
     332, 387–389, 444, 463, 516,  
     577, 592, 615, 627  
   imbalance, 5–6  
   security, 3–14, 45–59, 64, 82, 85, 142,  
     187, 202, 203, 251, 312, 332,  
     386–389, 399, 400, 408, 411,  
     426, 437, 454, 455, 469, 471,  
     472, 476–478, 480, 483, 490,  
     494, 518, 534, 535, 574–576,  
     583, 584, 589, 592, 593, 605,  
     617, 622, 623, 626, 627  
 French, P., 379  
 Frost, P., 321  
 Fujisaka, S., 231
- G**  
 Gabou, M.H., 305–313  
 Gachene, C.K.K., 165–180  
 Garrity, D.P., 12

Gee, G.W., 261  
 Gelaw, A.M., 63–71  
 Gender, 11, 90, 106, 197, 199, 469, 471,  
 483, 484, 515–529, 584,  
 587–598, 605, 608, 613,  
 614, 622, 625  
 Gender relations, 587–598  
 Geomorphology, 22, 24, 26, 37, 41, 283  
 Geopedological, 21–41  
 German, L., 528  
 Giller, K.E., 228, 245  
 Girmay, G., 71  
 Global warming, 46, 139, 143, 157, 316,  
 344, 348, 354, 534, 565, 566  
 Goat, 298, 331–340, 344, 348, 352, 562, 563,  
 565, 567, 595, 596, 615, 622  
 Gomes, R.C., 378  
 González-Estrada, E., 575  
 Goodman, L., 509  
 Graff-Zivin, J., 575  
 Gregorich, E.G., 580  
 Growth performance, 369, 376, 378  
 Gruneberg et al. (2010), 323  
 Gustafsson, M., 394

## H

Haggblade, S., 436  
 Haile, G.S., 69  
*Hakika*, 257, 260, 261, 263–267, 269  
 Hammel et al. (1999), 284  
 Hansen, D.O., 603–615  
 Hansen, L.A., 188  
 Hary, I., 337  
 Hassan, R.M., 533–551  
 Hatibu, N., 566  
 Hawando, T., 47  
 Herrick, J.E., 407–423  
 Herweg, K., 152  
 Hiederer, R., 323  
 Highlands, 24, 27, 29, 32, 37, 41, 47, 48, 87,  
 90, 94, 98, 99, 138, 140–143,  
 152, 297, 385–387, 390, 391,  
 394, 396, 401, 442, 444, 445,  
 469, 557, 559, 565, 611  
 Hoe cultivation, 228, 230  
 Hoffmann, T., 321  
 Holand, Ø., 367–379  
 Holter, J.B., 353  
 Honlonkou, A.N., 533–551  
 Hultgreen, G., 613  
 Hunter, L.M., 339  
 Hurni, H., 138, 143, 144, 149, 152

## I

Ingram, J.S.I., 579  
 In situ rainwater harvesting, 267  
 Integrated plant nutrient management (IPNM),  
 232  
 Intermediary organizations, 490, 495,  
 499–500, 503–504, 614  
 Itanna, F., 580

## J

Jahnke, H.E., 87  
 Jens, O.S., 188  
 Jindal, R., 506  
 Jones, P., 95  
 Just, R.E., 92

## K

Kabote, S.J., 467–484, 587–598  
 Kabubo-Mariara, J., 77  
 Kadigi, M.L., 555–568  
 Kahimba, F.C., 201–217  
 Kaltenrieder, J., 144, 149  
 Kangalawe, R.Y.M., 468  
 Karanja, F., 77  
 Karrar, A.B., 268  
 Karua, S.A., 339  
 Karuma, A.N., 165–180  
 Kasozi, S.M., 579  
 Kassie, B.T., 519  
 Kato, E., 75–106  
 Khandaker, Z.H., 369, 378  
 Khosa, M.K., 399  
 Kids, 332–340, 622  
 Kifaro, G.C., 331–340  
 Kilasara, M., 255–269  
 Kimaro, D.N., 390, 401  
 Kisetu, E., 255–269  
 Kitonga Forest Reserve, 316–318, 321, 324  
 Kizza, C.L., 37  
 Kounang, N., 306  
 Kraybill, D., 573–585, 603–615  
 Krishna, K.C., 149  
 Kusiluka, M.M., 526

## L

Lachica, M., 376  
 Lal, R., 3–14, 39, 45–59, 63–71, 137–160, 400,  
 401, 412, 603–615  
 Land  
 cover changes, 113–130, 619

- degradation, 22, 45–59, 77, 81, 82, 84, 276,  
     277, 295, 306–307, 316, 323, 332,  
     408, 414, 460, 565, 573, 574, 617,  
     623, 628  
 tenure, 84, 105, 224, 231, 286, 295,  
     297, 308, 411, 414, 503, 564,  
     576, 584  
 use, 12, 13, 22, 24, 34, 37, 39–41, 45–59,  
     63–71, 75, 76, 80, 89, 91, 97, 106,  
     114, 130, 142, 148, 150–152, 160,  
     277, 278, 295, 348–351, 355, 407,  
     413, 416, 418, 420, 421, 443, 463,  
     482, 484, 491–494, 499, 501, 502,  
     504, 506, 508, 510, 516, 519, 522,  
     523, 534, 535, 539, 559, 575, 576,  
     590, 605, 618, 620, 621, 624  
 Landon, J.R., 320, 451  
 Landscape dynamics, 21–41  
 Larson, D.F., 547, 548  
 Leduc, P., 613  
 Lehmann, J., 391  
 Lema, A.M., 566  
 Lema, M.A., 468  
 Lemenih, M., 580  
 Levy, B., 82, 96  
 Levy, Y., 399  
 Likoma, 332–334, 339, 340  
 Linden, P.J., 455  
 Lipper, L., 575  
 Litter fall, 49, 53–54, 59, 130, 300  
 Liu, W., 321  
 Livelihood, 22, 33, 64, 86, 87, 89, 90, 92,  
     95, 101, 106, 142, 166, 187, 188,  
     190, 191, 195, 197, 199, 203,  
     257, 290, 294, 306, 312, 316, 339,  
     345–347, 362, 369, 409–411, 414,  
     444, 463, 468–470, 481–484, 494,  
     498, 503–505, 508, 515, 516, 519,  
     522–528, 555–568, 579, 588–590,  
     594–598, 613, 615, 619, 621, 628  
 Livelihood security, 414  
 Livestock  
     migration, 411, 414–415  
     production, 87, 95, 142, 344–356, 358–359,  
         362, 368, 386, 389, 399, 408, 414,  
         473, 483, 534, 615, 621  
 Lobell, D.B., 10  
 Local governance, 499, 503  
 Local institutions, 82, 95, 98, 101, 199,  
     500, 507  
 Long, S.P., 176  
 Lowe, T.E., 378  
 Loyer, J.Y., 278  
 Ludi, E., 152  
 Lungu, O.I., 425–438  
 Lyamchai, C.Y., 268  
 Lyimo, J.G., 468  
**M**  
 Maathai, W., 79  
 Madulu, N.F., 564  
 Mahonge, C.P., 185–199  
 Mahoo, H.F., 201–217  
 Maisharou, A., 305–313  
 Maize, 6, 10, 37, 65, 92, 102, 117, 166–171,  
     175, 186, 203–205, 207–216,  
     236–240, 243, 245–250, 257,  
     259, 333, 370, 375, 389–392, 394,  
     427, 429, 432–436, 438, 441–464,  
     469, 477, 478, 480, 481, 483, 558,  
     559, 561–563, 565, 566, 575, 577,  
     613, 620, 627  
 Maize yield, 10, 166, 168, 175, 204, 210,  
     212, 215, 217, 236, 248, 390,  
     432, 433, 627  
 Majaliwa, J.G.M., 37  
 Majaliwa, M., 75–106  
 Majule, A.E., 468, 566  
 Maliti, E., 563  
 Malley, Z.J.U., 394  
 Mamiro, D.P., 467–484, 587–598  
 Mapiye, C., 371  
 Marenya, P., 103  
 Masarirambi, M.T., 170  
 Massawe, B.H.J., 255–269  
 Matata, L., 587–598  
 Mattee, A.Z., 185–199, 467–484, 587–598  
 Mbilinyi, B.P., 201–217  
 Mbungu, W.B., 201–217  
 Mbwambo, L., 321  
 McDonald, P., 368, 376  
 Mclauchlan, K.K., 69  
 McLean, E.O., 261  
 McSweeney, C., 156  
 Mdoe, N.S.Y., 555–568  
 Meat quality, 367–379, 621  
 Meena, H.E., 345, 352  
 Mekonen, K., 149  
 Mekonnen, M., 152  
 Mekuria, W., 69  
 Melesse, A.M., 152  
 Mengistu, D., 137–160  
 Meshack, M., 12  
 Messina, J., 235–251  
 Mhango, W.G., 12

- Milking, 332–337, 339, 340, 615  
 Minjingu Mazao fertilizer, 261  
 Miombo woodlands, 316, 321, 324, 325  
 Miriti, J.M., 169  
 Mkoga, Z.J., 396  
 Mlay, G.I., 555–568  
 Mmbaga, T.E., 268  
 Mnenwa, R., 563  
 Modeling, 143, 178, 180, 536, 578–580,  
     620, 621  
 Moloney, A.P., 378  
 Mo, M., 343–363  
 Mongi, H., 472  
 Moore, K.M., 489–510  
 Morgan, R.P., 151  
 Morita, S., 378  
 Moron-Fuenmayor, O.E., 378  
 Mortimore, M., 83  
 Mount Kilimanjaro, 573–585  
 Mpogole, H., 565  
 Msanya, B.M., 315–325  
 Mtenga, L.A., 336  
 Mtengeti, E.J., 367–379, 441–464  
 Muchenje, V., 378  
 Mugagga, F., 41  
 Muhikambele, V.C.M., 331–340  
 Muir, P.D., 379  
 Mulangu, F., 573–585  
 Mulebeke, R., 37  
 Mulumba, L.N., 289–302  
 Mulvaney, C.S., 319  
 Munishi, P.K.T., 315–325  
 Mushi, D.E., 331–340, 343–363,  
     367–379  
 Mussa, K.R., 185–199  
 Mwaliko, R.B.M., 259, 266  
 Mwandosya, M.J., 216, 345, 352, 354  
 Mwaseba, D.L., 185–199  
 Mweseba, D., 603–615
- N**
- Nadhomi, D.L., 37  
 Nakileza, B., 37  
 Natural forest, 47, 50–59, 64, 118–122,  
     124–126, 128, 130  
 Ndayisaba, P.C., 168  
 Ndegwa, S., 82, 96  
 Ndhlovu et al. (2013), 245  
 Ndiaye, R., 275–286  
 Nelson, N.O., 10  
 Net present value (NPV), 412, 413, 575
- Niger, 4, 76–80, 82–84, 86, 87, 89, 91–103,  
     105, 106, 169, 170, 175, 226,  
     230, 305–313, 522, 626, 628  
 Nitisols, 34, 141, 146, 169, 295  
 Nkombe, P.M., 195  
 Nkonya, E., 75–106  
 Nombo, C.I., 467–484, 587–598  
 Nsenga, J.V., 185–199  
 Nshubemuki, L., 321  
 Nutrient  
     management, 4, 11–13, 232, 236, 237,  
         239, 241, 243, 244, 397–398,  
         401, 460, 608, 618  
     mining, 7, 29, 224–226, 295, 391–395,  
         398, 457, 460, 463  
     removal, 292, 457, 459, 460, 462, 463  
     use efficiency, 237, 395  
 Nyagumbo, I., 245  
 Nyamangara, J., 235–251
- O**
- Oddvin, S., 367–379  
 Oenema, O., 359  
 Olsen, S.R., 261  
 Omonode, R.A., 69  
 Ongsomwang, S., 149  
 Orlhac, M., 188–189  
 Oseni, T.O., 170  
 Ostrom, E., 490  
 Oyiga, B., 166
- P**
- Pasture, 64–66, 68–70, 82, 84, 93, 170,  
     260, 264, 298, 301, 333, 337, 339,  
     345–347, 350, 351, 354–357, 362,  
     368–371, 373, 374, 376, 378, 379,  
     399, 400, 411, 414, 479, 482, 483,  
     520, 522, 580, 582, 595, 596, 607,  
     621, 624  
 Patish, 290  
 Perrin, N., 524, 525  
 Pieri, C.J.M.G., 12  
 Piha, M.I., 238, 239  
 Pimental, P., 339  
 Pimentel, D., 306  
 Pitesky, M.E., 351  
 Place, F., 75–106  
 Plantation species, 52, 54–56, 58  
 Plant population density, 429  
 Pope, R.D., 92

Population, 4–6, 10, 24, 25, 27, 28, 32, 41,  
46–48, 52, 64, 65, 87, 89, 93,  
95, 130, 138, 142, 172–174,  
203, 225, 230, 257, 276, 278,  
281, 292, 306, 307, 311, 344,  
345, 348, 350–352, 355, 386,  
387, 389, 391, 400, 408, 411,  
429, 442–444, 468–470, 479,  
481, 483, 484, 515, 535, 556,  
559, 560, 564, 565, 568, 573,  
574, 610, 614, 617

Poverty, 4, 14, 22, 48, 82, 103, 186, 196,  
202, 260, 290, 344, 346, 369,  
389, 398, 442, 444, 469, 476,  
483, 516, 534, 535, 555–568,  
574, 577, 588, 589, 604,  
617, 628

Precision farming, 618

Pretty, J., 11, 496

Priolo, A., 379

Probert et al. (1998), 206

Productivity, 21–41, 46, 49, 50, 58, 59,  
64, 75, 76, 79, 81, 82, 85, 90,  
92, 103–105, 115, 129, 138,  
139, 156, 167, 168, 175, 176,  
187, 201–232, 235–251, 259,  
260, 263, 277, 290, 295, 301,  
306, 310, 312, 313, 321, 345,  
346, 350, 353, 355–357, 361,  
367–379, 386–401, 416, 417,  
422, 423, 430, 434, 437,  
443–445, 460, 463, 479, 522,  
534, 537, 556, 557, 567, 574,  
577, 592, 604–607, 610, 613,  
615, 618, 620, 621, 628

Prokopy, L.S., 496

Public–private partnership (PPP), 445,  
527, 619

Puget, P., 69

**R**

Reij, C., 12

Renard, K.G., 142

Revised Universal Soil Loss Equation  
(RUSLE), 142, 150, 160

Ringler, C., 166

Ripoll-Bosch, R., 343–363

Robertson, J.B., 372

Rojas, M.M., 323

Rooting depth, 153, 172, 429

Rubanza, C.D.K., 368

Ruthenberg, H., 558

Rwehumbiza, F.B.R., 201–217, 259

**S**

Sadio, S., 278

Salinization, 167, 275–286, 418, 610

Sarr, B., 468

Sathaye, J., 548

Scherr, S.J., 505

Selemani, I.S., 367–379

Semalulu et al. (2012), 298

Semalulu, O., 37

Semi-arid, 6, 7, 24, 48, 138, 179, 186, 196,  
204, 207, 240, 246, 255–269,  
276, 278, 368, 369, 385–401,  
409, 467–484, 557, 566, 590,  
591, 594, 597, 611, 624

Semu, E., 315–325

Shade tree, 291, 293

Shames, S., 505

Sharma, S., 319

Sheikh, A.M., 324

Shelukindo, H.B., 315–325

Shiferaw, A., 152

Sibuga, K.P., 255–269

Sidahmed, A.E., 257

Sileshi, G., 168

Singh, B.R., 45–59, 63–71, 113–130,  
315–325, 603–615

Skarstein, R., 565

Skinner, E., 522

Smallholder, 4, 7, 11, 14, 65, 168, 177,  
179, 185–199, 203, 237–251,  
340, 430, 433, 434, 441–464,  
467–485, 490, 492, 493, 495,  
497, 499, 506, 510, 555–568,  
574–576, 583, 605–609, 611,  
613–615, 619

farmers, 7, 185–199, 203, 237, 241,  
243, 245, 246, 248, 340, 430,  
434, 443–445, 454, 463, 473,  
489, 490, 492, 499, 555–568,  
574–576, 583, 609, 613, 619

livelihoods, 473, 481

Smith, D.D., 142, 150

Smith, K.A., 359

Snapp, S., 235–251

Snyder, C.S., 613

SOC. *See* Soil organic carbon (SOC)

Social stability, 407–423

SOC stocks, 13, 50, 53, 69–71, 316, 319, 321

Sohngen, B., 575

Soil

carbon

market, 576

sequestration, 12–14, 71, 114, 575,  
578, 582, 584

Soil (*cont.*)

- degradation, 3, 9, 11, 38, 46, 58, 130, 277, 325, 386, 387, 390–396, 399, 408–411, 413–416, 418, 422, 457, 489, 611, 617, 618, 624
  - degradation and political unrest, 9, 11
  - depth, 65, 67, 121, 122, 124, 125, 127, 128, 138, 209, 285, 300, 301, 316–319, 321, 323–324, 429, 450
  - erosion, 24, 25, 32, 34, 36–39, 41, 46, 47, 137–160, 168, 228, 245, 257, 290, 307, 312, 321, 332, 390–391, 396, 399–401, 408, 418, 430, 615, 628
  - nutrients, 39, 57, 176, 177, 399, 418, 618
  - resistance and resilience, 407–423
  - types, 25, 32–35, 49, 114, 117, 121, 127, 141, 144, 174, 246, 266, 295, 316, 317, 319–321, 323, 324, 414, 494, 604
  - Soil organic carbon (SOC), 6, 13, 46, 48–53, 56–59, 63–71, 114, 115, 118–123, 125, 127–130, 139, 143, 226, 241, 242, 262, 300, 312, 315–325, 348, 351, 385, 396, 429, 493, 604–607, 610, 612, 614, 618, 619, 622–624
  - Soil organic matter (SOM), 4, 8, 11, 12, 46–50, 69, 71, 114, 129, 137–160, 207, 226, 231, 232, 291, 301, 395–398, 401, 418, 436, 519, 580, 581, 604–607, 610
  - Soils of Africa, 7, 333
  - Soler, C.M.T., 12
  - Solomon, D., 391
  - SOM. *See* Soil organic matter (SOM)
  - Sommers, L.E., 261
  - Sonneveld, B.G.J.S., 138
  - Sorghum varieties, 255
  - Spiotta, E.M., 261, 319
  - Srivastava, A.K., 10
  - Sterk, G., 152
  - Stillhardt, B., 152
  - Straw mulch, 226
  - Striga, 226, 227, 257, 259, 480
  - Sub-Saharan Africa (SSA), 5–14, 21–41, 46, 64, 75–106, 165–181, 186, 187, 202, 212, 217, 223–251, 257, 258, 269, 276, 401, 411, 414, 428, 468, 489, 490, 535, 556, 561, 573, 574, 576, 577, 604–609, 611–615, 617–619
  - Subsoil acidity, 430–434
  - Suckling, 332–338, 340, 622
  - Sumner, M.E., 432
  - Sundstøl, F., 343–363
  - Sustainable land and water management, 77, 90, 96
  - Sustainable soils management, 10, 11
  - Swai, E.Y., 255–269
  - Sylvetsen, J., 399
  - Synnevåg, G., 467–484, 587–598
- T**
- Tanzania, 4, 23, 175, 185, 203, 235, 315, 332, 344, 367, 385, 442, 467, 526, 555, 588, 613
  - Tax cut, 533–551
  - Teat, 332, 333, 335–337
  - Teferi, E., 152
  - Tembo, G., 436
  - Thinley, U., 149
  - Thiombiano, L., 12
  - Thomas, D., 614
  - Thomas, G.W., 261
  - Thornton, P., 95
  - Tillage technology, 433, 436
  - Tittonell, P., 12
  - Total nitrogen (TN), 51, 63–71, 113–130, 261, 392–394, 454, 624
  - Tradeoffs, 397, 398
  - Traditional agroforestry, 50, 58
  - Traoré, K., 12
  - Trujillo, W., 69
  - Trumbore, S.E., 143
  - Tschakert, P., 575
  - Tukahirwa, J.M.B., 37
  - Tumbo, S.D., 201–217
- U**
- Umar, B.B., 228
  - Urassa, J.K., 587–598
  - Urbanization, 5, 142
  - Usuga, J.C.L., 324
- V**
- van Lammeren, R., 149
  - Van Niekerk, W.A., 339
  - Van Remortel, R.D., 147
  - Van Soest, P.J., 372
  - van Velthuisen, H., 32
  - Vatn, A., 494
  - Vesterdal, L., 52



Vestergaard, M., 379

Vlek, P.L.G., 356

Vulnerability, 11, 99, 106, 166, 170,  
185–199, 248, 257, 271, 277,  
306, 308, 337, 361, 444, 468,  
482–484, 515, 516, 523, 524,  
565, 568, 577, 578, 589, 598,  
608, 624, 625

Vyn, T.J., 69

## W

Waage, J., 11

Waha, K., 12

Wahi, 257, 260, 261, 263–269

Walker, S.M., 129

Wall, P.C., 245

Wang, Q., 54

Wang, Z., 321

Warner, K., 524

Warren, A., 307

Water productivity, 243, 244, 259, 399

Weber, V., 284

Weitzman, M.L., 537

Were, K.O., 113–130

Wiesmeier, M., 321

Wischmeier, W.H., 142, 145, 150, 151

Wopereis, M.C.S., 284

Wunder, S., 494

## X

Xiao, G., 177

## Y

Yang, Y.S., 54

Young, A.J., 353

Yuan, Z., 316

## Z

Zingore, S., 235–251

Zougmoré, R., 12