

Integrated Science 9

Houneida Sakly · Kristen Yeom ·
Safwan Halabi · Mourad Said ·
Jayne Seekins · Moncef Tagina *Editors*

Trends of Artificial Intelligence and Big Data for E-Health

 Springer

Integrated Science

Volume 9

Editor-in-Chief

Nima Rezaei , Tehran University of Medical Sciences, Tehran, Iran

The **Integrated Science** Series aims to publish the most relevant and novel research in all areas of Formal Sciences, Physical and Chemical Sciences, Biological Sciences, Medical Sciences, and Social Sciences. We are especially focused on the research involving the integration of two or more academic fields offering an innovative view, which is one of the main focuses of Universal Scientific Education and Research Network (USERN), science without borders.

Integrated Science is committed to upholding the integrity of the scientific record and will follow the Committee on Publication Ethics (COPE) guidelines on how to deal with potential acts of misconduct and correcting the literature.

Houneida Sakly • Kristen Yeom •
Safwan Halabi • Mourad Said •
Jayne Seekins • Moncef Tagina
Editors

Trends of Artificial Intelligence and Big Data for E-Health

Editors

Houneida Sakly 
COSMOS Laboratory, National School
of Computer Science (ENSI)
Manouba University
Manouba, Tunisia

Safwan Halabi
Northwestern University
Chicago, IL, USA

Jayne Seekins
Department of Radiology
Stanford Medicine
Palo Alto, USA

Kristen Yeom
Department of Radiology
Stanford Medicine
Palo Alto, USA

Mourad Said
Carthage Medical International Center
Monastir and Sousse Medina Medical
Imaging Center
Monastir, Tunisia

Moncef Tagina
COSMOS Laboratory, National School
of Computer Science (ENSI)
Manouba University
Manouba, Tunisia

ISSN 2662-9461

Integrated Science

ISBN 978-3-031-11198-3

<https://doi.org/10.1007/978-3-031-11199-0>

ISSN 2662-947X (electronic)

ISBN 978-3-031-11199-0 (eBook)

© The Editor(s) (if applicable) and The Author(s), under exclusive license to Springer Nature Switzerland AG 2022

This work is subject to copyright. All rights are solely and exclusively licensed by the Publisher, whether the whole or part of the material is concerned, specifically the rights of translation, reprinting, reuse of illustrations, recitation, broadcasting, reproduction on microfilms or in any other physical way, and transmission or information storage and retrieval, electronic adaptation, computer software, or by similar or dissimilar methodology now known or hereafter developed.

The use of general descriptive names, registered names, trademarks, service marks, etc. in this publication does not imply, even in the absence of a specific statement, that such names are exempt from the relevant protective laws and regulations and therefore free for general use.

The publisher, the authors, and the editors are safe to assume that the advice and information in this book are believed to be true and accurate at the date of publication. Neither the publisher nor the authors or the editors give a warranty, expressed or implied, with respect to the material contained herein or for any errors or omissions that may have been made. The publisher remains neutral with regard to jurisdictional claims in published maps and institutional affiliations.

This Springer imprint is published by the registered company Springer Nature Switzerland AG
The registered company address is: Gewerbestrasse 11, 6330 Cham, Switzerland

Introduction

In this book, we examine technologies that have significant impact to the healthcare sector. Some of those burgeoning technologies include: (1) artificial intelligence (AI); (2) Big Data; (3) Internet of Medical Things (IoMT); and (4) blockchain. The term e-health (digital or connected health) refers to the use of information and communication technologies (ICTs) in various healthcare-related activities, patient populations, healthcare providers, and medical systems. E-health also encompasses a set of digital applications aimed at disease diagnosis, prevention, and treatment that expected to provide more precise, real-time solutions aimed at overcoming challenges in modern medicine, particularly addressing the increasing burden of chronic diseases (cancer, drug discovery, heart failure, Covid-19, etc.) and aging patient populations. E-health also opens potential for real-time personalized interaction between patients and physicians, disease surveillance, resource management, and targeted treatment strategies (e.g., precision health). AI can be applied at multiple levels, from disease prevention to diagnoses, therapeutic surveillance, and medical research. By leveraging AI and Big Data in medicine, we may identify previously unknown links to underlying biological and pathological mechanisms of various diseases.

In this context, a key to success in the future medicine lies in Big Data for clinical decision support, incorporating topics such as predictive and preventive medicine, aimed at disease prevention as well as personalized and participatory medicine that promotes dynamic patient–physician–systems interactions. This will lead to more precise disease diagnosis, treatment, and new adaptations as diseases evolve or recur. Internet of Medical Things (IoMT), connected to cloud platforms for data storage, management, and analysis, will optimize the electronic health record (EHR) and enable globalization of telemedicine. This rise in digital healthcare data does raise concern for the security and privacy of patient and provider information. Here, AI, including Blockchain technologies, may also play a key role for preserving privacy, security maintenance, as well as neutralizing malicious activities in real time. Unlike a centralized system with inherent vulnerabilities for hacking or healthcare data leaks, a blockchain strategy may provide an honest broker to allow for safe data exchange, new approaches for data encryption for added security of sensitive data, auditability, and secure healthcare transactions. In recent years, the combined use of (IoT) and blockchain

technologies has led to initiatives such as blockchain of IoMT (BIOMT) for improved security whereby (1) data does not pass through a cloud but sent directly to service platform; (2) hacking entry points are drastically reduced; (3) medical data are dematerialized, saving time; and (4) medical transactions occur with higher security and transparency.

Contents

AI and Big Data for Intelligent Health: Promise and Potential	1
Andre Lupp Mota, Suely Fazio Ferraciolli, Aline Sgnolf Ayres, Laura Lane Menezes Polsin, Claudia da Costa Leite, and Felipe Kitamura	
AI and Big Data for Cancer Segmentation, Detection and Prevention	15
Zodwa Dlamini, Rodney Hull, Rahaba Marima, Amanda Skepu, Stylianos Makrogkikas, Elias P. Koumoulos, George Bakas, Ioannis Vamvakaris, Konstantinos N. Syrigos, George Evangelou, Aglaia Kavidopoulou, and Georgios Lolos	
Radiology, AI and Big Data: Challenges and Opportunities for Medical Imaging	33
Houneida Sakly, Aline Sgnolf Ayres, Suely Fazio Ferraciolli, Claudia da Costa Leite, Felipe Kitamura, and Mourad Said	
Neuroradiology: Current Status and Future Prospects	57
Suely Fazio Ferraciolli, Andre Lupp Mota, Aline Sgnolf Ayres, Laura Lane Menezes Polsin, Felipe Kitamura, and Claudia da Costa Leite	
Big Data and AI in Cardiac Imaging	69
Charitha D. Reddy	
Artificial Intelligence and Big Data for COVID-19 Diagnosis	83
Houneida Sakly, Ahmed A. Al-Sayed, Mourad Said, Chawki Loussaief, Jayne Seekins, and Rachid Sakly	
AI and Big Data for Drug Discovery	121
Aglaia Kavidopoulou, Konstantinos N. Syrigos, Stylianos Makrogkikas, Zodwa Dlamini, Rodney Hull, Rahaba Marima, Amanda Skepu, Elias P. Koumoulos, George Bakas, Ioannis Vamvakaris, George Evangelou, and Georgios Lolos	

Blockchain Technologies for Internet of Medical Things (BIOMT) Based Healthcare Systems: A New Paradigm for COVID-19 Pandemic	139
Houneida Sakly, Mourad Said, Ahmed A. Al-Sayed, Chawki Loussaief, Rachid Sakly, and Jayne Seekins	
AI and Big Data for Therapeutic Strategies in Psychiatry	167
Shankru Guggari	
Distributed Learning in Healthcare	183
Anup Tuladhar, Deepthi Rajashekar, and Nils D. Forkert	
Cybersecurity in Healthcare	213
Brendan Kelly, Conor Quinn, Aonghus Lawlor, Ronan Killeen, and James Burrell	
Radiology and Radiomics: Towards Oncology Prediction with IA and Big Data	233
Aline Sgnolf Ayres, Suely Fazio Ferraciolli, Andre Lupp Mota, Laura Lane Menezes Polsin, and Claudia da Costa Leite	
General Conclusion	251

About the Editors

Houneida Sakly is a Ph.D. and Engineer in Medical Informatics. She is a member of the research program “deep learning analysis of Radiologic Imaging” in Stanford University. Certified in Healthcare Innovation with MIT-Harvard Medical School. Her main field of research is the data science (artificial intelligence, Big Data, blockchain, Internet of Things) applied in health care. She is a member in the Integrated Science Association (ISA) in the Universal Scientific Education and Research Network (USERN) in Tunisia. Currently, she is serving as a lead editor for various book and special issues in the field of digital transformation and data science in health care. Recently, she has won the Best Researcher Award in the International Conference on Cardiology and Cardiovascular Medicine—San Francisco, USA.

Kristen Yeom is a Professor of Radiology at Stanford University with a research focus on clinical and translational studies of quantitative MRI. She is also on the executive board for Center for Artificial Intelligence in Medicine and Imaging at Stanford and serves as the Chair of the American Society of Pediatric Neuroradiology Grant Committee. Her recent works include radiomic and machine learning strategies for brain tumor evaluation, as well as various computer vision tasks in clinical imaging toward precision. For further information (“<https://profiles.stanford.edu/kristen-yeom>”)

Dr. Safwan Halabi is an Associate Professor of Radiology at the Northwestern University School of Medicine, Vice-Chair of Radiology Informatics, and Associate CMIO at Lurie Children’s Hospital. He also serves as the Director of Fetal Imaging at The Chicago Institute for Fetal Health. He is board-certified in Radiology with a Certificate of Added Qualification in Pediatric Radiology. He is also board-certified in Clinical Informatics. He clinically practices fetal and pediatric imaging at Lurie Children’s Hospital. Dr. Halabi’s clinical and administrative leadership roles are directed at improving the quality of care, efficiency, and patient safety. He has also led strategic efforts to improve the enterprise imaging platforms at Lurie Children’s Hospital. He is a strong advocate of patient-centric care and has helped guide policies for radiology reports and image release to patients. He has published in peer-reviewed journals on various clinical and informatics topics. His

current academic and research interests include imaging informatics, deep/machine learning in imaging, artificial intelligence in medicine, clinical decision support, and patient-centric healthcare delivery. He is currently the Chair of the RSNA Informatics Data Science Committee and serves as a Board Member for the Society for Imaging Informatics in Medicine.

Mourad Said, MD is a Associate Professor in Radiology and Medical Imaging since 2002, Member of the regional committee Africa-Middle East of the Radiological Society of North America RSNA 2014–2018, and Author Reviewer for the prestigious Journal *Radiology* for many years—different scientific presentations in RSNA meetings.





He is board-certified in MRI from South Paris University—qualifications in Pediatric/Obstetric Radiology and MSK Imaging. He is actually interested in artificial intelligence in medical imaging, deep learning, and radiomics with different publications.

Jayne Seekins is a Clinical Assistant Professor of Radiology, Stanford University. Research interests include fellow, resident, and medical student education as well as Global Health. For further information (<https://profiles.stanford.edu/jayne-seekins>)

Moncef Tagina is a Professor of higher education and the co-founder of the COSMOS Laboratory in the National School of Computer Sciences (ENSI) in Tunisia (<http://www.ensi-uma.tn>). He is the Director of the Doctoral School and President of the thesis committee.



AI and Big Data for Intelligent Health: Promise and Potential

Andre Lupp Mota , Suely Fazio Ferraciolli , Aline Sgnolf Ayres ,
Laura Lane Menezes Polsin, Claudia da Costa Leite ,
and Felipe Kitamura

1 Introduction

Healthcare is an area of great complexity that produces a vast amount of information ranging from the results of scientific research, from which knowledge can be generated in clinical practice, where knowledge is actually applied. Many complex datasets from different types and sources are generated daily worldwide. If it were possible to interpret all of these data, could we grasp which questions to humanity's health problems could be answered?

A. L. Mota (✉)

Department of Surgery and Anatomy, Medicine School of Ribeirao Preto,
University of São Paulo, São Paulo, Brazil
e-mail: andre.lupp@alumni.usp.br

S. F. Ferraciolli

Dasa, São Paulo, Brazil
e-mail: suely.ferraciolli@hc.fm.usp.br

S. F. Ferraciolli · A. S. Ayres

UHG, São Paulo, Brazil
e-mail: aline.ayres@hc.fm.usp.br

S. F. Ferraciolli

Instituto de Radiologia, Hospital das Clinicas, School of Medicine,
University of São Paulo, São Paulo, Brazil

A. S. Ayres

Instituto do Cancer do Estado de São Paulo, Hospital das Clinicas,
School of Medicine, University of São Paulo, São Paulo, Brazil

Artificial intelligence, which was developed throughout the second half of the twentieth century and in the first decade of the twenty-first century, is associated with the improvement of computational power, made it possible for machines to perform some tasks previously restricted to humans. The development of tools such as machine learning has allowed computers to learn from humans and perform some of their tasks, which was later improved with the deep learning technique, enabling machines to self-learn and manipulate a massive amount of elaborated information.

Finally, massive amounts of data can now be stored, processed, and analyzed, enabling AI to respond to old and new problems. This digital revolution soon reached healthcare and changed traditional clinical research, clinical practice, and population health, impacting all healthcare specialties, which gradually integrated AI into their routine. The Covid-19 pandemic accelerated the incorporation of these new technologies and proved that they could provide quick answers and fill deficiencies characteristic of critical situations.

If used inclusively, AI can solve many of humanity's problems and improve the already consolidated processes. However, like every new tool, it must be supported by ethical and legal bases to guarantee safety and allow broad access to all, especially to less privileged populations, which can be the primary beneficiaries.

2 Artificial Intelligence

In the 1940s, AI emerged with the development of computational learning models similar to a simplified neuron. In the 1950s, researchers began to improve artificial systems to mimic human intelligence. In 1950, Alan Turing, considered the father

L. L. M. Polsin
University of Campinas, São Paulo, Brazil
e-mail: lau.lane@gmail.com

C. da Costa Leite
Fleury Group, São Paulo, Brazil
e-mail: claudia.leite@hc.fm.usp.br

C. da Costa Leite
Sirio Libanes Hospital, São Paulo, Brazil

F. Kitamura
Universidade Federal de São Paulo, Diagnósticos da América SA (Dasa), São Paulo, Brazil
e-mail: kitamura.felipe@gmail.com

C. da Costa Leite
Departamento de Radiologia e Oncologia, Faculdade de Medicina, Universidade de São Paulo, São Paulo, Brazil

of modern computer science, created the Turing test, which evaluates how close a machine came to human intelligence and later evaluated AI systems [1].

In 1956, during a conference in New Hampshire, USA, computational scientist John McCarthy used the term artificial intelligence for the first time. In 1958, Rosenblatt introduced a new system called perceptron, which consists of a mathematical model composed of several binary inputs that received different weights. The algorithm uses the weights for the desired output from a predetermined threshold. This system was later improved and used as the basis for creating neural networks [2]. Throughout the '70s and '80s, interest in AI development declined significantly owing to technological limitations. From the '90s and especially after the 2000s, fertile soil for AI growth appeared with increasing computer system capacity and the availability of big data [1].

Nowadays, artificial intelligence (AI) is a broad term concerning systems that perform tasks as humans do. It is a multidisciplinary field involving concepts from mathematics and computer science. In addition, some algorithms include statistical, psychological, philosophical, and linguistic concepts. The main requirements for AI are based on a triad of algorithms, high-performance computing infrastructure, and big data.

AI has many different applications, such as reasoning, which gives the ability to make inferences based on information; planning, which is the system's ability to elaborate a chain of actions autonomously to reach an end goal; natural language processing (NLP), which is the ability to train computers to understand written and spoken human language; and machine learning (ML), which is the computer's ability to learn from predefined examples, without being explicitly programmed [3].

In machine learning, a field called deep learning (DL) can automatically hierarchize the data given using algorithms called neural networks (NN), which are AI algorithms that resemble a human neuron. These NNs have three main components: input data; the model's activation function; and output data corresponding to the dendrites, cellular body, and axon of a biological neuron. All these concepts are further explained in the next section and are displayed in the circle diagram of Fig. 1.

2.1 Machine Learning

The great utility of machine learning is in processing large amounts of information, allowing predictions and/or decisions to be made. The subtypes of machine learning vary according to the dependence of the system on the information previously supplied to develop the learning process. The information can be offered after classification by humans or the algorithm is permitted to identify it for itself. Based on these characteristics, ML can be expressed as:

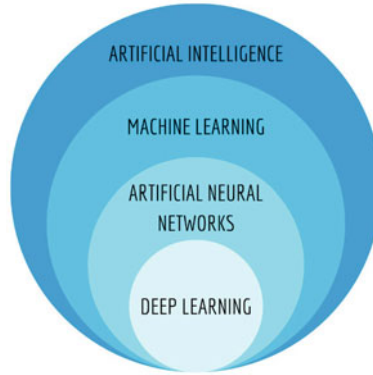

Fig. 1 Circle diagram of artificial intelligence, with machine learning, as one of its subsets, where machines can learn a human task without being explicit programmed. ML can use neural networks for many tasks, one of them is deep learning, that consists in the algorithm being able to deliver an automatic hierarchization of the data given

- Supervised: when databases are labeled, known as ground truth, to train the algorithms to classify the information or make more accurate predictions. An example of its application is in the identification of normal and abnormal radiological images.
- Semi-supervised: When the number of inputs is larger than the number of targets, aiming for a better model accuracy when the main dataset has few labeled samples and a large number of unlabeled ones [4].
- Unsupervised: algorithms analyze unlabeled databases, allowing the algorithm to discover patterns or groupings of data without human intervention [2]. This model cannot be used for prediction models because there is no outcome variable assigned to a single input data point, and it is advantageous when a massive amount of unlabeled information is available.

These types of learning are schematized in Fig. 2.

Another ML strategy is reinforcement learning, which is characterized by learning decisions by trial and error to reach the best goal and has excellent utility in robotics, games, and autonomous vehicles.

In ML, training a system increases its experience and performance. The quality of the algorithm development involves training and validation. Initially, the database was divided into three parts: training, validation, and testing, which generally had proportions of 80%, 10%, and 10% of the main dataset, respectively. However, this could be adapted according to the database size. In larger datasets, one could increase the percentage for training and reduce the proportion for validation, still guaranteeing an adequate amount of data. After achieving the best validation performance, the algorithm was tested to measure and confirm its final performance [5]. The data must not be mixed, that is, it must be explicitly used for the group it was allocated to [6] to prevent the algorithm from “memorizing” the data instead of

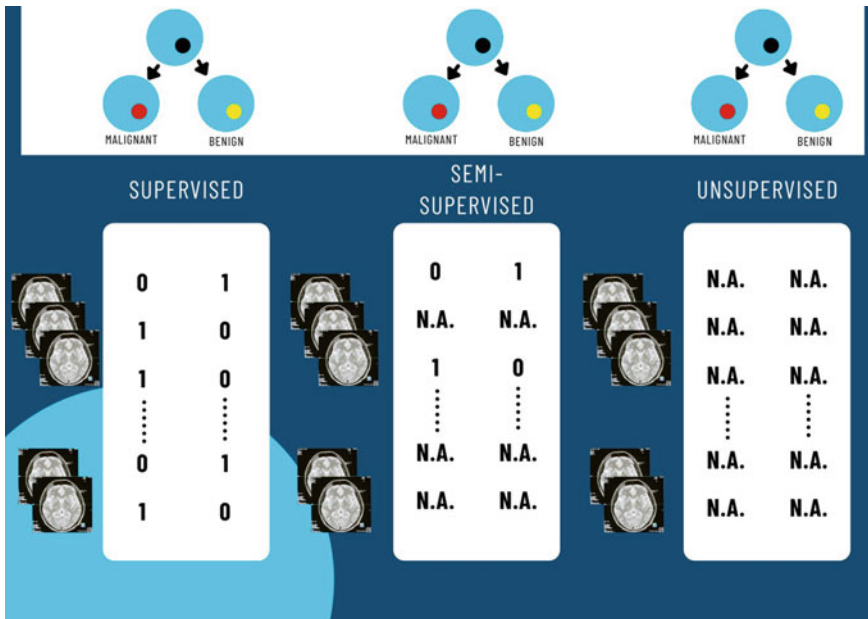

Fig. 2 Types of learning in ML: supervised, semi-supervised and unsupervised

learning from it. Therefore, the test set should be separated initially with data that has not been observed during training and validation.

Algorithms are instructions on how the system should work with information. Their creation involves programming languages such as Python, Java, C, C++, C#, and R [4].

The primary tasks performed by AI algorithms are classification, segmentation and regression. In classification, the system allocates information to specific classes. Applications of this task in healthcare include distinguishing between normal and abnormal patterns and enabling disease classification. Another example is the segmentation of a region, lesion, or anatomical structure according to their radiological characteristics, which classifies the image pixels that will or will not be part of the segmented area. Regarding regression, the algorithm predicts continuous target by establishing relationships between two or more variables and has great importance in healthcare in establishing prognosis and responses to certain drugs [5].

The types of algorithms used in ML depend on the complexity of the task and the type and amount of input information. The main algorithms used in ML in healthcare are as follows:

- **Linear classification:** These are used for classification and are based on linear relationships between the input and desired output values and can only be used when there is a linear relationship. They performed best with smaller databases.

Examples include linear regression, logistic regression, and support vector machines.

- Nonlinear classification: Uses kernel filters to separate nonlinear information in a database, performing classification and, in some cases, regression;
- Decision tree: Predicts the output variable by learning decision rules from the input. It can be used in both classification and regression and also works well for large databases.
- Artificial neural networks: These were inspired on neurons in the human brain and may be composed of multiple layers (input layer, one or more hidden layers, and an output layer). Each layer has many neurons with different learnable weights, which allows pattern recognition and problem-solving. It requires a large amount of complex information and allows for both classification, segmentation and regression. Deep neural networks use multiple layers to predict outputs and enable deep learning.

As previously mentioned, deep learning is a subtype of ML that allows a system to learn autonomously, using artificial neural networks with several layers to process large amounts of information, permitting the algorithm to establish hierarchies and standardizations [2]. One of the main utilities of DL may be its ability to discover complex correlations and conglomerates, which cannot be seen by human intellect.

DL is useful for processing unstructured data and is one of the main uses of image recognition. Therefore, it is widely used in healthcare, particularly in radiology and other specialties that can use imaging examinations, such as dermatology, pathology, and ophthalmology.

These AI algorithms require a large amount of data and computational power, and have many different hidden layer structures. Convolutional neural networks are the main networks used for medical images with classification/segmentation/regression tasks. The simplified scheme of a CNN is shown in Fig. 3, and a friendly introduction can be seen in a video from Luis Serrano [7].

Fig. 3 Example of a convolutional neural network (CNN), characterized by an input layer, several hidden layers, and an output layer

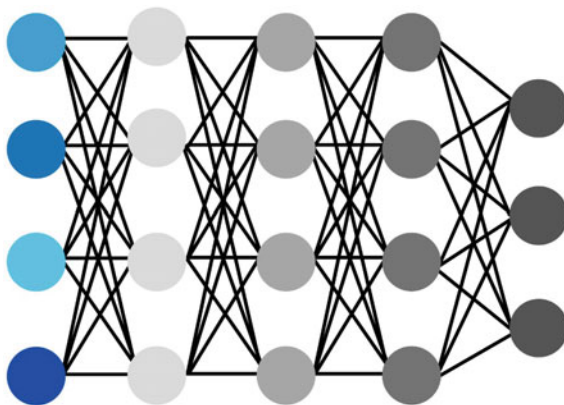

3 Big Data

Big data refers to a set of large amounts of varied and complex information that represents a great challenge for storage, access, analysis, and processing. These data are obtained from scientific research, social network interaction, internet posts, photos, videos, audio, text files, and various types of information from sensors and smartphones [8].

Big data comprises six characteristics, commonly called 6v's: value, volume, velocity, variety, veracity, and variability [9], as shown in Fig. 4.

Variety refers to the various types of data, which can be structured, that is, readily classified and analyzed; unstructured, which are not organized according to a predefined model of information (e.g., medical notes and images); and semi-structured, which are similar to a mixture of the other two types [8]. Volume represents the large and growing amount of data generated continuously, reaching magnitudes such as petabyte, exabyte, and zettabyte. Velocity refers to the latency of the time from creation to the final product of information processing. Value refers to the value added to information analysis. Variability is defined as the changes that information can present with time, location, and among different operators. Finally, veracity refers to the quality and relevance of the information [9].

The analysis of such a large amount of information is only possible owing to the development of artificial intelligence tools and powerful hardware. These tools make it possible to perform tasks such as anomaly detection, clustering, classification, association, summarization, and visualization [9].

Several ethical and legal issues have been raised about big data and are a cause for concern regarding its use in health care. One concerns the privacy and security of patient information, which requires encryption and anonymization algorithms as well as security solutions. Another issue concerns data ownership [9]. With the advent of these new technologies, several countries have adopted laws to protect the data used, particularly the patient data.

Fig. 4 The 6v's of big data

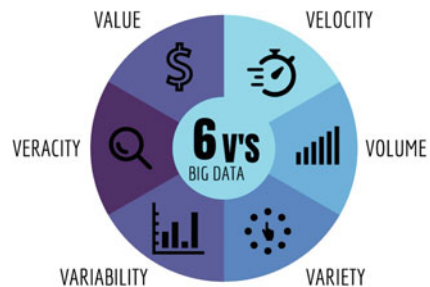

4 AI and Big Data in Healthcare

Healthcare has embraced the digital revolution in which AI enables the analysis and processing of vast amounts of information. Since then, algorithms have been used in clinical practice, research, and in population health.

For these new technologies to be inclusive, comprehensive, and to meet the demands of healthcare, nine conceptual elements for their use have been proposed [10], with schematic visualization in Fig. 5.

1. Personalized—Guarantees the individualization of care;
2. Predictive—Makes it possible to determine the predisposition to a particular condition;
3. Preventive—Develops prevention strategies;
4. Participatory—Allows the participation of the patient in his/her care;
5. Pervasive—Is widely available, anywhere, anytime, and to everyone;
6. Precise—Enables the identification of the condition and its precise treatment;
7. Privacy-preserving—Ensure privacy of information;
8. Protective—Ensuring the security of information and systems
9. Priced reasonably—Be affordable [10].

It is estimated that all medical specialties will use AI in the future, and deep learning will represent a large part of this use, mainly for pattern recognition using neural networks [11]. The use of AI in health care is already a reality that can be present throughout human life: from fertilization, acting in the selection of viable embryos, through childhood, adulthood, and old age; aiding diagnosis through imaging; recognizing conditions through wearable monitoring; promoting health through smart speaker/voice assistant services and chat bots; and predicting in-hospital outcomes [11]. This broad employment is made possible by the ability to process a wide variety of inputs, such as photographs, video, audio, and text,

Fig. 5 The 9 P's for the AI in healthcare



enabling the use of AI for diagnosis, prognosis, and treatment, leading to precision medicine.

The following section discusses examples of AI and big data at different levels of healthcare spanning clinical research, clinical practice, and population health.

One area of interest in the advances in AI and big data is the field known as omics, characterized by the study of various biological fields based on their structure function. The omics fields include genomics (study of genomes), epigenomics (study of non-genetic influences on gene expression), transcriptomics (study of RNA expression), proteomics (study of proteins), metabolomics (study of metabolites), interactomics (interaction between proteins and molecules), pharmacogenomics (study of pharmacology in the context of genomics), radiomics (study of radiological patterns), and diseasomics (study of diseases) [9].

The large amount and complexity of information can be integrated to search for biomarkers to predict new diseases, which are being developed using AI tools [9, 12]. Moreover, this information can be analyzed in conjunction with lifestyle and environmental characteristics, which form the basis of an emerging field in medicine: precision medicine. This makes it possible to customize the prevention and treatment of health conditions in an individual by defining the factors that predispose the individual to that specific condition within the great diversity of human biology [13].

In addition, in the field of research, IA can be used for *in silico* drug testing, reducing costs and time for clinical trials in drug development, helping in the evaluation of candidate substances as therapeutic agents, and excluding those with undesirable side effects. The use of nanotechnology with biocompatible nanomaterials enables the development of nanomedicines designed by molecular dynamic simulators using AI tools to develop substances with low side effects and achieve the desired therapeutic effects [14].

It is probably in radiology that AI has found one of the most significant applications in medicine, which is why the use of AI and big data in radiology is discussed in Chap. 3.

The development of digital pathology, which uses digital slide images, has opened this discipline to incorporate IA. Whole slide imaging (WSI), which allows complete evaluation of a tissue sample on one slide, has proven helpful in reducing the time for lesion identification compared to human evaluation. Algorithms can be developed to classify tumor types by identifying specific mutations that traditional techniques cannot recognize. New technologies have proven useful when integrating histopathological images with other sources such as omics data, clinical records, and demographic information. When used synergistically with pathologists, AI algorithms can also increase accuracy and reduce the time for slide evaluation [11, 15].

In ophthalmology, deep learning can be used for disease screening, such as diabetic retinopathy, retinopathy of prematurity (ROP), glaucoma and age-related macular degeneration [16]. Studies comparing the performance of humans and algorithms in evaluating fundus photographs or optical coherence tomography have shown to be as good as or better than expert evaluations. The prospects for

funduscopy imaging are beyond the ophthalmological scope. Evidence suggests that they may help identify changes that indicate increased cardiovascular risk and early signs of dementia [11]. In communities distant from big cities or places that lack medical professionals, these algorithms can be used to expand the availability of services through telemedicine [16].

In dermatology, IA allows the classification of neoplastic lesions using digitalized photographic or dermoscopic images. AI is being studied in gastroenterology to increase the accuracy of colonoscopy examinations in identifying intestinal polyps. In mental health, algorithms can be used to identify signs of mental disorders such as depression and suicide risk from data generated from the interaction of the machine with the patient [11].

In cardiology, AI has been used to evaluate examinations, such as electrocardiogram images for early identification of heart attack and arrhythmias, and echocardiography, to classify hypertrophic cardiomyopathy, amyloidosis, and pulmonary arterial hypertension [11]. The application of convolutional neural networks enables the use of video images to analyze photoplethysmographic facial signals and identify atrial fibrillation [17].

In mental health, AI has been employed as a self-help modality for patients with depression. With chatbot use, AI models can recognize, evaluate, and deal with negative emotions, helping the user alleviate depression and establish new automatic thoughts [18]. Another algorithm was developed to detect signs of severe depression in social networks in texts utilizing natural language processing, which can be used for suicide prevention [19].

AI has arrived in the operating room (OR) and is gaining relevance in optimizing the workflow of the OR, increasing safety, and improving surgical outcomes. AI systems can optimize surgical procedure scheduling, reduce delays, optimize resources, and reduce costs [20]. They can also be incorporated into monitoring systems to help the anesthesia team identify early potentially life-threatening situations, such as early recognition of hypotension and changes in the electrocardiographic record [21]. AI models can also be used for risk prediction by assessing the risk of mortality and surgical complications, and assisting in choosing the most appropriate technique for a given patient. Other tools that use AI can assist surgeons during the procedure, such as augmented reality and virtual reality, allowing the integration of preoperative images in real-time during the procedure [22]. AI has also been applied in robotic surgery to assist surgeons in complex operations, reducing errors, complications, and hospital stays [23]. In addition, it can be used to evaluate the skills of robot-assisted surgery trainees by assessing their performance on simulators [24].

AI tools can assist in point-of-care decision making by providing evidence-based support, increasing insights, and reducing diagnostic and treatment errors. They can help optimize resources and address shortages of professionals in underserved or remote areas using remote assistance, tele-discussion, or triage resources [11]. AI can assist the education of healthcare providers by providing digital training models for radiological or pathological image recognition, for example, by providing feedback to improve professional self-performance [15].

Another major revolution of AI is to enable patients to manage their own health data using wearable devices with sensors that allow them to monitor various health conditions such as diabetes, arrhythmias, hypertension, and asthma, among others, including the possibility of adding suggestions on when to seek medical help. Furthermore, patients can benefit from algorithms that assist with lifestyle guidelines to help manage diet and physical activity, for example [11].

In health systems, especially public health systems, AI tools can increase efficiency and improve effectiveness, reaching and benefitting a more extensive number of people. The ability of AI algorithms to make predictions is one of the most promising applications that can significantly affect health systems. It can be used in health protection, in which algorithms analyze data for disease surveillance and detection, and in health promotion, providing disease prevention based on risk and behaviors. Another developing use is to improve the efficiency of healthcare services using screening systems [25].

The Covid 19 pandemic was the first major AI test to help humanity find solutions to deal with a previously unknown disease that quickly faced resource depletion, a lack of professionals, and the need to find fast solutions. Throughout the pandemic, IA has been of great importance as a tool for epidemiological assessment to predict the number of new cases, deaths, and recoveries, aid in the diagnosis of the disease, identify virus subphenotyping, quantify lung lesions, and determine patient prognosis [26]. AI has helped in the development of new drugs and in the search for known drugs with potential therapeutic benefits. In addition, IA tools have been used to study the three-dimensional conformation of viral capsid proteins, helping speed up vaccine development.

During the Covid-19 pandemic, AI was used to monitor social distancing through smartphones and video cameras, facilitate the population's access to information about the disease, and help combat fake news. Due to the need for social isolation, telemedicine tools have been developed to triage symptoms and identify warning signs via video calls or chatbots, which are also very useful for identifying and managing symptoms related to psychiatric illnesses such as depression throughout the pandemic [26]. Another applicability tested during the pandemic was the use of robotic companion dogs or cats to mitigate the effects of social isolation on lonely or demented adults throughout the pandemic, providing well-being and quality of life during their time in isolation [27].

AI has also been used to help the elderly and people with disabilities, thereby improving their quality of life. In these systems, algorithms enable the recognition of facial expressions, thereby allowing the control of devices such as wheelchairs. Sensors to monitor activity, behavior, and the environment can be used for preventative measures or to trigger alerts once a risk situation has been identified, such as falls and incorrect medication administration. Other AI models can stimulate memory and prolong independence [28].

On one hand, if all the AI applications mentioned above can improve healthcare, some caveats are necessary. Generally, the implementation of AI systems is expensive. With this, it could leave low-and middle-income countries marginalized from advances in the field, and their populations, many of which are already

underserved, and are those that could benefit greatly from these technologies [29]. Another point of debate concerns the development of some algorithms that may have used the population characteristics of the majority in its development, thus excluding the inherent characteristics of minorities and making their use impossible in the real world, raising ethical dilemmas. Moreover, many people are not yet familiar with the technology to leverage its benefits, or may suffer from reduced human interaction. Other important issues are related to information privacy and data security. All of these issues have been widely discussed, and new strategies to ensure AI's inclusion and guarantee its ethical and legal aspects, including creating specific legislation, should be encouraged.

4.1 Core Messages

- Artificial intelligence (AI) is a broad term that defines systems that can perform tasks like humans
- One of the subdivisions of AI is machine learning (ML), which is the ability of a computer to learn from pre-defined examples, without being explicitly programmed
- Deep learning (DL) is a field of ML that uses Neural Networks to exercise the ability of autonomous learning, that is, without pre-labeled examples
- Big Data refers to an immense set of complex information that requires powerful technological resources for its storage, access, analysis and processing
- AI in healthcare is a very useful tool, due to the large amount and complexity of information analysed
- AI in healthcare is already consolidated in clinical practice in several specialties and it is a trend which all specialties will use in the future. In addition, AI shows promises in the areas of research and population health
- During the COVID-19 pandemic, AI was put to the test and was a very helpful in the search for faster ways to face the pandemic
- AI can be important in promoting the inclusion of people with disabilities and improving assistance to populations with limited resources
- AI should be considered in ethical and legal discussions aiming at greater inclusion and protection of patients.

4.2 Short Expert Opinion

We hope that in the coming years AI will be widely incorporated into healthcare practice, helping professionals in the most different specialties to offer higher quality care, which prevents errors and, at the same time, offers the best evidence of treatment in an individualized way. The function of AI systems should not be to replace professionals, but to assist them in their tasks in a way that can guarantee the principles of beneficence, non-maleficence, autonomy and justice for the

patients. In addition, respecting ethical and legal principles and seeking universal inclusion initiatives, AI can help in the search for much faster and more inclusive solutions to the health problems that plague humanity.

References

1. Muthukrishnan N, Maleki F, Ovens K, Reinhold C, Forghani B, Forghani R (2020) Brief history of artificial intelligence. *Neuroimaging Clin* 30(4):393–399
2. van Assen M, Lee SJ, De Cecco CN (2020) Artificial intelligence from A to Z: from neural network to legal framework. *Eur J Radiol* 129:109083
3. International Business Machines Corporation (IBM) (2021) Machine learning. Available from: <https://www.ibm.com/uk-en/analytics/machine-learning>
4. Do S, Song KD, Chung JW (2020) Basics of deep learning: a radiologist's guide to understanding published radiology articles on deep learning. *Korean J Radiol* 21(1):33–41
5. Montagnon E, Cerny M, Cadrin-Chênevert A, Hamilton V, Derennes T, Ilinca A, Tang A (2020) Deep learning workflow in radiology: a primer. *Insights Imaging* 11(1):1–15
6. Serrano L (2017) A friendly introduction to convolutional neural networks and image recognition. Available from <https://youtu.be/2-OI7ZB0MmU>
7. Maleki F, Ovens K, Najafian K, Forghani B, Reinhold C, Forghani R (2020) Overview of machine learning part 1: fundamentals and classic approaches. *Neuroimaging Clin* 30(4):e17–e32
8. Sagioglu S, Sinanc D (2013) Big data: a review. In: 2013 international conference on collaboration technologies and systems (CTS). IEEE, pp 42–47
9. Risteovski B, Chen M (2018) Big data analytics in medicine and healthcare. *J Integrative Bioinform* 15(3)
10. Sriram RD, Subrahmanian E (2020) Transforming health care through digital revolutions. *J Indian Inst Sci* 100(4):753–772
11. Topol EJ (2019) High-performance medicine: the convergence of human and artificial intelligence. *Nat Med* 25(1):44–56
12. Reel PS, Reel S, Pearson E, Trucco E, Jefferson E (2021) Using machine learning approaches for multi-omics data analysis: a review. *Biotechnol Adv* 49:107739
13. Subramanian M, Wojtuszczyz A, Favre L, Boughorbel S, Shan J, Letaief KB, Chouchane L (2020) Precision medicine in the era of artificial intelligence: implications in chronic disease management. *J Transl Med* 18(1):1–12
14. Zhu H (2020) Big data and artificial intelligence modeling for drug discovery. *Annu Rev Pharmacol Toxicol* 60:573–589
15. Niazi MKK, Parwani AV, Gurcan MN (2019) Digital pathology and artificial intelligence. *Lancet Oncol* 20(5):e253–e261
16. Ting D, Pasquale LR, Peng L, Campbell JP, Lee AY, Raman R, Tan G, Schmetterer L, Keane PA, Wong TY (2019) Artificial intelligence and deep learning in ophthalmology. *Br J Ophthalmol* 103(2):167–175. <https://doi.org/10.1136/bjophthalmol-2018-313173>
17. Yan BP, Lai WH, Chan CK, Au AC, Freedman B, Poh YC, Poh MZ (2020) High-throughput, contact-free detection of atrial fibrillation from video with deep learning. *JAMA Cardiol* 5(1):105–107
18. Liu H, Peng H, Song X, Xu C, Zhang M (2022) Using AI chatbots to provide self-help depression interventions for university students: a randomized trial of effectiveness. *Internet Intervent* 100495
19. Karmen C, Hsiung RC, Wetter T (2015) Screening internet forum participants for depression symptoms by assembling and enhancing multiple NLP methods. *Comput Methods Programs Biomed* 120(1):27–36

20. Rozario D (2020) Can machine learning optimize the efficiency of the operating room in the era of COVID-19? *Can J Surg* 63(6):E527
21. van der Ven WH, Veelo DP, Wijnberge M, van der Ster BJ, Vlaar AP, Geerts BF (2021) One of the first validations of an artificial intelligence algorithm for clinical use: the impact on intraoperative hypotension prediction and clinical decision-making. *Surgery* 169(6):1300–1303
22. Nedadur R, Wang B, Yanagawa B (2021) The cardiac surgeon’s guide to artificial intelligence. *Curr Opin Cardiol* 36(5):637–643
23. Chen M, Decary M (2020) Artificial intelligence in healthcare: an essential guide for health leaders. In: *Healthcare management forum*, vol 33, No 1. Sage CA: Los Angeles, CA: SAGE Publications, pp 10–18
24. Moglia A, Morelli L, D’Ischia R, Fatucchi LM, Pucci V, Berchiolli R, Cuschieri A et al (2022) Ensemble deep learning for the prediction of proficiency at a virtual simulator for robot-assisted surgery. *Surgical Endoscopy* 1–7
25. Panch T, Pearson-Stuttard J, Greaves F, Atun R (2019) Artificial intelligence: opportunities and risks for public health. *The Lancet Digital Health* 1(1):e13–e14
26. Xu Z, Su C, Xiao Y, Wang F (2021) Artificial intelligence for COVID-19: battling the pandemic with computational intelligence. *Intel Med*
27. Fogelson DM, Rutledge C, Zimbardo KS (2021) The impact of robotic companion pets on depression and loneliness for older adults with dementia during the COVID-19 pandemic. *J Holistic Nursing*, 089801012111064605
28. Rong G, Mendez A, Assi EB, Zhao B, Sawan M (2020) Artificial intelligence in healthcare: review and prediction case studies. *Engineering* 6(3):291–301
29. Mollura DJ, Culp MP, Pollack E, Battino G, Scheel JR, Mango VL, Dako F (2020) Artificial intelligence in low-and middle-income countries: innovating global health radiology. *Radiology* 297(3):513–520



Andre Lupp Mota, M.D., M.Sc. Graduation in Medicine at the Faculdade de Medicina de Ribeirão Preto—Universidade de São Paulo. Medical Residency in Cardiac Surgery at Universidade Federal de São Paulo. Master degree at Universidade Federal de São Paulo. PhD Candidate at Universidade de São Paulo.



AI and Big Data for Cancer Segmentation, Detection and Prevention

Zodwa Dlamini, Rodney Hull, Rahaba Marima, Amanda Skepu, Stylianos Makrogkikas, Elias P. Koumoulos, George Bakas, Ioannis Vamvakaris, Konstantinos N. Syrigos, George Evangelou, Aglaia Kavidopoulou, and Georgios Lolas

Perhaps it is conceivable that, in the future, some different kind of computer might be introduced, that makes critical use of continuous physical parameters-albeit within the standard theoretical framework of today's physics-enabling it to behave in a way that is essentially different from a digital computer.
Roger Penrose: Shadows of the mind: a search for the missing science of consciousness [1].

Z. Dlamini · R. Hull · R. Marima · A. Skepu · G. Lolas
SAMRC Precision Oncology Research Unit (PORU), Pan African Cancer Research Institute (PACRI), University of Pretoria, Hatfield 0028, South Africa

A. Skepu
Next Generation Health, Division 1, CSIR, Meiring Naude Road, Brummeria, Pretoria 001, South Africa

S. Makrogkikas
FALCONBIO PTE, Ltd., 32 Carpenter Street, SGInnovate, Singapore 059911, Singapore

E. P. Koumoulos · G. Bakas
Innovation in Research & Engineering Solutions (IRES), Boulevard Edmond Machtens 79/22, 1080 Brussels, Belgium

I. Vamvakaris
Pathology Department, Athens Chest Hospital "Sotiria", 11527 Athens, Greece

K. N. Syrigos · G. Evangelou · G. Lolas
3rd Department of Internal Medicine and Laboratory, National and Kapodistrian University of Athens (NKUA), Athens School of Medicine, 11527 Athens, Greece

E. P. Koumoulos · A. Kavidopoulou · G. Lolas (✉)
Integrate Computational & Mathematical Modeling Approaches (InCELLiA) P.C., Lavriou 1, 19500 Lavrion, Greece
e-mail: glolas@med.uoa.gr

1 Introduction

Long before the Common Era, in the eighth century BC, Homer introduced automata from workshops of the Greek god Hephaestus in his poem *The Iliad* [2]. Later, around the fourth century BC, Aristotle presented the epistemological basis of the division of knowledge into categories, with theory being the most critical and art being less important [2]. In addition, he pioneered syllogistic logic, which was the first formal deductive reasoning system. In the late first-century CE, the Heron of Alexandria built mythical automata and many other mechanical marvels. In the fifteenth and sixteenth centuries, Paracelsus was the first to introduce the magnetic or sympathetic system of medicine as the basis for magnetic healing [3]. However, there is still much more history behind the evolution of artificial intelligence that can be found in a detailed review of the subject in [4].

According to the National Cancer Institute at the National Institutes of Health (NIH) [5], a definition for cancer as a term is described as follows:

A term for diseases in which abnormal cells divide without control and can invade nearby tissues.

Looking at the cancer statistics reported by the World Health Organization (WHO), it is revealed that cancer is the second most common cause of death globally, with 10 million deaths per year. This number translates to approximately one in six deaths due to cancer globally [6].

In the US, the total number of cancer-related deaths between 2015 and 2018 increased tremendously [7]. In line with this result, Wilson et al. [8] presented a table (Table 1) of the number of publications concerning the application of Artificial Intelligence to cancer research during the period 1991–2018.

Between 2015 and 2018, the number of citations using AI in cancer as a search term decreased even though the number of papers increased. This shows that research on Artificial Intelligence and cancer has increased, but the interest of researchers on this topic has decreased.

However, between 2018 and 2021 Siegel et al. [9] stated that, since 2018, there has been a 33% decrease in the number of cancer-related deaths. This may be due to a reduction in smoking, as well as better diagnostics, resulting in earlier detection of cancer and better treatment. AI also plays a leading role in reducing smoking. In 2020, the World Health Organization (WHO) introduced AI into its tobacco quitting initiative to help people quit smoking and advance the precision and accuracy of diagnostics (that is, The diagnosis was made by a presumptive patient using chatbots, which can detect symptoms) [10].

1.1 Big Data and Artificial Intelligence (AI)

An interesting definition of big data was provided by De Mauro et al. [11] as follows:

Table 1 An overview of both the number of papers as well as citations related to artificial intelligence applications in cancer between 1991 and 2018 as adopted by [8]

Year published	Total number of papers	Total citations
2018	661	809
2017	503	3206
2016	435	3680
2015	349	4524
2014	284	4131
2013	268	5167
2012	202	4642
2011	173	4706
2010	146	5474
2009	114	3550
2008	88	3671
2007	68	2480
2006	58	2324
2005	45	1885
2004	26	1582
2003	39	3115
2002	17	3208
2001	15	964
2000	18	2040
1999	13	1043
1998	12	548
1997	9	420
1996	2	52
1995	2	297
1994	4	172
1993	0	0
1992	3	105
1991	1	2

Big Data is the Information asset characterized by such a High Volume, Velocity and Variety to require specific Technology and Analytical Methods for its transformation into Value.

As its name suggests, big data refer to a large amount of data that is available and collected by experts. Big data are vital to technological advancements because they are collected from every source to offer new perspectives and opportunities in modern healthcare. Dash et al. [12] argued that big data handling and manipulation is important for their efficient use and management. Because both handling and manipulation of big data cannot be achieved using traditional methods, the use of new and advanced techniques is inevitable. Although big data faces significant challenges owing to ethics, high costs, and privacy policies, it can transform medicine. Big data can be applied to science, academia, and industry. In healthcare,

big data combined with machine learning can be used to store and analyze a patient's scan. This can then form part of the electronic health record, enabling professionals to follow up with the patient, determine the efficiency of a new drug, and design better clinical trials.

Artificial intelligence and big data are key factors that contribute to the early detection and treatment of cancer. According to the Merriam-Webster dictionary [13], artificial intelligence is '*a branch of computer science dealing with the simulation of intelligent behavior in computers/The capability of a machine to imitate intelligent human behavior*' (Merriam-Webster).

AI can analyze more health data faster, safer, and more efficiently (i.e., electronic health records-gathering patient data and insights that lead to predictive analysis) than before. This results in better use of the data and improvement of current diagnostic techniques. Therefore, the aim of AI in healthcare is to examine and determine patterns in large and complex datasets in less time and more accurately than in previous studies [14]. Another reason that artificial intelligence is important in healthcare is that it can perform sophisticated nonlinear calculations and determine outcomes with minimal or no human interference.

1.2 Cancer Image Segmentation

Tumor segmentation involves the separation of tumors from normal tissues. Tumor segmentation is a very useful tool for cancer detection in general, as it provides valuable data for diagnosis and treatment planning, and is commonly used in brain tumors [15]. Manual segmentation is, by far, the most accurate method for segmentation method. However, in extensive studies, to achieve precise segmentation of cancerous lesions, more than one image modality with differing contrasts should be involved. In such cases, deep learning has emerged as an attractive solution for quantitative medical imaging analysis.

Despite significant efforts, patient diagnosis using tumor segmentation remains poor [16]. Various medical imaging techniques such as magnetic resonance imaging (MRI), computed tomography (CT), and positron emission tomography (PET) have been used to assess tumor localization and progression before and after treatment. Owing to its high resolution, noninvasive characteristics, and soft tissue contrast, MRI is generally the most commonly used modality for brain tumor diagnosis and treatment planning [16, 17].

In clinical practice, tumor segmentation is manually performed. Usually, an experienced radiologist segments all the affected regions by meticulously studying the scanned patient's images. This approach, which primarily depends on the radiologist, is laborious and subject to broad inter-and intra-rater variabilities [18]. Therefore, manual segmentation is limited to visual inspection and qualitative assessment, with marginal quantitative assessments.

Quantitative analysis of tumors, such as those of the brain, offers significant information that helps doctors to understand tumor characteristics and provides better options for treatment planning [17]. Information provided by quantitative

assessments sheds light on the characteristics and progression of the disease and its effects on actual anatomical structures [19]. The limitations of these assessments can be attributed to the variability in the size, shape, and location of lesions. Furthermore, various imaging modalities with distinct contrasts must be considered for accurate lesion segmentation [20]. Therefore, at present, many research activities aim to use computer algorithms to achieve automated tumor segmentation. This approach enables reproducibility, objectivity, and quantitative assessment. In addition, the application of convolutional neural networks (CNNs) to this task has emerged as a dominant field in brain tumor segmentation [21].

Similar to the segmentation of other tumors, brain tumor segmentation aims to identify the location and expansion of tumor areas. Qualitative and quantitative assessments play an important role in tumor segmentation. Depending on the human involvement, the segmentation of brain tumors can be branched into manual, semi-automatic, and fully. Automatic segmentation of brain tumors does not require human interaction. Prior knowledge and AI are required to understand and solve segmentation problems [17]. Automated segmentation methods can be further classified as generative and discriminating techniques. The latter typically relies on supervised learning, where knowledge of the interactions among manually annotated data, as well as image input, arose and learned from a large dataset. Owing to the complexity of medical images, discrimination methods may not be able to fully leverage training data. However, the use of deep learning methods is increasing owing to their exceptional performance in their ability to learn directly from data and computer visualization tasks. By contrast, generative methods use existing/prior knowledge of the distribution and appearance of different tissue types. Because deep learning requires large memory volume and computational resources, it serves as a limiting factor in the application of segmentation algorithms [17].

According to Pan [22], image processing can be categorized into different stages such as image acquisition, image preprocessing (deionizing/enhancement/restoration), image segmentation/feature extraction, and object recognition (see Fig. 1).

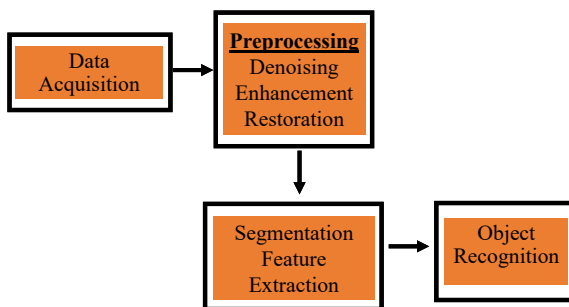

Fig. 1 A general representation of specific elements of classical image processing systems as adopted by [22]

Image Segmentation is characterized by a pixel-based selection of a Region Of Interest (ROI) where a similarity criterion or a threshold is performed locally. This method is used to evaluate and analyze Magnetic Resonance Imaging (MRI) medical scans. Ibrahim et al. [23] proposed the use of the Chaotic Salp Swarm Algorithm (CSSA), in the segmentation of images for breast cancer detection. In another study, Senthil Kumar et al. [24] used image segmentation algorithms to diagnose lung cancer using Computer Tomography (CT) scan images. Lastly, Shang et al. [25] proposed a model that utilizes the data sets from sequentially evaluated tomography and magnetic resonance image scans for left ventricle segmentation of the heart in patients. These were only some of the applications of Image Segmentation in cancer. Furthermore, there are several methods of image segmentation such as Region, Edge, Fuzzy Theory, Partial Differential Equation (PDE) Threshold based image segmentation; Semantic segmentation networks and Convolution Networks.

A. Region Based Segmentation

The region-based segmentation method uses a seed pixel inside the ROI as a reference point to correlate the neighboring pixels [26]. Thus, the region grew when similar adjacent pixels were identified. This similarity is based on similarity constraints, such as texture and intensity, which all pixels contained within a region have. Furthermore, this procedure is repeated, and the region grows until a pixel does not satisfy similarity constraints. Finally, all pixels in the image were part of the region.

According to Punitha et al. [26], the selection of the correct seed points, detection thresholds, and similarity constraints is crucial for the precision of the segmentation process. This method is used in planning the treatment of prostate cancer [27], breast cancer detection from mammogram images [28], and screening for cervical cancer improvement [29]. A detailed approach to region-growing-based image segmentation can be found in [30].

B. Edge Based Segmentation

Edge-based segmentation was considered one of the oldest and most basic methods by Sponton and Cardelino [31]. This reduces the size of data storage used by an image by focusing only on the important structural characteristics of the image. Thus, this method separates the image background from the object [32]. In 1980 Marr and Hildreth [33], creators of the Marr–Hildreth algorithm, proposed that the intensity of an image is related to its scale, thus, it needs operators different in size.

According to Saini et al. [34], this technique is commonly used to detect interruption of the gray level (such as points, lines, and edges) in images, making it a boundary-based method. To detect edges, it is important to use operators that recognize them. They are classified into two categories: first- and second-order derivative operators. The first group contained four operators: Prewitt, Sobel, Canny, and the test operators. The second method includes the Laplacian operator and zero crossing [34].

C. *Fuzzy Theory Based Image Segmentation*

The third method, fuzzy theory-based image segmentation, is an amalgamation of these two methods. According to Basir et al. [35], this method is used to repeatedly combine regions based on the maximum fuzzy integral criterion. Thus, an algorithm that automatically chooses the optimal parameters from a plethora of fuzzy densities with respect to the minimum cost value was used. This procedure results in fuzzy densities adjusted according to the image. This was performed in such a way that no human intervention was required. However, the evaluation process of the segmented images must be performed, and it is accomplished by utilizing magnetic resonance images (MRI) as well as natural images to establish that the strong segmentation achieved is better than that obtained with other approaches [35].

A new fuzzy algorithm based on the work of Khan [36] that uses morphology was introduced by Liu Yucheng. This algorithm uses morphological operations to smooth the image, and then performs gradient operations on the resultant image.

D. *Partial Differential Equation (PDE) Based Image Segmentation*

Partial differential equation (PDE) based image segmentation was first introduced in 1988 by Osher and Sethian [37]. According to Sliž and Mikulka [38], the partial differential equation (PDE) is based on the energy of the image function and describes the parametric curve evolution based on the energy of the image function. More specifically, the solution of the PDE drives image segmentation, which, although it can be implemented, cannot deal with topological changes in the segmented object. As Pan [22] stated, curve-evolution methods force one or more initial curve(s) onto an object's borders within an image, based on the gradient and/or information of the region. In addition, the use of finite-difference approximations for the PDEs is essential for these methods. Another curve-propagation method was proposed by Tara et al. [39]. In addition, Wei et al. [40] reported that a PDE-based method has anti-noise capacity.

Curve propagation is a popular technique in this field. This method has many applications in object extraction, tracking, and stereo reconstruction [39]. The aim of this approach is to use a propagation curve to partition the image. Therefore, a curve was created for the minimum cost function. For most inverse problems, minimizing the cost function is nontrivial and imposes certain smoothness constraints on the solution, which in the present case can be expressed as geometric constraints on the evolving curve [39].

E. *Threshold-Based Image Segmentation*

Threshold-based methods are among the most widely used and simplest for image segmentation. This method focuses on creating binary images from grayscale images because a binary image reduces the complexity of the data, and thus simplifies recognition and classification [41]. This is achieved by choosing a competent threshold value T [21]. T is the threshold value at which gray level values less than T are classified as black (0) and those greater than T are classified as white (1). Consequently, a binary picture was created that contained all relevant information

regarding the position and shape of the items of interest (foreground) [41]. Thus, this method is valuable for differentiating foreground from background [42].

The most challenging aspect of this strategy is determining the correct value for threshold T . Examining the histograms of the picture types that need to be segmented is one technique to tackle this challenge. Because the histogram in the best scenario displays only two main modes and a distinct valley (bimodal), the value of T , which is the valley point between the two main modes, was chosen. Histograms in real-world applications, on the other hand, are more problematic since they have multiple peaks but no obvious troughs, making the selection of the value T more tough [42].

F. *Semantic segmentation networks*

In contrast to other classification methods, semantic segmentation networks can categorize every pixel in an image as tumor or normal. This is important because there is no need to classify the entire area of the image as tumor or normal. Owing to the pooling layers, the output prediction is downsampled as the network architecture becomes deeper, and as a result, the sampling rate is minimized [43]. To maintain a dense output, Chen et al. [43] proposed a semantic segmentation framework to achieve downsampling using a dense deep convolutional neural network (DCNN), which uses an atrous convolution operation to replace traditional convolution and pooling operations. It can create dense predictions with the same receptive field through upsampling. However, performing semantic segmentation on a whole-slide image (WSI) requires time and memory for processing billions of pixels. In addition, most tissues in the WSI are normal, and semantic segmentation is not required [44].

G. *U-Net: Convolutional Networks*

U-Net networks can be used to solve various biomedical segmentation problems. This method was created by Ronneberger et al. [45] at the University of Freiburg and consists of a two-path architecture and end-to-end fully convolutional network (FCN). The first path is a contracting path that functions as an encoder and has the architecture of a CNN. It consists of a stack of three convolutions, each with a rectified linear unit (ReLU) and a two-two max-pooling operation with a stride of two for downsampling. It should be noted that the number of feature channels was doubled in each phase. The second path is an expansive path, which is a decoder that contains an upsampling of the feature map, a 2×2 convolution, and two 3×3 convolutions, each with a rectified linear unit (ReLU). The last layer was a 1×1 convolution, resulting in a convolutional network with 23 layers.

1.3 Cancer Detection

Cancer is the leading cause of death worldwide. Therefore, early detection and prevention are crucial. The use of AI techniques and deep learning approaches has

changed the manner in which detection is performed. AI also allows the collection of data from various scientific fields, converting them into effective diagnostic systems, ranging from radiographic images to genomics, pathology data, electronic health records, and social networks [46]. As Suzuki et al. [47] stated, many methods have been used for image analysis since the 1970s. Image analysis using deep learning is the most popular method used for this purpose. This method classifies and recognizes medical images based on the cancerous conditions. The most popular images analyzed were those of the colonic polyps.

Image and pattern recognition, as well as computer-aided diagnosis (CAD), are methods that can detect cancer earlier and more accurately. Bi et al. [46] stated that emerging research shows that the application of AI to medical imaging is advancing in four tumor types: the lung, prostate, brain, and breast. The application of AI in cancer imaging can perform three main clinical tasks: tumor detection, characterization, and monitoring. Tumor detection is associated with the object localization of interest in radiographs. Object localization is collectively known as computer-aided detection (CAD). AI detection tools can be used as initial screens against omission errors and reduce observational discrepancies. Image and pattern recognition, as well as computer-aided diagnosis (CAD), are methods that can detect cancer earlier and more accurately.

Chan et al. [48] stated that computer-aided diagnosis (CAD) is a tool that can be efficiently used by physicians to support decision-making. The method uses machine learning techniques and multidisciplinary knowledge to arrive at a diagnosis. In particular, scientists translate the features of an image into descriptors that use mathematical functions and image-processing techniques to obtain results. Furthermore, scientists should be careful when designing descriptors because tricky differences between normal and abnormal clinical conditions cannot be easily detected among populations. Although this method is useful and accurate, false-positive results can occur in some cases.

Al-Shamasneh and Obaidallah [49] noted that the use of CAD methods reduces the time and cost of examination and contributes to fewer unnecessary biopsies. CAD combined with computed tomography (CT), X-ray, magnetic resonance imaging (MRI), or mammogram images could be a useful tool to act as a reference for specialists in cancer diagnosis. CAD systems are typically used to detect or assist in the treatment of breast, brain, lung, and other cancers.

According to Bi et al. [46], CAD methods can be used as a supplementary tool to aid in the detection of cancers that were missed in the initial diagnostic imaging, normally found in low-dose CT screenings, brain metastases in MRIs, and microclassification clusters in screening mammography.

AI is commonly used to assist in the diagnosis of lung, breast, and prostate cancers as well as cancers of the central nervous system (Fig. 2). Following diagnosis, AI can be used to classify cancers into stage, extent, and so on. Alternatively, it can be used to genetically profile tumors. Following treatment, AI can be used to monitor any changes that occur, allowing for monitoring the course of the disease [46].

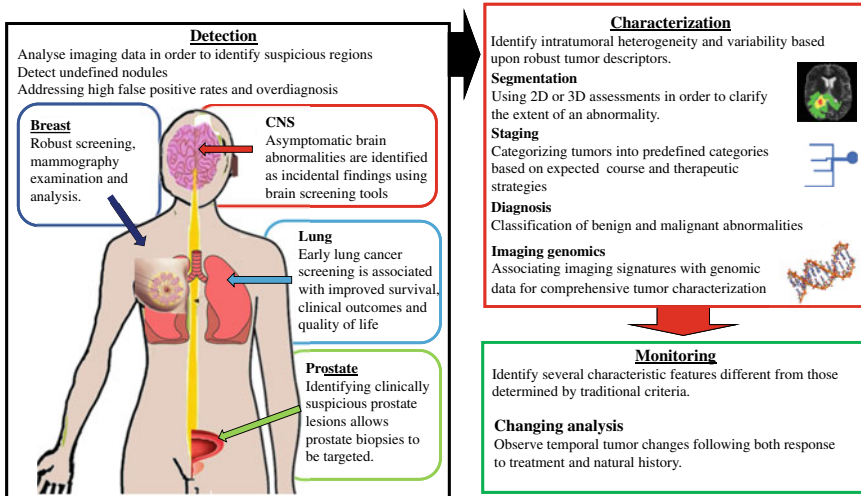

Fig. 2 Applications of artificial intelligence in cancer medical imaging can be summarized in the following three categories (as adopted by [46]): **a** detect abnormalities; **b** characterize a suspicious lesion through its shape, volume, molecular profile and stage of disease; and **c** determine through temporal monitoring prognosis and response to treatment (CNS: Central Nervous System; 2D: 2-Dimensional; 3D: 3-Dimensional)

Another field related to cancer prevention is the biological characterization of tumors. ‘Imaging genomics’ as presented by Linda Bi et al. [46] is a field that associates radiographic imaging features along with biological data (somatic mutations, gene expression, chromosome copy number and molecular signatures). Finally, AI plays a vital role in monitoring tumor progression. Not only can it be used as a tool to oversee tumor progression, but it can also be used to observe the response of a tumor to treatment.

1.4 Protein Structure Prediction

The primary method for detecting cancer is based on protein structure. It would be easier to detect abnormalities that lead to cancer formation if the structure of a protein could be predicted. Proteins are comprised of amino acid sequences and have four well-defined structural levels: *primary*, *secondary*, *tertiary*, and *quaternary*. The folding of proteins and their resulting structures can play a vital role in the proper functioning of the body. Therefore, rigid quality control mechanisms are responsible for coordinating the rates of protein synthesis and proteasomal degradation to prevent the formation of intracellular aggregates. If this regulation fails, a pathogenic mechanism is responsible for the increased levels of misfolded and aggregated proteins [50].

These aggregated proteins are commonly represented by alpha-synuclein (α S) proteins, which are major components of Lewy bodies [51]. Additionally, α S protein aggregate deposits constitute a pathogenic hallmark of synucleinopathies including Parkinson’s disease (PD), dementia with Lewy bodies (DLB), and multiple system atrophy (MSA) [51]. Thus, it is important to predict the structure of proteins to understand the mechanisms of these pathological conditions and cure them.

A typical pipeline for protein structure prediction proposes intermediate prediction steps known as protein structure annotations (PSA). Several PSAs such as torsion angles, contact density, half-sphere exposure, and distance maps can be used [52]. A pipeline for predicting protein structure is shown in Fig. 3.

More precisely, the prediction of the structure of a protein can reveal the amino acid sequence formation on a three-dimensional protein shape. Additionally, by examining the correlated variation of homologous sequences, which helps in the prediction of protein structures, it is feasible to establish which amino acid residues are in contact [50]. Accurate prediction of the distances between pairs of residues requires a trained neural network. Thus, the technique requires two basic biological assumptions: (1) conserved amino acids in the same positions are not random; rather, they reflect a very important part of the structure and function; and (2) by examining which amino acids are frequently mutated together, they can find amino acids that interact with one another. Consequently, its predictions are employed in the formulation of a mean force potential that accurately represents the structure of a protein. To build structures without sophisticated sampling techniques, a gradient descent algorithm can be used to maximize the resultant potential. **AlphaFold**, the

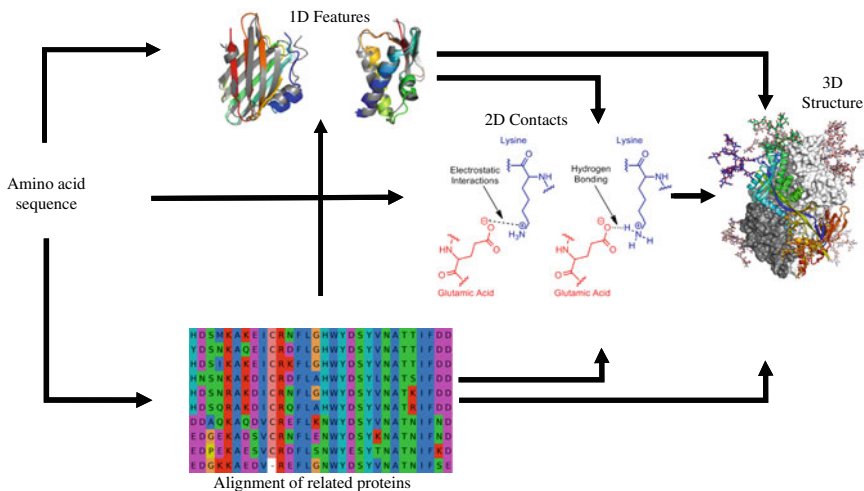

Fig. 3 A schematic representation of a generic pipeline for ab initio protein structure prediction as adopted by [52] where an evolutionary information in the form of alignments, 1D and 2D protein structure annotations (PSA) and 3D structures as intermediate steps is presented

resultant technology, can do high-precision analysis even for sequences with less homologous sequences [52].

Specifically, the **AlphaFold** system uses three deep-learning-based methods for free modeling (FM) protein structure prediction. These methods are described as follows [53].

1. *Prediction of the distance between pairs of residues within a protein.*
2. *Direct estimation of the accuracy of a candidate structure (termed the GDT-net).*
3. *Direct production of protein structures.*

An explanation of the 1st point was provided in the previous section. For the second point, GDT-net, as explained in Fig. 4 [53], was trained in a distributed and continuous environment. Candidate structures were generated from actors that performed simulated annealing, along with the latest GDT-net for all proteins in the training set [53]. Simultaneously, GDT-net is trained by learners on candidates sampled from actors [53].

1.5 Cancer Prevention

Since the 1970s, artificial intelligence (AI) has emerged as a significant tool in medicine, and is involved in disease prevention, diagnosis, and treatment. Regrettably, efforts to create an android that would provide a diagnosis to patients have been unsuccessful. Although the first attempt was unsuccessful, many of them were followed in the 2010s. Hence, the aim of machine-learning methods is to find new key relationships in complicated models and algorithms to make predictions using big data [54].

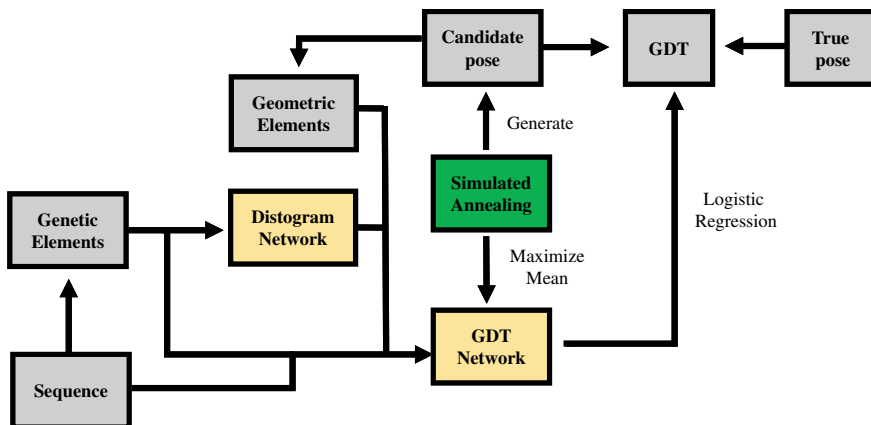

Fig. 4 A representation of the GDT-net system as adapted by [53]. With grey colour the feature extraction stages are presented while structure-prediction neural network and structure-realization are presented with yellow and green respectively

Screening techniques that can assist in cancer prevention, such as mammography, colonoscopy, dual-stain cytology tests, and breast magnetic resonance imaging (MRI), are used for early cancer prediction. When combined with AI, these techniques yield accurate predictions. Specifically, McKinney et al. [55] created an AI system that exceeded the capabilities of human diagnosticians, and the area below the receiver operating characteristic curve (AUC-ROC) for the average radiologist was less than that for the AI system by an absolute margin of 11.5%. Lui and Leung [56] created a deep learning model that could help endoscopists avoid missing colorectal lesions. Wentzensen et al. [57] created a deep learning-based, automated, dual-stained (DS) cytology method for screening breast cancer biopsies (Fig. 5).

Finally, Jiang et al. [58] applied AI to breast MRI. The aim was to value the effectiveness of an AI system that is used compared with the conventionally available software regarding the diagnostic performance of radiologists in the differentiation of cancer from non-cancer on dynamic contrast material-enhanced (DCE) breast MRI is improved if an AI system is used in comparison with commonly available software. The diagnostic performance of 19 breast radiologists improved from an AUC of 0.71–0.76 ($P = 0.04$) when the differentiation of cancers from benign lesions at breast MRI occurred with the use of an AI system. Also, the sensitivity was higher when BI-RADS 3 category was used as the cut-off point (from 90 to 94%) but not when using BI-RADS category 4a; specificities did not show differences.

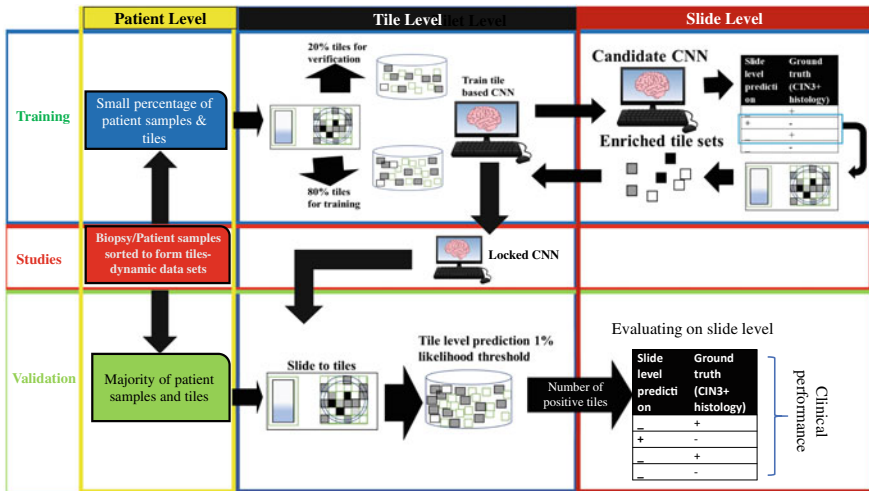

Fig. 5 Artificial intelligence study design as adopted by [57] where AI = artificial intelligence; CNN = convolutional neural network; CIN3 + = cervical intraepithelial neoplasia grade 3 or worse; and finally DS = dual stain

2 Conclusions

Despite valuable efforts by cancer researchers, clinicians, and patients, cancer continues to affect public health. It is indisputable that AI and big data are generating waves and emerging as potent solutions in the fight against cancer. Limited access to large-scale clinical training datasets poses an obstacle to the application of AI and big data in cancer detection, segmentation, and prevention. Nonetheless, significant advances have been made by researchers in the application of AI for the detection, characterization, and monitoring of lung, breast, prostate, and brain cancers. These advances pave the way for unlocking the great potential of AI for application on other cancer types. Not only do manual detection and segmentation processes require highly experienced clinicians, such as radiologists, they are also costly in terms of time and finances, while intra-and inter-variability discrepancies cannot be ignored by such traditional practices. Furthermore, qualitative assessments not only play a role in cancer detection and segmentation, but the role of quantitative assessments cannot be emphasized sufficiently. AI and big data provide immense room for quantitative assessment using segmentation algorithms, which can be leveraged for the identification of clinical biomarkers that can be used not only for tumor detection but also for prevention.

References

1. Penrose R (1994) *Shadows of the mind*, vol 4. Oxford University Press, Oxford
2. Coddington M (1991) *Seekers of the healing energy: Reich, Cayce, the Kahunas, and other masters of the vital force*. Inner Traditions/Bear & Co
3. McCorduck P, Cfe C (2004) *Machines who think: a personal inquiry into the history and prospects of artificial intelligence*. CRC Press
4. Kavidopoulou A (2021) *Applications for artificial intelligence in biomedical sciences*. National and Kapodistrian University of Athens, Athens, Greece
5. National Cancer Institute (2021) NCI dictionary of cancer terms, definition of cancer. <https://www.cancer.gov/publications/dictionaries/cancer-terms/def/cancer>
6. World Health Organisation (2021) Cancer. <https://www.who.int/news-room/fact-sheets/detail/cancer>
7. American Cancer Society (2021) Cancer facts and figures. <https://www.cancer.org/research/cancer-facts-statistics/all-cancer-facts-figures.html>
8. Tran BX, Latkin CA, Sharafeldin N, Nguyen K, Vu GT, Tam WWS, Cheung NM, Nguyen HLT, Ho CSH, Ho RCM (2019) Characterizing artificial intelligence applications in cancer research: a latent dirichlet allocation analysis. *JMIR Med Inform* 7(4):e14401. <https://doi.org/10.2196/14401>
9. Siegel RL, Miller KD, Jemal A (2020) Cancer statistics, 2020. *Ca Cancer J Clin* 70(1):7–30
10. World Health Organization (2020) AI for quitting tobacco initiative. <http://www.publicnow.com/view/9282C9C5897F0B8BFB5D677FAF39F5570079F8AE>
11. De Mauro A, Greco M, Grimaldi M (2016) A formal definition of big data based on its essential features. *Libr Rev* 65(3):122–135
12. Dash S, Shakyawar SK, Mt S, Kaushik S (2019) Big data in healthcare: management, analysis and future prospects. *J Big Data* 6(1):1–25
13. Merriam-Webster.com Af (2020) Artificial intelligence. <https://www.merriam-webster.com/dictionary/artificial%20intelligence>

14. Bohr A, Memarzadeh K (2020) Chapter 2—the rise of artificial intelligence in healthcare applications. In: Bohr A, Memarzadeh K (eds) *Artificial intelligence in healthcare*. Academic Press, pp 25–60. <https://doi.org/10.1016/B978-0-12-818438-7.00002-2>
15. Bousseham A, Bouattane O, Youssfi M, Raihani A (2019) Towards reinforced brain tumor segmentation on MRI images based on temperature changes on pathologic area. *Int J Biomed Imaging* 2019:1758948. <https://doi.org/10.1155/2019/1758948>
16. Menze BH, Jakab A, Bauer S, Farahani K, Kirby J, Burren Y, Porz N, Slotboom J, Wiest R (2014) The multimodal brain tumor image segmentation benchmark (BRATS). *IEEE Trans Med Imaging* 34(10):1993–2024
17. Magadza T, Viriri S (2021) Deep learning for brain tumor segmentation: a survey of state-of-the-art. *J Imaging* 7(2):19
18. Işın A, Direkoğlu C, Şah M (2016) Review of MRI-based brain tumor image segmentation using deep learning methods. *Proc Comput Sci* 102:317–324
19. Razzak M, Imran M, Xu G (2018) Efficient brain tumor segmentation with multiscale two-pathway-group convolutional neural networks. *IEEE J Biomed Health Inform* 23(5):1911–1919
20. Kamnitsas K, Ledig C, Newcombe VFJ, Simpson JP, Kane AD, Menon DK, Rueckert D, Glocker B (2017) Efficient multi-scale 3D CNN with fully connected CRF for accurate brain lesion segmentation. *Med Image Anal* 36:61–78
21. Muhammad K, Khan S, Del Ser J, de Albuquerque VHC (.2020) Deep learning for multigrade brain tumor classification in smart healthcare systems: a prospective survey. *IEEE Trans Neural Netw* 32(2):507–522
22. Pan Y (2007) *Image segmentation using PDE, variational, morphological and probabilistic methods*. University of Tennessee
23. Ibrahim A, Mohammed S, Ali HA, Hussein SE (2020) Breast cancer segmentation from thermal images based on chaotic salp swarm algorithm. *IEEE Access* 8:122121–122134
24. Senthil Kumar K, Venkatalakshmi K, Karthikeyan K (2019) Lung cancer detection using image segmentation by means of various evolutionary algorithms. *Comput Math Methods Med* 2019:4909846. <https://doi.org/10.1155/2019/4909846>
25. Shang H, Zhao S, Du H, Zhang J, Xing W, Shen H (2020) A new solution model for cardiac medical image segmentation. *J Thorac Dis* 12(12):7298–7312. <https://doi.org/10.21037/jtd-20-3339>
26. Punitha S, Amuthan A, Joseph KS (2018) Benign and malignant breast cancer segmentation using optimized region growing technique. *Future Comput Inform J* 3(2):348–358
27. Mazonakis M, Damilakis J, Varveris H, Prassopoulos P, Gourtsoyiannis N (2001) Image segmentation in treatment planning for prostate cancer using the region growing technique. *Br J Radiol* 74(879):243–248. <https://doi.org/10.1259/bjr.74.879.740243>
28. Senthilkumar B, Umamaheswari G, Karthik J (2010) A novel region growing segmentation algorithm for the detection of breast cancer. In: 2010 IEEE international conference on computational intelligence and computing research. IEEE, pp 1–4
29. Mat-Isa NA, Mashor MY, Othman NH (2005) Seeded region growing features extraction algorithm; its potential use in improving screening for cervical cancer. *Int J Comput Internet* 13(1):61–70
30. Mesanovic N, Grgic M, Huseinagic H, Males M, Skejic E, Smajlovic M (2011) Automatic CT image segmentation of the lungs with region growing algorithm. In: 18th international conference on systems, signals and image processing-IWSSIP
31. Spontón H, Cardelino J (2015) A review of classic edge detectors. *Image Process On Line* 5:90–123
32. Farag AA (1992) Edge-based image segmentation. *Remote Sens Rev* 6(1):95–121. <https://doi.org/10.1080/02757259209532148>
33. Marr D, Hildreth E (1980) Theory of edge detection. *Proc R Soc Lond B* 207(1167):187–217
34. Saini S, Arora K (2014) A study analysis on the different image segmentation techniques. *Int J Inf Comput Technol* 4(14):1445–1452

35. Basir O, Zhu H, Karray F (2003) Fuzzy based image segmentation. In: Fuzzy filters for image processing. Springer, pp 101–128
36. Khan MW (2014) A survey: image segmentation techniques. *Int J Future Comput Commun* 3(2):89
37. Osher S, Sethian JA (1988) Fronts propagating with curvature-dependent speed: algorithms based on Hamilton-Jacobi formulations. *J Comput Phys* 79(1):12–49
38. Sliž J, Mikulka J (2016) Advanced image segmentation methods using partial differential equations: a concise comparison. In: 2016 progress in electromagnetic research symposium (PIERS). IEEE, pp 1809–1812
39. Tara S, Reddy RB, Bharath R, Ramesh G (2014) Various image segmentation methods based on partial differential equation—a survey. *Int J Adv Comput Electron Eng* 3(1)
40. Wei J, Chan L (2016) An image segmentation method based on partial differential equation models. *Int J Simul Syst Sci* 17(36)
41. Bhargavi K, Jyothi S (2014) A survey on threshold based segmentation technique in image processing. *J Int J Innov Res* 3(12):234–239
42. Al-amari SS, Kalyakar NV, Khamitkar SD (2010) Image segmentation by using threshold techniques. *J Comput* 2(5):83–86
43. Chen L-C, Papandreu G, Kokkinos I, Murphy K, Yuille AL (2017) Deeplab: semantic image segmentation with deep convolutional nets, atrous convolution, and fully connected crfs. *IEEE Trans Pattern Anal Mach Intel* 40(4):834–848
44. Guo Z, Liu H, Ni H, Wang X, Su M, Guo W, Wang K, Jiang T, Qian Y (2019) A fast and refined cancer regions segmentation framework in whole-slide breast pathological images. *Sci Rep* 9(1):1–10
45. Ronneberger O, Fischer P, Brox T (2015) U-Net: convolutional networks for biomedical image segmentation. In: Cham, 2015. Medical image computing and computer-assisted intervention—MICCAI 2015. Springer International Publishing, pp 234–241
46. Bi WL, Hosny A, Schabath MB, Giger ML, Birkbak NJ, Mehrtash A, Allison T, Arnaout O, Abbosh C, Dunn IF, Mak RH, Tamimi RM, Tempany CM, Swanton C, Hoffmann U, Schwartz LH, Gillies RJ, Huang RY, Aerts H (2019) Artificial intelligence in cancer imaging: clinical challenges and applications. *CA Cancer J Clin* 69(2):127–157. <https://doi.org/10.3322/caac.21552>
47. Suzuki H, Yoshitaka T, Yoshio T, Tada T (2021) Artificial intelligence for cancer detection of the upper gastrointestinal tract. *Digest Endoscopy Official J Japan Gastroenterol Endoscopy Soc* 33(2):254–262. <https://doi.org/10.1111/den.13897>
48. Heang-Ping C, Ravi KS, Lubomir MH (2020) CAD and AI for breast cancer—recent development and challenges. *Br J Radiol* 93(1108):20190580. <https://doi.org/10.1259/bjr.20190580>
49. Al-shamasneh ARM, Obaidallah UH (2017) Artificial intelligence techniques for cancer detection and classification: review study. *Eur Sci J* 13(3):342–370
50. Senior AW, Evans R, Jumper J, Kirkpatrick J, Sifre L, Green T, Qin C, Židek A, Nelson AWR, Bridgland A (2020) Improved protein structure prediction using potentials from deep learning. *Nature* 577(7792):706–710
51. Meade RM, Fairlie DP, Mason JM (2019) Alpha-synuclein structure and Parkinson’s disease—lessons and emerging principles. *Mol Neurodegener* 14(1):29. <https://doi.org/10.1186/s13024-019-0329-1>
52. Torrisi M, Pollastri G, Le Q (2020) Deep learning methods in protein structure prediction. *Comput Struct Biotechnol J* 18:1301–1310
53. Senior AW, Evans R, Jumper J, Kirkpatrick J, Sifre L, Green T, Qin C, Židek A, Nelson AWR, Bridgland A (2019) Protein structure prediction using multiple deep neural networks in the 13th critical assessment of protein structure prediction (CASP13). *Proteins Struct Func Bioinform* 87(12):1141–1148

54. Leatherdale ST, Lee J (2019) Artificial intelligence (AI) and cancer prevention: the potential application of AI in cancer control programming needs to be explored in population laboratories such as COMPASS. *Cancer Causes Control CCC* 30(7):671–675. <https://doi.org/10.1007/s10552-019-01182-2>
55. McKinney SM, Sieniek M, Godbole V, Godwin J, Antropova N, Ashrafian H, Back T, Chesus M, Corrado GS, Darzi A, Etemadi M, Garcia-Vicente F, Gilbert FJ, Halling-Brown M, Hassabis D, Jansen S, Karthikesalingam A, Kelly CJ, King D, Ledsam JR, Melnick D, Mostofi H, Peng L, Reicher JJ, Romera-Paredes B, Sidebottom R, Suleyman M, Tse D, Young KC, De Fauw J, Shetty S (2020) International evaluation of an AI system for breast cancer screening. *Nature* 577(7788):89–94. <https://doi.org/10.1038/s41586-019-1799-6>
56. Lui TKL, Leung WK (2020) Is artificial intelligence the final answer to missed polyps in colonoscopy? *World J Gastroenterol* 26(35):5248–5255. <https://doi.org/10.3748/wjg.v26.i35.5248>
57. Wentzensen N, Lahrmann B, Clarke MA, Kinney W, Tokugawa D, Poitras N, Locke A, Bartels L, Krauthoff A, Walker J, Zuna R, Grewal KK, Goldhoff PE, Kingery JD, Castle PE, Schiffman M, Lorey TS, Grabe N (2021) Accuracy and efficiency of deep-learning-based automation of dual stain cytology in cervical cancer screening. *J Natl Cancer Inst* 113(1):72–79. <https://doi.org/10.1093/jnci/djaa066>
58. Jiang Y, Edwards AV, Newstead GM (2021) Artificial intelligence applied to breast MRI for improved diagnosis. *Radiology* 298(1):38–46. <https://doi.org/10.1148/radiol.2020200292>



Georgios Lolas I am currently the coordinator of Systems Medicine group of the Oncology Unit of the 3rd Department of Internal Medicine and Laboratory of the National and Kapodistrian University of Athens. I am also the co-founder of the start-up InCELLiA focusing on developing multiscale mathematical models for the designing of in silico therapies in a personalized and precise manner. Our group has already developed mathematical models describing complex processes such as tumor induced lymphangiogenesis and proteolysis. Lately, we have moved our attention on developing in silico models that are related to the newly established field of Cancer Neuroscience. More specifically, we investigate the active role of nervous system and subsequently chronic stress as emerging regulators of cancer initiation, growth and dissemination.



Radiology, AI and Big Data: Challenges and Opportunities for Medical Imaging

Houneida Sakly , Aline Sgnolf Ayres, Suely Fazio Ferraciolli ,
Claudia da Costa Leite, Felipe Kitamura , and Mourad Said

1 Introduction

Artificial intelligence (AI) and machine-learning techniques have been integrated into imaging diagnostics owing to technological advancements. These technologies allow for the detection of patterns and correlations in medical image data that are not detectable by humans as well as the connection of multiple medical data sources to generate medical knowledge for enhanced imaging diagnoses. One of the major responsibilities of translational clinical research in the twenty-first century is to continue to develop and investigate these technologies, particularly in medical

H. Sakly (✉)

COSMOS Laboratory -National School of Computer Sciences (ENSI),
University of Manouba, Manouba, Tunisia
e-mail: houneida.sakly@esiee.fr

A. S. Ayres · S. F. Ferraciolli
UHG, São Paulo, Brazil
e-mail: aline.ayres@hc.fm.usp.br

S. F. Ferraciolli
e-mail: suely.ferraciolli@hc.fm.usp.br

A. S. Ayres
Instituto do Cancer do Estado de São Paulo, Hospital das Clinicas, School of Medicine,
University of São Paulo, Universidade de São Paulo, São Paulo, Brasil

S. F. Ferraciolli
Dasa, São Paulo, Brazil

S. F. Ferraciolli · C. da Costa Leite
Instituto de Radiologia, Hospital das Clinicas, School of Medicine. University of São Paulo,
Universidade de São Paulo, São Paulo, Brasil
e-mail: claudia.leite@hc.fm.usp.br

imaging, which is a pioneer in hospital digitalization. The working group “Artificial Intelligence and Big Data” explored and created innovative ways based on a clinical understanding of data analysis in strong multidisciplinary collaboration, particularly with medical expertise and computer science. The goal is to enhance diagnosis, treatment assessment, and prognosis using machine learning and artificial intelligence techniques as well as to enable the development of tailored precision medicine [1, 2].

Experts regularly draw up a list of professions at risk or even those that are likely to disappear. In the medical world, radiology and pathology appear to be the most threatened species, to the point that the choices of future interns/residents are affected. Some researchers believe that radiologists can be replaced by powerful servers running advanced image-recognition algorithms trained on international databases with millions of patients. The server generates radiological reports without human intervention. The training of AI algorithms, generally based on neural-network-type approaches, requires a large number of reliable cases. However, the rarity of certain pathologies makes it impossible to collect the number of cases required to train the algorithm. Although AI systems have great potential for reading and recognizing images, their ability to write a structured report that considers a patient's clinical context is limited [3]. AI represents a new step in the development of medical imaging, which is a tremendous opportunity that arises when existing techniques for interpreting radiological examinations overcome their limitations. Because the speed of the machine increases the number of patients who may be examined at every shift, the number of images to be read increases dramatically, resulting in a substantially shorter reading time per image and a correspondingly larger possibility of missing a lesion. When this is considered, the potential role of AI in the radiological process becomes clear, and AI may assist in medical decision-making [4]. Based in the intensive use of big data in hospitals, a paradigm changes from a patient-centric to a data-centric approach has been advocated; this new manner of processing data is a first step toward the creation of artificial intelligence (AI). Big data has made a great number of medical scans accessible [5] and

C. da Costa Leite

Departamento de Radiologia e Oncologia, Faculdade de Medicina,
Universidade de São Paulo, São Paulo, Brasil

Fleury Group, São Paulo, Brasil

Sirio Libanes Hospital, São Paulo, Brazil

M. Said

Radiology and Medical Imaging Unit, International Center Carthage Medical, Monastir,
Tunisia

e-mail: mouradsaid@yahoo.fr

F. Kitamura

Universidade Federal de São Paulo, Diagnósticos da América SA (Dasa), São Paulo, Brazil

e-mail: kitamura.felipe@gmail.com

has great promise for training neural networks and deep learning in particular. The recent spiking of interpretation software by AI approaches speeds up this work, giving the radiologist additional time for interpretation, diagnosis, and talks with colleagues or even performing interventions, taking advantage of its benefits, and expanding radiologists' abilities with this new technology rather than fighting it [4]. The foundations of deep learning are available to every radiologist without the need for particular equipment, as they have been in the past when new imaging modalities were debuted. Understanding the concepts of tools that are becoming increasingly prevalent in industry is beneficial. We provide radiologists with the chance to become acquainted with deep learning approaches, starting with readymade codes, to provide them with the keys to comprehending this burgeoning technology [6].

2 AI and Radiology

Over the last few decades, the generation of large amounts of digital information has enabled the incorporation of AI into daily life. The success of this application by integrating information from different sources, helping the daily routine (online shopping, facial recognition, geolocation, etc.), and the greater efficiency of the algorithms in carrying out tasks have led to the introduction of this technology in the medical field. Several areas of medicine can (and already benefit from) the application of AI algorithms. Among the most promising areas, radiology is undoubtedly one of the fields with the most potential to gain from the development of this technology. Artificial intelligence significantly affects the work environment of radiologists. Prevention, diagnosis, and treatment are the three aspects of health care, and diagnoses are further subdivided into several approaches. Most modalities, such as magnetic resonance imaging (MRI) and computed tomography (CT) provide visual data. Subsequently, the data were evaluated to reach conclusions regarding medical issues [7].

The radiology department is one of the largest sources of digital information in medicine, resulting from the digitalization of medical images. Radiology services create vast quantities of data on a regular basis, making it a promising field for AI applications.

Artificial intelligence has been developed to (1) report and manage medical imaging segmentation issues [8] (registration (identifying the borders of a target lesion/structure) [3], detection (finding shapes/structures), (2) simplification of the input of information in radiology processes, and (3) classification [9] (i.e., dividing medical information into groups) (for example, natural language processing) [5]. Machine learning (ML) is a type of artificial intelligence (AI) that enters data into a computer ("machine") and uses models to extract actionable insights from the data. With the evolution of these approaches to deeper network topologies, known as deep neural networks (DNNs), the use of neural networks, a well-known machine learning method, has increased rapidly in recent years. The term 'deep learning' refers to the entire process. Previous studies have examined more complex designs [10].

The quality of the deployed models was determined by the quantity of the available relevant data. Therefore, it is crucial to have both historical data and a steady flow of fresh data. Consequently, big data is often used in the development of deep-learning solutions [11]. Deep learning researchers working on medical imaging encounter a number of obstacles, including (1) a number of legislative impediments, the bulk of which are connected to privacy concerns, obstructing data interchange across organizations, or even inside the same institution. (2) Data with a high resolution and dimensionality (e.g., 3D + time) typically lead to AI models with large parameters. (3) Furthermore, most medical imaging applications involve image annotations (i.e., segregation) to train AI systems, demanding large amounts of data [12]. To train and update medical imaging models, researchers researching the latest breakthroughs in machine learning must rearrange their procedures to accommodate the constant influx of high-quality, annotated data. It is necessary to divide the degree of research, production, and feedback maturity in the radiology process into stages. The ultimate goal is to encourage the integration of AI imaging into the radiological process, where inference-generating models evolve organically in response to the constant input of new medical data and radiologist feedback, resulting in continuous model learning.

3 Radiology and Big Data Industry for Medical Imaging

The radiology department is centralized in the healthcare industry. It is a naturally data-rich environment in which information can be mined, analyzed, and used to improve departmental operations, and has technical roots. The electronic health record (HER) system can drastically reduce the amount of time and effort required to plan and provide healthcare services. Therefore, they are widely used in hospitals. However, because these technologies are implemented in a variety of institutions, it is unclear whether they have the same effect [13].

Medical big data is a particularly rich but delicate type of big data that has enormous promise as a resource for EHR systems. Big data is a large-scale data storage system that has the potential to replace traditional database systems, data storage, useful information retrieval techniques, and all data management strategies. The four Vs of big data and big data analytics (velocity, veracity, volume, and variety) describe the capacity to manage data that have been created or generated [14]. Healthcare data included genomic structure, family health history, infection status, symptoms of a specific disease in any patient, previous surgeries, a historical record of any disease in any patient, or any structural changes in the human body as well as a variety of other data created and saved sequentially. The amount of data preserved in a big data storage space is referred to as the volume of data. The amount or quantity of data is referred to as data volume [15–17]. Medical information was also collected. For each patient, EMR is a technique for conserving data digitally rather than retaining and maintaining it in conventional analog ways. One of the four Vs values of a large data volume was used to define this technique.

Fig. 1 Various fields of the medical domain

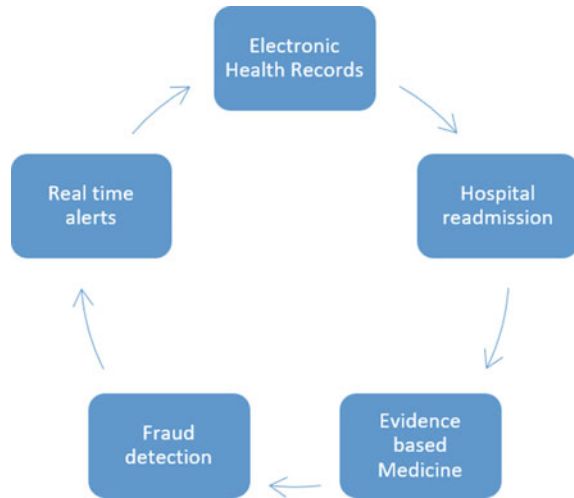

Volume refers to the amount of information obtained from a problem. Genetic structure and harmonic illness history are the focus of patient health history data [18]. The following sections outline some big data use cases that revolutionize the healthcare business. Figure 1 depicts the many disciplines in the medical sector.

A. Real-time notifications

The real-time application is a clinical decision-making aid. A prescription was written after the medical data of the patients were analyzed. This process will assist doctors in analyzing their patients' health situations and recommending appropriate management. A patient's treating physician will examine any ailments, such as high blood pressure or headache, rapid spike or reduction in blood pressure, or any other health abnormalities associated with the patient's condition, and then prescribe appropriate treatment. All treatment operations utilize the most cutting-edge big-data techniques [19].

B. Evidence-based medicine

Evidence-based medicine provides physicians with information about a patient's medical history and compares symptoms with those in a broader database of clinical data, making it easier to manage accurate, closer, and more effective therapies based on big data for decision-making [20].

C. The procedure of hospital readmissions

Based on medical and clinical reports, big data analytical algorithms identify at-risk patients and attempt to provide them with a lower readmission rate, allowing them to focus on their clinical treatment rather than readmission charges [21].

D. Fraud detection

It is vital that all records or information about each patient be kept private while monitoring their testing and health conditions. In domains such as personal

identity, medical information, and clinical testing, big data analysis tools may help to uncover fraud. Insurance fraud has become a global issue, with claimants seeking to obtain funds, while the healthcare system strives to prevent fraud using big-data tactics [22].

3.1 Technologies and Tools

Radiology departments are crucial in the healthcare industry. It has technological origins and is a naturally data-rich environment in which data can be mined, analyzed, and used to enhance departmental operations. Recent movements of many healthcare organizations have aided this trend in picture preservation and communication technology.

Picture archiving and communication systems (PACS) are computer networks that specialize in storing and retrieving medical sequences. These systems started as simple picture management systems, but have since grown to include frames, speech, text, medical data, and video recordings [23]. Verifying that all interface data formats correspond to different definitions and standards is inadequate. It is critical to have a common semantic understanding of data content across multiple interfaces and database areas. The fact that all data item identification criteria must be consistent across all components is a sub-problem related to this fundamental requirement. The validity of the set of criteria is correlated with the significant data items in our hospital information system (HIS), radiology information system (RIS), and image archive and communication system. A strategy was developed, and a prototype tool was built (PACS) [24]. Patient IDs and exam information can be smoothly mapped into exam reports by merging radiology information systems (RISs), picture archiving and communication systems (PACS), and reporting systems. For radiologists, report automation offers various potential advantages, including enhanced productivity and accuracy [25].

Case Example (RadMonitor, BigDataBench)

A. RadMonitor

RadMonitor is a platform-agnostic online application developed in our department to assist in the management of intricacies in information flow throughout a healthcare company, as shown in Fig. 2. The system tracks HL7 traffic and maintains the operating statistics in a database. The data were then displayed to the viewer as a tree map, which is a graphical visualization technique for displaying hierarchical data. Although RadMonitor was designed to investigate radiology operations, it may be used with nearly any other hierarchical dataset because of its XML backend [26].

The order message (ORM) and result message (ORU) data streams from Quovadx, previously Cloverleaf, are received by an HL7 application on the server at the

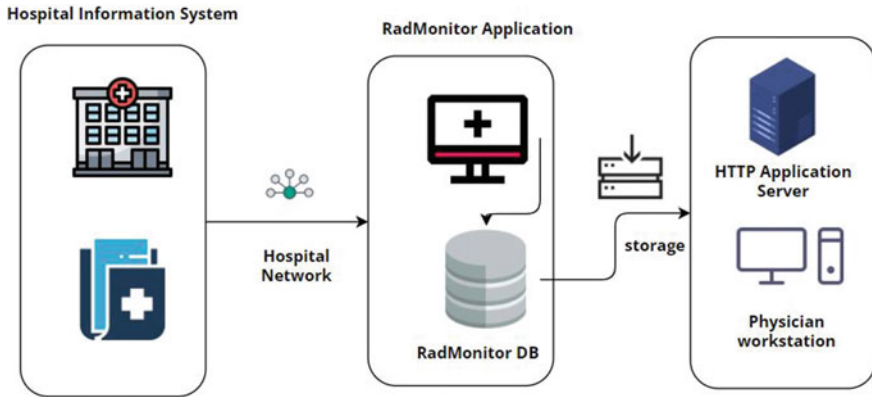

Fig. 2 Architecture of RadMonitor

backend. Processing HL7 communication allows mapping, routing, and extraction of information from the medical information system. The RadMonitor database contains statistical data that are essential for radiology operation management. Fields that track order status changes, as well as start and completion dictation and transcribing time events, are included in database entries [27].

B. BigdataBench

Several technological shifts have suggested that sphere-specific tackling and software design are the only methods forward. Architecture, systems, data operation, and machine literacy groups have devoted attention to slice-edge big data, AI algorithms, armatures, and systems in this setting. Unfortunately, the complexity, variety, dynamic workloads, and rapid growth of big data and artificial intelligence (AI) systems pose significant problems. For big data and AI benchmarking, the conventional benchmarking method for creating a new standard or deputy for every implicit workload is not scalable if not insolvable. Second, acclimatizing an armature to the features of one or more operations or a sphere of operations is prohibitively expensive [28]. The process of big data and AI may be seen as a channel, with one or further classes of computer units performing on colorful original or intermediate data inputs, called as data motifs. For big data and AI benchmarking, the conventional benchmarking fashion of creating a new standard or deputy for every implicit workload is hamstringing if not insolvable. Second, customizing the armature to meet the requirements of a single operation or application sphere is prohibitively expensive [29]. Big data and AI work may be conceived as a channel composed of one or more classes of computer units acting on a number of original or intermediate data inputs, each of which is obtained as a data motif in the big data bench approach [28].

Based on this methodology, BigData Bench4.0 delivers big data and the AI standard suite. Bigdata Bench4.0 includes 13 real-world datasets and 47 big data and AI marks for seven workload types: online services, offline analytics, graph

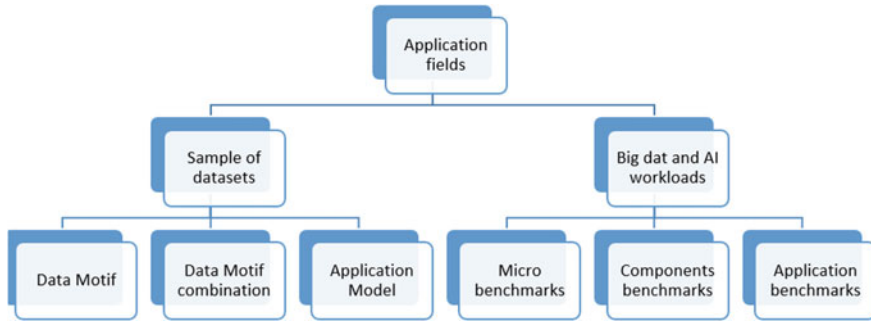

Fig. 3 Benchmark specification

analytics, AI, data storehouses, NoSQL, and streaming. It also included 13 real-world datasets and 47 big data and AI marks for seven different workload types: online services, offline analytics, graph analytics, AI, data storehouses, NoSQL, and streaming. Colorful executions using state-of-the-art and stylish-practice software heaps are available for each workload order. The full reason for the data, including structured, semi-structured, and unshaped ones, was considered. Data creators are hired to induce data of a certain size by using genuine datasets as seeds [30] (Fig. 3).

3.2 Radiology for Data Mining Radiology and Storage

EMRs are currently used by medical institutions to track patient progress, including diagnostic information, procedures performed, and treatment outcomes. EMR has been proven to be an important resource for large-scale analyses. Data mining and analysis are challenging because of the diversity, incompleteness, redundancy, and privacy of EMRs. Therefore, to increase data quality and data mining outcomes, source data must be prepared. Different types of data require different processing techniques. Traditional preparation methods such as data purification, integration, transformation, and reduction are required for the majority of structured data. Additional complicated and demanding processing is required for semi-structured or unstructured data such as medical language, which provides more health information, as shown in Fig. 4 [31]. Both strategies for extracting information from the medical literature are named entity recognition (NER) and recognition of entities (RE) (relation extraction).

As information technology and health-information systems have improved, EMRs have become increasingly common. Medical providers captured words, symbols, charts, scans, statistics, and other digital information produced by the HIS. EMRs and EHRs are electronic medical records that can be stored, exchanged, or duplicated. A multitude of clinical data (including demographics, individual history, conventions, laboratory test results, and vital signs) are becoming available, establishing EMR as valuable large-scale health data discovery [32].

Fig. 4 Flow of EMR data processing

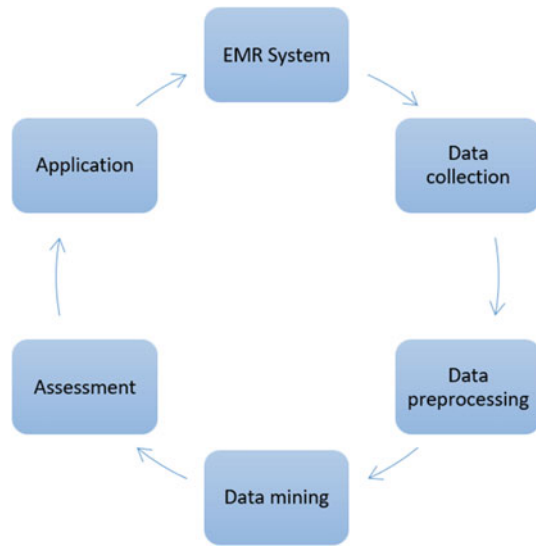

Recent improvements in data mining technology, such as natural language processing (NLP), have enabled the medical informatics sector to quantify concepts, such as uncertainty in reports. The next step from quantification to understanding is to create knowledge discovery databases that require a combination of standardized report content, data mining, and artificial intelligence (KDD). Advances in database technology will increase our capacity to acquire, analyze, and interpret report data as well as the possibility of developing data-driven and automated decision-making tools at the point of care. This might improve radiologists' report content by providing data-driven analysis for improved diagnostic and clinical findings as well as objective and thorough knowledge of ambiguity, defining the source of the issue, and delivering data-driven analysis [33, 34].

Current reporting methodologies, as outlined in the first part of this series, have several flaws that can be grouped into four categories: content, communication, analysis, and organization. Content refers to the facts and observations identified by a radiologist based on the collected imaging data [35]. The manner in which these contextual variables are provided to undertake appropriate and timely therapeutic action, resulting in a better clinical outcome, is referred to as communication. The process of understanding data, which may include imaging, technical, and clinical data, is referred to as unk analysis. The idea is to combine these various data sources to obtain reliable and reproducible results [31].

3.3 Radiology and Dark Data Exploration

Data visualization techniques provide effective ways to organize and present data in visually attractive formats, which not only speeds up the decision-making and

pattern identification processes, but also allows decision-makers to completely comprehend data insights and make well-informed judgments. With the advancements in technical and computing resources, scientific knowledge has grown exponentially worldwide. However, most of the information is unstructured, making it difficult to categorize and integrate into standard databases. Dark data refer to this type of information. Data visualization tools offer a potential way to investigate such data because they allow for the fast interpretation of information, detection of new trends, and identification of connections and patterns.

A massive amount of data is available in the form of scholarly publications, government reports, natural languages, and medical frames, accounting for approximately 80% [36] of all data created worldwide. However, most of the data are unstructured and cannot be classified or imported into standard databases. Dark data were used to describe this type of information. Data visualization approaches can address the problem of dealing with and analyzing large amounts of data. As a result of developments in computer technology, “big data” refers to a shift in the scale of data utilization and aggregation into large databases. The major difficulties in the development of big data in the radiation environment are the restatement of regular care particulars into black data or data that have not yet been collected, and the integration of databases that collect colorful types of information. The overall care process and quality of the acquired data should not be harmed by big data collection methods and structures. To produce, manage, and use big data in radiology, physicists, software inventors, and health authorities must collaboratively work [37].

4 Radiology and Machine Learning

Machine learning breakthroughs have shown promise in various sectors and applications, including medical imaging. Machine learning is a set of methods and a topic of study in data science that enables computers to learn and extract or classify patterns in the same manner as humans. Machines may potentially be able to assess and extract features from large data sets [38]. Recent research and advancements have resulted in promising diagnostic imaging technologies for future radiology [39]. Diagnostic and therapeutic applications of radiological imaging are rapidly increasing. The demand for faster, more precise, cost-effective, and less intrusive therapies has increased significantly. The use of imaging has also been boosted by technological improvements in the radiological imaging equipment. An example of technological development is the capacity to collect better and higher-quality sequences, allowing the visibility of tiny anatomic structures and anomalies [34]. Radiologists read and analyzed medical images using several modalities. Machine learning was used to automate medical image analysis and diagnosis. This can ease the burden on radiologists in terms of defining the patient prognosis [40, 41].

Machine literacy refers to the study of computer algorithms that can describe complicated patterns or correlations in empirical data and make applicable judgments. Artificial intelligence, pattern recognition, data mining, statistics, probability

proposition, optimization, statistical drugs, and theoretical computer wisdom are all covered in this content [42]. Machine literacy algorithms can be classified into several orders based on their principles. Markers in training samples, for example, can be used to distinguish between supervised, semi-supervised, and unsupervised literacy styles. In most cases, input compliances are made, but the affair compliance is constantly affected. Supervised literacy refers to the inference of a well-generalized functional relationship between the training and testing data. A series of equations with numerical portions or weights were used to represent this concept. Classification, regression, and reinforcement learning (RL) are examples of supervised learning techniques (RL). Unsupervised learning is used to determine correlations between samples or reveal hidden factors in the data. Clustering, density estimation, and blind source separation are some examples of unsupervised learning methods. Semi-supervised learning is classified as supervised or unsupervised learning. During the training phase, both labelled and unlabelled data were used. Because labeling data is expensive or difficult in certain situations, semisupervised learning techniques have been developed. Semi-supervised categorization and information recommendation systems are examples of semi-supervised learning [43–47].

There are several fields in which ML can be incorporated into radiology, including its application in radiology service flow (exam scheduling, schedule organization, report delivery deadline), test protocols, and image acquisition (choice of the most appropriate protocol, optimization of acquisition technique: quality control), and as a tool for radiologists (post-processing image, lesion detection tools, CAD, lesion segmentation, disease characterization, and follow-up comparison with previous studies). Finally, radiology, being a department closely linked to technology and generating high-dimensional digital information (big data), benefits from AI resources and can grow as a specialty based on the promising resources of AI [48].

1. Test scheduling: scheduling optimization, predicting shortages, and organization of the waiting list. Intelligent scheduling using ML techniques can optimize patient scheduling and reduce the possibility of missed follow-ups owing to a lack of medical care or missed exam schedules. In addition, ML applications can increase the safety of the examination by detecting patients who have contraindications (e.g., allergy to the contrast agent and implants/devices that are not magnetic field safe).
2. Test protocol: Select the best examination protocol based on clinical and patient data, allowing protocol optimization and less variability between studies. The radiation dose can be calculated according to the indication of the examination and the characteristics of each patient as well as the contrast dose (if indicated) and acquisition time [48].
3. DL has been shown to expand low-dose contrast-enhanced MRI, enabling future MRI scans with lower contrast volume. Data-processing technologies based on machine learning have the potential to reduce the test time and image artifacts. By reconstructing undersampled MRI data, AI may potentially be utilized to reduce the MRI scan duration (i.e., image capture time) [48]. PET/MRI experiments in which a DL algorithm was used to produce “pseudo”-CT scans

from MRI data fared better than existing clinical techniques in one research [49]. Reconstruction of routine-dose CT scans from low-dose scans can also be performed using neural networks.

4. Automated detection and interpretation of findings Algorithms that can help detect (computer-aided detection) and diagnose (computer-aided diagnosis) are already being studied and are sometimes applied in radiology. There is already promising experience with computer-aided detection for detecting suspicious lesions on mammography and chest CT for pulmonary nodules. However, computer-aided diagnosis is still a field of study, with good results in the assessment of bone age through radiography and interpretation of pulmonary nodules [39].
5. Post-processing: ML can aid in post-processing tasks such as registration, segmentation, and quantification. Deep learning algorithms were used to delineate and quantitatively analyze brain structures and abnormalities using brain MRI anatomical segmentation [39, 48, 49].
6. Machine learning methods have been extensively used in natural language processing (NLP) to generate and communicate reports (NLP). NLP can be used to recognize data from radiology report texts to assess the quality and performance of radiology departments. Furthermore, machine learning and natural language processing algorithms may enhance radiologist judgments and activate communication cascades in the event of significant results, making it easier for doctors and patients to retrieve crucial data from their reports [39, 48, 49].
7. Automated Data Integration and Analysis: Several ML techniques can be applied to integrate a rich database of medical records. Medical history, prior surgeries, test findings, pathology and radiology reports, genomes, and family medical histories are only a few examples of data sources. The availability of this data opens up possibilities for data mining, but also presents obstacles to integrating disparate data sources [39].

Other tools, such as clinical decision support, can alert physicians to submit the correct patient with a risk factor for a specific disease to the most suitable imaging study for their case. Physicians should be alert in an emergency service about the possibility of a poor evolution of a patient based on their clinical data and laboratory tests, alerting them to the need to perform imaging tests for investigation. Thus, this tool brings the proper imaging examination closer to the patient who will benefit from it [48].

4.1 Explainable Artificial Intelligence (XIA) for Radiology

Deep neural networks (DNNs) based on artificial intelligence (AI) have transformed this approach into real-world human tasks. Machine learning (ML) algorithms have become increasingly popular in recent years for automating various medical applications. This increase is due in part to an increase in research on deep learning (DL), a type of machine learning in which hundreds (or even billions) of neural parameters are learned to generalize task performance. Deep learning can dissect,

test, and run ML algorithms at a scale of bitsy edge bias owing to enhanced access to high-performance computing bumps via pall computing ecosystems, high-outurn AI accelerators to boost performance, and access to massive data datasets and storehouses [50, 51]. Deep neural networks (DNNs) are difficult to comprehend and understand because of the complex number of parameters to handle. Deep learning (DL) models may naturally learn or fail to learn representations from materials that a person can judge as relevant, regardless of cross-validation accuracy or other assessment metrics that would demonstrate a high learning performance. Non-AI experts and end users who are more concerned with obtaining the appropriate response will be unable to explain the decisions made by DNNs owing to their lack of understanding of the underlying operations/mechanisms of DNNs. Consequently, the capacity to understand AI judgments is sometimes disregarded in order to obtain state-of-the-art outcomes or cross-human-level accuracy [52–54]. As designated by the European General Data Protection Regulation, there has recently been a lot of interest in XAI, particularly from governments (GDPR) [55], demonstrating the importance of understanding AI ethics [56, 57], trust [58], bias [59], and the impact of adversarial examples [60] in deceiving classifier decisions. According to Miller et al. [61], individuals seek answers to specific activities for various reasons, one of which is curiosity. Another explanation might be that repeating the model generation process and obtaining better outcomes make learning easier. Each description should be reliable across comparable data points and similar or consistent explanations should be provided across time [62]. To improve human comprehension and trust in decision-making, as well as encourage fair judgments, explanations should make the AI system thorough. Consequently, an explanation or interpretable solution for ML systems is necessary to ensure openness, confidence, and justice in the decision-making process. Explanations can also be grounded in the parameters or activations of the trained models, which can be communicated using surrogates, similar to decision trees, slants, or other methods. Reinforcement learning approaches may explain why an agent chooses one option over another; interpretable and explainable AI concepts, however, are often generic, may be deceptive, and must include some reasoning [63, 64]. Decision tree and rule-based models are examples of intrinsically interpretable AI models. However, they have interpretability-versus-accuracy trade-off constraints when compared to deep learning models. This study examined many tactics and approaches used by academics to solve the topic of deep learning algorithm explainability. Otherwise, if the model parameters and architecture are understood beforehand, the techniques can be efficiently applied. Modern API-based AI services, on the other hand, provide additional issues due to the problem's relative 'black-box' character, in which the end-user only understands the deep learning model's input rather than the model itself [65]. Figure 6 depicts a comprehensive overview of the explainable and interpretable algorithms as well as a history of significant events and research publications divided into three taxonomies (Fig. 5).

XAI approaches have been classified based on their breadth and use in previous explainability studies. Classification based on the technology that underpins XAI

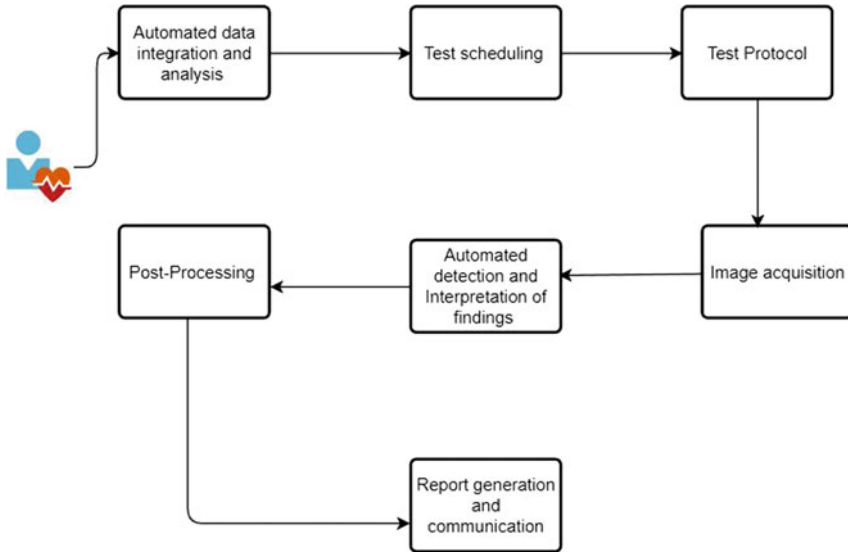

Fig. 5 Areas of AI use in radiology

deep-learning algorithms, emphasis on mathematical descriptions of major publications, and XAI algorithm evaluation procedures have all been established [66]. In this section, we summarize the taxonomies [67] covered in Fig. 5.

- **Scope:** Explanations can be local or universal and both styles can employ the same ideas. The individual feature attributions of a single instance of input data x from data population X are conveyed in a general fashion using locally explainable procedures.
- **Methodology:** The explainable model's core algorithmic notion can be classified based on implementation methodology. Backpropagation- or perturbation-based approaches can be used to classify local-and global-explainable algorithms. The explainable method in backpropagation-based approaches feeds one or more forwards through the neural network, and then constructs attributions using partial derivatives of the activations during the backpropagation phase.
- **Usage:** A well-developed explainable technique with a specified scope and approach can be included in a neural network model, or used as an external explanation algorithm. The model-intrinsic category encompasses any explainable algorithm that is dependent on model architecture. Most model-intrinsic algorithms are model-specific and require major modifications to the method or modest adjustments to the explainable algorithm hyperparameters to accommodate changes in the architecture.

The conclusion of a machine learning model is critical for ethical, legal, and safety considerations, particularly when AI algorithms are used in healthcare.

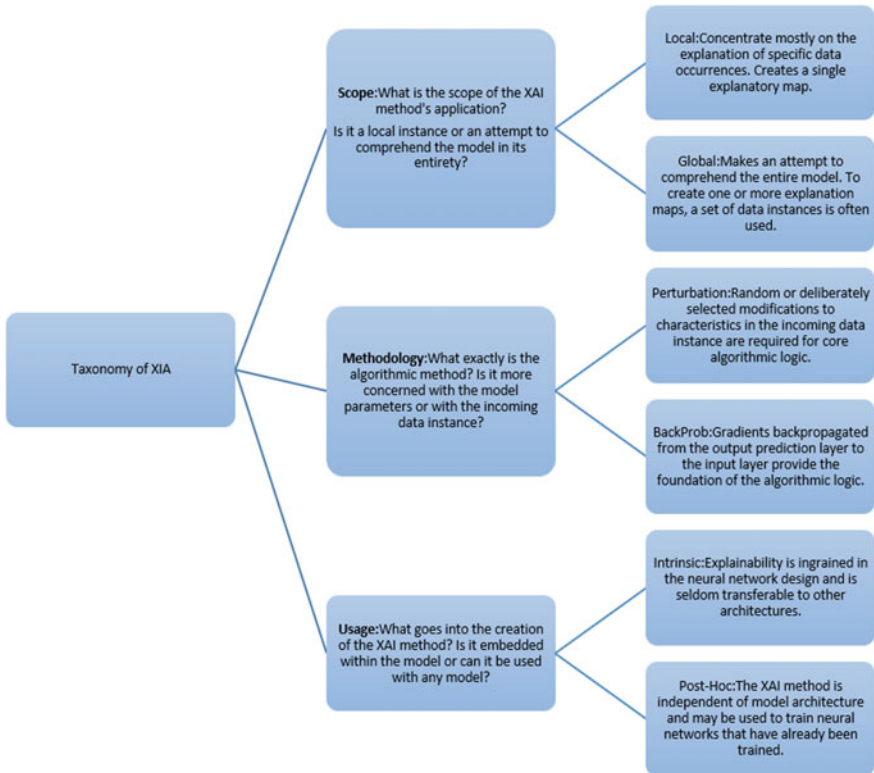

Fig. 6 Taxonomy of XIA

However, XAI is critical for several reasons. The preceding discussion identifies two major issues with XAI visuals and interpretability techniques: (1) the inability of human attention to construct XAI explanation maps for decision-making, and (2) the lack of a quantitative evaluation of the completeness and correctness of the explanation map. Consequently, the employment of visualization techniques for mission-critical applications may need to be revisited. It is also worth considering new ways of expressing and delivering explanations.

4.2 Artificial Intelligence of Things (AIoT) (AIOT) for Radiology

AI has recently gained considerable traction in radiology [68]. The Internet of Things (IoT) is a network of interconnected devices that may operate individually or collectively based on data gathered from each other [69]. Radiology is intricately tied to the Internet and is at the forefront of medical innovation. In the field of healthcare, the use of Internet-based technologies is becoming more common [70]

and has increased rapidly in recent years, with imaging being one of the most important applications. Several Internet-based applications and technologies have made progress in medicine, and radiology is well ahead of other clinical specialties in this regard [71]. Many radiography programs are available online, and new programs are often published. The growing relevance of the Internet in radiology has been boosted by the introduction of mobile devices and their incorporation into imaging workflows. IoT-enabled technology is shifting healthcare away from traditional hub-based systems and toward more personalized solutions owing to the increasing usage of wearable devices and smartphones. This section discusses how IoT may be integrated into radiology processes as well as how it affects resident and medical student teaching, research, and patient engagement in radiology [72]. Edge computing has recently received a lot of press [73], which is appropriate for IoT applications because of its high responsiveness, higher speed, and improved data security compared to fog and cloud computing infrastructures. Artificial intelligence of things (AIoT) combines the computational power of artificial intelligence with that of the real world. It is appropriate for IoT applications because of its high responsiveness, higher speed, and improved data security compared with fog and cloud computing infrastructures. The artificial intelligence of things (AIoT) combines the computational power of artificial intelligence with that of the real world [74] and the collective interoperability of the IoT, which pushes the intelligence of smart devices to new heights by enabling them to perform highly difficult tasks that are currently impossible with current IoT architectures. The Internet of Things (IoT), artificial intelligence (AI), big data, 5G, and other technologies are all part of industrial revolution 4.0 [75].

Cyber physical system (CPS), Internet of Things (IoT), resource availability, and cognitive computing are the four key components of the 4.0. Computing, communication [76], and entertainment are all components of information and communication technology (ICT), which aids in the transmission of information via digital electronic media [77]. It focuses on integrating novel computer science research disciplines, such as IoT, AI, big data, robots, and other structures for data analysis and predictive modeling to create a decentralized patient-friendly healthcare system, such as hospitals. Sensors linked to microcontrollers (e.g., Arduino) and integrated circuits (e.g., Raspberry Pi) monitor health statistics and vital factors including body temperature, pulse rate, respiration rate, blood glucose level, and ECG in IoT-based healthcare systems.

AIoT has enormous promise in overcoming the shortcomings of IoT in H4.0. Telemedicine, remote data collection, and algorithms are the three major components of the AIoT systems. As illustrated in Fig. 7, sensors for recording data or monitoring patient health are incorporated into the telemedicine sector as actuators that function physically in response to a signal via a healthcare provider (semi-automated system) or directly from an algorithm (fully automated system).

AI will be used to turn IoT data into valuable medical data for enhanced decision-making, laying the groundwork for future innovations such as IoT data as a service (IoTaaS). Because AI provides value to AIoT via machine-learning capabilities, and AIoT adds value to AI through connection, signaling, and data

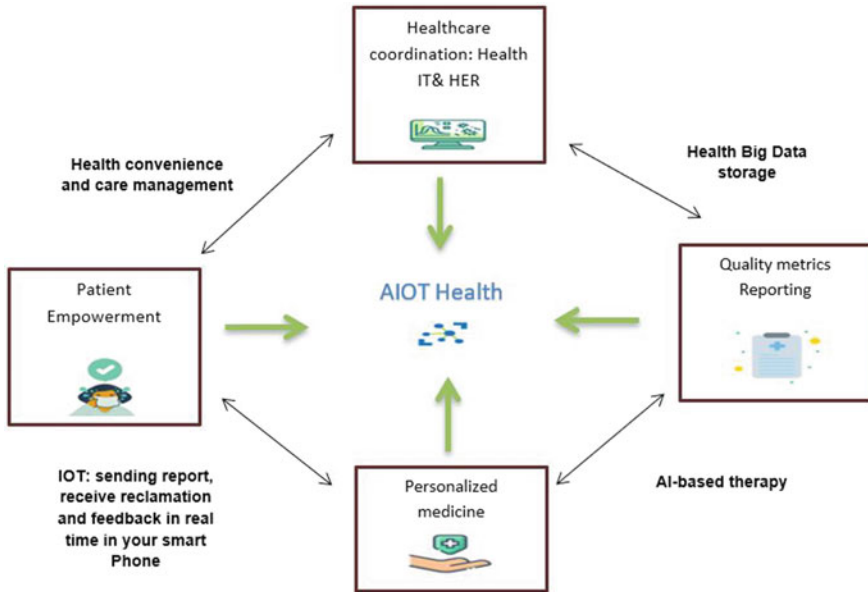

Fig. 7 AIOT for smart health

sharing, AIoT is transformative and mutually beneficial for both types of technology. As IoT networks extend throughout large medical sectors, the quantity of unstructured data in EHRs is expected to increase. IoT may assist in the development of large medical data analytics systems that can extract value from IoT data.

5 Conclusion

Radiology has a plethora of AI tool applications that would benefit considerably from the available resources. It has technological origins and is a naturally data-rich environment in which data can be mined, analyzed, and used to enhance departmental operations.

In addition to dealing with this big data, it is necessary to integrate clinical knowledge of the disease with technical developments to optimize the application of AI models. AI models that integrate a patient’s clinical information into the specific context of a given disease perform better.

Advancements in database technology will increase the capacity to record, track, and evaluate report data as well as the possibility of developing data-driven and automated decision-making tools at the point of care. This approach assists radiologists by providing data-driven analysis for better diagnostic and clinical findings as well as objective and thorough knowledge of ambiguity, identifying its underlying origins, and providing data-driven analysis.

Several fields can incorporate ML into the radiology department, including its application in patient service organization, test protocols, image acquisition, and as a tool for radiologist scan interpretation. Finally, radiology, being a department closely linked to technology and generating high-dimensional digital information (big data), benefits from AI resources and can grow as a specialty based on the promising resources of AI.

- **Perspectives**

Thus, the application of AI to radiology is promising. The benefits of this technology are already known and have been applied in some centers with good results. Advances in medical and technological knowledge for the development of models with applications in the organization of radiology departments and optimizing agendas, protocols, and scans have had a positive impact on both physicians and patients.

The development of tools that integrate clinical information and patient history will improve the interpretation of examinations by radiologists, contributing to better patient management.

It seems that the future of clinical practice will be the integration of physician and AI models, increasing the performance of clinical decisions, allowing the advancement of precision medicine, and the potential for developing personalized therapies, with a positive impact on the quality of life and survival of the population.

- **Bullets**

- Radiology is a rich field of AI tool applications, which will benefit significantly from its resources. It has technological origins and is a naturally data-rich environment in which data can be mined, analyzed, and used to enhance departmental operations.
- Big data is a massive data storage system that substitutes for a typical database system, as well as data storage, useful information retrieval procedures, and all data management strategies. The four Vs of why big data and big data analytics (velocity, veracity, volume, and variety) describe the capacity to manage data that has been created or generated.
- Medical big data are particularly rich and offer tremendous potential as a resource for EHR systems.
- Machine learning is a collection of techniques and a field of study within data science that allows computers to learn like people and to extract or categorize patterns. Machines may also be able to evaluate larger data volumes and extract their characteristics from such data.
- There are several fields in which ML can be incorporated into radiology, including its application in patient service flow, test protocols and image acquisition, and as a tool for the interpretation of radiologist examinations.

References

1. Syeda-Mahmood T (2018) Role of big data and machine learning in diagnostic decision support in radiology. *J Am Coll Radiol* 15:569–576. <https://doi.org/10.1016/j.jacr.2018.01.028>
2. Pinto dos Santos D, Baeßler B (2018) Big data, artificial intelligence, and structured reporting. *Eur Radiol Exp* 2:42. <https://doi.org/10.1186/s41747-018-0071-4>
3. Mendelson EB (2019) Artificial intelligence in breast imaging: potentials and limitations. *Am J Roentgenol* 212:293–299. <https://doi.org/10.2214/AJR.18.20532>
4. Syed AB, Zoga AC (2018) Artificial intelligence in radiology: current technology and future directions. *Semin Musculoskelet Radiol* 22:540–545. <https://doi.org/10.1055/s-0038-1673383>
5. Pisano ED, Garnett LR (2019) Big data and radiology research. *J Am Coll Radiol* 16:1347–1350. <https://doi.org/10.1016/j.jacr.2019.06.003>
6. Kim JH (2019) Imaging informatics: a new horizon for radiology in the era of artificial intelligence, big data, and data science. *J Korean Soc Radiol* 80:176–201. <https://doi.org/10.3348/jksr.2019.80.2.176>
7. Dikici E, Bigelow M, Prevedello LM, White RD, Erdal BS (2019) Integrating AI into radiology workflow: levels of research, production, and feedback maturity. [arXiv:191006424 \[eess\]](https://arxiv.org/abs/191006424)
8. Sharma N, Aggarwal LM (2010) Automated medical image segmentation techniques. *J Med Phys* 35:3–14. <https://doi.org/10.4103/0971-6203.58777>
9. Devi SND (2011) A survey on artificial intelligence approaches for medical image classification. *INDJST* 4:1583–1595. <https://doi.org/10.17485/ijst/2011/v4i11.35>
10. Sun C, Shrivastava A, Singh S, Gupta A (2017) Revisiting unreasonable effectiveness of data in deep learning era. In: 2017 IEEE international conference on computer vision (ICCV), pp 843–852
11. Abiodun OI, Jantan A, Omolara AE, Dada KV, Mohamed NA, Arshad H (2018) State-of-the-art in artificial neural network applications: a survey. *Heliyon* 4:e00938. <https://doi.org/10.1016/j.heliyon.2018.e00938>
12. Litjens G, Kooi T, Bejnordi BE, Setio AAA, Ciompi F, Ghafoorian M, van der Laak JAWM, van Ginneken B, Sánchez CI (2017) A survey on deep learning in medical image analysis. *Med Image Anal* 42:60–88. <https://doi.org/10.1016/j.media.2017.07.005>
13. Setia P, menon N, Srinivasan SS (2020) EHR application portfolio and hospital performance: effects across hospitals with varying administrative scale and clinical complexity. *Inform Manage* 57:103383. <https://doi.org/10.1016/j.im.2020.103383>
14. Bellazzi R (2014) Big data and biomedical informatics: a challenging opportunity. *Yearb Med Inform* 9:8–13. <https://doi.org/10.15265/IY-2014-0024>
15. Häyriinen K, Saranto K, Nykänen P (2008) Definition, structure, content, use and impacts of electronic health records: a review of the research literature. *Int J Med Inform* 77:291–304. <https://doi.org/10.1016/j.ijmedinf.2007.09.001>
16. Perera G, Holbrook A, Thabane L, Foster G, Willison DJ (2011) Views on health information sharing and privacy from primary care practices using electronic medical records. *Int J Med Inform* 80:94–101. <https://doi.org/10.1016/j.ijmedinf.2010.11.005>
17. Luo J, Wu M, Gopukumar D, Zhao Y (2016) Big data application in biomedical research and health care: a literature review. *Biomed Inform Insights* 8:1–10. <https://doi.org/10.4137/BII.S31559>
18. Buczak AL, Moniz LJ, Feighner BH, Lombardo JS (2009) Mining electronic medical records for patient care patterns. In: 2009 IEEE symposium on computational intelligence and data mining, pp 146–153
19. Pfeiffer Y, Schwappach D (2016) Taking up national safety alerts to improve patient safety in hospitals: the perspective of healthcare quality and risk managers. *Z Evid Fortbild Qual Gesundheitswes* 110–111:26–35. <https://doi.org/10.1016/j.zefq.2015.12.007>

20. Serrano-Guerrero J, Romero FP, Olivas JA (2020) A relevance and quality-based ranking algorithm applied to evidence-based medicine. *Comput Methods Programs Biomed* 191:105415. <https://doi.org/10.1016/j.cmpb.2020.105415>
21. Squires A, Ma C, Miner S, Feldman P, Jacobs EA, Jones SA (2021) Assessing the influence of patient language preference on 30 day hospital readmission risk from home health care: a retrospective analysis. *Int J Nursing Stud* 104093. <https://doi.org/10.1016/j.ijnurstu.2021.104093>
22. Thornton D, Mueller RM, Schoutsen P, van Hillegersberg J (2013) Predicting healthcare fraud in medicaid: a multidimensional data model and analysis techniques for fraud detection. *Procedia Technol* 9:1252–1264. <https://doi.org/10.1016/j.protecy.2013.12.140>
23. Papamichail D, Ploussi A, Kordolaimi S, Saradeas I, Kelekis NL, Efstathopoulos EP (2016) Extracting DICOM metadata from PACS recursively over local network. *Physica Med* 32:299. <https://doi.org/10.1016/j.ejmp.2016.07.141>
24. Nissen-Meyer S, König L, Reiser M (2003) Maintaining database consistency in an integrated, heterogeneous HIS–RIS–PACS environment. *Int Congr Ser* 1256:855–859. [https://doi.org/10.1016/S0531-5131\(03\)00441-2](https://doi.org/10.1016/S0531-5131(03)00441-2)
25. Kovacs MD, Cho MY, Burchett PF, Trambert M (2019) Benefits of integrated RIS/PACS/reporting due to automatic population of templated reports. *Curr Probl Diagn Radiol* 48:37–39. <https://doi.org/10.1067/j.cpradiol.2017.12.002>
26. Channin D Radiology data mining applications using imaging informatics
27. Chen R, Mongkolwat P, Channin D (2007) RadMonitor: radiology operations data mining in real time. *J Digital Imaging Official J Soc Comput Appl Radiol* 21:257–268. <https://doi.org/10.1007/s10278-007-9033-8>
28. Gao W, Zhan J, Wang L, Luo C, Zheng D, Wen X, Ren R, Zheng C, He X, Ye H, Tang H, Cao Z, Zhang S, Dai J (2018) BigDataBench: a scalable and unified big data and AI benchmark suite. *arXiv:180208254* [cs]
29. Gao W, Zhan J, Wang L, Luo C, Zheng D, Tang F, Xie B, Zheng C, Wen X, He X, Ye H, Ren R (2018) Data motifs: a lens towards fully understanding big data and AI workloads. In: *Proceedings of the 27th international conference on parallel architectures and compilation techniques*. Association for Computing Machinery, New York, NY, pp 1–14
30. Zhu Y, Zhan J, Weng C, Nambiar R, Zhang J, Chen X, Wang L (2014) BigOP: generating comprehensive big data workloads as a benchmarking framework
31. Sun W, Cai Z, Li Y, Liu F, Fang S, Wang G (2018) Data processing and text mining technologies on electronic medical records: a review. *J Healthc Eng* 2018:4302425. <https://doi.org/10.1155/2018/4302425>
32. Househ M, Aldosari B (2017) The hazards of data mining in healthcare. *Stud Health Technol Inform* 238:80–83
33. Reiner BI (2009) The challenges, opportunities, and imperative of structured reporting in medical imaging. *J Digit Imaging* 22:562–568. <https://doi.org/10.1007/s10278-009-9239-z>
34. Bhargavan M, Sunshine JH (2005) Utilization of radiology services in the United States: levels and trends in modalities, regions, and populations. *Radiology* 234:824–832. <https://doi.org/10.1148/radiol.2343031536>
35. Reiner BI, Siegel EL, Flagle C, Hooper FJ, Cox RE, Scanlon M (2000) Effect of filmless imaging on the utilization of radiologic services. *Radiology* 215:163–167. <https://doi.org/10.1148/radiology.215.1.r00ap41163>
36. Aggarwal S, Singh R (2020) Visual exploration and knowledge discovery from biomedical dark data. *arXiv:200913059* [cs]
37. Guihard S, Thariat J, Clavier J-B (2017) Big data and their perspectives in radiation therapy. *Bull Cancer* 104:147–156. <https://doi.org/10.1016/j.bulcan.2016.10.018>
38. Erickson BJ, Korfiatis P, Akkus Z, Kline TL (2017) Machine learning for medical imaging. *Radiographics* 37:505–515. <https://doi.org/10.1148/rg.2017160130>
39. Choy G, Khalilzadeh O, Michalski M, Do S, Samir AE, Pinykh OS, Geis JR, Pandharipande PV, Brink JA, Dreyer KJ (2018) Current applications and future impact of

- machine learning in radiology. *Radiology* 288:318–328. <https://doi.org/10.1148/radiol.2018171820>
40. Wang S, Summers RM (2012) Machine learning and radiology. *Med Image Anal* 16:933–951. <https://doi.org/10.1016/j.media.2012.02.005>
 41. Assad WA, Topaz M, Tu J, Zhou L (2017) The application of machine learning to evaluate the adequacy of information in radiology orders. In: 2017 IEEE international conference on bioinformatics and biomedicine (BIBM), pp 305–310
 42. Strøm H, Albury S, Sørensen LT (2018) Machine learning performance metrics and diagnostic context in radiology. In: 2018 11th CMI international conference: prospects and challenges towards developing a digital economy within the EU, pp 56–61
 43. Hussein S, Kandel P, Bolan CW, Wallace MB, Bagci U (2019) Lung and pancreatic tumor characterization in the deep learning era: novel supervised and unsupervised learning approaches. *IEEE Trans Med Imaging* 38:1777–1787. <https://doi.org/10.1109/TMI.2019.2894349>
 44. Choi K, Vania M, Kim S (2019) Semi-supervised learning for low-dose CT image restoration with hierarchical deep generative adversarial network (HD-GAN)*. In: 2019 41st annual international conference of the IEEE engineering in medicine and biology society (EMBC), pp 2683–2686
 45. Xanthis CG, Haris K, Filos D, Aletras AH (2019) Artificially generated training datasets for supervised machine learning techniques in magnetic resonance imaging: an example in myocardial segmentation. In: 2019 computing in cardiology (CinC), pp 1–2
 46. Santamaria-Macias N, Orejuela-Zapata JF, Pulgarin-Giraldo JD, Granados-Sanchez AM (2020) Critical diagnosis in brain MRI studies based on image signal intensity and supervised learning. In: 2020 IEEE Colombian conference on applications of computational intelligence (IEEE ColCACI 2020), pp 1–6
 47. Jie S, Xin F, Wen S (2009) Active learning for semi-supervised classification based on information entropy. In: 2009 international forum on information technology and applications, pp 591–595
 48. Kapoor N, Lacon R, Khorasani R (2020) Workflow applications of artificial intelligence in radiology and an overview of available tools. *J Am Coll Radiol* 17:1363–1370. <https://doi.org/10.1016/j.jacr.2020.08.016>
 49. Liu F, Jang H, Kijowski R, Bradshaw T, McMillan AB (2018) Deep learning MR imaging-based attenuation correction for PET/MR imaging. *Radiology* 286:676–684. <https://doi.org/10.1148/radiol.2017170700>
 50. Lee SM, Seo JB, Yun J, Cho Y-H, Vogel-Claussen J, Schiebler ML, Gefter WB, van Beek EJR, Goo JM, Lee KS, Hatabu H, Gee J, Kim N (2019) Deep learning applications in chest radiography and computed tomography: current state of the art. *J Thorac Imaging* 34:75–85. <https://doi.org/10.1097/RTI.0000000000000387>
 51. Chen R, Yang L, Goodison S, Sun Y (2019) Deep learning approach to identifying cancer subtypes using high-dimensional genomic data. *Bioinformatics (Oxford, England)* 36. <https://doi.org/10.1093/bioinformatics/btz769>
 52. Zheng S, Shen Z, Pei C, Ding W, Lin H, Zheng J, Pan L, Zheng B, Huang L (2021) Interpretative computer-aided lung cancer diagnosis: from radiology analysis to malignancy evaluation. *Comput Methods Programs Biomed* 210:106363. <https://doi.org/10.1016/j.cmpb.2021.106363>
 53. Hayashi Y (2020) New unified insights on deep learning in radiological and pathological images: beyond quantitative performances to qualitative interpretation. *Inform Med Unlocked* 19:100329. <https://doi.org/10.1016/j.imu.2020.100329>
 54. Park J, Riaz H, Kim H, Kim J (2020) Advanced cover glass defect detection and classification based on multi-DNN model. *Manuf Lett* 23:53–61. <https://doi.org/10.1016/j.mfglet.2019.12.006>
 55. Floridi L (2019) Establishing the rules for building trustworthy AI. *Nat Mach Intell* 1:261–262. <https://doi.org/10.1038/s42256-019-0055-y>

56. Cath C, Wachter S, Mittelstadt B, Taddeo M, Floridi L (2018) Artificial intelligence and the “Good Society”: the US, EU, and UK approach. *Sci Eng Ethics* 24:505–528. <https://doi.org/10.1007/s11948-017-9901-7>
57. Stahl BC, Wright D (2018) Ethics and privacy in AI and big data: implementing responsible research and innovation. *IEEE Security Privacy* 16:26–33. <https://doi.org/10.1109/MSP.2018.2701164>
58. Weld DS, Bansal G (2019) The challenge of crafting intelligible intelligence. *Commun ACM* 62:70–79. <https://doi.org/10.1145/3282486>
59. Challen R, Denny J, Pitt M, Gompels L, Edwards T, Tsaneva-Atanasova K (2019) Artificial intelligence, bias and clinical safety. *BMJ Qual Saf* 28:231–237. <https://doi.org/10.1136/bmjqs-2018-008370>
60. Huang S, Papernot N, Goodfellow I, Duan Y, Abbeel P (2017) Adversarial attacks on neural network policies. [arXiv:170202284](https://arxiv.org/abs/1702.02284) [cs, stat]
61. Miller T (2019) Explanation in artificial intelligence: insights from the social sciences. *Artif Intell* 267:1–38. <https://doi.org/10.1016/j.artint.2018.07.007>
62. Sokol K, Flach P (2020) Explainability fact sheets: a framework for systematic assessment of explainable approaches. In: *Proceedings of the 2020 conference on fairness, accountability, and transparency*, pp 56–67. <https://doi.org/10.1145/3351095.3372870>
63. Doran D, Schulz S, Besold TR (2017) What does explainable AI really mean? A new conceptualization of perspectives. [arXiv:171000794](https://arxiv.org/abs/1710.00794) [cs]
64. Rudin C (2019) Stop explaining black box machine learning models for high stakes decisions and use interpretable models instead. [arXiv:181110154](https://arxiv.org/abs/1811.10154) [cs, stat]
65. Castelvocchi D (2016) Can we open the black box of AI? *Nature News* 538:20. <https://doi.org/10.1038/538020a>
66. Adadi A, Berrada M (2018) Peeking inside the black-box: a survey on explainable artificial intelligence (XAI). *IEEE Access* 1–1. <https://doi.org/10.1109/ACCESS.2018.2870052>
67. Das A, Rad P (2020) Opportunities and challenges in explainable artificial intelligence (XAI): a survey. [arXiv:200611371](https://arxiv.org/abs/2006.11371) [cs]
68. Hosny A, Parmar C, Quackenbush J, Schwartz LH, Aerts HJWL (2018) Artificial intelligence in radiology. *Nat Rev Cancer* 18:500–510. <https://doi.org/10.1038/s41568-018-0016-5>
69. Gupta S, Johnson EM, Peacock JG, Jiang L, McBee MP, Sneider MB, Krupinski EA (2020) Radiology, mobile devices, and internet of things (IoT). *J Digit Imaging* 33:735–746. <https://doi.org/10.1007/s10278-019-00311-2>
70. Pradhan B, Bharti D, Chakravarty S, Ray SS, Voinova VV, Bonartsev AP, Pal K (2021) Internet of things and robotics in transforming current-day healthcare services. *J Healthc Eng* 2021:9999504. <https://doi.org/10.1155/2021/9999504>
71. Tun SYY, Madanian S, Mirza F (2021) Internet of things (IoT) applications for elderly care: a reflective review. *Aging Clin Exp Res* 33:855–867. <https://doi.org/10.1007/s40520-020-01545-9>
72. Desai D, Shende P (2021) Integration of internet of things with quantum dots: a state-of-the-art of medicine. *Curr Pharm Des* 27:2068–2075. <https://doi.org/10.2174/1381612827666210222113740>
73. Hassan N, Gillani S, Ahmed E, Yaqoob I, Imran M (2018) The role of edge computing in internet of things. *IEEE Commun Mag*. <https://doi.org/10.1109/MCOM.2018.1700906>
74. Ghosh A, Chakraborty D, Law A (2018) Artificial intelligence in Internet of things. *CAAI Trans Intel Technol* 3:208–218. <https://doi.org/10.1049/trit.2018.1008>
75. Lampropoulos G, Siakas K, Anastasiadis T (2019) Internet of things in the context of industry 4.0: an overview. *Int J Entrepreneurial Knowl* 7:4–19. <https://doi.org/10.2478/ijek-2019-0001>
76. Chen M, Ma Y, Li Y, Wu D, Zhang Y, Youn C-H (2017) Wearable 2.0: enabling human-cloud integration in next generation healthcare systems. *IEEE Commun Mag* 55:54–61. <https://doi.org/10.1109/MCOM.2017.1600410CM>
77. Javaid M, Haleem A (2019) Industry 4.0 applications in medical field: a brief review. *Current Med Res Pract* 9. <https://doi.org/10.1016/j.cmrp.2019.04.001>



Houneida Sakly is a Ph.D. and Engineer in Medical Informatics. She is a member of the research program “deep learning analysis of Radiologic Imaging” in Stanford university. Certified in Healthcare Innovation with MIT-Harvard Medical school. Her main field of research is the Data science (Artificial Intelligence, Big Data, blockchain, Internet of things...) applied in healthcare. She is a member in the Integrated Science Association (ISA) in the Universal Scientific Education and Research Network (USERN) in Tunisia. Currently, she is serving as a lead editor for various book and special issue in the field of digital Transformation and data science in Healthcare. Recently, she has won the Best Researcher Award in the International Conference on Cardiology and Cardiovascular Medicine—San Francisco, United States.



Neuroradiology: Current Status and Future Prospects

Suely Fazio Ferraciolli , Andre Lupp Mota , Aline Sgnolf Ayres ,
Laura Lane Menezes Polsin, Felipe Kitamura,
and Claudia da Costa Leite 

1 Introduction

One approach to understanding the future perspective of neuroradiology is to look at the past, see what has already happened, and compare it with the predictions made before. From this information, it is possible to try to make new forethoughts in the future.

In the PubMed search for articles with the words “neuroradiology” and “future” in the title or abstract, there were almost 200 results, from which the most interesting articles were included in this chapter. The first article in the list is the Neuroradiology editorial of 1976 [1]. The author, G Salomon, presented a lot of

S. F. Ferraciolli (✉)
Dasa, São Paulo, Brasil
e-mail: suely.ferraciolli@hc.fm.usp.br

S. F. Ferraciolli · A. S. Ayres
UHG, São Paulo, Brasil
e-mail: aline.ayres@hc.fm.usp.br

S. F. Ferraciolli
Instituto de Radiologia, Hospital das Clínicas, School of Medicine, University of São Paulo,
Universidade de São Paulo, São Paulo, Brasil

A. L. Mota
Departamento de Cirurgia e Anatomia, Faculdade de Medicina de Ribeirão Preto,
Universidade de São Paulo, São Paulo, Brasil
e-mail: andre.lupp@alumni.usp.br

A. S. Ayres
Instituto do Câncer do Estado de São Paulo, Hospital das Clínicas, School of Medicine,
University of São Paulo, Universidade de São Paulo, São Paulo, Brasil

enthusiasm for his future perspectives, especially with the new imaging technique called computed tomography (CT). Dr. Godfred Hounsfield built the first CT scanner in 1971 and performed the first imaging of a 41-year-old patient with a brain tumor. Needless to say, this new technology has changed the day-to-day lives of medical doctors, improving patient quality of life and survival in many cases.

In another article from 1990, “Neuroradiology: Past, Present, Future,” published in *Radiology* [2] by JM Taveras, takes us back in time. He reviewed all eras of neuro-radiology from the first period of development (from 1918 to 1939, when the first international conference on cranial radiology occurred). Through the second period of development (from 1939 to 1972, with the introduction of computed tomography), and ending in the modern period from 1973 to 1989 (remember that Taveras wrote the article in 1990), magnetic resonance imaging (MRI) began to be introduced. With the incorporation of new invasive neuroimaging, diagnostic, and therapeutic methods, a subfield of interventional neuroradiology has been established.

Another fascinating article is “Neuroradiology Back to the Future: Brain Imaging,” published in *AJNR* in 2012 [3]. Hoeffner et al. reviewed the entire path of neuroradiology up to 2012, showing how specialty has always been connected to the emergence, adaptation, and incorporation of new technologies. In their conclusion, the authors state, ‘It is impossible to know (but exciting to contemplate) what developments will occur in neuroradiology in the next 100 years. Hopefully, progress will continue to lead us to increasingly less invasive, safer, faster, and more specific techniques that result in earlier diagnosis and treatment with a positive impact on patient outcome.

If we compare the content of these articles with the current state of neuroradiology, we can see that they were correct in most of their predictions. However, sometimes these predictions do not match the current situation, presenting flaws concerning our present.

L. L. M. Polsin

University of Campinas, São Paulo, Brasil

e-mail: lau.lane@gmail.com

F. Kitamura

Universidade Federal de São Paulo, Diagnósticos da América SA (Dasa), São Paulo, Brasil

e-mail: kitamura.felipe@gmail.com

C. da Costa Leite

Fleury Group, São Paulo, Brasil

e-mail: claudia.leite@hc.fm.usp.br

Sirio Libanes Hospital, São Paulo, Brasil

Instituto de Radiologia, Hospital das Clínicas, School of Medicine,

University of São Paulo, Universidade de São Paulo, São Paulo, Brasil

Departamento de Radiologia e Oncologia, Faculdade de Medicina,

Universidade de São Paulo, São Paulo, Brasil

One of the reasons that may explain this is the concept of known and unknown, addressed in the famous speech by Donald Rumsfeld, the defense secretary of the US government in 2002. When we form our discourse, we base it on our previous knowledge of the world, and there are many things that we do not know and consider in our predictions, which can make them entirely wrong in the future. In his speech, Rumsfeld stated that there were: (1) Known Known: we know of their existence and understand them; (2) Known Unknown: we know of their existence, but do not understand them; (3) Unknown Known: we do not know of their existence, but understand them; and (4) Unknown Unknown: we do not know of their existence, nor do we understand them.

In the 2014 TextOre article on Analytics, Knows, and Unknowns [4], the authors said that it is precisely in these “Unknown Unknowns” that the possibility of analyzing large datasets (Big Data) through artificial intelligence (using machine learning/deep learning) may help us discover new relationships/hierarchization and create predictions based on them, which would not be possible without the use of these tools.

Therefore, if artificial intelligence may help us better understand our world, why is there so much fear about it? Whenever a new technology appears, we follow a pattern called the hype circle. This shows how the visibility of the new technology behaves over time after its appearance. Initially, there is a peak in inflated expectations, thinking that the new technology will solve all problems. There is a trough of disillusionment when we get frustrated because the new technology does not provide the answers/functionalities imagined before. After that, there is a slope of enlightenment when people begin to realize the actual applications of the new technology and in which activities it will really make a difference. Finally, there is a plateau in productivity, in which the new technology has a well-defined role in the day-to-day life of the professionals involved in its use.

As an example, we could use magnetic resonance imaging (MRI). Initially, MRI was believed to solve all medical problems related to diagnostic imaging since it would be so detailed that it would provide doctors with the correct diagnosis to treat their patients correctly. Moreover, it would be interpretable that radiology ceases as a specialty. Currently, we know that this did not occur. In contrast, several subspecialties in radiology have arisen precisely because of the degree of complexity of interpreting MRI images.

As we can see by comparing Gartner’s 2020 hype cycle with the 2021 hype cycle [5], most artificial intelligence techniques (natural language processing, machine learning, and deep learning) are descending into the trough of disillusionment. Some experts predicted that these technologies would already be at a plateau of productivity within two to five years, which is very encouraging.

Therefore, if you use the past to understand what led to the present state of neuroradiology and to predict its future, based on the “Known Knows” and discarding the fear caused by inflated expectations related to the implementation of new artificial intelligence (AI) technologies, it is plausible to consider that in the coming years, artificial intelligence algorithms will have practical applicability in the daily routine of neuroradiologists. With this, neuroradiologists will be able to

better use their work time, either to contact the patient or the requesting physician, expanding their functionalities by adapting these tools in their daily tasks, which will bring new important information to the reports (such as quantitative data and biomarkers), making them more efficient and accurate for the patients.

In this way, radiologists will be able to better understand the “Unknown Unknowns” present in neuroradiology, growing, updating, improving, and expanding their abilities using these new technologies, and determining a more precise and positive medicine for patients.

2 AI in Neuroradiology

2.1 Overview of Articles and Main CNS Subjects

In a review of articles published in recent years using the terms “artificial intelligence,” “machine learning,” “deep learning,” and “neuroradiology” in the PubMed search tool. Sixty-one published papers were found, with only one published from 1996, one in 2017, and the others from 2018 onwards.

In addition to its historical value, the 1996 publication [6] describes the use of computer-aided design (CAD) to aid the work of neuroradiologists. The software offered an interactive interface with the radiologist, characterized by data entry from CT and MRI images. The system provides a list of diagnostic hypotheses from the entered data by using a decision tree.

Since 1996 to the present day, computing power and processing speed have significantly increased, and it has become possible to create and implement increasingly complex artificial neural networks.

To be able to understand this subject a little more, especially machine learning (“machine learning”) and deep learning (“deep learning”), an article published in 2018 in AJNR has an excellent summary of all areas of artificial intelligence, with a good review for the reader [7]. Chapter ‘[Introduction Chapter: AI and Big Data for Intelligent Health: Promise and Potential](#)’ of this book can also be reviewed.

Another interesting article reviewed manuscripts published between 2014 and 2018 [8], discussing the 10 main areas of neuroradiology that presented research using machine learning techniques. These include Alzheimer’s disease, mild cognitive decline, brain tumors, schizophrenia, depression, Parkinson’s disease, attention deficit/hyperactivity disorder, autism spectrum disorder, epilepsy, multiple sclerosis, stroke, and traumatic brain injury. The main limitation reported in this study was the size of the study datasets, which were mostly small, with a sample (n) between 120 and 200 patients.

In the 2020 A systematic review article in Radiology: Artificial Intelligence [9] showed that the size of the dataset remains one of the main limitations observed when reviewing published articles discussing applications of AI in neuroradiology. In this study, most (80%) of the reviewed articles had datasets smaller than 1000, and 34% used a dataset smaller than 100. These numbers limit the generalizability

of the AI model used in these studies because the quality and size of these datasets significantly influence the results presented, and may not reflect the proper performance of the algorithm when tested on datasets from other institutions (generalization). Quantitative evaluation methods also varied widely among the studies, making it difficult to interpret and compare these papers, even for readers familiar with machine learning. Another problem was the lack of description of the methodology for implementing the algorithms, which may render them irreproducible. Finally, few studies have provided clinical validation for their models, limiting their implementation in a single healthcare setting. This subject will be addressed more extensively when we discuss the review paper by Olthof et al. [10], which evaluates algorithms that are already on the market.

Among other articles, many presented applications of automatic segmentation with classification, especially for tumors [11]. One of these articles, published by Rauschecker et al. [12], drew much attention for its excellent performance in providing differential diagnoses (involving 19 neurological pathologies, some common and some rare). This AI system combines deep learning techniques to analyze quantitative data extracted from images (using atlas-based registration and segmentation). These imaging features were combined with five clinical features using Bayesian inference to develop differential diagnoses ranked by probability. This algorithm performed similarly to a neuroradiologist, and its performance was better than that of general radiologists, neuroradiology residents, and general radiology residents. However, the dataset size was smaller than 100 (82 and 96 patients in the training and test sets, respectively), which may limit its generalizability and reduce the performance of this algorithm “in the real world”. However, this high level of accuracy in common and rare diseases has never been demonstrated before. This article is one of the many works that cause uneasiness in the reader and rekindle doubt about the possibility of replacing neuroradiologists with AI.

2.2 A Systematic Review of Applications Already Available

Olthof et al. [10] put our minds at ease because they carried out a systematic review (technographic, since it is a technological development analysis) of the possibilities of using AI in neuroradiology, evaluating the algorithms available on the market, and checking their potential impacts on the work of neuroradiologists. The purpose was to answer two questions: whether and how AI will influence the daily practice of neuroradiologists. This article identified all software offered on the market from 2017 to 2019, collecting structured information from them and grouping their potential impacts into supporting, extending, and replacing neuroradiologists’ tasks. They identified 37 applications from 27 different companies that together offered more than 111 features.

For the most part, these functions supported neuroradiologists’ activities, such as detecting and interpreting imaging findings, or extending their tasks, such as algorithms allowing the identification of additional information on imaging

examinations (e.g., those providing quantitative information on pathological findings). Only a small group of applications sought to replace tasks such as warnings about the occlusion of a large vessel in intracranial arterial angiotomography.

Another important point addressed by the authors was the scientific validation of AI products, which is usually limited, even with approval from regulatory agencies (FDA in the US and EC in the European Economic Area). More than half of the software products (68%) received regulatory approval from at least one of these entities. However, approximately 50% of the evaluated software did not provide information about their scientific validation. Furthermore, it is impossible to determine the actual clinical impact of these tools.

Another important piece of information highlighted in this work is that knowing the strengths and weaknesses of the application in use is crucial for improving quality, ensuring security, and understanding the eventual artifacts related to already known mechanisms. However, no specific information about the technical details of the algorithms or the training and validation data is available in the general information on these software websites. These data are essential for analyzing the reliability and applicability of these algorithms. Without this, the AI tool becomes a rugged black box for interpretation.

As for the imaging examinations on which the algorithms were based, half of them used MRI and half used CT scans. Most algorithms aim at only one pathology, and the most common pathologies are mild cognitive impairment and dementia, including Alzheimer's disease (7 applications; 19%), multiple sclerosis (4 applications; 11%), tumors (4 applications; 11%), traumatic brain injury (3 applications; 8%), Parkinson's disease (2 applications; 5%), and intracranial aneurysm (1 application; 3%). In all three regulatory approval groups (FDA, EC, and others), ischemic stroke, intracranial hemorrhage, and dementia were more frequent than in the other categories. An example of an AI algorithm for Alzheimer Disease is shown in Fig. 1.

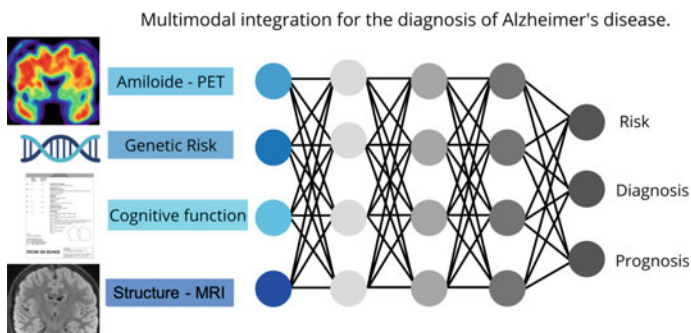

Fig. 1 Multimodal algorithm for Alzheimer disease

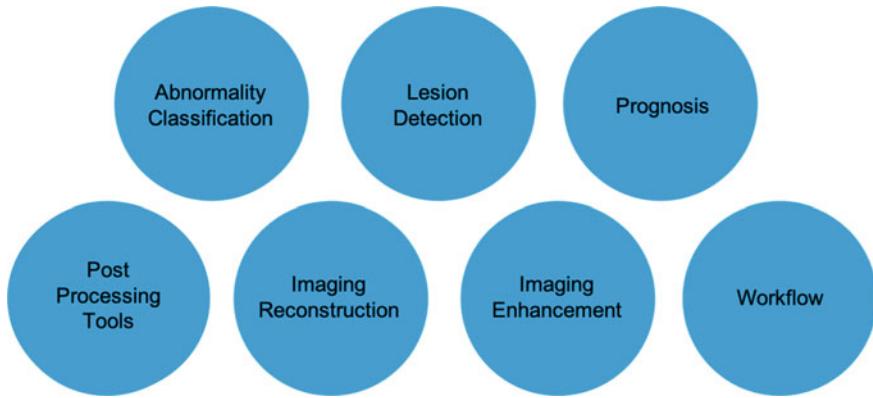

Fig. 2 Main functionalities of neuroradiology AI algorithms in the market, by Olthof et al.

The functionalities presented are divided into (shown in Fig. 2):

1. Quantitative information about pathology (13 applications, 12%): This measures the characteristics of pathological findings, as in the case of the algorithm that marks the location of hemorrhagic stroke and calculates the volume of the hematoma to aid in diagnosis and determine the patient's prognosis.
2. Marking of regions of interest or change detection (38 applications, 34%): visually marks the abnormal finding, as in the case of algorithms that automatically assess the presence of sizeable arterial trunk occlusion in intracranial CTA.
3. Classification, diagnosis, or probability of outcome (19 applications, 17%): interprets the imaging findings and provides a standardized diagnosis or classification, as in the case of algorithms that evaluate ischemic infarcts and provide the ASPECTS.
4. Report Preparation (15 applications, 14%): Organizes the diagnostic findings into a report, such as providing a comparative analysis with individuals of the same age group.
5. Automatic derivation of brain biomarkers (12 applications, 11%): compares quantitative information derived from normal or pathological findings with a specific disease group, such as hippocampal volume, with population curves to aid in the diagnosis of Alzheimer's disease.
6. Workflow and triage organization (12 applications, 11%): This facilitates the effectiveness of the diagnostic process, for example, by warning of abnormal tests that need to be reported as a priority.
7. Anatomical segmentation (two applications, 2%): Segment anatomical areas, such as algorithms that calculate the volume of brain regions.

Most of the algorithms' functionalities (39 applications; 54%) 'support' radiologists in performing their current tasks. Some other applications 'extend' the radiologists' work by providing quantitative information, which was impossible to

extract without the use of these algorithms (23 applications; 32%). Only a few algorithms (10 applications; 14%) offered functions that replaced specific tasks. A typical example of functionality substitution is the preparation of a report (with schematic reports filled with information). In both approved and not yet approved software, the most frequent category is “support,” followed by “extend” and “replace.”

The most numerous functionalities are directly related to the core of the radiologist’s business: finding and interpreting abnormalities, and making the correct diagnosis. The daily workflow of a neuroradiologist involves the tasks of information, indication, decision support, verification, acquisition, post-processing (of the imaging modality itself and within the PACS), prioritization, detection, segmentation, and quantification (of anatomical and pathological findings), interpretation, reporting, communication of imaging findings, reporting of critical findings, case discussion, peer review, and quality control. In general, AI will partially affect many tasks within this workflow, but others may not be changed.

As a result of this study [10], the main functionalities of the available software are to support (in detection and interpretation) and extend (with quantitative and biomarker information) the neuroradiologist’s tasks. The few algorithms that can replace physicians do so only for a limited set of tasks, such as reporting and analyzing a stroke patient. The authors concluded that AI is already a reality, and is currently available in clinical practice. However, none of the applications can replace the profession as a whole, although they can substitute for some specific tasks.

Therefore, AI algorithms could be used in:

Prioritizing studies in the PACS worklist based on the presence of pathology

- Workflow optimization
Quantification of anatomical structures and comparison with a control group based on age and biomarker derivation.
- Automated pathology detection and segmentation
Automated classification of pathology based on specific guidelines and criteria.
- Imaging screening and longitudinal analysis and follow-up of lesions Tumors and multiple sclerosis.

This list shows that neuroradiology will not be the same in the near future with the use of AI facilitating daily work.

2.3 Main Review Articles Published

In addition to this technographic review, several other review articles have been published in the past two years.

Lui et al. [13] presented the current status and future directions of AI in neuroradiology, with graphics showing an increasing number of publications, articles, and meeting posters/abstracts of neuroradiology on the subject. They also discussed

the most promising clinical applications of AI in neuroradiology, such as classification of abnormalities (e.g. urgent findings, such as hemorrhage, infarct, and mass effect) and detection of lesions (e.g. metastasis) and prediction of outcomes (e.g. predicting final stroke volume, tumor type, and prognosis), post-processing tools (for example, brain tumor volume quantification), and image reconstruction (e.g. fast MRI, low-dose CT) and enhancement (e.g. noise reduction, super-resolution) and workflow (for example, automate protocol choice and optimize scanner efficiency), citing many examples in the literature.

Kaka et al. [14], focus especially in the main tasks as: hemorrhage detection, stroke imaging, intracranial aneurysm screening, multiple sclerosis imaging, neuro-oncology, head and tumor imaging, and spine imaging. Duong et al. [15] divided the main applications of worklist prioritization, lesion detection, anatomic segmentation and volumetry, patient safety and quality improvement, precision medical education, and multimodal integration (in multiple sclerosis, epilepsy, and neurodegenerative disease), explaining many machine learning articles for each section. Kitamura et al. [16] also illustrated some applications of AI in neuroradiology and reviewed the machine learning challenges related to neuroradiology.

There are also specific reviews, such as the two stroke imaging reviews by Yedavalli et al. [17] and Soun et al. [18], describing the AI algorithms available in stroke imaging and summarizing the literature of AI applications for acute stroke triage, surveillance, and prediction, using different methods such as CT angiography and MRI. An example of a possible application of AI in acute stroke is shown in Fig. 3.

There are also many articles related to neuro-oncology, including those on the use of radiomics and radiogenomics, which will be discussed further in Chap. 12. There is one recent review dedicated to neuroradiologists, “Radiomics, machine learning, and artificial intelligence—what the neuroradiologist needs to know” [19], which explains the main principles (as shown in Fig. 4), utilization, and bias related to the use of these techniques.

Fig. 3 Use of AI in stroke detection

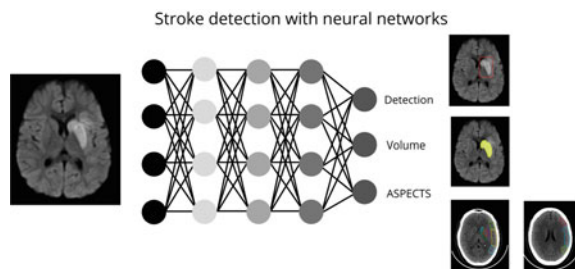

Nervous system tumors detection with radiomics

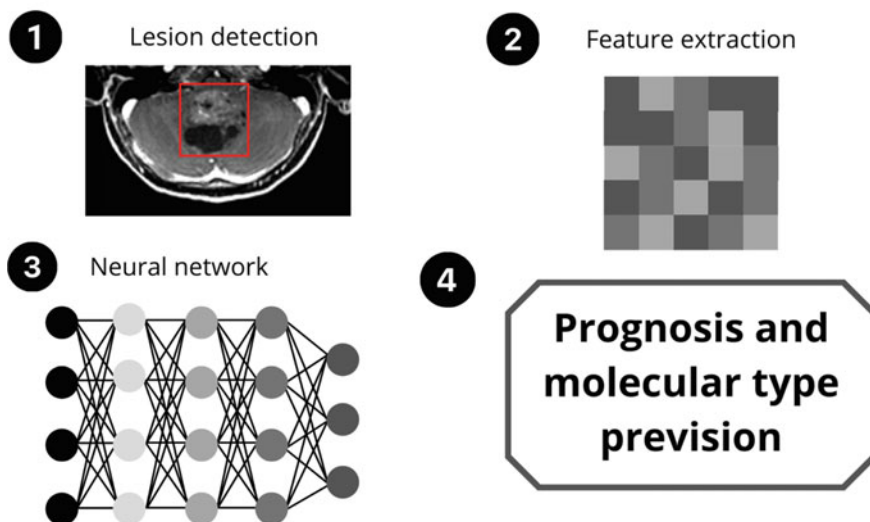

Fig. 4 Main steps of central nervous system tumors radiomics

3 Conclusion

The conclusion of that older article we cited [6], dated 1996, is nevertheless still very current: “The computer can function in one of two roles: as an independent interpreter that will analyze images with little or no input from the radiologist; or as an accessory interpreter that would act as an auxiliary brain for the radiologist.

Computers could assist radiologists, and radiologists could act as an eye for the computer rather than being displaced by it. This relationship represents ideal collaboration between both parties, complementing strengths and weaknesses.” This is the path that we should walk hand-in-hand.

Moreover, to conclude, we will use the words of the July 2019 Editorial of the Journal of Neuroradiology, [20] in which the authors make an almost poetic observation: “Artificial intelligence and neuroradiology cannot coexist side-by-side; they must be brought together to advance knowledge. Artificial intelligence must be a human-driven activity that shapes but does not replace the future of neuroradiology and neuroradiologists by extending our human skills to provide the best possible medical care.” With the use of AI in neuroradiology, we aimed to deliver better medicine with precision and positive clinical impact on the lives of our patients.

Perspectives:

Neuroradiology has been created and developed alongside with technological development. It could not be different with the assimilation of AI algorithm in daily routine for neuroradiological tasks. In the near future, AI application will help to improve and complement with new information the neuroradiology's reports, delivering a more accurate and personalized medicine for the patients.

Core messages:

The use of AI applications in neuroradiology is already a reality, making it necessary for neuroradiologists to understand how AI algorithms are made, which are the main bias and problems that they need to be aware of, as well as the main improvements and additional information that could be added to the reports, helping to diagnose and to better treat neurological diseases.

Short expert opinion:

In 30 years, we believe that AI algorithm will improve the neuroradiologists performance and reports, helping them to spend less time in laborious repetitive tasks and more time in important ones such as adding volumetric, biometric and quantitative information in the reports, positively impacting on the patients diagnosis, prognosis and treatment.

References

1. Salamon G (1976) Editorial: situation and future of neuroradiology. *Neuroradiology* 11(1):1–2. <https://doi.org/10.1007/BF00327250> PMID: 778653
2. Taveras JM (1990) Diamond Jubilee lecture. Neuroradiology: past, present, future. *Radiology* 175(3):593–602. <https://doi.org/10.1148/radiology.175.3.2188291>. PMID: 2188291
3. Hoeffner EG, Mukherji SK, Srinivasan A, Quint DJ (2012) Neuroradiology back to the future: brain imaging. *AJNR Am J Neuroradiol* 33(1):5–11. <https://doi.org/10.3174/ajnr.A2936>. Epub 2011 Dec 8. PMID: 22158930; PMCID: PMC7966158
4. TextOre Article, <https://www.textore.net/blog/2018/4/23/analytics-knowns-and-unknowns>
5. Gartner Hype Cycle, <https://www.gartner.com/en/articles/the-4-trends-that-prevail-on-the-gartner-hype-cycle-for-ai-2021>
6. Rasuli P, Rasouli F, Hammond DI, Amiri F (1996) An artificial intelligence program for the radiologic diagnosis of brain lesions. *Radiographics* 16(5):1207–1213. <https://doi.org/10.1148/radiographics.16.5.8888400> PMID: 8888400
7. Zaharchuk G, Gong E, Wintermark M, Rubin D, Langlotz CP (2018) Deep learning in neuroradiology. *AJNR Am J Neuroradiol* 39(10):1776–1784. <https://doi.org/10.3174/ajnr.A5543>
8. Sakai K, Yamada K (2019) Machine learning studies on major brain diseases: 5-year trends of 2014–2018. *Jpn J Radiol* 37(1):34–72. <https://doi.org/10.1007/s11604-018-0794-4>
9. Yao AD, Cheng DL, Pan I, Kitamura F (2020) Deep learning in neuroradiology: a systematic review of current algorithms and approaches for the new wave of imaging technology. *Radiol Artif Intel*. <https://doi.org/10.1148/ryai.2020190026>
10. Olthof AW, van Ooijen PMA, Rezazade Mehrizi MH (2020) Promises of artificial intelligence in neuroradiology: a systematic technographic review [published online ahead of print, 2020 Apr 22]. *Neuroradiology*. <https://doi.org/10.1007/s00234-020-02424-w>

11. Mzoughi H, Njeh I, Wali A et al (2020) Deep multi-scale 3D convolutional neural network (CNN) for MRI gliomas brain tumor classification [published online ahead of print, 2020 May 21]. *J Digit Imaging*. <https://doi.org/10.1007/s10278-020-00347-9>
12. Rauschecker AM, Rudie JD, Xie L et al (2020) Artificial intelligence system approaching neuroradiologist-level differential diagnosis accuracy at brain MRI. *Radiology* 295(3):626–637. <https://doi.org/10.1148/radiol.2020190283>
13. Lui YW, Chang PD, Zaharchuk G, Barboriak DP, Flanders AE, Wintermark M, Hess CP, Filippi CG (2020) Artificial intelligence in neuroradiology: current status and future directions. *AJNR Am J Neuroradiol* 41(8):E52–E59. <https://doi.org/10.3174/ajnr.A6681>. Epub 2020 Jul 30. PMID: 32732276; PMCID: PMC7658873
14. Kaka H, Zhang E, Khan N (2021) Artificial intelligence and deep learning in neuroradiology: exploring the new frontier. *Can Assoc Radiol J* 72(1):35–44. <https://doi.org/10.1177/0846537120954293> Epub 2020 Sep 18 PMID: 32946272
15. Duong MT, Rauschecker AM, Mohan S (2020) Diverse applications of artificial intelligence in neuroradiology. *Neuroimaging Clin N Am* 30(4):505–516. <https://doi.org/10.1016/j.nic.2020.07.003>. Epub 2020 Sep 17. PMID: 33039000; PMCID: PMC8530432
16. Kitamura FC, Pan I, Ferraciolli SF, Yeom KW, Abdala N (2021) Clinical artificial intelligence applications in radiology: neuro. *Radiol Clin North Am* 59(6):1003–1012. <https://doi.org/10.1016/j.rcl.2021.07.002> PMID: 34689869
17. Yedavalli VS, Tong E, Martin D, Yeom KW, Forkert ND (2021) Artificial intelligence in stroke imaging: current and future perspectives. *Clin Imaging* 69:246–254. <https://doi.org/10.1016/j.clinimag.2020.09.005> Epub 2020 Sep 21 PMID: 32980785
18. Soun JE, Chow DS, Nagamine M, Takhtawala RS, Filippi CG, Yu W, Chang PD (2021) Artificial intelligence and acute stroke imaging. *AJNR Am J Neuroradiol* 42(1):2–11. <https://doi.org/10.3174/ajnr.A6883>. Epub 2020 Nov 26. PMID: 33243898; PMCID: PMC7814792
19. Wagner MW, Namdar K, Biswas A, Monah S, Khalvati F, Ertl-Wagner BB (2021) Radiomics, machine learning, and artificial intelligence—what the neuroradiologist needs to know. *Neuroradiology* 63(12):1957–1967. <https://doi.org/10.1007/s00234-021-02813-9>. Epub 2021 Sep 18. PMID: 34537858; PMCID: PMC844969
20. Attyé A, Ognard J, Rousseau F, Ben SD (2019) Artificial neuroradiology: between human and artificial networks of neurons? *J Neuroradiol* 46(5):279–280. <https://doi.org/10.1016/j.neurad.2019.07.001>



Suely Fazio Ferraciolli Chief of Radiology of Sabara Hospital (Dasa). Vice-chief of the Magnetic Resonance Section of the Radiology Institute—Clinical Hospital of the University of São Paulo. Neuroradiologist at Dasa’s AI Lab and the Children’s Institute—Clinical Hospital of the University of São Paulo Brasil.



Big Data and AI in Cardiac Imaging

Charitha D. Reddy

1 Introduction

The utility of “big data” and artificial intelligence (AI) in healthcare is growing. As efforts to translate theoretical results into clinical practice have become more successful, there will be an exponential growth in the development of AI applications. Cardiac imaging is ripe for the use of artificial intelligence, as it is a frontline tool for diagnosis, generates large amounts of granular data, and can be used alone or with other clinical data for personalized disease management. Moreover, the multiple steps involved in cardiac imaging, such as image acquisition, image optimization, measurements, interpretation, and reporting, provide immense opportunities for improvement in any part of the chain (Fig. 1). AI has the potential to positively affect clinical outcomes, reduce variability, and increase accessibility to broader populations. In this chapter, we review the basic terminology of AI, explore some current AI applications in cardiac imaging, and discuss future challenges and opportunities in the field.

AI is defined as a computer system that can complete tasks that typically require human intelligence (e.g., visual recognition, speech processing, and decision-making) by using data as input [1]. Vast amounts of health data exist within the medical record and diagnostic testing to serve as input for algorithms designed to aid in diagnosis or management [2]. In the past, there were significant limitations in processing complex health data, but recent advances in collating, labeling, and machine learning techniques have helped popularize AI in healthcare [2]. Lastly, technological developments and increased user access to AI technologies have contributed to improved incorporation into clinical workflows. Thus, three impor-

C. D. Reddy (✉)

Stanford University, Lucile Packard Children’s Hospital, 750 Welch Rd, Ste 305,
Palo Alto, CA 94034, USA

e-mail: reddyc@stanford.edu

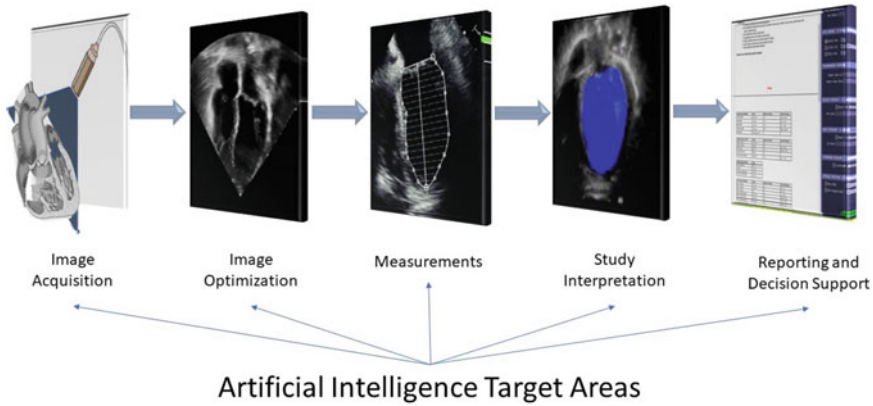

Fig. 1 Process of cardiac imaging chain (in echocardiography) and target areas for artificial intelligence

tant aspects to successfully implement AI applications in cardiac imaging are input data (source, amount, and variety), algorithm design, and validation and implementation strategy (testing, bias, and deployment).

2 Data Management

The Gartner Report defined successful use of “Big Data” using the concept of the “3Vs”: volume, variety, and velocity [3]. More recently, the addition of fourth and fifth “Vs” has been suggested—veracity and value. Volume refers to the need for large amounts of data, while variety refers to the type and source of data [3]. Velocity is the ability to generate and process datasets, while veracity focuses on the reliability and quality of said datasets [3, 4]. Value is less about the data and more about whether the endpoint results in actionable insights that have downstream impact [5]. Healthcare data can be obtained from electronic health records, patient-generated data (e.g., wearable devices, social media), laboratory results, imaging and diagnostic testing, genomic data, and outcomes, to name a few [6]. There has been growing interest in formally organizing the enormous volume of data, in the form of biobanks or public datasets in order to derive meaningful results [7, 8]. The benefits of applying AI to big data include the ability to rapidly digest large amounts of data and identify novel patterns that would otherwise be missed; humans would not be able to process the same amount or variety of data.

Big data has traditionally been touted as a necessity for successful implementation of AI in healthcare, but recent paradigm shifts suggest that smaller datasets can be effective as well. One way to use a smaller dataset effectively is to extract granular pieces of data. This is particularly beneficial in cardiac imaging, where each data point could focus at the pixel level (color, shapes, brightness, motion,

borders) or report level (phrases and descriptive terms) [9]. These derived data points are referred to as “features.” The features distilled from the dataset directly impact the success of an AI algorithm; the features and associated labelling should be accurate, diverse, and of high quality. Inaccurate features and the classification of input data adversely affect the ability of the algorithm to understand relevant real-world data.

3 Algorithm Design

Machine learning (ML) is a subset of AI that is characterized by the ability of an algorithm to improve task performance by “learning” from new data by identifying patterns without specific programming. Machine learning is categorized into two types: supervised and unsupervised. A supervised learning strategy trains the computational model to identify patterns by associating predetermined outcomes with input data [10]. In addition, Supervised models can be honed by selecting and weighting certain features over others to arrive at the desired outcome. Regression analysis, support vector machines, and random forests are all supervised learning methods [11, 12]. Neural networks are a more complex form of supervised learning, often referred to as deep learning, and are meant to recreate human thought processes. Convolutional neural networks (CNNs) are multi-layered neural networks that use prior experiences to improve on outcomes [9, 13]. Unsupervised learning models are comparatively free-form; the model is left to discover patterns in the data that may have never been identified before [14]. In this strategy, data is “clustered” into various categories based on similarities that the model has identified, and additional statistical evaluation is required to identify the actual similar characteristic or feature. Hierarchical, k-means, and model-based clustering are examples of cluster analysis types. A combination of supervised and unsupervised learning strategies was used. In this approach, an unsupervised model provides novel features that can be plugged into a supervised model to be weighted and used to predict an outcome [15].

4 Validation and Implementation

The successful validation and deployment of a machine learning model requires sufficient “training” and “testing” of data. To train the model, a subset of the total data is utilized for “training.” The model uses this subset of data to identify patterns and determine the features that are more or less important in predicting the determined outcome. “Testing” data is a separate subset (or new data) to assess the model’s ability to accurately predict the correct outcome despite never having seen the test data. This process is referred to as validation (Fig. 2). The ability of the model to handle variations in new data determines its generalizability and success

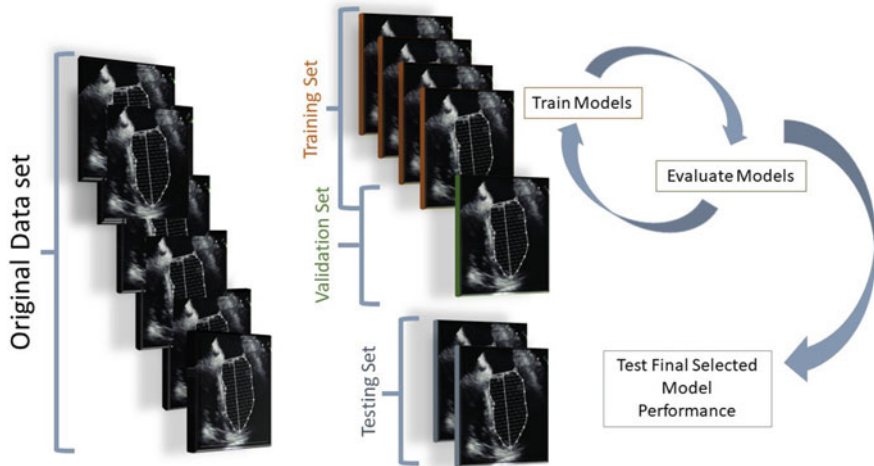

Fig. 2 Machine learning process of training, validation, and testing

in clinical practice. When a model is trained on insufficient data, there is a risk of “overfitting,” where the model can only work on data that is extremely close to the original dataset. This has the additional risk of introducing bias to a model if the data have certain homogenous characteristics that do not reflect real-world distribution. As AI technologies have been developed for imaging in clinical practice, their implementation depends on the ability to define important features in the imaging data, applying the correct type of machine learning, and designing deployable applications.

5 Implementation in Cardiac Imaging

AI has been steadily gaining traction in all forms of cardiac imaging, including echocardiography, magnetic resonance imaging (MRI), computed tomography (CT), and nuclear medicine. Unlike the early focus of AI on radiology applications with static image datasets, cardiac imaging poses additional challenges owing to the video-based or non-static format of the data. Moreover, there are multiple areas for potential improvement, including operator skill impacting image quality, variability in measurements, and differences in interpretation. The introduction of novel AI technologies that can tackle some of these challenges, while also decreasing costs and improving efficiency, could have a profound impact on patient care and outcomes. Machine learning applications in cardiac imaging are therefore primarily focused on the following four categories: image acquisition and quality, automated measurements, diagnostic support, and outcome prediction [9, 16, 17]. In this section, we review some of the current technologies that have been developed for various cardiac imaging modalities.

5.1 Echocardiography

Echocardiography is the most common imaging modality in cardiology and remains a frontline diagnostic and management tool. However, it is heavily dependent on operator skill for image acquisition, quality, and measurements, leading to considerable concerns about intra- and inter-observer variability in data collection and clinical interpretation [18, 19]. AI technologies are continually being developed to reduce variability and improve interpretation [20–26].

Narang et al. [27] used a deep-learning-based algorithm to aid novices in acquiring echocardiographic images. In this study, healthcare providers with no prior ultrasound experience performed ultrasound with or without deep learning guidance. With the deep learning algorithm, providers were able to obtain 10 standard transthoracic echocardiographic views that provided some diagnostic assessment for ventricular size and function [27]. EchoNet, a deep learning model, by Ghorbani et al. used CNNs to accurately identify cardiac structures and evaluate left ventricular function [28]. Zhang et al. trained CNNs on 14,035 echocardiograms to automatically identify 23 imaging planes, segment the images, measure cardiac structure and function, and detect disease [29]. This study demonstrated forward progress in the area of automated measurements by using the model to calculate left ventricular volumes, mass, and ejection fraction. The automated measurements for ejection fraction and longitudinal strain deviated from manual measurements by approximately 6 and 1.6% [29]. Currently, 3D echocardiography is generally considered to have better accuracy than 2D evaluation, but is limited in clinical practice due to a high standard of operator expertise [30]. However, Narang et al. used a machine learning-based algorithm to automate the measurement of dynamic left ventricular and left atrial volumes that showed it was both accurate compared to manual 3D measurements and MRI, as well as efficient by shortening the time required to analyze the datasets [22]. Knackstedt et al. [20] and Salte et al. [31] have already shown the successful clinical workflow implementation of full automated assessment of global longitudinal strain.

Studies have also begun to focus on the use of machine learning models to aid in diagnostic support and interpretation. Zhang et al. used the aforementioned dataset of >14,000 echocardiograms to effectively detect hypertrophic cardiomyopathy, pulmonary hypertension, and cardiac amyloidosis using two echocardiographic planes, with a C statistic (area under the receiving operating characteristic curve) of greater than 0.85 for all three diseases [29]. A few studies have evaluated the ability to accurately assess the severity of valve dysfunction; Moghaddasi et al. [32] and Playford et al. [33] used machine learning models to grade mitral and aortic valve dysfunction, respectively. Moghaddasi et al. developed a model that had greater than 99% overall sensitivity and specificity in predicting whether a mitral valve was normal and graded the severity of regurgitation [32]. The algorithm designed by Playford et al. used data from the entire echocardiogram, as opposed to only the left ventricular outflow tract, to more accurately predict severe aortic stenosis [33].

Deep learning models are also utilized in fetal echocardiography and pediatric echocardiography. Arnaout et al. [34] used 107,832 fetal echocardiogram images to

create a CNN to automatically identify standard fetal cardiac planes, automate segmentation to allow for biometric measurements, and differentiate between normal hearts and those with congenital heart disease. Le et al. [35] similarly studied a machine learning model using random forests to detect congenital heart disease using retrospective data. Others have studied how to automate image acquisition in fetal echocardiography, as well as interpreting Doppler signals [36–38] utilizing big data and artificial intelligence in pediatric echocardiography is relatively new, with a few studies in the abstract phase applying deep learning models to automate view identification, [39] and assessment of ejection fraction [40].

5.2 Cardiac Magnetic Resonance Imaging

Cardiac magnetic resonance imaging (CMR) has made significant strides in the application of deep learning to clinical practice. The use of AI in CMR has led to improvements in some areas that had previously been significant barriers to the widespread use of CMR. The extensive time required for image acquisition and post-processing, artifacts affecting image quality related to cardiac motion, and patient factors have been the focus of various studies aimed at streamlining the CMR imaging chain.

Leiner et al. and Frick et al. have both published on the automation of image acquisition planes, image optimization, and artifact detection [41, 42]. More recent work by Kustner et al. used deep learning methods to allow for reconstruction of low resolution CMR data to clinically comparable image quality as high resolution images in less than 1 min [43]. Similarly, Steeden et al. [44] used CNNs to recreate high resolution images from a low-resolution three-dimensional dataset in patients with congenital heart disease. Tissue characterization in CMR imaging often requires gadolinium contrast. However, Zhang et al. developed a CNN model to optimize existing imaging sequences, resulting in images with superior quality and comparable tissue burden quantification without the use of gadolinium [45].

Segmentation of image contours has historically been a manual task; however, this process is time-consuming and suffers from significant intra- and inter-observer variability. Multiple efforts have been successful at automatically segmenting right and left ventricles [46–50]. Owing to the relative scarcity of CMR data in patients, Winther et al. [50] used four separate sources to train a vendor-neutral CNN, which is an enormous advantage that allows for broader implementation. Bidhendi et al. [51] similarly demonstrated the success of a CNN in pediatric patients with congenital heart disease, which performed better than the baseline platform.

Radiomics, a relatively new area of study in cardiac imaging, is a method to extract features from large amounts of medical imaging data that can identify previously unseen patterns and characteristics. Texture analysis (TA) uses machine-learning strategies to evaluate subtle variations in image intensities at the pixel level. Multiple studies have already demonstrated the use of machine learning to accurately identify clinically relevant variations in imaging texture that are not obvious to the naked eye [52–54]. Mancio et al. [54] employed TA to quantify

tissue changes within the myocardium of patients with hypertrophic cardiomyopathy to help risk-stratify patients with a lower probability of having scar tissue. Neisius et al. [52] discovered features using TA that could identify differences between CMRs in patients with hypertension and hypertrophic cardiomyopathy, which is a common challenge in typical clinical practice.

CMR studies have also shown promise for predictive modelling and decision support. Bello et al. used CNN modeling to segment labeled CMR images to develop 3D models that identified features to predict survival in patients with pulmonary hypertension [55]. Diller et al. used a U-net algorithm to evaluate CMR video clips to automatically trace endocardial borders in two views to directly predict prognosis in patients with tetralogy of Fallot [56]. Kotu et al. used a combination of multiple machine learning algorithms to stratify patients into high and low risk of arrhythmia after myocardial infarction [57].

5.3 CT

Cardiac computed tomography (CCT) is an important imaging modality in cardiology owing to its efficiency and image quality, particularly for small structures within the heart. However, radiation dose is a constant area of concern. Machine learning algorithms utilizing CCT have focused on improving image quality while reducing contrast. Santini et al. used a supervised learning model to “transform” non-contrast CCT scans into an image quality comparable to contrast CCT scans [55]. Geng et al. [58] also focused on improving image quality by using an unsupervised method to reduce “noise” in non-contrast CCTs.

Automated measurements and segmentation have also been evaluated for CCT. Zreik et al. evaluated 55 patients as part of a training set to perform automatic segmentation of the left ventricle, which resulted in high sensitivity and specificity [59]. Coronary artery disease (CAD) is a primary disease state that utilizes CCT as a diagnostic tool. Given that CAD is a leading cause of mortality globally, [60] early diagnosis by CCT has shown benefits to aid in treatment and prevention [61] and can avoid unnecessary invasive testing [62, 63]. Coronary artery calcium (CAC) is used as a predictive score for adverse cardiac events [61] and multiple studies have tackled the ability to automatically estimate the value. Using a CNN architecture to generate a CAC score, Wolterink et al. [64] achieved able to reach 72%. In light of the focus on contrast reduction, Lessmann et al. [65] used non-contrast CT scans and the aforementioned model by Wolterink et al. to detect calcium and identify false positives by using paired CNNs. There was a high detection rate of CAC, but the model was less successful in identifying calcium in the mitral and aortic valves [65]. However, the potential to utilize non-contrast CTs to predict CACS is very promising.

Diagnostic interpretation is another important focus of the application of AI to CCT. Van Hamersvelt et al. [66] evaluated the use of texture analysis (TA) of the myocardium to automatically identify significant coronary artery stenosis in favor of a typical approach in which a model is trained to identify features determined by

a human expert. Using a combination of methods, including supervised and unsupervised techniques, a deep learning model showed an improved prediction of coronary stenosis [66].

Finally, CCT is one of the few cardiac imaging modalities that has used a broad registry to predict adverse cardiovascular events. Both Motwani et al. [67] and Van Rosendaal [68] utilized the CONFIRM (Coronary CT Angiography EvaluationN For Clinical Outcomes: An inteRnational Multicenter) registry [69, 70] to apply artificial intelligence to estimate the survival and prognosis of patients with cardiovascular disease. The Framingham risk score is widely accepted as a method for the risk stratification of patients; it uses a combination of patient demographics, laboratory values, and CAC. Motwani et al. [67] incorporated CCT data and clinical markers to train an AI-based algorithm that performed better than the Framingham score. Motwani et al. trained their model by ranking the importance of expert-determined features and placing more weight on some findings than on others. Van Rosendaal employed a similar strategy with imaging as the only input, and found comparable success [68].

6 Nuclear Medicine

Nuclear medicine in cardiac imaging typically encompasses myocardial perfusion imaging (MPI) by SPECT (single-photon emission computed tomography (SPECT) and positron emission tomography (PET). SPECT is more commonly used in clinical practice, although PET requires less radiation. SPECT is unique to other imaging modalities because many of the measurements are already automated, including quantitative perfusion assessment, ventricular volumes, myocardial mass, ejection fraction, myocardial thickening, and dyssynchrony. In fact, there is already a large registry, REFINE SPECT, with >20,000 patients from multiple centers collecting imaging and clinical data to serve as a dataset for AI applications [71]. Therefore, AI applications for SPECT are geared towards automating diagnosis, prognostication, and management [72].

Betancur et al. [73] used the REFINE SPECT registry to train and develop a deep learning algorithm to detect coronary artery stenosis in <1 s. The model was trained on catheterization-based coronary angiography to identify coronary artery stenosis and then given the automated SPECT images as an input and performed better than the conventional method (AUC 0.8 vs. 0.78) [73]. Nakajima et al. [74] used a supervised learning model based on expert labels from a multi-center dataset to design a neural network that performed better than human experts (AUC 0.97). Multiple studies have combined imaging variables and clinical factors to serve as inputs for machine learning models and have yielded better diagnostic accuracy than visual assessment alone [75, 76]. Haro Alonso et al. [77] compared a support vector machine (SVM) to traditional regression models to accurately predict cardiac death in patients. The study used SPECT data to train the model and found that the SVM performed better than the regression model (AUC 83 vs. 0.77).

7 Challenges and Pitfalls

The deployment of machine learning models in the real world remains one of the biggest challenges facing the incorporation of AI into clinical practice. Initial concerns about the inexplicability, or “black box” nature, of results from AI-derived data has plagued the adoption of AI in the healthcare field despite ongoing focus on designing models that are more transparent [78]. “Explainable AI” could include neural networks with built-in layers to assess decision-making and quality, allowing users to gain insight into the features that the model has selected [79]. Another approach asks the model to provide confidence intervals for its own predictions, allowing the user to provide clearer feedback focused on predictions that have wide intervals [80].

Another major challenge is the lack of infrastructure in most healthcare institutions, impacting the initiation of projects, inconsistent data labeling, difficulty navigating privacy laws and data sharing, and lack of technical support. This often limits research to single-center studies, often with retrospective data. While the model may perform well, it is unlikely to generalize widely and effectively impact clinical practice effectively [81] large datasets are necessary to adequately train deep learning models. This is especially difficult to overcome in patients with rare diseases or relatively small patient populations (congenital heart disease). In addition, the risk of utilizing narrow patient groups has been shown to result in a significant bias that could have a negative impact on the healthcare system; [82] it is of paramount importance to have adequately diverse datasets. Given the heavy involvement of vendors in cardiac imaging, it can also be challenging to incorporate vendor-neutral models, although there have been a few [83]. In the same vein, it is difficult to prove the benefit of AI-based care without extensive testing with human experts. Lastly, most clinicians do not have the opportunity to learn or experiment with AI concepts or how they can be incorporated into clinical practice. This can adversely affect the uptake of new technologies and the progress of stymie.

8 Future Directions

Despite the challenges mentioned in the previous section, the advances that have already been made in the areas of cardiac imaging and AI are impressive. For each imaging modality, studies have demonstrated improved image acquisition, quality, diagnostic accuracy, measurement automation, and outcome prediction. The results are promising and have the potential for far-reaching impacts on improving workflows and patient care. Future endeavors should focus on multicenter collaboration to create broadly representative datasets to encourage generalizable and reproducible results. Additional efforts should be placed on the effective deployment of algorithms and a way to compare algorithms that attempt to solve the same diagnostic question. As AI applications become more pervasive in healthcare, the

combination of imaging data and radiomics and the other “-omics” (genomics, proteomics, and metabolomics) will strengthen the ability of machine learning predictions to provide individualized care to patients.

References

1. Russell S, Norvig P (2003) *Artificial intelligence: a modern approach*, 2nd edn. Prentice Hall, Upper Saddle River, New Jersey
2. Darcy AM, Louie AK, Roberts LW (2016) Machine learning and the profession of medicine. *JAMA* 315(6):551–552
3. Beyer MLD (2012) The importance of “big data”: a definition
4. McAfee A, Brynjolfsson E (2012) Big data: the management revolution. *Harv Bus Rev* 90(10):60–66, 68, 128
5. George G, Haas MR, Pentland A (2014) Big data and management. In: Vol 57: academy of management Briarcliff manor, NY, pp 321–326
6. De Mauro A, Greco M, Grimaldi M (2016) A formal definition of big data based on its essential features. *Library Rev*
7. Coffey S, Lewandowski AJ, Garratt S et al (2017) Protocol and quality assurance for carotid imaging in 100,000 participants of UK Biobank: development and assessment. *Eur J Prev Cardiol* 24(17):1799–1806
8. Petersen SE, Matthews PM, Bamberg F et al (2013) Imaging in population science: cardiovascular magnetic resonance in 100,000 participants of UK Biobank - rationale, challenges and approaches. *J Cardiovasc Magn Reson* 15:46
9. Lee JG, Jun S, Cho YW et al (2017) deep learning in medical imaging: general overview. *Korean J Radiol* 18(4):570–584
10. Mayr A, Binder H, Gefeller O, Schmid M (2014) The evolution of boosting algorithms. From machine learning to statistical modelling. *Methods Inf Med* 53(6):419–427
11. Chykeyuk KCD, Noble JA (2011) Feature extraction and wall motion classification of 2D stress echocardiography with relevance vector machines. In: Paper presented at: international symposium on biomedical imaging
12. Domingos JS, Stebbing RV, Lesson P, Noble JA (2014) *Structured random forests for myocardium delineation in 3D echocardiography*, Springer International Publishing
13. Krittanawong C, Tunhasirwet A, Zhang H, Wang Z, Aydar M, Kitai T (2017) Deep learning with unsupervised feature in echocardiographic imaging. *J Am Coll Cardiol* 69(16):2100–2101
14. Aye CYL, Lewandowski AJ, Lamata P et al (2017) Disproportionate cardiac hypertrophy during early postnatal development in infants born preterm. *Pediatr Res* 82(1):36–46
15. Arsanjani R, Xu Y, Hayes SW et al (2013) Comparison of fully automated computer analysis and visual scoring for detection of coronary artery disease from myocardial perfusion SPECT in a large population. *J Nucl Med* 54(2):221–228
16. Stebbing RV, Namburete AI, Upton R, Leeson P, Noble JA (2015) Data-driven shape parameterization for segmentation of the right ventricle from 3D+t echocardiography. *Med Image Anal* 21(1):29–39
17. Fatima MPM (2017) Survey of machine learning algorithms for disease diagnosis. *J Intel Learn Syst Appl* 9:1–16
18. Davis A, Billick K, Horton K et al (2020) Artificial intelligence and echocardiography: a primer for cardiac sonographers. *J Am Soc Echocardiogr* 33(9):1061–1066
19. Nagata Y, Kado Y, Onoue T et al (2018) Impact of image quality on reliability of the measurements of left ventricular systolic function and global longitudinal strain in 2D echocardiography. *Echo Res Pract* 5(1):27–39

20. Knackstedt C, Bekkers SC, Schummers G et al (2015) Fully automated versus standard tracking of left ventricular ejection fraction and longitudinal strain: the FAST-EFs multicenter study. *J Am Coll Cardiol* 66(13):1456–1466
21. Volpato V, Mor-Avi V, Narang A et al (2019) Automated, machine learning-based, 3D echocardiographic quantification of left ventricular mass. *Echocardiography* 36(2):312–319
22. Narang A, Mor-Avi V, Prado A et al (2019) Machine learning based automated dynamic quantification of left heart chamber volumes. *Eur Heart J Cardiovasc Imaging* 20(5):541–549
23. Tamborini G, Piazzese C, Lang RM et al (2017) Feasibility and accuracy of automated software for transthoracic three-dimensional left ventricular volume and function analysis: comparisons with two-dimensional echocardiography, three-dimensional transthoracic manual method, and cardiac magnetic resonance imaging. *J Am Soc Echocardiogr* 30(11):1049–1058
24. Tsang W, Salgo IS, Medvedofsky D et al (2016) Transthoracic 3D echocardiographic left heart chamber quantification using an automated adaptive analytics algorithm. *JACC Cardiovasc Imaging* 9(7):769–782
25. Asch FM, Poilvert N, Abraham T et al (2019) Automated echocardiographic quantification of left ventricular ejection fraction without volume measurements using a machine learning algorithm mimicking a human expert. *Circ Cardiovasc Imaging* 12(9):e009303
26. Muraru D, Spadotto V, Cecchetto A et al (2016) New speckle-tracking algorithm for right ventricular volume analysis from three-dimensional echocardiographic data sets: validation with cardiac magnetic resonance and comparison with the previous analysis tool. *Eur Heart J Cardiovasc Imaging* 17(11):1279–1289
27. Narang ABR, Hong H, Thomas Y, Surette S, Cadieu C (2020) Acquisition of diagnostic echocardiographic images by novices using a deep learning based image guided algorithm. *J Am College Cardiol* 75:1564
28. Ghorbani A, Ouyang D, Abid A et al (2020) Deep learning interpretation of echocardiograms. *NPJ Digit Med* 3:10
29. Zhang J, Gajjala S, Agrawal P et al (2018) Fully automated echocardiogram interpretation in clinical practice. *Circulation* 138(16):1623–1635
30. Lang RM, Badano LP, Mor-Avi V et al (2015) Recommendations for cardiac chamber quantification by echocardiography in adults: an update from the American Society of Echocardiography and the European Association of Cardiovascular Imaging. *J Am Soc Echocardiogr* 28(1):1–39 e14
31. Salte IM, Oestvik A, Smistad E, Melichova D, Nguyen TM, Brunvand H (2020) Deep Learning/artificial intelligence of automatic measurement of global longitudinal strain by echocardiography. *Eur Heart J Cardiovasc Imaging* 21
32. Moghaddasi H, Nourian S (2016) Automatic assessment of mitral regurgitation severity based on extensive textural features on 2D echocardiography videos. *Comput Biol Med* 73:47–55
33. Playford D, Bordin E, Mohamad R, Stewart S, Strange G (2020) Enhanced diagnosis of severe aortic stenosis using artificial intelligence: a proof-of-concept study of 530,871 echocardiograms. *JACC Cardiovasc Imaging* 13(4):1087–1090
34. Arnaout R, Curran L, Zhao Y, Levine JC, Chinn E, Moon-Grady AJ (2021) An ensemble of neural networks provides expert-level prenatal detection of complex congenital heart disease. *Nat Med* 27(5):882–891
35. Le TKTV, Nguyen-Vo T-H (2020) Application of machine learning in screening of congenital heart disease using fetal echocardiography. *J Am Coll Cardiol* 75:648
36. Sulas E, Ortu E, Raffo L, Urru M, Tumbarello R, Pani D (2018) Automatic recognition of complete atrioventricular activity in fetal pulsed-wave doppler signals. *Annu Int Conf IEEE Eng Med Biol Soc* 2018:917–920
37. Dong J, Liu S, Liao Y et al (2020) A generic quality control framework for fetal ultrasound cardiac four-chamber planes. *IEEE J Biomed Health Inform* 24(4):931–942

38. Baumgartner CF, Kamnitsas K, Matthew J et al (2017) SonoNet: real-time detection and localisation of fetal standard scan planes in freehand ultrasound. *IEEE Trans Med Imaging* 36 (11):2204–2215
39. Gearhart A, Goto S, Powell A, Deo R (2021) An automated view identification model for pediatric echocardiography using artificial intelligence. In: Abstract oral presentation presented at american heart association scientific sessions
40. He B, Ouyang D, Lopez L, Zou J, Reddy C (2021) Video-based deep learning model for automated assessment of ejection fraction in pediatric patients. *American Heart Association Scientific Sessions*
41. Frick M, Paetsch I, den Harder C et al (2011) Fully automatic geometry planning for cardiac MR imaging and reproducibility of functional cardiac parameters. *J Magn Reson Imaging* 34 (2):457–467
42. Leiner T, Rueckert D, Suinesiaputra A et al (2019) Machine learning in cardiovascular magnetic resonance: basic concepts and applications. *J Cardiovasc Magn Reson* 21(1):61
43. Kustner T, Munoz C, Psenicny A et al (2021) Deep-learning based super-resolution for 3D isotropic coronary MR angiography in less than a minute. *Magn Reson Med* 86(5):2837–2852
44. Steeden JA, Quail M, Gotschy A et al (2020) Rapid whole-heart CMR with single volume super-resolution. *J Cardiovasc Magn Reson* 22(1):56
45. Zhang Q, Burrage MK, Lukaschuk E et al (2021) Toward replacing late gadolinium enhancement with artificial intelligence virtual native enhancement for gadolinium-free cardiovascular magnetic resonance tissue characterization in hypertrophic cardiomyopathy. *Circulation* 144(8):589–599
46. Duan J, Bello G, Schlemper J et al (2019) Automatic 3D bi-ventricular segmentation of cardiac images by a shape-refined multi-task deep learning approach. *IEEE Trans Med Imaging* 38(9):2151–2164
47. Avendi MR, Kheradvar A, Jafarkhani H (2016) A combined deep-learning and deformable-model approach to fully automatic segmentation of the left ventricle in cardiac MRI. *Med Image Anal* 30:108–119
48. Ruijsink B, Puyol-Anton E, Oksuz I et al (2020) Fully automated, quality-controlled cardiac analysis from CMR: validation and large-scale application to characterize cardiac function. *JACC Cardiovasc Imaging* 13(3):684–695
49. Sudlow C, Gallacher J, Allen N et al (2015) UK biobank: an open access resource for identifying the causes of a wide range of complex diseases of middle and old age. *PLoS Med* 12(3):e1001779
50. Winther HB, Hundt C, Schmidt B et al (2018) nu-net: deep learning for generalized biventricular mass and function parameters using multicenter cardiac MRI data. *JACC Cardiovasc Imaging* 11(7):1036–1038
51. Karimi-Bidhendi S, Arafati A, Cheng AL, Wu Y, Kheradvar A, Jafarkhani H (2020) Fullyautomated deeplearning segmentation of pediatric cardiovascular magnetic resonance of patients with complex congenital heart diseases. *J Cardiovasc Magn Reson* 22(1):80
52. Neisius U, El-Rewaify H, Nakamori S, Rodriguez J, Manning WJ, Nezafat R (2019) Radiomic analysis of myocardial native T1 imaging discriminates between hypertensive heart disease and hypertrophic cardiomyopathy. *JACC Cardiovasc Imaging* 12(10):1946–1954
53. Wang J, Yang F, Liu W et al (2020) Radiomic analysis of native T1 mapping images discriminates between MYH7 and MYBPC3-related hypertrophic cardiomyopathy. *J Magn Reson Imaging* 52(6):1714–1721
54. Mancio J, Pashakhanloo F, El-Rewaify H et al (2021) Machine learning phenotyping of scarred myocardium from cine in hypertrophic cardiomyopathy. *Eur Heart J Cardiovasc Imaging*
55. Bello GA, Dawes TJW, Duan J et al (2019) Deep learning cardiac motion analysis for human survival prediction. *Nat Mach Intel* 1:95–104
56. Diller GP, Orwat S, Vahle J et al (2020) Prediction of prognosis in patients with tetralogy of Fallot based on deep learning imaging analysis. *Heart* 106(13):1007–1014

57. Kotu LP, Engan K, Borhani R et al (2015) Cardiac magnetic resonance image-based classification of the risk of arrhythmias in post-myocardial infarction patients. *Artif Intell Med* 64(3):205–215
58. Geng M, Deng Y, Zhao Q et al (2018) Unsupervised/semi-supervised deep learning for low-dose CT enhancement
59. Zreik M, Leiner T, de Vos BD, van Hamersvelt RW, Viergever MA, Isgum I (2016) Automatic segmentation of the left ventricle in cardiac CT tomography using convolutional neural networks. In: Paper presented at international symposium biomedical imaging
60. Mozaffarian D, Benjamin EJ, Go AS (2016) Heart disease and stroke statistics—2016 update. Lippincott Williams and Wilkins Hagerstown
61. Denissen SJ, van der Aalst CM, Vonder M, Oudkerk M, de Koning HJ (2019) Impact of a cardiovascular disease risk screening result on preventive behaviour in asymptomatic participants of the ROBINSICA trial. *Eur J Prev Cardiol* 26(12):1313–1322
62. Moss AJ, Williams MC, Newby DE, Nicol ED (2017) The updated NICE guidelines: cardiac CT as the first-line test for coronary artery disease. *Curr Cardiovasc Imaging Rep* 10(5):15
63. Saraste A, Barbato E, Capodanno D et al (2019) Imaging in ESC clinical guidelines: chronic coronary syndromes. *Eur Heart J Cardiovasc Imaging* 20(11):1187–1197
64. Wolterink JM, Leiner T, de Vos BD, van Hamersvelt RW, Viergever MA, Isgum I (2016) Automatic coronary artery calcium scoring in cardiac CT angiography using paired convolutional neural networks. *Med Image Anal* 34:123–136
65. Lessmann N, van Ginneken B, Zreik M et al (2018) Automatic calcium scoring in low-dose chest CT using deep neural networks with dilated convolutions. *IEEE Trans Med Imaging* 37(2):615–625
66. van Hamersvelt RW, Zreik M, Voskuil M, Viergever MA, Isgum I, Leiner T (2019) Deep learning analysis of left ventricular myocardium in CT angiographic intermediate-degree coronary stenosis improves the diagnostic accuracy for identification of functionally significant stenosis. *Eur Radiol* 29(5):2350–2359
67. Motwani M, Dey D, Berman DS et al (2017) Machine learning for prediction of all-cause mortality in patients with suspected coronary artery disease: a 5-year multicentre prospective registry analysis. *Eur Heart J* 38(7):500–507
68. van Rosendaal AR, Maliakal G, Kolli KK et al (2018) Maximization of the usage of coronary CTA derived plaque information using a machine learning based algorithm to improve risk stratification; insights from the CONFIRM registry. *J Cardiovasc Comput Tomogr* 12(3):204–209
69. Min JK, Berman DS, Budoff MJ et al (2011) Rationale and design of the DeFACTO (determination of fractional flow reserve by anatomic computed tomographic angiography) study. *J Cardiovasc Comput Tomogr* 5(5):301–309
70. Hadamitzky M, Achenbach S, Al-Mallah M et al (2013) Optimized prognostic score for coronary computed tomographic angiography: results from the CONFIRM registry (COronary CT Angiography EvaluationN For Clinical Outcomes: an InteRnational Multicenter Registry). *J Am Coll Cardiol* 62(5):468–476
71. Slomka PJ, Betancur J, Liang JX et al (2020) Rationale and design of the REgistry of fast myocardial perfusion imaging with NExt generation SPECT (REFINE SPECT). *J Nucl Cardiol* 27(3):1010–1021
72. Slomka PJ, Dey D, Sitek A, Motwani M, Berman DS, Germano G (2017) Cardiac imaging: working towards fully-automated machine analysis & interpretation. *Expert Rev Med Devices* 14(3):197–212
73. Betancur J, Commandeur F, Motlagh M et al (2018) Deep learning for prediction of obstructive disease from fast myocardial perfusion SPECT: a multicenter study. *JACC Cardiovasc Imaging* 11(11):1654–1663
74. Nakajima K, Kudo T, Nakata T et al (2017) Diagnostic accuracy of an artificial neural network compared with statistical quantitation of myocardial perfusion images: a Japanese multicenter study. *Eur J Nucl Med Mol Imaging* 44(13):2280–2289

75. Arsanjani R, Dey D, Khachatryan T et al (2015) Prediction of revascularization after myocardial perfusion SPECT by machine learning in a large population. *J Nucl Cardiol* 22 (5):877–884
76. Arsanjani R, Xu Y, Dey D et al (2013) Improved accuracy of myocardial perfusion SPECT for the detection of coronary artery disease using a support vector machine algorithm. *J Nucl Med* 54(4):549–555
77. Haro Alonso D, Wernick MN, Yang Y, Germano G, Berman DS, Slomka P (2019) Prediction of cardiac death after adenosine myocardial perfusion SPECT based on machine learning. *J Nucl Cardiol* 26(5):1746–1754
78. Singh A, Sengupta S, Lakshminarayanan V (2020) Explainable deep learning models in medical image analysis. *J Imaging* 6(6)
79. Holzinger a BC, Pattichis C, Kell D (2017) What do we need to build explainable AI systems for the medical Domain?
80. Hazarika S, Biswas A, Shen HW (2018) Uncertainty visualization using copula-based analysis in mixed distribution models. *IEEE Trans Vis Comput Graph* 24(1):934–943
81. Keane PA, Topol EJ (2018) With an eye to AI and autonomous diagnosis. *NPJ Digit Med* 1:40
82. Puyol-Anton E, Ruijsink B, Mariscal Harana J, Piechnik SK, Neubauer S, Petersen SE (2021) Fairness in cardiac magnetic resonance imaging: assessing sex and racial bias in deep learning-based segmentation
83. Tao Q, Yan W, Wang Y et al (2019) Deep learning-based method for fully automatic quantification of left ventricle function from cine MR images: a multivendor, multicenter study. *Radiology* 290(1):81–88



Charitha D. Reddy-MD Clinical Assistant Professor, Department of Pediatrics, Division of Pediatric Cardiology at Stanford University, Lucile Packard Children's Hospital. Director of Pediatric Cardiology IS Innovations. For further information <https://profiles.stanford.edu/charitha-reddy?tab=bio>.



Artificial Intelligence and Big Data for COVID-19 Diagnosis

Houneida Sakly , Ahmed A. Al-Sayed, Mourad Said, Chawki Loussaief, Jayne Seekins, and Rachid Sakly

Machine learning can help process medical data and give medical professionals important insights, improving health outcomes and patient experiences. (IBM)

H. Sakly (✉)

COSMOS Laboratory, National School of Computer Sciences (ENSI), University of Manouba, Manouba, Tunisia

e-mail: houneida.sakly@esiee.fr

A. A. Al-Sayed

University of California, San Francisco, Berkeley, USA

e-mail: ahmed_alsayed@berkeley.edu

M. Said

Radiology and Medical Imaging Unit, International Center Carthage Medical, Monastir, Tunisia

e-mail: mouradsaid@yahoo.fr

C. Loussaief · R. Sakly

Higher School of Health Sciences and Techniques, Monastir, Tunisia

e-mail: prchawkiloussaief@gmail.com

R. Sakly

e-mail: rchid.esstsm@gmail.com

J. Seekins

Department of Radiology, Stanford Medicine, Palo Alto, USA

e-mail: jseekins@stanford.edu

1 Introduction

The World Health Organization (WHO) recently designated coronavirus disease 2019 (COVID-19) as an infectious pandemic.¹ Since the beginning of the epidemic, there have been over 243 million confirmed infections and over 4.9 million fatalities. Because of the rapid spread of the disease, most health institutions and hospitals are unprepared to deal with the influx of cases. With a 2–14 day incubation period, the severe acute respiratory syndrome coronavirus 2 (SARS-CoV2) is said to spread by tiny droplets and perhaps aerosols [1, 2]. COVID-19 positive persons may have symptoms such as fever, dry cough, bodily aches, shortness of breath, lack of taste and smell, sore throat, and diarrhea [3]. With such readily misconstrued symptoms and the danger of negative repercussions from a misdiagnosis, effective viral infection detection is one of the top objectives of medical organizations. Artificial Intelligence (AI) diagnostic models might relieve the burden on healthcare staff, allowing them to devote more time to patient care and vaccine research. It is vital to recognize the presence of infection early in order to provide treatment and save lives. According to a survey, symptoms may begin with a simple cold and progress to life-threatening pneumonia [4, 5]. The most prevalent form of diagnostic test is reverse transcription-polymerase chain reaction (RT-PCR) evaluation for the detection of viruses via pharyngeal swabs or blood samples. With an accuracy range of 81–96%, RT-PCR can deliver results in as little as a few hours up to two days. These tests, on the other hand, are unable to assess the degree of contamination, and their accuracy is contingent on the strength of the viral strain. Differentiating between coronavirus infections and other infections is a vital step toward appropriate diagnosis [6].

Positive individuals typically exhibit bilateral diffuse patchy opacities with some bibasilar sparing on chest X-ray images, which can assist in the diagnosis of the condition. Irritation of the lungs, and lymph adenopathy are salient features on computed tomography (CT) scans of COVID-19 patients. Lungs involvement shows a patterned dissemination of opacities (interlobular septal thickening layered on ground-glass opacities) [7]. The prime goal of evaluating the density of these patterns is to provide a truthful diagnosis, regulate the sternness of the ailment, and offer prognosis advice. Artificial intelligence (AI) performance for detecting infections and associated radiological characteristics from medical imaging, such as chest X-rays and CT scans, has proven to be beneficial in making truthful diagnoses [8, 9]. Machine learning and deep learning may be used to solve COVID-19 identification and segmentation difficulties in a number of different ways. Medical imaging analysis aided by AI offers great potential as a primary diagnostic tool for COVID-19 detection [10, 11]. The first step in the diagnosis is to identify deep features that may be used to detect COVID-19 radiological patterns on chest X-ray and CT scans. Machine learning-based prediction techniques have the potential to be used in prognostic analyses. As a result, several studies have employed algorithms such as Support Vector Machine (SVM) and Random Forests to provide critical

¹ <https://www.who.int/emergencies/diseases/novel-coronavirus-2019/situation-reports>.

insight into coronavirus infection prediction and diagnosis [12, 4]. By automating the COVID-19 diagnostic selection procedure, these automation technologies help ease the burden on healthcare workers. Early identification of infection can save time by allowing treatment to begin, while the disease is still mild, reducing the chance of consequences. The consequences of a misdiagnosis pose a major risk to the patient and can even be fatal. Automated systems face a number of challenges because of the enormous amount and velocity of data. Data cleaning and processing becomes a huge difficulty with such a large intake of cases, especially when high-resolution images are required. A consistent nursing and remote detection method for people will help in the wild trailing of suspected COVID-19 cases. Furthermore, the usage of such systems would generate a vast amount of data, presenting various opportunities for big data analytics tools to improve healthcare service quality [13, 14]. The Six V's [15] are a set of essential qualities of big data, which include value, volume, velocity, variety, veracity, and variability. The inventive definition of big data essential qualities, however, only considers three Vs: volume, velocity, and variety [16]. Big data analytics technologies are considered critical for gaining the knowledge needed to make judgments and take preventive steps [17]. As the large amount of available data on COVID-19 comes from various sources, it will be crucial to review the protagonists of big data analysis in governing COVID-19, as well as a promoter insight of the main contests and main uses of COVID-19 data prevention, as well as a number of correlated current frameworks with the goal of COVID-19 breakdown [18]. COVID-19 has been proven to benefit from big data in the battle against infectious illnesses. To combat the COVID-19 pandemic, big data may hold many intriguing possibilities. When big data is integrated with AI analytics, it helps researchers better understand the COVID-19 outbreak, viral structure, illness treatment, and vaccine manufacturing [19–21]. For instance, complex simulation models based on coronavirus data streams may be created using big data and powerful AI-based techniques to anticipate epidemics. This would allow health agencies to follow the coronavirus's progress and better plan preventative actions [31]. Because of their data aggregation capabilities, which allow them to use huge volumes of data for early detection, big data models can also assist in predicting the COVID-19 epidemic in the future. Furthermore, big data analytics as a diversity of medical sources, such as infected patients, can support the implementation of large-scale COVID-19 research and the creation of high-reliability treatment techniques [22–24].

2 COVID-19 Therapy and Health Informatics: Promises and Challenges

The worldwide health care community continues to grow to the defiance of the coronavirus complaint 2019 (COVID-19) epidemic, from combat zone caregivers to information processing experts. Clinical informatics is dependent on the relinquishment of specialized backing, which is critical for optimizing COVID-19

epidemic clinical operations. The requirement to produce a “new normal” for safe and operative care for all cases urged major advancements in data use, including the use of big data for exploration because traditional time-long studies were no longer an option, prophetic logical functionality retooled to assist prognosticate COVID-19, supersonic deployment of test attempts and trials of new drugs, development and implementation of innovative telemedicine care models, and the exponential expansion of the information technology system [25]. Loosening laws, encouraging cooperative practice between health systems and their merchandisers, and a worldwide need for answers created the ideal early slush for invention to sow at snappy rates. By keeping up with diurnal non-supervisory changes to offering day-to-day help to a tired bedside clinician, informaticists play a crucial part in a successful epidemic response strategy. Informatics are about fostering invention and advancing health care in the information age. As the new coronavirus spread throughout China and the world, informatics passed a DNA transformation to help frontline icons and discover a way to annihilate the contagion [26]. The Marvel X-Men™ conception, in which fictional characters’ transformation into icons is backed by hyper-accelerated inheritable mutation, is a good starting point for allowing the tremendous hops in informatics necessary to respond to COVID-19. Like numerous grand narratives, the speeding up of growth creates opponents as well as protagonists. The villains began as well-known data-related issues, such as a lack of an initial dataset for nursing evaluation and interventions or a lack of ICD-10 canons to register a new hazard complaint, but the pandemic quickly transformed them into major hurdles to finding answers [27, 28]. Informatics is much more than flow charts in an electronic health record (EHR). Experts in health informatics who work within a medical system handle a variety of data-related procedures in order to assist doctors in patient care. Architecting, locating the right seller, carrying backing, assuring nonsupervisory compliance, and establishing a structure similar to servers or interfaces can take months or times [29, 30]. A benchmark for classifying IT informatics solutions of the numerous activities elaborated in public health planning, replies, and retrieval was established based on this abstract model (Fig. 2). Indeed, seemingly basic procedures such as confirming that the EHR supports a new business strategy can take hundreds of hours to develop, test, educate, implement, and track compliance or effectiveness [31]. On the clinical side, IT infrastructure must be expanded to enable an increase in telehealth usage. To help preserve physician resources during a surge, all emergency departments were given the option of telehealth consultations for qualified patients who presented during the surge. The registration/check-in process now includes questions about travel and symptom screening (Fig. 1). All paperwork had to be completed in all patients treated for acute and elective treatment across the hospital and screened using the EHR by front desk personnel.

In care settings, interviews generated a predictive alert with clinical decision support to provide a suitable track for following clinical treatment, including any testing or isolation orders required, and front-line employees followed a uniform screening “script” using EHR templates as needed [26, 32].

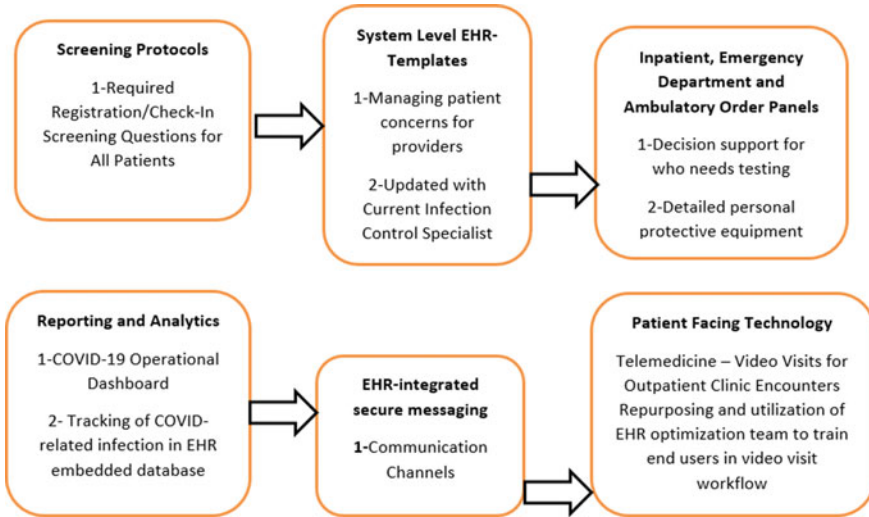

Fig. 1 Tools for managing a pandemic

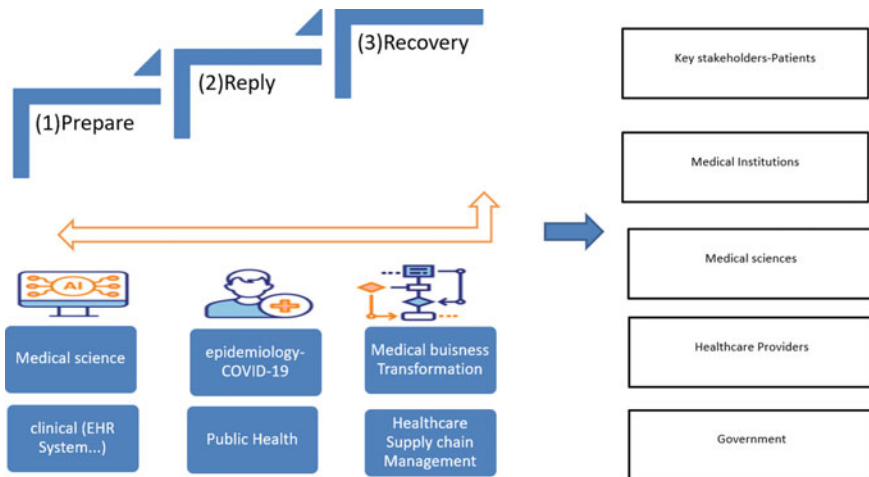

Fig. 2 Framework involved in preparing for, reacting to, and recovering from severe public health risks

At the time of ordering, clinical decision support in the form of screening criteria, specimen collection instructions, the requirement of defending equipment, and test result turnaround time estimates for simple assessment were supplied. The COVID-19 orders asked the ordering practitioner to answer a series of questions on the patient’s compliance with the testing requirements.

Our build structure allowed for fast adjustments to maintain the system in line with operational expectations because screening criteria and lab handling processes often changed after the first deployment. Our occupational health department used

COVID-19 ordering practices similar to avert infections. When it comes to IT resources, there are always conflicting priorities. A crisis, such as an emerging disease danger, is necessary to bring all stakeholders together to work toward a common objective. Each category includes a variety of informatics and technology solutions that can be used at different stages of a major health problem [33]. Furthermore, each sector is influenced by a certain stakeholder group. It should be noted that the project's finance and implementation may include a large number of parties. Each category has a wide range of informatics and technology solutions that can be applied at various stages of a serious health issue [34, 35].

Clinicians in various system institutions may manage in different areas where caretakers are required, either due to universal access security requirements; they may only travel inside their own hospital or to another hospital system [36]. Personnel from surgical and procedural sectors, as well as affiliated surgery centers and clinics, were given access as part of an all-hands-on-deck plan to successfully staffing in a significant surge situation. This information is now available to respiratory therapists, pharmacists, physical therapists, and others who interact directly with patients [37]. Non-bedside clinicians, such as nurse auditors, administrative function clinicians, and IT clinicians, are also provided access. From a compliance viewpoint, lowered constraints are required for this type of access to be possible. Reports on access availability monitoring have been utilized to assist in preventing misuse [38]. Big data is being utilized in the EHR to train predictive analytic (PA) algorithms to alleviate the cognitive burden on overworked doctors. The team created a sepsis/infection risk PA tool to detect inpatients with COVID-19 symptoms after an initial emerging disease screening on arrival. When a patient is at danger for COVID, the EHR alerts clinicians, allowing the patient to be evacuated, evaluated, and treated as needed while also ensuring the safety of the crew [39]. To stay current with CDC standards, the emerging disease screen (EDS) is updated on a regular basis. Many aspects of clinical decision support (CDS) are powered by EDS, which allows busy physicians when a patient tests positive for COVID or other developmental illnesses [40]. On the clinical side, IT infrastructure must be expanded to enable an increase in telehealth usage. To help preserve physician resources during a surge, all emergency departments were given the option of telehealth consultations for qualified patients who presented during the surge. On the clinical side, IT infrastructure must be expanded to enable an increase in telehealth usage. To help preserve physician resources during a surge in demand, all emergency departments were offered the option of performing telehealth consultations for approved patients [41, 42].

3 COVID-19 Infrastructures and Technological Solutions

The epidemic has generated a rush of interest in initiatives that would utilize cutting-edge technology to mitigate COVID-19's influence on our lives. To combat the coronavirus pandemic, a number of technological advances and applications

have been developed. Technology development, design, and use were all affected by the epidemic. It is critical to have a better understanding of the role that information systems and technology researchers may play in combating this global crisis [43]. The rapid adoption of telemedicine in response to the coronavirus threat reminds us that digital technologies may help with pandemic management and reduce risks both during and after the pandemic [44]. Many IT workers are helping to battle the outbreak in a variety of ways, including developing anti-virus software, tracking and forecasting the disease's growth, and protecting hospitals from cyberattacks [45]. The pandemic has consequences for manipulating information systems and implementation based on IT technology infrastructure. Researchers and practitioners in the fields of information systems and technology may assist with the analysis of COVID-19 pandemic data, such as the rate of interest in a prospective new promoter axis [44, 46].

Adapting, coping, and halting the information crisis were characterized as reforming organizations by improving crisis-driven agility and minimizing crisis-revealed fragility [47]. COVID-19's significant challenges should be assessed from the perspective of information systems and technology, with implications for further research and recommendations on COVID-19's influence on information management. It is impossible to overestimate the role of information systems and technology in civilization [48]. The pandemic of COVID-19 has emphasized the urgent need to shift the public health system from reactive to proactive, as well as to develop technology that provides restructured data for proactive decision-making. COVID-19 is unique among chronic illnesses in that it is extremely infectious, may be transmitted from person to person, and has a high mortality rate. Furthermore, since COVID-19 is a novel illness, scientific knowledge of the virus that causes it, as well as medical treatments and government and organization responses, are still in the early stages of development. COVID-19's impact on individuals and society is growing unanticipated. Because of the present pandemic situation and its ramifications, combating the COVID-19 pandemic necessitates extensive coordination of various factors [49–51].

To combat this problem, new technological solutions, such as mobile tracing COVID-19 and chatbots, have recently been exploited. These technologies may assist individuals, businesses, and society in dealing with the repercussions of the coronavirus pandemic. New technologies can aid in the detection of community-wide coronavirus propagation, monitoring of infected people's health, and treatment of COVID-19 patients [52, 53]. Machine learning, image recognition, and deep learning algorithms are examples of AI-based technologies that may be used to enable faster drug discovery and development of new therapies, as well as for early detection and diagnosis of infection [54]. A few businesses have also adopted AI systems created for other purposes to help with social distance enforcement and contract tracking [55]. During the COVID-19 outbreak, emergency 3D-printing of therapeutic items was proposed as a feasible method to alleviate shortages. In the field of crisis management, medical manufacturing and IT equipment within hospitals have been explored. Experts in health and additive manufacturing technology are anticipating this shift, but legislative reforms will be

required. A 3D-printed medical case study item developed during the COVID-19 epidemic offers the design and manufacture of a suture guide for heart surgery [56].

In the field of health, big data (or massive data) corresponds to all socio-demographic and health data available from different sources that collect data for various reasons. The use of these data has many advantages for COVID-19: identification of disease risk factors, aid in diagnosis, choice and monitoring of the effectiveness of treatments, pharmacovigilance, and epidemiology. Nevertheless, this raises many technical challenges and human beings and poses many ethical questions [57]. These standards have made it easier for hospitals and healthcare organizations to gather all of the data acquired for Covid-19 into biomedical data warehouses, which researchers can query through online interfaces. Many research groups now use integrated systems to link databases and aggregate data from cohorts.

As the number of mobile applications is constantly growing, it is advisable to integrate them into the e-health quality process, that is, to test them internally using the practices and tools made available to experts. The coronavirus pandemic has shaken for the medical industry, which has proven extremely resilient, that of mobile applications. With the massive use of telecommuting, the installation of professional applications for monitoring and trapping covid-19 has increased considerably, assuming you have been diagnosed with a COVID-19-related illness. In this case, health officials may be able to use the technology to track down any mobile application in the case of a suspected case [58]. The current COVID-19 epidemic has shattered provincial, radical, intellectual, spiritual, social, and educational barriers worldwide. An Internet of Things (IoT) equipped healthcare system is useful for effective monitoring of COVID-19 patients because it uses a linked network. This technology contributes to increasing patient satisfaction and decreasing readmission rates to hospitals. The use of the Internet of Things has a favorable impact on the healthcare expenses and treatment outcomes of infected patients. As a result, the goal of this research is to investigate, evaluate, and highlight the diverse applications of the well-known IoT idea, as well as to create a road map for dealing with them [59, 60]. Blockchain technology has been employed in the fight against COVID-19 to overcome the problems and trust concerns that arise with safeguarding privacy and fulfilling public health goals, such as tracking infected persons. Blockchain based on distributed ledgers is a type of digital ledger that records online medical encrypted transactions that use a consensus technique to operate. To support the fight against the coronavirus epidemic, a solution based on mHealth, blockchain technology, and AI was created [61, 62]. The technologies listed in Table 1 require data, people, and systems to be integrated and classified based on their primary focus and initial design intent for practical use. Data-centric technologies such as machine learning/deep learning, big data analytics, IoT, and blockchain are being utilized to combat COVID-19.

Table 1 Notes of COVID-19 technological solutions

Technologies	COVID-19 solutions examples	Sample	Tools—frameworks
Machine learning/deep learning	An explainable AI COVID-19 evaluation and lesion characterization from CT images using an automated method [63]	166 CT scans	http://perceivelab.com/covid-ai
	For stock price movement prediction, COVID-19 used a hybrid and parallel deep information fusion methodology [64]	Twitter data with extended horizon market data	COVID19-HPSMP framework
	COVID-19 classification and lesion localization from chest CT using a weakly-supervised framework [65]	3D CT volumes for COVID-19	https://github.com/sydney0zq/covid-19-detection
Big data	Deep features and SVM to classify images [66]	2138 images	Deep visual words (BoDVW)
	Researchers and decision-makers are paying more attention to technological advancements and big data analytics approaches for evaluating large quantities and types of data [67]	COVID statistics: https://covid.ourworldindata.org/data/owid-covid-data.xlsx , Google. 2020. Mobility data. https://www.google.com/covid19/mobility	Big data analytics techniques
	COVID-19 is being tracked utilizing big data and big technologies via a digital Pandora’s box [68]	The NHS is collaborating with a various of big tech companies, including Google, Amazon, and data-processing firm Palantir, to create a common data platform to aid with COVID-19 monitoring	Pandora’s box
IOT	Testing and tracking of IoT-COVID-19 can assist to limit the virus’s transmission, which is critical in the fight against the pandemic [69]	5000 subjects	IoT-enabled HVAC systems, sensor data integration for context-awareness

(continued)

Table 1 (continued)

Technologies	COVID-19 solutions examples	Sample	Tools—frameworks
	The AIoT was used in the COVID-19 pandemic prevention and control [70]	Data collected from GPS location	AI + IoT (AIoT), 5G
	CIoTVID: COVID-19: towards an open IoT-platform for infectious pandemic diseases [71]	The NGSI protocol was established by the open mobile alliance (OMA) to deal with context information. The FIWARE IoT agent, which supports MQTT and lightweight M2M protocols, will next process the data. FIWARE is an open-source platform for controlling internet of things (IoT) systems. In FIWARE, the OMA NGSI interface is a RESTful API that can be accessed over HTTP (https://knowage.readthedocs.io/en/6.1.1/user/NGSI/README/index.html)	CIoTVID platform
Blockchain	COVID-19 blockchain uses in health care [72]	A total of 85,375 articles were reviewed, with 415 full-length papers (37 of which were connected to COVID-19 and 378 which were not)	Ethereum and hyperledger platform
	Process claims and issue buyouts; develop a “digital identity” for healthy persons [73]	COVID-19 related health data	“Immunity certificates” or “immunity licenses”
Robotic applications	Robot-assisted surgery for gynecological cancer was employed during the COVID-19 outbreak [74]	Healthcare providers	Disposable surgical hat, medical protective mask (FFP3) with goggles/visor, work uniform, disposable latex gloves)
	Using four robotic arms to perform Senhance [®] robotic surgery at COVID-19 may reduce the risk of coronavirus infection among medical staff [75]	To date, our hospital has done 100 different types of gynaecological surgeries, 10 of which were performed utilizing four robotic arms	Senhance [®] robotic platform “ https://www.senhance.com ”

(continued)

Table 1 (continued)

Technologies	COVID-19 solutions examples	Sample	Tools—frameworks
3D printing	The effect of 3D printing on patient education, diagnosis, and treatment in medicine [76]	Copper3D NanoHack mask model, Lowell Makes mask design, and open-source non-adjustable venturi valve design, early reusable Prusa research 3D	Materialise “ https://www.materialise.com/en ”
	COVID-19-related supply shortages can be addressed using 3D printing technology [77]	N95 respirators masks with CAD format, Ventilator valves,	COVID-19 Specimen Collection Kit
	As part of a pandemic printing initiative, a new 3D-printed swab for detecting SARS-CoV-2 has been produced [78]	The study experiment included nasal swabs manufactured in 3D, 50 hospital staff who attended a COVID-19 clinic processing, and 2 patients with laboratory-confirmed COVID-19	3DMEDiTech “ https://www.3dmeditech.com ”
Mobile application	Smartphone applications for corona virus disease 2019 (COVID-19) and a quality assessment using the mobile application rating scale (MARS) [79]	18 apps were created to share up-to-date COVID-19 information, and 8 were used for contact tracing	PRISMA—mobile app
	Examine and rank the contents and features of the COVID-19 mobile applications [80]	223 COVID-19-related mobile apps, 28 in the play store	Both the android play store and the iOS app store include mHealth applications
	COVID-19, mobile health, and significant mental illness are all issues that need to be addressed [81]	With serious mental illnesses (SMI) patients	Mobile mental health

4 The Post-COVID-19 Era and e-Health

The use of the Internet for healthcare delivery is referred to as electronic health (e-Health), sometimes known as cybermedicine. Telemedicine, telesurgery, telerehabilitation, teledentistry, and ePrescribing are only a few options available [82]. Certain developments in healthcare delivery worldwide have been hastened by the epidemic. As many governments across the world struggle to curb the outbreak,

eHealth has become increasingly important. While eHealth services are not new, their acceptance by many healthcare organizations throughout the world has been examined, and regulations controlling their use have been devised to speed up their deployment. eHealth has become a requirement to maximize resources, partly due to the logistical and financial demands of the COVID-19 epidemic [83].

The rate of adoption varies because of the variances in pre-existing infrastructure between countries. Ironically, while eHealth is a critical resource for delivering healthcare to places with limited access to healthcare services, the same areas frequently lack access to the requirements for eHealth. Electricity and Internet access are not commonly available in low- and middle-income nations. Furthermore, the current economic situation makes it more difficult to utilize workaround solutions to these issues, exacerbating the problem of access [84]. Even when sufficient motivation exists, eHealth is not only a distant priority, but also a costly luxury in many countries, which ironically contributes to healthcare disparity.

Beyond infrastructure and financing, the discussion of eHealth encompasses a wide range of issues. Data privacy is still a major concern and a barrier to adoption in many wealthy countries. Despite being partly helpful during the epidemic, public anxieties persist that eHealth solutions will establish a permanent governmental monitoring system. As a result, government mandates may have a negative impact on the public adoption and usage of accessible eHealth technologies [85]. Thus, citizens must be involved in policymaking. They must be informed of the shifting scene as stakeholders in continuing innovation. Individual freedoms and common goods must be carefully balanced. This delicate balancing act is critical for government preparedness for the next pandemic, which will undoubtedly occur.

Another significant challenge confronting eHealth is end-user digital literacy. While continual technical improvements make the implementation of digital solutions simpler, they may also increase the difference between those who are digitally savvy and those who are not, producing even more inequality [86]. The degree to which digital technologies are used limits the utilitarian gains that drive eHealth solutions. Digital solutions should be made as simple to use as feasible while retaining a high level of cybersecurity and data protection. Communication portals, in particular, should not be difficult to set up and should make use of existing consumer technologies, such as PCs and mobile phones.

Despite the hurdles, eHealth will continue to flourish in the post-COVID age. Although each nation and location has a unique set of issues, worldwide legislation and actions have mostly favored eHealth. As previously stated, the pandemic has accelerated the global trend toward the adoption of a plethora of digital health solutions that fall under the eHealth banner. In the post-pandemic world, many of these are still applicable [87]. Such technology solutions would undoubtedly be beneficial in integrating disparate healthcare systems and perhaps lowering ever-increasing healthcare expenses.

5 Medical Digital Transformation by the COVID-19 Pandemic

The COVID-19 pandemic served as a stimulus for the digital transformation of the healthcare industry. Opportunities to provide healthcare appeared in the middle of the pandemic's social, economic, and regulatory uncertainties. Virtual outpatient visits have increased by 50–175 times in the United States, according to healthcare professionals. Telehealth use surged 38 times since the beginning of the outbreak. According to McKinsey and Company, virtual care might account for up to \$250 billion in US healthcare spending. According to their findings, Telehealth is currently used by 46% of patients to replace canceled in-person appointments, up from 11% in 2019. A similar upward trend was observed among healthcare providers, with 57% seeing telehealth in a more positive light than before the pandemic and 64% indicating that they are more comfortable using virtual solutions for healthcare delivery.

Virtual urgent care, virtual office visits, close virtual workplace visits, home health services, and tech-enabled medical supervision were highlighted as the major paths that might have the most effect. It is predicted that by using these channels to move to virtual delivery, 20% of all emergency department visits may be avoided, 24% of office visits could be virtualized, and another 9% could be managed remotely. Furthermore, virtual home health services with technology-enabled medicine administration might account for 2% of all outpatient volumes, and virtual home health attendant services could account for 35% of normal home health attendant services. However, to fully achieve the promise of delivering healthcare electronically, two key components must be prioritized: providing the correct treatment in the right location and providing a positive patient experience.

The shift to reimbursement based on outcomes as opposed to volume of service necessitates that patient must be cared for in the most appropriate setting. This means that patient populations must be segregated based on their clinical condition and based on their need for specialties with remote interactions that might be scaled up using home-based diagnostics and equipment. In addition, virtual healthcare delivery requires the development of provider competencies and the creation of incentives. Health systems must construct a sturdy infrastructure. Telehealth technology needs to be integrated with electronic health records, clinical protocols for appropriate telehealth visits must be defined, and hospital and physician practice processes must be revamped to support virtual care. Finally, measurable clinical outcomes must be tracked to quantify the value of virtual care [88, 89].

The pandemic response has forced many consumer service providers to digitize their services and offerings [88]. Limiting the spread of the virus was the aim, and convenience was the by-product. As such, patient experience, just as customer experience, is paramount for virtual healthcare delivery. Patient expectations of ease of use and equal effectiveness must be honored. Many healthcare systems have implemented “digital front-door services”. Digital front doors have arisen as a patient engagement buzzword in recent years. In its most basic definition, it refers to the digital means of scheduling appointments, finding and interacting with

healthcare providers, renewing medications, paying bills, and navigating the healthcare system among other services. Many healthcare systems have adopted these digital front-door services, but they remain crude. Therefore, these services will continue to improve [89].

6 Artificial Intelligence (AI) and Supply IT Infrastructure During COVID-19

With a few exceptions, most of the AI literature on COVID-19 detection is in the deep learning field. I have examined machine learning methods. Fully automated deep learning algorithms learn feature extraction directly from image data. In medical image processing, CNNs for deep feature representation and classification have demonstrated great performance, and they perform extremely well in the COVID-19 detection challenge. The ability of clinicians to diagnose patients is greatly aided by their knowledge of essential traits and patterns gained from data.

Deep neural networks are a type of learning system that layers several neuronal nodes on top of the other. They are gradient-based learners, meaning that their parameters vary in response to the model's classification/segmentation mistake. This involves employing stratified-class sampling to build up the model training, modifying the calculation of the learning rate over epochs, and performing a hyper-parameter has made significant progress in healthcare automation by providing for a variety of design alternatives that may be adjusted for significant features. Because of the computational capabilities of graphics processing units (GPUs) and distributed computing models, the proposed deep learning architectures can be taught and evaluated in clinical routine. Several studies have investigated a variety of CNN approaches, ML classifiers on deep features, capsule networks, CNN, and other methods for COVID-19 detection. This section examines a number of cutting-edge AI-based COVID-19 detection techniques. Table 2 summarizes the various classification and segmentation methods.

6.1 Classification for COVID-19

Various COVID-19 categorization research methods have been thoroughly examined. For the COVID-19 identification task, these investigations used two primary imaging modalities (chest X-ray/CT). The key takeaways from these books have been extensively examined. Chest X-ray images are considered the most reachable modality for diagnosing COVID-19 in the AI literature. The following are the several types of X-ray detection techniques: Transfer learning techniques [110–112], customized deep architectures [113–115], capsule networks and sequential CNN [116, 117], semi-supervised GAN techniques [118, 119], deep feature extraction and image processing techniques [120, 121], and CAD methodologies

Table 2 Overview of classification and segmentation methods

Techniques	Modality	Methodology	Library-API	Database
<i>Classification</i>				
Fine tuning/multi-class classification [90]	Chest X-ray	COVID-ResNet	rishav1122/Covid-ResNet	COVIDx (COVIDx CRX-2), “ https://github.com/rishav1122/Covid-ResNet ”
Cough acoustics diagnosis of COVID-19 [91]	Sound recordings	ConvNets and data augmentation	Saranga7/covid19-cough-diagnosis	DiCOVA “ https://github.com/Saranga7/covid19-cough-diagnosis ”
COVID-19 identification and diagnosis using a deep neural network [92]	X-ray	CoroNet	Keras, Tensorflow	Images of radiology from a variety of reliable sources (radiological society of North America (RSNA), “ https://github.com/drkhan107/CoroNet ”
COVID-19 detection using a channel-shuffled dual-branched CNN architecture [93]	Chest X-rays	CNN	PyTorch	A set of 558 COVID-19
Keep track of COVID-19 positive patients’ development [94]	Chest X-rays	Transfer learning	Python	“ https://github.com/feeee8023/covid-chestxray-dataset ”
COVID-19 disease infected patients: a deep bidirectional classification model [95]	CT	MADE-DBM model classification	MATLAB 2018b	Benchmark COVID-19 datasets
Unsupervised COVID-19 image clustering using a self-organizing feature map [96]	Chest X-ray	SOFM network	Python, OpenCV	https://github.com/king2b3/SOFM
Automated COVID-19 identification based on deep transfer learning [97]	CT	Deep transfer learning and data augmentation	MATLAB 2019a	349 positive COVID-19 CT scans from 216 individuals, as well as 397 non-COVID CT images
COVID R-CNN: a new framework for diagnosing novel coronavirus disease [98]	X-Ray	R-CNN	TensorFlow	5450 sample images

(continued)

Table 2 (continued)

Techniques	Modality	Methodology	Library-API	Database
COVID-19; contrastive cross-site learning with a redesigned net [99]	CT	Redesigned net	PyTorch	2482 CT scans were taken from 120 people, 1252 of whom tested positive for COVID-19 and 1230 of whom tested negative for COVID but had other signs of lung illness
<i>Segmentation</i>				
A hybrid COVID-19 detection model using a ranking-based diversity reduction strategy and an improved marine predators algorithm [100]	X-ray	A new algorithm for marine predators and a ranking-based diversity reduction	FADs algorithm	" https://github.com/feee8023/covid-chestxray-dataset "
A noise-resilient framework for automatic COVID-19 pneumonia lesion segmentation [101]	CT	(COPL-Net), 2D CNNs	Adaptive self-ensembling CNN	" https://github.com/HILab-giti/COPL-Net "
Inf-Net: automatic COVID-19 lung infection [102]	CT	Semi-Inf-Net + multi-class	PyTorch	" https://github.com/DengPingFan/Inf-Net "
Lung infection segmentation for COVID-19 pneumonia [103]	CT	Cascade convolutional network from	Python	" https://github.com/UCSD-A14H/COVID-CT "
In a quantitative analytic pipeline, evaluate the effect of lung segmentation accuracy [104]	CT	CNN	3D slicer 4.10.2 (https://www.slicer.org), Python U-Net	55 COVID-19 patients, " https://github.com/acil-bwh/ChestImagingPlatform/blob/develop/cip_python/dcnm/projects/lung_segmenter/lung_segmenter_dcnm.py "

(continued)

Table 2 (continued)

Techniques	Modality	Methodology	Library-API	Database
COVID-19 CT image segmentation using a fuzzy entropy-based improved marine predators algorithm for multi-level thresholding [105]	CT	For multi-level thresholding, a marine predators algorithm with fuzzy entropy is used	Matlab 2021a	13 COVID-19 patients
Diagnosis of COVID-19 using four-region lung segmentation based on deep learning [106]	Chest radiography	EfficientNet v0 and v	TensorFlow	“ https://github.com/younggon2/Research-Segmentation-Lung-CXR-COVID19 ”
Explainable artificial intelligence for the prognosis and COVID-19 lung segmentation [107]	Chest X-ray	U-Net CNN	Python	“ https://github.com/lucasxteixeira/covid19-segmentation-paper ”
COVID-19 lung infection: automated chest CT image segmentation [108]	Chest CT	3D U-Net	TensorFlow	“ https://github.com/frankramer-lab/covid19-MISenn ”
Assessment of semantic segmentation based in encoder-decoder pairs using COVID-19 CT’s in the dark [109]	CT	Encoder-decoder pairs	Pytorch	“ https://github.com/vri-ufpr/sparkinthedarklars2021 ”

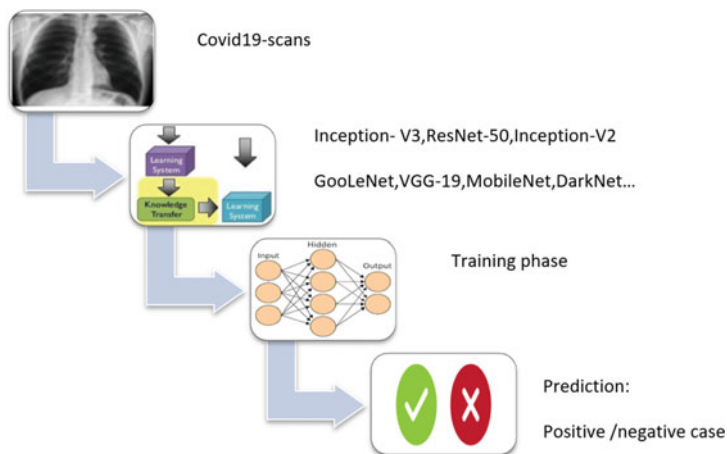

Fig. 3 Transfer learning process

and optimization algorithms [122, 123]. As shown in Fig. 3, transfer learning models apply prior experience-based knowledge to the dataset by altering or adding specialized layers to match the dataset.

In the CNN-sponsored COVID-19 study, this topic attracted a lot of attention. This field includes VGG networks, Residual networks, Inception, Xception CNNs, and a combination of architectures. Because of its ability to avoid the vanishing gradient problem, residual learning was a popular design paradigm in most CNN projects. To help in the diagnosis of COVID-19 chest X-rays, a multi-channel pre-trained ResNet architecture was presented [124]. Following that, three ResNet-based models were retrained one by one to categorize X-rays. A various method that includes pre-processing, augmentation, and crucial steps to implement transfer learning model was used to compare several networks [125]. The first stage used different ResNet topologies to recover viral pneumonia features from other pneumonia, whereas the second stage used different ResNet topologies to gain COVID from other viral pneumonia. A concatenation-based arrangement of transfer learning models was another sort of combination [126].

Deep features were extracted using the combined ResNet50V2 and Xception models to improve the classification based on feature vectors. The pretrained ResNet50 and InceptionV3 transfer learning architectures were employed with logistic regression to detect COVID-19 in a similar study [127].

Since COVID-19 has been related to airspace opacities in X-rays, the Resnet-based CNN is being used to train the task of identifying airspace opacities in chest X-rays [128]. The performance of multiple transfer learning CNNs has been compared in several different studies. For example, Minaee et al. used a custom-constructed dataset to report findings for four alternative architectures: ResNet18, ResNet50, SqueezeNet, and DenseNet-121 [89]. The performance of inception and Xception networks has been compared in several studies. Xception,

ResNet50, MobileNet, and Inception V3 were used to create a “recommendation network” that included four pre-trained architectures [129]. Pre-trained deep-learning models for recognizing COVID-19 or normal X-ray images (DenseNet121, ResNet50, VGG16, and VGG19) have also been reported. ResNet, VGG16, Xception, and Inception networks, as well as modified ResNet, VGG16, Xception, and Inception networks, were adapted for COVID-19 classification. The Xception net architecture was used to construct transfer learning models to correctly identify COVID-19 from chest X-rays. A multimodal classification model with enriched input data was published and tested on eight different transfer learning architectures. Transfer knowledge from previous designs, such as the DarkNet model, which started with fewer layers and filters and subsequently increased them depending on trial results [130]. Unlike current CNN architectures, customized CNN architectures are expressly created for classification applications [131]. The class decomposition technique is used for invention-scan irregularities in its class borders. A composite of three binary decision trees, each trained using a CNN model, was characterized using an external classifier [132]. Low-level features were extracted using a bespoke deep CNN model, which was then categorized using an Xception network [133]. For the classification of COVID-19 X-rays, the feature engineering technique was utilized to choose relief features from deep features from a pre-trained AlexNet CNN. Many CNN architectures have convolutional and pooling layers stacked in a linear pattern [134]. A network was designed with a 14-layer convolutional network, and spatial pyramid pooling was created for the multi-scale classification architecture [135]. Das et al. used an approach to minimize over-fitting and model complexity, and a truncated architecture was created utilizing the transfer learning technique [136]. The simplified InceptionV3-based architecture was pre-trained on the ImageNet database using an adjustable learning rate technique. Bridge et al. proposed a generalized extreme value distribution-based activation function that may be utilized with the Inception model to improve pre-trained InceptionV3 models. On unbalanced datasets, this resulted in a better classification performance than models using typical activation methods [136]. The GreyWolf Optimizer (GWO) method was used to optimize the architecture of the CNN feature extraction and classification components [137]. Many studies have backed up the effectiveness of the capsule network. Afshar et al. developed the COVID-CAPS model, which was pre-trained using an external X-ray dataset, to investigate the performance of various capsule net topologies [138]. A capsule network-based model with five distinct convolutional layers was constructed to provide richer feature maps to better understand its contribution [139]. COVID Diagnosis-Net was built using Deep Bayes-SqueezeNet [120] to include the benefits of data enhancement and network optimization. For a chest X-ray dataset, the network was developed using the SqueezeNet architecture, which was pre-trained and conducted Bayesian optimization as well as offline augmentation. A CycleGAN to enhance the sample count was developed using convolutional backbones as a feature extractor [121]. To forecast COVID-19, CT-based algorithms have used a range of feature extraction and assembly methods. Only a few studies have used the transfer learning technique for CT picture classification, in contrast to chest X-ray literature. Pathak et al. COVID-19 positive and

negative CT images were detected using deep transfer learning on ResNet32 with appropriate layers [140]. A number of studies on CT-based COVID-19 detection have been based on feature extraction. Yan et al., For example, based on the multi-scale spatial pyramid, constructed a CNN with a decomposition architecture (MSSP) [141], which was able to learn multi-scale feature representations without the need for massive amounts of training data. With the Enhanced kNN algorithm, Shaban et al. suggested a hybrid feature selection strategy [142], When paired with a classifier, it's a powerful combination. New heuristics were added to a standard kNN classifier, and the strategy included wrapper and filter feature selection strategies. Han et al. used a deep 3D multi-instance learning model to extract features at the instance level. To create patient-level classification, attention-based pooling of such instance labels is applied [143]. New heuristics were added to a standard kNN classifier, and the strategy included wrapper and filter feature selection strategies. Han et al. employed a deep 3d multi-instance learning model to extract features at the instance level. To produce patient-level classification, attention-based pooling of such instance labels is applied [124]. Similarly, Li et al. used a modified Rubik's cube Pro model as the backbone of the classification network to extract 3D attributes using a self-supervised technique. Wang et al. changed the network topology and learning mechanism for cosine annealing in their previously proposed pre-trained COVID-Net architecture [99]. They also showed how to deal with data heterogeneity and improve model performance using a collaborative learning technique. Ztürk et al. used a 2-stage classification model using an SVM classifier in a similar investigation [144]. The data were lightly augmented and subjected to numerous feature extraction methods before being over-sampled using the SMOTE technique. A Q-deformed entropy-based texture feature and deep CNN features to train a Bi-LSTM classifier for COVID-19 identification from CT slices was employed [145]. The combined feature collection was refined using a statistical ANOVA. Solutions provide settings for parameter adjustment based on classic CNNs. According, Pathak et al. [95] An LSTM network-based deep bidirectional classification model was proposed. A mixed density network is used in the bi-directional LSTM network, using a memetic adaptive differential evolution technique, and the hyperparameters were fine-tuned. COVID-19 traits were discovered from X-ray images using an unsupervised clustering-based technique. They used a self-organizing feature map to cluster infection incidences by analyzing each component of the image separately [96]. To develop a comparison of these networks, we used a deep CNN architecture for COVID-19 classification that used multi-objective differential evolution. It is a form of genetic algorithm that uses many rounds of mutation, crossover, and selection to improve the search for hyperparameters [146].

6.2 Segmentation for COVID-19

Singh et al. proposed a deep CNN architecture for COVID-19 classification that used multi-objective differential evolution to build a network comparison. It is a type of genetic algorithm that optimizes the search for hyperparameters through a

series of mutation, crossover, and selection phases. Automatic COVID-19 diagnosis approaches employing deep learning on CT images have garnered considerable interest as a way to speed up the examination process. However, the number and type of COVID-19 diagnosis datasets that may be utilized for training are limited, and the number of initial COVID-19 samples is substantially smaller than the average, resulting in a class imbalance problem. Because some classes have a lot of data and others have a lot of data, segmentation algorithms have a hard time learning discriminative boundaries. As a result, building robust deep neural networks with skewed data is a difficult yet critical challenge in the diagnosis of COVID-19.

The issue of AI efforts for COVID-19 identification using X-ray modalities has addressed the problem of segmentation. In X-ray, only a few studies on segmenting COVID-19-affected areas have been conducted. This is because, unlike CT, X-ray characteristics for COVID-19 localization and quantification are not commonly used in clinical settings. COVID-19 CT symptoms have been extensively researched, and their characteristics are typically used to identify COVID-19-affected areas. X-rays, on the other hand, are an excellent tool for diagnosing any type of pneumonia, prompting some studies to use them to divide COVID-19 infections into subgroups. The majority of algorithms are used for optimization. Abdel-Basset et al. developed a meta-heuristic approach that combines the slime mold technique (SMA) with the whale optimization algorithm to enhance Kapur's entropy [147]. The model uses thresholding approaches to extract the regions of interest in the X-ray image. Ground-glass or consolidative pulmonary opacities can be observed in the excised areas of the image. COVID-19 can manifest itself in several ways, including X-ray findings. On chest X-rays, the performance of the integrated SMA was compared to the performance of five algorithms: WOA, FireFly algorithm FFA, HHA, Lshade algorithm, and salp swarm. Abdel-Basset et al. proposed a hybrid detection model for X-ray image segmentation based on an improved marine predator algorithm (IMPA) and a ranking-based diversity reduction (RDR) approach [100]. The test of reverse transcription polymerase chain reaction (RT-PCR) [148] is used to detect viral RNA in sputum or a nasopharyngeal swab is currently the gold standard for detecting COVID-19. The RT-PCR test falls short of its main purpose of swiftly detecting and isolating positive patients due to the time it takes to receive results, the restricted availability of the material in hospitals, and its relatively poor sensitivity. Medical imaging, such as chest radiography or computed tomography (CT) scanners, may be utilized as a rapid screening alternative [149].

6.3 COVID-19 Risk Assessment and Prognosis

Early treatment and selection of the course of follow-up treatment are aided by COVID-19 risk analysis. Some studies have examined methods for predicting the severity of a viral infection in order to aid clinical prognosis. The assessment of the regression task for lung involvement and opacity in COVID-19 was modeled with

DenseNet applied to chest X-ray scans [150]. For feature extraction, fully connected layers were exhibited for the target predictions. Li et al. developed a convolutional Siamese network algorithm that learns from chest X-rays to assess COVID-19 pulmonary disease severity [151].

DenseNet121 was trained on a CheXpert dataset with weak labels as a Siamese network. To test the influence of COVID-19 on pulmonary risk, CNN learning was switched to a smaller COVID-19 training dataset that included a random forest classifier based on patient health data and symptoms [136]. A multivariable logistic regression-based risk prediction model [152] considering the input (sex, age, symptoms, blood test results, and CXR findings) of the patient were all taken into account for medical decision making. A deep learning-based survival model that can predict the risk of COVID-19 patients acquiring critical illness based on clinical parameters at the time of admission was described [153]. For survival modeling, the researchers developed a three-layer feed-forward neural network, which was then integrated with a deep learning survival Cox model, which was used to split patients into high- and low-risk groups, using CT-segmented lung lesion sites and clinical data as input. CT segmentation was used to identify consolidation (CL), ground-glass opacity (GGO), pulmonary effusion, and pleural effusion. Research into severity assessment and criticality prediction is the next stage in the automation of COVID-19 therapeutic regimens [154].

7 Big Data Management and IT Infrastructure During COVID-19

Health big data offer great prospects for innovation and progress in the sector. The COVID-19 crisis highlighted the value of this data and its usefulness for analysis, information, and awareness.

Patients who might benefit from preventative treatment or lifestyle modifications can be identified using big data analysis techniques; the most valuable patient nursing programs can be determined by collecting and analyzing medical procedure data; and the most valuable patient nursing programs can be determined by analyzing and drug treating patients' health status can be determined by analyzing and drug treating patients' health status. Technological advances have increased the volume of health data that are available exponentially. However, the sources and types of data remain heterogeneous and compartmentalized, making their use by health actors more complex [155, 156]. As shown in Fig. 4, the implementation of these first application cases makes it possible to deal with data collection, transformation, standardization, architecture, and storage issues as they arise [157].

The fast spread of the epidemic, along with its ever-changing patterns and symptoms, makes it increasingly impossible to manage. In addition, the epidemic has wreaked havoc on health systems and medical resource availability in a number of countries throughout the world, resulting in a high fatality rate.

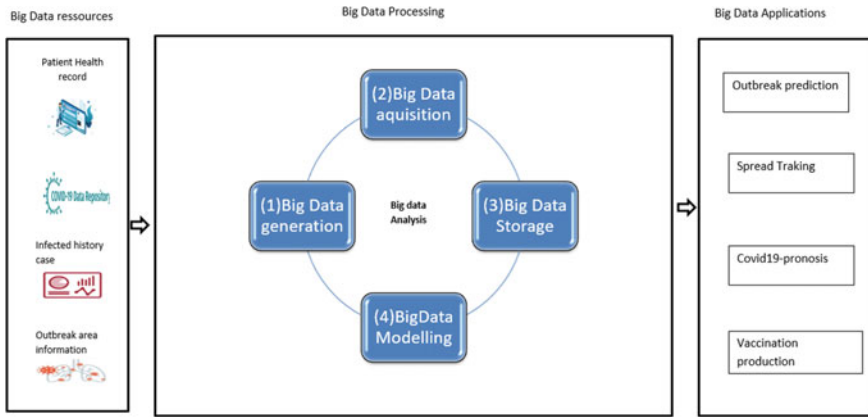

Fig. 4 Big data analytics

Individuals will be checked on a regular basis, and a remote detection device will help track suspected COVID-19 instances more quickly. Furthermore, the utilization of such systems will create a vast volume of data, opening up a variety of opportunities for big data analytics [158] to raise the level of healthcare service quality open-source software, such as the Apache project’s big data components, is widely accessible [159]. Cloud computing and distributed environments are considered crucial for building efficient medical data applications. The Six V’s [15] are a set of key qualities of big data, which include value, volume, velocity, variety, veracity, and variability [16]. Big data analysis methodologies are more likely to be employed to enhance the sector’s services and performance because of the features of big data that apply to data obtained from the healthcare business. Because of its capacity to foresee epidemics using large-scale data analytics, big data is crucial for combatting COVID19. During local or global disease outbreaks, big data analytics is progressively becoming a vital component for modeling viral propagation, infection control, and emergency response evaluations. The topic of data quality for covid-19 patients is also a major challenge. With millions of data created every day, problems of duplicates, updates, and availability of data are frequent. Guaranteeing the reliability of data in its operation involves the setting up of data management projects (governance, roles, mapping, repositories, processes, etc.). It is essential to establish rules, roles, and iterative processes for data management to ensure its integrity in a sustainable manner [20]. The establishment of a patient data warehouse for covid-19 can occur in the context of collecting, processing, and sharing massive volumes of data. A big data application can lead to privacy issues or even storage costs [160]. The volume and heterogeneity of health data sources and formats raise real complexities in terms of data integration, processing, and analysis. Current hospital information systems are generally made up of application silos that do not allow data to be sufficiently standardized and cross-referenced [161].

Prior to the COVID-19 pandemic, infectious disease case data reports were extensively dependent on early sickness detection and monitoring, as well as improving medical institutions, information processes, and storing and gathering a large amount of medical service data. The hospital information system (HIS) is a hospital information management system [162] including: (1) laboratory information system (LIS) [163], (2) Radiation Safety Information Management System (RASIMS), (3) Picture Archive and Communication System (Pacs), and Radiology Information System (RIS) [164] are considered the main servers implemented in hospital environments for data storage and management. In medical and health departments, data on patient coordinates, historical medical records, illnesses, test results, orders, operation records, and nursing records are all recorded in the electronic medical record system (EMRS) [31, 165]. Following the outbreak, the use of big data technologies to prevent and manage COVID-19 has become a critical step in medical decision-making. To manage epidemic monitoring and analysis, viral source tracking, epidemic prevention and treatment, and resource allocation, digital technologies such as big data, AI, and cloud computing are being used.

Utilizing big data technologies, the activity patterns of verified people and close connections were evaluated, and an epidemic spread model was developed using the positioning system. There is no doubt about the predictive competence that data offers us, but this advantage is perhaps all the more decisive in the medical field. Indeed, business intelligence in healthcare aims to help physicians make data-driven decisions in seconds and improve the treatment of covid 19 patients.

This is particularly useful in patients with a complex medical history and multiple comorbidities [166]. Healthcare systems that contain features and capabilities for analyzing massive volumes of data are known as big data analytics platforms. It allows medical decision-makers to sift through huge amounts of big data for previously undiscovered connections, market trends, and pertinent data. Table 3 outlines the most common big data analytics systems and data storage management platforms.

It will be feasible to simplify the actions of managing covid-19 patients using big data solutions in the healthcare industry. Time-constrained medical institutions may maximize staffing while anticipating diagnostic demands by using the correct human resource analytics, therefore expediting the treatment of patients afflicted by covid19. To combat the danger of covid-19, big data and healthcare are essential. This may also aid in the prevention of degeneration. Healthcare facilities can give correct preventative care and eventually account for hospital admissions by examining information such as kind of medicine, symptoms, and frequency of medical visits, among other things. This degree of risk assessment will not only result in lower inpatient expenditure, but it will also guarantee that space and resources are accessible to individuals who need them.

Table 3 Summary of big data tools

Tools	Features	Availability
Apache Hadoop [167]	Hadoop distributed file system (HDFS) distributed parallel processing of enormous amounts of data, including MapReduce YARN data storage and distributed processing (“yet another resource negotiator”)	https://hadoop.apache.org
IBM [168]	IBM big SQL, apache spark, text analytics, and data visualization are just a few of the big data tools available	https://www.ibm.com/analytics/hadoop/big-data-analytics
Amazon [169]	Data storage, data analysis systems data analytics is a term that refers to the study of apache spark, hive, presto, and other big data applications can be easily performed and scaled. scalable and easy to use apache spark, hive, presto, and other big data workloads	https://aws.amazon.com/emr/?c=a&sec=svr
Microsoft azure [170]	Using a cloud-based big data platform, you may design, assess, build, and manage applications. It offers the following goods and services: software as a service (SaaS) (SAAS). PaaS (platform as a service) is a term for infrastructure that is offered as a service	https://azure.microsoft.com/en-us/industries/healthcare/
Knime [171]	KNIME Server is corporate software that enables data scientists to collaborate, automate, manage, and deploy analytical applications and services. Non-experts may use the KNIME WebPortal or REST APIs to access data science	https://www.knime.com
Datameer [172]	Tools for data administration and modeling that are easy to use. Datameer spectrum is a non-programmable ETL++ tool and platform	https://www.datameer.com/healthcare/
Apache Cassandra [173]	Database management system with several servers and a distributed database	https://cassandra.apache.org/_/index.html
Chukwa [174]	Hadoop distributed file system (HDFS)	https://chukwa.apache.org
Rapiminer [171]	Regulatory compliance needs a thorough grasp of difficult data issues	https://rapidminer.com/industry/healthcare/
BigML [175]	BigML encrypts all connections using HTTPS, ensuring the safety of user data and discussions. The BigML team does not have access to any data in the system unless the user grants explicit permission	https://bigml.com
COVID-QF [176]	Over COVID-19, a big data-based framework for complex query execution	https://github.com/cqframework/covid-19
Apache spark [177]	Using apache spark, a multi-dimensional big data storing system for generated COVID-19 large-scale data	https://spark.apache.org

8 Conclusion

The COVID-19 outbreak has sparked great concern around the world. In a silver lining, the uproar may act as a motivation for artificial intelligence research and development to assist medical personnel in combatting the epidemic. While the advantages are clear, artificial intelligence models will never be able to completely replace doctors and radiologists. Nonetheless, in recent years, computer-assisted techniques for medical image processing have made significant progress, boosting medical research and practical applications. Recent research using deep learning and machine learning architectures has demonstrated the reliability of image-based COVID-19 diagnosis. The goal of this research is to examine how far these designs have progressed in terms of categorization and segmentation of COVID-19 symptoms using the modalities that have been used. The COVID-19 outbreak has sparked great concern around the world. In a silver lining, the uproar may act as a motivation for artificial intelligence research and development to assist medical personnel in combatting the epidemic. While the advantages are clear, artificial intelligence models will never be able to completely replace doctors and radiologists. Nonetheless, in recent years, computer-assisted techniques for medical image processing have made significant progress, boosting medical research and practical applications. The reliability of image-based COVID-19 diagnosis has been established in recent research employing deep learning and machine learning architectures. This study aims to examine the current accomplishments and progress of these architectures in the classification and segmentation of COVID-19 infection manifestations using the modalities utilized. Despite these advances, significant barriers remain, preventing future growth. Because of the urgency of this epidemic, humanity is counting scientific ingenuity to find a cure. Breakthroughs may happen quicker if medical practitioners and radiologists are engaged in the conceptualization and building of a framework for artificial intelligence models. While deep learning and machine learning have shown promise in the medical field, they also have great promise in other image-based classification and segmentation problems.

The massive amount of time and resources necessary, as well as hefty implementation costs, are now impeding this potential. Insufficient and uneven data are another difficulty for classification and segmentation algorithms, which leads to overfitting and erroneous predictions. Further advancements and innovations aimed at overcoming these limitations may significantly contribute to advances in biomedical image processing.

Controlling an epidemic requires a complete understanding of its features and behavior, which may be discovered through the collection and analysis of relevant big data. Big data analytics are critical for obtaining the data needed to make judgments and take precautionary steps. The huge volumes of data currently available pose technical challenges for their storage and operational capacities. Increasingly complex computer and statistical programs and algorithms are required.

References

1. Ejima K, Kim KS, Ludema C, Bento AI, Iwanami S, Fujita Y, Ohashi H, Koizumi Y, Watashi K, Aihara K, Nishiura H, Iwami S (2021) Estimation of the incubation period of COVID-19 using viral load data. *Epidemics* 35:100454. <https://doi.org/10.1016/j.epidem.2021.100454>
2. Zaki N, Mohamed EA (2021) The estimations of the COVID-19 incubation period: a scoping reviews of the literature. *J Infect Public Health* 14:638–646. <https://doi.org/10.1016/j.jiph.2021.01.019>
3. Teotônio IMSN, de Carvalho JL, Castro LC, Nitz N, Hagström L, Rios GG, de Fátima Rodrigues de Oliveira M, Dallago BSL, Hecht M (2021) Clinical and biochemical parameters of COVID-19 patients with prior or active dengue fever. *Acta Tropica* 214:105782. <https://doi.org/10.1016/j.actatropica.2020.105782>
4. Owais M, Yoon HS, Mahmood T, Haider A, Sultan H, Park KR (2021) Light-weighted ensemble network with multilevel activation visualization for robust diagnosis of COVID19 pneumonia from large-scale chest radiographic database. *Appl Soft Comput* 108:107490. <https://doi.org/10.1016/j.asoc.2021.107490>
5. Rosas J, Liaño FP, Cantó ML, Barea JMC, Beser AR, Rabasa JTA, Adsuar FM, Auli BV, López IF, Sainz AMG, Ramis PE, Pérez LR, Rebollo MLN, Lorigo RH, Escolar LG (2020) Experience with the use of baricitinib and tocilizumab monotherapy or combined, in patients with interstitial pneumonia secondary to coronavirus COVID19: a real-world study. *Reumatología Clínica*. <https://doi.org/10.1016/j.reuma.2020.10.009>
6. Karthik R, Menaka R, Hariharan M, Kathiresan GS (2021) AI for COVID-19 detection from radiographs: incisive analysis of state of the art techniques, key challenges and future directions. *IRBM*. <https://doi.org/10.1016/j.irbm.2021.07.002>
7. Xie Y, Wang X, Yang P, Zhang S (2020) COVID-19 complicated by acute pulmonary embolism. *Radiol Cardiothoracic Imaging* 2:e200067. <https://doi.org/10.1148/ryct.2020200067>
8. Shuja J, Alanazi E, Alasmay W, Alashaikh A (2020) COVID-19 open source data sets: a comprehensive survey. *Appl Intell*:1–30. <https://doi.org/10.1007/s10489-020-01862-6>
9. Alsharif W, Qurashi A (2021) Effectiveness of COVID-19 diagnosis and management tools: a review. *Radiography (Lond)* 27:682–687. <https://doi.org/10.1016/j.radi.2020.09.010>
10. Alakus TB, Turkoglu I (2020) Comparison of deep learning approaches to predict COVID-19 infection. *Chaos Solitons Fractals* 140:110120. <https://doi.org/10.1016/j.chaos.2020.110120>
11. Sufian A, Ghosh A, Sadiq AS, Smarandache F (2020) A survey on deep transfer learning to edge computing for mitigating the COVID-19 pandemic. *J Syst Architect* 108:101830. <https://doi.org/10.1016/j.sysarc.2020.101830>
12. Singh S, Parmar KS, Makkhan SJS, Kaur J, Peshoria S, Kumar J (2020) Study of ARIMA and least square support vector machine (LS-SVM) models for the prediction of SARS-CoV-2 confirmed cases in the most affected countries. *Chaos Solitons Fractals* 139:110086. <https://doi.org/10.1016/j.chaos.2020.110086>
13. Bachhety S, Kapania S, Jain R (2021) 2—big data analytics for healthcare: theory and applications. In: Khanna A, Gupta D, Dey N (eds) *Applications of big data in healthcare*. Academic Press, pp 45–67
14. Renugadevi N, Saravanan S, Naga Sudha CM (2021) Revolution of smart healthcare materials in big data analytics. *Mater Today Proc*. <https://doi.org/10.1016/j.matpr.2021.04.256>
15. Andreu-Perez J, Poon CCY, Merrifield RD, Wong STC, Yang G-Z (2015) Big data for health. *IEEE J Biomed Health Inform* 19:1193–1208. <https://doi.org/10.1109/JBHI.2015.2450362>
16. Hagar Y, Albers D, Pivovarov R, Chase H, Dukic V, Elhadad N (2014) Survival analysis with electronic health record data: experiments with chronic kidney disease. *Stat Anal Data Min* 7:385–403. <https://doi.org/10.1002/sam.11236>

17. Wang L, Alexander C (2021) Chapter 2—big data in personalized healthcare. In: Moustafa AA (ed) *Big data in psychiatry & neurology*. Academic Press, pp 35–49
18. Chugh S, Kumaram S, Sharma DK (2021) 3—application of tools and techniques of big data analytics for healthcare system. In: Khanna A, Gupta D, Dey N (eds) *Applications of big data in healthcare*. Academic Press, pp 69–84
19. Chae S, Kwon S, Lee D (2018) Predicting infectious disease using deep learning and big data. *Int J Environ Res Public Health* 15:E1596. <https://doi.org/10.3390/ijerph15081596>
20. Bansal S, Chowell G, Simonsen L, Vespignani A, Viboud C (2016) Big data for infectious disease surveillance and modeling. *J Infect Dis* 214:S375–S379. <https://doi.org/10.1093/infdis/jiw400>
21. Eisenstein M (2018) Infection forecasts powered by big data. *Nature* 555:S2–S4. <https://doi.org/10.1038/d41586-018-02473-5>
22. Mangono T, Smittenaar P, Caplan Y, Huang VS, Sutermeister S, Kemp H, Sgaier SK (2021) Information-seeking patterns during the COVID-19 pandemic across the United States: longitudinal analysis of google trends data. *J Med Internet Res* 23:e22933. <https://doi.org/10.2196/22933>
23. Chen C-M, Jyan H-W, Chien S-C, Jen H-H, Hsu C-Y, Lee P-C, Lee C-F, Yang Y-T, Chen M-Y, Chen L-S, Chen H-H, Chan C-C (2020) Containing COVID-19 among 627,386 persons in contact with the diamond princess cruise ship passengers who disembarked in Taiwan: big data analytics. *J Med Internet Res* 22:e19540. <https://doi.org/10.2196/19540>
24. Zhang S, Diao M, Yu W, Pei L, Lin Z, Chen D (2020) Estimation of the reproductive number of novel coronavirus (COVID-19) and the probable outbreak size on the diamond princess cruise ship: a data-driven analysis. *Int J Infect Dis* 93:201–204. <https://doi.org/10.1016/j.ijid.2020.02.033>
25. Padden JS (2020) Informatics X-men evolution to combat COVID-19. *Nurse Lead* 18:557–560. <https://doi.org/10.1016/j.mnl.2020.09.005>
26. Reeves JJ, Hollandsworth HM, Torriani FJ, Taplitz R, Abeles S, Tai-Seale M, Millen M, Clay BJ, Longhurst CA (2020) Rapid response to COVID-19: health informatics support for outbreak management in an academic health system. *J Am Med Inform Assoc* 27:853–859. <https://doi.org/10.1093/jamia/ocaa037>
27. Werley HH, Devine EC, Zorn CR, Ryan P, Westra BL (1991) The nursing minimum data set: abstraction tool for standardized, comparable, essential data. *Am J Public Health* 81:421–426
28. Dixon BE (2020) Applied public health informatics: an eHealth discipline focused on populations. *J Int Soc Telemed eHealth* 8:e14(1–8). <https://doi.org/10.29086/JISfTeH.8.e14>
29. Grange ES, Neil EJ, Stoffel M, Singh AP, Tseng E, Resco-Summers K, Fellner BJ, Lynch JB, Mathias PC, Mauritz-Miller K, Sutton PR, Leu MG (2020) Responding to COVID-19: the UW medicine information technology services experience. *Appl Clin Inform* 11:265–275. <https://doi.org/10.1055/s-0040-1709715>
30. Vilendrer S, Patel B, Chadwick W, Hwa M, Asch S, Pageler N, Ramdeo R, Saliba-Gustafsson EA, Strong P, Sharp C (2020) Rapid deployment of inpatient telemedicine in response to COVID-19 across three health systems. *J Am Med Inform Assoc* 27:1102–1109. <https://doi.org/10.1093/jamia/ocaa077>
31. Huang Y, Li X, Zhang G-Q (2021) ELII: a novel inverted index for fast temporal query, with application to a large COVID-19 EHR dataset. *J Biomed Inform* 117:103744. <https://doi.org/10.1016/j.jbi.2021.103744>
32. Dagliati A, Malovini A, Tibollo V, Bellazzi R (2021) Health informatics and EHR to support clinical research in the COVID-19 pandemic: an overview. *Brief Bioinform* 22:812–822. <https://doi.org/10.1093/bib/bbaa418>
33. Moore JH, Barnett I, Boland MR, Chen Y, Demiris G, Gonzalez-Hernandez G, Herman DS, Himes BE, Hubbard RA, Kim D, Morris JS, Mowery DL, Ritchie MD, Shen L, Urbanowicz R, Holmes JH (2020) Ideas for how informaticians can get involved with COVID-19 research. *BioData Mining* 13:3. <https://doi.org/10.1186/s13040-020-00213-y>

34. Brown JS, Bastarache L, Weiner MG (2021) Aggregating electronic health record data for COVID-19 research—caveat emptor. *JAMA Netw Open* 4:e2117175. <https://doi.org/10.1001/jamanetworkopen.2021.17175>
35. Pryor R, Atkinson C, Cooper K, Doll M, Godbout E, Stevens MP, Bearman G (2020) The electronic medical record and COVID-19: is it up to the challenge? *Am J Infect Control* 48:966–967. <https://doi.org/10.1016/j.ajic.2020.05.002>
36. Bowman S (2013) Impact of electronic health record systems on information integrity: quality and safety implications. *Perspect Health Inf Manage* 10:1c
37. Zarour M, Alenezi M, Ansari MTJ, Pandey AK, Ahmad M, Agrawal A, Kumar R, Khan RA (2021) Ensuring data integrity of healthcare information in the era of digital health. *Health Technol Lett* 8:66–77. <https://doi.org/10.1049/htl2.12008>
38. Graber ML, Byrne C, Johnston D (2017) The impact of electronic health records on diagnosis. *Diagnosis (Berl)* 4:211–223. <https://doi.org/10.1515/dx-2017-0012>
39. Zahabi M, Kaber DB, Swangnetr M (2015) Usability and safety in electronic medical records interface design: a review of recent literature and guideline formulation. *Hum Factors* 57:805–834. <https://doi.org/10.1177/0018720815576827>
40. Wu G, Yang P, Xie Y, Woodruff HC, Rao X, Guiot J, Frix A-N, Louis R, Moutschen M, Li J, Li J, Yan C, Du D, Zhao S, Ding Y, Liu B, Sun W, Albarello F, D’Abramo A, Schininà V, Nicastrì E, Occhipinti M, Barisione G, Barisione E, Halilaj I, Lovinfosse P, Wang X, Wu J, Lambin P (2020) Development of a clinical decision support system for severity risk prediction and triage of COVID-19 patients at hospital admission: an international multicentre study. *Eur Respir J* 56:2001104. <https://doi.org/10.1183/13993003.01104-2020>
41. Dixon BE, Grannis SJ, McAndrews C, Broyles AA, Mikels-Carrasco W, Wiensch A, Williams JL, Tachinardi U, Embi PJ (2021) Leveraging data visualization and a statewide health information exchange to support COVID-19 surveillance and response: application of public health informatics. *J Am Med Inform Assoc* 28:1363–1373. <https://doi.org/10.1093/jamia/ocab004>
42. Bookman RJ, Cimino JJ, Harle CA, Kost RG, Mooney S, Pfaff E, Rojevsky S, Tobin JN, Wilcox A, Tsinoremas NF (2021) Research informatics and the COVID-19 pandemic: challenges, innovations, lessons learned, and recommendations. *J Clin Transl Sci* 5.<https://doi.org/10.1017/cts.2021.26>
43. Sein MK (2020) The serendipitous impact of COVID-19 pandemic: a rare opportunity for research and practice. *Int J Inf Manage* 55:102164. <https://doi.org/10.1016/j.ijinfomgt.2020.102164>
44. Richter A (2020) Locked-down digital work. *Int J Inf Manage* 55:102157. <https://doi.org/10.1016/j.ijinfomgt.2020.102157>
45. Pranggono B, Arabo A (2021) COVID-19 pandemic cybersecurity issues. *Internet Technol Lett* 4:e247. <https://doi.org/10.1002/itl2.247>
46. O’Leary DE (2020) Evolving information systems and technology research issues for COVID-19 and other pandemics. *J Organ Comput Electron Commer* 30:1–8. <https://doi.org/10.1080/10919392.2020.1755790>
47. Dwivedi YK, Hughes DL, Coombs C, Constantiou I, Duan Y, Edwards JS, Gupta B, Lal B, Misra S, Prashant P, Raman R, Rana NP, Sharma SK, Upadhyay N (2020) Impact of COVID-19 pandemic on information management research and practice: transforming education, work and life. *Int J Inf Manage* 55:102211. <https://doi.org/10.1016/j.ijinfomgt.2020.102211>
48. Sharma A, Borah SB, Moses AC (2021) Responses to COVID-19: the role of governance, healthcare infrastructure, and learning from past pandemics. *J Bus Res* 122:597–607. <https://doi.org/10.1016/j.jbusres.2020.09.011>
49. Rehani B, Rodriguez JA, Nguyen JK, Patel MM, Ammanuel SG, Winford E, Dillon WP (2021) COVID-19 radiology preparedness, challenges & opportunities: responses from 18 countries. *Curr Probl Diagn Radiol*. <https://doi.org/10.1067/j.cpradiol.2021.03.017>

50. Gupta D, Bhatt S, Gupta M, Tosun AS (2021) Future smart connected communities to fight COVID-19 outbreak. *Internet Things* 13:100342. <https://doi.org/10.1016/j.iot.2020.100342>
51. Shahroz M, Ahmad F, Younis MS, Ahmad N, Kamel Boulos MN, Vinuesa R, Qadir J (2021) COVID-19 digital contact tracing applications and techniques: a review post initial deployments. *Transp Eng* 5:100072. <https://doi.org/10.1016/j.treng.2021.100072>
52. Goel I, Sharma S, Kashiramka S (2021) Effects of the COVID-19 pandemic in India: an analysis of policy and technological interventions. *Health Policy Technol* 10:151–164. <https://doi.org/10.1016/j.hlpt.2020.12.001>
53. Dodoo JE, Al-Samarraie H, Alzahrani AI (2021) Telemedicine use in sub-Saharan Africa: barriers and policy recommendations for COVID-19 and beyond. *Int J Med Informatics* 151:104467. <https://doi.org/10.1016/j.ijmedinf.2021.104467>
54. Brohi S, Zaman N, Brohi N, Brohi MN (2020) Key applications of state-of-the-art technologies to mitigate and eliminate COVID-19
55. Sipior JC (2020) Considerations for development and use of AI in response to COVID-19. *Int J Inf Manage* 55:102170. <https://doi.org/10.1016/j.ijinfomgt.2020.102170>
56. Laliève L, Adam J, Nataf P, Khonsari RH (2021) 3D-printed suture guide for thoracic and cardiovascular surgery produced during the COVID19 pandemic. *Ann 3D Printed Med* 1:100005. <https://doi.org/10.1016/j.stlm.2020.100005>
57. Bragazzi NL, Dai H, Damiani G, Behzadifar M, Martini M, Wu J (2020) How big data and artificial intelligence can help better manage the COVID-19 pandemic. *Int J Environ Res Public Health* 17:E3176. <https://doi.org/10.3390/ijerph17093176>
58. Kalgotra P, Gupta A, Sharda R (2021) Pandemic information support lifecycle: evidence from the evolution of mobile apps during COVID-19. *J Bus Res* 134:540–559. <https://doi.org/10.1016/j.jbusres.2021.06.002>
59. Singh RP, Javaid M, Haleem A, Suman R (2020) Internet of things (IoT) applications to fight against COVID-19 pandemic. *Diabetes Metab Syndr* 14:521–524. <https://doi.org/10.1016/j.dsx.2020.04.041>
60. Otoom M, Otoum N, Alzubaidi MA, Etoom Y, Banihani R (2020) An IoT-based framework for early identification and monitoring of COVID-19 cases. *Biomed Signal Process Control* 62:102149. <https://doi.org/10.1016/j.bspc.2020.102149>
61. Fusco A, Dicuonzo G, Dell’Atti V, Tatullo M (2020) Blockchain in healthcare: insights on COVID-19. *Int J Environ Res Public Health* 17:E7167. <https://doi.org/10.3390/ijerph17197167>
62. Tan L, Tivey D, Kopunic H, Babidge W, Langley S, Maddern G (2020) Part 2: blockchain technology in health care. *ANZ J Surg* 90:2415–2419. <https://doi.org/10.1111/ans.16455>
63. Pennisi M, Kavasidis I, Spampinato C, Schinina V, Palazzo S, Salanitra FP, Bellitto G, Rundo F, Aldinucci M, Cristofaro M, Campioni P, Pianura E, Di Stefano F, Petrone A, Albarello F, Ippolito G, Cuzzocrea S, Conoci S (2021) An explainable AI system for automated COVID-19 assessment and lesion categorization from CT-scans. *Artif Intell Med* 118:102114. <https://doi.org/10.1016/j.artmed.2021.102114>
64. Ronaghi F, Salimibeni M, Naderkhani F, Mohammadi A (2022) COVID19-HPSMP: COVID-19 adopted hybrid and parallel deep information fusion framework for stock price movement prediction. *Expert Syst Appl* 187:115879. <https://doi.org/10.1016/j.eswa.2021.115879>
65. Wang X, Deng X, Fu Q, Zhou Q, Feng J, Ma H, Liu W, Zheng C (2020) A weakly-supervised framework for COVID-19 classification and lesion localization from chest CT. *IEEE Trans Med Imaging* 39:2615–2625. <https://doi.org/10.1109/TMI.2020.2995965>
66. Sitaula C, Aryal S (2021) New bag of deep visual words based features to classify chest x-ray images for COVID-19 diagnosis. *Health Inf Sci Syst* 9:24. <https://doi.org/10.1007/s13755-021-00152-w>
67. Sözen ME, Sarıyer G, Ataman MG (2021) Big data analytics and COVID-19: investigating the relationship between government policies and cases in Poland, Turkey and South Korea. *Health Policy Plann.* <https://doi.org/10.1093/heapol/czab096>
68. Roberts SL. Tracking COVID-19 using big data and big tech: a digital Pandora’s Box

69. Umair M, Cheema MA, Cheema O, Li H, Lu H (2021) Impact of COVID-19 on IoT adoption in healthcare, smart homes, smart buildings, smart cities. *Transp Ind IoT Sensors* 21:3838. <https://doi.org/10.3390/s21113838>
70. Chen S-W, Gu X-W, Wang J-J, Zhu H-S (2021) AIoT used for COVID-19 pandemic prevention and control. *Contrast Media & Mole Imaging* 2021:e3257035. <https://doi.org/10.1155/2021/3257035>
71. Ramallo-González AP, González-Vidal A, Skarmeta AF (2021) CIoTVID: Towards an open IoT-platform for infective pandemic diseases such as COVID-19. *Sensors (Basel)* 21:E484. <https://doi.org/10.3390/s21020484>
72. Ng WY, Tan T-E, Movva PVH, Fang AHS, Yeo K-K, Ho D, Foo FSS, Xiao Z, Sun K, Wong TY, Sia AT-H, Ting DSW (2021) Blockchain applications in health care for COVID-19 and beyond: a systematic review. *Lancet Digit Health* S2589–7500(21):00210–00217. [https://doi.org/10.1016/S2589-7500\(21\)00210-7](https://doi.org/10.1016/S2589-7500(21)00210-7)
73. Bansal A, Garg C, Padappayil RP (2020) Optimizing the implementation of COVID-19 “immunity certificates” using blockchain. *J Med Syst* 44:140. <https://doi.org/10.1007/s10916-020-01616-4>
74. Kimmig R, Verheijen RHM, Rudnicki M (2020) Robot assisted surgery during the COVID-19 pandemic, especially for gynecological cancer: a statement of the society of European robotic gynaecological surgery (SERGS). *J Gynecol Oncol* 31:e59. <https://doi.org/10.3802/jgo.2020.31.e59>
75. Samalavicius NE, Siaulyis R, Janusonis V, Klimasauskiene V, Dulskas A (2020) Use of 4 robotic arms performing Senhance[®] robotic surgery may reduce the risk of coronavirus infection to medical professionals during COVID-19. *Euro J Obstetrics Gynecol Reprod Biol* 251:274–275. <https://doi.org/10.1016/j.ejogrb.2020.06.014>
76. Tino R, Moore R, Antoline S, Ravi P, Wake N, Ionita CN, Morris JM, Decker SJ, Sheikh A, Rybicki FJ, Chepelev LL (2020) COVID-19 and the role of 3D printing in medicine. *3D Print Med* 6:11. <https://doi.org/10.1186/s41205-020-00064-7>
77. Ishack S, Lipner SR (2020) Applications of 3D printing technology to address COVID-19—related supply shortages. *Am J Med* 133:771–773. <https://doi.org/10.1016/j.amjmed.2020.04.002>
78. Williams E, Bond K, Isles N, Chong B, Johnson D, Druce J, Hoang T, Ballard SA, Hall V, Muhi S, Buising KL, Lim S, Strugnell D, Catton M, Irving LB, Howden BP, Bert E, Williamson DA (2020) Pandemic printing: a novel 3D-printed swab for detecting SARS-CoV-2. *Med J Aust* 213:276–279. <https://doi.org/10.5694/mja2.50726>
79. Davalbhakta S, Advani S, Kumar S, Agarwal V, Bhojar S, Fedirko E, Misra DP, Goel A, Gupta L, Agarwal V (2020) A systematic review of smartphone applications available for corona virus disease 2019 (COVID19) and the assessment of their quality using the mobile application rating scale (MARS). *J Med Syst* 44:164. <https://doi.org/10.1007/s10916-020-01633-3>
80. Ming LC, Untong N, Aliudin NA, Osili N, Kifli N, Tan CS, Goh KW, Ng PW, Al-Worafi YM, Lee KS, Goh HP (2020) Mobile health apps on COVID-19 launched in the early days of the pandemic: content analysis and review. *JMIR Mhealth Uhealth* 8:e19796. <https://doi.org/10.2196/19796>
81. Torous J, Keshavan M (2020) COVID-19, mobile health and serious mental illness. *Schizophr Res* 218:36–37. <https://doi.org/10.1016/j.schres.2020.04.013>
82. Eysenbach G (2001) What is e-health? *J Med Internet Res* 3:e833. <https://doi.org/10.2196/jmir.3.2.e20>
83. Bitar H, Alismail S (2021) The role of eHealth, telehealth, and telemedicine for chronic disease patients during COVID-19 pandemic: a rapid systematic review. *Digit Health* 7:20552076211009396. <https://doi.org/10.1177/20552076211009396>
84. Li J, Seale H, Ray P, Rawlinson W, Lewis L, Macintyre CR (2012) Issues regarding the implementation of eHealth: preparing for future influenza pandemics. *Interact J Med Res* 1:e20. <https://doi.org/10.2196/ijmr.2357>

85. Gerli P, Arakpogun E, Elsahn Z, Olan F, Prime KS (2021) Beyond contact-tracing: the public value of ehealth application in a pandemic. *Gov Inf Q* 38. <https://doi.org/10.1016/j.giq.2021.101581>
86. Neter E, Brainin E (2012) eHealth literacy: extending the digital divide to the realm of health information. *J Med Internet Res* 14:e1619. <https://doi.org/10.2196/jmir.1619>
87. Scott RE, Mars M (2021) COVID-19 and eHealth: a promise or peril paradox? *J Int Soc Telemed eHealth* 9:e1(1–2). <https://doi.org/10.29086/JISfTeH.9.e1>
88. Palabindala V, Bharathidasan K (2021) Telemedicine in the COVID-19 era: a tricky transition. *J Community Hosp Intern Med Perspect* 11:302–303. <https://doi.org/10.1080/20009666.2021.1899581>
89. Dorn SD (2021) Backslide or forward progress? Virtual care at U.S. healthcare systems beyond the COVID-19 pandemic. *NPJ Digit Med* 4:6. <https://doi.org/10.1038/s41746-020-00379-z>
90. Farooq M, Hafeez A (2020) COVID-ResNet: a deep learning framework for screening of COVID19 from radiographs. [arXiv:200314395](https://arxiv.org/abs/200314395) [cs, eess]
91. Mahanta SK, Kaushik D, Jain S, Van Truong H, Guha K (2021) COVID-19 diagnosis from cough acoustics using ConvNets and data augmentation. [arXiv:211006123](https://arxiv.org/abs/211006123) [cs, eess]
92. Khan AI, Shah JL, Bhat MM (2020) CoroNet: a deep neural network for detection and diagnosis of COVID-19 from chest x-ray images. *Comput Methods Programs Biomed* 196:105581. <https://doi.org/10.1016/j.cmpb.2020.105581>
93. Karthik R, Menaka RMH (2021) Learning distinctive filters for COVID-19 detection from chest X-ray using shuffled residual CNN. *Appl Soft Comput* 99:106744. <https://doi.org/10.1016/j.asoc.2020.106744>
94. Cohen JP, Morrison P, Dao L (2020) COVID-19 image data collection. [arXiv:200311597](https://arxiv.org/abs/200311597) [cs, eess, q-bio]
95. Pathak Y, Shukla PK, Arya KV (2021) Deep bidirectional classification model for COVID-19 disease infected patients. *IEEE/ACM Trans Comput Biol Bioinf* 18:1234–1241. <https://doi.org/10.1109/TCBB.2020.3009859>
96. King B, Barve S, Ford A, Jha R (2020) Unsupervised clustering of COVID-19 chest X-ray images with a self-organizing feature map. In: 2020 IEEE 63rd international midwest symposium on circuits and systems (MWSCAS), pp 395–398
97. Ahuja S, Panigrahi BK, Dey N, Rajinikanth V, Gandhi TK (2021) Deep transfer learning-based automated detection of COVID-19 from lung CT scan slices. *Appl Intell* 51:571–585. <https://doi.org/10.1007/s10489-020-01826-w>
98. Shibly KH, Dey SK, Islam MT-U, Rahman MM (2020) COVID faster R-CNN: a novel framework to diagnose novel coronavirus disease (COVID-19) in X-ray images. *Inform Med Unlocked* 20:100405. <https://doi.org/10.1016/j.imu.2020.100405>
99. Wang Z, Liu Q, Dou Q (2020) Contrastive cross-site learning with redesigned net for COVID-19 CT classification. *IEEE J Biomed Health Inform* 24:2806–2813. <https://doi.org/10.1109/JBHI.2020.3023246>
100. Abdel-Basset M, Mohamed R, Elhoseny M, Chakraborty RK, Ryan M (2020) A hybrid COVID-19 detection model using an improved marine predators algorithm and a ranking-based diversity reduction strategy. *IEEE Access* 8:79521–79540. <https://doi.org/10.1109/ACCESS.2020.2990893>
101. Wang G, Liu X, Li C, Xu Z, Ruan J, Zhu H, Meng T, Li K, Huang N, Zhang S (2020) A noise-robust framework for automatic segmentation of COVID-19 pneumonia lesions from CT images. *IEEE Trans Med Imaging* 39:2653–2663. <https://doi.org/10.1109/TMI.2020.3000314>
102. Fan D-P, Zhou T, Ji G-P, Zhou Y, Chen G, Fu H, Shen J, Shao L (2020) Inf-Net: automatic COVID-19 lung infection segmentation from CT images. *IEEE Trans Med Imaging* 39:2626–2637. <https://doi.org/10.1109/TMI.2020.2996645>

103. Ranjbarzadeh R, Jafarzadeh Ghouschi S, Bendeche M, Amirabadi A, Ab Rahman MN, Baseri Saadi S, Aghamohammadi A, Kooshki Forooshani M (2021) Lung infection segmentation for COVID-19 pneumonia based on a cascade convolutional network from CT images. *Biomed Res Int* 2021:e5544742. <https://doi.org/10.1155/2021/5544742>
104. Berta L, Rizzetto F, De Mattia C, Lizio D, Felisi M, Colombo PE, Carrazza S, Gelmini S, Bianchi L, Artioli D, Travaglini F, Vanzulli A, Torresin A (2021) Automatic lung segmentation in COVID-19 patients: impact on quantitative computed tomography analysis. *Phys Med* 87:115–122. <https://doi.org/10.1016/j.ejmp.2021.06.001>
105. Elaziz MA, Ewees AA, Yousofi D, Alwerfali HSN, Awad QA, Lu S, Al-Qaness MAA (2020) An improved marine predators algorithm with fuzzy entropy for multi-level thresholding: real world example of COVID-19 CT image segmentation. *IEEE Access* 8:125306–125330. <https://doi.org/10.1109/ACCESS.2020.3007928>
106. Kim Y-G, Kim K, Wu D, Ren H, Tak WY, Park SY, Lee YR, Kang MK, Park JG, Kim BS, Chung WJ, Kalra MK, Li Q (2020) deep learning-based four-region lung segmentation in chest radiography for COVID-19 diagnosis. [arXiv:200912610](https://arxiv.org/abs/2009.12610) [cs, eess]
107. Teixeira LO, Pereira RM, Bertolini D, Oliveira LS, Nanni L, Cavalcanti GDC, Costa YMG (2021) Impact of lung segmentation on the diagnosis and explanation of COVID-19 in chest X-ray images. [arXiv:200909780](https://arxiv.org/abs/2009.09780) [cs, eess]
108. Müller D, Rey IS, Kramer F (2020) Automated chest CT image segmentation of COVID-19 lung infection based on 3D U-Net. [arXiv:200704774](https://arxiv.org/abs/2007.04774) [cs, eess]
109. Krinski BA, Ruiz DV, Todt E (2021) Spark in the dark: evaluating encoder-decoder pairs for COVID-19 CT's semantic segmentation. [arXiv:210914818](https://arxiv.org/abs/2109.14818) [cs, eess]
110. Civit-Masot J, Luna-Perejón F, Domínguez Morales M, Civit A (2020) Deep learning system for COVID-19 diagnosis aid using X-ray pulmonary images. *Appl Sci* 10:4640. <https://doi.org/10.3390/app10134640>
111. Pandit MK, Banday SA (2020) SARS n-CoV2-19 detection from chest x-ray images using deep neural networks. *Int J Pervasive Comput Commun* 16:419–427. <https://doi.org/10.1108/IJPC-06-2020-0060>
112. Makris A, Kontopoulos I, Tserpes K (2020) COVID-19 detection from chest X-ray images using deep learning and convolutional neural networks. In: 11th Hellenic conference on artificial intelligence. Association for Computing Machinery, New York, NY, USA, pp 60–66
113. Dey N, Zhang Y-D, Rajinikanth V, Pugalenth R, Raja NSM (2021) Customized VGG19 architecture for pneumonia detection in chest X-rays. *Pattern Recogn Lett* 143:67–74. <https://doi.org/10.1016/j.patrec.2020.12.010>
114. Wang W, Yu Z, Fu C, Cai D, He X (2021) COP: customized correlation-based filter level pruning method for deep CNN compression. *Neurocomputing* 464:533–545. <https://doi.org/10.1016/j.neucom.2021.08.098>
115. Zhang Z, Lin X, Li M, Wang Y (2021) A customized deep learning approach to integrate network-scale online traffic data imputation and prediction. *Transp Res Part C Emerging Technol* 132:103372. <https://doi.org/10.1016/j.trc.2021.103372>
116. Lee K, Joe H, Lim H, Kim K, Kim S, Han CW, Kim H-G (2021) Sequential routing framework: fully capsule network-based speech recognition. *Comput Speech Lang* 70:101228. <https://doi.org/10.1016/j.csl.2021.101228>
117. Shahin I, Hindawi N, Nassif AB, Alhudhaif A, Polat K (2022) Novel dual-channel long short-term memory compressed capsule networks for emotion recognition. *Expert Syst Appl* 188:116080. <https://doi.org/10.1016/j.eswa.2021.116080>
118. Deng X, Jiang P, Zhao D, Huang R, Shen H (2021) Effective semi-supervised learning for structured data using embedding GANs. *Pattern Recogn Lett* 151:127–134. <https://doi.org/10.1016/j.patrec.2021.07.019>
119. Zhang G, Pan Y, Zhang L (2021) Semi-supervised learning with GAN for automatic defect detection from images. *Autom Constr* 128:103764. <https://doi.org/10.1016/j.autcon.2021.103764>

120. Devulapalli S, Potti A, Krishnan R, Khan MdS (2021) Experimental evaluation of unsupervised image retrieval application using hybrid feature extraction by integrating deep learning and handcrafted techniques. *Mater Today Proc.* <https://doi.org/10.1016/j.matpr.2021.04.326>
121. Popescu DM, Abramson HG, Yu R, Lai C, Shade JK, Wu KC, Maggioni M, Trayanova NA (2021) Anatomically-informed deep learning on contrast-enhanced cardiac magnetic resonance imaging for scar segmentation and clinical feature extraction. *Cardiovascular Digital Health J.* <https://doi.org/10.1016/j.cvdhj.2021.11.007>
122. Costa G, Montemurro M (2020) Eigen-frequencies and harmonic responses in topology optimisation: a CAD-compatible algorithm. *Eng Struct* 214:110602. <https://doi.org/10.1016/j.engstruct.2020.110602>
123. Laishram R, Rabidas R (2021) WDO optimized detection for mammographic masses and its diagnosis: a unified CAD system. *Appl Soft Comput* 110:107620. <https://doi.org/10.1016/j.asoc.2021.107620>
124. Misra S, Jeon S, Lee S, Managuli R, Jang I-S, Kim C (2020) Multi-channel transfer learning of chest X-ray images for screening of COVID-19. *Electronics* 9:1388. <https://doi.org/10.3390/electronics9091388>
125. Jain G, Mittal D, Thakur D, Mittal MK (2020) A deep learning approach to detect COVID-19 coronavirus with X-ray images. *Biocybern Biomed Eng* 40:1391–1405. <https://doi.org/10.1016/j.bbe.2020.08.008>
126. Rahimzadeh M, Attar A (2020) A modified deep convolutional neural network for detecting COVID-19 and pneumonia from chest X-ray images based on the concatenation of Xception and ResNet50V2. *Inform Med Unlocked* 19:100360. <https://doi.org/10.1016/j.imu.2020.100360>
127. Arora V, Ng EY-K, Leekha RS, Darshan M, Singh A (2021) Transfer learning-based approach for detecting COVID-19 ailment in lung CT scan. *Comput Biol Med* 135:104575. <https://doi.org/10.1016/j.compbimed.2021.104575>
128. Che Azemin MZ, Hassan R, Mohd Tamrin MI, Md Ali MA (2020) COVID-19 deep learning prediction model using publicly available radiologist-adjudicated chest X-ray images as training data: preliminary findings. *Int J Biomed Imaging* 2020:e8828855. <https://doi.org/10.1155/2020/8828855>
129. Apostolopoulos ID, Mpesiana TA (2020) COVID-19: automatic detection from X-ray images utilizing transfer learning with convolutional neural networks. *Phys Eng Sci Med* 43:635–640. <https://doi.org/10.1007/s13246-020-00865-4>
130. Manickam A, Jiang J, Zhou Y, Sagar A, Soundrapandiyar R, Dinesh Jackson Samuel R (2021) Automated pneumonia detection on chest X-ray images: a deep learning approach with different optimizers and transfer learning architectures. *Measurement* 184:109953. <https://doi.org/10.1016/j.measurement.2021.109953>
131. Abbas A, Abdelsamea MM, Gaber MM (2021) Classification of COVID-19 in chest X-ray images using DeTraC deep convolutional neural network. *Appl Intell* 51:854–864. <https://doi.org/10.1007/s10489-020-01829-7>
132. Yoo SH, Geng H, Chiu TL, Yu SK, Cho DC, Heo J, Choi MS, Choi IH, Van Cung C, Nhung NV, Min BJ, Lee H (2020) Deep learning-based decision-tree classifier for COVID-19 diagnosis from chest X-ray imaging. *Front Med* 7:427. <https://doi.org/10.3389/fmed.2020.00427>
133. Narayan Das N, Kumar N, Kaur M, Kumar V, Singh D (2020) Automated deep transfer learning-based approach for detection of COVID-19 infection in chest X-rays. *IRBM.* <https://doi.org/10.1016/j.irbm.2020.07.001>
134. Haque KF, Abdelgawad A (2020) A deep learning approach to detect COVID-19 patients from chest X-ray images. *AI* 1:418–435. <https://doi.org/10.3390/ai1030027>
135. Abdani SR, Zulkifley MA, Mamat M (2020) U-net with spatial pyramid pooling module for segmenting oil palm plantations. In: 2020 IEEE 2nd international conference on artificial intelligence in engineering and technology (IICAJET). pp 1–5

136. Bridge J, Meng Y, Zhao Y, Du Y, Zhao M, Sun R, Zheng Y (2020) Introducing the GEV activation function for highly unbalanced data to develop COVID-19 diagnostic models. *IEEE J Biomed Health Inform* 24:2776–2786. <https://doi.org/10.1109/JBHI.2020.3012383>
137. Goel T, Murugan R, Mirjalili S, Chakrabartty DK (2021) OptCoNet: an optimized convolutional neural network for an automatic diagnosis of COVID-19. *Appl Intell* 51:1351–1366. <https://doi.org/10.1007/s10489-020-01904-z>
138. Afshar P, Heidarian S, Naderkhani F, Oikonomou A, Plataniotis KN, Mohammadi A (2020) COVID-CAPS: a capsule network-based framework for identification of COVID-19 cases from X-ray images. *Pattern Recogn Lett* 138:638–643. <https://doi.org/10.1016/j.patrec.2020.09.010>
139. Dhaya R (2020) Deep net model for detection of COVID-19 using radiographs based on ROC analysis. *J Innov Image Process* 2:135–140. <https://doi.org/10.36548/jiip.2020.3.003>
140. Deep transfer learning based classification model for COVID-19 disease. *IRBM* (2020). <https://doi.org/10.1016/j.irbm.2020.05.003>
141. Yan T, Wong PK, Ren H, Wang H, Wang J, Li Y (2020) Automatic distinction between COVID-19 and common pneumonia using multi-scale convolutional neural network on chest CT scans. *Chaos Solitons Fractals* 140:110153. <https://doi.org/10.1016/j.chaos.2020.110153>
142. Shaban WM, Rabie AH, Saleh AI, Abo-Elsoud MA (2020) A new COVID-19 patients detection strategy (CPDS) based on hybrid feature selection and enhanced KNN classifier. *Knowl-Based Syst* 205:106270. <https://doi.org/10.1016/j.knosys.2020.106270>
143. Han Z, Wei B, Hong Y, Li T, Cong J, Zhu X, Wei H, Zhang W (2020) Accurate screening of COVID-19 using attention-based deep 3D multiple instance learning. *IEEE Trans Med Imaging* 39:2584–2594. <https://doi.org/10.1109/TMI.2020.2996256>
144. Öztürk Ş, Özkaya U, Barstuğan M (2021) Classification of coronavirus (COVID-19) from X-ray and CT images using shrunken features. *Int J Imaging Syst Technol* 31:5–15. <https://doi.org/10.1002/ima.22469>
145. Hasan AM, AL-Jawad MM, Jalab HA, Shaiba H, Ibrahim RW, AL-Shamasneh AR (2020) Classification of COVID-19 coronavirus, pneumonia and healthy lungs in CT scans using Q-deformed entropy and deep learning features. *Entropy* 22:517. <https://doi.org/10.3390/e22050517>
146. Fung DLX, Liu Q, Zammit J, Leung CK-S, Hu P (2021) Self-supervised deep learning model for COVID-19 lung CT image segmentation highlighting putative causal relationship among age, underlying disease and COVID-19. *J Transl Med* 19:318. <https://doi.org/10.1186/s12967-021-02992-2>
147. Hurt B, Kligerman S, Hsiao A (2020) Deep learning localization of pneumonia: 2019 coronavirus (COVID-19) outbreak. *J Thorac Imaging* 35:W87. <https://doi.org/10.1097/RTI.0000000000000512>
148. Xu X, Jiang X, Ma C, Du P, Li X, Lv S, Yu L, Ni Q, Chen Y, Su J, Lang G, Li Y, Zhao H, Liu J, Xu K, Ruan L, Sheng J, Qiu Y, Wu W, Liang T, Li L (2020) A deep learning system to screen novel coronavirus disease 2019 pneumonia. *Engineering* 6:1122–1129. <https://doi.org/10.1016/j.eng.2020.04.010>
149. Wang S, Kang B, Ma J, Zeng X, Xiao M, Guo J, Cai M, Yang J, Li Y, Meng X, Xu B (2021) A deep learning algorithm using CT images to screen for corona virus disease (COVID-19). *Eur Radiol* 31:6096–6104. <https://doi.org/10.1007/s00330-021-07715-1>
150. Cohen JP, Dao L, Roth K, Morrison P, Bengio Y, Abbasi AF, Shen B, Mahsa HK, Ghassemi M, Li H, Duong TQ. Predicting COVID-19 pneumonia severity on chest X-ray with deep learning. *Cureus* 12:e9448. <https://doi.org/10.7759/cureus.9448>
151. Li MD, Arun NT, Gidwani M, Chang K, Deng F, Little BP, Mendoza DP, Lang M, Lee SI, O’Shea A, Parakh A, Singh P, Kalpathy-Cramer J (2020) Automated assessment and tracking of COVID-19 pulmonary disease severity on chest radiographs using convolutional Siamese neural networks. *Radiol Artif Intell* 2:e200079. <https://doi.org/10.1148/ryai.2020200079>

152. Ng M-Y, Wan EYF, Wong HYF, Leung ST, Lee JCY, Chin TW-Y, Lo CSY, Lui MM-S, Chan EHT, Fong AH-T, Fung SY, Ching OH, Chiu KW-H, Chung TWH, Vardhanbuthi V, Lam HYS, To KKW, Chiu JLF, Lam TPW, Khong PL, Liu RWT, Chan JWM, Wu AKL, Lung K-C, Hung IFN, Lau CS, Kuo MD, Ip MS-M (2020) Development and validation of risk prediction models for COVID-19 positivity in a hospital setting. *Int J Infect Dis* 101:74–82. <https://doi.org/10.1016/j.ijid.2020.09.022>
153. Liang W, Wang H, Huang X, Zhou J, Liu W (2020) 56 Gbit/s OOK signal in C-band over 20 km dispersion-uncompensated link transmission with receiver-side EDC algorithm. *IEEE Photonics J* 12:1–7. <https://doi.org/10.1109/JPHOT.2020.3027836>
154. Zhang K, Liu X, Shen J, Li Z, Sang Y, Wu X, Zha Y, Liang W, Wang C, Wang K, Ye L, Gao M, Zhou Z, Li L, Wang J, Yang Z, Cai H, Xu J, Yang L, Cai W, Xu W, Wu S, Zhang W, Jiang S, Zheng L, Zhang X, Wang L, Lu L, Li J, Yin H, Wang W, Li O, Zhang C, Liang L, Wu T, Deng R, Wei K, Zhou Y, Chen T, Lau JY-N, Fok M, He J, Lin T, Li W, Wang G (2020) Clinically applicable AI system for accurate diagnosis, quantitative measurements, and prognosis of COVID-19 pneumonia using computed tomography. *Cell* 181:1423–1433.e11. <https://doi.org/10.1016/j.cell.2020.04.045>
155. Ginsberg J, Mohebbi MH, Patel RS, Brammer L, Smolinski MS, Brilliant L (2009) Detecting influenza epidemics using search engine query data. *Nature* 457:1012–1014. <https://doi.org/10.1038/nature07634>
156. Bragazzi NL, Dai H, Damiani G, Behzadifar M, Martini M, Wu J (2020) How big data and artificial intelligence can help better manage the COVID-19 pandemic. *Int J Environ Res Public Health* 17:3176. <https://doi.org/10.3390/ijerph17093176>
157. Garattini C, Raffle J, Aisyah DN, Sartain F, Kozlakidis Z (2019) Big data analytics, infectious diseases and associated ethical impacts. *Philos Technol* 32:69–85. <https://doi.org/10.1007/s13347-017-0278-y>
158. Ajah I, Nweke H (2019) Big data and business analytics: trends, platforms, success factors and applications. *Big Data Cogn Comput* 3:32. <https://doi.org/10.3390/bdcc3020032>
159. White T (2012) Hadoop: the definitive guide, 3rd edn. Yahoo Press, Beijing
160. Chowell G, Cleaton JM, Viboud C (2016) Elucidating transmission patterns from internet reports: ebola and middle east respiratory syndrome as case studies. *J Infect Dis* 214:S421–S426. <https://doi.org/10.1093/infdis/jiw356>
161. Salathé M (2016) Digital pharmacovigilance and disease surveillance: combining traditional and big-data systems for better public health. *J Infect Dis* 214:S399–S403. <https://doi.org/10.1093/infdis/jiw281>
162. Zhao Y, Liu L, Qi Y, Lou F, Zhang J, Ma W (2020) Evaluation and design of public health information management system for primary health care units based on medical and health information. *J Infect Publ Health* 13:491–496. <https://doi.org/10.1016/j.jiph.2019.11.004>
163. Petrides AK, Tanasijevic MJ, Goonan EM, Landman AB, Kantartjis M, Bates DW, Melanson SEF (2017) Top ten challenges when interfacing a laboratory information system to an electronic health record: experience at a large academic medical center. *Int J Med Inform* 106:9–16. <https://doi.org/10.1016/j.ijmedinf.2017.06.008>
164. Mosser H, Urban M, Dürr M, Rüger W, Hruba W (1992) Integration of radiology and hospital information systems (RIS, HIS) with PACS: requirements of the radiologist. *Eur J Radiol* 16:69–73. [https://doi.org/10.1016/0720-048X\(92\)90248-8](https://doi.org/10.1016/0720-048X(92)90248-8)
165. EMRS adoption: exploring the effects of information security management awareness and perceived service quality. *Health Policy Technol* 7:365–373 (2018). <https://doi.org/10.1016/j.hlpt.2018.10.012>
166. Wu J, Wang J, Nicholas S, Maitland E, Fan Q (2020) Application of big data technology for COVID-19 prevention and control in China: lessons and recommendations. *J Med Internet Res* 22:e21980. <https://doi.org/10.2196/21980>
167. Rodger JA (2015) Discovery of medical big data analytics: improving the prediction of traumatic brain injury survival rates by data mining patient informatics processing software hybrid Hadoop hive. *Inform Med Unlocked* 1:17–26. <https://doi.org/10.1016/j.imu.2016.01.002>

168. Winters-Miner LA, Bolding P, Hill T, Nisbet B, Goldstein M, Hilbe JM, Walton N, Miner G, Brown EW, Kohn MS (2015) Chapter 25—IBM Watson for clinical decision support. In: Winters-Miner LA, Bolding PS, Hilbe JM, Goldstein M, Hill T, Nisbet R, Walton N, Miner GD (eds) Practical predictive analytics and decisioning systems for medicine. Academic Press, pp 1038–1040
169. Douine M, Lambert Y, Galindo MS, Mutricy L, Sanna A, Peterka C, Marchesini P, Hiwat H, Nacher M, Adenis A, Demar M, Musset L, Lazrek Y, Cairo H, Bordalo Miller J, Vreden S, Suarez-Mutis M (2021) Self-diagnosis and self-treatment of malaria in hard-to-reach and mobile populations of the Amazon: results of Malakit, an international multicentric intervention research project. *Lancet Regional Health Am*:100047. <https://doi.org/10.1016/j.lana.2021.100047>
170. Wu CH, Chiu RK, Yeh HM, Wang DW (2017) Implementation of a cloud-based electronic medical record exchange system in compliance with the integrating healthcare enterprise's cross-enterprise document sharing integration profile. *Int J Med Inform* 107:30–39. <https://doi.org/10.1016/j.ijmedinf.2017.09.001>
171. Santos-Pereira J, Gruenwald L, Bernardino J (2021) Top data mining tools for the healthcare industry. *J King Saud Univ Comput Inf Sci*. <https://doi.org/10.1016/j.jksuci.2021.06.002>
172. Mathew PS, Pillai AS (2015) Big data solutions in healthcare: problems and perspectives. In: 2015 international conference on innovations in information, embedded and communication systems (ICIIECS), pp 1–6
173. Dolezel D, McLeod A (2019) Big data analytics in healthcare: investigating the diffusion of innovation. *Perspect Health Inf Manage* 16:1a
174. Zhang H, Zang Z, Zhu H, Uddin MI, Amin MA (2022) Big data-assisted social media analytics for business model for business decision making system competitive analysis. *Inf Process Manage* 59:102762. <https://doi.org/10.1016/j.ipm.2021.102762>
175. Wang M, Tai C, Zhang Q, Yang Z, Li J, Shen K, Wang K (2021) Application of BigML in the classification evaluation of top coal caving. *Shock Vib* 2021:e8552247. <https://doi.org/10.1155/2021/8552247>
176. Khashan EA, Eldesouky AI, Fadel M, Elghamrawy SM (2020) A big data based framework for executing complex query over COVID-19 datasets (COVID-QF). [arXiv:200512271](https://arxiv.org/abs/2005.12271) [cs]
177. Elmeiligy MA, Desouky AIE, Elghamrawy SM (2020) A multi-dimensional big data storing system for generated COVID-19 large-scale data using apache spark. [arXiv:200505036](https://arxiv.org/abs/2005.05036) [cs]



Hounaida Sakly is a Ph.D. and Engineer in Medical Informatics. She is a member of the research program “deep learning analysis of Radiologic Imaging” in Stanford university. Certified in Healthcare Innovation with MIT-Harvard Medical school. Her main field of research is the Data science (Artificial Intelligence, Big Data, blockchain, Internet of things...) applied in healthcare. She is a member in the Integrated Science Association (ISA) in the Universal Scientific Education and Research Network (USERN) in Tunisia. Currently, she is serving as a lead editor for various book and special issue in the field of digital Transformation and data science in Healthcare. Recently, she has won the Best Researcher Award in the International Conference on Cardiology and Cardiovascular Medicine—San Francisco, United States.



AI and Big Data for Drug Discovery

Aglaiá Kavidopoulou, Konstantinos N. Syrigos,
Stylianos Makrogkikas, Zodwa Dlamini, Rodney Hull,
Rahaba Marima, Amanda Skepu, Elias P. Koumoulos, George Bakas,
Ioannis Vamvakaris, George Evangelou, and Georgios Lolas

One of the biggest challenges to medicine is the incorporation of information technology in our practices. Samuel Wilson

K. N. Syrigos · G. Evangelou · G. Lolas

3rd Department of Internal Medicine and Laboratory, National and Kapodistrian University of Athens (NKUA), Athens School of Medicine, 11527 Athens, Greece

S. Makrogkikas

FALCONBIO PTE, Ltd., SGINnovate, 32 Carpenter Street, Singapore 059911, Singapore

Z. Dlamini · R. Hull · R. Marima · A. Skepu · G. Lolas

SAMRC Precision Oncology Research Unit (PORU), Pan African Cancer Research Institute (PACRI), University of Pretoria, Hatfield 0028, South Africa

A. Skepu

Next Generation Health Division 1, CSIR, Meiring Naude Road, Brummeria, Pretoria 0001, South Africa

E. P. Koumoulos · G. Bakas

Innovation in Research and Engineering Solutions (IRES), Boulevard Edmond Machtens 79/22, 1080 Brussels, Belgium

A. Kavidopoulou · E. P. Koumoulos · G. Lolas (✉)

Integrate Computational & Mathematical Modeling Approaches (InCELLiA) P.C., Lavriou 1, 19500 Lavrion, Greece

e-mail: glolas@med.uoa.gr

I. Vamvakaris

Department of Pathology, Athens Chest Hospital “Sotiria”, 11527 Athens, Greece

1 Introduction

Drug research, discovery, and development are complex, costly, lengthy, and time-consuming [1]. In clinical studies, at least nine in ten drug candidates fail between phase 1 and regulatory approval in clinical trials [2]. As a result of this attrition, much financial and resource loss is induced (recent estimates range the cost of a drug's R&D from \$314 million to \$2.8 billion [3]). In drug discovery research, *in vitro* and *in silico* approaches play a significant role in lowering the costs, compared to conventional animal models. Using this new approach in the early stages of drug discovery research, it is possible to reduce the high number of drug attritions by selecting drug candidates with acceptable therapeutic activities, thereby avoiding inappropriate compounds with negative side effects [4–7]. Even though this *in vitro*-*in silico* modern technology seems better than the traditional animal model approach, the modern approach still has low correspondence to *in vivo* drug activities with regard to efficacy and undesirable side effects [8, 9]. On the other hand, AI can examine substances for their possible toxicities and biological functions using computational drug modeling. Existing computer models, such as quantitative structure–activity relationship (QSAR) models, can be used to predict a large number of novel compounds that are involved in a variety of biological outcomes. Existing models in commercial drug discovery software can be used to predict the physicochemical and pharmacokinetic properties of novel compounds. However, such models are not yet optimal for predicting new drug efficacy and side effects, as shown in Fig. 1 [9, 10]. For instance, with the QSAR model, issues around experimental data errors in training sets, the use of small training sets, and the lack of experimental validations are limiting factors [11, 12]. QSAR is based on the hypothesis of similarity in chemical structures; that is, similar compounds have similar activities. However, training sets are not adequate to address the high attrition rates in drug discovery research because they provide information on the chemical structure and target activity [12–14].

Chemical libraries have become indispensable tools for new drug development procedures [15, 16]. Chemical compounds can be combined together to refine the development process, and the combinatorial chemistry effort has, over the past decade, induced the development of high-throughput screening techniques (HTS) [17, 18]. HTS uses a standard protocol to screen for millions of compounds. Modern HTS techniques are commonly combined with robotic systems and have a significant impact on experimental testing cost reduction [19, 20]. Using HTS and combinatorial drug synthesis, data related to chemical responses grow rapidly, especially data related to the drug response of specific targets [21].

The four Vs are the issues related to big data: variety (source diversity), volume (data scale), velocity (data expansion), and veracity (data consistency) (data uncertainty) [22, 23]. Unfortunately, the conventional QSAR model and machine learning methods are not suitable for dealing with big datasets generated by drug discovery research involving thousands to millions of compounds [24]. Additionally, the sparsity and variety of the resulting data, coupled with complex

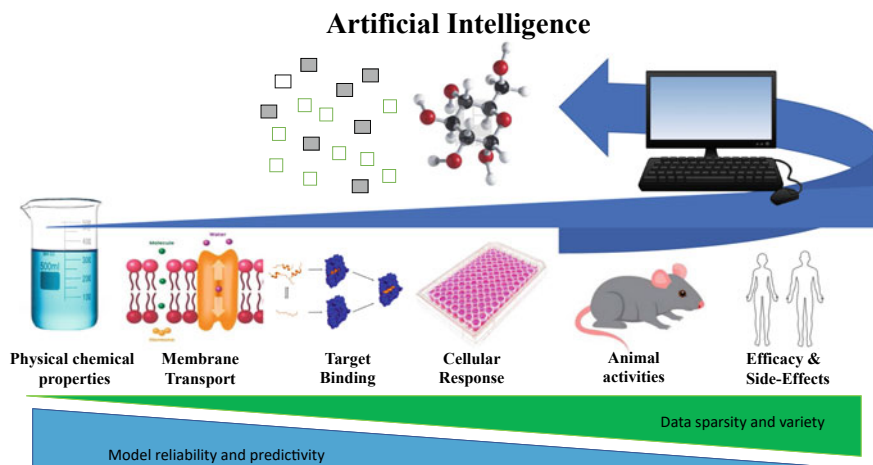

Fig. 1 A caricature representation of a QSAR model. AI can be used to predict physical–chemical properties, membrane transport, and target binding. Model reliability and predictivity are maximized in early stages of prediction: physical–chemical properties, membrane transport, and target binding but are minimized as the complexity increases from cell, to mice and finally humans

physiological mechanisms, such as drug responses, increase significantly when moving from *in vitro* to *in vivo* studies. To forecast medication efficacy and safety in *in vivo* models and in humans, complex scenarios incorporating big data necessitate the development of creative computational algorithms to deal with multidimensional, large-volume, and high-sparsity data sources. With the advancement of predictive modeling in drug discovery research, these unique computational methodologies allow AI to move from traditional machine learning to modern deep learning [25–27].

2 Big Data in Drug Discovery

Along with the development of HTS techniques, various data-sharing projects have also been developed. These include PubChem (chemical structure and associated biological properties public repository) [28] and ChEMBL [database comprising information on compound binding, function, toxicity, absorption, distribution, metabolism, and excretion (ADME)] [29]. Additional data-sharing sources are designed specifically for drugs and drug candidates, including DrugBank, DrugMatrix, and Binding Database (BindingDB). DrugBank (<https://www.drugbank.ca>) is a publicly accessible database containing information on all approved drugs and their mechanisms, interactions, and apposite targets [30]. DrugMatrix (<https://ntp.niehs.nih.gov/results/drugmatrix/index.html>) contains toxicogenomic information data of drugs [31]. BindingDB (<https://www.bindingdb.org/bind/index.jsp>) is also a public data resource sharing information regarding drug-target (protein/enzyme)

binding, illustrated as measured binding affinities [32]. To process and analyze these large datasets, advanced computational approaches such as cloud computation and graphics processing units (GPUs) are required [33, 34].

3 From Machine Learning to Deep Learning: AI Milestone

Although the concept of AI was introduced in the 1950s, the first QSAR study was conducted in the 1960s. Before the 1990s, linear regression computational approaches were used in the early stages of drug discovery [35, 36]. During these early stages, the chemical structures of the drugs were used as chemical descriptors for modeling [35, 37]. As AI applications have advanced in drug discovery, the development of novel chemical descriptors beyond chemical structures, such as molecular fingerprints, has significantly increased. In contrast to linear regression, machine-learning approaches between the 1990s and the 2000s were based on nonlinear modeling algorithms [35].

Data availability for drug discovery and advancements in computational approaches have led to innovative modeling techniques, such as large-scale networks. In 1989, the first application of a neural network in drug discovery was reported, followed by the application of various other neural networks, including the popular artificial neural network (ANN) [38]. The ANN approach has numerous variables, such as the input, thus forming a network through hundreds of artificial neurons, jointly contributing to the prediction of the output. The use of ANN approaches required advanced computational models and directly benefited from the computer hardware developments in the 1990s. Together with ANN approaches, the concept of deep learning was introduced in the 1980s [5]. Compared to other machine learning approaches, such as deep learning, ANNs do not demonstrate significant advantages when data availability is constrained for drug model development [35, 39]. Furthermore, between the 1990s and the 2000s, computational hardware models were still inadequate for training neural networks (such as ANN) with many hidden layers and large datasets for drug model development.

In the 2010s, when computer hardware used graphics processing units (GPUs) and cloud computing, significant progress in ANN was achieved. Advancements in computational models have benefited ANN approaches and subsequent deep neural networks (DNNs) with many hidden layers [40]. The deep learning milestone and big data concepts have been almost simultaneously published and are increasingly being applied to study complex biological systems and patterns, such as drug discovery research [41–43].

Convolutional neural networks (CNNs) are among the most commonly used deep learning approaches. CNNs are commonly used in cancer clinical image modeling diagnosis, heart disease, and Alzheimer's disease [44–46]. In drug discovery research, CNN approaches are used to analyze image data acquired from experimental HTS data [47]. CNNs have distinct advantages in image recognition;

hence, they are also used in the recognition of 3D experimental and virtual images to predict protein–ligand binding [48, 49]. CNNs have also been used to interpret drug molecular graphs for anticipated molecular features [50].

4 Recent Novel Targets by AI

A novel target and its associated small-molecule inhibitor involved in idiopathic pulmonary fibrosis has recently been proposed through AI-based approaches by Insilico Medicine a biotechnology company [51]. So far, small-molecule inhibitors have demonstrated acceptable efficacy in *in vitro* and *in vivo* models. This small-molecule inhibitor was nominated for investigation as a novel drug. This enabled studies to commence in December 2020 and will be targeted for clinical trials in early 2022. Depending on the clinical trial outcome, the novel target and its small-molecule inhibitor are the first candidates to be discovered, proposed, and approved using AI.

Currently, AI research has focused on deep learning, which is a subfield of machine learning. A characteristic of this new research field is that its artificial neural network (ANN) mimics the structure of the human brain [52].

Since DENDRAL and META-DENDRAL were introduced, chemists have been involved in AI applications. Chemists used AI to rethink some of their theories; DENDRAL induced new rules of mass spectral fragmentation and explored new fields, such as chemoinformatics. Chemoinformatics includes an environment with computational drug design tools ranging from classical structure-based QSAR and matched molecular pairs to free-energy perturbation [52]. Machine learning tools have been developed, such as QSAR modeling, which can analyze potential biologically active molecules from a pool of candidate compounds rapidly and at low cost. Therefore, drug development has evolved dramatically in the era of “big data” and machine learning, progressing toward deep learning methodologies. This new age promises a more powerful and effective means of working with massive amounts of data generated by modern drug development methods [52]. As a result of these advancements, artificial intelligence has been used to discover drugs. The four crucial primary stages of drug discovery are target identification and validation, compound screening and lead optimization, preclinical research, and clinical trials [53].

The first step is the study of the disease–target to identify the desirable molecule, which can be achieved by cellular and genetic evaluation of the molecule, genomic and proteomic analysis, and bioinformatic predictions [52].

The second step is devoted for formulation and testing of the optimal compound. To find the chemical, researchers used molecular libraries and methods like combinatorial chemistry, high-throughput screening, and virtual screening. To improve the functional qualities of newly synthesized drug candidates, structure–activity and *in silico* research, as well as cellular functional testing, are used. Finally, to investigate the chemical *in vivo*, animal models were used to perform pharmacokinetic and toxicity tests [52].

After passing all preclinical tests, step three entailed administering the medication candidate to patients in clinical research. Clinical trials were conducted in three stages: Phase I, drug safety (a small number of human subjects were tested); Phase II, drug efficacy (a small number of people affected by the specified ailment were tested); and Phase III, efficacy studies (a large number of people affected by the specified ailment were tested) [53]. The chemical has been reviewed for approval and commercialization by organizations such as the Food and Drug Administration (FDA) and the European Medicines Agency (EMA), since the therapeutic candidate's safety and efficacy have been shown in clinical trials (EMA) [53].

Specifically, AI can be used to design new molecules and plan synthesis if the system has the fundamental intelligence to generate autonomously innovative molecular representations that are structurally and chemically similar to existing medications. To put it another way, artificial intelligence has been used to develop new lead compounds that demonstrate the required activity in a virtual environment. Combining computational de novo design with AI can create a “computer chemist” who can learn from known and useful molecules to create chemically precise and synthesizable structures with predetermined biological activity. The most noteworthy outcomes of these efforts are molecular graph convolution techniques, variational autoencoders, and recurrent neural networks (RNNs) [52].

According to Olivecrona et al. [54], the training of an RNN using simplified molecular-input line-entry system (SMILES) representations from the ChEMBL database was used in an experiment to build novel compounds. Subsequently, new sequences were created using pre-trained RNNs that were tweaked using policy-based reinforcement learning. The training set performs the learning operation for sequences that follow conditional probability distributions. 94% of the sequences generated by the network corresponded to real chemical structures, 90% of which were new. After the molecular structure inputs were provided, machine learning and neural network methods were used to predict the activity of the compound.

According to Schneider [55], advanced machine learning requires large, well-annotated datasets that must be compiled or created. Furthermore, the chemical structure and observable pharmacological effects of a single drug have not been analyzed in a straightforward manner. Consequently, most medications have many biological targets and actions that are heavily influenced by the patient's genetic profile and other circumstances. Accordingly, several hurdles may arise in drug design, primarily due to intrinsically ill-posed problems caused by unknown contributing basics.

Schneider et al. [55] made an effort to create a non-human ‘drug designer’. He stated, “*Modern machine-learning methods are very fast and can consider several design goals in parallel. Therefore, our drug design software was used to identify important features and characteristics of known drugs. The obtained models were then used to automatically assemble new molecules with the desired properties learned from scratch.*”

Another neural network-based project is Atomwise [56], invented by Abraham Heifets and Izhar Wallach in California, USA. It uses machine learning technology to screen compounds quickly, and applies the same technology as in 2D image analysis as well as speech recognition, all utilized to perform molecular recognition (3D image recognition). However, human intervention is also inevitable.

PaccMann, INtERAcT, and pathway-induced multiple kernel learning (PIMKL) from IBM research are open-source deep-learning projects.

4.1 PaccMann

PaccMann [57] is an innovative approach for the prediction of anticancer compound sensitivity (cancer cell-drug sensitivity) using a multimodal attention-based neural network. This initiative is built on three pillars of drug sensitivity: the molecular structure of drugs, cancer cell transcriptome profiles, and prior knowledge of protein interactions within cells [57].

4.2 INtERAcT

INtERAcT [58] is a database that gathers information by reviewing cancer research publications, and derives interactions by applying unsupervised machine learning. An increasing number of biomedical publications is a rich source of new knowledge. Thus, a large amount of biological data are not immediately available, making it difficult for researchers to uncover these relationships. As a result, INtERAcT pulls information about protein–protein interactions from a large number of biomedical articles across a wide range of scientific fields in an entirely unsupervised manner. This makes it easier for researchers to use interactive data. It proposes a new metric for estimating the interaction score between two molecules in the space where the associated words are contained, based on vector representations of words previously assessed on a large amount of domain-specific data. All other methods were outperformed by this metric. It is also quite forgiving when it comes to parameter selection, which results in the identification of known molecular interactions in every cancer type analyzed [58].

4.3 PIMKL

PIMKL, or **pathway-induced multiple kernel learning** [59], is a machine-learning algorithm that can predict phenotypes from multiomic data. Specifically, this groundbreaking methodology can classify samples and provide a pathway-based molecular fingerprint of the signature that underlies classification. It integrates multimodal molecular measurements optimized from a set of pathway-induced kernels. These kernels were created using prior knowledge in the form of a molecular interaction network and a set of annotated gene sets. The links

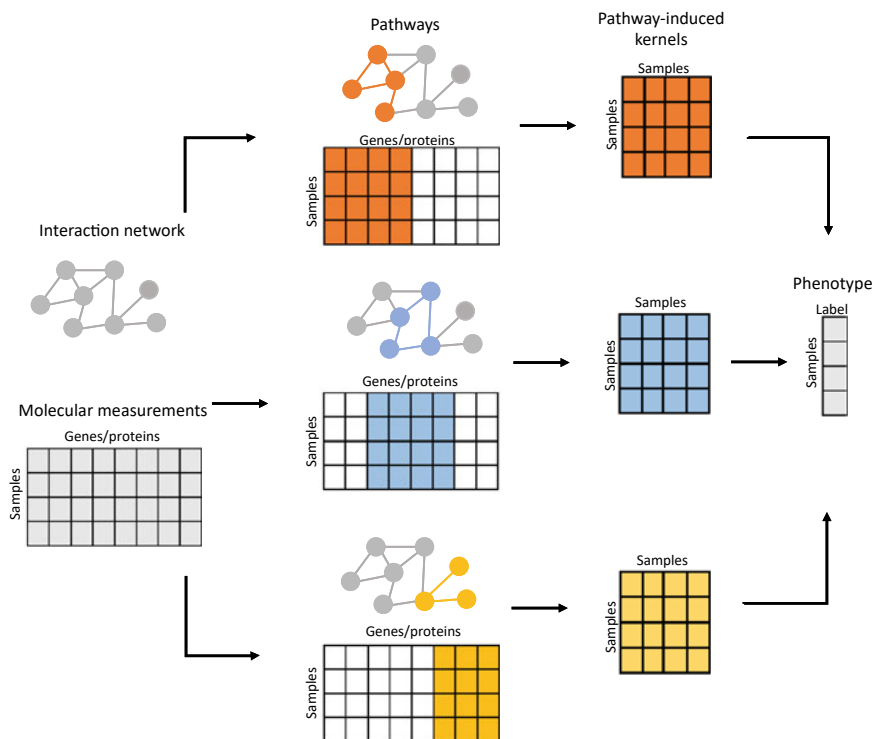

Fig. 2 A representation of the **PIMKL** concept as adopted by [59]. A network topology describes chemical interactions in PIMKL, and comparable sub-networks can be used to build a combination of pathway-induced kernels. After that, the complicated combination of kernels is optimized to anticipate a desired phenotype. The mixture's weights assign a value to each chosen pathway, offering light on the molecular pathways that contribute to the specific phenotype [59]

between these pathway-based kernels were then strengthened with the purpose of identifying a phenotype of interest. Finally, as illustrated in Fig. 2, PIMKL identifies the molecular pathways that aid in the prediction of the phenotype in question [60].

5 Deep Neural Networks

One of the most effective promoter strategies in drug development is the use of massive transcriptional response datasets to train deep neural networks (DNNs) to classify diverse medicines into therapeutic groups based on their transcriptional profiles. Aliper et al. [61] used DNNs to predict the pharmacological features of drugs by exploring the transcriptome data for repurposing. DNNs are multilayer networks of connected and interacting artificial neurons with multiple hidden layers

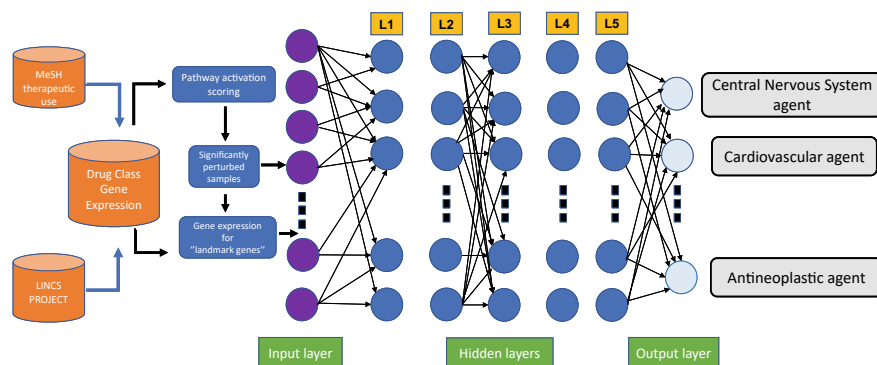

Fig. 3 A comprehensive summary of how deep neural networks are being used in drug discovery and development, as adopted by [61]

that perform data transformation. Although state-of-the-art results have outperformed human accuracy, the use of deep learning in biomedicine has been gradual. Furthermore, significant levels of accurate classification have been accomplished using traditional machine learning approaches, but these require the use of manually selected and tuned features. On the other hand, the greatest benefit of neural networks is the automatic feature of learning from massive datasets (details are presented in Fig. 3) [61].

The LINCS Project examined 678 drug samples from the A549, MCF-7, and PC-3 cell lines and related them to 12 therapeutic drug classes determined from MeSH. They employed both unprocessed and processed transcriptome data to train the DNN. For a pooled dataset of samples disturbed with varied concentrations of the medication for 6 and 24 h, the processed data were obtained utilizing pathway-activation-scoring methods. DNN achieved high classification accuracy in both processed and unprocessed data, even though the accuracy of the processed data was significantly better (for an overview see Fig. 4) [61].

6 AI in 3D Pharmacophore Models

A pharmacophore is a 3D molecular structure that contains the alignment of the molecular characteristics responsible for recognizing and binding to a pharmacological target [62]. The 3D molecular structure was used to identify lead compounds in ligand-based virtual screening via 3D-molecular similarity methods. The principle of this method is that similar compounds would have similar bioactivity [62].

The features obtained from the 3D alignment of the structure are employed in the development of machine learning algorithms that can predict binding locations and rank docking postures (i.e., the favored orientation of one molecule in accordance

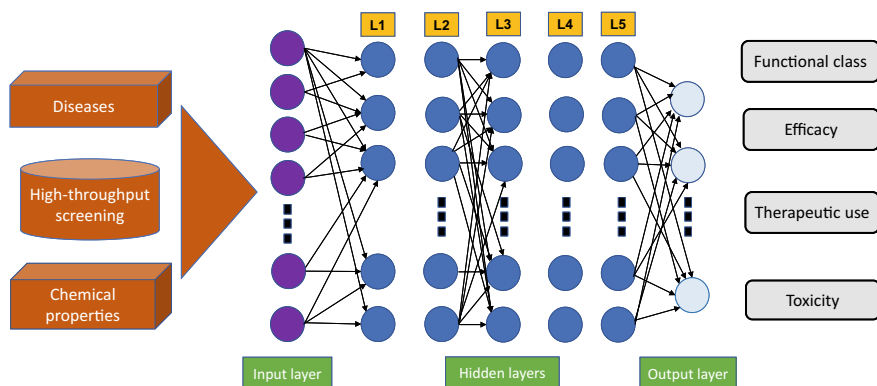

Fig. 4 Aliper et al. [61] used a training design in which gene expression data from the LINCS project were connected to 12 MeSH therapeutic use categories. The DNN was trained with 977 and 271 neural nodes, respectively, on gene expression level data for “landmark genes” and pathway activation scores for significantly perturbed samples, as adopted by [61]

with a second one when bound with each other, and the formation of a stable complex is accomplished).

Ballirani et al. [63] developed the HS-Pharm model, which is a knowledge-based strategy that takes advantage of atom-based fingerprints of known ligand-binding sites. These are fed into a random forest (RF) model (i.e., a machine learning model that creates output predictions by combining the results of a series of regression decision trees [3]) that can be used to rank cavity atoms that should be employed as ligand-binding targets.

Another model, Pharm-IF, was developed by Sato et al. [62] and is called Pharm-IF. This model is based on a pharmacophore interaction fingerprint using machine learning methods (i.e., support vector machines (SVMs) and RFs) rather than similarity-based ranking. Pharmacophoric descriptors were used to train a convolutional neural network (CNN) to locate cavities and predict binding affinities.

7 AI and Gene Profiling Analysis

Gene profiling analysis plays a vital role in drug development, as reported by Chengalvala et al. [60]. Specifically, accessibility to human genomes and a large number of experimental animals have enriched gene expression profiles and their connections to physiological outcomes. Gene expression profiles can be characterized as genetic fingerprints that are unique to a specific cell or tissue, providing information about their functions and thus contributing to the identification of new drug targets used for drug discovery techniques. Furthermore, if a large number of genes from different tissues or the same tissue need to be analyzed under a wide

range of experimental conditions or among different species, high-density DNA microarrays are among the most effective and versatile tools.

The first bioinformatics and microarray-based method for cancer diagnosis was developed in 1999 by Golub et al. [64]. The aim of this method was to create a powerful diagnostic platform that could classify leukemia based on genomes, identify known prognostic leukemia subtypes, and detect characteristic gene signatures to explicitly opt for individual patients who are at risk of relapse [65]. Furthermore, for feature selection and statistical analysis, this method employs the signal-to-noise (SN) technique.

For class discovery, this method uses both unsupervised learning (grouping samples based on the similarity of their gene expression profiles using self-organization maps (SOMs), as well as hierarchical and probabilistic clustering) and supervised learning (gathering tumors based on known differences and forming transcriptional profiles from defined groups using weighted voting, (SVM), and other methods) [65].

8 AI and Drug Screening

In addition to designing new drug molecules using artificial intelligence, it is also important to predict the features of new drugs, such as physicochemical properties, bioactivity, and toxicity.

The first characteristic refers to properties such as partition coefficient ($\log P$), solubility, intrinsic permeability of the drug, and degree of ionization [66]. These can be predicted using AI-based tools such as the QSPR workflow [67]. Deep learning algorithms such as undirected graph-recursive neural networks and graph-based convolutional neural networks (CVNNs) can be used to predict the solubility of substances [67]. Additionally, models (as well as graph kernels and kernel ridge-based models) were used to estimate the acid dissociation constants of the ANN-based molecules. Cell lines from various or the same species are utilized to create cellular permeability data for a variety of compounds to predict cellular permeability [67]. AI-assisted predictors were provided with this information. Support vector machines (SVMs), artificial neural networks (ANNs), k-nearest neighbor algorithms, probabilistic neural network algorithms, partial least squares (PLS), and chemical compounds for training can predict intestinal absorption based on the molecular mass, molecular surface area, molecular refractivity, total hydrogen count, molecular volume, total polar surface area, partition coefficient ($\log P$), solubility index ($\log S$), and rotatable bonds [67].

AI-assisted predictors can provide insight into the bioactivity of drug molecules. Bioactivity is based on the efficiency of a drug molecule linked to the target protein or receptor. If the drug molecule does not present affinity towards the targeted protein, delivery of the therapeutic response will not be able to be transferred. Unwanted affinities of the created therapeutic compounds with inappropriate proteins or receptors can lead to harm in some situations [67].

Artificial intelligence approaches are used to calculate a drug's binding affinity, taking into account the drug's properties or similarities with its target, to avoid such situations. Some apps for predicting such interactions include ChemMapper and the Similarity Ensemble Approach (SEA) [67].

Finally, AI-assisted predictors last can predict the toxicity of a drug. It is important to ensure that the drug molecules are present. To identify the toxicity of a compound, *in vitro* assays based on cells have been used in previous animal studies. **LimTox**, **pkCSM**, **admetSAR**, and **Toxtree** are web-based tools that can provide toxicity [67].

9 AI and Drug Delivery

Another important aspect of drug development is the establishment of tools that can provide successful drug delivery, frequently called nanorobots. Nanorobots are drug delivery vehicles that include integrated circuits, power supplies, sensors, and secure data backups. Computational technologies, such as artificial intelligence, have been used to preserve such data. Nanorobots are designed to bypass collision, identify the target, detect and attach, and excrete the body [67]. Based on physiological parameters, such as pH, they may navigate to the target location. Finally, implantable nanorobots (i.e., microchip implants) are employed for controlled drug administration, and dose, modified release, and controlled release should all be taken into consideration. AI tools such as neural networks, fuzzy logic, and integrators are some of the artificial intelligence tools used for that purpose [67].

10 AI in Clinical Trials

In the drug development process, clinical trials are one of the most crucial and critical steps [52]. The clinical development phase is responsible for ensuring the efficacy and safety of the new medicines. It was formed from four phases, as shown in Fig. 5 [68]. The pipeline of drug development is difficult to manage; thus, it is challenging to proceed with costly and time-consuming clinical trials as rapidly as possible. Every delay in the process of getting out of the market means millions of dollars in lost revenues for a blockbuster drug.

Most of the time, in clinical trials, all the information needed is gathered by human service suppliers amid patient visits without direct information from patients. As Nayak et al. [69] stated, all that information is collected from individualized computing gadgets (advanced cells and tablets), which billions of individuals are using. In this way, the data from every patient in a continuous and convenient way are entered into the devices and apps and stored on their own cell phones. Information on non-transferable ailments, such as hypertension and diabetes, can be collected and conveyed accurately through wearable medicinal

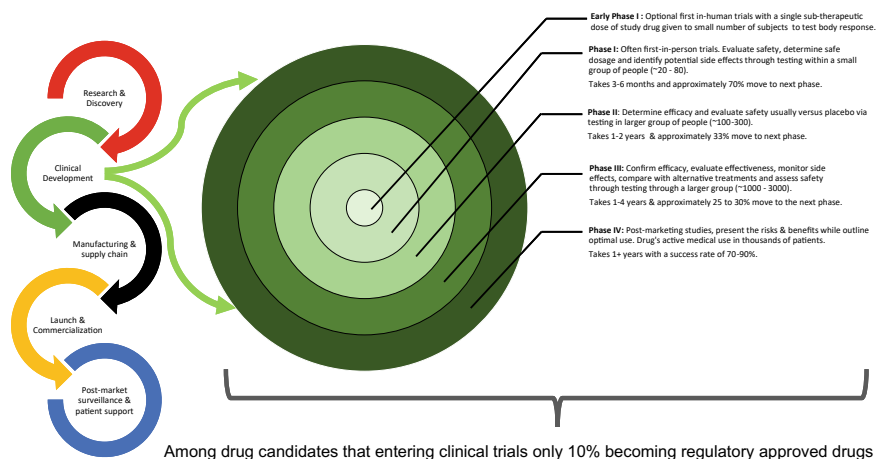

Fig. 5 An overview of the lengthy process of clinical development with the success rate to be just over 10% as adopted by [68]

gadgets. Next, all collected information will be published from cloud-based clinical trial frameworks in order for the results and registries of examiners and patients to be accessible on the web.

AI has also been applied to the design of clinical trials to make things easier. As Woo [70] pointed out, a protocol is followed in every clinical trial, which details how the study will be carried out. Months of delays and hundreds of thousands of dollars could be added to the total cost if a problem arises and changes to the current protocol are required [70]. To avoid this issue, all prior information essential for the design of a study as well as similar studies, clinical data, and regulatory information should be gathered from a variety of sources. For this purpose, AI-powered software can digest all the data faster and collect more data than a human can.

Trials.ai, a start-up company in San Diego, California, specializes in designing better trial protocols using its AI tool. Natural language processing (NLP) and other AI techniques collect and evaluate publicly available data such as journal articles and prescription labels. The company's software then uses these data to build the customer's proposed trial, taking into account elements such as the rigor of the eligibility criteria and the potential influence on outcomes such as cost, time, or participant retention [70].

It is also worth noting that even studies with well-designed protocols rely on the participants' ability to follow instructions. AI once again found a solution to this issue. AiCure, a data analysis firm based in New York City, offers a platform that allows users to capture videos of themselves taking medication using their smartphones. Subsequently, AiCure software analyzes the photographs and utilizes computer vision techniques to identify the person and the pill, confirming whether it was consumed [70].

11 Conclusions

AI and big data are promising tools for successful drug discovery research because of the high attrition rates of drug development and discovery. The ultimate aim was to remove human decision making and bias from the procedure. This can be achieved through the full automation of the machine learning process in combination with AI to select potential compounds and predict their interactions and side effects. Advances in modern machine learning approaches, such as deep learning, have improved the drug discovery research landscape with unique abilities to deal with big datasets. The application of big data in drug discovery may face specific challenges. Such challenges are often related to the need for large amount of data, sparsity in data, and their lack of interpretability. Furthermore, there is still a need to develop standard criteria and modelling workflows for the applicability of deep learning approaches. Nonetheless, AI and big data applications are revolutionizing drug discovery research, salvaging the image of this entity, and advancing healthcare quality.

References

1. Waring MJ, Arrowsmith J, Leach AR, Leeson PD, Mandrell S, Owen RM, Pairaudeau G, Pennie WD, Pickett SD, Wang J, Wallace O, Weir A (2015) An analysis of the attrition of drug candidates from four major pharmaceutical companies. *Nat Rev Drug Discovery* 14 (7):475–486
2. Fleming N (2018) How artificial intelligence is changing drug discovery. *Nature* 557(7707): S55–s57
3. Lindner C (2017) Automated image interpretation using statistical shape models. In: Zheng G, Li S, Szekely G (eds) *Statistical shape and deformation analysis: methods, implementation and applications*. Elsevier BV, pp 3–32
4. Zhang L, Tan J, Han D, Zhu H (2017) From machine learning to deep learning: progress in machine intelligence for rational drug discovery. *Drug Discovery Today* 22(11):1680–1685
5. Gawehn E, Hiss JA, Schneider G (2016) *Deep Learn Drug Discov* 35(1):3–14
6. Beresford AP, Segall M, Tarbit MH (2004) In silico prediction of ADME properties: are we making progress? *Curr Opin Drug Discov Devel* 7(1):36–42
7. Hughes JP, Rees S, Kalindjian SB, Philpott KL (2011) Principles of early drug discovery. *Br J Pharmacol* 162(6):1239–1249
8. Collins FS, Gray GM, Bucher JRJS (2008) Transforming environmental health protection. *Science* 319(5865):906
9. Cherkasov A, Muratov EN, Fourches D, Varnek A, Baskin II, Cronin M, Dearden J, Gramatica P, Martin YC, Todeschini R, Consonni V, Kuz'min VE, Cramer R, Benigni R, Yang C, Rathman J, Terfloth L, Gasteiger J, Richard A, Tropsha A (2014) QSAR modeling: where have you been? Where are you going to? *J Med Chem* 57(12):4977–5010
10. Zhu H, Bouhifd M, Donley E, Egnash L, Kleinstreuer N, Kroese ED, Liu Z, Luechtefeld T, Palmer J, Pamies D, Shen J, Strauss V, Wu S, Hartung T (2016) Supporting read-across using biological data. *Altex* 33(2):167–182
11. Roy PP, Leonard JT, Roy KJC, Systems IL (2008) Exploring the impact of size of training sets for the development of predictive QSAR models. *Chemometr Intell Labor Syst* 90(1):31–42
12. Zhao L, Wang W, Sedykh A, Zhu H (2017) Experimental errors in QSAR modeling sets: what we can do and what we cannot do. *ACS Omega* 2(6):2805–2812

13. Tetko IV, Sushko I, Pandey AK, Zhu H, Tropsha A, Papa E, Oberg T, Todeschini R, Fourches D, Varnek A (2008) Critical assessment of QSAR models of environmental toxicity against *Tetrahymena pyriformis*: focusing on applicability domain and overfitting by variable selection. *J Chem Inf Model* 48(9):1733–1746
14. Wang W, Kim MT, Sedykh A, Zhu H (2015) Developing enhanced blood-brain barrier permeability models: integrating external bio-assay data in QSAR modeling. *Pharm Res* 32(9):3055–3065
15. Liu R, Li X, Lam KS (2017) Combinatorial chemistry in drug discovery. *Curr Opin Chem Biol* 38:117–126
16. Kennedy JP, Williams L, Bridges TM, Daniels RN, Weaver D, Lindsley CW (2008) Application of combinatorial chemistry science on modern drug discovery. *J Comb Chem* 10(3):345–354
17. Zhu H, Xia M (2016) High-throughput screening assays in toxicology. Springer
18. Ingelse J, Auld DS, Jadhav A, Johnson RL, Simeonov A, Yasgar A, Zheng W, Austin CP (2006) Quantitative high-throughput screening: a titration-based approach that efficiently identifies biological activities in large chemical libraries. *Proc Natl Acad Sci USA* 103(31):11473–11478
19. Zhu H, Zhang J, Kim MT, Boison A, Sedykh A, Moran K (2014) Big data in chemical toxicity research: the use of high-throughput screening assays to identify potential toxicants. *Chem Res Toxicol* 27(10):1643–1651
20. Broach JR, Thorner JN (1996) High-throughput screening for drug discovery. *Nature* 384(6604 Suppl):14–16
21. Macarron R, Banks MN, Bojanic D, Burns DJ, Cirovic DA, Garyantes T, Green DV, Hertzberg RP, Janzen WP, Paslay JW, Schopfer U, Sittampalam GS (2011) Impact of high-throughput screening in biomedical research. *Nat Rev Drug Discov* 10(3):188–195
22. Ciallella HL, Zhu H (2019) Advancing computational toxicology in the big data era by artificial intelligence: data-driven and mechanism-driven modeling for chemical toxicity. *Chem Res Toxicol* 32(4):536–547
23. Lee CH, Yoon HJ (2017) Medical big data: promise and challenges. *Kidney Res Clin Practice* 36(1):3–11
24. Santos R, Ursu O, Gaulton A, Bento AP, Donadi RS, Bologa CG, Karlsson A, Al-Lazikani B, Hersey A, Oprea TI, Overington JP (2017) A comprehensive map of molecular drug targets. *Nat Rev Drug Discov* 16(1):19–34
25. Scheeder C, Heigwer F, Boutros M (2018) Machine learning and image-based profiling in drug discovery. *Curr Opin Syst Biol* 10:43–52
26. Hu Y, Bajorath J (2013) Compound promiscuity: what can we learn from current data? *Drug Discov Today* 18(13–14):644–650
27. Chatzidakis M, Botton GA (2019) Towards calibration-invariant spectroscopy using deep learning. *Sci Rep* 9(1):2126
28. Wang Y, Xiao J, Suzek TO, Zhang J, Wang J, Bryant SH (2009) PubChem: a public information system for analyzing bioactivities of small molecules. *Nucl Acids Res* 37(Web Server):W623–W633
29. Gaulton A, Bellis LJ, Bento AP, Chambers J, Davies M, Hersey A, Light Y, McGlinchey S, Michalovich D, Al-Lazikani B, Overington JP (2012) ChEMBL: a large-scale bioactivity database for drug discovery. *Nucl Acids Res* 40(Database):D1100–D1107
30. Wishart DS, Feunang YD, Guo AC, Lo EJ, Marcu A, Grant JR, Sajed T, Johnson D, Li C, Sayeeda Z, Assempour N, Iynkkaran I, Liu Y, Maciejewski A, Gale N, Wilson A, Chin L, Cummings R, Le D, Pon A, Knox C, Wilson M (2018) DrugBank 5.0: a major update to the DrugBank database for 2018. *Nucl Acids Res* 46(D1):D1074–D1082
31. Gilson MK, Liu T, Baitaluk M, Nicola G, Hwang L, Chong J (2016) BindingDB in 2015: a public database for medicinal chemistry, computational chemistry and systems pharmacology. *Nucl Acids Res* 44(D1):D1045–D1053

32. Armbrust M, Fox A, Griffith R, Joseph AD, Katz R, Konwinski A, Lee G, Patterson D, Rabkin A, Stoica I, Zaharia M (2010) A view of cloud computing. *Commun ACM* 53(4):50–58
33. Mirza B, Wang W, Wang J, Choi H, Chung NC, Ping P (2019) Machine learning and integrative analysis of biomedical big data. *Genes* 10(2)
34. Nickolls J, Dally WJ (2010) The GPU computing era. *IEEE Micro* 30(2):56–69
35. Zhu H (2020) Big data and artificial intelligence modeling for drug discovery. *Ann Rev Pharmacol Toxicol* 60(1):573–589
36. Russell SJ, Peter Norvig Artificial Intelligence A. Modern (2003) Approach. Upper Saddle River, New Jersey 7458:116–119
37. Labute P (2000) A widely applicable set of descriptors. *J Mol Graph Model* 18(4):464–477
38. Baskin II, Winkler D, Tetko IV (2016) A renaissance of neural networks in drug discovery. *Expert Opin Drug Discov* 11(8):785–795
39. Simmons K, Kinney J, Owens A, Kleier D, Bloch K, Argentar D, Walsh A, Vaidyanathan G (2008) Comparative study of machine-learning and chemometric tools for analysis of in-vivo high-throughput screening data. *J Chem Inf Model* 48(8):1663–1668
40. Hinton G, Deng L, Yu D, Dahl GE, Mohamed A-R, Jaitly N, Senior A, Vanhoucke V, Nguyen P, Sainath TN, Kingsbury B (2012) Deep neural networks for acoustic modeling in speech recognition: the shared views of four research groups. *IEEE Signal Process Mag* 29(6):82–97
41. Silver D, Huang A, Maddison CJ, Guez A, Sifre L, van den Driessche G, Schrittwieser J, Antonoglou I, Panneershelvam V, Lanctot M, Dieleman S, Grewe D, Nham J, Kalchbrenner N, Sutskever I, Lillicrap T, Leach M, Kavukcuoglu K, Graepel T, Hassabis D (2016) Mastering the game of Go with deep neural networks and tree search. *Nature* 529(7578):484–489
42. LeCun Y, Bengio Y, Hinton G (2015) Deep learning. *Nature* 521(7553):436–444
43. Xie L, Draizen EJ, Bourne PE (2017) Harnessing big data for systems pharmacology. *Annu Rev Pharmacol Toxicol* 57:245–262
44. Chougrad H, Zouaki H, Alheyane O (2018) Deep convolutional neural networks for breast cancer screening. *Comput Methods Programs Biomed* 157:19–30
45. Lin W, Tong T, Gao Q, Guo D, Du X, Yang Y, Guo G, Xiao M, Du M, Qu X (2018) Convolutional neural networks-based MRI image analysis for the Alzheimer’s disease prediction from mild cognitive impairment. *Front Neurosci* 12:777
46. Nirschl JJ, Janowczyk A, Peyster EG, Frank R, Margulies KB, Feldman MD, Madabhushi A (2018) A deep-learning classifier identifies patients with clinical heart failure using whole-slide images of H&E tissue. *PLoS ONE* 13(4):e0192726
47. Hofmarcher M, Rumetshofer E, Clevert DA, Hochreiter S, Klambauer G (2019) Accurate prediction of biological assays with high-throughput microscopy images and convolutional networks. *J Chem Inf Model* 59(3):1163–1171
48. Stepniewska-Dziubinska MM, Zielenkiewicz P, Siedlecki P (2018) Development and evaluation of a deep learning model for protein-ligand binding affinity prediction. *Bioinformatics* 34(21):3666–3674
49. Ragoza M, Hochuli J, Idrobo E, Sunseri J, Koes DR (2017) Protein-ligand scoring with convolutional neural networks. *J Chem Inf Model* 57(4):942–957
50. Altae-Tran H, Ramsundar B, Pappu AS, Pande V (2017) Low data drug discovery with one-shot learning. *ACS Cent Sci* 3(4):283–293
51. Gupta R, Srivastava D, Sahu M, Tiwari S, Ambasta RK, Kumar P (2021) Artificial intelligence to deep learning: machine intelligence approach for drug discovery. *Mol Divers* 25(3):1315–1360
52. Kavidopoulou A (2021) Applications for artificial intelligence in biomedical sciences. National and Kapodistrian University of Athens, Athens, Greece
53. Chan HCS, Shan H, Dahoun T, Vogel H, Yuan S (2019) Advancing drug discovery via artificial intelligence. *Trends Pharmacol Sci* 40(8):592–604

54. Olivecrona M, Blaschke T, Engkvist O, Chen H (2017) Molecular de-novo design through deep reinforcement learning. *J Cheminform* 9(1):48
55. Eureka. A Chemistry-Savvy AI Joins the Lab Team. <https://www.criver.com/eureka-a-chemistry-savvy-ai-joins-the-lab-team>
56. Kelder R. Commercializing deep neural networks for drug discovery. Eureka: a dose of science. <https://eureka.criver.com/commercializing-deep-neural-networks-for-drug-discovery>. Accessed 18 July
57. Born J, Manica M, Oskooei A, Cadow J, Rodríguez Martínez M (2020) PaccMannRL: designing anticancer drugs from transcriptomic data via reinforcement learning. Springer International Publishing, Cham, pp 231–233
58. Manica M, Mathis R, Cadow J, Rodríguez Martínez M (2019) Context-specific interaction networks from vector representation of words. *Nat Mach Intell* 1(4):181–190
59. Manica M, Cadow J, Mathis R, Rodríguez Martínez M (2019) PIMKL: pathway-induced multiple Kernel learning. *NPJ Syst Biol Appl* 5:8
60. Chengalvala MV, Chennathukuzhi VM, Johnston DS, Stevis PE, Kopf GS (2007) Gene expression profiling and its practice in drug development. *Curr Genomics* 8(4):262–270
61. Aliper A, Plis S, Artemov A, Ulloa A, Mamoshina P, Zhavoronkov A (2016) Deep learning applications for predicting pharmacological properties of drugs and drug repurposing using transcriptomic data. *Mol Pharm* 13(7):2524–2530
62. Sato T, Honma T, Yokoyama S (2010) Combining machine learning and pharmacophore-based interaction fingerprint for in silico screening. *J Chem Inf Model* 50(1):170–185
63. Barillari C, Marcou G, Rognan D (2008) Hot-spots-guided receptor-based pharmacophores (HS-Pharm): a knowledge-based approach to identify ligand-anchoring atoms in protein cavities and prioritize structure-based pharmacophores. *J Chem Inf Model* 48(7):1396–1410
64. Golub TR, Slonim DK, Tamayo P, Huard C, Gaasenbeek M, Mesirov JP, Coller H, Loh ML, Downing JR, Caligiuri MA, Bloomfield CD, Lander ES (1999) Molecular classification of cancer: class discovery and class prediction by gene expression monitoring. *Science* 286(5439):531–537
65. Zini G (2005) Artificial intelligence in hematology. *Hematology* 10(5):393–400
66. Paul D, Sanap G, Shenoy S, Kalyane D, Kalia K, Tekade RK (2021) Artificial intelligence in drug discovery and development. *Drug Discov Today* 26(1):80–93
67. Yang X, Wang Y, Byrne R, Schneider G, Yang S (2019) Concepts of artificial intelligence for computer-assisted drug discovery. *Chem Rev* 119(18):10520–10594
68. Taylor K, Properzi F, Cruz M (2020) Intelligent clinical trials: transforming through AI-enabled engagement
69. Nayak VS, Khan MS, Shukla BK, Chaturvedi P (2016) Artificial intelligence in clinical research. *Int J Clin Trials* 3(4):187–193
70. Woo M (2019) An AI boost for clinical trials. *Nature* 573(7775):S100–s102



Georgios Lolas I am currently the coordinator of Systems Medicine group of the Oncology Unit of the 3rd Department of Internal Medicine and Laboratory of the National and Kapodistrian University of Athens. I am also the co-founder of the start-up InCELLiA focusing on developing multiscale mathematical models for the designing of *in silico* therapies in a personalized and precise manner. Our group has already developed mathematical models describing complex processes such as tumor induced lymphangiogenesis and proteolysis. Lately, we have moved our attention on developing *in silico* models that are related to the newly established field of Cancer Neuroscience. More specifically, we investigate the active role of nervous system and subsequently chronic stress as emerging regulators of cancer initiation, growth and dissemination.



Blockchain Technologies for Internet of Medical Things (IoMT) Based Healthcare Systems: A New Paradigm for COVID-19 Pandemic

Houneida Sakly , Mourad Said, Ahmed A. Al-Sayed, Chawki Loussaief, Rachid Sakly, and Jayne Seekins

Blockchain in Healthcare Today (BHTY) is the world's first peer review journal that amplifies and disseminates distributed ledger technology research and innovations in the healthcare sector. (Andrew Bosworth—Meta's chief technology officer)

Those who design Internet of Medical Things devices are leading the charge into what has now become a digital health revolution. Smart, connected, and secure medical devices for telehealth, remote patient monitoring, and drug delivery compliance are completely changing the traditional healthcare delivery model. (Marten L. Smith Business Development Manager, Medical Products Group Microchip Technology, Inc.)

H. Sakly (✉)

COSMOS Laboratory, National School of Computer Sciences (ENSI),
University of Manouba, Manouba, Tunisia
e-mail: houneida.sakly@esiee.fr

M. Said

Radiology and Medical Imaging Unit, International Center Carthage Medical,
Monastir, Tunisia
e-mail: mouradsaid@yahoo.fr

A. A. Al-Sayed

University of California, San Francisco, Berkeley, USA
e-mail: ahmed_alsayed@berkeley.edu

C. Loussaief · R. Sakly

Higher School of Health Sciences and Techniques, Monastir, Tunisia
e-mail: prchawkiloussaief@gmail.com

R. Sakly

e-mail: rchid.esstsm@gmail.com

J. Seekins

Department of Radiology, Stanford University School of Medicine, Palo Alto, USA
e-mail: jseekins@stanford.edu

1 Introduction

The adoption of IoT-based concepts and practices in medicine and healthcare has the potential to reduce costs, increase healthcare quality, and improve customer-related reactions. The Internet of Medical Things (IoMT) is an IoT network of medical devices, sensors, and apps that uses computer networks to connect healthcare cyber and physical resources. The use of new smart technologies in IoMT-based frameworks has been regarded as a crucial factor in the uptake of telemedicine practices [1, 2].

With contemporary technological advancements, the fields of medicine and healthcare are rapidly increasing, and many new fields of human health diagnosis, treatment, and care are being developed. Wireless technology is improving, and 5G mobile technology enables the Internet of Medical Things (IoMT) to enhance patient care and prevent sickness more efficiently [3]. In the healthcare field, the Internet of Medical Things (IoMT) has been developed with other tactics to combat COVID-19, enhance the safety of frontline experts and covid-19 patients, boost effectiveness by reducing the disease's harshness in human lives, and lower fatality rates. Significant advancements in terms of applications and technology, as well as in diagnosing the healthcare cybersecurity crisis [4], have been made, which have been amplified by the quick and broad adoption of IoMT throughout the world. Several ongoing studies have suggested that integrating security measures with technology may lead to the adoption of secure IoMT applications. Furthermore, Artificial intelligence, big data, and blockchain technology paired with IoMT technologies present more viable possibilities. This chapter discusses the IoMT architecture, applications, technologies, and security advancements made in the fight against COVID-19 [5]. This study also contains critical information on specific IoMT architectural models, unique IoMT applications, IoMT security metrics, and technical guidance that could be applied to a variety of IoMT systems in the medical industry to address COVID-19 [6].

Financial resources and the ability to adapt to rapidly changing healthcare and medicine industries, as well as all other institutions that must accept these new technologies, are the most serious dangers associated with the deployment of Internet of Medical Things (IoMT) [7].

Governments will have to stay up with the shift as new technologies are employed in medical and healthcare by offering the best rules for these new services to the public. This requires large amounts of resources from various regulatory agencies and countries. Another issue is the wide range of available medical record-keeping technologies as well as the lack of compatibility and interoperability across many systems utilized by institutions. If data cannot be easily exchanged, they cannot be integrated and aggregated to facilitate information exchange and patient record sharing across many medical specialists, with whom the patient may have to interact. This may result in big data analysis and communication across organizations with mismatched database architectures [8]. The convergence of machine learning (ML) and artificial intelligence (AI) enhances the usefulness

(IoMT) [9]. Doctors can reach appropriate conclusions more quickly and reliably when dealing with massive amounts of streaming data from networked medical equipment. If the Internet of Things (IoT) or sensor network has a large number of base stations delivering data, a data center server will have problems acquiring, assessing, and processing data [10]. Data collection for the IoMT system will experience a concurrent bottleneck based on present technical solutions when the number of wireless sensor network base stations is considerable, resulting in data collection failure and a catastrophic impact on IoMT applications. Coronavirus disease (COVID-19) has suddenly appeared, putting the entire healthcare system on high alert. COVID-19 has spurred scientists to create a new 'Smart' healthcare system that emphasizes early detection, prevention, education, and handling. The role of IoMT applications in improving healthcare systems, an assessment of the current state of research demonstrating the effectiveness of IoMT benefits to patients and healthcare systems, and a brief overview of technologies that supplement IoMT, as well as the challenges that come with the development of a smart healthcare system are all discussed. IoMT and related technologies have solved various problems by utilizing remote monitoring, telemedicine, robots, and sensors. However, widespread adoption appears to be difficult because of issues such as data privacy and security, data management, scalability, and upgradeability [11].

For several years, blockchain registries have piqued the curiosity of healthcare industry participants. Distributed registers, such as storage and transmission technologies, may handle several challenges related to the medical and pharmaceutical fields as well as the research area. Some initiatives seem promising even though they are still in their early stages. Several healthcare firms are keen to develop a distributed patient registry that can be built on a blockchain architecture. Currently, information is not shared among physicians, and patients must disclose the results of past visits to each new expert on their own. One task made it more difficult for an uneducated patient who lacked a grasp of medical jargon and had no exact understanding of his file contents [12]. The overarching vision of blockchain technology for the future is to address many of the issues currently plaguing the healthcare industry, including the creation of a shared archive of health-related information for physicians and patients, independent of their electronic diagnosis, improving safety and secrecy, and allocating more resources to patient care rather than medical staff. This is the start of a blockchain revolution that is predicted to move from Bitcoin to the medical industry. Blockchain may have significant advantages in the context of intelligent health, especially when individuals and society as a whole benefit from effective and personalized solutions [13, 14].

Some crises are susceptible to blockchain technology; however, they have built-in security against others. Consequently, data security must be prioritized, particularly when utilized in healthcare. Blockchain technology should not be handled randomly in healthcare, because of its immutability. Massive files or those that change frequently may be kept outside, and all network credentials are kept confidential. Decentralized administration, immutable databases, sources of features, detectable features, resilient features, and the availability of features are some of the advantages of using blockchains over traditional methods of health database

management systems. any authorized user; however, encryption based on a patient's private key keeps it out of the hands of unauthorized users. Blockchain has the potential to provide a one-of-a-kind system for securely storing and retrieving personal records of authorized users. By eliminating misunderstandings among different healthcare professionals involved in caring for the same patient, numerous errors can be avoided, faster diagnosis and interventions can be performed, and care can be tailored to the particular needs of each patient [15, 16]. Healthcare providers can submit and share characteristics through a secure system, registering a specified set of standardized features on the network and keeping private encrypted stems to segregate information such as X-rays or other scans. The practice of contracts and standard endorsement processes can help achieve seamless communication in large medical network [17, 18]. The COVID-19 pandemic has exposed flaws in our health systems, revealing, among other things, the high vulnerability of supply chains, questions of sovereignty and interdependence, the inefficiency of overly centralized EHR systems, the importance of the state to assist healthcare providers to hold on and then restart, and a lack of international cooperation and alignment of health ecosystem strategies. This problem has also highlighted the relevance of medical data, which is a holy grail for modeling, choosing, and predicting, as well as the role of blockchain as a vital and tangible component in cybersecurity and storage strategies [19]. In other words, the crisis has highlighted the need for healthcare providers to rebuild their confidence, making their exchanges and medical transactions more dependable and safer [20]. In this section, we describe the benefits of combining connected medical devices with the blockchain technology. IOMTs are becoming more autonomous as they integrate cognitive abilities and can make judgments in real time based on collected data. Consequently, health users of IoT will need to create smart contracts that describe the business rules governing the different potential interactions between the network's health domain interveners. On the other hand, the shared ledger is used to keep track of the objects' activities (exchanges, flows, interactions, etc.) and make them available to all medical network members. The remainder of this chapter is organized as follows: Sect. 2 is provided to describe the IoMT concept for COVID-19; Sect. 3 is devoted to present the role of artificial intelligence and big data technology in IoMT; Sect. 4 we will present the concept of HealthBlock for secure blockchain-based healthcare data management system; Sect. 5 describes the paradigm of Chains of Medical Things (COMT) for Healthcare Integration; and the last section, the blockchain IoMT (BIOMT) insight for solving IoT security and healthcare issues will be developed.

2 IoMT Concept for COVID-19

The Internet of Medical Things (IoMT) is a collection of medical equipment and software that communicate with healthcare IT systems over the internet. Machine-to-machine communication, which is at the heart of IoMT, is enabled by

medical equipment outfitted with Wi-Fi technology. Cloud platforms such as Amazon's web services connect IoMT devices [21, 22] that store and analyze data input. IoMTs include patient wearable mHealth devices that may communicate information to caregivers, remote monitoring of covid-19 patients, tracking medicine or vaccine orders, and locating covid-19 patients admitted to hospitals. Oxygen pumps that connect to analytical dashboards and hospital beds with sensors that monitor patients' vital signs are examples of medical devices that can be transformed or installed as IoMT [23].

Many customer mobile devices are designed with RFID tags (RFIDs) and near-field communication (NFC) devices that allow devices to share information with computer systems, which are more viable uses for IoMT than ever before. RFID tags can also be affixed to covid-19 equipment and medical supplies, allowing hospital staff to keep track of them [24]. Data are collected via a variety of wearable sensors for quick monitoring, assessment, decision-making, and improved care approvals from doctors via IoMT devices to powerful cloud and data analytics layers. Telemedicine is the process of using IoMT devices to remotely monitor covid-19 patients in their homes. Patients do not have to travel to the hospital every time they have a medical query or change their condition with this form of processing [25]. Healthcare providers are becoming increasingly concerned about the security of sensitive data such as private health information, which goes through IoMT and is controlled under the Health Insurance Portability and Accountability Act. To provide versatility and scalability in IoMT systems in a variety of situations, the IoMT architecture comprises of multiple layers.

Indeed, the Internet of Things in Health has enabled covid-19 patients to benefit from a number of benefits, including the collection of more data to further specify the diagnosis, general improvements in diagnoses, more regular health monitoring, and better management of crises and health emergencies. Undeniably, most healthcare professionals are wary of IoT if they do not offer sufficient security for their patient data. The processes for gathering and utilizing data must be rigorous and entirely open to generate an environment of confidence that may expedite extensive growth. Healthcare options that are useful during the Covid-19 epidemic.

According to the layer functions in the IoT system, the IoMT architecture consists of multiple levels [26–29]:

1. **The sensor layer:** is the lowest layer and consists of integrated smart objects and sensors. These medical sensors enable real-time information processing by connecting real-world and physical measurements. Sensors come in a range of shapes and sizes, and each is employed for covid-19 patients that allows them to save a set of measurements of clinical symptoms. A sensor can detect a physical property and convert it into an interpretable signal. The majority of sensors connect to sensor gateways (aggregators) through a personal area network (PAN), such as Bluetooth, ZigBee, or ultra-wideband (UWB), or a local area network (LAN), such as WiFi or Ethernet. Wireless sensor networks (WSNs) have low data rates and low power consumption.

2. **The Gateways and network layers:** Vast amounts of data are generated by small sensors, necessitating a high-performance, reliable, and wired/wireless network architecture. Machine-to-machine (M2M) networks and applications are supported by networks connected using various protocols [30]. Multiple networks, each with their own set of access protocols and technologies, must be integrated into a heterogeneous configuration. To fulfill the communication needs for bandwidth, latency, or security, these networks may be public, private, or hybrid. Converged network-layer abstraction allows different hospitals and/or medical centers to communicate routed information independently, without jeopardizing security, privacy, or performance. In healthcare applications, each medical organization uses the network as if it were private.
3. **Management service layer:** Information processing, security controls, medical image analytics, storage of medical reports, and device management are all components of the management service layer. Various analytical approaches are used to extract relevant information from large amounts of raw data so that it can be processed more quickly. Furthermore, data-in-motion analysis, often known as streaming analytics, must be performed in real-time. By reducing recurring communication, analytics minimizes network layer stress and lowers sensor power consumption, allowing for quicker reactions to data established by the sensors. Information can be accessed, managed, or integrated during the data management. Furthermore, data filtering techniques such as data integration, data anonymization, and data synchronization are used to hide information specifics. Data abstraction was used to extract specific information from covid-19 patient. Finally, security should be included in all aspects of the IoT architecture. Security is used to secure data as they pass through the HER system. Medical data integrity allows genuine and dependable judgments by preventing unauthorized healthcare consumers or hackers from accessing the IoMT system. Physicians want to develop several security methods. Furthermore, numerous authentication and encryption methods for privacy and security, such as message authentication codes (MACs) and rivest shamir adleman (RSAs), ensure the legitimacy and confidentiality of transaction data while being sent across networks. Furthermore, an extensible authentication protocol is an authentication framework that supports various authentication techniques (EAP).

Technological solutions and policy methods are used to ensure the removal of sensitive data. To ensure data privacy, the European Network and Information Security Agency (ENISA) developed a data-privacy strategy based on a data-masking platform. Threats from other networks seek spoof data access while using IoT-distributed systems that incorporate embedded devices in public spaces. Therefore, IoT security must be implemented on a solid basis at several interacting levels.

4. **Application layer:** includes the various applications of the IoMT systems described in Fig. 1.

This IoT architecture is depicted in layers using various technologies that can be divided into three categories: network sharing, latency, and capacity, such as

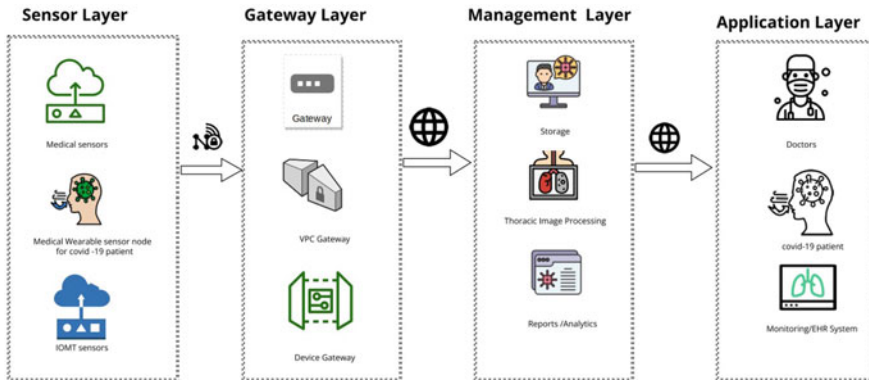

Fig. 1 Architecture of IoMT Layers for covid-19

software-defined radios and cognitive networks for radiologists; (ii) microprocessor chips and devices, such as low-power sensors and wireless sensor networks in hospitals and medical institutions; and (iii) service management to support IoMT applications, such as storage and streaming analytics.

3 Artificial Intelligence and Big Data Technology in IoMT for Covid-19 Management

“E-health” is a complicated field because it involves several actors in the medical manufacturing industry, all of whom are governed by regulations that are more or less adapted to today’s reality, especially as newly connected medical devices emerge, allowing covid-19 patients to take real-time control of their health. New information and communication technologies are at the core of the progress of the healthcare system, facilitating the flow of data among many stakeholders.

The volume of medical data created by the IoT is expanding as the number of connected things increases. Consequently, big data analytical tools are required to support and analyze them in real time [10]. These systems can quickly handle vast volumes of data continuously generated by IoMT devices and derive relevant insights for supporting medical decisions. Machine learning makes it possible to identify precise data models of covid-19. Using these patterns, medical institutions can establish predictive maintenance for EHR systems.

Devices connected to the IoT generate large amounts of data that are collected, stored, and processed [31]. Machine learning will then use these vast oceans of data to improve the processes and increase the autonomy of medical systems. Big data and the Internet of Medical Things are opening up new prospects for efficiency gains, whether in the fields of research, prevention, understanding covid-19 diseases or the efficacy of drugs and vaccines post pre-treatment. The analysis of the data collected by doctors, the hospital, or the patients themselves via connected objects

allows them to be contextualized, and their crossing helps to forge more precise scans of the problem analyzed [32].

The progress of these new technologies (Spark and Spark streaming) [33] makes it conceivable to process increasingly large volumes of data in real time but also to exploit them more quickly owing to the use of parallel, distributed calculation methods and memory, thereby opening the door to new use cases and creating value. By combining analytics with other techniques, such as machine learning, it is easy to imagine new applications that provide high value-added, such as predictive medicine.

If, until now, patient covid-19 management consisted of moving from a curative to a preventive logic (PCR test, awareness campaigns, vaccination, hygiene, etc.), the multiplication of connected objects and cross-analysis of data health systems now allows for the adoption of predictive logic through the study of medical antecedent data for covid-19 cases (chronic disease, consumption, drug, etc.) risk element localization. Machine learning allows for the enrichment of analytical models over time. Consequently, it is feasible to envision the development of a real-time automated alarm system that alerts doctors to the possibility of a problem before it occurs [34].

Personalized medicine consists of individualizing the treatments for covid-19 patients: On the one hand, sensors (placed either on the patient himself by means of connected objects such as a bracelet, or nearby, by example on smart hospital beds) collect data on a regular basis. However, this information is crossed and integrated with other data in business intelligence applications to improve the effectiveness of the treatments. Combined with 3D printing [35], personalized medicine offers even more attractive perspectives. The ability to collect, store, process, and return data is crucial. In addition to the phenomenal evolution of technologies for the intelligent use of these data [36], the communication protocols of connected objects have also significantly improved, making them lighter (MQTT) [37]. The means to promote the interoperability of data is to ensure that it is shared and to make the most of it to make medical decisions more efficient.

This section discusses how IoMT systems are being used, the impact of COVID-19, the supporting applications and technology used, and the potential design and security challenges. Table 1 presents the taxonomy of these insights.

4 Blockchain Concept for COVID-19

A system that manages transactions among partners in a dispersed network is what Blockchain is defined in the broadest sense. When we discuss transactions, we can refer to the transfer of assets, currencies, and exchanges as well as the recording of states in a register and the capacity to track actions [59]. In this situation, we are interested in medical transaction management. In such a situation, transaction management is of interest. For covid-19 patients, blockchain is a method for storing and sending medical data. It is designed to be transparent, secure, and operate

Table 1 Taxonomy IoMT pandemic mitigation

Application	Architecture	Technology	Security
<i>IoMT pandemic mitigation</i>			
Detection and prediction [38]	5 layers [39]	Device [40]	Confidentially [41]
Tracking and monitoring [42]	4 layers [43]	Big data [44]	Integrity [45]
Records/EHR [46]	3 layers [47]	Artificial intelligence [48]	Availability [49]
Telemedicine and mHealth [50]	Fog layers [51]	Blockchain [52]	Authenticity [53]
<i>IoMT framework-based AI and big data</i>			
Using IoMT and DNN, a drone-assisted covid-19 screening and detection framework for rural areas [54]			
Early covid-19 assessment using an IoT-based deep learning framework [55]			
COVID-19: a framework based on internet-of-medical-things-enabled edge computing [56]			
A cloud and IoMT-based big data analytics system was used during the COVID-19 pandemic [24]			
An intelligent framework based on disruptive technologies has been designed for COVID-19 analysis [57]			
A security management framework for big data in smart healthcare was developed for COVID-19 [58]			

without the need for a central control authority [60]. The study and potential implementation of a blockchain network make sense as soon as a medical transactional act between numerous stakeholders in the health area brings the principles of honesty, security, sharing, or traceability into play. The central idea is built on collective confidence rather than the presence of a centralized trustworthy third party. There is no third-party verifier or central control body in a blockchain system [61]. From a technical standpoint, the installation of a blockchain system is based on a chained and stored set of records in a distributed covid-19 patient database, using a revolutionary replication method. User anonymity depends on cryptographic keys. Asymmetric cryptography has also been used to sign and verify transactions.

The concept is the same: one can calculate a public key using a private key, but not vice versa. This concept is incorporated into blockchain, which is currently used in various secure systems. Finally, the blockchain’s core provides a built-in system for generating key pairs (private and public keys) that are required to sign medical transactions. Therefore, corrupting a node group to obtain an agreement is both difficult and expensive. Modifying a record, on the other hand, would have no influence on the global record chain’s security because a transaction would have to be recreated from the beginning of the network. Apart from security, Tend the blockchain is built on two other concepts: the concept of a distributed ledger (shared ledger) and the concept of a contract (smart contract) [62, 63]) (Fig. 2).

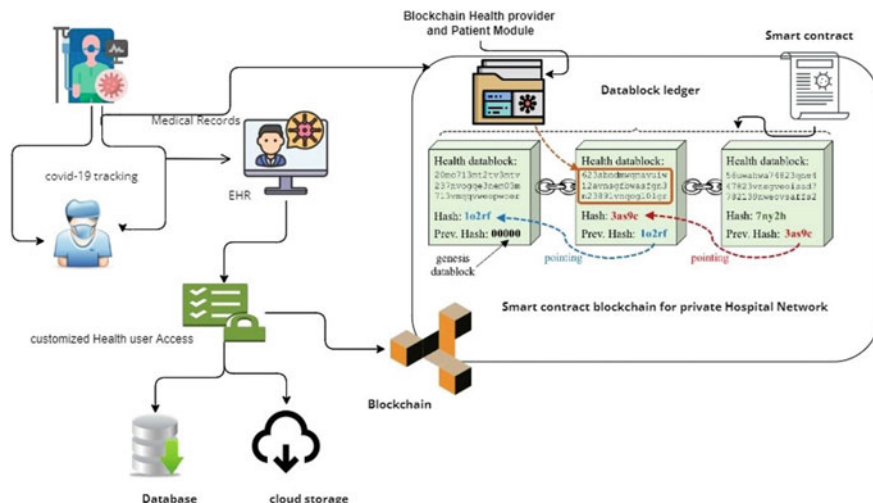

Fig. 2 Blockchain concept for COVID-19

The tamper-proof replicated and distributed ledger stores the entire history of medical transactions in the form of individual recordings chained together and timestamped. Thus, a blockchain-type network is a distributed register with a high level of security, based on very precise encryption techniques, and contains all transactions conducted since the inception of the network. All stakeholders in the healthcare network are involved in the replication process and each has a local copy. Rights and permissions govern the network, ensuring that each healthcare participant only sees relevant transactions [64, 65].

APIs would synchronize such registers in traditional methods (application programming interfaces). However, this method becomes more difficult when the number of integration points increases.

1. In terms of security, the overall susceptibility is increasing, and one of the nodes might frequently contaminate the entire hospital network.
2. End-to-end global supervision Producing real-time monitoring medical data and anticipating probable difficulties for covid-19 tracking becomes tricky.
3. Maintenance costs are often exorbitant when it comes to ensuring that updated and relevant information is opportunistically distributed to healthcare professionals in an opportune way. The blockchain method distributes, synchronizes, and duplicates the ledger, ensuring that all healthcare contributors have access to the same consistent, updated, and secure scans.

A distributed ledger serves as a unique spot in a blockchain network to determine the ownership of an asset or transaction (a shared ledger). Each healthcare provider has the same ledger state, which is updated for each transaction through peer-to-peer replication processes. After the register, the contract (or smart contract) was the second-founding notion. In a blockchain, a contract contains medical rules

that describe the conditions that must be followed and confirmed for a medical transaction in which the transfer conditions for an asset must be implemented. The contract also specifies the asset ownership, compliance, conditions, and security criteria. The contract is integrated into the blockchain, and each participant at the application level executes its rules throughout the transaction [66]. This process must be able to sign it as it is verifiable. Contracts must be established in an appropriate programming language for each local application connected to the Blockchain network. From a practical standpoint, it is frequently necessary to adjust covid-19 patient applications connected to the blockchain network. Consequently, these applications are loaded to implement and test the set of rules of a contract. In general, any regulation that has practical and medical applications during the transfer of an asset or the execution of a transaction can be entered into a contract [67].

5 HealthBlock: A Secure Blockchain-Based Healthcare Data Management System

Owing to the popularity of blockchain, numerous potential applications in the healthcare industry, such as electronic health record (EHR) systems, have been presented. As a result, we conducted a comprehensive literature evaluation of blockchain techniques built for EHR systems in this study, concentrating only on security and privacy issues. Prior to analyzing the (possible) uses of blockchain in EHR systems, we present the necessary background information pertaining to both EHR systems and blockchain as part of the assessment [68].

A central institution is entrusted with administering, organizing, and supervising the entire network in a centralized design, such as those that support a standard EHR system. A distributed design, on the other hand, ensures that all nodes are maintained without the assistance of a central authority. Blockchain technology has recently emerged as a promising solution to address such security concerns and challenges. To grasp the attractiveness of blockchain technology in healthcare, one must first grasp the characteristics that distinguish it from current data-sharing and management platforms [69]. At the outset, blockchain is a decentralized technology. Unlike traditional tools, which are centrally managed by a single intermediary, blockchain is a database distributed among all nodes of the network. Thus, each minor has a copy of the register. This technology lends itself to the sharing of information among several stakeholders such as hospitals, research centers, and pharmaceutical laboratories.

Blockchain also makes it possible to trace the origin and fate of recorded medical data. Unlike a centralized EHR system, in which an administrator controls this information in a blockchain, only the owner can save it and transfer it to other healthcare providers. In addition, although the ledger created by the blockchain is made available to all members of the network, the medical data it contains are

encrypted, which helps ensure the confidentiality and security of sensitive data [70]. Currently, it is difficult to clearly visualize all data related to covid-19 patient and accumulate them during their care journey. This information is usually obtained from a wide variety of sources, such as doctors, hospitals, insurance companies, pharmacists, and medical analysis laboratories for the PCR test. The medical software used by radiologists to collect and manage electronic health records differs and is not interoperable. Thus, information-sharing is difficult. In addition, although this information can be retrieved and assembled, it is not always clear in what order it was produced, and whether it was exhaustive. This problem is frequently encountered when admitting a covid-19 patient to a hospital. Healthcare professionals do not always have access to his history and do not have full visibility of the treatments he is taking, the history of his disease, or his medical history [71].

Clinical trials are a mandatory step in vaccine development for patient covid-19. Therefore, patient participation is a sine qua non in clinical trials. Informed consent was obtained from all the patients before the start of the trial. Through the inviolability and traceability of data, blockchain can provide a solid foundation for the inclusion of covid-19 patients in clinical trials. The blockchain can timestamp and store the steps of the consent process, ensuring authenticity and traceability. This would allow clinical research managers to share consent requests in real time [72]. The protocols of these trials for covid-19 patients can also be recorded on the blockchain, allowing patients to receive a notification with each protocol change, again requiring the collection of consent. Obtaining the latter must be a “lock” that prevents further study if it is not obtained [73]. The trial prosecution conditions can be encoded into the blockchain as a smart contract: “IF (condition) THEN (consequence)”. This system automatically triggered an event when coded clauses were present. In the case of a consent form, the smart contract could indicate that if a patient's covid-19 consent is recorded with their unique digital signature, the patient can be included in the trial. The blockchain, therefore, appears to be a solution that not only guarantees data integrity and traceability but also preserves the confidentiality of covid-19 patients. Indeed, each result and medical report produced during the trial can be recorded on a private blockchain managed by regulators and medical institutions [74]. The information then becomes immutable and transparent. Additionally, when confidentiality of medical data is required, the information can be encrypted, thus ensuring that identifiable data regarding patient covid-19 patients are not disclosed. Figure 3 represents the complex flows of information exchanged in a clinical trial and the possible interactions with the blockchain.

Thus, the main advantage of blockchain technology is the increased transparency and reliability of protocols and results of clinical trials. However, one of the essential conditions for the use of this technology for the traceability of medical information resulting from clinical trials is the digitization of data.

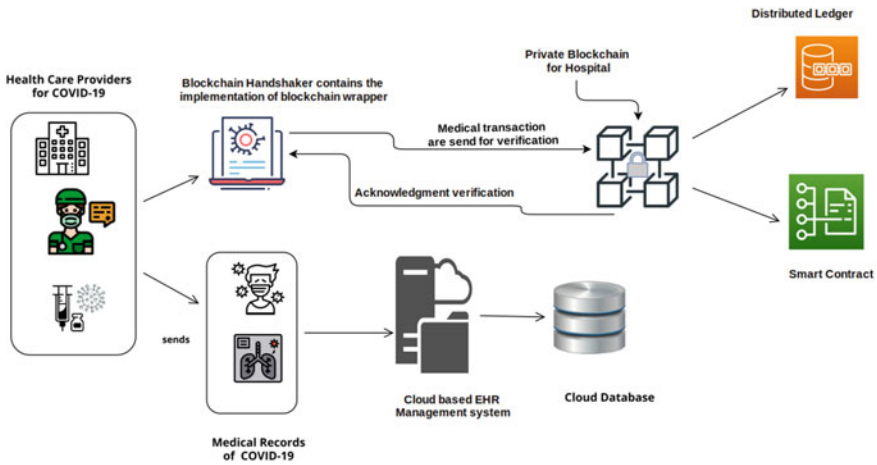

Fig. 3 A secure blockchain-based healthcare data management system

6 IOMT and Supply Chain for Covid-19 Patient Integration: Towards Chain of Medical Things (COMT)

The COVID-19 crisis highlighted the fragility of global supply chains. Companies seek to better understand a future marked by many factors of uncertainty, such as (1) the health sector weakened by the crisis, possible second wave of the health crisis, etc. This uncertain context forces actors in the medical industry to review their priorities. Making supply chains more resilient is urgently needed [75]. To this end, solutions for monitoring flows using the IoT have several advantages. Dealing with uncertainty requires resilience and agility. The increasing degree of uncertainty requires the faster detection of disturbances to remedy them as quickly as possible. Therefore, medical manufacturers need to improve the visibility of their covid-19 post-processing flows were operated. Therefore, it is important to measure their performance. With the right measurement tools, it becomes possible to manage the flow of admission more covid-19 [40]. The progressive optimization of supply chain networks must be based on objective visible medical data for the treatment of covid-19. Digital technologies can improve the visibility and control of logistics flow. Among digital technologies, the Internet of Things (IoMT) is gradually establishing itself as an effective tool for visibility into logistics flows for the admission of a covid patient-19. An IOMT logistics flow-monitoring solution consists of connected objects called trackers [76]. These trackers contain sensors that generate continuous medical data. Finally, they use communication networks that allow them to transmit the data collected to patients. The collected data were automatically processed to standardize the data and enrich them with additional data to help medical decisions. Real-time monitoring enables alert logic, allowing for corrective interventions as soon as possible. Opportunities for optimizing the supply

chain are revealed using the newly accumulated data. The availability of this data and the increased capacity to share it promote efficient collaboration between experts based on objective facts [77, 78].

Understanding the supply chain issue that must be solved is critical for properly utilizing IoMT's potential. As a result, it is vital to determine the appropriate data on which to base an effective reaction to the challenge provided by patient covid-19's post-and era treatment. Data can be accessed in various ways. What is this point? When do you think this is available?' Which medical device companies should have access to them?

The trackers were then injected into the flow. They generated and transmitted relevant medical data. These data provide real-time and end-to-end visibility of the flows. The speed of deployment is an advantage of IoMT solutions that are based on private hospital networks. This allows the quick collection of data without massive investment. The scalability of these solutions makes it possible to increase the volume, if necessary. IoMT data were then enriched with available medical, historical, and external data relevant to patients. Data science is used on cloud platforms for data collection, analysis, and feedback. They make it possible to transform data into information that is useful for medical decision making and action, as shown in Fig. 4.

The COVID-19 crisis has forced medical industries to focus on assessing their risks, and they will tend to diversify their suppliers of IOMT sensors and medical equipment for covid-19 patient in order to limit the risks of patient disruption. Additionally, the bankruptcy of certain suppliers necessitates the use of new partners. This implies starting new collaborations, building trust, piloting the start-up of new relationships, and evaluating performance. The IoMT monitoring solution makes it possible to make these new flows for medical establishments more reliable

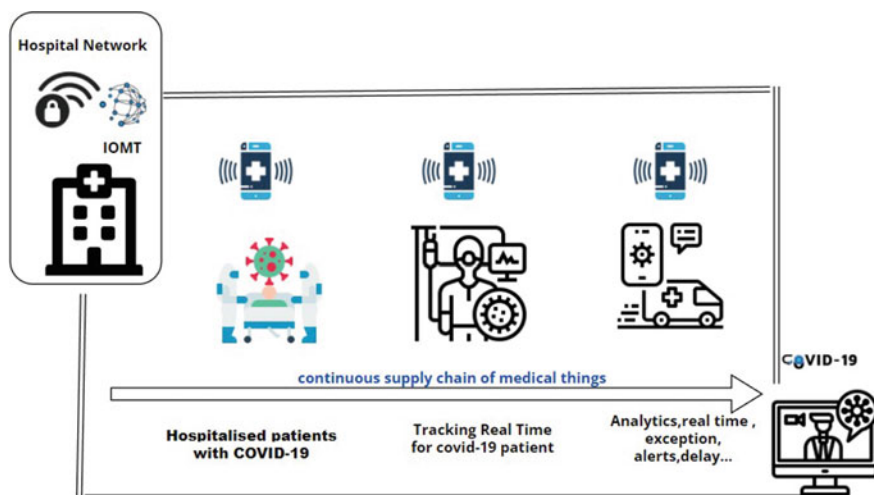

Fig. 4 IoMT and supply chain for Covid-19 patient integration

and to limit the associated risks. The use of visibility solutions based on IOMT enables the quick identification of supply chain optimization opportunities. Finally, increased automation in the management of supply chain flows allows operational cost reduction for experts and patients with covid-19. operators spend less time on flow-monitoring. They can decide faster by being alerted in real time and benefiting from the decision support provided by IOMT monitoring.

7 Blockchain IoMT (BloMT): A New Paradigm for Healthcare Security and Issues Related to the Internet of Things

COVID-19 is a rapidly spreading illness that has prompted countries to develop technologies for the detection of the coronavirus infection. Several countries have put much effort into combatting COVID-19. Many countries have used various methods to battle the pandemic, including gathering data on growth, monitoring, and leaking individuals' personal information. IOMT-based healthcare devices collect important data, offer extra insight via symptoms and behaviors, enable remote monitoring, and empower individuals to make better decisions regarding their own health. The medical distribution network is regulated by a blockchain, which provides the safe transmission of patient health information. The goal of installing mobile applications on smart devices is to save time and money, while improving the performance of infected patients.

The development of IoT will make use of blockchain services. The goal of this section is to decrease security concerns, remove failure points, streamline processes, and reduce costs. The combination of IoT and blockchain will make it possible to imagine breakthrough innovations in the field of health. A blockchain is a distributed ledger system in which transactions are recorded through multiple nodes. Although blocks are publicly visible, their content is available only from medical organizations with the correct encryption key [79]. Because transactions must be authorized by several parties before their acceptance, the blockchain guarantees a high degree of reliability. Additionally, transactions can be added only, not deleted or edited, making this solution attractive to organizations required to adhere to HIPAA [80] and other national regulatory frameworks. In an IoT network, the blockchain can not only facilitate medical transactions but also secure message exchanges between covid-19 patient tracking devices. By operating under integrated smart contracts, the two parties can share data without compromising the confidentiality of their health care owners. Although blockchain does not solve all security concerns for IoT devices, such as hacking devices for use in DDoS botnets [81], it does help protect data from malicious actors. With the proliferation of Internet of Medical Things (IoMT) devices, traditional server/client models of network traffic management are becoming too laborious and unwieldy to be effective. Conversely, the simplicity of distributed medical transactions in blockchains makes them interesting. Accompanied by the growth of computing equipment (edge

computing) and 5G networks [82, 83], this uncomplicated approach will allow for faster and more efficient communication among standalone devices without the need for single points of failure. The blockchain can also accurately record a sensor's or object's "activities" and transactions, allowing IoT devices to communicate without the need for a centralized authority. Blockchain and the Internet of Medical Things add complexity to hospital IT infrastructure in medical digital transformation technology [84]. These include blockchain transaction equipment and edge servers, middleware for encryption and authentication, and virtual computers for databases and distributed applications. While autonomous device communication and faster medical transactions can boost efficiency and increase availability, enhanced security can lower costs, ensuring optimal service quality remains necessary. In an Internet of Things (IoT)/blockchain environment, service delivery can be affected by loads, latencies, or errors. Owing to the highly distributed nature of blockchain, guaranteeing the provision of services is more difficult.

This requires the complete end-to-end visibility of the program and session flow, which includes load balancers, gateways, service providers (including DNS), networks, cloud servers, and databases. 19 patients, distributed or not, with all of their interdependencies. The announced development of blockchain-related Internet of Things equipment would result in an increase in DNS queries and related services, which could have a substantial influence on hospital and medical institution service delivery and performance [85, 86]. The ultralow latency of DNS services is problematic for medical business continuity and the performance quality of the IoT. If DNS performs poorly, IoT and blockchain services will also suffer. In other words, all swathes of connected experts/physicists, who increasingly rely on automation, would be at a standstill. DNS issues can interfere with medical transactions relating to patient covid-19 care. A proper covid-19 doctor/service expert tracking tool that provides IT teams with good insight into DNS issues, such as mistakes and busy servers, aids in the prevention of control loss [87, 88]. IT professionals will be able to comprehend the complete context of services and DNS anomalies that hurt user experience and application performance owing to the combination of intelligent data and enhanced analytics. However, blockchains are inextricably linked to the future of the connected item networks.

The Internet of Medical Things platforms and blockchain-based architecture for coronaviruses are summarized in Table. Two must have resistance (the capacity to sustain a functional state during a failure) and resilience qualities (implementation strategies aimed at restoring a functional state). The need to scale up in the face of a large number of connected medical objects, piloting (manufacturer independence and a lack of standards, resulting in isolated sub-assemblies that are sometimes incompatible), governance (split between many healthcare providers), heterogeneity (medical equipment, protocols, programming environments, and exchange formats), and the discovery of connected objects are all factors to consider. Lone platforms that distribute communication, medical data processing (access, filtering, aggregation, and storage), and administrative capacities as close to objects as possible can address these problems. As indicated in Fig. 5, these platforms will be

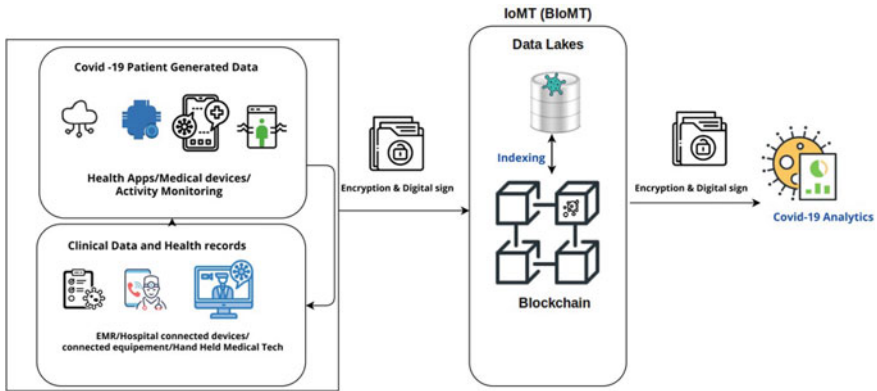

Fig. 5 Blockchain IoMT (BIoMT) architecture

sophisticated multi-agent systems for medical decision aid and tracking of covid-19 patients, and the blockchain will enable solutions of choice for building these platforms with IoT [89–92].

Even if the blockchain does not provide solutions to all of the difficulties of IOMT, it presents a set of intriguing traits and qualities that might make it a desirable component for IOMT systems. The discovery of related devices and hospital infrastructure creates a high level of complexity because of this relationship.

Furthermore, by forbidding this consideration, it is necessary to safeguard healthcare practitioners and patients from dangerous situations. By providing a resistant and verifiable record of authorizations connecting the choices of experts to IoT platforms, the blockchain solution enables objects to be legitimized, repudiated, and prohibited. This feature is an extension of permission management, which entails documenting the conditions of access to third-party data given by the owner. In this situation, the holder or administrator of an item will be able to describe its state (operational, outdated, open to the public, etc.) in a manner that is both traceable and nonrepudiable for patients (Table 2).

8 Conclusion

The most crucial return of EHR systems is access to enormous amounts of data, which may be utilized for better data analysis and machine learning, as well as other medical research activities like covid-19 forecasts. Wearable and other Internet of Medical Things (IoMT) devices may also gather and upload pertinent data, including data from EHR systems, to help with healthcare monitoring and personalized health services. Therefore, this non-exhaustive list of potential blockchain health applications has a real impact on the organization and efficiency of the

Table 2 Tools for IoT and blockchain-based framework for covid-19

IoT and blockchain-based framework for covid-19	Description
Aarogya Setu	This software collects location data that requires a constant connection to the mobile device, which is invasive in terms of privacy and security. This, as well as facilitating legal compliance criteria, is something it can accomplish [93]
Kwarantanna domowa	This software, among other things, allows users to investigate area health insurance institutions that, under plausible circumstances, would supply treatments as well as memories. People might also quickly alert a member of staff. Apart from individuals, app users typically have quick access to relevant information. This is useful during quarantine and as a means of communication with the counseling service. A self-monitoring setting for medical therapy a few days prior was also provided by the designers. This software's official developer is Poland [94]
Tawakkalna (covid-19 KSA)	The purpose of this app is to monitor people's movements around Saudi Arabia. This involves the movement's authorization as well as the health concerns of each patient. This is a China project simulation. It's a color-based classification system that represents a person's health. The color green indicates that the item is clean and safe to travel with. The perpetrator is represented by the yellow color, and he or she is not allowed to travel. The color red denotes that you are both afflicted and unable to go [95]
TraceTogether	It's intended to support ongoing regional efforts to combat the COVID-19 epidemic by allowing community-driven touch monitoring. The Singapore government released this software, which employs a modified Blue-trace standard to allow digital touch monitoring [96]
LetsBeatCOVID	It was designed to allow people to have a fast conversation about fitness, including the risk of COVID-19, in order to save more lives. MedShr, a medical app used by over a million doctors, provided this information [97]
CovidWatch	This software was developed in collaboration with Stanford University and represents the actual fortitude of people to sustain themselves and their communities while sacrificing their privacy. This uses Bluetooth signals to identify

(continued)

Table 2 (continued)

IoT and blockchain-based framework for covid-19	Description
	persons who are in close proximity to one another, or to notify people when they are in contact with infected people [98]
HaMagen	Contact tracing with IoTrace: a flexible, efficient, and privacy-preserving IoT-enabled architecture [99]
Covid-19 tracker	An association research from the COVID symptom tracker APP identified key predictors of COVID19 hospitalization [100]
COVID symptom tracker	Analysis of questionnaire data from an app-based tracking of self-reported COVID-19 symptoms [101]
Corona DataSpende	Quantifying the privacy-utility trade-offs in COVID-19 contact tracing apps [102]
COVID-19 blockchain framework	P2P-mobile application, and mass-surveillance system are anticipated to provide an effective system capable of assisting governments, health authorities, and citizens in making key decisions about illness detection, prediction, and prevention [103]
Framework for coronavirus (COVID-19) disease based on internet of things and blockchain	Through smart gadgets, the internet of things (IoT) and blockchain technologies are being implemented [104]
A blockchain-based safe framework for e-learning was developed for COVID-19	A blockchain-based EL framework is offered to assist EL designers in maintaining the security of EL data and the environment [105]
CovidChain	An anonymity-preserving blockchain-based framework for COVID-19 defense [106]
A blockchain framework for sharing contact information and a risk notification system has been developed for COVID-19	Through hierarchical smart contract design, users can form global agreements about how to handle and use their data, improving data usage transparency. In addition, a mechanism to protect user identity privacy from a range of perspectives, as well as smart contract notifications warning users to the risk of exposure [107]
DHP framework	Blockchain-based digital health passports; case study on international tourism during the COVID-19 pandemic [108]
Blockchain for multi-robot collaboration for COVID-19	The proposed framework can improve the intelligence, decentralization, and autonomous operations of connected multi-robot collaboration in the blockchain network [109]
Blockchain and ANFIS empowered IoMT application	A blockchain-based system for tracking patients' contacts using Bluetooth-enabled cellphones while maintaining their anonymity [110]

(continued)

Table 2 (continued)

IoT and blockchain-based framework for covid-19	Description
B5G framework using blockchain for COVID-19 diagnosis	Based on B5G network, an artificial intelligence-enabled edge-centric COVID-19 screening and diagnosis system was built using a blockchain-based safe transfer of patient data at the edge [111]
SPIN: a blockchain-based framework for COVID-19	SPIN is a sharing system based on a permissioned blockchain. COVID-19 data exchange between countries [112]
Blockchain-based supply chain traceability for COVID-19 PPE	Grounded on generic framework based on Ethereum smart contracts and decentralized storage systems to automate processes and information lePara>

healthcare system. However, it is important to note that this technology is only a tool and not a solution to all of the health care industry's ills. Blockchain implementation is possible only after real cooperation from all stakeholders. Therefore, it is necessary to perform significant upstream work on data digitization, medical process automation, medical staff backgrounds, and regulatory oversight. Faced with the many challenges posed by IOMT and e-health and the needs arising in terms of decentralization, traceability, and trust, blockchain offers answers. Without claiming to solve all the problems, it also opens the door to new horizons for the concept of blockchain coupled with IoMT (BIOMT) as a new direction for solving IoT security and healthcare issues. Consequently, it presents new fields of investigation for health actors.

References

1. Maksimovic M, Vujovic V, Perisic B (2015) A custom internet of things healthcare system
2. Cecil J, Cecil-Xavier A, Gupta A (2017) Foundational elements of next generation cyber physical and IoT frameworks for distributed collaboration. In: 2017 13th IEEE conference on automation science and engineering (CASE), pp 789–794
3. Dwivedi R, Mehrotra D, Chandra S (2021) Potential of internet of medical things (IoMT) applications in building a smart healthcare system: a systematic review. *J Oral Biol Craniofacial Res.* <https://doi.org/10.1016/j.jobcr.2021.11.010>
4. Tarikere S, Donner I, Woods D (2021) Diagnosing a healthcare cybersecurity crisis: the impact of IoMT advancements and 5G. *Bus Horiz* 64:799–807. <https://doi.org/10.1016/j.bushor.2021.07.015>
5. Ashfaq Z, Rafay A, Mumtaz R, Hassan Zaidi SM, Saleem H, Raza Zaidi SA, Mumtaz S, Haque A (2022) A review of enabling technologies for internet of medical things (IoMT) ecosystem. *Ain Shams Eng J* 13:101660. <https://doi.org/10.1016/j.asej.2021.101660>
6. Pratap Singh R, Javaid M, Haleem A, Vaishya R, Ali S (2020) Internet of medical things (IoMT) for orthopaedic in COVID-19 pandemic: roles, challenges, and applications. *J Clin Orthopaedics Trauma* 11:713–717. <https://doi.org/10.1016/j.jcot.2020.05.011>

7. Hajiheydari N, Delgosha MS, Olya H (2021) Scepticism and resistance to IoMT in healthcare: application of behavioural reasoning theory with configurational perspective. *Technol Forecast Soc Chang* 169:120807. <https://doi.org/10.1016/j.techfore.2021.120807>
8. Peng J, Cai K, Jin X (2020) High concurrency massive data collection algorithm for IoMT applications. *Comput Commun* 157:402–409. <https://doi.org/10.1016/j.comcom.2020.04.045>
9. Sridhar Raj S, Madijagan M (2021) Chapter four—parallel machine learning and deep learning approaches for internet of medical things (IoMT). In: Sangaiah AK, Mukhopadhyay S (eds) *Intelligent IoT systems in personalized health care*. Academic Press, pp 89–103
10. Syed L, Jabeen S, Manimala S, Alsaedi A (2019) Smart healthcare framework for ambient assisted living using IoMT and big data analytics techniques. *Future Gener Comput Syst* 101:136–151. <https://doi.org/10.1016/j.future.2019.06.004>
11. Cecil J, Gupta A, Pirela-Cruz M, Ramanathan P (2018) An IoMT based cyber training framework for orthopedic surgery using next generation internet technologies. *Inform Med Unlocked* 12:128–137. <https://doi.org/10.1016/j.imu.2018.05.002>
12. Mamun Q (2022) Blockchain technology in the future of healthcare. *Smart Health* 23:100223. <https://doi.org/10.1016/j.smhl.2021.100223>
13. Massaro M (2021) Digital transformation in the healthcare sector through blockchain technology. Insights from academic research and business developments. *Technovation* 102386. <https://doi.org/10.1016/j.technovation.2021.102386>
14. Hussien HM, Yasin SM, Udzir NI, Ninggal MIH, Salman S (2021) Blockchain technology in the healthcare industry: trends and opportunities. *J Ind Inf Integr* 22:100217. <https://doi.org/10.1016/j.jii.2021.100217>
15. Haleem A, Javaid M, Singh RP, Suman R, Rab S (2021) Blockchain technology applications in healthcare: an overview. *Int J Intell Netw* 2:130–139. <https://doi.org/10.1016/j.ijin.2021.09.005>
16. Sharma L, Olson J, Guha A, McDougal L (2021) How blockchain will transform the healthcare ecosystem. *Bus Horiz* 64:673–682. <https://doi.org/10.1016/j.bushor.2021.02.019>
17. Saranya R, Murugan A (2021) A systematic review of enabling blockchain in healthcare system: analysis, current status, challenges and future direction. *Mater Today Proc*. <https://doi.org/10.1016/j.matpr.2021.07.105>
18. Balasubramanian S, Shukla V, Sethi JS, Islam N, Saloum R (2021) A readiness assessment framework for blockchain adoption: a healthcare case study. *Technol Forecast Soc Chang* 165:120536. <https://doi.org/10.1016/j.techfore.2020.120536>
19. Zhang G, Yang Z, Liu W (2021) Blockchain-based privacy preserving e-health system for healthcare data in cloud. *Comput Netw* 108586. <https://doi.org/10.1016/j.comnet.2021.108586>
20. Soni M, Singh DK (2021) Blockchain-based security and privacy for biomedical and healthcare information exchange systems. *Mater Today Proc*. <https://doi.org/10.1016/j.matpr.2021.02.094>
21. Rojas I, Valenzuela O, Rojas F, Herrera LJ, Ortuño FM (2020) Bioinformatics and biomedical engineering: 8th international work-conference, IWBBIO 2020, Granada, Spain, May 6–8, 2020, proceedings. Springer Nature
22. Nguyen DC, Nguyen KD, Pathirana PN (2019) A mobile cloud based IoMT framework for automated health assessment and management. In: 2019 41st annual international conference of the IEEE engineering in medicine and biology society (EMBC), pp 6517–6520
23. Yang T, Gentile M, Shen C-F, Cheng C-M (2020) Combining point-of-care diagnostics and internet of medical things (IoMT) to combat the COVID-19 pandemic. *Diagnostics* 10:224. <https://doi.org/10.3390/diagnostics10040224>
24. Awotunde JB, Ogundokun RO, Misra S (2021) Cloud and IoMT-based big data analytics system during COVID-19 pandemic. In: Chakraborty C, Ghosh U, Ravi V, Shelke Y (eds) *Efficient data handling for massive internet of medical things: healthcare data analytics*. Springer International Publishing, Cham, pp 181–201

25. Sworna NS, Islam AKMM, Shatabda S, Islam S (2021) Towards development of IoT-ML driven healthcare systems: a survey. *J Netw Comput Appl* 196:103244. <https://doi.org/10.1016/j.jnca.2021.103244>
26. Mohd Aman AH, Hassan WH, Sameen S, Attarbashi ZS, Alizadeh M, Latiff LA (2021) IoMT amid COVID-19 pandemic: application, architecture, technology, and security. *J Netw Comput Appl* 174:102886. <https://doi.org/10.1016/j.jnca.2020.102886>
27. De Vito L, Picariello F, Tudosa I, Balestrieri E (2019) A novel method for compressed sensing based sampling of ECG signals in medical-IoT era
28. Rubi JNS, Gondim PRL (2019) IoMT platform for pervasive healthcare data aggregation, processing, and sharing based on OneM2M and OpenEHR. *Sensors* 19:4283. <https://doi.org/10.3390/s19194283>
29. Bharati S, Podder P, Mondal MRH, Paul PK (2021) Applications and challenges of cloud integrated IoMT. In: Hassanien AE, Khamparia A, Gupta D, Shankar K, Slowik A (eds) *Cognitive internet of medical things for smart healthcare: services and applications*. Springer International Publishing, Cham, pp 67–85
30. Husain S, Kunz A, Song J, Koshimizu T (2015) Interworking architecture between oneM2M service layer and underlying networks. In: 2014 IEEE Globecom workshops (GC Wkshps), 2014, pp 636–642. <https://doi.org/10.1109/GLOCOMW.2014.7063504>
31. Mehmood I, Anwar S, Dilawar A, Zulfiqar I, Abbas R (2020) Managing data diversity on the internet of medical things (IoMT). *Int J Inf Technol Comput Sci* 12:49–56. <https://doi.org/10.5815/ijitcs.2020.06.05>
32. Venkatesh DAN (2019) Reimagining the future of healthcare industry through internet of medical things (IoMT), artificial intelligence (AI), machine learning (ML), big data, mobile apps and advanced sensors. *SSRN Electron J*. <https://doi.org/10.2139/ssrn.3522960>
33. Bansal A, Atri A (2021) IoT's data processing using spark. In: *The smart cyber ecosystem for sustainable development*. Wiley, pp 91–109
34. Awotunde JB, Jimoh RG, Matiluko OE, Gbadamosi B, Ajamu GJ (2022) Artificial intelligence and an edge-IoMT-based system for combating COVID-19 pandemic. In: Tyagi AK, Abraham A, Kaklauskas A (eds) *Intelligent interactive multimedia systems for e-healthcare applications*. Springer, Singapore, pp 191–214
35. Nazir A, Azhar A, Nazir U, Liu Y-F, Waqar S Q, Chen J-E, Alanazi E (2021) The rise of 3D printing entangled with smart computer aided design during COVID-19 era. *J Manuf Syst* 60:774–786. <https://doi.org/10.1016/j.jmsy.2020.10.009>
36. Atanasov V, Sivkov Y (2020) Data fusion for IoMT in shipping. In: 2020 21st international symposium on electrical apparatus technologies (SIELA). pp 1–6
37. Rhbech A, Lotfi H, Bajit A, Barodi A, El Aidi S, Tamtaoui A (2020) An optimized and intelligent security-based message queuing protocol S-MQTT applied to medical IOT COVID-19 data monitoring platforms. In: 2020 international symposium on advanced electrical and communication technologies (ISAECT), pp 1–6
38. Sheeba Rani S, Selvakumar S, Pradeep Mohan Kumar K, Thanh Tai D, Dhiravida Chelvi E (2021) Internet of medical things (IoMT) with machine learning-based COVID-19 diagnosis model using chest X-ray images. In: *Data science for COVID-19*, pp 627–641. <https://doi.org/10.1016/B978-0-12-824536-1.00001-0>
39. Khan MA, Algarni F (2020) A healthcare monitoring system for the diagnosis of heart disease in the IoMT cloud environment using MSSO-ANFIS. *IEEE Access* 8:122259–122269. <https://doi.org/10.1109/ACCESS.2020.3006424>
40. Dai H-N, Wu Y, Wang H, Imran M, Haider N (2021) Blockchain-empowered edge intelligence for internet of medical things against COVID-19. *IEEE Internet Things Mag* 4:34–39. <https://doi.org/10.1109/IOTM.0011.2100030>
41. Lin H, Garg S, Hu J, Wang X, Jalil Piran M, Hossain MS (2021) Privacy-enhanced data fusion for COVID-19 applications in intelligent internet of medical things. *IEEE Internet Things J* 8:15683–15693. <https://doi.org/10.1109/JIOT.2020.3033129>

42. Ndiaye M, Oyewobi SS, Abu-Mahfouz AM, Hancke GP, Kurien AM, Djouani K (2020) IoT in the wake of COVID-19: a survey on contributions, challenges and evolution. *IEEE Access* 8:186821–186839. <https://doi.org/10.1109/ACCESS.2020.3030090>
43. Rizk D, Rizk R, Hsu S (2019) Applied layered-security model to IoMT. In: 2019 IEEE international conference on intelligence and security informatics (ISI), pp 227–227
44. Mbunge E, Akinnuwesi B, Fashoto SG, Metfula AS, Mashwama P (2021) A critical review of emerging technologies for tackling COVID-19 pandemic. *Human Behavior Emerg Technol* 3:25–39. <https://doi.org/10.1002/hbe2.237>
45. Masud M, Gaba GS, Alqahtani S, Muhammad G, Gupta BB, Kumar P, Ghoneim A (2021) A lightweight and robust secure key establishment protocol for internet of medical things in COVID-19 patients care. *IEEE Internet Things J* 8:15694–15703. <https://doi.org/10.1109/JIOT.2020.3047662>
46. Zeng P, Zhang Z, Lu R, Choo K-KR (2021) Efficient policy-hiding and large universe attribute-based encryption with public traceability for internet of medical things. *IEEE Internet Things J* 8:10963–10972. <https://doi.org/10.1109/JIOT.2021.3051362>
47. Rani S, Ahmed SH, Talwar R, Malhotra J, Song H (2017) IoMT: a reliable cross layer protocol for internet of multimedia things. *IEEE Internet Things J* 4:832–839. <https://doi.org/10.1109/JIOT.2017.2671460>
48. Awotunde JB, Ajagbe SA, Idowu IR, Ndunagu JN (2021) An enhanced cloud-IoMT-based and machine learning for effective COVID-19 diagnosis system. In: Al-Turjman F, Nayyar A, Devi A, Shukla PK (eds) *Intelligence of things: AI-IoT based critical-applications and innovations*. Springer International Publishing, Cham, pp 55–76
49. Tai Y, Gao B, Li Q, Yu Z, Zhu C, Chang V (2021) Trustworthy and intelligent COVID-19 diagnostic IoMT through XR and deep-learning-based clinic data access. *IEEE Internet Things J* 8:15965–15976. <https://doi.org/10.1109/JIOT.2021.3055804>
50. Fourati LC, Rekhis S, Ayed S, Jmaiel M (2021) Connected medical kiosks to counter COVID-19: needs, architecture & design guidelines. In: 2021 international wireless communications and mobile computing (IWCMC), pp 2032–2037
51. Razdan S, Sharma S (2021) Internet of medical things (IoMT): overview, emerging technologies, and case studies. In: *IETE technical review*, pp 1–14. <https://doi.org/10.1080/02564602.2021.1927863>
52. Dai H-N, Imran M, Haider N (2020) Blockchain-enabled internet of medical things to combat COVID-19. *IEEE Internet Things Mag* 3:52–57. <https://doi.org/10.1109/IOTM.0001.2000087>
53. Das AK, Bera B, Giri D (2021) AI and blockchain-based cloud-assisted secure vaccine distribution and tracking in IoMT-enabled COVID-19 environment. *IEEE Internet Things Mag* 4:26–32. <https://doi.org/10.1109/IOTM.0001.2100016>
54. Naren N, Chamola V, Baitragunta S, Chintanpalli A, Mishra P, Yenuganti S, Guizani M (2021) IoMT and DNN-enabled drone-assisted covid-19 screening and detection framework for rural areas. *IEEE Internet Things Mag* 4:4–9. <https://doi.org/10.1109/IOTM.0011.2100053>
55. Ahmed I, Ahmad A, Jeon G (2021) An IoT-based deep learning framework for early assessment of covid-19. *IEEE Internet Things J* 8:15855–15862. <https://doi.org/10.1109/JIOT.2020.3034074>
56. Rahman MdA, Hossain MS (2021) An internet-of-medical-things-enabled edge computing framework for tackling COVID-19. *IEEE Internet Things J* 8:15847–15854. <https://doi.org/10.1109/JIOT.2021.3051080>
57. Abdel-Basset M, Chang V, Nabeeh NA (2021) An intelligent framework using disruptive technologies for COVID-19 analysis. *Technol Forecast Soc Chang* 163:120431. <https://doi.org/10.1016/j.techfore.2020.120431>
58. Sarosh P, Parah SA, Bhat GM, Muhammad K (2021) A security management framework for big data in smart healthcare. *Big Data Res* 25:100225. <https://doi.org/10.1016/j.bdr.2021.100225>

59. Nofer M, Gomber P, Hinz O, Schiereck D (2017) Blockchain. *Bus Inf Syst Eng* 59:183–187. <https://doi.org/10.1007/s12599-017-0467-3>
60. Hasselgren A, Kravevska K, Gligoroski D, Pedersen SA, Faxvaag A (2020) Blockchain in healthcare and health sciences—a scoping review. *Int J Med Inform* 134:104040. <https://doi.org/10.1016/j.ijmedinf.2019.104040>
61. De Aguiar EJ, Faical BS, Krishnamachari B, Ueyama J (2020) A survey of blockchain-based strategies for healthcare. *ACM Comput Surv* 53:1–27. <https://doi.org/10.1145/3376915>
62. Khatoun A (2020) A blockchain-based smart contract system for healthcare management. *Electronics* 9:94. <https://doi.org/10.3390/electronics9010094>
63. Griggs KN, Ossipova O, Kohlios CP, Baccarini AN, Howson EA, Hayajneh T (2018) Healthcare blockchain system using smart contracts for secure automated remote patient monitoring. *J Med Syst* 42:130. <https://doi.org/10.1007/s10916-018-0982-x>
64. Zghaibeh M, Farooq U, Hasan NU, Baig I (2020) SHealth: a blockchain-based health system with smart contracts capabilities. *IEEE Access* 8:70030–70043. <https://doi.org/10.1109/ACCESS.2020.2986789>
65. Novikov SP, Kazakov OD, Kulagina NA, Azarenko NY (2018) Blockchain and smart contracts in a decentralized health infrastructure. In: 2018 IEEE international conference “quality management, transport and information security, information technologies” (IT QM IS), pp 697–703
66. Dasaklis TK, Casino F, Patsakis C (2018) Blockchain meets smart health: towards next generation healthcare services. In: 2018 9th international conference on information, intelligence, systems and applications (IISA), pp 1–8
67. Pham HL, Tran TH, Nakashima Y (2018) A secure remote healthcare system for hospital using blockchain smart contract. In: 2018 IEEE Globecom workshops (GC Wkshps), pp 1–6
68. Shahnaz A, Qamar U, Khalid A (2019) Using blockchain for electronic health records. *IEEE Access* 7:147782–147795. <https://doi.org/10.1109/ACCESS.2019.2946373>
69. Dubovitskaya A, Baig F, Xu Z, Shukla R, Zambani PS, Swaminathan A, Jahangir MM, Chowdhry K, Lachhani R, Idnani N, Schumacher M, Aberer K, Stoller SD, Ryu S, Wang F (2020) ACTION-EHR: patient-centric blockchain-based electronic health record data management for cancer care. *J Med Internet Res* 22:e13598. <https://doi.org/10.2196/13598>
70. Tariq N, Qamar A, Asim M, Khan FA (2020) Blockchain and smart healthcare security: a survey. *Proc Comput Sci* 175:615–620. <https://doi.org/10.1016/j.procs.2020.07.089>
71. Shi S, He D, Li L, Kumar N, Khan MK, Choo K-KR (2020) Applications of blockchain in ensuring the security and privacy of electronic health record systems: a survey. *Comput Secur* 97:101966. <https://doi.org/10.1016/j.cose.2020.101966>
72. Zhuang Y, Sheets L, Shae Z, Tsai JJP, Shyu C-R (2018) Applying blockchain technology for health information exchange and persistent monitoring for clinical trials. *AMIA Annu Symp Proc* 2018:1167–1175
73. Fusco A, Dicuonzo G, Dell’Atti V, Tatullo M (2020) Blockchain in healthcare: insights on COVID-19. *Int J Environ Res Public Health* 17:E7167. <https://doi.org/10.3390/ijerph17197167>
74. Christodoulou K, Christodoulou P, Zinonos Z, Carayannis EG, Chatzichristofis SA (2020) Health information exchange with blockchain amid covid-19-like pandemics. In: 2020 16th international conference on distributed computing in sensor systems (DCOSS), pp 412–417
75. Li X, Tao B, Dai H-N, Imran M, Wan D, Li D (2021) Is blockchain for internet of medical things a panacea for COVID-19 pandemic? *Pervasive Mob Comput* 75:101434. <https://doi.org/10.1016/j.pmcj.2021.101434>
76. Udgata SK, Suryadevara NK (2021) COVID-19, sensors, and internet of medical things (IoMT). In: Udgata SK, Suryadevara NK (eds) *Internet of things and sensor network for COVID-19*. Springer, Singapore, pp 39–53
77. Kumar M, Rani R (2021) SAI-BA-IoMT: secure AI-based blockchain-assisted internet of medical things tool to moderate the outbreak of COVID-19 crisis. [arXiv:210809539](https://arxiv.org/abs/210809539) [cs]

78. Mareiniss DP (2020) The impending storm: COVID-19, pandemics and our overwhelmed emergency departments. *Am J Emerg Med* 38:1293–1294. <https://doi.org/10.1016/j.ajem.2020.03.033>
79. Tan L, Yu K, Shi N, Yang C, Wei W, Lu H (2021) Towards secure and privacy-preserving data sharing for COVID-19 medical records: a blockchain-empowered approach. *IEEE Trans Netw Sci Eng*:1–1. <https://doi.org/10.1109/TNSE.2021.3101842>
80. Theodos K, Sittig S (2020) Health information privacy laws in the digital age: HIPAA doesn't apply. *Perspect Health Inf Manage* 18:11
81. Sajid A (2020) A taxonomy of cyber-attacks on computer networks. University of Bradford
82. Jolley D, Paterson JL (2020) Pylons ablaze: examining the role of 5G COVID-19 conspiracy beliefs and support for violence. *Br J Soc Psychol* 59:628–640. <https://doi.org/10.1111/bjso.12394>
83. Siriwardhana Y, Gür G, Ylianttila M, Liyanage M (2021) The role of 5G for digital healthcare against COVID-19 pandemic: opportunities and challenges. *ICT Express* 7:244–252. <https://doi.org/10.1016/j.icte.2020.10.002>
84. Sittig DF, Singh H (2020) COVID-19 and the need for a national health information technology infrastructure. *JAMA* 323:2373–2374. <https://doi.org/10.1001/jama.2020.7239>
85. Vyas A, Sundara Raman R, Ceccio N, Lutscher PM, Ensafi R (2021) Lost in transmission: investigating filtering of COVID-19 websites. In: Borisov N, Diaz C (eds) *Financial cryptography and data security*. Springer, Berlin, Heidelberg, pp 417–436
86. Al-Kuraishy HM, Al-Gareeb AI, Qusti S, Alshammari EM, Gyebi GA, Batiha GE (2021) Covid-19-induced dysautonomia: a menace of sympathetic storm. *ASN Neuro* 13:17590914211057636. <https://doi.org/10.1177/17590914211057635>
87. Jung Y, Agulto R (2021) A public platform for virtual IoT-based monitoring and tracking of COVID-19. *Electronics* 10:12. <https://doi.org/10.3390/electronics10010012>
88. Xia P, Nabeel M, Khalil I, Wang H, Yu T (2021) Identifying and characterizing COVID-19 themed malicious domain campaigns. In: *Proceedings of the eleventh ACM conference on data and application security and privacy*. Association for Computing Machinery, New York, NY, USA, pp 209–220
89. Qi R, Feng C, Liu Z, Mrad N (2017) Blockchain-powered internet of things, E-governance and E-democracy. In: Vinod Kumar TM (ed) *E-democracy for smart cities*. Springer, Singapore, pp 509–520
90. Shah H, Shah M, Tanwar S, Kumar N (2021) Blockchain for COVID-19: a comprehensive review. *Pers Ubiquit Comput*. <https://doi.org/10.1007/s00779-021-01610-8>
91. Marbough D, Abbasi T, Maasmi F, Omar IA, Debe MS, Salah K, Jayaraman R, Ellahham S (2020) Blockchain for COVID-19: review, opportunities, and a trusted tracking system. *Arab J Sci Eng* 45:9895–9911. <https://doi.org/10.1007/s13369-020-04950-4>
92. Ltd I-IB (2020) COVID-19 response and recovery in smart sustainable city governance and management: data-driven internet of things systems and machine learning-based analytics. *Geopolit Hist Int Relat* 12:16–22
93. Nagori V (2021) “Aarogya Setu”: the mobile application that monitors and mitigates the risks of COVID-19 pandemic spread in India. *J Inf Technol Teach Cases* 11:66–80. <https://doi.org/10.1177/2043886920985863>
94. Dąbrowska-Kłosińska P, Grzelak A, Nimark A (2021) The use of covid-19 digital applications and unavoidable threats to the protection of health data and privacy. *Białostockie Studia Prawnicze* 26:61–94. <https://doi.org/10.15290/bsp.2021.26.03.04>
95. Binkheder S, Aldekhyyel RN, AlMogbel A, Al-Twairish N, Alhumaid N, Aldekhyyel SN, Jamal AA (2021) Public perceptions around mHealth applications during COVID-19 pandemic: a network and sentiment analysis of tweets in Saudi Arabia. *Int J Environ Res Public Health* 18:13388. <https://doi.org/10.3390/ijerph182413388>
96. Stevens H, Haines MB (2020) TraceTogether: pandemic response, democracy, and technology. <https://doi.org/10.1215/18752160-8698301>

97. Verma J, Mishra AS (2020) COVID-19 infection: disease detection and mobile technology. *PeerJ* 8:e10345. <https://doi.org/10.7717/peerj.10345>
98. Wang D, Liu F (2020) Privacy risk and preservation for COVID-19 contact tracing apps. [arXiv:2006.15433](https://arxiv.org/abs/2006.15433) [cs]
99. Tedeschi P, Bakiras S, Di Pietro R (2021) IoTrace: a flexible, efficient, and privacy-preserving IoT-enabled architecture for contact tracing. *IEEE Commun Mag* 59:82–88. <https://doi.org/10.1109/MCOM.001.2000729>
100. Lochlainn MN, Lee KA, Sudre CH, Varsavsky T, Cardoso MJ, Menni C, Bowyer RCE, Nguyen LH, Drew DA, Ganesh S, Cadet JL du, Visconti A, Freidin MB, Modat M, Graham MS, Pujol JC, Murray B, Moustafa JSE-S, Zhang X, Davies R, Falchi M, Wolf J, Spector TD, Chan AT, Ourselin S, Steves CJ, COPE Consortium (2020) Key predictors of attending hospital with COVID19: an association study from the COVID symptom tracker app in 2,618,948 individuals
101. Zens M, Brammertz A, Herpich J, Südkamp N, Hinterseer M (2020) App-based tracking of self-reported COVID-19 symptoms: analysis of questionnaire data. *J Med Internet Res* 22:e21956. <https://doi.org/10.2196/21956>
102. Ocheja P, Cao Y, Ding S, Yoshikawa M (2020) Quantifying the privacy-utility trade-offs in COVID-19 contact tracing apps. [arXiv:2012.13061](https://arxiv.org/abs/2012.13061) [cs]
103. Torky M, Hassanien AE (2020) COVID-19 blockchain framework: innovative approach. [arXiv:2004.06081](https://arxiv.org/abs/2004.06081) [cs]
104. Alam T (2020) Internet of things and blockchain-based framework for coronavirus (COVID-19) disease. Social Science Research Network, Rochester, NY
105. Humayun M (2020) Blockchain-based secure framework for e-learning during COVID-19. *INDJST* 13:1328–1341. <https://doi.org/10.17485/IJST/v13i12.152>
106. Choudhury H, Goswami B, Gurung SK (2021) CovidChain: an anonymity preserving blockchain based framework for protection against covid-19. *Inf Secur J Glob Perspect* 30:257–280. <https://doi.org/10.1080/19393555.2021.1921315>
107. Song J, Gu T, Fang Z, Feng X, Ge Y, Fu H, Hu P, Mohapatra P (2021) Blockchain meets COVID-19: a framework for contact information sharing and risk notification system. In: 2021 IEEE 18th international conference on mobile ad hoc and smart systems (MASS), pp 269–277
108. Angelopoulos CM, Damianou A, Katos V (2005) DHP framework: digital health passports using blockchain—use case on international tourism during the COVID-19 pandemic. *Mon Not R Astron Soc* 359:567–579. <https://doi.org/10.1111/j.1365-2966.2005.08922.x>
109. Alsamhi SH, Lee B (2020) Blockchain for multi-robot collaboration to combat COVID-19 and future pandemics. [arXiv:2010.02137](https://arxiv.org/abs/2010.02137) [cs, eess]
110. Aslam B, Javed AR, Chakraborty C, Nebhen J, Raqib S, Rizwan M (2021) Blockchain and ANFIS empowered IoMT application for privacy preserved contact tracing in COVID-19 pandemic. *Pers Ubiquit Comput*. <https://doi.org/10.1007/s00779-021-01596-3>
111. Muhammad G, Hossain MS (2021) A deep-learning-based edge-centric COVID-19-like pandemic screening and diagnosis system within a B5G framework using blockchain. *IEEE Netw* 35:74–81. <https://doi.org/10.1109/MNET.011.2000326>
112. Alabdulkarim Y, Alameer A, Almkaynizi M, Almaslukh A (2021) SPIN: a blockchain-based framework for sharing COVID-19 pandemic information across nations. *Appl Sci* 11:8767. <https://doi.org/10.3390/app11188767>
113. Omar I, Debe M, Jayaraman R, Salah K, Omar M, Arshad J (2020) Blockchain-based supply chain traceability for COVID-19 PPE. <https://doi.org/10.36227/techrxiv.13227623.v1>



Houneida Sakly is a Ph.D. and Engineer in Medical Informatics. She is a member of the research program “deep learning analysis of Radiologic Imaging” in Stanford university. Certified in Healthcare Innovation with MIT-Harvard Medical school. Her main field of research is the Data science (Artificial Intelligence, Big Data, blockchain, Internet of things...) applied in healthcare. She is a member in the Integrated Science Association (ISA) in the Universal Scientific Education and Research Network (USERN) in Tunisia. Currently, she is serving as a lead editor for various book and special issue in the field of digital Transformation and data science in Healthcare. Recently, she has won the Best Researcher Award in the International Conference on Cardiology and Cardiovascular Medicine—San Francisco, United States.



AI and Big Data for Therapeutic Strategies in Psychiatry

Shankru Guggari

There is hope, even when your brain tells you there isn't.
John Green.

1 Introduction

Artificial intelligence (AI) and big data are used to develop tools that help patients or professionals such as psychiatrists, psychologists, social workers, occupational therapists, nurses, pharmacists, or counselors. In Study 1, five people encounter these types of disorders. Mental disorders usually have a strong influence on individuals' daily activities, significant suffering to their families, and a starting point for socioeconomic burden. Generally, these disorders are faced by young, healthy people and socially and economically critical segments. Therefore, it is a crucial and real-time requirement to monitor, providing highly significant treatment with an efficient way to detect it in the population. Development of tools for psychiatric disorders requires a deep understanding of mental illness, the present mental healthcare system, and, more importantly, medical ethics.

Various mental disorders vary in clinical presentation and cause. Autism, suicide, depression, schizophrenia, dementia, and attention-deficit hyperactivity disorder are few. Comorbidity or a single patient with more than one disorder is the main challenge for both machine learning and big data approaches. Psychiatry is a medical domain related to the treatment of people with mental illnesses. Generally,

S. Guggari (✉)
Machine Intelligence Research Labs, Berkeley, USA

School of Computer Science and Engineering, KLE Technological University,
Hubballi, India

psychiatric disorders occur due to higher functions of the brain and are highly associated with social, cultural, and experiential factors. There are two approaches in computational psychiatry: theory driven (mechanistic models for explicit hypotheses) and data-driven approaches [1]. The main challenges of psychological disorders are: Mental disorders are unique, these follow multivariate and multi-model in nature, Curse of dimensionality i.e. size of the data set, Fuzziness and unreliable labels of a disease in psychiatry [2].

The structure of the chapter: Artificial Intelligence in psychiatric disease is introduced in Sect. 2, Big Data in Psychiatric is introduced in Sect. 3, Datasets and Tools are introduced in Sect. 4, and the usage of AI models in psychiatric disorders is presented in Sect. 5. Finally, concluding remarks are presented in Sect. 6.

2 Artificial Intelligence in Psychiatric Disease

In general, AI helps in clinical outcomes, patient safety, and cost-effective solutions in the healthcare domain. In mental health diseases, it helps approximately in all stages, such as diagnosis, prognosis, and treatment. It takes care of patient flow activities, such as bed occupancy, electronic health records, and readmission risk [3]. AI techniques have been used to treat psychiatric disorders. Brain structure and function are the main biological phenotypes and diagnostic biomarkers of psychiatric disorders. Therefore, AI-related techniques provide detailed descriptions and characteristics of different psychiatric disorders to diagnose psychiatric disorders [4].

2.1 Machine Learning for Psychiatric Diseases

Present treatment for psychiatric disease is purely based on the experiential terms of the patient, rather than the objective markers of the illness. Previously, a set of events was performed to alleviate the symptoms of psychiatric patients, such as (i) Identification of new disease mechanisms using neuroscience studies. (ii) Explored new innovative treatments for the new disease i.e. design and test of candidate molecular components. (iii) Validate the new treatment using a large clinical trial, all of which encounter a few difficulties. Artificial intelligent approaches such as machine learning (ML) and deep learning models have the potential to improve the well-being of psychiatric patients.

Machine learning models discover general rules or principles from observations without using any instructions. These are characterized as (i) Make some formal assumptions, (ii) Allow the data, *speak for themselves*, and (iii) capacity to mine the structured knowledge from big or extensive data. These models are mainly grouped into supervised (development of models such as decision trees, neural networks, or support vector machines using few training samples) and unsupervised (these directly discover features and feed those features into quantitative models) techniques.

Psychiatric disorders are the main research area in brain science. To date, psychiatrists have diagnosed diseases based on subjective experience rather than the pathophysiology of the disease [5, 6]. This leads to a misdiagnosis of diseases by psychiatrists and provides incorrect treatment. Therefore, it is essential to develop effective treatments based on the etiology and pathogenesis of psychiatric diseases. The brain structure and its functions are major diagnostic biomarkers and biological phenotypes of psychiatric disorders [7]. This helps AI-related approaches to characterize various psychiatric disorders and enhance support for diagnosing mental-related disorders.

Magnetic resonance imaging (MRI), Kinesics diagnosis, and electroencephalography (EEG) are the three main brain observations in the study of psychiatric disorders. MRI is usually used to understand behavioral and cognitive neuroscience, which helps detect psychiatric abnormalities that cannot be detected by computed tomography (CT). Various AI applications have been developed with the support of MRI [8–11]. MRI is a crucial diagnostic tool. It has a few drawbacks; for example, it is not efficient for the imaging process (takes a long time). We need to optimize the key parameters in the big data. This requires very high computer configurations. EEG signals help to understand how information is processed by the human brain and diagnose psychiatric disorders. It has a high temporal resolution compared to that of CT and MRI. These signals are utilized in the diagnosis of depression, anxiety or psychosis. More specifically, these signals are used in the time resolution in the millisecond range. In EEG data, too many factors need to be considered so that there is a large amount of noise while building the classification model. Kinetic data such as facial expression and behavioral data are helpful for studying the pathogenesis, development transition, and diagnosis assistance for psychiatric disorders [12–14].

2.2 Opportunities

Current drug treatment for psychiatric disorders is successful in every second patient [15]. The best possible treatment for psychiatric disease is not based on knowledge of the causes of mental illness for a given patient or does not depend on the complex mechanism of the disease. The trial-and-error method is used to treat a few mental disorders [16]. Psychotherapy or specific drug treatment is successful, more effective for a few patient subgroups, and not successful for some patient groups with similar diagnoses. This challenge provides new opportunities to develop algorithmic frameworks for the diverse psychiatric conditions of patients to predict individual treatment [17].

Machine learning models offer either fully or partially suited clinical predictions at the individual level. All these models are conceptually placed between genetic risk variants and the clinical symptoms of the patient. These models can be directly used to predict inherently valid and useful clinical objects, such as drug dosage. ML models are naturally applicable to single-subject-level predictions. Therefore, it is essential to tune them for group-level analyses. ML models provide an opportunity

to focus on improvements in classification accuracy and model evaluation using different sampling techniques [18].

Machine learning models provide a two-step workflow [19]. Initially, structured knowledge is extracted from an openly available large dataset or dataset provided by hospitals. In the next step, the built model is shared as a collaborative research product. This product can be later tuned with little effort for a large number of patients with different mental disorders. In psychiatric medicine, ML models must be exploited for observational data such as movement and sleeping patterns, genetic variants, brain scans, or blood or metabolic samples. as they gathered without a controlled experimental setup [17].

In psychiatry practice, the main challenge is to identify whether a person has mental illness or not. It is very important to choose the appropriate treatment if a person has a mental illness. ML models provide an opportunity to predict treatment and treatment options. These models are applicable when we want to distinguish between two groups of patients or two treatment options by considering a wide number of outcomes. These also provide rankings for possible options based on pertinence. A single model needs to predict several psychiatric diagnoses based on disease categories. In brief, ML models handle multiple outcomes simultaneously [20].

In psychiatry, using various heterogeneous datasets such as experiential, behavioral, or genetic measurements of psychiatric diseases and their complex relationships can be described using small dimensions or features. These parameters can be easily obtained using ML models [21].

The development of explainable prediction models is another opportunity for building the model and generating explanations for the predictions.

2.3 Challenges

There are many reasons for extending ML models to psychology. These models suffer severely from a few challenges in everyday applications. Now, we are introducing a few challenges to precision medicine in the field of psychiatry [22–27].

1. All ML models followed a multistep workflow. As the dataset changes, these models require the manual tuning of the parameters. Therefore, it is difficult to reproduce a highly efficient model.
2. The primary limitation of all ML benchmark models is the availability of the data. In the psychiatric domain, datasets are unable to provide information such as medical history, presence of more than two medical conditions in the patient, progression in symptoms, treatment, and response.
3. The characteristics of mental disorders are time dependent. The lack of longitudinal data (data collected from sensors, voice data from smartphones, etc.) in model building is another pitfall in terms of the performance of the model. These longitudinal data help to understand the diverse behavior, sleeping

patterns, and geographical movement of people with mental illness is another challenge.

4. The prediction of the model is highly dependent on the training data. In psychiatric institutes, data are collected with respect to subject they research and researchers are not aware of the influencing features such as drug usage, heartbeat, age or gender etc. which they have collected for the experiment. This typically affects the performance of the model.
5. Clinical data were gathered from different centers under various clinical conditions. These data suffer from quality, and in some cases, useful information may be missed. In summary, heterogeneous and incomplete data are the most important and frequently encountered challenges in the psychiatric domain.
6. Psychiatric disorder evaluation is either laboratory or semi-supervised evaluation. Machine learning models are highly beneficial when evaluating them rigorously with different groups of participants.
7. Internal validity of the clinical data is the major challenge.
8. Results of machine learning models are related to current samples which are used while building the model.
9. Lack of data pool availability.
10. Detection of influence factors which effects high prediction such as age, gender, smoking, drug usage, or physiological noise like respiration and heart beat.

2.4 Deep Learning Models for Psychiatric Disorders

Deep learning (DL) models are very popular in the machine learning domain because of their adaptability to high-dimensional datasets. DL models are hierarchical models that achieve higher levels of abstraction and provide stacking of consecutive nonlinear transformations. These advantages help DL models to use various psychiatric disorders. DL models avoid manual feature extraction and feature selection, and attain less bias. These models are widely used in various applications of psychiatric diseases such as brain age and sex prediction [28], neuroimaging data [29], and neurological disorders [12]. Various neuroimaging datasets with respect to deep learning were described in [30]. DL models have made great progress in diagnosing psychiatric disorders but suffer from higher requirements for computer configurations (hardware), a large amount of data quantity, and time consumption to carry out the experiments [4].

3 Big Data in Psychiatry

Generally, the diagnosis of mental-related issues is based on the patient's interview and self-reported experience. With the increase in personal digital devices, it is very easy to capture movement using the movement information of the patient using a digital phenotype [31]. This helps to predict the mental status of an individual by



Fig. 1 Research framework of digital phenotyping for mental health

utilizing both active and passive data. The research framework of digital phenotyping for mental disorders is shown in Fig. 1, which has four layers: conceptual, sensing, computing, and application.

The conceptual layer deals with five important factors: biological, emotional, behavioral, social, and cognitive capabilities of mental health. The sensing layer is a physical layer that includes data generation and collection. Collection of data from ubiquitous sensors (wearable and smart phones), social media platforms, health care systems, etc. The computing layer provides brief information related to behavioral anomaly detection, affect recognition, cognitive analytics, social analytics, and biomarker analytics. Finally, key applications of digital phenotyping of mental health are described in the application layers.

There are two mechanisms and pragmatics in the field of psychiatry, where big data are used. Omics is a well-known mechanism for identifying the etiological mechanisms of human diseases. Genomic and proteomic omics is popular in traditional research. More recently, researchers are working towards metagenomics and metabolomics, which are collections of quantitative big data. On the other hand, pragmatics are like electronic health records, which are big data.

Numerous applications have been proposed for the treatment of psychiatric disorders. EmotionCheck [32] is utilized to control the anxiety of an individual and provide feedback via vibrations. Energy is the main challenge in this device for continuous monitoring. MoodRhythm [33] and CrossCheck [34] are used to predict a user's daily activities, infer sleep duration, and track sociability using audio data collected through a microphone. Mobile applications such as Ginger.io and MindStrong are used to quantify and understand the behavior of a patient through smartphones.

Integrating multimodal and heterogeneous data is a major challenge in digital phenotyping. These applications are not adopted for diagnosis because of the lack of rigorous evaluations using big data. Most of these applications do not consider social incentives. The main limitations with regard to this domain data are its governance and security, velocity of data acquisition, storage capacity, and collection of the data are not always based on the research questions and are not aware of influence factors [35].

3.1 Challenges of Big Data in Psychology

Data collection in a big data context is a human process that involves patients and their behaviors, such as purchasing decisions, reacting to emails, status updates, etc.

Challenges of big data research in psychology:

- (1) Various technologies and statistical constraints are emerged as constant challenge.
- (2) Gap in adopting current methodological training in psychology. It is essential to concentrate more on quantitative methodologies. It is equally important to make use of other disciplines, such as computer science and business analytics, to generate useful behavioral data. Therefore, it is time for psychology students to choose courses that are helpful in conducting multidisciplinary research, as many business schools are adopting courses related to psychology departments.
- (3) Quality of the data which collected from various methodologies and deriving meaningful psychological variable.
- (4) In exploratory analysis, understand what big data say is very important but are insights from big data can applied? Is the major concern.

3.2 Opportunities of Big Data in Psychiatry

Big data in psychiatry is a crucial component for the treatment of patients and provides brief information regarding their disorders. It also helps psychiatry professionals understand the disorders quickly and enhance their productivity. The following are the few opportunities described in the literature with respect to big data in psychiatry [36–41]:

- (1) Provides an opportunity for clinical data mining.
- (2) It creates chances to produce new clinical distinctions and phenotypes based on observational data with the help of few aggregated measurements.
- (3) It allows to explore previously unavailable clinical questions so that controlled trials can be performed for new hypotheses.
- (4) Effective Opportunity for epidemiologic research.
- (5) Generalizes the conclusions which are derived from the randomized clinical trials.
- (6) Observational evidences for randomized controlled trials.
- (7) Demonstrates relationship between parameters such as genetic findings and rare diseases.
- (8) It provides sufficient data to study the sub-populations that are underrepresented. For example, we used an integrative data analysis technique for heroin addicts by combining two independent datasets to generate a suitable sample size.
- (9) Combination of both behavior data and omics data enhances the possibilities of finding new biomarkers for psychiatric illnesses.
- (10) Provides an opportunity to analyze the human behavior and actions.

4 Datasets and Tools

Various datasets such as electronic health records, administrative datasets, case registers involving de novo datasets, and surveys and biobanks have been discussed in the literature [35]. The RDoC is a platform used to categorize large sets of data for the implementation of machine learning models developed by the National Institute of Mental Health. It is the integration of different large psychopathological domains to validate the diagnostic structure [27]. In another study, PredPsych: A toolbox in experimental psychology for analyzing quantitative behavioral data [42]. The Autism Brain Imaging Data Exchange (ABIDE) is a data-sharing initiative that consists of more than 20 scanning sites. It consists of more than 2000 features with structural and functional MRI scans of children with autism (ABIDE-I and ABIDE-II) and structural MRI (s-MRI) [29]. Figure 2 shows the neuroimaging datasets for the classification of psychiatric patients.

Monitoring is an important and effective component in the treatment. Supervision of nurses are required at regular intervals, sometimes it might take hours together. In few cases the patients may face problem in night, which leads to lower chances of a faster recovery and increase length of stay at hospital. Barrera et al. [43] introduced AI based digitally assisted nursing observations and enhance patient and staff experiences. This tool support nurses to take observations remotely using a sensor. It utilizes computer vision, signal processing. Here, AI is used to observe micromovements by using pulse and breathing rate. Experience Sampling Method is used to collect longitudinal data of participants experiences. This data is utilized for diagnosis psychosis spectrum disorder [44]. Integration study is performed using clinical research datasets for creating effective bipolar disorder

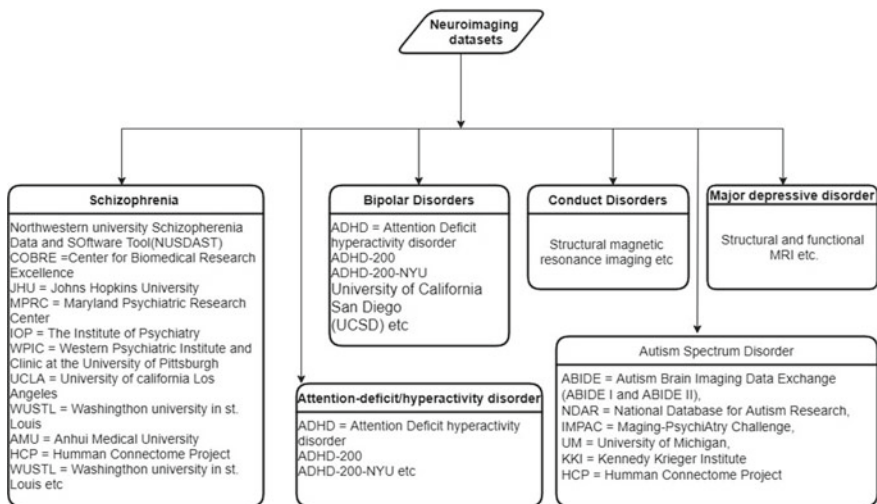

Fig. 2 Neuroimaging datasets

datasets [45]. Transcranial magnetic stimulation and electroencephalography (TMS-EEG) is a tool to study the neurophysiologic biomarkers for psychiatric disorders [46]. Similarly, An automated tool P.266 is used for psychiatric diagnosis which uses free speech [47]. AyuSoft prakriti diagnostic tool has been extensively used in Ayurveda research to diagnose psychiatric disorders [48]. Patient Participation Culture Tool for inpatient PSYchiatric wards to analyze psychometric properties [49].

5 Usage of AI Models in Psychiatry

Machine learning is a data-driven technique in which the initial model is built based on the initial inputs. Tune the model in the next step, and finally, the model is utilized to predict the unknown data or event based on its past and present learnt experience. Predictive analytics is a challenging and important task in machine-learning models. As mentioned earlier, the curse of dimensionality is the main obstacle in psychiatry. This can be overcome using three techniques: feature engineering, that is, creating useful predictors from the given input data, using unsupervised techniques such as principal component analysis to transform the given input to the lower dimensions, and finally, adopting penalty techniques such as regularization and Bayesian models to reduce the model complexity [2].

- (1) Suicide prediction model for the Korean population: Suicide is a crucial and very important health disease in the modern world. It is the most prominent health concern for human health and wellness. According to the World Health Organization, nearly 800,000 people die due to suicide. It highly affects the society and individuals of the nation. The present study used 372,813 individuals' medical checkup data from 2009 to 2015 in Korea. A random forest algorithm was used to build the model. It utilizes a five-fold cross-validation technique to calculate the performance of the model. Experiments were conducted using the R software. The study used medical check-up data collected from the National Health Insurance Sharing Service between 2009 and 2015. This study effectively classifies suicide and non-suicide categories. It also indicates that the suicide group had lower income, alcohol consumption, and smoking. The dataset was divided into 70% and 30% of the training and test datasets, respectively. Model performance was measured using the area under the curve (AUC), accuracy, sensitivity, and specificity. In summary, the model identified high-risk groups in the population [46]. Another study predicted suicide attempts among medical college students in China. It uses 4882 medical students for the experiment. Data were collected via an online platform using WeChat social media. It adopts a random forest model and utilizes a five-fold cross-validation technique to understand the performance model. The performance of the model was measured using the area under the curve (AUC), sensitivity, specificity, and classification accuracy. The experimental

analysis was performed using the MATLAB software. It demonstrated accuracy, sensitivity, and specificity of 90%, 73.5%, and 91.6%, respectively. This makes use of female participants a major drawback of this study. The studies suggested that the application of ML models assists in improving the efficiency of suicide prevention [50].

- (2) Prediction of criminal offense of psychiatric patients: This study uses ML models such as random forest, elastic net, and support vector machine. It makes use of 1240 patient details, which have information on clinical and sociodemographic features, are considered as potential predictors. Feature selection techniques were considered for model generality and interpretability. It is a binary (violent and nonviolent) classification model. This indicates 82.5% sensitivity and 60% specificity [51].
- (3) Depression: It is a psychological disorder, and persistent sadness for at least 2 weeks is one of the characteristics of this disease. During this period, the patient was unable to perform daily activities. A study was conducted to identify whether a person was depressed or not. Sociodemographic and psychosocial information was used to conduct the experiments. Six different ML models were used in this study. K-Best features, minimum redundancy and maximum relevance, and Boruta feature selection techniques were utilized to extract the most relevant features from the dataset. The class imbalance problem of the dataset is addressed with the support of the synthetic minority oversampling technique (SMOTE) to improve the classification accuracy in predicting depression. The AdaBoost model indicates the highest (92.56%) among all the ML models. The efficiency of the models is based on metrics such as sensitivity, specificity, precision, F1-score, and area under the curve [52]. In another study, textual-based feature methods were used to detect depression. The study makes use of social media posts with words such as depression or diagnosis. It uses both ensemble and single models. Experiments were performed using both labeled and non-Twitter datasets. The results show that the proposed model effectively detects depression without the important keywords mentioned earlier [53].
- (4) Psychosis: The symptoms of first-episode psychosis vary greatly. These may vary from population to population and show different potential illness courses. A clustering ML model was adopted to examine the dimensional structure of symptoms, which enhanced the identification of individual trajectories at the initial stage of the illness. This also indicates the potential risk factors. Principal component analysis was used to identify the dimensions. Fuzzy clustering (an unsupervised ML model) demonstrates the clinical subgroups of patients. This study provides a better understanding of the heterogeneous profile of first-episode psychosis [54]. A study was performed to predict patients with psychotic disorders. The experience sampling method was used to collect the data. The ReliefF method was used for the feature selection. It uses random forest, support vector machines, Gaussian processes, logistic regression, and neural networks to build models with different sampling techniques, such as cross-validation or training/testing. The stability of the

model is based on Monte Carlo simulations. Support vector machines with radial kernels provide better performance (82% accuracy) [44].

6 Conclusions

In summary, there is a need to understand the complexities of mental disorders, such as diagnosis and treatment. The impact of these complexities on AI and big data space diagnosis is a major step in the treatment of mental illnesses. In this scenario, ML and big data technologies help us understand which group of people are at risk. These will also provide interventions that save lives, and many cases prevent illness. ML models describe trends and variables of the larger population and help organize social events to decrease these disorders. In some cases, clinicians are unable to predict which patients are at risk. Predictive tools have the potential to fill this gap and save the lives of patients with mental illnesses. Predictive models support patients by providing more useful information regarding the treatment of mental disorders. These tools also help patients' families plan for different clinical courses.

These tools help in the selection of optimal treatments from a range of psychiatric interventions without affecting efficacy. AI technology provides personalized and virtual treatments using digital therapeutic applications. These usually replace traditional psychotherapies. Monitoring patients with mental illness is an essential task for clinicians to gain a deeper understanding of their condition and symptoms. Clinicians must frequently report patients to non-hospitalized patients. Automated and semi-automated tools help in this type of scenario. All use-cases of this domain must take care of ethical issues such as patient dignity, right or present medical ethics, etc.

Future Scopes

- (1) Develop sharpen AI models (using natural language processing techniques) that provide consequential insights from human dialogue and communications to better understand psychiatric disorders.
- (2) Design federated machine-learning models in which a centralized model was developed using decentralized data. These models are very helpful for community-based healthcare services. This kind of service is highly encouraged to treat patients with mental illnesses.
- (3) Developing new techniques and applications for human-computer interaction will help to provide non-intrusive sensing so that researchers can continuously gather the mental conditions of a patient.
- (4) Current studies utilize classic shallow models. The high-dimensional features of a dataset face serious challenges in this context. Hope deep learning models will address these challenges.
- (5) Adopt unsupervised learning models for automatic annotation for psychiatric disorders datasets.

- (6) Rigorous research needs to be performed using ensemble, migration, and multiview learning approaches to process big psychiatric disorder data to improve the performance of the models.
- (7) Need to study the psychiatry diseases at cellular level.
- (8) Deep learning models have a promising role in the development of future biological neuroimaging biomarkers for psychiatric disorders.

References

1. Rutledge RB, Chekroud AM, Huys QJ (2019) Machine learning and big data in psychiatry: toward clinical applications. *Curr Opin Neurobiol* 55:152–159
2. Hahn T, Nierenberg AA, Whitfield-Gabrieli S (2017) Predictive analytics in mental health: applications, guidelines, challenges and perspectives. *Mol Psychiatry* 22:37–43
3. Cecula P, Yu J, Dawoodbhoy FM, Delaney J, Tan J, Peacock I, Cox B (2021) Applications of artificial intelligence to improve patient flow on mental health inpatient units—narrative literature review. *Heliyon* 7:e06626
4. Liu G-D, Li Y-C, Zhang W, Zhang L (2020) A brief review of artificial intelligence applications and algorithms for psychiatric disorders. *Engineering* 6:462–467
5. Insel TR (2014) The NIMH research domain criteria (RDoC) project: precision medicine for psychiatry. *Am J Psychiatry* 171:395–397
6. Kalmady SV, Greiner R, Agrawal R, Shivakumar V, Narayanaswamy JC (2019) Brown MRG towards artificial intelligence in mental health by improving schizophrenia prediction with multiple brain parcellation ensemble-learning. *NPJ Schizophr* 5(1):2
7. Silverman BG, Hanrahan N, Huang L, Rabinowitz EF, Lim S (2016) Artificial intelligence in behavioral and mental health care
8. Rosen BR, Huang SY, Stufflebeam SM (2015) Pushing the limits of human neuroimaging. *JAMA* 314:993–994
9. Hategan A, Bourgeois JA, Cheng T, Young J (2018) Neuropsychology and neuroimaging in clinical geriatric psychiatry. In: *Geriatric psychiatry study guide*. Springer, pp 23–38
10. Park MTM, Raznahan A, Shaw P, Gogtay N, Lerch JP, Chakravarty MM (2018) Neuroanatomical phenotypes in mental illness: identifying convergent and divergent cortical phenotypes across autism, ADHD and schizophrenia. *J Psychiatry Neurosci* 43:201
11. Arbabshirani MR, Plis S, Sui J, Calhoun VD (2017) Single subject prediction of brain disorders in neuroimaging: promises and pitfalls. *Neuroimage* 145:137–165
12. Vieira S, Pinaya WH, Mechelli A (2017) Using deep learning to investigate the neuroimaging correlates of psychiatric and neurological disorders: methods and applications. *Neurosci Biobehav Rev* 74:58–75
13. Reneman L, van der Pluijm M, Schranter A, van de Giessen E (2021) Imaging of the dopamine system with focus on pharmacological MRI and neuromelanin imaging. *Eur J Radiol* 140:109752
14. Koike S, Tanaka SC, Okada T, Aso T, Yamashita A, Yamashita O, Asano M, Maikusa N, Morita K, Okada N (2021) Brain/MINDS beyond human brain MRI project: a protocol for multi-level harmonization across brain disorders throughout the lifespan. *NeuroImage Clin* 30:102600
15. Wong EH, Yocca F, Smith MA, Lee C-M (2010) Challenges and opportunities for drug discovery in psychiatric disorders: the drug hunters' perspective. *Int J Neuropsychopharmacol* 13:1269–1284
16. Rush AJ, Trivedi MH, Wisniewski SR, Nierenberg AA, Stewart JW, Warden D, Niederehe G, Thase ME, Lavori PW, Lebowitz BD (2008) Acute and longer-term outcomes in depressed outpatients requiring one or several treatment steps: a STAR*D report. *Focus* 6:128–142

17. Drysdale AT, Grosenick L, Downar J, Dunlop K, Mansouri F, Meng Y, Fetcho RN, Zebley B, Oathes DJ, Etkin A (2017) Resting-state connectivity biomarkers define neurophysiological subtypes of depression. *Nat Med* 23:28–38
18. Huys QJ, Maia TV, Frank MJ (2016) Computational psychiatry as a bridge from neuroscience to clinical applications. *Nat Neurosci* 19:404–413
19. Woo C-W, Chang LJ, Lindquist MA, Wager TD (2017) Building better biomarkers: brain models in translational neuroimaging. *Nat Neurosci* 20:365–377
20. Bzdok D, Meyer-Lindenberg A (2018) Machine learning for precision psychiatry: opportunities and challenges. *Biol Psychiatry Cogn Neurosci Neuroimaging* 3:223–230
21. Van Os J (2016) “Schizophrenia” does not exist. *BMJ* 352
22. Squeglia LM, Ball TM, Jacobus J, Brumback T, McKenna BS, Nguyen-Louie TT, Sorg SF, Paulus MP, Tapert SF (2017) Neural predictors of initiating alcohol use during adolescence. *Am J Psychiatry* 174:172–185
23. Eyre HA, Singh AB, Reynolds C III (2016) Tech giants enter mental health. *World Psychiatry* 15:21
24. Manyika J, Chui M, Bisson P, Woetzel J, Dobbs R, Bughin J, Aharon D (2015) Unlocking the potential of the internet of things. *McKinsey Glob Inst* 1
25. Weinberger DR, Radulescu E (2016) Finding the elusive psychiatric “lesion” with 21st-century neuroanatomy: a note of caution. *Am J Psychiatry* 173:27–33
26. Verma S (2019) Weapons of math destruction: how big data increases inequality and threatens democracy. *Vikalpa* 44:97–98
27. Tai AM, Albuquerque A, Carmona NE, Subramaniepillai M, Cha DS, Sheko M, Lee Y, Mansur R, McIntyre RS (2019) Machine learning and big data: implications for disease modeling and therapeutic discovery in psychiatry. *Artif Intell Med* 99:101704
28. Peng H, Gong W, Beckmann CF, Vedaldi A, Smith SM (2021) Accurate brain age prediction with lightweight deep neural networks. *Med Image Anal* 68:101871
29. Quak M, van de Mortel L, Thomas RM, van Wingen G (2021) Deep learning applications for the classification of psychiatric disorders using neuroimaging data: systematic review and meta-analysis. *NeuroImage Clin* 30
30. Heinsfeld AS, Franco AR, Craddock RC, Buchweitz A, Meneguzzi F (2018) Identification of autism spectrum disorder using deep learning and the ABIDE dataset. *NeuroImage Clin* 17:16–23
31. Liang Y, Zheng X, Zeng DD (2019) A survey on big data-driven digital phenotyping of mental health. *Inf Fusion* 52:290–307
32. Costa J, Adams AT, Jung MF, Guimbretière F, Choudhury T (2016) EmotionCheck: leveraging bodily signals and false feedback to regulate our emotions. In: *Proceedings of the 2016 ACM international joint conference on pervasive and ubiquitous computing*, pp 758–769
33. Voids S, Matthews M, Abdullah S, Xi M, Green M, Jang WJ, Hu D, Weinrich J, Patil P, Rabbi M (2013) Moodrhythm: tracking and supporting daily rhythms. In: *Proceedings of the 2013 ACM conference on pervasive and ubiquitous computing adjunct publication*, pp 67–70
34. Wang R, Aung MS, Abdullah S, Brian R, Campbell AT, Choudhury T, Hauser M, Kane J, Merrill M, Scherer EA (2016) CrossCheck: toward passive sensing and detection of mental health changes in people with schizophrenia. In: *Proceedings of the 2016 ACM international joint conference on pervasive and ubiquitous computing*, pp 886–897
35. Stewart R, Davis K (2016) ‘Big data’ in mental health research: current status and emerging possibilities. *Soc Psychiatry Psychiatr Epidemiol* 51:1055–1072
36. Murdoch TB, Detsky AS (2013) The inevitable application of big data to health care. *JAMA* 309:1351–1352
37. Titunik R (2015) Can big data solve the fundamental problem of causal inference? *PS Polit Sci Polit* 48:75–79
38. Fan J, Han F, Liu H (2014) Challenges of big data analysis. *Natl Sci Rev* 1:293–314
39. Srinivasan S, Moser RP, Willis G, Riley W, Alexander M, Berrigan D, Kobrin S (2015) Small is essential: importance of subpopulation research in cancer control



40. Monteith S, Glenn T, Geddes J, Bauer M (2015) Big data are coming to psychiatry: a general introduction. *Int J Bipolar Disord* 3:1–11
41. McIntyre RS, Cha DS, Jerrell JM, Swardfager W, Kim RD, Costa LG, Baskaran A, Soczynska JK, Woldeyohannes HO, Mansur RB (2014) Advancing biomarker research: utilizing ‘big data’ approaches for the characterization and prevention of bipolar disorder. *Bipolar Disord* 16:531–547
42. Koul A, Becchio C, Cavallo A (2018) PredPsych: a toolbox for predictive machine learning-based approach in experimental psychology research. *Behav Res Methods* 50:1657–1672
43. Barrera A, Gee C, Wood A, Gibson O, Bayley D, Geddes J (2020) Introducing artificial intelligence in acute psychiatric inpatient care: qualitative study of its use to conduct nursing observations. *Evid Based Ment Health* 23:34–38
44. Stamate D, Katrinecz A, Stahl D, Verhagen SJ, Delespaul PA, van Os J, Guloksuz S (2019) Identifying psychosis spectrum disorder from experience sampling data using machine learning approaches. *Schizophr Res* 209:156–163
45. Eyler LT, Aebi ME, Daly RE, Hansen K, Tatsuoka C, Young RC, Sajatovic M (2019) Understanding aging in bipolar disorder by integrating archival clinical research datasets. *Am J Geriatr Psychiatry* 27:1122–1134
46. Cao K-X, Ma M-L, Wang C-Z, Iqbal J, Si J-J, Xue Y-X, Yang J-L (2021) TMS-EEG: an emerging tool to study the neurophysiologic biomarkers of psychiatric disorders. *Neuropharmacology* 108574
47. Horev S, Stukalin YS, Hagin M, Harazi R, Popovic D (2019) P.266 automated tool for psychiatric diagnosis based on free speech. *Eur Neuropsychopharmacol* 29:S198–S199
48. Bhargav H, Jasti N, More P, Kumar V, Chikkanna U, Kumar RK, Varambally S (2021) Correlation of prakriti diagnosis using AyuSoft prakriti diagnostic tool with clinician rating in patients with psychiatric disorders. *J Ayurveda Integr Med* 12:365–368
49. Malfait S, Vandewalle J, Eeckloo K, Colman R, Van Hecke A (2017) The development and validation of the patient participation culture tool for inpatient psychiatric wards (PaCT-PSY). *Arch Psychiatr Nurs* 31:463–469
50. Shen Y, Zhang W, Chan BSM, Zhang Y, Meng F, Kennon EA, Wu HE, Luo X, Zhang X (2020) Detecting risk of suicide attempts among Chinese medical college students using a machine learning algorithm. *J Affect Disord* 273:18–23
51. Watts D, Moulden H, Mamak M, Upfold C, Chaimowitz G, Kapczynski F (2021) Predicting offenses among individuals with psychiatric disorders—a machine learning approach. *J Psychiatr Res* 138:146–154
52. Zulfiker MS, Kabir N, Biswas AA, Nazneen T, Uddin MS (2021) An in-depth analysis of machine learning approaches to predict depression. *Curr Res Behav Sci* 2:100044
53. Chiong R, Budhi GS, Dhakal S, Chiong F (2021) A textual-based featuring approach for depression detection using machine learning classifiers and social media texts. *Comput Biol Med*:104499
54. Amoretti S, Verdolini N, Mezquida G, Rabelo-da-Ponte FD, Cuesta MJ, Pina-Camacho L, Gomez-Ramiro M, De-la-Cámara C, González-Pinto A, Díaz-Caneja CM (2021) Identifying clinical clusters with distinct trajectories in first-episode psychosis through an unsupervised machine learning technique. *Eur Neuropsychopharmacol* 47:112–129



Shankru Guggari obtained his Ph.D. in computer science and Engineering domain. He is currently working on building robust classification techniques. Recently, he has won the best research paper award in the international conference. Pattern recognition, IOT and Machine learning are the interested research area of him. He has published some of his research works in international conferences and reputed journals published by Elsevier, springer etc. He has more than 4 years of industry and 2 years in academic research experience. Currently, he is serving as a lead editor for edited book, will publish by the Elsevier. He has delivered technical talks in various platforms. He is also served as guest editor for few special issues related to AI and ML domains.



Distributed Learning in Healthcare

Anup Tuladhar , Deepthi Rajashekar , and Nils D. Forkert 

1 Introduction

Artificial intelligence (AI) with the subfield of machine learning (ML) and especially deep learning (DL) are all around us today, and many solutions and tools making use of this technology often achieve a performance similar to that of human observers [1]. Healthcare is no exception to this, [2] and it is expected that these data-driven advances enable prevention of diseases before they develop, an earlier and better diagnosis of diseases, and better patient-individual patient care (from treatment to rehabilitation). These three main pillars of precision medicine have the potential to reduce healthcare costs [3, 4].

A. Tuladhar (✉) · D. Rajashekar · N. D. Forkert
Department of Radiology, University of Calgary, Calgary, AB, Canada
e-mail: anup.tuladhar@ucalgary.ca

D. Rajashekar
e-mail: deepthi.rajashekar1@ucalgary.ca

N. D. Forkert
e-mail: nils.forkert@ucalgary.ca

A. Tuladhar · D. Rajashekar · N. D. Forkert
Hotchkiss Brain Institute, University of Calgary, Calgary, AB, Canada

Department of Clinical Neurosciences, University of Calgary, Calgary, AB, Canada

N. D. Forkert
Alberta Children's Hospital Research Institute, University of Calgary, Calgary, AB, Canada
Department of Electrical and Software Engineering, University of Calgary, Calgary, AB, Canada

From an AI standpoint, problems in healthcare are mostly related to predictive modeling of patient outcomes and recovery, developing prognostic support systems for disease screening, or predictive modeling of operational events in healthcare. In the sub-field of predictive analytics for diagnostic support alone, AI techniques have successfully been applied in many specialties, such as radiology [5, 6], cardiology [7–9], neurology [10–16], endocrinology [17], nephrology [18], and otologic diseases [19]. AI has also been successfully used in drug discovery [20, 21] and for understanding patient recovery using personal healthcare data from wearable devices or smartphone apps [22].

The performance of these AI-based models depends on many factors, such as (1) the fidelity of the sample data to true disease populations and (2) the size of the data used for training the models. If the training data are sampled from a homogenous patient cohort (not representative of the general population), the performance of the model on unseen datasets collected from a different sample population will be considerably low. This is commonly referred to as the lack of generalizability of AI solutions, which can ultimately introduce considerable racial, gender, social, and other biases. A similar phenomenon is likely to occur when the training datasets are heterogeneous but small in number (relative to the number of features describing each patient's data). This is a classic example of model complexity, which is substantially higher than the variability captured in the training dataset, often leading to model overfitting.

Thus, it is necessary to train AI models on large-scale heterogeneous datasets that are representative of the true disease population, thereby enhancing model robustness and generalizability to unseen patient data.

1.1 Caveats of Central Learning

The traditional approach to building these effective AI solutions has been to train them on large volumes of healthcare data that are obtained from multiple sources into a centralized data repository, ensuring data variety and veracity. A simplified, yet typical, setup of the central big data-driven machine learning framework is depicted in Fig. 1a. Here, data are aggregated from multiple participating institutions into a single data center, the AI model is developed using this centralized data, and the knowledge is disseminated to the stakeholders of the AI model, such as clinicians, healthcare providers, researchers, pharmaceutical companies, and hospital caregivers.

Individual healthcare providers and research institutions barely have access to sufficient healthcare data to train robust and reliable machine learning models, especially in the case of rare diseases. Thus, one important resource to develop successful AI models are large-scale databases that are curated for scientific advancements and/or commercial value. Briefly, they can be categorized as follows.

- (1) Regional or nationwide data lakes: These are databases curated by national collaborative health care providers, public health, and government agencies.

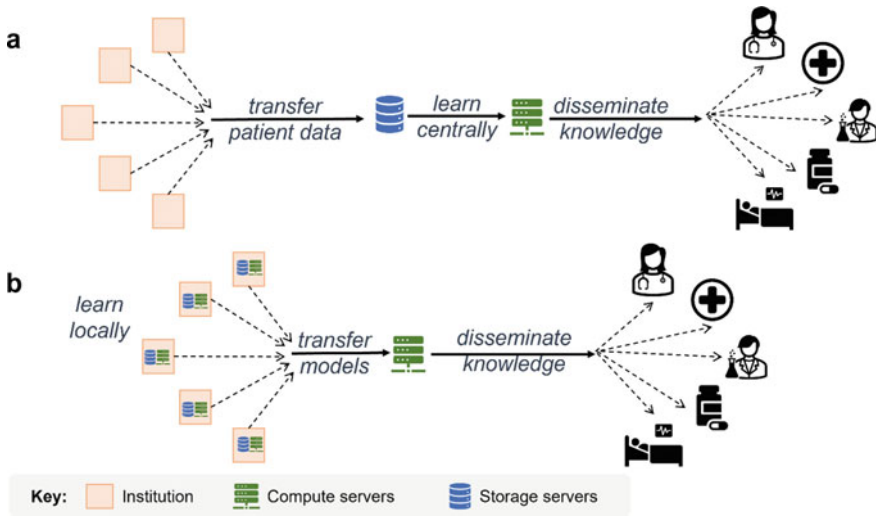

Fig. 1 Illustrative comparison of key differences between **a** central learning and **b** distributed learning

Typical examples include the French Health Data Hub [23], National Safe Haven from NHS Scotland [24], and Health Data Research UK [25].

- (2) Population studies: These comprehensive data sources often integrate multi-modal clinical information such as basic clinical data, imaging, biospecimens data, neuropsychological assessments, survey data, and disease information for a large population, both cross-sectional and longitudinal. Common examples include the UK Biobank [26] and the Canadian Biobank [27].
- (3) Pathology-focused studies: These secondary datasets are often curated by institution level or provincial clinical trials [28], or pathology-specific research consortiums such as ADNI [29], PPMI [30], HERMES [31], and OASIS [32, 33].

While this centralized data collection approach has resulted in many advanced AI solutions, there are various conceptual, regulatory, and technical limitations in the centralized learning paradigm with respect to healthcare that prevent the widespread adoption of this approach for any disease. First, AI models trained on curated datasets from a few select sources are likely to have hidden biases introduced by patient demographics or data acquisition protocols. These hidden biases might skew the model performance on unseen test data that are sampled from a different patient sub-population, such as rare disease phenotypes. Furthermore, there are often ethical, legal, and regulatory challenges to centralize sensitive patient information. These regulations require medical data to be anonymized, such that patients cannot be re-identified, a common security threat in healthcare. Despite the strict measures to safely transfer anonymized patient health information to a central repository, one cannot guarantee that any aspect of sensitive patient information

will not be leaked during data transfer. Thus, ensuring the privacy of the patient’s medical records while building robust AI models is a non-trivial endeavor, this creates the need to develop AI strategies that support data privacy in healthcare.

1.2 Motivation for Distributed Learning

The optimal approach to upholding the security of patient information is to ensure that the patient data do not leave the participating institution to create a centralized data repository in the first place. One way to eliminate data transfer is by conceptualizing the model training process such that the AI models are trained locally at the participating institutions and design a way to aggregate the learned

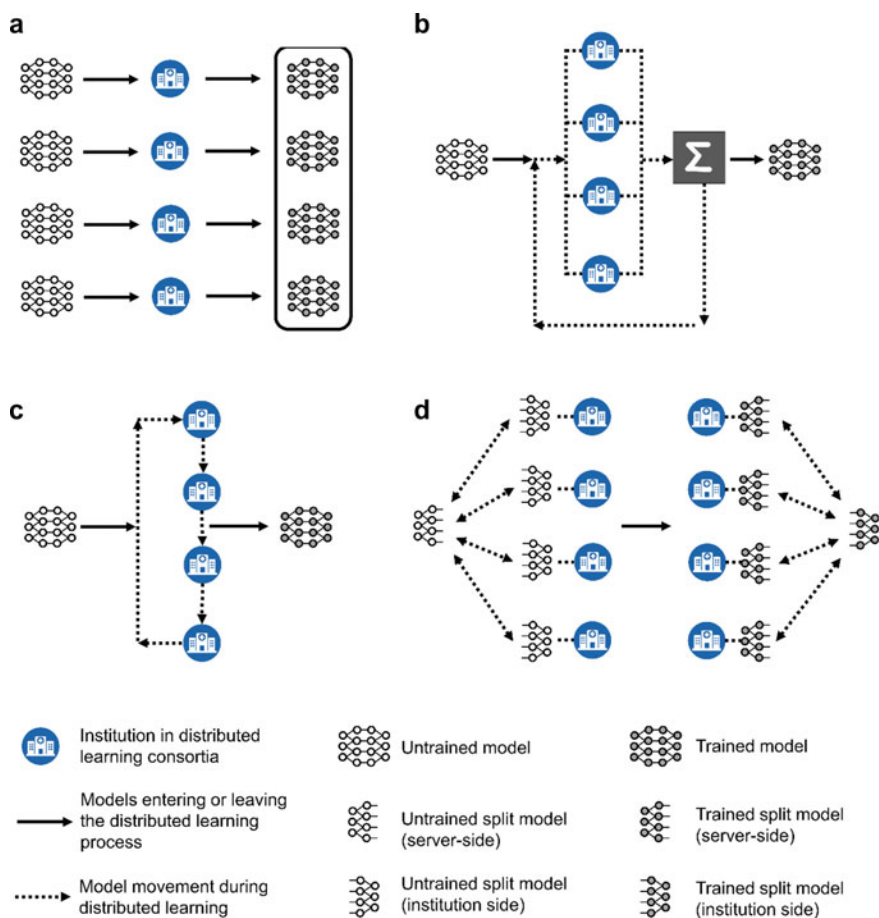

Fig. 2 Distributed learning methods. **a** Global ensemble method **b** Parameter aggregation **c** Traveling model **d** Split learning

knowledge from each site (see Fig. 1b). This style of AI model development is often referred to as *distributed learning*. Figure 2 depicts a broad categorization of distributed learning. A detailed review of these methods and their applications in healthcare is presented in Sect. 2.

Within this context, a participating institution can be any entity that is capable of collecting and storing healthcare data locally. The scale of these entities can range from government agencies, hospitals, clinics, or even individual patient data collected via wearables or other mobile health platforms. Additionally, these institutions are also required to have the technological capabilities to train AI models locally and to ensure that confidential patient information does not leave the safety of the institution's health data management protocols.

Multiple institutions participating in the distributed learning of an AI model form a collaborative network, referred to as a consortium, to share the experiences learned locally at each institution. Contrary to central learning, in the distributed learning framework, individual institutions within the consortia collaborate on model training (instead of data sharing) (Fig. 1). This, in turn, requires that the datasets maintained at each participating institution of the consortia should follow a standard set of guidelines and quality control procedures while still following the national healthcare regulations ensuring confidentiality and patient privacy [34–37]. The scope of a consortium can be designed either horizontally or vertically, as illustrated in Fig. 3. The most common approach is the horizontal split of patient information (Fig. 2a), where multiple institutions train on the same set of descriptors (i.e., input features) for a given patient dataset (Fig. 3a). Here, the data sample from each institution is comprised of an exclusive set of individuals, while the features curated at each center are standardized [38]. It is also possible for institutions to contain data on the same patient sample, but provide a different type or subset of features acquired. For instance, one institution can contain only imaging data, whereas another institution within the consortia can contain biospecimen data for the same patient sample. This type of distribution by patient descriptors is known as a vertical split (Fig. 3b).

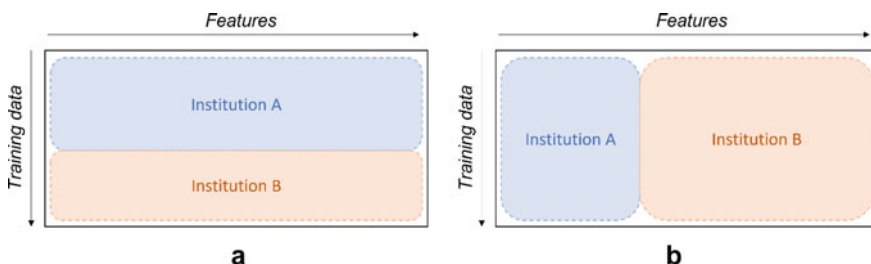

Fig. 3 Two modes of data distributions: **a** horizontal split of data across institutions **b** vertical split of data across input features

The remainder of this chapter is organized as follows. Section 2 describes the various methods that can be used to implement distributed learning in real-life scenarios and provide relevant and current applications in healthcare. These applications range from distributed learning employing radiology data, electronic health records, and personal smartphone data to learn tasks such as tissue segmentation, disease stage classification, and patient recovery trends, respectively. Section 3 reviews the current challenges and considerations in designing a distributed learning framework for healthcare applications. Section 4 provides a future outlook of distributed learning and its principles, and is meant to serve as a hitchhiker's guide to employing distributed learning. Finally, the chapter concludes with key observations and core messages related to distributed learning.

2 Distributed Learning Methods

Distributed learning addresses the problem of data privacy and governance by avoiding data sharing and training models locally at the healthcare provider or data holders. Thus, data holders can retain control over how and when the data are used in all stages of the artificial intelligence model development process.

Thus, the main challenge of distributed learning is to develop methods that can achieve accuracies similar to a hypothetical central learning model that could have been created if all the decentralized data were aggregated into a single dataset. In lieu of transferring data from a center, what is transferred is the model parameters from the locally trained model. By combining locally trained models from members of the distributed learning consortia or training such models sequentially at the data contributors, a global model can be created that leverages the knowledge derived from a large amount and variety of data to achieve accuracies greater than any locally trained model alone. To date, there are four established distributed learning methods that have shown promise: global ensembling, parameter aggregation, traveling models, and split learning methods. These methods are described in detail below.

2.1 Global Ensemble

The global ensemble method is potentially the simplest form of distributed learning and, briefly described, uses an ensemble of independently trained models (Fig. 2a). Each participating institution shares a model that is fully trained using only its own private data. These locally trained models retain their own unique parameters and form a global ensemble of independent models. At inference, the global model combines predictions from independent models into a single prediction [39–41]. Although a central server can be used to ensemble the locally trained model, this method easily lends itself to a decentralized peer-to-peer design in which trained models are directly shared between consortia members. A key consideration for this

distributed learning approach is the combination of these individual predictions. Averaging predictions, such as probabilities, classification outputs, and regression outputs, are the simplest form. However, this does not account for bias or poor performance in some local models, which can unduly affect the accuracy of the global ensemble. Methods to account for skewed or poor local model performance, such as weighting individual models by the number of datasets they were trained on, can be used to improve the performance of the global ensemble [41]. The global ensemble method has been used to train AI models for disease prediction using both imaging [39, 40] and non-imaging medical data [41] (Table 1).

This method has a low communication overhead during model training and provides more flexibility for participating institutions. As the institutions only share models after local training is complete, only a single communication round is needed. A potential benefit as well as a drawback of this approach is that the AI models, in theory, used at each institution can be different (e.g., support vector machine in one institution and artificial neural network in another institution). While this gives the participating institutions some flexibility, different models are potentially harder to combine. This flexibility in model details also means that the global ensemble method can be used for both horizontally and vertically partitioned data (Fig. 3), as different models can be trained on different feature sets. Furthermore, they can update their local model on new data without needing to retrain the entire global ensemble at each institution and can elect to remove their model from the ensemble without having to retrain the global model at each institution. A limitation of the global ensemble approach is that training is not performed on the overall pool of data, and the overall performance of the global model is restricted by the performance of individual locally trained models. Thus, the benefits of this approach are primarily in improving performance at inference and not during training. While this may be sufficient when problems are simple and local dataset sizes are large enough to train individual models with fair performance, it may be inadequate for more challenging tasks such as in medical imaging or with small local dataset sizes, such as in rare diseases [41]. Furthermore, as the global ensemble consists of many models, the computational cost at inference may be higher compared to approaches that use a single model.

2.2 Parameter Aggregation

The parameter aggregation method, often referred to as federated learning [42, 43], creates a single global model by aggregating the parameters of locally trained models (Fig. 2b). Same like in case of the global ensemble approach, each participating institution trains local models in parallel on their local data and shares the model parameters. However, in contrast to the global ensemble methods, the models are not used separately to make inferences on new data, which are then combined; instead, the model parameters from each contributing center are aggregated together to construct a single global model. This is often an iterative process, where the global model is sent to institutions for a few rounds of local training, returned for parameter

Table 1 Current applications of distributed learning

Problem	AI model(s) used	Distributed learning method(s)	Data (source)
Disease prediction (dementia, heart disease, liver disease, breast cancer) [41]	Artificial neural network, Support vector machine, Random forests	Global ensemble	Tabular medical data from various sources (heart disease [141], diabetes [142], ADNI [29], breast cancer [143])
Disease prediction (schizophrenia) [40]	Support vector machine	Global ensemble	Medical imaging (Patient data from multiple hospitals)
Disease prediction (retinal fundus, breast cancer) [39]	Convolutional neural network	Global ensemble, Traveling model	Medical imaging (Kaggle diabetic retinopathy [144], USF Digital Mammography DDSM) [145]
Mortality prediction [49]	Artificial neural network	Parameter aggregation	EHR (eICU collaborative research database) [146]
Disease prediction (dyspnea) [46]	Bayesian network	Parameter aggregation	EHR (Patient data from multiple hospital)
Drug discovery [50]	Artificial neural network	Parameter aggregation	Quantitative structure–activity relationships (multiple)
Predicting hospitalizations [147]	Support vector machine	Parameter aggregation	EHR (Boston Medical Center)
Adverse drug reaction prediction [148]	Support vector machine, artificial neural network, logistic regression	Parameter aggregation	EHR (Limited IBM MarketScan Explorys Claims EMR, LCED)
Mobile activity monitoring [52]	Artificial neural network	Parameter aggregation	Smartphone wearable device data (Heterogeneity Human Activity Recognition (HHAR)) [149]
Mobile activity monitoring [150]	Artificial neural network	Parameter aggregation	Smartphone wearable device data [151]
Mobile disease monitoring (Parkinson's) [51]	Convolutional neural network	Parameter aggregation	Smartphone wearable device data (UCI Smartphone dataset [152] and Parkinson's patient wearable device data)
Disease prediction (Covid-19) [47]	Convolutional neural network	Parameter aggregation	Medical imaging (COVIDx dataset [153])
Lesion segmentation (Brain tumor) [48]	Convolutional neural network	Parameter aggregation, Traveling model	Medical imaging (BRaTS 2017 [154])

(continued)

Table 1 (continued)

Problem	AI model(s) used	Distributed learning method(s)	Data (source)
Disease prediction [63]	Convolutional neural network	Split learning	Medical imaging (Kaggle Diabetic retinopathy [144], Chest X-ray CheXpert [155])
Disease prediction (Arrhythmia diagnosis) [64]	Convolutional neural network	Split learning	Electrocardiograms (MIT-BIH Arrhythmia dataset [156])
Disease prediction (Covid-19, bone fracture) [62]	Convolutional neural network	Split learning	Medical imaging (Covid-19 Chest CT scans, MURA bone x-ray dataset [157])
Disease prediction [54]	Convolutional neural network	Traveling model	Medical imaging (NIH Chest X-ray dataset [158], Kaggle diabetic retinopathy [144])
Disease prediction [55]	Support vector machine, artificial neural network, logistic regression	Traveling model	Medical data (breast cancer [143], diabetes [142], NSCLC-Radiomics dataset [159, 160], NSCLC Stage III cancer dataset [161])
Mortality prediction, disease prediction (breast cancer) [56]	Artificial neural network	Traveling model	EHR (eICU collaborative research database) [146], Genome data (TCGA Cancer Genome Atlas) [162]

aggregation, and sent out again for local training. This loop of local training and global aggregation is repeated until a predefined model convergence criterion is met. The coordination of the overall training process is most often performed using a central server that orchestrates local training and parameter aggregation. Decentralized training is also possible in this approach by using a peer-to-peer design, where model updates can be shared between all participants or a subset of participants [44, 45]. The parameter aggregation method has been used to train AI models for many healthcare applications, such as disease prediction [46, 47], brain tumor segmentation in medical imaging [48], mortality prediction in critical care [49], drug discovery [50], and mobile disease monitoring [51, 52] (Table 1).

As in the global ensemble method, a key consideration in the parameter aggregation method is how to best combine locally trained models. In the context of deep learning models, the model parameters are learned weights and biases. In this case, the local updates can be aggregated by combining gradient updates to those parameters, referred to as federated stochastic gradient descent (FedSGD) [42], or by combining the parameters themselves, referred to as federated averaging (FedAvg) [43]. Combining the model gradients in FedSGD is computationally

efficient and provides a model convergence guarantee [42]. However, FedSGD has a higher communication cost because gradient updates need to be communicated in each local training iteration. Conversely, combining the updated model parameters in FedAvg can have a lower communication cost, as local models may be trained for multiple iterations before the parameters are averaged [43]. However, convergence is not guaranteed in FedAvg and generally performs worse than FedSGD when trained on heterogeneous or skewed local datasets [53]. One exception is when FedAvg is performed after each local training iteration, in which case FedAvg and FedSGD are equivalent. Improvements to the baseline FedAvg algorithm have been suggested, such as FedProx, which provides a theoretical convergence guarantee and has more robust convergence in practice [53].

The parameter aggregation method trains a global model on the total pool of available data, which may enable a greater overall performance compared to the global ensemble method. Additionally, the computational cost at inference is lower than that in the global ensemble approach, as only a single model needs to be executed. However, this comes at a greater communication cost, as model parameters need to be transmitted and received multiple times over the course of training. Furthermore, all institutions must use the same type of model for this distributed learning approach and update the model with new local data and removing data from a single center requires retraining at all participating institutions, incurring significant computational and communication costs.

2.3 Traveling Model

The basic idea of the traveling model, also referred to as cyclical weight transfer [54], is to create a single global model that is trained on all local datasets (Fig. 2c). In contrast to the parameter aggregation method, a single-traveling model is trained sequentially at all institutions. The traveling model performs local training at a single institution and updates itself after each institution. The order of training may be defined in any way, such as training at the largest institutions first, randomly selecting the training order, or in case of ongoing studies traveling to every institution where data becomes available. The model may visit each institution just once, which is beneficial as the healthcare data used for training can be removed from the local compute clusters immediately after training is finished. However, multiple traveling cycles often result in a better performance [39, 54]. The coordination of the overall training process can be performed using a centralized server or in a decentralized peer-to-peer fashion. The traveling model method has been used to train AI models for disease prediction [54, 55], brain tumor segmentation in medical imaging [48], and mortality prediction in critical care [56] (Table 1).

As the traveling model is a single model that is trained on all the data, it may be more suitable than the global ensemble and parameter aggregation methods when local dataset sizes are very small, such as in rare diseases or in the case of very small contributing institutions that only provide data for a single patient [55]. This method has many of the same considerations as the parameter aggregation method.

First, communication costs may be similarly high with the traveling model and inversely related to the number of local training iterations performed in each traveling round. As model updates are performed after training at a single institution, there is a risk that a large number of local training iterations may impede model convergence. Similar to the parameter aggregation method, the traveling model method may struggle with convergence on heterogeneous and skewed local datasets [57]. Furthermore, updating the trained traveling model with new local data or removing datasets from the training sets may also require retraining at all institutions, with the associated significant computational and communication costs. Finally, as the traveling model is trained sequentially at institutions, it is important to monitor the model for catastrophic forgetting [58], where models forget previously learned knowledge and adapt training methods to protect against it [59]. This will be especially relevant if the traveling model can only train on the data once or when updating the model with new local data.

2.4 Split Learning

The basic idea of the split learning method, which was primarily designed for neural network models, is to split the computational burden of model training between local hardware at contributing institutions and a central server [60, 61] (Fig. 2d). Therefore, the model is trained at each institution on the local data up to an intermediate layer, the so-called split layer, in the neural network. The model parameters at this split layer are sent back to the central server, where training of the remaining neural network layers continues using the split layers from all institutions. The training predictions are finally sent back to the local machines to compare against ground truths and calculate the backpropagation error signal used to update the entire model. This method requires a central server to participate in training and coordinate with the local machines. The split learning method has primarily been used to train AI models for medical imaging applications [62–64] (Table 1).

Compared to the parameter aggregation and traveling model methods, the split learning method is more communication efficient and has a lower computational burden for local institutions. Although split learning requires constant communication between a local compute unit and the central server during training, the size of this communication is much smaller than in other methods, as only the neural network parameters from the split layer need to be transferred. One distinct advantage of split learning compared to the parameter aggregation method and the traveling model is its suitability for vertically partitioned data, as different feature sets can be aggregated on the central server. In split learning, datasets with different features can be used by concatenating intermediate layers from local datasets. Furthermore, it may offer better privacy, as neither the central server nor the local institution has the entire model. This may offer better protection against model inversion attacks that attempt to reconstruct the training data [65] (see Sect. 3.3). However, these benefits come at the cost of increased complexity and training times, and the continual need for a central server, even during inference. Recent

studies have explored the possibility of combining split learning with federated learning to improve training times [66]. As in the parameter aggregation and traveling model methods, updating the split learning model with new data or removing data from a contributing center may incur computational and communication costs to perform retraining across all institutions.

3 Challenges and Considerations

While distributed learning offers many clear advantages over traditional centralized learning in terms of healthcare data privacy and data governance, it does not solve all the issues inherent to training artificial intelligence models on healthcare data. Challenges and considerations remain in addressing the challenge of heterogeneous and skewed data distributions inherent in distributed medical data, the communication and computational efficiency of methods, privacy and security protection, and model interpretability and fairness.

3.1 Heterogeneous Data Distributions

Training models on diverse healthcare data are favorable for achieving generalizable and fair AI models. However, heterogeneous data distributions in local data pose a challenge for distributed learning algorithms and strategies. This data heterogeneity can be a result of factors such as differences in local healthcare guidelines leading to differences in acquired data such as imaging modalities, different medical equipment devices, variability in local demographics due to geographical and socioeconomic diversity, shifts in the data distribution over time, and even different measurement units.

Generally, current applications of distributed learning use model designs and learning algorithms that were primarily developed for centralized training on independent and identically distributed (IID) data and apply these to the distributed learning context with skewed non-IID data. As a result, local datasets that distributed models train on may be skewed in their feature distribution, label distribution, or quantity. Improving the performance of distributed learning algorithms on non-IID data is an active area of research [67–72]. As distributed learning becomes the de facto method of developing artificial intelligence models for healthcare, both model design and learning algorithms may need to be redesigned specifically for the distributed learning context.

Another consideration with heterogeneous data distributions is that a consensus solution reached through a global model may not necessarily be desirable in all cases. While this global model may optimize model performance across all data and learn generalizable features for a given task, embracing the heterogeneity of local datasets may help to personalize the global solution for the local context [67, 73]. Multiple methods have been investigated to personalize models trained with

distributed learning on local datasets, such as fine-tuning the consensus model on local datasets, adaptive training to facilitate collaboration between institutions with statistically similar private datasets [70], multi-task learning to learn relationships between heterogeneous local datasets [74], or using private personalized layers in local training and inference [75]. Incorporating personalization into distributed learning may be particularly relevant when training models for personalized medicine or using them in under-represented patient populations.

3.2 Computational and Communication Costs

Since collaboration in distributed learning is achieved by sharing locally trained models, there is a greater burden of computational power and network communication costs that must be shouldered by participating institutions. Training large models, such as the BERT or GPT-3 language models used with EHRs [76, 77], may be too slow or expensive for participants, especially small and rural clinics. Furthermore, this may also exclude large centers in third-world countries, which could result in highly biased AI models. Thus, considerations of computational costs need to be taken into account when choosing models to train with distributed learning [78]. As most distributed learning approaches (parameter aggregation, traveling model, split learning) require iterative rounds of model sharing to train a global model, communication costs and communication efficiency are active areas of research in distributed learning. Briefly described, improving the communication efficiency of distributed learning systems is currently tackled in three ways: reducing the size of model updates, reducing the frequency of model updates, and reducing the number of institutions in a given training round.

The size of the model updates can be reduced using model compression, which also reduces the computational costs of the model. A number of model compression techniques can be used such as network pruning, weight quantization, and model distillation [78–84]. Models can also be compressed using lossy compression methods, such as random rotations and subsampling [78, 84], before sending them to the central server or peers. In the parameter aggregation approach, federated dropout reduces communication costs by training smaller sub-models, which are subsets of the global model, at local institutions [78, 85]. In the split learning approach, the choice of the split layer directly impacts the communication costs and can be chosen with the primary aim of reducing the size of model updates [60, 61].

Reducing the frequency of updates in the parameter aggregation and traveling model approaches will naturally make distributed learning methods more communication efficient. As local computation costs and communication frequency are interlinked in distributed learning, this trade-off must also be considered when improving communication efficiency, as slow convergence due to infrequent communication may increase the overall communication cost. Rather than updating models at fixed frequencies, such as a given number of epochs, models can also be updated based on a dynamic criterion, such as parameter divergence from a reference model [86] or partitioned variational inference to allow participants to decide

how much local training should be done before communicating the update [87]. Alternatively, one-shot distributed learning can be used to train the global model from just one round of communication [39, 41, 54, 79, 88, 89].

Rather than requiring all participating institutions to perform local training in each round of distributed learning, restricting the number of institutions participating in a given round will reduce the overall communication cost. For example, participant selection can be performed in a random fashion. However, more informed approaches may be more efficient. This could be as simple as training more frequently at institutions with large datasets or using information from the training process as part of the participant selection strategy, such as local losses [90] or the size of gradient updates [91]. Peer-to-peer distributed learning can also reduce communication costs, such as in RingFed, where model updates are performed peer-to-peer and only the final model is sent to the central server [71]. Finally, it has been suggested that reinforcement learning can be used to optimize the computational and communication costs during distributed learning by managing participant selection and communication resources [69, 92, 93].

3.3 Privacy and Security

While avoiding the sharing of sensitive and private healthcare data offers clear benefits for data confidentiality, it might not be enough to fully protect patient data, and further measures might be needed to guarantee data privacy and security. Distributed learning requires network communication between local hardware and a coordinating server or other consortia participants to receive and transmit model parameters. This could potentially create an opportunity for a malicious attacker to access local training data if proper network security protection is not in place, such as using a virtual private network or sandboxing the model training and model transfer functions. However, even with protection in place against direct access to patient data, vulnerabilities remain [94]. These can be at the level of participating institutions in the collaborative process, the central entity coordinating the distributed learning process, or malicious attacks on the training process or the trained model. Thus, additional considerations are needed to protect the privacy and security of healthcare data.

While distributed learning avoids the need to share healthcare data, the shared model information may still be vulnerable to data leakage. For example, artificial neural networks learn representations of training data, which can be seen as a type of memory mechanism within their learned parameters. Model inversion attacks, for example, using generative models, may be able to reconstruct data used for training [95–97], such as imaging data [65, 98], from model information using training gradients, model updates, or the final model parameters [97, 99–101]. The vulnerability of models to inversion attacks depends on the type of distributed learning used. Methods that share the entire model (e.g., the global ensemble method, parameter aggregation method, and traveling model) have an increased risk of these attacks. Even if data reconstruction is incomplete, they can be combined with other

types of privacy attacks, such as re-identification attacks or membership inference attacks, to compromise patient privacy. This may be especially problematic in the case of distributed learning on vertically partitioned data, as the training process and the learned model must address health record linkage across participants [102]. In such cases, information leakage may compromise more than one participating institution. Several protection mechanisms have been proposed to address these potential privacy risks, such as sharing less sensitive models or update data [103–105], differential privacy [106–108], or incorporating defense strategies against inversion attacks such as adversarial training [109, 110], and is an active area of research. Furthermore, current privacy measures, such as the data perturbations used in differential privacy, require a trade-off with model performance, which must be considered [72, 106, 111–113].

These privacy and security vulnerabilities can be exploited by multiple parties in the distributed learning process, such as unscrupulous consortia members, commercial or other entities coordinating model training, or malicious attackers. While enforceable collaboration agreements among trustworthy consortia participants, such as a network of hospitals, may obviate the need for protection against intentional privacy and security attacks, the multi-party nature of model training and sharing may also increase the security risk. Generally, malicious attacks against a single institution with weaker security protocols, such as smaller or underprivileged hospitals, may pose a risk to the entire consortia with some distributed learning methods (parameter aggregation, traveling model, split learning). These malicious attacks could attempt to reconstruct or infer properties from private data at a compromised location or from other institutions from the consortia. Alternatively, the attacks could attempt to compromise the training process and corrupt the model using model poisoning attacks [94, 114, 115]. Furthermore, as distributed learning becomes the standard approach to machine learning model training and commercial interest in creating and deploying models increases, enforcing accountability in distributed learning consortia may become increasingly difficult. This may be especially the case when the distributed learning network crosses national boundaries and individual participants have limited recourse in response to any compromises of data security and privacy. Methods to improve privacy and security, such as differential privacy [106–108], secure multi-party computation [34, 116], or homomorphic encryption [34, 117, 118], can be used alongside distributed learning to increase the overall privacy and security protection of patient data.

3.4 Model Interpretability and Fairness

While tremendous advances in machine learning, especially deep learning, have resulted in many reliable, accurate, and robust models developed in the academic setting [1], these models are often limited in terms of replicability, transparency, and explainability. This, in turn, hinders the translation of such AI-based solutions into the clinical setting. Furthermore, attempts to explain the workings of the so-called black box deep learning solutions can also be a means to validate the AI

framework itself and can enhance the acceptability and trust of health care providers and patients. This growing subfield of research, known as explainable AI (XAI), has resulted in various methods to improve model interpretation both as part of model training and as an analysis tool to use after model training. However, research in this domain is still sparse in the context of distributed learning methods.

For example, when images are used directly as inputs to a convolutional neural network, model interpretability can begin by visually checking which parts of the image or radiological scan maximally influence the network towards an inference. Within this context, saliency maps [119], class-activation maps [120], and attention maps [121] are widely used methods to probe the network (after training) to visualize the understanding of unseen data. Alternatively, networks can also be interpreted by changing conditional inputs and observing the change in the desired targets, known as counterfactual-based analysis [122]. Furthermore, so-called self-explainable invertible models utilizing normalizing flows not only predict an outcome based on the input features but also allow data exploration for a given outcome [123, 124].

While improving the interpretability of an AI model helps improve clinician confidence in using these diagnostic decision support systems, they do pose a trade-off with data privacy. Identifying the most important features that lead to a certain prediction might reveal certain aspects of the nature of the dataset that make data rediscovery more likely. However, a solution to the interpretability problem has been proposed for the vertical federated learning framework using Shapley values for feature importance [125]. There is a definite requirement to balance the trade-off between model explainability and data privacy in the distributed learning paradigm. To this end, the use of invertible models and other counterfactual-based analyses has yet to be explored in this context.

Another probable reason that might hinder the translation of distributed learning solutions into the clinical setting is that underprivileged institutions may not contribute to any training data. These include hospitals or clinics that do not have the infrastructure for electronic data management, storage, or computational capabilities, or patients with poor socio-economic backgrounds who may not have access to today's standard of healthcare. As a result, these hospitals may not acquire measures of patient recovery that are comparable to the participating institutions in the federated consortia, and therefore, may not be able to use federated models. Furthermore, a lack of training data from under-represented populations will lead to issues with model fairness, as models trained on biased datasets tend to produce biased results [126].

To overcome the problem of biased AI models, various model debiasing methods have been proposed in the central learning paradigm [127, 128]. Briefly described, these strategies attempt to remove the effect of bias or confounding factors during model training. A similar solution has been adapted to distributed learning where the training objective is optimized such that the training frequency is weighted to appropriately represent the frequency of rare cases [129]. However, this research is still in its infancy, and it remains to be seen if techniques developed for the central learning paradigm can be applied to the distributed learning paradigm

and the unique challenges it entails. Given the trade-offs between de-biasing and privacy preservation [130], the need to develop distributed AI solutions that are unbiased, interpretable, and still reduce the likelihood of data leakage cannot be overlooked.

4 Outlook

Distributed learning offers an infrastructural approach for training artificial intelligence models on sensitive and private healthcare data. It has the potential to increase the quantity and diversity of data sources that can be used to develop robust and reliable artificial intelligence. Advances in distributed learning methods continue to improve performance on heterogeneous data, reduce computational and communication costs, increase privacy and security, and guarantee and expand model interpretability and fairness. However, the widespread adoption of distributed learning will also require addressing some open problems.

While distributed learning methods help to increase the quantity and variety of model training data, another important factor that impacts the value of the resulting models is data quality. As most healthcare data are collected with the aim of aiding human decision-making and not with the aim of providing training data for artificial intelligence models, the format and quality of available data may not be immediately suitable for model training. For example, in medical image analysis, differences in medical images due to different imaging parameters and scanners used can negatively impact the accuracy of models [131]. In such cases, data harmonization strategies, such as histogram matching, image resampling, image-to-image translation, and style transfer [131–134], can be used to ameliorate differences that are not relevant to the actual AI task. Thus, consideration of how to filter, correct, and complete data without access to the actual data from the contributing centers to ensure data quality will be a key consideration for distributed learning system implementation.

The healthcare environment within which the distributed learning system will operate is dynamic, and consideration of how to handle changing participation and data availability will also be important. As artificial intelligence driven healthcare solutions become more popular and the value of participation in the model training process becomes more apparent, the number of participants in the collaborative network may increase with time. Even with a static number of collaborators, the amount of data available for training increases over time. How different distributed learning methods handle new data and the associated costs need to be considered in system design. For example, adding new participants or data in the global ensemble method will be as simple as training a single local model at the participating site, whereas the parameter aggregation, traveling model, and split model methods may require costly re-training for all participants. Other important considerations are participant or data unavailability when performing model updates and compliance with regulatory demands on the right to be forgotten, such as machine unlearning to

‘un-train’ a model when consent for data use is removed [135, 136]. As models continue to be updated, they must be monitored for a potential statistical drift [137] to ensure that learning does not lead to catastrophic forgetting [58, 59]. Within this context, it remains an open challenge to interpret, investigate, and debug model failures when global access to training data is unavailable.

Training artificial intelligence models involves computational, communication, and personnel costs. Although large healthcare institutions may have the resources to bear this cost, smaller institutions such as hospitals in rural or under-funded regions may not have the resources to participate in distributed learning. This bears the risk of undercutting the amount of data an artificial intelligence model can be trained on, reducing the overall value of the model, and creating biased models that are not representative of the general patient population. Incentive schemes and revenue models may be needed to encourage participation and compensate for the computational, communication, and personnel costs needed for distributed learning. The incentive mechanisms may also incorporate collaboration fairness by assessing the value of their data contributions to the distributed learning system, whether simply through data size or more sophisticated valuation methods such as “leave one out” participant valuation or Shapley value for data valuation [138–140]. Fair incentive schemes and revenue models increase the overall participation in distributed learning and the value of artificial intelligence models for healthcare.

Distributed learning is a promising approach for training AI models that prioritize data privacy and security. It replaces the traditional method of centralized model training, which requires sharing and collecting private and sensitive patient data. Multiple approaches to distributed learning are available, and efforts are ongoing to improve the performance, computation and communication efficiency, and privacy and security of these methods. Training AI models with distributed learning directly addresses the need for reliable and representative data for AI solutions in healthcare. The widespread adoption of distributed learning will provide the ability to train accurate, robust, generalizable, and unbiased models, and may open up novel research and business opportunities that have the potential to improve healthcare.

5 Core Messages

- Distributed learning is a promising approach to training machine learning models that replace the traditional method of sharing and collecting data for centralized model training.
- This approach directly addresses the need for reliable and representative data for AI solutions in healthcare, while avoiding the need to share private and sensitive patient data at a central location.
- Multiple approaches to distributed learning are available, and efforts are ongoing to improve the performance, computation and communication efficiency, and privacy and security of these methods.

- The ability to train accurate, robust, generalizable, and unbiased models while retaining control over data usage and governance may open up novel research and business opportunities that have the potential to improve healthcare.

The future of e-health and healthcare in general will come to rely on artificial intelligence technologies driven by big data. The amount of healthcare data being collected is growing exponentially within both traditional healthcare settings, such as hospitals, and at the individual level, such as with wearable devices. Distributed learning will become the standard approach to training artificial intelligence models in healthcare and beyond, as it is better suited to address issues of data privacy and data governance. Incorporating these key considerations into the design of artificial intelligence and big data systems may encourage increased participation in the healthcare data economy. This will, in turn, increase the amount of available data that can be used to train advanced models. As healthcare shifts towards precision medicine, distributed learning may need to shift from primarily training at healthcare institutions to primarily training on highly personalized datasets, such as those stored on smart devices. This ability to train accurate models from large amounts of distributed data will be especially important for precision medicine, as models will need to be trained on local datasets at the individual level while still learning a large amount and variety of data.

Acknowledgements This work was supported by the Natural Sciences and Engineering Research Council of Canada (AT, NDF), Canadian Institutes of Health Research (NDF), Canada Research Chairs program (NDF), and the River Fund at Calgary Foundation (NDF).

References

1. Vercio LL, Amador K, Bannister JJ, Crites S, Gutierrez A, MacDonald ME, Moore J, Mouches P, Rajashekar D, Schimert S, Subbanna N, Tuladhar A, Wang N, Wilms M, Winder A, Forkert ND (2020) Supervised machine learning tools: a tutorial for clinicians. *J Neural Eng* 17:062001. <https://doi.org/10.1088/1741-2552/abbff2>
2. Noorbakhsh-Sabet N, Zand R, Zhang Y, Abedi V (2019) Artificial intelligence transforms the future of healthcare. *Am J Med* 132:795–801. <https://doi.org/10.1016/j.amjmed.2019.01.017>
3. Ginsburg GS, Phillips KA (2018) Precision medicine: from science to value. *Health Affair* 37:694–701. <https://doi.org/10.1377/hlthaff.2017.1624>
4. MacEachern SJ, Forkert ND (2020) Machine learning for precision medicine. *Genome*. <https://doi.org/10.1139/gen-2020-0131>
5. Pesapane F, Codari M, Sardanelli F (2018) Artificial intelligence in medical imaging: threat or opportunity? Radiologists again at the forefront of innovation in medicine. *Euro Radiol Exp* 2:35. <https://doi.org/10.1186/s41747-018-0061-6>
6. Tuladhar A, Schimert S, Rajashekar D, Kniep HC, Fiehler J, Forkert ND (2020) Automatic segmentation of stroke lesions in non-contrast computed tomography datasets with convolutional neural networks. *IEEE Access* 8:94871–94879. <https://doi.org/10.1109/access.2020.2995632>

7. Halcox JPJ, Wareham K, Cardew A, Gilmore M, Barry JP, Phillips C, Gravenor MB (2017) Assessment of remote heart rhythm sampling using the AliveCor heart monitor to screen for atrial fibrillation. *Circulation* 136:1784–1794. <https://doi.org/10.1161/circulationaha.117.030583>
8. Mouches P, Langner S, Domin M, Hill MD, Forkert ND (2021) Influence of cardiovascular risk-factors on morphological changes of cerebral arteries in healthy adults across the life span. *Sci Rep-UK* 11:12236. <https://doi.org/10.1038/s41598-021-91669-3>
9. Phellan R, Lindner T, Helle M, Falcao A, Yasuda C, Sokolska M, Jager RH, Forkert ND (2019) Segmentation-based blood flow parameter refinement in cerebrovascular structures using 4D arterial spin labeling MRA. *IEEE Trans Bio-Med Eng* 67:1–1. <https://doi.org/10.1109/tbme.2019.2951082>
10. Winder A, d'Esterre CD, Menon BK, Fiehler J, Forkert ND (2020) Automatic arterial input function selection in CT and MR perfusion datasets using deep convolutional neural networks. *Med Phys* 47:4199–4211. <https://doi.org/10.1002/mp.14351>
11. Winder A, Wilms M, Fiehler J, Forkert ND (2021) Treatment efficacy analysis in acute ischemic stroke patients using in silico modeling based on machine learning: a proof-of-principle. *Biomedicine* 9:1357. <https://doi.org/10.3390/biomedicine9101357>
12. Dorsey ER, Glidden AM, Holloway MR, Birbeck GL, Schwamm LH (2018) Teleneurology and mobile technologies: the future of neurological care. *Nat Rev Neurol* 14:285–297. <https://doi.org/10.1038/nrneurol.2018.31>
13. Gill S, Mouches P, Hu S, Rajashekar D, MacMaster FP, Smith EE, Forkert ND, Ismail Z, Initiative ADN (2020) Using machine learning to predict dementia from neuropsychiatric symptom and neuroimaging data. *J Alzheimer's Dis* 75:277–288. <https://doi.org/10.3233/jad-191169>
14. Rajashekar D, Mouchès P, Fiehler J, Menon BK, Goyal M, Demchuk AM, Hill MD, Dukelow SP, Forkert ND (2020) Structural integrity of white matter tracts as a predictor of acute ischemic stroke outcome. *Int J Stroke* 15:965–972. <https://doi.org/10.1177/1747493020915251>
15. Rajashekar D, Wilms M, Hecker KG, Hill MD, Dukelow S, Fiehler J, Forkert ND (2020) The impact of covariates in voxel-wise lesion-symptom mapping. *Front Neurol* 11:854. <https://doi.org/10.3389/fneur.2020.00854>
16. Talai AS, Sedlacik J, Boelmans K, Forkert ND (2021) Utility of multi-modal MRI for differentiating of Parkinson's disease and progressive supranuclear palsy using machine learning. *Front Neurol* 12:648548. <https://doi.org/10.3389/fneur.2021.648548>
17. Lawton J, Blackburn M, Allen J, Campbell F, Elleri D, Leelarathna L, Rankin D, Tauschmann M, Thabit H, Hovorka R (2018) Patients' and caregivers' experiences of using continuous glucose monitoring to support diabetes self-management: qualitative study. *BMC Endocr Disord* 18:12. <https://doi.org/10.1186/s12902-018-0239-1>
18. Niel O, Boussard C, Bastard P (2018) Artificial intelligence can predict GFR decline during the course of ADPKD. *Am J Kidney Dis* 71:911–912. <https://doi.org/10.1053/j.ajkd.2018.01.051>
19. Livingstone D, Talai AS, Chau J, Forkert ND (2019) Building an otoscopic screening prototype tool using deep learning. *J Otolaryngol- Head Neck Surg* 48:66. <https://doi.org/10.1186/s40463-019-0389-9>
20. Paul D, Sanap G, Shenoy S, Kalyane D, Kalia K, Tekade RK (2021) Artificial intelligence in drug discovery and development. *Drug Discov Today* 26:80–93. <https://doi.org/10.1016/j.drudis.2020.10.010>
21. Fleming N (2018) How artificial intelligence is changing drug discovery. *Nature* 557:S55–S57. <https://doi.org/10.1038/d41586-018-05267-x>
22. Briganti G, Moine OL (2020) Artificial intelligence in medicine: today and tomorrow. *Front Med* 7:27. <https://doi.org/10.3389/fmed.2020.00027>

23. Cuggia M, Combes S (2019) The French health data hub and the German medical informatics initiatives: two national projects to promote data sharing in healthcare. *Yearbook Med Inform* 28:195–202
24. Charter for Safe Havens in Scotland, handling unconsented data from national health service patient records to support research and statistics. <https://www.gov.scot/publications/charter-safe-havens-scotland-handling-unconsented-data-national-health-service-patient-records-support-research-statistics/pages/4/>. Accessed 6 Dec 2021
25. Health Data Research UK. <https://www.hdruk.ac.uk/>. Accessed 6 Dec 2021
26. Sudlow C, Gallacher J, Allen N, Beral V, Burton P, Danesh J, Downey P, Elliott P, Green J, Landray M, Liu B, Matthews P, Ong G, Pell J, Silman A, Young A, Sprosen T, Peakman T, Collins R (2015) UK biobank: an open access resource for identifying the causes of a wide range of complex diseases of middle and old age. *Plos Med* 12:e1001779. <https://doi.org/10.1371/journal.pmed.1001779>
27. Canadian Health Measures Survey Biobank. <https://www.statcan.gc.ca/en/microdata/biobank>. Accessed 6 Dec 2021
28. Demchuk AM, Goyal M, Menon BK, Eesa M, Ryckborst KJ, Kamal N, Patil S, Mishra S, Almekhlafi M, Randhawa PA, Roy D, Willinsky R, Montanera W, Silver FL, Shuaib A, Rempel J, Jovin T, Frei D, Sapkota B, Thornton JM, Poppe A, Tampieri D, Lum C, Weill A, Sajobi TT, Hill MD, Investigators ET (2014) Endovascular treatment for small core and anterior circulation proximal occlusion with emphasis on minimizing CT to recanalization times (ESCAPE) trial: methodology. *Int J Stroke* 10:429–438. <https://doi.org/10.1111/ijvs.12424>
29. Weiner MW, Aisen PS, Jack CR, Jagust WJ, Trojanowski JQ, Shaw L, Saykin AJ, Morris JC, Cairns N, Beckett LA, Toga A, Green R, Walter S, Soares H, Snyder P, Siemers E, Potter W, Cole PE, Schmidt M, Initiative ADN (2010) The Alzheimer’s disease neuroimaging initiative: progress report and future plans. *Alzheimer’s Dementia* 6:202–211. e7. <https://doi.org/10.1016/j.jalz.2010.03.007>
30. Initiative TPPM, Kang J-H, Mollenhauer B, Coffey CS, Toledo JB, Weintraub D, Galasko DR, Irwin DJ, Deerlin VV, Chen-Plotkin AS, Caspell-Garcia C, Waligórska T, Taylor P, Shah N, Pan S, Zero P, Frasier M, Marek K, Kieburz K, Jennings D, Tanner CM, Simuni T, Singleton A, Toga AW, Chowdhury S, Trojanowski JQ, Shaw LM (2016) CSF biomarkers associated with disease heterogeneity in early Parkinson’s disease: the Parkinson’s progression markers initiative study. *Acta Neuropathol* 131:935–949. <https://doi.org/10.1007/s00401-016-1552-2>
31. Kang J-H, Irwin DJ, Chen-Plotkin AS, Siderowf A, Caspell C, Coffey CS, Waligórska T, Taylor P, Pan S, Frasier M, Marek K, Kieburz K, Jennings D, Simuni T, Tanner CM, Singleton A, Toga AW, Chowdhury S, Mollenhauer B, Trojanowski JQ, Shaw LM, Lasch S, Flagg E, Poewe W, Sherer T, Meunier C, Rudolph A, Casaceli C, Seibyl J, Mendick S, Schuff N, Uribe L, Yankey J, Crawford K, Scutti A, Casalin P, Malferrari G, Hawkins K, Russell D, Leary L, Factor S, Sommerfeld B, Hogarth P, Pighetti E, Williams K, Standaert D, Guthrie S, Hauser R, Jankovic J, Hunter C, Stern M, Darin A, Leverenz J, Baca M, Frank S, Thomas C-A, Richard I, Deeley C, Rees L, Sprenger F, Oertel W, Willeke D, Shill H, Fernandez H, Mule J, Berg D, Gauss K, Galasko D, Fontaine D, Mari Z, McCoy A, Brooks D, Shah B, Barone P, Isaacson S, James A, Espay A, Espay K, Rowe D, Ranola M (2013) Association of cerebrospinal fluid β -amyloid 1–42, T-tau, P-tau181, and α -Synuclein levels with clinical features of drug-naïve patients with early Parkinson disease. *JAMA Neurol* 70:1277–1287. <https://doi.org/10.1001/jamaneurol.2013.3861>
32. LaMontagne PJ, Benzinger TLS, Morris JC, Keefe S, Hornbeck R, Xiong C, Grant E, Hassenstab J, Moulder K, Vlassenko AG, Raichle ME, Cruchaga C, Marcus D (2019) OASIS-3: longitudinal neuroimaging, clinical, and cognitive dataset for normal aging and alzheimer disease. *Medrxiv* 2019.12.13.19014902. <https://doi.org/10.1101/2019.12.13.19014902>

33. Marcus DS, Wang TH, Parker J, Csernansky JG, Morris JC, Buckner RL (2007) Open access series of imaging studies (OASIS): cross-sectional MRI data in young, middle aged, nondemented, and demented older adults. *J Cogn Neurosci* 19:1498–1507. <https://doi.org/10.1162/jocn.2007.19.9.1498>
34. Kaissis GA, Makowski MR, Rückert D, Braren RF (2020) Secure, privacy-preserving and federated machine learning in medical imaging. *Nat Mach Intell* 2:305–311. <https://doi.org/10.1038/s42256-020-0186-1>
35. Rieke N, Hancox J, Li W, Milletari F, Roth HR, Albarqouni S, Bakas S, Galtier MN, Landman BA, Maier-Hein K, Ourselin S, Sheller M, Summers RM, Trask A, Xu D, Baust M, Cardoso MJ (2020) The future of digital health with federated learning. *NPJ Digital Med* 3:119. <https://doi.org/10.1038/s41746-020-00323-1>
36. Khan MA, Alkaabi N (2021) Rebirth of distributed AI—A review of eHealth research. *Sensors* 21:4999. <https://doi.org/10.3390/s21154999>
37. Zerka F, Barakat S, Walsh S, Bogowicz M, Leijenaar RTH, Jochems A, Miraglio B, Townend D, Lambin P (2020) Systematic review of privacy-preserving distributed machine learning from federated databases in health care. *JCO Clin Cancer Inform* 4:184–200. <https://doi.org/10.1200/cci.19.00047>
38. Yang Q, Liu Y, Chen T, Tong Y (2019) Federated machine learning: concept and applications. *ACM Trans Intell Syst Technol* 10:1–19. <https://doi.org/10.1145/3298981>
39. Chang K, Balachandar N, Lam C, Yi D, Brown J, Beers A, Rosen B, Rubin DL, Kalpathy-Cramer J (2018) Distributed deep learning networks among institutions for medical imaging. *J Am Med Inform Assoc* 25:945–954. <https://doi.org/10.1093/jamia/ocy017>
40. Dluhoš P, Schwarz D, Cahn W, van Haren N, Kahn R, Španiel F, Horáček J, Kašpárek T, Schnack H (2017) Multi-center machine learning in imaging psychiatry: a meta-model approach. *Neuroimage* 155:10–24. <https://doi.org/10.1016/j.neuroimage.2017.03.027>
41. Tuladhar A, Gill S, Ismail Z, Forkert ND (2020) Building machine learning models without sharing patient data: a simulation-based analysis of distributed learning by ensembling. *J Biomed Inform.* <https://doi.org/10.1016/j.jbi.2020.103424>
42. Konečný J, McMahan HB, Ramage D, Richtárik P (2016) Federated optimization: distributed machine learning for on-device intelligence. *Arxiv*
43. McMahan HB, Moore E, Ramage D, Hampson S, Arcas BA y (2016) Communication-efficient learning of deep networks from decentralized data. *Arxiv*
44. Warnat-Herresthal S, Schultze H, Shastry KL, Manamohan S, Mukherjee S, Garg V, Sarveswara R, Händler K, Pickkers P, Aziz NA, Ktena S, Tran F, Bitzer M, Ossowski S, Casadei N, Herr C, Petersheim D, Behrends U, Kern F, Fehlmann T, Schommers P, Lehmann C, Augustin M, Rybnik J, Altmüller J, Mishra N, Bernardes JP, Krämer B, Bonaguro L, Schulte-Schrepping J, Domenico ED, Siever C, Kraut M, Desai M, Monnet B, Saridaki M, Siegel CM, Drews A, Nuesch-Germano M, Theis H, Heyckendorf J, Schreiber S, Kim-Hellmuth S, (COVAS) C-19 AS, Balfanz P, Eggermann T, Boor P, Hausmann R, Kuhn H, Isfort S, Stingl JC, Schmalzing G, Kuhl CK, Röhrig R, Marx G, Uhlig S, Dahl E, Müller-Wieland D, Dreher M, Marx N, Nattermann J, Skowasch D, Kurth I, Keller A, Bals R, Nürnberg P, Rieß O, Rosenstiel P, Netea MG, Theis F, Mukherjee S, Backes M, Aschenbrenner AC, Ulas T, (DeCOI) DC-19 OI, Angelov A, Bartholomäus A, Becker A, Bezdan D, Blumert C, Bonifacio E, Bork P, Boyke B, Blum H, Clavel T, Colome-Tatche M, Cornberg M, Velázquez IADLR, Diefenbach A, Diltthey A, Fischer N, Förstner K, Franzenburg S, Frick J-S, Gabernet G, Gagneur J, Ganzmueller T, Gauder M, Geißert J, Goesmann A, Göpel S, Grundhoff A, Grundmann H, Hain T, Hanses F, Hehr U, Heimbach A, Hoepfer M, Horn F, Hübschmann D, Hummel M, Iftner T, Iftner A, Illig T, Janssen S, Kalinowski J, Kallies R, Kehr B, Keppler OT, Klein C, Knop M, Kohlbacher O, Köhrer K, Korb J, Kreamsner PG, Kühnert D, Landthaler M, Li Y, Ludwig KU, Makarewicz O, Marz M, McHardy AC, Mertes C, Münchhoff M, Nahsen S, Nöthen M, Ntoumi F, Overmann J, Peter S, Pfeffer K, Pink I, Poetsch AR, Protzer U, Pühler

- A, Rajewsky N, Ralser M, Reiche K, Ripke S, Rocha UN da, Saliba A-E, Sander LE, Sawitzki B, Scheithauer S, Schiffer P, Schmid-Burgk J, Schneider W, Schulte E-C, Sczyrba A, Sharaf ML, Singh Y, Sonnabend M, Stegle O, Stoye J, Vehreschild J, Velavan TP, Vogel J, Volland S, Kleist M von, Walker A, Walter J, Wiczorek D, Winkler S, Ziebuhr J, Breteler MMB, Giamarellos-Bourboulis EJ, Kox M, Becker M, Cheran S, Woodacre MS, Goh EL, Schultze JL (2021) Swarm learning for decentralized and confidential clinical machine learning. *Nature* 594:265–270. <https://doi.org/10.1038/s41586-021-03583-3>
45. Roy AG, Siddiqui S, Pölsterl S, Navab N, Wachinger C (2019) BrainTorrent: a peer-to-peer environment for decentralized federated learning. *Arxiv*
 46. Jochems A, Deist TM, van Soest J, Eble M, Bulens P, Coucke P, Dries W, Lambin P, Dekker A (2016) Distributed learning: developing a predictive model based on data from multiple hospitals without data leaving the hospital—a real life proof of concept. *Radiother Oncol* 121:459–467. <https://doi.org/10.1016/j.radonc.2016.10.002>
 47. Liu B, Yan B, Zhou Y, Yang Y, Zhang Y (2020) Experiments of federated learning for COVID-19 chest x-ray images. *Arxiv*
 48. Sheller MJ, Edwards B, Reina GA, Martin J, Pati S, Kotrotsou A, Milchenko M, Xu W, Marcus D, Colen RR, Bakas S (2020) Federated learning in medicine: facilitating multi-institutional collaborations without sharing patient data. *Sci Rep-UK* 10:12598. <https://doi.org/10.1038/s41598-020-69250-1>
 49. Huang L, Shea AL, Qian H, Masurkar A, Deng H, Liu D (2019) Patient clustering improves efficiency of federated machine learning to predict mortality and hospital stay time using distributed electronic medical records. *J Biomed Inform* 99:103291. <https://doi.org/10.1016/j.jbi.2019.103291>
 50. Chen S, Xue D, Chuai G, Yang Q, Liu Q (2020) FL-QSAR: a federated learning-based QSAR prototype for collaborative drug discovery. *Bioinformatics* 36:5492–5498. <https://doi.org/10.1093/bioinformatics/btaa1006>
 51. Chen Y, Qin X, Wang J, Yu C, Gao W (2019) FedHealth: a federated transfer learning framework for wearable healthcare. *IEEE Intell Syst* 35:83–93. <https://doi.org/10.1109/mis.2020.2988604>
 52. Gudur GK, Perepu SK (2020) Federated learning with heterogeneous labels and models for mobile activity monitoring. *Arxiv*
 53. Zhao Y, Li M, Lai L, Suda N, Civin D, Chandra V (2018) Federated learning with non-IID data. *Arxiv*
 54. Balachandar N, Chang K, Kalpathy-Cramer J, Rubin DL (2020) Accounting for data variability in multi-institutional distributed deep learning for medical imaging. *J Am Med Inform Assoc* 27:700–708. <https://doi.org/10.1093/jamia/ocaa017>
 55. Zerka F, Urovi V, Bottari F, Leijenaar RTH, Walsh S, Gabrani-Juma H, Gueuning M, Vaidyanathan A, Vos W, Occhipinti M, Woodruff HC, Dumontier M, Lambin P (2021) Privacy preserving distributed learning classifiers—sequential learning with small sets of data. *Comput Biol Med* 136:104716. <https://doi.org/10.1016/j.compbimed.2021.104716>
 56. Beaulieu-Jones BK, Yuan W, Finlayson SG, Wu ZS (2018) Privacy-preserving distributed deep learning for clinical data. *Arxiv*
 57. Qu L, Balachandar N, Rubin DL (2021) An experimental study of data heterogeneity in federated learning methods for medical imaging. *Arxiv*
 58. French RM, French RM (1999) Catastrophic forgetting in connectionist networks. *Trends Cogn Sci* 3:128–135. [https://doi.org/10.1016/s1364-6613\(99\)01294-2](https://doi.org/10.1016/s1364-6613(99)01294-2)
 59. Kirkpatrick J, Pascanu R, Rabinowitz N, Veness J, Desjardins G, Rusu AA, Milan K, Quan J, Ramalho T, Grabska-Barwinska A, Hassabis D, Clopath C, Kumaran D, Hadsell R (2017) Overcoming catastrophic forgetting in neural networks. *Proc Natl Acad Sci* 114:3521–3526. <https://doi.org/10.1073/pnas.1611835114>
 60. Vepakomma P, Gupta O, Swedish T, Raskar R (2018) Split learning for health: distributed deep learning without sharing raw patient data. *Arxiv*

61. Gupta O, Raskar R (2018) Distributed learning of deep neural network over multiple agents. *J Netw Comput Appl* 116:1–8. <https://doi.org/10.1016/j.jnca.2018.05.003>
62. Ha YJ, Yoo M, Lee G, Jung S, Choi SW, Kim J, Yoo S (2021) Spatio-temporal split learning for privacy-preserving medical platforms: case studies with COVID-19 CT, x-ray, and cholesterol data. *IEEE Access* 9:121046–121059. <https://doi.org/10.1109/access.2021.3108455>
63. Poirot MG, Vepakomma P, Chang K, Kalpathy-Cramer J, Gupta R, Raskar R (2019) Split learning for collaborative deep learning in healthcare. *Arxiv*
64. Abuadba S, Kim K, Kim M, Thapa C, Camtepe SA, Gao Y, Kim H, Nepal S (2020) Can we use split learning on 1D CNN models for privacy preserving training? *Arxiv*
65. Subbanna N, Wilms M, Tuladhar A, Forkert ND (2021) An analysis of the vulnerability of two common deep learning-based medical image segmentation techniques to model inversion attacks. *Sensors* 21:3874. <https://doi.org/10.3390/s21113874>
66. Thapa C, Chamikara MAP, Camtepe S, Sun L (2020) SplitFed: when federated learning meets split learning. *Arxiv*
67. Yoo JH, Son HM, Jeong H, Jang E-H, Kim AY, Yu HY, Jeon HJ, Chung T-M (2021) Personalized federated learning with clustering: non-IID heart rate variability data application. *Arxiv*
68. Yeganeh Y, Farshad A, Navab N, Albarqouni S (2020) Inverse distance aggregation for federated learning with non-IID data. *Arxiv*
69. Wang H, Kaplan Z, Niu D, Li B (2020) Optimizing federated learning on non-IID data with reinforcement learning. In: *IEEE Infocom 2020—IEEE Conference on Computer Communications*, vol 00, pp 1698–1707. <https://doi.org/10.1109/infocom41043.2020.9155494>
70. Huang Y, Chu L, Zhou Z, Wang L, Liu J, Pei J, Zhang Y (2020) Personalized cross-silo federated learning on non-IID data. *Arxiv*
71. Yang G, Mu K, Song C, Yang Z, Gong T (2021) RingFed: reducing communication costs in federated learning on non-IID data. *Arxiv*
72. Kairouz P, McMahan HB, Avent B, Bellet A, Bennis M, Bhagoji AN, Bonawitz K, Charles Z, Cormode G, Cummings R, D’Oliveira RGL, Eichner H, Rouayheb SE, Evans D, Gardner J, Garrett Z, Gascón A, Ghazi B, Gibbons PB, Gruteser M, Harchaoui Z, He C, He L, Huo Z, Hutchinson B, Hsu J, Jaggi M, Javidi T, Joshi G, Khodak M, Konečný J, Korolova A, Koushanfar F, Koyejo S, Lepoint T, Liu Y, Mittal P, Mohri M, Nock R, Özgür A, Pagh R, Raykova M, Qi H, Ramage D, Raskar R, Song D, Song W, Stich SU, Sun Z, Suresh AT, Tramèr F, Vepakomma P, Wang J, Xiong L, Xu Z, Yang Q, Yu FX, Yu H, Zhao S (2019) Advances and open problems in federated learning. *Arxiv*
73. Tan AZ, Yu H, Cui L, Yang Q (2021) Towards personalized federated learning. *Arxiv*
74. Smith V, Chiang C-K, Sanjabi M, Talwalkar A (2017) Federated Multi-Task Learning. *Arxiv*
75. Arivazhagan MG, Aggarwal V, Singh AK, Choudhary S (2019) Federated learning with personalization layers. *Arxiv*
76. Korngiebel DM, Mooney SD (2021) Considering the possibilities and pitfalls of generative pre-trained transformer 3 (GPT-3) in healthcare delivery. *NPJ Digital Med* 4:93. <https://doi.org/10.1038/s41746-021-00464-x>
77. Li Y, Rao S, Solares JRA, Hassaine A, Ramakrishnan R, Canoy D, Zhu Y, Rahimi K, Salimi-Khorshidi G (2020) BEHRT: transformer for electronic health records. *Sci Rep-UK* 10:7155. <https://doi.org/10.1038/s41598-020-62922-y>
78. Caldas S, Konečný J, McMahan HB, Talwalkar A (2018) Expanding the reach of federated learning by reducing client resource requirements. *Arxiv*
79. Zhou Y, Pu G, Ma X, Li X, Wu D (2020) Distilled one-shot federated learning. *Arxiv*
80. Wang J, Hu J, Mills J, Min G (2021) Federated ensemble model-based reinforcement learning. *Arxiv*
81. Hinton G, Vinyals O, Dean J (2015) Distilling the knowledge in a neural network. *Arxiv*

82. Jiang Y, Wang S, Valls V, Ko BJ, Lee W-H, Leung KK, Tassiulas L (2019) Model pruning enables efficient federated learning on edge devices. Arxiv
83. Zhu M, Gupta S (2017) To prune, or not to prune: exploring the efficacy of pruning for model compression. Arxiv
84. Konečný J, McMahan HB, Yu FX, Richtárik P, Suresh AT, Bacon D (2016) Federated learning: strategies for improving communication efficiency. Arxiv
85. Bouacida N, Hou J, Zang H, Liu X (2020) Adaptive federated dropout: improving communication efficiency and generalization for federated learning. Arxiv
86. Kamp M, Adilova L, Sicking J, Hüger F, Schlicht P, Wirtz T, Wrobel S (2018) Efficient decentralized deep learning by dynamic model averaging. Arxiv
87. Bui TD, Nguyen CV, Swaroop S, Turner RE (2018) Partitioned variational inference: a unified framework encompassing federated and continual learning. Arxiv
88. Guha N, Talwalkar A, Smith V (2019) One-shot federated learning. Arxiv
89. Sharifnassab A, Salehkaleybar S, Golestani SJ (2019) Order optimal one-shot distributed learning. Arxiv
90. Cho YJ, Wang J, Joshi G (2020) Client selection in federated learning: convergence analysis and power-of-choice selection strategies. Arxiv
91. Shokri R, Shmatikov V (2015) Privacy-preserving deep learning. In: Proceedings of 22nd ACM SIGSAC conference on computer and communications security, pp 1310–1321. <https://doi.org/10.1145/2810103.2813687>
92. Yu S, Chen X, Zhou Z, Gong X, Wu D (2020) When deep reinforcement learning meets federated learning: intelligent multi-timescale resource management for multi-access edge computing in 5G ultra dense network. Arxiv
93. Anh TT, Luong NC, Niyato D, Kim DI, Wang L-C (2019) Efficient training management for mobile crowd-machine learning: a deep reinforcement learning approach. IEEE Wirel Commun Lett 8:1345–1348. <https://doi.org/10.1109/lwc.2019.2917133>
94. Lyu L, Yu H, Yang Q (2020) Threats to federated learning: a survey. Arxiv
95. Hernández-Cano A, Cammarota R, Imani M (2021) PRID: model inversion privacy attacks in hyperdimensional learning systems. In: 2021 58th ACM IEEE design automation Conference, DAC, vol 00, pp 553–558. <https://doi.org/10.1109/dac18074.2021.9586217>
96. Zhang Y, Jia R, Pei H, Wang W, Li B, Song D (2020) The secret revealer: generative model-inversion attacks against deep neural networks. In: 2020 IEEE CVF conference on computer vision and pattern recognition, CVPR, vol 00, pp 250–258. <https://doi.org/10.1109/cvpr42600.2020.00033>
97. Nasr M, Shokri R, Houmansadr A (2019) Comprehensive privacy analysis of deep learning: passive and active white-box inference attacks against centralized and federated learning, pp 739–753
98. Wu B, Zhao S, Sun G, Zhang X, Su Z, Zeng C, Liu Z (2019) P3SGD: patient privacy preserving SGD for regularizing deep CNNs in pathological image classification. In: 2019 IEEE CVF conference on computer vision and pattern recognition, CVPR, vol 00, pp 2094–2103. <https://doi.org/10.1109/cvpr.2019.00220>
99. Wang Z, Song M, Zhang Z, Song Y, Wang Q, Qi H (2019) Beyond inferring class representatives: user-level privacy leakage from federated learning. In: IEEE Infocom 2019 —IEEE conference on computer communication, vol 00, pp 2512–2520. <https://doi.org/10.1109/infocom.2019.8737416>
100. Ligeng Z, Song H (2020) Deep leakage from gradients. Springer International Publishing, Cham, pp 17–31
101. Thuringham B, Evans D, Malkin T, Xu D, Hitaj B, Ateniese G, Perez-Cruz F (2017) Deep models under the GAN. In: Proceedings of the 2017 ACM SIGSAC conference on computing and communications security, pp 603–618. <https://doi.org/10.1145/3133956.3134012>
102. Christen P (2012) Data matching, concepts and techniques for record linkage, entity resolution, and duplicate detection. <https://doi.org/10.1007/978-3-642-31164-2>

103. Xu J, Xu Z, Walker P, Wang F (2020) Federated patient hashing. *Proc AAAI Conf Artif Intell* 34:6486–6493. <https://doi.org/10.1609/aaai.v34i04.6121>
104. Li W, Milletari F, Xu D, Rieke N, Hancox J, Zhu W, Baust M, Cheng Y, Ourselin S, Cardoso MJ, Feng A (2019) Privacy-preserving federated brain tumour segmentation. *Arxiv*
105. Lyu L (2021) DP-SIGNSGD: when efficiency meets privacy and robustness. In: *ICASSP 2021—2021 IEEE international conference on acoustics, speech, and signal processing, ICASSP, vol 00*, pp 3070–3074. <https://doi.org/10.1109/icassp39728.2021.9414538>
106. Wei K, Li J, Ding M, Ma C, Yang HH, Farokhi F, Jin S, Quek TQS, Poor HV (2020) Federated learning with differential privacy: algorithms and performance analysis. *IEEE Trans Inform Foren Sec* 15:3454–3469. <https://doi.org/10.1109/tifs.2020.2988575>
107. Ziller A, Usynin D, Remerscheid N, Knolle M, Makowski M, Braren R, Rueckert D, Kaissis G (2021) Differentially private federated deep learning for multi-site medical image segmentation. *Arxiv*
108. Malekzadeh M, Hasircioglu B, Mital N, Katarya K, Ozfatura ME, Gündüz D (2021) Dopamine: differentially private federated learning on medical data. *Arxiv*
109. Taihong X, Yi-Hsuan T, Kihyuk S, Manmohan C, Ming-Hsuan Y (2020) Adversarial learning of privacy-preserving and task-oriented representations. *Proc AAAI Conf Artif Intell* 34:12434–12441. <https://doi.org/10.1609/aaai.v34i07.6930>
110. Goodfellow IJ, Pouget-Abadie J, Mirza M, Xu B, Warde-Farley D, Ozair S, Courville A, Bengio Y (2014) Generative adversarial networks. *arXiv.org*
111. Croft WL, Sack J-R, Shi W (2021) Obfuscation of images via differential privacy: from facial images to general images. *Peer Peer Netw Appl* 14:1705–1733. <https://doi.org/10.1007/s12083-021-01091-9>
112. Liyue F (2018) *Image pixelization with differential privacy*. Springer International Publishing, pp 148–162
113. Li T, Sahu AK, Talwalkar A, Smith V (2020) Federated learning: challenges, methods, and future directions. *IEEE Sign Proc Mag* 37:50–60. <https://doi.org/10.1109/msp.2020.2975749>
114. Fang M, Cao X, Jia J, Gong NZ (2019) Local model poisoning attacks to byzantine-robust federated learning. *Arxiv*
115. Sun G, Cong Y, Dong J, Wang Q, Lyu L, Liu J (2021) Data poisoning attacks on federated machine learning. *IEEE Internet Things*, p 1. <https://doi.org/10.1109/jiot.2021.3128646>
116. Zhao C, Zhao S, Zhao M, Chen Z, Gao C-Z, Li H, Tan Y (2019) Secure multi-party computation: theory, practice and applications. *Inform Sci* 476:357–372. <https://doi.org/10.1016/j.ins.2018.10.024>
117. Acar A, Aksu H, Uluagac AS, Conti M (2018) A survey on homomorphic encryption schemes: theory and implementation. *ACM Comput Surv Csur* 51:79. <https://doi.org/10.1145/3214303>
118. Hesamifard E, Takabi H, Ghasemi M (2017) CryptoDL: deep neural networks over encrypted data. *Arxiv*
119. Simonyan K, Vedaldi A, Zisserman A (2013) Deep inside convolutional networks: visualising image classification models and saliency maps. *Arxiv*
120. Selvaraju RR, Cogswell M, Das A, Vedantam R, Parikh D, Batra D (2017) Grad-CAM: visual explanations from deep networks via gradient-based localization. In: *2017 IEEE International conference on computer vision, ICCV*, pp 618–626. <https://doi.org/10.1109/iccv.2017.74>
121. Vaswani A, Shazeer N, Parmar N, Uszkoreit J, Jones L, Gomez AN, Kaiser Ł ukasz, Polosukhin I, Attention is all you need. In: *Advances in neural information processing systems*. Curran Associates, Inc.
122. Byrne RMJ (2019) Counterfactuals in explainable artificial intelligence (XAI): evidence from human reasoning. In: *Proceedings of the twenty-eighth international joint conference on artificial intelligence, IJCAI-19*. International joint conferences on artificial intelligence organization, pp 6276–6282

123. Kobyzev I, Prince SJD, Brubaker MA (2019) Normalizing flows: an introduction and review of current methods. *IEEE Trans Pattern Anal* 43:3964–3979. <https://doi.org/10.1109/tpami.2020.2992934>
124. Wilms M, Mouches P, Bannister JJ, Rajashekar D, Langer S, Forkert NDD, Nils F (2021) Towards self-explainable classifiers and regressors in neuroimaging with normalizing flows. In: Abdulkadir A et al (eds) *Machine learning in clinical neuroimaging. MLCN 2021. Lecture notes in computer science*, vol 13001. Springer, Cham
125. Wang G (2019) Interpret federated learning with shapley values. Arxiv
126. Gupta R, Liu Y, Tang J, Prakash BA, Ahmad MA, Patel A, Eckert C, Kumar V, Teredesai A (2020) Fairness in machine learning for healthcare. In: *Proc 26th ACM SIGKDD international conference on knowledge discovery & data mining*, pp 3529–3530. <https://doi.org/10.1145/3394486.3406461>
127. Bahadori MT, Heckerman DE (2020) Debiasing concept-based explanations with causal analysis. Arxiv
128. Chen Z, Bei Y, Rudin C (2020) Concept whitening for interpretable image recognition. *Nat Mach Intell* 2:772–782. <https://doi.org/10.1038/s42256-020-00265-z>
129. Acar DAE, Zhao Y, Zhu R, Matas R, Mattina M, Whatmough P, Saligrama V (2021) Debiasing model updates for improving personalized federated training 139:21–31
130. Barbano CA, Tagatiglione E, Grangetto M (2021) Bridging the gap between debiasing and privacy for deep learning. In: *2021 IEEE CVF International conference on computer vision and working, ICCVW*, vol 00, pp 3799–3808. <https://doi.org/10.1109/iccvw54120.2021.00424>
131. Glocker B, Robinson R, Castro DC, Dou Q, Konukoglu E (2019) Machine learning with multi-site imaging data: an empirical study on the impact of scanner effects. Arxiv
132. Robert R, Qi D, de Daniel C, Konstantinos K, de Marius G, Ronald MS, Daniel R, Ben G (2020) Image-level harmonization of multi-site data using image-and-spatial transformer networks. Springer International Publishing, pp 710–719
133. Bashyam VM, Doshi J, Erus G, Srinivasan D, Abdulkadir A, Habes M, Fan Y, Masters CL, Maruff P, Zhuo C, Völzke H, Johnson SC, Fripp J, Koutsouleris N, Satterthwaite TD, Wolf DH, Gur RE, Gur RC, Morris JC, Albert MS, Grabe HJ, Resnick SM, Bryan RN, Wolk DA, Shou H, Nasrallah IM, Davatzikos C (2020) Medical image harmonization using deep learning based canonical mapping: toward robust and generalizable learning in imaging. Arxiv
134. Modanwal G, Vellal A, Buda M, Mazurowski MA (2020) MRI image harmonization using cycle-consistent generative adversarial network. In: *Medical imaging 2020 computer diagnosis*, vol 11314, pp 1131413–1131413–6. <https://doi.org/10.1117/12.2551301>
135. Bourtole L, Chandrasekaran V, Choquette-Choo CA, Jia H, Travers A, Zhang B, Lie D, Papernot N (2021) Machine unlearning. In: *2021 IEEE symposium on security and privacy*, vol 00, pp 141–159. <https://doi.org/10.1109/sp40001.2021.00019>
136. Villaronga EF, Kieseberg P, Li T (2018) Humans forget, machines remember: artificial intelligence and the right to be forgotten. *Comput Law Secur Rev* 34:304–313. <https://doi.org/10.1016/j.clsr.2017.08.007>
137. Nelson K, Corbin G, Anania M, Kovacs M, Tobias J, Blowers M (2015) Evaluating model drift in machine learning algorithms. In: *2015 IEEE symposium on computational intelligence for security and defence applications, CISDA*, pp 1–8. <https://doi.org/10.1109/cisda.2015.7208643>
138. Tianhao W, Johannes R, Ce Z, Ruoxi J, Dawn S (2020) A principled approach to data valuation for federated learning. Springer International Publishing, Cham, pp 153–167
139. Shuyue W, Yongxin T, Zimu Z, Tianshu S (2020) Efficient and fair data valuation for horizontal federated learning. Springer International Publishing, Cham, pp 139–152
140. Fan Z, Fang H, Zhou Z, Pei J, Friedlander MP, Liu C, Zhang Y (2021) Improving fairness for data valuation in federated learning. Arxiv

141. Detrano R, Janosi A, Steinbrunn W, Pfisterer M, Schmid J-J, Sandhu S, Guppy KH, Lee S, Froelicher V (1989) International application of a new probability algorithm for the diagnosis of coronary artery disease. *Am J Cardiol* 64:304–310. [https://doi.org/10.1016/0002-9149\(89\)90524-9](https://doi.org/10.1016/0002-9149(89)90524-9)
142. Smith JW, Everhart JE, Dickson WC, Knowler WC, Johannes RS (1988) Using the ADAP learning algorithm to forecast the onset of diabetes mellitus. In: Proceedings of the annual symposium on computer application in medical care, pp 261–265
143. Wolberg WH, Street WN, Heisey DM, Mangasarian OL (1995) Computer-derived nuclear features distinguish malignant from benign breast cytology. *Hum Pathol* 26:792–796. [https://doi.org/10.1016/0046-8177\(95\)90229-5](https://doi.org/10.1016/0046-8177(95)90229-5)
144. Kaggle Diabetic Retinopathy Detection. <https://www.kaggle.com/c/diabetic-retinopathy-detection/overview>. Accessed 6 Dec 2021
145. USF Digital Mammography. <http://www.eng.usf.edu/cvprg/mammography/database.html>. Accessed 6 Dec 2021
146. Pollard TJ, Johnson AEW, Raffa JD, Celi LA, Mark RG, Badawi O (2018) The eICU collaborative research database, a freely available multi-center database for critical care research. *Sci Data* 5:180178. <https://doi.org/10.1038/sdata.2018.178>
147. Brisimi TS, Chen R, Mela T, Olshevsky A, Paschalidis ICh, Shi W (2018) Federated learning of predictive models from federated electronic health records. *Int J Med Inform* 112:59–67. <https://doi.org/10.1016/j.ijmedinf.2018.01.007>
148. Choudhury O, Park Y, Salonidis T, Gkoulalas-Divanis A, Sylla I, Das AK (2019) Predicting adverse drug reactions on distributed health data using federated learning. In: AMIA annual symposium proceedings, AMIA symposium, vol 2019, pp 313–322
149. Song J, Abdelzaher T, Mascolo C, Stisen A, Blunck H, Bhattacharya S, Prentow TS, Kjærgaard MB, Dey A, Sonne T, Jensen MM (2015) Smart devices are different. In: Proceedings of the 13th ACM conference on embedded networked sensor systems, pp 127–140. <https://doi.org/10.1145/2809695.2809718>
150. Wu Q, Chen X, Zhou Z, Zhang J (2020) FedHome: cloud-edge based personalized federated learning for in-home health monitoring. *IEEE Trans Mobile Comput*, p 1. <https://doi.org/10.1109/tmc.2020.3045266>
151. George V, Charikleia C, Thodoris M, Matthew P, Manolis T, The mobiact dataset: recognition of activities of daily living using smartphones. SCITEPRESS, pp 143–151
152. Davide A, Alessandro G, Luca O, Xavier P, Jorge LR-O (2012) Human activity recognition on smartphones using a multiclass hardware-friendly support vector machine. Springer, Berlin Heidelberg, pp 216–223
153. Wang L, Lin ZQ, Wong A (2020) COVID-Net: a tailored deep convolutional neural network design for detection of COVID-19 cases from chest X-ray images. *Sci Rep-UK* 10:19549. <https://doi.org/10.1038/s41598-020-76550-z>
154. Menze BH, Jakab A, Bauer S, Kalpathy-Cramer J, Farahani K, Kirby J, Burren Y, Porz N, Slotboom J, Wiest R, Lanczi L, Gerstner E, Weber M-A, Arbel T, Avants BB, Ayache N, Buendia P, Collins DL, Cordier N, Corso JJ, Criminisi A, Das T, Delingette H, Demiralp C, Durst CR, Dojat M, Doyle S, Festa J, Forbes F, Geremia E, Glocker B, Golland P, Guo X, Hamamci A, Iftekharuddin KM, Jena R, John NM, Konukoglu E, Lashkari D, Mariz JA, Meier R, Pereira S, Precup D, Price SJ, Raviv TR, Reza SMS, Ryan M, Sarikaya D, Schwartz L, Shin H-C, Shotton J, Silva CA, Sousa N, Subbanna NK, Szekely G, Taylor TJ, Thomas OM, Tustison NJ, Unal G, Vasseur F, Wintermark M, Ye DH, Zhao L, Zhao B, Zikic D, Prastawa M, Reyes M, Leemput KV (2015) The multimodal brain tumor image segmentation benchmark (BRATS). *IEEE Trans Med Imaging* 34:1993–2024. <https://doi.org/10.1109/tmi.2014.2377694>
155. Irvin J, Rajpurkar P, Ko M, Yu Y, Ciurea-Ilcus S, Chute C, Marklund H, Haghgoo B, Ball R, Shpanskaya K, Seekins J, Mong DA, Halabi SS, Sandberg JK, Jones R, Larson DB, Langlotz CP, Patel BN, Lungren MP, Ng AY (2019) CheXpert: a large chest radiograph dataset with uncertainty labels and expert comparison. *Arxiv*

156. Moody GB, Mark RG (2001) The impact of the MIT-BIH Arrhythmia database. *IEEE Eng Med Biol* 20:45–50. <https://doi.org/10.1109/51.932724>
157. Rajpurkar P, Irvin J, Bagul A, Ding D, Duan T, Mehta H, Yang B, Zhu K, Laird D, Ball RL, Langlotz C, Shpanskaya K, Lungren MP, Ng AY (2017) MURA: large dataset for abnormality detection in musculoskeletal radiographs. *Arxiv*
158. Wang X, Peng Y, Lu L, Lu Z, Bagheri M, Summers RM (2017) ChestX-Ray8: hospital-scale chest x-ray database and benchmarks on weakly-supervised classification and localization of common thorax diseases. In: 2017 IEEE conference on computer vision and pattern Recognition, CVPR, pp 3462–3471. <https://doi.org/10.1109/cvpr.2017.369>
159. Bakr S, Gevaert O, Echegaray S, Ayers K, Zhou M, Shafiq M, Zheng H, Benson JA, Zhang W, Leung ANC, Kadoch M, Hoang CD, Shrager J, Quon A, Rubin DL, Plevritis SK, Napel S (2018) A radiogenomic dataset of non-small cell lung cancer. *Sci Data* 5:180202. <https://doi.org/10.1038/sdata.2018.202>
160. Clark K, Vendt B, Smith K, Freymann J, Kirby J, Koppel P, Moore S, Phillips S, Maffitt D, Pringle M, Tarbox L, Prior F (2013) The cancer imaging archive (TCIA): maintaining and operating a public information repository. *J Digit Imaging* 26:1045–1057. <https://doi.org/10.1007/s10278-013-9622-7>
161. Oberije C, Ruyscher DD, Houben R, van de Heuvel M, Uytterlinde W, Deasy JO, Belderbos J, Dingemans A-MC, Rimmer A, Din S, Lambin P (2015) A validated prediction model for overall survival from stage iii non-small cell lung cancer: toward survival prediction for individual patients. *Int J Radiat Oncol Biol Phys* 92:935–944. <https://doi.org/10.1016/j.ijrobp.2015.02.048>
162. Weinstein JN, Collisson EA, Mills GB, Shaw KR, Ozenberger BA, Ellrott K, Shmulevich I, Sander C, Stuart JM, Network CGAR (2013) The cancer genome atlas pan-cancer analysis project. *Nat Genet* 45:1113–1120. <https://doi.org/10.1038/ng.2764>



Anup Tuladhar was born in Kathmandu, Nepal, in 1987. He received his B.A.Sc. in Chemical Engineering from the University of Waterloo, Canada in 2011 and received his Ph.D. in Biomedical Engineering from the University of Toronto, Canada in 2018.

From 2005 to 2011, he was a research assistant with various labs as part of the University of Waterloo's Co-op Program, including Defence Research and Development Canada (2008), Nippon Telegraph and Telecommunication's Sensory and Emotion Research Group (2009–2010), and Bio-acoustic MEMS in Medicine Lab in Harvard (2010). He is currently a postdoctoral fellow in machine learning and medical imaging at the University of Calgary, Calgary, AB, Canada. His research interests include machine learning for medical informatics, data privacy, distributed machine learning, and computational neuroscience.

Dr. Tuladhar is a recipient of the T. Chen Fong Postdoctoral Fellowship in Medical Imaging Science and the Natural Science and Engineering Research Council (NSERC) Postdoctoral Fellowship.



Deepthi Rajashekar was born in Karnataka, India, in 1991. She completed her B.Eng. degree from PES University, India, in 2013, majoring in information science and pattern recognition. In 2014, she was a Research Assistant with the Center for Pattern Recognition, PES University, India. She received an M.Sc. in Computer Science from Dalhousie University, Canada, in 2017. During this time, her research focus was on user behavior modeling using machine learning and artificial intelligence techniques for cybersecurity applications. In 2021, she completed her doctoral education and now is a postdoctoral fellow at the University of Calgary. Her research interests include medical image analysis, lesion-deficit mapping in stroke patients, stroke rehabilitation, deep learning, and computer-aided decision support systems using machine learning methods.



Nils D. Forkert is an assistant professor and Canada Research Chair at the University of Calgary in the Departments of Radiology and Clinical Neurosciences. He received his German diploma in Computer Science in 2009 from the University of Hamburg, his master's degree in medical physics in 2012 from the Technical University of Kaiserslautern, his Ph.D. in Computer Science in 2013 from the University of Hamburg, and completed a postdoctoral fellowship at Stanford University before joining the University of Calgary in 2014.

Prof. Forkert is an imaging and machine learning scientist who develops new image processing methods, predictive algorithms, and software tools for the analysis of medical data. This includes the extraction of clinically relevant imaging parameters and biomarkers describing the morphology and function of organs with the aim of supporting clinical studies and preclinical research, as well as developing computer-aided diagnosis and patient-specific prediction models using machine learning based on multimodal medical data.



Cybersecurity in Healthcare

Brendan Kelly, Conor Quinn, Aonghus Lawlor, Ronan Killeen,
and James Burrell

The five most efficient cyber defenders are: Anticipation, Education, Detection, Reaction and Resilience. Do remember: “Cybersecurity is much more than an IT topic”.

—Stephane Nappo

1 Introduction

Digital health technology includes the integration of a myriad of medical devices, wireless technologies, data warehouses, sensors and wearables, and even social networks, all with an emphasis on real-time connectivity. These advancements in

B. Kelly (✉) · R. Killeen
St Vincent’s University Hospital, Elm Park, Dublin, Ireland
e-mail: brendan.kelly@st-vincentis.ie

R. Killeen
e-mail: rp.killeen@st-vincentis.ie

B. Kelly · A. Lawlor
Insight Centre for Data Analytics, University College, Dublin, Ireland
e-mail: aonghus.lawlor@insight-centre.org

C. Quinn
Cyber Security to Boston College, Chestnut Hill, USA
e-mail: quinnwx@bc.edu

J. Burrell
Boston College, Boston, USA
e-mail: james.burrell@bc.edu

technology provide opportunities for patient care; however, they also pose a risk to healthcare providers in the form of challenges to personal data, privacy, and security. These cybersecurity threats are not entirely new to healthcare, but have certainly become more abundant with the digital health revolution and have been identified as one of the major healthcare risks of 2021 [1]. Cybersecurity represents both external threats and accidental errors by internal staff, which can pose particular risks. Fortunately, healthcare providers and device manufacturers have the advantage of being able to take inspiration from other industries that are leading the way in the field. This chapter seeks to provide an introduction to digital health as it pertains to cybersecurity, a background to both general and healthcare specific cybersecurity challenges, general approaches to improving security through both detection and preventative techniques, and ways in which technology can increase security while mitigating risks.

Herein we propose to highlight how common cybersecurity issues need to be considered for the development and integration of artificial intelligence (AI) and Big Data projects in healthcare both for the benefit of patients, healthcare providers, institutions and industry partners.

2 Introduction to Health Information Technology (HIT)

Over the last decade, there has been an explosion in the volume of medical data [2]. Coupled with this, there is a shortage of medical experts with the expertise required to interpret these data [3]. The application of analytical processes, including AI, has been suggested as a potential solution to address this supply/demand issue [4]. In parallel with this issue is a new focus on “personalised medicine”, whereby data can be leveraged to provide individually tailored care and treatment for a patient [5]. To fill this niche in the market, there has been a huge growth in the digital health sector. While there are many potential benefits and some improvements in patient outcomes are now being delivered, the adoption of these technologies is not without risk to healthcare providers [6]. While any new technology or medical device comes with a degree of risk, medical device manufacturers and healthcare delivery organisations have a duty to be informed of potential risks and take steps to mitigate them.

2.1 The Electronic Health Record

The electronic health record (EHR) [7] is now the dominant source of administrative and clinical data that contains medical history, pharmacological prescriptions, laboratory and imaging, and other patient and population data [8]. The EHR was originally proposed as an almost universally positive step for digital health. The potential benefits were clear.

- Allow for up-to-date medical records that can be easily accessed and edited.
- Records can be viewed simultaneously in multiple locations, allowing for enhanced communication between clinicians.
- Reduction of medical errors through fail safety and checks.
- Increased legibility of records

Furthermore, in theory, the EHR should lead to gains in efficiency, allowing for more time for clinicians and enabling the achievement of business goals.

However, along with all the potential benefits, there are drawbacks related to privacy and security. One of the key potential security concerns relates to the number of different systems and services (radiology information system (RIS), medical laboratory results, billing) that need to interact with the EHR, giving many potential points of access. The ability of multiple users to interact with the EHR is a cornerstone of its value. Multiple users, however, pose risks to their own. Those with permissions to download or access the Internet have the potential to be exploited. Restricting permissions may help to limit this risk. Any system with multiple users is also likely to be impacted by phishing attacks that gather credentials in the hope of using them to compromise a system. Strong security controls (such as encryption) are an obvious first step in ensuring security; however, it can be a double-edged sword because it reduces the usability of the end user.

2.2 Complicating Factors

An interesting challenge inextricably linked with the increasing connectivity of the “Internet of Things” is the integration of legacy devices with a digital health environment where there is a continuous flow of information. Many of these devices and infrastructure have been designed without network connectivity capabilities. This invites unique challenges for IT departments tasked with the integration of legacy technology. In addition, with technologies such as 5G wireless networks enabling faster remote capabilities such as telemedicine and robotics support robotic-assisted surgical procedures, the need for the integrity of these applications has never been higher. There is also an elevated risk associated with the use of end-of-life software that has been clearly demonstrated in attacks on healthcare providers such as the Irish Health Service Executive (HSE) “Conti” and the UK National Health Service (NHS) “WannaCry” ransomware attacks [9].

2.3 Data

A modern advent in digital health is the ability to leverage the increasing volumes of data collected by hospitals and healthcare systems in the form of data analytics and extension AI. AI provides the ability for computers to mimic human behaviour and depends on the availability of large volumes of data. It is in this way linked to big data. Machine learning is a subset of AI where computers are able to

demonstrate learning characteristics without being explicitly programmed and has shown great promise in the processing and analysis of tabular medical data. More recently, advances in deep learning, such as convolutional neural networks and natural language processes, with recurrent neural networks have made significant progress in the analysis of image analysis and language-based tasks (such as translation). The black-box nature of these modern data science methods leads to potential issues, such as adversarial attacks.

2.4 Trends

Cyber threats have increased steadily over the past several years across all sectors [10]. There has been an exponential growth in data breaches and organisations suffering cybersecurity-related issues (i.e. ransom payments). Cybersecurity relates to the use of controls, processes, and technologies to protect systems and data from these cyber threats [11]. Mandatory, regulatory backed, cybersecurity programs are becoming mainstream, and healthcare is of particular focus due to the sensitivity of healthcare data. The core goals of an organisation's cybersecurity program can be defined within the information security model known as the 'CIA Triad'. The CIA triad relates to the principles of confidentiality, integrity, and availability of data. The definitions of these terms are provided in Table 1 [12].

The healthcare sector is one of the most targeted sectors globally, and digital health has been impacted by a large number of high-profile incidents. In one survey over 110 million patients and 81% of 223 organisations experienced a compromise of data in the year 2015 [13]. Figure 1 shows a detailed breakdown of the targets within the healthcare sector. Figure 2 illustrates the patterns used to exploit these targets. Governments, regulators, and organisations have been forced to make improvements in their handling of cybersecurity threats to protect individuals and their data. Different industries have differing concerns, with varying degrees of cybersecurity maturity. Healthcare lags behind the leading industries when it comes to securing vital data [14]. As a result, cybersecurity in the healthcare industry is of growing concern, which is viewed as having immature cybersecurity practices and is a prime target for data theft [14]. This lack of maturity in healthcare cybersecurity programs can be a result of limited resources, lack of financial backing, fragmented governance, and cultural behaviours. In addition, there is consistent underinvestment in information technology, resulting in legacy IT issues [14]. Examples of this

Table 1 The CIA Triad

Term	Definition
Confidentiality	Data is not disclosed (intentionally or unintentionally) to unauthorised individuals
Integrity	Data is not altered from its original state either accidentally or maliciously, by unauthorised individuals
Availability	Data is accessible and usable by authorized individuals

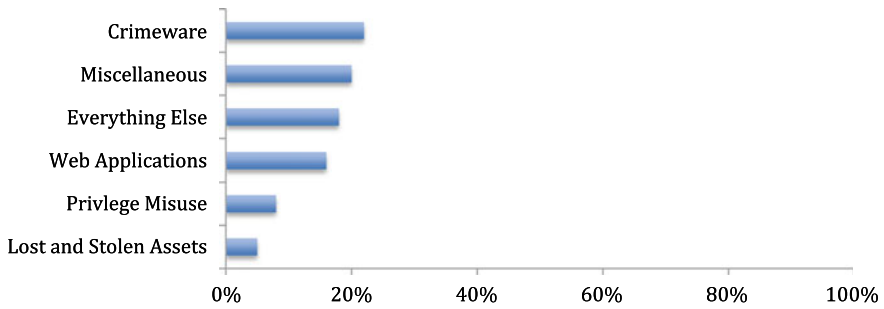

Fig. 1 Patterns in Healthcare industry incidents (n = 798). Adapted from Verizon Communications (2020). 2020 Data Breach Investigations Report (DBIR). <https://enterprise.verizon.com/en-gb/resources/reports/2020-data-breach-investigations-report.pdf>

have already been identified in the banking industry [15], and prioritisation of cybersecurity resources should be considered in healthcare to avoid the same poor outcomes.

2.5 Health Information Technology

Health information technology (HIT) presents a unique scenario for healthcare and cybersecurity practitioners, where the creation and development of technology must meet the principles of the CIA triad to protect the confidentiality, integrity, and availability of information of individuals, while also balancing useability, interoperability, and accuracy. In addition, once the HIT is operationalised within an organisation, the technology must be secure and robust enough to resist cyber-attacks even with an immature cybersecurity program [14].

3 Regulatory Compliance and Standards

As highlighted in the previous section, the rise in cybersecurity threats to organisations has forced governments and regulators to compel organisations to establish robust cybersecurity programs to protect sensitive personal information. In terms of the healthcare sector, primary legislative actions that have resulted in the improvement of cybersecurity program maturity are the U.S. Health Insurance Portability and Accountability Act (HIPAA) and the European Union General Data Protection Regulation (GDPR) [16, 17]. These regulations are data protection and privacy-focused, with the aim of providing accountability for organisations that collect, store, and process sensitive personal information. As part of meeting these regulations, several related requirements must be implemented, and as a result, drive maturity improvement in cybersecurity programs.

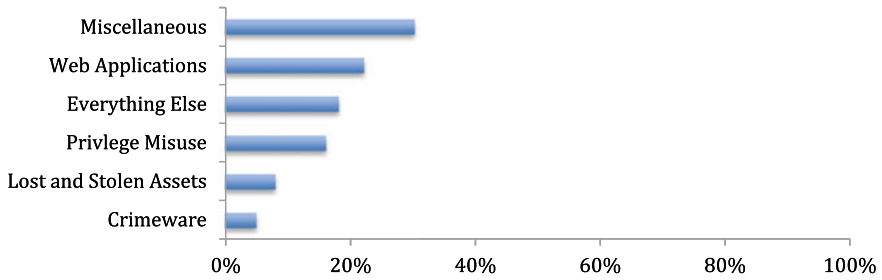

Fig. 2 Patterns in Healthcare industry breaches (n = 521). Adapted from Verizon Communications (2020). 2020 Data Breach Investigations Report (DBIR). <https://enterprise.verizon.com/en-gb/resources/reports/2020-data-breach-investigations-report.pdf>

3.1 HIPAA

HIPAA has a defined security rule, which extends to the physical and cyber domains. It has a requirement that physicians should protect electronically stored, protected health information (known as “ePHI”) of patients, through the use of appropriate administrative, physical, and technical safeguards. This is to guarantee the confidentiality, integrity, and security of this information [16]. Furthermore the Security Rule in HIPAA applies to any healthcare provider that transmits health information in an electronic format. As a result, the scope of HIPAA compliance includes healthcare institutions storing and transmitting health-related data in addition to HIT, which transmits, receives, or records health related information.

Physical safeguards for ePHI are required by the HIPAA Security Rule. This includes maintaining controls that achieve the CIA triad (Table 1) as well as employee compliance [16].

3.2 GDPR

The GDPR, although not cybersecurity or healthcare-specific, requires organisations that hold personal information (health-related data included) to protect and use it in appropriate ways. Concerning security, the GDPR ‘security principle’ Article 5 (1)(f) highlights the ‘integrity and confidentiality’ of personal data. It states that personal data should be ‘*Processed in a manner that ensures appropriate security of the personal data, including protection against unauthorised or unlawful processing and against accidental loss, destruction or damage, using appropriate technical or organisational measures*’.

Although the GDPR does not mandate specific security controls, similar to HIPAA, security controls must be appropriate for the risk and protect the confidentiality and integrity of personal data.

3.3 Compliance

Data protection regulatory compliance can be a driver of cybersecurity within an organisation. The controls an organisation decides to implement must comply with the requirements of the regulation and be reasonable in their protection. The definition of 'reasonable' is still a source of debate, but the guiding factors should be aligned with industry best practices and leading cybersecurity frameworks. Although regulation alone may not be a strong driver, the repercussions imposed by failure to comply with regulations to adequately protect individuals' data can be a motivating factor for this increasing cybersecurity.

3.4 Security Controls

There is an interesting interplay between increasing security control and compliance. Compliance with regulatory requirements may appear to provide security; however, in practice, it may not provide an enhanced level of security and often struggle to maintain pace with technological advancement. Security controls are updated regularly, and in some cases, may provide greater protection than requirements listed by regulators. For example, in practice there are situations that may arise on shared facilities where only one user is given particular permissions and may lead to the account being left "logged in" all the time. It is important that appropriate steps are taken to maintain adequate patient and corporate safety while minimising the impact on the performance of technology users, which ultimately reduces the time spent on patient care. These issues also affect big data and AI as they apply to digital health, where the requirement for security may not be adequate to protect these systems or regulations may not prescribe the use of these systems to help secure the organisation.

3.5 De-identification

De-identification is a key step in maintaining patient privacy, especially with the sharing of patient data. However, this process is not as simple as it appears. A common example of added complications in de-identification occurs with medical imaging. Many software services are available for de-identification that remove the patient's name and date of birth. However, this is far from full anonymisation, as most files contain metadata, which is not so easily removed and often contains other information that could be used to re-identify the patient. Furthermore, the medical images themselves often contain identifiable information, such as data that can be reconstructed to provide an image of the patient's face. This emphasises some of the additional complexities encountered in Healthcare specific use cases [18].

3.6 Transfer

Data often need to be transferred to another site to facilitate the analysis. This transfer can be physical or over a network connection. Health care institutions may not have the computing power necessary to perform the analysis, necessitating transfer either to a university, industry partner, or other organisation with adequate computational resources. The addition of this step to the pipeline increased the attack surface. Whether data are stored locally or remotely, the security and privacy of the stored data is an important consideration which includes both hardware and software applications and access, control, and the integrity of the systems governing these processes.

3.7 Devices

The importance of different healthcare devices and information systems to freely exchange information is well established [19]. The framework for integration between different vendors and technologies is outlined in Health Level 7 (HL7). HL7 Version 3, which is based on XML, involves the transfer of text data without encryption. To facilitate transfer between different technologies, HL7 assumes that encryption will take place at a lower level and provides no protocol-level encryption. As communication relies on establishing short-term client connections, it has been established that HL 7 could be vulnerable to “man in the middle” attacks. The requirement for communication between devices using a consistent streamlined protocol has been a fundamental challenge for cybersecurity in healthcare. Consistent communication between technologies for a particular protocol or format has the potential to increase speed and consistency (e.g. facilitating the use of simple regular expressions or direct string manipulation).

3.8 Labelling

Data labelling is one of the most interesting challenges in both big data and AI for digital health [20]. A malicious attacker can gain access to the data labels used to train an AI algorithm or used to form the foundational integrity of a large dataset, where the outputs of any model could be significantly compromised. A further complication is that the performance of models trained on faulty data might only become apparent when the model is implemented on external data. This type of compromise has the potential to harm patients.

4 Information Security and Data Privacy

Information security and data privacy concerns exist across the creation, implementation, and operation of HIT. The issues affect both the organisations that create and utilise HIT, where cybersecurity and data privacy may be lacking in medical devices, and the medical device has sufficient cybersecurity and privacy controls. These devices may be integrated and operated in institutions that have weak cybersecurity controls to provide adequate protection.

There is an increasing focus on the cybersecurity aspect of HIT, Internet of Things (IoT) medical devices, and wearable health devices [21]. There are various cybersecurity and data privacy elements that must be considered during the development process of HIT devices.

4.1 Software Development

There have been a variety of different software development methodologies in circulation for several years, including agile, waterfall, and scrum. What all methodologies have in common is the planning, analysis, development, implementation, and release phases with varying levels of iterations between each phase. Traditionally, cybersecurity has been thought to occur only when the project has been completed. This usually requires vulnerability scans and penetration tests to determine the existence of vulnerabilities in the completed project, and ‘bolt-on’ fixes may be required to plug security gaps. The cost of identifying and fixing security issues increases with the need for fundamental changes in a product/device which is a consideration for profit-driven organisations.

As the practices in software development matures and the concern of cybersecurity-related issues increases, there is a growing interest in the development of software-based solutions in the process of DevOps and DevSecOps. These processes consist of shifting the thought of cybersecurity earlier in the development process (‘shifting left’). Shifting cybersecurity left in the development process allows security to be built into a product from the start and allows cybersecurity-related issues to be identified earlier within the development process. This process allows for iterations between phases, where cybersecurity issues can be addressed and resolved. Current trends indicate that this process can lead to the production of more secure devices/systems [22]. In addition, security issues identified later in the project can be rectified sooner at a lower cost than at the end of a project.

4.2 Third Parties

As healthcare institutions rely on third parties for the development and creation of new technology, the industry is not immune to rising incidents of supply chain

attacks, where attackers access organisations by compromising third-party providers. A recent example was the Solarwinds attack, where the software provider Solarwinds source code was compromised by installing malicious backdoors which impacted thousands of organisations using their software. The California Department of State Hospitals was included in the list of victims. Although Solarwinds is not a healthcare technology, the plausibility of an attack on a healthcare technology provider is plausible. Trend Micro, a leading cybersecurity company, also highlighted the concern with third parties and supply chain risks for hospitals, highlighting potential vectors for compromise including device firmware attacks, mHealth mobile app compromise, source code compromise during manufacturing, etc.

4.3 Privacy

As previously highlighted, there are information and data privacy concerns associated with technology as it is being created and implemented. This concern does not stop at the perimeter of the produced device. As previously mentioned, the shortcomings of cybersecurity programs within the healthcare industry show vulnerabilities within institutions [13, 14]. Although a medical device may have been created with privacy as a priority, the overall security can be difficult to maintain if organisations do not have adequate cybersecurity controls.

According to the Verizon 2020 Data Breach Investigations Report [23], the increase in data breaches recorded in that year was reflected across multiple industries, including healthcare. The report lists miscellaneous errors and web applications as the top two verticals for an attack. Although errors and attacks on web applications can occur across any industry, the report states that as healthcare organisations make new methods of interacting with patients, they in turn introduce additional attack surfaces [23].

4.4 Transformation

Organisations and healthcare institutions are currently undergoing digital transformation in terms of utilising third-party providers for more innovative technology and cloud-based solutions to accommodate flexibility and scalability. The security issues already highlighted continue to apply to these domains, and in some circumstances may represent a risk for healthcare institutions despite having limited control over the risk factor. In 2017, Nuance Communications suffered a ransomware attack, the systems that were affected were mainly transcription services and imaging orders for healthcare customers. The results of these attacks included critical systems for healthcare institutions which impacted patient care. Due to the nature of the attack, it also spread from Nuance to other healthcare institutions through shared connections.

4.5 Industry Standards

The nature of the industry-specific technology utilised within healthcare institutions represents unique issues that are more effectively addressed by security practitioners with a focus in the healthcare field to identify security issues with common healthcare technologies. For example, Digital Imaging and Communications in Medicine (DICOM) is the international 30-year-old standard protocol for managing and transmitting medical images, such as ultrasound, MRI, X-ray, and CT scans [24]. In 2019, researchers highlighted the possibility of “*showing how an attacker can use deep learning to add or remove evidence of medical conditions from volumetric (3D) medical scans*” (i.e. DICOM files) [25]. The researchers showed that it is possible to infiltrate healthcare institutions and use malware to alter the Digital Imaging and Communications in Medicine file format. Although there is no evidence of such an attack actually taking place, the use case highlights that attack vectors exist that are unique to the healthcare sector and have not been previously examined. This reiterates the need for security assessment of healthcare technologies and processes, even industry standards that have been utilised for many years, based on changes in technology and attack vectors.

4.6 Ethics

The ethics associated with the use of patient data for training and testing AI algorithms is complex and a matter of debate [26]. There are two high-level perspectives associated with this ethical debate. One is from the patient's individual point of view, where their data are used directly for their own healthcare benefit, for example, a wearable smartwatch. The other level of use of data is to benefit society as opposed to the individual to whom the data relates. These two different use cases raise separate ethical concerns with the corresponding cyber security issues. Larson and colleagues [27] argue thus rather than considering who “owns” the data either the institution or the patient to whom it relates, it is more useful to consider data as a resource that can benefit society. From this viewpoint, taking all necessary measures to ensure the integrity of the data is paramount. Kurpinski [28] observed that almost every healthcare institution had a third-party request to purchase their data. While the ethics of buying data are still a subject for debate, it is clear that security and confidentiality updates are inextricably linked with good ethical standards. This is especially true when a patient may not directly benefit from the sharing of data. Medicine is becoming increasingly personalised which involves analysis of patient-level data as well as “big data” and tailoring solutions for individual patients [29]. It is clear that where an individual may make decisions about their healthcare based on data that they have shared, it is necessary to ensure the integrity of the data and the reasons for any decision made concerning the data.

5 Hardware and Software-Based Security Models

Although the maturity of cybersecurity programs within healthcare institutions may be at a level of concern, there are several recurring issues that will alleviate some risks.

5.1 Legacy Software

As previously mentioned, because the nature of technologies utilised within healthcare is unique to their environment, there can be a reliance on systems that are based on legacy software for operations. These systems require legacy software (i.e. Microsoft Windows 7 operating system) for operations are at risk because they are not supported by the vendor and do not have the latest security controls. If a vulnerability is discovered as part of a legacy software, it may not receive a fix and can become a permanent risk. Healthcare institutions should maintain a robust lifecycle and asset management programs to determine the scope of their support infrastructure and to identify the risks of legacy software.

5.2 Identity Management

Identity management in the case of large healthcare organisations can be difficult because of the transient nature of the work done on site. Healthcare professionals require mobility within the hospital to interact with patients requiring various levels of care at different locations. This type of work environment can lead to shared devices/user accounts across the organisation. Ensuring a robust identity management capability within healthcare institutions for access management and privileged access management requires the establishment and compliance with processes and procedures to ensure that the correct users access the correct devices securely using multi-factor authentication.

5.3 Network Security

Healthcare institutions require systems to communicate with each other across organisations. This can range from diagnostics to patient care systems. ‘Flat’ networks describe a device on a network that are able to interact with another device within the same network with very little routing/switching controls. Ensuring correct network segmentation is conducted when creating these communication paths can greatly reduce the risk of stopping ransomware/malware infections that spread across organisations.

5.4 Audit and Logging

Medical devices are created to serve a particular medical purpose and ensure the accuracy and safety of that action. Limited logging capabilities may be performed by devices for actions taken by a user. When an incident occurs, these logs can be reviewed to determine the root cause and drive cyber security improvement based on lessons learned. Ensuring that medical devices can log activities can increase the overall security of institutions.

5.5 Solutions

Addressing the issues highlighted above will improve the cybersecurity programs of healthcare institutions and, consequently, improve the safety of sensitive patient data. In addition, there are examples of how AI and big data can be used to address some of these cybersecurity concerns. The advances in using this technology in cybersecurity have improved over the past few years. AI and big data can identify trends in vast amounts of structured and unstructured data which in a healthcare setting can be valuable in identifying malicious activity. AI can be used to identify malicious activity on networks and host devices that would be outside the baseline usage to identify unusual activity historically via audit logs.

In response to difficulties concerning the volume of training days required for accurate models and various issues pertaining to data access, different proposals have been put forward in order to sate data-hungry algorithms.

Data augmentation methods have been well established [30]. In medical imaging data, for example, it is very common to augment training data by resizing, rotating, or using symmetry operations. Recently, with the advent of generative adversarial networks, it has become possible to create synthetic data for training [31]. This is now possible using tabular and medical imaging data. The cybersecurity issues outlined above carry forward the generation of synthetic data. Small changes in algorithms to generate synthetic data could instigate a decrease and change in the performance of models trained on these data. Similarly, a single malicious incident where a mislabelled data point could be propagated forward, causing more damage. It may be more difficult to identify anomalous data that have been poisoned because of the nature of it being artificially created. However, there are advantages of synthetic data from a privacy perspective, as systems are trained on created data, the privacy of individual data is not relied upon, and in the case of a data breach, the use of synthetic data mitigates concerns.

Distributed Privacy

Distributed privacy has been suggested as a possible solution to enable institutions to share data [32]. This involves sharing networks whereby only necessary data are sent from institution to institution, and any identifiable information is kept at the source location. This has the possibility of increasing privacy, but is dependent on the fundamental principles of cyber security outlined above.

Federated Learning

A further innovation to enable the development of more robust models is federated (or distributed) learning [33]. The concept behind federated learning is that rather than data being collected centrally and the training and testing of a model being performed on that central data, the model is trained locally, whether at different hospitals, institutions, or individual devices. Theoretically, this should allow for training robust models on diverse datasets without the associated legal and security complications of accessing such diverse data. Through this system, sensitive data can remain with its data controller for the owner while still facilitating distributed training. With each participant retaining responsibility for their own clinical data and employing local corporate governance, these federated models should enable data access. The difficulty from a security point of view is using an increased number of nodes, and the number of access points that require security controls also increases. If a single node is compromised, the confidentiality and integrity of the model may not be maintained. Ensuring that systems are up to date with the correct controls that comply with security standards is a large task with the potential for error. This type of model can introduce security weaknesses that grow exponentially.

As the concept of federated learning has grown in recent years for the training of AI-based technology, security and privacy concerns are not yet fully understood and realised. Recent studies have highlighted the potential implications of this learning method. Mothukuri et al. included the security concerns of poisoning (data and model), inference, and backdoor attacks. Each of these security concerns has a differential likelihood of being realised with differing impacts on the over system. The study highlights that this process of learning is in its infancy and that future work would need to be done to understand the security and threats of zero-day attacks, trusted traceability, and well-designed APIs [34].

6 Security and Privacy Implications of Artificial Intelligence

6.1 Languages and Platforms

AI models are typically built using open-source platforms. Recently, Python has become the most popular language for the development of artificial intelligence in addition to languages such as R and C [35]. Applications that are created using these programming languages are routinely targeted for attack, as attackers try to maximise the usage of their resources for a large pool of targets. Furthermore, machine learning projects are often built using open-source libraries and modules, such as numpy or scikit learning. The use of these libraries and modules has created unique security challenges for practitioners. If a vulnerability is identified within these packages, obtaining a fix for it may not be straightforward. Additionally, as more open source libraries and modules are used, it may become more difficult to

track which modules are used without the use of mature development processes. This can lead to unidentified vulnerabilities within software products and is particularly relevant to the advent and popularity of high-level APIs Keras and Pytorch which allowed developers to employ machine learning without direct control. The particular algorithm used also has particular cybersecurity concerns. CNNs have been shown to be susceptible to malicious attacks [36]. Furthermore, tree-based algorithms which are prone to overfitting can be targeted in particular ways, such as changing small portions of the training data.

6.2 Testing

Another important consideration is implementation which often occurs after several phases of “in silico” testing. It is possible that performance will dramatically change between testing and implementation. As such, practitioners need to be vigilant during the implementation phase. If the purpose of the implemented model is to augment performance, human-computer interaction must be taken into account. Furthermore, if the proposed use case is implemented as an autonomous device, there are additional levels of security concerns critical to this is reporting and communication of real-time alerts, and the need for ongoing oversight is an additional security consideration.

6.3 Implementation

Implementation issues such as an audit of performance must be taken into consideration. Regular audits and clinical governance are of paramount importance for the safe introduction of digital health systems. This is further complicated by the fact that many of the proposed systems will implement continuous learning. This means that, rather than the product or device being static, it will continue to learn from ongoing experience and has potential benefits in terms of performance accuracy. It is unavoidably associated with ongoing risk as problems occur when things change.

The developing technique of federated learning, which also shares many similarities with distributed learning, is an area of research which is concerned with developing more robust models that are trained on local nodes and aggregated together into a central model. This facilitates, in theory, the use of more diverse data with much larger sample sizes without the need to transfer physical data between nodes. The use of federated learning should reduce local data governance issues, including particular data privacy and data access rights at individual institutions through the use of distributed nodes rather than open sharing of clinical data. Distributed systems operate based on remote local execution of training iterations and the use of a central algorithm. As such, the data remain at a local institution while contributing to a centralised model.

7 Conclusion

Herein, we have provided an introduction to cybersecurity as it pertains to the application of AI and big data to health data. There are, of course, specific use case cybersecurity concerns that vary from task to task and depend on particular hardware and software; however, general principles form the foundation of any cybersecurity regime. While issues such as multivendor connectivity, multiple users, and legacy software make the implementation of security principles more difficult in digital health, the value and sensitive nature of the data make overcoming these barriers all the more crucial. While increased connectivity makes modern cybersecurity more complex, there are opportunities to use emerging techniques to develop innovative security solutions which will be critical for the ongoing growth in the use of AI and big data in digital health.

References

1. ECRI (2021) Top 10 health technology hazards for 2021 expert insights from health devices. https://assets.ecri.org/PDF/Solutions/Device-Evaluations/ECRI-Top10Hazards_2021_EB.pdf
2. Dinov ID (2016) Volume and value of big healthcare data. *J Med Stat Inform* 4:3
3. Rimmer A (2017) Radiologist shortage leaves patient care at risk, warns Royal College. *BMJ* 359:j4683
4. Meskó B, Hetényi G, Gyórfy Z (2018) Will artificial intelligence solve the human resource crisis in healthcare? *BMC Health Serv Res* 18:545
5. Armstrong S (2017) Data, data everywhere: the challenges of personalised medicine. *BMJ* 359:j4546
6. Kenny LM, Nevin M, Fitzpatrick K (2021) Ethics and standards in the use of artificial intelligence in medicine on behalf of the Royal Australian and New Zealand College of radiologists. *J Med Imag Radiat Oncol* 65:486–494
7. Menachemi N, Collum TH (2011) Benefits and drawbacks of electronic health record systems. *Risk Manage Healthc Policy* 4:47–55
8. Gianfrancesco MA, Tamang S, Yazdany J, Schmajuk G (2018) Potential biases in machine learning algorithms using electronic health record data. *JAMA Int Med* 178:1544
9. Houghton F (2029) Cybersecurity, ransomware attacks and health: exploring the public health implications of the recent cyberattack on Ireland's health service. In: *Medicina Internacia Revuo—international medicine review*
10. Kaur J, Ramkumar KR (2021) The recent trends in cybersecurity: a review. *J King Saud Univ - Comput Inform Sci*. <https://doi.org/10.1016/j.jksuci.2021.01.018>
11. Governance I. What is cybersecurity. <https://www.itgovernance.co.uk/what-is-cybersecurity>. Accessed 25 Aug 2021
12. CSO, The CIA triad: definition, components and examples. <https://www.csoonline.com/article/3519908/the-cia-triad-definition-components-and-examples.html>. Accessed 25 Aug 2021
13. Kruse CS, Frederick B, Jacobson T, Monticone DK (2016) Cybersecurity in healthcare: a systematic review of modern threats and trends. *Technol Health Care* 2016; Preprint: 1–10
14. Martin G, Martin P, Hankin C, Darzi A, Kinross J (2017) Cybersecurity and healthcare: how safe are we? *BMJ* 358:j3179
15. Panja B, Fattaleh D, Mercado M, Robinson A, Meharia P (2013) Cybersecurity in banking and financial sector: security analysis of a mobile banking application. In: 2013 International conference on collaboration technologies and systems, CTS, pp 397–403

16. Services USD of H& H. Summary of the HIPAA security rule. <https://www.hhs.gov/hipaa/for-professionals/security/laws-regulations/index.html>. Accessed 25 Aug 2021
17. Office IC. Guide protection/ guide to the general data protection regulation (GDPR). <https://ico.org.uk/for-organisations/guide-to-data-protection/guide-to-the-general-data-protection-regulation-gdpr/security/>. Accessed 25 Aug 2021
18. Schwarz CG, Kremers WK, Therneau TM et al (2019) Identification of anonymous MRI research participants with face-recognition software. *New England J Med* 381:1684–1686
19. Dolin RH, Alschuler L, Boyer S et al (2006) HL7 clinical document architecture, release 2. *J Am Med Inform Assoc* 13:30–39
20. Harvey H, Glocker B (2019) Artificial intelligence in medical imaging, opportunities, applications and risks, pp 61–72
21. Lu Y, Xu LD (2019) Internet of things (IoT) cybersecurity research: a review of current research topics. *IEEE Internet Things* 6:2103–2115
22. Diaz J, Pérez JE, Lopez-Peña MA, Mena GA, Yagüe A (2019) Self-service cybersecurity monitoring as enabler for DevSecOps. *IEEE Access* 7:100283–100295
23. (DBIR) 2021 Data breach investigations report. 2021 Data breach investigations report (DBIR). https://enterprise.verizon.com/resources/reports/2021/2021-data-breach-investigations-report.pdf?_ga=2.196284591.2055812423.1629911946-954072054.1629911946
24. Mildenerger P, Eichelberg M, Martin E (2002) Introduction to the DICOM standard. *Eur Radiol* 12:920–927
25. Mirsky Y, Mahler T, Shelef I, Elovici Y (2019) CT-GAN: malicious tampering of 3D medical imagery using deep learning. *Arxiv* 2019
26. Geis JR, Brady AP, Wu CC et al (2019) Ethics of artificial intelligence in radiology: summary of the joint European and North American multisociety statement. *Can Assoc Radiol J* 70:329–334
27. Larson DB, Magnus DC, Lungren MP, Shah NH, Langlotz CP (2020) Ethics of using and sharing clinical imaging data for artificial intelligence: a proposed framework. *Radiology* 295:192536
28. Krupinski EA (2020) An ethics framework for clinical imaging data sharing and the greater good. *Radiology* 295:200416
29. Cirillo D, Valencia A (2019) Big data analytics for personalized medicine. *Curr Opinion Biotech* 58:161–167
30. Hussain Z, Gimenez F, Yi D, Rubin D (2017) Differential data augmentation techniques for medical imaging classification tasks. In: *AMIA Annual symposium proceedings of AMIA symposium 2017*, pp 979–984
31. Korkinof D, Harvey H, Heindl A et al (2020) Perceived realism of high-resolution generative adversarial network–derived synthetic mammograms. *Radiol Artif Intell* 3:e190181
32. Ding Y, Sato H (2020) Derepo: a distributed privacy-preserving data repository with decentralized access control for smart health. In: *2020 7th IEEE international conference on cyber security and cloud computing CSCLOUD, 2020 6th IEEE international conference on edge computing and scalable cloud EDGECOM 2020*, vol 00, pp 29–35
33. Rieke N, Hancox J, Li W et al (2020) The future of digital health with federated learning. *NPJ Digital Med* 3:119
34. Mothukuri V, Parizi RM, Pouriyeh S, Huang Y, Dehghantanha A, Srivastava G (2021) A survey on security and privacy of federated learning. *Future Gener Comput Syst* 115:619–640
35. Gonzalez D, Zimmermann T, Nagappan N (2020) The state of the ML-universe. In: *Proceedings of the 17th International conference on mining software repositories 2020*, pp 431–442
36. Eichelberg M, Kleber K, Kämmerer M (2020) Cybersecurity challenges for PACS and medical imaging. *Acad Radiol* 27:1126–1139



Dr. Brendan Kelly MB BCh BAO BSc MSc MRCSI, 2020 Fulbright Scholar to Stanford University, California, USA, ICAT HRB/Wellcome Trust Academic Fellow/PhD Candidate Insight Centre for Data Analytics University College Dublin, Belfield Dublin 4, Ireland, Honorary Clinical Lecturer and Specialist Registrar in Radiology St Vincent's University Hospital, Dublin 4, Ireland.



Conor Quinn is a Research Fellow focused on cyber security, with his work centring around researching cyber security incidents to determine how they happened and to recommend improvements to increase security of organisations. He is recognised as the inaugural Fulbright Scholar in cyber security to Boston College from Dublin, Ireland. He is a specialist in digital forensics and incident response, holding qualifications including GIAC Certified Forensic Analyst (GCFA) and MSc in Digital Investigations and Forensic Computing (University College Dublin).



Dr. Aonghus Lawlor is an Assistant Professor at the University College Dublin (UCD) and a Funded Investigator at the Insight Centre for Data Analytics. He works in the areas of Machine Learning, Artificial Intelligence, Explainable AI, Recommender Systems and Medical Imaging. Aonghus has been actively involved in several research projects in these areas and has been the co-PI of some large Industrial projects. Aonghus has also received several research grants from Enterprise Ireland and the Science Foundation of Ireland, and his research has led to several patents.



Prof Ronan Killeen is a consultant radiologist working within St Vincent's Healthcare Group and The Royal Victoria Eye and Ear Hospital in Dublin, Ireland. He is Clinical Professor of Radiology in University College Dublin. Ronan did his fellowship training in New York Presbyterian Hospital in Neuroradiology and Molecular imaging and is board certified by ABNM. He has published more than 100 papers, written several book chapters and authored a book on PET CT in Oncology.





His particular interests are in multimodality advanced imaging of neurological disease, artificial intelligence and healthcare digital innovation. Ronan is the current Chair of the Research Ethics Committee in St Vincent's Healthcare Group and the Chair of the Imaging Task Group for the HSE National Dementia Office, Ireland.



Dr. James Burrell is an associate professor of information and computer science and cyber and national security research fellow at public and private academic institutions. He is the founding director of a cyber security research laboratory and principal investigator for federal cybersecurity grant awards. His current research is focused on information security, artificial intelligence, quantum technologies, and technology policy. He earned B.S., M. S., Ed.S., and Ph.D. degrees in electrical engineering and computer and information science disciplines. He is recognized as a Senior Member of the Association of Computer Machinery (ACM) and Institute of Electrical and Electronics Engineers (IEEE) and maintains professional certifications to include Certified Information Systems Security Professional (CISSP) and GIAC Information Security Professional (GISP).



Radiology and Radiomics: Towards Oncology Prediction with IA and Big Data

Aline Sgnolf Ayres , Suely Fazio Ferraciolli , Andre Lupp Mota ,
Laura Lane Menezes Polsin, and Claudia da Costa Leite 

1 Introduction

Radiomics is the process of converting medical images into quantitative images and is driven by the concept that imaging studies contain information on pathophysiological processes that can be revealed only by quantitative analysis [1].

Historically, radiology is based on qualitative and subjective image evaluation, which delegates correct interpretation to the radiologist. Thus, medical reasoning is the result of objective knowledge and a subjective assessment of patterns, and finally, a complex equation that combines the findings, subjectively attributing them importance, resulting in the diagnosis. However, this method is time-consuming and requires radiologist experience [2].

A. S. Ayres (✉)
Neuroradiologist UHG, São Paulo, Brasil
e-mail: aline.ayres@hc.fm.usp.br

Instituto do Cancer do Estado de São Paulo, Hospital das Clinicas, School of Medicine,
University of São Paulo, Universidade de São Paulo, São Paulo, Brasil

S. F. Ferraciolli
Dasa, São Paulo, Brasil
e-mail: suely.ferraciolli@hc.fm.usp.br

UHG, São Paulo, Brasil

Instituto de Radiologia, Hospital das Clinicas, School of Medicine, University of São Paulo,
Universidade de São Paulo, São Paulo, Brasil

A. L. Mota
Departamento de Cirurgia e Anatomia - Faculdade de Medicina de Ribeirao Preto,
Universidade de São Paulo, São Paulo, Brasil

Radiomics emerged as a field of knowledge to transform diagnostic reasoning, often a laborious and subjective task, into a quantitative process, based on information generated in the images [2].

Radiomics is designed to extract and organize many features from digital medical images (big data) and perform statistical calculations that can correlate findings with a specific diagnosis, genetic characteristics, staging, response to treatment, or outcome. This process ideally links imaging data with clinical information from patients, thereby improving the decision-making power of the model [3].

This process began with the acquisition of high-quality and reproducible images. These images were standardized and evaluated, and the volume of interest was selected and segmented. The segmented volume was then subjected to artificial intelligence (AI) models to extract the features and correlate them with the patient's data. Finally, statistical calculations were performed by associating a specific feature (or combining a pool of features) with the diagnosis.

Features can be classified as semantic and agnostic. Semantics correspond to those that are part of the radiologist's lexicon (size, shape, location, and spiculation). Agnostics are features extracted mathematically. They can be assorted as first, second, or higher orders features and they are described in the radiologist's report. The first-order features describes the distribution of individual voxels without reporting their spatial relationships. They are based on histograms and are expressed using average, median, maximum, and minimum values, as well as uniformity (entropy) of the image intensities, skewness (asymmetry), and kurtosis (flatness) of the histogram values [1–3].

Second-order features reflect the statistical relationship between voxels, which may be similar or opposite and are called texture features. These features can express the heterogeneity of tumors. Higher-order statistical methods impose filter grids on the image to extract repetitive and nonrepetitive patterns, including fractal analyses [2, 3]. These features are summarized in Fig. 1.

At the beginning of radiomic expansion, the features were previously selected, and the model should statistically relate them to a certain outcome. This process, known as supervised machine learning, has yielded good results; however, the results generally resemble human performance. An alternative to supervised

L. L. M. Polsin
University of Campinas, São Paulo, Brasil

C. da Costa Leite
Grupo Fleury, São Paulo, Brasil
e-mail: claudia.leite@hc.fm.usp.br

Hospital Sirio Libanes, São Paulo, Brasil

Departamento de Radiologia e Oncologia, Faculdade de Medicina,
Universidade de São Paulo, São Paulo, Brasil

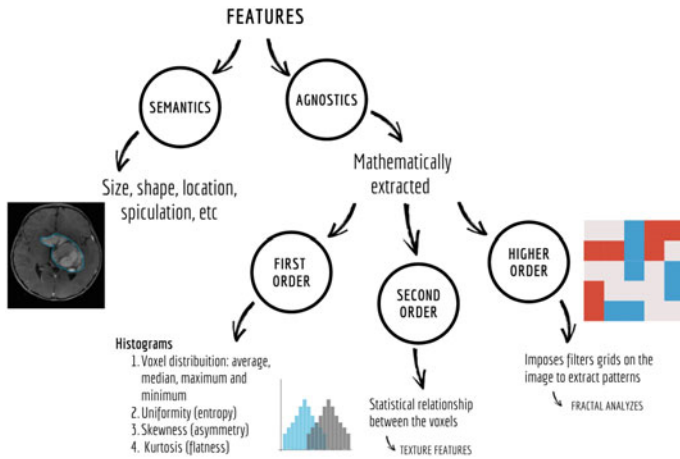

Fig. 1 Radiomic features

machine learning is a more modern method that delegates to the model the task to identify among the features generated, which were individually (or as a group) those that resulted in a greater statistical power.

Deep learning, a field of machine learning, is based on a model’s ability to identify characteristics that may not be perceptible to human evaluation and statistically correlate with a given outcome [4].

The conventional machine-learning feature-based radiomics workflow differs from the deep-learning radiomics approach. The deep learning method uses different neural network architectures, such as convolutional neural networks (CNNs), to generate and point out the most valuable features from input data. Autoencoder networks, which are an unsupervised type of CNN, aim to compress the image information and trace a short and representative of feature vector. Usually, deep-learning-based radiomics uses a multilayer system of neural networks trained to learn and recognize valuable features for problem classification in imaging data. With this technique, it is not necessary to select predefined features. Different combinations of the extracted feature vectors were then combined and evaluated to generate features with a level of abstraction and complexity even higher. The last step is to identify features that could be applied for problem classification by the neural network or quit the network and proceed model generation similar to feature-based radiomics approaches already described using several classifiers from conventional machine learning, such as decision trees, regression models, or support vector machines. Finally, deep learning-based radiomics functions on segmented and unsegmented images, whereas feature-based radiomics demand segmented images for feature extraction [1, 2, 4].

Radiogenomics is a field of radiomics that correlates image data with the genetic alterations of a lesion and has been shown to be very promising. In the era of precision medicine, genetic characterization of lesions has proven to be an efficient tool in therapeutic planning, survival prediction, and, in an increasing number of

cases, in the choice of target therapies. Thus, a desirable result is the possibility of molecularly characterizing a lesion on diagnostic imaging scans, which will significantly contribute to patient counseling and therapeutic planning.

The main application of radiogenomics is oncology; almost all cancer patients undergo imaging scans, and the ability to extract information on the main genetic tumor alterations without biopsy is encouraging. In addition to saving the patient from an invasive procedure, with morbidities inherent to any procedure, biopsy evaluates only part of a lesion and may often not demonstrate its main mutations. It is also important to consider that this type of evaluation is performed by specialist pathologists and requires advanced technological resources that are not widely available. In addition, this process is time-consuming and expensive. Therefore, genetic characterization of the tumor as a whole in a diagnostic scan is an important tool in oncology and precision medicine, adding benefits to treatment planning and increasing the availability of more specific diagnoses for a larger percentage of the population. An example of a radiogenomic pipeline is shown in Fig. 2.

Image patterns that reflect the physiopathological alteration determined by genetic mutation have already been described. A good example is the mismatch sign in gliomas. The signal of the T2/FLAIR mismatch corresponds to the hyper-signal drop in the FLAIR sequence when compared to the T2 sequence on brain magnetic resonance imaging (MRI) study and has a good correlation with IDH mutation and absence of 1p19q genes codeletion, a finding with almost 100% specificity [5].

In the clinical context of glioma, this information can be added to the report and currently contributes to patient counseling, surgical planning, and histopathological and molecular evaluations. Thus, based on this example, we can believe that AI

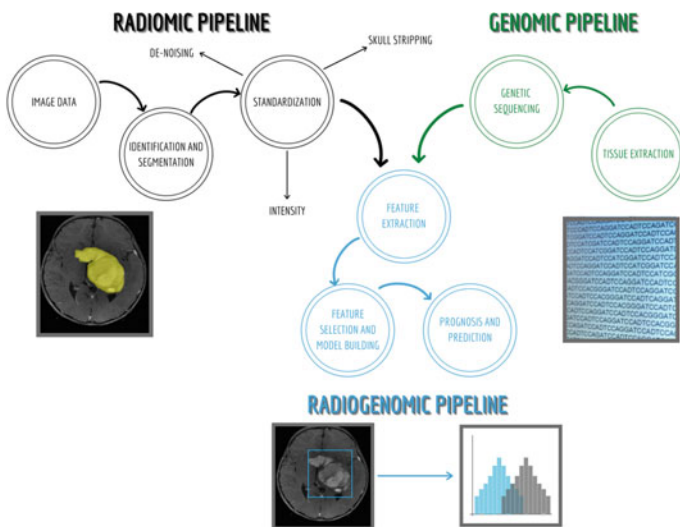

Fig. 2 Radiogenomic pipeline

models can identify other characteristics, many of which are not perceptible to the human eye and reflect some pathophysiological alterations related to genetic mutations.

In addition to tumor molecular characterization at diagnosis, radiogenomics also allows for the evaluation of genetic mutations throughout oncological follow-up. Once disease progression is characterized (either by tumor growth or changes in its characteristics), imaging studies will be able to detect this evolution and reveal which new mutations are present. Thus, again, the patient is spared from a new invasive procedure, with an impact on the patient's morbidity, in addition to the cost reduction of an already onerous treatment.

2 Big Data for Oncology Management

Big data can be defined as “a term that describes large volumes of high-velocity, complex, and variable data that require advanced techniques and technologies to enable the capture, storage, distribution, management, and analysis of the information.” Owing to the complexity of multidimensional data, AI techniques are required to extract the necessary information from this source.

There are various methods for generating big data in medicine, including genomics, proteomics, or metabolomics. Radiomic processes produce a large amount of data (features) that can be evaluated individually or together and require complex technology for storage, organization, and interpretation. In addition to this information, there are demographic, clinical, and laboratory data, as well as lifestyle and cultural data, which can be evaluated as a group. Thus, a complex and essential field for the development of radiomics is the ability to deal with big data, which encompasses the systematic collection and organization of data and its correct interpretation. This set of high-dimensional information (big data) has great applications in oncology to establish relationships between available data and possible outcomes [2]. In addition, we can use data extracted from wearable devices, laboratory exams, medical reports, family history, social media, and geographic and demographic status to serve as input for machine learning algorithms to help the user improve and prevent diseases (including cancer).

3 Areas of Radiomics/Radiogenomics

Oncology benefits directly from the development of radiomics and radiogenomics. As previously mentioned, almost all patients with cancer underwent imaging scans. Thus these data can be used for early tumor detection, diagnosis, and treatment follow-up, through objective data, without the need for subjective interpretation [2].

Tumor detection is a field of extensive exploration in oncology, with the main objective of detecting lesions as early as possible. For the most part, small lesions have simpler therapeutic proposals, with less morbidity and generally longer survival. Most neoplasm staging criteria (TNM) include lesion dimensions as part of their classification. RECIST 1.1 establishes injury size as the main feature to include a lesion as a target injury. Therefore, the size of the tumor has a direct relationship with treatment response and survival, and all patients benefit from earlier detection of their disease. Models of AI that can detect small, potentially oncological abnormalities (computer-aided detection (CAD)) contribute to the screening of patients with risk factors or that fit epidemiologically in a specific risk group, such as in the evaluation of pulmonary nodules in a smoker group or the mammographic screening of patients with a familial history of breast cancer.

As soon as a lesion is detected, it must be characterized to narrow the differential diagnosis and help in therapeutic planning. Radiogenomic evaluation will contribute to this step, since detected lesions may already have their main molecular changes characterized in the diagnostic study itself, allowing for better treatment planning. In addition to molecular characterization, models of stratification of the risk of recurrence, treatment response pattern (if the profile evaluated indicates a good response to radiotherapy/chemotherapy or surgery only), early recurrence risk, and survival can be applied. This information helps the doctor and patient, allowing therapy decisions to be made in a reasoned manner and with greater awareness, statistically evaluating the risks, benefits, and costs.

Finally, AI models can also perform image follow-up, making comparative studies through volumetric measurements of lesions and changes in image patterns, or detection of disease distance progression. This evaluation could be challenging when small changes are observed between the two examinations and often cannot be detected by the human eye. Using volumetric measurements and textural analysis, models that compare lesions over time can characterize slight changes and thus detect tumor progression in an earlier and more objective way. In this context, rescue therapies can be applied earlier with a potential impact on survival. Examples of radiomics utilization in oncology are summarized in Fig. 3.

Therefore, radiomics can significantly contribute to decision-making in cancer patients from diagnosis until follow-up after treatment. There are numerous radiomics and radiogenomics research initiatives in all areas of oncology. Efforts are being made to deepen the knowledge and generalize the results to incorporate this technology into the daily workflow, adding benefits to the treatment of cancer patients.

4 Neuroradiology Applications

Historically, neuroradiological development has been intrinsically connected to technological innovations, as we could see in the past few years, the practical application of new and advanced MRI sequences such as dynamic susceptibility

Fig. 3 Uses of radiomic/radiogenomic in oncology

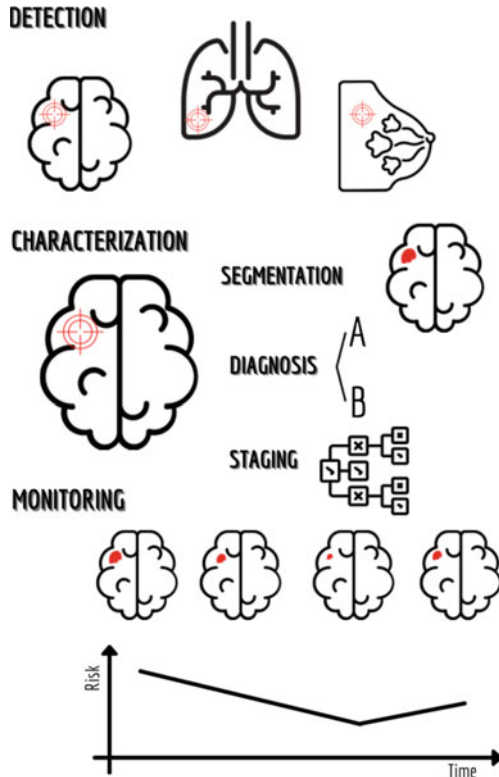

contrast (DSC), spectroscopy, diffusion tensor imaging (DTI), and function, which enable the assessment of the physiological behavior of several central nervous system (CNS) injuries.

Neuro-oncology has already been incorporated into clinical practice for the interpretation of advanced MRI sequences in the assessment of CNS tumors, and currently, the advancement of radiogenomics research points to the assimilation of this technology in the near future.

In 2021, the World Health Organization published the 5th edition of the primary CNS tumor classification system [6]. The glioma category was reorganized with guidance to classify these tumors in combination with their genetic and histological changes. These advances have resulted in a better understanding of the impact of genetic changes on tumorigenesis, treatment response, and survival.

Isocitrate dehydrogenase (IDH) plays a central role in the classification and prognosis of patients with diffuse glioma. IDH protects cells against oxidative stress [7].

Diffuse low-grade (grade II) gliomas are usually IDH-mutated, and most patients with high-grade gliomas are wild-type (not mutated) and have a worse prognosis. These tumor types are classified as grade IV astrocytomas when they are

IDH-mutated (with a better prognosis and response to treatment compared to GBM-WT). Due to their important prognostic role, diffuse gliomas should be classified as mutated or IDH wild-type, with better tumor characterization, as well as helping therapeutic planning, once patients with gliomas IDH WT are treated more aggressively.

Imaging studies can already grade glioma in low and high grades, based on its characteristics in conventional and advanced MRI sequences, thus having a good contribution to the glioma phenotype. This information is important, but the current scenario is insufficient [7]. It is necessary to follow the progress of the WHO 2021 classification and, therefore, to study which image patterns (phenotypes) may be related to molecular changes (genotypes).

Recent studies have evaluated AI models of patients with GBM to classify IDH status with promising results, but they still require external validation [8, 9].

Codeletion of genes 1p and 19q associated with the IDH mutation is the genetic signature of oligodendrogliomas (grades II and III) [6]. Its presence is diagnostic of oligodendrogliomas and is associated with longer survival and a better response to treatment. A recent systematic review of AI techniques applied to classify low-grade gliomas based on IDH mutations and codeletion of 1p19q genes has demonstrated good results. Some groups have achieved high specificity and sensitivity, especially those associated with conventional radiomics using convolutional neural network-derived features [10].

Other molecular changes can also be evaluated to better characterize gliomas and for prognostic evaluation. The P53 gene, EGFR amplification, VEGF mutation, MGMT gene methylation, CDKN2A/B homozygosity, and H3K27m and H3.G34 histone mutations are some of the main molecular changes that may have an impact on survival and response to treatment. These are targets of studies in radiomics/radiogenomics, with promising results, but still require validation [11].

This information is important, but the current scenario is insufficient [7]. It is necessary to follow the progress of the WHO 2021 classification and, therefore, to study which image patterns (phenotypes) may be related to molecular changes (genotypes).

In addition to their role in the characterization of gliomas, in the era of precision medicine, these molecular changes can also guide treatment, aiming to develop and apply targeted therapy.

The BRAF oncogene can undergo two main changes: BRAF fusion and the BRAF V600E mutation. BRAF fusion manifests when the gene mixes with other mutations, resulting in the upregulation of several downstream pathways. The BRAF V600E mutation activates BRAF, damaging the mitogen-activated p. V600E protein kinase (MAPK) pathway. Low-grade gliomas in children or circumscribed gliomas with BRAF V600E mutation may have a more aggressive disease course if they cannot be surgically resected.

Thus, a target drug with action in the mitogen-activated protein kinase pathway was developed and could be used to treat pediatric patients with low-grade gliomas refractory to first-line chemotherapy with promising results. A recent study used radiomics to characterize BRAF mutations in low-grade gliomas in children. In

addition to the benefits already discussed, this finding is especially important in this group of diseases because some tumors are located in eloquent areas, which increases biopsy procedure morbidity [12].

This information is valuable for therapeutic planning and could assist pathologist interpretation. In addition, it should be considered that in the future, this type of information may lower the costs of assessing the molecular profile of tumors, which can be characterized based on imaging findings.

In addition to gliomas, medulloblastomas are targets for radiogenomic research, with a good correlation between imaging findings and molecular profiles. The molecular classification of medulloblastoma is important and has an impact on survival. They can be classified into wingless (WNT), sonic hedgehog (SHH), group 3, and group 4, the latter with a worse prognosis, which may also be the target of more aggressive treatment and, in the future, of targeted therapy. Perreault et al. evaluated 47 pediatric patients. There was a good correlation between the lesion topography and molecular profile: those located in the midline next to the IV ventricle had groups 3 and 4 mutations, those located in the cerebellar hemisphere were of the SHH type, and those located in the middle cerebellar peduncle had the WNT mutation [13]. These phenotype-genotype correlations could enable us to make a better and more precise diagnosis, making it possible to rule out biopsy in some cases in the near future.

5 Breast Imaging Applications

Breast cancer is one of leading cause of cancer-related death in the world. Breast cancer screening using mammography is considered effective in reducing breast cancer-related mortality. Early diagnosis is a fundamental strategy that results in more effective treatment and increased survival. Thus, patients with small non-metastatic primary lesions can be treated more efficiently, with the potential for longer survival of 5 years. In addition, the early detection and treatment of breast cancer also impact the quality of life, as these women undergo less invasive surgical procedures. Many countries have adopted mammography as a screening tool for the entire population, aiming for early diagnosis with consequent mortality reduction [14].

However, a large number of examinations and the use of double reading in some countries result in a high workload for radiologists, reducing efficiency and increased cost. Specially, it is important to decrease missing and interpretation mistakes of detectable lesions on mammography, which accounts to approximately 25% of detectable cancers not diagnosed at screening exams [15].

The need to improve the accuracy of mammography, tomosynthesis, and MRI has spurred several studies in this area. Some researchers have investigated the application of radiomics to distinguish benign mammary lesions from normal mammary parenchyma and malignant lesions. In general, these studies demonstrated radiomic improvements in diagnostic accuracy in breast imaging [14].

In a large multicenter study, the performance of an AI model for diagnosing breast cancer in digital mammograms was superior to radiologists [16].

Researchers have shown that radiologists have improved diagnostic accuracy for breast cancer detection in mammography when applying an AI computer system for assistance, increasing the reading time. Radiologists with less experience benefited the most from this tool [16].

Another promising area for radiomic applications is the automatic identification of normal mammograms in breast cancer screening studies to reduce the workload for radiologists [14].

In current radiological practice, tumor evaluation on mammography, ultrasound, or magnetic resonance studies is broadly qualitative, including subjective assessments, such as the aspect of the tumor (e.g., spiculated, rounded, with cysts or necrosis, microcalcification), density, enhancement pattern and anatomical relationship with surrounding tissues in to propose further treatment. As in other areas of oncology, breast cancer treatment has evolved, and in addition to early diagnosis, personalized treatment based on specific characteristics of each tumor and individual characteristics of the patient has a direct impact on disease therapy planning and survival. In this scenario, the systematic evaluation of medical data and images is a necessary step in personalized medicine [15].

A study conducted in Germany demonstrated higher performance in screening mammogram evaluations by radiologists assisted by AI compared to those who did not use this tool. This study suggests that the AI system can help evaluate and interpret equivocal cases, suggesting its clinical relevance [15].

Similar studies are also being conducted for the evaluation of breast MRI, suggesting the application of AI in this imaging modality [16].

In addition to its application in mammography evaluation, AI can be used to assist pathologists in interpreting slides. Digitization of pathology slides for primary diagnosis is a rich field that can provide more broadly available and accurate diagnosis, classification, and prediction of breast tumor behavior [14].

6 Lung Imaging Applications

Lung cancer is one of the most common types of cancers worldwide. Despite being a common disease, it can be a silent, with most patients experiencing unspecific symptoms until a late stage, which can lead to poor clinical outcomes. Therefore, it is important to scan high-risk populations for early detection of pulmonary cancer and provide more treatment options. Meanwhile, new and different therapeutic strategies have challenged the selection of eligible patients. This rich field of research is aimed at solving practical problems in lung cancer management.

Recent data revealed a slight increase in the 5-year survival of lung cancer patients in the United States, which is a reflection of early detection, more accurate diagnosis, and, mainly, in the development of personalized therapies [17].

The development of artificial intelligence (AI) models that can assist in the early diagnosis of lung cancer is a fertile field with potential for population applications. CT evaluation during lung cancer screening is extremely challenging and time consuming, in which there could be multiple nodules that measure only a few millimeters and needed to be analysed. One potential solution is the use of AI.

A number of computer-aided detection (CAD) systems and radiomic and deep learning techniques in the field of pulmonary nodule assessment are already under development, with some showing good results. The main problems are still false positives and the difficulty of generalization. Therefore, this issue has not yet been completely resolved. Among all the methods, radiomics and deep learning appear to be the most accurate, and they will probably become robust, sensitive, and accurate CAD tools for radiologists [18].

In addition to the early diagnosis of lung cancer with the evaluation of pulmonary nodules on CT scans, a recent review of AI application in patients with lung cancer evaluated several studies with good performance in characterization, prediction of response to treatment, and survival [19].

Similar findings have also been reported by other authors in the literature, with Aerts et al. [19] showing that a radiomic-specific feature evaluated before treatment helps predict EGFR mutation-related response to therapy in patients with non-small cell lung cancer (NSCLC).

In 2019, Google AI and collaborators built a deep learning convolutional neural network AI model to detect and characterize lung cancer risk using only CT scan input [20]. Similarly, a risk prediction model called the lung cancer prediction CNN (LCP-CNN) was developed to evaluate lung nodules and predict malignancy risk, reaching an AUC of 89.6% [21]. This is a great example of how AI algorithms may help not only in early and correct diagnosis, but also in treatment and prognosis.

7 Gastrointestinal Tract Imaging Applications

Hepatocellular carcinoma (HCC) is a major complication in patients with chronic liver disease (cirrhosis), being the main cause of cancer related death in this population. The prognosis of HCC depends on its stage at the time of diagnosis; therefore, screening imaging is critical for early detection and selection of treatment strategies. Currently, imaging assessment of HCC is based on a objective feature, the tumor size, and other subjective characteristics, which may vary greatly among radiologists.

The management of HCC patients may positively impact the development of radiomics, allowing personalized medicine to be applied to these patients, allowing better and earlier diagnosis, minimizing unnecessary surgeries, reducing costs, and optimizing available resources. Santos et al., in a recent review, raised several studies that demonstrated the potential application of radiomics for HCC patients, suggesting that textural features can be related to pathological findings, such as microvascular invasion and histological grade, helping in treatment decision and

predicting patient outcome and prognosis. Notably, when radiomic data are combined with clinical information, prediction models are more accurate and precise. Recent research has evaluated the application of radiomics in HCC using CT and MRI images with promising results [22].

Colorectal cancer (CRC) has a high incidence in the population and can be sporadic or hereditary (non-polypoid hereditary CRC, HNPCC/Lynch syndrome). The oncogenes involved in CRC of greatest clinical importance are those of the RAS family (K-RAS, N-RAS, H-RAS) and BRAF, whose resulting proteins are located on the cell membrane and are potential targets for monoclonal antibody treatment. In addition, the presence of mutations in these genes has become a predictive biomarker of the treatment response to these antibodies.

Recent research has shown that BRAF mutant colorectal carcinoma can be distinguished from BRAF wild type based on values for the derived radiomics texture features of standard deviation and mean value of positive pixels. A longer 5-year overall survival in patients with advanced-stage CRC tumors was associated with lower skewness and higher mean values [23].

The treatment of patients with CRC is based on neoadjuvant radio/chemotherapy and surgery, depending on the stage. Nowadays, the major clinical challenge in rectal cancer is to detect a complete response before surgery after neoadjuvant chemo/radiotherapy in patients with CRC. MRI is the method of choice for interpreting morphological and functional sequences; however, its assessment can be challenging, even for an expert radiologist. Horvat et al. evaluated radiomics and conventional imaging interpretation and were able to show that diffusion-weighted images and T2W radiomics signature performed better than subjective qualitative analysis [24]. Similar results were reported in the quantitative assessment of DWI and dynamic contrast-enhanced MRI [25].

In a recent review of radiomics and CRC, the authors highlighted the importance of continuing radiomics studies, as current works already point to promising results for outcome assessment/treatment response and radiogenomics [26].

Evaluation of patients with esophageal cancer is another important field of research in the radiomics of gastrointestinal tumors. Patients with locally advanced esophageal squamous cell carcinoma have a poor prognosis owing to late diagnosis and limited treatment strategies. The standard of care for patients with advanced disease is surgery and chemoradiotherapy (CRT). Predicting outcomes is challenging. Radiomic evaluation using positron emission tomography with fluorodeoxyglucose (PET/CT) preoperatively in this group of patients was performed by a research group and managed to establish a list of patients who did not benefit from radio/chemotherapy treatment. Thus, this group of patients could be treated with another option. They showed that a pre-therapeutic radiomics signature could point out patients at risk of early tumor recurrence or death [27].

In these different types of gastrointestinal cancers, we can already see that radiomic and radiogenomic may become an essential tool for tumor assessment, diagnosis, prognosis, and treatment in the near future.

8 Radiotherapy Implications

Planning radiotherapy (RT) treatment is a delicate and time-consuming process. Outlining the irradiated lesion can be challenging, and it affects the treatment response and related complications. Currently, this process is mainly manual and laborious, and may be subject to variability among doctors. Thus, extracting objective information from the imaging tests used for diagnosis and radiotherapy planning can improve the quality of this task. In addition to the challenge of properly delineating the lesion, we must consider the amount of information available in the different types of examinations (CT, MRI, PET) that can interfere with tumor treatment planning. In addition to tumor extension anatomical data, advanced MRI sequences and metabolic information generated by PET can contribute to a better characterization of tumor extension; therefore, it is necessary to integrate these data into the treatment planning exam [28]. Therefore, the automated extraction of image resources through radiomic processes and their integration may help reduce the variability in tumor delimitation, improve the precision of the contour, and expand information about its extension [29].

An important issue to be considered in cancer treatment is the possible heterogeneity of the tumor tissue, which reflects diverse microenvironments and could result in different radiotherapy responses within the lesion. Thus, recognizing areas that may be more resistant to RT and delivering a higher dose to these regions can also be applied in radiomics. The application of radiomic signatures as textural features can be of great interest for identifying tumor heterogeneity and guiding precise radiation therapy treatment. It will be possible to provide a standard heterogeneous dose in areas suspected to be more radioresistant than could be identified on functional images such as PET and advanced MRI sequences [29].

Advanced RT techniques, such as intensity-modulated radiation treatment (IMRT) and stereotactic body radiotherapy (SBRT), allow a higher dose of radiation to be delivered to the tumor with less involvement of the adjacent healthy tissues, thus generating less normal tissue damage. Thus, in these treatment modalities, which often require more than one radiotherapy session, high precision in planning and reproducibility throughout the treatment is necessary, which can also be very challenging. Some studies have already used radiomic techniques to detect and correct possible errors in positioning and in the delivered dose, correcting the collimator's position, which can interfere with the treatment result and its complications [30].

Another potential application of radiomics is to predict possible treatment complications, such as actinic pneumonitis and xerostomia secondary to radiotherapy treatment. In the era of precision and personalized medicine, it will be possible to identify the patients most susceptible to such complications and thus adjust the planning and dose delivered to the tumor in individuals at high risk of toxicity [29].

The evolution of the biological target volume (which combines anatomical and biological information of the tumor based on advanced MRI and PET sequences for RT planning) is believed to be the concept of radiomic target volume (193). The process involves automatic segmentation of the lesion, supervised by a doctor. The radiomic characteristics of the segmented tumor were then automatically extracted. Based on radiomic data, it may be possible to identify regions of major and minor tumor heterogeneity. Finally, treatment planning can be based on information on the histological behavior and radioresistance potential, with an increase in the dose for high-risk volumes and a lower dose for low-risk volumes to limit toxicity [28].

9 Conclusion

Oncology will benefit significantly from radiomics/radiogenomics resources. As already pointed out, as the vast majority of cancer patients undergo several imaging scans and different types of diagnostic evaluations throughout the course of the disease, these may provide doctors with a rich source of data that may lead to precision medicine. In addition to imaging scans, these patients are subjected to laboratory tests, biopsies, and molecular and histological evaluations of their lesions, generating an enormous amount of information that can be correlated with each other. Therefore, it is clear that part of the development of radiomics involves capturing and organizing this enormous amount of information generated, allowing the creation of a high-quality database, as well as its curation, to value the data with greater relevance—a challenge without a doubt.

In addition to dealing with this big data, integrating clinical knowledge of the disease with technical development and application of AI models is necessary. Usually, AI models that integrate a patient's clinical information in a specific context of a given disease have better performance. Recent studies have also shown that we can achieve better model results when the doctor has previously selected the information to be processed; therefore, when only cases already evaluated by a radiologist were subjected to a specific model for a given disease, its accuracy would increase, especially in the radiogenomics field and in cases of treatment planning and survival evaluation.

Models that aim to detect abnormalities in tests that a radiologist will evaluate also play an important role in population screening tests, such as mammograms for women and chest CT for smoking patients. These tools can be of great help, especially in services without subspecialist doctors and in places with a large workload for radiologists. These models have been shown to increase the detection rate, especially when used by physicians with less experience.

Finally, the application of radiomics and radiogenomics in daily practice remains objective. In addition to the technical difficulties of the models under development and ethical issues to be considered, the challenge of generalizing the results is yet to be overcome. The vast majority of published studies use their own databases, usually with an insufficient number of cases, which can generate results that apply

only to that specific group. Additionally, several studies have developed their own models. This type of evaluation often creates conditions for applying this knowledge only under the conditions created in published studies. Therefore, to advance the application of radiomics and radiogenomics, the generalization of the results is essential. Therefore, the main recommendations for future studies point to the use of open-source software, some of which are already available and are in an advanced validation stage. Another critical point is the use of public datasets from different parts of the world, validated by internationally recognized institutions, attesting to the quality of the available information. Finally, collaboration between different research institutions with the objective of sharing the database, allowing the models to be trained and validated in different populations, as well as the sharing of the model's technology to generalize the results, are essential steps in this research field.

With the results of the radiomic/radiogenomic models, we could have improved not only in cancer diagnosis and treatment, but also in the patients' prognosis and outcome, and even have some progress on prevention and health promotion leading to precision medicine (as shown in Fig. 4).

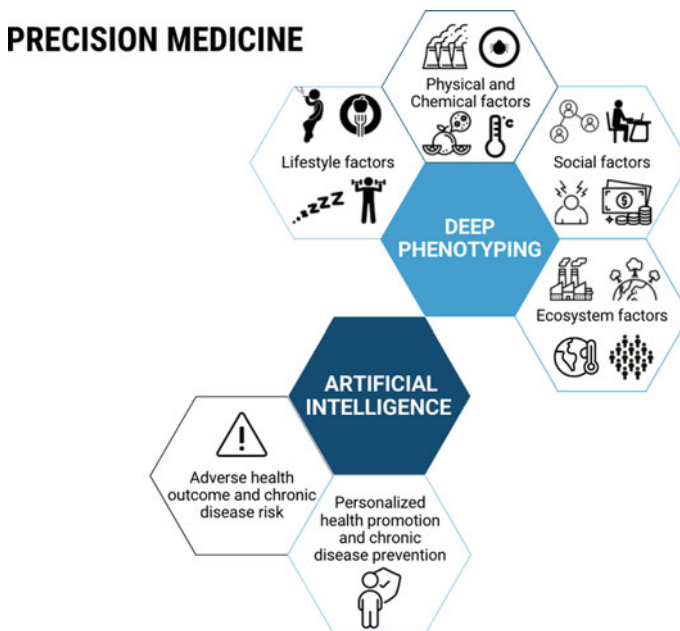

Fig. 4 Radiomic/radiogenomic for precision medicine

• Perspectives

The application of radiomics and radiogenomics in oncology remains a complex issue. The benefits of this technology are well known. Advances in medical and technological knowledge have accelerated the development of models with applications in the medical field. It seems to us that the future of clinical practice will be the integration between physician and AI models, increasing the performance of clinical decisions, with greater availability of molecular diagnostic resources for a wide number of patients, allowing the advancement of precision medicine and potential for the development of personalized therapies, with a positive impact on the quality of life and survival of the oncology population.

References

1. Shimizu H, Keiichi I (2020) Artificial intelligence in oncology. *Cancer Sci* 111(5):1452–1460. <https://doi.org/10.1111/cas.14377>
2. Hosny A, Parmar C, Quackenbush J, Schwartz LH, Aerts HJWL (2018) Artificial intelligence in radiology. *Nat Rev Cancer* 18(8):500–510. <https://doi.org/10.1038/s41568-018-0016-5>
3. Gillies RJ, Kinahan PE, Hricak H (2016) Radiomics: images are more than pictures, they are data. *Radiology* 278(2):563–577. <https://doi.org/10.1148/radiol.2015151169>
4. Zaharchuk G, Gong E, Wintermark M, Rubin D, Langlotz CP (2018) Deep learning in neuroradiology. *Am J Neuroradiol* 39(10):1776–1784. <https://doi.org/10.3174/ajnr.A5543>
5. Broen MPG, Smits M, Wijnenga MMJ et al (2018) The T2-FLAIR mismatch sign as an imaging marker for non-enhancing IDH-mutant, 1p/19q-intact lower-grade glioma: a validation study. *Neuro Oncol* 20(10):1393–1399. <https://doi.org/10.1093/neuonc/noy048>
6. Louis DN, Perry A, Wesseling P, Brat DJ, Cree IA, Figarella-Branger D, Hawkins C, Ng HK, Pfister SM, Reifenberger G, Soffietti R, von Deimling A, Ellison DW (2021) The 2021 WHO classification of tumors of the central nervous system: a summary. *Neuro Oncol* 23(8):1231–1251. <https://doi.org/10.1093/neuonc/noab106>. PMID: 34185076; PMCID: PMC8328013
7. Johnson DR, Guerin JB, Giannini C, Morris JM, Eckel LJ, Kaufmann TJ (2017) 2016 updates to the WHO brain tumor classification system: what the radiologist needs to know. *Radiographics* 37(7):2164–2180. <https://doi.org/10.1148/rg.2017170037>
8. Gutman DC, Young RJ (2021) IDH glioma radiogenomics in the era of deep learning. *Neuro Oncol* 23(2):182–183. <https://doi.org/10.1093/neuonc/noaa294>
9. Wu S, Meng J, Yu Q, Li P, Fu S (2019) Radiomics-based machine learning methods for isocitrate dehydrogenase genotype prediction of diffuse gliomas. *J Cancer Res Clin Oncol* 145(3):543–550. <https://doi.org/10.1007/s00432-018-2787-1>
10. Koppen J, Murthy SV (2021) Noninvasive determination of IDH and 1p19q status of lower-grade gliomas using MRI radiomics: a systematic review, pp 1–8
11. Aneja S, Chang E, Omuro A (2019) Applications of artificial intelligence in neuro-oncology. *Curr Opin Neurol* 32(6):850–856. <https://doi.org/10.1097/WCO.0000000000000761>
12. Wagner MW, Hainc N, Khalvati F et al (2021) Radiomics of pediatric low-grade gliomas: toward a pretherapeutic differentiation of BRAF-mutated and BRAF-fused tumors. *Am J Neuroradiol* 42(4):759–765. <https://doi.org/10.3174/ajnr.a6998>
13. Iv M, Zhou M, Shpanskaya K et al (2019) MR imaging-based radiomic signatures of distinct molecular subgroups of medulloblastoma. *Am J Neuroradiol* 40(1):154–161. <https://doi.org/10.3174/ajnr.A5899>

14. Ibrahim A, Gamble P, Jaroensri R et al (2020) Artificial intelligence in digital breast pathology: techniques and applications. *The Breast* 49:267–273. <https://doi.org/10.1016/j.breast.2019.12.007>
15. Zhou L, Wu X, Huang S et al (2020) Lymph node metastasis prediction from primary breast cancer US images using deep learning. *Radiology* 294(1):19–28. <https://doi.org/10.1148/radiol.2019190372>
16. Granzier RWY, Verbakel NMH, Ibrahim A et al (2020) MRI-based radiomics in breast cancer: feature robustness with respect to inter-observer segmentation variability. *Sci Rep* 10(1):1–11. <https://doi.org/10.1038/s41598-020-70940-z>
17. The Lancet. Lung cancer: some progress, but still a lot more to do. *Lancet* 394(10212):1880. [https://doi.org/10.1016/S0140-6736\(19\)32795-3](https://doi.org/10.1016/S0140-6736(19)32795-3)
18. Binczyk F, Prazuch W, Bozek P, Polanska J (2021) Radiomics and artificial intelligence in lung cancer screening. *Transl Lung Cancer Res* 10(2):1186–1199. <https://doi.org/10.21037/tlcr-20-708>
19. Aerts HJ, Grossmann P, Tan Y, Oxnard GR, Rizvi N, Schwartz LH, Zhao B (2016) Defining a radiomic response phenotype: a pilot study using targeted therapy in NSCLC. *Sci Rep* 6:33860. <https://doi.org/10.1038/srep33860>
20. Ardila D, Kiraly AP, Bharadwaj S et al (2019) End-to-end lung cancer screening with three-dimensional deep learning on low-dose chest computed tomography. *Nat Med* 25(6):954–961. <https://doi.org/10.1038/s41591-019-0447-x>
21. Baldwin DR, Gustafson J, Pickup L et al (2020) External validation of a convolutional neural network artificial intelligence tool to predict malignancy in pulmonary nodules. *Thorax* 75(4):306–312. <https://doi.org/10.1136/thoraxjnl-2019-214104>
22. Miranda Magalhaes Santos JM, Clemente Oliveira B, Araujo-Filho J de AB et al (2020) State-of-the-art in radiomics of hepatocellular carcinoma: a review of basic principles, applications, and limitations. *Abdom Radiol* 45(2):342–353. <https://doi.org/10.1007/s00261-019-02299-3>
23. Negreros-Osuna AA, Parakh A, Corcoran RB et al (2020) Radiomics texture features in advanced colorectal cancer: correlation with BRAF mutation and 5-year overall survival. *Radiol Imaging Cancer* 2(5):e190084. <https://doi.org/10.1148/rycan.2020190084>
24. Horvat N, Veeraraghavan H, Khan M et al (2018) MR imaging of rectal cancer: radiomics analysis to assess treatment response after neoadjuvant therapy. *Radiology* 287(3):833–843. <https://doi.org/10.1148/radiol.2018172300>
25. De Cecco CN, Ciolina M, Caruso D et al (2016) Performance of diffusion-weighted imaging, perfusion imaging, and texture analysis in predicting tumoral response to neoadjuvant chemoradiotherapy in rectal cancer patients studied with 3T MR: initial experience. *Abdom Radiol* 41(9):1728–1735. <https://doi.org/10.1007/s00261-016-0733-8>
26. Horvat N, Bates DDB, Petkovska I (2019) Novel imaging techniques of rectal cancer: what do radiomics and radiogenomics have to offer? A literature review. *Abdom Radiol* 44(11):3764–3774. <https://doi.org/10.1007/s00261-019-02042-y>
27. Li Y, Beck M, Päßler T et al (2020) A FDG-PET radiomics signature detects esophageal squamous cell carcinoma patients who do not benefit from chemoradiation. *Sci Rep* 10(1):1–9. <https://doi.org/10.1038/s41598-020-74701-w>
28. Reuzé S, Schernberg A, Orlhac F et al (2018) Radiomics in nuclear medicine applied to radiation therapy: methods, pitfalls, and challenges. *Int J Radiat Oncol Biol Phys* 102(4):1117–1142. <https://doi.org/10.1016/j.ijrobp.2018.05.022>
29. Pillai M, Adapa K, Das SK et al (2019) Using artificial intelligence to improve the quality and safety of radiation therapy. *J Am Coll Radiol* 16(9):1267–1272. <https://doi.org/10.1016/j.jacr.2019.06.001>

30. Wootton LS, Nyflot MJ, Chaovalitwongse WA, Ford E (2018) Error detection in intensity-modulated radiation therapy quality assurance using radiomic analysis of gamma distributions. *Int J Radiat Oncol Biol Phys* 102(1):219–228. <https://doi.org/10.1016/j.ijrobp.2018.05.033>



Aline Sgnolf Ayres Neuroradiologist UHGroup; Instituto do Cancer do Estado de São Paulo/ Hospital das Clínicas, Universidade de São Paulo – Brasil.

General Conclusion

Big Data and Artificial Intelligence (AI) are anticipated as major solutions for healthcare advancement. These solutions are already addressing the sector's needs and issues, particularly in light of the Covid-19 crisis. Furthermore, by elevating the pandemic threat, these technologies have demonstrated their usefulness in reshaping the global e-health environment. As the systems become more efficient, they will satisfy the requirements of patients and assist health systems in the administration, analysis, and evaluation of their operations.

The growth in the information provided and collected will lead to an expansion in the data collected. Big Data will therefore become more widespread in the health sector to manage and optimize this flow of data circulating between players in the field. AI can be a solution to collect, analyze, and incorporate large amounts of data, while offering treatment suggestions for a patient. AI also makes it possible to automate certain diagnostic or decision-making tasks, particularly in terms of patient and medical staff orientation.

The main conclusion that will be raised in this book is to exhibit the crucial interest of artificial intelligence and Big Data for medical decision making and data analysis in different fields of e-health such as radiology, cancer prevention, pharmaceutical discovery, Covid-19 detection, blockchain of Internet of Medical Things, cardiac imaging, cybersecurity, and Internet of Medical Things. Big Data analytics and AI can use clinical data repositories which can lead to increasingly sophisticated informed decisions. When ensuring confidentiality, the security of the data, establishing protocols, and good governance, improving technologies will grab the attention of this burgeoning field. The challenges of intelligent health depend on the opportunities provided by the community of experts to make health systems more sustainable. In intelligent healthcare, Big Data is based on massive data collected routinely or automatically, and the reusability of this data could include links between existing databases to improve the performance and efficiency of the health system.

Therefore, Big Data and AI will produce significant and accurate results for medical decision making while using patient data and clinical history to support more personalized medical inference. The potential of intelligent health allows us to monitor and control patients with chronic conditions and track their progress during therapy.