



Development of an Algorithm for Preparing to Start an Resistojet Propulsion System

Andrii Pohudin^(✉) , Sergii Gubin , Olha Pohudina , and Svitlana Sinchenko 

National Aerospace University Kharkiv Aviation Institute, Chkalova Street, 17, Kharkiv 61070, Ukraine

Abstract. The object for the creation of algorithms is the process of preparation for the start of the resistojet propulsion system (RJPS) in terms of duration and low energy consumption. The aim is to test the algorithm for reducing energy consumption and preparation time for the start of RJPS. The methods used are mathematical and simulation modeling of power supply processes of an resistojet propulsion system. The obtained results: simulation models of the primary converter of solar energy into electricity taking into account the change of light and temperature, chemical energy storage taking into account the operating modes and the dynamic model of changing the load of RJPS. The scientific novelty of the obtained results is as follows: the obtained limit values of current-voltage characteristics of the solar cell unit in terms of lighting and temperature, the charging and discharge characteristics of the chemical battery are obtained, the algorithm of preparation for RJPS start is obtained.

Keywords: Spacecraft · Electric heating propulsion system · Photovoltaic battery · Chemical battery · Start-up algorithm

1 Introduction

At present, small spacecraft (SSC) groups have become widespread [1]. You can use a space tug (ST) to create an SSC group. Electric rocket engines are installed on the ST to perform orbital maneuvers. The simplest in design, and the cheapest in the price of traction is an electric heating propulsion system (RJPS). But it has some peculiarities of use. Thus, for the operation of RJPS it is necessary to make a preliminary heating of the working fluid and units of RJPS. This time is very long, so the urgent scientific task is to reduce the time of preparation of RJPS for launch.

The power supply system of the ST is limited [2], so a pre-limited amount of energy is supplied which should be enough for the operation of the RJPS.

In general, the operating conditions of the RJPS are to limit the initial temperature of the structure of the RJPS and the propellant, the heating temperature range of the RJPS in the pauses between switch-on, the voltage range of the power supply. The system under consideration uses a propellant – gaseous ammonia [3] (thrust is created by the products of its decomposition – nitrogen and hydrogen). The immediate problem is that the preparation time for such an RJPS before the first start of the thruster is several hours.

If we consider the start of one thruster with a duration of one start – up to 20 min and limiting the DC supply voltage from 24 to 34 V and the temperature of normal operation of the RJPS from 273 K to 313 K, it is possible to build and model an algorithm that will limit the energy required to prepare for the launch, and the duration itself.

2 Computational Simulation of Experiment

Since RJPS is installed on the ST, the initial start and stop points of the propulsion system are not initially determined (this is due to the location of the ST in the initial orbit, where it has not yet been detected when the SSC withdrawal maneuver begins). This imposes a number of power and current voltage restrictions on the central bus of the RJPS power supply system, (PSS). In this case, the voltage and the amount of electricity supplied by the source (solar array, SA) and storage (chemical battery, CU) can be expressed within the limits of discharge/charge characteristics of CU. Which in turn are determined by the magnitude of the discharge/charge current, the temperature of the electrochemical system and the current capacity of the CU. The output voltage of the SA and, accordingly, its output current is limited by the level of illumination, the value of temperature and the level of degradation of the elements. It can be concluded that it is difficult for ST to determine the required dynamic characteristics of CU and SA, so use ranges of random values in the range of limit values of CU and SA voltage. $24B < V_{PSS} < 34B$, and $10, 5A < I_{PSS} < 16, 3A$ current strength, respectively.

For the power supply of RJPS we give the energy characteristics of the SA taking into account the solar energy, chemical energy storage and program the cyclogram of energy consumption of RJPS for the test problem of orbital maneuvering. The main elements will be described by substitution schemes. SA is conveniently described in the form of the Shockley model for a photovoltaic converter [4], which is shown in Fig. 1.

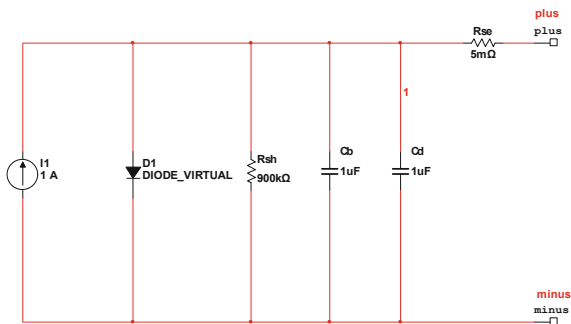

Fig. 1. SA substitution scheme in the form of the Shockley model, where $I1$ – DC generator, $D1$ – diode operating in direct bias mode, characterizes the diode properties of the p-n junction, Rsh – shunt resistance, Rse – series resistance, Cb , Cd – barrier and diffusion capacities, respectively, they are required when high switching speed, do not work in static mode, plus, minus – power outputs from the SA.

The shape and size of the current-voltage characteristic depend on the parameter that characterizes the quality of the transition, the values of the shunt and series resistances

and the total radiation energy converted into electrical energy regardless of the spectral distribution of radiation intensity.

When modeling the SA substitution scheme in the form of the Shockley model, the limiting conditions of the current-voltage characteristics of the SA operation are obtained. Figure 2 shows the characteristics of lighting, and Fig. 3 presents a characteristic of temperature.

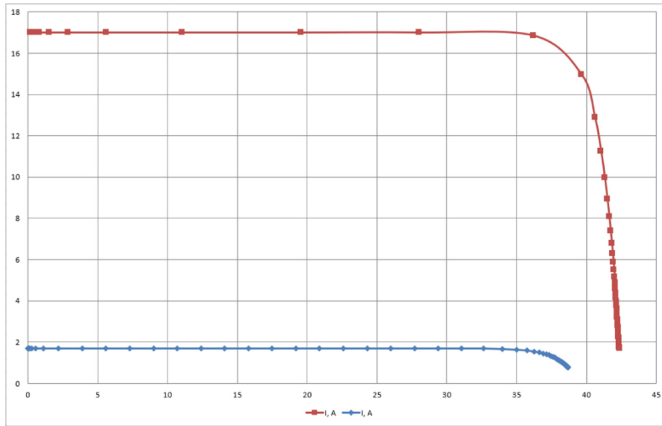

Fig. 2. Limit values of C-V characteristics of SA on illumination

The upper edge of the range corresponds to the power supplied at an average value of out-of-atmosphere lighting of 1360 W/m^2 . The lower edge of the range corresponds to the minimum illumination, which for the task is 10% of the maximum value, namely 136 W/m^2 .

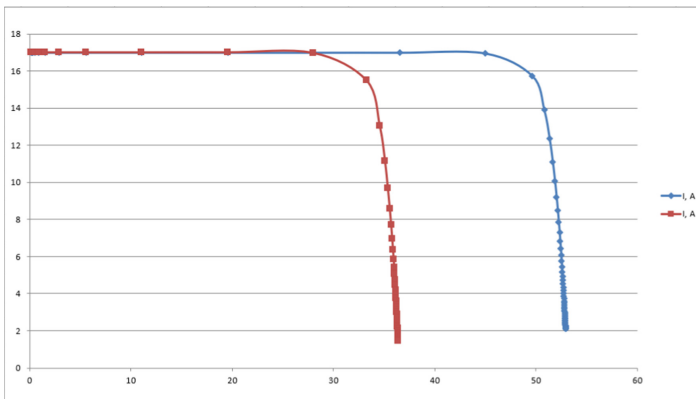

Fig. 3. Limit values of C-V characteristics of SA by temperature

At the maximum heating of SA we have red area of functioning, accordingly at the minimum heating – blue area of functioning.

To provide 34 V, it is necessary to sequentially switch 17 photoelectrical converters (FEC) [5], because each converter produces 2.5 V. To provide 16.5 A current, it is necessary to connect 28 strings in parallel (line FEC, mounted in length). That is, the SA is a parallelogram with sides 17 by 28 FEC. Each FEC has a size of 8×4 cm, so we have a FEC size 135×112 cm.

The CU substitution scheme (Fig. 4) is based on resistive capacitive cells that emulate activation and concentration polarization. In addition, the circuit includes a varistor (resistor, which resistance depends on the applied voltage) [6] to describe the final concentration polarization, internal resistance and the basic source of electromotive force.

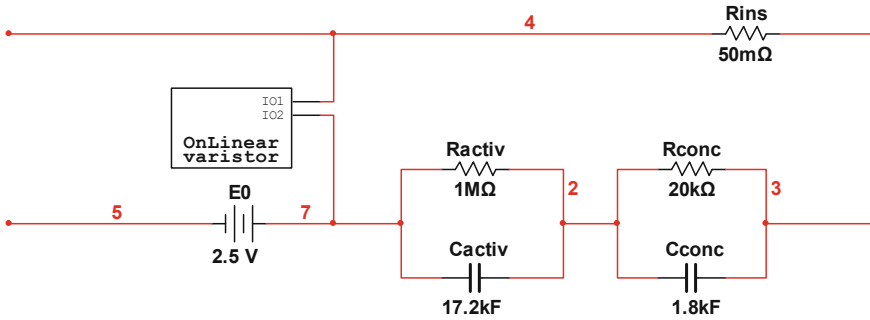

Fig. 4. CU substitution scheme, where OnLinervaristor – varistor, Ractiv – resistor cell activation polarization, Rconc – resistor cell concentration polarization, Rins – internal resistance of CU, Cactiv – capacitor cell activation polarization, Cconc – capacitor of concentration polarization cell, E0 – element of constant voltage 5 V.

When modeling the CU substitution scheme, charging and discharge characteristics are obtained. Figure 5 shows the characteristics of the CU charge depending on the current, and in Fig. 6 presents the discharge characteristic of CU depending on the discharge current.

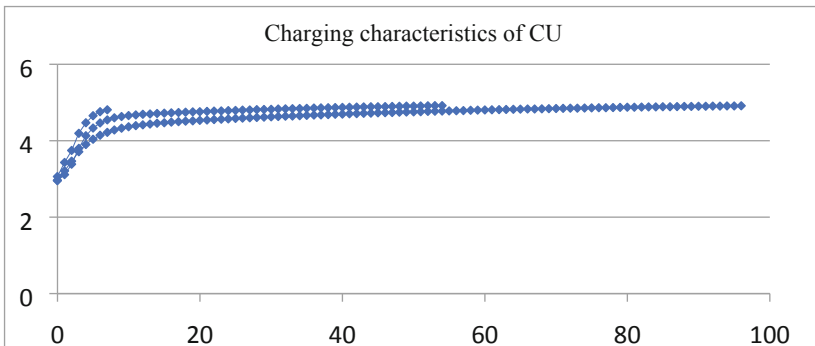

Fig. 5. Charging characteristics of CU

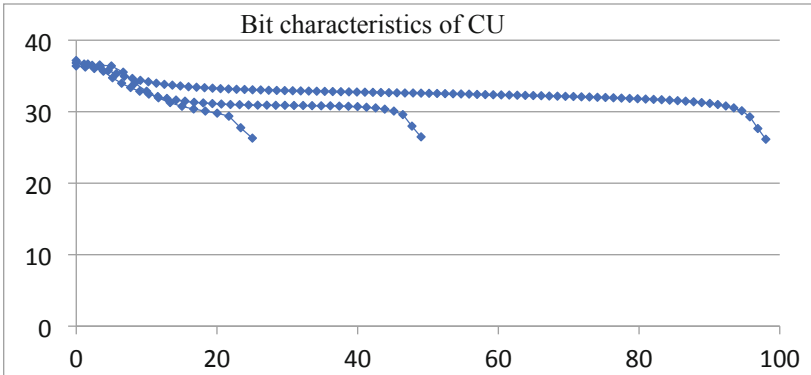

Fig. 6. Bit characteristics of CU

According to the flight dynamics, a CU capacity of 7.5 A·h is sufficient for RJPS power supply in the shadow area. To simplify this, choose a standard CU at $8 \text{ A} \times \text{h}$. In this case, the SA is formed in such a way that at the point of maximum power provides a voltage greater than the limit value.

According to the developed mathematical model of the process of heating the elements of RJPS, and taking into account the capabilities of the power supply system above, it is proposed to create an algorithm for preparation for the launch of RJPS. Let's start with the list of RJPS commands, which is presented in Table 1:

Table 1. List of RJPS commands

Marking	Functional purpose of the command
RJPS CU1on	Power on CU RJPS
RJPS CUoff	Power off CU RJPS
Interface commands	
InstArrPrev	Use an array of previous values
OffRP	Disable all running procedures
OnPPAT	Activation of the preparation procedure and operation of the acceleration thruster
OnPPDT	Switch-on of the procedure of preparation and operation of the deceleration engine

Next, procedures should be developed to prepare the elements of the RJPS for start. The algorithm of preparation for the first start of RJPS will have the form presented in Fig. 7. This algorithm is represented by UML (Unified Modeling Language) [7].

The end time of the algorithm is due to the completion of the heating of the balloon, steam generator (SG) and thruster.

According to the created algorithm we will build the cyclogram of work of power consumption of RJPS realized by algorithm of start. The cyclogram of preheating of RJPS elements in the lossless mode from the moment of receipt of the command from CU on switching-on is presented in Fig. 8.

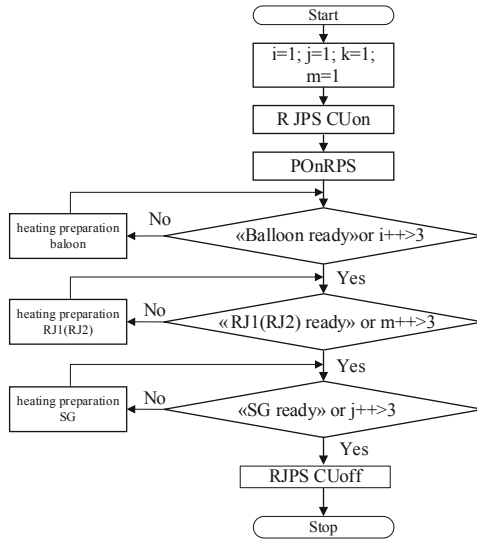

Fig. 7. Algorithm of preparation for the first start of RJPS

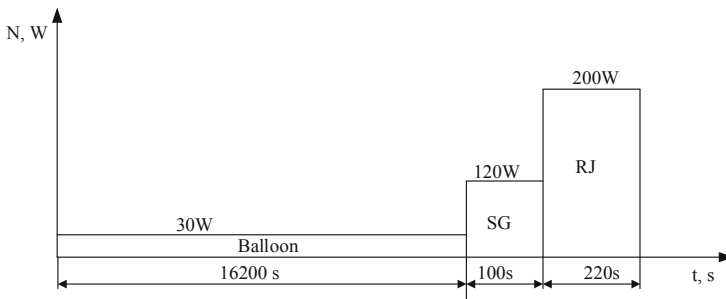

Fig. 8. Cyclogram of heating of RJPS elements and pressure rise in the receiver.

Thus, the time to prepare RJPS for start is 16520 s.

In flow mode, the balloon heater consumes 30 W, while the thruster heater constantly consumes 200 W, and the SG heater 120 W, 15 W are used for CU and solenoid valves. The peak load on the space tug EPS from the RJPS does not exceed 350 W.

To reduce the start-up time of the RJPS, someone can simultaneously perform processes occurring in the units of the RJPS. This makes it clear that it does not make sense to open the solenoid valves at the same time. Therefore, to reduce the start-up time, it is necessary to heat simultaneously the balloon, thruster and SG, which will make the return of EPS ST increased requirements [8]. Thus, we have the following options:

- the balloon and the SG are heated simultaneously, then the thruster is heated;
- the balloon and the thruster are heated simultaneously, then the SG is heated;
- balloon, SG, thruster are heated simultaneously.

The most efficient option is option 3, but it in turn will be the most energy consuming.

Next, it should be noted that the heating of the SG and the thruster in the heating mode must begin with the heating of the balloon, so that by the end of the balloon heating the SG and the thruster were also in the operating temperature range.

Based on the above proposed cyclogram will take the form shown in Fig. 9.

Another way to reduce the preparation time of the RJPS for the first start is to increase the capacity of the balloon heater. Thus, increasing the power supplied to the balloon heater. Without exceeding the consumption of the provided 350 W PSS, it is necessary to supply 130 W to the balloon heater, while heating the SG and then the thruster. Thus, the cyclogram will take the form shown in Fig. 10.

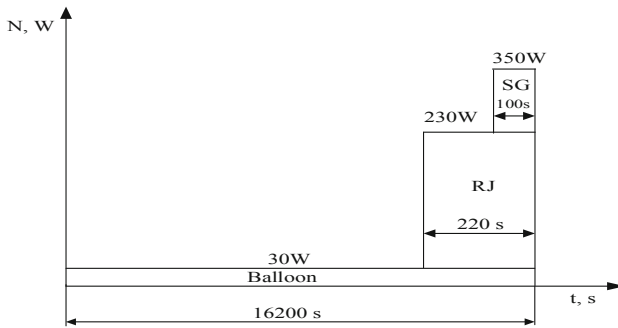

Fig. 9. Cyclogram of RJPS start-up with simultaneous heating of elements.

But there is another way to ensure a minimum time to start the RJPS. To do this, all the power of 350 W emitted by PSS can be applied to each of the elements of the RJPS, which are pre-heated separately. The most difficult element of heating is the balloon, so first it is heated. After that, heat the next mass element, namely the thruster. Finally, heat the SG. We will supply 350 W for each element in series. We obtain graphs of heating of the balloon (Fig. 11), SG (Fig. 12), thruster (Fig. 13).

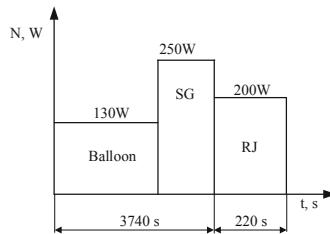

Fig. 10. Cyclogram of RJPS startup with maximum power balloon heater

The balloon will be heated to a set temperature of 308 K. Figure 11 shows the heating of the balloon with a heater at a power of 30 W – black line, 130 W – red line, and the blue line – 350 W.

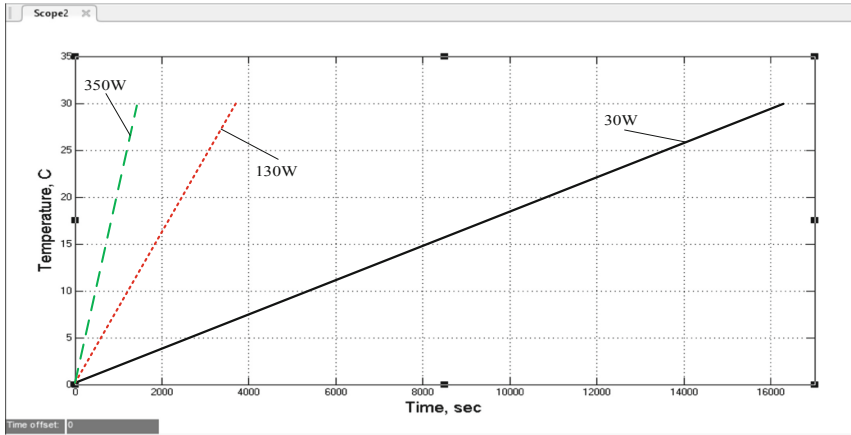

Fig. 11. Balloon heating

When the power supplied to the balloon heater increases, the time of the set temperature 308 K decreases. When all the energy provided by the PSS supplied to the balloon heater, the heating time is 1388 s.

The SG will be heated to the set temperature of 333 K. Figure 12 shows the heating of the SG by a heater at a power of 120 W – black line and heating 350 W – red line.

When the power supplied to the SG increases, the time of the set temperature 333 K decreases. When all the energy provided by the PSS is supplied to the SG, the heating time is 34 s.

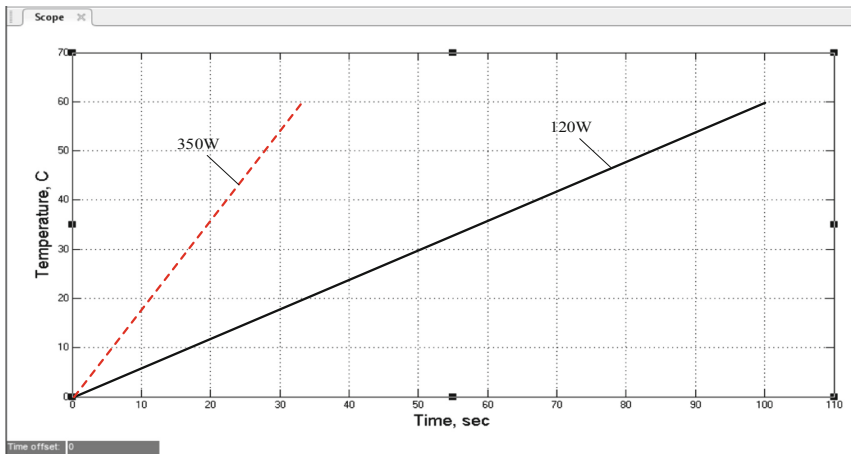

Fig. 12. SG heating.

The thruster will be heated to a set temperature of 1373 K. Figure 13 shows the heating of the thruster by the heater at a power of 200 W – black line, 150 W – green line and heating 350 W – red line.

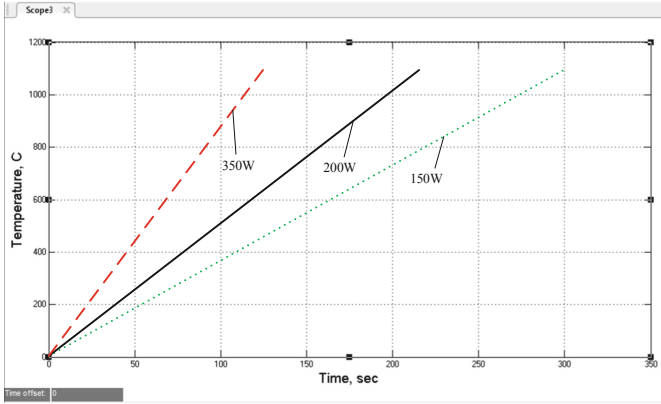

Fig. 13. Thruster heating.

When the power supplied to the thruster increases, the time of the set temperature 1373 K decreases. When all the energy provided by the PSS is supplied to the thruster, the warm-up time is 125 s.

According to the received schedules we will build the cyclogram with the minimum time of preparation of RJPS (Fig. 14). After all elements of RJPS are ready for start we pass to an mass flow rate operation mode.

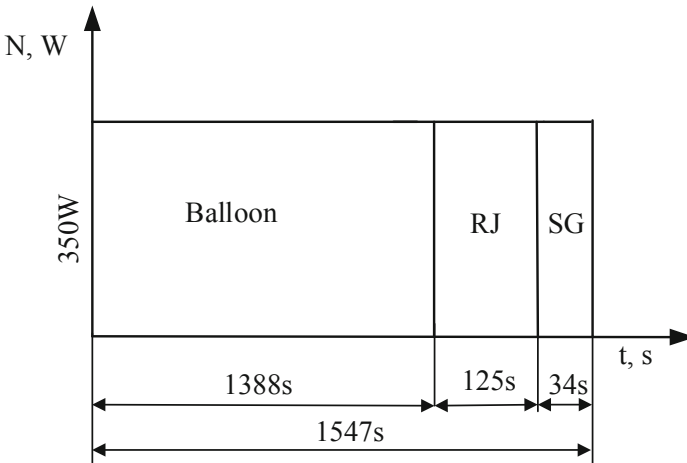

Fig. 14. Cyclogram of heating of each element of RJPS separately

After simulation, it was found that the time to prepare the RJPS for start-up was reduced from 16520 s to 1547 s, due to the fact that the total power provided by the PSS is supplied in the selected sequence by weight from heaviest to lightest.

In the flow mode, the power of the PSS is distributed as follows:

$$W_{PSS} = W_B + W_{SG} + W_{RJ} = 30 + 120 + 200 = 300W$$

The disadvantage of such heating may be that the power of the PSS is not enough to perform the heating of the elements of the RJPS with maximum power. This requires a preliminary calculation of the orbit, which will provide the PSS charging with SA.

Thus, the algorithm of the first start-up of RJPS with redistribution of power supply among RJPS elements is received. The algorithm takes into account the partial or complete failure of one or all heating elements. If all heaters fail, the RJPS switches to the gas jet thruster mode, i.e. the propellant is no longer divided into components, but flows down through the thruster nozzle. This increases the cost of the propellant, but the ST can continue to perform tasks in space.

According to the results of simulation in the ElectronicWorkBench environment of RJPS according to the task, cyclograms were obtained showing the compliance of the algorithm according to which the preparation for start can be realized in one orbit of the spacecraft from the available power of the power system. The simulation was performed according to the scheme shown in Fig. 15. In the process of modeling the algorithms of Figs. 9 and 11 were considered. The initial condition was that the chemical battery on the first orbit has zero capacity. Under such conditions, according to the first cycle, normal operation is possible only at the fourth orbit, and according to the second cycle, normal operation is possible from the second one, and at the first orbit the thruster consumption does not go beyond the normal range.

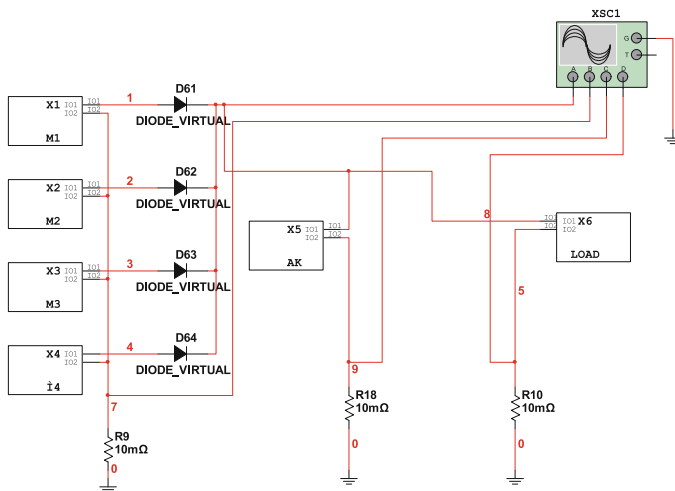

Fig. 15. Scheme for modeling RJPS, where X1–X4 units of the photovoltaic battery; X5 – chemical battery; X6 – EJPS; XSC1 four-beam oscilloscope.

According to the cyclogram of Fig. 9 the simulation results obtained shown in Fig. 16.

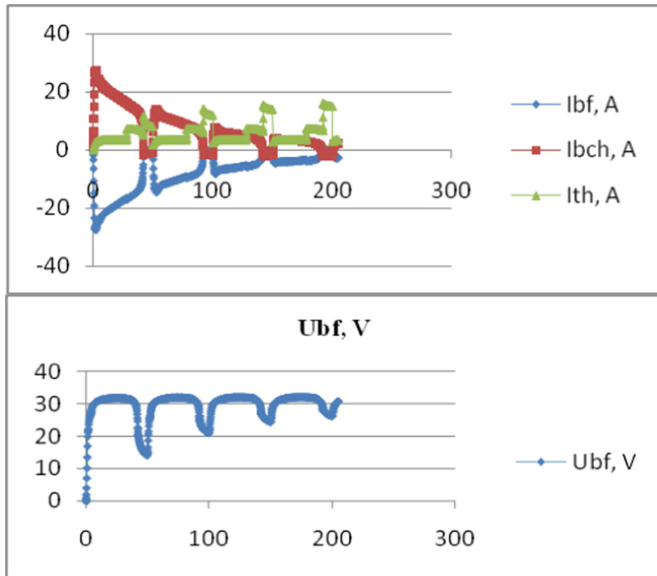

Fig. 16. The results of modeling the work of RJPS with step energy consumption

According to the cyclogram of Fig. 11 obtained the simulation results shown in Fig. 17.

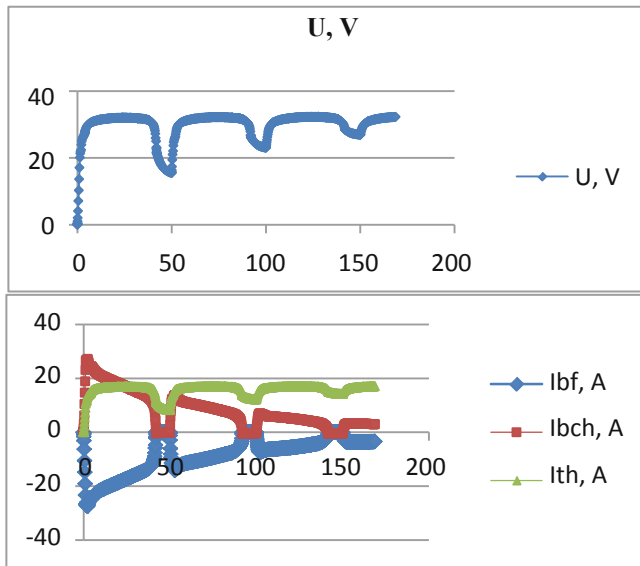

Fig. 17. The results of modeling the work of RJPS with constant energy consumption

3 Conclusion

Having conducted a study of the dynamic characteristics of RJPS, we can give the following recommendations for its use:

- in order to reduce the time of preparation of the RJPS for the first start, it is necessary to increase the requirements for EPS in the ST, namely it is necessary to increase the power provided to the RJPS over 350 W;
- in order to reduce the duration of preparation of the RJPS for the first start, it is further necessary to increase the capacity of the balloon, SG and thruster heaters;
- in order to increase the time of operation of the ST in orbit, it is necessary to increase the store of propellant;
- for the mode of complete or partial failure of the elements of the RJPS to develop and test separate algorithms of the RJPS operation in order to continue the task.

References

1. Ganswind, I.N.: Small spacecraft in earth remote sensing. *Explor. Earth Space* **5**, 82–88 (2019)
2. Blinov, V.N., et al.: Experimental studies of arcjet thruster in pulsed mode of operation for corrective propulsion systems of small spacecraft. *J. Phys.: Conf. Ser.* **1441**(1) (2020)
3. Zóltowski, A., Gis, W.: Ammonia emissions in SI engines fueled with LPG. *Energies* **14**, 691 (2021). <https://doi.org/10.3390/en14030691>
4. Komilov, M.: Study of the effect of optical layer thickness on the photoelectric parameters of silicon-based solar cells using Sentaurus TCAD. *Sci. Eur.* **72–1**, 52–54 (2021)
5. Dhinesh, V., Vijayakumar, G., Saravanan, S.: A photovoltaic modeling module with different converters for grid operations. *Int. J. Innov. Res. Technol.* **6**(8), 89–95 (2020)
6. Martzloff, F.D., Levinson, L.M.: Surge-protective devices. In: *Electronic Ceramics*, pp. 275–305. CRC Press (2020)
7. Oberhauser, R.: VR-UML: the unified modeling language in virtual reality – an immersive modeling experience. In: Shishkov, B. (ed.) *BMSD 2021. LNBIP*, vol. 422, pp. 40–58. Springer, Cham (2021). https://doi.org/10.1007/978-3-030-79976-2_3
8. Pohudin, A.V., Gubin, S.V., Sinchenko, S.V., Shulga, I.M., Pohudina, O.K.: A mathematical model of electric Ohmic propulsion system dynamics. In: *2020 IEEE 15th International Conference on Computer Sciences and Information Technologies (CSIT)*, vol. 1, pp. 1–4 (2020). <https://doi.org/10.1109/CSIT49958.2020.9322028>