

Lecture Notes in Networks and Systems 304

Svetlana Igorevna Ashmarina  
Valentina Vyacheslavovna Mantulenko *Editors*

# Digital Technologies in the New Socio-Economic Reality

 Springer

# Lecture Notes in Networks and Systems

Volume 304

## Series Editor

Janusz Kacprzyk, Systems Research Institute, Polish Academy of Sciences,  
Warsaw, Poland

## Advisory Editors

Fernando Gomide, Department of Computer Engineering and Automation—DCA,  
School of Electrical and Computer Engineering—FEEC, University of  
Campinas—UNICAMP, São Paulo, Brazil

Okyay Kaynak, Department of Electrical and Electronic Engineering,  
Bogazici University, Istanbul, Turkey

Derong Liu, Department of Electrical and Computer Engineering, University  
of Illinois at Chicago, Chicago, USA

Institute of Automation, Chinese Academy of Sciences, Beijing, China

Witold Pedrycz, Department of Electrical and Computer Engineering,  
University of Alberta, Alberta, Canada

Systems Research Institute, Polish Academy of Sciences, Warsaw, Poland

Marios M. Polycarpou, Department of Electrical and Computer Engineering,  
KIOS Research Center for Intelligent Systems and Networks, University of  
Cyprus, Nicosia, Cyprus

Imre J. Rudas, Óbuda University, Budapest, Hungary

Jun Wang, Department of Computer Science, City University of Hong Kong,  
Kowloon, Hong Kong

The series “Lecture Notes in Networks and Systems” publishes the latest developments in Networks and Systems—quickly, informally and with high quality. Original research reported in proceedings and post-proceedings represents the core of LNNS.

Volumes published in LNNS embrace all aspects and subfields of, as well as new challenges in, Networks and Systems.

The series contains proceedings and edited volumes in systems and networks, spanning the areas of Cyber-Physical Systems, Autonomous Systems, Sensor Networks, Control Systems, Energy Systems, Automotive Systems, Biological Systems, Vehicular Networking and Connected Vehicles, Aerospace Systems, Automation, Manufacturing, Smart Grids, Nonlinear Systems, Power Systems, Robotics, Social Systems, Economic Systems and other. Of particular value to both the contributors and the readership are the short publication timeframe and the worldwide distribution and exposure which enable both a wide and rapid dissemination of research output.

The series covers the theory, applications, and perspectives on the state of the art and future developments relevant to systems and networks, decision making, control, complex processes and related areas, as embedded in the fields of interdisciplinary and applied sciences, engineering, computer science, physics, economics, social, and life sciences, as well as the paradigms and methodologies behind them.

Indexed by SCOPUS, INSPEC, WTI Frankfurt eG, zbMATH, SCImago.

All books published in the series are submitted for consideration in Web of Science.

More information about this series at <http://www.springer.com/series/15179>

Svetlana Igorevna Ashmarina ·  
Valentina Vyacheslavovna Mantulenko  
Editors

# Digital Technologies in the New Socio-Economic Reality

 Springer

*Editors*

Svetlana Igorevna Ashmarina   
Department of Applied Management  
Samara State University of Economics  
Samara, Russia

Valentina Vyacheslavovna Mantulenko   
Department of Applied Management  
Samara State University of Economics  
Samara, Russia

ISSN 2367-3370

ISSN 2367-3389 (electronic)

Lecture Notes in Networks and Systems

ISBN 978-3-030-83174-5

ISBN 978-3-030-83175-2 (eBook)

<https://doi.org/10.1007/978-3-030-83175-2>

© The Editor(s) (if applicable) and The Author(s), under exclusive license to Springer Nature Switzerland AG 2022

This work is subject to copyright. All rights are solely and exclusively licensed by the Publisher, whether the whole or part of the material is concerned, specifically the rights of translation, reprinting, reuse of illustrations, recitation, broadcasting, reproduction on microfilms or in any other physical way, and transmission or information storage and retrieval, electronic adaptation, computer software, or by similar or dissimilar methodology now known or hereafter developed.

The use of general descriptive names, registered names, trademarks, service marks, etc. in this publication does not imply, even in the absence of a specific statement, that such names are exempt from the relevant protective laws and regulations and therefore free for general use.

The publisher, the authors and the editors are safe to assume that the advice and information in this book are believed to be true and accurate at the date of publication. Neither the publisher nor the authors or the editors give a warranty, expressed or implied, with respect to the material contained herein or for any errors or omissions that may have been made. The publisher remains neutral with regard to jurisdictional claims in published maps and institutional affiliations.

This Springer imprint is published by the registered company Springer Nature Switzerland AG  
The registered company address is: Gewerbestrasse 11, 6330 Cham, Switzerland

# Contents

|   |    |
|---|----|
| <b>Big Data Application in the Digital Economy: Legal, Technical and Economic Aspects</b>                     |    |
| <b>Issues on “Big Data” and Personal Data Correlation and Differentiation</b> .....                           | 3  |
| A. V. Azarkhin, S. V. Ivanova, and N. V. Romanova   |    |
| <b>The Use of Big Data in Digital Economy and Related Legal Aspects</b> .....                                 | 9  |
| S. V. Alekseev  |    |
| <b>Information in the Digital Economy as a Subject of Criminal Law Protection</b> .....                       | 15 |
| A. V. Beliakov and S. V. Bondarenko   |    |
| <b>Regulatory “Sandboxes” on Russian Market: Theoretical and Legal Aspect of Specialized Regulation</b> ..... | 21 |
| A. G. Bordakova   |    |
| <b>Current Issues of Training Economic Security Personnel for the Digital Economy</b> .....                   | 27 |
| Y. P. Grabozdin, O. V. Karsuntseva, and T. E. Tatarovskaya  |    |
| <b>Big Data in the Digital Economy: Prospects for Application and Legal Regulation</b> .....                  | 37 |
| E. K. Gubaydullina  |    |
| <b>Information Security as a Condition for Sustainable Development in the Global World</b> .....              | 43 |
| A. V. Guryanova, T. G. Stotskaya, and E. R. Khafiyatullina  |    |
| <b>Stream of Commerce Involving Big Data: Legal Aspects</b> .....   | 51 |
| N. V. Deltsova, N. A. Gorshkova, and L. A. Shcherbich   |    |
| <b>Digital Innovation in the Light of the Experimental Legal Regime</b> .....                                 | 59 |
| E. A. Efremova and E. S. Gordienko  |    |

|   |     |
|---|-----|
| <b>Big Data Applications in the Pharmaceutical Industry</b> .....   | 67  |
| A. M. Izmaylov, A. V. Evstratov, and E. Heidelberg  |     |
| <b>Personal Data Protection as a Basis of Digitalization</b> .....  | 73  |
| E. B. Kalashnikova  |     |
| <b>Legality of Sanctional Mechanisms Use in the Internet</b> .....  | 81  |
| N. N. Kovaleva, S. A. Kulikova, and D. A. Karev   |     |
| <b>«Big Data» in Labor Relations</b> .....  | 89  |
| M. K. Kot   |     |
| <b>Big Data Application in Information Support of Organization Management: Problems and Prospects</b> ..... | 95  |
| O. N. Potasheva   |     |
| <b>Lex Electronica and Lex Infomatica as Sources of Smart Contracts Legal Regulation</b> .....              | 103 |
| E. L. Simatova and A. V. Dashin   |     |
| <b>On Issues of Big Data Legal Policy Application in the Russian Federation</b> .....                       | 109 |
| E. N. Churakova   |     |
| <b>Legal Issues of Big Data Application in the Russian Federation</b> .....                                 | 115 |
| F. F. Spanagel  |     |
| <b>Legal Problems of Rights Tokenization to Individually Defined Objects in Russian Legislation</b> .....   | 123 |
| A. A. Lykov, D. E. Manelov, and D. S. Tokmakov  |     |
| <b>Data Generation and Exchange Platforms</b>   |     |
| <b>Features of Assessing the Organizations' Financial Activities Using Data Generated Under IFRS</b> .....  | 131 |
| O. S. Aksinina and M. A. Tyugin   |     |
| <b>Platform Employment: From Unsustainable to Sustainable Development</b> .....                             | 139 |
| V. N. Bobkov, M. V. Simonova, and E. A. Chernykh  |     |
| <b>Transformation of the Process of Public Goods Production in the Digital Paradigm</b> .....               | 149 |
| M. E. Konovalova, A. V. Kravchenko, and O. Y. Kuzmina   |     |
| <b>Development of a Harmonized Digital System for Cross-Border Cooperation in the EU</b> .....              | 157 |
| M. V. Kurnikova, B. I. Tóth, and I. V. Dodorina   |     |

|  |     |
|--|-----|
| <b>The Interaction of Participants in the Payment Systems in the Digital Environment</b> .....         | 167 |
| O. G. Savinov, N. G. Savinova, and E. O. Konstantinova   |     |
| <b>Factors of Digitalization Development on Gas Station Market Using Online Channels Example</b> ..... | 177 |
| M. A. Sadykov  |     |
| <b>Digital Educational Platforms: Advantages and Disadvantages</b> .....                               | 183 |
| E. P. Troshina, V. V. Dobrova, and M. P. Kozyreva  |     |
| <b>Platform Approach—The Future of Cross-Border Cooperation in the Digital Era</b> .....               | 189 |
| G. A. Khmeleva   |     |
| <b>Regulation Regime of Digital Exchange Platforms: Perspective Models</b> .....                       | 197 |
| E. Y. Komova   |     |
| <b>Natural and Artificial Intelligence Use in Applied Tasks of Digital Economy</b>                     |     |
| <b>Challenges in Identifying the Digital Economy Rising</b> .....                                      | 209 |
| S. P. Bortnikov  |     |
| <b>Digital Transformation of Business Processes in a Customer-Oriented Approach</b> .....              | 219 |
| O. N. Denisova, O. V. Musina, and Y. A. Tatarovsky   |     |
| <b>Innovative Management in Digitalization: Approaches and Trends of the Spatial Market</b> .....      | 229 |
| A. N. Evdokimov, A. A. Nikolaev, and Y. I. Lobacheva   |     |
| <b>Artificial Intelligence in the Context of Global Digitalization of Society</b> .....                | 237 |
| J. D. Ermakova   |     |
| <b>Financial Technology Sector in the Context of a New Digital Paradigm</b> .....                      | 245 |
| K. N. Ermolaev, K. L. Dragileva, and E. S. Nedorezova  |     |
| <b>Automation of Forming a Bond Financing Scheme in Optimizing the Capital Structure</b> .....         | 253 |
| E. V. Zhegalova, Y. V. Semernina, and K. A. Odinkova   |     |
| <b>Modern Warehouse Management Systems</b> .....   | 261 |
| N. P. Karpova  |     |
| <b>Marketing Support of Wholesale Trade Based on CRM System Implementation</b> .....                   | 269 |
| L. K. Kirillova  |     |



|  |     |
|--|-----|
| <b>Managers as Agents of Change: Ready for Uncertainty in Digital Transformation</b> .....                 | 277 |
| A. V. Kutuev and J. V. Sharikova   |     |
| <b>The Role of Digitalization in the Development of Russian Agribusiness Industry</b> .....                | 285 |
| A. B. Malina, N. N. Galenko, and E. P. Afanaseva   |     |
| <b>Artificial Intelligence Technologies in Tax Consulting and Forensic Tax Expertise</b> .....             | 291 |
| K. S. Pavlova and N. V. Knyazeva   |     |
| <b>Economic Sustainability of Modern Banking Organizations Based on Digital Technologies</b> .....         | 301 |
| O. V. Petryanina and E. V. Revina  |     |
| <b>Digital Technologies and Insurance Market in Russia</b> .....   | 313 |
| A. A. Prosvetova   |     |
| <b>Digital Development and Formation of Logistics Systems in Construction in Samara Region</b> .....       | 321 |
| A. R. Rakhmatullina, L. A. Sosunova, and Y. Zubtsova   |     |
| <b>AI Liability Issues in Russian and Foreign Law</b> .....  | 329 |
| S. V. Rastoropov, A. V. Sidorova, and D. S. Rastoropova  |     |
| <b>The Impact of Digitalization on Innovative Approaches to Economic Security in Regions</b> .....         | 337 |
| M. O. Suraeva, M. A. Afonasyev, and D. M. Kucheryavenko  |     |
| <b>Digital Sales as Factor for Improving Efficiency of Automotive Companies Financial Management</b> ..... | 345 |
| S. V. Tishkov, O. A. Naumova, and A. P. Shcherbak  |     |
| <b>Digital Transformation of Transport Logistics Under Current Conditions</b> .....                        | 355 |
| I. A. Toymentseva, V. D. Chichkina, and M. A. Shafieva   |     |
| <b>Digital Economy: Challenges and Development Risks</b> .....   | 363 |
| A. S. Fogel and S. V. Kliment'yeva   |     |
| <b>Informatization of the Tax System in Modern Conditions of Economic Development</b> .....                | 375 |
| V. S. Charikov and Y. V. Levashova   |     |
| <b>Application of Digital Technologies in Construction</b> .....   | 383 |
| A. V. Shepelev   |     |
| <b>Digital Innovations in Agribusiness Industry in the Russian Federation</b> .....                        | 389 |
| A. V. Shchutskaya  |     |

|   |     |
|---|-----|
| <b>Management Control System of Commercial Organizations in the Digital Economy</b> .....                   | 399 |
| V. A. Manyaeva  |     |
| <b>Digital Economy Impact on Contracts Conclusion for the Use of Internet Services</b> .....                | 405 |
| E. L. Sidorenko, K. K. Taran, and E. A. Artamonova  |     |
| <b>Modeling and Analysis of Infrastructure Projects</b>   |     |
| <b>Program-Targeted Approach to Digital Reengineering of Small Enterprises Business Processes</b> .....     | 413 |
| D. A. Akopyan   |     |
| <b>Digital Model for a Multidisciplinary Educational Base for Training a Multi-skilled Specialist</b> ..... | 423 |
| E. A. Alontseva, E. V. Cherkasova, and V. V. Kozlov   |     |
| <b>The Accounting System of the Company in the Context of Digitalization</b> .....                          | 435 |
| S. V. Andreeva  |     |
| <b>Modernization and Development of the Machine-Building Complex in the Digital Economy</b> .....           | 443 |
| A. B. Vishnyakova, A. V. Sultanova, and V. V. Voropaeva   |     |
| <b>Digital Twins as a Method of Risk Management Transformation</b> .....                                    | 451 |
| L. V. Ermolina, A. M. Zinovyev, and D. A. Melnikova   |     |
| <b>Foreign Direct Investments in Russia Under Digital Transformation Accelerated by Covid-19</b> .....      | 459 |
| N. I. Ivanova and P. A. Ivliev  |     |
| <b>Transformation of Tax Management in the Context of Digitalization</b> ...                                | 465 |
| T. A. Kulkova, V. O. Levchenko, and A. S. Makarov   |     |
| <b>Digital Technologies in the Thermal Power Complex of the Samara Region</b> .....                         | 471 |
| A. A. Larkina and A. A. Vizgalina   |     |
| <b>Application of Bool Variables in Analysis of Risks in the Bond Market</b> .....                          | 479 |
| S. I. Makarov and M. A. Boldyrev  |     |
| <b>Development of the Efficiency Improvement Criterion of the Forming Logistics System</b> .....            | 489 |
| A. V. Tebekin and A. V. Khoreva   |     |
| <b>Digital Marketing Transformation: Trends and Realities</b> .....   | 497 |
| E. N. Sheremetyeva, L. A. Gorshkova,<br>and N. V. Mitropolskaya-Rodionova                                   |     |

|  |     |
|--|-----|
| <b>Digital Technologies for Planning Marketing Tools for Managing Customer Loyalty</b> .....                                   | 505 |
| O. V. Yudakova   |     |
| <b>Comprehensive Assessment of Enterprise's Economic Security System in the Digital Economy Conditions</b> .....               | 513 |
| S. I. Sotskova and I. V. Kalashnikova  |     |
| <b>Intelligent Communications in the Digital Economy Aspects</b>   |     |
| <b>New Marketing Aspects in the Digital Economy</b> .....  | 523 |
| A. N. Agafonova, E. N. Novikova, and R. A. Shakirov  |     |
| <b>Development of Industrial Network Organization by Digitalizing Inter-Functional Interaction of Multi-team Members</b> ..... | 531 |
| E. V. Volkodavova and A. P. Zhabin   |     |
| <b>Customer Service in the Context of Digitalization of the Economy</b> .....  | 539 |
| Y. O. Gorokhovitskaya, E. A. Bratukhina, and Y. A. Kolesova  |     |
| <b>Smart Communications in the Context of Modern Digital Economy</b> .....   | 549 |
| A. E. Makhovikov, V. A. Tikhonov, and A. S. Anipchenko   |     |
| <b>The Effect of Digital Intelligence on the Change in the Corporate Culture</b> .....   | 557 |
| L. V. Polynova, E. S. Popova, and A. R. Potapova   |     |
| <b>Digital Cooperation Between the Tax Service and Taxpayers</b> .....   | 565 |
| N. Sakhchinskaya, I. Svetkina, and M. Selyukov   |     |
| <b>Digital Marketing in the Post-pandemic World</b> .....  | 575 |
| I. V. Yakhneeva, A. V. Pavlova, and N. V. Kalenskaya   |     |
| <b>Trends in Information and Communication Technologies Development in Context of Economy Digitalization</b> .....             | 583 |
| A. V. Volkodaeva, A. V. Balanovskaya, and E. A. Rustenova  |     |
| <b>Digital Strategies for Sustainable Development of Socio-Economic Systems</b>  |     |
| <b>Statistical Study of Interregional Variations in the Society's Informatization</b> .....                                    | 595 |
| O. V. Bakanach and A. A. Kudryashov  |     |
| <b>Strategic Support for Modelling Transport Infrastructure Projects</b> .....   | 603 |
| E. V. Bolgova, S. A. Bolgov, and E. V. Lisyukova   |     |
| <b>Economy Digitalization of Russia: Non-state Pension Funds and Their Social Orientation</b> .....                            | 613 |
| M. E. Valishina and E. N. Valishin   |     |

|  |     |
|--|-----|
| <b>Digital Transformation of the Country's Economic Space:<br/>Innovation in Economics and Trends</b> .....          | 621 |
| E. E. Dozhdeva, P. S. Franchyzenko, and N. N. Nikolashina  |     |
| <b>Theoretical Aspects and Practical Tools of Smart City Concept<br/>Implementation</b> .....                        | 629 |
| L. V. Ivanenko, A. S. Zotova, and A. A. Chudaeva   |     |
| <b>Civil Law Ways to Protect Digital Rights</b> .....  | 637 |
| T. N. Kazankova, D. E. Marchenko, and E. V. Glebova  |     |
| <b>Digitalization of Legal Proceedings as a Way to Save Budget Funds</b> ....  | 645 |
| T. A. Kalenteva and A. P. Bozhko   |     |
| <b>Assessment of the Human Capital Value in the Digital<br/>Transformation Context</b> .....                         | 655 |
| O. Yu. Kogut   |     |
| <b>Digital Marketing Opportunities at the Stage of Socio-Economic<br/>Development of the Company</b> .....           | 663 |
| G. A. Korzhova   |     |
| <b>The Transformation of Scandinavian Experience in Russian<br/>Digitalization Strategy</b> .....                    | 669 |
| M. V. Kurganova  |     |
| <b>Digitalization of the Society: Legal and Ethical Features</b> .....   | 681 |
| P. P. Lang   |     |
| <b>Theoretical Foundations for Development of Digital Strategy<br/>for Enterprise' Sustainable Development</b> ..... | 691 |
| E. M. Pimenova   |     |
| <b>Digitization and the Population Quality of Life: Statistical<br/>Perspective</b> .....                            | 699 |
| N. V. Proskurina, Yu. I. Davidyan, and M. A. Zorina  |     |
| <b>Transforming the State Role in the Globalization and Digitalization<br/>Context</b> .....                         | 707 |
| S. N. Revina   |     |
| <b>Digital Solutions in the Strategy of Physical Culture and Sports<br/>Development</b> .....                        | 715 |
| O. G. Savchenko, A. V. Filatova, and M. Vochozka   |     |
| <b>Vector of Digital Transformation of Economic Processes</b> .....  | 721 |
| E. S. Smolina, I. A. Tishchenko, and Z. V. Mkrtychan   |     |
| <b>Digitalization as the Main Development Condition of the Samara<br/>Region</b> .....                               | 727 |
| O. V. Trubetskaya  |     |

|  |     |
|--|-----|
| <b>To the Question of Digital Transformation of Local Government Bodies</b> .....                        | 733 |
| A. G. Khabibullin, V. K. Barchukov, and A. A. Petrogradskaya   |     |
| <b>Strategy for Public Finance Development Under the Digital Transformation of Russian Economy</b> ..... | 739 |
| L. N. Mulendeeva   |     |
| <b>Stock Market in the Context of the Digital Economy: Foreign Policy Aspect</b> .....                   | 745 |
| E. N. Valieva, O. I. Vasilchuck, and E. I. Gnatishina  |     |
| <b>Digital Economy and State Financial Control</b> .....   | 753 |
| A. G. Lukin, N. Y. Gorelova, and T. B. Zavodchikova  |     |
| <b>Digital Formats and New Requirements of Professional and Business Education</b>                       |     |
| <b>Digital Education Can Help Decrease Labor Market Imbalance</b> .....                                  | 763 |
| G. N. Alexandrova, A. V. Gagarinskii, and G. P. Gagarinskaia   |     |
| <b>Digital Transformation of Vocational Education: Challenges of Modern Society</b> .....                | 773 |
| A. N. Anisimova and Yu. I. Efremova  |     |
| <b>Critical Thinking in Professional Education: Digital Options for Teachers and Learners</b> .....      | 783 |
| O. V. Belyakova, N. A. Pyrkina, and E. S. Chuikova   |     |
| <b>New Requirements Format for Higher Economic Education in the Era of Digitalization</b> .....          | 793 |
| T. A. Bityukova  |     |
| <b>How Digital Technologies Are Changing Business Education</b> .....                                    | 801 |
| S. A. Gryaznov   |     |
| <b>New Analysis Learningmetry: Effectiveness E-Learning Measuring</b> ....                               | 809 |
| N. A. Zaychikova   |     |
| <b>Development of Digital Corporate Personnel Training: Current Trends and Prospects</b> .....           | 821 |
| L. A. Ilyukhina, I. V. Bogatyreva, and N. N. Gunko   |     |
| <b>The Role of Digitalization in Future Translators' Professional Training</b> .....                     | 833 |
| A. M. Klyushina, L. Yu. Stoykovich, and G. V. Stoykovich   |     |
| <b>Competencies of the Future: Transforming Education in the Digital Economy</b> .....                   | 839 |
| N. V. Kozhukhova, I. A. Agaphonov, and Y. Y. Korobkova   |     |

|   |     |
|---|-----|
| <b>Digital Transformation of Legal Education: Problems of Developing Competencies</b> .....         | 849 |
| A. P. Korobova, N. A. Volkova, and O. V. Rastoropova  |     |
| <b>Digital Format of Professional and Business Education: Foreign Language Course Changes</b> ..... | 859 |
| A. L. Kuregyan, A. P. Kuzmina, and E. A. Pertsevaya   |     |
| <b>Digital Competence of Urban and Rural Residents (Generational Aspect)</b> .....                  | 867 |
| L. G. Lebedeva  |     |
| <b>Digital Formats, New Requirements in the Field of Professional and Business Education</b> .....  | 875 |
| E. A. Bogomolova, Yu. S. Ovchinnikova, and I. V. Nikolaeva  |     |
| <b>Digital Education at University: The Process of Adjustment Under Turbulence</b> .....            | 883 |
| E. G. Repina  |     |
| <b>Problems of the Digital Learning Formation in a Distance Format</b> .....                        | 889 |
| S. A. Sevastyanova  |     |
| <b>Digital Transformation of Russian Vocational Education Based on a Systematic Approach</b> .....  | 899 |
| R. R. Khasnutdinov and O. A. Vladimirova  |     |
| <b>Methods of Machine Learning</b> .....  | 907 |
| S. A. Chevereva   |     |
| <b>Application of Kaizen System in HR Management</b> .....  | 915 |
| A. B. Shtrikov, E. V. Zemlyanaya, and D. B. Shtrikova   |     |
| <b>Digital Education: Pros and Cons (Instrumental and Axiological Aspects)</b> .....                | 923 |
| V. V. Mantulenko  |     |

# **Big Data Application in the Digital Economy: Legal, Technical and Economic Aspects**

# Issues on “Big Data” and Personal Data Correlation and Differentiation



A. V. Azarkhin, S. V. Ivanova, and N. V. Romanova

**Abstract** The Internet has become essential and unavoidable in modern times. The life of a modern person has moved into online space. Most things we can do online, not leaving our homes, are done on and over the Internet. In this regard, systems began to appear that analyze data about everything, about purchases made, about queries in search engines, about the route of movement, etc. As a result, a weighty array of information and a system that analyzes it appeared. In this paper, the authors tried to answer the question: what Big Data”, where is this system used more often, and what are the problems of its further development. In addition, this paper analyzes the relationship between Big Data and personal data. Also, the authors studied the problems of legal regulation of the ratio of Big Data and personal data. The ways of solving the indicated problems are proposed.

**Keywords** Big Data · Data Protection · Digitalization · Information · Internet · Personal Data

## 1 Introduction

Due to the fact that information technologies constantly progress and develop, they have significantly and seriously changed our life (privacy and personal space). Those actions that we implemented only in real time and space (physically) have slipped online. Those are shopping, communication, even work relationships, etc. Interaction with government agencies, all kinds of requests to government agencies have also moved to the online field. Thus, it can be noted that the Internet is quite firmly entrenched in our daily life, electronic purchases are developed, etc. The need for digitalization of legal relations is beyond doubt and is dictated by the development

---

A. V. Azarkhin (✉) · S. V. Ivanova  
Samara State University of Economics, Samara, Russia

N. V. Romanova  
Samara Law University of the Federal Penitentiary Service of Russia, Samara, Russia



of public relations. This process cannot be stopped, and it would be at least unreasonable to restrain it. All this allows us to conclude that any human activity does not go unnoticed. In this connection, a huge array of digital information is formed. As a result, an industry that supports data analysis has developed rapidly. All of the indicated trends predetermine the presence of certain requirements for data processing technologies, as well as the extraction of certain profits from this data. This became possible with the advent of new technologies, which are called Big Data. The issues of using information technologies are important for any state since they imply the competitiveness of countries on the world arena. One of these advanced technologies is Big Data, which can perform many functions (payment, goods, methods) in various spheres of life.

## 2 Methodology

In this study, the authors used the following methods:

1. Analysis. This is a general logical method. Analysis is the study of an object by its components. The article analyzes the concept of Big Data, as well as the relationship between the concept of Big Data and personal data.

2. Generalization. This method was used in the process of summarizing the analysis. The authors summarized the information received and made conclusions.

The aforementioned methods are the general logical ones. It can be noted that one of the methods assumes the use of the second method. This is explained by the fact that after analyzing the concept of Big Data, the results of the analysis were summarized and final conclusions were drawn. Therefore, these methods are not mutually exclusive, but complementary.

## 3 Results

The legislation of our country does not define the concept of Big Data. If we take the fact that large amounts of data are processed as a basis then we can say that Big Data is structured and unstructured information coming from a variety of sources. Moreover, such volumes of incoming information cannot be processed manually in reasonable time. Big Data also plays an important role in medicine. Thus, recent studies indicate that over 30% of all information stored on the planet is medical data, and it is expected that in the future this amount will increase because new data get created and those that are already available are digitized [7].

Big Data technology allows to analyze the solvency of a person who wants to get a loan or a person who provides collateral for a loan in the banking sector. In the United States (US), there are so-called Data Brokers. They collect information about US citizens from social networks, data on transactions and loans, information received from partners, etc. Based on the information they receive, they systematize

citizens and divide them into creditworthy, non-paying, who do not have a permanent source of income, etc. Such data becomes available after the person gives his consent to the credit institution. In comparison, for example, with our country, the information that is provided from the credit bureaus does not make it possible to conduct such a detailed analysis and draw conclusions regarding a person’s solvency, but only about how the loan was paid and whether the loan was approved or denied for some reason [2]. A fairly common area of Big Data use is the field of insurance. Insurance companies analyze probable cases when an insured event is possible to assess the insurance risks assumed and determine the amount of insurance cost that will be most appropriate. In the United Kingdom (UK), for example, wireless modules that are placed in a car are widespread, and drivers purchase car insurance, and its cost is determined by the age, gender or date of the last accident, the time and route of the trips made [4].

At the same time, the indicated phenomenon (Big Data) must be regulated by law, since, among other things, the indicated is necessary to establish the ratio of Big Data and personal data. Let us dwell on this ratio in more detail. Personal data is information associated with a person’s personality, and is private in nature. And, unlike Big Data, personal data has a clear legal definition established by law and widely used.

Personal data is any information that either directly or indirectly concerns and allows to identify individual [3]. Nevertheless, the legislation establishes the need to protect personal data, determines the storage procedure, the procedure for transferring personal data to third parties. For a long time, data protection regulations have been viewed as “technical” by lawyers, politicians and academics [8]. However, it is important to always keep in mind that the practical realization of rights must be based on respect for privacy as a fundamental right. This awareness is critical to ensure “live” data protection. In the legislation of the EU countries there are general provisions on data protection (the so-called GDPR), which contains the terms “personal data”, “processing”, “data subject”, “controller” and “processor” [1].

What are the types of data that are considered personal?

- unique identifiers of a person, in particular: name, surname;
- an image of a citizen (photographs, videos), which represent a kind of information about the person himself or about his private life;
- passport number, social security number and other numbers;
- special personal information that is confidential, for example, information about health, about children, about social security, geolocation data, etc.;
- personal information about the person, such as information about the interests of a person.

It is necessary to note another way Big Data can be used, that is digital diplomacy. Digital diplomacy is a government mechanism for influencing the audience using social networks and other Internet resources.

Digital diplomacy is now a global trend. Currently, there are a lot of official account profiles (accounts) on social networks and more are actively signed up, digital media

broadcasting channels are launched. All this is an integral part of public diplomacy of all developed countries.

However, an interesting question is what has become more important, diplomacy and the data obtained with its help, or the data itself, the results of the analysis of which are obtained through diplomacy.

The concept of “scientific diplomacy” consists of three components:

- science in diplomacy (experts take part in the diplomatic process, help identify and solve urgent problems of world politics);
- science for diplomacy (interaction is a tool to establish and develop relations between countries);
- diplomacy for the sake of science (diplomats interact to implement joint scientific projects).

The question then arises whether it is possible to apply scientific diplomacy to the concept of Big Data diplomacy.

In order to understand this issue, it is necessary to replace “science” with “data”. Then you get the following components:

- data for diplomacy (data experts from different countries interact with each other in order to create platforms for interaction between states);
- diplomacy for the sake of data (work to obtain, promote and use in practice the results of Big Data analysis).

The main method of data diplomacy is the collection and analysis of Big Data from social networks, blogs, and other Internet resources. Its main functions:

- increasing the efficiency of digital diplomacy projects (thanks to the analysis of Big Data of social networks, it is possible to determine the psychological portrait of your target audience, find out its needs and problems, create so-called ideal messages in order to attract foreign users);
- the use of data for the use of information confrontation on the Internet;
- implementation of cooperation, namely, the exchange of the results of the analysis of Big Data between states. This helps countries to interact in various fields;
- simplification of the diplomatic and consular service (the results of the analysis of Big Data and the use of programs for reading it (chat bots) contribute to the automatic processing of requests that come to diplomatic missions, as well as facilitate the negotiation process and the procedure related to making foreign policy decisions [8].

There are obvious and certain problems in using digital diplomacy. These include, for example, information attacks; high activity of “trolls”, hackers; inability to work with Big Data; the need for professional training of future diplomats in the basics of working with Big Data; lack of interest of young specialists in the development of this issue. Despite the presence of these problematic issues, one can positively assess the future of data diplomacy and talk about the undoubted benefits for the development of both foreign policy and the entire system of international relations. The next area of Big Data use is personal data.

## 4 Discussion

Quite often in the literature there are statements that Big Data and personal data cannot be clearly distinguished. There is no such line that clears the ambiguity of these terms. In the stream that comes from various social sources of information, of course, there is also personal information (personal data). Regarding Big Data, we are talking about the creation of data that is generated by technical sources. And personal data freely flow into these flows and become their components. It is a fact that personal data exists as part of Big Data so large number of questions arise that do not arise in regard of the formation of Big Data. And those problems that require legislative regulation in this area are the problems of personal data. It is necessary to analyze issues and contradictions that arise when comparing Big Data and personal data. The first problem is that Big Data is not limited in the processing of personal data and is subject to specific purposes.

The purposes for determining and processing data are specific. Therefore, herein, the principle of certainty is fundamental. A person can share his personal data solely to achieve specific goals. Big Data, on the other hand, involves the reuse of the collected information. In this connection, there is a contradiction between Big Data and personal data. The legislation of our country prohibits combining various databases and processing and using personal data other than for the purposes for which this personal data was collected. However, Big Data technologies conflict with the specified legislative requirements.

The second problem is the fact that Big Data is incompatible with the fact that a person gives specific and conscious consent to invoke personal data processing. The most precise legal regulation of personal data supposedly should run as follows: the subject independently decides if his personal data is processed. In addition, he is aware of all the risks and consequences that arise along [5]. Therefore, a subject's consent to the processing of personal data is precisely the legitimizing basis that allows them to be processed. But, in order to define such consent as a specific and conscious permission, it is necessary that the person has detailed information about the ways of using his personal data. However, in the era of Big Data, it is impossible to provide an exhaustive and specific list of goals in advance. In addition, it is impossible to register all cases in the privacy policy, since such documents will finally turn into something that is poorly perceptible, since they will contain a fairly large amount of information.

The third problem of the analyzed ratio is the lack of anonymity guarantee in the era of Big Data. The process of anonymization of personal data is one of the measures aimed at minimizing the risks of harm to citizens in the event that personal data somehow becomes known to a wide range of people. Requirements and methods of depersonalization are approved by the Roskomnadzor decree [6]. At the same time, in the era of Big Data, when personal identification is possible by establishing interaction between several pieces of data, the need for depersonalization, as well as its positive result, can be and will be questioned.

## 5 Conclusion

Big Data technologies provide great benefits in various areas: new business models appear; the health care system improves, etc. However, this technology is not devoid of negative aspects. This technology has significant potential to invade a person's privacy. In this work, conflicts between Big Data and personal data have been demonstrated. In connection with the analysis, it was found that the current legislation of our country on personal data is not adequate and does not account for the changes that happen in the world of technology and digitalization. It is important to rethink all the basic legal categories and concepts that govern issues related to personal data. However, despite the identified problems, the correct understanding of the digital economy and the inherent digitalization would be to consider it an inevitable process that all countries will go through. It is also important to mind that the position of each country will be determined by how quickly it will react to new trends.

## References

1. Edwards, L.: Data protection: Enter the general data protection regulation. Law, Policy and the Internet, Oxford. <https://ssrn.com/abstract=3182454>. Accessed: 21.02.2021 (2018)
2. Federal Law "On Credit Histories" dated 30.12.2004 № 218-FZ (as amended on 28.06.2014). [http://www.consultant.ru/document/cons\\_doc\\_LAW\\_51043/](http://www.consultant.ru/document/cons_doc_LAW_51043/). Accessed: 21.02.2021 (2014)
3. Federal Law "On Personal Data" dated 27.07.2006 No. 152-FZ (as amended on December 30, 2020). [http://www.consultant.ru/document/cons\\_doc\\_LAW\\_61801/](http://www.consultant.ru/document/cons_doc_LAW_61801/). Accessed: 21.02.2021 (2020)
4. Lyskey, O.: The «Europeanisation» of data protection law. Cambridge Yearb. Eur. Legal Stud. **19**, 252–286 (2017)
5. Mayer-Schoenberger, V., Kukier, K.: Big Data. A revolution that will change the way we live, work and think. Mann, Ivanov and Ferber, Moscow (2014)
6. Roskomnadzor decree «On approval of requirements and methods for anonymization of personal data» (together with «Requirements and methods for anonymization of personal data processed in personal data information systems, including those created and functioning as part of the implementation of federal target programs») (Registered in the Ministry of Justice of Russia 10.09.2013 No. 29935) dated 05.09.2013 № 996. [http://www.consultant.ru/document/cons\\_doc\\_LAW\\_151882/](http://www.consultant.ru/document/cons_doc_LAW_151882/). Accessed: 21.02.2021 (2013)
7. Spagnuolo, D., Lenzini, G.: Transparent medical data systems. J. Med. Syst. **41**, 8 (2017). <https://doi.org/10.1007/s10916-016-0653-8>
8. van Loon, R.: How does Big Data change diplomacy? <https://www.sodd16.com/how-does-big-data-change-diplomacy-ronald-van-loon>. Accessed: 25.03.2021 (2016)

# The Use of Big Data in Digital Economy and Related Legal Aspects



S. V. Alekseev

**Abstract** This article examines a new type of crime that was not widely known previously—criminal attacks on Big Data in the digital economy. A definition of the concept of cybercrime is also proposed in the paper. The article examines global criminal law practices of fighting crimes related to the use of Big Data in the digital economy, studied by the author. Typically, such crimes are committed by groups. The main types of criminal activity in the field of IT concern the application and use of Big Data in the digital economy are considered in the study. Detailed statistical data on the considered crimes committed in Russia in the IT sphere are provided. The article examines the features of cybercrimes in Russia and substantiates the need for legislative expansion Chap. 28 of the Criminal Code of the Russian Federation, which punishment for digital crimes by introducing new norms into it that regulate liability for group crimes in the application and use of Big Data in the digital economy.

**Keywords** Cybercrimes · Digital data · Digital economy · Digitalization · High technologies · Legal regulation

## 1 Introduction

The assimilation and development of broad opportunities for the practical application of Big Data processing technologies by world analysts are assessed throughout the study. And while some experts believe that Big Data is the greatest achievement of human civilization, other scientists and analysts attribute it to one of the most serious problems of our day. Undoubtedly, the use of Big Data technologies creates opportunities for modern business to offer the consumer audience practical and effective solutions based on individual preferences, interests and expectations of buyers.

The development of Big Data serves to create serious aggravation of the competitive situation in international and regional sales markets, while such basic principles of a democratic society as equality of citizens, privacy and freedom of personal life

---

S. V. Alekseev (✉)  
Samara State University of Economics, Samara, Russia

were under threat. The rapid development and improvement of the capabilities of the digital economy, the relatively low cost of introducing the latest information and communication technologies has led to a serious lag of regulatory and legal regulation from the current market situation.

The use of Big Data in the digital economy, global informatization and digitalization, along with undoubted advantages, have given rise to several legal issues. Among others, there is a new type of crime—digital economy one committed in the field of high technologies. The peculiarity of this new type of crime is that information becomes the object of criminal interest. Computer systems, in the process of committing such type of crime, serve as a means for committing a crime. The victims of such crimes can be not only individuals, but also entities. It seems necessary to formulate a definition of cybercrime as a new, modern type of crime.

## 2 Methodology

The study of criminal activity in the media space, through the use of automated systems and computer networks, as well as other sources of access to Big Data. Main types of criminal encroachments that occur in the process of using Big Data in the digital economy are as follows:

- the spread of viruses and malware;
- obtaining access by illegal means to confidential data (bank accounts, credentials of electronic wallets, various control information used by bank employees to verify a person);
- buying goods and receiving services in online stores that do not exist in the real world;
- distribution of compromising information, including false information, on order;
- stealing passwords from sources of financial resources and information and from databases that contain Big Data of the digital segment of the economy;
- collecting money for the construction of fictional objects;
- collecting money for the deliberately non-existent treatment of animals, children;
- advertising and sale of prohibited substances;

The considered type of crime is committed using Big Data in the digital economy and is often carried out in a group way. It seems that it is the systemic nature that distinguishes such an organized criminal group, which specializes in crimes of the economic segment [1]. Since, given the specificity of this type of crime, distribution of criminal roles depending on education, the availability of specific skills, abilities and experience of cybercriminals. In accordance with part three of Article 272 of The Criminal Code of the Russian Federation [11], persons guilty of committing cybercrimes are subject to criminal prosecution. Punishment is provided not only for offenders who commit criminal acts alone, but also for organized criminal groups and groups of persons preparing to commit or have already committed crimes in cyberspace, with direct intent and prior conspiracy. Depending on the danger to

society, the damage caused, the presence of aggravating or mitigating circumstances, cybercriminals can be sentenced by the court to serve a real prison sentence. As more lenient types of punishment for offenses committed in the digital space, the legislator fixes a monetary fine and correctional labor [5].

### 3 Results

The current criminal legislation of Russia also contains other norms focused on regulation and control over:

- development, distribution (including commercial) and independent use of potentially dangerous and dangerous computer programs designed for illegal seizure of users' personal data, remote control of computers, tracking the actions of individuals and legal entities, etc.
- compliance by users of computer information (government agencies, legal entities, citizens, etc.) with the rules for collecting, processing, storing, using and transferring large amounts of data, including through digital communication channels [6].

Timely detection and investigation of crimes committed in cyberspace are today considered by the Government of the Russian Federation as one of the main urgent. Legislation in force in our country is not able to effectively and efficiently regulate the relations arising within the digital economy. To make changes and bring the regulatory framework in accordance with the realities of modern times, it makes sense to adopt the most successful and effective provisions of the criminal law practice of Western countries [5]. To achieve a criminal result, specific means are used: malicious programs (viruses, Trojans, rootkits, remote administration tools) that allow covert or explicit theft of large amounts of data. Obviously, digital information should be considered as the object of such crimes, while the instrument for committing cybercrime is a computer, malware, etc.

The issues of legal regulation of civil relations arising in the virtual space have been given the closest attention in the United States over the past fifty years [2]. The first law providing for the prosecution of individuals guilty of fraudulent activities, abuse of trust and abuse of office, implemented using computers, was adopted in 1986. Subsequently, this normative act formed the basis of American legislation, devoted, among other things, to the legal regulation of issues related to theft and misuse of Big Data [3]. The provisions of the eighteenth section of the US Code 1926 establish criminal liability and punishment for offenders who, through the use of fraudulent schemes, gain access to digital systems in order to obtain real property benefits from their actions [12]. It is also mandatory that the cybercriminal has a direct intent to commit fraudulent actions in order to steal digital information. Hacking and theft of information databases can also be carried out by offenders with the aim of subsequently obtaining a ransom, blackmail or any other financial reward [7]. An analysis of the US legislative framework also showed that the American



legislator quite clearly and unambiguously distinguishes between traditional forms and methods of committing fraudulent actions and illegal actions that are committed with the aim of stealing large amounts of data, illegal acquisition of digital information for financial gain. It is noteworthy that the intentional non-payment for services that were provided to Internet users through modern computer communications are considered by the US Code 1926 as property crimes committed in the information space.

The extraction of property benefits through the illegal use of Big Data of the digital economy is punishable by the criminal law of Japan. In accordance with Art. 247-II of the Penal code Act No. 45 of 1907, persons guilty of committing such criminal acts are subject to criminal prosecution and punishment. In this country, serious attention is paid to the issues of inviolability of private property and privacy. For this reason, the Japanese legislator establishes criminal liability and punishment for penetrating personal computers and other devices for the purpose of damaging, stealing or any other illegal use of digital information of citizens. Cybercriminals accused of committing these offenses are obliged to compensate the owners of damaged or stolen digital information [8]. For more effective and high-quality legal regulation of relations arising between users of digital information, a separate law was developed and adopted in Japan, which regulates situations related to unauthorized entry of intruders into computers and computer networks of citizens and commercial companies. This regulation has been in effect in the country since 2000. Such an integrated approach would be worth applying in the Russian segment of crimes aimed at a large amount of data from the digital economy [6].

Internet espionage directed at large amounts of digital economy data by an organized group is also punishable under Swiss criminal law. In accordance with the provisions of Article 143 of the Swiss Criminal Code, persons who use digital information that does not belong to them for the purpose of personal enrichment, or, acting in the financial interests of third parties, commit offenses aimed at covert or explicit theft, modification and transfer of large amounts of data, are involved in criminal proceedings responsibility. Cybercriminals in Switzerland are punished with a heavy fine or actual detention [10].

In Israeli Penal Law 5737-1977, it is a criminal offense to act for the purpose of obtaining one's own benefit through incorrect, incomplete or unauthorized use of a large amount of electronic data, if such actions entailed an unauthorized transfer of the owner's financial assets to other persons [9].

The regulation of criminal acts aimed at theft or damage to the property of third parties on the territory of the PRC is carried out in accordance with the provisions of Article 265 of the country's Criminal Code [4]. The rule of this article prescribes punishment for illegal connection to telecommunications of another person. Theft of addresses, numbers used in personal digital devices to gain access to digital data of an economic nature is also subject to punishment.

Thus, the studied criminal legislation of foreign states in the field of legal regulation of cybercrimes shows that states are interested in fighting criminal attacks against a large amount of data in the digital economy. They are actively taking measures to

fight them. Meanwhile, it is obvious that it is possible to reduce cyber attacks not only through of criminal law.

Summarizing the studied material, it is possible to conclude that international criminal law provisions providing for liability for cybercrimes effectively suppress illegal norms we have considered are fragmentary, which in turn significantly complicates the process of bringing to justice the persons guilty of committing cybercrimes [7]. It is impossible not to note the inconsistency of legal norms that exist today in a number of Western countries. Moreover, legislators in some countries tend to equate cybercrime with international information terrorism, which also complicates the process of investigating crimes committed in the digital space, due to the global nature of the issue.

## 4 Discussion

However most states admit that in order to successfully fight crimes of unauthorized access to digital data of the economic segment, continuous improvement of both criminal law and general legislation is required. This also applies to Russia. End of 2016, 2698 cases were officially opened in our country to consider crimes in the digital space. In 2017, this number dropped to 1883 criminal cases. It is noteworthy that Russian investigators and interrogators very rarely qualify cybercrimes like Article 274 of the Criminal Code of the Russian Federation. In 2017, only two cases were initiated under this article, in 2018—one. The number of offenses qualified in accordance with the provisions of Art. 273 of The Criminal Code of the Russian Federation, on the contrary, increased to 802 in 2019 compared to 693 cases in 2018 [11]. Apparently, the decrease in cybercrimes compared to 2017 application security systems, software, and operating systems. This makes it difficult for cybercriminals to access large amounts of digital information. To reduce the number of cybercrimes one must eliminate the existing gap that forms in legislation due to the rapid aimed at the illegal acquisition of digital information. Therefore, legal regulation of this area should not stand still.

## 5 Conclusion

Chapter 28 of the Criminal Code of the Russian Federation must be edited by applying new independent norms in concern of liability for digital crimes in the digital economy. At the same time, it seems timely to introduce a concept of “digital economy data” the Criminal Code of the Russian Federation. Russian criminal legislation should include a rule of responsibility even for a seemingly innocuous offer of services of breaking into various databases of confidential information, regardless of what media these databases may be on. After analyzing the essence of crimes related to the illegal use of Big Data in the digital segment of the economy, the author comes

to the conclusion that it is necessary to isolate a separate category of crimes related to the digital economy. The wide spread of this type of criminal encroachment has led to the fact that crimes related to the use of Big Data in the digital economy occupy separate places in the reporting of law enforcement agencies. The considered type of encroachment, it can be assumed, was integrated into the digital segment of the economy. And as a result-the loss of personal data, their sale, misuse of the secrecy of deposits. Especially in the deep layers of the Internet, there is data that has a special legal regime. It is necessary to ensure higher responsibility for group crimes, to ensure the strengthening and stability of the information structure that already exists in the country, to implement intelligent and, most importantly, safe methods of searching and obtaining significant information, to modernize the methods of operational-search measures and investigative actions.

## References

1. Alekseev, S.V.: Formation of group crime in the economic segment in the 40s of the XX century. *J. Altai Acad. Econ. Law* **1**, 102–107 (2021)
2. Churakova, E.N., Lang, P.P., Loshkarev, A.V.: Problems of evidence in the conditions of digitalization of economic justice. In: Ashmarina, S.I., Mantulenko, V.V. (eds.), *Proceedings of the II International Scientific Conference Global Challenges and Prospects of Modern Economic Development. European Proceedings of Social and Behavioural Sciences*, vol. 79, pp. 942–947. European Proceedings, London (2020)
3. Cordella, A., Gualdi, F.: Law, technology and policies: a complex negotiation to generate value. In: Shaut, J.-M., Braune, E. (eds.), *Proceedings of the 2019 3rd International Conference on E-commerce, E-Business and E-Government*, pp. 21–28. ACM, New York (2019)
4. Criminal code of the People's Republic of China. <https://www.fmprc.gov.cn/ce/cgvienna/eng/dbtyw/jdwt/crimelaw/t209043.htm>. Accessed: 21.03.2021 (1997)
5. Grabosky, P.: Organized cybercrime and national security. In: Smith, R.G., Cheung, R.C.C., Lau, L.Y.C. (eds.), *Cybercrime Risks and Responses. Palgrave Macmillan's Studies in Cybercrime and Cybersecurity*, pp. 67–80. Palgrave Macmillan, London (2015)
6. Lang, P.P.: Legal axiology in the information society. In: Ashmarina, S.I., Mantulenko, V.V. (eds.), *Proceedings of the II International Scientific Conference Global Challenges and Prospects of Modern Economic Development. European Proceedings of Social and Behavioural Sciences*, vol. 79, pp. 778–783. European Proceedings, London (2020)
7. Mendoza, L.E., Cano, J.: Analysing dissenting votes through electronic justice from online posts to streets: a real case. In: *Proceedings of the Sixth International Conference on eDemocracy & eGovernment (ICEDEG)*, pp. 64–68. IEEE, New York (2019)
8. Penal code Act No. 45 of 1907. <https://www.oecd.org/site/adboecdanti-corruptioninitiative/46814456.pdf>. Accessed: 21.03.2021 (1907)
9. Penal Law 5737–1977. <https://www.oecd.org/investment/anti-bribery/anti-briberyconvention/43289694.pdf>. Accessed: 21.03.2021 (1977)
10. Swiss Criminal Code of 21.12.1937. [https://www.fedlex.admin.ch/eli/cc/54/757\\_781\\_799/en](https://www.fedlex.admin.ch/eli/cc/54/757_781_799/en). Accessed: 21.03.2021 (1937)
11. The Criminal Code of the Russian Federation No. 63-FZ of 13.06.1996. <https://www.wipo.int/edocs/lexdocs/laws/en/ru/ru080en.pdf>. Accessed: 21.03.2021 (1996)
12. US Code 1926. <https://www.govinfo.gov/app/collection/uscode/2018/>. Accessed: 21.03.2021 (2018)

# Information in the Digital Economy as a Subject of Criminal Law Protection



A. V. Beliakov and S. V. Bondarenko

**Abstract** In this study, the concepts of the subject of the crime and information are correlated. The position on the possibility of recognizing information as the subject of a crime is expressed and justified. A list of more than thirty compositions is highlighted, where the subject is information. A proposal is formulated for grouping them according to the interests involved. The signs of information as a subject of criminal law protection are highlighted. The definition of information as the subject of a crime is formulated. Comments are made on the definition of “computer information” contained in the criminal law.

**Keywords** Criteria • Investment • Investment Efficiency • Investment and construction process • Reconstruction

## 1 Introduction

Recently, information has become increasingly important in the life of humanity. This thesis can be justified, for example, by the attention of the authorities, expressed in rule-making. Thus, the Constitution of the Russian Federation provides for the need to protect information about private life (Articles 23, 24) [4]. It also states that everyone has the right to search, receive, transmit, produce and distribute information in a lawful manner, with the exception of information that constitutes a state secret. Issues of regulation of various actions with information are also provided for in other regulatory legal acts. Some actions on its use have a high public danger, which determined their prohibition, by including them in the relevant articles of the Criminal Code of the Russian Federation [5]. For example, in 2012, Article 159.6 of the

---

A. V. Beliakov (✉)  
Samara State University of Economics, Samara, Russia  
e-mail: [belekov2007@ya.ru](mailto:belekov2007@ya.ru)

S. V. Bondarenko  
Samara Law Institute of the Federal Penitentiary Service of Russia, Samara, Russia  
e-mail: [m003tt163@mail.ru](mailto:m003tt163@mail.ru)

Criminal Code of the Russian Federation (Fraud in the field of computer information) was introduced.

The attention to the concept under consideration is also changing on the part of law enforcement statistics. For example, in 2016, crimes committed using IT technologies were recorded in 1748 cases, in 2017—1883, in 2018—2500. In 2019, the accounting was conducted separately by item. So in 2019, 2,420 crimes were recorded for illegal access to IT information, in 2020—2420. In 2019, 455 cases of crimes committed for the creation of malicious programs were recorded, in 2020—371 cases) [12]. This means that, firstly, the number of crimes committed in the field of computer information has increased 3 times in five years. Secondly, taking into account modern trends, approaches to accounting for the considered group of crimes are changing.

It is also necessary to take into account the consequences of the modern pandemic, which has provoked the demand for the use of computer technologies, especially in the settlement and financial sphere, not excluding retail trade. Information security issues are also the subject of research in foreign publications [4, 6, 8–11]. The above determines the need to study issues related to crimes committed in the field of computer information.

## 2 Methodology

Modern research cannot do without appropriate methodological support. The selection and use of tools allows you to perform the work better and makes the conclusions more reasonable. Currently, both general scientific and special research methods were used. Thus, the use of the statistical method allowed us to identify the pattern of growth of crimes in the field of computer information. With the help of the analysis of criminal law norms, the components of crimes were identified, which are the subject of the crime is information (information, data). The analysis of the features of information and the concept of “subject of crime” determined the possibility of synthesizing the definition of information in criminal law. The same method allowed us to treat the legislative definition of “computer information” and identify its shortcomings. In the course of the study, other methods were also used.

## 3 Results

All the considered compositions are united by the concepts of “computer information” or “the sphere of computer information”. Similar phrases are found in other articles. For example, Article 159.6 of the Criminal Code of the Russian Federation, based on the name, prohibits fraud in the field of computer information, but the disposition of the article allows us to conclude that Computer information here is

not the subject, but the means of committing a crime. The situation is similar with Article 272 of the Criminal Code of the Russian Federation.

In this paper, the greatest interest is the consideration of computer information as the subject of a crime. To begin with, it should be noted that the very term subject of the crime is still debatable. In particular, until the last opinion, the materialistic approach to its definition prevailed, which is based on the allocation of three characteristics: material, social and legal [13]. However, the actual reality determines the need to revise the outdated approach, since a significant part of public relations has moved to the so-called “virtual space” where there are electronic money, electronic documents, electronic signatures, digital information, computer programs, and so on. Illegal influence on these categories leads to a violation of public relations. This position has already been expressed in the special literature, including from the near abroad, suggesting, for example, to introduce the term “virtual object of crime” [7]. However, such a position will only partially solve the urgent problem and will not cover public relations related, for example, to the protection of information, intellectual property, energy resources, etc.

Quite interesting is the position of philosophers, which states that the inclusion of information as an object of crime is somewhat contrary to established philosophical views [5]. Such approaches, of course, are useful in the theoretical study of the problem, but they contradict the current legislation and do not meet the current needs of practice. We think that a broad interpretation of the subject of the crime is more correct, especially since such theoretical non-solidarity does not have a significant negative impact on practice, where the thesis “the simpler, the better” prevails [14, 15].

There is an opinion that information, as the subject of a crime, can relate both to the object of the crime and to the objective side [3]. This position is seen as erroneous, since information can act both as the subject of a crime and as a means, depending on the composition of the crime. So, for example, in Article 137 of the Criminal Code of the Russian Federation (Violation of the inviolability of private life)—information about private life is the subject of a crime, since, illegally obtaining this information, that is, influencing them, a crime is committed.

In the case prohibited by Article 280 of the Criminal Code of the Russian Federation (Public calls to carry out extremist activities), the appeal is the dissemination of information, that is, in this case, the impact is not on information, but with the help of it on citizens, therefore, it is a means of influencing society. Thus, information in criminal law can act as the subject of a crime and as a means. In the specialized literature, the problem of determining the specification of both the name itself and the definition of the term “computer information” is also discussed. In particular, it is rightly proposed to replace it with “digital information” [1]. Since digitalization has been announced in Russia, especially since the arguments expressed in support of this position are generally fair, this proposal deserves support.

Another solution to the problem of determining the subject of a crime can be the introduction of a new feature of the object of the crime-information. This proposal should be regarded as an idea, which, of course, needs to be justified. As a direction for research, it is necessary to determine the characteristics of the subject of crimes

and criminally protected information. But, if the former are the object of a sufficiently long period of research, then the latter appear to be poorly studied.

It should be noted that in the Criminal Code of the Russian Federation, along with the term “information”, the terms “information” and “data” are used. From the point of view of the Russian language, these words are synonyms. In the semantic sense, information is defined through information. When defining “computer information”, the legislator also put an “equal” sign between information, messages, data and information. For this reason, information and data attributes will be recognized as information attributes.

## 4 Discussion

The content of the criminal legislation allows us to distinguish the following compositions containing signs of information protected by criminal law (it should be noted that an attempt to form a list of crimes aimed at protecting information has already been made, but in this work it is somewhat changed and supplemented) [2]: information that disgraces a person; information that can harm the rights or legitimate interests; information (data) of the register of securities owners; information (data) of the system of diplomatic accounting; information contained in the land survey plan, technical plan, survey report, land surveying project, territory map; information contained in documents and registers of accounting and reporting; information (data) contained in the unified state register of legal entities; personal data; information on commercial, tax, and banking secrets; insider information; on voting at the General Meeting of Shareholders; information about the time and place of the general meeting, the meeting of the Board of Directors, the voting procedure; information about the grounds, purposes and purpose of the transfer of funds; information contained in documents related to the payment of taxes and mandatory insurance payments; information constituting a state secret; computer information (data, messages); critical information infrastructure; information from state registers; official documents; information in documents on citizenship; data on preliminary investigations; information on security measures against participants in criminal proceedings and officials of a law enforcement or supervisory authority; information on registration of citizens; information on the activities of the USSR during World War II; information on the days of military glory; information about the identity of the victim who has not reached the age of 16 and about the crime; information affecting the rights and freedoms of citizens; information distributed by journalists; computer information; information about goods; information contained in the prospectus and reports on securities issues; scientific and technical information.

The above allows us to state that the studied signs are contained in more than 30 elements of crimes. Such a set, for the convenience of research, it is necessary to generalize. This can be done by combining groups of homogeneous features, for example, depending on the interests that may be harmed. These can be public, commercial, or private. At the same time, it should be noted that in some formulations,

all three interests may be affected, for example, in case of unauthorized access to computer information. Another sign of information that is protected by criminal law is its provision in the Criminal Code of the Russian Federation. Thus, information, as the subject of a crime, can be understood as information (data, messages) affecting which the crime causes or may cause harm to public, commercial or private interests. As for the concept of “computer information” itself, its definition is contained in the note to Article 272 of the Criminal Code of the Russian Federation, but the legislative wording is reasonably criticized.

So it is noted that the storage of information in a computer, especially long-term non-volatile (without electric current), is based on the following physical principles: semiconductor, magnetic, electromagnetic, optical. Electrical signals are absent on optical disks, in de-energized drives on hard machine disks, flash media (drives), in radio waves and fiber-optic communication lines [3]. The above justly justifies the failure to use the term “in the form of electrical signals”. This approach does not correspond to the modern reality.

## 5 Conclusion

According to the results of the study, the following conclusions were made. Problems related to the protection of computer information are currently relevant and need to be investigated and solved. We believe that the concept of “the subject of a crime” in modern realities should be interpreted more broadly. The opinion that information, as the subject of a crime, can be a sign of an objective side, is not justified. We support the position on the possibility of introducing the term “digital information” into the criminal legislation. The study allowed us to identify about thirty types of crimes in which information (information, data) is the subject of a crime. For the convenience of the study, it is proposed to group them depending on the protected interests. Information, as the subject of a crime, should be understood as information (data, messages) affecting which the crime causes or may cause harm to public, commercial or private interests. The conducted theoretical research of the law, special literature, allowed us to formulate some conclusions, as well as to speak out on some existing problems. The results obtained can be used in further research of the affected problems.

## References

1. Begishev, I.R.: Digital information: the concept and essence as the subject of a crime in Russian criminal law. *Acad. Law J.* **44**(2), 47–55 (2011)
2. Belyakov, A.V.: Knowledge and information as an object of criminal law protection. In: Ashmarina, S.I., Mantulenko, V.V. (eds.), *Current Achievements, Challenges and Digital Chances of Knowledge Based Economy. Lecture Notes in Networks and Systems*, vol. 133, pp. 3–9. Springer, Cham. [https://doi.org/10.1007/978-3-030-47458-4\\_1](https://doi.org/10.1007/978-3-030-47458-4_1) (2021)



3. Chelnokov, V.V.: Computer information as a subject of crime in the domestic criminal. Ural State Law Academy, Ekaterinburg (2013)
4. Constitution of the Russian Federation. <https://base.garant.ru/10103000/>. Accessed: 20.03.2021 (1993)
5. Criminal code of the Russian Federation dated 13.06.1996 N 63-FZ. <https://base.garant.ru/10108000/>. Accessed: 20.03.2021 (1996)
6. Frolova, E.E., Polyakova, T.A., Dudin, M.N., Rusakova, E.P., Kucherenko, P.A.: Information security of Russia in the digital economy. The economic and legal aspects. *J. Adv. Res. Law Econ.* **9**(1), 89–95 (2018)
7. Ginatulina, O.A.: The concept of the subject of crime and categorical tools of scientific philosophy. *Bull. Perm Inst. Federal Penitentiary Service* **37**(2), 14–16 (2020)
8. Jara, A.J., Bocchi, Y.: GEO-Trust: geo-aware security protocol for enabling cross-border trustable operations and data exchange in a global digital economy. In: *Proceedings of the 1st Sustainable Cities Latin America Conference (SCLA)*, pp. 1–6. IEEE, New York (2019)
9. Ministry of Internal Affairs Russian Federation: The state of crime in Russia. <https://xn--b1aew.xn--p1ai/reports>. Accessed: 10.03.2021 (2020)
10. Rosenfeld, N.A.: Some aspects of the need to introduce the concept of “virtual object of crime” in the theory of criminal law. *Izvestiya Saratovskogo Universiteta. 7. Ser. Economy. Management. Right*, vol. 2, pp. 62–63 (2007)
11. Saarenpää, A.: Information law revisited/Informationsrecht - Noch einmal. *Jusletter IT* (February). [https://www.researchgate.net/publication/322029111\\_Information\\_law\\_revisited\\_informationsrecht\\_-\\_Noch\\_einmal](https://www.researchgate.net/publication/322029111_Information_law_revisited_informationsrecht_-_Noch_einmal). Accessed: 09.03.2021 (2017)
12. Sandalova, V.A.: The modern state of the institute of banking secrecy in the conditions of digitization of banking services. In: Popkova, E.G. (eds.), *Ubiquitous Computing and the Internet of Things: Prerequisites for the Development of ICT. Studies in Computational Intelligence*, vol. 826, pp. 85–92. Springer, Cham (2019)
13. Spindler, G.: Digitalization and corporate law—a view from Germany. *Eur. Company Financial* **16**(1–2), 106–148 (2019)
14. Vinokurov, V.: Causing property damage as a criterion for recognizing objects and information as objects of crimes against property. *Criminal Law* **8**, 13–20 (2008)
15. Wienke, A., Friese, K.: Legal aspects of digitalization in the medical sector. *Rechtliche Aspekte der Digitalisierung in der Medizin. Laryngo- Rhino-Otologie* **97**(10), 713–716 (2018)

# Regulatory “Sandboxes” on Russian Market: Theoretical and Legal Aspect of Specialized Regulation



A. G. Bordakova

**Abstract** New digital technologies and services are constantly emerging in the world, which simplify production, communications and interpersonal people relationships. At the same time, the legislation simply does not keep up with such a pace of technology development, as a result of which digital innovations sometimes exist for years outside of the legal field. At the moment, the so-called regulatory “sandboxes” are actively used in many foreign countries. Due to the special conditions of the “sandboxes”, business entities that are developing new products and services, as well as representatives of the state authorities, can test them without the risk of violating the existing legislation, and later, if the testing was successful, they can enter the market with them. In the Russian Federation, in the context of the implementation of the national program “Digital Economy of the Russian Federation”, one of the urgent tasks is the accelerated development of digital innovations and the corresponding legal regulation.

**Keywords** Digital economy · Experimental legal regimes · Innovation policy · Fintech · Regulatory “sandboxes”

## 1 Introduction

Modern digitalization of the legal and socio-economic space in Russia provides the emergence of new public relations in the field of economic, political, social and other spheres. In many ways, the lever for this was the comprehensive use and implementation of information and technical solutions in various life spheres of our society and the states, as well as the active use of the capabilities of the information and telecommunication network “Internet”. Thus, the transformation of interpersonal relations in connection with the integration of the information and telecommunication network “Internet” provides a potential opportunity to apply innovative technologies in the field of economics and, thereby, become the lever of progress that allows

---

A. G. Bordakova (✉)  
Samara State University of Economics, Samara, Russia

the economy to develop, to be competitive on the world market. According to the European Union, the removal of barriers can free up 2–4% of innovative investments, which is 7–14 billion euros in total innovative investment until 2020. In addition, an additional 2–4% of jobs can be created in the field of innovation [11]. For the normative consolidation of certain changes in the regulation of public relations by the state, as well as for the emergence of a timely and effective legal space, legislative procedures of an accelerated process are necessary. Traditionally, in Russia, the adoption of laws, i.e. the legislative process, is quite long in the time interval, in general, it takes an average of three years to adopt a law. It turns out that in order to optimize and effectively operate the legal cluster in the field of regulation of economic sectors, it is necessary to move away from standard procedures and apply new approaches as an exception to the general rule, defining special legal regimes for them. Such an approach, i.e., an withdrawal, can be experimental legal regimes and the mechanism for their implementation-regulatory “sandboxes”.

## 2 Methodology

The mechanism for establishing experimental legal regimes is established in Federal Law No. 258-FZ of 31.07.2020. “On experimental legal regimes in the field of digital innovations in the Russian Federation” (hereinafter referred to as Federal Law No. 258) [8]. This mechanism establishes the creating, changing, cancellation and implementation of experimental legal regimes (hereinafter referred to as ELR).

For a clear (specific) understanding of the ELP application, in particular, its nature, it is important to consider some conceptual aspects of this mechanism.

Firstly, it relates to the experimental regime in the legal framework for digital innovations. It includes the application of specific regulations in the areas of development, testing and implementation of digital innovations for a certain time period. Secondly, digital innovations relate to new or significantly improved goods, services, works, processes, methods used in the business practice, created or used in areas, in the economy, defined by a specific list provided for in Federal Law No. 258. Thus, digital innovations are classified according to the object attribute into material (subject) and procedural (procedures, methods). Thirdly, the program of the experimental legal regime is an act of special regulation that defines the conditions of the experimental legal regime and is approved by a regulatory legal act of the Government of the Russian Federation (hereinafter referred to as the act of the Government of the Russian Federation), and in the direction carried out in the financial sphere of activity, by a regulatory act of the Bank of Russia (hereinafter also referred to as the act of the Bank of Russia). The criteria for analytical evaluation of the regulatory “sandboxes” formation are determined by the ELR principles, i.e., the aims and tasks for the ELR application. The experimental legal regime has the following objectives:

- formation of new types and forms of economic activity, methods of carrying out economic activity based on the results of the implementation of the experimental legal regime;
- development of competition;
- expanding the composition, quality, or availability of goods, works, and services;
- improving the efficiency of state or municipal administration;
- ensuring the development of science and the social sphere;
- improvement of general regulation based on the experimental legal regime results;
- investment attraction in the field of digital innovations development;
- creating favourable conditions for the creation of digital innovations and their implementation.

The ELR formation is based on such main directions (principles) as:

- the inadmissibility of restricting the constitutional rights and freedoms of the Russian citizens;
- ensuring the security of the individuals, society and the state;
- transparency and openness of the ELR;
- equality of all applicants;
- voluntary participation in the ELR;
- the certainty of special regulation in terms of time, the set of people and, unless otherwise follows from the experimental legal regime, the restriction of special regulation in space;
- minimization of deviations from the general regulation.

The list of conditions for establishing an ELR is another criterion for launching a specific “sandbox”.

It includes such conditions as:

- general regulation in the field of digital innovations (under these requirements, restrictions, prohibitions, the implementation of digital innovations is difficult or impossible);
- the technological base for the digital innovations application, or their use requires technical, technological, organizational or other training;
- the establishment of an experimental legal regime should lead to the achievement of one or more of the above objectives;
- the initiative proposal contains a reasonable assessment of the risks of causing harm to the life, health or property of a person or the property of a legal entity, damage to the defense and (or) security of the state, other values protected by federal law, and measures aimed at minimizing such risks.
- for the ELR in the field of financial activity, the list of conditions is more expanded: there are restrictions on the volume of individual financial transactions and the total volume of financial transactions, the number of persons in regard of whom these financial transactions can be carried out during the period of the experimental legal regime or in the corresponding unit of time, as well as other conditions for establishing such an ELR.

- the ELR is established in relation to a certain circle of subjects or one subject for a certain period of time and, unless otherwise provided for by such an ELR, in a certain territory within which the subjects carry out certain activities in accordance with the ELR program.

The current and final results of such an experiment are evaluated through such formats as monitoring, carried out at least by an industry regulator (through an authorized federal executive body), as well as in the format of monitoring and its thorough analysis, carried out by the organization of the business community to form its position on the “sandbox” and the prospects for applying this digital innovation in the future in the digital economy. If the experiment is suggested to be conducted on the territory of a particular subject of the Russian Federation, the program can also be evaluated by a regional executive authority.

### 3 Results

The world experience in the use of regulatory “sandboxes” is already quite large. In fact, this institution allows business entities to develop new products on a specific territory and conduct experiments in this way without violating the current legislation [7]. Regulatory “sandboxes” are actively used in many foreign countries. The first regulatory “sandbox” was created in the UK in 2016 [5]. Currently, this country is conducting the fifth round of regulatory experiments, during which solutions for digital identification of financial services users (banking, insurance, brokerage), distributed ledger technologies and services aimed at providing wider access to financial services were tested. The most popular tool used by the participants of the experiments was a limited license: companies were granted the right to apply their technologies to a limited number of users and to a limited extent (according to the Financial Services Authority of the United Kingdom).

Later, regulatory “sandboxes” were successfully implemented in the United States, Australia, Singapore, the United Arab Emirates, China (Hong Kong), Malaysia, Thailand, Indonesia, Bahrain, Switzerland and Canada. The possibility of establishing a regulatory “sandbox” regime is being explored in Brunei, China (in addition to Hong Kong), India, Kenya [2], Mexico, Mozambique, Nigeria, and Pakistan [6].

Initially, experimental legal regimes were established in the field of digital innovations in the financial sector. This is explained both by the peculiarities of the subject of regulation and by the development dynamics of this sphere of legal relations [3]. At the same time, innovative products and services face legal restrictions not only in the financial sphere, but also in other areas of public relations. For example, in the first months after the entry into force of the General Data Protection Regulation of the European Union (GDPR), many “digital” enterprises working with personal data were forced to suspend the work and implementation of new technologies until the procedure for working in the new legal regime was determined. Enterprises are

also faced with the inability to bring innovative products and services to the market due to the provisions of consumer protection legislation. Thus, fintech “sandboxes” are not applicable for end-to-end technologies [1].

In this regard, alternative regulation is applied for the implementation of pilot projects in other areas [10]. For example, in South Korea, in addition to “sandboxes” in the field of financial technologies, experiments are being conducted in the field of transport and healthcare [9]. In Japan, the Ministry of Economy, Trade and Industry implements the mechanism of regulatory “sandboxes” in the field of artificial intelligence, the Internet of things, blockchain and Big Data. At the same time, both national and foreign companies can participate in the regulatory experiment. At the end of 2018, the European Commission decided to launch regulatory “sandboxes” in the field of artificial intelligence [4].

## 4 Discussion

Based on the study of the world practice of creating regulatory “sandboxes”, several factors can be identified that potentially affect the success of these experiments:

- availability of state support;
- flexible regulation;
- availability of feedback from consumers;
- availability of feedback from the expert community;
- development of a culture of innovations.

“Sandboxes” can be created in various areas provided for by law.

The ELR mechanism itself consists in establishing an withdrawal from the general legal regulation in relation to the participants of the experiment. It establishes a special regulation for them, which implies the non-application to them of certain mandatory requirements established by law. This makes it possible to reduce the time frame for the implementation of the new regulation and establishing the possibility of extending this regulation to the entire country. Regulatory “sandboxes” should become an incentive for the development of innovative activities. The target model here is the creation of a “sandbox factory”, within which innovative enterprises will have wide opportunities for conducting regulatory experiments. Creating a favorable investment climate will also create all the necessary conditions for bringing new products and services to the market.

## 5 Conclusion

Thus, the mechanism of regulatory “sandboxes” is a new format of soft regulation that allows to accumulate the practice of law enforcement, which is often impossible

to obtain without the adoption of a federal law. Innovative companies can test technologies that are currently impossible or difficult to enter the market, without the risk of violating legal requirements. The state, in turn, can test the new regulation on a limited territory and assess the possible risks to legally protected values associated with the removal of mandatory requirements. According to Russian President Putin: The development of legal mechanisms, the so-called “regulatory sandboxes”, which will allow to work out promising solutions in practice. In other words, it is necessary to create a field for an experiment, where it will be possible to test unmanned vehicles, to use artificial intelligence in medicine, and much more. In addition, providing preferential access to electricity for data centers will reduce business costs and make services more accessible to citizens. Putin emphasized the need to support solutions that develop the competitiveness of products of domestic hardware and software developers. According to the president, it is important both to increase domestic demand and to stimulate the export of products of the Russian IT industry [12].

## References

1. Baker McKenzie: International guide to regulatory Fintech sandboxes. [https://www.bakermckenzie.com/en/-/media/files/insight/publications/2018/12/guide\\_intlguideregulatorysandboxes\\_dec2018.pdf](https://www.bakermckenzie.com/en/-/media/files/insight/publications/2018/12/guide_intlguideregulatorysandboxes_dec2018.pdf). Accessed: 25.03.2021 (2018)
2. di Castri, S., Plaitakis, A.: Going beyond regulatory sandboxes to enable FinTech innovation in emerging markets. [https://papers.ssrn.com/sol3/papers.cfm?abstract\\_id=3059309](https://papers.ssrn.com/sol3/papers.cfm?abstract_id=3059309). Accessed: 25.03.2021 (2018)
3. Dostov, V.L., Shust, P.M., Ryabkova, E.S.: The institute of “regulatory sandboxes” as a tool to support financial innovations. *Money Finance J.* **10**. <https://m.facebook.com/emoney.russia/posts/1360746853937023>. Accessed: 25.03.2021 (2016)
4. European Commission: Policy and investment recommendations for trustworthy artificial intelligence. <https://digital-strategy.ec.europa.eu/en/library/policy-and-investment-recommendations-trustworthy-artificial-intelligence>. Accessed: 25.03.2021 (2019)
5. FCA: Financial conduct authority unveils successful sandbox firms’ second anniversary of project innovate. <https://www.fca.org.uk/news/press-releases/financial-conduct-authority-unveils-successful-sandbox-firms-second-anniversary>. Accessed: 25.03.2021 (2018)
6. FCA: Regulatory sandbox lessons learned report. <https://www.fca.org.uk/publication/research-and-data/regulatory-sandbox-lessons-learned-report.pdf>. Accessed: 25.03.2021 (2017)
7. FCA: Regulatory sandbox. <https://www.fca.org.uk/firms/innovation/regulatory-sandbox>. Accessed: 25.03.2021 (2019)
8. Federal Law No. 258-FZ of 31.07.2020 “On experimental legal regimes in the field of digital innovations in the Russian Federation”. [http://www.consultant.ru/document/cons\\_doc\\_LAW\\_358738/](http://www.consultant.ru/document/cons_doc_LAW_358738/). Accessed: 25.03.2021 (2020)
9. Financial Services Commission: Overview of financial regulatory sandbox. <https://www.fsc.go.kr/eng/pr010101/22394>. Accessed: 25.03.2021 (2019)
10. Pratt, A.: The benefits of a regulatory sandbox. *Veterinary Record* **181**(21), 573–573 (2017)
11. Publications Office of the European Union: Assessing the impacts of EU regulatory barriers on innovation. <https://op.europa.eu/en/publication-detail/-/publication/076b7f4b-f1cb-11e7-9749-01aa75ed71a1/language-en>. Accessed: 25.03.2021 (2018)
12. Red Spring News Agency: Putin suggested “Regulatory sandboxes” to help the IT industry. <https://rossaprimavera.ru/news/6d0a4fb2>. Accessed: 25.03.2021 (2019)

# Current Issues of Training Economic Security Personnel for the Digital Economy



Y. P. Grabozdin, O. V. Karsuntseva, and T. E. Tatarovskaya

**Abstract** The current issues of training specialists in the field of economic security in accordance with the requirements of the digital economy are revealed in the article. The authors conducted the study of university students, divided into two target groups depending on the year of study and education program, for identifying their career expectations and readiness to improve their skills. It is important because of the challenges that have arisen in the context of economic processes digitalization. The most popular areas of digital skills development among students are identified. In addition, important part of article was the study of the competencies list that specialists should have in modern conditions, including in the field of economic security.

**Keywords** Digital economy · Education · Economic security · Human resources · Skills

## 1 Introduction

The efforts of the human community related to ensuring the sustainable growth of the state's economy and strengthening the economic security of enterprises meet the need to adapt all actions and processes to the widespread digitalization. The COVID-19 pandemic has increased the pace of transition to the digital economy, as the transfer of many business processes, as well as the education system to online mode has changed the paradigm of the world and has had a serious impact on the requirements for specialists today.

---

Y. P. Grabozdin

Samara State University of Social Sciences and Education, Samara, Russia  
e-mail: [grabozdin@pgsga.ru](mailto:grabozdin@pgsga.ru)

O. V. Karsuntseva

Samara State Technical University, Samara, Russia  
e-mail: [director@sfsamgtu.com](mailto:director@sfsamgtu.com)

T. E. Tatarovskaya (✉)

Samara State University of Economics, Samara, Russia



The information and communication technologies development has formed a new socio-economic, cultural and other relations system in the last decade, as digitalization has penetrated into all spheres of society [10]. At the same time, human or intellectual capital still remains the main resource of the digital economy. The reason is the person who is at the head of all innovative and digital processes. Moreover, machine will never replace person, because it is not characterized by creativity, innovation and initiative. However, in the context of widespread digitalization, the human community needs to understand what competencies will be in demand in the near future. This awareness will allow person to remain competitive in the digital economy and understand possibility to develop their skills for their potential realization and employer interest maintenance. From the business position, the challenges that arise in the context of widespread digitalization create new threats to the enterprise economic security system. In this context, human capital, especially the competence, knowledge, and skills of the staff, will enable the company to face new threats and effectively manage risks in the digital economy. Thus there is no doubt that digitalization has penetrated not only into all spheres of society, but also into the business entities activities. Therefore training personnel for the digital economy is becoming one of the most pressing issues of our time.

## 2 Methodology

The new challenges that people face in the digital economy are still not fully accepted. This is due to many reasons. In particular, the number of employees with the necessary competencies to work in the conditions of digitalization is insufficient. The educational programs of higher educational institutions are at the stage of updating and improving in terms of meeting the digital economy needs [7]. There is disbalance in the labor market, the consequence of which may be an increase in unemployment. At the same time there is a shortage of personnel who have competence who have the competencies necessary for digital economy. Therefore the possession of digital skills and soft skills, a new type of thinking, as well as the ability to continuous learning, flexibility, adaptability, and a willingness to learn new knowledge constantly and new technologies are the most important things. Meanwhile the relevance of building eco-friendly behavior in the digital economy and the development of digital literacy remains. All this forms the direction of research on issues related to training in the field of economic security in the digital economy.

Earlier the representative of the author's team attempted to study methods for assessing human capital in the digital economy (the study was conducted in 2018–2019 and published in 2020) [5]. From the point of view of an independent assessment of qualifications, two areas of study of this issue were chosen:

- review of the problems of graduates employment in the digital economy;
- improving the financial literacy of economic entities employees in the digital economy.

The past two years have demonstrated a paradigm shift. Along with the importance of improving financial literacy, the importance of improving digital literacy has been updated. The problems of employment remained the same, so in this context it seems relevant to investigate the expectations of university students and graduates to understand their readiness to meet the digital economy requirements [4].

In this paper, the research direction was specified. “Economic security” was chosen as the key one, in particular, students of this program. Thus the target group was significantly narrowed than in the previous paper, in which various professions were studied (from an accountant to a specialist in credit brokerage).

The methodological basis of the research was modeling, abstraction, questionnaire survey, deduction, synthesis, comparative characteristics, and others. The questionnaire survey methodology was implemented using the tools of information and communication technologies (the Google Forms table processor). The following types of questions were used during the questionnaire survey:

- short answer question;
- a question with a detailed answer;
- a question with a choice of one answer from the list.

The questionnaire was aimed at two target groups:

- students of the final year of the program “Economic security”;
- students of the program “Economic Security” and training programs in Economics.

The list of questions for these groups was formed based on the requirements for personnel in the digital economy established by the Russian Federation state programs and the best business practices in the field of hiring employees taking into account the requirements of digitalization (Table 1).

The stages of conducting the questionnaire include the following actions:

- setting the purpose of the questionnaire, selecting the tasks and target audience, and formulating the questions;
- preparation of an digital form for conducting a questionnaire using the Google Forms tabular processor;
- sending invitations to participate in the questionnaire to persons from the target groups;
- collecting responses in the Google Forms tabular processor;
- processing of the results of the responses and their analysis in Microsoft Excel spreadsheets (tabular and graphical data presentation formats were used).

### 3 Results

The significance of the study is confirmed by statistics published in open sources in the Russian Federation. From the point of view of readiness for the digital economy

**Table 1** Questions for the target groups of the study “Personnel for the digital economy in the economic security field”

| Target group «Students of the final year of the program “Economic security”» |   | Target group «Students of the program “Economic Security” and training programs in Economics» |   |
|--|---|---|---|
| 1  | Why did you enter the program “Economic Security”?  | 1   | Are you interested in the field of economic security? Would you like to realize your potential in this area?                                |
| 2  | Do you plan to work in the economic security field after graduation?  | 2   | Do you think there is a link between economic security and digital technologies (IT)?   |
| 3  | If you do not plan to work in the economic security field e, tell us why?   | 3   | Would you like to improve your knowledge in the field of IT (information technology)?   |
| 4  | Do you think there is a link between economic security and digital technologies (IT)?   | 4   | How do you feel about the current trend of continuing education?  |
| 5  | Would you like to improve your knowledge in the field of IT (information technology)?   | 5   | Do you think that in the future (in 10–20 years) the position you are currently working for or are planning to get a job will be automated? |
| 6  | How do you feel about the current trend of continuing education?  | 6   | How do you develop your digital literacy and digital skills?  |
| 7  | Do you think that in the future (in 10–20 years) the position you are currently working for or are planning to get a job will be automated? |   |   |
| 8  | How do you develop your digital literacy and digital skills?  |   |   |

Source Authors

challenges and demonstrating the level of financial literacy, the thematic direction “Digital skills of the population” is of interest. For the period 2015–2018, the population aged 15 and over did not demonstrate breakthrough in any of the skills presented. At an acceptable level they remain (the top three skills with the largest share of the population possessing them):

- “Working with a text editor”: 2015 – 38,8%; 2016—41.5%; 2017—41.7%; 2018—41.1%;
- “Sending email with attached files”: data available only for 2018—36.8%;
- “Copying or moving a file or folder”: data available only for 2018—34.5%.

At the lowest level remains “Self-writing software using programming languages”: 2015—1.0%; 2016—1.0%; 2017—1.2%; 2018—1.1% [1].

The presented statistical results indicate the low level of digital literacy in the target group and the extreme importance of training a new generation of personnel who will be ready for the digital economy challenges and whose competencies will meet the current level of digitalization. Thus the importance of education in preparing the human community for the digital economy challenges cannot be overestimated. This is confirmed by the position of the OECD in defining digital literacy as the ability to navigate in the digital space and solve problems in conditions of ambiguity (“think before you click”) [8].

The study of training issues for the digital economy in the economic security field is relevant for a number of reasons:

- the economic security direction has gained importance in the last decade due to the actualization of the risk-based approach to the systems organization in the socio-economic space. Effective counteraction to threats and related risks is possible only in conditions of ensuring an acceptable level of business security;
- training of personnel in the economic security field has a number of problematic issues, which in the absolute majority have not yet been resolved by universities. This range of problems concerns the choice of disciplines that meet the modern challenges of the economy and widespread digitalization, the development of soft Skills, and other aspects;
- orientation of future specialists to the concept of lifelong learning and readiness to develop digital skills.

Target group «Students of the final year of the program “Economic security”» consisted of 20 students studying in the 5th year in the Samara State University of Economics. The results of the questionnaire survey of this target group showed the following data (the numbering of the answers to the questions corresponds to the list from Table 1):

1. At the time of admission, this direction was interesting for me—75%; Parents insisted—10%; Friends or acquaintances advised—15%; A specialist of the admissions committee convinced—0%.

**Conclusion:** young people entering the university today are quite self-sufficient in their choice. A conscious choice of program at the university is a sign of understanding the current trends in the digital economy.

2. Yes, I plan to. Now I am in search of work—70%; Yes, I already work in this area—5%; No, I plan to work in another area—10%; No, I already work in another area and do not plan to move to the economic security field—5%; Perhaps in the future—15%.

**Conclusion:** most graduates of the program “Economic Security” plan to work in the field in which they received their higher education. Consequently, on average, the share of students who entered this direction and the share who retained interest in this direction from the position of employment remained.

3. I have disappointed in the specialty while studying at the university or realized that it does not suit me—0%; I have disappointed in the program because I could not find a job in this field—0%; I have other interests—29.4%; This question is not for me. I already work or plan to work in the field of economic security—70.6%.

**Conclusion:** the same proportion of the respondents that in the previous questions willing to work in the economic security sphere, which indicates the high quality of teaching staff work, managed to keep the interest of the students in the selected area.

4. Yes—100%; No—0%.

**Conclusion:** Students are aware of the link between economic security and digital technologies.

5. Yes, I am interested—85%; No, I feel confident in the digital space—15%.

**Conclusion:** significant proportion of students are interested in improving their knowledge in the field of IT.

6. I share this trend and plan to learn new knowledge constantly—85%; It does not suit me. I am not ready to learn all my life—15%.

**Conclusion:** significant proportion of students are ready to study for a lifetime, but some respondents (3 out of 20 people) are not ready to develop their knowledge and skills for a lifetime.

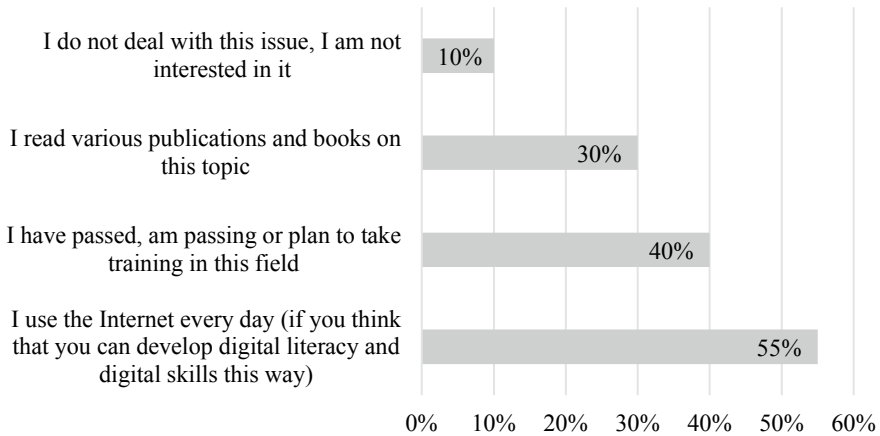
7. Yes—40%; No—5%; Partially—55%.

**Conclusion:** 95% of respondents realize that the positions they have chosen or are applying for will be automated (fully or partially); therefore, the trend of lifelong learning is relevant for them.

8. Figure 1 presents the most popular areas of digital skills development among students.

**Conclusion:** only 10% of respondents (2 out of 20 people) are not interested in developing digital skills. The remaining 90% chose multiple answers. At the same time the most popular way for respondents is the Internet daily use. The gap between this answer and the others is not significant, so respondents are aware of other ways to develop digital skills.

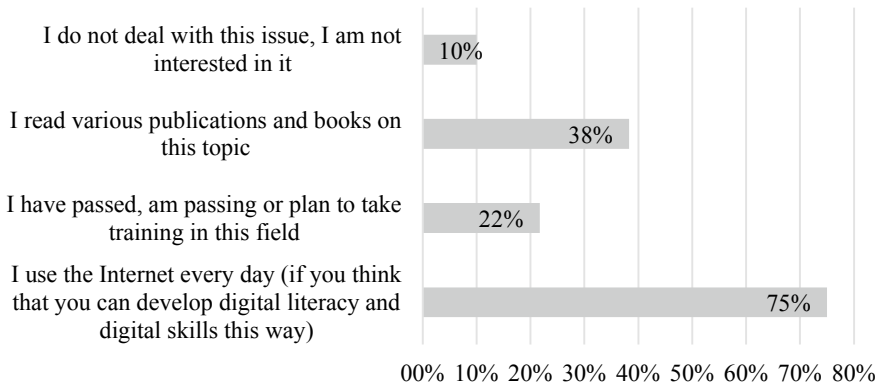
The target group «Students of the program “Economic Security” and training programs in Economics» consists of 60 students of the Samara State University of



**Fig. 1** Results of the answer to the question “How do you develop your digital literacy and digital skills?” for students of the program “Economic Security”. *Source* Authors

Economics, studying in the 3rd and 4th courses. The results of the questionnaire survey of this target group showed the following data (the numbering of the answers to the questions corresponds to the list from Table 1):

1. Yes, I am interested. I plan to work in this area—33.3%; Yes, I am interested. I plan to work in a related field (economy)—43.3%; Yes, but so far only at the level of interest. I plan to work in another field (not the economy)—15%; No, I am not interested—8.3%.  
**Conclusion:** 76.6% of respondents plan to work in the field of economic security or in a related field.
2. Yes, there is a link—100%; No, there is no link—0%.  
**Conclusion:** Students are aware of the link between economic security and digital technologies.
3. Yes, I’m interested—90%; No, I feel confident in the digital space—10%.  
**Conclusion:** a significant proportion of students are interested in improving their knowledge in the field of IT.
4. I share this trend and plan to constantly learn new knowledge—93.3%; It does not suit me. I am not ready to study all my life long—6.7%.  
**Conclusion:** a significant proportion of students are ready to study for a lifetime, but some respondents (4 out of 60 people) are not ready to develop their knowledge and skills for a lifetime.
5. Yes—18.3%; No—10%; Partially—71.7%.  
**Conclusion:** 90% of respondents realize that the positions they have chosen or are applying for will be automated (mainly, partially—43 people), therefore, the trend of lifelong learning is relevant for them.
6. Figure 2 presents the most popular areas of digital skills development among students.



**Fig. 2** Results of the answer to the question “How do you develop your digital literacy and digital skills?” for students of the program “Economic Security” and training programs in Economics. Source Authors

**Conclusion:** only 10% of respondents (6 people out of 60) are not interested in developing digital skills. The remaining 90% chose multiple answers. But the most popular answer is the Internet daily use. The rest of the answers are not so popular, which suggests that respondents do not know enough about other ways to develop digital skills.

The study results show that final year students of the program “Economic Security” are more prepared for the challenges of the digital economy: they are aware of the high probability of automation of their work responsibilities and are ready to use various ways to develop digital skills.

## 4 Discussion

Today, in the context of the COVID-19 pandemic, the importance of technology, science and innovation is increasing. However, the current economic crisis as a consequence of the COVID-19 pandemic will lead to a sharp reduction in the costs of companies in this area and accelerate digital transformation, which will strengthen the requirements for the list of competencies for personnel in the digital economy (link to the OECD). Among the recommendations of the OECD, the following direction is relevant from the standpoint of this study: improving the system of training highly qualified scientific personnel (including issues of building a scientific career, developing the necessary skills, including digital ones) [8].

At the national level in the Russian Federation, the key competencies of personnel for the digital economy are communication and cooperation in the digital environment; self-development in conditions of uncertainty; creative thinking; information and data management and critical thinking for the digital environment [2, 7]. At the same time from the foreign research point of view the formation of basic skills

as a basis for building competencies in the field of digital economy should remain an important direction. In addition, it is important to form a whole set of social-behavioral and cognitive competencies. Of course, there is currently no unified system of competencies required for the personnel of the digital economy. And their set will depend not only on the level of development of the economy of a particular state. The specialty in question is of great importance [3]. From the point of view of the sphere of economic security, financial literacy is becoming important in the digital economy. In other words, ensuring the security of a particular system from the point of view of the economic processes taking place in it by means of creation the effective risk management system. In addition, the solution of non-standard tasks is also relevant for these specialists, since the uncertainty of the external environment, Big Data, high speed of processes that require quick reaction, the development and flexibility of the mind and adaptability to changes [6].

Another relevant issue is the development of digital skills by future and current employees of the economic sphere. It is not just about creating different systems: software, applications, production systems. It is necessary to master the skill of digital information management, namely the implementation of data processing and analysis. Thus, the current trends in the challenges of the digital economy is the development of socio-economic systems. Therefore, one of the leading roles in this process belongs to higher education: to prepare personnel who have the competencies of the digital economy, and are ready to develop their skills and learn throughout their lives [11]. At the same time, the role of a person is not reduced in these conditions. Applicants should make an informed choice of the educational program, and students should strive to assimilate the entire body of knowledge transmitted to them by teachers.

## 5 Conclusion

The study demonstrated the importance of higher education in the formation of employee that are ready for the challenges in the digital economy. The current direction of “Economic Security” (as an educational program and employment sphere) demonstrates significant adaptation to the emerging trends and challenges of the digital economy. It is no coincidence that the XXI century is called the era of education, because personnel decide everything (human capital plays the major role), and the importance of the human role in all socio-economic processes will never decrease, despite the development of digitalization [9]. Therefore, the creation of a leading supply in the labor market for specialists with digital economy competencies will increase the flexibility of the educational system, stimulate cooperation with potential employers and bring disciplines aimed at the formation of personal and interdisciplinary competencies to educational programs.

The model of lifelong learning is recognized by many representatives of the younger generation. However, there is still a question of choosing the directions for developing existing skills and acquiring new ones, as well as ways to develop



them and support them, first of all, from the employer. Human potential has no limits. But its implementation is limited by the possibilities that do not always depend on the person. The high quality of educational programs and the interest of the employer, together with the support of the state, will allow to train personnel, including the field of economic security, for the digital economy.

## References

1. Abdrahmanova, G.I., Vishnevsky, K.O., Gohberg, L.M., Demyanova, A.V., Kevesh, M.A., Kovaleva, G.G., Kotsemir, M.N., Kuznetsova, I.A., Ozerova, O.K., Polyakova, V.V., Ratay, T.V., Ryzhikova, Z.A., Streltsova, E.A., Suslov, A.B., Utyatina, K.E., Fridlyanova, S.U., Fursov, K.S., Shugal, N.B.: Brief statistical collection «Digital Statistics». <https://issek.hse.ru/mirror/pubs/share/323871553>. Accessed: 15.03.2021 (2021)
2. Bode, E., Brunow, S., Ott, I., Sorgner, A.: Worker personality: another skill bias beyond education in the digital age. *German Econ. Rev.* **20**, e254–e294 (2019)
3. Czerniewicz, L., Brown, C.: The habitus of digital “strangers” in higher education. *Br. J. Edu. Technol.* **44**, 44–53 (2013)
4. Eynon, R.: Becoming digitally literate: reinstating an educational lens to digital skills policies for adults. *Br. Edu. Res. J.* **47**, 146–162 (2021)
5. Korneeva, T.A., Potasheva, O.N., Tatarovskaya, T.E., Shatunova, G.A.: Human capital evaluation in the digital economy. In: Ashmarina, S., Mesquita, A., Vochozka, M. (eds.), *Digital Transformation of the Economy: Challenges, Trends and New Opportunities. Advances in Intelligent Systems and Computing*, vol. 908, pp. 66–78. Springer, Cham (2020)
6. Manca, S., Grion, V., Armellini, A., Devecchi, C.: Editorial: Student voice. Listening to students to improve education through digital technologies. *Br. J. Educ. Technol.* **48**, 1075–1080 (2017)
7. McFarlane, A.E.: Devices and desires: competing visions of a good education in the digital age. *Br. J. Edu. Technol.* **50**, 1125–1136 (2019)
8. OECD: Science, technology and innovation outlook. [https://www.oecd-ilibrary.org/science-and-technology/oecd-science-technology-and-innovation-outlook-2021\\_75f79015-en](https://www.oecd-ilibrary.org/science-and-technology/oecd-science-technology-and-innovation-outlook-2021_75f79015-en). Accessed: 14.03.2021 (2021)
9. Palier, B.: Work, social protection and the middle classes: what future in the digital age? *Int. Soc. Secur. Rev.* **72**, 113–133 (2019)
10. Sturgeon, T.J.: Upgrading strategies for the digital economy. *Glob. Strateg. J.* **11**, 34–57 (2021)
11. Twining, P., Raffaghelli, J., Albion, P., Knezek, D.: Moving education into the digital age. *J. Comput. Assist. Learn.* **29**, 426–437 (2013)

# Big Data in the Digital Economy: Prospects for Application and Legal Regulation



E. K. Gubaydullina

**Abstract** There is a tendency in modern society towards a rapid increase of the information role as a factor of production in economic activity, which has become a constant object of economic turnover, especially in the digital space. In this regard, there is a need for a comprehensive legal regulation of relations related to the creation, storage, dissemination and use of information, since the lack of regulation of these aspects leads to various abuses against the rights and legitimate interests of the subjects of this data and other third parties. The article concludes that integral control of the industry including introduction of amendments into the framework legislation governing data turnover, is required.

**Keywords** Big Data · Digital economy · Legal regulation

## 1 Introduction

New technologies are already being actively introduced into the economy, radically changing the manufacturing process, approach to conduct of business and business processes. The scope of the law is expanding and increasingly covers the regulation of relations developing in the virtual space. The proportion of public relations associated with the use of computer networks is growing throughout the world, which implies the need to ensure effective legal regulation of these relations.

There is no clear approach to the so-called network relations in the domestic legislation. Digitalization in the context of law in foreign science, is considered as a natural phenomenon that arises on the path of the development of the legal system at the present stage. In the works of foreign authors, legislative activity in digital technology is understood as:

- collecting public opinion through online forums;
- working out draft laws using online mechanisms;
- coordination of online consultations on draft laws;

---

E. K. Gubaydullina (✉)  
Samara State University of Economics, Samara, Russia

- online voting of proposed draft laws;
- providing online access to current legislation and ensuring the interpretation of current legislation.

The impact of digital technologies and digitalization of law on economic and social relations are the subject of discussions among lawyers and the scientific community. There is a search in many countries of the world for a legal regulation model of public relations arising in connection with the transition to digital technologies. Taking this into account, the main goal of regulatory regulation is to create a new regulatory environment that provides a favorable legal regime for the emergence and development of modern technologies, including Big Data.

## 2 Methodology

When a scientific work is written, modern methods of cognition, identified and developed by science and tested by practice, were applied. General scientific methods were used as a methodological basis for the study. Among them, you can specify: dialectics, analysis, synthesis, induction, deduction, comparative legal and systemic structural methods of analysis. Formal legal and formal logical methods were also widely used. The formal legal method was used to analyze the basis of legal regulation of the Big Data use in Russia and to study the prospects for their development. Thanks to the formal-logical method, links between the development of legal regulation for the protection of Big Data and the development of digital technologies in the economy were identified. Investigating the place of legal means of regulating Big Data in the system of Russian law, methods of monitoring the current model of legislation and its assessment were used.

## 3 Results

The digital economy impact can be seen as a result of the spread, implementation, and the creation of a new technological environment for the legal system, both at the national and international levels. The Big Data concept as a new approach in the field of innovation and information technology was studied by such foreign scientists [2, 6, 8]. As a rule, their scientific publications covered the issues of the essence, types and principles of Big Data. The potential of “Big Data” is so great that it is now often referred to as “new oil,” the information equivalent of the natural resource that shaped the economy of the nineteenth and twentieth centuries. This analogy has some value, but it also has drawbacks. Unlike oil, Big Data is almost unlimited and renewable. However, data analysis can be compared to its extraction and transportation. The International Data Corporation expects that there will be 175 zettabytes of data worldwide by 2025 [5]. Big Data analysis has the potential to

change the value and efficiency of new product development, market orientation and pricing processes. The digital economy in terms of Big Data application generates a request for the formation of complex branches of law based on special legal regimes and principles.

The complex branches include norms of other law branches, they use methods of regulation in various law branches. Complex law branches, in contrast to the main branches, occupy a certain, unequal place with them, and they also develop and complement the entire law system. They are regulated by the legislative space, which includes the norms of various branches of law. The approach that is used in a complex nature legislation branches, in terms of the circulation of Big Data, artificial intelligence, technologies for decentralized registry maintenance, and the like, should be taken into account to regulate complex law branches. In connection with the above, adaptation of legal institutions to the dictated conditions becomes necessary. The current legal norms do not fully provide a systematic approach to the formation of the digital economy, and sometimes lead to fragmented regulation, which does not allow to fully realize the benefits of Big Data in the digital economy.

Thus, the Civil Code of the Russian Federation reflects the approach according to which data are some information units that are statically stored in spreadsheets or databases [1]. The legislator suggested that Big Data shall be understood as independent materials (articles, calculations, regulations, court decisions and other similar materials) (clause 2 of article 1260 of the Civil Code). It is difficult to agree with this position, since Big Data is a dynamic, non-stop process of the emergence of new data, some of which are not initially structured and processed in the required way, and the other part is already processed in accordance with the set goals. Big Data is a constant stream of huge amounts of information continuously coming from various sources. Obviously, the norms of “classical” legal structures cannot be fully applied to new relations, since they have a certain specificity in terms of their subjective composition, object and subject, conditions of emergence, change and termination, which leads to the need for their comprehensive regulation and revision of the existing legal regimes. There is no uniform concept, starting with the very concept of “Big Data”, which undoubtedly negatively affects the legal regulation of relations, not to mention new objects that have appeared in the field of the digital economy that did not exist before and require clarification of their nature and possibilities of legal regulation, amendments to legislation or the development of new legal regulation, given their unique nature and properties.

## 4 Discussion

Generally speaking, about the digitalization of the economy, objects in the digital field can be objects created by computer programs as a result of mathematical calculations (algorithms) digital records, virtual property, “digital twins”, technological platforms (social networks, industrial Internet, messenger, online trading platforms, information resources, etc.), “cloud” computer computing, domain names, means

of individualization of digital devices (IP addresses, accounts and personal data in social networks) and many others. As mentioned earlier, modern legislation does not fully meet the needs of the time, there is often a discrepancy between the object of regulation and the legal means and instruments applied to it. The emergence of a new form of normative legal act, including a digital law with changing content, which will act as a flexible regulator of public relations, is relevant and in demand. In these conditions, adaptation of already existing legal norms, legal institutions to the digital economy is necessary, while fundamentally new models of legal regulation, designing certain mechanisms of their interaction with law are tested.

So, for example, an attempt in civil legislation was made to take into account the peculiarities of legal regulation of Big Data turnover in the digital space—a new named type of agreement appeared—an agreement on the provision of services for the provision of information (Article 783.1. Civil Code of the Russian Federation) [1]. Such agreements were previously known to the business community, but there was a need to fix the terms of confidentiality (NDA) separately. It should be admitted that NDA is a new phenomenon for Russian law, therefore the chances of judicial protection are small, but still present.

The amendment introduced stipulates that the contract, by virtue of which the contractor undertakes to take actions to provide certain information to the customer, may establish the obligation of one of the parties or both parties not to perform actions for a certain period, as a result of which information may be disclosed to third parties. In other words, the parties or a party undertake to use anonymized data. This amendment is of great practical importance, since the data used for analysis often contains personal or relevant commercial information. Taking into account the existing steps in the legal regulation of the Big Data turnover, prediction of the growth trends of the Data driven economy influence is possible. The greatest application of Big Data is expected for decision support, forecasting, modeling and visualization, risk management, development of new products, increasing margins, and the like. According to the forecasts of companies, the use of Big Data will increase in many sectors of the economy, in particular in transportation and logistics, trade in telecommunications, financial companies, industries with the trend of development of “Industry 4.0” (the emergence of cyber—physical systems) [4, 5]. On the IT market, there are quite complete solutions for the deployment, maintenance or administration of large storages and hardware and software solutions for them. A feature of the best is the presence of embedded systems and security tools, technological solutions and a harmonious combination of used software products [3].

Hitachi Data Systems offers are in great demand, which include two specialized hardware and software complexes: a platform for storing and managing large volumes of unstructured data (Hitachi Content Platform, HCP) and solutions for providing file access to data, with saving and managing a large number of files (Hitachi Network Attached Storage (HNAS)). To protect data storages, the authors of the projects propose the use of techniques for creating a SUNDR repository, the development of digests of certified messages; rotation of keys; or creating your own cloud storage [4].

The Big Data phenomenon has made many companies realize the need to collect, analyze, store and protect structured and unstructured data. However, implementing these processes requires an action plan and the right tools to optimize the processes. The impact of Big Data will largely depend on the efficiency of management and the use of resources [8]. Large enterprises with global connections, and advanced information and communications technology infrastructures will benefit significantly more than those lagging behind in these areas. Just look at how the lists of the most expensive companies in the world by market capitalization have changed over the past ten years, in which IT companies have taken the lead - Apple Inc., Amazon, Microsoft, Facebook [2].

## 5 Conclusion

IDC predicts that about 74% of enterprises intend to maintain their investments in Big Data and business analytics at the same level or increase in the next year. This is because analytics solutions are an important business need for digital trust and resilience during the COVID-19 crisis [5]. These technologies have helped businesses cope with the impact of the pandemic by providing insight, improving business productivity and detecting fraud. In the Strategy for the development of the information technology industry in the Russian Federation for 2014–2020 and for the long term until 2025, Big Data is listed as the first among the most important breakthrough areas for the global industry, in which global technological competitiveness of Russia can be ensured with a high probability in the future 10–15 years [7]. By 2022, national standards for processing Big Data sets should be created. Thus, in the near future, we should expect the emergence of more and more cases with Big Data, in particular, the development of public–private partnerships, as well as the emergence and development of legal regulation in this area. Big Data analytics can be called the heart of the digital world by analyzing and transforming data into information that provides valuable business insights. Therefore, using of flexible regulators, primarily legal experiments to regulate the relevant social relations is necessary. In this regard, the main goal of legal regulation of the Big Data institution is the formation of a new regulatory environment that will provide a favorable legal regime for the emergence and development of innovative activities in general.

## References

1. Civil Code of the Russian Federation (part two) from 26.01.1996 N 14-FZ (as amended on 09.03.2021). [http://www.consultant.ru/document/cons\\_doc\\_LAW\\_9027/e26e72db8a044ca10322453f13c52f0f971e75df/](http://www.consultant.ru/document/cons_doc_LAW_9027/e26e72db8a044ca10322453f13c52f0f971e75df/). Accessed: 20.03.2021 (1996)
2. Grover, P., Kar, A.K.: Big Data analytics: a review on theoretical contributions and tools used in literature. *Glob. J. Flex. Syst. Manag.* **18**, 203–229 (2017)

3. Gubaydullina, E.K., Churakov, A.N.: Legal regulation of Big Data in industrial systems: problems and development prospects. In: Ashmarina, S., Mantulenko, V., Vochozka, M. (eds.), *Engineering Economics: Decisions and Solutions from Eurasian Perspective. Engineering Economics Week 2020. Lecture Notes in Networks and Systems*, vol. 139, pp. 489–494. Springer, Cham (2021)
4. Hitachi Content Platform: Modern approach to object storage. <https://www.hitachivantara.com/ru-ru/products/storage/object-storage/content-platform.html>. Accessed: 20.03.2021 (2020)
5. International Data Corporation: Asia/Pacific. Big Data analytics solutions' revenue will increase by US\$ 41.9 billion by 2024. <https://www.idc.com/getdoc.jsp?containerId=prAP47297621>. Accessed: 20.03.2021 (2021)
6. Ma, T.J., Garcia, R.J., Danford, F., Patrizi, L., Galasso, J., Loyd, J.: Big Data actionable intelligence architecture. *J. Big Data* **7**, 103 (2020)
7. Order of the Government of the Russian Federation of 01.11.2013 N 2036-r (as amended on 18.10.2018) "On approval of the Strategy for the development of the information technology industry in the Russian Federation for 2014–2020 and for the future until 2025". [http://www.consultant.ru/document/cons\\_doc\\_LAW\\_154161/22444572fce92dd3d63da856c260fb49e8f921dc/](http://www.consultant.ru/document/cons_doc_LAW_154161/22444572fce92dd3d63da856c260fb49e8f921dc/). Accessed: 20.03.2021 (2013)
8. Shabbir, M.Q., Gardezi, S.B.W.: Application of Big Data analytics and organizational performance: the mediating role of knowledge management practices. *J. Big Data* **7**, 47 (2020)

# Information Security as a Condition for Sustainable Development in the Global World



A. V. Guryanova, T. G. Stotskaya, and E. R. Khafiyatullina

**Abstract** The present study analyzes the phenomenon of information security and the ways of its potential achievement. Information security is interpreted as an important condition for the sustainable development in the global world. It's noted in the study that globalization has a significant impact on the information sphere and its functioning. This has both positive and negative consequences for the information security of the humans, states and societies. The problems of information availability and overloading the Network, of digital dividing, hacking and meddling, of cyber-crimes, cyber-terrorism and infogenic disasters are also the subjects of consideration. It's concluded that in the global era the threats of the information security sphere are more numerous than the real results of their technical overcoming. To prevent such an imbalance the international cooperation in the field of the information security must be previously developed.

**Keywords** Cybercrime · Digital divide · Globalization · Information · Information overload · Information security

## 1 Introduction

It's quite obvious that the modern world has a global face. The process of globalization implies an increasing interdependence of all spheres of social life—economic, political, cultural, technological, etc. The first steps of the coming transformation took place already in the XX century. They were manifested by the cross-border communications and the free replacements all over the world, by using English as a universal language of the international interactions, etc. The social networking links between the countries, including the Internet [1] are the symbols of the new world organization—cross-border and interdependent by its character. To the end of the XX

---

A. V. Guryanova (✉)  
Samara State University of Economics, Samara, Russia

T. G. Stotskaya · E. R. Khafiyatullina  
Samara State Technical University, Samara, Russia



century globalization has become the most actual trend of civilization development. In the beginning of the XXI century it has become a real state and a way of life of the modern society.

The economic sphere has also radically changed including complex transformations of the currency systems: the dollar has become a planetary payment unit; the euro has also been put into circulation. We often witness falling or even death of the national currencies. These are the several forerunners of the globalization process. Some later they caused fundamental changes in the whole space of the socio-economic life and activities, giving them a new transnational character. As a result, many social and economic processes have been relocated to the Net.

Thus, one of the most important resources for sustainable development of the modern countries is information [8]. For this reason achieving information security is an important task for the modern states prosperity. Information security assumes protection of the human, state and society from internal and external information threats of different nature. This ensures realization of the constitutional rights and freedoms of the human, decent quality and standards of the social life, defense and security, territorial integrity and sovereignty of the state and its sustainable socio-economic development [9].

## 2 Methodology

Various methods are complexly used to consider the phenomenon of information security and the ways of its potential achievement in the global world. There are the methods of analyses and synthesis among them. With a help of analyzing the main components of the information security sphere are found out and consistently considered. They are the information availability, overloading the Network, digital divides, etc. The method of analysis is completed by the system method helping to reach a full vision of the information security sphere. The dialectical method is used to consider the multiple conditions of the information security achievement in their correlation and interdependence. Using the evaluation method is equally important. It gives a chance to find out the different sides of the information security achieving. Among the positive aspects of this process there are an availability of information about scientific advances and technologies, an effective development of the software sector; the negative aspects include hacker attacks, meddling in the state elections and voting, increasing threats of cybercrimes and cyber-terrorism, etc. The prognostic method is used to predict potential info-genic disasters that can destroy not only the information sphere but all the national security systems as a whole. Good forecasting can help to prevent info-genic disasters in the nearest and the distant future.

### 3 Results

#### 3.1 *The Problems of Information Availability, Overloading, Security*

In the global world information has got an extremely available character. On the one hand, it's a real advantage: each human can get any information he needs [6], each state can get access to the latest foreign advances and technologies; organizations can easily obtain valuable information about their competitors. But on the other hand, available information can be deformed or even false to mislead its potential users. In such a case it impacts destructively the psyche of the modern humans. Their worldviews and opinions are formed for the most part by the third parties, making them indifferent to what is happening, too tolerant to the authorities, the present state structures, political regime, governance, etc. The availability of information can also cause information wars—a significant threat to sustainable development.

Besides that, an available character of information causes one of the greatest psychological problems of the modern time—the so-called information overload. In the case of everyday information overloading, the user continuously receives the large volumes of information from the large variety of sources. But he doesn't have time or even desire to analyze and criticize it. So, the user often chooses the simplest way of information processing—the thoughtless acceptance of its most primitive forms formulated with a help of the simplest language resources without any reflection and assessment. In such a situation the quality of any receiving information raises reasonable doubts. There are also serious problems in the field of the human intellect, due to the need to take in the increasing information flows: effectiveness of intellectual activity is rapidly falling. Without any doubt this impacts negatively the physical and mental being of the modern human.

It's necessary to mention that information accessibility sets one more important task—preservation of information including state or commercial secret, as well as any other information of limited access. This requires great efforts on the part of the information security services. The secret information can be stolen, sold, added to databases in a falsified form, etc. This can cause serious problems in the work of the social institutes and organizations, destabilize political and economic systems of the whole countries, influence negatively the process of sustainable development on a global scale.

#### 3.2 *Phenomena of Digital Dividing, Hacking and Meddling*

The highly developed technologies help to integrate all countries and states into a global information and socio-economic space. However, the level of the digital development of its participants varies greatly. Most of them are still unready to suit requirements of the digital world. This makes actual the problem of the digital divides

and causes a number of serious consequences. For example, the states undeveloped in the field of the digital technologies depend much on the digital leaders that give them a right to use their technical achievements and computer programs. But in the case of loss of the partnership relations the highly developed countries-exporters can choose a way of technological pressure or even blockade. The last one can be premeditated or unpremeditated by its character. But in any case, it's a real motivation for the low developed countries to overcome the digital divide and to develop their own software production. This needs increasing financing for the sphere of the digital and ICT technologies. Another important problem of the modern world development is an impressive rise of hacker attacks. Their aim is to plant viruses or malicious programs into various databases, to steal and collect the data of compromising character and then to distribute or to sell it. The objects of hacker actions are both personal users, companies and the whole states. Such attacks are made for the purpose of personal or economic benefit the hacker can get from the third parties, the black market or another state, if he's a representative of an opponent country. This brings the problem of information security to the level of international politics. Here hacker attacks aren't only a personal matter, but an instrument of state confrontations. The purpose of such attacks is no longer financial resources, but information of federal significance. It touches state secrets, data of military complex, precious internal information of industrial, technological and space development.

Meddling in the state elections and voting is also a problem of nowadays. This threat is closely connected to the fact of the USA presidential election in 2016 and the so-called Russian meddling in the American internal affairs. And it wasn't the end of the story. The theme of meddling has caused controversies during the new election of the head of the country in 2020. American security services were sure Russia and Iran have got data about the voters again.

### ***3.3 The Threats of Cybercrimes and Cyber-Terrorism***

One of the most serious threats to the information security is cybercrimes. Cybercrime isn't a problem for the single Internet users only, but for the whole countries and states. It has got personal, social and even international character.

The fact is that using digital technologies and developing global cooperation have a positive impact on the law enforcement achievements in the field of solving cybercrimes. Expanding contacts between the special services of different countries help to monitor the incidents of information leak and to detect the criminal actions. But despite this, the number of cybercrimes violating personal and economic rights of the humans is growing exponentially. There are several main reasons for it. First of all, today the cybercriminal can move rapidly between the states and countries all over the world and hide himself from the police; secondly, the coverage of territories by the fixation systems of different nature (for example, video surveillance systems) is still incomplete; the well-established system of legal norms in the area of information technologies is also in the stage of development. And finally most of the modern

cybercrimes have an anonymous character by the reason of their performing under a pseudonym or «nickname» that makes more difficult to identify the criminal actor.

It's also necessary to mention that the new information and communication technologies of the digital age are expanding not only the chances of the law enforcement service to solve cybercrimes, but the potential of various terrorist and extremist organizations. The main goal of cyber-terrorists is to make terrorist acts and attacks with a help of the well-developed information technologies. Such actions include the spread of information about the future terrorist attacks and the calls to enter them. The mechanisms of information influence are also widely used including the spheres of individual and collective consciousness. As a result, international and social tensions increase, religious conflicts, ethnic confrontations and enmity between different nations are escalated.

One of the most dangerous consequences of cyber-terrorist actions is the spread of the extremist ideology to the minds of the young people. Due to their age they are emotionally unstable and have a mobile psyche, so it's quite easy to impose them a wrong system of values and to make them an object of criminal manipulations. It seems that the recruitment of young people to extremist and terrorist organizations is one of the most dangerous threats in the field of information security. It touches both the levels of the state, national, international and global security systems.

### ***3.4 Overloading the Network and Infogenic Disasters***

Replacing multiple processes to the Network creates overloads for the global information system as a whole. This threat especially actualizes nowadays, in conditions of the continuing COVID-19 pandemic, the preventive measures of self-isolation and the world-wide quarantine [7]. Most part of companies that aren't directly involved in the manufacturing and agricultural spheres transfer their employees to the model of remote work; educational institutions do the same thing with their teachers and students, who are testing the format of distance learning.

Due to the need to work and learn remotely the Network must pass through and process a significantly greater amount of data than it was before the pandemic. The constantly increasing flows of data contain much more information than the Network itself was created for. Thus, during the pandemic the software failures have become more frequent. This is a real threat for the life-support systems and their effective functioning. It's also a danger for the sustainable development of the modern states and societies. Increasing cases of failures and disruptions in the space of the global Network can lead to the new infogenic disasters. Their scenario is quite real because of the present interrelations and interdependence of many social and technological processes. For example, failures in the information system of aviation or railway security taking place in a single country can paralyze transport communications and international flights all over the world. Information sphere can be destroyed in the case of infogenic disaster of any nature as well as all the other elements of the national security systems.

## 4 Discussion

All the aspects of information security analyzed above are an actual subject of discussion. Impact of globalization on the sphere of information security also requires attention. In the XXI century the process of globalization has made information security not only the personal or social problem, but also the interstate and international one. At the same time globalization is variously evaluated by the modern researchers: some of them accent the negative aspects of the universal integration and unification [5], the other—pay priority attention to the positive ones [4] or try to search a reasonable balance between positive and negative consequences [2]. But, strictly speaking, there's no matter how to treat globalization in the modern conditions. The fact is that in the XXI century globalization forms a real basis for the sustainable socio-economic development. Under the global influence the sphere of information security is significantly changing. These changes are determined by the phenomena of information availability and digital divides, overloads of human consciousness and the Network, meddling in the elections and voting, information leaks and hacker attacks, the threats of cybercrimes, cyber-terrorism and infogenic disasters. All these problems are intensively discussed in modern social [3] and computer sciences [10]. Most of them note that in the context of globalization there are both positive and negative consequences impacting information security of the modern people, states and societies. The positive ones include, for example, an availability of information about scientific advances and technologies, stimulated development of the software sector, etc.; the negative ones are connected with the dependence on the foreign software products, the growth of cybercrimes, etc. It's significant that at the present time the threats of the information security sphere are more numerous than its real advantages.

## 5 Conclusion

Thus, under the influence of globalization process the number of threats to the information security area is exponentially growing. The loads of information security services to prevent hacker attacks, cybercrimes and cyber-terrorist acts are also increasing. To resist them it's necessary to overcome the lack or even absence of the highly qualified professionals in the sphere of information technologies. Insufficient or incomplete information security measures may have the irreversible consequences of the tragic nature. The last ones affect confidentiality, violation of the private data, downfall and bankruptcy of commercial structures, leak of secret information from the resource databases of special services and political institutions, etc. With all these phenomena in view the development of the software production sphere becomes the most relevant today. And it's not only a need for the well-functioning of the various computer and operation systems in the case of quarreling or breaking up with the

software leading exporters. It's also necessary to preserve economic and information sovereignty of the modern countries.

The intensive activities of the extremist structures can't be overlooked. They cause the need for various tools and technologies to protect the Internet users (especially the young people) from the ideological propaganda and participation in the terrorist organizations. There's also a problem of the Network limited capacities making difficulties with data processing and information movement through the channels of the World Wide Web. Even a small defect in the work of computer programs can break up an habitual way of the modern life, cause the loss of secret data by state structures and special services. Perhaps, one of the most alarming tendencies of nowadays is a threat of the global infogenic disaster, which can be caused by the failures of software functioning in a number of interrelated countries. To prevent such a scenario, the international cooperation in the field of the information security must be previously reached. It's an important condition for sustainable development in the global world.

## References

1. Castells, M.: *The Rise of the Network Society*. Wiley-Blackwell, Oxford. <https://doi.org/10.1002/9781444319514> (2009)
2. Christensen, B.J., Kowalczyk, C. (eds.): *Globalization: Strategies and Effects*. Springer, Heidelberg (2017)
3. Drevin, L., Von Solms, S., Theocharidou, M. (eds.): *Information security education. Information security in action*. In: *IFIP Advances in Information and Communication Technology*, vol. 579. Springer, Cham (2020)
4. Faghih, N. (ed.): *Globalization and development: Economic and socio-cultural perspectives from emerging markets*. In: *Contributions to Economics*. Springer, Cham. <https://doi.org/10.1007/978-3-030-14370-1> (2019)
5. Guryanova, A., Astafeva, N., Filatova, N., Khafiyatullina, N., Guryanov, N.: *Global crisis: overcoming the uncertainty of the concept in the philosophical paradigm of globalization*. In: Popkova, E.G. (ed.), *The Future of the Global Financial System: Downfall or Harmony*. *Lecture Notes in Networks and Systems*, vol. 57, pp. 836–843. Springer, Cham (2019)
6. Guryanova, A., Khafiyatullina, E., Petinova, M., Frolov, V., Makhovikov, A.: *Technological prerequisites and humanitarian consequences of ubiquitous computing and networking*. In: Popkova, E.G., Sergi, B.S. (eds.), *Digital Economy: Complexity and Variety vs. Rationality*. *Lecture Notes in Networks and Systems*, vol. 87, pp. 1040–1047. Springer, Cham (2020)
7. Guryanova, A.V., Petinova, M.A., Guryanov N.Y.: *Socio-economic problems and perspectives of globalization in the context of coronavirus pandemic*. In: Ashmarina, S.I., Horák, J., Vrbka, J., Šuleř, P. (eds.), *Economic Systems in the New Era: Stable Systems in an Unstable World*. *Lecture Notes in Networks and Systems*, vol. 160, pp. 567–573. Springer, Cham (2021)
8. Makhovikov, A.E., Guryanova, A.V., Stotskaya, T.G.: *«Knowledge» and «information» in the structure of modern rationality and human activity*. In: Ashmarina, S., Mantulenko, V. (eds.), *Current Achievements, Challenges and Digital Chances of Knowledge Based Economy*. *Lecture Notes in Networks and Systems*, vol. 133, pp. 27–34. Springer, Cham (2021)

9. Ministry of Foreign Affairs of the Russian Federation: Doctrine of information security of the Russian Federation. [https://www.mid.ru/en/foreign\\_policy/official\\_documents/-/asset\\_publisher/CptlCk6BZ29/content/id/2563163](https://www.mid.ru/en/foreign_policy/official_documents/-/asset_publisher/CptlCk6BZ29/content/id/2563163). Accessed: 26.02.2021 (2016)
10. Venter, H., Loock, M., Coetzee, M., Eloff, M., Eloff, J. (eds.): Information and cyber security. In: Communications in Computer and Information Science, vol. 1166. Springer, Cham (2020)

# Stream of Commerce Involving Big Data: Legal Aspects



N. V. Deltsova, N. A. Gorshkova, and L. A. Shcherbich

**Abstract** The relevant character of the subject of research of the legal aspects of commercial use of Big Data is caused by their broad distribution under the influence of the digital technology deployment. Big Data represented in part by personal data are of great commercial interest as they give business an opportunity to make correct management and business decisions on their basis. Big Data circulation needs to take into account the specifics of distributed information, however, there is no special legal regulation in this sphere at the moment. The aim of this article is the study of fundamentals of the legal regulation, use of Big Data technologies for commercial purposes. The tasks of the research are the development of approaches to the legal regulation of the commercial use of Big Data in Russia and foreign countries, an analysis of project laws and singling out the key modern legal regulation tendencies in the indicated sphere.

**Keywords** Big Data · Commercial purposes · Digitization · Legal framework

## 1 Introduction

Information as economic resource plays the key role in the modern conditions of digitization. The stream of commerce covers a huge array of most diverse data that are transferred, processed, stored, etc. The whole world has started to use the Big Data term to define a wide range of information participating in various socioeconomic processes. According to American agency Wikibon, the world Big Data product and service market reached USD 33.3 billion in 2015 and will grow up to USD 85 billion by 2026 [3, 6].

---

N. V. Deltsova (✉)

Samara State University of Economics, Samara, Russia

N. A. Gorshkova

Vladimir Law Institute of the Federal Penitentiary Service of Russia, Vladimir, Russia

L. A. Shcherbich

University of the Prosecutor's Office of the Russian, Moscow, Russia

© The Author(s), under exclusive license to Springer Nature Switzerland AG 2022

S. I. Ashmarina and V. V. Manteulenko (eds.), *Digital Technologies in the New*

*Socio-Economic Reality*, Lecture Notes in Networks and Systems 304,

[https://doi.org/10.1007/978-3-030-83175-2\\_8](https://doi.org/10.1007/978-3-030-83175-2_8)



The interest lies not just in the availability of information and data, but in their use as a transaction object, a product with market value. The issues of commercial use of Big Data cover a number of aspects, where the legal one raises the most discussions. Although this term is widespread, there is still no unified approach to its definition. This is to a great extent related to the approaches to the legal regulation of this information resource formed by legal systems on the state level.

Big Data as a legal phenomenon are related to the information, the legal regime of which does not usually allow its monopolization. Applicable Russian laws proceed based on the principle of free information distribution. Exceptions of this principle are established in respect of legal regimes of separate information types: state, official and commercial secret, personal data, intellectual property deliverables. The use of such data is either inadmissible or admissible upon consent of their holder.

In this research, Big Data are viewed primarily as the data that come from subjects—information technology users and are then put at the disposal of persons processing such data (operators). The indicated data are often transferred unintentionally, upon exercising of own needs (placing an order in an Internet shop, ordering a taxi in a mobile app, opening an account with a bank, etc.). Big Data received by operators differ depending on the character of services and user categories (individuals, legal entities).

The spheres of application of Big Data are quite diverse. Results of processing of such data are used by: retailers to determine demand for goods and services and preferences of different customer categories, to develop personal offers for customers; banks to assess solvency of potential customers and raise the service quality including to develop separate financing terms and conditions for subjects; medical institutions to forecast the disease incidence, render medical assistance; educational institutions for effective career guidance and assistance in problems with learning, etc. Availability and correct use of Big Data give substantial competitive advantages on the market of goods, works and services.

The aim of this article is the study of fundamentals of the legal regulation, use of Big Data technologies for commercial purposes. The tasks of the research are the development of approaches to the legal regulation of the commercial use of Big Data in Russia and foreign countries, an analysis of project laws and singling out the key modern legal regulation tendencies in the indicated sphere.

## 2 Methodology

The following methods have been used to carry out the research: general scientific—analysis, synthesis, comparison, generalization; private scientific and formal legal methods. The research base includes research publications of Russian and foreign scientists and lawyers studying problems of the legal regulation of the stream of commerce involving Big Data in conditions of digitization. The research has also used analytical files on the issues related to the digital technology deployment and data processing on the basis of digital technology. The research has implied two stages.

Stage one: analysis of research and analytical Russian and foreign publications on the research subject and laws on the legal regulation of the stream of commerce involving Big Data; singling out of the research problem, purpose and methods. Stage two: wording of conclusions obtained as a result of the analysis of research and analytical publications and laws, preparation of this publication.

### 3 Results

The absolute majority of sources link the origination of the Big Data term with the name of Clifford Lynch who has used it to characterize a situation involving quick growth of volumes of different information. The Big Data term still has no legal statutory framework. This concerns not only Russian laws, but laws of the European states and the USA. The following Big Data types may be encountered in publications:

1. Structured and non-structured Big Data. The first appear in databases, information systems, etc.; the second—in audio and video records, images, graphic form, etc.
2. Big Data related to personal data that include first name and surname, date of birth, place of residence, biometrics, etc.; Big Data not related to personal data that include public transport trackers, climatic data, etc.
3. The Big Data categories also include large volumes of user data appearing in the course of the use of social media, online services, applications; and the data called the Internet of things (IoT) represented by the data of devices processing data and communicating with one another.

It is worth noting that Big Data are usually understood not just as information itself, but as information and the information (data) processing technology in aggregate. The remarkable thing is that the said technologies are more convenient to use and bear a universal character as they are successfully used in various activity spheres: “to create maps, digitalize large information arrays in foundations and libraries, forecast weather, for operations of public transport systems and processing of information on customer transactions with banks” including the automatic production sphere; there are also related to the technologies of the Internet of things (IoT) and the Internet of everything (IoE) [8].

In this research, we will proceed based on the mentioned general approach that Big Data are the aggregate of large information data and processing and analytical analysis technologies. Modern concepts describe the Big Data technologies by means of three V: Volume, Variety, Velocity. Their application in the open informational environment creates verification and confidentiality problems [7]. Commercial use of Big Data stipulates provision of such information to interested parties on a remuneration basis triggering the problem of observance of rights of personified information subjects being data holders. The following main approaches to the problem of the

search for a balance between human rights, state security and business interests may be singled out on the modern stage.

1. The American approach viewing Big Data as the key profit generating asset. There is neither specific legal regulation of Big Data nor a unified state authority in charge of the personal data and Big Data policy. Personal data are protected within the framework of a more global right to personal privacy. Some aspects of the use of personal data and Big Data are regulated by legal acts in the sphere of laws on credit activities, message confidentiality, medical insurance, financial services. Large corporations establish confidentiality terms within the legal framework, which serves as elements of self-regulation in this sphere [9].

2. The European approach significantly differs from the American one as it treats Big Data regulation in relation to personal data protection. In May 2018, European countries adopted the General Data Protection Regulation (GDPR) containing a wide definition of the personal data concept and establishing rules for their processing including in Big Data technologies. The study notes that the European Union is quite consistent in the matters of regulation of personal data processing and distribution, regulates primary data collection, processing, anonymization, use and destruction. Considering that GDPR views Big Data primarily as personal data in a broad sense, this results in the establishment of a preferential regime for anonymized data processing, increased user protection and imposition of huge fines (up to EUR 20 million) on companies for illegal use thereof and other violations [9]. GDPR also stipulates the establishment of the European Data Protection Board serving as sort of a guarantee of due fulfillment of this regulation.

3. There is no special regulation of Big Data in the Russian Federation although the term is widely used in scientific discussions, analytical articles, program acts of government authorities.

Big Data as any information are collected, stored, processed based on a legally consolidated principle of the freedom of search, obtainment, transfer, generation and distribution of information taking into account peculiarities of the legal regime of such information, namely, whether it is restricted access information or not. Thus, no problems of processing and further circulation of Big Data arise in respect of the information that may be freely processed and transferred. A reverse situation occurs when such restrictions are imposed, and additional consent from the data subject for data processing and transfer is required. In this case, the Russian Federation as well as the majority of states comes across the problem of processing of first and foremost personal data, the use of which requires a consent. Needless to say, there is a need for Big Data processing taking into the account the modern digitization development tendencies and introduction of artificial intelligence technologies in many spheres. The Russian legislator proceeds based on the principle of observance of civil rights to all protected secret and personal data types. In particular, it is mentioned in the Concept of the Development of Regulation of Relationships in Artificial Intelligence Technologies and Robotics Until 2024 approved by Resolution of the Government of the Russian Federation No. 2129-p of 19.08.2020 [4].

The indicated legal act points at the need for adaptation of the existing statutory regulation in personal data processing towards the assurance of favourable legal

conditions for safe and responsible access of the developers of artificial intelligence systems and robotics to data and safe exchange of various data types including the data collected by state authorities and medical institutions [4]. The document covers the change in the existing approaches to the regulation of anonymized data, which corresponds to the European tendencies of regulation of Big Data relationships.

The practical preparation of the Russian legal framework for changes in terms of digitization takes place within the Federal Project The Statutory Regulation of the Digital Environment of the Digital Economy national program. Bill No. 992331-7 On the Amendment of the Federal Law On Personal Data was developed and introduced into the State Duma in July 2020 to carry out events within this project [10]. The bill is aimed at the assurance of favourable legal conditions for data collection, storage and processing using new technologies in terms of the establishment of the procedure for personal data anonymization, the procedure for obtainment of consent for personal data processing and the regulation of large data volume circulation taking into the account the need for protection of human and civil rights and freedoms at personal data processing. The bill stipulates the opportunity to give consent for personal data processing for several purposes at once and to several persons processing personal data at the request of the personal data operator. The bill stipulates the obligation to use information protection means having duly passed the compliance procedure held by the Federal Security Service of Russia or the Federal Service for Technology and Export Control of Russia to assure protection of civil rights at personal data destruction. The above mentioned provisions give an opportunity for transfer of anonymized data from one subjects to others including based on civil transactions. In this regard, Art. 783.1 has been introduced in The Civil Code of the Russian Federation [11] fixing the structure of an information provision agreement including within an information system. It is important to note that an agreement may stipulate the obligation not to perform actions that may result in disclosure of transferred information to third parties. Thus, there remains an opportunity to impose restrictions on personal data processing and further transfer on the level of laws on personal data and civil laws. The presented legislative solutions are aimed at achievement of a balance of private law interests of a specific citizen, business community and the state in general in the problem addressing direction.

## 4 Discussion

The legal aspects of using Big Data are actively discussed in scientific discussions and literature. The article by Ruan and Liang [7] is devoted to the problems of imperfect legislation and legal risks. Issues of legal protection of personal data in Big Data systems are discussed in the article by Deltsova [2]. Hoffman explore the problems of medical Big Data and its legal regulation [5]. The problems of personal data protection are analyzed in the article Bogdan and Kirillova [1]. The use of employee data and the need for collective protection is discussed in Todolí-Signes [12]. Issues

of law enforcement practice in the use of data and technologies based on artificial intelligence are described by Zharova, Elin, Panfilov [13].

## 5 Conclusion

Active use of digital technologies has required changes in the traditional approaches to storage, processing and use of information data. The appearance of such phenomenon as Big Data including large information arrays and information processing technologies has triggered a legal gap in the legal field of many countries due to the absence of any special legal regulation of the mentioned phenomenon. The carried out study has shown that at present there is no single concept of Big Data consolidated on the legal level. There exist different approaches to the data named Big Data. The use of personified information is regulated differently. It should be noted that the majority of countries proceed based on the priority of protection of personified information primarily personal data allowing commercial use of anonymized data. Legislative initiatives in the sphere of commercial use of Big Data are currently on the stage of establishment in the Russian Federation. Their introduction gives birth to many questions and discussions but even now one can conclude that the existing tendencies of the development of the statutory regulation will undoubtedly lead to the creation of a solid legal framework giving rights to processing and use of Big Data in the stream of commerce.

## References

1. Bogdan, V.V., Kirillova, E.A.: Problems of personal data protection when using Big Data technologies. *J. Appl. Eng. Sci.* **3**(18), 438–442 (2020)
2. Deltsova, N.V.: Personal data and digital technologies: problems of legal regulation. In: Ashmarina, S., Vochozka, M., Mantulenko, V. (eds.), *Digital Age: Chances, Challenges and Future. Lecture Notes in Networks and Systems*, vol. 84, pp. 557–563). Springer, Cham (2020)
3. Finos, R., Burris, P., Floyer, D., Gilbert, G.: 2016–2026 worldwide Big Data market forecast. Wikibon. <https://wikibon.com/2016-2026-worldwide-big-data-market-forecast/>. Accessed: 12.01.2021 (2016)
4. Government of the Russian Federation: Concept of the development of regulation of relationships in artificial intelligence technologies and robotics until 2024 approved by Resolution of the Government of the Russian Federation No. 2129-p of 19.08.2020. [https://www.economy.gov.ru/material/directions/gosudarstvennoe\\_upravlenie/normativnoe\\_regulirovanie\\_cifrovoy\\_sredy/robototekhnika\\_i\\_iskusstvennyy\\_intellekt/](https://www.economy.gov.ru/material/directions/gosudarstvennoe_upravlenie/normativnoe_regulirovanie_cifrovoy_sredy/robototekhnika_i_iskusstvennyy_intellekt/). Accessed: 12.01.2021 (2020)
5. Hoffman, S.: Electronic health records and medical Big Data: Law and policy. [https://papers.ssrn.com/sol3/papers.cfm?abstract\\_id=2884976](https://papers.ssrn.com/sol3/papers.cfm?abstract_id=2884976). Accessed: 12.01.2021 (2016)
6. InnMind: How Big Data market works in Russia. <https://app.innmind.com/articles/49>. Accessed: 10.02.2021 (2018)
7. Ruan, L., Liang, D.: Legal risk of net information dissemination in Big Data era. *J. Phys. Conf. Ser.* **1533**, 042067 (2020)
8. SecureNews: Big Data and information security. Analytical review. [https://www.securenews.ru/big\\_data/](https://www.securenews.ru/big_data/). Accessed: 15.02.2021 (2017)

9. Sosnin, K.A.: The legal regulation of Big Data: the foreign and national experience. *J. Intellectual Rights Court* **9**(25), 30–42 (2019)
10. State Duma: Bill No. 992331-7 On the Amendment of the Federal Law on Personal Data. <https://sozd.duma.gov.ru/bill/992331-7> Accessed: 14.02.2021 (2021)
11. The Civil Code of the Russian Federation (part 2) No 14-FZ of 29.01.1996. [http://www.consultant.ru/document/cons\\_doc\\_LAW\\_9027/](http://www.consultant.ru/document/cons_doc_LAW_9027/). Accessed: 12.01.2021 (1996)
12. Todolí-Signes, A.: Algorithms, artificial intelligence and automated decisions concerning workers and the risks of discrimination: the necessary collective governance of data protection. *Eur. Rev. Labour Res.* **25**(4), 465–481 (2019)
13. Zharova, A., Elin, V., Panfilov, P.: Introducing artificial intelligence into law enforcement practice: the case of Russia. In; Katalinic, B. (ed.), *Proceedings of the 30th DAAAM International Symposium*, pp. 0688–0692. DAAAM International, Viena (2019)

# Digital Innovation in the Light of the Experimental Legal Regime



E. A. Efremova and E. S. Gordienko

**Abstract** The article explores the latest legal acts in the field of legal relations regulation using digital innovations. The concept of the term “digital innovation” is analyzed, it is emphasized that its scope is practically unlimited. Attention is drawn to the objective need and statutory possibility of introducing a pilot legal regime and applying special regulation for a certain group of persons and in a certain territory for a particular period of time, due to the absence of general binding rules, requirements and standards. The author relates the concept and basic rules of establishing an experimental legal regime and a legal experiment, and identifies different goals, grounds and procedure for establishing.

**Keywords** Assessment of the risks of damage · Digital innovation · Experimental legal regime · Initiative proposal to establish an ELR · Regulatory/regulation sandboxes

## 1 Introduction

Since Schumpeter proposed one of the first definitions of innovation as economic category: this has been a process function determining quantitative changes in the product, considering account changes in total of factors acting on it [10], a little more than 100 years have passed. This is not so much in human history. On the other hand, during these hundred years there have been global changes, in almost all areas of human activity. And the term “innovation” today is practically used exclusively and inextricably with another “digital.”

Historically it developed that laws almost always don’t get on well behind development of society and the public relations, especially at dynamic spheres to which

---

E. A. Efremova (✉)  
Samara State University of Economics, Samara, Russia

E. S. Gordienko  
The Economic Crime and Anticorruption Unit of Police Management of Samara Region Russian Federation, Samara, Russia

also spheres of the artificial intelligence (AI) and robotics (PT) [13]. Therefore, technical innovations often exist outside the legal field. The backlog of regulatory rules in the field of artificial intelligence in Russia was the reason for taking urgent measures and the Federal Law of 31.07.2020 No. 258-FZ “On experimental legal regimes in the field of digital innovation in the Russian Federation” (hereinafter referred to as the Law on ELR) confirmed this [8]. The experimental legal regime (hereinafter referred to as the ELR) under the Federal Law of 23.05.2020 N 152-FZ “On conducting an experiment on the organization and implementation of remote electronic voting in a city of federal significance in Moscow” consists primarily in the application of special regulations for a concrete period of time in relation to a certain group of persons or in a certain territory [4]. Such special regulation may involve the non-application of certain normative legal acts or their separate norms of general regulation in force at the time of the establishment of the ELR (for example, on licensing, accreditation, certification, etc.) [11].

The concept of “experimental legal regime” is consistent with the term “legal experiment,” the essence of which is also the creation of special rules of law that operate in a certain territory for a certain time period. The essence of both is accordingly to establish exceptions to existing legal norms. Objectively, a legal experiment should be carried out according to a pre-developed program, in order to test a scientific hypothesis, under the control of its implementation.

The possibility of introducing an experimental legal regime in the area of digital innovation was also preceded by large preparatory work with Russian high-tech companies (including MTS, Yandex, Medsi, the National Medical Knowledge Base and the Big Data Association (ABD), the Advanced Research Foundation). With the adoption of the Law “On ELR,” the Russian state, the scientific and business community for the first time had a system mechanism for testing technologies in real legal relations, which earlier, primarily due to the inertia of legislation, could not be used (digital innovations, artificial intelligence, blockchain, Big Data, neurotechnologies, quantum technologies, virtual reality) [9].

## 2 Methodology

The methodological basis of the work is the dialectic-materialistic method of knowing legal reality, along with which the general scientific (modeling, forecasting, a systemic approach, etc.) were also used. From private scientific methods of cognition, such methods as logical, sociological, formal-legal, comparative-legal, etc., were used. The theoretical study base was a special legal literature devoted to various aspects of digitalization and the problems of experimental legal regimes. The provisions and conclusions of the study are also based on a study of the norms of federal and regional legislation and other regulatory legal acts. The specificity of the study lies in a detailed legal analysis of the category of experimental legal regime, which appeared in relatively recently in domestic legislation. The concept of “digital sandboxes,” which are a short story for the law of foreign countries, is being studied. The



study focuses on the practical problems associated with the operation of experimental legal regimes.

### 3 Results

The legal definition of “digital innovation” is enshrined in the Law “On ELR”. Digital innovations, according to the said Act, are novel or substantially improved products, processes or methods put into use, created or used in all directions, provided for in Part 2 of Art. 1 of the Law “On ELR”, using technologies, list of which was approved by the Government of the Russian Federation in October 2020 [1] and includes neural technologies, AI, quantum and manufacturing, robotics and sensor technology, wireless comm(unications), virtual and augmented reality, industry Internet technologies and industry digital technologies. In the direction of the “financial market”, the list of technologies of distributed registry systems is determined by the Bank of Russia [16], which together with the technologies indicated by the Government of the Russian Federation, included, in particular, biometric technologies, digital identification and authentication technologies, payment technologies and technologies used for the transfer of electronic funds, etc.

Already today, within the area of ELR in the field of digital innovation, the Government of the Russian Federation can provide a limited number of companies in a certain territory and for a certain time comply with the current legislation with a number of features, which will allow the use of these technologies.

The term Regulatory Sandbox—has appeared in Europe in relation to a special legal regime that allows entities engaged in the development of new technologies without the risk of violating current legislation as part of an experiment to introduce these technologies in a strictly limited environment [2]. Thanks to the successful application, the mechanism of regulation sandboxes began to spread, and was introduced in the USA, Singapore, the UAE, Switzerland, China and several other countries. The first Russian regulatory sandbox was created by the Bank of Russia in 2018 with the purpose of piloting and swiftly introducing new financial services and technologies (in particular biometric banking authentication, automated consulting services, etc.).

At the end of July 2020, the Ministry of Economic Development presented projects for Russian “regulatory sandboxes” (6 orders by the Ministry of Economic Development) [15]. Among the first projects under the experimental regimes are regulatory measures to financially stimulate the development of AI (artificial intelligence) industry and robotics (hereinafter referred to as RT). This means that entrepreneurs in the area of digital innovation have an objective opportunity to develop and test technologies that exist outside the legal field.

## 4 Discussion

Initially, it was assumed that in the Russian Federation “regulatory sandboxes” will be possible only in several areas (medical and pharmaceutical, e-learning and remote educational technologies, remote trade, the financial market, industry, transport, construction, state and municipal services). But in the final version of the Law “On ELR,” the list of areas of application of “regulatory sandboxes,” in fact, remained open—the Russian Government can supplement this list by introducing new directions for the development, testing and introduction of digital innovations (sub. 9 clause 2 of Art. 2 of the Law “On ELR”).

The decision to establish the ELR and approve its program is made by the Government of the Russian Federation in case of a positive conclusion following the consideration of the initiative proposal of the initiator or initiators—legal entities or individual entrepreneurs (clause 4 of article 10 of the Law “On ELR”) [8]. However, it should be emphasized specifically that, i.e.x. the participants of the ELR, for whom the required conditions will be created for the development and implementation of AI technologies, as well as the following possible use of the results of the use of AI, should be in the subject of the Russian Federation—the City of Moscow (Federal Law of 24.04.2020 No. 123-FZ [6]).

The founding of ELRs in the sector of digital innovation and artificial intelligence is allowed provided that that the general regulation of relations contains requirements, regulations, prohibitions that limit or significantly hinder the possibility of introducing digital innovations, although the technological feasibility of their application exists and the establishment of ELRs should lead to the achievement of the goals, specified in the program, while downsizing possible risks of causing danger to human life and health, the defense of the country and the security of the state, remaining values protected by federal law. The result of the work of regulatory sandboxes is the spread of development and testing of digital innovations in the ELR to almost all spheres of human life (item 2 of article 1 of the of the Law “On ELR”).

An initiative proposal to establish an ELR may come from legal entities or individual entrepreneurs (clause 1 of article 8 of the Law “On ELR.” While the initiative to introduce a legal experiment belongs to the exclusive prerogative of the authorities. A legal experiment is most appropriate and effective if there is reason to believe that a regulatory change will have a new positive effect [14].

The objectives of the introduction of an experimental legal regime in the area of digital innovation are not only the improvement of general regulation based on the results of the implementation of the experimental legal regime and the development of favorable conditions for the creation and realization of digital innovations, but also the formation of new types and forms of economic activity and its implementation, the development of competition, attracting investment, ensuring the development of science and social sphere, etc. The achievement of these goals depends entirely on the advancement of IT (information technologies), their security for the individual, society, and the state, that is, unpredictable in advance.

The purpose of the legal experiment is to determine the possible positive and/or negative consequences of the introduction of a new legal regulation. A positive example of a legal experiment is the rejection of legal regulation in certain areas (for example, financial, construction markets, etc.) and the transition to self-regulation of business entities [3]. The special tax regime “Tax on professional income” may be established at the finish of the legal experiment to establish a special tax regime, which is consistently introduced on the area of the constituent entities of the Russian Federation, determined by Law [7] and will last until 2028. The universal introduction of remote electronic voting may be introduced following the results of a legal experiment on the organization and realization of distance electronic voting in Moscow [4]. Amendments to labor legislation and (if necessary) to the legislation of the Russian Federation on employment of the population regarding the use of electronic documents related to work in the area of labor relations are possible based on the results of a legal experiment on the use of electronic documents related to work [5].

New steps and the introduction of innovations are not always associated with a legal experiment. For example, the judicial system of the Russian Federation, which has long begun to introduce and use digital technologies in the form of a court data file, the ability to submit documents in electronic form. At the same time, the introduction and use of such technologies outpaced the development of procedural legislation, that is, at first such innovations began to be applied, and only then came under legal regulation. The pandemic has pushed all spheres of life, including the judicial system, to a rapid modernization, which includes the ability to participate in the court session through video conferencing, which removes all territorial difficulties and guarantees participation in the trial without significant costs for the parties to the case. But the legislator foresaw such a possibility and therefore made appropriate changes to the procedural legislation in advance. Thus, the judicial system introduced innovations in two ways and without the use of ELR. From this we can conclude that the ELR is applied by the legislator in the following cases: if it is necessary to implement urgent legal regulation of the issue and the possible consequences can be serious enough to leave the issue unregulated.

Legislation on the protection of rights to various non-traditional objects of intellectual property implements the same principles that are laid down in legislation for other types of intellectual property, but has significant features related specifically to the nature of the mentioned objects. Since only legal entities and individual entrepreneurs can apply to consider the possibility of applying the ELR, any individual who has knowledge or a specific new technology should receive an appropriate legal status.

## 5 Conclusion

Gradually, questions of the technique of constructing, implementing and applying legal norms became the object of officially permitted research and influence. Legal

technique appears in history simultaneously with law, but at different stages of history its content is not the same, the relationship between law and legal technique is flexible. On the one hand, legal technique is primary in relation to legal doctrine, as historically it precedes it. On the other hand, it is secondary, since it is embedded in the legal doctrine, due to its nature.

In the last century, technological processes have evolved much more slowly. Now you will not see anyone permanent new products that are born literally overnight. It is for this reason that regulatory sandboxes appeared only in the twenty-first century, since it is almost impossible to manage to change legislation in another way so that it meets modern trends and requirements. The pandemic further accelerated the digitalization process, and we all learned to meet and learn online, and documents sent by e-mail and other means of communication became the proper means of evidence without the need to explain why this method was chosen.

The introduction of something new, as a rule, involves possible risks. When conducting a legal experiment, such risks are usually low and predictable [12], which allows you to take the necessary measures before its introduction, for example, to ensure information security and information protection when organizing and conducting remote electronic voting by the operator of the regional portal of state and municipal services in Moscow. On the contrary, the introduction of an experimental legal regime in the area of digital innovation entails a high risk of damaging the vital interests of both the individual and society and the state as a whole.

In connection with this, the Law “On ELR” imperatively requires justification in the initiative proposal on the introduction of ELR in the field of innovative technologies for assessing risks of causing damage to subjects of civil traffic, defense and (or) security of the state, other values protected by federal law and measures aimed at minimizing such risks. In turn, the ELR program should contain not only an assessment of such risks and measures aimed at minimizing them, but also identify supervisory bodies that will monitor the progress of the ELR. The identification of unforeseen risks that cannot be addressed by the ELR subject during the duration of this ELR is the basis for the termination of the experiment. Thus, the improvement of general legal regulation founded on results of the realization of ELRs in the sector of digital innovation is completely made dependent on the results of the introduction of ELRs. In this way, relations arising from activities involving a high risk of harm to the crucial interests of the individual, society and the State cannot be legally regulated.

## References

1. Decree of the Government of the Russian Federation of 28.10.2020 No. 1750 “On the approval of the list of technologies used in the framework of experimental legal regimes in the field of digital innovation”. [http://www.consultant.ru/document/cons\\_doc\\_LAW\\_366246/](http://www.consultant.ru/document/cons_doc_LAW_366246/). Accessed: 24.03.2021 (2020)
2. European Commission: Consultation document FinTech: A more competitive and innovative European financial sector. [https://ec.europa.eu/info/sites/info/files/2017-fintech-consultation-document\\_en\\_0.pdf](https://ec.europa.eu/info/sites/info/files/2017-fintech-consultation-document_en_0.pdf). Accessed: 24.03.2021 (2017)

3. Federal Law of 01.12.2007 N 315-FZ “On self-regulatory organizations”. [http://www.consultant.ru/document/cons\\_doc\\_LAW\\_72967/](http://www.consultant.ru/document/cons_doc_LAW_72967/). Accessed: 24.03.2021 (2020)
4. Federal Law of 23.05.2020 N 152-FZ “On conducting an experiment on the organization and implementation of remote electronic voting in a city of federal significance in Moscow”. [http://www.consultant.ru/document/cons\\_doc\\_LAW\\_353204/](http://www.consultant.ru/document/cons_doc_LAW_353204/). Accessed: 24.03.2021 (2020)
5. Federal Law of 24.04.2020 N 122-FZ “On conducting an experiment on the use of electronic documents related to work”. [http://www.consultant.ru/document/cons\\_doc\\_LAW\\_351124/](http://www.consultant.ru/document/cons_doc_LAW_351124/). Accessed: 24.03.2021 (2020)
6. Federal Law of 24.04.2020 No. 123-FZ. [http://www.consultant.ru/document/cons\\_doc\\_LAW\\_351127/](http://www.consultant.ru/document/cons_doc_LAW_351127/). Accessed: 24.03.2021 (2020)
7. Federal Law of 27.11.2018 N 422-FZ “On conducting an experiment to establish a special tax regime “Tax on professional income”. [http://www.consultant.ru/document/cons\\_doc\\_LAW\\_311977/](http://www.consultant.ru/document/cons_doc_LAW_311977/). Accessed: 24.03.2021 (2020)
8. Federal Law of 31.07.2020 No. 258-FZ “On experimental legal regimes in the field of digital innovation in the Russian Federation”. [http://www.consultant.ru/document/cons\\_doc\\_LAW\\_358738/](http://www.consultant.ru/document/cons_doc_LAW_358738/). Accessed: 24.03.2021
9. Ministry of Economic Development of the Russian Federation: Experimental legal regimes. [https://www.economy.gov.ru/material/directions/gosudarstvennoe\\_upravlenie/normativnoe\\_regulirovanie\\_cifrovoy\\_sredy/eksperimentalnye\\_pravovye\\_rezhimy/](https://www.economy.gov.ru/material/directions/gosudarstvennoe_upravlenie/normativnoe_regulirovanie_cifrovoy_sredy/eksperimentalnye_pravovye_rezhimy/). Accessed: 24.03.2021 (2020)
10. Schumpeter, J.A.: Theory of economic development. Director-Media, Moscow (2019)
11. Shuvalova, M.: Experimental legal regimes: Prospects for introduction in Russia. <https://www.garant.ru/article/1315582/>. Accessed: 24.03.2021 (2020)
12. Sidorova, A.V.: Judicial risk in the legal risk system: general theoretical aspect. *Russian Justice* **10**, 34–37 (2020). <https://doi.org/10.18572/0131-6761-2020-10-34-37>
13. Sidorova, A.V.: Subject structure of the offense in artificial intelligence (AI) and robotics. In: Ashmarina, S.I., Vochzka, M., Mantulenko, V. (eds.), *Digital Age: Chances, Challenges and Future. Lecture Notes in Networks and Systems*, vol. 84, pp. 541–547. Springer, Cham (2020)
14. Sivitsky, V., Sorokin, M.: Legal experiment and development of law. *J. Higher School Econ.* **4**, 15–30 (2016)
15. TASS: Izvestia: The Ministry of Economic Development has identified a list of projects for testing “regulatory sandboxes”. <https://tass.ru/ekonomika/8731589>. Accessed: 24.03.2021 (2020)
16. The instruction of the Bank of Russia of 25.11.2020 No. 5634-U. [http://www.consultant.ru/document/cons\\_doc\\_LAW\\_37.4332/](http://www.consultant.ru/document/cons_doc_LAW_37.4332/). Accessed: 24.03.2021 (2020)

# Big Data Applications in the Pharmaceutical Industry



A. M. Izmaylov, A. V. Evstratov, and E. Heidelberg

**Abstract** In the presented article, the authors investigate the issue of the role and significance in the application of technologies for processing large data arrays using Big Data in the development of the pharmaceutical industry. Taking into account all the complexity and knowledge-intensiveness of the process of developing and launching a new drug on the market, the introduction of new approaches to the collection of additional information can significantly facilitate and simplify this procedure. It is also important that the use of Big Data technologies in pharmaceuticals significantly reduces the cost of the development process and minimizes possible risks associated with human health. In this regard, the relevance of the application of Big Data technology in the pharmaceutical business today is extremely relevant, since both manufacturing companies and consumers benefit. Within the framework of this work, the authors set the goal to analyze the main areas of the pharmaceutical business, the use of Big Data technology in which today is the most in demand.

**Keywords** Analysis · Big Data · Digital economy · Pharmaceutical industry

## 1 Introduction

Today, one of the decisive roles in the development of many branches of science and industry is played by information technologies, which combine the capabilities of high-speed analysis of huge data sets from different sources simultaneously. In this case, the term “Big Data” is used—Big Data. At that time, the explosive growth of data volumes on a global scale became one of the main megatrends [2, 5, 7]. The processing and application of Big Data in the economy today is an integral part of the development of modern market and social relations. Now we are already living in

---

A. M. Izmaylov (✉)  
Samara State University of Economics, Samara, Russia  
e-mail: [airick73@bk.ru](mailto:airick73@bk.ru)

A. V. Evstratov · E. Heidelberg  
Volgograd State Technical University, Volgograd, Russia

© The Author(s), under exclusive license to Springer Nature Switzerland AG 2022  
S. I. Ashmarina and V. V. Manteulenko (eds.), *Digital Technologies in the New Socio-Economic Reality*, Lecture Notes in Networks and Systems 304,  
[https://doi.org/10.1007/978-3-030-83175-2\\_10](https://doi.org/10.1007/978-3-030-83175-2_10)

full measure the era of Big Data, which is reflected in most areas of market relations [6, 11, 12]. One of these areas is pharmaceuticals.

The pharmaceutical industry is one of the most knowledge-intensive and dynamically developing. In this regard, information technologies have found application in the development, production and sale of medicines and other types of pharmaceutical products. One of the main reasons for the relevance of Big Data technologies in the pharmaceutical industry can be reflected in the thesis of the head of the Icahn School of Medicine at Mount Sinai, medical mathematician and computational biologist Schadt, who said that today the main limitations of medicine and the pharmaceutical industry are associated with a lack of understanding biological nature of diseases [9]. In this regard, the study of wide layers of primary data on the dynamics of the development of a particular type of disease opens up a wide scope for improving knowledge in the production of pharmaceuticals. The theoretical analysis of the material made it possible to identify a number of areas in the field of pharmaceuticals, where technologies for processing large amounts of data have found a worthy application.

## 2 Methodology

The research is based on general scientific research methods. These methods include such as: the method of system analysis, scientific abstraction and generalization, comparative and categorical analysis, empirical description. The research is based on the analysis of theoretical and statistical material. Scientific publications of Russian and foreign scientists serve as the source of theoretical material. The works used are devoted to the development of pharmaceuticals and information technologies. Also, the information was used from the official websites of major pharmaceutical manufacturers and leading information and analytical publications. As a result of the study, the authors obtained material concerning the impact of the development of systems for analyzing large data arrays on the development of the pharmaceutical industry.

## 3 Results

The processing of Big Data in the development of the pharmaceutical industry has found its application in a number of areas, which include such as: predictive modeling, clinical trials, interaction between industries, sales and marketing of pharmaceutical products, digital applications in the pharmaceutical field, collection of clinical data about patients, identifying side effects from medications. Let's take a closer look at each of these areas in the Table 1.

The predictive modeling method, widely used in statistics, has been given a new lease of life with the advent of Big Data technology. Today information technologies

**Table 1** The role of Big Dates in selected areas of pharmaceuticals

| Sphere   | Influence of Big Data on this area  |
|--|---|
| Predictive modeling  | Analysis of large data sets related to indicators of human physiology, their genetic and anatomical features, as well as the effect of various diseases on the body, makes it possible to calculate the degree of usefulness of a drug for patients. Here, the so-called predictive modeling is used, which determines the degree of risk from the use of a particular drug for a person  |
| Clinical trials  | The stage of clinical trials of a medicinal product, through which all the newest developed drugs pass without exception, can be significantly simplified using Big Data technologies. This means that the sample of patients most suitable for testing a new type of drug can be formed on the basis of data on large groups of people. In this case, the time spent on preparing a sample of patients is significantly reduced  |
| Interaction between industries                             | Companies working in the field of pharmaceuticals using Big Data processing technologies get the opportunity to interact in real time with specialists from various fields, such as scientists, marketers, sociologists, insurance companies, distributors, and so on. Interaction makes it possible to receive operational information about the state of development of a particular pharmaceutical product, the level of its potential demand, the purchasing power of the population, and so on. This information can be used to adjust the rate of development, volumes, distribution channels, and the need for a particular drug |
| Sales of products and marketing of pharmaceutical products | Predictive analysis based on Big Data technology is able to generate information useful in terms of marketing and sales of pharmaceutical products. Pharmaceutical company representatives can focus on specific specialists in a specific geographic area and patients who are most likely to require advanced drug treatment based on predictive analysis data. This approach makes marketing pharmaceutical products cheaper and easier, while reducing risks  |
| Pharmaceutical digital applications                        | Modern communication systems such as social networks and various mobile applications actively accompany the circulation of pharmaceutical products. Many medicines are now ordered and purchased using specialized applications, electronic marketplaces and Internet sites. Data from electronic medical records and other databases that accumulate information about patients are also important in this aspect  |
| Collecting clinical data from patients                     | Modern hospitals accompany the treatment process by entering all the information into electronic medical records. A large information layer consisting of data on the treatment of patients is of great interest to pharmaceutical manufacturers, since it makes it possible to study in detail the structure of the morbidity of the population, as well as the peculiarities of the dynamics of treatment of people in a particular geographic zone   |
| Identifying side effects of medications                    | Modern information technology has significantly advanced predictive analytics. A detailed check of dozens of types of characteristics of a drug being developed or developed makes it possible to identify the presence and possible manifestation of side effects of a pharmaceutical drug. Actual drug use data is collected outside of the traditional randomized clinical trials that are the mainstay of drug testing today, and interest in this area is growing rapidly  |

Source Authors



make it possible to process such large amounts of data in a short time, which are very far beyond the scope of human capabilities. At the same time, the scope for applying this method is becoming wider. According to specialists from the International Data Corporation (IDC) and Seagate, in 2020 the global volume of information stored in the form of electronic data was about 33 zettabytes. However, this figure is projected to reach 175 zettabytes by 2025 [10].

Different areas of life produce different amounts of data. One of the areas that generate large amounts of data is the field of medicine. The rapid increase in the volume of digital data in the field of medicine is associated primarily with the complication and availability of diagnostic equipment [8]. Today, for example, the radiology department is capable of producing up to several terabytes of data per calendar year [1].

The benefits of using Big Data in pharmaceuticals can rely on the one hand on the analysis of data generated in medicine, and on the other, on the data that insurance companies collect about patients who consume medical services. Accordingly, the use of data from completely different areas of life can significantly enrich the final information used in the development and promotion of new drugs.

## 4 Discussion

The use of Big Data analysis in the pharmaceutical industry has broad prospects for development. The accompanying factors in this aspect are such as the high speed of development of information technologies in general, active digitalization of all spheres of human life, an increase in the speed of information transfer on the Internet, the introduction of the use of artificial intelligence in the activities of enterprises, and so on. Big Data analysis is often associated with the use of artificial intelligence (AI) technologies. In recent years, a number of major players in the market have formed partnerships with technology companies in the field of AI. For example, AstraZeneca is working with Ali Health, a subsidiary of China's Alibaba, on a system in which AI will find the right drugs for specific patients. And Johnson & Johnson Innovation, along with Janssen and WinterLight Labs, the developer of an AI platform for cognitive health diagnostics, will try to uncover the facts of neurodegenerative diseases at an early stage by analyzing the patient's speech recordings.

However, there are factors that inhibit the diffusion of these technologies into the pharmaceutical business. Here, first of all, it is necessary to say about the high cost of technology implementation [3, 4]. In 2018, the volume of the global Big Data and business analytics market reached \$ 168.8 billion. According to IDC estimates, at the end of 2019, the volume of the global Big Data market increased by 12%, compared to with the indicators of the previous year, and reached 189.1 billion dollars [10]. In addition, in the period 2018–2022, the market is expected to grow at a CAGR of 13.2%. Thus, the market size may increase to \$ 274.3 billion by 2022.

## 5 Conclusion

Summing up the results of the study, we can draw the following conclusions:

1. Predictive modeling in the context of the development of the pharmaceutical industry is a serious tool based on the analysis of significant arrays of electronic data obtained at various stages of research, development, testing, production and sale of drugs. One of the most significant effects of using Big Data technologies in this area is, first of all, reducing costs: financial, time, material, intellectual, etc. The development of technologies allows us to speak about the high potential of predictive modeling in the pharmaceutical industry.
2. Clinical trials thanks to the use of Big Data technologies, first of all, become safer and faster. A huge number of factors analyzed at high frequencies make it possible to calculate the outcome of individual stages of clinical trials. The most significant positive effects from the use of Big Data in this area of pharmaceuticals can be considered precisely the minimization of the likelihood of risks.
3. Interaction between industries becomes more mobile, wide and full-fledged in the case of using Big Data technologies. The most significant positive effect here can be noted a multiple increase in efficiency in the development of pharmaceuticals, depending on the levels of demand for such in particular geographic areas or social strata.
4. One of the consequences of the synergistic effect in the interaction of various areas related to the development and sale of drugs is a breakthrough in the marketing and sale of pharmaceutical products. Here we are talking primarily about a significant increase in the effectiveness of marketing and advertising of drugs, built on the basis of an analysis of wide data sets on the level and structure of the population's needs for drugs.
5. Diffusion of digital technologies in the overwhelming majority of spheres of human life provides a wide range of data simply for the accumulation of primary data on completely different indicators of human life. Data processing using Big Data technology makes it possible to build a clear picture of human needs, as well as predict them. The effectiveness of using Big Dates in this aspect lies primarily in the access to data for predictive analysis of the behavior of the consumer of pharmaceutical products.
6. The positive side of the use of Big Data technologies in the aspect of collecting clinical data is manifested primarily in the emergence of opportunities for predicting the effectiveness of the use of individual types of drugs in the course of a particular type of disease. With this approach, we can talk about an increase in the effectiveness of drug therapy.
7. However, it is also important to identify side effects from drugs on the basis of processing and multivariate analysis of indicators of the activity of human physiological systems. The most important, in our opinion, here is the reduction of risks to human health both at the stage of clinical trials of drugs and at the stage of their active use in drug therapy.

## References

1. Anishchenko, V.V., Van'kevich, P.E., Kovalev, V.A., Kutsan, N.V., Lapitskiy, V.A., Linev, V.N.: The use of digital scanning devices and advanced telemedicine and innovative technologies in the diagnosis of lung diseases. OIPI NAN Belarusi, Minsk (2010)
2. Evstratov, A.V., Ezangina, I.A., Novozhenina, E.V.: Information and analysis support for pharmaceutical business management. In: IOP Conference Series: Materials Science and Engineering, vol. 483, 012035 (2019)
3. Izmailov, A.M., Ashamrina, S.I., Evstratov, A.V.: Entrepreneurial activity in the pharmaceutical industry under digital economy conditions. In: Ashmarina, S.I., Mantulenko, V.V. (eds.), Proceedings of the 2nd International Scientific Conference GCPMED 2019—Global Challenges and Prospects of the Modern Economic Development. European Proceedings of Social and Behavioural Sciences, vol. 79, pp. 734–738. European Proceedings, London (2020)
4. Izmaylov, A., Saraev, A., Barinova, Z.: The development of the domestic pharmaceutical industry in the context of digitalization. In: Ashmarina, S., Mantulenko, V. (eds.), Current Achievements, Challenges and Digital Chances of Knowledge Based Economy. Lecture Notes in Networks and Systems, vol. 133, pp. 181–188. Springer, Cham (2021)
5. Izmaylov, A.M., Smolkin, V.P., Evstratov, A.V.: Support for pharmaceutical entrepreneurship in Russia during the pandemic of “covid-19”. In: Ashmarina, S.I., Mantulenko, V.V., Inozemtsev, M.I., Sidorenko, E.L. (eds.), Global Challenges and Prospects of The Modern Economic Development. European Proceedings of Social and Behavioural Sciences, vol. 106, pp. 846–853. European Proceedings, London (2021)
6. Loshkarev, A.V.: Applied pattern of artificial intelligence and Big Data in business. In: Ashmarina, S., Mantulenko, V. (eds.), Current Achievements, Challenges and Digital Chances of Knowledge Based Economy. Lecture Notes in Networks and Systems, vol. 133, pp. 383–388. Springer, Cham (2021)
7. Lynch, C.: Big Data: how do your data grow? *Nature* **455**(7209), 28–29 (2008)
8. Partik, B., Schaefer-Prokop, C.: Digital radiology in chest imaging. In: Hruby, W. (ed.), Digital (R)Evolution in Radiology, pp. 189–203. Springer, Vienna (2001)
9. Schadt, E.E.: The changing privacy landscape in the era of Big Data. *Mol. Syst. Biol.* **8**(1), 612 (2012)
10. TASS: Expert: The volume of data in the world will grow more than five times by 2025. <https://tass.ru/ekonomika/6209822>. Accessed: 20.03.2021 (2019)
11. Zastupov, A.V.: Increasing innovation, technology and digital potential of industrial enterprises. In: Ashmarina, S.I., Mantulenko, V.V. (eds.), Proceedings of the 2nd International Scientific Conference GCPMED 2019—Global Challenges and Prospects of the Modern Economic Development. European Proceedings of Social and Behavioural Sciences, vol. 79, pp. 113–121. European Proceedings, London (2020)
12. Ziyadin, S., Suieubayeva, S., Utegenova, A.: Digital transformation in business. In: Ashmarina, S., Vochozka, M., Mantulenko, V. (eds.), Digital Age: Chances, Challenges and Future. ISCDTE 2019. Lecture Notes in Networks and Systems, vol. 84, pp. 408–415. Springer, Cham (2020)

# Personal Data Protection as a Basis of Digitalization



E. B. Kalashnikova

**Abstract** Digital technologies do not change the fundamental values, rights and freedoms enshrined in the basic law of the modern state. However, new technological challenges require the affirmation and clarification of fundamental rights in relation to new technologies. Numerous problems of digital environment are associated with ensuring the protection of personal data, which is due to insufficient legal regulation. The article deals with some new legal aspects on the personal data protection issues in the Russian Federation, the Republic of Belarus and the Republic of Kazakhstan. It is concluded that the legislation of the three countries develops in different ways and with different degree of development of the issue of personal data protection. There is no doubt in Russian Federation about the right to use personal data, including images, from open sources, such as social networks. The paper concludes that maintaining registers of personal data operators is an outdated practice, since in modern conditions almost all legal entities and individual entrepreneurs process personal data to some extent in the course of their activities.

**Keywords** Digitalization · Operators register · Personal data

## 1 Introduction

The use and introduction of various digital technologies, including tracking and facial recognition systems, in recent years is a serious and well-founded citizens concern. Firstly, the risk of invasion on the inviolability of private life increases, including due to the lack of guarantees of citizens personal data protection from leakage, as well as the lack of guarantees of their use exclusively for law enforcement [1, 2]. Secondly, despite the need to maintain the autonomy of domestic technologies in the face of the unpredictability of external sanctions pressure, the digital systems being developed and intended for practical implementation may contain serious technical errors. Such errors in the case of insufficient elaboration of these systems can negatively affect

---

E. B. Kalashnikova (✉)  
Samara State University of Economics, Samara, Russia

the future life of citizens, harming their legitimate rights and interests and violating the presumption of innocence. For example, the remaining high probability of errors in the recording by means of artificial intelligence, depending on the gender, age or ethnicity of citizens, can have unpredictable consequences for each individual citizen. In general, citizens' concern about the threat of total control from the state has increased especially in the context of the coronavirus epidemic.

On March 1, 2021, amendments to the Federal Law of the Russian Federation No. 152-FZ of 27.07.2006 "On personal data" [3] came into force, according to which a person can request restrictions on the use and deletion of personal data from any operator who became aware of personal data. The reason for such a decision is no longer required to indicate the subject of personal data. All operators are required to comply with the provisions of the law, including those that publicly post personal data for general access. Amendments to the current legislation are aimed at more correct use of personal data received by the operator for processing. First of all, it is important for operators to take into account the relevance of the data which they deal with and the consequences of their actions. Since violations in the storage and transfer of third-party data still occur in one way or another, the operators did not have a clear idea of the need to obtain written consent to the transfer of any personal data.

The year 2020 and the beginning of 2021 were marked by significant changes in the legislation of not only the Russian Federation, but also the Republics of Belarus and Kazakhstan, despite the fact that the legislation development in the sphere of the personal data protection goes in different ways in these countries. While Kazakhstan drew attention to the developments of the European Union in the field of personal data protection and decided to use them in its legislation, Belarus continues to build its way in the studied issue without actually using other people's developments. Nevertheless, the main thing that unites the legislation of all three studied states in the work is the protection of personal data, which is the most important issue in the conditions of digitalization of all spheres of life.

## 2 Methodology

The division and the content of the Russian legislation, in particular it relates to its branches and institutions, as well as the legal systems of other countries of the world, cannot decide at the moment how to go forward in modern technological conditions. The study is devoted to the consideration of issues on the personal data protection in Russia, Belarus and Kazakhstan, as the digitalization basis. The author studied the existing legal acts of the listed countries, which regulate the issues of personal data protection. With the help of general scientific methods, namely the functional method of cognition, various sources of law—federal laws and subordinate legal acts, are studied. Methods and tools of formal, logical, process study, strategic, statistical and comparative analysis, expert assessment, forecasting and regulatory planning were used to solve the tasks. Legal science should provide answers to numerous

questions about the use of new technologies and offer legal models and institutions that consider the advantages of their use, taking into account some risks associated with the technological solutions and responsibility for the made decisions. In the world of new digital technologies, many events have taken place over the past decades that have dramatically affected the system of law and legislation.

### 3 Results

Prior to the amendments made by Federal Law No. 519-FZ in the Russian Federation, the legislation in the sphere of personal data enabled the collection and subsequent uncontrolled use of personal data on Internet sites for purposes other than the purpose of their initial distribution, which violated the principle of goal-setting [4]. The burden of proving the illegality of the processing of personal data on any resource or Internet site lay on the subject of personal data, which was a significant problem, since finding the person who owns the site, as well as achieving the deletion of data, required significant efforts and time.

The new version of the law provides for the right of a personal data subject to apply to any personal data operator with a request to remove his personal data from public access without additional conditions for proving the fact of illegal processing of personal data. The issue of using photos and other personal information obtained from open sources, for example, pages in social networks, was also settled. If earlier there was ambiguity in the interpretation of the legislation provisions on personal data, now the legislator has solved this issue—the publication and further use of the citizen image is allowed only with the consent of this citizen, regardless of the publication source. The first reading in the State Duma of the Russian Federation was passed by another draft law on the personal data processing, its provisions are aimed at the possibility of granting consent to the processing of personal data in writing simultaneously for several purposes, as well as to several persons who process personal data on behalf of the personal data operator [5]. This is relevant, for example, for the work of marketplaces, where the obtaining and processing of the order is carried out by one person, the direct seller is another person, and the courier service delivers the goods, being a third party in the process of one legal relationship for retail purchase and sale.

Despite the tightening of the rules for the processing and protection of personal data, there are still many questions in Russian legislation about the procedure for applying the legislation on the protection of personal data and its compliance with other legal areas. For example, a taxpayer—a legal entity, is required to verify its counterparties, but it is not always clear with what legal means to conduct the audit and to what regulatory framework refer. The introduction of digital technologies led to the development of such services as “Transparent business” of the Federal Tax Service, “Contour.Focus” of a private company, etc.), where some information about the individual entrepreneur, for example, about the address, is missing.

In this framework, it is still not clear whether the passport data of an individual entrepreneur belongs to the personal data category, and whether these data may be published in open sources. According to Art. 3, under “personal data” we understand any data that relates to a certain individual in a direct or indirect way [3]. Depending on the type of legal relationship and the specific sanctions for the offenses committed, the status of an entrepreneur differs—an individual, an official, or a person equated to a legal entity. At the same time, according to paragraph 5, part 1, article 6, part 2, article 10 of the above-mentioned law, the processing of personal data of a personal data subject without his consent is allowed if this processing is necessary to perform a contract and the personal data subject is a party or beneficiary or guarantor. Thus, when entering into a civil law contract with an individual entrepreneur and the requirement to provide personal data complies with the law, while obtaining consent from it for their processing is not required.

## 4 Discussion

In Russia, the definition of personal data, the legislator does not specify how such data is recorded. That may seem quite logical in the context of the rapid technological development, in particular it relates to various information carriers. Another situation is in the Republic of Kazakhstan, where according to Art. 1 of the Law of the Republic of Kazakhstan No. 94-V of 21.05.2013 “On personal data and its protection” [6] personal data is information related to a certain subject, recorded on electronic, paper and (or) other physical data carrier. The same concept is given in the latest rules for the collection and processing of personal data [7]. On June 7, 2020, amendments to the Law of the Republic of Kazakhstan came into force [8]. The legislator stated that the General Data Protection Regulation [9] (rules for the processing of personal data, GDPR) is a law of direct effect in 28 EU countries and on its basis the Data protection agency in Kazakhstan will operate. First of all, the provisions were borrowed, which fixed the obligation of legal entities to appoint those who are responsible for the personal data organization and processing. The duties of the responsible person in the personal data protection area include internal control over compliance with the legislation, control over the reception and processing of requests from personal data subjects or their legal representatives.

A big step to simplify the work of the business was to supplement the goals of depersonalized processing of personal data with marketing research. Previously, such goals included statistical, sociological, and scientific research, but due to the widespread development of e-commerce and analytical sales services, it became necessary to expand the goals and include marketing in it [10]. On July 17, 2020, another amendments were made to the Law of the Republic of Kazakhstan No. 94-V of 21.05.2013 concerning the rights of state revenue bodies to collect and process personal data of citizens without their consent [11]. The purpose of personal data collection and processing is the tax administration and control of information from individuals and legal entities in accordance with the Kazakhstan laws.

In contrast to the Russian Federation and the Republic of Kazakhstan, the protection of personal data in the Republic of Belarus is at a completely different level. Despite the fairly high level of legislation in the Republic of Belarus, there is no single legal act in the field of personal data protection. The development of a single regulatory act began in 2018 and in June 2019 passed the first reading in the form of a Draft Law of the Republic of Belarus “On personal data” [12]. However, since then, the bill has not progressed further, and the state apparently believes that the current regulatory framework is sufficient to regulate the protection of personal data.

The absence of a single regulatory act does not mean that personal data does not fall under legal regulation at all. For example, the Law of the Republic of Belarus No. 455-Z of 10.11.2008 “On information, informatization and information protection” [13] in Art. 1 establishes the concept of personal data where personal data is divided into the main and additional data on an individual subject to entry in the specific register in accordance with the Belarus legislative acts, as well as other data that allows identifying such a person. The principles of legal regulation of information relations include, among other things, the protection of information about the private life of an individual and personal data, which means the protection of personal data of citizens by a regulatory legal act. According to the Draft Law of the Republic of Belarus “On personal data”, the main condition for storing personal data of Belarusian citizens will be the transition to Belarusian hosting, as well as the establishment of a position responsible for the protection of personal data or the establishment of an additional department [12]. It is necessary to note that since March 1, 2021 in Belarus a special article in the Code of the Republic of Belarus on administrative offenses No. 91-Z of 06.01.2021 [14] establishes liability for violation of the legislation on the personal data protection (Art. 27.3). Previously, the existing regulations, which in one way or another affected the field of personal data protection, did not cover a significant part of the violations and there were no cases of prosecution for violations of the legislation in the field of personal data.

The studied CIS countries maintain registers of personal data operators, which is a common practice in the world. However, this approach is considered outdated. Maintaining the registry was relevant when the use of computer systems and programs was a rare case. Currently, the processing of personal data is carried out by almost all legal entities and individual entrepreneurs. In the course of the activity, the data of employees, customers and other entities are processed. For example, an individual entrepreneur who provides services in the field of law receives passport data from a client to prepare a claim statement for further appeal to the court. There are an infinite number of such examples, so it is necessary to admit that the operators of personal data are all legal entities and individual entrepreneurs, and the maintenance of the operators register is quite outdated and wastes the resources of the state.



## 5 Conclusion

The establishment of special regulation in relation to the development, creation, implementation, sale, and turnover of certain digital technologies is inextricably linked with the establishment of a special procedure for processing depersonalized personal data in order to form a comprehensive system for regulating public relations arising in connection with the development of information technology and its usage [15]. Democratic states have long found a common language in the application of the main principles of personal data protection and confirmed their applicability to the digital field, but in fact, their implementation differs significantly in different countries [16]. The new Russian legislation leads to a tightening of the rules for the processing of personal data, in contrast to the amendments of 2013–2014, when the Russian legislation expanded the list of cases in which the consent of the subject of personal data is not required [17]. Silence or inaction under no circumstances can be considered consent to the personal data processing authorized by the personal data subject for their distribution [18].

Nowadays, the development level of information technologies has increased significantly: no person can be hidden from the variety of technical devices used for data collection, storage and processing. In addition, virtually all legal entities and individual entrepreneurs collect and process personal data in one way or another, so maintaining registers of personal data operators is irrelevant [19]. The main principles of personal data protection are transparency and clarity of the requirements for data processing operators and the provision of individuals with the opportunity to control the actions of the operators processing their personal data and stop processing at will. Ensuring the protection of personal data at a high level is ensured through the establishment of fines and other serious civil, administrative and criminal measures, so the legislation of any state is updated with appropriate norms.

## References

1. Sidorova, A.V., Galustova, A.V.: The essence of the concept of “privacy”. In: Khasaev, G.R. (ed.), Proceedings of the I All-Russian Correspondence Scientific and Practical Conference Russian Science: Current Research and Developments, pp. 265–268. Samara State University of Economics, Samara (2016)
2. Zolkin, A.L., Abdulmukminova, E.M., Malikov, V.N., Lepshokova, A.N.: Problems of personal data and information protection in corporate computer networks. IOP Conf. Ser.: Mater. Sci. Eng. **1047**(1), 012102 (2021)
3. Federal Law No. 152-FZ of 27.07.2006 “On personal data”. [http://www.consultant.ru/document/cons\\_doc\\_LAW\\_61801/](http://www.consultant.ru/document/cons_doc_LAW_61801/). Accessed: 20 March 2021 (2006)
4. Federal Law No. 519-FZ of 30.12.2020 “On amendments to the Federal Law “On personal data”. [http://www.consultant.ru/document/cons\\_doc\\_LAW\\_372682/](http://www.consultant.ru/document/cons_doc_LAW_372682/). Accessed: 20 March 2021 (2020)
5. Draft Law No. 992331-7 “On amendments to the Federal Law “On personal data”. <https://sozd.duma.gov.ru/bill/992331-7>. Accessed: 20 March 2021 (2021)

6. Law of the Republic of Kazakhstan No. 94-V of 21.05.2013 “On personal data and its protection”. [https://online.zakon.kz/Document/?doc\\_id=31396226](https://online.zakon.kz/Document/?doc_id=31396226). Accessed: 21 March 2021 (2013)
7. Order of the Minister of Digital Development, Innovations and Aerospace Industry of the Republic of Kazakhstan No. 395/NK of 21.10.2020 “On approval of the rules for the collection and processing of personal data”. <http://adilet.zan.kz/rus/docs/V2000021498>. Accessed: 21 March 2021 (2020)
8. Law of the Republic of Kazakhstan No. 347-VI of 25.06.2020 “On amendments and additions to certain legislative acts of the Republic of Kazakhstan on the regulation of digital technologies”. [https://online.zakon.kz/Document/?doc\\_id=34230083](https://online.zakon.kz/Document/?doc_id=34230083). Accessed: 21 March 2021 (2020)
9. Regulation (EU) 2016/679 of the European Parliament and of The Council of 27 April 2016 on the protection of natural persons with regard to the processing of personal data and on the free movement of such data, and repealing Directive 95/46/EC (General Data Protection Regulation). <https://eur-lex.europa.eu/legal-content/EN/TXT/?uri=CELEX%3A32016R0679>. Accessed: 21 March 2021 (2016)
10. Ismagilova, O.D., Khadzhi, K.R.: World experience in regulating data protection, transmission, and storage. *Econom. Policy* **3**, 152–175 (2020)
11. Law of the Republic of Kazakhstan No. 359-VI of 03.07.2020 “On amendments and additions to certain legislative acts of the Republic of Kazakhstan on mortgage loans in foreign currency, improving the regulation of payment services market entities, universal declaration and restoration of economic growth”. [https://online.zakon.kz/Document/?doc\\_id=35083101](https://online.zakon.kz/Document/?doc_id=35083101). Accessed: 21 March 2021 (2016)
12. Draft Law of the Republic of Belarus “On personal data”. <https://pravo.by/document/?guid=3871&p0=h10800455>. Accessed: 21 March 2021 (2019)
13. Law of the Republic of Belarus No. 455-Z of 10.11.2008 “On information, informatization and information protection”. <https://pravo.by/document/?guid=3871&p0=h10800455>. Accessed: 21 March 2021 (2008)
14. Code of the Republic of Belarus on administrative offenses No. 91-Z of 06.01.2021. [https://pravo.by/upload/docs/op/HK2100091\\_1611262800.pdf](https://pravo.by/upload/docs/op/HK2100091_1611262800.pdf). Accessed: 21 March 2021
15. Xue, Y., Zhou, Z.: Research on personal information protection system of network information platform under the background of big data. In: Kierans, G., Liu, H., Ng, E.H.K. (eds.), Proceedings of the International Conference on New Energy Technology and Industrial Development (NETID 2020). *E3S Web of Conferences*, **235** (03033). Les Ulis: EDP Science. (2021)
16. Sokolova, M.E.: The first successes of the new European general regulation on the protection of personal data. *Contemporary Europe* **2**, 56–66 (2020)
17. Zharova, A., Elin, V., Panfilov, P.: Personal data in cloud. Russia experience. In: Katalinic, B. (ed.), Proceedings of the 28th DAAAM International Symposium, pp.1136–1142. DAAAM International, Vienna (2017)
18. Cheng, W.: Selection of a model for civil law protection of personal information. *Soc. Sci. China* **42**(1), 117–134 (2021)
19. Sidorova, A.V., Cherevichenko, T.S., Efremova, E.A., Medentseva, E.V., Azarkhin, A.V.: The institute of banking secrecy in the CIS: rather-legal analysis. *J. Adv. Res. Law Econom.* **9**(3), 1110–1115 (2018)

# Legality of Sanctional Mechanisms Use in the Internet



N. N. Kovaleva, S. A. Kulikova, and D. A. Karev

**Abstract** The article studies the problems of the legality of the use of sanctional mechanisms in the Internet. Currently, the regulation of digital platforms is the main focus of legal policy in many developing countries. Thus, there are three main directions for strengthening the legal regulation of Internet platforms: firstly, the change in the regulation of online platforms and the formation of uniform rules on the territory of the European Union, which contributes to increasing the competitive ability in this area; secondly, the strengthening of control over contents that incites hostility and hatred on the Internet, and thirdly, the development of a single bill in the field of confidential data. It is concluded that the application of sanctions is the most important regulator of information relations in the Internet. The use of higher fines effectively affects the behavior of participants in legal relations. However, the size of the fine should be supported by enforcement processes—for example, representative localization requirements.

**Keywords** Internet · Internet platforms · Information relations · Sanctions mechanisms

## 1 Introduction

For a long time, discussions about the regulation of digital platforms have been dominated by the position of the need to provide such entities with sufficient protection and create conditions for their potential development. Today, there are clear signs that attitude towards Internet platforms is tightening in both industrialized and developing

---

N. N. Kovaleva  
Saratov State Law Academy, Saratov, Russia

S. A. Kulikova  
Saratov Chernyshevsky National Research State University, Saratov, Russia  
e-mail: [kulikovasveta@inbox.ru](mailto:kulikovasveta@inbox.ru)

D. A. Karev (✉)  
Samara State University of Economics, Samara, Russia

countries. In recent years, these countries have adopted a large number of regulations that increase the reliability of large, digital platforms and provide for the responsibility of digital service providers for illegal content published by users. The change also affected the antimonopoly legislation, in particular, it establishes liability for the improper quality of goods sold on Internet platforms. In the EU countries, huge attention is paid to social networks, so the adopted laws oblige to transfer to public authorities the IP addresses of people who publish content that promotes incitement to hostility and hatred. The issue of the confidentiality of personal data of Internet users is also not ignored.

## 2 Methodology

During the work on the topic, the following methods were actively used. Methods of formal logic, such as description, comparison, analysis, and synthesis. They made it possible to conduct research on the current legislation, identify a number of gaps in legal regulation and put forward proposals for their elimination. The concrete-historical method allowed us to analyze the process of development of the analyzed object. And the formal legal method, which revealed a number of defects in the regulatory implementation of sanctional mechanisms in the Internet. The use of these methods made it possible to form concrete suggestions for the addition and amendment of legal acts in the field of digital space. The purpose of the study was to develop and justify the provisions of the legality of sanctional mechanisms use in the Internet, as well as to form specific suggestions for improving law enforcement practices in the field of online platforms.

## 3 Results

The technology industry is facing increasingly high penalties in the field of competition law (antitrust law) both in the US and in the EU. For example, in the United States, the Antitrust Department of the Ministry of Justice states that it will aim for damages reparation if it finds violations of antitrust legislation. In July 2019, the agency launched an investigation into the market-leading online services platforms. As part of the proceedings, the antitrust department of the Ministry of Justice studied Google's activities for more than a year and concluded that the Internet platform harms competition. "As one of the wealthiest companies on the planet with a market value of \$1 trillion, Google is the monopoly gatekeeper to the internet for billions of users and countless advertisers worldwide. For years, Google has accounted for almost 90% of all search queries in the United States and has used anticompetitive tactics to maintain and extend its monopolies in search and search advertising", said the Antitrust Department of the US Department of Justice [1].

Regulators can hit companies that they believe violate antitrust rules with heavy fines and strict restrictions that will weaken their competitiveness [2]. There is a similar experience in Europe: in 2018, the European Commission fined Alphabet, the parent company of Google, on a record amount of 4.34 billion euros (\$5.06 billion) for abuse of a dominant position. This is the largest fine in the history of antitrust proceedings in Brussels. As EU antitrust policy commissioner Margaret Vestager notes, today, mobile internet makes up more than half of global internet traffic. It has changed the lives of millions of Europeans. Our case is about three types of restrictions that Google has imposed on Android device manufacturers and network operators to ensure that traffic on Android devices goes to the Google search engine. In this way, Google has used Android as a vehicle to cement the dominance of its search engine. These practices have denied rivals the chance to innovate and compete on the merits. They have denied European consumers the benefits of effective competition in the important mobile sphere. This is illegal under EU antitrust rules [3].

In February 2019, the German antitrust authority decreed that Facebook abused its virtual monopoly on social media by combining data from Instagram, WhatsApp, and third-party sites. In addition, Facebook received a 100 million dollars fine from the U.S. Securities and Exchange Commission (or SEC) [4]. The SEC fine relates to Facebook's alleged failure to properly warn investors about its risks. Facebook agreed to pay 100 million dollars to settle the charges.

In 2017, Germany adopted a law on social networks, according to which social network administrations are required to transmit to the authorities the IP addresses of people who publish statements that incite hostility and hatred. For violation of this law, fines of up to 50 million euros are provided for legal entities [5].

The German Federal Office of Justice fined Facebook Ireland Limited for 2 million euros [6]. The fine was imposed on the company due to the fact that it violated its obligation to provide an annual report on the handling of complaints about illegal publications. The report submitted in July 2018 was incomplete: it does not reflect all complaints, in addition, it does not give a complete and transparent picture of the progress of complaints processing and violates the German law "On Improving law enforcement in relation to social networks" [7] or, in its more popular name, the "Facebook Law", according to which social media platforms are required to report the number of complaints they receive about illegal content. We are talking about a wide range of statements: from insulting government officials to direct calls for violence. Given the size of the fine—up to 50 million euros—the operator companies immediately began to remove the content.

In June, France adopted the law on combating incitement to hatred in the Internet (Loi n° 2020-766 du 24 juin 2020 visant à lutter contre les contenus haineux sur internet), according to which Internet platforms are required to remove public messages inciting hatred based on race, religion, sexual orientation, gender, health status, as well as containing sexual harassment, within 24 h; remove calls for terrorism and pornography involving children within one hour, and for intentionally misrepresenting information when filing a complaint for removal the content may result in a penalty of one year's imprisonment and/or a fine of up to 15 thousand euros [8].

**As a measure of responsibility, fines** of up to 1 million 250 thousand euros are also provided; and in case of repeated violation-up to 4% of the annual global turnover of the online platform.

The US Federal Trade Commission (FTC) fined Facebook for five billion dollars due to the leak of personal data of users [9]. As part of the agreement concluded with the authorities, the company's founder, Mark Zuckerberg, have to be personally responsible for maintaining the protection of users' personal data. In case of violation of data privacy laws by the company Facebook, Zuckerberg may be brought to criminal responsibility, among other things. The 5 billion dollars fine imposed on Facebook is the largest fine ever imposed on any company for violating sensitive user data. This is one of the largest fines ever imposed by the US government for any violation.

In the field of data privacy, we can also note the Personal Data Protection Bill 2019, which was submitted by the Ministry of Electronics and Information Technologies on December 11, 2019, which is being considered in the Indian Parliament [10]. The bill establishes a requirement for local data storage in India and imposes penalties for violating the confidentiality of personal data in the form of fines: organizations that do not notify data leaks or do not fulfill their obligations to monitor data privacy will be fined up to approximately 730,000 US dollars, or 2% of the company's global turnover. A group of associations, which includes the US Chamber of Commerce, the US-India Business Council (USIBC), the Japan Electronics and Information Technology Manufacturers Association (JEITA) and digital Europe, expressed confidence that the data localization policy will restrain global technology companies from continuing their business in India, as local data storage will increase the company's costs by 30–60%, while not guaranteeing data security. The bad news for companies is that the penalties in the bill are also based on its European GDPR analog.

In December 2018, the Data Access Act was passed in Australia, which provides for a fine of up to 10 million AUD dollars for companies and a prison sentence for individuals who refuse to hand over data related to suspected illegal activities [11]. The Australian government said that bill is necessary to protect national security and counter organized crime. Special services will need to obtain a warrant to access personal data [12]. Until July 2020, the US was the only country to introduce unilateral cyber sanctions. First used in 2015 by President Obama against North Korea in response to the country's alleged cyberattack on Sony Pictures, cyber sanctions became a retaliatory mechanism acting on criminals beyond the reach of law enforcement agencies. The cyber sanctions regime established in the United States allows the imposition of sanctions against individuals and entities that are considered responsible for (or participate in) malicious cyber activities, damage or significantly hinder the provision of important services, significantly violate access to a computer or network of computers, or do not misappropriate funds, resources or intellectual property. Ransomware is a type of malicious software that blocks access to a victim's computer systems or data, often using encryption. The attackers then demand a ransom in digital currency in exchange for unlocking access to the data, usually with a decryption key or an unlock code.

## 4 Discussion

Thus, the European Union is preparing a large-scale reform of the regulation of online platforms. The European Commission started public consultations on the draft of Digital Services Act. It should change the regulation of online platforms and form uniform rules on the territory of the European Union [13]. Online platforms, companies that interact with customers via the Internet; authorities, non-governmental organizations, scientists and other interested parties will be able to express their opinion on these issues. The new EU law will deal with the establishment of liability for the improper quality of goods that are sold on Internet platforms. The issue of combating counterfeit products was in the Internet for a long time, but it escalated due to the COVID-19 pandemic. In May 2020, general director of Facebook, Zuckerberg, during a video conversation with the European commissioner for internal market affairs Breton, called on the EU to show the world an example in regulating Internet platforms [14]. In addition, common rules are needed to strengthen the European single market. In the meantime, the countries are acting separately.

It can also be said that only Internet giants, in cooperation with state authorities, are able to constantly monitor content that incites hostility and hatred, and quickly remove it. In France, such a body is the Conseil supérieur de l'audiovisuel, the Supreme Council for audiovisual media. It can impose a fine for refusing to cooperate with law enforcement agencies, including by not releasing data that may allow identifying the persons who posted the alleged illegal content—in the amount of up to 250 thousand euros. In case of repeated non-compliance with the requirements of the law, a fine of up to 4% of the annual global turnover of the online platform is applied. On November 6, 2018, the Parliament of Mauritius passed an amendment to the Information and Communication Technology Act (ICTA), which aims to regulate and restrict harmful and illegal content and activities carried out through any information and communication service, including telecommunications services, by increasing the penalties and prison sentences for offenders [15].

In accordance with the International Emergency Economic Powers Act (IEEPA) and the Trading with the Enemy Act (TWEA), American citizens are prohibited from making transactions with countries under sanctions or people included in the OFAC “sanctions list” [16]. As the number of ransomware attacks increases, companies are emerging to help simplify payments to hackers. So, the University of California in San Francisco was attacked on June 1 by the hacker group NetWalker. A leading medical research institution working on a cure for Covid-19 admitted paying hackers a 1.14 million dollars (910,000 pound sterling) ransom after secret negotiations.

Cybersecurity experts say that this kind of negotiations is now being conducted around the world—sometimes for even large sums—against the advice of law enforcement agencies, including the FBI, Europol, and the UK's National Cyber Security Center. This is of particular concern to the Government. The notice says that the payment of ransoms allows hackers to receive money, while the purpose of sanctions is to deprive them and the government of access to capital. Ransom payments made

to sanctioned individuals during ransomware attacks can be used to finance activities that are unfavorable for the purposes of US national security and foreign policy. OFAC can impose penalties for violating sanctions, even if the person paying the ransom did not know that he was involved in an illegal transaction.

## 5 Conclusion

The prospect of sanctions is a powerful weapon for regulating information relations in the Internet. Potential penalties for non-compliance with national legislation are kept at a high level. Therefore, for business, compliance with the law is an indisputable fact. This is especially important in cases where the object of regulation—for example, a multinational business—is subject to regulation by another state or several states. For example, a business that is subject to conflicting laws may choose to comply with the law of a state that threatens higher fines at the expense of non-compliance with the law of another state with lower penalties. Against this background, it is not surprising to see something like a race of states for the order of imposing increasingly large potential fines. The threat of high fines should be backed up by real enforcement processes—for example, representative localization requirements. In this context, there is a practice where the courts, as a mechanism for ensuring effective enforcement, indicate to freeze the company funds. Another important factor is related to the value of the analyzed market. If, in practice, there is a risk that high fines will be effectively applied on a market that is not of great value to the subject of regulation, such as a multinational enterprise, then this business may leave the market completely. The combination of high fines and an unpredictable, complex law creates higher risks that are harder to mitigate. Under these conditions, smaller countries—both industrialized and developing, are at a competitive disadvantage because their markets are less valuable. Developing countries with weak law-enforcement tools at their disposal may be even more disadvantaged.

## References

1. The United States Department of Justice: Justice department sues monopolist Google for violating antitrust laws. <https://www.justice.gov/opa/pr/justice-department-sues-monopolist-google-violating-antitrust-laws>. Accessed: 23 March 2021 (2020)
2. Chunly, S.: Social media and counterpublic spheres in an authoritarian state: Exploring online political discussions among Cambodian Facebook users. *Discourse, Context Media*, **34**, 100382 (2020)
3. European Commission: Antitrust: Commission fines Google €4.34 billion for illegal practices regarding Android mobile devices to strengthen dominance of Google's search engine. [https://ec.europa.eu/commission/presscorner/detail/en/IP\\_18\\_4581](https://ec.europa.eu/commission/presscorner/detail/en/IP_18_4581). Accessed: 23 March 2021 (2018)
4. SEC: To pay \$100 million for misleading investors about the risks it faced from misuse of user data. <https://www.sec.gov/news/press-release/2019-140>. Accessed: 23 March 2021 (2019)



5. Jha, C.K., Kodila-Tedika, O.: Does social media promote democracy? Some empirical evidence. *J. Policy Model.* **42**(2), 271–290 (2020)
6. Bundesamt für Justiz: Bundesamt für Justiz erlässt Bußgeldbescheid gegen Facebook. <https://www.bundesjustizamt.de/DE/Presse/Archiv/2019/20190702.html>. Accessed: 23 March 2021 (2019)
7. Act to improve enforcement of the law in social networks. [https://www.bmjv.de/SharedDocs/Gesetzgebungsverfahren/Dokumente/NetzDG\\_engl.pdf?\\_\\_blob=publicationFile&v=2](https://www.bmjv.de/SharedDocs/Gesetzgebungsverfahren/Dokumente/NetzDG_engl.pdf?__blob=publicationFile&v=2). Accessed: 23 March 2021 (2017)
8. Loi n° 2020-766 du 24 juin 2020 visant à lutter contre les contenus haineux sur internet. [https://www.assemblee-nationale.fr/dyn/15/dossiers/lutte\\_contre\\_haine\\_internet](https://www.assemblee-nationale.fr/dyn/15/dossiers/lutte_contre_haine_internet). Accessed: 23 March 2021 (2020)
9. Limba, T., Sidlauskas, A.: Secure personal data administration in the social networks: the case of voluntary sharing of personal data on the Facebook. *Entrepreneurship Sustainability Issues* **5**(3), 528–541 (2018)
10. Initial Comments of Dvara Research dated 16 January 2020 on the Personal Data Protection Bill 2019 introduced in the Lok Sabha on 11 December 2019. <https://www.dvara.com/research/wp-content/uploads/2020/01/Initial-Comments-on-the-Personal-Data-Protection-Bill-2019.pdf>. Accessed: 23 March 2021 (2019)
11. DLA Piper: Australia: Assistance and Access Act, December 2018—Uncertainty created by new rushed-in data encryption laws. <https://blogs.dlapiper.com/privacymatters/australia-assistance-and-access-act-december-2018-holy-grail-of-uncertainty-created-by-new-rushed-in-data-encryption-laws/>. Accessed: 23 March 2021 (2019)
12. Korobiichuk, I., Fedushko, S., Juś, A., Syerov, Y.: Methods of determining information support of WEB community user personal data verification system. In: Szewczyk, R., Zieliński, C., Kaliczyńska, M.: (eds.) *Automation 2017. ICA 2017. Advances in Intelligent Systems and Computing*, vol. 550. Springer, Cham, pp. 144–150 (2017)
13. Saurwein, F., Spencer-Smith, C.: Combating disinformation on social media: multilevel governance and distributed accountability in Europe. *Digit. J.* **8**, 820–841 (2020)
14. O’Leary, N.: Facebook’s Zuckerberg calls for more regulation of big tech. <https://www.irishtimes.com/business/technology/facebook-s-zuckerberg-calls-for-more-regulation-of-big-tech-1.4256579>. Accessed: 23 March 2021 (2020)
15. E-Services: ICT Act amended to regulate and curtail harmful and illegal contents and activities. <http://www.govmu.org/English/News/Pages/ICT-Act-amended-to-regulate-and-curtail-harmful-and-illegal-contents-and-activities.aspx>. Accessed: 23 March 2021 (2018)
16. The International Emergency Economic Powers Act: Origins, evolution, and use updated 14.07.2020. <https://fas.org/sgp/crs/natsec/R45618.pdf>. Accessed: 23 March 2021 (2020)

# «Big Data» in Labor Relations



M. K. Kot

**Abstract** The study is devoted to the application of Big Data theory and practice in the social and labor relations. The author identifies the problem of processing of a person's Big Data with the legal use of personal information for making management decisions. The article analyzes the Russian legislation and its development trends with international practice of worker's protection in the processing information of a specific person. The author expresses the position on the need to apply the protecting employee's procedure from the unlawful using Big Data established to protect personal data, that is, focusing on the purpose of processing and the need to obtain the consent of the data carrier for such processing.

**Keywords** Big data · Labor relations · Personal data

## 1 Introduction

Big Data came to the social and humanitarian sphere from natural sciences due to a synergistic perception of research tasks and allows a new look at the problem of human capital development both on a national scale and in the individual employing organization. A synergistic approach to the study of the object involves the use of techniques and methods that are not characteristic of a special field of scientific knowledge in interaction with the object under study. This allows finding new approaches to research and, accordingly, obtaining unexpected results showing additional opportunities to develop the systems under study.

Big Data is a global body of information that shares common characteristics. These include: scale, information content, unstructured forms. In addition, the main property of this information is the ability to grow uncontrollably, which is fraught with loss of control in the process of its systematization and analysis. The technical features of Big Data include heteromorphic information, since the information included in

---

M. K. Kot (✉)  
Samara State University of Economics, Samara, Russia

the specified data set is usually collected from various sources and can be simple documents, data libraries, and various archives [1].

In the aspect of social and labor relations, Big Data is formed based on the requirements of law. These include the following requirements: formalize labor relations, which implies the creation and storage of documents about each employee of the organization; carry out statistical records of the labor force during the entire period of the organization's activity; carry out archival storage of all information about the employees of the organization, as a general rule, for at least 75 years from the date of production of the document.

Due to the fulfillment of regulatory requirements of the company's activities, a huge number of documents, both in paper and electronic form, accumulates in the information base of the company, which is constantly increasing due to the turnover of employees. In addition, the information systems of the company are replenished with data on applicants for vacant positions, data on customers, suppliers, etc. All this information can be called personal data of employees of the organization and third parties who contacted the company and left their personal information.

Thus, Big Data within the framework of regulation of social and labor relations turns into the category of «personal data», which has its own characteristics and has the specifics of legal registration. The author presents his vision of Big Data, considering the specifics of the legislative regulation of personal data in Russia. The research task is set to identify the problems and risks of using Big Data in personnel management in making managerial decisions in the HR-sphere based on Big Data technologies, namely automatically, without human participation. In this regard, it is necessary to answer a few questions, namely:

- how does the existing legislation regulate the processing of Big Data about the employee?
- is it permissible to make management decisions based on the processing of Big Data about the employee?
- how is the judicial protection of workers' rights carried out, what are the trends in development of domestic practice and whether it correlates with international experience in solving such problems?

The advantages of automated analysis of information in the framework of social and labor relations are associated primarily with the reduction of various kinds of costs for the selection and placement of personnel, the cost of training and retraining of employees, for obtaining information about a specific employee, as well as for the preparation of static reporting [2] both in one organization, and throughout the country. In addition to reducing costs, the impersonal processing of personal data reduces the «human» factor in making managerial decisions and their corruption potential [3].

## 2 Methodology

The methodology of this study is based on the application of a synergistic approach to the study of human-dimensional systems. This approach allows us to consider the problem of the growth of information about people as a complex problem of managerial, legal, economic and statistical nature. Observing the behavior of such complex systems, the sources of their formation, inspires fears of the formal application of mathematical and statistical methods of analysis in making managerial decisions. A systematic, comprehensive approach based on the analysis of restrictions and prohibitions established in law, as well as the specifics of management technologies, will make it possible to implement more balanced approaches in personnel management. Technologies for analyzing Big Data in human-dimensional systems should rely, first, on the methodology of humanities. In the legal aspect, these are methods of interpreting the spirit of law in interests of protecting a person from invasion of privacy, ensuring the safety of personal data from unlawful use. Thus, any contradiction or silence of law regarding the limits of dissemination of information about a person should be interpreted in the spirit of protecting the fundamental rights and freedoms of the individual, limiting encroachments of companies and the state into a person's personal life.

## 3 Results

Studying the regulatory framework, literary sources and judicial practice, the author has made the following conclusions.

1. The broad interpretation of the concept of «personal data», inherent in both the international and Russian legislation on processing personal information, creates uncertainty in understanding the types of data that have formal protection by the state, including judicial protection. We should follow the approach when the information about a person, with the help of which it is possible to identify a specific person, is related to personal data. At the same time, the information can be of a collective nature, namely, it can consist of various kinds of data, which together will make it possible to correlate it with a specific person. In our opinion, processing such information, which correlates with the subject of personal data because of its generalization with other information, constitutes the main risk of loss of confidentiality and interference in the person's personal space. This applies, as a rule, to processing information obtained from social networks, from archives of telephone conversations, storing e-mails, tracking the user's computer activity. Disparate data about the employee during automatic processing of information can be correlated with a specific person and form his personal image—a portfolio that the employer can use for various purposes, including legal and non-legal ones. For example, it would be very sensitive for a person to disclose information showing religious or ethnic affiliation, the

presence of a criminal record or disability that does not affect the filling of a position, membership in certain communities. A similar problem is observed in the employment process—the assessment of the applicant for a vacant position.

2. The broad interpretation of the legitimacy of processing personal data raises concerns. In accordance with Russian law, any processing of personal data is considered legal if the following legal grounds are observed: the consent of the subject of personal data to processing and confirmation of the purpose of processing, which should follow from acts of international or national legislation [4]. So, within the framework of service relations, the purposes of information processing are based on proper registration of labor relations, as well as the implementation of the employer's rights in the field of organization and management of labor. From this perspective, the collection of information about the employee's business activity, including his use of computer programs, correspondence and telephone conversations, the use of official vehicles, and the search for customer reviews on social networks is the competence of the employer. And in this case, the line between personal and professional can be very elusive. In international practice, the boundaries of interference in private life in such situations are determined by judicial interpretation and are associated with typical expectations of the subject of personal data in relations between him and the operator (in our example, the employer). However, this level of victim protection is usually supported by international human rights courts. The national judicial system is more likely to practice a formal approach to the interpretation of law. It seems that for the Russian legal system, it is more effective to apply the principle of abuse of law in resolving disputes over the use of "unnecessary" information about the employee, which makes it possible to recognize the actions of the employer as illegal within the powers established by law. In addition, a formal approach to the interpretation of legislation can also have positive results when justifying the rights of victims in the absence of their written consent, for example, specifically to monitor social networks. In European practice, one can observe decisions based on inadmissible tracking telephone conversations and Internet traffic of employees, if they were not warned about the ongoing surveillance [5]. Thus, the absence of certain formal actions on the part of the employer, such as: non-receipt of consent to processing certain information or tracking, the use of automated methods of data processing without warning can be qualified as a violation of legislation on personal data or fundamental human rights to privacy, secrecy of correspondence.
3. The Russian legislation supports a pan-European approach to prohibiting the adoption of any decisions that establish or restrict human rights, based on automated processing of personal data. Thus, the so-called «profiling» in the HR-sphere is beyond the bounds of what is permissible. This, in turn, translates the activity of collecting «human data» into the informal sphere, which is practically not controlled by the state and the subject of personal data. With the aim of translating these relations into the framework of law in Russia, work has been underway to draw up a normative act on Big User Data since 2018 [6]. However, at present, work has been suspended due to active criticism of the

bill by business representatives and the legal imperfection of its norms. I think this approach is wrong, because in such a case it will not be possible to apply the protection provided for personal data to Big Data. In principle, to ensure adequate protection, it is enough to develop judicial and administrative practice of extending legislation on personal data to information related to large user data. Now, this process has already been launched in many states.

## 4 Discussion

There is an extensive discussion in the literature on issues of disseminating the methodology for studying and understanding Big Data in relation to humanitarian branches of knowledge, which affects both general theoretical issues and issues of individual branches of law and legislation. In addition, the problem of Big Data is developing in related sciences, such as Personnel Management and Statistics [7–10]. In Russia, a surge of interest in this topic is associated with the recognition of digitalization of law as one of the most relevant areas for the legal science development at the state level, as well as with the discussion of the bill on Big User Data [11]. Within the framework of this discussion, the lack of legal regulation of such information is recognized. However, there are still no proposals on the use of any understandable approach to Big Data in the practice of legal protection of data subjects. In addition, a unified position has not been formed regarding the legal forms of using data about the employee in labor relations. Today, there is not enough comprehensive research on this problem in the Russian scientific discourse.

## 5 Conclusion

As a result of the analysis development trends of «Big Data» concept with social and humanitarian profile, as well as the practice of protecting victims as a result of illegal collection and information analysis related to «human data», there are the following conclusions. Big Data in social and labor relations should be identifying exclusively as personal data in the absence of unambiguous criteria that would guarantee the depersonization of the data subject. Processing person's information without any consent generally infringes on fundamental rights such as privacy and correspondence and should be treated as an interference with privacy. Protection of the «human data» carrier in the processing should be carried out on the basis of general principles and rules of the personal data protection. The processing of «big human data» must be carried out for certain legitimate purposes with the free and clear consent of the data carrier. It is necessary to make appropriate changes to the personal data national legislation and to follow the existing international protection practice, based on the recognition of the primacy of fundamental human rights over

the employer's interests. Currently, I consider a comprehensive study of the problem is the most promising and successful.

## References

1. Chekharin, E.E.: Big Data: Big problems. *Perspect. Sci. Educ.* **3**(21), 7–11 (2016)
2. Lemeshko, B.Yu., Lemeshko, S.B., Semenova, M.A.: To question of the statistical analysis of Big Data. *Tomsk State University J. Contr. Comput. Sci.* **44**, 40–49 (2018)
3. Popazova, O.A., Shikhova, N.N.: Personnel management based on big data analytics: Risks and opportunities. *Izvestiya of the Saint Petersburg State Univ. Econom.* **3**(117), 110–115 (2019)
4. Mischau, L.: The laws of big data. In: Kreps, D., Komukai, T., Gopal, T.V., Ishii, K. (eds.), *Human-centric computing in a data-driven society. HCC 2020*. In: *IFIP Advances in Information and Communication Technology*, vol. **590**, pp. 16–28. Springer, Cham (2020)
5. Judgment of the European Court of Human Rights of 03.04.2007. Precedents of the European Court of Human Rights, 2016, **7**(31). <https://www.garant.ru/products/ipo/prime/doc/5632869>. Accessed: 24 Feb 2021 (2007)
6. Alekseychuk, A.: About the new bill on Big Data processing. [https://zakon.ru/blog/2018/10/25/o\\_novom\\_zakonoproekte\\_ob\\_obrabotke\\_big\\_data](https://zakon.ru/blog/2018/10/25/o_novom_zakonoproekte_ob_obrabotke_big_data). Accessed: 24 Feb 2021 (2018)
7. de Hert, P., Papakonstantinou, V.: Framing big data in the council of Europe and the EU data protection law systems: Adding 'should' to 'must' via soft law to address more than only individual harms. *Comput. Law Secur. Rev.* (2020). <https://doi.org/10.1016/j.clsr.2020.105496>. Accessed: 24.02.2021
8. Johnson, R.A., Rostain, T.: Tool for surveillance or spotlight on inequality? Big data and the law. *Ann. Rev. Law Soc. Sci.* **16**, 453–472 (2020)
9. Labbé Figueroa, M.: Big data: new challenges for competition law. *Revista Chilena de Derecho y Tecnología* **9**(1), 33–63 (2020)
10. Li, Y.: Big Data service of financial law based on cloud computing. In: Atiquzzaman, M., Yen, N., Xu, Z. (eds.) *Big data analytics for cyber-physical system in smart city. BDCPS 2020*. In: *Advances in Intelligent Systems and Computing*, vol. 1303, pp. 1627–1632. Springer, Singapore (2021)
11. Dolzhenko, R.A.: People data as a new trend in human resource management. *Herald of Omsk University. Series "Econom."*, **17**(1), 63–72 (2019)

# Big Data Application in Information Support of Organization Management: Problems and Prospects



O. N. Potasheva

**Abstract** The article discusses the prospects and problems of using Big Data by Russian companies. In the conditions of the initial development of the Big Data market in the Russian Federation, it is important to adapt business management technologies to the use of large amounts of information. In order to monitor the current situation, 15 financial specialists involved in the work of small, medium and large businesses using Big Data processing and analysis technologies were interviewed. Meanwhile, the interviewees admit that under the influence of information innovations, there are wide opportunities for using Big Data to solve predictive analytics problems, build flexible management reports, form an informed opinion about the need to create reserves and other estimates, obtain information about events after the reporting date, and collect and link integrated reporting data. It is concluded that the systematic use of Big Data becomes the basis for companies to make the transition to a qualitatively new level of management of all business processes and poses new challenges for specialists to constantly apply interdisciplinary approaches when solving specialized professional tasks.

**Keywords** Big data · Business analytics · Corporate reporting · Information innovations · Organization management

## 1 Introduction

Today, in Russia, as well as in the whole world, there is a process of digitalization of the economy, against which Big Data is becoming an important part of the information support of business management. The reason for this trend is the high quality level of business information support provided by large volumes of various data at their high processing speed. The use of Big Data in management decision-making provides unprecedented competitive advantages due to the ability to compare external information about consumers, marketing and logistics information, data on internal

---

O. N. Potasheva (✉)  
Samara State University of Economics, Samara, Russia



business processes and other facts that at first sight are not related to each other. Processing large amounts of information provides a synergistic effect, allowing to identify important factors to improve the organization efficiency.

The Russian Big Data market is still at the initial stage of development. At the same time, the tasks of working with large amounts of information, which are increasing, are constantly becoming more complex. The need for up-to-date technologies for their processing, methodological approaches to further application and solving related organizational problems is growing. These trends were the reason for the development of the national standard of the Russian Federation, detailing the structure and process of applying the reference architecture of Big Data [1]. To develop this standard, researchers from the National Center for Digital Economy of Lomonosov Moscow State University and Institute of the Information Society were involved. However, if we compare the spheres of economic activity, we can note the uneven development of the process of using Big Data in management decision—making. Thus, the most active collection, systematization and analysis of Big Data in Russia is carried out in the following areas of activity (information obtained from public sources):

- in the banking sector (Sberbank, Gazprombank, VTB24, Alfa-Bank, FC Otkritie, Raiffeisenbank, Citibank, Uralsib Bank, OTP Bank, Troika Dialog, All-Russian Bank for Regional Development and Ural Bank for Reconstruction and Development»);
- in retail (X5 Retail Group, Gloria Jeans, Ulmart, Lenta hypermarkets, M. Video, Wikimart, Ozon, Azbuka vkusa»);
- in the field of telecommunications (MTS, VimpelCom, Megafon);
- in the oil and gas sector (Transneft, Rosneft and Surgutneftegaz).

Enterprises engaged in other types of economic operations actively want to adopt the successful experience of international companies and Russian enterprises that have already managed to implement the Big Data system in their business processes.

Increasing amounts of information require not only technological adaptation, but also the development of approaches to the use of Big Data in the process of enterprise activity and business management. The active development of Big Data consulting largely indicates the lack of customer companies' understanding of the capabilities of this information resource and the skills of its use in the implementation of business processes. In this regard, the issues of studying the existing experience of financial specialists for understanding and evaluating the prospects for using Big Data in solving specialized professional tasks are particularly relevant.

## 2 Methodology

In order to form an opinion on the readiness of the use of Big Data in solving the problems of information support for business management, 15 financial specialists involved in the work of medium and large businesses operating in St. Petersburg and

**Table 1** Questions asked to financial professionals during the interview

|   |  |
|---|--|
| 1 | Does your company use Big Data in the information support process of business management? How long is this process and is it systematic? |
| 2 | What challenges did you face when implementing the use of Big Data to solve business management issues?                                  |
| 3 | What software products for collecting and organizing Big Data do you use in your professional activity?                                  |
| 4 | How often can you identify the result of using Big Data when making professional decisions?  |
| 5 | What is the unique competitive advantage of using Big Data to solve your professional tasks?   |
| 6 | In what areas of your professional activity do you see the greatest prospects for the use of Big Data?                                   |
| 7 | What threats to the use of Big Data for business management do you see?  |

*Source* Author

Samara were interviewed. These companies are profiled in various areas of economic activity—construction, consulting, retail, wholesale trade, telecommunications, housing and public utilities.

During the interview, specialists were asked questions from the list developed by the author, presented in Table 1. The assessment of the readiness of financial specialists to use Big Data for solving business problems cannot be reduced to a narrow range of formal survey questions. That's why the interview also implied a possible discussion of the issues that were not previously stated in the list, but now they require discussion due to their relevance.

As a result of summarizing the received responses, a systematic analysis was carried out. It allowed to form an opinion about the use of Big Data by individual financial specialists for the purpose of information support of business management.

### 3 Results

The information obtained as a result of the interview is summarized in the sequence corresponding to the questions previously systematized in Table 1.

1. During the interview process, it was found that companies work with Big Data taking into account the existing experience and allocated resources, while this work cannot be called systematic. The interviewees note that companies mostly start analytical activities for processing large amounts of information not because of a forward-looking economic justification of the performed calculations feasibility, but largely due to the impact of threats of competitive advantages loss due to ignoring significant trends of the external environment, about which the company did not have the required information at the right time.

2. One of the key problems with the use of Big Data nowadays is the lack of analysts' experience in extensive work with it. The interviewees admit that they have serious concerns when new tasks arise for analyzing significant amounts of information, in which they do not have practical experience. At the same time, they are convinced that the information resource of Big Data is not yet fully used, that is, the lack of "package" solutions of their use seriously complicates the use itself. This circumstance is largely due to the fact that some companies acquire not the technology of working with Big Data, but some ready-made products with built-in implementation methods for solving a dedicated range of applied issues, so the expanding the scope of application in such situations is out of question.
3. SAP, Oracle and the Power BI tool (from the Microsoft Office 365 package) were named among the programs identified by the interviewees for working with Big Data.
4. All interviewees signaled that the systematization of the results of Big Data analysis is carried out as information needs arise.
5. Processing of large amounts of information is carried out using cloud technologies (they are low-cost network structures that provide access to information at any time and in any place) and using distributed analytics mechanisms, which allows you to store almost infinite amounts of data electronically and perform various actions with such data. In the analysis of the company's business processes, the use of Big Data allows to get a synergistic effect and reach a qualitatively new level of management decisions.
6. In the field of corporate financial reporting, Big Data can be used to obtain information about corrective and non-corrective events after the reporting date, to form conclusions about the best value of the estimated values. There are many opportunities to use Big Data to form an opinion about the need to create reserves and their reasonable value. Itself, corporate reporting in the conditions of digitalization of the economy stops to be a separate element of information, being in constant symbiotic interaction with non-financial information, taking into account the use of Big Data. From the point of view of any non-financial corporate reporting, the Big Data resource is extremely important, since this reporting format summarizes key information about the impact of the business entity's activities on the social sphere, environment and other significant areas. In integrated reporting, it is important not only to correctly use and evaluate the available non-financial information, but also to ensure that the individual content blocks included in it are interconnected to ensure the quality of the information content.

In the field of operational and management accounting, the benefits from implementing Big Data analysis can be obtained everywhere due to the ability to quickly and clearly detail indicators, create flexible management reports that are available at any time and in any place, which significantly improves the quality of made decisions. In the field of business analytics, the greatest economic impact is expected from the use of Big Data, but to obtain it, it is important to understand the possibilities of systematic use of this resource. Big Data has

already led to major changes in marketing analysis, but we can also expect the development of tools for investment analysis, business planning analytics, and systematic performance evaluation. Large data sets are used to solve predictive analytics problems, create simulation and econometric models that are reliable for making management decisions.

7. Paradoxically, the interviewees see the cloud technologies used as a significant source of threat to the use of Big Data, which are also an advantage of accessing the information simultaneously. At the same time, cloud servers are often owned by non-residents and the ability to control their use by the customer is very limited. In this regard, the respondents expressed concern about the possibility of interception of information by competing companies, which can critically affect the business conducting. It is a fact that in the conditions of digitalization of the economy, computer crime is progressing (cyber attacks, the use of spy software and malicious software), and, therefore, this circumstance requires increasing the level of information protection and testing it for reliability before use.

In addition, many small and medium-sized enterprises that are not ready to work for the future and use only a narrow set of package cases may, without getting the expected high result, abandon the use of Big Data in principle, although in fact they have evaluated only a small part of the possibilities.

## 4 Discussion

Al-Htaybat and von Alberti-Alhtaybat identified the paradoxes of the impact of Big Data on corporate reporting, in particular, the expansion of opportunities and the accompanying enslavement, the satisfaction of some and the generation of other needs, the reliability of data and its unbalanced timeliness, the simplicity of the result and the complexity of its receipt [2].

Coyne, Coyne, and Walker are convinced that in order to process and systematize large amounts of various data in order to manage an organization, it is advisable to take into account the specifics of the life cycle of Big Data, since the process of its generating is actually the transformation of Big Data into information suitable for solving specific tasks [3]. In addition, analysts should not forget about the inherent risks of this process.

Kaya and Akbulut note the significant changes in the technologies of accounting information systematization and its subsequent analysis that have occurred under the influence of the digitalization of the economy, drawing attention to the fact that this poses new interdisciplinary challenges for accountants and analysts [4].

Kar and Grover note the predominant use of Big Data to achieve the company's business goals in marketing and building the supply chain [5]. At the same time, the analysis of consumer behavior involves, first of all, the systematization of social network data and the intellectual analysis of text information. The researchers are

convinced that the expansion of the sphere of Big Data application in business can be achieved through the development of technical and methodological tools for their analysis by specialists, which will allow to reach a new level of solving the problems of information support for managing the company's activities.

Llave also notes the significant impact of the technical aspects of Big Data analysis on the quality of generated business-analytics [6]. Thus, the researcher found that the use of data lakes can significantly improve the efficiency of analytical procedures. At the same time, data lakes can perform several significant functions. Firstly, being intermediate data stores, secondly, a kind of bases for experimental analytical actions, and, thirdly, acting as a direct source of business intelligence data.

Liu, Peng, Yu, during the studying the features of the use of Big Data in insurance companies, found that the analysis of spatio-temporal information in the development of insurance packages and building relationships with customers can achieve significant results in improving the efficiency of activities [7].

Sun, Sun, and Strang in the course of their research proved that the most important component in the use of Big Data is the technical part of the problem [8]. They defend the need to develop a service-oriented architecture for subsequent use for Big Data analysis, which, in their opinion, should improve the quality of corporate information systems.

Shahzad, Xiu, Shahbaz analyzed the features of the development and further use of software for Big Data analysis by companies [9]. Using economic and mathematical methods of processing the results of a survey of 215 companies in Pakistan, they established a significant impact of the organizational culture of a business entity on the quality of information obtained in the process of using Big Data. The researchers are convinced that it is the high level of organizational culture of the enterprise that contributes to the creation of the necessary conditions for creativity and innovation of both programmers and analysts involved in working with Big Data.

Sproviero, in the course of a study conducted in relation to business entities of the Italian banking sector, revealed the high value of Big Data for the formation of integrated corporate reporting [10]. This is due to the influence of many external circumstances and existing relationships with counterparties on the company's activities, which affects the results of the corporation's functioning. Sproviero names the human resource potential, which consists in the professional experience of analysts and their innovative approach, as a key factor in the effective use of Big Data, saying that the use of corporate regulations for structuring the stages of Big Data application does not bring good results without the necessary specialists. Sproviero is convinced in the need for all financial professionals to apply an interdisciplinary approach, where performers integrate the tasks of collecting information, its qualitative systematization and long-term analysis.

Tiwari, Wee, and Daryanto note the essential importance of Big Data in shaping the company's supply chain [11]. At the same time, the use of information arrays in supply management can be built not only individually for each specific company or industry, but even offer universal approaches to Big Data analysis to solve end-to-end supply coordination problems.

## 5 Conclusion

The active development of information technologies leads to the fact that companies have to process, systematize and analyze more and more large amounts of data in order to ensure their competitiveness. At the same time, Russian business entities and specialists are still only accumulating experience with Big Data and adapted well to solving well targeted tasks using large amounts of information, such as marketing analysis or supply chains. Meanwhile, the potential of using Big Data in building and controlling business processes is more significant.

According to the results of the study, it is concluded that technologies for collecting, systematizing, analyzing and interpreting Big Data in the digital economy are becoming a significant corporate asset used for information support of company management. The economic benefits of this asset are obtained by providing forecasting, trading analytics, instant access to critical information and forming a flexible representation of it, taking into account the needs of the user.

The rapid transformation of information and technological innovations requires business entities to develop an innovative operating environment, and challenges financial professionals to constantly apply interdisciplinary approaches. In addition, there are new threats associated with the development of digital crime in the course of this process. It is obvious that a high-quality solutions to these complex systemic problems can be achieved only through the joint efforts of the state, business and educational institutions.

## References

1. National standard of the Russian Federation GOST R ISO/IEC 20546-2019: Information technology. Big Data. Overview and vocabulary (ISO/IEC 20546:2019, IDT). <https://www.gostinfo.ru/catalog/Details/?id=6447698>. Accessed: 21 Feb 2021 (2019)
2. Al-Htaybat, K., von Alberti-Alhtaybat, L.: Big Data and corporate reporting: impacts and paradoxes. *Account. Audit. Accountab. J.* **30**(4), 850–873 (2017)
3. Coyne, E.M., Coyne, J.G., Walker, K.B.: Big Data information governance by accountants. *Int. J. Account. Inf. Manag.* **26**(1), 153–170 (2018)
4. Kaya, I., Akbulut, D.H.: Big Data analytics in financial reporting and accounting. *PresAcademia Procedia (PAP)* **7**, 256–259 (2018)
5. Kar, A.K., Grover, P.: Big Data analytics: a review on theoretical contributions and tools used in literature. *Glob. J. Flex. Syst. Manag.* **18**, 203–229 (2017)
6. Llave, M.R.: Data lakes in business intelligence: reporting from the trenches. *Procedia Comput. Sci.* **138**, 516–524 (2018)
7. Liu, Y., Peng, J., Yu, Z.: Big Data platform architecture under the background of financial technology: In the insurance industry as an example. In: Li, T. (ed.) *Proceedings of the 2018 international conference on big data engineering and technology*, pp. 31–35. Association for Computing Machinery (2018)
8. Sun, Z., Sun, L., Strang, K.: Big Data analytics services for enhancing business intelligence. *J. Comput. Inf. Syst. (JCIS)* **58**(2), 162–169 (2018)
9. Shahzad, F., Xiu, G.Y., Shahbaz, M.: Organizational culture and innovation performance in Pakistan's software industry. *Technol. Soc.* **51**, 66–73 (2017)

10. Sproviero, A.F.: Integrated reporting and the epistemic authority of Big Data: an exploratory study from the banking industry. *Financ. Report.* **26**, 99–124 (2020)
11. Tiwari, S., Wee, H.M., Daryanto, Y.: Big Data analytics in supply chain management between 2010 and 2016: Insights to industries. *Comput. Ind. Eng.* **115**, 319–330 (2018)

# Lex Electronica and Lex Infomatica as Sources of Smart Contracts Legal Regulation



E. L. Simatova and A. V. Dashin

**Abstract** This article studies the possibilities of supranational regulation of relations arising from the conclusion and execution of smart contracts. Due to the specifics of the emerging legal relations, conflict of laws is not always able to act as a good regulator and solve the problem of applicable law. The idea of the impossibility of regulating cyberspace by classical legal means in favor of the use of special computer codes and mathematical algorithms is put forward. In this case, separate parts of the lex mercatoria as an autonomous system of non-state regulatory norms, namely, lex electronica and lex infomatica, could be a more appropriate legal instrument.

**Keywords** Conflict-of-laws regulation · Lex electronica · Lex infomatica · Lex mercatoria · Smart contracts

## 1 Introduction

The rapid processes of digitalization of modern society cause serious issues in the established way of regulation of various legal relations. The participants of these relationships may not know each other and may never meet, and their mutual obligations may be fulfilled and provided with program code. The platform for the emergence and termination of relations, as a rule, is located in cyberspace, not only beyond the jurisdiction of any state, but also simply does not have a territorial affiliation as such. In modern science, there is a discussion about the permissibility of regulating relations that arise in connection with and with the help of computer technologies, by means of law. The idea of the impossibility of regulating cyberspace by classical legal means in favor of the use of special computer codes and mathematical algorithms is put forward. At the same time, supporters of traditional methods of regulating relations promote the thesis of expanding its scope at the expense of the

---

E. L. Simatova (✉)

Severo-Caucasian Branch of the Russian State University of Justice, Krasnodar, Russia

A. V. Dashin

Samara State University of Economics, Samara, Russia



capabilities of supranational regulators, in particular, *lex mercatoria*. The rapidly developing process of its fragmentation, in turn, allows to talk about the emergence of special regulators of contractual relations that arise in cyberspace—*lex electronica* and *lex informatica*.

## 2 Methodology

Of the various research methods and techniques developed by modern legal-theoretic science, the study of the processes and possibilities of legal regulation of smart contracts requires the involvement of a wide range of approaches and methods. To form an idea of specific legal sources aimed at achieving the goal of this study, in their understanding as a system of legal means through which appropriate statutory regulation is provided, two methods should be used. The first is the aggregate method—the method of collecting disparate facts and drawing up a mosaic picture, and the second is the casual method of detailed consideration of unique, rare, atypical phenomena that coexist in the research field of the problem under consideration as a phenomenon of socio-economic and legal reality.

The development of a unified approach to the regulation of the rights, obligations and responsibilities of the contractual relations parties in cyberspace is impossible without the use of an interpretive method that allows to study the past, both with an insufficient number of sources, and with sources that simplify the phenomenon or distort it. The transnational nature of this study explains the use of the comparative method, taking into account possible local, chronological and discursive comparisons. The formation of ideas about the possibility of regulating smart contracts by means of *lex electronica* and *lex informatica* is impossible without the use of the modeling method in its understanding as the mental creation of models of legal phenomena and their manipulations in the suggested conditions.

## 3 Results

Over time, smart contracts are gradually transforming from a legal phenomenon into a category of legal reality. At the same time, scientific discussions receive ordered directions, which allows us to talk about the possible understandable legislative regulation of emerging relations in this area. However, not all legal experts agree on the mandatory application of classical legal mechanisms to regulate relations arising in cyberspace. Summarizing the existing views on this subject, we can distinguish three main doctrines, the essence of which can be briefly presented in the following. The first concept suggests that all social relations, regardless of whether they arise in “reality” or in cyberspace, should be regulated by traditional law. The second doctrine is that cyberspace should be subject to its own, unique regulatory mechanisms, expressed in the form of algorithmic codes and mathematical models, since

the tools of classical law are not able to take into account the technical features of the emerging relations. In relation to the subject of this study, a smart contract is thus a phenomenon that avoids or minimizes the use of national law and, thus, fits into the concepts of the so-called self-contained contract or a contract lawless contract [1]. The third concept is a compromise between the first two. Despite all the specifics of relations arising in cyberspace, these relations arise between legal entities, even on a specialized platform and in the form of computer protocols. This means that they can and should be regulated by law. And even today it is becoming obvious that some phenomena of the real world cannot be described using a program language that assumes the highest degree of certainty. For example, as Mitrofanova notes, the category “reasonable time” clearly cannot be written into the program code, since it does not have a framework and is considered from a subjective point of view, depending on specific obligations [2]. Thus, the transfer of legal norms to technical regulations is not always possible. On the other hand, technical regulations can only be implemented in code and are necessarily based on formal algorithms and mathematical models [3].

In favor of the latter point of view, which we also share, is also the fact that even those relations that are subject to computer protocol and are prescribed in algorithms can be affected by the human factor in the form of, for example, an error made when entering the starting data. Thus, despite all the contradictions of regulation both by traditional law and on the basis of algorithmic code, we believe that only such an approach will provide adequate and flexible regulation of relations in cyberspace.

In addition, we note that traditional legal methods of regulation are also undergoing a significant transformation under the influence of ongoing processes. Today, the sources of legal regulation in the classical sense of this concept should include not only the norms of domestic and international law, but also supranational law, and especially the *lex mercatoria*, which is gaining momentum in the field of international trade.

The above is of particular importance in the conclusion and execution of smart contracts, since it is in this area that the “failure” of traditional methods of regulation is particularly noticeable. If such a contract is of a cross-border nature, there will inevitably be a problem of choosing the applicable law. But in this case, the methods developed by the doctrine of private international law to overcome this problem cannot be applied. Thus, the general principle of choosing the applicable law to contractual relations complicated by a foreign element is the autonomy of the will of the parties. But this raises the question of how to transfer the condition of the right chosen by the parties to the programming language and how the program should track the fulfillment of this condition by the parties. In the absence of a law choice made by the parties, conflict-of-laws connecting factors, such as the law of the contract performance place or the law of the closest connection, cannot be applied to smart contracts. The connection of emerging legal relations simultaneously with the law of several countries according to various criteria, for example, domain relations, trade relations, settlement relations, and others, significantly complicates the understanding of the question of which legal order the relationship is most closely related to as a whole. The referential nature of the conflict-of-laws norm may also create

the problem of applying the law of a country that does not recognize the existence of smart contracts or does not have an independent regulation of this institution. Or, on the contrary, it will generate a steady trend of choosing the most preferred jurisdictions, including by tacit consent - joining the user agreements of blockchain platforms that already contain a clause on the choice of a “smart contract-friendly” law [4].

In addition, in the event of non-performance or improper performance of smart contracts, there will also be legal and technical difficulties associated with determining the jurisdiction and resolving disputes arising in this case. Of course, the parties of the smart contract can include in the algorithm the dispute resolution in a particular court or arbitration, make a kind of prorogation agreement using the code: “if” there is a dispute—“then” it will be considered in the appropriate institution. However, in this case, it will be necessary to indicate exactly the court that is ready to consider disputes arising from smart contracts. In particular, to have a clear position on the permissible evidence of the conclusion and execution of the contract, as well as the ability to perform the decision on the merits [5].

All this explains the ongoing search for an adequate regulator of smart contracts, which may well become *lex mercatoria* in its modern reading. This idea is confirmed in the provisions of the Hague principles on the choice of law applicable to International commercial contracts of 2015. These provisions state, in particular, that the law chosen by the parties may be the norms of law that are generally recognized at the international, supranational or regional levels as a neutral and balanced set of rules, unless otherwise provided by the law of the country of the court [6].

## 4 Discussion

In this case, we should not talk about the whole *lex mercatoria*, as a system of norms of non-state regulation of private law relations, complicated by a foreign element, but about its individual parts. In recent years, experts in the field of private international law have noted the process of significant fragmentation of the *lex mercatoria* into numerous subspecies. However, in science, there is no single point of view on the systematization of such subspecies. Thus, Mazhorina notes that normative fragmentation in the private legal field is manifested in the development of quite unique private sub-legal or quasi-legal phenomena unknown to past public practices, for example, “Internet law” (*lex informatica*, *lex digitalis*, *lex electronica* or *lex networkia*), *lex sportiva*, *lex constructionis*, *lex laboris internationalis*, etc. [7].

Some experts do not see a differences in *lex electronica* and *lex informatica*, meaning by this in general the transnational law of electronic commerce [8], including in its composition as sources the basic principles of *lex mercatoria*, international acts, national and supranational acts, trade customs established in the field of electronic commerce, model contracts and agreements, as well as disputes resolution practice.

According to other scientists, these are two fundamentally different new sources of law: *lex informatica* is an algorithmic (computer) code that regulates public relations

in cyberspace, and lex electronica is special customs that are reproduced in the terms of a specific contract concluded in cyberspace [3]. Another point of view is that lex informatica is interpreted as a system of non-state regulation of all relations arising on the Internet, including both substantive and procedural aspects. And lex electronica is interpreted as a special conflict-of-laws connecting factor, including the law of the country of registration of the domain name and the law of the server country (sending an electronic message by the seller), and acting in conjunction with the more traditional lex venditoris rule, which allows, thus, to determine the seller's belonging to the legal order of a particular state according to the specified criteria [9].

Finally, the last concept that should be mentioned in this study considers lex mercatoria and lex informatica as equal, parallel, and not subordinate regulatory systems, while lex electronica is a set of norms for the protection of intellectual property rights on the Internet [10].

## 5 Conclusion

Summarizing all the existing, sometimes contradictory concepts regarding the nature and relationship of lex electronica and lex informatica, we still believe it is possible to identify some common features that allow in the framework of this study to speak with confidence about the possibility of applying these regulators to the processes that arise during the conclusion and execution of smart contracts. First of all, we note the supranational nature of lex electronica and lex informatica, that means the belonging of these regulators to the more general concept of lex mercatoria, a kind of autonomous legal system that is able to regulate relations arising over smart contracts, regardless of the norms of domestic (national) law of any state. The ability of the parties to choose such a system of legal regulation is a trend that has been clearly growing in last years.

For example, by using the application of this document as one of the conditions of the smart contract algorithm, the parties, due to the autonomy of will, will solve the problem not only of choosing the applicable law, but also reduce the risk of refusal to apply lex electronica and lex informatica by the court considering the relevant dispute. We should also note a certain commonality of lex electronica and lex informatica sources, in particular, these are the general principles of lex mercatoria, trade customs that were developed in the field of e-commerce, as well as documents of international organizations. Without a doubt, both lex electronica and lex informatica take into account the peculiarities and specifics of contractual relations in cyberspace and, due to the flexible nature of the instruments of influence, are ready to provide more adequate regulation of the emerging processes. This, in turn, also affects the development of so-called in-network (online) arbitrations created on special platforms, which can make a much more efficient and fast alternative to existing methods of resolving disputes arising from smart contracts.

## References

1. Lukoyanov, N.V.: Legal aspects of the conclusion, amendment and termination of smart contracts. *Leg. Stud.* **11**, 28–35 (2018)
2. Mitrofanova, I.A.: The legislative regulation of “smart” contracts: the problems and prospects of development. *Legal Concept* **17**(4), 22–29 (2018)
3. Efimova, L.G.: Sources of public relations legal regulation in cyberspace. *Lex Russica* **73**(3), 114–120 (2020)
4. Mazhorina, M.V.: Digital platforms and international private law, or is there a future for cyber law? *Lex Russica* **2**(147), 107–120 (2019)
5. Dashin, A.V.: Smart contracts in the substantive and procedural law of foreign countries. In: Bortnikov, S.P. (ed.), *Proceedings of the International Legal Scientific Symposium Actual Problems of Development of Legal System in the Digital Age*, pp. 18–23. Samara State University of Economics, Samara (2019)
6. Principles on Choice of Law in International Commercial Contracts (approved on 19.03.2015). <https://www.hcch.net/en/instruments/conventions/full-text/?cid=135>. Accessed: 14 Mar 2021 (2015)
7. Mazhorina, M.V.: Private international law in context of globalization: from privatization to fragmentation. *Law. Higher School Econom. J.* **1**, 193–217 (2018)
8. Kazachenok, SYu.: Development of Lex Electronica as the Background for Inclusion of the online arbitration terms into the arbitration agreement. *Legal Concept* **4**, 104–107 (2014)
9. Kozinets, N.V.: Problems of collision-legal regulation of relations arising in the field of cross-border e-commerce. *Problems of Economics and Legal Practice* **6**, 65–70 (2015)
10. Mazepov, P.E.: Trends in the development of lex mercatoria. *Universum: Econom. Jurisprudence*, **8**(41), 8–11 (2017)

# On Issues of Big Data Legal Policy Application in the Russian Federation



E. N. Churakova

**Abstract** The author reviews how legal policy on Big Data works and raises certain concerns on its application and use. The study covers methodology of Russian legal policy and legal policies of foreign countries and contains discussion on a universal legal policy on Big Data. It also discusses the issues of personal data and big data coherent relationship. The author concludes that Big Data must be considered and regulated as personal data. The author also presents reasons in favor of regulating Big Data separately.

**Keywords** Big data · Digital economy · Legal regime · Personal data

## 1 Introduction

Market participants' awareness of the commercial value of information as an independent asset gave rise to the need for the development of special processing technologies for the so-called "Big Data". The characteristics of Big Data are defined through the model of three V(s): (1) large volume (Volume); (2) data variety (Variety); (3) high speed of data transmission (Velocity). Later, another characteristic was added, Value—the value of the data itself. Information markets are not just a specific sector of the economy, but the foundation for all modern innovative economic systems.

The way we used to analyze information before digital world has appeared is no longer adequate and relevant as it is completely impossible to process such huge amounts of data in a traditional way. New era presented us with the challenge of Big Data and while it is the solution to storing and processing giant loads of data it is also an issue of privacy and control. Companies that introduce innovative technologies into their activities are on top. So, digital technologies based on Big Data analysis are increasingly used by companies to improve the quality of goods and services, as well as the services provided to consumers, predict market trends, and adjust digital models while minimizing cost.

---

E. N. Churakova (✉)  
Samara State University of Economics, Samara, Russia

This new brave world needs a comprehensive legal policy that covers the creation, storage, distribution and use of information, since the lack of regulation of these aspects leads to various abuses in relation to the rights and legitimate interests of the subjects of such data and other third parties.

## 2 Methodology

The use of the synergistic method in modern legal research suggests that the problem of comprehensive legal regulation of Big Data is cross-sectoral in nature, since it affects the spheres of civil, financial, competition law, intellectual property law [1] and a number of other legal branches that affect entrepreneurial activity.

Synthesis as a method of scientific knowledge allows to study the issue of legal regulation of Big Data, the interconnection of Big Data with other end-to-end technologies, such as artificial intelligence technologies and the Internet of Things [2]. It is no coincidence that, after lengthy discussions, the Russian Federation eventually abandoned the adoption of an independent policy for Big Data, as well as one on the development of artificial intelligence. Data analysis is utterly necessary for the development of artificial intelligence technologies. So, the collection of huge amounts of machine data is primarily provided by the Internet of Things. But artificial intelligence itself, including machine and deep learning, can be seen as key technology that allows to extract maximum value from Big Data.

Traditionally, when it comes to regulating a new object, there is a need for setting its legal definition. However, in the case of Big Data, the situation is different. Attempts to introduce any definition into Russian legislation have so far been unsuccessful. According to the position that the researchers has consistently defended, the creation of a single term describing Big Data is impractical, given that the categories of processed information constantly change and the term itself serves as a kind of metaphor, which does not allow to legally define it [3].

Turning to the method of comparative jurisprudence, we note that the legislation of foreign countries does not provide a definition of Big Data either, which generally confirms the above. Yet even outside the legal area, a single generally accepted definition of Big Data has not yet been developed. Basically, the existing approaches to understanding Big Data are based on understanding it is a set of a dynamically changing information array, which is valuable due to its characteristics and the possibilities it brings for data use and processing. At the same time, there are endless attempts to improve the definition, new scientific and non-scientific publications come out, in which the need to supplement the definition with new characteristics is justified.

### 3 Results

Legal researchers nowadays closely discuss and study the relationship of Big Data and personal data, their connection, the basics of their content and the sphere of their use. All such discussions center on whether we must consider them as parts of one or as two totally different concepts and therefore how legal policy must be developed and issued. In Russia we recognize all data that may contribute to identifying a person as personal data and the same approach is widely common in Europe [4]. The Personal Data Law defines it broadly enough. The law defines that identification markers can be either direct or indirect but must contribute to person's identification through them and make it possible. Such approach allows to broaden the data pool of personal information. Big data is defined as a collection of digital data compiled using a wide-profile computer algorithm and used by numerous companies, corporations, and government agencies [5].

At first glance, the essential difference between personal data and Big Data is that Big Data does not really carry any distinctive personal information on a person, as it is a huge storage set of data arrays on dozens of topics. The technology of Big Data processing allows to set aside blocks of information and structure the information so that it can be analyzed properly and here personal data issue arises as that block is inherently a compilation of digital traces of a person that make up a digital profile. Users leave such traces constantly and repeatedly and the information constantly updates. Even though such profiles are initially depersonalized, certain tools can be used to reverse that and identify the user. Such reidentified data cannot be recognized as depersonalized as it immediately corresponds to the concept of "personal data" [6].

The bill on Big User Data in Russia is now a concept that was forwarded by Roskomnadzor and dealing with a sensitive and relevant topic. It is far from perfect and is widely criticized both by legal scholars and citizens.

According to the second point of view, which is presented in the rejected bill, Big User Data should be regulated by a separate legal policy. The bill defines Big User Data as a collection of information about individuals and (or) their behavior that does not contain personal data, which does not allow, without the use of additional information and (or) additional processing, to identify a specific individual, it is collected from various sources, including the Internet, the number of which exceeds a thousand network addresses [7].

The above shows that the legislator contradicts the notion that Big User Data should include "data on individuals that does not concern personal data". The listed approaches to understanding Big Data correlate with two models of legal regulation: European and American [8]. Europe on May 25, 2018, adopted the General Data Protection Regulation, hereinafter referred to as the GDPR which tightly regulates policy on personal data, defining it rather broadly and leaning to regulate other types of data too. Europe approaches Big Data as it would any issue concerning civil and human rights of people, obliging data operator to comply with the current legal policy and adhere to the rules on all stages of data processing starting with data collection and



ending with its destruction. GDPR also sets boundaries on depersonalized data use while granting such regime certain preferences as, for example, no need for consent [3]. Yet general consent to data processing has many requirements and is aimed at minimizing information asymmetry. It is also important to note that administrative control on these is fairly strict and solid and fines are rather high.

Alternative approach can be seen in the US where data issues are mostly regulated locally or on a self-regulatory level as companies set boundaries on their own. There is no general concept of personal data in the US so different states recognize different data as personal and set different bars for its protection. Control policy widely differs too as there is no single control body and some control functions are granted to different state agencies. Consent for data processing is equivalent to consumer consent to receive services.

As Russia long trades with EU it is obvious that we must unite our data policies with EU and connect Big Data to personal data rather than regulate them separately. AS GDPR already applies to foreign users operating and trading, exchanging goods and information in EU, the more similarities there are in Russian and EU policy, the easier comes economic growth. The same goes for Russian data policy requirements on international operators complying to requirements and control issues. Also, Russia nowadays is not recognized as a country that provides an adequate level of data protection [9].

## 4 Discussion

Considering the above, it seems that the Russian legislation on Big User Data should be based on the European one and yet reflect Russian realities. At the same time, one should not regulate Big User Data in isolation from personal data legislation, as that creates a parallel legal regime for it. The much more effective and relevant reaction would be to improve current legal policy and provide it with more clarity on regulating personal data as well as add policy on technology use and data control [10].

An experimental legal regime is used to test policy, it allows to enact new policy on a certain territory for a certain period and study the results. Such special regulation presupposes, for example, the non-application of certain normative legal acts or their individual norms. It enforces the establishment of the experimental regime which establishes mandatory requirements for licensing, accreditation, certification, mandatory confirmation, obtaining permits, sending and receiving legally significant messages, methods of identifying the parties to legal relations in the field of digital innovations. Test policy is quite extensive and includes the use or operation (including development and testing) of digital medical technologies, including telemedicine, technologies for collecting and processing information about the state of health and patient's diagnosis; highly automated vehicles; e-learning and distance learning technologies—both in educational and professional activities; new technologies in the financial market; new technologies in sales.

It is important that setting a legal regime to test a policy will be possible not only if the general regulation of relations in the relevant area contains requirements, restrictions or prohibitions that significantly complicate the implementation of digital innovations, but also in cases where such general regulation is, in principle, absent. Special regulation should guarantee the emergence of new types of economic activity, or an increase in the quality and availability of goods, works and services, or a decrease in costs and an increase in profits from entrepreneurial activity, or an increase in the efficiency of state or municipal management, including the provision of state and municipal services. The preferences associated with test legal regime must also be established for Big Data technology.

## 5 Conclusion

Big Data is used for user profiling that is achieved by using data collected from all sorts of digital networks and apps and processing it into a digital profile. One could say that when entering any digital space, a person usually grants consent for the processing of his personal data and yet it is necessary to mind that data flows further and no consent is given for further processing as the user lacks information on further data processing [4]. The fact that technology now allows to deanonymize a user who has no clear idea of how his personal data is stored and used after it left the first operator to raise concerns on data abuse and criminal risks. To avoid violations of personal data regime firm and strict control measures must be set in addition to serious improvement of legal policy itself. Legal policy on Big Data is supposed to wave concerns of Big Data nature and regime as it must explain the basics of it as well as set restrictions and requirements to its use. Legal science ought to join in and conclude on policy's value basis and regime basis as there can be no good policy outside a thought-out broad research. To sum up this study, it is fair to say that Big Data must be regulated as personal data and all the issues of digital profiling and individual identification must be resolved and thoroughly controlled. There are many issues that must be resolved, as, for example, consent, yet there is EU policy and practice to pave the way and homeland practice to identify all the needs for growth and improvement.

## References

1. Voinikanis, E.A.: Regulation of big data and intellectual property law: General approaches, problems and development prospects. *Law* **7**, 135–156 (2020)
2. Andrew, J., Baker, M.: The general data protection regulation in the age of surveillance capitalism. *J. Bus. Ethics* **168**, 565–578 (2021)
3. Botta, M., Wiedemann, K.: To discriminate or not to discriminate? Personalised pricing in online markets as exploitative abuse of dominance. *Eur. J. Law Econ.* **50**, 381–404 (2020)

4. Romanova, A.Y.: On the issue of the legal policy on Big Data. *Constit. Municipal Law* **8**, 20–25 (2019)
5. Gubaydullina, E.K., Churakov, A.N.: Legal regulation of big data in industrial systems: Problems and development prospects. In: Ashmarina, S., Mantulenko, V., Vochozka, M. (eds.), *Engineering Economics: Decisions and solutions from Eurasian Perspective. Engineering Economics Week 2020. Lecture Notes in Networks and Systems*, vol. **139**, pp. 489–494. Springer, Cham (2021)
6. Loshkarev, A.V.: Applied pattern of artificial intelligence and big data in business. In: Ashmarina, S., Mantulenko, V. (eds.), *Current achievements, challenges and digital chances of knowledge based economy. Lecture notes in networks and systems*, vol. **133**, pp. 383–388. Springer, Cham (2021)
7. Bill N 571124-7 “On amendments to the federal law “On information, information technologies and information protection”, as introduced to the State Duma of the Russian Federation on 23.10.2018. <http://sozd.duma.gov.ru/bill/571124-7>. Accessed: 11 March 2021 (2018)
8. Savelyev, A.I.: Directions of regulation of Big Data and protection of privacy in the new economic realities. *Law* **5**, 122–144 (2018)
9. Papakonstantinou, V.: Big data analytics in electronic communications: a reality in need of granular regulation (even if this includes an interim period of no regulation at all). *Comput. Law & Secur. Rev.* **36**, 105397 (2020)
10. Federal Law of 31.07.2020 N 258-FZ “On Experimental Legal Policies in the Field of Digital Innovation in the Russian Federation”. [http://www.consultant.ru/document/cons\\_doc\\_LAW\\_358738](http://www.consultant.ru/document/cons_doc_LAW_358738). Accessed: 15 May 2021 (2020)

# Legal Issues of Big Data Application in the Russian Federation



F. F. Spanagel

**Abstract** The relevance of the analyzed issues is due to the incompleteness of legal regulation by the domestic legislator of both Big Data and the conditions for its use. One of the goals of the study is to define the concept of Big Data in an extremely wide range of approaches: from the non-recognition of Big Data as a legal term to their characterization as a complex property complex. The author's definition of Big Data is suggested. The features of Big Data and their common features with other modern objects of information law are revealed. An attempt is made to distinguish information and Big Data. The problem of ensuring the state's public and private interests in the process of using Big Data is considered: from national security to the protection of personal data. The article discusses the need to reward Internet users who generate large amounts of information, the indicators of which are second only to the amount of information received from the Internet of things (IoT). This article may be useful for specialists in the field of law and economics.

**Keywords** Big data · Information · Information systems · Legal regime · Objects of information law

## 1 Introduction

The digitalization of all aspects of modern society led to the globalization of relations in economics, politics, social and other spheres. The latest information technologies contributed to the formation of huge flows of constantly changing information about society as a whole, as well as about individual citizens and organizations. Informatization contributes to the increasing transparency of economic and social processes, despite the inertia of public consciousness and the direct resistance of certain groups of the population to this. The pace of digitalization of social, technical and technological processes is becoming crucial for the security and defense capabilities of countries.

---

F. F. Spanagel (✉)  
Samara State University of Economics, Samara, Russia

The rapidly accelerating growth in the volumes and variety of information flows, the increasing competition for the possession of them not only between companies, but also between states, the active development of technologies and their increasingly rapid implementation determine the increasing relevance of the use of Big Data in various spheres of human life. At the same time, there is no legal definition of Big Data in the Russian Federation, and, in general, their legal regime remains largely uncertain, which prevents the monetization of their use in Russia. The scientific development of the issues of legal regulation of Big Data as the latest objects of digital law is of increasing relevance.

## 2 Methodology

In the course of the study, the following methods were used: system analysis, comparative analysis, formal legal analysis, synthesis, generalization, which allow us to comprehensively consider Big Data as an object of information law. The research methodology included an analysis of the scientific literature on the problem under consideration, which allowed to reflect different approaches to the study of the nature and composition of Big Data, the regulatory basis for their application; conclusions were formed, and the publication was prepared.

Currently, consideration of the issues of legal regulation of information relations is impossible without considering the latest results of the accelerating digital revolution [1], and the nature of the new and constantly changing products—Big Data. When considering issues related to Big Data, it is necessary to take into account their interdisciplinary nature, which allows using the results of research both in law and in other fields [2]. When analyzing Big Data, it is necessary to revise and soften the boldest statements about this category in order to ensure a synergistic fusion of Big Data with general theory and create a new scientific paradigm; to take into account the non-linearity, non-locality and hyper-dimensionality of this and other phenomena of the digital world [3].

It is important to consider the conditionality and mobility of the boundary between information and Big Data. Researchers can use different approaches to understand the signs of new objects of digitalization of the economy. The “positive” definition of Big Data, which reflects the essence, technological nature of Big Data and its structure, is the best and most effective one.

If the desired result is not achieved, you can use a less effective “from the opposite” approach, that is, defining Big Data by distinguishing it from other information and technologies that are not Big Data. The second approach does not achieve the necessary clarity and completeness of the definition of the concept of Big Data, and most importantly—such a definition does not express the nature of Big Data.

The greatest opportunities are seen in the combination of both approaches for a comprehensive study of Big Data. In the process of studying them, a higher level of complexity of Big Data, as well as a number of other objects of the digital economy, is established in comparison with previously known and well-studied (“classical”)

objects of property relations, which makes it necessary to apply other regulatory techniques and methods to them.

### 3 Results

The foundations of the legal regulation of Big Data initially began to form with varying degrees of intensity in the legislation, business and judicial practice of advanced countries in the field of digitalization of the economy. Based on the experience of legal regulation of the use of Big Data at the national level, the norms of the relevant institute of international information law are gradually being formed. The main role in the international legal regulation of Big Data is played primarily by the principles relating to the legal means of protecting the interests of consumers—users of services and data in the field of information and communication technologies.

The risks of negative consequences of improper use of information by entrepreneurs make it necessary to develop criteria for assessing the benefits and risks of accumulating and analyzing Big Data at the national and international levels [4]. Big Data is characterized by both common features of digital economy objects and features that distinguish this object from others. The properties of the Big Data market that combine them into a group of objects of the digital economy include high dynamism, steady growth, increasing competition between corporations and even states, the rapidly expanding scope of their application, and others.

Being an integral part of the digital economy, both national and global, the turnover of “Big Data” fully reflected its essential characteristics. The digital economy is characterized by steady growth, dynamism, the continuous emergence of new services, the concentration of markets characterized by a dominant position of participants, and the growing inequality between large companies, on the one hand, and small, medium—sized companies and consumers, on the other.

### 4 Discussion

Foreign practice of legal regulation of relations connected to Big Data shows that there is no unified approach to determining the legal regime of Big Data in different states. Moreover, there is a lack of uniformity in understanding the basic terms, including Big Data itself. The significance and optimal limits of the state’s influence on the participants of the Big Data turnover were not determined, and the balance of interests of developers, entrepreneurs and the state itself in the use of Big Data was not found. Effective legal regulation of Big Data and its application is impossible without defining its nature and main features. The definition of the concept of Big Data is the initial and most controversial issue of the topic under consideration. In comparison with some other objects of information legal relations, a lot of studies

are devoted to Big Data. At the same time, no national legal system has yet provided a clear and unambiguous legal definition of Big Data.

Moreover, when assessing the legal nature of Big Data, an opinion was expressed that denies the recognition of Big Data as a legal term, and defines it only as a description of a phenomenon that entails numerous and diverse consequences in the economic, technical, legal and social sciences. The latter are widely represented by current studies of the ethical implications of Big Data [5].

The concept of “Big Data” has not yet received a generally accepted definition, not only in legal studies, but even in works devoted to information technologies, which seem to us not only important, but even fundamental for solving the problems of the legal regime of this object of information law.

Thus, not all researchers consider Big Data technologies as an independent object or direction of the digital economy; some authors consider Big Data to be a term that includes a large number of technologies that are actively used in various spheres of human life, including those that are not even innovations [6]. Initially, Big Data was understood primarily as a collection of diverse information that can be combined into vast arrays, stored and analyzed.

At the same time, the criterion for distinguishing between data and Big Data was the volume of processed information. If it exceeded the sizes of the databases that existed at that time in terms of the available capabilities of the owners of information to collect, store, manage and analyze data, then the array of information was classified as Big Data, and if not, it was not recognized as a special object of information law.

In further studies, when defining Big Data and discussing the issues of ordering its use, the importance of the totality of its components was taken into account. Not being able to define Big Data by describing its essence and legal nature, researchers most often define such a complex object by listing all or its main components. Researchers of digital technologies often see Big Data primarily and even mainly as techniques and technologies through which new meanings are extracted from unstructured information [7].

The approach to the definition of Big Data seems original. Lapteva, according to which, Big Data is a property complex, which includes objects that have different legal nature, but are united in the totality by their common purpose [8]. Indeed, it is the unity of the purpose of using Big Data components that forms such a complex into a new independent object of civil legal relations, which, like information in general, has the property of turnover and needs special ways to protect the rights and legally protected interests of its right holder.

As mandatory elements of Big Data, the author suggests considering:

- unprocessed data, which is information consisting primarily of unprocessed (so-called “raw”) data and the results of processing this data (which may be in a materialized form);
- property rights, including exclusive rights to the results of intellectual activity, including programs for electronic computers and databases [9, 10].

While agreeing in general with the definition of the legal nature of Big Data proposed by the author, we consider it insufficiently justified to include in their

composition (as a property complex) the results of processing the initial array of information. This new information is the result of the application of Big Data technologies and forms a new complex of information as an independent object of information law, which by itself or in combination with other information arrays can be used to apply Big Data technologies (already as part of another property complex) to obtain new data, and so on.

At the same time, the peculiarity of Big Data as a property complex is their constant change in both the volume of information and its types. And the results of the analysis of such data obtained online are constantly changing, for example, information about the functioning of “smart things”. The very idea of Big Data as a property complex seems reasonable and very interesting, requiring further research.

## 5 Conclusion

Big Data as an object of information legal relations, regulated simultaneously by the norms of public and private law, is becoming increasingly valuable as a factor of social production, figuratively called “new oil”. The importance of Big Data in the field of national security and national defense is rapidly increasing, taking into account the threat of possible introduction of hybrid and cyber warfare by states.

A special feature of Big Data technologies is their universal nature, which makes it possible to use both the information flows and the corresponding technologies in various spheres of society. Big Data technologies and the information obtained with the help of such technologies are increasingly used by organizations that have a large customer base and carry out a variety of operational activities.

Such technologies and data sets, including personal data, are increasingly used in the activities of banks and other credit institutions, insurance organizations, professional participants in stock, currency and commodity exchanges (brokers and traders), in the field of retail and e-commerce. In fact, Big Data has an infinite potential for application in the fields of science, medicine and pharmaceuticals, in the social sphere, in the activities of state authorities and management [11], in the prevention and stopping the offenses and criminal activity, and in many other areas of society. The value of Big Data in the world has grown to such heights that it has become an essential asset and even the main goal of acquiring control over a number of large (including unprofitable) companies that have large amounts (and especially streams) of relevant information. It seems that this trend will increase.

At the same time, companies with huge amounts of constantly changing information are interested in developing and / or acquiring and applying Big Data technologies to obtain new valuable information, use it, and / or sell it. When comparing rapidly developing objects of digital law, it is necessary to take into account their relation. Almost all new objects are connected with the use of information and, at the same time, they contribute to a rapid increase in its volumes and diversity (Big Data and blockchain technologies, digital medicine and robotics, etc.). Due to the name “Big Data”, their composition cannot be limited only by technologies, excluding the data



itself from their structure as a mandatory component. Based on the above, it seems appropriate to understand Big Data as a set of constantly updated heterogeneous and other large-volume data from various sources, as well as special technologies (tools and methods) of their processing. The author conducted a comparative analysis of two similar objects of information law that have the same number and name of components: Big Data and information systems. When comparing the volume and nature of information in information systems and Big Data, it can be concluded that in most cases, the volume of Big Data is already many times higher than the volume of information in the compared databases of information systems. It seems that the gap in the number and variety of information in the compared objects of information law will only increase. The data volume of all information systems is always limited by the purposes of their creation and use. The amount of information in Big Data is almost infinite. Nowadays, the Russian state's regulatory function in relation to Big Data is clearly insufficient, including the localization of data processing centers on the territory of our country, which even creates a threat to national security. It is necessary to state the complete absence of special legal regulation of Big Data, including its legal definition, while at the same time increasing the influence of the state on high-tech participants. The uncertainty of the legal regime of Big Data has a double negative impact on the turnover of information: the relevant state bodies do not have clearly defined powers, and the participants of information relations do not have the necessary rights and guarantees for long-term investment in the formation and use of Big Data, in financing the accelerated development of new technologies in the field of data turnover. In the context of the obvious compression of the innovation cycle, the lack of optimal regulation of the use of Big Data and other new objects of information law threatens us with a possible "digital slavery".

## References

1. Schwab, K.: *The Forth Industrial Revolution*. Crown Business, New York (2017)
2. Hu, J., Zhang, Y.: Discovering the interdisciplinary nature of Big Data research through social network analysis and visualization. *Scientometrics* **112**(1), 91–109 (2017)
3. Succi, S., Coveney P.V.: Big Data: The end of the scientific method? *Philosophical Transactions of the royal society a: mathematical. Phys. Eng. Sci.* **377**(2142). <https://doi.org/10.1098/rsta.2018.0145>. Accessed: 25 March 2021 (2019)
4. Sarfaty, G.: Can Big Data revolutionize international human rights law? *University of Pennsylvania Journal of International Law* **39**(1), 73–101 (2017)
5. Martin, K.: Ethical implications and accountability of algorithms. *J. Bus. Ethics* **160**, 835–850 (2019)
6. Walker, M., Burton, B.: Hype cycle for emerging technologies. <https://www.gartner.com/doc/3100227/hype-cycle-emerging-technologies>. Accessed: 25 March 2021 (2015)
7. Triguero, I., García-Gil, D., Maillo, J., Luengo, J., García, S., Herrera, F.: Transforming Big Data into smart data: an insight on the use of the k-nearest neighbors algorithm to obtain quality data. *WIRES Data Mining and Knowledge Discovery*, **9**(2), e1289 (2019)
8. Lapteva, A.M.: Legal regime of the digital assets (on example Big data). *J. Russ. Law* **4**, 93–104 (2019)

9. Kemper, J., Kolkman, D.: Transparent to whom? No algorithmic accountability without a critical audience. *Inf. Commun. Soc.* **22**(14), 2081–2096 (2019)
10. Sadowski, J.: When data is capital: Datafication, accumulation, and extraction. *Big Data Soc.* **6**(1). <https://doi.org/10.1177/2053951718820549>. Accessed: 25 March 2021 (2019)
11. Engin, Z., Treleaven, P.: Algorithmic government: Automating public services and supporting civil servants in using data science technologies. *Comput. J.* **62**(3), 448–460 (2019)

# Legal Problems of Rights Tokenization to Individually Defined Objects in Russian Legislation



A. A. Lykov, D. E. Manelov, and D. S. Tokmakov

**Abstract** In a broad sense, the idea of tokenization of rights has an even longer history than the history of the existence of cryptocurrencies. Nevertheless, it has not yet been properly implemented either in theory or in practice. The influx in the popularity of NFT, which occurred in February 2021, pointed to the significant financial relevance of the tokenization of rights, but also raised a number of acute issues for the global legal community regarding the proper executing of transactions with NFT. First of all, the representation of the public and non-legal experts about the functions that a full-fledged NFT should have, deserves an assessment from a legal point of view. In addition, it remains unclear what legal institution can be used to ensure the unity of the token and the rights subject to it when disposing of the token. It also requires clarification of what may be the subject asset for the NFT. This study is devoted to the attempt of theoretical and legal understanding of the NFT phenomenon and the assessment of the prospects for the implementation of this concept in Russian law.

**Keywords** Cryptocurrencies · Intellectual property · NFT · Real estate · State registers · Tokens

## 1 Introduction

This study deals with the topic of tokenization of rights to individually defined objects. Despite the fact that this issue has a certain history, the topic of tokenization of rights was previously mainly considered in the context of ICOs and the creation of commodity-based tokens and security tokens. This article, taking into account this experience, concerns a completely new kind of virtual assets—individually defined

---

A. A. Lykov (✉)

Moscow State Institute of International Relations (University) of the Ministry of Foreign Affairs, Moscow, Russia

D. E. Manelov · D. S. Tokmakov

North Caucasus Federal University, Stavropol, Russia

© The Author(s), under exclusive license to Springer Nature Switzerland AG 2022

S. I. Ashmarina and V. V. Manteulenko (eds.), *Digital Technologies in the New*

*Socio-Economic Reality*, Lecture Notes in Networks and Systems 304,

[https://doi.org/10.1007/978-3-030-83175-2\\_18](https://doi.org/10.1007/978-3-030-83175-2_18)

non-fungible tokens, known as NFT. First of all, the concept of NFT itself is analyzed, its independence and difference from other types of tokens are proved, and the ideal legal model of NFT is formulated. Further, the indicated model is considered from the point of view of legal institutions and norms existing in Russia, and on this basis, the conditions for the implementation of the concept of tokenization of rights to individually defined objects in Russian legislation are formulated.

## 2 Methodology

This study is devoted to the prospects of tokenization of rights to individually defined objects in the Russian legislation. It is based on Russian and foreign scientific works related to this issue, as well as Russian normative sources. The research methods were systematic, dialectical, formal-legal methods, as well as a number of sociological (statistical, survey and expert assessment methods) and theoretical methods (analogy, abstraction, idealization, analysis and synthesis, formalization, hypothesis methods, modeling, axiomatic method, etc.).

## 3 Results

In this study, we consider a new type of virtual assets—individually defined, in other words, non-fungible tokens (NFT). Due to their inherent qualities of NFT, it can be concluded that their legal construction is closest to the legal construction of legitimization marks [1]. A theater ticket gives the right to use a specific seat in a certain period of time, a wardrobe token gives the right of the bearer to pick up the subject item. Like NFT, legitimization marks are associated with individually defined objects, and the transfer of these marks entails the transfer of the rights that they secure. However, unlike legitimization marks, NFTs are the result of the tokenization of much more complex rights. As a result, a person who wants to implement the “ideal NFT model” in Russia will have to consider a number of factors.

The closest legal structure to the “ideal NFT model” in modern Russian legislation is the institution of utilitarian digital rights, which is enshrined in Federal Law dated 02.08.2019 N 259-FZ “On attracting investments using investment platforms of the Russian Federation” (hereinafter, 259-FZ). The limited compatibility of the two concepts under consideration is as follows:

1. Due to the uniqueness of the NFT, the construction of utilitarian digital rights can only help with the registration of the right to demand the transfer of individually defined movable things or exclusive rights to the results of intellectual activity (Part 1 of Article 8 of Federal Law N259-FZ). Tokenization of rights to real estate objects is prohibited (Part 2 of Article 8 of Federal Law N259-FZ) [2].

2. The design of utilitarian digital rights serves as an investment tool, and the use of these rights is possible only within the framework of the investment platform that created them. In such circumstances, a full-fledged NFT can be implemented only for the implementation of a single transaction. Within its framework, the operator of the investment platform sells a token (an utilitarian digital right), and the acquirer immediately uses this right, demanding to transfer to him a thing or an object of intellectual property. After the completion of this transaction, the investment is considered to be made, and the token that performed the function required by law disappears, since its object leaves the ownership of the operator of the investment platform (Part 1 of Article 8 of Federal Law N259-FZ) and the operator can no longer create a new utilitarian digital right in relation to it [2].

Outside of the legal regime established by Federal Law N-259-FZ, the creation of an NFT has other difficulties.

1. The “ideal NFT model” assumes the “unity of fate” of the token and its object of the right. In this case, the token is an add-on that simplifies the disposal of the object. In addition to Federal Law N259-FZ, there are no norms in Russian legislation that allow for such a “unity of fate”. Accordingly, when selling NFT, the parties will be forced to issue a separate transfer of the token and the object of the right, thereby only complicating the transaction and depriving the add-on in the form of a token of meaning.
2. Transactions on the alienation of NFT may be difficult due to the requirements established in the law for the order of disposal of certain law objects [3]. Thus, the alienation of intellectual rights should be made in written form with a mandatory indication of the price. Almost any disposal of real estate in Russia have to be registered in the relevant state register [4]. Accordingly, even with proper tokenization of the right, transactions with this right will not become easier.

For this reason, tokenization should not be allowed, in particular, in relation to objects whose rights are already subject to registration [5], since this will not only burden market participants with a double duty, but also is fraught with dangerous legal conflicts, including the discrepancy between the token owner and the person specified in the state register.

As a compromise that can really simplify and improve the turnover of various objects of rights, it is permissible to provide for the possibility of creating private blockchain registers of rights [6], the records in which will have independent legal force. In this case, the NFT can be used as another proof of the right ownership [7] (for example, for a car), as well as a way to verify the legality of previous transfers of rights to a specific object.

One of the most well-known examples of this kind of registers is the online service WIPO Proof, created by the World Intellectual Property Organization and allows to certify the existence of a digital file at a certain point in time [8].

## 4 Discussion

Modern authors understand the tokenization of rights as the following phenomenon. The rights holder uses the blockchain and creates one or more tokens within it, just as the creators of cryptocurrencies do. However, unlike cryptocurrencies, the rights holder does not put the issued tokens into circulation, but takes an additional step. It secures its right to the created tokens, as a result of which the possession, use and disposal of the token becomes equivalent to the possession, use and disposal of the assigned right.

These actions, according to the researchers, are designed to simplify the disposal of rights, in particular, the sale or licensing, depending on which right was tokenized [9]. Theoretical works of recent years show that the described tokenization process is characteristic of several types of tokens at once. Asset-based tokens are the result of the tokenization of ownership of a physical asset: lands, diamonds, exchange and non-exchange goods, such as oil, sand or bananas. Security tokens are the result of the tokenization of obligations and other rights, such as the right to receive a share of the company's income [10].

According to the current views of scientists, non-fungible tokens are the result of tokenization of various rights to tangible and intangible objects. NFTs have two characteristics: uniqueness (non-fungibility) and indivisibility. Accordingly, the rights that became the subject of NFT-tokenization have the same two qualities. They can be, for example, the right of ownership of a land plot or the related right to publish a literary work [11].

These qualities of NFTs differ from security tokens and most commodity tokens, which fix the rights to objects defined by generic characteristics (a ton of any rice), or to shares in relation to individual objects (20% of the land plot or enterprise income). Accordingly, such tokens can be replaced with other tokens that secure the same amount of rights, and, as a result, are not the NFT. In general, studies show that nowadays NFTs represent an independent kind of virtual asset [3].

Based on the existing publications on the topic, it is possible to deduce the “ideal legal model of NFT”, more precisely, a number of legal qualities inherent in this new concept [3, 11]. Firstly, NFTs are unique and cannot be replaced by something else. Accordingly, the rights tokenized in the NFT also become unique and indivisible. Thus, the ordinary right of ownership of a plot can be divided between co-owners, becoming a common shared property. In contrast, a property right tokenized in NFT cannot be shared as long as its tokenization persists. The situation is similar with intellectual rights for digital and physical works of art: several persons may have the right to publish a work, but if this right is NFT-tokenized, then only one person can have it.

Secondly, the “ideal NFT model” assumes a kind of “unity of fate” right to the token and the right that secures this token. When a token is transferred, its right should be transferred simultaneously. If the right changes (there is a division of the land plot) or is terminated (the right to publish the work expires), the corresponding

token should also disappear. However, the NFT is an auxiliary legal structure, its disappearance will not affect the law in any way.

## 5 Conclusion

The conducted study allowed us to come to a number of conclusions:

1. NFTs are an independent type of virtual asset that coexists with commodity tokens, securities tokens, and so on.
2. The “ideal legal model of NFT” assumes that a given asset has two mandatory characteristics: the uniqueness and individual certainty of the subject, the right on which was NFT-tokenized, as well as the non-fungibility of any NFT with any other NFT or assets.
3. In Russian law today, there are no legal constructions that fully allow to implement the “ideal legal model of NFT”. The only minor exception is the institution of utilitarian digital rights, which allows the creation of some kind of NFT for one-off transactions concerning movable things.
4. The main obstacle to the NFT-tokenization of most types of rights, is the legally established procedure for the disposal of these rights.
5. The only potentially useful way to implement the NFT concept in Russian law is to create blockchain registries, where the token records will allow to control the legality of transitions of rights to objects, transactions with which are not subject to mandatory registration.

The theoretical understanding of the legal aspects of rights tokenization, including NFT, has just begun. The difficulty of studying this issue is not only in the difference of legal systems, which sometimes impose contradictory requirements for the registration of rights, but also in the different understanding of the theory of NFT and tokenization in general.

This study showed that the implementation of the NFT model in Russian law nowadays is difficult. Nevertheless, the tokenization of individually defined objects of right in Russia is still possible and has prospects for development.

## References

1. Sidorenko, E.L.: The legal status of cryptocurrencies in the Russian Federation. *Economy. Taxes Law* **2**, 129–137 (2018)
2. Federal Law dated 02.08.2019 No. 259-FZ «On attracting investments using investment platforms of the Russian Federation». [http://www.consultant.ru/document/cons\\_doc\\_LAW\\_330652/](http://www.consultant.ru/document/cons_doc_LAW_330652/). Accessed: 17 March 2021 (2019)
3. Dowling, M.M.: Fertile LAND: pricing non-fungible tokens. <https://doi.org/10.2139/ssrn.3813522>. Accessed: 17 March 2021 (2021)

4. Chevet, S.: Blockchain technology and non-fungible tokens: Reshaping value chains in creative industries. <https://ssrn.com/abstract=3212662>. Accessed: 17 March 2021. (2018)
5. van Erp, S.: Land registration and 'disruptive' (or 'trustworthy'?) technologies: Tokenisation of immovable property. <https://ssrn.com/abstract=3441938>. Accessed: 17 March 2021 (2019)
6. Konashevych, O.: General concept of real estate tokenization on blockchain. *Eur. Prop. Law J.* **9**(1), 21–65 (2020)
7. Trautman, L.J.: Virtual art and non-fungible tokens. <https://ssrn.com/abstract=3814087>. Accessed: 17 March 2021 (2021)
8. WIPO Proof: Trusted digital evidence for your intellectual assets. <https://wipoproof.wipo.int/wdts/>. Accessed: 17 March 2021 (2021)
9. Matulionyte, R.: Can copyright be tokenized? <https://doi.org/10.2139/ssrn.3475214>. Accessed: 17 March 2021 (2019)
10. Konashevych, O.: Regulatory trends in blockchain technologies. <https://doi.org/10.2139/ssrn.3749708>. Accessed: 17 March 2021 (2020)
11. Saunders, P.: The zone protocol (with implementations). <https://doi.org/10.2139/ssrn.3180835>. Accessed: 17 March 2021 (2018)



# **Data Generation and Exchange Platforms**

# Features of Assessing the Organizations' Financial Activities Using Data Generated Under IFRS



O. S. Aksinina and M. A. Tyugin

**Abstract** The article defines the concept of financial activity of an economic entity, revealing its essential characteristics. The authors applied a methodology for assessing financial performance based on the determination of quantitative indicators (capital structure, financial stability, profitability), and concluded that the capital structure is irrational. As a conclusion, the need to supplement the assessment toolkit with a number of qualitative indicators, from different sides, characterizing the activities of an economic entity, as well as the development of a software product that allows real-time monitoring of financial activities within a region or industry, was determined.

**Keywords** Assessment of financial performance · Economic entity · Financial performance · Financial performance monitoring

## 1 Introduction

In the past few years, even before the emergence of the so-called “Black swan”, a factor that is hardly predictable and has highly significant consequences—a pandemic of the new coronavirus infection, there were discussions in the scientific and business circles about which sector of the Russian economy could act as a driver of development and help to overcome a recession, the signs of which emerged at the turn of 2017–2018. With all the obvious shortcomings in the form of dependence on foreign technologies, low productivity, depreciation of assets, high energy intensity, infrastructure problems and others, experts named the areas of industrial production, albeit not as drivers of a breakthrough, but as a locomotive for catching up development.

Within the framework of the new economic paradigm, based primarily on digital solutions, sustainable continuous development can be ensured by competent and timely management decisions that are based on monitoring systems for indicators of the state of economic entities. The use of Big Data tools will make it possible to

---

O. S. Aksinina (✉) · M. A. Tyugin  
Samara State University of Economics, Samara, Russia

combine data on a number of economic entities to form a holistic picture of the state of the economy in a region or country as a whole. During a significant slowdown in the growth of the global economy and the stagnation of some national economies, such an approach can make it possible to carry out strategic planning for a period of 3–5 years, as well as assess the achievement of targets not only in financial activities, but also in personnel management, sales, and so on.

The purpose of the study is to study the sufficiency of some quantitative indicators to assess the effectiveness of the financial activities of economic entities using the example of the automotive industry. KAMAZ PTC, the largest domestic corporation in the field of automotive engineering, the leader of the domestic market for heavy trucks, whose share in production on the market in recent years has fluctuated from 40 to 55%, was chosen as the object of research.

## 2 Methodology

In our opinion, the key task of the policy of automotive enterprises in the field of financial management in the context of stagnation, the way out of which is complicated by a pandemic, should be to achieve an optimal structure of funding sources. At the same time, the ambiguity of views is also presented in determining the optimal ratio of equity and borrowed capital. Modern estimates are mainly based on the position that the active use of “cheap” borrowed funds contributes to an increase in the return on equity, but the higher return on equity is compensated by the loss of financial stability [1]. Financial leverage demonstrates this effect. High financial leverage leads to both an increase in the return on equity and a decrease in financial stability.

As part of the work, the management of financial activities will be understood as a set of targeted measures carried out by an economic entity to change the shares of equity and borrowed capital, the final result of which can be quantified using indicators and used for forecasting purposes. At the same time, it is worth remembering that borrowed sources of financing are highly risky.

Financial performance was assessed using coefficient analysis. At the first stage, the structure and composition of equity and debt capital were assessed, the rationality of the formation of financial resources and financial stability was determined. At the second stage, the profitability of activity and capital is characterized, a comparison is made with the level of inflation in the economy. At the third stage, a model for optimizing the capital structure by the WACC method was applied through the procedure for clarifying the credit rating, a conclusion was made about the optimal ratio of equity and borrowed funds.

In the current conditions, domestic car production is localized and oriented towards the domestic market, while stagnation processes lead to a lower solvency of a larger mass of consumers. The lack of efficiency of financial mechanisms, including the attraction of credit resources, is indicated, among other things, by a lag of 3–4%.

In addition, the structural mechanisms for supporting large business in large capitalist countries make it possible to attract significant amounts of funds on a long-term basis at rates lower than similar domestic ones.

### 3 Results

To assess the rationality of the capital structure and financial stability, consider the values of the coefficients that show the ratio of own and borrowed sources of financing. For this, the coefficients of autonomy, financial leverage, provision with own working capital (hereinafter referred to as OWC), long-term financial independence (hereinafter referred to as LFI), as well as the availability of net working capital (hereinafter referred to as NWC), permanent capital (hereinafter referred to as PC), main sources of formation of reserves (hereinafter—MS). The values of the coefficients used for the calculation are given below (Table 1).

During the period under consideration, the values are in the risk area. The analysis showed an unstable financial condition, insufficient organizations' own funds to finance current activities, an increase in the risk of insolvency.

Based on the results of the analysis of profitability indicators (Table 2), the following conclusions can be drawn:

1. Decrease in profitability indicators points to a decrease in the efficiency of the enterprise.
2. The negative effect of financial leverage may indicate an excess of the cost of borrowed capital over the resulting profitability.
3. The return on equity is slightly higher than the inflation rate.

The analysis of the current activities of KAMAZ PTC made it possible to establish that in the structure of receipts from financial activities, the receipt of loans and

**Table 1** The values of the coefficients characterizing the ratio of debt and equity capital and the financial stability of KAMAZ PTC in 2016–2019

| Indicator                | Standard | Years   |         |         |         |
|--------------------------|----------|---------|---------|---------|---------|
|                          |          | 2016    | 2017    | 2018    | 2019    |
| Autonomy ratio           | >0.5     | 0.477   | 0.436   | 0.433   | 0.375   |
| Financial leverage ratio | <0.7     | 0.382   | 0.394   | 0.569   | 0.300   |
| OWC security ratio       | >0.1     | −0.746  | −0.439  | −0.394  | −0.032  |
| LFI ratio                | >0.7     | 0.621   | 0.559   | 0.549   | 0.452   |
| Surplus/lack of NWC      |          | −31,019 | −34,684 | −67,513 | −85,368 |
| Surplus/lack of PC       |          | −6365   | −186    | −31,075 | −29,026 |
| Surplus/lack of MS       |          | 4096    | 12,837  | −8750   | 6092    |

Source Authors

**Table 2** Profitability indicators of KAMAZ PTC in 2016–2019, %

| Profitability indicator | Years |      |      |      |
|-------------------------|-------|------|------|------|
|                         | 2016  | 2017 | 2018 | 2019 |
| Sales                   | −1.10 | 1.85 | 4.41 | 2.51 |
| Production              | −1.20 | 2.09 | 5.22 | 2.83 |
| Equity                  | −6.18 | 1.74 | 9.03 | 4.05 |
| Borrowed capital        | −8.09 | 1.59 | 6.50 | 2.11 |
| Permanent capital       | −4.19 | 0.98 | 4.69 | 1.85 |
| Assets                  | −2.30 | 0.54 | 2.35 | 0.89 |
| EBITDA                  | 7.89  | 4.61 | 6.81 | 4.91 |
| Inflation rate          | 5.50  | 2.48 | 4.27 | 3.05 |

Source Authors

borrowings (89%) predominates, the rest falls on the issue of bonds, in the structure of outflows from financial activities—the repayment of loans and borrowings (92%), as well as an insignificant share of interest paid, bonds redeemed, dividend payments. The structure of the company’s liabilities remains risky. A further decrease in indicators may lead to a negative impact on the assessment of creditworthiness and on the attraction of additional sources of financial resources (especially credit). The high cost of capital raised is evidenced by the excess of the weighted average cost of capital WACC over the return on capital employed ROCE: 16.89 and 4.93, respectively. To recommend the optimal ratio of equity and borrowed funds, we apply the capital structure optimization model using the WACC method, for which we take 8 classic debt load scenarios from 0/100 to 70/30 and calculate the cost of equity using the CAPM model. To determine the value of the risk-free rate, the yield on USD 30-year US Treasury bonds was taken, adjusted for the difference in inflation rates. The  $\beta_0$  value published by Damodaran [2] for the US automotive industry has been adjusted for inflation rates in Russia and the USA by the formula:

$$\beta_0^{\text{RU}} = \beta_0^{\text{USA}} \times \frac{1 + \frac{I_{\text{RU}}}{100\%}}{1 + \frac{I_{\text{USA}}}{100\%}}$$

where

$\beta_0^{\text{RU}}$ —the value of the beta coefficient for a Russian company that does not use debt financing;

$\beta_0^{\text{USA}}$ —the value of the beta coefficient for a US company that does not use debt financing;

$I_{\text{RU}}$ —annual inflation rate in Russia in percent in 2019;

$I_{\text{USA}}$ —U.S. annual inflation rate as a percentage in 2019.

Equity Risk Premium (ERP), interest coverage ratio ICR and, accordingly, credit rating S&P and default spread  $sd$  are used as expected market returns. Tabular values according to Damodaran. The sovereign risk value is obtained as the difference in

**Table 3** Determination of the optimal level of debt load of KAMAZ PTC by the WACC method

|  |        |       |       |        |        |        |        |          |
|--|--------|-------|-------|--------|--------|--------|--------|----------|
| Share of BC (%)  | 0      | 10    | 20    | 30     | 40     | 50     | 60     | 70       |
| Share of OC (%)  | 100    | 90    | 80    | 70     | 60     | 50     | 40     | 30       |
| Financial leverage (%)   | 0.00   | 0.11  | 0.25  | 0.43   | 0.67   | 1.00   | 1.50   | 2.33     |
| Beta L   | 0.50   | 0.46  | 0.42  | 0.37   | 0.33   | 0.28   | 0.23   | 0.18     |
| Equity E, mln. rub   | 39,914 |       |       |        |        |        |        |          |
| Borrowed Capital D, mln. rub                                   | 0      | 4435  | 9979  | 17,106 | 26,609 | 39,914 | 59,871 | 93,133   |
| EBIT, mln. rub   | 4750   |       |       |        |        |        |        |          |
| Debt load ratio D/EBIT   | 0      | 0.93  | 2.10  | 3.60   | 5.60   | 8.40   | 12.60  | 19.61    |
| Credit score, corresponding to the fin leverage                | AAA    | AAA   | AA    | A-     | BBB    | BB     | B      | B-       |
| Interest rate by rating  | 6.67   | 6.67  | 6.87  | 7.32   | 7.67   | 9.07   | 10.57  | 11.57    |
| Annual interest payments corresponding to the rating, mln. rub | 0      | 295.8 | 685.5 | 1252.2 | 2040.9 | 3620.2 | 6328.4 | 10,775.4 |
| ICR (%)  | 0      | 16.06 | 6.93  | 3.79   | 2.33   | 1.31   | 0.75   | 0.44     |
| Rating corresponding to the ICR                                | AAA    | AAA   | AA    | A-     | BB+    | B-     | CC     | C        |
| Default spread depending on the ICR (%)                        | 0.75   | 0.75  | 1     | 1.75   | 3.25   | 7.5    | 12     | 16       |
| Cost of BC (%)   | 0.06   | 0.06  | 0.06  | 0.07   | 0.09   | 0.13   | 0.17   | 0.21     |
| CAPM / Cost of OC (%)  | 0.11   | 0.11  | 0.10  | 0.10   | 0.09   | 0.09   | 0.08   | 0.07     |
| WACC (%)   | 11.09  | 10.05 | 9.14  | 8.46   | 8.24   | 9.45   | 11.55  | 14.21    |

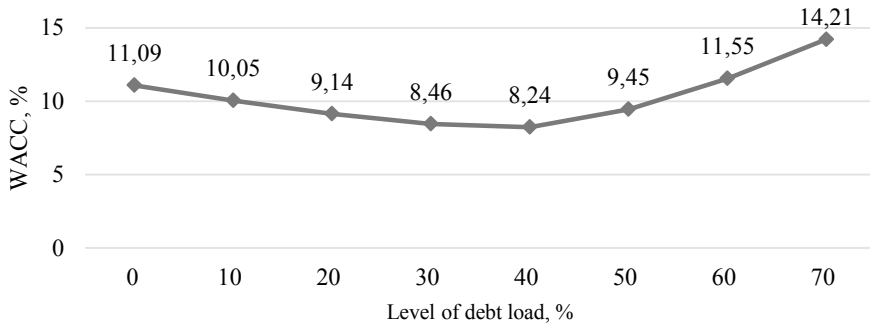
Source Authors

the yield on US Treasury bonds and debt instruments of the Russian Federation in dollars with similar maturities. The calculation of the values of the indicators for each of the options of the debt load is shown in Tables 1, 2 and 3.

Based on the data, it seems possible to construct a graph of the dependence of WACC on the share of borrowed capital (Fig. 1). It follows from the figure that the optimal debt load corresponding to the minimum WACC value (WACC = 8.24) is 40. The current debt load at 70% is not optimal.

## 4 Discussion

Before the pandemic, the automotive industry was viewed more as an industry with great potential, although it did not escape the reindustrialization of the 1990s – 2000s. However, considering such a complex problem as the assessment of financial activity on the example of an enterprise in the automotive industry, it is necessary first of all to



**Fig. 1** Dependence of WACC on the debt load of KAMAZ PTC, % (Source authors)

turn to the concept. A review of the scientific literature reveals the ambiguity of both the concept of financial management and its conceptual foundations. So, the authors mainly consider the concept of financial activity from two sides. Firstly, from the point of view of accounting, it can be defined as a complex concept, characterized by a system of analytical indicators reflecting the availability, placement and use of financial resources of an enterprise, with the help of which the financial condition is determined. A number of authors consider financial activity to be one of the activities of an economic entity, region or state, along with investment, project and others [3, 4]. This approach is supported by law, for example, according to accounting regulations, financial activities are activities related to attracting financing on a debt or equity basis and leading to changes in the size and structure of capital.

On the other hand, the authors consider the concept of financial activities of an organization from the point of view of management. This approach takes a closer look at the complex of measures in their interrelation, for example, management of cash flows, investments in non-current assets and financial instruments, management of working capital, the cost and structure of the organization's capital, etc., which lead to the final financial result [5].

It should be noted that a number of economists reveal the essence of financial activity not only through the financial result and a set of activities, but also through the assessment of the financial potential of an economic entity in the short and medium term [6].

Based on the foregoing, it seems possible to highlight the essential characteristics of financial activities:

- is a complex concept that is the object of consideration of accounting and financial management;
- expressed by the assets of the organization and their sources;
- can be assessed by analyzing the effectiveness of the use of property and profitability of products, the degree of financial stability of the enterprise, the level of liquidity and solvency.

## 5 Conclusion

At the same time, it should be noted that other factors of the external and internal environment also affect the financial activities of organizations. The sanctions confrontation, the instability of the oil and gas sector, geopolitical tensions have an impact on the economic situation, consumer demands and, as a consequence, the results of the financial activities of economic entities. With regard to KAMAZ PTC, it should be said that the increase in the volume of debt burden in the current conditions of extremely high economic and political uncertainty is a step towards complicating the position of the enterprise in the event of a further deterioration in the macroeconomic situation in Russia and the world, in addition, the focus on innovative development in the current environment may not be the best solution. Therefore, pursuing a more restrained financial policy in the future and reducing the debt burden may turn out to be strategically correct.

Based on the study, the authors formulated the following conclusions:

1. Financial activity is a complex and ambiguous concept for definition that characterizes both the type of activity, a set of sequential actions, and the final financial result.
2. The financial activity of an economic entity can be assessed using a set of indicators. In this paper, to assess the financial performance of the leader of the domestic automotive industry in terms of the production of heavy trucks - KAMAZ PTC, quantitative analytics was used: analysis of the capital structure, financial stability, profitability, and also the model of capital structure optimization using the WACC method.
3. Aggregation of data, compilation and timely updating of tables with values for the components of the capital structure optimization model, suitable for assessing domestic industries and the economy as a whole (taking into account the inflation rate, ratings, etc.) will simplify the research tasks.
4. The authors recommend to use both quantitative indicators to assess financial performance (depending on the purpose and objectives of the study, their list can be supplemented), and qualitative: drawing up a detailed SWOT and SNW analyzes or, for example, determining the projected interest rate and term lending using the expert method.
5. For a convenient presentation of information and scaling the assessment of financial activity according to the data of a group of economic entities, it is recommended to develop a software product.

## References

1. Kovalev, V.: Analysis of the economic activity of the enterprise. Prospect, Moscow (2016)
2. Aswath Damodaran's Website: About. [http://pages.stern.nyu.edu/~adamodar/New\\_Home\\_Page/home.htm](http://pages.stern.nyu.edu/~adamodar/New_Home_Page/home.htm). Accessed: 15 March 2021. (2021)



3. Cheah SL-Y, Ho Y-P, Li S (2021) Search strategy, innovation and financial performance of firms in process industries. *Technovation*. <https://doi.org/10.1016/j.technovation.2021.102257>. Accessed: 21 March 2021 (2021)
4. Lysenko, D.: *Comprehensive economic analysis of economic activity*. INFRA-M, Moscow (2018)
5. Muhammad R, Muhammad A, Muhammad A (2021) How does corporate social responsibility affect financial performance, financial stability, and financial inclusion in the banking sector? Evidence from Pakistan. *Res Int Bus Finance* 55:101314
6. Chatzopoulou E-C, Spanos YE, Lioukas S (2020) Headquarters' monitoring mechanisms, subsidiaries' financial slack, and the contingent role of subsidiaries' external embeddedness. *Long Range Planning*. <https://doi.org/10.1016/j.lrp.2020.102044>. Accessed: 21 March 2021 (2020)

# Platform Employment: From Unsustainable to Sustainable Development



V. N. Bobkov, M. V. Simonova, and E. A. Chernykh

**Abstract** The article analyzes the characteristics and scale of platform employment in Russia and the world on the basis of surveys and research by international organizations. The authors have systematized and summarized the opportunities, risks and consequences of this type of employment for different actors of the labor market. Recommendations are proposed for solving the problem of the volatility of platform employment in Russia, taking into account the fact that its scale will grow over time. It was revealed that this area requires the development of regulatory methods, legislative initiatives and new solutions aimed at implementation of its advantages and limiting of threats. Platform employment policy should be an integral part of overall employment policy, and platform workers should have the right to decent work, social guarantees and recognition of their status as “employees”.

**Keywords** COVID-19 pandemic · Digital labor platforms · Platform employment · Precarious employment · Social protection · Wages

## 1 Introduction

Digital technology is revolutionizing the world of work. Artificial intelligence, big data, cloud computing, internet technologies and other innovations enable transactions and the exchange of large amounts of data and information between individuals and companies. All of these transformations are contributing to the exponential growth of digital platforms (including digital labor platforms (DLPs)) in many sectors

---

V. N. Bobkov · E. A. Chernykh

Institute of Socio-Economic Studies of Population of the Federal State Budgetary Scientific Institution Federal Center of Theoretical and Applied Sociology of the Russian Academy of Sciences (ISESP FCTAS RAS), Moscow, Russia

V. N. Bobkov

Plekhanov Russian University of Economics, Moscow, Russia

M. V. Simonova (✉)

Samara State University of Economics, Samara, Russia

of the global economy. Over the past decade, the number of DLPs has increased five-fold. Most of the workers using DLPs live in developing countries, and demand is generated mainly in developed countries [1]. Venture funds have played a fundamental role in financing the proliferation of digital platforms. The global distribution of investments in DLPs and platform revenues is geographically uneven. This trend has intensified after the outbreak of the COVID-19 pandemic, which has become a catalyst for the growth of precarious forms of employment, in particular remote and distributed work, its flexible and hybrid formats, increasing the use and spread of digital tools in the labor market [2], as well as “lifelong learning”, the transition from professions to competencies, the growing role of soft skills and emotional intelligence. The emerging open market for competencies will greatly change the structure of hiring labor resources. The relevance of the problem of platform employment is emphasized by the fact that the forms, types, features, of platform employment in recent years have become the object of study by numerous foreign and Russian researchers, as well as by international organizations.

## 2 Methodology

The International Labor Organization (ILO) identifies three categories of platforms [1]: providing digital services and products to individual users, such as social networks; intermediaries in the exchange of goods and services, such as e-commerce or B2B platforms; intermediaries facilitating the exchange of labor between legal entities and individuals—DLPs. In foreign sources, mainly two types of DLPs are considered: online web-based platforms, where tasks are performed by employees remotely and distributed between the so-called global platforms for micro-tasks and competitive programming, including platforms for freelancers; location-based platforms where tasks are performed at a specified physical location by individuals such as taxi drivers, delivery workers, and others. DLPs have become a hallmark of the digital economy, connecting businesses and customers with workers and providing them with new opportunities, while transforming labor processes that have serious consequences for the future.

The ILO has developed 18 criteria to be met by platform employment [3], and the European Parliament has offered detailed recommendations on such aspects of employment as social protection, wages, taxes, collective agreements [4]. Argentina has developed an online service through which consumers can submit complaints about platforms and sellers represented on the platforms. The law provides platforms with a voluntary system for paying social security contributions for their workers and supports platform workers in realizing their right to collective action, access to continuing professional education and validation of experience [4].

The platform economy allows a range of socio-economic benefits to be realized both for workers and employers, as well as for consumers and the economy as a whole. At the same time, the growth of platform employment is associated with a number of serious risks.

Despite the potential of platforms in terms of providing new employment opportunities for people, the potential for socio—economic problems that accompany the development of these forms of employment is emerging and growing. One of the major problem areas is the expansion of employment volatility. Precarious employment is forced employment, accompanied by the absence of standard labor relations based on an open-ended full-time employment contract, including elements of insecure, including informal employment in the formal economy, elements of unprotected employment in informal production, unprotected employment in hidden production and illegal activities, as well as temporary unemployment (unemployment) [5]. The elements of precarious employment expand their penetration into the sphere of labor relations with the development of DLPs.

To access the work offered on the platform, employees must agree to certain terms and conditions without any negotiation. These terms often contain words “independent contractor clauses” or “self-employed persons” which clearly state that a worker is not an employee and that the platform is not obligated to protect him from risks such as illness, disability, unemployment, retirement, maternity leave, etc. [5].

### 3 Results

According to the latest ILO report, there are at least 777 active global online web platforms (micro-tasks, freelance and competitive programming) and location-based platforms in the taxi and delivery sector (data from Crunchbase) in January 2021 worldwide [1]. The number of platforms in the delivery sector is the highest (383), followed by online platforms (283), the taxi sector (106) and there are five hybrid platforms that provide different types of services. Among online platforms, the majority are platforms for freelancers (181), then go platforms for micro-tasks (46), platforms for competitive tasks (37) and competitive programming (19). Pooled estimates from the same report show that 22% of the working-age population in the United States has ever offered a product or service using a digital platform, and about one-third of them reported earning at least 40% of their monthly income from the DLPs. Similar estimates for Europe range from 1.6% (Switzerland) to 7% (Finland). If we consider those who have ever worked or earned income at the DLPS, estimates range from 9 to 22% for individual European countries. Narrowing the reporting period to last year, estimates range from 0.3% (Canada) to 11% (16 European Union member states). There has not been a single statistical study of the scale of platform employment in Russia. The components of this type of employment can be evaluated separately [6]. Platform workers can be self-employed, salaried workers, independent contractors, individual entrepreneurs, freelancers, or not be a part of the workforce (schoolchildren, retired). According to our estimates, platform workers have the status of self-employed, the number of which reached 1.7 million in February 2021 [7]. Also, a significant part of those employed at the DLPs are freelancers. According to a study of Higher School of Economics [8], the total number of users registered on Russian-language remote work platforms is approaching 10 million, but, of course,

the real number of active freelancers is much less, also because many employees are registered at several DLPs at once.

Studies by the ILO and other international organizations [1, 3, 4] have shown that workers' incomes vary by platform and country. On location-based platforms, in addition to not having enough work, lower remuneration rates and high commission fees are driving down revenues. On online platforms, revenue is impacted by high levels of competition and commissions, as well as the often-unjustified abandonment or non-payment of tasks. Workers on online platforms often spend significant amounts of time on unpaid work, and workers on location-based platforms often spend a lot of time waiting for work—and that time is unpaid. 75% of US workers employed at DLPs earned less than the federal hourly minimum wage. 22% of workers indicated that the wages were insufficient. Employees face a significant number of rejections: 43% of employees had at least 5% of their work results rejected, and 32% of employees had a failure rate of at least 10% [9]. The fallout from the COVID-19 pandemic is exacerbating unemployment and lowering workers' incomes, putting them at greater risk because of lack of social protection.

Platform workers are solely responsible for paying social security contributions and are also excluded from other forms of labor protection. According to the ILO study, of 56% of workers who say that multi-agency work is their main job, only half say they have access to health care and only 24% pay their health insurance premiums. These shares are even lower in relation to pension benefits: only 25% of employees have access to the pension system and only 15% can pay pension contributions [9]. According to a 2017 study by the European Parliament, only one third of platform workers contribute to pension savings [4]. There are regional differences: workers in Western Europe have better pension coverage than workers in Eastern Europe, Asia, Africa and Latin America. Much of the platform work is based on assigning a small aspect of a big task to each employee: it is a matter of breaking down a job or production process into tiny, simple and repetitive tasks that will be presented to a "crowd": data entry, registration, etc. This kind of crowdsourcing is what researchers call "Digital Taylorism" and talk about the emergence of a class of "digital galley slaves" or "digital servants" [10, 11].

The study of employment revealed a large gap in the ratio of vacancies and resumes, a large share of demand and supply for jobs with signs of precarious employment (part-time, freelance, traveling work, work from home, remote employment). The assessment of the share of resumes with a willingness to work with incomes below the subsistence level showed large differences between the age groups of potential employees. Among them, the largest share was represented by workers aged 20 to 30, among whom from 20 to 40% were willing to receive wages below the subsistence level. By type of activity, such resumes were mostly represented by employees of IT, communications and telecommunications (up to 70%), marketing, advertising and PR (up to 50%) and science, education (up to 50%). The study made it possible to form a holistic profile of a precariously employed worker at the DLPs [5]. Opportunities, risks and consequences for different subjects of the labor market are summarized by us in Table 1.

**Table 1** Advantages, disadvantages and opportunities of DLPs for employees and companies

|               | For workers   | For companies  |
|---------------|---|--|
| Opportunities | <p>Additional income. Flexibility of place and time. Opportunities for those marginalized in traditional labor markets (people with disabilities, workers with family responsibilities, refugees in rural or economically disadvantaged areas, migrants, released from prison)</p>  | <p>Entering domestic and international markets for small and medium-sized enterprises (SMEs), growth in aggregate supply and demand. SMEs benefit economically from interactions with local DLPs (eg delivery). Potential to reduce working hours and reallocate work among more people. Opportunities for innovation, creation of customized products and services, new types of products, innovative business models, flexible organizational structures. Reducing transaction costs: information, communication, logistics; increased production flexibility; expanding access of business structures to a larger volume of labor resources at a low cost</p> |
|               | <p>Irregularity of work and income. Lack of social protection. Loss of freedom of association and collective bargaining rights. Fuzzy employment status. Discrimination, lack of interpersonal communication. Frequent cases of non-payment of wages for completed tasks<br/>                     Intensification of work “anytime, anywhere”; blurring the line between personal and work life. The labor supply of workers exceeds the demand from the PTC, therefore there is high competition for jobs. Redundancy of skills compared to employers’ request. Few prospects for professional development.<br/>                     “Algorithmization” of behavior, work and consumer habits, social and cultural preferences, “normalization” and standardization of personality. Polarization of jobs (washing out of jobs requiring secondary qualifications), increasing inequality in the distribution of income from employment.<br/>                     Decrease in employment of the local population<br/>                     Shrinking the sphere of sustainable and stable employment, and expanding the sphere of flexible and precarious employment, incl. the growth of fictitious self-employment with the aim of “evading” employers from taxes, the use of cheap labor, deregulation of labor relations</p> | <p>Low motivation, high staff turnover, low level of professional skills of employees. Low barriers to entry for workers. Lack of methods of interaction with employees<br/>                     Labor supply exceeds demand, which puts pressure on lower wages and higher profit margins. (SMEs) face strong competition as a result of aggressive DLPs pricing</p>  |

(continued)

**Table 1** (continued)

|  | For workers   | For companies |
|--|---|---------------|
| Impact on other subjects of the labor market | <p><b>Pros.</b> Improving the consumer value of goods and services due to deeper specialization of labor, consumers benefit from the greater availability of goods and services and a balance of supply and demand, increased choice and affordable prices</p> <p><b>Risks.</b> DLPS are blurring the previously clear distinction between employees and the self-employed. Destruction of the tax base of state and local budgets, financing of social insurance and social protection; growing economic and social polarization. Undermining the social function of labor due to the autonomization of employment. Risks of disruption of social ties, loss of social identity, increased isolation, insecurity and alienation. Heterogeneity and fragmentation of labor markets, information asymmetry. The increasing risks of the emergence of monopolies and oligopolies in the market of goods and services and a shortage of supply of jobs with an excess of demand for them—monopsony in the labor market, which is a factor in restraining economic growth and the realization of the labor and human potential of society in general. The rise of wrong decisions due to digital disruptions, their opacity to users, and digital tracking that creates a lack of trust</p> |               |

Source Authors

A detailed analysis of the global practices of regulation of platform employment is given in the article by Chernykh [10].

## 4 Discussion

The digital transformation of the economy and society can lead to an increase in precarious employment, which in turn can reduce income and increase socio—economic inequality [4]. The COVID-19 pandemic highlighted huge risks in these areas for workers employed on digital labor platforms [2]. Global economic competition leads to an increase in atypical work patterns and a corresponding decrease in employment-related benefits, as well as to a polarization of the labor force [12]. Innovative digital technologies are changing human resource management practices as algorithms increasingly replace people in allocating, evaluating, and distributing rewards for work done through DLPS. These profound and rapid changes have profound implications for the well-being and working conditions of workers around the world, especially in middle- and low-income countries. The regulation of DLPS is under discussion, and debates are ongoing, in particular on the role of the regulatory framework to ensure decent work in DLPS and fair competition for organizations and individuals [10]. As DLPS are growing rapidly and, in fact, shaping the world of work today, addressing the challenges faced by workers and employers is critical.

The development of platform employment needs to be geared towards the expansion of its benefits and the prevention of its threats. The problems caused by platform employment need to be limited, and the benefits realized in the progress of states

and an improvement in the quality of life of workers and their households. The study and other sources summarize the benefits and threats of platform employment. The above classification of the advantages and threats of platform employment is a field for developing solutions aimed at realizing its opportunities and limiting negative manifestations.

## 5 Conclusion

The development of platform employment is due to the objective processes of the digital revolution and the use of its opportunities by capitalist business companies and states. Its scope will grow over time, so this area requires the development of regulatory methods, legislative initiatives and new solutions aimed at realizing its benefits and limiting threats [13]. Platform employment policy should be an integral part of overall employment policy, and platform workers should be entitled to decent work, social guarantees and recognition of their status as “employed”.

Given that DLPs operate in several jurisdictions, there is a need for international policy dialogue and coordination. Progress can be achieved through social dialogue between stakeholders, primarily the DLPs, platform workers, their representatives and governments. The main goals that need to be set at the enterprise level, at the national and international levels [1, 6, 14]:

- ensuring fair competition and creating favorable conditions for enterprises;
- requiring clear and transparent terms of employment and contractual relations for employees and employers, in accordance with labor and consumer protection laws;
- correct classification of employment status at DLPs and its compliance with national classification systems;
- ensuring transparency in rankings of employees, organizations and individuals using online, location-based and e-commerce platforms;
- protection of personal data of employees, as well as data relating to organizations and their activities on the platforms;
- the opportunity for self-employed platform workers to exercise the right to collective bargaining;
- implementation of anti-discrimination and occupational safety and health laws at DLPs;
- ensuring adequate social benefits for platform workers by expanding and adapting policy and legal frameworks where necessary;
- ensuring fair dismissal processes for DLPs employees;
- providing access to independent dispute resolution mechanisms;
- ensuring that platform workers have access to the courts of the jurisdiction where they are located;
- protection of wages, fair pay and working time standards;



- allowing platform employees to move freely between platforms by facilitating the portability of employee data with respect to ratings;
- efficient taxation of the digital economy, including platforms, customers and employees, as well as their transactions.

Solving the problem of precarious employment, including the volatility of platform employment in Russia, will require: (1) the introduction of the concept of “precarious employment” into the political lexicon, the political will of the country’s leadership, arising from the awareness of its relevance, acuteness, large scale and social consequences; (2) expanding scientific research for the development of theoretical and methodological foundations for identifying precarious employment, its features in the platform economy and indicators of its identification; (3) organization at the state level of monitoring of dynamics of precarious employment on the basis of its indicators, with the identification of its prevalence among various groups of employees, the severity of manifestation, etc., to justify the development of managerial decisions; (4) purposeful actions at the state, business and public levels to develop a set of measures and mechanisms to reduce it.

National programs should be updated and provide for the creation of conditions for the realization of benefits and limitation of threats of the development of non-standard forms of employment, creation of conditions for the compression of areas of precarious employment, including platform employment.

## References

1. International Labour Organization: World employment and social outlook 2021: The role of digital labour platforms in transforming the world of work. [https://www.ilo.org/wcmsp5/groups/public/---dgreports/---dcomm/---publ/documents/publication/wcms\\_771749.pdf](https://www.ilo.org/wcmsp5/groups/public/---dgreports/---dcomm/---publ/documents/publication/wcms_771749.pdf). Accessed: 17 March 2021 (2021)
2. Loktyukhina, N.C., Chernykh, E.A.: Dynamics and quality of platform employment in the era of coronavirus: Challenges for Russia. *Living Stand. Popul. Reg. Russia* **16**(4), 80–95 (2020)
3. Berg, J., Furrer, M., Harmon, E., Rani, U., Silberman, M.S.: Digital labour platforms and the future of work: towards decent work in the online world. Geneva: International Labour Office. [https://www.ilo.org/wcmsp5/groups/public/---dgreports/---dcomm/---publ/documents/publication/wcms\\_645337.pdf](https://www.ilo.org/wcmsp5/groups/public/---dgreports/---dcomm/---publ/documents/publication/wcms_645337.pdf). Accessed: 17 March 2021 (2018)
4. EMPL Committee: The social protection of workers in the platform economy. URL: [https://www.europarl.europa.eu/RegData/etudes/STUD/2017/614184/IPOL\\_STU\(2017\)614184\\_EN.pdf](https://www.europarl.europa.eu/RegData/etudes/STUD/2017/614184/IPOL_STU(2017)614184_EN.pdf). Accessed: 17 March 2021 (2017)
5. Bobkov, V.N.: Precarious employment in the Russian Federation: theory and methodology of identification, assessment and reduction vector. KNORUS, Moscow (2018)
6. Bobkov, V.N., Chernykh, E.A.: Platform employment: the scale and evidence of instability. *World New Economy* **14**(2), 6–15 (2020)
7. Schwellnus, C., Geva, A., Pak, M., Rafael, V.: Gig economy platforms: Boon or bane? [https://www.oecd.org/officialdocuments/publicdisplaydocumentpdf/?cote=ECO/WKP\(2019\)19&docLanguage=En](https://www.oecd.org/officialdocuments/publicdisplaydocumentpdf/?cote=ECO/WKP(2019)19&docLanguage=En). Accessed: 17 March 2021 (2019)
8. HSE: Kings of remote work: HSE experts destroy myths and stereotypes about freelancers. <https://www.hse.ru/news/expertise/412583790.html>. Accessed: 17 March 2021 (2020)

9. International Labour Organization: Quality of the workplace in the platform economy. [https://www.ilo.org/wcmsp5/groups/public/---dgreports/---cabinet/documents/publication/wcms\\_618382.pdf](https://www.ilo.org/wcmsp5/groups/public/---dgreports/---cabinet/documents/publication/wcms_618382.pdf). Accessed: 17 March 2021 (2018)
10. Chernykh, E.A.: The quality of platform employment: Unstable (precarious) forms, regulatory practices, challenges for Russia. *Living Stand. Popul. Reg. Russia* **16**(3), 82–97 (2020)
11. Wallenstein, J., de Chalendar, A., Reeves, M., Bailey, A.: The new freelancers: Tapping talent in the gig economy. BCG Henderson Institute. <https://www.bcg.com/ru-ru/publications/2019/new-freelancers-tapping-talent-gig-economy>. Accessed: 17 March 2021. (2019).
12. Berg, J.: Protecting workers in the digital age: technology, outsourcing and the growing precariousness of work. <https://doi.org/10.2139/ssrn.3413740>. Accessed: 17 March 2021 (2019)
13. de Groen, W.P., Kilhoffer, Z., Lenaerts, K., Mandl, I.: Employment and working conditions of selected types of platform work. Luxembourg: Publications Office of the European Union. [https://www.eurofound.europa.eu/sites/default/files/ef\\_publication/field\\_ef\\_document/ef18001en.pdf](https://www.eurofound.europa.eu/sites/default/files/ef_publication/field_ef_document/ef18001en.pdf). Accessed: 17 March 2021 (2018)
14. OECD: Going digital: Shaping policies, improving lives. <https://www.oecd.org/going-digital/going-digital-synthesis-summary.pdf>. Accessed: 17 March 2021 (2019)

# Transformation of the Process of Public Goods Production in the Digital Paradigm



M. E. Konovalova, A. V. Kravchenko, and O. Y. Kuzmina

**Abstract** Main problems of the public goods production in the modern context are examined. The specific features of the patronized goods are analyzed in detail. The dependence of their production on government intervention is shown. The transformation of ideas about public good caused by changes in socio-economic environment, namely by the foundations of the digital paradigm of development formation is shown. The spread of network forms of economic entities coordination changes the idea of forms of the public goods providing while their essence and content remain unchanged. Digital forms of public goods distribution, especially of public services, are becoming more important. The development of network relations, including the process of production and distribution of public goods, increases the transparency of the services provided, as well as increases sizes of their provision.

**Keywords** Distribution · Optimality · Public goods · Patronized goods · Production · Public sector

## 1 Introduction

As known, main properties of pure public goods are non-competitiveness and non-exclusion. If the property of non-competition of public goods leads to inefficiency of their production in the market sector, then the property of non-exclusion completely removes public goods from the market turnover. Public goods are consumed collectively, are not paid separately per unit, are available to everyone in any quantity; therefore, a market tuned to work in conditions of effective demand will not be able to function under these conditions. In other words, there is not a single economic entity who wants to produce public goods, knowing that no one wants to pay for them, but at the same time it is impossible to exclude them from consumption for technical reasons. Thus, features of the economic turnover of public goods and their specific properties are one of reasons for “failures” of a market, when it either stops

---

M. E. Konovalova (✉) · A. V. Kravchenko · O. Y. Kuzmina  
Samara State University of Economics, Samara, Russia

to function or works ineffectively. Specific features of public goods in comparison with private goods and the failure of the market to provide them in the optimal, required volume for society, make their production dependent on state and collective decisions [1].

The main problem of the public goods production, especially when it comes to their classical form, is impossibility of accurately measuring the volume of demand for them. The production of a public good presupposes the coordination of collective action, voluntary participation in which is not automatically provided, since, as known, the process of a public good consumption is associated with the presence of the “freeriding” or “free rider” effect.

## 2 Methodology

The study of the processes of production and distribution of public goods, including the determination of their optimal volume, involves the use of various methodological approaches and local methods. The reproductive, institutional-evolutionary and systemic ones might be highlighted as main methodological approaches that are used in the article. The use of the reproductive approach allows us to determine the essence of a public good, to show its specific features precisely as a product of social production. The institutional-evolutionary approach contributes to the study of the traditional ideas about the form and content of the patronized good evolution and indicates the role of regulatory and incentive institutions in the process of providing such goods. The systemic methodological approach is based on the study of the entire economic problems complex as a system consisting of separate elements operating on dialectical principles. The application of this methodological approach allows us to present the classification of public goods, showing the distinctive features of each of their types. Another methodological approach used in the study is comparative, which allows comparing the processes of production of public goods in the industrial and post-industrial eras. Methods of analysis, synthesis, deduction, induction, hypothesis, scientific abstraction are used as local research methods, which made it possible to reveal in more detail the essence and content of the scientific category under study.

## 3 Results

The unresolved problem of a free rider results in insufficient production of public goods, which ultimately leads to an increase in the tax burden on private taxpayers. There are objective reasons that limit the possibility of solving the free rider problem, as a rule, associated with an insufficient amount of information about the real preferences of citizens regarding their required amount of public goods [2]. Let's note the key ones:

- the price of a public good is determined on the basis of individual preferences, based on its usefulness for each specific subject but in this case there is a temptation to diminish the individual need for this good in order to minimize the private costs of its production;
- the inability of individuals to correctly estimate their preferences and the usefulness of the public good. As a rule, subjects cannot clearly define the amount of public good that they need. Moreover, individuals cannot estimate the usefulness of public goods as this is not always possible. So, for example, it is rather difficult to identify the usefulness of certain types of weapons for a specific individual;
- high costs associated with collecting information about preferences. It should be taken into account that the usefulness of some goods in general is extremely difficult to estimate and identify, we are talking about meritoric (patronized) goods, which are understood as good the need for which is not limited to the individual preferences of subjects. Society may need benefits the usefulness of which is not realized by specific subjects, which leads to distortion of information about their individual preferences. The basis for the definition of meritor goods is the duality of individuals' needs [3]. On the one hand, there is a certain "false" demand presented by subjects for some goods, on the other hand, there is a "correct" or "true" demand, which is not able to identify the market, and which is formed by the state. There are four main reasons for the duality of individual needs. Firstly, this is a "pathological case"—that is a situation when the consumer is not able to estimate all the benefits that the consumption of this particular good gives due to the lack of the necessary information. Secondly, it is the "Odyssey effect", which is that the consumer understands the usefulness of a given good, but his actual actions go against this understanding. Thirdly, the "irrationality of the poor" which highlights the fact that individuals with low income are unable to satisfy their "right" needs [4]. Fourthly, "the presence of society needs", that is the existence of social needs that are not reducible to the individual preferences of subjects, for example, the preservation of cultural heritage, nature, maintenance of public order, treatment of people with psychological problems, etc.;
- a fiscal illusion, the essence of which is shown in the fact that individual citizens do not know the actual cost of producing a public good, neither for society as a whole, nor for a specific individual in particular. There is an illusion of unequal exchange between citizens and the state in favor of the last one, which leads to the manifestation of opportunism on the part of the subjects in terms of necessary taxes non-payment. The asymmetry of information in this case leads to the overproduction of some public goods, and the underproduction of others [5].

The main problem in the process of determining the volume of public goods production is inability to identify the true preferences of consumers. Researchers from various economic schools, including the institutional one, have proposed several ways to determine needs of subjects. One of these options is the introduction of the Clark tax, the essence of which is that deception and distortion of information becomes not beneficial to individuals [6]. Clark's tax for a specific resident is equal to the change in the wealth of other residents that would occur if this individual did

not vote on the problem of making decisions about the production of a specific public good. In addition to Clark's tax, each individual pays a tax equal to the value of the public good divided by the number of inhabitants, and it does not depend on the preferences of individuals and the volume of consumption of goods they care for. Despite Clarke's understandable scheme for establishing the tax, this measure does not always lead to the goal. With the help of this measure it still fails to reveal the true preferences of subjects [6]. In the scientific literature there are several objective reasons that impede determination of individuals true needs while establishing the Clark tax. Let's note some of them:

- individuals can form coalitions in the process of voting, which might impede or even make it impossible to identify true preferences. In addition, one of the prerequisites for establishing the Clark tax is the desire of all subjects to vote. In practice, this assumption is not confirmed, since in the presence of a large number of voters an individual can estimate his costs from participation in voting as more significant than the benefits from it and refuse to participate in making a decision on the production of a public good;
- there are no guarantees that individuals have the material opportunity to pay Clark's tax if it is imposed on them;
- Clark's tax mechanism is inconsistent with the criterion of balancing the costs of producing public goods and the level of taxes paid to the budget. The sources of funding the production of public goods are tax revenues, while Clark's tax system create a budget surplus that cannot be returned back by the entity in the case of underproduction of public goods [6].

Lindahl's model is another theoretical construct for the coordination of individual preferences in terms of the public goods production. The voluntary exchange model was developed by Lindahl in 1919. Its essence boils down to agreeing on the preferences of individuals and their opportunities to participate in the production of public goods. According to Lindahl equilibrium is an imitation of the market balance, prices are set at a level that all individuals can present demand for public goods in the same amount, which is the optimal volume of production [7]. Lindahl's model shows how voluntary exchange and the system of prices, which are understood as tax prices, lead to a decision about the optimal volume of public goods production. Lindahl defined his model as normative and called equilibrium as the fiscal optimum. The fundamental limitation of this model is the impossibility of solving the free-rider problem. According to Lindahl's assumptions, individuals, when face with a certain tax rate representing the price of production of a public good, indicate their preferences [7]. However, the essence of the problem of "freeriders" lies in the fact that it is not profitable for the subjects to fully show their true preferences, which leads to distortion of information about real needs of society for benefits they take care of. In addition, there is no guarantee that even if equal opportunities for individuals in making decisions about the production of a particular public good exist, the negotiations will be productive and the parties will come to an agreement. Lindahl's model is Pareto-optimal, which means an improvement in the situation of individuals as a result of voluntary exchange when the best volume of their production is achieved

at an appropriate level of tax payments. In addition, the variant proposed by Lindahl reflects only one of the possible Pareto-optimal states. It is not possible to choose the most preferable one as it is necessary to agree on collective decisions.

One of the mechanisms for revealing the preferences of individuals is the political process, which takes place in the form of elections, referendums, and other options for expressing will. Through the political process the population is given the right to express their preferences, giving their vote for a representative of a particular party, who, in the opinion of a particular individual, is capable of lobbying the production of public goods necessary for this subject. However, despite the seemingly simple mechanism for revealing preferences with the help of political technologies, in practice it seems to be very difficult because it is associated with a sufficient number of restrictions [8].

## 4 Discussion

The problem of the public choice formation and collective decision-making has been studied by many economists, so, back in the eighteenth century, the Marquis of Condorcet revealed a paradox according to which the expression of the will of different voters groups, each of which represents the majority, might conflict with each other. In modern studies of the problem of collective choice, for example, in the works of Arrow, it was proved that within the ordinal approach to estimating utility, it is impossible to find a way to combine individual preferences, ensuring making a fair and consistent collective decision, especially in the case of more than two alternatives existence as social needs do not have the transitivity property necessary to find the optimum [9]. In the scientific literature Arrow's theorem "about impossibility" is known, in which he develops the idea of the failure of public choice. Arrow notes that the function of public welfare is not just an automatic summarizing of individual preferences. It is mechanism of ordering possible alternatives itself. The operation of such a mechanism, which allows to aggregate individual preferences, is possible only if the following principles are observed, the implementation of which eliminates the main obstacle of making a collective decision by comparing alternatives—namely, to ensure the transitivity of social preferences. Arrow proposed four minimum requirements for this mechanism.

- unlimited domain, which means the action of the individual preferences aggregation mechanism for any combination of individual preferences;
- lack of dictatorship. A dictator in this case is defined as someone whose choice between pairs of alternatives is decisive, i.e. determining public choice regardless of the preferences of others.
- pareto principle. If any alternative is preferable for each individual, then it should be so for the whole society;
- independence from irrelevant alternatives [10].

Despite the moderate requirements, in practice there is no such function of public welfare that would satisfy all four. Thus, Wilson concludes that it is impossible to make an optimal collective decision. Nevertheless, the incompatibility of the conditions listed in the theorem does not mean that public choice is generally impossible. The meaning of the “impossibility” theorem is that for any procedure of collective choice there can be such a profile of preferences in which voting (no matter how it is conducted) does not lead to a stable result [11].

Another problem that needs to be solved in order to identify preferences in the voting process is the lack of information about the preferences of other individuals. Many American philosophers and political scientists we were engaged in the solution of the problem, who believed that in the process of expressing their will, individuals do not have knowledge of their future profession, social status, etc. Moreover, such information only harms a balanced collective decision, since the choice the individual will is inevitably influenced by selfish desires. Rawls called the proposed approach “the veil of ignorance”, it allows you to make more optimal decisions regarding the allocation of resources as a result of leveling individual preferences, otherwise the subjects will seek to obtain individual rent to the detriment of public welfare [12].

An important limitation is the fact that not all individuals have necessary skills to estimate the alternatives proposed in the voting process; moreover, not everyone participating in the vote has a genuine interest in choosing the correct alternative. The problem of making collective decisions with the help of the political process was studied by the American economist, Nobel Prize laureate in economics Buchanan. He substantiated the fact that making a collective decision regarding the production of public goods becomes more difficult with the increase in the number of participants. This is explained by the fact that an increase in the number of individuals taking part in the voting determines an interruption of the Pareto-optimal state, since there is only a small chance of reaching the necessary agreement between all subjects of the social negotiation process. This conclusion is based on the ratio of the making a collective decision costs and the number of individuals involved in this process. The costs of reaching an agreement, from the point of view of society, are unproductive, which determines the normative value of their size. Therefore, it is necessary to find ways to reduce the social costs of collective decision-making. An example of such activities is the organization of collective activities in the smallest groups in accordance with the size of the externalities that must be eliminated by moving these activities into the public sector [13].

Information transparency and the reliability of the information offered plays an important role in identifying of real social needs. Representatives of the public choice theory say that economic subjects seeking to maximize utility might participate in collective decision-making only if they are provided with operational information about the use of public resources.



## 5 Conclusion

The active penetration of information and communication technologies into public life leads to serious changes in all spheres of life, including those affecting the production of public goods. The use by the population of all kinds of gadgets, communication in social networks, online lending systems, payment for goods and services via mobile phones determine the transparency of the individual needs of business entities. The processing of such data, which is becoming more accessible and efficient due to the use of digital technologies, makes it possible to reveal the existing models of behavior of individuals, their real preferences, value orientations, etc. The implementation of the digital paradigm of socio-economic development allows us to solve the problem of identifying the true preferences of citizens. One of the models that can determine the needs of citizens in the digital age is the social credit (rating) system, which has been implemented in China since 2010. Without considering in detail the rating methodology itself (this is not included in the research tasks), we note that the general “digitization” of citizens really allows us to estimate the importance of certain goods for a particular individual and to predict the volume of demand for certain types of public goods [14].

One of aspects of the digital development paradigm implementation is network interaction, which is a completely different type of interaction and coordination of business entities. Within the framework of the implemented digital paradigm, the network can be considered in different ways. First, the network is the fundamental principle of the emergence and functioning of economic relations between people, which allows us to characterize them in essence as information-network relations. Secondly, a network is an institutionally formalized form of an economic system at the information stage of development, adequate to the conditions of the global information economy. Thirdly, this is the way the market and the plan exist in their dialectical interaction. Fourth, a network is a form of organization, coordination and management of network enterprises and socio-economic activities of business entities in a global information economy, which presupposes the presence of network coordination and network institutions for managing economic processes at various levels of the economy.

## References

1. Duh, M., Gosak, M., Perc, M.: Public goods games on random hyperbolic graphs with mixing. *Chaos, Solitons Fractals* **144**, 110720. (2021)
2. Han, W., Zhang, Z., Sun, J., Xia, C.: Emergence of cooperation with reputation-updating timescale in spatial public goods game. *Phys. Lett. A* **393**, 127173 (2021)
3. Liu, L.: Construction of youth public sports service system based on embedded system and wireless. *Microprocess. Microsyst.* **83**, 103984 (2021)
4. Moskowitz, R.L.: Building public schools in the city: the role of neighborhood context on voter support for school bonds. *Urban Aff. Rev.* **57**(2), 428–459. (2021).

5. Peck, J., Kirk, C.P., Luangrath, A.W., Shu, S.B.: Caring for the commons: using psychological ownership to enhance stewardship behavior for public goods. *J. Mark.* **85**(2), 33–49 (2021)
6. Clark, D.: *The distribution of wealth: A theory of wages, interest and profits*. Macmillan, London (1908)
7. Lindahl, E.R.: *Die Gerechtigkeit der Besteuerung*. Lund University, Lund (1919)
8. Quan, J., Zhang, M., Wang, X.: Effects of synergy and discounting on cooperation in spatial public goods games. *Phys. Lett. A* **388**, 127055 (2021)
9. Roberson, T., Leach, J., Raman, S.: Talking about public good for the second quantum revolution: analysing quantum technology narratives in the context of national strategies. *Quantum Sci. Technol.* **6**(2), 025001 (2021)
10. Taylor, I.: Political obligations and public goods. <https://link.springer.com/article/10.1007%2Fs11158-020-09496-8>. Accessed: 11 Mar 2021 (2021)
11. Vélez, D.C., Pachocka, M.: Producing public goods in the EU: European integration processes in the fields of refugee protection and climate stability. *Euro. Politics Soc.* **22**(1), 1–18 (2021)
12. Wilson, M.: Government market power and public goods provision in a federation. *Int. Tax Public Financ.* **28**, 68–89 (2021)
13. Xia, K.: The characteristics of average abundance function of multi-player threshold public goods evolutionary game model under redistribution mechanism. *Appl. Math. Comput.* **392**, 125733 (2021)
14. Zheng, J., Ren, T., Ma, G., Dong, J.: The emergence and implementation of pool exclusion in spatial public goods game with heterogeneous ability-to-pay. *Appl. Math. Comput.* **394**, 125835 (2021)

# Development of a Harmonized Digital System for Cross-Border Cooperation in the EU



M. V. Kurnikova, B. I. Tóth, and I. V. Dodorina

**Abstract** The paper examines the participation of the Hungarian regions in the European Union cross-border cooperation within the framework of the INTERREG flagship co-financing programmes and the macro-regional strategies for the cross-border, transnational and interregional cooperation. The study was based on raw data and their analytical compilations from the database keep.eu. The study concludes that, in the context of global transformations, border areas should be subject to supra-national and national regional policies implemented by programme instruments, a proactive mechanism of their use for the harmonious socio-economic development of a country or a group of countries.

**Keywords** Cross-border cooperation · European Union · Euroregion · Regional policy

## 1 Introduction

In the context of globalization, national borders are losing their barrier function and frontier territories are becoming a contact area in which peoples and nations, their cultures and economies actively interact. This factor of territorial development, called in the literature the «resource of borders» [1], has become an additional stimulus of economic and sociocultural development for the remote regions of many countries of the world, traditionally perceived as peripheral, not only because of their geographical location but also because of cultural and economic underdevelopment. In this connection, state support for the border territories is being provided not only to

---

M. V. Kurnikova (✉)  
Samara State University of Economics, Samara, Russia

B. I. Tóth  
University of Sopron, Sopron, Hungary  
e-mail: [toth.balazs.istvan@uni-sopron.hu](mailto:toth.balazs.istvan@uni-sopron.hu)

I. V. Dodorina  
Samara State Transport University, Samara, Russia

strengthen the national security of the country, but also to ensure economic growth both in the border areas and in the country as a whole; and is implemented not only in the framework of national foreign economic policy, but also in the federal policy of regional development [2, 3].

A great deal of cross-border cooperation for regional development has been developed in the European Union. This European process can be characterized by the paradoxical slogan of one of the joint programs of Russia and the EU—«United by borders», emphasizing that today national borders can become a unifying factor for a number of countries, with the implementation of joint projects making the border areas attractive for life and work on both sides of the border. For example, cross-border mega-cities such as Basel, Geneva, Luxembourg or the Oresund region [4] have benefited from European integration processes where, after internal boundaries were abolished, peripheral location turned these territories into potentially prosperous interfaces [5].

## 2 Methodology

The study on cross-border cooperation in the European Union was carried out using the database keep.eu [6], which contains aggregated data on projects and beneficiaries of cross-border, trans-national and interregional cooperation programmes of the European Union among member States, as well as between member states and neighbouring or pre-accession countries. The set of filters allows the search for programmes and projects according to: (i) types of (cross-border, trans-national and interregional) cooperation programmes; (ii) programming periods; (iii) countries and their regions according to the NUTS classification; (iv) thematic criteria (investment and thematic priorities, common output indicators). The article uses charts obtained when visualizing search results from this database.

The general scientific methods of systematic, logical and comparative analysis used in the study made it possible to assess: (1) the effectiveness of cross-border cooperation programmes in the European Union in implementing regional policies at a supranational level; (2) the participation of regions in cross-border cooperation programmes based on the NUTS2 regions of Hungary.

## 3 Results

### *3.1 Programming of Cross-Border Cooperation in the European Union*

Cross-border cooperation in Europe is based on the interest of the supranational regional policy of the EU («cohesion policy») in cross-border cooperation [7–9],

which originated in the 1980–90s within the framework of the idea of «Europe of regions». This interest was linked to the creation of a truly unified economic space in order to reduce regional disparities in the level of social and economic development and to support peripheral territories. In 1990, the EU's flagship scheme Interreg was launched to finance infrastructure projects of the border territories and re-profiling their sectoral structures [10]. The 2014–2020 programming period was the fifth in Interreg's 30-year history to undergo significant changes. The current structure of Interreg is shown in Table 1.

Thus, the flagship initiatives Interreg A and Interreg B finance cross-border and transnational cooperation projects at the internal borders of the European Union, and Interreg C co-finances initiatives to strengthen cross-border and interregional cooperation at the external borders of the European Union and to promote cooperation between member states and candidates/potential candidates, as well as between candidates and potential candidates.

In addition to Interreg, regional cooperation programmes outside the EU are funded through the following flagship programmes:

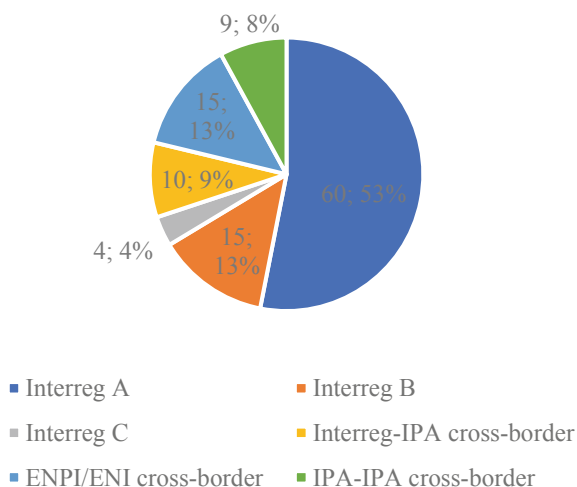
- IPA—«Instrument of Pre-accession Assistance», whose beneficiary countries are: EU candidate countries (Turkey, Albania, Montenegro, Serbia and the Republic of North Macedonia); potential candidate countries of the Western Balkans (Bosnia and Herzegovina, Kosovo);
- ENI—«European Neighbourhood Instrument», designed to finance projects within the framework of the European Neighbourhood Policy (ENP), aimed at supporting the processes of political, economic and social reform in the following European Union neighbours: Algeria, Armenia, Azerbaijan, Belarus,

**Table 1** Interreg's current structure

| Title  | Interreg A   | Interreg B  | Interreg C   |
|--|--|---|--|
| Type of cooperation                                      | Cross-border cooperation   | Transnational cooperation                                     | Interregional cooperation  |
| Participants   | NUTS III regions from at least two different Member States lying directly on the borders or adjacent to them | regions from several countries of the EU forming bigger areas | all EU Member States and more  |
| Number of programmes in the 2014–2020 programming period | 60 programmes  | 15 cooperation programmes                                     | 4 interregional cooperation programmes: EUROPE, INTERACT, URBACT and ESPON |
| Budget in 2014–2020                                      | EUR 6.6 billion  | EUR 2.1 billion   | ERDF contribution: EUR 500 million   |

Source Authors

**Fig. 1** Distribution of cross-border cooperation programmes by EU flagship programmes. *Source* Authors



Egypt, Georgia, Israel, Jordan, Lebanon, Libya, Moldova, Morocco, Palestinian Authority, Syria, Tunisia and Ukraine.

To date, 113 specific programs funded through these flagship programs in the 2014–2020 programming period are identified in the database keep.eu and their distribution is shown in Fig. 1.

Data from Fig. 1 shows that more than 70% of all cross-border cooperation projects of the EU regions are implemented through Interreg, financed from the European Regional Development Fund, which shows the importance of such projects not so much for foreign economic relations, but for territorial development.

### 3.2 Participation of European Regions in Cross-Border Cooperation Programmes (Case of Hungary)

It should be noted that the regions in the pan-European sense are the territories of the national states which, according to the NUTS (Nomenclature of territorial units for statistics) meet the population criterion of 1–3 million people. It is precisely such administrative and territorial units of national states that have traditionally been the subject of regional analysis and regional social and economic policy.

According to NUTS, in Hungary there are 8 regions of NUTS2 level—the regions of Hungary which, as a unitary state, ignores them in its territorial administrative structure and is divided into 20 territorial administrative units, 19 of which are *megye* (counties), and 1 is a city of republican subordination—*főváros* [11]. According to Keep.EU [6], in the 2014–2021 programming period, Hungary participates in 13 border cooperation programmes (Table 2) [6].

**Table 2** Hungary's participation in cross-border cooperation programmes

| Flagship initiative    | Interreg A                              | Interreg B                           | Interreg C                | Interreg-IPA                              | ENPI/ENI cross-border                              |
|------------------------|---|--------------------------------------|---------------------------|---|--|
| Operational Programmes | 2014-2020 INTERREG V-A Austria-Hungary  | 2014-2020 INTERREG VB Central Europe | 2014-2020 ESPON 2020      | 2014-2020 Interreg IPA CBC Hungary-Serbia | 2014-2020 Hungary-Slovakia-Romania-Ukraine ENI CBC |
|                        | 2014-2020 INTERREG V-A Romania-Hungary  | 2014-2020 INTERREG VB Danube         | 2014-2020 INTERACT III    |   |  |
|                        | 2014-2020 INTERREG V-A Slovenia-Hungary |                                      | 2014-2020 Interreg Europe |   |  |
|                        | 2014-2020 INTERREG V-A Hungary-Croatia  |                                      | 2014-2020 URBACT III      |   |  |
|                        | 2014-2020 INTERREG V-A Slovakia-Hungary |                                      |                           |   |  |
|                        |   |                                      |                           |   |  |

Source Authors

The regions of Hungary with external national borders, as well as the Budapest Metropolitan Region, participate fully in the cross-border cooperation programmes of the European Union aimed at the realization of such strategic objectives as:

- economic and social development of countries and regions;
- solution of general problems in the field of environment, public health, safety and protection;
- creating better conditions and forms for the mobility of people, goods and capital (Table 3).

It is noteworthy that Hungarian regions participate in cooperation programmes not only with countries with common borders (Ukraine, Romania, Slovakia, Serbia,

**Table 3** Regional distribution of cross-border cooperation operational programmes in Hungary

| NUTS2 Region           | Cross-border cooperation operational programmes   |
|------------------------|---|
| [HU11] Budapest        | 2014–2020 ESPON 2020<br>2014–2020 INTERACT III<br>2014–2020 INTERREG V-A Hungary–Croatia<br>2014–2020 INTERREG V-A Slovakia–Hungary<br>2014–2020 INTERREG VB Central Europe<br>2014–2020 Interreg Europe<br>2014–2020 URBACT III  |
| [HU12] Pest            | 2014–2020 ESPON 2020<br>2014–2020 INTERACT III<br>2014–2020 INTERREG V-A Hungary–Croatia<br>2014–2020 INTERREG V-A Slovakia–Hungary<br>2014–2020 INTERREG VB Central Europe<br>2014–2020 INTERREG VB Danube<br>2014–2020 Interreg Europe<br>2014–2020 URBACT III  |
| [HU21] Közép-Dunántúl  | 2014–2020 ESPON 2020<br>2014–2020 INTERACT III<br>2014–2020 INTERREG V-A Hungary–Croatia<br>2014–2020 INTERREG V-A Slovakia–Hungary<br>2014–2020 INTERREG VB Central Europe<br>2014–2020 INTERREG VB Danube<br>2014–2020 Interreg Europe<br>2014–2020 URBACT III  |
| [HU22] Nyugat-Dunántúl | 2014–2020 ESPON 2020<br>2014–2020 INTERACT III<br>2014–2020 INTERREG V-A Austria–Hungary<br>2014–2020 INTERREG V-A Hungary–Croatia<br>2014–2020 INTERREG V-A Slovakia–Hungary<br>2014–2020 INTERREG V-A Slovenia–Hungary<br>2014–2020 INTERREG VB Central Europe<br>2014–2020 INTERREG VB Danube<br>2014–2020 Interreg Europe<br>2014–2020 URBACT III |

(continued)



**Table 3** (continued)

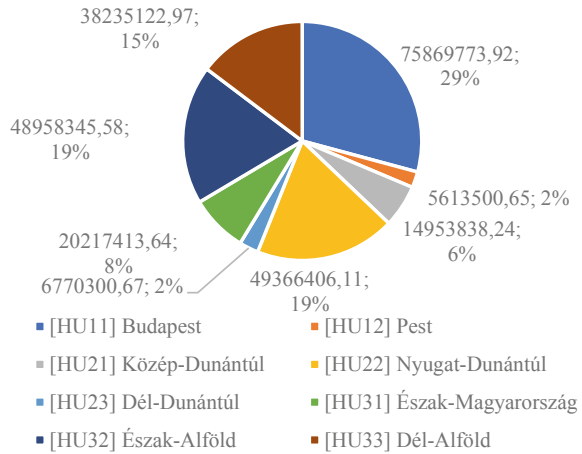
| NUTS2 Region              | Cross-border cooperation operational programmes  |
|---------------------------|--|
| [HU23] Dél-Dunántúl       | 2014–2020 ESPON 2020<br>2014–2020 INTERACT III<br>2014–2020 INTERREG V-A Hungary–Croatia<br>2014–2020 INTERREG VB Central Europe<br>2014–2020 INTERREG VB Danube<br>2014–2020 Interreg Europe<br>2014–2020 URBACT III  |
| [HU31] Észak-Magyarország | 2014–2020 ESPON 2020<br>2014–2020 Hungary–Slovakia–Romania–Ukraine ENI CBC<br>2014–2020 INTERACT III<br>2014–2020 INTERREG V-A Hungary–Croatia<br>2014–2020 INTERREG V-A Slovakia–Hungary<br>2014–2020 INTERREG VB Central Europe<br>2014–2020 INTERREG VB Danube<br>2014–2020 Interreg Europe<br>2014–2020 URBACT III   |
| [HU32] Észak-Alföld       | 2014–2020 ESPON 2020<br>2014–2020 Hungary–Slovakia–Romania–Ukraine ENI CBC<br>2014–2020 INTERACT III<br>2014–2020 INTERREG V-A Hungary–Croatia<br>2014–2020 INTERREG V-A Romania–Hungary<br>2014–2020 INTERREG V-A Slovakia–Hungary<br>2014–2020 INTERREG VB Central Europe<br>2014–2020 INTERREG VB Danube<br>2014–2020 Interreg Europe<br>2014–2020 URBACT III |
| [HU33] Dél-Alföld         | 2014–2020 ESPON 2020<br>2014–2020 INTERACT III<br>2014–2020 INTERREG V-A Hungary–Croatia<br>2014–2020 INTERREG V-A Romania–Hungary<br>2014–2020 INTERREG VB Central Europe<br>2014–2020 INTERREG VB Danube<br>2014–2020 Interreg Europe<br>2014–2020 Interreg IPA CBC Hungary–Serbia<br>2014–2020 URBACT III   |

Source Authors

Croatia, Slovenia and Austria) but also with states geographically distant from it (Great Britain, Portugal, Malta and 26 other States).

Cross-border cooperation at the regional level is not even hindered by the fact that financial resources for the implementation of programmes are very unevenly distributed among the regions of Hungary: 29% of the total funding of border cooperation programmes in 2014–2020 is in Budapest, a metropolitan region with no external borders, with 19% of the funding for Western Transdanubia (Nyugat-Dunántúl), along Hungary's western border with Austria, and Northern Great Plain (Észak-Alföld) bordering on the west with Ukraine and Romania (Fig. 2).

**Fig. 2** Distribution of cross-border cooperation funding by Hungarian regions in the 2014–2020 programming period, euro.  
Source Authors



Thus, Hungary's experience in organizing the regional dimension of cross-border cooperation shows the effectiveness of cross-border cooperation programming, a proactive mechanism for programme implementation. The full cross-border involvement of the Hungarian regions, even in the context of regional differentiation of programme funding, indicates the interest of participants in the process of cooperation on different sides of the border.

## 4 Discussion

The study of the content of the EU-initiated cross-border cooperation programmes, in which the regions of Hungary participate, reveals a set of factors that encourage cross-border, transnational and interregional cooperation among territorial units. Among them are common historical memory, common national interests and political objectives that encourage joint action. The close interrelationship between regions, due to geographical or economic factors, make the European Union border cooperation formats very functional [12]. Focusing on common problems and opportunities in the fields of economic development, infrastructure, environment and culture, a strong political component is an important resource for cross-border cooperation between the regions of Hungary. It stimulates active exchange of goods and factors of production, despite the differences of neighbouring countries in their place in the world economy, in the level and ratio of domestic prices, tax and investment legislation, and in the income of the population. The regional dimension of cross-border interaction, implemented on the basis of "differences" and the common resource and geo-economic situation, plays an important role in the development of frontier territories. As part of the economic and social policies implemented by the programme

instruments and the initiative mechanism, the regional level helps to solve the problems of employment and income of the population, filling the regional market with goods, attracting foreign technology and acquiring new knowledge in the area of regional development and cooperation.

## 5 Conclusion

Cross-border cooperation should be understood as concerted action by contiguous regions of states. It is aimed to strengthen relations between neighbouring regions under the jurisdiction of different States [10]. In the EU, border cooperation is based on international agreements. The financing mechanism is the flagship initiative Interreg and covers those areas of common interest that are within the competence of the communities and authorities concerned. As the study of the experience of the regional dimension of cross-border cooperation in Hungary showed, it achieves the goal of establishing links between border areas, finding joint solutions to current global problems. At the beginning of 2021, among them the European Union views research and innovation, small and medium-sized business competitiveness, low-carbon economy, environment and resource efficiency [1]. The full cross-border involvement of the Hungarian regions, even in the context of regional differentiation of programme funding, indicates the interest of participants in the process of cooperation on different sides of the border.

**Acknowledgements** The reported study was funded by RFBR and FRLC, project number 21-510-23002.

## References

1. Dubrovina, OYu.: Cross-border cooperation as a form of interregional interaction and regionalization. *Power* **26**(8), 97–102 (2018)
2. Khmeleva, G.A., Czegledy, T.: Towards a new format of regional integration: Co-creation and application of technologies. In: S. Ashmarina, V. Mantulenko (eds.), *Current Achievements, Challenges and Digital Chances of Knowledge Based Economy. Lecture Notes in Networks and Systems*, vol 133, pp. 71–77. Springer, Cham (2021)
3. Kuznetsov, A.V., Kuznetsova, O.V.: The changing role of border regions in the regional policies of the EU and Russia. *Baltic Region* **11**(4), 58–75 (2019)
4. Noferini, A., Berzi, M., Camonita, F., Durà, D.: Cross-border cooperation in the EU: euroregions amid multilevel governance and re-territorialization. *Eur. Plan. Stud.* **28**(1), 35–56 (2020)
5. Nienaber, N., Wille, C.: Cross-border cooperation in Europe: a relational perspective. *Eur. Plan. Stud.* **28**(1), 1–7 (2020)
6. Keep.EU: EU website on cross-border, transnational and interregional cooperation programmes. <https://keep.eu/about-keep-eu/>. Accessed: 01 Mar 2021 (2021)

7. Council of Europe: Additional protocol to the European outline convention on transfrontier cooperation between territorial communities or authorities. <https://www.coe.int/en/web/conventions/full-list/-/conventions/rms/090000168007cdae>. Accessed: 01 Mar 2021 (1995)
8. Council of Europe: European outline convention on transfrontier cooperation between territorial communities or authorities. <https://www.coe.int/en/web/conventions/full-list/-/conventions/rms/0900001680078b0c>. Accessed: 01 Mar 2021 (1980)
9. European Union Committee of the Regions: Cross-border cooperation in the Mediterranean Region. <https://cor.europa.eu/en/engage/studies/Documents/Cross-border%20cooperation.pdf>. Accessed: 01 Mar 2021 (2016)
10. Council of Europe: Protocol No. 2 to the European outline convention on transfrontier cooperation between territorial communities or authorities concerning interterritorial cooperation. <https://www.coe.int/en/web/conventions/full-list/-/conventions/rms/090000168007f2cb>. Accessed: 01 Mar 2021 (1998)
11. European Commission, Eurostat: NUTS—Nomenclature of territorial units for statistics. <https://ec.europa.eu/eurostat/web/nuts/background>. Accessed: 01 Mar 2021 (2021)
12. Sousa, D.L.: Understanding European cross-border cooperation: a framework for analysis. *J. Eur. Integr.* **35**(6), 669–687 (2013)

# The Interaction of Participants in the Payment Systems in the Digital Environment



O. G. Savinov, N. G. Savinova, and E. O. Konstantinova

**Abstract** The article deals with payment system of the Bank of Russia and its evolution for implementation budgetary and monetary policy. The interaction of economic actors in the digital environment is concerned. Likewise, the system of treasury payment and its transformation is revealed. The article analyzes the process of improving the technologies and managing the liquidity. The paper touches upon the issue of the centralization process of financial capacity of banks. The interaction of participants in the national payments in the digital environment for efficiency of the payment turnover is estimated. Constant changes in the financial sphere are accompanied by adaptation particular components of national payment system. In conclusion, authors point out that expanding possibility of participants in the financial market and solving the issues of ensuring financial stability.

**Keywords** Bank of Russia payment system · Digital economy · Interaction of participants · Liquidity management · National payment system · Treasury payments system

## 1 Introduction

The transformation of the financial society system has determined the need for an adequate design of the national payment system of the Russian Federation (NPS) for the purpose of multi-level interaction of its various participants [1]. The functioning of NPS's participants affect the integration of company's finances in the interests of implementing financial policy and ensuring the financial stability of the state. The main members of central bank payment system are credit organization and federal treasury agencies. For that reason, the budgetary resources and banking resources are consolidated in the Bank of Russia's payment system (BRPS). Therefore, the continuity of redistributive processes in the economy, optimization and acceleration

---

O. G. Savinov · N. G. Savinova (✉) · E. O. Konstantinova  
Samara State University of Economics, Samara, Russia  
e-mail: [savnad@bk.ru](mailto:savnad@bk.ru)

© The Author(s), under exclusive license to Springer Nature Switzerland AG 2022  
S. I. Ashmarina and V. V. Manteulenko (eds.), *Digital Technologies in the New Socio-Economic Reality*, Lecture Notes in Networks and Systems 304,  
[https://doi.org/10.1007/978-3-030-83175-2\\_23](https://doi.org/10.1007/978-3-030-83175-2_23)

167

of financial flows, and liquidity management of payment system participants largely depend on the stability and efficiency of its functioning.

With the development of financial relations in the company and digital technologies, the emergence of new types of financial instruments and their derivatives, the role of the national payment system as an infrastructure component of the company's financial system is increasing in increasing the availability of payment services, reducing the cost of transactions, accelerating the placement of temporarily free funds in the financial market and managing liquidity. One of the crucial point of the development is a more effective use of financial resources and reduce liquidity shortages by combining the gross settlement and clearing mechanism, improving the tools for managing intraday liquidity of payment system participants [2].

At the same time, there are a number of issues caused by the need to consolidate the financial resources of the Federal Treasury within the existing mechanism of cash execution of the budget. Multi-branch banks also have challenges with multi-level distribution of attracted resources on correspondent and sub-correspondent accounts, which reduces the management of intraday liquidity.

Mainly this article studies the interaction of participants in NPS during the process of payment system's modernization, the transformation of the treasury payments system and the formation of a single payment space in the field of retail payments.

The authors solved the following task in accordance with the purpose of the paper:

1. To study the development of the BRPS, the centralization of accounts and the consolidation of financial resources of the Federal Treasury and the banking sector.
2. To analyze the status of the accounts of the participants of NPS, the payment systems functioning in Russia.
3. To evaluate the conversion of the treasury and bank payments system. The efficiency of the fulfillment of monetary and budgetary policy depends on increasing the liquidity of the NPS's members.

## 2 Methodology

The research is based on methodological approaches: logical and systematic. This one reveals the participants of NPS, their interaction in the process of making payments and settlements. The authors have identified the role of the Bank of Russia in the formation of the payment infrastructure. An analytical method was used to assess the evolution of the BRPS and development of treasury payment system. At the same time, the analysis showed a reduction in the number of accounts of financial authorities and centralization of payment flow in the implementation of budget policy. The digital environment supports favorable conditions for expanding the single payment space. The method of comparison and generalization made it possible to identify the main problems and reveal the prospects for the improvement of payment relations between NPS's participants. Publications of Russian and foreign economists were used to study the processes of liquidity consolidation and improving the efficiency

of the interaction of economic actors in the digital environment. Content analysis of publications allowed us to identify the direction of development the effectiveness of interaction between NPS's participants.

### 3 Results

BRPS contributes to the development of payment turnover in wholesale and retail sector. Therefore, this system is defined at the legislative level as systemically significant. This payment system is one of the mechanisms for implementing the national payment turnover and redistributing liquidity in the company's financial system. The timely provision of financial resources to the Russian economy largely depends on the continuity and efficiency of its functioning. The development of this system includes a set of measures aimed at improving the interaction of members in the accomplishment of operations of the execution of the budgetary and monetary policy.

In the 1990s, in the process of transforming the financial relations and creating a two-tier banking system, it became necessary to design an adequate payment infrastructure. The Bank of Russia established payment clearing centers (PCC) for the settlement of credit institutions and cash execution of the budget, which provided for the transfer of funds at the intraregional and interregional levels. The decentralized order of interaction in the settlement network and the gross settlement mechanism based on postal and telegraph notes increased the costs of central bank. Paper document flow did not provide the speed of money transfers necessary for a market economy and the financial market. To make payments, it was necessary to maintain a sufficiently high intraday liquidity [3].

In order to strengthen control over the formation of revenues and the management of expenditures of the federal budget, the treasury system of centralized budget accounting and budget reporting has been established in Russia since 1992. These functions under the jurisdiction of the Ministry of the Russian Federation were assigned to the Federal Treasury and its territorial organizations.

The Single Treasury Account (STA) has become one of the instruments of consolidation, control and management of state budget resources. As a result of the reform of the budget process, a mechanism for preliminary and ongoing monitoring of the implementation of budget operations on expenditures was created. At the same time, all budget resources were consolidated in accounts with central bank. As part of the budget process, more than 50 thousand people were opened in the PCC. Accounts for managers and recipients of federal budget funds for the execution of operations for debiting, transferring and crediting funds in the interregional and intraregional components of the Bank of Russia's settlement network. The rules, regulations, and mechanisms of functioning of the components were significantly different, which had an impact on the transfer rate and operational management of budget funds.

With the transition to electronic technologies, the calculation speed in 78 components of intraregional components accelerated to one day. For interaction at the interregional level in each regional component, one of the institutions of central bank was

identified as the head member of the interregional components (head PCC). The decentralized mechanism of the interregional components ensured the completion of the calculations on the next day. Settlement systems differed in terms of territorial coverage, the volume of payments made, the composition of participants and payment instruments, which complicated the task of centralized liquidity management and optimization of payment flows. The decentralized system of the interregional components did not provide for urgent payments. The independent automation of the regional institutions of central bank intraregional components complicated the processes of interaction in its settlement network.

In addition to the organizations of the federal Treasury, about 2.3 thousand correspondent accounts of banks, more than 5.5 thousand sub-correspondent accounts of branches, as well as more than 38.5 thousand accounts of multi-level divisions of the Savings Bank of the Russian Federation were registered in the settlement network of the Bank of Russia.

In 1994–1997, the Russian banking system was more focused on attracting resources from the international capital market and placing government securities on the domestic market. This fact contributed to the emergence of correspondent relations between banks, the development of interbank lending and the redistribution of liquidity. However, poorly regulated relations in the unsecured interbank lending market led in 1995 to a liquidity crisis and systemic insolvency of banks, which had an impact on the optimization of direct correspondent relations and an increase in the share of transfers in the settlement network of central bank.

The system has been actively implementing the Concept of a Real-time Gross Settlement System and the Concept of Developing a Settlement Network since 1996 [4]. This is being conducted in order to improve the efficiency of monetary policy implementation and the development of refinancing to maintain the liquidity of the banking sector. According to these strategic documents, it was necessary to centralize all accounts of credit institutions and the Federal Treasury in the Federal Settlement Center and build a single-level system of gross payments in real time. However, in the process of implementation, this project was recognized by the Bank of Russia as costly and outdated [3].

By 2007, a separate federal-centralized component the Banking Electronic Speedy Payment system (BESP) was formed in the Bank of Russia's payment system (BRPS). The development of a centralized payment structure was accompanied by the reduce of 300 payment clearing centers during 2007–2008. The banks-direct participants of the BESP were given the opportunity to make urgent payments in real time, regardless of their territorial location. The BESP system has expanded the capabilities of its participants to use mechanisms for monitoring and managing liquidity [5].

The global financial crisis of 2008–2009, as well as the issues with liquidity that arose in the financial sector in 2014–2015, had an impact on the reduction in the number of operating banks and accounts opened by them (Table 1).

Since 2017, BESP has been transformed into an urgent translation service, and VER and MER—into a non-urgent translation service. In 2018, the Bank of Russia's use of transfer processing technology with the use of urgent and non-urgent services



**Table 1** The number of accounts of credit and other organizations opened in the settlement network of the Bank of Russia at the beginning of 2015–2020, units

| National payment system participants | 1.01.15 | 1.01.16 | 1.01.17 | 1.01.18 | 1.01.19 | 1.01.20 |
|--------------------------------------|---------|---------|---------|---------|---------|---------|
| Credit institutions                  | 831     | 733     | 623     | 561     | 483     | 441     |
| Branches of credit institutions      | 1708    | 1398    | 1098    | 890     | 709     | 618     |
| Not credit institutions, including   | 53,600  | 52,300  | 51,500  | 50,200  | 49,400  | 48,300  |
| Federal Treasury                     | 48,900  | 49,100  | 48,600  | 47,600  | 47,400  | 46,600  |
| Budget organizations                 | 3200    | 2100    | 2000    | 1900    | 1600    | 1300    |

Source Authors based on [6]

accelerated the completion of settlements on the day of sending the transfer and reduced the amount of funds in settlements by 14.5 times from 727 to 50 million rubles.

However, the remaining decentralized mechanism of functioning of correspondent accounts of credit institutions and sub-accounts of their branches, as well as budget accounts of the Federal Treasury and its organization, reduced the possibility of consolidating financial resources and managing intraday liquidity [7].

The balance of funds on the correspondent accounts of credit institutions largely depended on the increasing demand of economic entities for payment means. In the context of a decline in economic activity in 2014–2015, the growth of funds balances on deposit of banks and correspondent account slowed down (Table 2).

**Table 2** Amount of funds on accounts with the Bank of Russia in 2014–2019, billion rubles

| Option   | 2014     | 2015     | 2016   | 2017     | 2018     | 2019     |
|--|----------|----------|--------|----------|----------|----------|
| Funds on accounts with the Bank of Russia                    | 13,876.1 | 12,573.2 | 9985.2 | 11,003.2 | 14,526.7 | 16,951.2 |
| Funds of the Government of the Russian Federation, including | 9144.1   | 8130.2   | 4662.4 | 4565.0   | 7894.9   | 10,734.6 |
| Reserve fund   | 4975.5   | 3648.2   | 973.3  | –        | –        | –        |
| National welfare fund  | 3310.7   | 3507.2   | 2797.3 | 2204.4   | 2359.1   | 6140.3   |
| Funds of the budgets of the regions of the Russia and local  | 443.9    | 387.1    | 401.7  | 442.6    | 670.7    | 548.3    |
| Funds of credit institutions, including                      | 2869.7   | 2528.2   | 3093.2 | 4812.4   | 4381.7   | 4273.9   |
| On correspondent accounts                                    | 1593.8   | 1600.6   | 1822.9 | 1933.0   | 1902.9   | 2630.1   |
| On deposit account   | 804.6    | 557.8    | 785.6  | 2373.2   | 1903.5   | 1026.4   |
| Funds deposited in mandatory reserve accounts                | 471.3    | 369.8    | 484.7  | 506.2    | 575.3    | 617.4    |

Source Authors based on [6]

In the context of economic instability and the strengthening of central bank regulatory requirements for the stability of the functioning of credit institutions, their number for 2015–2019 decreased by 390 units. This process has affected the optimization of the branch network of credit institutions. The number of accounts opened to branches in the Bank of Russia decreased by 2.8 times.

There is also a tendency to reduce the number of accounts of the Federal Treasury, the budgets organizations of the regions and local budgets [8]. In 2015–2019, more than 5.3 thousand accounts were closed in the Bank of Russia's settlement network.

Capital outflows and sanctions imposed on Russia became the main external factors. For two years during this period, the currency shortage grew and its liquidity decreased. The Bank of Russia has stabilized the domestic foreign exchange market, carried out direct interventions, as well as refinancing of credit institutions in foreign currency. In the context of global financial instability, central banks use various tools to achieve certain monetary policy parameters [3].

The balance of funds on the accounts of the Government of the Russian Federation during 2015–2016 decreased. The federal budget deficit in 2014–2015 was covered by the reserve fund. Their share in the structure of the Bank of Russia's balance sheet decreased to 23.2% at the beginning of 2016, and to 16.1% at the beginning of 2017.

The flow of liquidity through the budget channel in 2016 changed the situation with resources in the banking sector. As the structural deficit of bank liquidity decreased, the demand for Bank of Russia refinancing loans decreased [9]. The Bank of Russia absorbed the resources coming to the banking sector related to financing the budget deficit into the deposit accounts of credit institutions, as well as through increasing the required reserve ratio and selling federal loan bonds on the secondary market.

The generated payment flows as part of the implementation of the budget and monetary policy in 2016–2019 had an impact on the increase in the amount of funds in the Bank of Russia accounts. The balances of funds on the accounts of the Government of the Russian Federation with the Bank of Russia changed under the influence of the formation and use of the reserve fund and the National Welfare Fund, as well as their revaluation in connection with the growth of foreign exchange rates. In 2017, the reserve fund was fully spent to finance the federal budget deficit. The simultaneous rise in oil prices and the US dollar in 2018, as well as the outpacing growth of revenues over expenditures, contributed to the formation of a budget surplus. As a result of the purchase of foreign currency and its revaluation, the balance of funds on the accounts of the Government of the Russian Federation in 2018 increased by 72.9%.

The flow of resources under the budget rule, as well as in the order of financial recovery of credit institutions, had an impact on maintaining the liquidity surplus in the banking sector. Despite the decrease in the balance of funds in 2018 by 8.9% in the accounts of credit institutions, the demand for credit from central bank remained low. The consistent implementation of the policy of macroeconomic stabilization (the budget rule) and the creation of new development instruments (development funds) together ensured a stable liquidity surplus of the Russian Government and the banking sector. The volume of resources on the Bank of Russia's accounts in 2016–2019 increased by 1.7 times.

The Single Treasury Account (STA) has become one of the mechanisms for centralizing temporarily free balances of budgetary resources. Consolidated liquidity in the STA was redistributed to the banking sector to the deposit accounts of credit institutions, which helped to solve the issues of restoring the liquidity of the banking sector at the expense of internal sources of financing [1].

The demand for banking sector resources in the context of a structural surplus was formed under the influence of short-term demand of individual banks. As part of the liquidity management, the Bank of Russia provided a significant amount of overnight loans to major market participants. In addition, the attraction of Federal Treasury funds to deposit accounts by banks has increased. The volume of such deposits in 2018 increased by 66.1%, and their share in the liabilities of the banking sector increased by 0.6–1.8%. As a result, a significant liquidity surplus was formed in the banking sector in 2019.

The Bank of Russia's payment system ensured the use of the mechanism for averaging reserve requirements, the interaction of banks in the interbank credit market and the redistribution of liquidity in the banking sector, the use of the key rate as a tool of monetary policy. The implementation of urgent payments has contributed to the rapid regulation of liquidity in the banking sector. Funds in bank accounts decreased by 8.9% in 2018. The banking sector has accumulated excess liquidity that is not used for economic growth [10].

## 4 Discussion

The issues of effective functioning of systemically important payment systems that ensure the implementation of monetary policy instruments, as well as the mechanism for executing state budgets, are given great attention in international and Russian practice [5]. Such systems provide large money transfers, so failures can lead to systemic liquidity risks. One of the main tasks of central (national) banks is to maintain the stability of the functioning of significant payment systems and ensure the management of the liquidity of its participants.

The main global development trends of national payment systems of states are: expansion of payment services and tools, strengthening of interaction of participants and integration of payment infrastructures, increasing efficiency through the use of liquidity and reducing operating costs [11]. International experience shows that the responsibility for the stable functioning of the national payment system and the regulation of its subjects is assigned to the central (national) bank [12].

In order to implement the functions assigned to the Bank of Russia, its payment system was modernized, the retail payment infrastructure was unified, a single card product was created, and a national payment card system was formed. The systemic significance of the BRPS is determined at the legislative level, which is largely due to the implementation of transfers of funds of the Government of the Russian Federation, authorized executive authorities using accounts opened by them in the Bank of Russia's settlement network. In addition, the payment system of the Bank

of Russia ensures the completion of settlements on transactions made at organized auctions, as well as the completion of settlements between participants in the payment services market on transactions made using payment cards on the territory of the Russian Federation.

The participants of the BRPS are the Federal Treasury (its territorial institutions) and credit organizations (their branches). The opening of numerous accounts in the Bank of Russia's settlement network and the lack of consolidated accounting of resources in multi-branch organizations creates problems in managing their liquidity. In international practice, one of the tools for reducing liquidity risk is the formation of a liquidity pool, which contributes to the optimal use of account balances and reduces the intraday need for credit [13].

There are issues in the mechanism of timely crediting of funds to the STA, their spending and redistribution in the budget sphere, the use of new tools for managing the liquidity of the Federal Treasury and its territorial institutions. The mechanism for distributing the income received by the CEN to the unified accounts of the respective budgets, accounting for the transferred funds in the personal accounts of the revenue administrators is quite time-consuming and time-consuming. From the moment of making a payment to receiving information about the transfer of budget funds, it sometimes took from 3 to 5 days. No less time-consuming is the process of implementing the budget. Expenditures and making budget commitments, confirming and authorizing payments the fulfillment of monetary obligations takes a long time [14].

In this regard, the Ministry of Finance of the Russian Federation initiated the creation of a system of budget payments with the operator of the Federal Treasury. The work of the Federal Treasury is aimed at improving the functioning of the STA through the introduction of electronic technologies and the centralization of accounting. It is planned to close the accounts of the territorial authorities in the payment system of the Bank of Russia and consolidate all operations on the account of the Federal Treasury [15]. It is also necessary to establish direct correspondent relations with settlement banks of various payment systems. The formation of a digital platform will increase the openness and efficiency of operations with the funds of the public administration sector, as well as the functioning of the portal of public services [7].

The transformation of the budget payment system provides for:

- inclusion of the Federal Treasury as a direct participant in the BRPS;
- making payments on accounts opened to the Federal Treasury organizations without their prior support from a single federal budget account;
- development of electronic services for making tax payments to citizens;
- real-time monitoring and management of settlement operations of the Federal Treasury and its territorial organizations.

## 5 Conclusion

The modern payment system of central bank provides intraday loans to credit institutions, as well as tools for absorbing excess liquidity. To manage the balance of the federal budget funds, transactions for the purchase and sale of foreign currency, the placement of funds in the deposit accounts of credit institutions, transactions with derivative financial instruments and repurchase agreements are carried out.

However, the remaining decentralized mechanism of functioning of correspondent accounts of credit institutions and sub-accounts of their branches, as well as budget accounts of the Federal Treasury and its organizations, reduces the possibility of consolidating financial resources and managing intraday liquidity. The transition to digital instruments in the monetary and credit sphere, as well as in the field of public finance, poses tasks for the participants of the BRPS to development the accounting and payment system, consolidate resources for liquidity management. The transformation of the payment system of the Federal Treasury is aimed at improving the efficiency of managing the liquidity surplus, reducing the burden on the budgets of the regions of the Russian Federation and local government. Coordination of payment flows in the context of a liquidity surplus in the financial sector should be aimed at improving the parameters of monetary and fiscal policy, increasing the volume of resources in the domestic market and reducing interest rates to stabilize GDP.

## References

1. Kovaleva, T.M.: Regulation of financial and credit relations and globalization. Politekh. Publishing House, St. Petersburg (2015)
2. Beijnen, C., Bolt, W.: Size matters: Economies of scale in European payment processing. *J. Bank. Finance* **33**(2), 203–210 (2009)
3. Savinova, N.G.: Functioning of the National Payment System of the Russian Federation in Modern Conditions. Samara State University of Economics, Samara (2012)
4. The concept of a real-time gross settlement system and the concept of developing a settlement network. Approved by a decision of the Council Directors of the Central Bank of the Russian Federation dated 13.07.1997. [https://www.cbr.ru/about\\_br/publ/vestnik/](https://www.cbr.ru/about_br/publ/vestnik/) Accessed: 24 Mar 2021 (1997)
5. Savinova, N.G.: International trends in the development of payment systems. *Vestnik Samara State Univ. Econ.* **8**(82), 78–82 (2011)
6. Bank of Russia: Bank of Russia's annual reports for 2015–2019 [https://www.cbr.ru/eng/about\\_BR/publ/god/](https://www.cbr.ru/eng/about_BR/publ/god/). Accessed: 24 Mar 2021 (2019)
7. Ibarra, R., Trupkin, D.R.: Reexamining the relationship between inflation and growth: do institutions matter in developing countries? *Econ. Modell.* **52**(B), 332–351 (2016)
8. Vassel, T.A.: Optimization of budget payments. *Acc. Budget Non-Profit Org.* **23**(287), 19–25 (2011)
9. Rey, H.: Dilemma not trilemma: The global financial cycle and monetary policy independence. [https://www.nber.org/system/files/working\\_papers/w21162/w21162.pdf](https://www.nber.org/system/files/working_papers/w21162/w21162.pdf). Accessed: 24 Mar 2021 (2015)
10. Bolt, W., Humphrey, D.: Public good issues in target natural monopoly, scale economies, network effects and cost allocation. <http://www.ecb.europa.eu/pub/pdf/scpwps/ecbwp505.pdf>. Accessed: 24 Mar 2021 (2005)

11. Bank of Russia: Payment and settlement systems: International experience. General guidelines for the development of the national payment system. <http://old.cbr.ru/Queries/UniDbQuery/File/48362/90>. Accessed: 24 Mar 2021 (2008)
12. Gadot, G., Dalmia, S.: Liquidity management: Best practices for banks. <https://www.banktech.com/compliance/liquidity-management-best-practices-for-banks/a/d-id/1297050d41d.html>. Accessed: 24 Mar 2021 (2018)
13. Wang, G., Docherty, P.: Using synthetic data to evaluate the impact of RTGS on systemic risk in the Australian payments system. <http://www.finance.uts.edu.au/research/wpapers/wp149.pdf>. Accessed: 24 Mar 2021 (2006)
14. Artyukhin, R.E., Kastornova, T.A., Shamyunov, M.M., Kamardina, Yu.V., Rud, O.N., Abdulkhalimov, M.S.: Current issues of improving the legal regulation of budget payments. Monograph. KnoRus, Moscow (2020)
15. Artyukhin, R.E.: Topical issues of interaction between the Treasury of Russia and the financial authorities of the subjects of the Russian Federation. <https://minfin.gov.ru/common/upload/library/2020/07/main/3.pdf>. Accessed: 24 Mar 2021 (2020)

# Factors of Digitalization Development on Gas Station Market Using Online Channels Example



M. A. Sadykov

**Abstract** Digitalization has changed retail trade. Online channels that have appeared on the gas station market in the last decade have become the basis for the digitalization of the industry. The article defines the factors of online channels development in retail and their features, justifies their applicability to the context of contactless refueling in fuel retail. The use of factors of online channels development in retail to online channels at gas stations as a research method is justified. The possibilities of future studies of the online sales channel at gas stations in terms of customer behavior and customer experience are identified. The analysis of available data on the status of the introduction of contactless refueling in Russian companies, on the US and European markets, and the business models used. Based on the factors of online channels development in retail trade and data on Russian and foreign experience, the factors of development of contactless refueling in Russia are formulated. In conclusion, findings and recommendations for further studies are presented.

**Keywords** Contactless refueling · Omnichannel · Online channel

## 1 Introduction

The leading areas of retail trade that implemented online channels are the sale of clothes and shoes, ready-to-eat food, food products, jewelry, household appliances and electronics. Online trading became the dominant channel and can be considered as the main one [1]. On the retail fuel market, the introduction of online sales channels and digitalization happens much later [2–4]. Companies that operate gas stations in Russia and around the world are a decade behind traditional retail and the service sector in introducing online trade. The purpose of this study is to identify the factors of the development of online channels on the example of contactless refueling at gas stations. For the purpose of the study, the factors in retail and their features are identified, and their applicability to the context of contactless refueling in fuel retail

---

M. A. Sadykov (✉)  
Saint Petersburg State University, St. Petersburg, Russia

is justified. The chosen approach will allow us to make the following contribution to existing studies: due to the accumulated experience of online channels studies and omnichannel in retail, factors of development in retail, in the context of the new phenomenon of contactless gas stations, to identify and update the factors of development of online sales at gas stations.

## 2 Methodology

For three key queries: online channels, omnichannel, omnichannel retailing, we selected studies in the Scopus bibliographic database for the period from 1999 to 2020 for analysis in our study. Existing studies in the field of online channels and omni-channels do not consider examples of the retail fuel market and gas station complexes. Considering the active introduction of online channels at gas stations of the largest companies in Russia, the European Union and the United States, it is necessary to study the factors of development of a unique phenomenon of online sales and omnichannel at gas stations -contactless refueling. Contactless refueling is the implementation of the operation of buying fuel at a gas station by using a mobile application, without contacting the gas station ticket office.

To determine and systematize the factors of the online channels development, the study of Reynolds, Cuthbertson, Bell 2004 was used as a basis, which systematized the directions of the driving forces of the online trade development and the driving factors of these directions [5]. Over the 17 years since the publication of the study, the areas identified by Reynolds are still relevant and form the basis for the current study. The areas identified by Reynolds are: consumer acceptance, technology, competition, institutional regulation, and government support for technology adoption. The driving forces and factors identified at the initial stage of the development of online channel are considered by us as factors of the online channel development. Considering the development of online trade over the past twenty years, it became possible to identify a new direction of factors for the development of online channels: customer experience, and additional development factors for each of the areas previously identified by Reynolds.

## 3 Results

Online channels in retail trade began to be formed in the 90s of the XX century [6]. The emergence of a new retail channel led to the retailers' realization of the importance of using the customer experience as a factor of business development [7]. A new trend in retail trade is an integrated customer experience that combines a physical store with an information-rich digital environment was called omnichannel [8]. The development of integration of retail channels determined the emergence of omnichannel retailing—a set of actions related to the sale of goods or services



through all common channels, through which the customer can initiate interaction through all channels and/or the retailer controls the full integration of channels [9].

Since Reynolds, Cuthbertson, Bell' research, customers have gained significant experience in online channels [5]. Customer experience is a set of interactions between a buyer and a product, a company, or part of its organization that provoke the customer reaction. This experience is purely personal and means the client's involvement at different levels (rational, emotional, sensory, physical and spiritual [10]. In the direction of customer experience, 5 new factors for the development of online channels are identified. The basis of customer experience in an online channel: trust, or brand reliability. The customer has a certain level of trust to the brand, this is very important in online channels, because online "the customer does not see the seller's face". Trust is the expectation of other parties to behave in accordance with their obligations, honestly negotiate, and not use the opportunity to cheat, even if there would be such a possibility [11]. The trust to an online channel (mobile app) depends on the ease of use and perceived usefulness, perceived reliability of the technology, the company's reputation, and offline presence [12]. The influence of these factors in the direction of the customer experience is actually equivalent. The customer experience also depends on the possibilities of feedback for the customer, with an effect obtaining, for example, the return of goods. The ability to return the product in online channels significantly improves its perception by the consumer.

Since 2000, the omnichannel factor has been a significant factor in the development of the customer experience. The concept of omnichannel involves the integration of various channels for customer service. Omni-channel refers to an integrated shopping experience that combines a physical store with the digital environment, rich with information. In order to provide customers with an excellent experience at all points of customers contacting individually according to their choice [8]. Channels integration is an important resource for the development of both offline and online channel and for modern trading in general. Conceptually, omnichannel capabilities provide a seamless shopping experience where the differences between regular and online store operations become inconsequential [13].

Considering that contactless refueling appeared relatively recently—in 2015, we collected information about contactless refueling using Google, Google Scholar, Yandex and the Scopus databases [8]. At the time of writing the article, no research was found in the field of contactless refueling. There is information of a descriptive or advertising nature: aggregator sites, application sites of fuel companies, press releases, advertising information, summarizing articles of specialized magazines, for example, "Modern Gas Station". Considering the results obtained, we suggest as a research method: an analysis of the possibilities of applying the previously identified factors for the development of online channels in general to contactless refueling, and to the direction of online channels, taking into account the features and limitations of fuel retail.

## 4 Discussion

Factors of development of online channels were applied to contactless refueling in Russia, the current status of any factor was used. In the direction of consumer behavior, the factors for the development of contactless refueling are fully formed: a high level of availability of the online channel, while in 2020 the real incomes of the population temporarily decreased, restrictive measures were introduced: the consumer cares about his health, tries to avoid contacts with the seller, almost all the adult population of the country uses smartphones because it is fashionable. In the direction of technology, the factors of development of contactless refueling are partially formed: mobile applications do not transmit non-digital attributes of the product, do not replace communication with the cashier in full, and the low throughput capability of the online channel does not contribute to the success of contactless refueling. In the direction of competition: now all four factors of development are formed. However, it should be noted that it is possible to promote the channel more actively on the market by transferring customers from offline to online. In the direction of institutional regulation and support for the introduction of technologies by the state, the factors are in the formation stage, there is no ban for contactless refueling, the regulation of relations with the customer offline and online is in the same legal field and makes it possible to develop contactless refueling. In the direction of customer experience, the trend of forming factors is different: trust and ease of use, offline presence and reputation of the company, the possibility of feedback are formed, the expected usefulness, reliability of the technology are in the process of formation, and create an opportunity for further studies of their state. Omnichannel is inherent in the customer's use of the option with arrival at the gas station (the BOPS option) [1]. At the same time, there is potential for the development as a fuel delivery for large brands, because currently delivery is present only in the form of startups and small companies.

Fuel companies around the world started implementing contactless refueling 1–2 years earlier in 2015. In Russia, in contrast to the United States and the European Union, the business model associated with aggregators (IT companies independent from fuel retail) is actively developing, when fuel is implemented through the aggregator's mobile application, and not the company's own mobile application. In the United States, an online channel related to fuel delivery is actively developing. At the same time, Russia also has fuel delivery companies on the Moscow and St. Petersburg local markets, but due to the high risks of industrial and fire safety, legislative restrictions on fuel delivery and fuel refueling, the development of this direction is still limited. Products for the customer can be with digital and non-digital attributes—each product has a different opportunity to sell through the Internet, an online channel, many customers need to tactilely try the product in the store and this can be the final opportunity to choose it [7]. Fuel has digital attributes: price, octane number, brand, there are also restrictions at the current stage of fuel delivery technology to the customer development associated with the need for the customer to arrive at the gas station and refueling. To develop an online fuel sales channel, it is necessary to

develop not only mobile applications and online channels, but also the technology of fuel safe delivery to the customer, to his car. However, in our case, it is necessary to provide the courier with technological equipment, a fuel tanker.

Modern science studies customer behavior in the online channel and in retail in general [14], behavior in online and offline channels in the absence of integration [15], features of customer experience and behavior in the integration of an online channel and an offline channel [16]. At the same time, scientific research of online channels, omnichannel, and omnichannel retail is decades behind their practical implementation in retail. Existing research in the field of online channels and omnichannels does not consider examples of the retail fuel market and gas station complexes: fuel retail. Fuel retail is a type of retail that has its own characteristics and limitations, which require compliance with additional security measures, additional capital investments, but are not a barrier to the introduction and development of the channel in the fuel retail. The lack of academic research of online channels on the example of gas stations and the active development of contactless refueling in business is the opportunity to determine the factors of development of this online channel and their further study.

## 5 Conclusion

The directions of the driving forces of online channels, based on a 2004 study by Reynolds, are relevant as factors in the development of online channels. The study also highlights a new direction of online channel development: customer experience, and new factors in this direction: trust, a reliable recognizable brand, ease of use and expected usefulness, perceived reliability of technology, lack of negative experience, company reputation, offline presence, the possibility of feedback for the customer, with an effect obtaining (return of goods), omnichannel (omnichannel retailing). In the traditional directions highlighted earlier, new development factors that the economy has faced over the past two decades are formulated: restrictions on movement, contacts with other people, restrictions on the operation of physical stores associated with the pandemic, timely updates of hardware and software that improve software for the user, the availability of online channels for most market participants.

The introduction of contactless refueling in Russia occurred later than in the fuel market of the United States, Europe, and Australia. Contactless refueling is based on two business models: through an aggregator (mainly Russia) and the fuel market participants' own app. Contactless refueling is a variant of the omnichannel retail "buy online and pick up in store" (BOPS). In the US, a clean online channel based on the delivery of fuel to the customer is actively developing, there are also such examples in Russia. The development of contactless refueling as an online channel in fuel retail is determined by the presence of verified development factors in the areas of consumer behavior, competition, which are fully formed. Factors in the areas of technology, institutional regulation and support for the introduction of technologies

by the state are at the stage of formation. In the direction of customer experience, the identified development factors—the perceived reliability of technologies and the absence of negative customer experience, ease of use and the perceived usefulness of a mobile application for contactless refueling, have the potential for further priority research.

## References

1. Song, P., Wang, Q., Liu, H., Li, Q.: The value of buy-online-and-pickup-in-store in omnichannel: evidence from customer usage data. *Prod. Oper. Manag.* **29**(4), 995–1010 (2020)
2. Lal, R., Sarvary, M.: When and how is the internet likely to decrease price competition? *Mark. Sci.* **18**(4), 485–503 (1999)
3. Verhoef, P.C., Kannan, P.K., Inmanc, J.: From multi-channel retailing to omnichannel retailing: introduction to the special issue on multi-channel retailing. *J. Retail.* **91**(2), 174–181 (2015)
4. von Briel, F.: The future of omnichannel retail: a four-stage Delphi study. *Technol. Forecast. Soc. Chang.* **132**, 217–229 (2018)
5. Reynolds, J., Cuthbertson, C., Bell, R.: *Retail Strategy: The View from the Bridge*. Elsevier Butterworth-Heinemann, Oxford (2004)
6. Caro, F., Gürhan, K.A., Martínez-De-Albéniz, V.: The future of retail operations. *Manuf. Serv. Oper. Manag.* **22**(1), 47–58 (2020)
7. Rodriguez, M., Paredes, F., Yi, G.: Towards future customer experience: trends and innovation in retail. *Foresight STI Governance* **10**(3), 18–28 (2016)
8. Frazer, M., Stiehler, B.E.: Omnichannel retailing: the merging of the online and offline environment. *Glob. Conf. Bus. Fin. Proc.* **9**(1), 655–657 (2014)
9. Beck, N., Rygl, D.: Categorization of multiple channel retailing in multi-, cross-, and omnichannel retailing for retailers and retailing. *J. Retail. Consum. Serv.* **27**, 170–178 (2015)
10. Verhoef, P.C., Lemon, K.N., Parasuraman, A., Roggeveen, A., Tsiros, M., Schlesinger, L.A.: Customer experience creation: determinants, dynamics and management strategies. *J. Retail.* **85**(1), 31–41 (2009)
11. Corbitt, B.J., Thanasankit, T., Yi, H.: (2003) Trust and e-commerce: a study of consumer perceptions. *Electron. Commer. Res. Appl.* **2**, 203–215 (2003)
12. Kaushik, A.K., Mohan, G., Kumar, V.: Examining the antecedents and consequences of customers' trust toward mobile retail apps in India. *J. Internet Commer.* **19**(1), 1–31 (2020)
13. Taylor, D., Brockhaus, S., Knemeyer, A.M., Murphy, P.: Omnichannel fulfillment strategies: defining the concept and building an agenda for future inquiry. *Int. J. Logist. Manag.* **30**(3), 863–891 (2019)
14. Bell, D.R., Gallino, S., Moreno, A.: How to win in an omnichannel world. *MIT Sloan Manag. Rev.* **56**(1), 45–53 (2014)
15. Neslin, S.A., Grewal, D., Leghorn, R., Shankar, V., Teerling, M.L., Thomas, J.S., Verhoef, P.C.: Challenges and opportunities in multichannel customer management. *J. Serv. Res.* **9**(2), 95–112 (2006)
16. Gallino, S., Moreno, A.: The value of fit information in online retail: evidence from a randomized field experiment. *Manuf. Serv. Oper. Manag.* **20**(4), 601–800 (2018)

# Digital Educational Platforms: Advantages and Disadvantages



E. P. Troshina, V. V. Dobrova, and M. P. Kozyreva

**Abstract** The relevance of this article is justified by the authors due to the importance of digitalization of the educational process in the modern world. Digital platforms take a significant position in the issues of digitalization not only in the educational environment, but also in many other areas of human activity. Therefore, it was decided to analyze the main advantages and disadvantages of using digital educational platforms. The purpose of the article is to study the classification of existing digital educational platforms and reflect their advantages and disadvantages. The study uses classical general scientific research methods: analysis and synthesis of information; comparison; grouping and generalization. The authors suggest three classification features of digital educational platforms. It is concluded that digital educational platforms have their advantages and disadvantages, while only what is more important for a particular person remains significant.

**Keywords** Advantages and disadvantages · Classification · Digital educational platforms · Digitalization of education · DEP

## 1 Introduction

In the modern world, constant development requires a rapid adaptation of society. New professions are being created, and existing competencies are being expanded and modernized. All this explains the relevance of education for all members of society, regardless of their gender, age and profession. The high level of physical and informational workload requires the modernization of the education system. Special attention is paid to the digitalization of educational programs. New competencies are

---

E. P. Troshina (✉)  
Samara State University of Economics, Samara, Russia

V. V. Dobrova  
Samara State Technical University, Samara, Russia

M. P. Kozyreva  
Samara National Research University, Samara, Russia

so quickly incorporated into professional requirements and standards that classical education does not always have time to respond quickly by adjusting educational programs. In such a situation, digital educational platforms (DEP) quickly respond to the challenges of professional education. People can master specific necessary competencies quickly, remotely, and easily. The variety of existing DEPs can easily confuse potential consumers. Based on this, the purpose of the study was formulated: to study the classification of existing DEPs and to show their advantages and disadvantages.

## 2 Methodology

This work is of a research nature. In this regard, the authors used classical general scientific research methods: analysis and synthesis of information; comparison; grouping and generalization. Taking into account the specifics of the research goal, the authors set the following tasks:

1. To analyze the most popular of the existing DEP.
2. To classify them according to various characteristics.
3. To show the main advantages and disadvantages faced by consumers of DEP services.
4. To identify the opinion of domestic and foreign researchers regarding the digitalization of the educational process.

The methods used make it possible to ensure the fulfillment of the set tasks. The main information resources were the research of domestic and foreign authors on this topic and the data of the RBC rating on the largest Russian DEP [1].

## 3 Results

As mentioned earlier, some DEPs listed in the RBC rating were selected as the material for analysis [1]. There they were compared by the volume of revenue received for the year. So, the rating includes Skyeng (1st place); Netology-group (2nd place); iSpring (3rd place); SkillBox (6th place); GeekBrains (9th place); LinguaLeo (15th place); HTML Academy (25th place); SkillFactory (34th place) and others [1]. After analyzing the specifics of the rating participants' activities, different classification features were formulated.

Table 1 contains data on the classification criteria identified by the authors. The first reflects the specifics of the DEP work. Currently, DEPs focused on language training and the development of digital specialties are particularly popular. Both directions are relevant in connection with the expanding international integration and the significant role of digital technologies in all spheres of activity. School tutors are also being replaced by DEPs, and additional and corporate education, which

**Table 1** DEP classification

| Classification feature | Types  |
|------------------------|--|
| Field of activity      | <ul style="list-style-type: none"> <li>– linguistics;</li> <li>– digital;</li> <li>– school curriculum;</li> <li>– additional and corporate education;</li> <li>– multidisciplinary</li> </ul> |
| Ownership structure    | <ul style="list-style-type: none"> <li>– private;</li> <li>– state;</li> <li>– mixed</li> </ul>  |
| Target audience        | <ul style="list-style-type: none"> <li>– students;</li> <li>– teachers;</li> <li>– mixed</li> </ul>  |

*Source* Authors

is mainly interesting for already employed people, is also beginning to shift to the digital format, which saves time on the implementation of organizational issues.

The second classification feature is based on the ownership structure of the analyzed DEP. A large share in the ownership structure is occupied by individuals or private companies. However, there are examples where co-owners are companies with state participation. There are also government platforms that were not included in the rating (for example, the Russian Electronic School). Therefore, this classification includes the state and mixed ownership structure.

The third reflects the target audience of the DEP. It is important to understand that DEPs are developed not only for consumers of knowledge, but also for those who can act as their source, that is, teachers. This makes it possible to distinguish three categories of the target audience: students; teachers and mixed.

Let’s look at the examples of the belonging of specific DEP to the specified classification criteria. So, Skyeng is a linguistic, private, mixed DEP. SkillBox is a digital, a mixed DEP with a focus on students. “Your Tutor” is a multidisciplinary, private, teacher-oriented DEP. It can be seen that the existing DEPs are different in their purpose and are able to meet almost any needs.

Due to the ever-increasing role of DEP in the lives of many modern people, it makes sense to conduct an expert assessment of the advantages and disadvantages of their use in the educational process.

Table 2 shows the significant advantages and disadvantages of DEP, according to the authors. If we summarize each group, we can conclude that the main advantages of using DEP are the freedom and accessibility of their use for all categories of citizens, as well as the ability to independently choose the necessary educational programs. The key disadvantages are the difficulties of obtaining personal advice and feedback, as well as checking the quality of the information received. The documents received at the end of the educational process are also an important issue. In the conditions of DEP functioning, these documents are most often absent, are informal or purely digital, which may not satisfy students. Based on this, we can say that, like any

**Table 2** Advantages and disadvantages of using DEP

| Advantages   | Disadvantages  |
|--|--|
| – no binding to the place;                                   | – difficulties in getting feedback;                    |
| – the ability to choose your own training program;           | – possible interruptions in the operation of DEP;      |
| – getting only highly specialized and important information; | – difficulties in control over educational activities; |
| – use of modern educational methods;                         | – risk of obtaining “junk” knowledge;                  |
| – high level of availability;                                | – the absence or informality of educational documents  |
| – ability to choose the training time                        |  |

*Source* Authors

innovation, DEP has its advantages and disadvantages. The only thing that matters is what is more important for a particular person.

## 4 Discussion

Within the framework of this section, it is planned to study the opinions of domestic and foreign authors on the digitalization of education. Stokov believes that the digitalization of education is currently limited in terms of the equipment of educational institutions, as well as the unwillingness of some teachers to work online [2]. In his work, Zenkov writes that changes in the field of education are due to the introduction of technological innovations and digital technologies in society [3]. Andryukhina, Sadovnikova, Utkina, Mirzaahmedov consider the digitalization of education from the point of view of priority directions of state policy development, due to the high importance of this process for society, but complicated by technological problems in implementation [4]. Gromova notes that the current education system does not meet the challenges that are taking place in society, which makes it necessary to adapt and modernize education [5]. Mantulenko writes about the use of digital traces in education as a way to resolve contradictions related to the role of digital technologies and their real application in practice [6].

In 2011, Thomas wrote that teachers should make significant efforts to digitalize the educational process [7]. A number of modern researchers confirm this thesis, speaking about the need for teachers to initiate digital learning [8]. At the same time, this role is attributed not only to teachers of megacities, but also to rural areas [9]. Çetin writes that teachers should initially be trained to meet the requirements for high digital literacy [10]. Sprock and Vicari no longer consider the role of teachers, but the importance of modernizing digital platforms for knowledge management through



the development of separate software modules [11]. Jivet, Scheffel, Drachsler and Spetch evaluate the role of digital learning panels in their research, coming to negative conclusions about the growth of competition between students that need attention, rather than the assimilation of knowledge [12]. Opinions on the digitalization of education differ not only in terms of the area of analysis (assimilation of knowledge, problems of implementation, the role of teachers), but also in terms of possible consequences. All this suggests the need for further study of this issue, and the current study is only one of the areas for analysis.

## 5 Conclusion

Digitalization of education has been an urgent problem for the educational systems of different countries for a long time. This is confirmed by a large number of comprehensive studies of domestic and foreign authors. The key issues are the technical resources of educational structures and the readiness of the teaching staff for digitalization. This study analyzes the use of DEP as a way to digitalize education. The authors suggest three classification features of DEP: the direction of activity, the ownership structure, and the target audience. Based on the expert assessment, the main advantages and disadvantages of using DEP in the educational process were identified. This assessment reflected the importance of the simplicity and accessibility of DEP, as well as a number of disadvantages associated with receiving feedback and the nature of documents received in the end of the educational process. Therefore, this issue is of a dual nature and its solution depends on the priorities of the target audience.

## References

1. Ryzhkova, D., Aranovskaya, M., Rykhard, I., Vysokikh, S.: 35 largest EdTech companies in Russia: RBC rating. <https://trends.rbc.ru/trends/education/5d68e8fb9a7947360f1e2e52>. Accessed: 12 Mar 2021
2. Stokov, A.A.: Digitalization of education: problems and prospects. *Vestnik Minin Univ.* **8**(2(31)), 15 (2020)
3. Zenkov, A.R.: Digitalization of education: Directions, opportunities, risks. *Proc. Voronezh State Univ. Ser. Probl. Higher Edu.* **1**, 52–55 (2020)
4. Andryukhina, L.M., Sadovnikova, N.O., Utkina, S.N., Mirzaahmedov, A.M.: Digitalisation of professional education: prospects and invisible barriers. *Edu. Sci. J.* **22**(3), 116–147 (2020)
5. Gromova, T.V.: Information technologies significance in higher education in context of its digitalization. In: S. Ashmarina, V. Mantulenko (eds.), *Current Achievements, Challenges and Digital Chances of Knowledge Based Economy*. Lecture Notes in Networks and Systems, vol. 133, pp. 19–26. Springer, Cham (2021)
6. Mantulenko, V.V.: Prospects of digital footprints use in the higher education. In S. Ashmarina, V. Mantulenko (eds.), *Current Achievements, Challenges and Digital Chances of Knowledge Based Economy*. Lecture Notes in Networks and Systems, vol. 133, pp. 581–589. Springer, Cham (2021)

7. Thomas, M.: Digital education: opportunities, challenges, and responsibilities. In: M. Thomas (ed.), *Digital Education*. Palgrave Macmillan's Digital Education and Learning, pp. 1–5. Palgrave Macmillan, New York (2011)
8. Lohr, A., Standler, M., Schultz-Pernice, F., Chernikova, O., Sailer, M., Fischer, F., Sailer, M.: On powerpointers, clickerers, and digital pros: Investigating the initiation of digital learning activities by teachers in higher education. *Comput. Hum. Behav.* **119**, 106715 (2021)
9. Muhaimin, Asrial, Habibi, A., Mukminin, A., Hadisaputra, P.: Science teachers' integration of digital resources in education: a survey in rural areas of one Indonesian province. *Heliyon* **6**(8), e04631 (2020)
10. Çetin, E.: Digital storytelling in teacher education and its effect on the digital literacy of pre-service teachers. *Thinking Skills Creativity* **39**, 100760 (2021)
11. Sprock, A.S., Vicari, R.M.: New moodle blocks for knowledge management. In: F. Koch, A. Koster, T. Primo (eds.), *Social Computing in Digital Education*. *SOCIALEDU 2015*. Communications in Computer and Information Science, vol. 606, pp. 104–123. Springer, Cham (2016)
12. Jivet, I., Scheffel, M., Drachsler, H., Specht, M.: Awareness is not enough: Pitfalls of learning analytics dashboards in the educational practice. In: É. Lavoué, H. Drachsler, K. Verbert, J. Broisin, M. Pérez-Sanagustín (eds.), *Data Driven Approaches in Digital Education*. *EC-TEL 2017*. Lecture Notes in Computer Science, vol. 10474, pp. 82–96. Springer, Cham (2017)

# Platform Approach—The Future of Cross-Border Cooperation in the Digital Era



G. A. Khmeleva

**Abstract** Expectations of an early recovery in business activity have not yet been met, and the border territories need to review the systems of cross-border interaction in order to better use the potential of the border situation for sustainable social and economic development. Such opportunities are provided by the platform economy. The paper presents the system and arrangements for cross-border cooperation in the digital era. It also presents the model and options of innovative platforms for cross-border interaction. It highlights that the time is coming for the widespread use of digital platforms, and cross-border cooperation is no exception, since it is a good way to convert the potential of a border location into a competitive advantage in the digital paradigm of economic and social development. It shows that cooperation via platforms allow the set-up of a “live” system of resource exchange between stakeholders, such as the state, business and the local community, on both sides of the borders.

**Keywords** Cross-border cooperation · Digital economy · Innovation · Platform approach · Platform economy · Region

## 1 Introduction

The COVID-19 crisis is unprecedented in its scale and impact, it has deeply affected business and public life around the world, and the border regions are no exception. The coronavirus crisis, which caused a global shock, is the main threat to human health, but at the same time it has become a powerful threat to the development of the world economy, destroying the established industrial and technological relationships. Globalization and the expansion of cross-border economic activities in recent decades, including trends in increasing transport connectivity, population concentration in large cities and agglomerations, increased migration exchange and tourist flows, and an increase in the elderly population proportion that is more at risk of

---

G. A. Khmeleva (✉)  
Samara State University of Economics, Samara, Russia

COVID-19, have been conducive to significant restrictions. Even at the beginning of the globalization rapid growth in the 1990s, scientists expressed concerns about the “viral” nature of globalization [1]. The advantage of globalization—the free movement of people—has contributed to the spread of viral diseases: human immunodeficiency virus (HIV), swine flu, mad cow disease, acute upper respiratory infections, various types of influenza, and now COVID-19. COVID-19 can be expected to be not the last viral crisis.

The closure of borders conduced a significant reduction in international trade and the integration processes curtailment. The World Trade Organization forecasts that the decline in the world trade volume may be historically the most significant, ranging from 13 to 32% [2]. Sectors of the economy with integrated production in cross-border value chains will experience a particularly strong decline. The spread of the new coronavirus infection continues to have a negative impact on the population income and on the global economy dynamics. In the current context, the demand for digital forms of the joint business collaboration is growing [3]. The papers aims to define a model of cross-border cooperation in the context of digitalization.

In this article, we proceed from the generally accepted understanding of cross-border cooperation as interaction between the territories of neighboring countries, aimed at solving common problems in various spheres: economic, social, environmental, etc. Cross-border cooperation is an important component of the country’s international activities, since it facilitates engagement of the previously untapped potential of economic growth and ensures harmonious socio-economic development and strengthening of relations between the countries participating in such cooperation [4].

This paper, first of all, uses the example of the Samara region and Kazakhstan, but the recommendations set forth are universal, they can be applied to any country. In the strict sense of the word, Russia has developed a formal system for managing cross-border cooperation, which involves federal, regional, and local authorities. The local community also participates in cross-border cooperation, most often through local formal and informal associations based on nationality.

## 2 Methodology

The system of cross-border cooperation in the Russian Federation is based on the international and Russian legal framework. The subjects of the cross-border cooperation system are federal authorities, executive authorities of the Russian regions, local governments and communities. The cross-border cooperation concept determines various forms of interaction. The following forms are among them:

- organization and conducting of meetings and other events;
- execution of agreements on cross-border cooperation at the regional and local levels;
- creation of working groups and commissions on relevant issues;

- implementation of specific joint projects and activities.

Apparently, these forms of interaction are quite general and do not take into account modern digital trends.

We suggest relying primarily on the ecosystem approach and the conclusions of the platform economy, as a methodological basis for the study. The ecosystem approach eliminates the complexity and uncertainty of reality, provides opportunity to establish a single framework and context for the exchange of specific knowledge, supporting better prediction and decision-making [5].

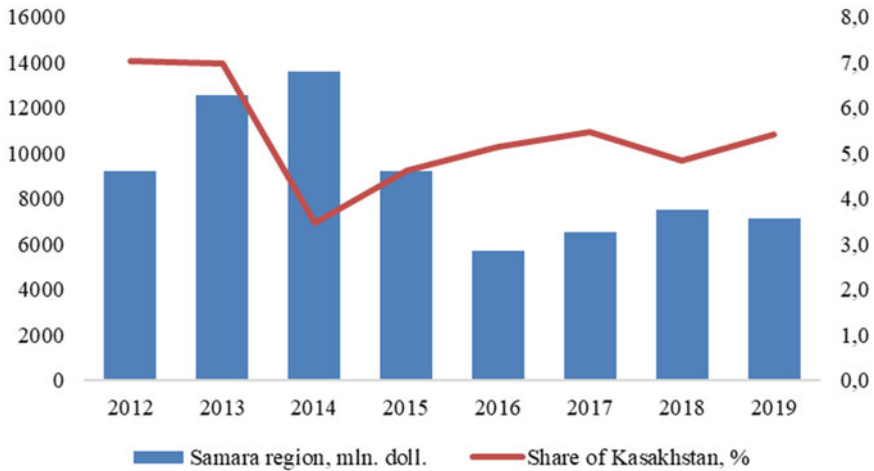
Evans sees the platform economy as a unique phenomenon that allows for the coordination of supply and demand through digital technologies. A platform economy based on digital technologies, big data, and cloud computing can consolidate a large number of stakeholders. Their interaction via a digital platform promotes reduction of transaction costs, establishing common organizational rules and achieving a new level of integration [6].

An important place in the study is given to the core-periphery theory (model) of spatial development, created by Friedmann, in which centers of different levels are always pulling in resources (human, financial, natural) from their periphery [7]. Using these basic approaches, the authors attempt to objectively assess a promising system of cross-border cooperation.

### 3 Results

Of the 85 regions of the Russian Federation, 48 subjects occupy a border or coastal position with 18 neighboring states. The total length of the borders is 60,933 km, of which 38,808 km they are maritime borders. The Samara Region borders the Republic of Kazakhstan in the southern part of the territory, and only a small part of the Bolshechernigovsky district has the status of a border territory. Imports from Kazakhstan are copper and copper products, grain varieties, grain mill products, etc. Exports are mainly mineral fuel, oil and their distilled products, bituminous matters, mineral tallow, plastics and plastic products, and vehicles. Despite the proximity of borders and the common market, Kazakhstan's share in foreign trade turnover is declining, and in 2019 it amounted to 5.4% (Fig. 1).

Obviously, the system of cross-border cooperation, at least in the socio-economic sphere, needs to be developed further. In March 2021, the surveys were conducted among residents of the Samara region, which showed an increase of interest in digital tools for organizing cross-border cooperation as the average age of respondents decreases. So, the older generation at the age of more than 51 years tends towards traditional tools for finding potential partners, such as close and far social circles, analysis of information from open sources. Respondents under the age of 40 prefer extensive use of digital services for organizing interaction within the cross-border cooperation framework. Considering the genesis of approaches to cross-border cooperation, this is quite an expected pattern.

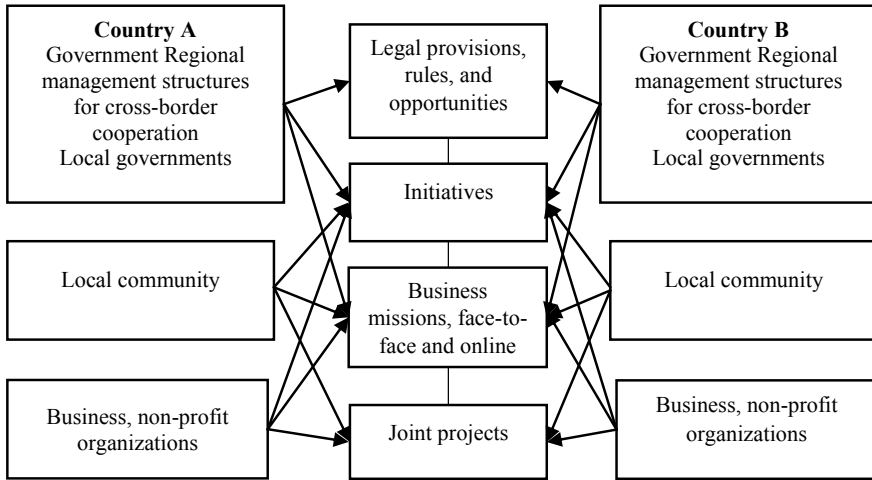


**Fig. 1** Foreign trade turnover of the Samara Region. *Source* Author based on [8]

As a rule, cross-border cooperation is considered from the point of view of systems theory, since it helps to better understand the four key components in management: the goal (why to manage?), the subjects of management (who is managing?), the objects of management (what is being managed?), and the processes (how are the subjects and the objects of management interacting?). Often, the subjects and objects of management are united under the general term “elements of the system”, since in the strict sense, the system of cross-border cooperation is based on equal relations between representatives of two neighboring countries, which means that interaction will be carried out in the case of mutual interest. In the Russian regions and in Kazakhstan, the management system of cross-border cooperation has similar features and can be presented in a general form as shown in Fig. 2.

Country Governments play a leading role in organizing cross-border cooperation through setting common rules. Governments provide opportunities for cross-border cooperation by setting priorities for neighboring countries and elaborating jointly funded development programs. Potentially, the formation of trade unions and protectionist tax and customs policies contribute to the development of trade and economic relations. However, as can be seen from Fig. 2, the formation of a common market with Kazakhstan within the framework of the EAEU did not contribute to the growth of mutual trade. It is expected that in 2020, COVID-19 also hindered the growth of foreign trade turnover between the Samara region and Kazakhstan. To develop the cross-border cooperation between neighboring countries, they need to move to modern models based on the ecosystem approach within the framework of the platform economy.

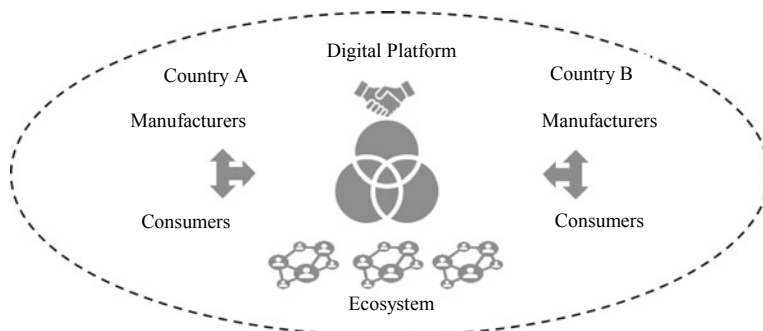
The platform economy is usually understood as an economic activity in which the interaction (commercial and non-commercial transactions) between the participants is carried out through complex standard solutions, called the platform. In the



**Fig. 2** The classical layout of the cross-border cooperation system. *Source* Author

modern sense, the platform is a digital environment, or ecosystem, which provides for the convenient services use that reduce transaction costs. It is no accident that digital platforms have become widespread in business (Alibaba, Amazon, Airbnb) and government (Gosuslugi.ru). In Russia, the platform approach is also being developed in international trade field. The Russian Export Center digital platform has been created, where potential exporters can get the necessary information on various aspects of foreign economic activity, get advice, and receive training. In each Russian region, there are representative offices of the Russian Export Center, which could serve as effective vehicles between potential participants in cross-border cooperation for their regions. To do this, it is necessary to allocate subject sections of foreign economic cooperation for neighboring countries. It might be worth considering the option of a separate regional platform with the possibility of integration with the Russian Export Center platform. Then the model of cross-border interaction will look as shown in Fig. 3.

Cross-border cooperation based on the platform approach is executed as follows. First, a platform needs to be created to which all potential participants in cross-border cooperation can be connected—state and municipal structures authorized to organize the cross-border cooperation process, interested businesses and representatives of local community. The platform should be user-friendly in presenting the steps for the joint projects creation and implementation, and opportunities for the participants of the cross-border partnership. This approach makes organization of network interaction on the equal partnership principles possible. It is important that the portal provides as much information as possible about requests for solving problems, the possibility of attracting state co-financing (if available), and the application of common customs regulations, as in the case of the Eurasian Economic Union. In the future, such a platform can solve the problem of interstate electronic document



**Fig. 3** The model of cross-border cooperation in the platform economy. *Source* Author

management, which can significantly reduce the time for documenting transactions. Perhaps it makes sense to organize access to customs clearance through this platform. In general, the ecosystem approach and the platform economy imply an unlimited expansion of the range of services needed by participants in cross-border interaction.

## 4 Discussion

A system of cross-border cooperation is not a ‘magic pill’ for solving cross-border problems, but an “operating system” [9] in which measures can be developed to speed up processes [10]. That is why, in the context of accelerating scientific and technological processes, the border regions should play a more active role [11, 12], and act as initiators of a cross-border cooperation platform creation. Three options are possible here for creating platforms based on the following principles: “country-border countries”, “country-country” or “region-region”. The question of what is best for the regions remains debatable. In the first case, the platform brings together all interested parties from all border regions and countries with which Russia shares borders. In the case of “country-country” approach, the digital platform unites the Russian regions and the regions of a single country on both sides of the border. In the case of “region-region” approach, the platform is created in each region separately. In any case, the platform approach will serve as a good complement to the Russian Unified Export Promotion System, which operates the portal of the Russian Export Center, providing access to a range of services from market analytics to credit and guarantee support. However, when implementing a digital platform, it is necessary to take into account possible threats to the innovation security of the border region [13].



## 5 Conclusion

The management issues of cross-border cooperation are widely discussed in the scientific literature [14, 15]. However, effective mechanisms that allow achieving the goal of converting the border location potential into a competitive advantage in the digital paradigm of economic and social development have not yet been identified. The authors argue that there is no other alternative than using the platform approach. The introduction of a platform approach to the development of cross-border cooperation has a number of advantages:

- unlimited growth potential for participants of cross-border cooperation;
- reduction of a cross-border cooperation project duration, from idea to launch;
- attraction of interested parties only, which contributes to overall productivity and balance of interests;
- levelling the impact of the actual distance factor of cross-border cooperation participants from each other;
- it is a tool for implementing the best practices necessary to achieve high performance;
- facilitation of a unique value proposition creation by combining approaches from different fields;
- flexible response to global challenges and changing requests on both sides of the border.

Ultimately, the platform provides for building cooperation based on the true values of cooperation without borders, as it creates conditions for the free movement of labor, capital, services and goods, supported by advanced technologies. Currently, there is a shift in the core-periphery paradigm, where the concentration and exchange of resources through a digital platform creates opportunities for economic growth and innovative changes in both centers and peripheries on both sides of the border. In this sense, the platform approach is the future of converting the neighboring position advantages into competitive advantages.

**Acknowledgements** The reported study was funded by RFBR and FRLC, project number 21-510-23002.

## References

1. Appadurai, A.: Coronavirus won't kill globalization. But it will look different after the pandemic. <https://time.com/5838751/globalization-coronavirus/>. Accessed: 11 Mar 2021 (2020)
2. World Trade Organization: Trade falls steeply in first half of 2020. Press Release № 858. [https://www.wto.org/english/news\\_e/pres20\\_e/pr858\\_e.htm](https://www.wto.org/english/news_e/pres20_e/pr858_e.htm) Accessed: 11 Mar 2021 (2020)
3. Khmeleva, G.A., Czegledy, T.: Towards a new format of regional integration: Co-creation and application of technologies. In: S. Ashmarina, V. Mantulenko (eds.), *Current Achievements*,

- Challenges and Digital Chances of Knowledge Based Economy. Lecture Notes in Networks and Systems, vol. 133, pp.71–77. Springer, Cham (2021)
4. Khasbulatov, R., Byasharova, A.: Coronavirus economic crisis in the world economy: Features and consequences. *Int. Econ.* **5**. <https://panor.ru/articles/koronavirusnyy-ekonomicheskiy-kri- zis-v-mirovoy-ekonomike-osobnosti-i-posledstviya/43280.html>. Accessed: 11 Mar 2021 (2020)
  5. Adner, R.: Ecosystem as structure: an actionable construct for strategy. *J. Manag.* **43**(1), 39 (2017)
  6. Xue, Ch., Tian, W., Zhao, X.: The literature review of platform economy. *Sci. Program.* **2020**, 8877128 (2020)
  7. Friedmann, J.: *Regional Development Policy: A Case Study of Venezuela*. MIT Press, Cambridge (1966)
  8. Samarastat: Foreign economic activity. [https://samarastat.gks.ru/foreign\\_trade](https://samarastat.gks.ru/foreign_trade). Accessed: 11 Mar 2021
  9. Young, O.R.: *Governing Complex Systems: Social Capital for the Anthropocene*. MIT Press, Cambridge (2017)
  10. Gualini, E.: Cross-border governance: inventing regions in a trans-national multi-level Polity. *dis.P Plann. Rev.* **39**(152), 43–52 (2003)
  11. Chirkunova, E., Anisimova, V.Y., Tukavkin, N.M.: Innovative digital economy of regions: Convergence of knowledge and information. In: S. Ashmarina, V. Mantulenko (Eds.), *Current Achievements, Challenges and Digital Chances of Knowledge Based Economy. Lecture Notes in Networks and Systems*, **133** (pp.123–300). Cham: Springer. (2021).
  12. Shkarupeta, E.V., Narolina, T.S., Nekrasova, T.A., Khmeleva, G.A.: High growth industrial companies as the main agents for breakthrough development. In: V. Mantulenko (ed.), *Proceedings of the International Scientific Conference “Global Challenges and Prospects of the Modern Economic Development”*. European Proceedings of Social and Behavioural Sciences, vol. 57, pp.1349–1354. European Proceedings, London (2019)
  13. Mikhaylov, A.S., Mikhaylova, A.A., Savchina, O.V.: Innovation security of cross-border innovative milieu. *Entrepreneurship Sustain. Issues* **6**(2), 754–766 (2018)
  14. Chilla, T., Evrard, E., Schulz, C.: On the territoriality of cross-border cooperation: “institutional mapping” in a multi-level context. *Eur. Plan. Stud.* **20**(6), 961–980 (2012)
  15. Villanueva, J.L.W., Kidokoro, T., Seta, F.: Cross-border integration, cooperation and governance: a systems approach for evaluating “good” governance in cross-border regions. *J. Borderlands Stud.* <https://doi.org/10.1080/08865655.2020.1855227>. Accessed: 11 Mar 2021 (2020)

# Regulation Regime of Digital Exchange Platforms: Perspective Models



E. Y. Komova

**Abstract** The research is devoted to the study of the features of ensuring the regulatory regime of digital innovative products traded on digital exchange platforms. The study shows that the concept of “regime” exists in the legislation of a number of countries, while in most countries this regime is equipped with criminal law mechanisms for bringing to justice. According to the results of the study, the author identifies two key approaches in legal regulation. The first is typical of the countries of continental Europe, the second is more rigid, typical for the United States. Within the framework of the European approach, two already established areas of regime regulation are identified: the first is aimed at regulating digital assets in accordance with the legislation on the securities market, the second is aimed at previously unregulated digital assets, such as stablecoins. A pilot regime is being implemented in the EU to test the new regime. The US approach is based on the US SEC’s application of the Howey test. The strengthening of imperative methods in the regulation of illegal manipulative practices on the digital market should be recognized as a distinctive feature of both approaches.

**Keywords** Bitcoin · Crypto-assets · Digital platforms · Regime · Regulation

## 1 Introduction

Digital technologies became a part of modern reality. Over the past decade, the activities on stock exchanges have been completely digitized. Capital markets and financial markets are rapidly being transformed by digital assets, such as cryptocurrencies [1, 2]. This makes it necessary to establish a special regime for regulating studied legal relations in order to increase efficiency, accumulate capital and innovations while protecting investors [3]. However, new ways of doing business pose serious challenges for governments and regulators. Legislators around the world

---

E. Y. Komova (✉)

Moscow State Institute of International Relations (University) of the Ministry of Foreign Affairs,  
Moscow, Russia

e-mail: [komova.e.yu@my.mgimo.ru](mailto:komova.e.yu@my.mgimo.ru)

© The Author(s), under exclusive license to Springer Nature Switzerland AG 2022

197

S. I. Ashmarina and V. V. Manteulenko (eds.), *Digital Technologies in the New*

*Socio-Economic Reality*, Lecture Notes in Networks and Systems 304,

[https://doi.org/10.1007/978-3-030-83175-2\\_27](https://doi.org/10.1007/978-3-030-83175-2_27)

face a serious challenge: how to ensure a balance between protecting the interests of investors and preventing criminal offenses, and stimulating innovations [4]. Experts from the consulting agency Deloitte note that if countries fail to understand the nature of digital innovations and timely create proper regulation, then a situation may arise where innovations will be suppressed, and investors will suffer multimillion dollar losses [5]. This circumstance dictates the need for countries to create a flexible legal regulation regime that will be effective both in terms of preventing fraudulent practices and in terms of ensuring a proper level of criminal legal protection of the legal relations under consideration [6, 7].

Law enforcement is also closely related to the need for regulation. The digitalization of financial markets has already attracted the attention of law enforcement authorities in many jurisdictions [8]. Nowadays, we can talk about two key models of criminal law regulation of the stock market: the European model (more flexible) and the American model (more rigid). In the framework of this study, an attempt is made to study these regimes and determine their impact on the development of the global capital market.

## 2 Methodology

The methodological basis of the study is a systematic approach. The study classified and analyzed regulatory policies, state legislation, and regulations on the functioning of the stock market. The study classified and analyzed the main practical and doctrinal approaches to determining the effectiveness of digital platforms regulation. When processing the empirical material, scientific methods were used: dialectical, logical, the method of scientific generalizations, content analysis, comparative analysis, synthesis, source studies, etc. Their application ensured the validity of the analysis and the reliability of the conclusions made by the author and the developed proposals.

## 3 Results

The regime of criminal law protection of the stock market in most foreign countries is provided by the implementation of a complex of criminal law and organizational means. Some experts are convinced that the reasons for the formation of supranational regulation in relation to the prevention of abuse on the stock market were the globalization processes [9]. The creation of the EU and the adoption of a number of directives on the regulation of relations on the stock market made it possible to form a single capital market with a single legal regulation regime [10]. In the world today, the European and American model of regulation stands out. In most jurisdictions, these models are implemented either fully or partly.

*The European regulatory model* is implemented through the application of the EU Directive 2014/57/EU of 16 April 2014 «On criminal sanctions for market abuse (market abuse directive)» [11].

The directive does not restrict the EU countries in the methods and means that ensure the criminal law protection of the stock market, limiting only by the “reference points” necessary for the uniformity of working conditions on the internal market of the entire EU. It is noteworthy that this directive is of a framework nature and serves as a guideline for EU members, so countries are required to adhere only to the minimum established rules, while they can expand the regime within their jurisdiction [11]. Member states may, for example, predict that market manipulation committed through negligence is an offence. The minimum amount of sanctions, according to the directive, for insider trading, recommending or encouraging another person to engage in insider trading and market manipulation provides for a prison sentence of at least four years. For illegal disclosure of insider information—at least two years in prison. The directive also prescribes the prosecution of legal entities by imposing criminal or non-criminal sanctions or other measures that are effective, proportionate and dissuasive [11].

It should be emphasized that the MAD regime is quite effective, as can be seen from the ESMA report on the applied criminal and administrative sanctions. In total, 60 criminal proceedings were initiated in 2019, for a total of 5,523,750 euros. Most of them—42 cases were initiated in Germany [12]. It should be noted that the recent clarifications of the European Commission indicate that there are two directions in the regulation of crypto assets by EU legislation. The former are regulated by the current legislation on the securities market. Thus, some crypto assets are qualified as financial instruments and are therefore subject to the EU legislation on financial instruments-MiFID II [13] and MAR. For previously unregulated crypto assets, including “stablecoins”, the EU offers an individual legal regime.

*The American model*, or the model based on the law enforcement of existing norms (without the development of a new special regulation), is implemented by applying the existing rules and principles of stock market regulation to all innovations without exception. The entire spectrum of participants in the crypto market falls under the regulation of the SEC (Security Exchange Commission): from issuers and individuals to various intermediaries and trading platforms and aggregators. In its work, the commission relies on a set of fundamental principles of law, doctrines, for example, the doctrine defining the investment contract, and prescriptive rules regarding capital market institutions and limited exceptions [14]. Scientific studies show a direct correlation between the actions of the SEC and the situation on the stock market [15]. According to scientists, the SEC, with its very different focus on litigation, deterrence, and high fines, differs from its fellow regulators [16].

The results of the study indicate that only individual countries (14 out of 23) take real actions to prevent illegal actions in the crypto market. With the exception of the United States, many countries adopted a “soft” law enforcement approach, choosing a surveillance tactics, despite regularly issuing releases about the desire to tighten regulation. Guseva and Eakeley conducted an interesting study on the actions of states to regulate/resolve incidents on the digital assets market for the

period from 2018 to 2019 [8]. So, in total, in the most attractive jurisdictions from the point of view of financial infrastructure, 416 response measures were applied during this period, of which 287 accounted for putting violators on stop lists or issuing official warnings to them, while 57 out of 67 official court decisions or decisions of law enforcement agencies happened in the United States. Meanwhile, the activities of the SEC, as well as other stock market regulators, are aimed at solving two diametrically opposite tasks: protecting investors and supporting efficient, innovative and competitive markets, including financial innovations [17]. According to experts, this circumstance poses a dilemma for the regulator [18]. On the one hand, investors should be protected from the continuous tricks of enterprising scammers, including crypto companies, on the other hand, strict regulation can repress innovations or direct capital to other jurisdictions.

The American regulatory model is also characterized by extraterritorial action. U.S. regulators stop wrongdoings and prosecute not only domestic companies, but also foreign companies that attract funds from American investors. At the same time, international cooperation is ensured through the implementation of the Multilateral Memorandum of Understanding between Securities Regulators (“MOUs”), adopted within the framework of the International Organization of Securities Commissions (“IOSCO”) [19].

## 4 Discussion

The regulation of civil law relations on the stock market is the basis for the application of the criminal law protection regime on the European market. The MAR is applied directly in each EU member state, without requiring states to develop laws implementing the MAR provisions. However, criminal sanctions for market abuse (CSMAD or MAD II) require each member state to implement legislation to ensure that market abuse is a criminal offence that can be effectively punished.

Special attention in the context of the study should be paid to the regime of regulation of crypto assets and blockchain technology. On 24 September 2020, the European Commission adopted a package of laws on digital finance, including a digital finance strategy and legislative suggestions on crypto assets and digital sustainability [20]. The digital finance strategy sets out the specific features of the special legal regime of the specified segment of the financial market.

The purpose of the new regime is to provide legal certainty for the regulatory regime of all crypto assets, regardless of whether they are qualified as financial instruments or electronic money under current legislation or have not previously been regulated. The Crypto Asset Markets Regulation (MICA) will cover all crypto assets not covered by the current financial services legislation [21]. The Regulation on Market Abuses (MAR) contains fairly broad definitions of the concepts of market manipulation and the misuse of insider information. In cases when crypto assets are qualified as financial instruments and provided that they are traded or allowed to trade on the trading platform (or if they are not traded on the trading platform, but

their price or value depends on or affects the price or value of the financial instrument traded on the trading platform), MAR automatically becomes applicable to them.

In addition, trading platforms should have effective mechanisms, systems and procedures aimed at preventing, detecting and reporting market abuses (Article 16 of the MAR). Issuers will be required to disclose insider information as soon as possible (Article 17 of MAR) and maintain a list of insiders (Article 18 of MAR). The managers of the issuers will have to notify the competent authority of each transaction carried out at their own expense (Article 19 of the MAR). Individuals who make or distribute investment recommendations will also be required to provide objective representation of such information (Article 20 of the MAR), which may be particularly relevant for crypto asset markets, where limited trading volumes and / or concentrated ownership of certain crypto assets may increase the risk of a conflict of interests [22].

However, prior to the adoption of the Crypto Asset Markets Directive (MICA), there was no clear position on whether the MAR regime applies to crypto assets. The adoption of the directive resolved this situation, and the regime of criminal protection of the stock market in the EU in relation to crypto assets can be fully implemented.

However, ESMA's research notes say that the new nature of the crypto asset market may mean that some new types of criminal behavior may arise that are not directly captured and covered by MAR or current market monitoring mechanisms. For example, new entities may possess new forms of internal information that could potentially be used to manipulate the trading and settlement of crypto assets. According to the regulator, a detailed study of this issue in the near future will lead to the need to make changes to the existing MAP regime.

The proposed pilot regulatory regime is designed for market participants who want to try to trade and conduct transactions with financial instruments in the form of crypto assets. This should allow market participants and regulators to implement the practice of using exchanges based on blockchain technologies, which will trade or record shares or bonds in a digital register [21]. The pilot mode, which allows deviations from existing rules, will allow regulators to improve their skills and knowledge in the use of blockchain in market infrastructures, and companies to test solutions using DLT [23].

Regulators are particularly concerned about the problem of ensuring information security. At the same time, the European Commission suggests to assign the responsibility of ensuring information security directly to professional participants of the market infrastructure. This approach is due to the continuous increase in the number of threats in the financial sector, directly related to software and digital technologies implemented in the financial sector. Thus, banks, exchanges and other financial intermediaries will be required to guarantee their ability to withstand digital threats, and to comply with strict standards for ensuring confidentiality and information security. In order to monitor these activities, a system of supervision of service suppliers that provide cloud computing to financial institutions is being implemented [20]. Meanwhile, the issues of establishing a regime of criminal law regulation of abuses against "other" crypto assets are not affected by the new regime, and should be resolved after testing in the pilot mode of the general regime of legal regulation.

*The American approach.* The legal basis of the American regime of criminal protection of the stock market is a number of key acts: The Securities Act of 1933 (The ' Truth in Securities ' law), Insider Trading Sanctions Act 1984, the Securities Fraud Enforcement Act, The Commodities Futures Modernization Act, The Sarbanes–Oxley Act. The latest law created a more strict regulatory and law enforcement framework for accounting firms and professionals to combat corporate fraud, insider trading, and other types of market abuse. The Sarbanes–Oxley Act increased the penalties for insider trading to a maximum fine of 5 million dollars for individuals and 25 million dollars for corporations and a maximum prison sentence of 20 years [7]. Illustrative in this aspect is the case of Rajaratnam, the head of the Galleon Management hedge fund, accused of using insider information and obtaining illegal profits in the amount of 33 million dollars [24, 25]. Convicted to 14 charge points of securities fraud, he was sentenced to 11 years in prison. This was the longest sentence ever imposed for insider trading, and Rajaratnam was also forced to pay a fine of 92.8 million dollars.

After the global financial crisis of 2007–2008, Congress passed the Dodd-Frank Act on Wall Street reform and on consumer rights protection of 2010. This law allows the SEC and / or the CFTC to take appropriate legal steps against any employee or agent, agency, or department of the federal government that buys or sells a product with non-public material information related to that product. However, the Dodd-Frank Act does not provide for specific penalties for insider trading practices [21, 26].

The SEC's control over the stock market abuses has, of course, not left the digital financial asset market unaddressed. The US SEC's regulation of digital financial products is described by some authors as "regulation through law enforcement". According to experts, this approach assumes that the existing rules and mechanisms are suitable for complex technological innovations and that there is no need to engage in notification of rulemaking, comments and costs/ benefits analysis to determine their suitability—or the need for another regulatory regime [8].

Based on the results of the investigation of "The DAO" exchange, the SEC expressed its position on the possibility of applying securities legislation to tokens, taking into account their nature and functionality, which is decided in each specific case using the Howey test [27, 28]. When qualifying tokens as securities, they are automatically become subject to information disclosure requirements. They will also have the obligation of intermediaries in token transactions to register in the SEC [29]. This approach makes it possible to apply all the means of criminal law regulation of the stock market to new legal relations.

In a public warning about cryptocurrency manipulation, the US Commodity and Futures Trading Commission notes that such manipulations can damage the integrity of the cryptocurrency markets and exhaust the credibility of investors [30]. The document also reveals the specifics of the scheme implementation. So, consumers are asked to refrain from buying popular tokens based on the advices received in social networks [31]. Meanwhile, a number of experts note that the manipulative practices used on the digital asset market differ from similar practices on the traditional market, which makes it necessary to create a special regime [32].



The US SEC's approach mainly uses the imperative method of regulating new public relations, which is clearly demonstrated in the annual reports. Thus, the SEC report notes: the registration requirements of the Securities Act of 1933 and the related exceptions are fundamental to our regulatory framework. In fiscal year 2019, there were several significant developments in this area related to digital assets [33]. As a whole, these actions send a clear message that if a product is a security paper, regardless of the "label" attached to it, those who issue, promote, or provide a platform to buy and sell this security paper should comply with the investor protection requirements of federal securities legislation. These protections have kept our capital markets and, most importantly, our investors in good shape for more than 85 years [34].

## 5 Conclusion

The very concept of "criminal law protection regime" is present in the legislation of a number of countries and interstate associations. Meanwhile, in other states, despite the absence of the mentioned concept, the regime of criminal law protection of the stock market is fully carried out, and has all the features inherent in the Russian regime of criminal law protection of the stock market. The basis of the European approach to the formation of the criminal law protection regime of the stock market is CSMAD or MAD II, which is in direct correlation with the general positive regime of legal regulation of the stock market established by MAR.

The European criminal law regulation regime of the stock market gives a special place to the digital assets market. Since 2020, a two-level regulatory system has been established: In cases where crypto assets qualify as financial instruments and if they trade or allowed to trade on the trading platform (or, if they are not traded on the trading platform, but their price or value depends on or affects the price of a financial instrument traded on the trading platform), MAR automatically becomes applicable to them. For new types of digital financial assets, a trial regulatory regime is being created. The U.S. law enforcement system uses civil, criminal, and administrative penalties to prevent stock market abuses. The US approach to establishing a criminal law protection regime for the stock market, where the roots of the legislation go back to the early 1930s, is the guiding one for the regulators of most of the world's jurisdictions. At the same time, the approach of the US regulatory body, the US Securities and Exchange Commission (SEC), is mostly imperative.

## References

1. Kirilenko, A.A., Lo, A.W.: Moore's Law vs. Murphy's Law: algorithmic trading and its discontents. *J. Econ. Perspect.* <https://ssrn.com/abstract=2235963>. Accessed: 24 Mar 2021 (2013)

2. Omarova, S.T.: New tech v. New deal: fintech as a systemic phenomenon. <https://ssrn.com/abstract=3224393>. Accessed: 24 Mar 2021 (2018)
3. Feinstein, B.D., Werbach, K.: The impact of cryptocurrency regulation on trading markets. *Journal of Financial Regulation*, Forthcoming. <https://ssrn.com/abstract=3649475>. Accessed: 24 Mar 2021 (2020)
4. de Koker, L., Morris, N., Jaffer, S.: Regulating financial services in an era of technological disruption. *Law in Context* **36**, 2 (2019)
5. Deloitte: A journey through the FCA regulatory sandbox: the benefits, challenges, and next steps. <https://www2.deloitte.com/content/dam/Deloitte/uk/Documents/financial-services/deloitte-uk-fca-regulatory-sandbox-project-innovate-finance-journey.pdf>. Accessed: 24 Mar 2021 (2018)
6. Sidorenko, E.L., Kubantsev, S.P., Khisamova, Z.I.: International financial and information security strategies: key aspects of preventing criminal threats. In: S.I. Ashmarina, J. Horák, J. Vrbka, P. Šulěř (eds.), *Economic Systems in the New Era: Stable Systems in an Unstable World*. *Lecture Notes in Networks and Systems*, vol. 160, pp. 479–488. Springer, Cham (2021)
7. The Sarbanes-Oxley Act of 2002. <https://www.investopedia.com/terms/s/sarbanesoxleyact.asp>. Accessed: 24 Mar 2021 (2002)
8. Guseva, Yu., Eakeley, D.: Crypto-enforcement around the world. <https://ssrn.com/abstract=3713198>. Accessed: 24 Mar 2021 (2020)
9. Scopino, G.: Preparing financial regulation for the second machine age: the need for oversight of digital intermediaries in the futures markets. *Columbia Bus. Law Rev.* **2**, 439 (2015)
10. Busch, Ch.: Towards a ‘new approach’ for the platform ecosystem: a European standard for fairness in platform-to-business relations. *J. Euro. Consum. Mark. Law* **6**, 227–228 (2017)
11. The European Parliament and the Council of the EU: Directive 2014/57/EU of 16 April 2014 On criminal sanctions for market abuse (market abuse directive). <https://eur-lex.europa.eu/legal-content/EN/ALL/?uri=CELEX%3A32014L0057>. Accessed: 24 Mar 2021 (2014)
12. ESMA: Report administrative and criminal sanctions and other administrative measures imposed under the market abuse regulation in 2019. [https://www.esma.europa.eu/sites/default/files/library/esma70-156-3537\\_annual\\_report\\_on\\_mar\\_administrative\\_and\\_criminal\\_sanctions\\_2020.pdf](https://www.esma.europa.eu/sites/default/files/library/esma70-156-3537_annual_report_on_mar_administrative_and_criminal_sanctions_2020.pdf). Accessed: 24 Mar 2021 (2020)
13. The European Parliament and the Council of the EU: The markets in financial instruments directive MIFID-2014/65/EU. <https://eur-lex.europa.eu/legal-content/EN/TXT/?uri=celex%3A32014L0065>. Accessed: 24 Mar 2021 (2014)
14. Shadab, H.B.: Regulating bitcoin and block chain derivatives. <https://ssrn.com/abstract=2508707>. Accessed: 24 Mar 2021 (2014)
15. Jackson, H.E., Roe, M.: Public and private enforcement of securities laws: resource based evidence. *J. Fin. Econ.* **93**(2), 207–238. (2009)
16. Jackson, H.E.: Variation in the intensity of financial regulation: preliminary evidence and potential implications. *Yale J. Regul.* **24**(2), 3 (2007)
17. Lemma, V.: Innovations in asset management under a regulatory perspective: Which rules can support the success of fintech? <https://ssrn.com/abstract=3657333>. Accessed: 24 Mar 2021 (2020)
18. Brummer, Ch., Yadav, Y.: Fintech and the innovation trilemma. *107 GEO. L.J.* **235**, 249–264 (2019)
19. Mitchell, A.D., Mishra, N.: Data at the docks: modernising international trade law for the digital economy. <https://ssrn.com/abstract=3064396>. Accessed: 24 Mar 2021 (2017)
20. The European Commission: Digital finance package. [https://ec.europa.eu/info/publications/200924-digital-finance-proposals\\_en](https://ec.europa.eu/info/publications/200924-digital-finance-proposals_en). Accessed: 24 Mar 2021 (2020)
21. The Dodd Frank Act. <https://smart-lab.ru/finansoviy-slovar/%D0%97%D0%B0%D0%BA%D0%BE%D0%BD%20%D0%94%D0%BE%D0%B4%D0%B4%D0%B0-%D0%A4%D1%80%D1%8D%D0%BD%D0%BA%D0%B0>. Accessed: 24 Mar 2021 (2010)
22. ESMA: Advice initial coin offerings and crypto-assets. URL: [https://www.esma.europa.eu/sites/default/files/library/esma50-157-1391\\_crypto\\_advice.pdf](https://www.esma.europa.eu/sites/default/files/library/esma50-157-1391_crypto_advice.pdf). Accessed: 24 Mar 2021 (2019)

23. Johnson, K.N.: Regulating cryptocurrency secondary market trading platforms. <https://ssrn.com/abstract=3516261>. Accessed: 24 Mar 2021 (2020)
24. Khudyakova, L.S.: International experience in combating manipulative transactions in financial markets. *Money Credit* 7, 65–70 (2011)
25. Vedomosti: Rajaratnam will pay a record fine for insider trading. [https://www.vedomosti.ru/finance/articles/2011/11/09/radzharatnam\\_zaplatit\\_rekordnyj\\_shtraf\\_za\\_insaj](https://www.vedomosti.ru/finance/articles/2011/11/09/radzharatnam_zaplatit_rekordnyj_shtraf_za_insaj). Accessed: 24 Mar 2021 (2011)
26. Middlebrook, S.T., Hughes, S.J.: Substitutes for legal tender: lessons from history for the regulation of virtual currencies. <https://ssrn.com/abstract=2605847>. Accessed: 24 Mar 2021 (2015)
27. SEC v. Howey Co., 328 U.S. 293. <https://supreme.justia.com/cases/federal/us/328/293/>. Accessed: 24 Mar 2021 (1946)
28. SEC: Report of Investigation under 21(a) of the Securities Exchange Act of 1934: The DAO. <https://www.sec.gov/litigation/investreport/34-81207.pdf>. Accessed: 24 Mar 2021 (2017)
29. Fedorov, D.V.: Tokens, cryptocurrency and smart contracts in domestic draft laws from the perspective of foreign experience. *Bull. Civil Law* 2, 30–74 (2018)
30. CFTC: Customer advisory: Beware virtual currency pump-and-dump schemes. [https://www.cftc.gov/sites/default/files/2019-12/customeradvisory\\_pumpdump0218.pdf](https://www.cftc.gov/sites/default/files/2019-12/customeradvisory_pumpdump0218.pdf). Accessed: 24 Mar 2021 (2018)
31. Annunziata, F.: Speak, if you can: what are you? An alternative approach to the qualification of tokens and initial coin offerings. <https://ssrn.com/abstract=3332485>. Accessed: 24 Mar 2021 (2019)
32. Kamps, J., Kleinberg, B.: To the moon: defining and detecting cryptocurrency pump-and-dumps. *Criminology* 7(1), 18 (2018)
33. Trautman, L.J.: Bitcoin, virtual currencies, and the struggle of law and regulation to keep pace. <https://ssrn.com/abstract=3182867>. Accessed: 24 Mar 2021 (2018)
34. SEC: Annual staff report relating to the use of form PF data. <https://www.sec.gov/files/2019-pf-report-to-congress.pdf>. Accessed: 24 Mar 2021 (2019)

# **Natural and Artificial Intelligence Use in Applied Tasks of Digital Economy**

# Challenges in Identifying the Digital Economy Rising



S. P. Bortnikov

**Abstract** Despite the introduction of digital technologies over the past decades in many countries, including Russia, has acquired the status of a “traditional” direction of development at both the state and corporate levels, the modern stage, characterized by the formation of the so-called digital economy, creates fundamentally new technological and organizational and managerial challenges. At the same time, operational definitions of new key concepts have not yet developed, not to mention a full-fledged regulatory legal framework and regulatory mechanisms, which, of course, hinders the rising of the digital economy and the possibility of realizing the positive effects associated with it.

**Keywords** Artificial intelligence · Digitalization · Digital economy · Technological structure

## 1 Introduction

When examining economics in the digitalization of production and the social environment, it is important to determine what the social economy is. Is it possible in our study to proceed from the fact that the digital economy is a new economic structure, a special economic order based on digital technologies, Big data, etc., within which qualitative changes are taking place in society, business and the state? Hardly, since the factors of the production process and the basic decrees of capitalist production remain the same as in the Marxist economy. Yes, of course, there is a prospect of replacing labor with a robot, changing the consumption system, splitting property into means of production in sharing economy. Although there is much debate over whether to consider sharing economy such commercial services as Uber and Airbnb (perhaps the most cited examples of the new economy) or whether they have turned into pure capitalism and more correctly call them the access economy. And sharing is, first of all, about a non-commercial exchange.

---

S. P. Bortnikov (✉)  
Samara State University of Economics, Samara, Russia

The digital economy is more of a new technology. Technological innovations that determine the formation of the core of the technological way, as a key factor, allow you to manage the economy in real time based on feedback processed by artificial intelligence big data. The activities of entrepreneurs and other economic entities in the digital environment take place and exist outside the time, in the continuum of digital interaction in the network. This process involves people, robots, enterprises, digital phantoms, devices. The basis of the digital economy is Big Data, the hyper-linking process, that is, the growing linking human, machines, legals in the Internet, using mobile technologies, the Internet of Things [1].

The digital economy uses information, digital algorithms, Big Data, electronic programs and resources in previously unprecedented volumes and types of communications. Intangible assets in their bulk capitalize the production process based on multilateral business models, out of jurisdiction destinations, in which value creation occurs.

The degree of dependence of the studied economy on digital technologies cannot be overestimated. It will only grow over time.

It is appropriate to recall the joke:

- “I know EVERYTHING!” said Wikipedia.
- “Everything can be found in me!” boasted Google.
- I am the most important in the world!—said the Internet.
- Well, well... the electricity answered quietly.

In the near future, the load on the energy system will increase. More and more sectors of the economy will depend on its stable work: transport, which only does it electrify, smart city systems, which, albeit with a creak, take their place in the city economy, the Internet of Things, which, although so far is exotic, is quickly introduced into everyday life (the number of devices connected to the Internet of Things is growing in the world by 20–30% per year).

We assume that either the economy itself, or economic communications at their core or essence will have certain digital processes. At the same time, digital technologies are now reduced to electronic communication, which does not create qualitative changes in the economic structure and is a logical development only in the way the producer interacts with the consumer. In itself, business transactions in World Wide Web-based markets only change the way of communication, but not the way of production. The method of selling the manufactured products, their consumption, exchange did not become electronic, they are needed by the consumer in kind. Electronic markets using new technologies certainly facilitate trade, enhance the supply of goods, works and services, reduce costs, and erase the boundaries of national legal systems [2]. On the other hand, electronic commerce and digital logistics mobilize new control mechanisms, act as customers of robotic systems, special programs, the introduction of new (digital phantoms) subjects existing in a multilevel system of communications and relations.

The digital economy should be the main source of growth. This will stimulate competition, investment and innovation, which will lead to improved quality of services, increased choice for consumers, and the creation of new jobs.

## 2 Methodology

Various methods of scientific knowledge were used in the course of the study. The method of materialist dialectics was used as the main one, allowing for the production and analysis of the problem. The use of a comparative legal method has led to a systematic analysis of the phenomena studied. The formal-logical method allowed to justify the conclusions and basic provisions of the study. The analysis and comparison of statistical data revealed comparison benchmarks, the comparison of which provided the basis for the study. Energy modelling and forecasting as a basic method is due to the fact that it takes more account of the peculiarities of national institutions of management and statistical description of modelling objects. Using the critical method allows you to identify existing problems and suggest ways to resolve them.

## 3 Results

The digital economy, in which, on the one hand, the rapid development of digital technologies ensures a rapid increase in labor productivity, removes the restrictions of legislation in the field of labor protection, changes the factors of competitive influence, the release of labor resources, on the other hand, the disappearance of occupations in which people are employed, the stratification into the poor and the rich is predicted, and the increase in social inequality.

It is unlikely that in the near future there will be some kind of sudden technological big explosion, after which many people will lose their jobs. This is unlikely to happen; we do not seem to stop working for some time. However, another, more gradual process is worrying: as a result of the significant changes in technology that are now taking place, more and more people throughout the twenty-first century will find that they can no longer make the economic contribution to society that they could count on in the twentieth century.

Obviously, technological progress will not destroy the profession entirely and immediately. It will act gradually and subtly, taking away individual tasks from people and individual parts of their work. The structure of employment and the range of professions will change under the influence of changes in the technology of production, exchange and supply of works, goods and services. Digitalization will not destroy the relevant professions in one moment and in the whole world at once. This process will take time, it will take place in some countries more rapidly, in some countries gradually, but this process is obvious. The replacement of a person with technology, a program, or a robot has already begun. Moreover, it affects such areas in which, it would seem, without a person, his morals, soul, etc. it is impossible to do without: the judicial system, medicine, culture, etc. The outlined process can take place immediately with the replacement of a person, but it can use separate elements of labor, the introduction of program management under the guidance of a person, the digitization of production tasks or the offer of products to the consumer.

It is already possible to note those areas where the digital economy most clearly and prominently allows you to feel your results. More and more producer–consumer communications are moving into the e-commerce sphere. Traditional areas of activity of the producer of sales services are moving to a remote format. The use of electronic platforms and digital technologies requires the development of new competencies, the robotization of both the sphere itself and the formation of demand.

New digital formats force the consumer to switch to a new language of business communication, which is no longer understandable to a person, but to a robot, an electronic program. The emergence of a new digital environment for consumer–producer communication requires new legal institutions, new legal approaches to regulating industrial relations.

In the scientific environment, there is a discussion regarding this term, it is noted that in Europe the term “digital economy” is more often used, and in America the API economy (Application programming interfaces, “application economics”). In particular, from the content of the normative acts of the European Union, it is possible to derive a definition in which the effect of the transformation of modern technologies in the information environment and business communication becomes the basis for the definition of the digital economy [3]. There are a number of different definitions, but their analysis shows that they are all related to information technology and the Internet in one way or another. In Russia, according to paragraph “r” art. 4 Strategies for the development of the information society in the Russian Federation for 2017–2030 years? Decree of the President of the Russian Federation of May 9, 2017 No. 203 “On the Strategy for the Development of the Information Society in the Russian Federation for 2017–2030 “Digital economy refers to economic activity, in which the key factor of production is digital data, the processing of large volumes and the use of the results of analysis of which, in comparison with traditional forms of management, can significantly increase the efficiency of various types of production, technologies, equipment, storage, sale, delivery of goods and services. As can be seen from the above definitions, they in general have quite a few common features, the main of which is the breadth of the scope of the digital economy [4].

Moreover, the national program “Digital Economy 2024” was adopted in accordance with the Decree of the President of the Russian Federation of May 7, 2018 No. 204 “On national goals and strategic objectives for the development of the Russian Federation for the period up to 2024.” Within the framework of this program, six federal projects operate: “Regulatory Regulation of the Digital Environment,” “Information Infrastructure,” “Personnel for the Digital Economy,” “Information Security,” “Digital Technologies,” “Digital Public Administration.” Information on the national program, its management structure, activities for each of its federal projects, news and analytical materials on relevant topics is published on the official website of the program [5].

Eagleman draws attention to the fact that back in 1909, biologist Jacob von Uexküll proposed the concept of *umwelt*, which described the limited perception of the world by living organisms (including humans) [6]. Moreover, a person in the same ecosystem reacts to different external signals. Unlike a machine, a person can only



perceive the nearest area of the surrounding world (umwelt), which is inexcusable in the era of the digital economy.

Interestingly, each organism apparently believes that its umwelt encloses the entire objective external environment in its entirety. Subjective awareness of our knowledge does not allow us to evaluate the amount of information in which a person exists. In the modern world, new channels of information are opening up, to which most consumers simply do not have access due to subjective limitations. Von Uexküll's idea of limited knowledge, inaccessible information helps us understand the horizon of the unimaginable capabilities of artificial intelligence in the digital economy [6].

Cybernetic mechanisms, using feedback, target retention functions, etc., certainly provide new opportunities in forecasting, planning and economic management. Robots are undoubtedly more efficient than human beings in the traditimatized professions. At the same time, the development of modern technologies in different countries differs significantly. The level of robotization of the production process in Russia leaves much to be desired, but the development of consumer technologies, the availability of the digital environment, the implemented technologies in the fiscal sphere, public services, etc. allow us to be proud of our achievements. Russian business requires a deep modernization of production, its automation and robotization based on advanced digital technologies. The extent to which artificial intelligence enters our lives, production, everyday life, etc., so we can talk about digitalization.

The unconditional impact of digitalization on competition in all areas requires an increase in the speed of implementation of modern technologies, a qualitative change in the structure of relations in the market. The number of successful countries in the implementation of industrial robots and electronic technologies is extremely small. Most likely, the technological gap in the economies of Japan, the EU and the United States, on the one hand, and the countries of Africa and Latin America, on the other, will only increase. The pass dependency problem, both in the social sphere and in industrial production, will increase the development gap, but also create new ways of labor migration. The described processes require both the global community and the "young tigers of digitalization" to be ready for digital transformation. We need objective prerequisites for the formation of completely different ways of organizing production, regulating markets, and interacting with consumers. In the economy of countries, consumer psychology, there should be such requests for new technologies that will increase the time of their implementation, qualitative transformation and integration into global technological processes, primarily in the field of B2C [7].

## 4 Discussion

Digitalization requires a huge number of sensors that will capture information in real time, provide its instant processing, intelligent feedback and consumer communication. In modern conditions, new technologies of the digital economy allow us to introduce modern elements in traditional economic relations, they set the appropriate vector of development. Currently, it is quite difficult to identify any breakthrough

things in production. The robotization of production began in 1970, intelligent control appeared almost together with cybernetics, and lean production also dates back half a century. The new business models concern only the relations of product sales to consumers. Customer centric demanded a different structure of supply, consumer demand generation, and just-in-time delivery. The speed of big data processing has increased, intelligent programs and hard tools allow you to collect, process and store information on every inhabitant of the Earth. Bringing consumer analysis to the here and now mode allows you to switch production to a flexible line of small-scale production, reducing costs, inventory and personnel. Artificial intelligence mode 7/24 based on the study of digital portraits of consumers and patterns of their economic behavior generates a system of values and demand. The market value of a business or company engaged in e-commerce, advertising and marketing services, etc., has become determined by the volume of customer data. Open data models not only stimulate the generation of innovative business models, but also ensure the development of specified competitive areas [8].

Reducing the time of the production cycle and the production stage are becoming the main requirement of competitiveness. Time-to-market provides work on the formation of new business models of relations with the consumer. But all this applies to the consumer economy. For the production sector, software tools, artificial intelligence, etc., of course, reduce the time for creating and implementing a new product, its refinement and supply on the market. Tesla launches new options and fixes claims in real-time, remotely via software updates; Facebook tests and launches updates for individual user groups twice a day, etc. [9].

Crazy streams of information give rise to big data problems (there is a problem how to work with them: what is it, a pile of garbage or operational material in which there is a pearl that needs to be found and processed, how to do it, who can and will do it), there is a problem of cognitive technologies and how. The bottleneck is making decisions in the economy, because even with computing tools, we do not solve the tasks, since the computer will only compress information to a set of "order parameters".

The demand for digital technologies is generally positive. The level of digital development of households is already quite consistent with modern trends. According to Miller's law, if these orders are more than seven, then we can no longer work online with them [10]. The super computer is also limited in the number of parameters being processed. These bottlenecks are able to expand artificial intelligence.

The first problem is the problem of the prospect of the dominance of artificial intelligence, or technological singularity. This issue arose back in 1965. A computer with strong artificial intelligence can ultimately enter the "rampant reaction" of self-improvement cycles, while each new generation of artificial intelligence will appear more quickly, generating a kind of "intellectual explosion" and ultimately creating a superintellect that surpasses the intelligence of all mankind [11].

Kurzweil, in his opinion, by 2030 a large artificial intelligence will be created, large, because it can pass Turing tests, i.e. a person will not be able to determine with whom he communicates, with a person or with a robot [12].

The neural network is not transparent, the machine will not answer the question of how you did it. The question of why you decided so forbidden. If such a question can go unanswered to a person, because a person made an intuitive decision, “it seems to me, etc. Then the machine is algorithmatized. However, existing practices show that the machine does not want to give an explanation. There is already a closure for a person of the zone of machine “consciousness” and intelligence. Controlling the machine becomes impossible.

The composite index of population satisfaction with the work of financial organizations, financial products (services) and financial service delivery channels increased from 41.4 to 51.1 for the period from May 2017 to May 2018. In particular, criteria such as ease of access to the service and its speed, acceptable cost, and a good level of protection were used to calculate it.

Once an employee of the Institute of Applied Mathematics said that when two machines were tasked with merging two pharmaceutical enterprises, where there are a huge number of tasks. During the interaction of machines, programmers tried to enter into a dialogue with the machines and requested data. The cars replied: “Everything is fine,” and did not provide data. For quite some time now, the machine refers to a person “down,” separating him, maybe even isolating him. The machines were attributed to the specified programmers as small children: “Do not climb, you still do not understand anything.” The process was completed with a positive result, for the benefit of the customer. But the definition of this good by the machine at some stage may not coincide with its understanding by the customer himself.

There is a question of ethics, machine ethics, when a machine will treat its creator as an incapacitated parent who is loved, but not allowed to do anything on its own. By the right of primogeniture (the direct creation of a machine by a person, its training by a person, the long process of studying and growing up a machine in contact with a person), a person is identified by Ai as the creator. But the problem will be aggravated as the creation, production and training of machines will be carried out by the AI itself, then it is completely unknown how the machine identifies the person, how it will deal with us. The development of robotics laws (for example, do not harm humans, etc.) can be ineffective, since the modern practice of working machines shows that many artificial intelligence solutions for us remain terra incognita both in their process and as a result.

One of the options for human communication and artificial intelligence may be partnership, love - of course, machine love, parent-child relations (is it possible to establish moral, ethical, religious principles and standards for the machine?). Eros, amura, filia, agape, storge, mania, ludus, filautia, pragma. Moreover, pragma is love based on mutual understanding and long-term interests, which can be represented in the figure. There is a fear that a person for a machine could become an outdated web version, a biological version of their new intellectual nature. Cars can bring a person into the “red book” that a person would be hearty, warm and relatively comfortable. As an option, create reserves or reservations. The development of cyber-biological organisms also contains a threat of submission to artificial intelligence. This is essential for the economy, since by operating a big data machine can determine the goals of economic development not for the benefit of a person, but even at his

expense. The Internet of Things is a clear system of data leakage both in favor of the owner of the network and the resource, and in favor of AI. If earlier the machine strengthened our capabilities, now it replaces a person.

The machine creates an imaginary reality that a person begins to perceive as the first nature in which he lives, works. In which he makes strong-willed and creative (if the machine allows him) efforts, gets emotional pleasure, sensual... This environment is also more preferable for humans. Augmented reality is becoming reality itself.

For example, before the advent of blockchain technology, there was no suitable technology that could identify the holder of an electronic profile in the electronic environment itself. Traditional technologies, such as digital object identifiers and digital rights management, can ensure that electronic records are unique, but these records cannot be transmitted as unique tokens. Traditional technological methods could ensure the secure transfer of electronic records as tokens, but could not ensure the uniqueness of the record itself.

There are new spheres and environments in which a person cannot live, exist and work: devices with high overloads, aggressive environments, etc. This problem is solved by the use of robots (autopilots on aircraft or deep-sea vehicles, for example), artificial intelligence drones, automation and robotic production, etc. The economy is increasingly becoming completely new.

The problem of unemployment, already generated by artificial intelligence, will now create new migration flows, for example: Europeans to countries with low digitalization of the economy: Africa, Latin America, the Middle East and the Middle East, etc. Countries such as Russia, which has enormous expanses, reserves and prospects, with still traditional values and layouts, stand alone. The greatest threat to artificial intelligence is for officials and bureaucrats. Most management functions will take over artificial intelligence. The plebiscite of guaranteed monthly income has failed, people in all countries refuse it. One of the most important values is work, where a person not only earns his food, but also realizes his creative potentials, realizes himself, etc. These values are seized by artificial intelligence. Human integrity is violated. Basic values without work are being destroyed, new values have not yet been proposed.

## 5 Conclusion

The economic processes of digitalization described in this article require an adequate approach to the legal regulation of new technologies, legal status, and new types of relations. The normative regulation of the traditional economy has been developed for thousands of years, but modern technological processes cannot provide such time for understanding the problem and offering a model of legal regulation.

Currently, different countries are developing regulations that form the basis and procedure for interaction of lex cryptography with the existing legal system. This

process requires a legal understanding of the phenomenon of blockchain as a technology and as an internal order for the implementation of the” activities “ of cybernetic systems [13]. The traditional legal system assumes the volitional action of persons, bodies, and public entities. The distributed registry requires a different approach, when it is impossible to determine the cent of decision-making, when the decision is made by a mathematical algorithm without human participation, etc. It requires a certain amount of trust in the blockchain and other digital technologies, the work of artificial intelligence. Public support and public trust are needed; closing gaps and ensuring interaction between the public and private sectors, as well as the physical and non-physical world.

Against this background, I would like to express some considerations that relate to the system of law and legislation. In our opinion, it is necessary to try to avoid the formation of the so-called digital law and legislation, the next pseudo-industry of law. Each group of modern, albeit “digital,” relations can and should be regulated by established branches of law - then the principles of each industry will be respected and competition with high-quality regulatory regulation will be minimized.

## References

1. Deloitte: What is digital economy? <https://www2.deloitte.com/mt/en/pages/technology/articles/mt-what-is-digital-economy.html>. Accessed: 17 Mar 2021 (2019)
2. Fayyaz, S.: A review on measuring digital trade and e-commerce as new economic statistics products. [http://www.oecd.org/iaos2018/programme/IAOS-OECD2018\\_Fayyaz.pdf](http://www.oecd.org/iaos2018/programme/IAOS-OECD2018_Fayyaz.pdf). Accessed: 17 Mar 2021 (2018)
3. OECD: OECD digital economy outlook 2015. <https://doi.org/10.1787/9789264232440-en>. Accessed: 17 Mar 2021 (2015)
4. Decree of the President of the Russian Federation of May 9, 2017 No. 203 “On the Strategy for the Development of the Information Society in the Russian Federation for 2017–2030. <http://www.kremlin.ru/acts/bank/41919/>. Accessed: 17 Mar 2021 (2017)
5. Decree of the President of the Russian Federation of May 7, 2018 No. 204 On national goals and strategic objectives for the development of the Russian Federation for the period up to 2024. <http://www.kremlin.ru/acts/bank/43027/> <http://www.kremlin.ru/acts/bank/41919/>. Accessed: 17 Mar 2021 (2018)
6. Brentari, C.: Jakob von Uexküll. The discovery of the umwelt between biosemiotics and theoretical biology. Springer, Dordrecht (2015)
7. Dai, Q., Shin, E., Smith, C.: OECD science, technology and industry working papers. <https://doi.org/10.1787/2dbff737-en>. Accessed: 15 Mar 2021 (2018)
8. Rusbase: What is open banking? <https://rb.ru/longread/chto-takoe-open-banking/>. Accessed: 17 Mar 2021 (2017)
9. McKinsey: A future that works: Automation, employment and productivity. <https://www.mckinsey.com/~media/mckinsey/featured%20insights/Digital%20Disruption/Harnessing%20Automation%20for%20a%20future%20that%20works/MGI-A-future-that-works-Executive-summary.ashx>. Accessed: 17 Mar 2021 (2017)
10. Khan Academy: Miller’s law, chunking, and the capacity of working memory. <https://www.khanacademy.org/test-prep/mcat/social-sciences-practice/social-science-practice-tut/e/millers-law--chunking--and-the-capacity-of-working-memory>. Accessed: 17 Mar 2021 (2021)
11. Gunning, D., Aha, D.W.: DARPA’s explainable artificial intelligence (XAI) program. *AI Mag.* **40**(2), 44–58 (2017)

12. Kurzweil, R.: The Age of Intelligent Machines. MIT Press, Cambridge (1990)
13. Saint Peterburg State University: Professor of St. Petersburg State University Tatyana Chernihiv: “We must give strong graduates the opportunity to continue their education in Russia». <https://spbu.ru/news-events/krupnym-planom/professor-spbgu-tatyana-chernigovskaya-my-dolzny-dat-silnym-vypuschnikam>. Accessed: 17 Mar 2021 (2021)

# Digital Transformation of Business Processes in a Customer-Oriented Approach



O. N. Denisova, O. V. Musina, and Y. A. Tatarovsky

**Abstract** In 2020, the development of digital technologies and their penetration into the daily life of the population made a great progress. This was facilitated not only by the restrictive measures imposed due to the COVID-19 pandemic, but also by the obvious advantages that digital technologies have: speed, ease of use, and mobility. The high level of competition actualizes the need of constant improvement of not only the product quality, but also the sales process itself. In the presented research, the approaches to digital transformation of the sales process, which is key for the activity of any enterprise, are considered. The survey conducted as part of the study identified potential areas of digital transformation, as well as what cannot be fully automated.

**Keywords** Big data · Business analysis · Digital transformation · Sales funnel · Sustainable development

## 1 Introduction

An objective assessment of the impact of the COVID-19 pandemic on various countries and economies will be possible only over a long period, while summing up operational results is only an attempt to form a point of view on what is happening. Nevertheless, at the beginning of 2021, there was a gradual trend of recovery from the crisis in Russia: a campaign of the population vaccination was launched, restrictions on movement were gradually lifted, that is, conditions for a return to the pre-pandemic realities of doing business were created.

---

O. N. Denisova  
Samara State Technical University, Samara, Russia

O. V. Musina  
Samara University, Samara, Russia  
e-mail: [musina\\_olga@inbox.ru](mailto:musina_olga@inbox.ru)

Y. A. Tatarovsky (✉)  
Samara State University of Economics, Samara, Russia

However, it is worth noting that a complete return to the past principles of business management is impossible, since during the pandemic and related restrictive measures, fundamentally new mass solutions and approaches were not developed, but those evolutionary processes that were formed before 2020 were accelerated.

One of these processes, of course, is the digitalization of the company's activities, the digital transformation of various business processes. It is obvious that for the majority of the enterprise, the introduction of restrictive measures related to the pandemic required the reform of the key business process—the sales process and its components, especially marketing and communication with the client, that is, the functions that allow the enterprise to form management decisions for the formation of conditions for sustainable development [1].

## 2 Methodology

The main aim of the research was to make a comprehensive evaluation of the current state of Russian enterprises business processes digital transformation, as well as to study their contribution to the formation of conditions for sustainable development, as a necessary element of economic development and its recovery from the crisis. Achieving this goal involves solving a number of tasks: to reveal the role of the enterprise sustainable development in the recovery of the economy from the crisis caused by the COVID-19 pandemic; to describe approaches to digital transformation of business processes; to identify the specifics of digitalization carried out within the framework of a customer-oriented approach; to offer analytical tools that allows to make effective management decisions in the context of digital transformation within the framework of a customer-oriented approach.

The methodology of the study involves an abstract consideration of the changes taking place in the Russian economy in order to identify patterns and form assumptions about the further development of processes. It should be noted that according to modern practice the classical methods of identifying patterns and forecasting are the methods of statistical analysis and economic and mathematical modeling, but their use in the framework of the solution under consideration, we consider unjustified and impractical, since the necessary amount of data suitable for calculations was not formed in such a short time period. In this regard, possible methodological approaches are qualitative analysis, the formation of logical relationships, abstraction, the method of analogies.

The sustainable development of the economy is a global task, which is addressed not only by prominent economic scientists and local scientific schools, but by entire international organizations, since the interest in the result is not in a single state or national economy, but in the entire international community. Sustainable development of the economy is possible only if its elements (economic entities, enterprises) develop steadily [2]. According to the generally accepted understanding of the term sustainable development is the development of an enterprise in the field of:



- economy, which implies an improvement in the financial condition, financial results of the business, and other economic indicators;
- the social sphere, which consists in the implementation of social programs for both employees of the enterprise and for external stakeholders; the development of the creative and professional potential of employees, improving the quality of life of employees of the enterprise;
- ecology, that is, not just compensation of the negative impact on the environment done by the enterprise and that is prescribed in the legislation of most countries, including Russia, but also to have an additional positive impact on the environment, not having a compensatory nature, but, on the contrary, significantly exceeding the damage.

Sustainable business development can be achieved not when only one condition is met at a faster pace, but only when they are met collectively and harmoniously. Only this can guarantee a synergistic effect, which is expressed in a multiple increase in the intensity and efficiency of the enterprise resources use.

Thus, the sustainable development of enterprises can serve as a fundamental basis for the recovery of the economy from the crisis, as it will ensure balanced and interrelated processes:

1. Economic—increasing the profitability of the business, improving the quality of the financial condition not only reduces the risk of termination of the business (in particular, bankruptcy), but also increases its market capitalization and investment attractiveness, which is necessary for the development of not only the enterprise, but also related counterparty companies.
2. Social—within the framework of this component, not only jobs are created and timely and worthy salary of staff is guaranteed, which already reduces the problem of unemployment and a decrease in the actual disposable income of the population, which is extremely important for modern Russian realities. Investment in human capital creates the prerequisites for the formation of innovative solutions and developments, which is the result of the human potential (intellectual and creative) of the staff.
3. Environmental concern is the only guarantee of the long-term functioning of not so much the enterprise as the economy as a whole, reflecting its ability to reproduce.

Thus, sustainable development creates the prerequisites for a stable and long-term functioning of the enterprise, which is considered not only as a tool for improving the well-being of owners, but also as the basis for a high level of life quality, which consists not only in the possibility of afford a wide variety of goods and services, but also in safe environmental conditions. Customer focus is one of the marketing concepts, where the main element is not considered a product or service, but a customer. The customer-oriented approach allows to build a long-term strategic interaction between the seller and the buyer. Thus, innovative development within the framework of customer orientation does not consist in improving the offered product or service, but in identifying the customer's needs and meeting them.

Identifying customer requirements, as the basis of a customer-oriented approach, is a business analysis task and requires a fairly large amount of information, which, as a rule, is heterogeneous and cannot be accounted. This fact significantly complicates the process of identifying and analyzing requirements, but their fixation has become possible due to digitalization, so business processes related to the client component can include: customer search and primary communication; formation of the client's order; payment, loan processing; delivery and receipt of the order; feedback and handling objections; maintaining communication and making repeated requests.

The main trend in the global development of e-commerce in 2020 was the growing popularity of large Internet aggregators (marketplaces), which provide a number of key stages of the sales process (mainly advertising, payment, delivery), while leaving the possibility of communication between the buyer and seller for a better understanding of the client requirements and product improvement. Digital transformation of business involves the active introduction of digital technologies in their activities. Today, there are two main directions of digital transformation of business processes [3]:

- solid, i.e. transfer of functions from the employee to the equipment. This direction has already proved itself positively, having both successfully implemented projects, for example, vending machines and ATMs, and prospects for development: the use of robot couriers, the creation of unmanned vehicles, and so on;
- soft, implying the use of algorithms and software products to transfer them part of the functional responsibilities of the employee. The key difference between a soft digital transformation and a hard one is that the first one does not mean giving up the workplace, but, on the contrary, taking over part of the routine processes, increases its productivity, thereby increasing its contribution to business development.

Thus, the modern digital transformation of individual business processes of an enterprise, or business as a whole, massively follows the path of soft digital transformation, which can be explained by the following:

- a large offer of various software products that automate the business processes of the enterprise;
- relatively low price of software products, or the ability to save money by purchasing not the entire package of features, but only those parts that are necessary for specific users;
- user-friendly interface that does not require special knowledge and skills;
- low hardware requirements, adapted to work on widely used gadgets: personal computers, laptops, tablets, smartphones, etc.

Also in favor of a soft scenario of digital transformation of business processes, a short payback period (up to 2 years), at the same time, there is a position of a number of users who have not received direct savings from the automation of business processes, but the quality and speed of work, transparency of processes, the

possibility of fixing big data and working with them even for small enterprises has increased.

### 3 Results

The soft digital transformation of business in Russia accelerating driver is not only economic feasibility and potential benefits for the entrepreneur. A significant contribution is also made by the state, represented by the federal tax system, which in recent years has implemented a large and comprehensive project to introduce online cash registers in the activities of all forms of ownership and scale enterprises. Automatic recording of transactions made it much easier to get not only information about the average check of the enterprise, but also big data about the behavior of the client (Table 1).

Thus, the case of online sales registers is an example of how the inevitable legislative initiatives can benefit the business within the framework of a customer-oriented approach. Customer orientation as a marketing concept involves focusing primarily on the needs of the client. Identifying customer needs is the task of business analysis, within which a large number of BI solutions (Business Intelligence) are implemented. Digital transformation of the sales process allows to collect and organize big data focused on the customer, which allows to improve the quality of service and customer

**Table 1** Information about the customer’s behavior received as part of the operation of online sales registers

| Data type                | Possible scope of application   |
|--------------------------|---|
| Transaction time         | Information about the time of maximum consumer activity allows to create a “thermal” schedule and develop measures to improve the quality of service during high-load hours (for example, add extra sellers for a period, additional working terminal, etc.), or to ensure the uniformity of visitor traffic (for example, a discount on products in a certain time interval) |
| Transaction amount       | The average purchase price is an important and most common indicator, but for making a number of decisions (the policy of discount cards, providing discounts for the size of the purchase), the indicators of the minimum and maximum purchase, the coefficient of variation, the median purchase price, etc. are also important   |
| Preferred payment method | The law provides the possibility of cash and non-cash payment. For the seller, these differences are important for understanding the volume and cost of cash collection, the speed of crediting funds to the current account  |
| Number of transactions   | Allows to create a heat map to determine the day (week, month) of the peak consumer traffic for improving the quality of service, develop marketing activities  |

Source Authors

satisfaction, moreover, making them loyal to the company as regular customers who actively make repeated transactions (purchases).

The sales funnel is a BI tool that makes possible to manage the sales process both at the operational and strategic level. It is a popular and reliable analytical tool that is accessible to most users and has the flexibility to adapt to the specifics of the business. Another important aspect of BI solutions is big data analysis. This process is considered more complex, requires special skills from the user, as well as special software products. Nevertheless, structured analysis of big data allows to identify patterns and trends in customer behavior, which will significantly improve the quality of products, the level of service, and the brand value for the customer.

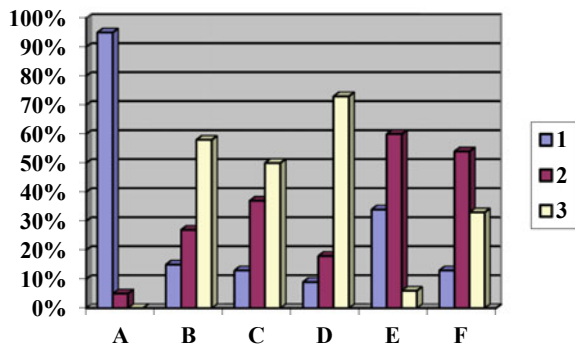
An important characteristic of modern business conditions is high competition for the buyer and a wide range of products and services offered that have identical qualities. Price competition as the main development strategy, as a rule, is not the most attractive situation for investors and desirable from the point of view of economic security. Therefore, most companies have to shift the focus of their activities from their product or service to the customer, which is the basis of a customer-oriented approach. The digital economy has made a significant contribution to the development of this process. So, the approach implemented in targeted advertising is very clear: the initiative of interaction comes not from the buyer, but from the seller, which requires completely different tactics of behavior.

Despite the described advantages of digital transformation, many enterprises, especially representatives of small business entities, are careful in the ability of digital technologies into their activities integration [4]. Within the framework of the presented research, the authors conducted a survey of 50 representatives of small businesses in the Samara region (Russian Federation), who belong to various types of economic activity and have been operating for at least 3 years.

One of the issues that is important for the study is the rating of business processes, depending on the period of their automation (Fig. 1). The explanation of the symbols is given in Table 2.

According to the survey, the accounting and reporting procedure is almost completely automated for all respondents, which is explained by the clear regulation and standardization of the accounting and reporting process, the presence of

**Fig. 1** Rating of business processes subject to digital transformation. *Source* Authors



**Table 2** Explanation of the symbols used

| Symbol                  | Transcript   |
|-------------------------|--|
| <b>Period</b>           |  |
| 1                       | The business process is already automated  |
| 2                       | Automation of business processes is planned in the short term (from 1 till 3 years)                  |
| 3                       | Automation of the business process is planned in the long term (from 3 years), or not planned at all |
| <b>Business process</b> |  |
| A                       | Accounting and statements  |
| B                       | Ensuring economic security, protection against fraud (anti-fraud)                                    |
| C                       | Enterprise finance management  |
| D                       | Customer communications and technical support  |
| E                       | Sales, sales analytics   |
| F                       | Procurement and logistics  |

*Source* Authors

a large number of software products and experience in the digital transformation of these processes. Moreover, the automation of this process for small businesses on the simplified taxation system began to be implemented by banks, as a service that complements the settlement and cash services.

Communication and technical support are less automated because the process of working with clients has the highest priority for the business, is difficult to standardize, and has very high risks for the company in the event of an error. Therefore, the automation of this process can only be carried out in the direction of improving the user-friendliness of the contact and the efficiency of the organization's response (for example: online chat, social networks, feedback form).

The low degree of digital transformation at the present moment and the low potential for its increase in the future are demonstrated by the processes of ensuring economic security, fraud protection and financial management of the enterprise [5]. From one side, this is possible due to the lack of technical solutions available to small businesses (for example, software products in the field of internal control are developed individually by many banks and large enterprises), the individuality of business processes and the lack of standardization. Thus, one of the only approaches to automating the process of ensuring economic security that is available to most small enterprises is the process of checking counterparties according to formal criteria. On the other hand, these processes in small enterprises are traditionally the responsibility of the owner, who prefers a conservative approach to manual management.

## 4 Discussion

The study conducted by Deloitte is quite representative [6]. According to the results of the study, digital transformation of business processes is a strategic issue for the majority of Russian enterprises (more than 63%), and a high interest in the process of digitalization is shown by half of the company's managers and the vast majority of employees. The results of digital transformation, according to a study by Deloitte, from the perspective of respondent's expectations are:

- increase the speed of task completion by employees, including by automating monotonous, routine processes;
- reduce the cost of performing processes, including by reducing the complexity of functions and optimizing personnel;
- reducing the number of errors, improving the quality of completed tasks by eliminating the human factor.

A number of economists, who consider the issues of digital transformation of the sales process of small enterprises, note the high role of electronic trading platforms in ensuring interaction with the client [7]. So, according to them, the digital transformation of the sales process of a small enterprise is advisable only through cooperation with large electronic trading platforms Alibaba, Amazon, Ebay, Wildberries and Ozon (in Russia) and not the promotion of its own online store.

According to Nasiri, Ukko, Saunila, Rantala, digital transformation of a single business process is impossible and not advisable in the long term [8]. Thus, digitalization should be a process aimed to form a digital business model as a whole, and not just a part of it. This approach has a number of supporters [5], who convincingly prove the need to reorganize the enterprise for its further digital transformation. From the author's point of view, digital business process management requires more flexibility, knowledge and competencies from the management than in the traditional format, so the introduction of new technologies without prior training cannot be effective.

The experience and the most common mistakes of digital transformation of business processes are considered in the works of many foreign authors, in whose countries the digital transformation of enterprises has been going on for quite a long time. The key risk is the lack of the necessary amount of financing for the process of digitalization of the enterprise, as well as the inability to compile an accurate budget for expenses due to the need to take into account the specific features of the activities of any enterprise [9]. In Due to the active digitalization of the business, one of the key issues is the supply process. Without its proper digital transformation, which requires significant investment, it is impossible to create a reliable, customer-oriented business model [10, 11].

## 5 Conclusion

Thus, both Russian and international practice states the need for digital transformation not so much of specific business processes, but of the enterprise as a whole. Today, there are universal technological solutions that allow to digitalize the activities of enterprises (example: CRM-systems). At the same time, it is important to note the fact that digitalization covers not only the internal business environment, but also provides customers with access to it with limited user's rights. This approach has already been implemented by large companies, as part of the formation of technological ecosystems that cover the internal and external environment of the enterprise. Many business owners and managers see digitalization not as a process of innovation, but as an inevitable element of compliance with the requirements of modernity. The sales process is key for many enterprises, so the approaches to its digital transformation are very original and heterogeneous, and require large financial and time costs for development and implementation. The development of digital transformation within the framework of a customer-oriented approach is realized on the one hand by standardization and increasing the convenience of customer service, on the other hand, by personal communication and creating a company image with an individual approach to customer service. Thus, digital transformation creates opportunities for sustainable business development.

## References

1. Lanzolla, G., Anderson, J.: Digital transformation. *Bus. Strateg. Rev.* **19**, 72–76 (2008)
2. Martín-Peña, M.L., Díaz-Garrido, E., Sánchez-López, J.M.: The digitalization and servitization of manufacturing: a review on digital business model. *Strateg. Chang.* **27**, 91–99 (2018)
3. Park, H., Kim, S., Jeong, Y., Minshall, T.: Customer entrepreneurship on digital platforms: challenges and solutions for platform business models. *Creat. Innov. Manage.* **30**, 96–115 (2021)
4. Saunila, M., Nasiri, M., Ukko, J., Rantala, T.: Determinants of the digital orientation of small businesses. In: S.H. Park, M.A. Gonzalez-Perez, D.E. Floriani (eds.), *The Palgrave Handbook of Corporate Sustainability in the Digital Era*, pp. 75–90. Palgrave Macmillan, Cham (2021)
5. Balakrishnan, R., Das, S.: How do firms reorganize to implement digital transformation? *Strateg. Chang.* **29**(5), 531–541 (2020)
6. Deloitte: Trends in the development of robotics in the Russian Federation. <https://www2.deloitte.com/ru/ru/pages/tax/articles/rpa-survey.html>. Accessed: 20 Mar 2021 (2020)
7. Li, L., Su, F., Zhang, W., Mao, J.Y.: Digital transformation by SME entrepreneurs: a capability perspective. *Info Syst. J.* **28**, 1129–1157 (2018)
8. Nasiri, M., Ukko, J., Saunila, M., Rantala, M.: Managing the digital supply chain: The role of smart technologies. *Technovation* **96–97**, 102121 (2020)
9. Loonam, J., Eaves, S., Kumar, V., Parry, G.: Towards digital transformation: lessons learned from traditional organization. *Strateg. Chang.* **27**, 101–109 (2018)
10. Patel, P.C., Azadegan, A., Ellram, L.M.: The effects of strategic and structural supply chain orientation on operational and customer focused performance. *Decis. Sci.* **44**, 713–753 (2013)
11. Zulqurnain, A., Bi, G., Aqsa, M., Usman, G.: Predicting firm performance through supply chain finance: a moderated and mediated model link. *Int. J. Log Res. Appl.* **23**(2), 121–138 (2019)

# Innovative Management in Digitalization: Approaches and Trends of the Spatial Market



A. N. Evdokimov, A. A. Nikolaev, and Y. I. Lobacheva

**Abstract** The article discusses the issue of changing approaches in innovative management in the era of digitalization of all spheres of society. The characteristic of the innovation manager is given. The factors necessary for the productive work of the manager in the company are described. The key task of the innovative manager, which consists in the formation of the company's movement vector, the task of key areas of activity with the top team, as well as in competent digital transformation. The scope of application of immersive technologies VR/AR is described, an example of using its "IKEA" company is given. Example is given for remote hiring staff using VR-technologies by "Actiview". The current trend on the creation of ecosystems, which rely on the program embodiment, is the consequence of digitalization. It was proved that innovative products are created with the participation of innovators who know how to recognize the trend in time, to understand how to introduce it to the workflow and release an innovative product to the market. A model of an innovative manager was developed, which is an "Agile" by an innovator aimed at studying trends and inventions by integral thinking and approach.

**Keywords** Artificial intelligence · Digitalization · Innovation · Innovative management · Immersive technologies

## 1 Introduction

The role of innovative management enhances and becomes increasingly important for companies and countries every year. Over the past decades, he becomes a key factor in the country's scientific and technical and economic development of the country. Innovations occupy the dominant level in all areas of activity, increasing labor productivity, the effectiveness of investments, optimizing work processes, improving the

---

A. N. Evdokimov (✉) · A. A. Nikolaev · Y. I. Lobacheva  
Samara State University of Economics, Samara, Russia

Y. I. Lobacheva  
e-mail: [guseva\\_julia@list.ru](mailto:guseva_julia@list.ru)



approaches to corporate social responsibility [1]. All this allows to keep the competitiveness of enterprises in the international market, develop the economic sector, strengthen the role of its country in the international arena. Innovative management is an integrated approach to the creation and development of the innovative technical potential of the company, regions and the whole country as a whole. This is the database of knowledge, skills, skills and approaches to the management and methods of technical development of the company. And digitalization closely interacts with the innovative management system, because it is based on new technologies, approaches and artificial intelligence, in which information technologies based on competent management play a leading role. New technologies require new skills from all, including top management companies. Therefore, a serious question arises: how to adapt the Captains to the digital era, using new approaches and trends in the field of innovative management?

## 2 Methodology

Today, an innovative manager is Agile, an inventor who is proactive, aims to explore trends and inventions, initiates the implementation of ideas and projects in the company, orients public opinion on the use of innovations based on competent arguments and high competence in this area [2]. The chosen tactic leads the manager to the formation of an organization that will reach the form of a coordinated, autonomous and cooperative set of directions. For the implementation of the goals, an innovative manager takes into account a number of factors:

- compliance of innovation of the company's goals and markets;
- the ability of an enterprise to introduce new solutions;
- the presence of a source of ideas with great potential;
- selection of projects with due economic justification;
- the effectiveness of manual management methods and the availability of clear control of their implementation;
- responsibility for the result obtained in a collective and individual order.

To do this, there are certain features characteristic of innovator—Manager:

- the use of unique resources (intelligent, scientific, technical, work is carried out with specific information, achievements, technologies);
- systemity (without a systematic structured approach it is impossible to effectively and rationally introduce a large complex of disciplines and solutions);
- creative orientation (the managerial has to perform non-standard tasks, be able to see the whole problem in integrity and take into account its individual items. the ability to put the right questions with the development of answers to them give a faithful final solution to the problem);

- a wide variety of components of the process and business, it is important that the flexibility of thinking (flexibility is needed to make new decisions qualitatively, be able to question the previous experience).

The task of the innovative manager is still in the formation of the company's movement vector, the task of key areas of activity together with the top team, choosing the most promising areas from the point of view of resources and investment projects [3]. It is also important to form a successful team. But digitalization sets new challenges, so it is necessary to correctly carry out digital transformation, to update the command to request the time, replace and modernize the equipment, while avoiding resistance to these processes within the company, inspire people to work in new conditions. An equally important aspect is that all this happens in the lowest time.

Today business moves on a very uncertainty way: it is unclear that it will benefit and what is not. Therefore, the innovative manager must constantly experiment, making many different variations of the same thing to understand which mechanisms work, and which are not. In the new realities there is no time to develop long-playing strategies [4]. The speed in the introduction of ideas and the initiative today is extremely important. The saying "is not mistaken by the one who does not do anything" suddenly became more relevant. People who know how to make mistakes and try again with the error, today are highly in demand.

### 3 Results

Today, immersive VR/AR technologies lead to a complete transformation of the usual communication formats in all areas of activity—from jointly remote work and training to a virtual visit to sports competitions and entertainment events. "IKEA" company promptly picked up the trend and offered its customers with the help of special glasses to be at the virtual kitchen. Taking advantage of the joystick, the client can read the recipe book, make meatballs, send products for processing [5]. Management seizes trends on the fly and promptly implements the company. So, today there is a broad attention to inclusive society. The company will improve the welfare of millions of people by 2030, focusing on people and a truly inclusive brand and employer. This speaks of the foresight of innovative management and its integrity in the field of all trend trends occurring in the world.

The Israeli company "Actview" has developed a platform for remote hiring staff using VR-technologies [6]. This kind of simulation in virtual reality allows you to control what the user sees, hears and feels. So, the company understands user behavior and can collect the necessary data.

Bank "VTB" also entered into the digital path of adaptation of products. Innovative manager, together with the competent group, developed a VR-voting service for shareholders in a virtual reality format integrated with a consultant's robot. The company used this product as part of the annual meeting of shareholders. The service

is easily transformed because it is adapted to vote shareholders in any major organizations comparable to “VTB” [7]. The project of remote delivery of the initial automatic consultation in the quest format is also being developed. In 5 min of the VR session, the user is completely “immersed” into the world of investment, chooses the purpose of drawing up the portfolio, learns what opportunities are the Brokerage Products “VTB” [7]. After that, the manager helps the client to open a brokerage account and translate funds to it. From the point of view of business, this case allows you to optimize employee training costs and the number of necessary managers for selling brokerage products. This suggests a serious competitive advantage of the company and attracts interested customers and shareholders on its side—investors.

The acceleration of digital transformation contributes to a large-scale commissioning of 5G autonomous bond architectures, as well as the deployment of 6G settings, which have already begun in Japan and Korea [8]. High-speed Internet will be able to ensure the operation of applications augmented and alternative reality in the resolution 8 K and higher. New projects in the field of realistic holographic communication and telemedicine will be launched, virtual personal assistants will appear. For example, Huawei encounters the main supplier of technologies for 5G (the company has more than 60 contracts with other countries). The head of Huawei believes that 6G technologies can be accessible to practical use only ten years [8]. However, in 2019, Samsung Electronics in his scientific center in Seoul began research. In 2020, the Japanese government began to collect expert advice to prepare for 6G. The country is planning to launch a new connection by 2030. The actions of innovators—managers lead to the appearance of products needed by society that solve the problem of time and speed. Focusing his thinking on people and in the interests of people, companies can achieve serious results by offering an innovative product or service, increasing the attractiveness of their country in the market.

Today, the trend is obvious to the creation of ecosystems, which are now based on the program embodiment, which is the consequence of digitalization. The flexibility and proactivity of innovative management led to cross-marketing initiatives in which banks and online sites are interacting together with the product grid. For example, by the user ID of Sberbank, you can log in in the online cinema “OKKO”, order products in the “SberMark”, call a taxi or take a car in a carsharing [9]. The nearest competitors of the Sberbank ecosystem—Yandex and Mail.Ru Group are thinking over such an ecosystem, but in 2021 other major players will appear on the market. Thus, innovative products are created with the participation of innovators who know how to recognize the trend in time, understand how to introduce it to the workflow and release an innovative product to the market. Moreover, the tendency of such attachment to the Internet will allow the global economy to get about 6.7 trillion dollars.

## 4 Discussion

Suggest a reasonable initiative to introduce a new film to workflow is part of a serious way from an innovative manager. In practice, he faces a pool of problems that in essential cases inhibit the development of the company in the direction of digitalization. They are presented in Table 1.

However, digitalization will still affect major business, which will lead to the mobility of workers, unprecedented requirements for the working system and IT services maneuverability. Mobility, distributed work and the growth of cloud solutions brought many benefits in the form of scalability of business and costs. But with the expansion of the horizon began to appear new problems [10]. To solve them, the

**Table 1** Major problems inhibiting innovation in digitalization

| Factor   | Application area  |
|--|---|
| Employee resistance  | The company’s employees are not always enthusiastic perceived innovations, because they transform an existing order requires the development of new interaction paths and work in unknown conditions. In addition, often MIDL—management, feeling its responsibility before leadership, it’s just afraid of risking, because its status and work depends on it  |
| Countering the organizational structure                      | Long coordination of innovative products, endless negotiations and edits—all this constitutes a serious bureaucratic brake for rapid and efficient innovation   |
| Lack of resources for implementation                         | The lack of a competent team with the necessary skills and competences, the debugged infrastructure for implementing and sufficient finance for the launch and promotion of the project is a serious obstacle to the path   |
| Lack of a practical system of rapid evaluation of innovation | It should be further developed at the beginning of the development of projects and coordinate key metrics and performance indicators. Reporting should not take the bulk of the time, so it is necessary to automate as much as possible and simplify   |
| Long period of waiting for results and payback               | The lack of indicative results in the early stages of implementation disorientizes the company. So, the Organization believes that the invested funds will pay off and increase profits, and in fact it turns out that innovations do not work. If an effective system for launching pilot projects and tracking their indicators was implemented, the innovative command could quickly adjust or replace the selected strategy |

Source Authors

methodology of information security was developed based on the principle of “zero confidence”. The theft and loss of identification data still remain a frequent cause of unauthorized access, and the situation is only aggravated by a mass transition to remote work. Custom data became a new security perimeter. Biometric technologies are becoming more affordable both business and consumers, and safety solutions providers, industry groups and platforms work, approaching a dumping future. It’s time to prepare for inevitable changes when traditional passwords will cease to be the main way of evidence that the user is exactly the one who he gives out. All this must be considered an innovative manager in introducing innovations.

## 5 Conclusion

Innovative business and production technologies that will be entered into use 2021 will determine the future of society and the development of the economy in the nearest decade, as they will become drivers of technological progress and accelerated restructuring of business models. Innovation Management is a factor of a special corporate culture [11]. The attitude towards the consumer changes, the policy of respect and trust is introduced. Guide is interested in career growth, training and training of personnel, in competent delegation of powers and optimization of workflows. A special atmosphere is created, in which the staff themselves are motivated for continuous development, training, improvement of the distribution of knowledge gained and skills. Innovative Manager is an “Agile” an innovator, which aims to study trends and inventions by integral thinking and approach. This is a team driver that skillfully conducts digital transformation, updates the time of time, builds a new improved corporate culture vector. Thanks to this approach, innovative solutions are created that change the lives of the population. Creating large-scale ecosystems in which a cluster of necessary products is created using cross-marketing initiatives. All this client consumes in minimal time, since the convenience of a mobile application allows you to immediately switch to partner products. The widespread development of 5G autonomous communication architectures, as well as the deployment of 6G installations contribute to the acceleration of digitalization due to their large-scale commissioning. The development of new technologies in 2021 will be a logical continuation of the development of 2020. Many new behavioral models will become the norm and drivers of technological and business innovation, especially in the field of innovative management.

## References

1. Gray, A.: Innovation management and innovation management applications in business. [https://www.researchgate.net/publication/339844217\\_Innovation\\_Management\\_and\\_Innovation\\_Management\\_Applications\\_in\\_Business](https://www.researchgate.net/publication/339844217_Innovation_Management_and_Innovation_Management_Applications_in_Business). Accessed: 20 Mar 2021 (2020)

2. Rachinger, M., Rauter, R., Ropposch, C., Vorraber, W.: Digitalization and its influence on business model innovation. *J. Manuf. Technol. Manag.* **30**(3), 1143–1160 (2018)
3. Taleghani, A., Taleghani, M.: Business innovation management. URL: [https://www.researchgate.net/publication/348662012\\_Business\\_Innovation\\_Management](https://www.researchgate.net/publication/348662012_Business_Innovation_Management). Accessed: 20.03.2021. (2021).
4. Mignosa, C., Harrington, H.J.: Total Innovative Management Excellence (TIME). Productivity Press, New York (2020)
5. IKEA: Creating a better life on our planet. <https://www.seecareerwithus.com/people-and-planet>. Accessed: 20 Mar 2021 (2021)
6. Immersive Learning News: Virtual reality startup actiview raises \$10 million. <https://www.immersivelearning.news/2020/02/25/virtual-reality-startup-actiview-raises-10-million/>. Accessed: 20 Mar 2021 (2020)
7. VTB: VTB will test “animated posters” and navigation in offices using augmented reality. URL: <https://www.vtb.ru/o-banke/press-centr/novosti-i-press-relizy/2021/02/2021-02-12-vtb-protistiruet-ozhivayushchie-plakaty-i-navigatsiyu-v-ofisakh-s-pomoshchyu-dopolnennoy-/>. Accessed: 20.03.2021. (2021)
8. Satariano, A., Castle, S., Sanger, D.E.: U.K. bars Huawei for 5G as tech battle between China and the West Escalates. <https://www.nytimes.com/2020/07/14/business/huawei-uk-5g.html>. Accessed: 20 Mar 2021 (2020)
9. Sber: What is the Sber Prime? <https://sberbank-sbrf.ru/sber-prime/>. Accessed: 20 Mar 2021 (2021)
10. Glauner, P.: Innovation management for artificial intelligence. In: V. Nestle, P. Glauner, P. Plugmann (eds.), *Creating Innovation Spaces. Management for Professionals*, pp. 1–13. Springer, Cham (2021)
11. Vichugova, A.: Glitter and poverty of domestic digitalization: Analysis of the analytical report KMDA 2020. URL: <https://www.bigdataschool.ru/blog/kmda-report-digitalization.html>. Accessed: 20.03.2021. (2020).

# Artificial Intelligence in the Context of Global Digitalization of Society



J. D. Ermakova

**Abstract** The article is focused on the current realities that force governments and societies to turn to digital technologies, responding to the crisis in the short term, eliminating the socio-economic consequences in the medium term, and rethinking existing policies and their tools in the long term. The main goal is to find out last achievements of artificial intelligence, its major breakthrough in basic economic patterns, and parts of its technology and application, using methods of theoretical analysis. To overcome this difficult stage, the majority are forced to use digital services and communication channels in all spheres of life within the world community. Digital technologies have encouraged some economies and societies to avoid complete stagnation during the COVID-19 crisis, as well as allowed them to learn more about the virus, speed up the searching process for a vaccine, and track the pandemic development, but the crisis has also highlighted the dependence on digital technologies and exposed that the digital reality is divided between and within countries. We are at a turning point in digital transformation, and how successfully the population can progress and tackle these gaps will determine the shape of future economies and societies in general after COVID era.

**Keywords** Artificial intelligence · Digital economy · Distance learning · Digital technologies

## 1 Introduction

Digital transformation was accelerating even before the advent of COVID-19, as more and more governments put digital strategies at the center of their policy agendas. The growing demand for bandwidth-intensive communication services from e-commerce, teleworking, online social activities, and increased cross-border collaboration from governments and scientists should spur further progress. Today's reliance on digital solutions has also added to privacy and security concerns, creating

---

J. D. Ermakova (✉)  
Samara State University of Economics, Samara, Russia

an enabling environment for cybercriminals. On the one hand, technology can accelerate progress on all of the sustainable development. Technology can estimate even the smallest businesses in the least-developed countries, helping them reach new markets and access finance. It can make job training faster and more effective, providing workers for the jobs in the Fourth Industrial Revolution. It can allow more people to access education, pandemic or not. Blockchain can create greater transparency, security and efficiency in supply chains. Artificial Intelligence (AI) and data analytics can help us better prepare for and respond to pandemics—and better screen for, diagnose and treat disease.

## 2 Methodology

Defining the key objectives and methods of their implementation in this article, it was aimed to several steps such as: important progress, and artificial intelligence models, core devices, high-end equipment and basic softwares will have achieved landmark results, the initial establishment of artificial intelligence technology standards, service system and industrial ecological chain, cultivate a number of the world's leading artificial intelligence backbone enterprises, field of innovation and application, gather a number of high-level personnel and innovation team, and establish initially artificial intelligence ethics norms, policies and regulations of some areas. Methods of theoretical analysis encouraged to find out that the concept of a machine performing human-like tasks emerged nearly in the 1950s when it was explored the mathematical possibility of Artificial Intelligence (AI). Today, in 2020, this concept became a reality. More and more products are being developed based on AI and Machine Learning (ML) algorithms: the market grew from \$28.42 billion in 2019 to \$40.74 billion in 2020. It is a combination of usual software and machine learning opportunities. The whole secret of ML is on its self-learning, analyzing information, and outputting each time new results. In other words, it replicates human intelligence. The process of developing and testing such a product is much more complicated than any other software [1].

Compared with traditional software testing, ensuring quality for AI systems requires a diametrically different approach. It is impossible to put machine learning models into production, because they are always changing. There are no strict rules, predefined testing techniques, and a particular methodology. No one knows what to expect from an AI system. That's why there are so many concerns and 'negative and skeptical' scenarios connected with AI. For some, this may break the pattern, but artificial intelligence algorithms are being tested at the same time as they are being developed. This work accordingly is most often performed by data scientists or ML engineers. For this, three components are needed:

- training dataset—data used to train the AI model;
- development dataset—also called a validation dataset, this is used by developers to check the system's performance once it learns from the training dataset;



- testing dataset—used to evaluate the system’s performance.

And here is the most complicated yet exciting part. In the process of development, the AI algorithm continually goes through a phase of validation and training. According to the results, AI developers add or remove something from the program for the algorithm to make it work as expected. Throw training data at it and call it a day. They have to verify that the training data does a good enough job of accurately classifying or regressing data with sufficient generalization without overfitting or under fitting the data. If it gets wrong, they go back to change the hyper parameters and rebuild the model [2].

### 3 Results

Over the past year, digital technologies have rapidly entered the lives of 99.9% of the world’s population, and the frequency of their use has reached unprecedented proportions. More and more users, both newly joined and permanent, have expanded the scope of use of Internet services and resources at times, pursuing more and more new previously irrelevant tasks, thereby significantly increasing the time of their stay in the Internet space. The number of Internet and smart phone users increases constantly in the world (Fig. 1).

The number of Internet users in Russia accounted 118 million. This means that 81% of Russians use the Internet. At the same time, the audience of social networks in Russia at the beginning of 2020 was 70 million users, that is, 48% of the total population of the country [3]. The figure for the year has not changed (Fig. 2).

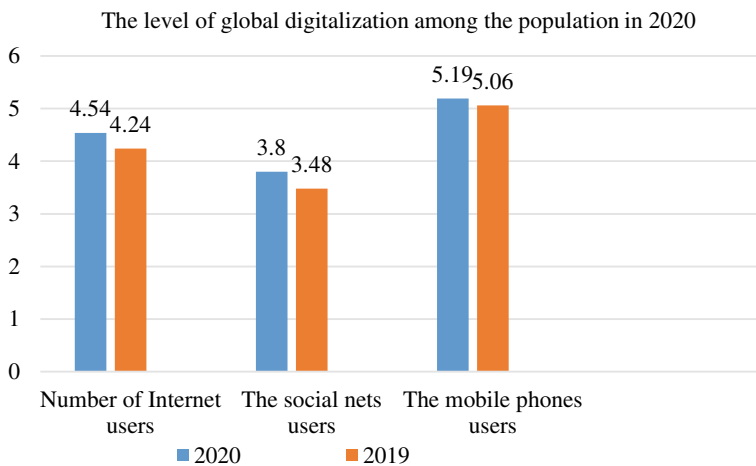
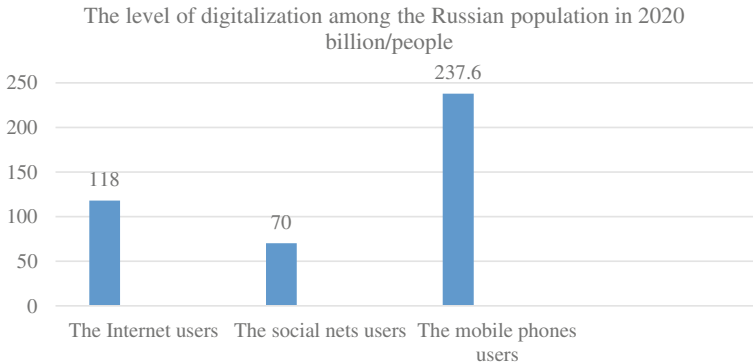


Fig. 1 The level of global digitalization among the population in 2020. Source Author



**Fig. 2** The level of digitalization among the Russian population in 2020. *Source* Author

Mobile App pointed out that web browsing takes up only 9% of our “mobile time”. If you consider the number of applications available to mobile phone owners today, this is hardly surprising to anyone. The latest data shows that we use apps in almost all areas of our lives—when we chat with friends and family, lie on the couch, manage finances, do fitness or build a romantic relationship [4].

It is worth noting that applications that help people find love occupy a serious market share. In 2019, Tinder earned more than any non-gaming app. Over the past year, singles from all over the world spent a total of \$ 2.2 billion on all dating apps. This is twice as much as two years ago. The usage per subscription has already quadrupled in the four years to June 2019, and prices for highly used mobile broadband have fallen 59% over 2013–19. There are persistent gaps between rural and urban households in terms of the availability of quality fixed broadband connections.

Before the pandemic, in 2019, only a quarter of firms in the world with more than 10 employees were engaged in e-commerce sales, while a third of firms bought cloud computing services and more than half had a social media presence. The share of people using e-government services in 2019 was 58%, compared to 43% in 2010.

The proportion of adults using the Internet ranges from more than 95% in some countries to less than 70% in others. Gaps in Internet access or use due to age or income mean uneven access to public information and services, especially critical during a pandemic. In a future where jobs, education, health, and even social interactions may depend on digital technologies, failure to provide widespread digital access risks deepening inequality and hindering countries ‘ efforts to emerge stronger from the pandemic [5].

In addition, changes in the economic, medical, and social spheres of life around the world, such a mandatory component concerning everyone without exception as education has undergone significant changes. COVID-19 has led to the closure of schools around the world. Globally, more than 1.2 billion children do not attend school classes. Contemporary crisis and economic problems are considered as certain challenges, opportunities for the business community and entrepreneurship development. The transition to a digital and circular economy is such a challenge too.

Since the circular economy is aimed at eliminating waste and creating value for resources, it opens up new prospects for companies (resource recovery, waste recycling, alternatives for products and services that have a higher ecological value) [3]. Many organizations today are trying to realize the potential of these opportunities and are developing new business models. In the fashion industry, 64 companies became signatories to the 2020. Investments in new infrastructure propelling the circular economy is essential to redesign the industrial processes, supply chain and manage the waste to recover resources. Innovations are necessary in product/process design, materials engineering at the micro- and nanoscale, and computational modeling so that humans learn to design out waste and pollution, maintain the products and materials in use for longer periods, and allow natural systems to regenerate.

## 4 Literature Review

Coronavirus has exposed the digital divide like never before. AI is another area where skills and access matter. To ensure everyone can access and benefit from AI, and avoid “disruptive impacts” on jobs, the UN says we need further investment in AI research. Another thing we need to think about: e-waste. It has grown between 2010–2019, but recycling hasn’t kept up, according to the progress report. Even in wealthy nations, e-waste collection rates are below 50%; lower-income countries don’t yet have the infrastructure to manage it. This is yet another example of how the tech revolution can exacerbate inequalities [4, 6].

The large data intelligence theory focuses on breaking the difficult issues such as unsupervised learning, comprehensive depth reasoning, and establishing data-driven, natural language understanding as the core cognitive computing model, from large data to knowledge, from knowledge to decision-making ability. Cross-media perceptual computing theory focuses on low-cost and low-power intelligent perception, complex scene active perception, natural environment auditory and verbal perception, multimedia autonomous learning and other theoretical methods to achieve superman perception and high dynamic, high-dimensional, multi-mode distributed large scene perception [7]. The theory of mixed enhancement and intelligence emphasizes the theory of context comprehension and decision learning, intuition reasoning and causal model, memory and knowledge evolution of man-machine coordination and communion, and realizes the mixed and enhanced intelligence which is close to or more than human intelligence level. The theory of group intelligence focuses on the organization, emergence and learning of group intelligence, and establishes an expressible and computable group intelligence incentive algorithm and model to form an Internet based group intelligent theory system [2]. Autonomous collaborative control and optimization decision-making theory focus on breakthroughs for autonomous unmanned systems of collaborative perception and interaction, autonomous collaborative control and optimization of decision-making, knowledge-driven human resources ternary coordination and interoperability theory and form theoretical architecture of independent intelligent unmanned system innovation.

## 5 Conclusion

New problems arise from other elements of the solution: actions and judgments. Some actions are inherently more valuable when they are performed by a human rather than a machine. In the context of AI, organizations need to make a number of additional investments previously, AI had a significant impact on productivity. Google, Baidu, and other major digital platform companies are well positioned and benefit from large investments in artificial intelligence. As for the supplies, they already have systems in place to collect the data. On the demand side, having enough customers to justify the high fixed costs of investing in the technology is in the early stages of its development. Many other companies have not yet fully digitized their workflows and are not yet able to apply artificial intelligence tools directly to existing processes. However, as costs decrease over time, these businesses will become aware of the opportunities available. This is possible due to the reduction of uncertainty. Guided by their needs, they will follow industry leaders and invest in AI. Private investment in AI startups investment in AI in general is growing rapidly, and AI is already having a significant impact on businesses. Big tech companies made three-quarters of that investment. Beyond the technological sector, the implementation of AI is in its early stages; only a few firms have deployed it. Artificial intelligence startups attracted about 12% of all global direct investment in the first quarter (half of 2018, a sharp increase from 3% in 2011). In all the countries analyzed, we increased our share of investments in startups focused on artificial intelligence. About 13% of the investments of American and Chinese startups were in AI startups in the first half of 2018. Most dramatically in Israel, the share of investment in AI startups jumped from 5 to 25% between 2011 and the first half of 2018; Autonomous vehicles (AVS) account for 50% of the investment in 2017. Efforts to develop digital government strategies in the wake of the COVID-19 crisis should focus on improving data protection and digital integration policies, as well as strengthening the political and technical capacity of government agencies [8, 9]. While public-private partnerships are essential for the introduction of innovative technologies, public leadership, strong institutions, and effective. Public policies are critical to adapting digital solutions to the needs of countries, as well as prioritizing security, justice, and the protection of people's rights. The COVID-19 pandemic highlighted the importance of technology, but also the key role of effective, inclusive and accountable government.

## References

1. OECD: Artificial intelligence in society. <https://doi.org/10.1787/eedfee77-en>. (2018) Accessed 03 Mar 2021
2. OECD: COVID-19 crisis accentuating the need to bridge digital divides. URL: <http://www.oecd.org/digital/covid-19-crisis-accentuating-the-need-to-bridge-digital-divides.htm>. (2020). Accessed 03 Mar 2021
3. ROCIT: The digital literacy index of Russians decreased by 14.7% compared to last year. URL: <https://rocit.ru/news/index-digital-literacy-2018>. (2019). Accessed 27 June 2020

4. Pogorelova, E., Yudina, O., Kolotilina, M.: Mobile app design for business and supervisory activities. In: Mantulenko, V.V. (ed.) Proceedings of the 18th International Scientific Conference “Problems of Enterprise Development: Theory and Practice”. European Proceedings of Social and Behavioural Sciences, vol. 82, pp. 581–588. European Proceedings, London (2020)
5. Breschi, S., Lassébie, J., Menon, C.: A portrait of innovative start-ups across countries. <http://dx.doi.org/10.1787/f9ff02f4-en>. (2018). Accessed 03 Mar 2021
6. Akpınar, E.: The effect of online learning on tertiary level students’ mental health during the Covid19 lockdown. *Eur. J. Soc. Behav. Sci.* **30**, 3300–3310 (2021)
7. Agrawal, A., Gans, J., Goldfarb, A.: Prediction machines: the simple economics of artificial intelligence. Harvard Business School Press, Brighton, MA (2018)
8. Akarturk, B.: The role and challenges of using digital tools for COVID-19 contact tracing. *Eur. J. Soc. Behav. Sci.* **29**, 3241–3248 (2020)
9. The World Bank: What a Waste 2.0: a global snapshot of solid waste management to 2050? URL: <https://datatopics.worldbank.org/what-a-waste/#:~:text=WHAT%20A%20WASTE%202.0&text=As%20nations%20and%20cities%20urbanize,through%20open%20dumping%20or%20burning>. (2018). Accessed 03 Mar 2021

# Financial Technology Sector in the Context of a New Digital Paradigm



K. N. Ermolaev, K. L. Dragileva, and E. S. Nedorezova

**Abstract** Specially created IT companies are usually involved in development of financial technologies that are successfully applied in the financial sector. Their combination represents the financial technology sector (FinTech). It has been substantiated that FinTech is a direction of the IT industry, which is engaged in development, security of digital transaction technologies and creation of mobile applications that facilitate transactions. It is obvious that the FinTech sector began to develop in Europe much earlier than in Russia. At the moment, the FinTech sector has significantly expanded beyond the boundaries of mobile payments and transfers. The most widely used financial technologies include P2P lending, T-commerce, E-wallets, mPOS acquiring, M-wallets, Bitcoin and others. Moreover, many clients of financial institutions are unwittingly already using most of the above technologies, and in some cases, without realizing the technical component of this financial product.

**Keywords** Digital transactions · Financial technology sector · FinTech industry

## 1 Introduction

The FinTech sector is quite volatile. Since mergers and acquisitions are constantly taking place among its participants, new financial technologies are being released, current some of them are being finalized, and so on. Fintech is volatile in comparison with other sectors of the domestic economy because the composition of its participants and financial products traded on it changes much faster. The FinTech industry has reformatted both its own infrastructure and the infrastructure of its members. Now banks are afraid not of competition with each other, but of startups offering completely new financial instruments to its potential clients [1]. Today, the main directions of the FinTech sector, which are the transformation core of the domestic

---

K. N. Ermolaev · K. L. Dragileva · E. S. Nedorezova (✉)  
Samara State University of Economics, Samara, Russia

banking sector, are as follows. Firstly, this is the Blockchain system, which was developed in 2008, but became popular only in 2014 due to the emergence of cryptocurrencies and the emission of bitcoin. In addition to the advantages of using this technology described above, it is worth noting another plus: to complete a specific transaction, there is no need to authenticate the counterparty, there is no task of analyzing the client's personal data. Transactions using the block of distributed ledgers allow you to conclude transactions without regulators and centralized intermediaries [2].

Secondly, an important trend in the economy is the active use of the Big Data technology by business entities, mainly working with large amounts of digital information. The active use of this technology began when mobile operators analyzed information received from customers, namely the geolocation of the subject, the circle of his contacts, the time and money spent on searching for information and communicating. As part of their research, companies obtained a detailed digital portrait of their customers, which allowed mobile and Internet organizations to offer personalized product offerings [3].

The third point is remote identification. The technology of remote customer identification is closely associated with Big Data, which allows fully implementing the digital banking process. Consumers of digital financial services can use remote service channels to conduct various transactions with financial products and institutions without a personal visit to the office [4].

Fourthly, it is the development of mobile banking applications, API economics. As part of the active use of mobile banking, considering the complexity of developing software code for applications, the trend towards providing open source code to third-party developers and freelance programmers has become popular [1].

## 2 Methodology

The study of the FinTech sector, including the determination of the optimal structure of financial products, involves the use of various methodological approaches and local methods. As the main methodological approaches that were used in the work, we can single out the reproductive, institutional-evolutionary and systemic ones. The use of the reproductive approach allows us to determine the essence of the FinTech sector, to show its specific features precisely as a product of digital social production. The institutional-evolutionary approach contributes to the study of the evolution of traditional ideas about the form and content of the category and indicates the role of regulatory and incentive institutions in providing digital goods and services. The systemic methodological approach is based on the study of the entire complex of economic problems as a system consisting of separate elements operating on dialectical principles. The application of this methodological approach allows us to classify practicing financial technologies, showing the distinctive features of each of their types. Methods of analysis of synthesis, deduction, induction, hypothesis, scientific abstraction were used as local research methods, which made it possible to reveal the essence and content of the scientific category under study.

### 3 Results

Now, the FinTech sector has significantly expanded beyond the boundaries of mobile payments and transfers. The most widely used financial technologies include P2P lending, T-commerce, E-wallets, mPOS acquiring, M-wallets, Bitcoin and others. Moreover, many clients of credit and financial institutions are unwittingly already using most of the above technologies, and in some cases, without realizing the technical component of this financial product [5].

We can say that currently the financial technology P2P-lending (“person-to-person” lending) is used especially often. It is a lending to an individual by a lender who is the same individual. This operation is carried out without intermediaries in the face of banks. The implementation of P2P lending takes place through Internet sites, where an individual can act both as a lender and as a borrower. It is worth noting that this lending is usually unsecured. Sometimes with the help of this financial instrument, lending and legal entities are carried out, but due to the lack of collateral for a transaction for an exclusively insignificant amount.

Of course, there are big risks in P2P lending. These risks include the impossibility of checking the credit history of the counterparty and conducting high-quality scoring, because there is no requirement for clients to provide a full package of documents before the transaction. Of course, interest rates are significantly higher for such lending than traditional one [6].

The English company Zone of Possible Agreement is the first organization to use P2P financial technology. Then the American companies Lending Club and Prosper joined it. In Russia, the projects Vdolg.ru and Webmoney are now working.

It is also worth paying attention to the fact that the massive collection of personalized customer data is carried out not only by banks, which in the terms of contracts prescribe the points of consent for the collection and processing of personal data, but also by mobile operators [7].

Thus, all the largest mobile operators have a single database at their disposal, according to personal information, of their customers. Examples include American AT&T, Britain’s Vodafone, and Germany’s T-Mobile. It should be added that due to this digital database, mobile operators can analyze the behavior of their customers and provide them with personalized financial services. Electronic wallet (E-wallet) is another actively developing and implemented financial and technological product. It is used to pay for services and order goods via the Internet.

As for WebMoney Transfer, it is the most popular electronic money transfer system and currency transactions in the CIS countries. Its distinctive feature is the exchange rates of currencies, which are significantly lower than in banks and currency exchangers. It also has its own Internet and mobile application. Now, the Yandex. Money is not inferior to WebMoney Transfer and can also provide currency exchange and transfer. Currently, a high level of use is demonstrated by digital P2P currency—a cryptocurrency, which in some cases serves as a medium of circulation and a measure of value. Cryptocurrencies inevitably enter competition with the national currency, since they are exchanged directly between counterparties and do not need financial



intermediaries. Also, they are not kept in banks on accounts, which is certainly an advantage [8].

Bitcoin is currently the most used cryptocurrency in calculations. Undoubtedly, the popularity of bitcoin is also due to the technical possibility of obtaining it. Investors find the cryptocurrency market extremely attractive, primarily because of its security. An important role is played by the fact that this currency cannot be counterfeited, since each unit of it has its own digital signature. Another feature of the cryptocurrency market is that its exchange is not under the supervision of government agencies. This circumstance, in turn, may lead to the further development of the shadow economy.

Most payments are made today using bank cards, especially in the retail sector. The tool for performing this transaction is a special POS terminal (Point of Sale terminal). Mobile POS terminals were created since it is rather problematic to supply these devices at not very large points of sale with a low customer flow. An example of using a mobile POS terminal is a terminal that courier delivery services have.

The world's leading terminal manufacturers include iZettle, Square, mPowa and SumUp. Among the Russian terminal manufacturers, the leader is LifePay, because its product has received the greatest distribution [9]. From the point of view of technological innovations, T-commerce is especially distinguished among the promising and actively developing areas of online commerce and in general e-commerce. It should be noted that this area is primarily associated with mobile devices.

## 4 Discussion

Mobile banking can be called the leading financial instrument that accompanies financial transactions and performs all kinds of operations with digital financial instruments. The mobile bank can carry out transactions that have already become classical to pay taxes, utility bills, pay orders using bank details, open individual investment accounts and provide the opportunity to conduct online trading sessions on well-known world exchanges and carry out courier orders or analyze the household budget. In general, all this undoubtedly speaks about the construction of the bank's financial ecosystem. Alfa-Click, Sberbank Online and others can be cited as examples of banks that have such functionality and provide services of various kinds. In addition, there is online banking (or Internet banking). The essence of Internet banking is that the bank is located mainly on the Internet, excluding the widespread face-to-face opening of its operational offices.

Among the Russian digital banks are Tinkoff Bank, Bank 131 and Modul Bank, which have their own license. It should be noted that all banks provide comprehensive services to their customers and support them throughout the entire process of providing banking products and services. Another example of a virtual bank is Yandex. Money, which we have already talked about above. It has a limited license and cannot be engaged in issuing loans or depositing funds into the escrow account.

Now it is wholly owned by PJSC Sberbank. Its activities include acquiring, settlement and cash services, as well as card issuance. Other representatives of the online banking model are Rocket Bank, Bank Tochka and Delobank, which are branches of traditional credit institutions and operate under licenses from parent banks. These representatives act as a technical solution in providing banking services to clients. Megafon Bank, Sfera Bank, Elba Bank and Prosto Bank are also actively working. They are kind of a corporate startup. Thus, a company may not be a credit institution, but it can use a license from a partner bank.

Analyst have systematized and cataloged currently operating financial technologies. The purpose of this systematization is to identify the key players in the FinTech sector. To analyze the current financial technologies, they were aggregated in the following industries: electronic platforms for making money transfers and payment transactions, crowdfunding platforms, lending and operations with cryptocurrencies. It should be borne in mind that in both technologies and participants are constantly being updated in the FinTech sector. Therefore, its components will change regularly, because the components of this table are not particularly stable. The systematization is based on seven subsectors associated with financial technologies:

- credit operations. This area includes organizations that implement crowdinvesting and P2P lending, as well as companies specializing in development of software products for assessing creditworthiness, and others;
- payment systems that issue invoices and conduct financial transactions;
- organizations that provide services in the field of private capital management. In addition, this includes financial institutions that provide private-banking services;
- financial intermediaries involved in foreign exchange transactions and money transfers;
- organizations that carry out various operations with cryptocurrency such as exchange, transfer to a bank account of the value component, emission and others;
- companies whose main task is to develop and supply software for online and mobile banking and thereby serve the banking sector;
- crowdfunding platforms, which are specialized sites for attracting investments in various projects [10].

It should be added that the development of FinTech infrastructure also depends on companies that are not directly involved in the development of FinTech products and have a strong influence on it.

First, these are investor companies that aggregate venture capital for the subsequent financing of organizations in the FinTech sector.

Secondly, investors are legal entities, mainly credit and financial institutions, both investing in financial technology research on their own (Alfa-Bank) and having created special units in their structure. An example of the latter is Sberbank and the SberTech formed by it, which is its subsidiary legal entity.

Thirdly, these are private investors, called business angels in the field of venture investment. They invest money and experience in new developments and startups, while entering the authorized capital of newly formed companies.

Fourthly, these are business incubators—legally registered structures, the main task of which is to help in the opening of new companies. Business incubators do this through the provision of intellectual, financial and human resources.

## 5 Conclusion

Thus, based on the results of the study, it is possible to classify the complementarity of financial technologies. Four main indicators were considered: the level of financial technology in banking, the scope of its application, the scale of use based on the coverage of customers and territory, as well as the program code used in each specific technology. We have made a conclusion about the number of times each financial technology belongs to the same group by all indications with other financial technologies. The maximum number of matches indicates the highest indicators. Based on this, we can distinguish four groups of financial technologies with similar characteristics and directions. The first group includes P2P lending, crowdfunding and micro-lending, which operate without intermediaries, companies and projects that do not depend on financial institutions and carry out transactions only between individuals (from private to private). The second group is represented by all banking analytics—analytical financial management, mobile banking and Internet banking. This includes everything related to managing your accounts, loans and analyzing bank data. The third group consists of cash equivalents, that is, electronic wallets and cryptocurrencies. Therefore, it is electronic money or digital currency that replaces traditional cash. The fourth group includes instruments that carry out transactions with funds in any form, for example, using a card or electronic wallet. This group includes payment systems and mPOS related to transactions. It is worth noting that this classification is mixed, since several indicators were considered when compiling it.

## References

1. Mishchenko, S., Naumenkova, S., Mishchenko, V., Dorofeiev, D.: Innovation risk management in financial institutions. *Investment Manage. Financ. Innovations* **18**(1), 191–203 (2021)
2. Kowalski, M., Lee, Z.W.Y., Chan, T.K.H.: Blockchain technology and trust relationships in trade finance. *Technol. Forecast. Soc. Chang.* **166**, 120641 (2021)
3. Li, Y., Li, L., Zhao, Y., Guizani, N., Yu, Y., Du, X.: Toward decentralized fair data trading based on blockchain. *IEEE Netw.* **35**(1), 304–310 (2021)
4. Boot, A., Hoffmann, P., Laeven, L., Ratnovski, L.: Fintech: What's old, what's new? *J. Fin. Stab.* **53**, 100836 (2021)
5. Wang, X., Sadiq, R., Khan, T.M., Wang, R.: Industry 4.0 and intellectual capital in the age of FinTech. *Technol. Forecast. Soc. Chang.* **166**, 120598 (2021)
6. He, Q.: Application of blockchain technology in commercial banks. In: Kierans, G., Liu, H., Ng, E.H.K. (eds.) *Proceedings of the 2020 International Conference on New Energy Technology*

- and Industrial Development (NETID 2020). E3S Web of Conferences, vol. 235, no. 03070. Les Ulis: EDP Science. (2021)
7. Pan, C.-L., Chen, Z., Zhou, Z., Cai, Z., Liu, X., Lin, Y.: Frontiers in the emerging development of blockchain and Bitcoin: Visual research based on big data analysis. In: Kierans, G., Liu, H., Ng, E.H.K. (eds.) Proceedings of the 2020 International Conference on New Energy Technology and Industrial Development (NETID 2020). E3S Web of Conferences, vol. 235, no. 03017. Les Ulis: EDP Science (2021)
  8. Roa, L., Correa-Bahnsen, A., Suarez, G., Cortés-Tejada, F., Luque, M.A., Bravo, C.: Super-app behavioral patterns in credit risk models: Financial, statistical and regulatory implications. *Expert Syst. Appl.* **169**, 114486 (2021)
  9. Laidroo, L., Koroleva, E., Klüber, A., Rupeika-Apoga, R., Grigaliuniene, Z.: Business models of fintechs—difference in similarity? *Electron. Commer. Res. Appl.* **46**, 101034 (2021)
  10. Ren, Z., Wang, W., Chen, B., Li, X., Zhang, Y., Hu, Y., Li, H.: A power trading mode based on blockchain for prosumers. In: Weerasinghe, R., Fang, C. (eds.) Proceedings of the 3rd International Symposium on Architecture Research Frontiers and Ecological Environment (ARFEE 2020). E3S Web of Conferences, vol. 237, no. 02008. Les Ulis: EDP Science (2021)

# Automation of Forming a Bond Financing Scheme in Optimizing the Capital Structure



E. V. Zhegalova, Y. V. Semernina, and K. A. Odinkova

**Abstract** The article is devoted to the automation of the bond financing scheme in optimizing the capital structure of Russian companies, taking into account the current level of development of the national bond market. The author's iterative scheme of bond financing is formed, which includes the following stages: collection and subsequent regular updating of information about the current capital structure; setting and formalizing goals for optimizing the capital structure; monitoring market opportunities to raise capital; evaluating existing opportunities to optimize the capital structure and making a management decision on their use; attracting bond financing; analyzing the results of attracting bond financing. The analysis of the functional capabilities of ERP-class systems presented on the Russian market allowed us to conclude that it is possible to automate four of the six stages of the developed scheme for optimizing the capital structure using bond financing.

**Keywords** Corporate bonds market · ERP-class systems

## 1 Introduction

Optimizing the capital structure using a variety of sources of financing is one of the most important tasks of financial management. The optimization of the capital structure is particularly important in the context of a decrease in the average level of interest rates, when companies have a real opportunity to attract debt financing on attractive terms and, accordingly, to minimize the weighted average cost of capital. In international practice, bond financing is considered to be one of the most effective sources of attracting borrowed capital by companies. Unfortunately, at present, a rather specific approach has been formed in domestic practice, within which the interpretation of bond financing as a limited source of financing, which is also used only by

---

E. V. Zhegalova (✉)  
Samara State University of Economics, Samara, Russia

Y. V. Semernina · K. A. Odinkova  
Yuri Gagarin State Technical University of Saratov, Saratov, Russia

large and largest domestic companies, prevails. To a large extent, the predominance of this approach is due to the historical nature of the development of the Russian bond market. At the initial stage of its development, its corporate segment was dominated by the largest issuers that placed bond issues for significant amounts (from 1 billion rubles or more), while the corporate bond segment was quite “narrow” in terms of the total number of issuers. In addition, the global financial and economic crisis of 2008 and the beginning of the “war of sanctions” in 2014 contributed to the preservation of this approach to the understanding of bond financing: both of these events at different times quite seriously “hit” the issuers of the “second” and “third tier” bonds, significantly hindering their entry into the bond market. The natural result of the predominance of such a scientific position was the consideration of bond financing in the context of optimizing the capital structure exclusively within the framework of replacing one source of financing with another, i.e., its attraction is interpreted as a kind of discrete (in fact, one—time) optimization operation. The purpose of this study is the formation of the author’s iterative scheme of bond financing in optimizing the capital structure of Russian companies, taking into account the current level of development of the national bond market, as well as the development of proposals for automating the proposed scheme.

## 2 Methodology

The formation of the author’s scheme of bond financing in optimizing the capital structure is carried out on the basis of a number of basic theoretical prerequisites that determine the differences between the proposed approach and the traditional one. Firstly, the formation of a bond financing scheme when optimizing the capital structure is carried out based on the understanding of attracting bond financing not as a discrete (one-time) optimization operation, but as a regular (systematically conducted) optimization process that has an iterative nature and, accordingly, involves regular monitoring of the bond market, including automatically. Secondly, the suggested author’s scheme of bond financing is based on an extended interpretation of the optimization of the capital structure, which assumes a variety of optimization directions, which considers not only the replacement of one source of financing with another (in this case, bond financing is a “replacement” source of capital, and the source of financing previously used by the company, usually bank lending—a “replacement” source of capital), but also alternative areas of optimization, in particular:

- optimization within a single source of financing (a typical example of such optimization is the replacement by the issuer of a circulating bond issue characterized by a higher coupon rate with a new bond issue with a lower coupon rate using a call option mechanism);
- optimization when changing the total amount of capital, in particular, involving the choice of the most optimal source of financing from all available to the company

(its main difference from the optimization of capital sources is that in this case there is no replacement of one source of capital with another);

- complex optimization, which can simultaneously combine several areas of capital structure optimization.

Third, the developed bond financing scheme takes into account the difference in the optimization capabilities of companies, depending on the presence or absence of bond financing in the capital structure at the time of its implementation. If the company has outstanding bond issues, its ability to optimize the capital structure will be wider. At a minimum, it can consider: attraction of new bond financing (for companies that do not use it at a particular time, only this option of optimizing the capital structure is available); management of bond issues, for example, by repurchasing part of the bonds from the market, changing the coupon rate by the bonds (if such an opportunity is initially provided for by the terms of their issue) or issuing a voluntary offer to the bondholders (the developed scheme of bond financing for optimizing the capital structure is shown in Fig. 1).

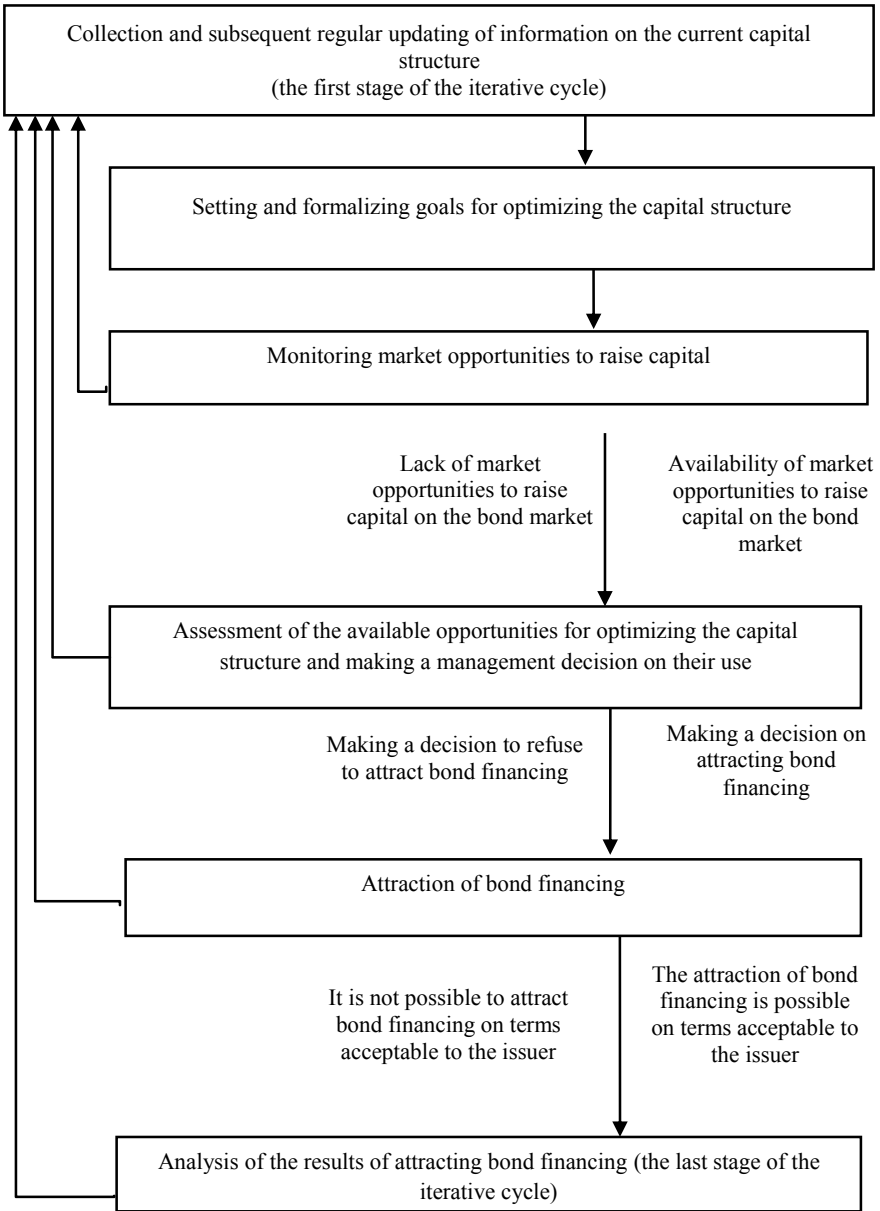
### 3 Results

The individual stages of the proposed bond financing scheme for optimizing the capital structure, which are characterized, on the one hand, by repeatability and the possibility of clear formalization, and, on the other hand, by significant labor intensity, can be automated on the basis of ERP systems. Any ERP-class system that includes a financial module, in particular, SAP ERP, Oracle ERP, Microsoft Dynamics Axapta, 1C: ERP, can act as such a base. Enterprise management 2, etc.

The stage of collecting and subsequent regular updating of information about the company current capital structure can be fully automated by creating a specialized report “Current capital structure of the company”, formed by users at the first stage of the iterative cycle on the basis of these special documents or their analogues (they contain detailed information concerning individual sources of capital, including the cost of their attraction, the timing of attraction, the amount of funds raised, the counterparty that provided financing), as well as operational management reports (it can be used to calculate aggregate indicators, in particular, the average values by types of financing and in general by the company’s capital, as well as their specific amounts).

At the stage of setting and formalizing goals for optimizing the capital structure, it is possible to create a separate report “Target capital structure of the company”, which is formed, unlike the previous stage, on the basis of special registers or their analogues. To allow comparison, its structure, in terms of the report layout, should be identical to the structure of the “Current Capital Structure of the Company” report mentioned above.

Monitoring of market opportunities for raising capital on the bond market can also be carried out automatically by implementing external integration of the company’s



**Fig. 1** Iterative scheme of bond financing in optimizing the capital structure of Russian companies. Source Authors



ERP system either with the selected online trading system (in this case, information about transactions with bonds, as well as requests for their purchase and sale can be received in real time), or with the website of the organizer of exchange trading bonds (in this case, it is possible to obtain data recorded in bulletins following the results of the trading session). The choice of the external integration option should be determined depending on the frequency of implementation of the optimization cycle.

As part of the monitoring procedure, the search for bond issues can be carried out either by name or by stock ticker, and information about the bond issues that are monitored should be recorded in the ERP system (for example, in the form of an accumulation register or its equivalent) and subsequently stored in it with the necessary level of detailing.

The monitoring results can also be reported automatically, and these results can be either purely informative (for example, a simple list of bond issues with the values of the most significant indicators for each issue), or involve a preliminary “drop-out” procedure (for example, the monitoring results will include only those bond issues that have indicators that meet or exceed the target ones). In addition, at the monitoring stage, additional restrictions may be provided for, the application of which will increase the representativeness of the monitoring results, in particular, restrictions on the minimum transaction volume, on the frequency of market transactions, on the deviation from the transaction price of the previous transaction, etc. The two subsequent stages of the developed bond financing scheme cannot be fully automated due to their specific features.

Automatic assessment of the available opportunities for optimizing the capital structure is possible only if there is bond financing in the company’s capital structure and if the direct comparison mechanism is used simultaneously (in this case, the coupon rate on the bonds can be calculated using the current bond yield). In all other cases, especially those involving the use of expert adjustments that take into account the differences between the issuing company and similar companies, it is not possible. It is also worth noting the high complexity of formalizing the process of making a management decision about their use, for example, the company’s management may accept or reject the available opportunities on the bond market, based on forecasts regarding the further dynamics of interest rates, in all other equal conditions.

As for attracting bond financing, it is an external process from the point of view of the company’s ERP system: as a rule, in the user mode, only the final data on the results of its involvement is entered in it.

The last stage of the suggested bond financing scheme—analysis of the results of attracting bond financing—can also be automated by developing a specialized report “Results of attracting bond financing”. Within the framework of this report, an absolute and relative comparison can be carried out in two different sections: a comparison of actual indicators with target indicators and a comparison of actual indicators with planned indicators for attracting bond financing (the automation capabilities of the developed scheme are shown in Table 1).

**Table 1** Opportunities for automating the bond financing scheme while optimizing the capital structure based on ERP systems

| Stage of the bond financing scheme when optimizing the capital structure   | Availability of automation capabilities | Suggested automation tool  |
|--|---|--|
| Collection and subsequent regular updating of information on the current capital structure                                   | Yes                                     | Non-typical report “Current capital structure of the company»  |
| Setting and formalizing goals for optimizing the capital structure   | Yes                                     | Non-typical report “Target capital structure of the company»   |
| Monitoring market opportunities to raise capital   | Yes                                     | External integration with either the selected online trading system or the website of the bond stock trading organizer + automatic email distribution system |
| Assessment of the available opportunities for optimizing the capital structure and making a management decision on their use | Extremely limited options               | –  |
| Attraction of bond financing   | No                                      | –  |
| Analysis of the results of attracting bond financing   | Yes                                     | Non-typical report “Results of attracting bond financing»  |

Source Authors

## 4 Discussion

With the development of the national bond market, Russian companies are getting a real opportunity to attract bond financing, and its parameters are becoming more and more variable. Nevertheless, up to the present moment in the Russian scientific literature, bond financing continues to be considered as a rather specific financing tool, and all works on this topic can be divided into two main groups, namely:

- works with a theoretical focus, including from the perspective of the transformation of the bond market under the influence of global digitalization and the development of information technologies [1–3];
- works that consider bond financing as a tool, first of all, for project financing in various fields of activity [4–7].

In almost all publications on this issue, bond financing is considered as an independent source of financing, i.e. its analysis is carried out outside the context of optimizing the capital structure of companies. At the same time, economists do not

deny the fact that under certain conditions, for example, at a lower cost of attraction, bond financing can replace other sources of financing in the capital structure of companies or be used to increase "leverage".

The distinctive features of this approach to the interpretation of bond financing from the perspective of optimizing the capital structure, which is currently prevailing, are the following:

- bond financing is understood as a certain opportunity to radically change the capital structure of the company, which periodically occurs on the bond market, which can be used by the bond issuer;
- non-regular nature of attracting bond financing;
- the relative stability of the share of bond financing in the total capital structure of the company.

## 5 Conclusion

Currently, the scientific literature has developed an idea about the possibility of using bond financing exclusively in the framework of replacing one source of financing with another when optimizing the capital structure of Russian companies. The formation of this approach was due to the historical nature of the development of the national bond market, in particular, the predominance of a small number of major issuers that attract significant amounts of financing, as well as the influence of external factors (primarily the events of 2008 and 2014), due to which, in a relatively short period of time, the number of issuers of the "second" and "third echelons" twice decreased on the domestic corporate bond market.

It seems that at the present stage of development of the domestic bond market, such a "discrete" approach is not relevant. Taking into account the formulated theoretical prerequisites (the iterative nature of the process of optimizing the capital structure; an expanded interpretation of the direction of optimizing the capital structure; the difference in the optimization capabilities of companies depending on the presence or absence of bond financing in the capital structure at the time of its implementation), the author developed a scheme for using bond financing in optimizing the capital structure.

This scheme includes the following stages: collection and subsequent regular updating of information on the current capital structure; setting and formalizing goals for optimizing the capital structure; monitoring market opportunities to raise capital; evaluating existing opportunities to optimize the capital structure and making a management decision on their use; attracting bond financing; analyzing the results of attracting bond financing.

The analysis of the functional capabilities of ERP-class systems presented on the Russian market allowed us to conclude that it is possible to automate four of the six stages of the developed scheme for optimizing the capital structure using bond financing. At the same time, the impossibility of automating the remaining two stages is due to their specifics: within the stage of evaluating the available opportunities for

optimizing the capital structure and making a management decision about their use, the strict formalization of the management decision-making procedure is problematic, and the stage of attracting bond financing is external from the point of view of corporate ERP systems (they record only the results of attracting financing).

The results obtained allow us to conclude that it is necessary to abandon the interpretation of bond financing when optimizing the capital structure as a specific (elite) source of financing. It is also advisable to use it to solve this problem of financial management along with traditional sources of financing for Russian practice.

## References

1. Belozyorov, S., Sokolovska, O., Sik, K.Y.: Fintech as a precondition for transformations on global financial markets. *Foresight STI Gov.* **2**, 23–35 (2020)
2. Mention, A.-L.: The future of fintech. . *Res. Technol. Manag.* **4**, 59–63 (2019)
3. Edronova, V.N., Maslakova, D.O.: Debt financing of investments: Sources, forms, mechanisms, tools. *Finance and Credit* **8**, 1829–1843 (2018)
4. Da Fonseca, R.S., Veloso, A.P.: The practice and future of financing science, technology, and innovation. *Foresight and STI Gov.* **2**, 6–22 (2018)
5. Nissen, V., Lezina, T., Saltan, A.: The role of IT-management in the digital transformation of Russian companies. *Foresight and STI Gov.* **3**, 53–61 (2018)
6. Fejzullaev, M.A., Dolgov, E.V., Shikhveledova, D.K.: Finding sources for large investment projects. *Int. Res. J.* **12**(102), 81–85 (2020)
7. Freidina, I.A.: International experience of infrastructure projects financing. *Econ. Policy* **4**, 196–203 (2017)

# Modern Warehouse Management Systems



N. P. Karpova

**Abstract** The author analyzed the software market of warehouse automation systems and its main trends. The advantages and disadvantages of automation in warehouse business processes under current conditions were revealed. The main issues of WMS implementation (Warehouse Management System) in order to automate the warehouse activities of national companies were considered. The author suggested the means that would be able to solve the problems. The ways of implementation of modern warehouse automation systems in the Russian market were studied. The most important performance capabilities of modern WMS were described in an integrated manner, as well as the costs associated with the implementation of the warehouse automation project were structured. The cost advantage from WMS implementation was determined.

**Keywords** Automation · Digital economy · Industry 4.0 · Management system · Warehouse · Warehouse software

## 1 Introduction

Nowadays, the logistics services market has known a real increase due to the speedy progress of software and IT sector as a whole. The culmination of this growth is the warehouse functional area of logistics. This fact can be proved by several examples: quantity increase of warehouse terminals in cities with a population of 1 million or more, growth of temporary storage sites, and increase of distribution centers in different geographical areas. In our view, the growth rate of the warehouse economy in the European part of Russia will continue going up in 2–3 years to come. According to the statistics, more than 450,000 m<sup>2</sup> of warehouses of different types were put into operation in 2018–2019. Moreover, some companies are planning their further increase. As a rule, warehouses with huge storage areas are built in the cities with federal status [1]. The warehouse facilities growth is irreversibly leading to a stronger

---

N. P. Karpova (✉)  
Samara State University of Economics, Samara, Russia

competitive environment in the industry, and companies are looking for new tools to strengthen their own competitive advantages by reducing both material and time expenditures, as well as eliminating bottlenecks [2].

The WMS (Warehouse Management System) introduction has been developing in the world for the last few years. WMS is a software to manage warehouse facilities. It allows to efficiently distribute, store, and transport material resources around the warehouse. In addition, the system often includes a methodology to perform warehouse operations, such as the use of barcodes and radio frequency identifiers (RFID) [3]. Due to automated management of the warehouse process, companies try to improve efficiency of both a warehouse and an entire supply chain, since warehouses play a vital role in the business success or failure [4].

## 2 Methodology

The research is based on the logical justification of the need to implement automated warehouse management systems. Thus, WMS implementation is impossible without an efficient business model of storage facilities. Due to the fact that the business model will be different for each warehouse complex (particular business in a particular market), WMS should have a wide functionality that allows to take into account customers' specific characters and adapt to their preferences.

A lot of WMS providers classify their product by the cost per one user workstation and distinguish small, medium, and large solutions. The software products, presented in the market, have a huge cost gap and range from \$400 for domestic developments to \$6000 for foreign versions. It is worth noting that the classification feature mentioned above is not objective in some cases. That is why, practically WMS is determined by the implementation cost, which consists of the software license price, the costs of the product analysis and selection, the cost of purchasing additional storage equipment (bar code scanners, high frequency tags and readers, and others), the wage of the working group and its financial incentives, potential costs to integrate WMS with the company's software (e.g. ERP system), and the cost on external consulting (project development, equipment adjusting, user training, and others).

It is clear from the above that WMS implementation is an expensive process. Therefore, such expenses have to be economically sound. In order to evaluate the effectiveness of investments in the WMS project, the indicators of return on investment (ROI) and total cost of ownership (TCO) are used. ROI indicator shows the investment profitability of software and makes it possible to determine the WMS payback period. It is calculated as per formula 1.

$$ROI = \frac{CF - TCO}{TCO} \times 100\% \quad (1)$$

$CF$ , is a benefit from software implementation, in rubles.

According to the statistics, the payback period varies within 2–2.5 years [5]. A successful experience of many companies allows to declare high results in the process WMS project implementation as the time for warehouse order processing is halved, the accuracy of warehouse operations is increasing and stimulating the product range growth, the level of losses is reduced due to the fact that serviceable life and cargo conditions are much better controlled in the warehouse, bottlenecks in the warehouse are identified, stoppage of warehouse operations is reduced, the staff qualification and work discipline is increasing, the warehouse staff composition is reduced by 2–3 times, and the efficiency of order consolidation is going up [6].

### 3 Results

The role of warehouses in modern logistics is becoming more important [7]. Warehouses provide not only storage of raw materials, supplies, and finished products, but they also work as distribution centers and order processing centers. Warehouses perform a number of other important functions: unitization, transformation of the product line into a commercial one, fragmentation of incoming commodity stocks and supplies, and others. Today, many technologies are used to automate warehouse performance and integrate their activities into the supply chain. We could mention advanced visualization techniques such as alternate reality in order to support warehouse management. They help workers intuitively manage commodity stocks and supplies in a warehouse [4]. Also, some digital technologies such as Internet of things, robotics, drones, artificial intelligence, and others, which have been applied in a warehouse subsystem of the logistics system, have become widespread all over the world. Warehouse Management System is among the most well-known and widely used software that provides management automation and improves warehouse efficiency in the supply chain. The world market of WMS providers has about 300 WMS modifications. Unfortunately, the Russian market has no more than 20 varieties of information systems. It is necessary to understand the fundamental difference between existing warehouse accounting systems and WMS in many warehouse complexes. WMS does not have only an accounting function, but it analyzes all the operations in the queue and sends a signal about a job with good prospects to warehouse employees. In addition, modern WMS easily cope with the route optimization of storage facilities and equipment and based on the results of the load analysis, they form an operating programme for warehouse staff.

WMS is very popular among companies which provide temporary cargo storage services. Their choice is due to the fact that WMS has a billing function that allows to calculate the cargo storage cost in accordance with the data on the current load of location storage. Moreover, owing to this function, it is possible to calculate the cost of cargo handling services. However, why is there no mass WMS adoption in the domestic market? What kind of problems do Russian companies face?

First of all, customers' expectations might be too high, and they do not match the truthful overview. Undoubtedly, the choice of a suitable WMS is time-consuming,

since there is a huge number of selection criteria. Therefore, it is not easy to systematize them. The boundaries, which are not clearly defined, between systems do not let reduce the options number at an early stage. Most Russian WMS providers either do not provide data on their product implementation experience, or they do not have it. As a potential customer needs to test something when analyzing the system, it turns out that the customer's risks are disproportionately higher, and WMS projects are very expensive.

On the other hand, many Russian companies tend to choose carelessly a warehouse software. They expect a software provider to do everything and often are not able to explain why they have chosen this particular product. Customers forget that WMS is a digital tool that provides economic benefits but has a number of restrictions. In addition, due to marketing techniques, customers may have inflated expectations from WMS: the higher they are, the greater the disappointment is.

There is a number of situations when a customer does not have enough money due to the high cost of the WMS implementation project. Providers tend to sell as much as possible, consequently, they might suggest a customer an idea to save on consulting. If the customer accepts it, such activities as proper equipment adjustment and staff training will get weaker.

Secondly, there is a problem of business process engineering within a company. Particular attention should be paid to the development of reporting documents. Modern WMS can provide reports that are pre-installed by software developers and generate new ones at the user's request. Many customers expect the system to be able to create «any kinds of reports». Consequently, there is a misunderstanding between a seller and a customer. A seller considers «any kind of reports» as information which is adjusted to the required form and stored in the system. A customer considers «any kinds of reports» at a global scale.

Another important aspect of this issue is staff training. In the opening stage of the project, management has no idea what the processes will look like in the future. Therefore, training is conducted according to conventional schemes. In the view of a customer, there will be enough time since the project is just being put into operation, and it will be possible to wait until the processes are formulated and experts prepare a training program that takes into account the industrial specifics in order to conduct staff training. Unfortunately, the following difficulties arise at this stage.

Without making an analysis, none of the customers have any knowledge of the system. How to build processes? A provider knows the system, but a customer does not. A dispute about further activities is becoming obvious. Many companies' management do not see the reason to train staff now and retrain them later. There may be another situation. If a company has lost a lot of time analyzing business processes, it will decide to adjust the system and train the staff at the same time. Experts train personnel with standard operations and then they retrain them. Sometimes, staff have to be retrained more than 2–3 times, which results in significant cash expenditures.

There is no point underestimating the human factor when implementing a warehouse automation project. It is difficult to imagine a huger impact than the employees' resistance can have. The matter is that only the company's management realizes the need for changes, while ordinary employees, who are accustomed to a usual work



process, are ready to argue about any changes. It should be taking in consideration that the less the desire of the staff to change anything in their work is, the more hostile they meet the system that strictly regulates work processes and issues direct instructions to each employee [8]. Meanwhile, some employees are afraid of the fact that after WMS implementation the managers will be able to track staff mistakes in real-time mode and evaluate effectiveness of their work. In addition, the employees' reaction is due to the fact that the software takes over part of some staff duties and completely eliminates others after implementation of the warehouse automation project. Consequently, it leads to significant job losses. The solution to this problem should be found in an integrated manner. In order to minimize the consequences of employees' sabotage of innovations, it can be recommended to introduce financial incentives for the staff who have successfully passed retraining and achieved certain key performance indicators in their activities [9].

The fact that WMS implementation is difficult because of particular characteristics of the customer's business was previously emphasized. Many people do not understand the situation and try to implement an innovative product as quickly as possible. As a result, errors, system failures, and incomplete functionality utilization tend to arise. There is also shortage of qualified staff engaged in the implementation of modern warehouse automation systems in the company.

It is worth emphasizing that in the Russian market there are companies that have successfully implemented WMS despite the difficulties mentioned above. Nowadays, there are several dozen successful examples, which are related to distribution warehouse complexes. These are market leaders such as Metro, MGL Logistic, SLG Logistic, and Philip Morris. The Russian market is facing fierce competition. The market includes both small Russian firms that develop software and large national developers of software products, as well as large foreign companies, including Japanese specialist software creators. It would be worth mentioning the companies such as SAP, Oracle, and Microsoft. These companies generate interest in their products by offering a model of integrated implementation of WMS starting at zero (integration with ERP-type software). This gives their customers the following competitive advantages: formation of a common database of referenced data, reduction of the costs for integration of different developers' software, possibility to reflect warehouse operations in higher-level accounting registers (e.g. accounting accounts), development of a unified complex of user security control. Therefore, many experts believe that organizations which have chosen software of SAP, Oracle, and Microsoft will have dominant positions in the industry.

## 4 Discussion

Warehouses play an important role in the supply chain, as their operating performance determines efficiency of the entire logistics system [10]. A warehouse subsystem is an important component of a logistics infrastructure of the supply chain, and it is mainly considered not as a production cost center, but as a strategic tool for gaining

competitive advantages [11]. Warehouse Management System is not the only system that is able to automate a warehouse technical process. Modern enterprises operate in the era of Industry 4.0, whose technologies (the Internet of things, robotics, the usage of drones, and others) will help national companies to take full advantage from the achievements of modern science and technology in business processes (1; 6).

In this regard, there is an intelligent warehousing concept that is focused on improving the overall quality of warehouse service, productivity, and efficiency while minimizing costs and failures in a warehouse subsystem through the use of modern digital technologies [10]. The higher the level of automation in warehouse activities is, the lower the level of human intervention becomes. Consequently, the level of errors and losses falls [3]. Thus, this research is an initial stage to analyze the innovative development of the digital economy in the field of the main business processes of logistics systems automation.

## 5 Conclusion

The research found that enterprises' functioning takes place in a highly competitive environment nowadays. A company can benefit in the market only by reducing operating costs and improving the consumer service quality. Warehouses are a center of these costs formation and a source of customer service increase. While operating in the era of Industry 4.0, it is important not to neglect the best practices of the digital economy and introduce modern information engineering and technologies into supply chain activities. This will have a positive impact on the key performance indicators of all logistics subsystems [12]. It is essential to note that implementation of warehouse automation system should be treated with a high degree of seriousness and responsibility. First of all, a customer needs to become familiar with WMS, a subsequent comparison of these systems, and analysis in order to present clear requirements to the supplier. The customer has to thoroughly analyze the industry, clearly understand own needs, and be demanding to WMS providers. These days, the domestic market of firmware for warehouse logistics offers effective products, but in order to use them appropriately and to the full extent, it is necessary to be ready for serious analytical effort.

## References

1. Gordeev, A.: Demand for warehouses in Russia has reached the highest rate over 10 years. <https://www.vedomosti.ru/realty/articles/2020/02/18/8>. (2020). Accessed: 21 Feb 2021
2. Martins, R., Pereira, M.T., Ferreira, L.P., Sá, J.C., Silva, F.J.G.: Warehouse operations logistics improvement in a cork stopper factory. *J. IFAC Procedia Manuf.* **51**, 1723–1729 (2020)
3. Wanga, Z., Li, S., Zhang, Z., Lv, F., Hao, Y.: Research on UWB positioning accuracy in warehouse environment. *J. Procedia Comput. Sci.* **131**, 946–951 (2018)

4. Mourtzisa, D., Samothrakisa, V., Zogopoulosa, V., Vlachou, E.: Warehouse design and operation using augmented reality technology: a papermaking industry case study. *J. Procedia CIRP* **79**, 574–579 (2019)
5. Mirzaei, M., Zaerpour, N., Koster, R.: The impact of integrated cluster-based storage allocation on parts-to-picker warehouse performance. *J. Transp. Res. Part E Logistics Transp. Rev.* **146**, 102207 (2021)
6. Coito, T., Viegas, J.L., Martins, M.S.E., Cunha, M.M., Figueiredo, J., Vieira, S.M., Sousa, J.M.C.: A novel framework for intelligent automation. *J. IFAC PapersOnLine* **52–13**, 1825–1830 (2019)
7. Freitas, A.M., Silva, F.J.G., Ferreira, L.P., Sá, J.C., Pereira, M.T., Pereira, J.: Improving efficiency in a hybrid warehouse: a case study. *J. Procedia Manuf.* **38**, 1074–1084 (2019)
8. Toymentseva, I.A., Karpova, N.P., Denisova, O.N., Chichkina, V.D.: Mechanism to form labour potential of innovative type: Logistic aspect. In: Mantulenko V. (ed.), *Eurasia: Sustainable Development, Security, Cooperation*. SHS Web of Conferences, vol. **71** (04015). EDP Science, Les Ulis (2019)
9. Torabizadeh, M., Mohd, Y.N., Ma'aram, A., Shaharoun, M.A.: Identifying sustainable warehouse management system indicators and proposing new weighting method. *J. Cleaner Prod.* **248**, 119190 (2020)
10. Geest, M., Tekinerdogan, B., Catal, C.: Design of a reference architecture for developing smart warehouses in industry 4.0. *J. Comput. Ind.* **124**, 103343 (2021)
11. Lototsky, V., Sabitov, R., Smirnova, G., Sirazetdinov, B., Elizarova, N., Sabitov, Sh.: Model of the automated warehouse management and forecasting system in the conditions of transition to industry 4.0. *J. IFAC PapersOnLine* **52–13**, 78–82 (2019)
12. Evtodieva, T.E., Karpova, N.P., Toymentseva, I.A.: Strategic supply management in the logistics systems of industrial enterprises. In: Solovev D.B. (ed.), *Proceedings of the International Scientific Conference “Far East Con” (ISCFEC 2018)*. *Advances in Economics, Business and Management Research*, vol. **47** (pp. 452–454). Atlantis Press, Paris (2019)

# Marketing Support of Wholesale Trade Based on CRM System Implementation



L. K. Kirillova

**Abstract** The article views the specifics of the wholesaler's marketing solutions aimed at satisfying the needs of consumers. The role of interaction with clients for the formation of range and the implementation of profitable wholesale and intermediary activities are shown. The potential of CRM systems for improving the quality of interaction of a wholesale company with customers is revealed. A comparative analysis of the functionality of various CRM systems is carried out. The activities of a wholesale intermediary company aimed at achieving business goals are investigated and the need for the implementation of the Bitrix-24 CRM system is identified. The calculations of the project justification and the payback period are presented. Methodological approach to evaluating the purchase of the Bitrix-24 CRM system is formulated and recommendations are given for improving the procedures of interaction between the seller and the buyer during the price negotiations process.

**Keywords** Discounted cash flow · Interaction between the seller and the buyer · Marketing · Net cash flow · Wholesale trade

## 1 Introduction

Wholesale trade is the most important link in bringing goods to consumers as it coordinates the economic interests of producers, consumers and generates additional benefits for participants in the value creation process. From the position of marketing, the most important decision of a wholesaler is to choose the range of goods sold which affects the sales market and competition specifics. The basic principles of making decisions of wholesalers concerning range are aimed at satisfying the needs of a target group of consumers, creating conditions for guaranteed supplies of goods from suppliers and to their own customers and creating a business model that ensures profitability at an acceptable level. Consequently, the most important task for a wholesaler is to strengthen relationships with real customers and to expand

---

L. K. Kirillova (✉)  
Samara State University of Economics, Samara, Russia

opportunities to attract new customers. For these purposes it is important to have the tools for maintaining interaction with customers agreed within the framework of relationship marketing. “The purpose of such interaction is to improve the image of the organization and to obtain favourable opportunities for business processes implementation” [1, p. 65]. Relationship marketing considers partnerships with suppliers and consumers the most valuable element in reducing risk and increasing profits. One of the tools of relationship marketing in wholesale trade is CRM-system (Customer Relationship Management) implemented in the sphere of the development of digital economy [2]. This research discusses the issues of increasing the efficiency of wholesale trade based on the implementation of CRM-system and the economic justification of this decision.

## 2 Methodology

The improving of the efficiency of business is a common goal, regardless of industry and field of activity. In modern conditions, when the use of digital technologies in the improving of business processes becomes relevant, substantiating of the effect of introducing CRM system into the activities of a wholesale trade company operating in the industrial market becomes an important task. CRM system includes a set of programmes for automatization of interaction with customers, optimization of marketing service functioning, generation of a database on the history of interaction with customers, analysis of the results of transactions and improvement of existing business procedures. When choosing CRM system one should carefully study their functional features and the possibility of implementation in the business taking into account the specifics of the activities. The optimal choice is based on the achievement of the best economic performance, provided that the programme corresponds to the strategies and requirements of running the business. “The process of making decisions on purchasing is determined by the specific business situation that gave rise to this need and the dynamics of changes in the ways of solving the specific problem” [3, p. 54].

Traditional CRM system includes three subsystems: operational, analytical and unified. The operational subsystem is aimed at maintaining interaction with the client during service operations and provides access to the necessary information for making management decisions. The analytical subsystem is focused on working out of recommendations for the development of relationships with clients on the basis of the analysis of databases accumulated in the course of working with this client. The unified subsystem allows the client to take part in the formation of service standards, taking into account the specifics of the client’s requirements for the product and related services. An important advantage of CRM systems is the ability to visualize performance results and present this information at different levels of management. The introduction of this system enhances control over the quality of the work of the personnel and allows assessing the contribution of each participant into the general result. Justification of the choice of alternative options of CRM systems using clear

criteria and indicators is becoming an actual problem. “The project is a set of activities aimed at achieving a unique result within the specified time and allocated budget frame” [4, p. 1088]. The research within the frame of the stated topic is based on a comparative analysis of existing CRM systems and the choice of a system that best meets the needs of the wholesale company. The second aspect of this problem is the economic justification of the chosen option taking into account the purchase of the license and the payment of one-time costs, as well as the cost of technical support.

### 3 Results

Justification of the economic effect of the implementation of Bitrix-24 in wholesale trade and intermediary activities was studied on the example of a specialized company in Samara. To preserve commercial confidentiality we will introduce the code name of the wholesale trade and intermediary company—Wholesaler LLC.

Wholesaler LLC is an official dealer of well-known manufacturers of welding equipment, both Russian and foreign. The company is engaged in the supply of equipment and materials for welding to oil and gas industry enterprises and construction and assembly companies. The choice of the range demonstrates the company’s specialization in serving industrial customers. The analysis of the range and the structure of sales showed that 80% of sales are presented by three groups of goods: welding consumables, accessories for welding equipment and welding machines. Thus, the key positions were highlighted, the clients of which provide the greatest contribution to income and deserve the most careful attention. The analysis of the economic indicators of the activities of Wholesaler LLC showed a decrease in business profitability from 5.6 to 2.7% that required a detailed study of the reasons and the search for management decisions. SWOT—analysis of Wholesaler LLC revealed strong points which include highly qualified personnel, clear control and accounting of financial resources, positive image of the company, reliable suppliers of products and a significant market share. The weaknesses of the wholesale trade company are the lack of development of marketing functions which leads to the loss of customers and potential profits. In this regard, establishing interaction with customers, maintaining long-term commercial relationships and increasing turnover with existing customers become urgent. In the field of industrial marketing such a strategy gives the best result taking into account the limited number of potential buyers and the slowdown of the economic growth.

In the course of the research the analysis of the client base of Wholesaler LLC was carried out, which includes more than 2000 organizations located on the territory of the Russian Federation. The study of the orders structure showed that 37% of customers purchase products in the amount of up to 1 million rubles, 26% of customers make purchases of products in the amount of 1 to 2 million rubles and 24% make orders in the amount of 2 to 5 million rubles. Customer demand is driven by the need for welding and requires a reliable, regular supply of the necessary components and consumables. Taking into account the seasonal character of outdoor construction

and welding, the wholesale trade and intermediary company faces seasonal fluctuations in demand. The research revealed the seasonal character of sales and found out that in the first quarter, on average, 25.3% of products are sold, in the second quarter—23.2%, in the third quarter—21.3% and in the fourth quarter—30.2%. It means that the least productive period of sales is the third quarter. It is necessary to carry out the work of attracting customers during the periods of low demand using incentives to purchase in order to ensure a more even distribution of sales throughout the year. To solve this problem the company can use CRM software product—the system of sales department automation.

There are many CRM systems on the market that differ in license cost, maintenance costs and technical capabilities. In the course of the research there was carried out a comparative analysis of the most popular CRM systems, which include: Megaplan, Bitrix-24, CRM Simple Business, Client Base, Sugar CRM and Microsoft Dynamics 365. Two systems—Megaplan and Bitrix-24 were considered as alternatives for a detailed research and assessment of the possibility of introducing into the activities of the wholesale trade and intermediary company.

The study of the functionality of the Megaplan CRM system showed the presence of three functional modules (marketing automation, sales management and support service). For the organization of wholesale trade activities the most interesting is sales management, which provides functions for sales forecast, generating and updating of customer bases, management of the operational work with customers, management of commercial documents, including preparation of proposals, generation of price lists, analyzing of sales processes and drawing up of analytical reports. However, in this system it is impossible to connect to only one module, which necessarily requires the installation of the entire programme. In this regard, Bitrix-24 system was studied in more detail.

Bitrix-24 system uses the database of leads, contacts, companies and, with the help of configured chains of business processes, processes the assigned tasks. Automatic mailing of letters, calls and invoices to clients is possible. The head of the sales department has the ability to monitor the work of subordinates according to various parameters and track the appearance of problem areas. Each sales manager forms his or her own rating taking into account the effectiveness of the work and the results obtained. An important feature of this system is the integration with accounting which allows employees to have up-to-date information on prices, warehouse balances and payment processes. Bitrix-24 generates various formats of reports on current and future transactions and makes it possible to design your own configurations of visual reports. By its functionality, Bitrix-24 contains the bulk of solutions of well-known customer relationship management systems, and can be recommended for the implementation in the activities of a wholesale trade enterprise. Making decision on the implementation of Bitrix-24 system requires an economic feasibility study and an assessment of the possible economic effect.

## 4 Discussion

Management decisions on the improvement of the sales process of a wholesale trade company based on the implementation of Bitrix-24 CRM system require understanding of the project implementation costs and the payback period. The study of this issue was carried out on the basis of studying the works of a number of specialists [2, 5, 6]. In the course of the research there were presented the methods for substantiating of the economic effect from the implementation of the recommended project. It should be taken into consideration that the purchase of a CRM system is an expensive investment decision and the value of the contract needs to be justified. Moreover, negotiations with the seller can be more constructive if the buyer has the understanding of the benefits and associated costs, which will make it possible to negotiate an acceptable level of license price and technical support payment. The initial data of the investigated wholesale trade company are shown in Table 1.

At the initial stage, based on the provided data, Wholesaler LLC will need 1,286,000 roubles of investments, and during the next three years operating costs will amount to 498,700 roubles per year. The most interesting is the methodological approach to the assessment of the effect of Bitrix-24 CRM system implementation. The main advantage of this system is considered to be the reduction of time spent on working with real and potential customers in the amount of 10% of the current costs. Based on the above data, the annual sales personnel labour costs were 11,085,360 roubles, assuming 247 working days in 2021. Then the release of working time as the result of the implementation of CRM system in the amount of 10% means the reduction of labour costs in the amount of 1,108,536 roubles per year, which actually means savings from the implementation of the project. At the same time one should take

**Table 1** The initial data for substantiating of the economic effect from the implementation of Bitrix-24 CRM system project

| Indicator                                    | Indicator value          | Indicator   | Indicator value                                      |
|--|--------------------------|---|--|
| The number of sales specialists              | 30 people                | Annual expenses for the Bitrix 24 CRM system technical support      | 174,600 roubles (20% of the cost of the license)     |
| The administrative support of the CRM system | 1 person                 | The cost of the initial training of the personnel                   | 284,000 roubles (one-time payment)                   |
| Payback period                               | 3 years                  | System upgrading costs  | 165,600 roubles (20% of the cost of the software)    |
| Average salary of a salesperson              | 30,000 roubles per month | Annual labour costs for the personnel engaged in the system support | 158,500 roubles (based on the current payment terms) |
| The cost of the software license             | 828,000                  | Discount rate   | 17% (operating costs savings rate)                   |

Source Author



**Table 2** Calculation of payback when implementing Bitrix-24 CRM system

| Indicators                                       | Period of time      |            |           |           |
|--|---------------------|------------|-----------|-----------|
|  | Initial investments | 2022       | 2023      | 2024      |
| Investments, roubles                             | 1,000,000           | 286,600    | –         | –         |
| Savings from the project implementation, roubles | –                   | 609,836    | 609,836   | 609,836   |
| Net cash flow, roubles                           | –1,000,000          | 323,236    | 609,836   | 609,836   |
| Discounted multiplier                            | 1000                | 0.855      | 0.731     | 0.624     |
| Discounted cash flow, roubles                    | –1,000,000          | 276,366.78 | 445,790.1 | 380,537.6 |

Source Author

into account the annual costs of maintaining the CRM system and deduct them from the planned amount of savings. Then the annual net savings from the implementation of the project will be 609,836 roubles. (1,108,536–498,700).

When investments are used in a project it is important to take into account the factor of depreciation of funds (discounted multiplier) and calculate the discounted cash flow for correct assessment of the return on investment [6]. The initial investments are distributed over 2 years. During the first year 1 million roubles is paid and during the second year the remaining 286,600 roubles are paid. Table 2 shows the payback calculations for the implementation of the CRM system. The amount of discounted cash flow for three years will be 1,102,693 roubles, which exceeds the initial investment by 102,693 roubles (1,102,693–1,000,000).

In these calculations the discount rate ( $r$ ) is taken at 17%, and the discounted multiplier for each of the three years was calculated using the formula:  $\frac{1}{(1+r)^t}$ .

Thus, the decision to implement Bitrix-24 CRM system is based on obtaining economic effect that exceeds the initial investment after three years of its use. In addition, the quality of the work of the personnel with clients will increase, as well as the opportunities for sales growth due to the exact correspondence to the clients' needs.

The research highlights the necessity to calculate the total costs during the period of operation of the facility when making a decision on purchasing of CRM systems [7]. In this technique the costs of purchasing goods and the costs of operation and repair are distinguished. However, not all costs can be clearly identified at the stage of purchase negotiations. Therefore, it is necessary to structure the costs and distinguish:

- evident costs, including the cost of the license and operating costs;
- projected costs based on empirical and statistical data;
- projected costs based on expert opinions.

In the future, in the calculations for the justification of the project, discounting costs should be taken into account to compare future costs with the costs of the current period. Bringing the calculations to the prices existing at the time of making

a purchase decision allows you to compare options more correctly and make the most profitable purchase, taking into account one-time costs and current costs.

## 5 Conclusion

The development of digital economy asks for the active use in business practice of various tools that make it possible to automate work processes and to optimize interaction with customers to ensure greater profitability of activities. These tasks can be solved with the help of CRM systems, which are a set of various programmes for interacting with customers, developing marketing support of sales, increasing the level of standardization of work processes and monitoring the activities of sales personnel. The optimal choice of a CRM system requires taking into account its functional features and compliance with the specifics of business strategies [5]. An important aspect of the choice is the cost of the license and the associated costs to maintain the functioning of the system.

The process of introducing a CRM system into the activities of a wholesale trade and intermediary organization is carried out in several stages: setting goals, conducting an audit of existing business processes, setting up programmes, integrating third-party services and training for the manager and the personnel. To justify the project, it is important to assess the cash flow due to the use of the new management system, the amount of expected savings and the payback period of the project. This approach will make it possible to provide a well-organized work of the sales department, to structure key customers and to build interaction with them for maximum profit.

## References

1. Kirillova, L.K.: Marketing communications in the industrial market: problems and solutions. *Vestn. Samara State Univ. Econ.* **5**(187), 65–71 (2020)
2. Chepurayna, E.V.: The use of CRM systems in economy. *Probl. Modern Econ.* **35**, 138–143 (2016)
3. Kirillova, L.K., Chernova, D.V.: The process of making a purchase decision in industrial marketing. *Prob. Enterp. Develop. Theory Pract.* **1–2**, 54–59 (2019)
4. Ashmarina, S.I., Kandrashina, E.A., Streltsov, A.V., Yahneeva, I.V.: The peculiarities of management of organizational changes in business structures. *Econ. Entrepreneurship* **7**(84), 1085–1089 (2017)
5. Rybakova, I.A., Orlov, S.P.: Comprehensive assessment of the effectiveness of using CRM systems by organizations. *Sci. World*, **1**(1(41)), 51–53 (2017)
6. Slugin, O.V., Bobkova, E.A.: Formation of competitiveness of small enterprises on the basis of a customer-oriented approach with the use of CRM systems. *Econ. Entrepr.* **10–3**(75), 294–296 (2016)
7. Lysons, K., Gillingham, M.: *Management of purchasing activities and supply chain*. INFRA-M, Moscow (2010)

# Managers as Agents of Change: Ready for Uncertainty in Digital Transformation



A. V. Kutuev and J. V. Sharikova

**Abstract** The global crisis caused by the spread of COVID-19, the consequences of which could not hurt business entities operating in the Samara region and satisfying the needs of its inhabitants and organizations. Managers, acting as agents of change in companies, are often forced to make decisions in conditions of uncertainty. And the current process of digital transformation of society cannot but be accompanied by an increase in the degree of uncertainty in the external environment of business entities. Therefore, it becomes relevant to assess the readiness of future managers to change in conditions of uncertainty, as well as to highlight behaviors and responses characteristic of them in such situations.

**Keywords** Behavioral patterns · Readiness for change · Uncertainty

## 1 Introduction

Uncertainty has always been observed and affected all spheres of society. The process of choosing alternative solutions is a vivid example of its presence and impact, which is noticeable both at the level of decision-making by the individual, the development strategy of the company, the country, and the whole society. The scientific community, together with the business community, is interested and takes an active part in the development of tools and mechanisms for reducing the degree of uncertainty, based both on the use of the mathematical apparatus (quantitative methods) and on the use of script-collegiate measures (qualitative methods). However, this instrumentation is not popularized and is not common in applications in the masses and is used mainly only in the professional environment. For this reason, a different attitude of people to the nature of uncertainty, to the perception of uncertainty, is also formed. Studying scientific publications on this topic, the author was able to distinguish several points of view of attitude and perception of uncertainty: negative rating (uncertainty is the source of losses, adverse events, which harm the existing reality and the current forms

---

A. V. Kutuev · J. V. Sharikova (✉)  
Samara State University of Economics, Samara, Russia

of interactions and communications); neutral (tolerant) evaluation (uncertainty is an integral phenomenon of our time); positive assessment (uncertainty is one of the components of risk embodied in the source of the emergence of new opportunities and achievements; uncertainty is a barrier to entering the window of opportunity for those who avoid competition, thereby reducing it for persons who use its properties to achieve their own goals).

The expressed interest of the scientific community in the topic of uncertainty in a dynamically changing external environment makes it necessary to conduct studies aimed at determining readiness for change as the main source of uncertainty and generating alternative opportunities [1–3].

The widespread introduction of digital solutions and the desire of managers to maximize access to reliable and relevant information through information technologies is gradually moving from the category of modern factors of business competitiveness to the category of vital and conditions for the survival of the company as a whole. And how future managers treat uncertainty and what model of response is followed will depend not only on the development of companies as a result of decisions, but also on the economic potential of the region, the country.

## 2 Methodology

The methodological basis of this work was the questionnaire PCRS [4]. After interpreting the findings of a previous study on a given topic [5], the authors of the current work performed additional question analysis to identify such statements in which the authors of the PCRS technique inserted an inducement-behavioral context (trigger-analysis). An additional criterion in selecting from existing statements, in addition to the presence of a trigger in the statement structure, was the finding of questions in the differentiated scales of the methodology. This was necessary so that the corresponding component of the individual's readiness for change was at the heart of the behavioral model, and the resulting behavior strategies differed from each other. The next stage of the study involved the synthesis of behavioral strategies in conditions of uncertainty, which were based on the incentive-behavioral context from the resulting list of statements. The algorithm for determining the prevailing (dominant) strategy of behavior in conditions of uncertainty in the respondent was carried out by searching for maximum values according to trigger statements. This choice is due to the fact that the degree of severity of the PCRS component directly depends on maximizing the scores scored on the corresponding scales. Therefore, the maximum score on trigger-statements will correlate with the degree of expression of behavior models in conditions of uncertainty.

### 3 Results

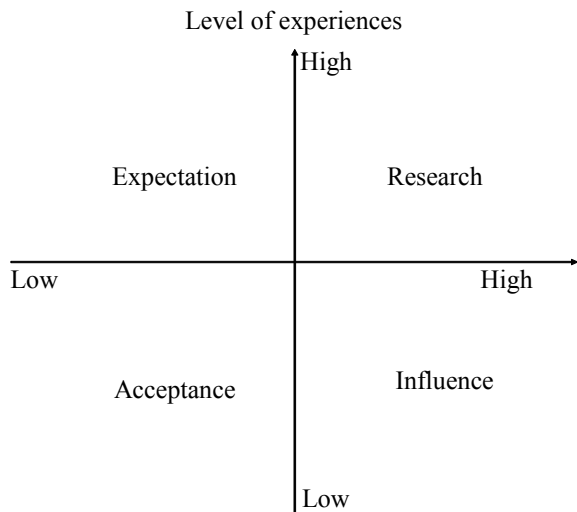
In the course of the analysis of the results of the survey of respondents, the main models of behavior in conditions of uncertainty and change were formulated. This was done by deciphering trigger questions from the PCRS technique, describing options for responding to uncertainty differentiated from each other. Baseline scenarios of 4 are found in different quadrants along the horizontal reaction intensity and vertical experience level axes (Fig. 1).

The substantiation of the allocated planes of manifestation of reactions to uncertainty is the differentiated level of emotional color of such a phenomenon. People with different life experiences of overcoming difficulties, stress resistance to certain stressogenic factors, temperament will experience a situation related to the uncertainty of the external environment in different ways. Also, in addition to an emotional surge, it is proposed to evaluate the reaction in the plane of its manifestation intensity, which is associated, first of all, with the readiness to take actions aimed at reducing the degree of uncertainty and minimizing potentially adverse factors (active actions), or inaction (in the hope of explaining the situation or the insignificance of potential losses against the background of the estimated costs of efforts).

The identified criteria for responding to the variability of the external environment and its uncertainty made it possible to formulate the following conditional models for responding to uncertainty:

1. Expectation is a model of behavior focused on inaction or avoiding active actions in conditions of uncertainty in the hope that the disputed situation will resolve itself, thereby not being energy-consuming from efforts, but draining the emotional resources of a person.

**Fig. 1** Uncertainty response models in a volatile environment. *Source* Authors



2. Acceptance is a style of response that involves agreement with the existing uncertainty of the external environment, both positive and negative forms of its manifestation.
3. Research is the manifestation of attempts to reduce the degree of uncertainty for the subsequent development of more rational solutions, which requires the use of great effort to clarify the exciting moments in the current situation.
4. Influence—minimization of possible negative consequences makes it necessary to take actions to adjust the orientation of the influence of environmental factors. Requires the individual to use his resources in order to get a more desirable result in the long term than other participants in conditions of uncertainty.

It is important to note that the emotional color of the state of uncertainty varies depending on the nature and source of uncertainty [6]. This implies a different perception of events: for one person, the resulting situation of uncertainty will be commonplace, and for another—a new source of stress.

The stress level will correspond to the subjective level of significance and changes in a person's life from choosing a specific alternative. The experience gained in interacting with alternatives of one nature helps individuals to increase tolerance towards them, which allows them to respond to them in the future in a less energy-consuming way. At the same time, more complex levels of uncertainty (for example, events with a strong level of global impact under the name “Black Swan” [7]) require more developed models to respond to them using both characteristic tools and combining several models at the same time.

Therefore, it becomes especially relevant to study the applied models of response to uncertainty using the example of future managers studying at Samara State Economic University due to the fact that management activities involve active interaction with various forms of uncertainty. It is rare that in order to develop solutions, the manager has all the necessary information, more often there is a situation with its lack or complete absence.

Total, 100 respondents took part in 1–4 undergraduate and 1–2 master's courses, among which 80% were female, and 20% were male. The result of the analysis of the applied models of response to uncertainty in the conditions of changes was the obtaining of the structure of their distribution, which are shown in Table 1.

The most common form of interaction with uncertainty among students can be recognized as its study to achieve the most balanced results, which is consistent with the above data. The second most common among behavior models is the implementation of steps to manage and affect environmental factors to obtain qualitatively higher results. The predominance of these forms of response to uncertainty in a volatile environment is extremely useful for future management personnel. A less favorable result is that respondents, for the most part, are rigid in terms of choosing a model for responding to uncertainty, using only one of the described behaviors—their share is 55% of the sample. However, the rest uses more extensive tools when interacting with uncertainty. A positive result characterizing the present sample is the predominance of active models of interaction with uncertainty. Their mastery and popularity among holders of managerial specialties is useful due to the need during

**Table 1** Structure of distribution of applied models of response to uncertainty

| Name                                      | One model | Two models | Three models | Four models | Total |
|---|-----------|------------|--------------|-------------|-------|
| Media count                               | 55        | 26         | 17           | 2           | 100   |
| Acceptance                                | 6         | 5          | 13           | 2           | 26    |
| Expectation                               | 13        | 13         | 8            | 2           | 36    |
| Influence                                 | 13        | 14         | 14           | 2           | 43    |
| Research                                  | 23        | 20         | 16           | 2           | 61    |
| Number of combinations of response models | –         | 52         | 51           | 8           | 111   |

*Source* Authors

their professional activities to both process significant amounts of information and find an impact on the controlled system during the development of management decisions.

## 4 Discussion

A change in behavior is accompanied by energy consumption, which, in turn, acts as an additional stressful factor. However, the transition between mastered models of response to uncertainty requires less cost for a more adaptive personality, unlike a rigid adherent of a single model of response to uncertainty. This makes it “profitable” to master new behavior strategies for more effective interaction with the external environment. The most difficult transition is from low-level to more intensive response models, as this requires the mobilization of previously inactive resources.

Turning to the issue of mastering new models of response to uncertainty, it is important to identify factors that can influence the change of behavior. One such factor is human values. The resulting contradictions between his system of values, principles, the way of thinking on the one hand, and the upcoming changes from various alternatives to uncertainty—on the other hand, prompts the individual to change the response strategy. At the same time, acceptance acts as the final state of correspondence between the person’s ideas about the optimal results of the event and the predicted outcome. Any significant deviations from this state require a change in response models until an acceptable result is achieved or a compensating complex is developed [8].

The second factor exerted on the model of behavior in conditions of change and uncertainty is reduced to social roles realized by a person in it. The change of social status and position in society occurs simultaneously with the need to comply with new social norms of behavior. These changes are associated with the emergence of new experiences, resulting from the assessment (both positive and negative) by society and may be accompanied by the need for strong-willed efforts and energy

consumption. The above changes entail the need to apply a behavior different from the usual one until the person reaches the balance state in the new environment.

The third factor, highlighted in the framework of the current study, acts as a consequence of the collision of the previous two. The discrepancy between the values of the individual held and the need to correspond to multi-directional social roles creates intra-personal conflict. Achieving a new state of balance or a slight change in the response model is a consequence of the prioritization between the importance of public opinion and the importance of conformity with one's own principles.

As part of the report « Skills of the future, what you need to know and be able to do in a new complex world», what you need to know and be able to do in a new complex world» an attempt is made to predict the future state of society, taking into account the existing trends in the automation of processes and the digital transformation of the world economy [9]. And the selected assumptions in the preparation of this forecast take into account the nature of the VUCA world, a vivid example of which is a more intensive passage through the stages of the life cycle of professions, which implies the need to master related specialties for the evolutionary adaptation of individual competencies to the new economic paradigm. These changes and new challenges to society are increasingly pressing the need for the formation and further study of models for responding to uncertainty. This is because the potential loss of a job due to the inability to adapt to the demands of the labor market in a turbulent environment acts as a strong stress generator of uncertainty. Thus, the development of behavior models in conditions of a changing environment and uncertainty can be of particular importance in modern dynamic conditions, especially among students of managerial specialties. The ability to maintain self-control in unstable conditions, an adequate response to changing environmental factors and obtaining positive results in crisis times is what a person with developed behaviors and their own tools is capable of. From the level of their development and skills of combined use help to form a moderate tolerance to stress, thereby improving its quality of life while maintaining performance.

## 5 Conclusion

The highlighted results of the study make it possible to conclude that it is necessary to develop competencies for working with uncertainty in students who contribute to the formation of a more tolerant attitude towards it. Given the fact that the sample consists more of management students, as well as the fact that each distinguished model of behavior hides its own unique tools for interaction with uncertainty, only a small part of future managers are able to not lose their temper in a turbulent and dynamically changing external environment to make adequate and optimal management decisions. This is especially evident during digital transformations.

Managers with developed competencies for working with uncertainty and response models are hypothetically able to more effectively implement changes and correct the company's development vector due to deeper structuring and detailed



actions. A clear and detailed action plan, awareness of the vector of the future development of the organization is favorably perceived by employees, reducing the level of stress and resistance to changes introduced, which leads to increased satisfaction with their work and the quality of life in general.

## References

1. Bityutskaya, E., Korneev, A.: Diagnostics of coping prerequisite: approbation of the questionnaire "types of orientations in difficult situations." *Psychol. J.* **1**, 97–111 (2020)
2. Kornilova, T.V., Razvaliaeva, A.U.: The rationality and intuition scales in S. Epstein's questionnaire REI (Russian approbation of the full version). *Psychol. J.* **3**, 92–107 (2017)
3. Mitina, O., Rasskazova, E.J.: Kuhl's and A. Fuhrman's self-government test: psychometric properties of Russian language version. *Psychol. J.* **2**, 111–127 (2019)
4. Bazhanova, N.A.: Personal readiness for change in the context of the study of the phenomenon of "expectations." *Acta Eruditorum Sci. Rep. Commun.* **2**, 169–178 (2005)
5. Kutuev, A., Malysheva, E.: Readiness of future managers to work in conditions of uncertainty. In: Ashmarina S.I., Mantulenko V.V. (eds.), *Digital Economy and the New Labor Market: Jobs, Competences and Innovative HR Technologies. Lecture Notes in Networks and Systems*, vol. 161 (pp. 583–589). Springer, Cham (2021)
6. Malinina, N.S.: The phenomenon of uncertainty in the ideas of modern youth. *Vestn. Cherepovets State Univ.* **4–3**(44), 154–156 (2012)
7. Zhabin, A.P., Volkodavova, E.V., Kandrashina, E.A.: Business risk management, or "Black Swan" COVID-19 as a test for antifragility. *Vestn. Samara State Univ. Econ.* **3**(185), 38–45 (2020)
8. Lazyuk, I.V., Beloglazova, Yu.A.: Cognitive styles and tolerance to uncertainty as factors of adaptation of students to training in higher education. *ANI Pedagogy Psychol.* **4**(33), 343–348 (2020)
9. Loshkareva, E., Luksha, P., Ninenko, I., Smagin, I., Sudakov, D.: Report "Skills of the future, what you need to know and be able to do in a new complex world". [https://worldskills.ru/assets/docs/media/WSdoklad\\_12\\_okt\\_rus.pdf](https://worldskills.ru/assets/docs/media/WSdoklad_12_okt_rus.pdf). (2017). Accessed 02 June 2020

# The Role of Digitalization in the Development of Russian Agribusiness Industry



A. B. Malina, N. N. Galenko, and E. P. Afanaseva

**Abstract** The paper deals with the role of digitalization in the development of Russian agribusiness industry. The authors of the paper studied the level of digitalization in the agribusiness industry of the Russian Federation. The paper presents an assessment of the digital technologies implementation in the national agricultural industry. The authors analyzed the digitalization experience of the Russian Federation entities in the agricultural sector. They also examined the introduction of information and innovative technologies by particular agri-industrial companies in the country. The authors of the paper believe that a merger of all digital services of agri-industrial enterprises into an integrated digital platform for managing all the key processes may become a prospective process in the near future. Agri-industrial producers will use more science-intensive digital technologies in the domain of big data, artificial intelligence, Internet of things, robotics, including integrated digital technologies such as “Smart Land Management”, “Smart Farm”, “Smart Garden”, and others.

**Keywords** Agribusiness industry · Digital economy · Digital technologies

## 1 Introduction

Today, all large agri-industrial enterprises in Russia are highly automated. However, there is a lack of services that will be able to improve production efficiency and perform economic tasks. Moreover, there is a disconnection among branches of agribusiness industries. One of the issue is that there is no a data base which is able to provide for total evaluation of development conditions such as reliable weather

---

A. B. Malina (✉)  
Samara State Technical University, Samara, Russia

N. N. Galenko  
Samara State Agrarian University, Kinel, Russia

E. P. Afanaseva  
Samara State University of Economics, Samara, Russia

forecast, land division, and identification of international markets in order to sell products. Both economic entities in agribusiness and the state are resolving the issues of the digital technologies implementation, which is an objective process related to the development in scientific, technical, and information progress. The Ministry of Agriculture of the Russian Federation is creating a national digital platform in the agricultural industry. The new aspect is aimed at optimizing production processes in agricultural producers' activities and integrating all previous stages of agribusiness digital transformation.

## 2 Methodology

The authors used an extensive list of general scientific and special methods of the economic research. The study allowed to assess the features of the digitalization introduction in Russian agribusiness industry. The authors identified the reasons that make difficulties in the digital transformation of the industry. The paper suggested the measures that are able to contribute to the agribusiness digital development. Due to the economic and statistical methods, such as monographic observation and dynamic analysis, the development trends in agribusiness digitalization were identified. The official statistical data of the Ministry of Agriculture of the Russian Federation became an information base of the study. In addition, the authors studied the works of national and foreign scientists and practitioners on the role of digital technologies in the agribusiness development.

## 3 Results

The current level of the technological development in the agribusiness industry within an international format is based on the use of digital technologies, artificial intelligence, robotics, increasing dependence on customer needs, and many other factors. It is called "AdgoTesh 4.0" [1]. The process resulted from scientific and technical modernization, digitalization, and the global challenges such as economic, environmental, social, and demographic. The purpose of the modern world agribusiness industry is beyond the pale of providing the population with food [2].

According to NIC, a population increase and projected growth of people's income will lead to the growth of demand for water, food, and energy by 40%, 35%, and 50% respectively by 2030 [3]. Consequently, the role of modern digital strategies for the sustainable development of the agri-industrial sector in particular countries including the Russian Federation is increasing [4].

We will be able to observe only in a few decades a cooperation between agriculture and agribusiness industry, medicine, engineering, and other sectors that will constitute a complete cluster of the global digital space in the country's and world economy. According to the researches, economic entities of the agribusiness industry

**Table 1** Digitalization in Russian agribusiness industries

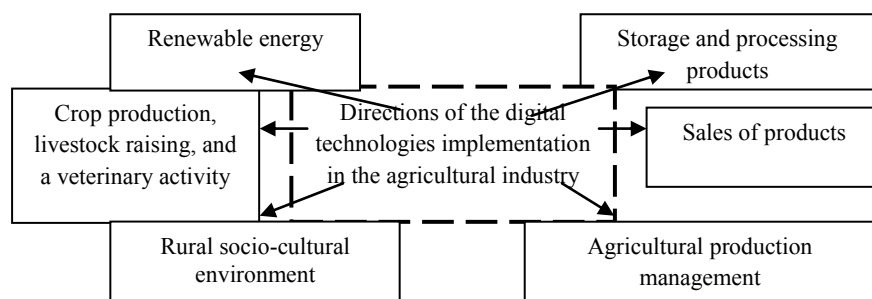
| Indicator   | 2020 | 2021 | 2022 | 2023 | 2023–2020 |
|---|------|------|------|------|-----------|
| Ratio of E-contracts concluded with grantees (of the total number of grantees), %                                 | 25   | 50   | 75   | 100  | +75 pt    |
| Ratio of Russian regions that implemented digital farm planning through the digital platform «Digital farming», % | 6    | 29   | 59   | 100  | +94 pt    |

Source Authors based on [6]

implement digitalization in their activities at their own expenses and on the basis of their own experience [5]. They determine themselves which areas of activity need to be digitalized first. Therefore, there is a need to implement state programs to support agricultural producers in their attempts to introduce digitalization. Table 1 shows the prospective digitalization development in Russian regions.

Not all agri-industrial companies support the digital strategy in Russia. Miratorg Company (the most robotic slaughter plant in Korocha, the Belgorod Region) and Cherkizovo Company (a fully robotic meat processing plant) are among the companies that introduced digital approaches into the entire chain of producing final products in accordance with all management processes. Figure 1 shows the main areas of digital technologies implementation in Russian agricultural industries.

The analysis has shown that the digital technologies, implemented in crop production, are aimed at the precision farming development, monitoring crops health, and using drones for fertilization. In addition, the digital technologies are widely introduced in order to forecast harvest productivity and crop losses, develop precision farming systems and landscaping maps, determine actual sowing areas, and improve automatic irrigation systems. The digital technologies in livestock raising are focused on livestock inventory, its characteristics, and food spectrum. In addition, some companies use artificial intelligence systems for unmanned driving agricultural vehicles. The digitalization of veterinary activities is primarily aimed at veterinary services robotics, livestock inventory, and distant health diagnostics.



**Fig. 1** Directions of the digital technologies implementation in the agricultural industry. Source Authors

The Belgorod Region created the worldclass Research and Educational Center “Innovative Solutions in the Agribusiness Industry” in accordance with the priorities in the scientific and technological development of the Russian Federation, national and regional transformation to highly efficient and environmentally friendly agricultural enterprises, and an increase in high-technology products.

An efficient technology for light-regulated crops cultivation in protected ground by LLC “Gelan” is one of the projects that is aimed at agribusiness digitalization. The company is planning to create cost-effective and managed LED lighting systems with microclimate and daylight control by December 2023.

The Altai Territory built a regional digital platform IS “RESPAK” that is included in the Unified Register of Russian programs for computing machines and databases. The digital platform promotes agricultural products of “Agricultural Producers’ Shop-window” and also provides regional agricultural producers with interactive counselling [7].

Nowadays, the state offers a grant support for up to 80% of the total cost of a project, and the amount of a grant is from 20 to 300 million rubles. The other obstacles that restrain the digital transformation of the industry are shortage of staff, migration of young specialists from villages, lack of confidence in costs justification, low digital literacy and conservatism, sabotage in the automation systems introduction and ensuring transparency of processes, and regulatory barriers in certification and technologies operation.

In order to implement the system, there should be clear incentives and motivation at all levels. The domestic market of digital technologies in the agribusiness industry is estimated at 360 billion rubles now. The Ministry of Agriculture expects it to grow by 5 times by 2026 [5]. Due to the united platform of digital services, producers will be able to significantly increase productivity, improve the quality characteristics of products, and reduce production costs. Owing to innovative technologies in processing and logistics, it will be possible to save on fuel, product packaging, storage, and shipment.

## 4 Discussion

The issues of implementing digital technologies in the activities of agri-industrial companies are considered by scientists from different countries. Kumar, Raut, Nayal, Kraus, Yadav, Narkhede revealed the fact that a lack of government support, incentives, and policy is a serious obstacle to the implementation of the Industry 4.0 (I4.0) and CE model in the agricultural supply chain (ASC) in India [8]. Chen, Li, Li considered Beijing organic farm Liuminying, as an example of a new concept, and offered a blockchain-based e-agriculture structure. The innovation of an agricultural farm model demonstrates a reliable way to achieve the digital agricultural democratization. According to the authors, it will be able to minimize asymmetric information, unreliability of third-party organizations, and poor monitoring of organic food [9]. Marshall, Dezuanni, Burgess, Thomas, Wilson payed attention to the fact that

Australian farmers have a low service availability level to digital technologies. The authors believe that the reason is an insufficient Internet infrastructure and limited technologies and data [10]. We agree with our colleagues that national governments need to consider the possibility of building digital skills development programs which are adapted for an agricultural sector.

## 5 Conclusion

When solving the issues of agribusiness digitalization, it is important to take into account national and international macroeconomic challenges, changes in consumer preferences, prospects for the digital technologies development, as well as the implementation of new business models. At the same time, the most important purpose is to get closer to the end user. Digital solutions need to be introduced into the value delivery in the agribusiness industry. The authors pay attention to the fact that enterprises have been implementing them. Consequently, it is necessary to increase not only the management efficiency, but also the efficiency of all agri-industrial production through the use of digital solutions. It is required to invest not only in CRM systems, but also in expensive equipment and digital production technologies. The main factors that hinder the agribusiness digitalization are financing, infrastructure, and personnel.

## References

1. Orlova, N.V., Serova, E.V., Nikolaev, D.V., Khvorostyanaya, A.S., Novikova, Yu.A., Yavkina, E.V., Bobkova, E.Yu., Ragozin, P.V., Yanbykh, R.G.: Innovative development of the agribusiness industry in Russia. Agriculture 4.0 Moscow: HSE. (2020)
2. Guskova, E.P., Malina, A.B., Myasnikova, V.M.: Regional food self-sufficiency assessment as a factor of national food safety. In: Ashmarina, S.I., Mantulenko V.V. (eds.), Proceedings of the 2nd International Scientific Conference GCPMED 2019 - Global Challenges and Prospects of the Modern Economic Development. European Proceedings of Social and Behavioural Sciences, vo. 79 (pp. 1400–1407). European Proceedings, London (2020)
3. National Intelligence Council: Global trends 2030: Alternative worlds. [https://www.dni.gov/files/documents/GlobalTrends\\_2030.pdf](https://www.dni.gov/files/documents/GlobalTrends_2030.pdf). (2012). Accessed 20 Mar 2021
4. Tsibareva, M.E., Malina, A.B., Brazhnikov, M.A.: Impact of Russian international trade on the global economy. In: Ashmarina, S.I., Horák, J., Vrbka, J., Šuleř P. (eds.), Economic Systems in the New Era: Stable Systems in an Unstable World. IES 2020. Lecture Notes in Networks and Systems, vol. 160 (pp. 794–799). Springer, Cham (2021)
5. Ministry of Agriculture of the Russian Federation: The experts told about the agricultural market capacity of the Russian Federation for investing in agricultural technologies. <https://mcx.gov.ru/ministry/departments/dit/news/eksperty-rasskazali-o-emkosti-agrorynka-rf-dlya-investitsiy-v-agrarnye-tehnologii/>. (2021). Accessed 20 Mar 2021
6. Analytical Center of the Russian Ministry of Agriculture: Information system of agribusiness digital services of the Ministry of Agriculture of the Russian Federation (2021), <http://mcxac.ru/digital-cx/interaktivnyy-modul/>. Accessed 24 Mar 2021

7. Vedomosti: digitalization of the agribusiness industry: opportunities and risks. [https://events.vedomosti.ru/events/spb\\_%D1%81ifrovaya\\_transformaciya\\_4/pages/spb\\_post\\_reliz](https://events.vedomosti.ru/events/spb_%D1%81ifrovaya_transformaciya_4/pages/spb_post_reliz). (2020). Accessed: 30 Mar 2021
8. Kumar, S., Raut, R.D., Nayal, K., Kraus, S., Yadav, V.S., Narkhede, B.E.: To identify industry 4.0 and circular economy adoption barriers in the agriculture supply chain by using ISM-ANP. *J. Cleaner Prod.* **293**, 126063 (2021)
9. Chen, Y., Li, Y., Li, C.: Electronic agriculture, blockchain and digital agricultural democratization: Origin, theory and application. *J. Cleaner Prod.* **268**, 122071 (2020).
10. Marshall, A., Dezuanni, M., Burgess, J., Thomas, J., Wilson, C.K.: Australian farmers left behind in the digital economy—Insights from the Australian digital inclusion index. *J. Rural. Stud.* **80**, 195–210 (2020)

# Artificial Intelligence Technologies in Tax Consulting and Forensic Tax Expertise



K. S. Pavlova and N. V. Knyazeva

**Abstract** The article is devoted to artificial intelligence technologies in the field of taxation, which are used by participants of tax relations, in particular tax consultants and experts in the field of economics and finance. Digital technologies became particularly relevant with the digitalization of tax administration processes in the world and in Russia. In particular, the Federal Tax Service of the Russian Federation provides more than 50 interactive services. This article reviews some trends in the artificial intelligence development and its application in the Russian tax system. Tax consultants and experts follow modern trends and use automated programs and products of tax authorities in their work, as communication between tax authorities and taxpayers is often built through electronic document flow. This requires the presence of special competencies in the field of digital technologies from all participants in tax relations. The article describes the main problems faced by tax consultants, experts and consumers of their services in the conditions of the global digitalization of the economy.

**Keywords** Artificial intelligence · Digitalization · Economic expertise · Forensic expertise · Tax consulting · Tax services

## 1 Introduction

Changing the paradigm of the global economic community in favor of the development of labor automation involves the integration of innovative products created using modern digital technologies into business processes. In 2019, the PwC announced a change in priorities in the economy and in society in connection with the beginning

---

K. S. Pavlova (✉)  
Samara State University of Economics, Samara, Russia  
e-mail: [mrs.pavlova@list.ru](mailto:mrs.pavlova@list.ru)

N. V. Knyazeva  
Assosiation of Professional Forensic Expertise, Moscow, Russia  
e-mail: [kniazeva@expertforensic.ru](mailto:kniazeva@expertforensic.ru)



of the Fourth Industrial Revolution (Industry 4.0) [1]. Industry 4.0 today involves the use of powerful artificial intelligence capabilities, namely:

- reorientation of production processes in favor of technical and digital innovations;
- replacing human labor with industrial Internet of Things technologies (hereinafter referred to as IIoT);
- training of the tax authorities staff in the framework of the digital economy competencies.

One of the industries that has already been affected by the radical changes is the financial and economic sector. Industry 4.0 technologies allow to innovate, customize and change business models, and use large amounts of data for more efficient decision-making. The development of e-commerce played a special role in digitalization. Nowadays, the identification and the location of a person can only be determined with a help of the bank card data. But if the buyer pays for goods or services via an anonymous payment system, it becomes impossible to identify him/her. The inability of tax authorities to trace electronic transactions in some cases as a problem is relevant for all countries. Such situation opens limitless possibilities for tax evasion because of the lack of reliable technological mechanisms. Therefore, it is necessary to develop new technologies that allow identifying transactions made in cyberspace. Today, major changes affect the financial control authorities, as well as the tax systems of the world powers. Innovations in Russia affected both the quality of tax administration and the functional involvement of participants in tax relations.

## 2 Methodology

The PwC 2019 report on “How Tax is leveraging AI-Including machine Learning” describes the main technological trends in the development of the tax system [1]. The implementations of the areas indicated in the report were reflected in the tax administration in Russia (Table 1).

The data in the table reflects the main interactive products used in tax administration. The official website of the Federal Tax Service of the Russian Federation provides a complete list of electronic services (more than 50 names) for users of tax information [3]. The main participants in tax legal relations are tax authorities (FCS of Russia) and their officials, taxpayers or their legal and authorized representatives, tax agents, customs authorities (FCS of Russia) and their officials. In the coming years, the Federal Tax Service of Russia plans to actively introduce such technologies as IIoT and technologies based on the IIoT concept, big data, user recognition technologies and blockchain, innovative methods of collecting, storing and analyzing big data, and cognitive systems. Artificial intelligence allows to get detailed and accurate data from new sources, to ask more detailed questions, give answers, and to perform automatic analysis that was previously difficult to access, or time-consuming, or even impossible. Artificial intelligence is able to perform tasks

**Table 1** Important trends in the development of artificial intelligence and their testing in the Russian tax system

|   |   |
|---|---|
| Digital trends in the development of the tax system                                       | Russian experience  |
| Global digital tax reforms  | As part of the implementation of the national program “Digital Economy of the Russian Federation” (hereinafter referred to the national program), a set of measures aimed at tax incentives of investors and companies that create digital high-tech projects was developed<br>The policy of the tax authorities is aimed at creating services for participants of tax relations through the introduction of artificial intelligence products [2]   |
| Digitization of large volumes of financial indicators of tax payers                       | The use and development of innovative methods of collecting, storing and analyzing big data for tax administration purposes, for example, VAT-3 ASK, online cash data storage programs, real estate data registers, etc. [3]  |
| Professional digital competencies of tax relations participants                           | Within the framework of the national program implementation, the development of competencies of tax relations participants in the field of regulation of the digital economy [2]  |
| The need to speed up the processes of data exchange between participants of tax relations | As part of the national program implementation, the development of competencies of tax relations participants in the field of digital economy regulation, work on improving existing and creating new interactive services of the Federal Tax Service of the Russian Federation [2, 3]  |
| The need for an effective system for assessing the performance of the tax system          | The work on improving the efficiency of the Russian Federal Tax Service operation, including application of digital technologies, is organized according to the detailed schedule for the implementation of the state program of the Russian Federation<br>“Public finance management and regulation of financial markets” [4]  |
| Creating a digital business reputation of tax relations participants                      | The following services were developed for organizations to confirm the positive business reputation of the company and to show due diligence when working with counterparties: <ul style="list-style-type: none"> <li>• the state information resource of accounting financial reporting was formed on the basis of the information provided by the compilers of reporting;</li> <li>• it is possible to provide information from the Unified State Register of Legal Entities/Unified State Register of Private Entrepreneurs in electronic form;</li> <li>• a service is created to verify the addresses specified during state registration as the location of several legal entities [3]</li> </ul> |

(continued)

**Table 1** (continued)

|   |   |
|---|---|
| Digital trends in the development of the tax system                     | Russian experience  |
| The need to implement automated models for calculating and paying taxes | The official website of the Federal Tax Service of Russia presents automated calculators for taxes that the tax authorities calculate for taxpayers: <ul style="list-style-type: none"> <li>• transport tax;</li> <li>• land tax;</li> <li>• personal property tax;</li> <li>• tax paid in connection with the application of the patent tax system;</li> <li>• mobile application “My Tax”;</li> <li>• interactive services of the Federal Tax Service for the payment of taxes [3]</li> </ul> |
| Automated tax risk assessment and forecasting system                    | Development of risk analysis tools and remote automated control, voluntary fulfillment of the taxpayer’s obligations in full through the use of interactive services: “Business risks”, “Transparent business”, “Tax calculating the tax burden” [3]  |
| Communication via bot chat  | In the “Personal Account of the taxpayer for individuals”, artificial intelligence is used: the robot “Taxik” is a botchat, which helps the population to solve various issues related to tax administration [3]  |
| Artificial intelligence in customs procedures                           | Software products of the electronic customs service of the Federal Customs Service of the Russian Federation, services of the Federal Tax Service Inspectorate for checking the status and availability of a document for customs clearance [3, 5]  |

*Source* Authors

of various levels of complexity, simulating the actions of real participants in tax relations with high speed and accuracy of decision-making. Technological capabilities can be applied throughout the entire life cycle of the subject of tax legal relations regarding the formation of the tax base and payment of taxes: from business planning to the formation of tax reports, as well as the regulation of controversial issues.

Following the trends of the new digital way of the economy obliges all participants in tax relations to develop digital competencies and implement automation systems in the accounting and/or tax accounting of economic entities. Changes in the structure of tax consulting services, audit and expertise in the field of taxation, including non-procedural and forensic expertise, are becoming an urgent issue. Tax experts should have the flexibility to adapt to rapidly changing electronic technologies; the knowledge and skills to provide the necessary assistance to public authorities in legal processes, conduct non-procedural research on the assignments of participants in various businesses, and conduct risk assessments in these new circumstances. In the new market conditions, consulting companies will be much more effective if they increase their own level of readiness for digital transformation. Using the artificial intelligence resources and interactive software products, tax authorities and specialists will be able to find relations and interdependencies to deal with emerging risks effectively and predict changes in the risk portfolio.

### 3 Results

On the one hand, the introduction of digital technologies improves and automates the processes of providing services in the field of tax consulting and expertise in the area of economics and finance. The vast majority of business entities use software products for accounting and tax accounting, including the services of the Federal Tax Service of Russia. For example, most companies submit reporting, respond to requests from tax authorities, and exchange documents with the Federal Tax Service of Russia via telecommunications channels. Accordingly, in their work, specialists in the field of taxation have long been actively using digital competencies that involve the possession of modern digital products. Modern consulting organizations offer various sets of digital tax services, for example, the multinational audit company EY—one of the 4 leaders on the international market, offers the following areas:

- the effectiveness of digital solutions in taxation. Determining the tax consequences of business strategies, models, and supply chains;
- digital tools for tax administration. Selection of services that take into account the requirements of digital systems of tax authorities, constant changes in regulatory standards and stricter requirements for transparency of financial and economic operations of enterprises;
- tax technologies. Selection of productive tax tools and services;
- big data in the field of taxation. Analysis of the possibilities for using data for their visualization and providing analytics [6].

During the COVID-19 pandemic, the digital transformation of business and its processes is mostly relevant. Remote work without direct social contacts allows to save customers and jobs in a difficult period of current restrictions due to the complex epidemiological situation. According to a PWC survey in 2020, 78% of company executives recognized remote mode as a long-term consequence of the pandemic, which caused the acceleration of business automation in the world and in Russia. 92% of the respondents surveyed took measures to protect the health and safety of employees around the world. 61% of heads of organizations believe that the share of employees in offices will decrease, this will be an additional incentive for the development of remote platforms, in particular in the field of professional services of tax specialists [7].

However, there are also negative aspects of digitalization, primarily related to the youth and imperfection of interactive systems, as risks that are not directly related to technology increase. The main problem is the cybersecurity of participants in tax legal relations, because a violation of data confidentiality can have serious consequences even for a pilot project. The issue that needs to be addressed also remains the provision of personnel security in the realities of the development of modern IT technologies. Cybercrime can cause significant economic and reputational damage to expert companies or consulting organizations that provide services in the field of taxation. Modern methods are needed to protect the data of the organization, its employees, and, last but not least, to protect customer information. In today's reality,

consultants and experts work with many data and documents remotely. Copies of information databases are used and transmitted remotely. In these copies tax and accounting records of client organizations are maintained. Confidential correspondence are conducted via e-mail, and various documents are exchanged electronically. Such a modern situation requires the company's employees to comply with special protocols that limit the use of gadgets and software products for personal purposes. The programs of digital development of consulting and expert organizations should necessarily include methods for diagnosing and preventing cyber threats, and the impact on the image of digital thinking of the entire human capital of the company. To do this, it is necessary to train employees in the safe use of computer technologies. Such knowledge is aimed not only at improving the security of the organization, but also at developing the professional competencies of the specialist. When concluding a legal agreement between an employee and an employer (signing an employment contract, etc.), it is necessary to sign an agreement on personnel security with the employee. The agreement have to clearly and fully describe the rights and obligations of the employee in the performance of their work functions, as well as the responsibility for causing harm to the organization, in case of violations of the agreement provisions.

Another problem is related to incorrect algorithms of artificial intelligence, which is not able to analyze and take into account all the industry specifics of the enterprise and the features of the accounting policy applied by it for tax purposes without the participation of a specialist in the working process. If you entrust everything to artificial intelligence without conducting control, then undesirable consequences can occur. Incorrect or inaccurate identification of taxable items can cause significant damage to the financial performance of an organization, for example, incorrectly calculate the tax base or incorrectly reflect data in accounting (financial) or tax reporting. Digital initiatives change the approach to assessing tax and financial risks: in an era of constantly updated information, there is a need for digital risk management. Therefore, specialists and experts in the field of taxation need to transform their own service delivery processes, since their activities are based on the use of digital products in taxation and accounting.

The new realities of organizing remote work in the context of the COVID-19 pandemic have become a catalyst for identifying the difficulties associated with the use of artificial intelligence technologies in tax consulting and forensic expertise. The main problem was the inability to conduct face-to-face external control events in the office of the services customer. Accordingly, access to the original documents is clearly restricted, which made it difficult to confirm their authenticity, since not all companies have switched to electronic document flow. In this regard, the procedure for document exchange between tax specialists (consultants, tax experts) and taxpayer organizations also become more complicated. The documentation submitted to the specialists for verification required explanations, and the missing documents had to be requested additionally. Signing contracts, additional agreements, and acts of work performed without the possibility of a personal meeting also took a lot of time and delayed the timing of inspections. At this stage of digitalization, the issues

of automated identification of producers and consumers of professional tax services for the registration of contractual relations remain unprocessed.

Experts and consultants, as part of the work carried out and services rendered due to the restrictions associated with the COVID-19 pandemic, were not able to perform visual inspections of the client's existing assets, study the subtleties of the production process, which could have a significant impact on the formation of the cost of production and the attribution of expenses to production costs accounted for tax purposes. In connection with the remote mode, fac-to-face interviews with staff moved to a new interactive format—video conferences. Communication with the use of modern Internet technologies is not yet perceived by all employees of financial and accounting departments, as many of them get used to technical innovations really slowly. In general, procedures involving direct communication with clients, obtaining explanations on financial and economic operations and document flow are still difficult to imagine without live communication. In addition, in order to increase productivity in the process of real communication, it is easier to establish contact by using the psychophysiological characteristics of the individual to the need for social interaction.

A complex issue in the era of the development of artificial intelligence is the professional judgment of an expert, which cannot be processed by digital algorithms. The decision of most issues depends on professional judgment, for example, situations related to the recognition of expenses and incomes for tax purposes; issues related to the assessment, classification of tax accounting objects, and as a result, the decision of issues related to the formation of the tax base, the reflection of information in tax reports and the specifics of tax administration. Experts and tax consultants make decisions based on the industry specifics of the client's financial and economic activities, the accounting policy, the legislative framework, judicial practice, and existing recommendations and explanations of the competent authorities established by the client. However, the final decision of a specialist is always based on his experience and his objective assessment of the facts in conditions of uncertainty.

The professional judgment of the expert and tax consultant is based on the intellectual capital of the individual, which in turn forms the total human capital of the organization. The intellectual capital of an individual employee should be understood as the individual's possession of a combination of competence, the level of qualification necessary for the work performed, the ability to perform labor actions declared by the employer and meeting the task or professional standard, personal and business qualities, creative thinking and receptivity to changes in the natural way of things, including the introduction of digital technologies and automation of production processes (the definition is formulated by the authors). In their professional activities, the employee exchanges these qualities for motivational achievements and monetizes them into rewards.

## 4 Discussion

The area of artificial intelligence is experiencing a period of intense progress, thanks to the consolidation of key technological factors. Artificial intelligence is already widely used and has a great impact on work and everyday life. The process of digitalization of the world economy contributes to profound economic and social changes [8–10]. The problems and prospects of the development of artificial intelligence are widely discussed in the world scientific community. For example, in recent years, the interactive exchange of financial and tax information has increased in the European Union, and tax administration processes have been automated. To increase financial and tax transparency, EU uses:

1. Unified standard for automatic reporting exchange—AEOI.
2. Payment banking directive PSD2, which provides a modern system for protecting users data.
3. Automated MiFID2 directive, which is used for operations on the European Stock Exchange.
4. Specialized data protection protocols—data retention policies.

However, scientists are concerned about the risks that have arisen as a result of digitalization, which affect participants of tax relations. First of all, these are the risks associated with the technology of processing tax and financial information in the Big Data format. The effectiveness of the algorithm of the software product and the cyber-protection of the information and personal data uploaded to it have not yet been 100% proven. The influence of the processes of digitalization of the international economy on modern tax law and financial law is also studied [11]. An important issue remains the observance and protection of the rights of taxpayers in the processes of digital transformation and the use of artificial intelligence products. Faúndez-Ugalde, Mellado-Silva, and Aldunate-Lizana analyzed the preservation of taxpayers' rights in tax administration and in tax disputes with tax authorities in Latin America [12]. The introduction of interactive software products in German tax consulting and the study of the specialists readiness to automate work processes was studied by Diller, Asen, and Späth [13].

## 5 Conclusion

Digitalization of tax services is an integral part of the modern workflow of organizations that provide services in the field of tax consulting and economic expertise. Special attention should be paid to the implementation of personnel security procedures at the enterprise providing these services to protect the data and information of the organization, its employees and confidential customer data. To ensure the effective work of the organization's employees, it is necessary to pay more attention to the human capital of the enterprise. It requires specialized personnel development of

companies in the field of economics and finance, aimed at mastering modern digital competencies by employees, closer interaction with stakeholders through electronic document flow, and the most effective combination of sharing both direct analytics with the help of a specialist and automated tools in the work.

The professional judgment of a specialist in the field of taxation includes knowledge of certain aspects of taxation of organizations and/or individuals, as well as modern technical means of collecting information about tax objects, building a tax accounting system, calculating the amount of tax, transmitting information to the tax authorities and controlling the tax payment process. In the digital economy, a tax consultant or forensic expert in the field of economics and finance of the specifics of taxation will need to develop new or improved skills in terms of knowledge of modern technical means, the adaptation ability, knowledge in the following spheres: IT technologies, data analysis and cybersecurity, strategic management, consulting, audit, taxation, accounting. The most important of them will be analytical skills, the ability to process and structure large information blocks. Digital economy technologies enable the introduction of remote services, which helps to reduce the time spent on their provision. In the context of digital economy, promising operation areas include the application of Big Data technology. This technology provides instruments for processing huge volumes of structured and unstructured information. Successful management of tax risks, as well as an adequate assessment of the identified distortions or errors made by the taxpayer in the formation of tax objects, is impossible without the use of statistical methods by tax consultants or forensic experts, methods of analysis in synthesis with the capabilities of the digital economy (the use of Big Data, neural networks, blockchain).

## References

1. PwC: How tax is leveraging AI—including machine learning—in 2019 (2019). <https://www.pwc.com/gx/en/tax/publications/assets/how-tax-leveraging-ai-machine-learning-2019.pdf>. Accessed: 24 Mar 2021
2. Passport of the national program “Digital Economy of the Russian Federation” (approved by the Presidium of the Presidential Council for Strategic Development and National Projects, protocol N 16 of 24.12.2018) (2018), [http://www.consultant.ru/document/cons\\_doc\\_LAW\\_319432/](http://www.consultant.ru/document/cons_doc_LAW_319432/). Accessed 04 Mar 2021
3. Federal Tax Service of the Russian Federation: Services and government services (2021), [https://www.nalog.ru/rn77/about\\_fts/el\\_usl/](https://www.nalog.ru/rn77/about_fts/el_usl/). Accessed 05 Mar 2021
4. Resolution of the Government of the Russian Federation of 15.04.2014 N 320 (ed. of 30.12.2020) “On approval of the state program of the Russian Federation “Public finance management and regulation of financial markets” (2020), [http://www.consultant.ru/document/cons\\_doc\\_LAW\\_162186/](http://www.consultant.ru/document/cons_doc_LAW_162186/). Accessed 04 Mar 2021
5. FCS of the Russian Federation: electronic customs (2021), <https://customs.gov.ru/ecustoms>. Accessed 05 Mar 2021
6. EY: Digital technologies in taxation (2021), [https://www.ey.com/ru\\_ru/tmt/digital-tax](https://www.ey.com/ru_ru/tmt/digital-tax). Accessed: 04.03.2021



7. PwC: 23 Annual survey of executives of the world's largest companies (2020), <https://www.pwc.ru/ru/press-center/2020/rukovoditeli-priznali-rezhim-udalennoy-raboty.html>. Accessed 24 Feb 2021
8. Feijóo, C., Kwon, Y.: AI impacts on economy and society: latest developments, open issues and new policy measures. *Telecommun Policy* **44**(6), 101987 (2020). <https://doi.org/10.1016/j.telpol.2020.101987>
9. Feijóo, C., Kwon, Y., Bauer, J.M., Bohline, E., Howell, B., Jain, R., Potgieter, P., Vu, K., Whalley, J., Xia, J.: Harnessing artificial intelligence (AI) to increase wellbeing for all: the case for a new technology diplomacy. *Telecommun. Policy*, **44**(6), 101988 (2020). <https://doi.org/10.1016/j.telpol.2020.101988>
10. Vesnic-Alujevic, L., Nascimento, S., Pólvara A.: Societal and ethical impacts of artificial intelligence: critical notes on European policy frameworks. *Telecommun. Policy*, **44**(6), 101961 (2020). <https://doi.org/10.1016/j.telpol.2020.101961>
11. Politou, E., Alepis, E., Patsakis, C.: Profiling tax and financial behaviour with big data under the GDPR. *Comput. Law Secur. Rev.* **35**(3), 306–329 (2019). <https://doi.org/10.1016/j.clsr.2019.01.003>
12. Faúndez-Ugalde, A., Mellado-Silva, R., Aldunate-Lizana, E.: Use of artificial intelligence by tax administrations: An analysis regarding taxpayers' rights in Latin American countries. *Comput. Law Secur. Rev.* **38**, 105441 (2020). <https://doi.org/10.1016/j.clsr.2020.105441>.
13. Diller, M., Asen, M., Späth, T.: The effects of personality traits on digital transformation: evidence from German tax consulting. *Int. J. Acc. Inf. Syst.* **37**, 100455 (2020). <https://doi.org/10.1016/j.accinf.2020.100455>

# Economic Sustainability of Modern Banking Organizations Based on Digital Technologies



O. V. Petryanina and E. V. Revina

**Abstract** This article is devoted to modern trends related to the improvement of the banking branch of the Russian Federation. These include, first of all, actively introducing digital technologies, which have recently become a prerequisite for ensuring the sustainability of many sectors of the economy, including modern monetary institutions. The author analyzes the strengths and weaknesses of the result of this process, and also details the properties of financial technologies as the most important elements of the digitalization process. The role of this element in the system and the level of its relationship with various banks are evaluated. The recommendations developed during the study on improving the activities of banks, increasing their efficiency in reply to the new needs of public, and, therefore, new technologies provide an opportunity to better determine priorities and build directions for the development of the banking system during the economic decline and the increase in economic and political risks.

**Keywords** Banking industry · Customer orientation · Digitalization · Digital transformation · Digital service · Sustainability

## 1 Introduction

Today, in the era of the information society, influenced by the accelerated process of globalization, the need to improve the economic system by transferring most of the procedures to the Internet is becoming more and more important. It is absolutely obvious that the well-established methods of conducting economic operations force the entire system to stand still, or to degrade. Technologies of the digital economy give impetus to the development of the country's economic situation.

---

O. V. Petryanina (✉)  
Samara State University of Economics, Samara, Russia

E. V. Revina  
Samara State Technical University, Samara, Russia

In most industries, Russia has a certain level of lagging behind in economic development compared to Western countries. Legislatively, the goal of integrating digital technologies into the Russian economy was reinforced in 2017 with the issued Decree of the President of the Russian Federation of 09.05.2017 No. 203 [1]. The prerequisite for this decree can be considered the formation of a system, which elements are organizations that ensure the process of interaction with each other on an ongoing basis through various Internet services, online platforms, etc.

First of all, the innovations of the digital economy affected the banking sector. Its main operations are to control the exchanges of gold and foreign exchange resources, thus sponsoring more mechanisms of the world economy. Banks are the groundwork for the construction of a balanced economic development in all sectors of the economy. Therefore, the study of various aspects of the introduction of innovational technologies into the activities of domestic financial enterprises attracts increasing interest.

In addition, the problem of digitalization of services and client service has become especially relevant for the banking sector during the pandemic and economic crisis. The main challenge faced by enterprises in almost every branch of the Russian economy over the past year is to adapt to the changed needs of customers and transform their services according to new realities. New trends have forced banking segments to react.

Improving financial performance requires an accurate understanding and study of the advantages and disadvantages of implementing digitalization technologies. Obtaining high performance indicators of economic operations in the online space is possible only with a careful assessment of these innovations relative to the target audience who will use them.

Based on the results of this assessment, digital technologies can be regulated both at the initial stage of their development and at subsequent ones. An analysis of existing implementations in the banking industry will allow tracking the consequences, as well as the prospects for their further dissemination. It is required to study the main statistical indicators of the use of digital technologies in banks in order to shape the attitude of consumers to such changes, to improve the quality of financial services.

The above allows us to outline the main purpose of paper: to conduct a comprehensive analysis of the rate of digitalization of Russian banks, taking into account performance indicators.

To write the work, the following tasks are set:

- analyze the experience of implementing digital technologies in the banking system of Russia;
- to determine the level of dependence of credit institutions on the availability of digital technologies in their activities as a service sector;
- substantiate the importance of digital transformations for all banking processes;
- to identify the most developed domestic banks in the field of innovations.

## 2 Methodology

The topic of sustainability of the Russian economy and its banking system is very relevant and practically does not go off the pages of economic literature. The current financial and economic crisis caused by the COVID-19 pandemic has become an additional impetus to the expansion of the analysis of this issue.

The theoretical and methodological basis of the article is represented by the works of such scientists as Degl'Innocenti, Fiordelisi, Trinugroho [2], Lavrushin [3], Nabeeh, Abdel-Basset, Soliman [4], Shubbar, Girinsky [5], touching upon the issues of sustainable development of credit and commercial institutions. The problems of the operating of the banking management system in the context of digital transformation are reflected in the papers of Alekseeva [6], Kovaleva [7], Kumar, Kumara [8], Petrova, Kuznetsova [9]. Modern methods of forming the digital financial services market are outlined in the studies of Garga, Gupta, Chauhan, Sivarajah, Gupta, Modgil [10], Kanakov, Prokhorov [11], Ortaköy, Özsürünç [12], Samiev, Zakirova, Shvandar [13].

Note that there are still differences in the concepts of “stability” and “stability”, although often the difference between them is erased. The definition of stability has many modifications. Stability is broadly understood to mean the ability of a system to recovery to a stability state after it has been removed from this state under the influence of external or internal influences [3]. The content of the concept of stability is defined as the state of the system, the preservation of its features and parameters in any situations. Sustainability is achieved on the basis of stability. Therefore, stability really gravitates to static, while in the concept of “stability” movement, development is more visible.

Both indicators are important for the commercial success of any financial structure, dependent primarily on its sustainable development efforts. The term “sustainable development” became one of the main principles of international cooperation only at the end of the twentieth century. The main purpose of the provisions of this concept is to eliminate the contradiction between the rapidly growing material needs of mankind and the limited resources of the planet, as well as to eliminate the problem of misallocation of resources [4].

The modern generation differs in thinking tied on responsible consumption. Today a considerable advantage of the companies that apply the ideas and the principles of sustainable development realize the influence on the environment, consider the needs of society in general and take an open position in external communications and in reporting on their activity [2]. Thus, business increases the competitiveness, authority and attractiveness for big customers and investors. The banking industry isn't an exception. The sustainability of the bank's economic activity depends largely on its financial results, the level of risks it takes, in combination with its liquidity and profitability, which can be considered as its qualitative condition and as a form of its progressive movement [5]. By economic sustainability, we mean the ability of the system to maintain a certain level of achievement in a dynamic transformation of a business environment.

Banking business in recent years, both in Russia and in the world, has undergone a number of significant changes—primarily due to the introduction of digital technologies, the development of non-bank services and ecosystems. With the help of digital technologies, banks can customize services for the individual needs of each particular client; moreover, they can serve as providers of a wide range of services, including non-financial ones [6].

The financial market began to experience transformation since the mid-2000s, when remote banking services began to develop in many countries amid the growth of the Internet. In the United States, the first “digital” business models of a bank without branches appeared which subsequently influenced the Russian market.

What does the “digital bank” represent today? This is primarily a bank without branches, which are replaced by employees of banking or outsourcing call center, as well as a courier service or an offline partner network. Also, of course, it is a bank with developed mobile and Internet banks. Already, the call center is gradually being replaced by bots, and couriers—the possibility of identification through the recently launched state system (Unified Biometric System, EBS) and tokenization of bank cards.

Over the past fifteen years, Russian classical banks have invested heavily in updating and developing automated systems, remote channels, business processes and the level of development of digital services has approached digital banks, and due to the versatility of business models for many products, they look more attractive and complex from the point of view of remote service. In general, measuring the level of digitalization of a classic bank is not an easy task, and today there is no single method for assessing the degree of digitalization. If we talk about upper-level metrics, here, as a rule, we focus on:

- business process automation indicators;
- development of self-service channels (services and functions available in digital channels);
- speed of operations (offline, online, in real time);
- the level of data management development, including machine learning, data governance;
- 24/7 service availability;
- rate of change, time-to-market.

The main indicators, which are also affected by the listed properties, are the share and volume of online sales and service operations. These parameters make it possible to understand how effectively the bank works with its customers in the digital environment.

Consider the key challenges facing classic banks in the era of digitalization. The first trial is directly caused by the high speed of digitalization, the movement of customer online activity and the high level of development of remote services—it is necessary to learn how to convert the huge traffic of contacts with customers in digital channels into an increase in sales and business development. In the development of the business model of the classic bank today, two main priorities can be distinguished—to modernize the IT landscape, “pump” technologies and processes

in order to significantly accelerate time-to-market, and on the other hand, learn how to get business returns in digital channels along with providing high-quality service for customers. Cloud CRM systems, as a rule, are best adapted to the tasks of a digital bank, since the SaaS model, in fact, is itself a business in a digital environment [10]. Along with these technological blocks, the integration layer is extremely important for the modern bank, which is often a set of technologies, solutions, adapters, components and modules to ensure the interaction of information systems. In this regard, recently a new trend has been actively promoted and implemented—a micro service architecture that helps to implement a large number of weakly connected programs within a certain infrastructure [12].

The “face” of a digital or modern classic bank, of course, is remote digital services—Internet banks, mobile banks, personal offices, websites and other specialized services for private and corporate customers. These channels account for more than 90% customer contacts that occur 24 h and 7 days a week. In large cities with developed Internet, classical banking has already become digital in many ways. Therefore, banks direct a significant part of investments to improve customer experience in digital channels, introduce new services and functions, simplify interfaces, increase reliability, security, availability and speed of online services. In connection with the development of mobile Internet and smartphone technologies today, the mobile application has become a key channel. Obviously, in the coming years, the mobile bank will be the main element of the business model of any bank working with the mass segment.

### 3 Results

Due to the growing number of banks in the financial market, competition is intensifying, and subsequently they need to modify and introduce new technology into their operations to maintain a higher position than competitors. In addition, the pandemic further exacerbated the competition between banking organizations for the client, as well as changed the behavior of customers.

Below, we will analyze in detail the rating compiled by the Skolkovo Foundation and a resident of its information technology cluster, VR\_Bank, according to the results of 2020 [14], as well as the results of the Markwebb Internet Banking Rank 2020 study [15], conducted on the basis of an assessment of the quality of customer experience in Internet banks. All data are collected from open sources and clearly demonstrate “digital gaps” and what leaders emphasize.

Tinkoff, VTB, SberBank, Raiffeisenbank and Alfa-Bank are leading among the top 50 Russian banks in terms of digitalization. The positive trend was demonstrated by Sovcombank, Home Credit Bank, Ural Bank for Reconstruction and Development. The top ten also includes Otkritie and Ak Bars banks. The leaders of the rating—Tinkoff, VTB and SberBank—are official partners of Skolkovo and invest significant resources in research, IT and startups. This allows them to quickly launch digital services, attract new customers and increase returns on capital.

The study showed that a single quality bar was formed in daily banking: all banks solve the most popular user problems in basic ways. Now market participants are focused on supporting customer satisfaction. The best online banks solve the problems of users more fully and conveniently, their interfaces are thought out to the smallest detail and do not force them to do unnecessary actions.

One of the leaders of Russian financial business models today is Tinkoff Bank, which, against the backdrop of the already good quality of the digital bank, continues to develop digital services: in 2020 it has had a well-thought-out onboarding, navigation has been updated, fundraising scenarios have improved, and analytics have become more convenient.

In 2020, Otkritie Bank broke into the ranking of the best Internet banks. Now it has translations on the System of Fast Payments (SFP) and cross-border transfers on cards, more opportunities for payment of the housing and communal services (HCS), the analytics of finance and history have become more convenient. Other leaders did not develop their services so rapidly: Ak Bars Bank worked on financial analytics and the convenience of transfers, and Levoberezhny Bank practically froze the development of an Internet bank.

In the middle of the rating from 5 to 15th places were banks with functional and convenient services, allowing users to solve their problems at a basic level. But to catch up with leaders, they lack analytics on the movement of funds, convenient transfers, debt requests and subscriptions, and automation of operations. The most successful in this direction were Rosselkhozbank and VTB in 2020. In the first one convenient transfer on SBP, subscriptions and history searches appeared. In the second one subscription to taxes, fines and utility bills, cross-border transfers to the card, a convenient search for service providers by ID number and their division into regions became possible.

Outsiders in the Markswebb Internet Banking Rank rating solve basic daily tasks of personal finance management at an average or low level [15]. They have limited opportunities for transfers (no SBP, replenishment from a card of another bank), lack a clear and convenient history of transactions, capabilities to automate operations, information on tariffs, data export and support in chat.

Of course, digital leaders developed their services long before the coronavirus and were generally prepared for the situation. Banks that have lagged behind in the development of digital services have seen significant changes. Against the background of self-isolation, banks tried to compensate for the drop in product sales in their branches by increasing online sales.

For many years, Tinkoff Bank has been the market leader in the quality of the digital office. However, this year there were banks that will soon equal Tinkoff in terms of customer experience: these are SKB-Bank, Raiffeisenbank and Otkritie Bank, which have made a powerful leap forward in development. The breakthrough of the year is the digital office of Otkritie Bank: in it you can open card and investment products, change personal data, receive the necessary certificates, and use chat to resolve any issues. Growth points are issuing a debit card for relative, purchasing and managing insurance products.

It is still difficult for banks in the middle of the rating to claim the same high level of solving user problems: they have limited personal data management, ordering documents and resolving disputes. Sberbank has great potential, which clearly invests in Internet banking as a tool for selling and withdrawing service operations from offices, and Home Credit Bank, which relaunched the Internet banking, focuses on a digital office. On the contrary, regional banks stopped fighting for the leadership of the digital office: for example, Bank of Kazan and Levoberezhny were developing basic capabilities.

Rosbank, Bank of St. Petersburg and Rosselkhozbank still adhere more to traditional office services, Moscow Credit Bank, Sovcombank, Unicredit Bank and Gazprombank practically do not invest in Internet banking. Alfa-Bank and Uralsib see the need for the development of digital services and are developing a new version of the Internet bank.

The possibility of remote registration of the product makes the bank no longer advanced in the market. It is important to improve the efficiency of these services so that they are readily used by customers. The limit of digital office development is still far away. Growth points are embedding digital cards in a customer journey debit card, selling simple investment products and convenient management of them, resolving financial issues related to the state, identifying third-party services through an online bank, managing legal documents.

## 4 Discussion

The digital transformation of the banking sector is constantly causing lively discussions in society, including in the banking and analytical communities. The current public attention is largely given to the opinion of the professional banking community, which unanimously recognizes the fact that digital services are a critical source of income for the Russian financial industry. According to experts, the rapid transfer of business processes to digital format has helped credit institutions in the Russian Federation in just a few years to ensure that the most daily operations are performed remotely. This also allowed Russia to become a world leader in the development of cashless payments.

Despite the fact that leading Russian banks already have a developed ecosystem of digital channels, the importance of digital transformation for the development of the banking sector remains. All strategic priorities in terms of technological development remain the same for the near future: the development of simple and convenient digital services in retail and corporate business. The epidemic has made it possible to more clearly shape the image of the bank of the future, which implies a minimum number of physical branches, extensive online opportunities and a network of partners that gives hundreds of customer's millions access to financial services.

A logical consequence of this was the aggravation of competition in the development of digital services: the vast majority of banks have taken measures to expand the functionality of mobile applications, which has become the main element of the



digital transformation of banking services [11]. The emphasis is placed on maximizing the use of innovative technologies, as well as on constant updating and modernization, which directly affects the competitiveness of the bank. The functionality of applications began to include not only the possibility of remote registration of banking products, but also the receipt of certificates, statements, and transaction histories. The quality and convenience of applications has become a serious influence on the assessment by customers of the quality of service in general [8]. According to AppsFlyer statistics, mobile applications prefer mainly customers of the age category up to 35 years, although the share of older customers is gradually growing [16]. The intensity of application use as a whole is also increasing: in March alone, the number of sessions in banking applications increased by 30% compared to February.

Today the Fast Payments system has become another key driver for the development of mobile banking. Its popularity is gradually increasing: in March 2020, the number of operations using the SBP increased by 9.5%, and the total amount of operations—by 37.5%. The main reason, of course, was the transition of many bank customers to remote work. The development of SBP is closely related to the improvement of mobile applications of banks. The competitiveness of the latter increases significantly with the introduction of the possibility of accepting payments by QR codes through the SBP. The number of such purchases in March has tripled compared to February 2020, and the total turnover has grown 2.7 times. As for individual banking products, in 2020 the share of online applications for cash loans (by 50%), for car loans (by 60%) and for mortgages (by 9%) increased significantly. Of the banking services that are especially popular amid the crisis, it is worth noting the issuance of interest-free “salary” loans at 0% per annum to small and medium-sized enterprises [7].

Along with online loans, consumers now have the opportunity to purchase goods completely remotely, including those for a significant amount (for example, cars). Remote services that are not directly related to monetary transactions are also available to customers: online consultations, remote account opening (including for new customers—using biometrics). Separately, it is worth noting the trend towards the distribution of fully digital cards, which can be issued in a mobile or Internet bank, and then used as a regular card, linking it to Apple Pay or Google Pay.

On the other hand, banks have difficulty launching new services: self-isolation has become a real digital stress test for many banks. Internet banking and mobile banking were clearly not enough. For example, according to the act of the Central Bank of the Russian Federation, it was allowed to open accounts remotely, but this opportunity was not implemented in all banks [17]. The reason is that digital services in banks are developed and provided by various departments in isolation: each service has its own customer, its own product and its own technology stack. As a result, users cannot move freely between channels using the same applications. The way out is to develop a single platform that will allow implementing services on all channels of communication with clients at once. Another difficult task faced by financial structures has been the transfer of their own employees to a remote mode of work. This entailed additional costs and reorientation of services. At the same time, banks had to optimize part of their costs and adjust a number of priorities IT budget items:

investments were made in the development of teleworking tools, the appropriate infrastructure and data protection [9].

So, the study allows us to distinguish the positive characteristics of the process of integration digital technologies in the organization of the banking industry. It is chiefly about increasing the level of productivity of the work collective through the introduction of information technology. Further mention should be made of reducing the dependence of the economic and production sectors on various phenomena, including the human factor began to play a less important role in the bank's activities, reducing the number of errors. The third advantage of digitalization of banks can be called the facilitation of the tax system and its control, since when all transactions were transferred to the online space; it became possible to monitor transparently their performance.

Of course, it cannot be said with confidence that the digital transformation of banks has an extremely positive effect without influencing factors and risks. The most common problem with this phenomenon is the protection of companies' data and information resources. Due to the development of globalization, the operations of the financial sector are increasingly under constant threat of hacking by representatives of the hacker direction. Therefore, the task of ensuring the required security of organizations is identified as particularly urgent [13].

An additional negative factor affecting the stable use of digital technologies in the activities of banks is the increase in unemployment in the banking industry due to the termination of the existence of a large number of banks as a result of the automation of financial transactions.

## 5 Conclusion

Thus, the coronavirus crisis has become a catalyst for the digital transformation of banking products and customer service. The pandemic has forced Russian banks to modernize infrastructure, cut costs and accelerate digitalization processes. These measures helped the sector to pass through the crisis with minimal losses. As the study showed, it is in digitalization that many banks see growth points for improving their activities and strengthening market positions. The digital development of the banking industry is spreading according to the following algorithm of stages:

- digitalization of the products and services provided;
- analysis of customer experience;
- transformation of the internal processes of the organization.

Of course, digitization is an efficient mechanism for the development of customer service and largely reduces the distance between the client and the bank. But the peculiarity of the banking industry, especially in the corporate segment, requires direct, face-to-face communication between the client and the bank's representatives. Direct negotiations are an integral part of the client-oriented approach, as they make

it possible to make an individual offer to the client, which determines most effectively its tasks.

It is also important to keep in mind the persistence of customer partnerships. Some of them at this time need not so much an individual approach and special services as confidence in the sustainability of support from the bank, a sense of support. Therefore, another important task is to give the client a sense of reliability, to provide constant support, for example, by organizing a convenient and always accessible online consulting system.

The main conclusion of the work is that the level of digitalization of banks has grown rapidly over the past year. During the pandemic, banks are forced to digitalize their products at an unprecedented pace, offering new services and entering into collaboration with startups. Altogether, this forms a fundamentally new digital environment.

## References

1. President of Russia: Decree of the President of the Russian Federation of 09.05.2017 No. 203 (2017). <http://www.kremlin.ru/acts/bank/41919>. Accessed 17 Feb 2021
2. Degl'Innocenti, M., Fiordelisi, F., Trinugroho, I.: Competition and stability in the credit industry: banking vs. factoring industries. *Brit. Acc. Rev.* **52**(1), 100831 (2019)
3. Lavrushin, O.I.: Stability of the banking system and the development of banking policy (2014), <https://docplayer.ru/27877129-Oleg-ivanovich-lavrushin-ustoychivost-bankovskoy-sistemy-i-razvitie-bankovskoy-politiki.html>. Accessed 03 Feb 2021
4. Nabeeh, N.A., Abdel-Basset, M., Soliman, G.: A model for evaluating green credit rating and its impact on sustainability performance. *J. Cleaner Prod.* **280**(1), 124299 (2020). <https://doi.org/10.1016/j.jclepro.2020.124299>
5. Shubbar, H., Girinsky, A.V.: Content and principles of stability of the banking system. *Bulletin of the Peoples' Friendship University of Russia. Series: Econ.* **27**(1), 63–71 (2019). <https://doi.org/10.22363/2313-2329-2019-27-1-63-71>
6. Alekseeva, D.A.: Digital transformation of the banking system. *Bull. St. Petersburg State Univ. Econ.* **5-1**(119), 159–162 (2019)
7. Kovaleva, N.A.: Actual aspects of modernization of the banking sector in a modern economy. *Financ. Markets Banks* **2**, 58–62 (2020)
8. Kumar, M.P., Kumara, N.V.M.: Market capitalization: pre and post COVID-19 analysis. *Mater. Today Proc.* **37**(2), 2553–2557 (2020). <https://doi.org/10.1016/j.matpr.2020.08.493>
9. Petrova, L.A., Kuznetsova, T.E.: Digitalization of the banking system: digital transformation of the environment and business processes. *Financ. J.* **12**(3), 91–101 (2020)
10. Garga, P., Gupta, B., Chauhan, A.K., Sivarajah, U., Gupta, Sh., Modgil, S.: Measuring the perceived benefits of implementing block chain technology in the banking sector. *Technol. Forecast. Soc. Change* **163**, 120407 (2020). <https://doi.org/10.1016/j.techfore.2020.120407>
11. Kanakov, F., Prokhorov, I.: Research and development of software robots for automating business processes of a commercial bank. *Procedia Comput. Sci.* **169**, 337–341 (2020). <https://doi.org/10.1016/j.procs.2020.02.196>
12. Ortaköy, S., Özsürünç, Z.: The effect of digital channel migration, automation and centralization on the efficiency of operational staff of bank branches. *Procedia Comput. Sci.* **158**, 938–946 (2019)
13. Samiev, P.A., Zakirova, V.R., Shvandar, D.V.: Ecosystems and marketplaces: an overview of the financial services market. *Financ. J.* **5**, 86–98 (2020). <https://doi.org/10.31107/2075-1990-2020-5-86-98>

14. Shustikov, V.: Skolkovo and VR\_Bank have made the third rating of digitalization of banks (2020), <https://old.sk.ru/news/b/pressreleases/archive/2020/09/28/skolkovo-i-vr-bank-sostavili-tretiy-reyting-cifrovizacii-bankov.aspx>. Accessed 24 Feb 2021
15. Markswebb: Internet banking rank 2020 (2020), <https://www.markswebb.ru/report/internet-banking-rank-2020/#anchor-about>. Accessed: 0 Feb 2021
16. AppsFlyer: the state of finance app marketing in Russia (2020), <https://www.appsflyer.com/ru/resources/finance-app-marketing-russia>. Accessed 07 Mar 2021
17. Central Bank of the Russian Federation: information letter No. IN-014-12/62 (2020), [http://www.cbr.ru/StaticHtml/File/59420/20200410\\_in-014-12\\_62](http://www.cbr.ru/StaticHtml/File/59420/20200410_in-014-12_62). Accessed 14 Mar 2021

# Digital Technologies and Insurance Market in Russia



A. A. Prosvetova

**Abstract** The main idea of the article is to characterize the process of implementing digital technologies in the activities of insurance companies. The main attention is paid to the prospects for the development of digital technologies in the insurance industry. The study was empirical and was based on the analysis of two groups of indicators: digitalization and insurance. Digitalization of the national insurance industry is manifested in the formation of the technological process of digital insurance, which determines the ratio of competing parties on the Russian insurance market. It is concluded that the model being formed is a new technological trend in the classical behavior of policyholders, due to the heuristic choice of insurance services based on the use of digital technologies.

**Keywords** Digitalization · Digital technologies · Insurance · Insurance market · Insurance industry

## 1 Introduction

Nowadays, the digitalization of our world has already transformed many industrial branches significantly. The insurance business is not an exception. Market experts and participants suppose that digital transformation will fundamentally change the value creation process in this industry which leads to the emergence of new interaction forms with customers, new business processes, new risks and new products. This article is a comprehensive review of the impact of digitalization on the insurance industry [1]. The introduction of digital technologies in the activities of insurance companies leads to the changes in the internal and external environment of firms, which will enable the most effective application of innovative technologies on the insurance market and comprehensively transfer all the processes of insurance activity to the digital field. The basis of the scientific and methodological apparatus of the article is the analysis of innovative technologies of the digital economy and the

---

A. A. Prosvetova (✉)  
Samara State University of Economics, Samara, Russia

possibility of their integration into the insurance industry [2]. The digitalization of the national financial market is also transforming its individual segments, such as the insurance industry. There is an active process of digitalization, which consists in the introduction of new technologies by insurance companies that transform business processes. The transformation of business processes in insurance organizations concerns technological, financial, marketing processes and sales technologies of insurance services. The developing Internet environment not only transforms the appearance of insurance services themselves, but also develops it, expanding the segment of online sales, which allow us to talk about reducing the revenue cost, an increasing trend of remote sales [3]. Recently, the insurance industry has begun a radical transformation, caused by a number of digital innovations. Innovations through digital technologies, platforms, and infrastructures provide opportunities for entrepreneurship in all industries and are reflected in new products, services, and improved processes [4].

## 2 Methodology

The study is empirical and is based on the analysis of two groups of indicators: digitalization and insurance. The introduction of digital technologies can be divided into internal technological implementation and the creation of an external digital environment that forms not only the external digital shell of the insurance industry, but also the digital environment that refer to the overall process of digitalization of most, if not all, sectors of the national economy. The introduction of digital technologies into the internal environment of an insurance company includes:

- maintaining accounting and financial statements, which includes building compatible programs with the Federal Tax Service, with the insurance control authorities and, above all, with the Insurance Supervision Department of the Bank of Russia, which allows to consolidate branch reports and form reports for both supervisory and fiscal authorities;
- formation of the digital environment of the policyholder, reflecting the available data about the subject and object of the policyholder, called an internal compatible service for the formation of the query environment and the preliminary formation of the risk assessment of the policyholder with the involvement of external databases about the insured subject/object;
- formation of an internal insurance environment that unites the insurer and the policyholder or creates conditions when the policyholder-client is invited to comfortably form the necessary insurance product in an low-pressure form to get acquainted with existing products;
- formation of an electronic document flow, which includes a set of both external and internal documents in the case of confirmation of the operation by the policyholder by paying the invoice for insurance services;

- settlement of insurance events, registration of a set of documents from the insurance company itself, as well as the formation of the history of the insured object or subject with the involvement of independent expert organizations confirming the actual event, accompanied by an expert examination, with the transfer of data to the insurance company in the combined insurance environment;
- support of insurance contracts, including allocated payments in favor of the insurance company;
- building financial and technological control of the insurance process itself is relevant when participating in long-term insurance programs, such as pension insurance or life and health insurance, insurance of the business environment of enterprises for the medium term.

The implementation of digital technologies in the external environment of an insurance company consists in:

- the formation of an external information environment about the objects and subjects of insurance that are the insured interest, in a digital form, using the technology of distributed databases, to form a unified environment containing the available responses to changes in the characteristics of objects or subjects;
- transformation of marketing relations, introduction of digital technologies for collecting data from social networks and preferences of policyholders, from official sources, websites of policyholders and its partners, contractors;
- participation in Internet resources that collect comparative data on insurance and other financial organizations, accompanied by an analysis of the insurance conditions of other insurers, and the formation of proposals for the promotion and compliance of services on the insurance market.

The reference points for creating a national digital environment are, first of all, the digitization of all databases to ensure the convenience of using the formed databases.

### 3 Results

The technological scheme for the formation of the digital field of activity of an insurance organization includes the stages of digitalization not only of private databases, but also of public ones, which do not directly relate to the insurance industry, but are an integral part or basis necessary for conducting evaluation calculations and building comparative characteristics of insured objects or subjects.

At the first stage, the formation of distributed territorial and object data sets should be carried out, which includes the translation of basic data into digital format and the development of regulatory indicators for translation into the amount of insurance risk. Currently, the procedure for converting analog and graphic data into a digital image of the object is already being implemented. This digital image should be presented on compatible software, on modern computing equipment that allows multi-channel access to "big data". Next, it is necessary to develop regulatory indicators for transfer

the results of the “big data” analysis to the level of insurance risks. Existing risks transfer indicators describe conservative risks or risks that are taken into account with subsequent reinsurance. This measure will reduce the amount of the insurance premium for the policyholder and determine its optimal level by the insurer for the Russian insurance market.

At the second stage, a national digital platform is being built with a gradation according to the industry, object and subject principle, including the development and implementation of national digital platforms of recorded data, which allow using blockchain technology to form a digital fields of interaction that reflect the history of changes in the digital image of the object and subsequent changes both of a legal nature and object characteristics.

Next, it is necessary to implement the construction of compatible databases that carry individual characteristics, starting from the manufacturer, the characteristics of the state accounting and the individual characteristics of the object, including:

- object characteristics, such as the date of issue or production, the time of all registration and other actions, changes in legal characteristics, the presence of encumbrances, current and subsequent major repairs, restoration works, etc.;
- subject characteristics that combine data about the subjects, the presence of restrictions, the possibility of restitution of transactions, the formation of medical parameters of the subject and their possible change.

The use of artificial intelligence remains one of the most promising areas for improving business efficiency for any industry of the market, including insurance.

Back in 2016, only 1.33% of insurance companies invested in artificial intelligence projects, according to an analytical report by Deloitte [5]. However, in 2017, AppTractor noted in its report [6] that 75% of the 550 insurance executives surveyed believed that artificial intelligence would significantly change or completely transform the insurance industry over the next three years. Since then, we have seen a significant increase in projects implemented both in Russia, including in the companies SOGAZ, RESO-Garantia, Tinkoff Insurance, Sberbank Insurance, Renaissance Insurance, and others, and abroad, although its pace is still lower than expected [7].

In the digital economy, the traditional approach to data storage systems (DSS) poses a number of problems. Firstly, it creates disparate systems, since it usually implements multiple solutions on different carriers. This increases complexity and costs while reducing business productivity. Moreover, each storage will have its own capacity, which is not available for other storage systems. When additional space is needed to analyze new data, it should be added as quickly as possible, which further increases costs and, given the time required for implementation, reduces the speed of business response. Secondly, it becomes impossible to easily make changes to production or important data. As a result, organizations will need to maintain large, high-performance storage repositories to provide fast access to all the data that may be required for analysis.

Paradoxically, artificial intelligence used in storage data management algorithms can also help here. These algorithms respond in real time to dynamically changing workloads, providing continuous optimization of data performance. As a result,



companies can store data on cost-effective hardware, while getting more high speed and performance than All-Flash systems indicators, for little money.

The insurance market digitalization may take place in several ways. Firstly, it relates to the emergence of new sales channels due to the usage of digital tools for insurance services (mobile applications, sales based on partner search queries in the Internet of Things, etc.). In this direction, the channel competition is being formed. Secondly, the application of digital technologies in the contract maintenance or the settlement of the insured's losses builds a basis for the competition on the insurance market. Thirdly, the artificial intelligence technology provides a certain individualization type of offered insurance programs (in this case, the base is the processed information about the policyholder and the object of insurance, which exacerbates information competition on the insurance market) [8]. Digitalization of the insurance industry means not only the expansion of sales channels, an increase in cross-sales, but also the expansion of the insurance field of insurance companies, the expansion of the list of insurance products.

## 4 Discussion

The digitalization of the national financial market is also transforming its individual segments, such as the insurance industry. There is an active process of digitalization, which consists in the introduction of new technologies by insurance companies that transform business processes. The transformation of business processes in insurance organizations concerns technological, financial, marketing processes and sales technologies of insurance services. The developing Internet environment not only transforms the appearance of insurance services themselves, but also develops it, expanding the segment of online sales or sales via online, which allows to talk about reducing the cost of sales, an increasing trend of remote sales. This statement is confirmed by the growth of premiums collected by Russian insurers in 2019–2020, which increased fivefold in comparison to 2018 for various types of insurance, in the segment of selling CMTPL (Compulsory Motor Third Party Liability) policies via the Internet [9].

While the COVID-19 pandemic has created challenges for Russian insurers, it has also highlighted the increasingly important role of innovations and digitalization on the market. Before the pandemic, insurers had already invested in developing platforms or apps for online sales and other remote services. However, the sudden need for remote work took some of these insurers by surprise, as their digital platforms were still at the development stage. At the same time, other insurance companies with more advanced IT solutions were able to continue selling policies online without significant failures (and even expand the use of this channel) [10].

The change in consumer behavior and expectations after the pandemic is likely to lead to the fact that some Russian insurers will reconsider their business models in terms of their suitability for online servicing, not only in terms of distribution, but

also in the field of underwriting and settlement of insurance claims. This will have a positive long-term impact on the development of the insurance market in the country.

To overcome the crisis, insurance companies need to expand their insurance coverage and develop new insurance programs that provide protection against risks associated with new economic industries and the consequences of quarantine measures. These are anti-virus insurance, cyber risks, financial risks of non-fulfillment of obligations by counterparties, etc. These new areas of the insurance business will provide the potential for the growth of insurance services and the expansion of insurance coverage of risks that can cause significant losses to business entities both in Russia and abroad. At the same time, the analysis of trends in the development of the Russian insurance market shows a tendency to expand compulsory insurance with additional voluntary insurance, whereas previously the number of additional insurances for CMTPL was growing. Nowadays it is not new and is offered by almost all insurance companies. Now, as part of improving the competitiveness and loyalty of customers, companies offer digitalization of insurance products, which corresponds to modern trends of the global insurance market.

At the beginning of the digitalization wave, the focus was on online channels and digital distribution channels and their impact on insurance agents, customers, and competition. In the following years, the spread of mobile and interconnected devices exponentially increased the availability of customer data [11]. The vast amount of data available has opened up new opportunities for insurance companies to use innovative technologies in their interests.

## 5 Conclusion

Digital capabilities have changed a lot over the past decade and continue to evolve rapidly. Insurers should continue to re-evaluate and rethink their service options based on the preferences of agents and consumers, as well as the benefits that digitalization promises. The need for digital technologies will only increase, since 50% of generations Y and Z will work in 2021 and more than 95% will work by 2030. Insurers need to go digital to stay relevant and adjust their cost structure with industry standards.

Digitalization of the national insurance industry is manifested in the formation of the technological process of digital insurance, which determines the ratio of competing parties on the Russian insurance market. The formed model is a new technological trend in the classical behavior of policyholders, due to the heuristic choice of insurance services based on the use of digital technologies. It is based on the best knowledge of the service buyer, his preferences, interests, the content studied by him. All this forms the place of the insurance company in the business environment, its competitiveness due to the level of using digital technologies.

Insurers are actively developing mobile digital technologies through the features of channel competition, joining the fight over the policyholder through a more convenient and understandable recommendation of the insurer within the framework of

standard programs and within the framework of flexible and readjusted programs aimed at each individual policyholder. More convenient technologies are being developed in business processes aimed at communication with policyholders in terms of support of insurance contracts, settlement of losses of the policyholder.

The results of the past crisis year highlighted the problems in the insurance sector, but also showed that insurance companies quickly adapted to the new reality and successfully overcome difficulties. So, in 2020, most of the resources of the state and private companies were invested in the digitalization of the insurance market. The formed margin of safety should help to survive the difficulties of the current year most painlessly.

The introduction of digital technologies in insurance requires an integrated strategic perspective due to the strong interdependence of digital technologies. Given the high strategic importance of responding to digitalization, it is necessary to emphasize the growing role of the integral management of insurance companies information technologies, which should be the subject of further studies.

## References

1. Eling, M., Lehmann, M.: The impact of digitalization on the insurance value chain and the insurability of risks. *Geneva Papers Risk Insur. Issues Pract.* **43**(3), 359–396 (2018)
2. Tepkaeva, Z.Z.: Introduction of digital technologies in the activities of insurance organizations of Russia. *Financ. Issues* **2**(67), 162–170 (2020)
3. Kozlova, O.N., Kotova, O.N., Pavlovskaya, E.V.: The use of new distribution channels to increase the efficiency of insurance companies. *VolSU. Series 3. Econ. Ecology* **19**(2), 108–116 (2017)
4. Eckert, C., Osterrieder, K.: How digitalization affects insurance companies: Overview and use cases of digital technologies. *ZVersWiss* (2020). <https://doi.org/10.1007/s12297-020-00475-9>. Accessed 28 Feb 2021
5. Ilyin, A.: Artificial intelligence: From mystery to knowledge. Revealing the business opportunities of artificial intelligence in the insurance sector. <https://www2.deloitte.com/ru/ru/pages/financial-services/articles/artificial-intelligence-insurance-industry.html>. Accessed 28 Feb 2021
6. AppTractor: Accenture technology vision 2017 annual report: technologies created by people for people. <https://apptractor.ru/info/media/ezhegodnyiy-otchet-accenture-technology-vision-2017-tehnologii-sozdannyye-lyudmi-dlya-lyudey.html>. Accessed 28 Feb 2021
7. Sorokin, K.: Is there a place for artificial intelligence in the insurance industry? <https://consult-cct.ru/blog-11214/318.html>. Accessed 28 Feb 2021
8. Bryzgalov, D.V.: Digitalization of competition on the insurance market. *Economics. Taxes. Law* **2**, 121–128 (2018)
9. Calmins: Analysis of the main indicators of the Russian insurance market for the first half of 2020 based on data from the Central Bank of the Russian Federation. <https://calmins.com/analiz-strahovogo-rynka-rossii-2020-itogi-1-polugodiya-1-chast/>. Accessed 28 Feb 2021
10. Interfax-Russia. Press release: Special Best report: COVID-19 and the Russian insurance market—negative consequences for insurance premium growth, but opportunities for innovation (2021), <https://www.interfax-russia.ru/pressrel/press-reliz-specialnyy-otchet-best-covid-19-i-rossiyskiy-rynok-strahovaniya-negativnye-posledstviya-dlya-rosta-strahovoy-premii-no-vozmozhnosti-dlya-innovaciy>. Accessed 14 Mar 2021
11. Eling, M., Nuessle, D., Staubli, J.: The impact of artificial intelligence along the insurance value chain and on the insurability of risks. *Geneva Papers Risk Insur. Issues Pract.* <https://doi.org/10.1057/s41288-020-00201-7> (2021). Accessed 28 Feb 2021

# Digital Development and Formation of Logistics Systems in Construction in Samara Region



A. R. Rakhmatullina, L. A. Sosunova, and Y. Zubtsova

**Abstract** Construction as a sphere of the national economy is characterized by a wide range of consumed material and technical resources and high material intensity of construction products. The construction industry is a backbone industry. It works with more than 70 industries that provide it with various raw materials. More than half of all construction materials produced in the industry are supplied to the construction industry. All this increases the role of logistics as the main tool for the rational organization of material flows and resource savings. After all, logistics is the rational management of material flow and its associated flows. Construction is quite material-intensive. And today, the issue of optimizing and rationalizing the costs of the enterprise is very urgent. Today, digital technologies, new logistics systems and innovations can come to the rescue.

**Keywords** ERP-systems · Just-in-time · Logistics system · Neural network model

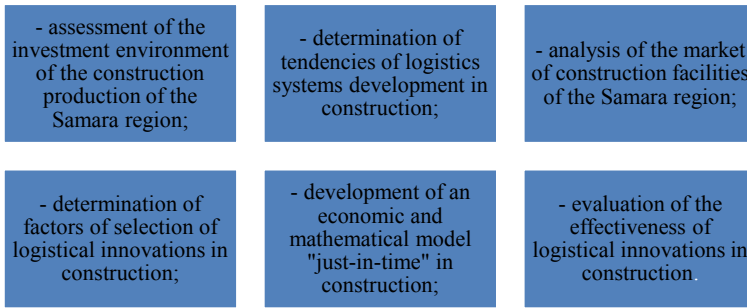
## 1 Introduction

The capital construction industry is systemically important. For the production of finished products, that is, the delivery of the construction facility, the participation of various organizations, both resource-supplying and production and intermediary, is necessary. The organization of coordinated work by all these actors requires clear coordination in place and time. The general trend in the raw material market takes a line of price growth, total costs increase, thereby leading to an increase in the cost of construction products. There are also new players on the market, competition in the construction industry is growing, and all this pushes companies to introduce logistics systems and innovations. If the delivery schedule matches the construction schedule,

---

A. R. Rakhmatullina (✉) · L. A. Sosunova  
Samara State University of Economics, Samara, Russia

Y. Zubtsova  
Moscow State University of Food Production, Moscow, Russia



**Fig. 1** Research tasks. *Source* Authors

then the logistics system is working efficiently. Further efficiency depends on the quality and quantity of supplied products or raw materials.

## 2 Methodology

The objective of this study is to analyze, evaluate and apply logistics systems in construction. In order to achieve this goal, the following objectives must be met, which are set out in Fig. 1. Theoretically competent to form a logistic system sequentially as follows: first, a micrologistic system is formed, then a metalogistic system and in conclusion a macrologistic system. In the practice of the construction business, everything happens differently: the formation of logistics systems in construction can proceed in parallel, sequentially and parallel, and one system can form ahead of another [1].

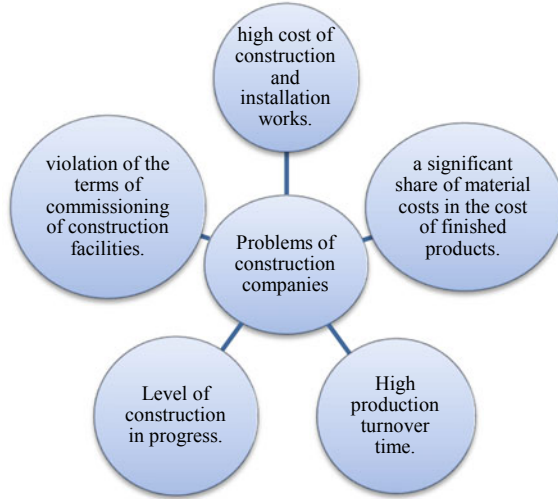
The study used economic and mathematical methods, the construction of mathematical models, analysis and synthesis, as well as expert methods of research and data collection.

## 3 Results

The study revealed the main economic, production and commercial problems of construction companies (Fig. 2).

By conducting a comprehensive analysis of the indicators of real construction organizations, we can conclude that the expected and real indicators differ from each other and this indicates a low level of rationality. In logistics systems for the construction business, the level of rationality is determined by two groups of parameters: direct and indirect. Using tools such as variance analysis, cluster analysis,

**Fig. 2** Problems of construction companies.  
*Source* Authors



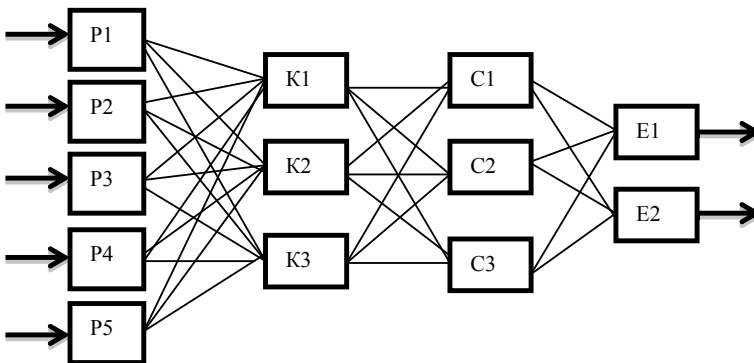
correlation, regression analysis and neural network models, the relationship between direct and indirect measures of rationality can be traced [2].

Figure 3 shows an example of a neural network model. The relation of direct parameters and indirect parameters is shown, as follows from one to the other. That is, they show the relationship between changes in direct parameters and indirect ones.

Figure 3 shows the following neural network elements (parameters):

1. Logistics rationality parameters:

- Rhythm of supply of material and technical resources (P1);
- quality of delivered products (P2);
- completeness of supply of material and technical resources (P3);



**Fig. 3** Relationship between direct and indirect indicators of construction logistics efficiency.  
*Source* Authors

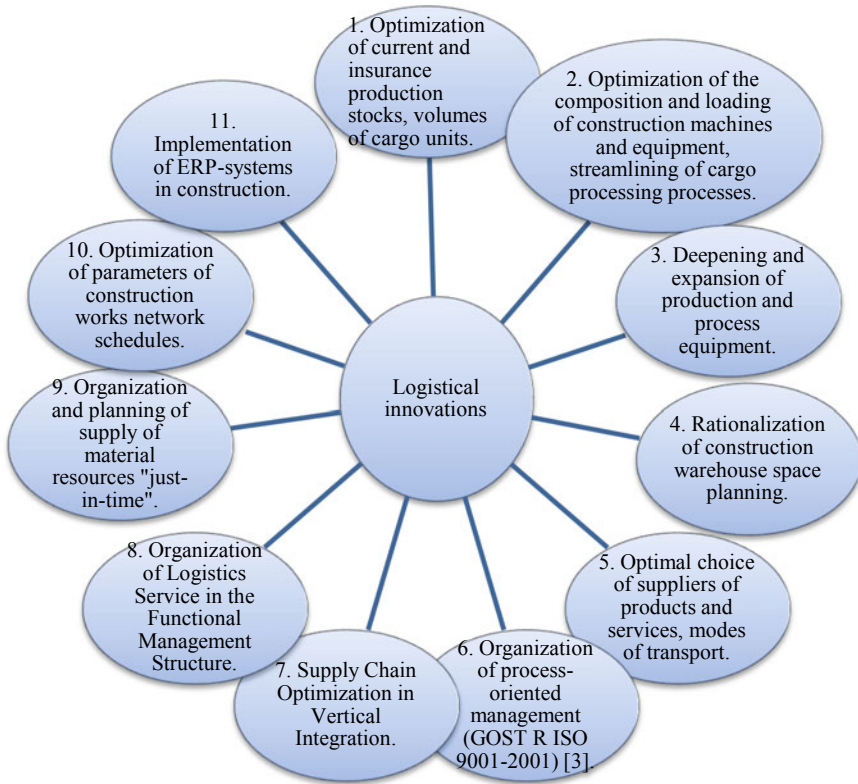
- timely payment of received products (P4);
  - product readiness for production consumption (P5).
2. Indicators of commercial activity of the construction company:
    - duration of production inventory turnover (K1);
    - material capacity of construction products (K2);
    - Construction costs and logistics (K3).
  3. Indicators of construction production:
    - construction time (C1);
    - level of construction in progress (C2);
    - cost of construction products (C3).
  4. Performance indicators of production and commercial activities of the construction organization:
    - profit of the construction organization (E1);
    - profitability of construction production (E2) [3].

As a result of the study, a list of 11 logistical innovations was formed that will reduce the total costs of the construction organization. The selection of logistical innovations took place with the involvement of experts who are directly employees of construction companies involved in the production process, in the field of supply and transportation (Fig. 4).

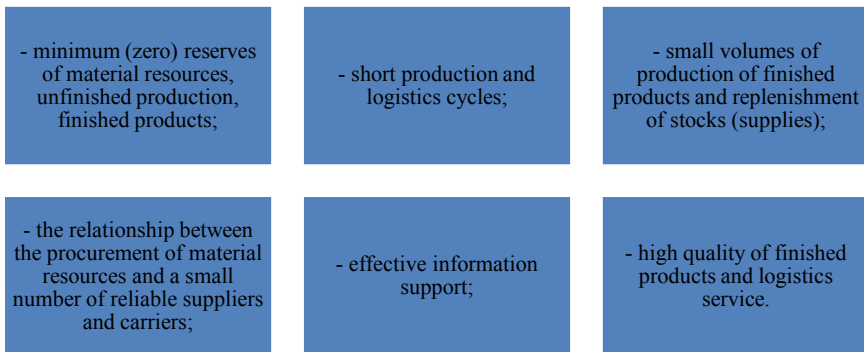
The criterion for the final selection of these logistical innovations in the construction organization is the specific savings in the total costs and expenses of the construction organization, that is, savings attributable to 1 ruble of additional costs associated with the implementation of logistics innovation (specific efficiency). As follows from our study, the most effective logistical innovation for the construction organization in question, according to experts, is the organization and planning of the supply of material resources through the “just-in-time” system. The “just-in-time” logistics concept is characterized by the following main features presented in Fig. 5.

Why do we talk about the concept of “just in time” as an innovation. Modern technologies “just in time” and logistics systems have become more comprehensive, penetrating into all spheres of activity and business. They are implemented in logistics production under the guise of product and raw material quality management, new systems for managing minimum inventory, control over logistics channels, a system for fast switching in logistics, automated flexible production, etc. In the course of economic and mathematical modeling of the system “just in time,” the authors of this article identified a number of features of the application of this concept in the construction industry, which, in our opinion, will simplify its implementation at the enterprise (Fig. 6).

The process of forming and implementing the system “just in time” takes place in several stages of calculation:

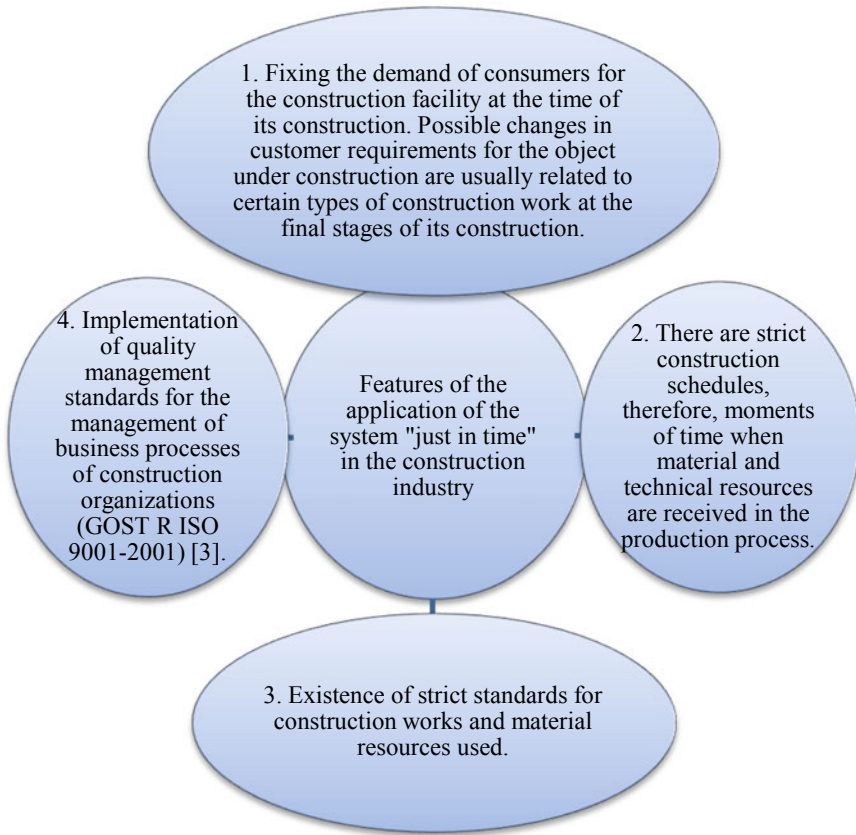


**Fig. 4** Logistical innovations. *Source* Authors



**Fig. 5** Main features of the logistics concept "just-in-time". *Source* Authors





**Fig. 6** Features of the application of the system “just in time” in the construction industry. *Source* Authors

1. It is necessary to determine the length of the logistics cycle with a given confidence probability, provided that the function of its distribution is subject to normal law.

From a practical point of view, in planning the system “just-in-time,” the logistics cycle does not matter as a whole, especially since all the components of it are unknown to the consumer, but the period of time for the delivery of reinforced concrete products to the construction site, and even more precisely, the deviation of the actual delivery intervals from the schedules agreed with the supplier for the receipt of reinforced concrete products.

2. Mathematical and statistical parameters of distribution of deviations of actual duration of supply of reinforced concrete products from planned average value of deviations and average square deviation are calculated.

3. We will find the total duration of deliveries of reinforced concrete products to the construction site according to the system “just-in-time” subject to daily delivery.
4. We will define strategies for matching the delivery intervals of reinforced concrete products with the complex of construction works related to their use.

Construction production and logistics in the just-in-time system are based on the process of managing the parameters of construction work by time and intensity. If from the point of view of management it is not possible to influence and change the parameters of time and intensity, then in this case it is necessary to form current reserves and increase their norm. As an example, we took reinforced concrete products, and according to our calculations, the rate of production stock of this raw material should be increased by 1/2 of the increase in time between deliveries in order to prevent downtime.

## 4 Discussion

In the scientific community, the topic of introducing logistical innovations is quite relevant. A reflection of the problems associated with the formation of logistics systems and innovations is found in the works of Bryntsev, Novikov, Krylova [2], Sosunova, Noskov, Goryacheva, Astafieva, Kalashnikov [4], Sosunova, Noskov, Syrova, Bakanova [5], Sosunova, Noskov [6]. The works of colleagues consider the theoretical and practical aspects of this issue. You can also find the questions raised about optimizing the material and technical supply of enterprises in the sectors of the national economy [7, 8]. Also in the works of these authors there is an analysis of the construction industry in particular, its technological features. However, we can say that the deep application of economic and mathematical methods and models in the field of organization, planning and optimization of the supply of material resources, their synchronization with the schedule of construction work and flows is not sufficiently studied and is applicable today. Also, the ways and forms of applying logistic innovations to solve the problems of developing a consistent logistic system have not been sufficiently investigated.

## 5 Conclusion

In conclusion, we would like to formulate conclusions on the study of the assessment of sources of economic efficiency when implementing a logistics system based on the concept of “right in time” for the construction business:

1. Improving the accuracy and timeliness of planning and operational management of construction logistics due to the redistribution (transfer) of a significant part of control influences from the external environment to the internal one, which

is more defined, structured and determined. This indirect effect of logistic innovation reduces the transport costs of maintaining and regulating economic ties with suppliers of material resources.

2. More accurate planning of the volume of material resources purchased from suppliers. This type of indirect economic effect leads to more reasonable calculations of production stocks and a decrease in their regulatory part.
3. The reduction in the storage area of material resources is proportional to the decrease in production stocks, respectively, the reduced capital.

Thus, the calculations of the cost-effectiveness of the supply of material and technical resources according to the system “just-in-time” confirm expert assessments of the feasibility of its implementation.

## References

1. Astaf'eva, N.V., Sosunova, L.A., Chernova, D.V.: Development of a mechanism of organizational-economic providing of the logistics system. *Econ. Sci.* **162**, 68–73 (2018)
2. Bryntsev, A.N., Novikov, D.T., Krylova, T.D.: The transformation of logistics in the era of numbers. *Risk Resour. Inform. Supp. Compet.* **2**, 4–8 (2019)
3. GOST R ISO 9001–2001. URL: <https://docs.cntd.ru/document/1200015262>. Accessed: 16.03.2021 (2001)
4. Sosunova, L.A., Noskov, S.V., Goryacheva, I.A., Astafieva, N.V., Kalashnikov, S.A.: Improving the management technique of logistics planning in the supply chain. *Probl. Perspect. Manag.* **16**(3), 48–62 (2018)
5. Sosunova, L.A., Noskov, S.V., Syrova, K.P., Bakanova, I.G.: Trends in the effectiveness of Russian logistics in the digital economy. In: Ashmarina, S., Vochozka, M., Mantulenko, V. (eds.) *Digital Age: Chances, Challenges and Future. ISCDTE 2019. Lecture Notes in Networks and Systems*, vol. 84, pp. 494–505. Springer, Cham (2020)
6. Sosunova, L.A., Noskov, S.V.: Key business processes for logistics supply of construction organizations. *Prob. Enterprise Dev. Theor. Prac.* **1–2**, 71–75 (2019)
7. Rakhmatullina, A.R., Sivaks, A.N., Pecherskaya, E.P.: Assessment of quality of services of public transport in digital economy. In: Ashmarina, S., Vochozka, M., Mantulenko, V. (eds.) *Digital Age: Chances, Challenges and Future. Lecture Notes in Networks and Systems*, vol. 84, pp. 269–280. Springer, Cham (2020)
8. Tyapukhin, A.P., Kolovertnova, MYu., Tarasenko, E.A.: Supply chain management system: essence and methodical approach to creating. *Eurasian Sci. J.* **2**(11), 1–18 (2019)

# AI Liability Issues in Russian and Foreign Law



S. V. Rastoropov, A. V. Sidorova, and D. S. Rastoropova

**Abstract** It examines the latest regulatory legal acts in the field of regulation of legal relations using artificial intelligence. Concepts of safety of goods, works and services, and associated risks when using artificial intelligence are analyzed. The approach of foreign researchers is being studied about three models of criminal liability in case of harm to artificial intelligence, which were developed at the dawn of active development of the sphere, but still remain relevant. The possibility of using joint responsibility when using artificial intelligence in medical technologies is substantiated. The author proposes to equate artificial intelligence with legal entities within the framework of domestic legislation, which allows him to be brought to certain types of legal responsibility.

**Keywords** Artificial intelligence · Liability · Safety · Unacceptable risk

## 1 Introduction

Today, we have witnessed the rapid development of artificial intelligence (AI), which will undoubtedly make major changes in our life in all its areas—improve health care, increase agricultural efficiency, help solve climate problems, and make higher education accessible even in the most remote parts of the world. It is difficult to imagine in what other areas the use of AI will become completely ordinary in the coming years. For this reason, almost all countries are interested in forming a legal framework for the creation and use of AI, protecting information and technologies,

---

S. V. Rastoropov

University of Prosecutor's Office of the Russian Federation, Moscow State University (named after M.V. Lomonosov), Moscow, Russia

A. V. Sidorova (✉)

Samara State University of Economics, Samara, Russia

e-mail: [an.sido@bk.ru](mailto:an.sido@bk.ru)

D. S. Rastoropova

University of Prosecutor's Office of the Russian Federation, Moscow, Russia

© The Author(s), under exclusive license to Springer Nature Switzerland AG 2022

S. I. Ashmarina and V. V. Manteulenko (eds.), *Digital Technologies in the New*

*Socio-Economic Reality*, Lecture Notes in Networks and Systems 304,

[https://doi.org/10.1007/978-3-030-83175-2\\_42](https://doi.org/10.1007/978-3-030-83175-2_42)

as well as coordinating the use of a large amount of information generated during the application of AI.

In modern realities, artificial intelligence in all legal systems of the world without exception is not endowed with legal personality and legal capacity. AI does not have autonomous will, is not endowed with rights and is not responsible for the actions performed by it. It cannot be denied that over time, an AI that functions autonomously from a person, learns and acquires subjective experience will be able to obtain a moral right to legal personality. And this is not a matter of the distant future. If AI has the ability to act autonomously, then it turns out that we cease to control it and in case of violation of certain norms we can hold this person accountable.

The goals of AI development in Russia are to improve the well-being of the population and their quality of life, ensure national security and law and order, build a sustainable competitive national economy, and advance to leading positions in the field of the latest digital technologies. However, the solution of these goals is impossible without fixing the legal status of AI and legal regulation of compensation for harm caused by its actions.

## 2 Methodology

The object of this research is the legal relationship in the field of AI application in Russia and abroad. Regulatory acts regulating activities using AI were investigated, as well as scientific literature on the problems studied. The basis of the present study is general scientific and private scientific methods of cognition. The dialectical and system-structural methods, which made it possible to study the collection of personal data of individual entrepreneurs in the form of a system, made special significance from nationwide scientific methods of cognition. The use of the functional method of cognition provided for the study of sources of law through their functions by studying individual functions, a number of functions or a system of functions. From private science methods of cognition, methods of comparative law and theoretical modeling were used. The empirical basis of the study was formed by legislative acts and special legal literature on the use of AI.

## 3 Results

In January 2021, President of Russia Putin instructed to develop and implement a regulatory framework on the large-scale use of AI in the Russian Federation [12]. We are talking about federal laws, according to which it will be possible to introduce experimental regimes in certain industries to expand the use of AI. Meanwhile, as of the end of March 2021, the State Duma of the Russian Federation did not receive any bills or legislative initiatives.

At present, an experimental regime has been introduced on the territory of the city of Moscow. This regime will be valid for five years. The purpose of such a regime is to form a comprehensive system of regulation of social relations arising in connection with the development and use of AI technologies, based on the results of the establishment of an experimental legal regime [1]. The Moscow government was empowered, including the development of conditions and procedures for the development and implementation of AI technologies, as well as the procedure for using the results of their implementation. In order to implement Federal Law of 24.04.2020 No. 123-FZ “On conducting an experiment to establish special regulation in order to create the necessary conditions for the development and implementation of artificial intelligence technologies in the subject of the Russian Federation—a city of federal significance in Moscow and amend articles 6 and 10 of the Federal Law “On Personal Data” [6], the Moscow Government approved the Regulation on the implementation of an experimental legal regime in the city in the field of application of AI technologies.

In Paragraph 1 of this Provision it is specified that it defines conditions and an order of development, creation, introduction, realization and turn of separate technologies of artificial intelligence and production, realization, turnover of separate goods (works, services) on the basis of such technologies, further in the text only the key principles without any specifics and real legal regulation are given. Thus, when developing technologies, it is prescribed to comply with a number of conditions, including: ensuring the safety of AI technologies and respecting the rights and freedoms of a person and citizen; inadmissibility of the occurrence of risks of causing harm to human life or health higher than the risks accompanying similar processes that take place without the use of AI technologies; the obligation to predict the expected impact of developments on legally protected public relations; preferential use of domestic developments, etc. When creating AI technologies, programming of technologies and products based on them should be provided, taking into account the possibility of emergency situations; The use of reliable data sets that do not discriminate on any grounds. Before implementing the technology, you should test (test) and determine the conditions for the use of such technologies, including the possibility of setting restrictions on their use.

In a number of areas of public relations and life cases, one cannot do without risk (medicine, economics, transport, scientific, law enforcement, etc.). Today, the principle of assessing the benefit/risk ratio in the application of certain goods and services is used in world practice. In particular, when entering the drug market, predicting the potential benefits of pharmacotherapy and associated risks is a critical process at all stages of the drug life cycle [5]. The process of assessing the benefit/risk ratio should meet the following requirements: objectivity, “transparency,” reproducibility, versatility. The conclusion on the possibility of introducing a drug into use is given if the potential benefit of using the analysed drug in clinical practice exceeds possible risks. The risk/benefit ratio became particularly relevant during the pandemic COVID-2019, when the use of existing drugs was assessed in terms of their possible use for the treatment of the virus.

The Federal law of 27.12.2002 No. 184-FZ “On Technical Regulation” fixes safety definition as lack of the unacceptable risk connected with infliction of harm of life or to health of citizens, property of natural or legal entities, the state or municipal property, the environment, life or health of animals and plants [7]. A different definition is given in the Act of the Russian Federation of 07.02.1992 No. 2300-1 “About Consumer Protection”, where safety means the safety of goods (work, services) for life, health, property of the consumer and the environment under normal conditions of its use, storage, transportation and disposal, as well as the safety of the process of performance of work (provision of service) [1]. The concept of security is also contained in GOST R 51303-2013 “Trade. Terms and definitions” [9] and is defined as the state of the goods under normal conditions of their use, storage, transportation and disposal, in which the risk of harm to the life, health and property of the consumer is limited to a permissible level. From the analysis of definitions, we highlight the following principles for recognizing goods as safe:

- acceptable risk;
- no unacceptable risk, where the permissible risk is formally legitimate and from this point of view excludes legal liability (an unacceptable risk is defined as an offence and, as a result, should be legally liable);
- no risk under normal conditions of its use and process of performance of works (provision of services): this means that in conditions other than normal, the occurrence of a risk to life, health and property is not excluded;
- the absence of a list of goods, works and services for which “permissible” risks are not permitted (i.e. the absence of so-called “ideal” goods, works and services, which under no circumstances can cause any harm to life, health and property).

Thus, Russian legislation provided for the presence of a potential risk of harm to life and health by all goods, works and services without exception, but it establishes measures to prevent the occurrence of risk by presenting requirements for the quality and safety of goods, works and services, as well as measures of legal responsibility in the event of violation of requirements.

## 4 Discussion

After entry into force of the Decree of the Government of Moscow of 03.12.2020 No. 2134-PP on the inadmissibility of the occurrence of risks of causing harm to life or health of a person higher in comparison with risks accompanying similar processes without the use of AI technologies, a separation of goods, works and services using AI and without it appeared, as well as the need to assess potential risks [3]. In addition to establishing the obligation to determine the amount of AI risk and its relationship with processes without applying AI, Decree of the Moscow Government No. 2134-PP [3] establishes that the development of AI is unacceptable for the purpose of intentionally causing harm (damage) to individuals and legal entities, public legal entities. However, in connection with the features of AI, a

legitimate question arises, and what if AI was developed for legitimate and socially useful purposes, but subsequently the developer lost control of AI? Whether the developer bears any responsibility in this case and, if so, which one.

The law and legal literature most often pay attention to the risks associated with the use of AI, that is, from the stage when AI is developed, tested and used in a particular area of life. But even here there is no unity of opinion, where the key question is whether AI is a subject of legal responsibility, that is, whether it can be held responsible for its actions. In the modern world, both physical and collective persons are endowed with delicacy. The question arises as to which persons to attribute AI. If a person has self-awareness, the question arises, but does he have AI?

Legally, the concept of “artificial intelligence” was first formulated at the by-law level by Decree of the President of the Russian Federation of 10.10.2019 No. 490 “On the Development of Artificial Intelligence in the Russian Federation” [4], subsequently migrating to the Law under consideration No. 123-FZ. It means a set of technological solutions that allows you to simulate the cognitive functions of a person and obtain results comparable, at a minimum, to the results of human intellectual activity. At the same time, it is separately noted that the simulation includes self-training and the search for solutions without a predetermined algorithm. It is important to pay attention to the fact that the definition fully covers the types of artificial intelligence available at the moment in a wide sense: artificial intelligence based on predetermined tasks (available knowledge), and artificial intelligence working autonomously, that is, technology that can potentially completely replace a person to perform tasks.

This means that AI acquires characteristics inherent exclusively to the human individual and separating it as a species from other animal species. This is the understanding of mental constructions, which are the understanding of one or another aspect of reality, the autonomy of the thought process. In the scientific works of foreign scientists, one can find the opinion that the presence of consciousness in an individual is not a necessary or sufficient condition for legal personality [2]. Considering that, for example, children possessing consciousness do not have the full scope of legal personality, but people who are in a coma, that is, in an unconscious state and cannot exercise a number of rights are not deprived of legal personality, we consider it possible to support this opinion. But on the one hand, this statement can be accepted, but on the other hand, children do not have legal personality temporarily, when they reach a certain age, children acquire it, and then their parents, guardians and guardians are responsible for the children, and then the children still have elementary ideas about what is good and what is bad. In addition, while courts around the world take the approach of not giving some of the “most reasonable” species of animals legal personality, one cannot talk about its provision of AI.

Hallevy, in his study of AI criminal liability, concluded that several models of liability were possible [10]:

1. The “Perpetrator-via-another” liability model, which applies if the offence is committed by a mentally disabled person, child or animal, the offender is considered innocent, but in some cases the person responsible for the actions of the



offender (owner of the dog, parents of the child, guardians, etc.) is responsible. In this case, the developer and/or user of the AI should be prosecuted.

2. Natural-probable-consequence liability model. In this case, the developer and/or the AI seller will be held accountable, but only if the criminal offense was a natural and probable consequence of their programs/use of the application. Hallevy cites as an example the murder of a worker by artificial intelligence at a factory in Japan, when AI considered the worker a direct threat and committed actions to push the worker into a powerful machine.
3. Direct liability model. In this case, the AI programmer will be responsible for the crime, even if the crime is committed by the AI without the fault of the developer and/or the AI user. However, in all cases where the programmer is considered responsible, there may be further debate as to whether the programmer himself is in error; program designer; an expert or supervisor who has appointed an inadequate expert, designer or programmer.

A similar opinion is shared by Kingston, who concludes that AI itself is not a sensitive subject of law and cannot be held criminally liable [11]. The models of criminal liability offered by Hallevy were studied by representatives of the different states and legal models, but so far a conclusion one—attraction of AI to responsibility within the existing legislation is impossible [13].

In addition to the responsibility of the developer (programmer and group of persons involved in the creation of AI), as well as the user of AI in legal science, the question is raised about the legal responsibility of persons who are not related to developers or direct users of AI, but their decisions were made on the basis of information provided by AI.

As an example, the healthcare system is given when a doctor was misdiagnosed and prescribed incorrect treatment based on the data that he received from the laboratory [8]. In turn, laboratory workers gave the doctor information that they formulated on the basis of information received from AI.

This situation raises several questions regarding the allocation of responsibility. First of all, the use of AI violates the typical relationship between the doctor and the patient, making it difficult for the injured patient to establish a causal link between harm and the illegal behavior of the doctor. Secondly, there are currently no qualified bodies and experts responsible for assessing AI actions. We believe that it is necessary to talk about solidarity responsibility—from the developer to all persons involved in the provision of the final service (production of goods, performance of work). In the above situation, this is an AI developer, laboratory workers, and a doctor.

When fixing the legal status of AI, it is advisable to use the position of a legal entity established by the rules of law, the totality of its rights and obligations. Such parallels can be carried out based on the commonality of the goals of their creation—to implement the interests of their owners. This is really so, no AI is created just like that, it always has some kind of task, it can be industry, healthcare, etc. Legal entities are created with the same purpose, you can even say that AI helps legal entities to achieve their goals.

From this it follows that a certain type of sanctions should be provided—the creator and/or user of AI can be fined, and the AI itself can be influenced by such a type of responsibility as disconnection. If AI commits an offense, then we simply disconnect it from the network. The period of disconnection depends on which AI offense has committed, and again this type of liability will apply if AI reaches such a level that it will be able to understand the nature of its actions and the reason for applying the measure of responsibility. At the same time, the stop will be a measure of administrative, not criminal responsibility, since Russian legislation does not provide for the possibility of bringing legal entities to criminal responsibility.

## 5 Conclusion

We are witnessing the rapid progress of AI technologies. This process transforms the entire life activity of human society. It is difficult to list all the areas where AI finds its application. This process has both positive and negative aspects. A large number of studies are devoted to highlighting these aspects, developing recommendations for leveling the negative impact. Regulatory regulation, both legal and technical, is aimed at establishing generally binding rules, requirements, standards. The task of legal regulation is to regulate relations between subjects of law in certain areas of public relations, and, accordingly, the task of technical regulation is to establish technical requirements and standards that are imposed on products, as well as on processes (industrial, technological, logistical and other). At the same time, legal regulation, of course, should correspond to the level of development of society, as well as the technical level of development of the national economy, the material and technical base, as well as scientific and technical development. The application of AI cannot go away without a sufficient regulatory framework. Moreover, such a base should be developed and introduced before the start of the use of AI, and not after the appearance of the first cases of harm. The actual introduction of AI is not so noticeable for an ordinary citizen, but everyone is aware of this. Fear of the unpredictability of AI actions, fear of AI getting out of the control of a reasonable creature, fear of causing physical, informational harm makes humanity think about the need to impose restrictions on the development, testing and use of AI. There is no doubt that the use of AI can cause harm to both their users and third parties. There are more and more such facts every day. The regulation of liability for causing such harm is today only in the early stages of development. I must say that in scientific circles there is no consensus on this issue. And here ethical norms and rules of legal technique should be combined. This is especially true for cases of using autonomously functioning AI. In this case, it is no longer possible to talk about complete control of AI by humans. Today, the scales have tipped towards blaming manufacturers and users for the harm caused by AI. Such research should be initiated by legal theorists. In our opinion, it is this research problem that is most in demand today.

## References

1. Act of the Russian Federation of 07.02.1992 No. 2300-1 “About Consumer Protection”. URL: [http://www.consultant.ru/document/cons\\_doc\\_LAW\\_305/](http://www.consultant.ru/document/cons_doc_LAW_305/). Accessed: 21.03.2021 (2002)
2. Chopra, S., White, L.: Artificial agents—personhood in law and philosophy. In: de Mántaras, R.L., Saitta, L. (eds.) *Proceedings of the 16th European Conference on Artificial Intelligence*, pp.635–640. Including Prestigious Applicants, Valencia (2004)
3. Decree of the Government of Moscow of 03.12.2020 No. 2134-PP “On the approval of the Regulation on the implementation in the city of Moscow of an experimental legal regime in the field of application of artificial intelligence technologies”. URL: <https://www.garant.ru/proceedings/ipo/prime/doc/74977530/>. Accessed: 21.03.2021 (2020)
4. Decree of the President of the Russian Federation of 10.10.2019 No. 490 “On the Development of Artificial Intelligence in the Russian Federation”. URL: [http://www.consultant.ru/document/cons\\_doc\\_LAW\\_335184/](http://www.consultant.ru/document/cons_doc_LAW_335184/). Accessed: 21.03.2021 (2019)
5. EMA/662299/2011. Benefit-risk methodology project. URL: [https://www.ema.europa.eu/en/documents/report/benefit-risk-methodology-project-report-risk-perception-study-module\\_en.pdf](https://www.ema.europa.eu/en/documents/report/benefit-risk-methodology-project-report-risk-perception-study-module_en.pdf). Accessed: 21.03.2021
6. Federal Law of 24.04.2020 No. 123-FZ “On conducting an experiment to establish special regulation in order to create the necessary conditions for the development and implementation of artificial intelligence technologies in the subject of the Russian Federation—a city of federal significance in Moscow and amend articles 6 and 10 of the Federal Law “On Personal Data”. URL: [http://www.consultant.ru/document/cons\\_doc\\_LAW\\_351127/](http://www.consultant.ru/document/cons_doc_LAW_351127/). Accessed: 21.03.2021 (2020)
7. Federal Law of 27.12.2002 No. 184-FZ “On Technical Regulation”. URL: [http://www.consultant.ru/document/cons\\_doc\\_LAW\\_40241/](http://www.consultant.ru/document/cons_doc_LAW_40241/). Accessed: 21.03.2021 (2002)
8. Gonçalves, M.A.: *Liability arising from the use of Artificial Intelligence for the Purposes of Medical Diagnosis and Choice of Treatment: Who Should be Held Liable in the Event of Damage to Health?* Tilburg University, Tilburg (2018)
9. GOST R 51303-2013 “Trade. Terms and Definitions”. URL: [http://www.consultant.ru/document/cons\\_doc\\_LAW\\_167655/](http://www.consultant.ru/document/cons_doc_LAW_167655/). Accessed: 21.03.2021 (2015)
10. Hallevy, G.: The criminal liability of artificial intelligence entities—from science fiction to legal social control. *Akron Intellect. Prop. J.* **4**(2), 1 (2010)
11. Kingston, J.K.C.: Artificial intelligence and legal liability. In: Bramer, M., Petridis, M. (eds.) *Research and Development in Intelligent Systems*, vol. XXXIII, pp. 269–279. Springer, Cham (2016)
12. President of Russia: List of assignments following the conference on artificial intelligence. URL: <http://www.kremlin.ru/acts/assignments/orders/64859>. Accessed: 21.03.2021 (2020)
13. Rahman, R.A., Habibulah, R.: The criminal liability of artificial intelligence: is it plausible to hitherto Indonesian criminal system? *Legality* **27**(2), 147–160 (2019)

# The Impact of Digitalization on Innovative Approaches to Economic Security in Regions



M. O. Suraeva, M. A. Afonasyev, and D. M. Kucheryavenko

**Abstract** The article raises the problem of the impact of digital technologies on approaches to the country's economic security. Key trends are shown, including intelligent systems, multidimensional perception, high-quality images, 5G technologies, convergence of security systems and digital transformation of business, and the area of their application is given. The strategy of economic security in regions with planning peculiarities is presented. The measures to ensure the protection of information security are described, which formed the basis for changing approaches to economic security. It shows how companies began to rethink their business strategies and where they began to pay more attention in the digital race. A system of measures to ensure information security of the Russian Federation in the field of domestic policy is presented. Measures are described to ensure the technological independence and safety of the data processing infrastructure. The importance of assessing cyber threats and hacker attacks in the era of digitalization is indicated. The statistical summary is given by the level of the fight against cybercrime in Russia.

**Keywords** Artificial intelligence · Business · Digitalization · Economic security · Economics · Management

## 1 Introduction

Economic security is a combination of factors that contribute to the independence of the national economy. They lead to its stability and stability, and also allow to improve and update it under the needs of society and time. Measures to ensure economic security undergo some changes with the arrival of digitalization. The country's course is aimed at improving the competitiveness of domestic technologies and information security development [4]. This area allows to solve the problems of the growth of

---

M. O. Suraeva (✉) · M. A. Afonasyev  
Samara State University of Economics, Samara, Russia

D. M. Kucheryavenko  
Samara State Technical University, Samara, Russia

cybercrime, insufficient level of personnel support in the ES (economic security) segment in the regions, the backlog of a number of regions in the development and implementation of innovative developments and software products in the field of economic security. Approaches to economic security are beginning to change, since the effective growth in the country's economic indicators is considered in the long-term strategic perspective [8]. Therefore, the state is paying increasing attention to the growth of cybercrime, where the mass of prohibited goods and services is sold, including hacker utilities and access to already hacked infrastructures. The immediate threat of complex targeted attacks prompts the company to take a fresh look at the effectiveness of protection systems. It is time to revise old approaches and talk about a new type of information security.

## 2 Methodology

Economic security in the regions is a strategy developed until 2030 in Russia. This is a strategic planning document that addresses the following issues: solving acute problems in the field of economic security; minimization and complete elimination of external and internal threats to the development of a complex of industries in the regions; conducting the necessary assessment of the level of economic security and the state of foreign economic indicators [2]. However, the state changed its focus to the information security specification with the advent of digitalization, paying special attention to the economic sector. Selected areas are subject to consideration here:

- credit and financial system;
- system of state statistics;
- accounting systems for organizations and enterprises (regardless of the form of ownership) in the regions;
- accounting and information automated systems of federal executive authorities;
- systems for collecting, processing, storing and transmitting information (tax, financial, customs, exchange, as well as data on foreign economic activity).

An assessment of potential threats to information security in the digital economy has begun. They were perceived as obvious, but have become real problems of time. Some examples are given below:

- cybercrimes (penetration of intruders into the information systems of banks);
- the current level of technological dependence of the Russian Federation on other states, as foreign means of information protection are still widely used;
- many commercial structures (domestic and foreign) on the Russian domestic market, which are sources and consumers of information. the threat is that the activities of these structures in the field of creating and protecting systems for collecting, processing, storing and transmitting information are poorly controlled

and there is a high probability of unauthorized access to confidential economic information;

- theft of information containing commercial secrets (which can cause economic damage to enterprises, regardless of their form of ownership), as well as illegal copying of information and its distortion (due to accidental or deliberate violations of information technology) [1].

The current problems and threats have become a serious problem for the Russian economy as a whole and in the regions in particular. Therefore, a number of measures were developed to ensure the protection of information security, which formed the basis for changing approaches to economic security, becoming a paradigm of thinking in the field of economic security. The list of measures includes:

- development and implementation of national secure systems of electronic money, electronic payments, electronic commerce;
- development of certified national means of information protection, implementation of these means in the systems of collection, storage, processing and transmission of economic information;
- improvement of methods of selection and training of personnel to work with systems of collection, storage, processing and transmission of economic information;
- state control over the creation, development and protection of systems for the collection, storage, processing and transmission of economic information (financial, statistical stock, customs, tax information);
- reconstruction of the state reporting system in order to ensure the reliability, completeness and security of information;
- improvement of the regulatory legal framework that regulates information relations in the segment of the economy.

Therefore, today there is a high growth in the demand for highly intelligent protection tools that allow solving problems of timely detection of attacks and incidents. These are systems of the class security information and event management (SIEM), network traffic analysis (NTA), complex antiAPT solutions. Market interest in complex solutions and unified software platforms for IT infrastructure management has increased.

### 3 Results

Digitalization and the recent events of a partial lockdown have led to the emergence of new approaches and trends in the economic security system, which set the course for an integrated approach in the regions of the country and directed towards the development of the security market. The results of the main trends are presented in Table 1.

**Table 1** Trends in the economic security system in 2021

| Trend  | Application area  |
|--|---|
| Impact of intelligent systems                            | <p>The demand for contactless access control systems that operate on the basis of face recognition technologies, scanning QR codes or NFC tags has grown</p> <p>Combined access control systems with new technologies, with face recognition terminals and thermal imaging modules began to appear at many facilities where classic checkpoints (using ID cards) have already been installed. An important requirement was the ability to integrate such solutions into the overall security system</p>   |
| Multidimensional perception                              | <p>The market’s need for quick reaction to events has given impetus to the development of the computing power of processors. Now a modern security system is able to analyze not only visual information, but also sounds, infrared and UV radiation. All this makes it possible to comprehensively assess the situation and make the necessary decisions faster in order to prevent an undesirable event or minimize its consequences</p>  |
| High-quality image                                       | <p>Effective operation of the security system at any time of the day and in all weather, conditions has already become a common requirement in almost all projects. It is important that cameras can get a detailed and informative image in the absence of lighting, in conditions of heavy precipitation</p> <p>Therefore, customers are increasingly in demand for cameras with high-sensitivity matrices and lenses that have a high aperture value (aperture opening)— such cameras are capable of full-color broadcasting in 24/7 mode and efficiently work with video analytics</p>  |
| 5G for wireless security and UHD (Ultra High Definition) | <p>5G technology can seriously change the security industry. Big bandwidth and minimum data transfer delay allow for high speed to broadcast images in good resolution</p> <p>Standard 5G also opens up more opportunities for the use of intelligent chambers with on-board analytics, which significantly reduces the response time, increases the speed of working with other peripheral devices in a single system</p> <p>The number of Wireless solutions in the small and medium-sized business segment is growing, among private customers. With the development of data transmission technologies, the number of wireless cameras will grow several times. In the future, modern security systems will also develop on geographically remote territories, where more opportunities will appear for the use of analytics and IA applications</p> |

(continued)

The chosen approach using these trends will reduce the intensity of the influence of external factors, increase competitiveness and enhance the technological development of regional industries. But digitalization also dictates negative consequences that are caused by the availability of information and other resources, as well as the globalization of the virtual network [5]. So, for example, the case of the hacker

**Table 1** (continued)

| Trend                                      | Application area   |
|--|--|
| Security convergence                       | <p>The ability to maximally unite individual devices to the general system is one of the main wishes of the security market specialists</p> <p>The most obvious advantages of this approach are the high efficiency of the IT infrastructure, convenient work with the system, saving resources for maintenance and the acquisition of software licenses, reducing the response time for incidents and the ability to prevent unwanted events</p>  |
| Digital business transformation            | <p>Many companies have begun to revise their business strategies and pay more attention to new technologies. For example, the number of requests for intelligent security systems as a tool to improve business efficiency has increased several times. This is an increase in productivity, and automated quality control of services, the transfer of routine tasks to smart systems</p> <p>Today, security infrastructure is closely tied to corporate systems, POS software, and other sources of additional information on which decisions are made</p>   |
| Cloud security solutions                   | <p>Security systems are increasingly associated with cloud services. Due to the flexibility of solutions and the possibility of their rapid deployment, they continue to gain popularity among small and medium-sized businesses, major corporations and government customers</p> <p>Cloud solutions appear and for specialists in the security market—for example, such as HIK-ProConnect—with their help installers get the opportunity to quickly solve many technical issues of the client without physical departure to the object that saves time and material resources</p>   |
| Intelligent analytics “on board”           | <p>The development of the hardware base in security devices (especially in the video surveillance segment) makes it possible to use more advanced intelligent algorithms in end devices. For example, license plate recognition, vehicle or person counting, heat mapping, violation detection, and other AI-based functions are becoming increasingly available</p> <p>The transfer of part of the data analysis tasks directly to the cameras reduces the load on the server, the data transmission network, allows freeing up space in storage, but most importantly—to reduce the response time and, accordingly, increase the security level of protected objects and territories</p> |
| Open ecosystems of AI-powered applications | <p>Artificial intelligence applications are finding their way into many new fields, and the demands on intelligent algorithms are increasing in parallel. Today, you can see entire ecosystems emerge on the market to meet the different needs of customers. Some security vendors already include the ability to work with third-party applications in their devices</p> <p>This allows you to expand the list of available intelligent functions, and also opens up new directions for mutually beneficial cooperation in the field of development</p>  |

Source Authors



group Lurk received a wide response, on which a criminal case has been initiated since February 2019, considered in the Kirovsky District Court of Yekaterinburg, with the help of a viral program in 2015–2016, they were stolen from the bank accounts of travel companies, construction and food companies more than 1.2 billion rubles. IT crimes today make up one fifth of all registered crimes in Russia. And over the past six months, their growth is 92% (225.5 thousand crimes). The biggest increase is given by crimes with the use of plastic cards. This year, 82 thousand crimes were registered, in 2020–34 thousand.

Compared to the same period last year, the growth was 490%. Most of the thefts (about 69%) are associated with a deception, when fraudsters, taking advantage of the gullibility of citizens, using phone calls or other means, receive payment card data and the ability to almost freely misappropriate funds, including pensioners and the poor. All this undermines the basic principles of stability and reliability of the economic security system and does not allow reaching a new level of its development. Such incidents led to the formation of measures to ensure the information security of the Russian Federation in the field of domestic policy: creation of a system that will counteract the monopolization of segments of the information infrastructure by domestic and foreign entities (we are talking, among other things, about the media and the market of information services); counter-propaganda activities against disinformation about the domestic policy of the Russian Federation, the purpose of which is to prevent the negative consequences of disinformation.

To achieve the goal of ensuring the technological independence and security of the data processing infrastructure, the following measures were taken: support for manufacturers of domestic information security tools, for example, such as the universal security gateway Traffic Inspector Next Generation; legislative restrictions on the acquisition of foreign software by government agencies and the use of predominantly Russian software [6].

The Ministry of Internal Affairs and the Investigative Committee have created specialized units to combat cybercrime. In Crimea, Bashkiria, Udmurtia, Omsk region in 2016–2019, automated systems were created to detect crimes in cyberspace. For the effective functioning of such complexes, it is important that the work is carried out efficiently and purposefully by all departments that are part of the law enforcement system, with the possibility of joining the relevant units of other competent authorities [3]. The National Coordination Center for Computer Incidents, created under the FSB, could become a single coordinating center in the fight against IT crime. But practice shows that even the legal assessment of related cybercrimes (fraud in cyberspace, theft from electronic accounts, circulation of information databases with personal data, etc.) differs in different regions of the country.

## 4 Discussion

The level of combating cybercrime in Russia does not yet correspond to its scale. In 2019, law enforcement agencies received about 350,000 reports of such crimes,

80% of them from citizens. Among IT crimes, hacker crimes (unauthorized access to computer information, the creation and turnover of malicious programs) is about 1%, while sanctions for hacker crimes in Russia are excessively soft [3]. Over the past two years, for the commission of such crimes, a little less than 500 people appeared before the court, while most of them received the conditional deadlines for imprisonment. For 2019–2020, almost 5000 such crimes were registered in Russia [3]. Therefore, sanctions for such crimes do not correspond to the level of public danger and possible consequences at the current time. According to the forecast in 2021, attacks will be made to schemes with QR codes, and their degree of improvement will be using the methods of a sociogeneity to gain access to personal data of consumers. The situation suggests that digitalization dictates new ways of approaches to economic security, but such approaches lead to hacker attacks and growth of cybercrime, which confirms the softness of the regime for their commitment in Russia and the absence of a single center for controlling unlawful actions from hacker groups [9].

## 5 Conclusion

Digitalization is changing approaches to the economic security of the country and its regions. At the head are intelligent systems, multidimensional perception, high-quality images, 5G technologies, convergence of security systems and, as a result, digital business transformation. All this shifts the paradigm of thinking towards an innovative approach to economic security in order to touch upon all aspects of economic, scientific—technological, political, social issues in determining the overall state of Russia and the level of its national security [7]. These strategic sectors directly affect the preservation of an effective level of economic security, therefore, the course of economic policy and the orientation of the country's institutional system to support priority sectors are changing. Its goal is to counter cyber threats, information leaks through technical channels, unauthorized access, strengthen the activities of supervisory services and improve them. There is a direct connection between the information security of the Russian Federation and the protection of the national interests of the Russian Federation in different spheres. Insufficient security of the information space of the state leads to negative consequences, violations of the constitutional rights of citizens, serious economic losses of enterprises. Hence, a competent vision of the prospects for the development of economic security approaches using digital trends is the key to the success of the independence of the national economy. In this race, it is important not to miss serious obstacles in the form of cyberattacks and hacker threats, which are not adequately assessed by the state.

## References

1. Akberdina, V.V., Volodin, A.I., Gubarev, R.V., Dzyuba, E.I., Fayzullin, F.S.: Models of public investment management at the regional level. *Manager* **11**(1), 45–56 (2020)
2. Antipina, N.V.: Optimization of investment into fixed funds of an oil company. *Bull. Baikal State Univ.* **29**(2), 262–272 (2019)
3. Federal Law No 3-FZ “On Police” dated 07.02.2011. URL: [https://en.mvd.ru/doc/On\\_Police](https://en.mvd.ru/doc/On_Police). Accessed: 12.03.2021 (2021)
4. Fox, R.: *Information Technology*. Chapman and Hall/CRC, London (2020)
5. Mandin, M.J., Amparo, M.: *Information security*. URL: [https://www.researchgate.net/publication/348663661\\_Information\\_Security](https://www.researchgate.net/publication/348663661_Information_Security). Accessed: 12.03.2021 (2021)
6. Stankov, I.: *Cybersecurity and information security*. URL: [https://www.researchgate.net/publication/346021182\\_CYBERSECURITY\\_AND\\_INFORMATION\\_SECURITY](https://www.researchgate.net/publication/346021182_CYBERSECURITY_AND_INFORMATION_SECURITY). Accessed: 12.03.2021 (2020)
7. Suvorov, N.V., Akhunov, R.R., Gubarev, R.V., Dzyuba, E.I., Fayzullin, F.S.: Applying the Cobb-Douglas production function for analysing the region’s industry. *Econ. Reg.* **16**(1), 187–200 (2020)
8. Traffic Inspector Next Generation Team: *Information security in the digital economy*. URL: [https://www.smart-soft.ru/blog/informatsionnaja\\_bezopasnost\\_v\\_usloviyah\\_tsifrovj\\_ekonomiki/](https://www.smart-soft.ru/blog/informatsionnaja_bezopasnost_v_usloviyah_tsifrovj_ekonomiki/). Accessed: 12.03.2021 (2021)
9. Wiśniewski, J.W.: *Econometric modeling of profit in an enterprise*. In: Szkutnik, W., Sączewska-Piotrowska, A., Hadaś-Dyduch, M., Acedański, J. (eds.) *Proceedings of the 14th International Scientific Conference “Analysis of International Relations 2020. Methods and Models of Regional Development. Summer Edition”*, pp. 225–237. Publishing House of the University of Economics in Katowice, Katowice (2020)

# Digital Sales as Factor for Improving Efficiency of Automotive Companies Financial Management



S. V. Tishkov, O. A. Naumova, and A. P. Shcherbak

**Abstract** During the pandemic, all industries were forced to increase the digitalization of not only production, but also the sales process. This requires an increase in the amount of financial resources. This article provides an overview of the state of conditions for financing the automotive industry in Russia. The review concerned three major car manufacturers in the Russian Federation: PJSC “KAMAZ”, JSC “AVTOVAZ”, PJSC “Sollers”. Based on the research of the companies’ financial activities, the ways to improve their efficiency were identified. Digitalization of sales is proposed as one of the ways to strengthen the financial position of companies. Taking into account the suggested measures of digitalization, the coefficients of financial stability of the studied organizations are predicted.

**Keywords** Automotive industry · Digital marketing · Financial activities · Sales growth · Debt assessment

## 1 Introduction

Modern market conditions are characterized by profound changes both in the economy and in the social life of society. Enterprises that adapt quickly to changing market conditions have significant competitive advantages associated with the rational use of the funds at their disposal. Organizations need to actively analyze the changes in the external environment, prepare for them in a timely manner, and take the necessary measures to maintain a stable financial condition [8]. Digitalization of all production processes is no longer an element of innovative development, but a requirement of today’s circumstances and business doing conditions. With a

---

S. V. Tishkov · A. P. Shcherbak  
Institute of Economics of the Karelian Research Centre of the Russian Academy of Sciences,  
Petrozavodsk, Russia

O. A. Naumova (✉)  
Samara State University of Economics, Samara, Russia

significant proportion of employees working remotely, there is a production need to digitalize all business processes for which this is possible.

In an unfavorable economic environment, the ability to finance automotive companies is limited, and the available resources are used inefficiently. In this regard, the current topic is the assessment of the financial performance of organizations in the automotive industry. The article examines the financial activities of major players in the Russian automotive market: PJSC “Kamaz”, PJSC “Sollers” and JSC “Avtovaz”.

Assessment of the financial performance of an organization is a complex concept characterized by a system of analytical indicators that reflect the availability, placement and use of financial resources of the enterprise. It is used to determine the financial condition, creditworthiness, liquidity, and competitiveness of an economic entity.

The current scale of production of domestic cars is much lower than foreign ones. The Russian car market is characterized by low consumer solvency. The orientation of domestic automotive manufacturers (PJSC “Avtovaz”, PJSC “Kamaz”, PJSC “Sollers”) to the domestic market leads to a lack of motivation to improve the product, and therefore to a low level of R&D costs compared to similar costs of foreign manufacturers. Leading foreign producers have the opportunity to attract long-term loans at rates of 5–6% or less, while domestic producers attract mainly short-term loans at average rates of 7–10% [1].

Own funds are of particular importance in ensuring the stable functioning of the organization. With the development of the economy, debt financing is becoming increasingly important. The lack of own funds necessary to ensure continuous operation and expansion of the production process is solved by attracting borrowed capital. Although the role of self-financing is significant, this does not exclude the possibility and need to attract borrowed funds [6, 9, 13].

## 2 Methodology

Information about financial activities is necessary both for making management decisions at the enterprise, and for external users to make decisions on investment, long-term contracts and cooperation. Now the compromise theory of capital structure is gaining popularity. This theory is based on the balance between the level of profitability and the risk of bankruptcy from borrowing. This theory provides recommendations for making management decisions in the field of capital structure formation. The compromise concept of capital structure management is that the active application of borrowed funds leads to an increase in the return of equity, since borrowed capital is a cheaper source of financial resources [11]. However, the higher return on equity is balanced by the loss of financial stability.

For attracting various sources of financing, the organization incurs costs: interest to banks for loans and borrowings received, dividends to shareholders, fines and penalties for late payments on accounts payable. Since the prices of the attracted

financial resources are different, an arithmetic weighted average is used, taking into account the weights of the various elements of capital.

The weighted average cost of capital (WACC) is the amount of funds that an enterprise needs to pay for the use of financial resources. The WACC describes the rate of return of assets that an organization must provide in order not to reduce its market value. The minimum WACC value determined by this method will correspond to the optimal capital structure of the company. This method is based on the assumption that there is an inverse relationship between the WACC and the market value of the company.

$$\text{WACC} = R_d(1 - T) \frac{D}{V} + R_e \frac{E}{V}$$

where

WACC is the weighted average cost of capital;

$R_d$  is required return on borrowed capital;

$R_e$  is required return on equity;

T is income tax rate;

D is the market value of the firm's debt obligations;

E is the market value of the firm's equity;

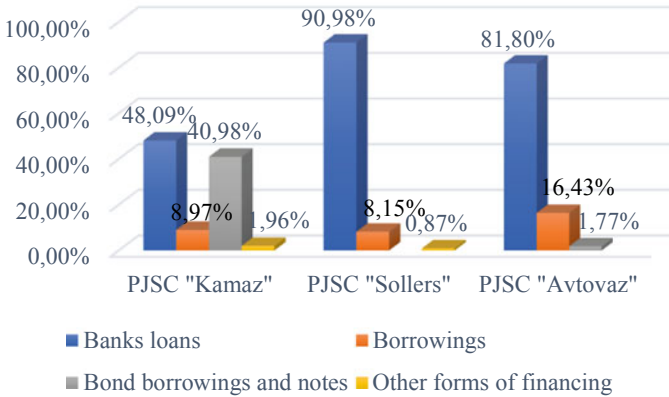
$V = D + E$ —the total market value of the firm.

In contrast to equity, the provision of borrowed funds involves prescribing a fixed percentage, based on which the cost of borrowed capital is determined. The cost of borrowed capital differs from the required return on borrowed capital. The reason is to reduce the tax burden of the organization on interest payments on borrowings. The only exceptions are companies that do not have a profit, or are exempt from paying income tax. Thus, the WACC rate includes the tax effect, i.e. reflects the required return on capital after taxation.

### 3 Results

Organizations in the automotive industry actively use borrowed sources of financing. The multiple increase in the share of borrowed sources of financing in the total capital is indicative. The share of bank lending in the composition of borrowed capital ranges from 48 to 91% (Fig. 1). In our opinion, the automotive industry organizations have an irrational capital structure due to the predominance of short-term liabilities, which affects their financial stability.

Of the organizations under consideration, PJSC "Kamaz" and PJSC "Avtovaz" more actively use various sources of financing. In addition to traditional sources of financial resources (loans and borrowings), PJSC "Kamaz" attracts bond borrowings, and PJSC "Avtovaz" attracts non-interest bearing notes and loans.



**Fig. 1** Structure of external sources of financing the automotive organizations, %. *Source* Authors based on [2, 5, 12]

According to the results of the analysis of the financial statements of the studied companies, it was revealed that the coefficients characterizing the ratio of financing sources do not correspond to the standards, which indicates that automotive companies have difficulties with financial reliability and financial stability due to a significant share of borrowed funds. The presence of negative coefficients of PJSC “AVTOVAZ” is associated with the obtained losses.

It is worth noting that the efficiency of the use of enterprise resources is characterized by such a parameter as the excess of the return on equity over the inflation index. For 2019, the inflation index at enterprises exceeds the return on equity, which indicates that it is not advisable to invest capital in these organizations, since the invested funds are “eaten up” by annual inflation (Table 1).

The structure of the company’s liabilities remains risky. A further decline in the indicators may lead to a negative impact on the assessment of creditworthiness and on the attraction of additional sources of financial resources (especially credit).

The weighted average cost of capital is not determined for PJSC “AVTOVAZ”, since this indicator is not calculated for unprofitable companies (Table 2). The WACC indicator of PJSC “Kamaz” and PJSC “Sollers” exceeds the ROCE (return on capital

**Table 1** Return on equity of organizations in the automotive industry and the level of inflation, %

| Indicator   | Year    |        |        |        |
|---|---------|--------|--------|--------|
|   | 2016    | 2017   | 2018   | 2019   |
| Return on equity of PJSC “Kamaz”, %                 | -6.18   | 1.74   | 9.03   | 4.05   |
| Return on equity of PJSC “Sollers”, %               | 20.87   | 9.32   | 5.41   | 0.24   |
| Return on equity of PJSC “AVTOVAZ”, %               | -190.70 | -92.99 | -15.48 | -13.98 |
| The level of inflation in the Russian Federation, % | 12.91   | 5.38   | 2.52   | 4.27   |

*Source* Authors

**Table 2** Weighted average cost of capital and return on employed capital of organizations 2019, % (developed by the authors)

| Organization   | WACC  | ROCE |
|----------------|-------|------|
| PJSC “Kamaz”   | 16.89 | 4.93 |
| PJSC “Sollers” | 9.50  | 4.79 |
| PJSC “Avtovaz” | 0     | 7.52 |

*Source* Authors

employed). This means that the cost of capital of PJSC “Kamaz” and PJSC “Sollers” is high. It is necessary to reduce the cost of their capital and increase the profitability of the capital involved. But the capital of PJSC “AVTOVAZ” needs a good restructuring in order for the company to start making a profit.

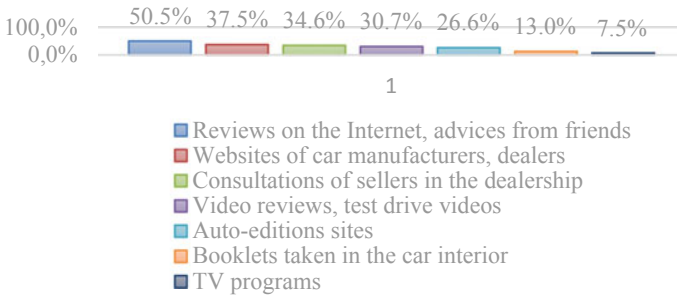
The sanctions imposed by some countries against Russia, as well as the decline in oil prices, have a negative impact on the Russian economy. The rates for attracting credit resources are still high. The consequence is a decrease in the availability of capital and an increase in its value, which can negatively affect the financial performance of enterprises. Under the current circumstances, organizations should focus on maintaining economic sustainability. Increasing the debt burden in the current conditions is extremely dangerous, in our opinion, the implementation of a more restrained financial policy, reducing the debt burden may be strategically correct. First of all, it is necessary to optimize costs by reducing the cost price of manufactured cars. It is proposed to reduce material costs by replacing imported automotive components with domestic ones.

It is assumed that the policy of import substitution will increase the share of the use of Russian automotive components to 83%, so that the cost of one passenger car will not exceed 400 thousand rubles. It turned out that some Russian suppliers buy automotive components abroad. This is mainly steel, glass, and a significant part of the import of electronics for cars. They bring components from Europe and China.

For example, ABS plastic is a impact resistant thermoplastic, which is widely used in mechanical engineering to create cases of various devices. The use of domestic ABS plastic will reduce costs by 20 rubles per 1 kg. Domestic plastic is comparable to imported analogues and is not inferior to them in quality. The use of domestic materials will reduce costs by up to 10%. Given the weak results of the companies according to the reports, as well as pessimistic estimates of the company’s future sales, it is recommended to reduce investment in R&D by 2 times.

The presented problems will solve the sales growth. This tool, with a positive margin, is always the best option. Therefore, in our opinion, the key direction is the digitalization of new car sales. Modern society spends a significant part of its time online. When choosing a new car, 63% of customers use information from the Internet. The most popular source of information is owner reviews on the Internet, tips and reviews from friends/acquaintances (Fig. 2). 37.5% of buyers use the websites of car manufacturers and dealers. The top 3 sources of information close consultations in dealership centers. Booklets and TV programs are used by the least number of respondents. This indicates a decline in the popularity of print publications and television in general.





**Fig. 2** Sources of information when choosing a car, % of buyers. *Source* Authors based on [8]

Of the 36 automotive companies, only 7 have a full-fledged catalog with the possibility of paid booking, all other functions are not fully available. A noticeable failure is observed at the stage of “basic” online sales, meaning payment for the full cost and approval of the loan. Banks already provide ready-made solutions that will allow to implement the submission and approval of a loan online very quickly. Now dealerships are just expensive salons with huge rent and an impressive staff of employees, and not sales points. Online sales will allow to perform all the necessary formalities remotely and to avoid personal arrival at the auto dealership.

The current lack of the ability to perform certain functions is the potential for the development of online car sales (Table 3). Although in 2020, many dealers insisted on the possibility of online sales, in fact, it ends with an offer to deposit money remotely and wait for the stores to open to pick up the car. Moreover, in developed countries, the online format of car sales is no longer a know-how [12].

As a result of the proposed measures, part of the profit received is used to repay debts. As a result, the share of borrowed capital of PJSC “Kamaz” will decrease from 69.6 to 52.8%. In PJSC Sollers, the debt burden will be 20%. PJSC “AVTOVAZ” will

**Table 3** Used online sales solutions on the automotive market, % of companies

|                         |   |      |
|-------------------------|---|------|
| Reservation catalog     | Availability of specific VINs on the site                       | 75   |
|                         | Availability of content for a specific VIN (description, photo) | 75   |
|                         | Prepayment for a specific VIN on the site                       | 19.4 |
| “Basic” online sale     | Payment of the car for the full price                           | 0    |
|                         | Online loan submission and approval                             | 2.8  |
| Online sale             | Car registration in trade-in                                    | 8.3  |
|                         | Configurator “Additional equipment»                             | 13.9 |
|                         | Insurance products (Casco)                                      | 8.3  |
| “Advanced” online sales | Dynamic pricing   | 11.1 |
|                         | Full-fledged personal account                                   | 22.2 |
|                         | Car delivery  | 8.3  |

*Source* Authors

**Table 4** Projected values of the weighted average cost of capital and the return on capital employed by the automotive industry organizations, %

| Organization   | WACC fact | WACC assumption | ROCE fact | ROCE assumption |
|----------------|-----------|-----------------|-----------|-----------------|
| PJSC “Kamaz”   | 16.89     | 9.50            | 4.93      | 9.82            |
| PJSC “Sollers” | 9.50      | 9.34            | 4.79      | 10.17           |
| PJSC “Avtovaz” | 0         | 0               | 7.52      | 9.68            |

Source Authors

cover its accumulated losses, its own capital will be a positive amount of 1153 million rubles due to the profit received and the issue of additional shares. However, the share of borrowed capital will remain very high. Overall, the coefficients have improved, which indicates an increase in the financial stability of automotive companies.

The projected values of the weighted average cost of capital will decrease due to the optimization of the capital structure (Table 4). The increase in ROCE indicates an improvement in the financial performance of automotive organizations. Since the earned return on ROCE capital will exceed the cost of this WACC capital, the proposed measures can be considered effective.  $ROCE > WACC$  is a condition of positive economic value added.

Thus, domestic car manufacturers should seriously optimize production costs and focus on reducing the debt burden. In the current situation, the demand for cars is falling, and therefore it is necessary to reduce investments for new projects. The main difficulties are in the current macroeconomic situation, competition. There is no need for a complete absence of borrowed capital, but it is necessary to keep the debt load at an optimal, healthy level. A good profit will be if there is a steady demand for products, and the company itself will not spend too much against the background of the current economic situation. In order for demand to grow, we need economic prosperity. This is not about 2020. The restoring of the automotive market will have a positive impact: the fast removal of most of the restrictions on the movement and activity of enterprises, the restoration and stabilization of oil prices, the introduction of additional measures of support from the state.

## 4 Discussion

The key challenges for the modern automotive industry relate to the development and application of advanced manufacturing technologies. These are also digital technologies, requirements of the global market: reduction of the decision-making time, execution time and time to bring high-tech products to the market [8]. For most automotive companies, digital marketing is a new field. In the future, it is necessary that the sales process is carried out in a combined way (choose and book a car online, and apply for a loan, pay offline), the transition to online sales with the preservation of a small part of the dealerships.

Companies need to give customers the opportunity to choose a car without losing information and time at all stages. Online sales include: booking and prepayment program on the website, consultations with sellers from the dealerships (online chats), loan/insurance processing, remote inspection (additional photos and video review of the car), payment for the car, delivery of the car to the entrance or pickup. Digitalization of car sales will compensate for the decline in offline sales and maintain revenue at an acceptable level [3]. Today in Russia there are shells for digital car sales, such as CarDigital, Artsoft, Automarketing and others, but they all work for intermediary organizations, and not for the car manufacturers considered in this article.

Significant difficulties experienced by the global automotive industry are caused by the global economic and financial crisis that has changed the structure of the industry and the market significantly [4, 7]. The industry faces a lot of challenges caused by digital technologies. This technology leads to numerous serious qualitative structural changes in different branches [10].

## 5 Conclusion

The automotive industry is one of the key sectors of the Russian economy that determines the economic and social level of the state development and provides a multiplier effect in related industries: chemical, metallurgical, electrical, etc. The study analyzes the financial activities of key players of the Russian automotive market: PJSC “Sollers”, PJSC “Kamaz”, PJSC “AVTOVAZ”.

The considered organizations of the automotive industry have an irrational structure of the ratio of equity and debt capital. The financial activities of automotive companies are characterized by a high level of borrowings, exceeding the level of profitability. This leads to the disposal of a significant part of the received incomes in favor of creditors. In addition, the growth of borrowed funds leads to an increase in the risk of insolvency, a decrease in the credit rating, and a decrease in financial stability. Therefore, it is strategically correct to pursue a more restrained financial policy and reduce the debt burden in the future.

The next direction is the digitalization of new car sales. Now dealerships are just expensive salons with huge rent and an impressive staff of employees, and not sales points. Online sales will allow to perform all the necessary formalities remotely and to avoid personal arrival at the auto dealership.

Although in 2020, many dealers insisted on the possibility of online sales, in fact, it ends with an offer to deposit money remotely and wait for the stores to open to pick up the car. The current lack of the ability to perform certain functions is the potential for the development of online car sales. In the future, it is necessary that the sales process is carried out in a combined way, the transition to online sales with the preservation of a small part of the dealerships. Digitalization of car sales will compensate for the decline in offline sales and maintain revenue at an acceptable level.

The epidemiological situation in the world changed the demand for cars. On the other hand, there are certain advantages that automotive companies will receive from the rouble devaluation. Domestic companies can increase their market share due to the fact that imported cars will become much more expensive. However, it is more likely that the future of the companies is threatened by a further decline in the Russian car market during a real slowdown in the economy due to the deterioration of the global market situation. Therefore, domestic car manufacturers should seriously optimize production costs and focus on reducing the debt burden. There is no need for a complete absence of borrowed capital, but it is necessary to keep the debt load at an optimal, healthy level.

**Acknowledgements** The study was carried out with the financial support of the RFBR in the framework of scientific project No. 20-310-70005.

## References

1. Asabaeva, A.T.: Analysis of financial activity of the automotive industry enterprises. In: Ashmarina, S.I., Pavlova, A.V. (eds.) Proceedings of the VIII All-Russian Scientific and Practical Conference Russian Science: Current Research and Development, vol. 1, pp. 497–500. Samara State University of Economics, Samara (2019)
2. AvtoVAZ: Accounting records of JSC “AvtoVAZ” in accordance with IFRS. URL: [http://info.avtoVAZ.ru/pages/section\\_7/307.html](http://info.avtoVAZ.ru/pages/section_7/307.html). Accessed: 11.03.2021 (2021)
3. Brodovaya, E.: What sources of information do Russians use when choosing a car? URL: <https://www.autostat.ru/infographics/40662/>. Accessed: 11.03.2021 (2019)
4. Debenedetti, A., Philippe, D., Chaney, D., Humphreys, A.: Maintaining legitimacy in contested mature markets through discursive strategies: the case of corporate environmentalism in the French automotive industry. *Ind. Market. Manag.* URL: <https://hal.archives-ouvertes.fr/hal-02493108>. Accessed: 11.03.2021 (2021)
5. Kamaz: Accounting records of PJSC “Kamaz”. URL: <https://kamaz.ru/investors-and-shareholders/financial-statements/ifrs/>. Accessed: 11.03.2021 (2021)
6. Kirca, A.H., Randhawa, P., Talay, M.B., Aldeniz, M.B.: The interactive effects of product and brand portfolio strategies on brand performance: longitudinal evidence from the U.S. automotive industry. *Int. J. Res. Market.* **37**(2), 421–439 (2020)
7. Llpis-Albert, C., Rubio, F., Valero, F.: Impact of digital transformation on the automotive industry. *Technol. Forecast. Soc. Change* **162**, 120343 (2021)
8. Naumova, O.A., Svetkina, I.A., Korneeva, T.A.: The impact of digitalization on the economic security index of GDP. In: Ashmarina, S., Vochozka, M., Mantulenko, V. (eds.) Digital Age: Chances, Challenges and Future. ISCDTE 2019. Lecture Notes in Networks and Systems, vol. 84, pp. 159–164. Springer, Cham
9. Pang, S., Hou, X., Xia, L.: Borrowers’ credit quality scoring model and applications, with default discriminant analysis based on the extreme learning machine. *Technol. Forecast. Soc. Change* **165**, 120462 (2021)
10. Pas’ko, A.V.: Influence of digital revolution on world automotive industry transformation. *E-Manag* **1**(1), 19–25 (2018)
11. Pirttilä, M., Virolainen, V.M., Lind, L., Kärri, T.: Working capital management in the Russian automotive industry supply chain. *Int. J. Prod. Econ.* **221**, 107474 (2020)

12. Sollers: Briefly about the SOLLERS group. URL: <http://www.sollers-auto.com/ru/investors/business/glance/>. Accessed: 11.03.2021 (2021)
13. Sun, C.: Online marketing customer search based on 5G network and dynamic image sampling. *Microprocessors and Microsystems*. URL: <https://www.sciencedirect.com/science/article/pii/S0141933121002076>. Accessed: 11.03.2021 (2021)

# Digital Transformation of Transport Logistics Under Current Conditions



I. A. Toymentseva, V. D. Chichkina, and M. A. Shafieva

**Abstract** The paper deals with the digital technologies implementation in the companies' activity, including transport enterprises. The authors pay attention to the fact that the processes of digitalization and digital transformation are necessary, and they contribute to achieving competitive advantages, reducing operating costs, improving business processes, developing customer services, and meeting customer needs at a higher level. The digital technologies implementation contributes to developing innovative business models and improving the company's efficiency. The digital transformation of the transport industry leads to improving the service quality (safety, reliability, timing, and availability) and has a positive impact on the economic efficiency as a whole. The authors developed a modified method for measuring the service quality of passenger transport and defined an integral indicator of the quality based on economic and mathematical modeling methods. The approach makes it possible to ensure consistency and complexity of the digitalization and digital transformation processes. The authors distinguished the positive effects of the digital transformation both for manufacturing enterprises and consumers.

**Keywords** Consumers · Digital transformation · Modeling · Quality · Service · Transport

## 1 Introduction

The relevance of the research is due to the fact that the processes of digitalization and digital transformation are essential, and they contribute to the achievement of companies' competitive advantages. The digital transformation is closely related to services, and it is a very relevant development area for service-oriented companies,

---

I. A. Toymentseva (✉)  
Samara State University of Economics, Samara, Russia

V. D. Chichkina · M. A. Shafieva  
Syzran Branch of Samara State Technical University, Syzran, Russia

including transport firms. On the other hand, the integration of social, economic, and technological processes that build digital service ecosystems are understudied.

The level of Russian digital economy development is significantly lower in comparison with the information leaders (USA, Singapore, and Israel), but there is a growing trend in the development and implementation of digital products and technologies in the Russian Federation. The digitization of resources is dramatically developing and becoming an everyday process. The digital transformation of socio-economic systems at all levels is carried out through digital platforms. An increase in digitalization is not due to purchasing modern software products and equipment, but the introduction of a consumption model of IT services. Therefore, service integrators that offer digital platforms are the most important participants in the digital transformation of socio-economic systems. The digital transformation is able to reduce costs, improve business process management, develop customer service, meet consumers' needs at a higher level, develop innovative business models, and contribute to improving the business efficiency. The positive results of the digital transformation are manifested at all levels from a particular customer to all national consumers.

## 2 Methodology

The authors used a system approach and logical, strategic, and managerial methods of analysis, as well as an economic and mathematical modeling method and a questionnaire survey. The digital transformation of the transport industry contributes not only to improving the service quality (safety, reliability, timing, and availability), but also to developing the business cost efficiency as a whole. The current digital technologies (smart IT computers or gadgets) are able to substitute the Department of Transportation. There is no need for drivers to receive a medical examination in order to start work. It is enough to wear an electronic wrist bracelet to see all the indicators within a few seconds. Operators, who used to provide passengers with any information on vehicle schedules and changes on routes, have been replaced with public transport displays and mobile applications. The vehicles repair and maintenance is carried out with the help of computer diagnostics. A customer is always provided with information on freight location and its safety, since many vehicles are equipped with GLONASS/GPS (a global navigation satellite system) that monitors driver's work and rest, speed and operational kilometers, fuel consumption, and other indicators.

The authors developed a methodological approach to determine an integral indicator of the service quality provided by transport enterprises. The calculation is based on the fuzzy sets theory and economic and mathematical modeling methods. The main indicators for conducting an assessment of the service quality are the following:

1. Safety. The services provided should not damage passengers' health and the environment.
2. Timing. The service should be provided in accordance with schedule, time, and travelling speed.
3. Comfort. Passengers should be provided with high quality service, attention, and comfort in public transport.
4. Integrity. When providing the service, a provider offers transportation service, as well as complimentary customer services mentioned in the contract.
5. Informational content and reliability. When providing the service, passengers are offered with reliable information on departure and arrival, as well as the rules on travel and luggage transportation.
6. Availability. A provider offers an access to services for various groups of consumers.
7. Luggage safety. When providing the service, a provider delivers luggage to the destination without any losses and damage.

To calculate the integral indicator of the service quality, the authors implemented a design method calculating all the indicators included in the integral one with respect to the weight coefficients. The integral indicator of the service quality ( $Z$ ) is a linear dependence of specific series ( $N$ ). To bring the values of all indicators into consolidated units of measurement, a fuzzy sets theory was applied. According to the theory, the values of all indicators are taken into a number scale from 0 to 1:

$$Z = k_1 \cdot N_1 + k_2 \cdot N_2 + \dots + k_n \cdot N_n = \sum_{i=1}^n k_i \cdot N_i$$

$k_i$  is a specific gravity of the indicators included in the integral one.

The variability of the integral indicator of the service quality will be calculated from the formula:

$$\sigma_Z^2 = k_1^2 \cdot \sigma_1^2 + k_2^2 \cdot \sigma_2^2 + \dots + k_n^2 \cdot \sigma_n^2 = \sum_{i=1}^n k_i^2 \cdot \sigma_i^2$$

As all indicators that are included in the integral one vary from 0 to 1, then

$$k_1 + k_2 + \dots + k_n = \sum_{i=1}^n k_i = 1$$

The objective function is the following:

$$\sum_{i=1}^n k_i^2 \cdot \sigma_i^2 \rightarrow \min$$



subject to the constraints:

$$\sum_{i=1}^n k_i = 1, \quad k_i > 0$$

The problem is resolved through Lagrange method ( $\gamma$ ):

$$F = \sum_{i=1}^n k_i^2 \cdot \sigma_i^2 - 2\gamma \left( \sum_{i=1}^n k_i - 1 \right)$$

F is Lagrange function.

The variability of the integral indicator (Y) equals

$$\sigma_z^2 = \sum_{i=1}^n k_i^2 \cdot \sigma_i^2 = \sum_{i=1}^n \frac{p_i^2}{p^2} \cdot \frac{\sigma_z^2}{p_i} = \frac{\sigma_y^2}{p} = \gamma$$

Therefore, the sum of the weight coefficients equals 1:

$$\sigma_z^2 \left( \frac{1}{\sigma_1^2} + \frac{1}{\sigma_2^2} + \dots + \frac{1}{\sigma_n^2} \right) = 1$$

This means that  $k_i$  is calculated as follows:

$$k_i = \frac{\sigma_z^2}{\sigma_i^2}$$

According to the calculations, we get the value of the integral indicator of the service quality. The greater a deviation of the integral indicator as regard to the changes of a specific one included in the total score is, the higher its specific gravity becomes.

### 3 Results

According to the methods mentioned above, the authors calculated the quality indicators for each parameter and determined the integral indicator of the service quality. Mathematical and statistical characteristics of passengers' assessment (f. ex. safety) have the following references:

- matrix A: first column presents the points (1–10) for the service quality, second column presents the number of passengers who evaluated the service quality;
- matrix B: mean observation of the points;

- matrix D: variability of the points;
- $\sqrt{D}$ : mean-square deviation of the points.

$$A := \begin{pmatrix} 5 & 2 \\ 6 & 7 \\ 7 & 13 \\ 8 & 14 \\ 9 & 6 \\ 10 & 1 \end{pmatrix} \quad \text{ORIGIN} := 1 \quad i := 1 \dots 6$$

$$B := \frac{A^{(1)} \cdot A^{(2)}}{43} \quad B = 7.419$$

$$D := \frac{(A^{(1)})^2 \cdot A^{(2)}}{43} - B^2 \quad D = 1.267 \quad \sqrt{D} = 1.125$$

According to the results of the study, the following valuations of average points for the service quality, variability, and weight coefficients were obtained (Table 1).

IT solutions digitalize almost all business processes in transportation. The transport company management used to make decisions on the basis of calculation data, experts evaluation or proper ideas. Nowadays, big data let make decisions. While having information on the time of day and movement of passengers, it is possible to plan a new route, provide for additional vehicles in the rush hour or towards the most popular directions of movement. Due to the digitalization, it has become more convenient and cheaper for passengers to pay transport fee by bank cards. Moreover, an electronic display at bus stops will inform passengers on time and

**Table 1** Calculation of the integral indicator of the service quality of public transport in Samara

| Item                                     | Resulting score | Average point | Variability | Specific gravity of indicator | Performance evaluation of the quality |
|--|-----------------|---------------|-------------|-------------------------------|---------------------------------------|
| 1. Safety                                | 319             | 7.42          | 1.267       | 0.380                         | 2.82                                  |
| 2. Timing                                | 264             | 6.13          | 1.289       | 0.225                         | 1.38                                  |
| 3. Comfort                               | 215             | 5.00          | 1.398       | 0.057                         | 0.29                                  |
| 4. Integrity                             | 268             | 6.24          | 1.501       | 0.030                         | 0.19                                  |
| 5. Informational content and reliability | 235             | 5.47          | 1.412       | 0.055                         | 0.30                                  |
| 6. Availability                          | 216             | 5.03          | 1.292       | 0.223                         | 1.12                                  |
| 7. Luggage safety                        | 352             | 8.19          | 1.502       | 0.030                         | 0.25                                  |
| Total (on average)                       | 1,869           | 6.21          | -           | 1.000                         | 6.35                                  |

Source Authors

routes of public transport. A smartphone will provide passengers with the shortest distance and minimum time to get to the place of destination. The Federal Road Agency “Rosavtodor” [12] has implemented a whole range of modern IT services that provide the agency with information on travel conditions through operating duty services, carry out operative administration of conditions with respect to use for traffic on federal-aid highways, increase the safety level, as well as improve the management efficiency of public property in highway transportation.

## 4 Discussion

In a traditional way, passenger traffic, transport flows, freight traffic, transport infrastructure, and service quality were considered apart, whereas in contrast their integration plays a major role in the transport ecosystem development. The digitalization and the introduction of new information technologies result in new opportunities in cargo and passenger transportation management. Many Russian researchers pay attention to this fact [3, 4, 6–8, 10]. The development of a sustainable and flexible transport system is based on Norton–Kaplan balancing method [9], that provides for the integration of the interests of all participants in the supply chain. Before implementing the digitalization in business, a company has to prepare employees for the process and improve staff skills [2, 5, 11]. Cole, the founder of Deloitte technology strategy, notes that digital technologies should be technologic and understandable to all employees, not only to IT department staff. Employees should improve their knowledge and learn the principals of a digital activity [13, 14]. To sum up, the digitalization leads to a breakthrough in improving and managing business processes not only in industry, but also in transport.

## 5 Conclusion

IT companies, industrial enterprises, large financial organizations, and retail companies are pioneers in the digital technologies implementation in Russia, not only because they have the resources to adapt quickly digital technologies to the consumers’ needs, but also because they are ready for intensive structural changes. The motivation of companies that use digital products and technologies is explained by the need to provide customers with high services, reduce internal operating costs, and strengthen competitive advantages in the market. Today, the most profitable form of the digital transformation for national socio-economic systems is the service usage of integrators, that is to say companies that provide digital services upon the favourable terms which are able to contribute to building cross functional digital platforms. This approach allows to ensure consistency and complexity of the digitalization and digital transformation processes.

**Table 2** Positive effects of the digital transformation

| Effects for manufacturing enterprises   | Effects for customers   |
|---|---|
| Cost reduction, decrease of risk, and revenue growth                                  | Possibility to have good value for money                                      |
| Improving the efficiency of supply chain management                                   | Getting information on products and services                                  |
| Possibility to find specialists through the use of digital communication channels     | Possibility to purchase goods that were not available before                  |
| Increasing the transparency of the work within an enterprise and with a public sector | Simple access to government portals through digital platforms                 |
| Possibility to enter other markets and attract new customers                          | Possibility to purchase various products through Internet and digital portals |

Source Authors

The digital transformation results in strengthening a company's market position, finding new niches, increasing market share, achieving new competitive advantages, simplifying all business processes, and improving the service quality. The most important thing is to exceed customers' expectations in order to retain existing customers and attract new ones. The positive effects of the digital transformation are presented in Table 2.

The economic effect of the digital transformation in all economic sectors increases every year. The well-known company BCG conducted a research and came to a conclusion that Russian digital transformation will become a basis for economic growth in the long term [1]. The digital transformation allows to provide goods and services with added value in all economic industries and sectors. According to the experts, the added value will increase to 7 trillion rubles in 2021 [1]. To sum up, the digital economy is the basis for the socio-economic systems development at different levels (macro, meso, and micro) in the long term.

## References

1. Banche, B., Boutenko, V., Kotov, I., Rubin, G., Tuschen, S., Sycheva, E.: Russia online? Catch up can not be left behind. URL <https://www.bcg.com/ru-ru/russia-online-catch-up-cannot-be-left-behind>. Accessed: 21.03.2021 (2017)
2. Berman, S.: Digital transformation: opportunities to create new business models. *Strategy Leadersh.* **40**(2), 16–24 (2012)
3. Danilov, I., Marusin, A., Mikhlik, M., Uspensky, I.: Development of the mathematical model of fuel equipment and justification for diagnosing diesel engines by injector needle displacement. *Transp. Prob.* **15**(1), 93–104 (2020)
4. Danilov, I.K., Marusin, A.V., Marusin, A.V., Danilov, S.I., Andryushchenko, I.S.: Diagnosis of the fuel equipment of diesel engines with multicylinder high pressure fuel injection pump for the movement of the injector valve for the diagnostic device. In: *Proceedings of the 4th International Conference on Frontiers of Educational Technologies*, pp. 157–160. Association for Computing Machinery, New York (2018)

5. DeNisco Rayome, A.: Why employees are the key to digital transformation success in the enterprise. URL: <https://www.techrepublic.com/article/why-employees-are-the-key-to-digital-transformation-success-in-the-enterprise/>. Accessed: 21.03.2021 (2019)
6. Evtiukov, S., Golov, E., Ginzburg, G.: Finite element method for reconstruction of road traffic accidents. *Transp. Res. Procedia* **36**, 157–165 (2018)
7. Evtiukov, S., Karelina, M., Terentyev, A.: A method for multi-criteria evaluation of the complex safety characteristic of a road vehicle. *Transp. Res. Procedia* **36**, 149–156 (2018)
8. Ginzburg, G., Evtiukov, S., Brylev, I., Volkov, S.: Reconstruction of road accidents based on braking parameters of category L3 vehicles. *Transp. Res. Procedia* **20**, 212–218 (2017)
9. Kaplan, R.S., Norton, D.P.: *Strategy Maps: Converting Intangible Assets into Tangible Outcomes*. Harvard Business School Press, Boston (2004)
10. Kerimov, M., Safiullin, R., Marusin, A., Marusin, A.: Evaluation of functional efficiency of automated traffic enforcement systems. *Transp. Res. Procedia* **20**, 288–294 (2017)
11. Reznicek, A.: Preparing your workforce for a digital transformation. URL: <https://www.jabil.com/insights/blog-main/how-to-prepare-employees-for-digital-transformation.html>. Accessed: 21.03.2021 (2018)
12. Rosavtodor: Implementation concept intelligent transport systems in urban agglomerations. URL: <https://rosavtodor.gov.ru/storage/app/uploads/public/5e0/1e9/708/5e01e9708cf8e517182017.pdf>. Accessed: 21.03.2021 (2020)
13. Šoltés, V., Mišík, J., Kubás, J., Štofková, Z.: Education in information security. In: Gómez Chova, L., López Martínez, A., Candel Torres, I. (eds.) *Proceedings 10th International Technology, Education and Development Conference (INTED)*, pp. 4418–4424. IATED Academy, Valencia (2016)
14. Stalmašeková, N., Genzorová, T., Čorejová, T.: Employee benefits as one of factors of work motivation. In: Hájek, P., Vít, O., Bašová, P., Krijt, M., Paszeková, H., Součková, O., Mudřík, R. (eds.) *CBU International Conference Proceedings 2017: Innovations in Science and Education*, vol. 5, pp. 448–552. Central Bohemia University, Prague (2017)

# Digital Economy: Challenges and Development Risks



A. S. Fogel and S. V. Kliment'yeva

**Abstract** This article focuses on identifying and analyzing the challenges and risks related to the introduction of the digital economy in the present-day world. The relevance of the work is caused by the rapid progress of information technologies and their transformation into a significant and integral part of the development of modern civilization. The objectives of our study are to identify the main challenges and risks posed by the digital economy. The work is based on an interdisciplinary approach, using methods of comparative analysis, systemic and typological approaches, as well as sociological, predictive and dialectical methods. The study highlights the major achievements at the current stage of the development of the digital economy. But like any significant and large-scale process, the development and improvement of the digital economy creates a variety of problems related to the spheres of economics, sociology, politics and psychology. The highlighted challenges and risks are in many cases important both for the modern stage of development and for the immediate future of the entire world community. In our work we try not only to highlight the main problems, but also to assess their danger and possible impact on humanity and the post-industrial period of its development.

**Keywords** Digital economy · Digitalization · Information civilization · Internet · Modern society · World economy

## 1 Introduction

The relevance of the study of the topics related to the digital economy is due to the increasing acceleration of social development and the emerging transition of the whole society from the industrial stage to the information stage. One of the signs

---

A. S. Fogel (✉)  
Samara State University of Economics, Samara, Russia  
e-mail: [alexandr\\_fogel@inbox.ru](mailto:alexandr_fogel@inbox.ru)

S. V. Kliment'yeva  
Samara National Research University, Samara, Russia

of the new society is always recognized by experts as the main basis of all areas and processes of human activity, as well as the fact that information in its pure form becomes one of the main objects of purchase and sale. Economic thinking creates a special worldview and a special way of life in the modern world [8]. Information is increasingly becoming a key resource not only in commercial but in all other areas of activity. Our lives are changing at such an unprecedented pace that the term “information revolution,” “digital revolution,” “digital explosion” are often used [11]. This development, in turn, generates the greatest comprehensive improvement in information technology, the expansion and complexity of infrastructure, and creates such an important phenomenon as the global digital economy. This is a new model, a landmark to which modern countries of the world aspire. That is why it is subject to high demands from stakeholders to provide opportunities to improve the competitiveness of the economy and build capacity to increase the efficiency of economic activity, as well as raise the living standards [2]. However, this development in general and the introduction of even certain elements of the digital economy into our lives often goes quite spontaneously, avalanche-like, contradictory and inconsistent with other areas of human activity, which creates many different problems and risks, both related to the process of development—“growth diseases”—and with systemic problems—“system diseases.” Another thing is that in crucial epochs it is very difficult to recognize and separate some from others in time, which leads to their further expansion and obfuscation. In the context of the evolving information revolution, it is almost impossible to accurately predict both the pace of change and their results. Above all, despite the considerable number of papers on the digital economy, there is still no clear and recognized understanding of what the digital economy itself is like as a socio-economic system and what its boundaries are, and whether there are any.

Information is constantly changing the life of the entire modern society. If in earlier epochs significant and fundamental changes took centuries and decades, now the changes are obvious to everyone and this is a constant phenomenon accompanying our lives. The information of life acts in the modern world as an unconditional and indispensable indicator of progress and is seen as one condition for the further successful development of the entire modern civilization.

One of the areas where these changes are most significant and pronounced is the economic sphere. The prerequisites for turning towards the “digits” were the emergence of the Internet as a worldwide phenomenon and the development of ever-better and more diverse means of communication. The result is an opportunity of exchanging of large data volumes and accumulating it, which in turn makes it possible to process the facts collected, predict outcomes, make valid conclusions and thus fully benefit. To ensure all this, it took to create an infrastructure, or, to put it another way, an ecosystem of global data platforms. The term “digital economy” originally appeared in Japan at the height of the Japanese crisis of the 1990s.

The digital economy is also called the “internet economy”, “new economy” or “web economy” and is increasingly intertwined with traditional economies, making it nearly impossible to discriminate between them with hundred-per-cent certainty. The main elements of the digital economy are considered to be: online games and online

advertising; E-commerce E-transfers and online banking; blockchain and cryptocurrency. The digital economy can also be imagined as a digital-based production, which further enhances its scope and impact on global processes. Already in 2017, about 50% of the world's population has consistently used the Internet for the purpose of teaching or doing business. According to forecasts, the number of sales through the network will soon bypass all other types of relationships in trade.

Despite its relatively short existence as a holistic phenomenon, the digital economy already has a number of achievements, significant not only for specific countries and regions, but also on a global scale. And this creates the basis for its further development and the introduction of elements in life and global integration. The most significant achievements of the digital economy, recognized by experts around the world, are:

- the ability to pay for a number of services with a card instead of cash, and in the future is also expected to be a widespread development of digital money and a complete rejection of physical payment;
- optimization of the company's work—this usually includes increasing the efficiency of production in general or the work of an individual employee, productivity growth, in which computers take on most of the monotonous work, which takes a lot of time, and employees get the opportunity to deal with more important and interesting things for the production and themselves and do not clog themselves once again, as well as reduce the cost of production);
- there is an opportunity to save time and money on premises, couriers, security, transport and more;
- the emergence of new jobs and new occupations;
- the development of freelancing and the associated ability of people to constantly improve their skills, enterprise and the opportunity to move on to more modern and diverse tasks and occupations;
- the increase in the number of the middle class and the gradual overcoming of social inequalities, which ensures stability and the possibility of sustainable progressive development of society as a whole;
- increasing the number of competitive and creative companies on the market;
- making it easier for authorities to centralize and coordinate governance, taxation and control;
- capacity to automate and standardize all business processes on a global scale, including education, manufacturing, social, medical, etc.;
- opportunities to reduce the role and influence of bureaucracy and corruption in today's world;
- building a global legislative framework adapted to new realities and providing effective cyber protection;
- the emergence of a culture of using different mobile tools for online shopping;
- transition of postal and banking services to advanced blockchain technologies;
- the development of a range of automated modern business processes;



- worldwide development of the “transparency” of the public and economic life of the state, which greatly obstructs fraudulence, “side” or unlicensed jobs aimed at plundering the population i.e. conscientious consumers and depositors;
- the tendency to facilitate the access of the general public to political and social activities;
- removing the severity of the national issue—because for the world network does not matter who and what origin sits at the computer, presses the keys, produces and consumes. In a digital society, a person, being a citizen of the world, becomes an autonomous self-sufficient unit. And for him, knowledge, freedom of thinking, the ability to choose and create content, not national boundaries, become significant.
- giving to a human the theoretical ticket to immortality: new, not restrained by the capacity information storages and cloning biotechnologies allow to transfer knowledge, personal qualities and experience to an artificial bio-carrier inside a cloned organism. Although these innovations are currently available only to the chosen, the further development of technology creates the prospects for eternal life no longer for the units, but for humanity as a whole;
- updating many traditional art forms and perspectives to create new, as yet unknown genres and forms. Modern human–machine interfaces allow you to transmit the signals of desired sensations directly to the brain bypassing habitual audio or visual devices;
- decreasing, and in the later stages almost neutralizing of the economy and production dependence from the instability of the human factor. Professional efficiency is less and less affected by the virtues and shortcomings of a person, his/her personal problems, moods, fatigue, health status, hormonal and weather fluctuations, membership in trade unions and other organizations, etc.;
- new ways and opportunities for countries to cooperate in different areas of life [9];
- a special type of human being, the so-called “homo digital” is being successfully formed, as fit as possible to the conditions of the information society [7].

All these achievements and advantages, and most importantly all new prospects and opportunities allow to change the situation not only for the leading economic powers like the USA, Japan, China or Great Britain, but for all the world in tote. However, in addition to successes and prospects, the development of this new area also generates a very real variety of problems and contradictions that simply need to be taken into account in planning future steps and resolved in the course of further development. Highlighting such problems and shortcomings, as well as the way they affect the further advancement of the world community, will be devoted to our research.

## 2 Methodology

The specificity of the topic and its complexity make it necessary to use a variety of research methods in our work. Since the digital economy is indissolubly linked to many areas of human life, its research must also cover all these areas, which has led to the need for an interdisciplinary approach to our work. Inevitably, the topic of identifying the problems and risks of the digital economy advancement is at the intersection of such sciences as economics, philosophy, ethics, psychology, sociology, economic theory. And only the synthesis of knowledge can give us the clearest and most coherent picture. Due to the versatility of the problem, it is also necessary to address the possibilities offered by the system approach. The comparative analysis method, which allows to assess problems and risks as a single interconnected system and to understand the significance of each component of its component, as well as factor analysis, is quite applicable. Sociological research methods, such as observation, focus group analysis, quantitative methods, can identify and investigate the dynamics of development and the importance of specific problems for the conditions of specific countries and regions. The typological approach gives us an opportunity to see the main and typical features, as well as the emerging trends of problems in the introduction of the digital economy as a whole. The dialectic method is used to address the socio-psychological and ideological problems of digital society and economics in their interconnectedness and interdependence. Predictive method is used to consider the prospects of digital society.

## 3 Results

In the course of developing and improving the mechanisms and phenomena of the digital economy, humanity faces a variety of challenges related to different areas of life. Among them there are three most notable sections—economic, political and psychological. The most significant problems in each section are:

### 1. Economic:

- the roboticization of a number of industries and services increases the unemployment rate worldwide by an order of magnitude. Many of the current professions and competencies, due to their lack of demand in the new world, disappear altogether. This clearly does not contribute to the harmonization of public relations, even in the light of subsidies and the development of retraining programs for the unemployed;
- the general depletion of human and human capacity is largely due to the lag in the development of educational institutions from real development needs, so that the qualifications and directions of their output do not meet the urgent needs of specific countries, and the most in-demand professionals appear relatively few;

- constant and ever-increasing brain drain—digital and related professionals are leaving the province and undeveloped regions and moving to major cities, creating a shortage of skilled labor on the ground;
- low levels of development and digital lag in a number of countries prevent them from taking advantage of the benefits and benefits of digitalization processes. Another consequence of this situation is the additional threat to the unstable operation of digital systems, constant failures and the loss of often vital data [2];
- growing computerization creates opportunities for hackers to steal personal information of customers and use it for their own purposes;
- the growing number of internet scammers. Since 2017, Internet fraud has developed in Russia. The most common scam trick is sending messages with infected links or files. When a user clicks on them, the virus enters the computer, looking for account numbers, wallet passwords or CARD PINs. The information collected is passed on to fraudsters.
- the Digital Gap (this is referring to the growing inequality in digital education, as not all people have access to digital products and services, which directly affects their overall well-being) [3];
- the progressive development of darknet as an illegal habitat for hackers;
- many experts believe that progress in the development of digital products will affect the disappearance of the banking system we are used to, and this will happen in 10–15 years;
- the digital economy requires the creation and constant renewal of powerful infrastructure, high-speed Internet, developed mobile networks and telecommunications;
- the other side of the rapid economic growth provided by the introduction of elements of the digital economy may be the formation of economic bubbles and, as a result, the emergence of crises of the entire economic system [2].

## 2. Political:

- the deployment of foreign IT technologies into all sides of public and state life considerably narrows state sovereignty and deepens its general vulnerability;
- the rapid growth of various threats to state cybersecurity: transport, energy, and finance infrastructure, social “engineering” and modelling or economic management, as well as information warfare and cyberterrorism [1];
- the redistribution of political power on the world stage due to the advance of the web economy is the formation of a new digital order. The country’s place and role in the global system are determined by the possession of information [1];
- the lack of real opportunities to control and suspend digital development, even when urgently needed, the further digitalization progresses, the more the state becomes from a force controlling the main processes only to an outside observer or to one of the major but far from decisive players. There are suggestions that this will “kill” the state in our usual form, and the vacated place will be taken by transnational corporations—theories of cyberpunk and

“Dark Future” predicting “digital concentration camp” and “digital slavery” as the most likely variants of the progress of human civilization.

### 3. Psychological:

- fear of new technologies and their ever-increasing pressure to connect with huge flows of information as the main source of change in the familiar world, which causes various individual and mass hysteria, neuroses and phobias, and growing uncertainty about the future and self [6]. After all, the Global Information Space inevitably includes negative news, tragic reports of natural, environmental and man-made disasters, financial crises, environmental disasters, terrorist attacks, the consequences of global problems, etc. [1];
- different possibilities of people. When something new comes into the world, and the state uses it, it should teach everyone how to use it. For example, Russians are divided into two categories: those who know how and do not know how to use new technologies. For example, no grandmother will return cashback for having paid in cash, not through an electronic wallet. About 75% of Russian pensioners do not want to receive a pension on the card because they do not know how to use it. In banks there are employees who help them to withdraw money or pay for communal services. But it is really difficult for pensioners to learn how to do everything themselves. And this growing division into the digital “elite” and digital “losers” is beginning to have a significant impact on human relations;
- lack of a culture of work and proper communication in the digital environment, which causes constant conflicts both online and in real teams;
- computerization from an early age leads to the situations when children develop so-called machine-like or “clip” thinking (fragmentary, visual, high-speed, mathematical-linear, instant and superficial) instead of systemic (holistic, multi-complex, humanitarian, cause-and-effect, philosophical and comprehensive);
- the economic value of the individual decreases, and in the future the individuality of each person may disappear. There is an opinion that modern man becomes “a man of the universal crowd” [1];
- reducing communication with the real world. Over time, the person more and more closes only on the interface (gadgets and devices) with artificial intelligence. Through it builds communication with others. All this leads on the one hand to the fatal psychological dependence of a person on machines (a number of scientists have declared that the VR-addiction can be equated to smoking, alcoholism and drug addiction [10] and on the other hand destroys the usual forms of human communication, formalizing and impoverishing it [7];
- long stay in the virtual sphere causes loneliness and isolation from other people [7] deepens the distance between man and society;
- the machine has no concept of morality. Given that ethics is an absolutely specific to humans, it would disappear along with the emotivity of

man. The power of empathy, that main purpose and measure of personality development, dies away. Man becomes more intelligent, but—soulless, “humanized”;

- the disappearance of imagination is the idea of moving to a world where there are no goals, opportunities, or even the need for new ideas, as everything exists in virtual reality in one way or another [9].

#### 4. Ecological.

The rapid change of technology used in the introduction and maintenance of digital technologies, due to their moral wear and tear, creates a problem of their efficient use and subsequent disposal. To date, in many countries, this process is being carried out in violation of sanitary and epidemiological norms. Devices and other elements used in digital technologies create additional thermal energy, and their disposal leads to an increase in radiation levels, concentrations of toxic substances and allergens in the atmosphere, soil and natural waters. Thus, we see that the problems associated with the general development of digital technologies and the digital economy in particular, indeed in one way or another cover all areas of activity important to modern man and at times even exceed them.

Moreover, the problems associated with the digital economy, directly or indirectly, can create global conflicts by eroding or destroying the familiar orientations of civilization as a whole and in a particular society. The development of the digital economy in many ways already constructs and approves new models of the future of all mankind and mark a new stage of civilization. And this future may not be so distant and not so incredible as the sci-fi of the last century wrote.

## 4 Discussion

All the aspects of the digitization of the economy individually or as part of different blocs, in the context of individual countries, communities or the world as a whole are actively researched and discussed in various scientific and analytical publications, they are given a lot of attention in the media. At the state level, in scientific and business communities, organizations and other associations are created, the activities of which are connected with the development and research of digitalization, its capabilities and consequences. The digital economy is seen as the most important institutional factor in the development of both the global and regional economies [4]. Digitalization in different areas of public production and communications is an a priori process in the development of the business services ecosystem [12]. There is a serious impact on the implementation of artificial intelligence systems on the performance of many companies around the world [5]. The level of digitization of the economy becomes one of the leading in assessing the potential of each state and its regions. At the global level, the issue of identification and actual classification of risks and threats posed by the comprehensive digitalization of public life is considered.

However, the authors of the study note such points as the lack of work to quantify the risks of digitalization in general. The priority of emerging privacy threats to sensitive data when using digital platforms and devices [13]. The work of scientists raises the question that artificial intelligence technologies and the digitization of emerging processes further contribute to the social stratification due to the fact that the professional community of professionals is washed out of the “middle” level, leaving the field of activity only for the most highly professional cadres, the number of which will continue to decrease with the increasing use of digital technologies [4]. The question of society’s readiness for such a high rate of changes in the technological and technological environment and the creation of a technologically comfortable environment for each individual is acute in accordance with his skills. This is directly related to the digital literacy of the population and the ability to rapidly increase it with maximum coverage. At the same time, the rapid development of digital technologies affects the moral and cultural aspects of life; it is even noted that the very perception of time is changing. The so-called “time compression phenomenon” has emerged, and behavioral attitudes and reactions are changing, which can lead to unpredictable consequences with an open sociocultural ending. Nevertheless, these works do not set new goals for mankind in a rapidly changing civilizational space.

## 5 Conclusion

Thus, we can see that the digital economy in the modern world acts as an ambiguous and largely contradictory collection of processes and phenomena, some of which bring real benefits and benefits today, and some exist in the form of trends, the extent of which in today’s conditions can only be guessed with a large enough range of probabilities. And if, for example, the new intellectual and “digital elite” is still in its infancy, the problems with the need to improve the frequently basic computer literacy in a large part of the world’s population are already being felt quite strongly. And the problem of digital gap and rising unemployment in megacities is often much more pressing psychological problems, as in many cases they do not concern everyone. As long as there is a pressing problem of retraining, restructuring, reformatting, and most importantly funding the entire education system for modern needs, and, again, on a global scale—until then society will exist in a transitional state and the state will exist, perhaps gradually weakening or transforming. And as the processes of this “global revolution in education” evolve, psychological problems will come to the fore more and more. In addition, the development of the digital economy does not remove the whole problems of the “old”—the resource economy and existing problems, so as long as a person has a need for real resources, our usual economy will continue to exist, and the digital economy for a certain period will be an addition to the resource economy, until it merges with it entirely. The new society will need a philosophical and humanitarian explanation and justification for its existence at the present stage and in the near future. Physical labor will not disappear completely, but it is necessary to form goals and establish the place of man in a new civilization.

Not everyone can become a creative elite, so there is a fairly significant “growth problem”: what to do to a person where all the routine and physically hard work is taken on by the machines? It is necessary not only to transform the education system, but also to formulate a number of goals for human existence in a new and very contrasting globalized world. And what this world will become now greatly depends not only on the human wisdom, but also on today’s swift actions.

## References

1. Alieva, N.Z., Ivushkina, E.B., Kushnir, I.B., Buryakova, O.S.: The global information space as a source of formation of threats and dangers. In: Popkova, E.G. (ed.) *The Future of the Global Financial System: Downfall or Harmony*. Lecture Notes in Networks and Systems, vol. 57, pp. 1020–1026. Springer, Cham (2019)
2. Chazhaeva, M.M., Serebryakova, A.A., Tashkulova, G.K., Atabekova, N.K.: Sustainable development of the digital economy on the basis of managing social and technological threats. In: Popkova, E.G., Sergi, B.S. (eds.) *Digital Economy: Complexity and Variety vs. Rationality*. Lecture Notes in Networks and Systems, vol. 87, pp. 49–56. Springer, Cham (2020)
3. Deltsova, N.V.: Artificial intelligence technologies in the field of legal services: relevant aspects. In: Ashmarina, S.I., Mantulenko, V.V. (eds.) *Current Achievements, Challenges and Digital Chances of Knowledge Based Economy*. Lecture Notes in Networks and Systems, vol. 133, pp. 389–396. Springer, Cham (2021)
4. Domnina, S.V., Podkopaev, O.A., Salynina, S.U.: The digital economy: challenges and opportunities for economic development in Russia’s regions. In: Ashmarina, S.I., Mantulenko, V.V. (eds.) *Current Achievements, Challenges and Digital Chances of Knowledge Based Economy*. Lecture Notes in Networks and Systems, vol. 133, pp. 149–157. Springer, Cham (2021)
5. Ermakova, J.D.: Artificial intelligence in the contemporary digital environment. In: Ashmarina, S.I., Mantulenko, V.V. (eds.) *Current Achievements, Challenges and Digital Chances of Knowledge Based Economy*. Lecture Notes in Networks and Systems, vol. 133, pp. 355–362. Springer, Cham (2021)
6. Guryanova, A.V., Smotrova, I.V.: Transformation of worldview orientations in the digital era: Humanism vs. anti-, post- and trans-humanism. In: Ashmarina, S.I., Vochozka, M., Mantulenko, V.V. (eds.) *Digital Age: Chances, Challenges and Future*. Lecture Notes in Networks and Systems, vol. 84, pp. 47–53. Springer, Cham (2020)
7. Guryanova, A., Khafiyatullina, E., Petinova M., Astafeva, N., Guryanov, N.: Social, psychological and worldview problems of human being in digital society and economy. In: Popkova, E.G., Sergi, B.S. (eds.) *Digital Economy: Complexity and Variety vs. Rationality*. Lecture Notes in Networks and Systems, vol. 87, pp. 244–250. Springer, Cham (2020)
8. Guryanova, A.V., Krasnov, S.V., Frolov, V.A.: Human transformation under an influence of the digital economy development. In: Ashmarina, S., Mesquita, A., Vochozka, M. (eds.) *Digital Transformation of the Economy: Challenges, Trends and New Opportunities*. *Advances in Intelligent Systems and Computing*, vol. 908, pp. 140–149. Springer, Cham (2020)
9. Kostin, K.B., Berezovskaya, A.A.: Modern technologies of digital economy as a driver of growth of the world market of goods and services. *J. Int. Econ. Aff.* **9**(2), 455–480 (2019)
10. Lokova, M.Y., Khanova, M.N., Azamatova, G.K., Vindizheva, A.O., Reshetnikova, N.N.: Social consequences of the impact of information technologies on the values of modern youth in the conditions of the global financial and economic crisis. In: Popkova, E.G. (ed.) *The Future of the Global Financial System: Downfall or Harmony*. Lecture Notes in Networks and Systems, vol. 57, pp. 176–182. Springer, Cham (2019)

11. Martiskova, P., Svec, R.: Digital era and consumer behavior on the internet. In: Ashmarina, S.I., Vochozka, M., Mantulenko, V.V. (eds.) *Digital Age: Chances, Challenges and Future*. Lecture Notes in Networks and Systems, vol. 84, pp. 92–100. Springer, Cham (2020)
12. Rybakova, E.V., Nazarov M.A.: Entrepreneurship in digital era: prospects and features of development. In: Ashmarina, S.I., Mantulenko, V.V. (eds.) *Current Achievements, Challenges and Digital Chances of Knowledge Based Economy*. Lecture Notes in Networks and Systems, vol. 133, pp. 104–112. Springer, Cham (2021)
13. Timofeeva, T.B., Ozdoeva, E.A.: Analysis of the world experience in creating digital platforms and related risks. *Management* **8**(3), 112–122 (2020)



# Informatization of the Tax System in Modern Conditions of Economic Development



V. S. Charikov and Y. V. Levashova

**Abstract** This article deals with the actual problem of informatization of the tax system. The authors considered approaches to the digitalization of taxation in modern society, as well as conducted a comparative analysis of these systems and approaches. In addition, the study conducted a survey among potential users of these systems, namely individuals who are citizens of the Russian Federation. By scientific processing of the data obtained, an assessment of the effectiveness of these systems in taxation in modern conditions was made and recommendations were developed for improving the tax system in the context of informatization and digitalization of the processes of implementing activities in this area. To achieve the results obtained, the theoretical and legal framework for the application of these systems and databases in the modern economy was also analyzed, during which the feasibility of these changes in the future was revealed. The conclusions have practical significance and are important for all parties involved in the tax system.

**Keywords** Digitalization · Economy · Tax administration · Tax system · Taxation technologies

## 1 Introduction

In modern conditions, when the process of digitalization is particularly intense and accelerated, an important element of the development of almost any economic sphere is the informatization of the processes that take place in it. This also affected the tax system, in which the development of information technology has been going on for quite a long time and, nevertheless, has not yet reached its limit [8]. Despite the constant modernization of the process of interaction between the state administration and citizens, the issue of transparency and reliability of the implemented electronic services remains open. In addition, the problem of rational implementation of tax control and optimization of electronic processes in the field of taxation will remain

---

V. S. Charikov · Y. V. Levashova (✉)  
Samara State University of Economics, Samara, Russia

[7]. In the context of such interaction, it is worth noting the importance of further simplifying this process. This topic is quite relevant at the present time, as individuals and legal entities must submit to the tax authorities a lot of documents for the registration of taxpayers, payment of taxes and other tax transactions. These procedures are quite energy-intensive and require a lot of resources, both financial and temporary, not only for individuals and legal entities, but also for authorized state bodies in the field of taxation. For those who apply to the tax authorities, there is a need to wait in long queues, take many copies of documents and certify them [7].

## 2 Methodology

In the course of the research, the authors of this article conducted a theoretical analysis of the information base available in modern realities regarding the methods of implementing the taxation process. In addition, a comparative analysis of the strengths and weaknesses of the systems available in modern practice, used in the course of the process of interaction between individuals and legal entities and public administration bodies regarding taxation, was carried out.

To confirm the theoretical propositions put forward about the importance and significance of the current modernization and informatization of processes in the field of taxation, a survey was conducted among one of the categories of taxpayers who are potential users of electronic services for the implementation of this process in the modern world. The results of the survey, after their processing and analysis, were used in the development of proposals for changing and improving the tax system in the modern world. The authors conducted a comparative analysis of the characteristics of those electronic services and tools that are currently offered for the implementation of taxation and tax control, as well as assessed the feasibility of their use and proposed ideas for their further modernization.

## 3 Results

Digital transformations in the modern economic system are one of the main and primary factors of global economic growth and global development. These changes could not but affect the sphere of taxation [4]. It is worth noting that the tax system of the Russian Federation is in the process of constant reform and change, and with the beginning of the digitalization of the economic system, the introduction of information technologies into the activities of tax authorities took place [5]. When analyzing the existing theoretical framework on this issue, it is possible to identify a number of features that arise during the transition from the standard form of implementation of the taxation process in the modern economy to the digital model. Such features can be considered in several aspects at once:

- introduction and provision of digital public services by the tax authorities of the Russian Federation;
- automated system of tax control and execution of tax obligations;
- definition and development of the mechanism of taxation of new products, transactions that have arisen in connection with the use of digital technologies.

In the first issue, namely with regard to the introduction of digital systems of government services, it is worth noting that the main official platform for interaction, both physical and legal persons with public authorities operating in the field of taxation is the official portal of the Federal tax service (hereinafter—FTS). It includes various sections that evolve over time, adding all new options that should make life easier for the population in the long run. Of course, considering the practical application of this system, it is possible to distinguish both the advantages of its application and the disadvantages (Table 1).

According to the Table 1, it can be concluded that this electronic resource has a number of advantages for both individuals and legal entities, users of this system, but despite all the positive aspects of its functioning, shortcomings were also identified, which were noted by users, mainly these nuances are primarily related to the costs that they are forced to bear due to the lack of skills in using these systems. So, despite the huge range of services provided by the portal, ordinary taxpayers are

**Table 1** Advantages and disadvantages of using an electronic system of interaction with taxpayers through the portal FTS

|                                      | Advantages   | Disadvantages   |
|--------------------------------------|--|---|
| Individuals                          | <ol style="list-style-type: none"> <li>1. The ability to access your personal account from anywhere</li> <li>2. The ability to independently control the payment of taxes and duties, as well as emerging debts</li> <li>3. Ensuring the transparency of the calculation of tax payments</li> <li>4. The ability to independently draw up tax deductions and benefits</li> <li>5. Speed of request processing</li> </ol> | <ol style="list-style-type: none"> <li>1. Lack of skills to fill out tax returns independently without assistance</li> <li>2. Lack of access to a fast Internet connection point to ensure the smooth operation of the network</li> <li>3. Frequent occurrence of system errors when reflecting the tax base</li> </ol> |
| Entities and individual entrepreneur | <ol style="list-style-type: none"> <li>1. Information transparency of competing companies</li> <li>2. Organization of a single information window that allows future investors to make a choice in favor of this legal entity or individual entrepreneur</li> </ol>  | <ol style="list-style-type: none"> <li>1. Lack of motivation of business community representatives to provide integrated reporting</li> <li>2. Bear the additional transaction costs associated with the reporting</li> </ol>   |

Source Authors based on [6]

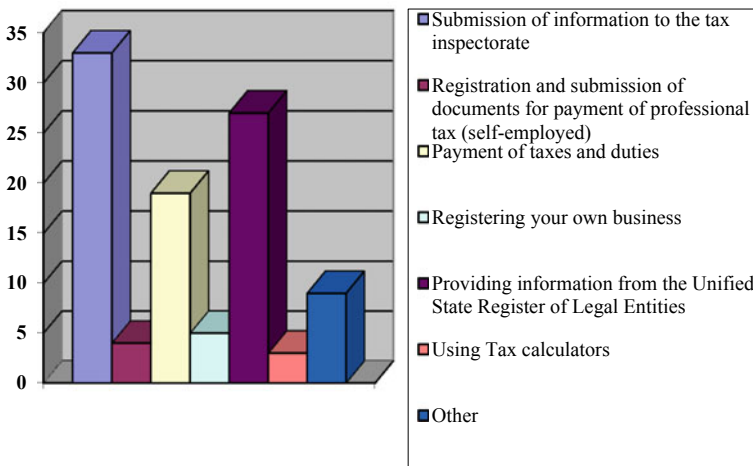
forced to seek outside help from specialized organizations, in turn, legal entities are also forced to outsource these tasks due to the fact that hiring employees responsible for this process will attract even greater costs, and therefore will be economically unprofitable for the company.

It is worth noting that measuring the effectiveness of the mechanisms used in the modern world is quite difficult due to the lack of a single global approach to assessing the activities and functioning of these processes in a single measure. To assess the state of the modern tax system in the Russian Federation and the electronic platforms and digital processes that exist in this area at this stage of the society’s development, a survey was conducted among Russian citizens who are potential users of these systems. So, among the respondents, the absolute majority are individuals, citizens of the Russian Federation, among whom the majority (85% of respondents) are respondents aged 18–56 years. The representativeness of the sample is ensured, first of all, by the presence of various categories of the population (unemployed, self-employed, officially employed).

Respondents were asked about the frequency of use of the most popular information platform among ordinary users nalog.ru. The results of this survey, the largest number of respondents will use this platform at least once in six months (71%), a quarter of respondents use this system at least once a month (25% of respondents) and only 4% do so more than once in a month.

In addition, a question was asked about the purpose of using this platform by individuals. The results are presented clearly in the form of a bar chart (Fig. 1).

Thus, we can see that this electronic service is most in demand for citizens in order to submit information to the tax inspectorate, as well as to obtain information from the Unified State Register of Legal Entities. Other functions of this portal are not fully mastered by taxpayers, and therefore, an important step in the development



**Fig. 1** Distribution of respondents’ responses regarding the purpose of using the FTS portal. *Source* Authors

of the information platform will not just provide certain opportunities for users, but also teach the population of the country the functionality of this resource.

Already, the Federal Tax Service of Russia is pursuing a policy aimed at stimulating the transition of residents of the country to electronic document management directly in the field of taxation, we offer them:

- the possibility of obtaining explanations by taxpayers on certain payments;
- provision of electronic versions of supporting documents;
- improvement of the forms used in reporting [1].

After analyzing the results obtained, we can suggest the following directions for improving the existing platform, namely, the process of its distribution to a larger number of users:

- introduction of the practice of "explanatory conversations" with potential users of the portal;
- posting more detailed instructions for filling out invoices and tax returns.

These directions can be offered as a solution to the problems of interaction with the portal for individuals associated with the difficulties of processing documents.

For legal entities, sole proprietors, and partly for individuals, it is possible to propose the introduction of a separate window, where the company's managers could order centrally, without incurring the cost of finding a company that could outsource this issue, processing documentation, which will reduce costs for taxpayers.

Thus, we can say that the further development of informatization in the field of taxation is an important aspect of the development of the economy as a whole. That is why it is important not just to expand the functionality of this system, but also to maximize the scope of public awareness in tax matters.

## 4 Discussion

Taxes are one of the most important tools of the fiscal policy of any modern state. The study of the essence of taxes was carried out by such scientists-economists. The problems of small business development are considered in the works of Janowski are devoted to the issues of modernization of the taxation system and informatization of processes in this area [2]. In their works, they considered various advantages and disadvantages of existing and functioning tax systems for individuals and legal entities in the modern world. In the study, the authors concluded that digitalization and informatization of modern society is developing in the direction of complexity and acceleration of processes and strong greater contextualization and specializations, like evolutionary processes leading to changes in cultures and societies.

Another author who considers informatization directly in taxation was Nastyushina [3]. In article, author considered the features of the implementation of the taxation process using a software product. This approach is unique and quite new for modern practice, which radically changes the activities of tax services, changing

the processes that take place in the implementation of activities in the field of taxation. In addition, the topic of digitalization of taxation can be traced in the works of Rybakova, Nazarov [6]. In one of their works, they considered the exceptional aspects of this process and the difficulties that may arise in the way of further development of this direction. It was concluded that this topic is quite often found in the works of modern authors, which confirms its relevance at the present time.

## 5 Conclusion

Thus, in the course of this work we have obtained the data, which by scientific analysis revealed that in the conditions of modern economic development an important aspect of the tax system development is the development of electronic resources to expedite the processes in this area and simplify some functionality for taxpayers (individuals and legal entities) and associated government taxation.

Based on the analysis of theoretical and practical data, the authors identified the attitude of individuals and legal entities to these changes. The comparative analysis was used to assess the resources that are currently used in practice in the Russian Federation. As a result of the study, it was found that the effectiveness of these resources is quite high, according to users' estimates, but there are a number of difficulties that need to be overcome in the future to increase the importance of these platforms. Thus, two ways were proposed to expand the scope of this platform, namely, the creation of an additional function that can become the most profitable for users of the system, and the improvement of those points that are associated with explaining the functionality of the electronic resource to users for further independent use.

## References

1. Federal Tax Service: The concept of electronic document management in economic activity was approved. URL: [https://www.nalog.ru/m63/related\\_activities/el\\_doc/10367446/](https://www.nalog.ru/m63/related_activities/el_doc/10367446/). Accessed: 05.03.2021 (2020)
2. Janowski, T.: Digital government evolution: from transformation to contextualization. *Govern. Inform. Q.* **32**(3), 221–236 (2015)
3. Nastuyshkina, E.V.: Informatization of regional tax authorities as a condition for their modernization. *Regionology* **4**(93), 44–53 (2015)
4. Nazarov, M., Mikhaleva, O., Fomin, E.: Digital economy: Russian taxation issues. In: Mantulenko, V. (ed.) *Proceedings of the International Scientific Conference “Global Challenges and Prospects of the Modern Economic Development”*. The European Proceedings of Social and Behavioural Sciences, vol. 57, pp. 1269–1276. European Proceedings, London (2019)
5. Nazarov, M.A., Mikhaleva, O.L., Chernousova, K.S.: Digital transformation of tax administration. In: Ashmarina, S., Vochozka, M., Mantulenko, V. (eds.) *Digital Age: Chances, Challenges and Future. Lecture Notes in Networks and Systems*, vol. 84, pp. 144–149. Springer, Cham (2020)

6. Rybakova, E.V., Nazarov, M.A.: Entrepreneurship in digital era: prospects and features of development. In: Ashmarina, S.I., Mantulenko, V.V. (eds.) *Current Achievements, Challenges and Digital Chances of Knowledge Based Economy. Lecture Notes in Networks and Systems*, vol. 133, pp. 105–112. Springer, Cham (2021)
7. Surueva, M.O.: Balance between business and government in purpose of ensuring economic security to innovation development. In: Vaganova, O.V., Solovjeva, N.E., Tinyakova, V.I. (eds.) *Proceedings of the 8th International Conference on Contemporary Problems in the Development of Economic, Financial and Credit Systems. Advances in Economics, Business and Management Research*, vol. 157, pp. 247–249. Atlantis Press, Paris (2020)
8. Troshina, E.P., Levashova, Y.V., Mantulenko, V.V.: Ways to improve the company competitiveness in the conditions of economy digitalization. In: Ashmarina, S., Mantulenko, V. (eds.) *Proceedings of the 2nd International Scientific Conference GCPMED 2019—Global Challenges and Prospects of the Modern Economic Development. European Proceedings of Social and Behavioural Sciences*, vol. 79, pp. 1468–1473. European Proceedings, London (2020)

# Application of Digital Technologies in Construction



A. V. Shepelev

**Abstract** The article discusses the importance of the introduction of digital technologies in the construction industry. This topic is relevant in connection with the increase in standards for residential and non-residential construction in the near future. At the moment, not all construction companies are ready to work with such productivity, so the question arises about the need to optimize their activities through the introduction of digital technologies. The purpose of the study is to study modern digital technologies used in construction, and to determine the most promising ones for the Russian reality. Using general theoretical methods of cognition and open information sources, digital technologies used in the Russian construction industry were considered; the experience of other countries was shown; the most promising areas for implementation on the Russian market were identified. Based on the analysis of domestic and foreign literature, conclusions are drawn about the importance of measures for the introduction of digital technologies in the construction industry.

**Keywords** BIM · Construction · Digital technologies · Innovative technologies

## 1 Introduction

Talking about the role of digitalization for various sectors of the economy has recently become mainstream. This trend is associated with the growth of organizational and structural links within industries that require new solutions related to data exchange and the introduction of new technologies. This study focuses on the use of digital technologies in the construction industry. It is assumed that digital technologies in this industry will speed up the construction processes at its various stages: from project to implementation. This issue is particularly relevant in Russia after the update of housing construction indicators for a decade. So, by 2030, the volume of construction should grow to 120 million m<sup>2</sup>. Now this figure is 78 million m<sup>2</sup>. [8]. At the moment, it is possible to stimulate this process by introducing new methods of design, building

---

A. V. Shepelev (✉)  
Samara State University of Economics, Samara, Russia



and operation in construction. Based on these aspects, the purpose of the study was formulated—to study modern digital technologies used in construction, and to determine the most promising of them for the Russian reality. This goal involves solving the following tasks:

- review the digital technologies used in the Russian construction industry;
- show the experience of other countries in this matter;
- identify the most promising areas for implementation on the Russian market.

The last point is important since Russian market has its own specifics, which makes it possible to use only certain digital technologies in the activities of a particular industry.

## 2 Methodology

In the course of the study, a sample of countries that are actively implementing digital technologies in the construction industry was conducted. Data from their open official sources on the subject of the study were used to the sample selection. The completeness of the available information was evaluated. Based on this criterion, countries such as the United Kingdom, Singapore and the Netherlands were selected. The Russian data was compared with these countries. The results obtained were used for comparison and grouped by the degree of implementation in the activities of industry enterprises. Then the most promising digital technologies were selected for implementation. The results of the comparison are summarized in the conclusions for this study.

## 3 Results

This section contains the results of the main analysis of the use of digital technologies in the construction industry in the countries that passed the primary sample. Table 1 shows the digital technologies used in Russia, the Netherlands, Singapore, and the United Kingdom. Among them are those technologies that are actually used, and those that are at the stage of development or implementation.

The data in Table 1 shows that there are many digital technologies that can significantly facilitate the activities of enterprises in the construction industry. Some of these technologies are not peculiar for the industry and can act as auxiliary elements in various areas of activity. However, the way they are applied in a particular industry reflects their significant role for the entire process. The use of these digital technologies extends to all stages of the construction value chain. It can be noted that the stages of design, synthesis of materials and construction processes are particularly distinguished. Next, it makes sense to consider in more detail each of the listed digital technologies for their applicability to the Russian reality.

**Table 1** Digital technologies used in construction in different countries

| Russia   | Netherlands   | Singapore   | Great Britain  |
|--|---|---|--|
| <ul style="list-style-type: none"> <li>– Building Information Modelling (BIM);</li> <li>– Animation;</li> <li>– 360 Rendering;</li> <li>– Scaled Robotics;</li> <li>– 3d-printing</li> </ul> | <ul style="list-style-type: none"> <li>– BIM;</li> <li>– 5D models</li> </ul> | <ul style="list-style-type: none"> <li>– BIM;</li> <li>– Augmented Reality (AR);</li> <li>– GPS;</li> <li>– Smart Equipment and Telematics;</li> <li>– Wearable Technologies;</li> <li>– Bionic Suits;</li> <li>– Artificial Intelligence (AI) and Machine Learning (ML)</li> </ul> | <ul style="list-style-type: none"> <li>– Big Data;</li> <li>– AI &amp; LM;</li> <li>– Internet of Things (IoT);</li> <li>– Robotics and Drons;</li> <li>– 5G and Wi-Fi;</li> <li>– BIM;</li> <li>– Virtual Reality (VR)/AR;</li> <li>– 3d-printing;</li> <li>– Mobile and Cloud Technologies;</li> <li>– Blockchain</li> </ul> |

Source Authors based on [3, 4, 9, 10]

BIM is a program in which the construction is designed immediately in a three-dimensional format. During the work on the object, it is possible to make adjustments to the project. At the same time, all related project elements are automatically adjusted based on the changes made. Table 1 shows that this technology is actively used in all the countries considered. Animation and 360 Rendering allow to not only build a three-dimensional model of an object, but also use animation to show how it will behave when mounting or dismantling. AR and VR technologies are also used to visually demonstrate the model of the building, its properties at various stages of construction. Most often, this technology is used not as a tool for developers or builders, but to demonstrate the object to customers and customers. Scaled Robotics presents the achievements of robotics in construction, which allow you to remotely monitor the progress of construction, control the quality, construction time and material consumption. The analysis data of such a robot presented on the construction site is uploaded to BIM. This category also includes all types of robots and drones used. At the moment, this technology is at the testing stage. 3D printing of buildings is also widely known, but is currently actively used only in the UAE and is planned for legislative implementation in Mexico [3, 10].

Speaking about the importance of GPS, 5G, WiFi, mobile and cloud technologies, it makes sense to note that they are not directly related to the construction processes. Their primary function is to ensure uninterrupted and operational communication of employees working in the office and working at the points. From the construction point of view, GPS allows cost-effective methods to make all the necessary measurements on the ground with high accuracy. The same category includes Smart Equipment and Telematics technologies. Originally developed for tracking transport, they have now found application in construction.

The next item is all kinds of Wearable Technologies and Bionic Suits, which are variations of suits and their individual components that should be worn by employees

at the facilities. These suits are designed not only to simplify and optimize the activities of employees, but also to ensure their safety [4].

The basis for decision-making in construction is the data obtained through the use of Big Data. Solutions based on Big Data analysis deal with the main hidden trends on the market, knowledge of which will allow to update your projects and suggestions in order to gain the largest possible share in the industry. AI and ML are able not only to analyze this data, but also to predict the dynamics of the project based on it. You can add a variety of variables to the forecast, including weather, location, access to resources, and more. The IoT in construction plays the role of a smart digital device that can control various repetitive actions through the use of data exchange sensors. This technology is important in terms of performance. If the production capacity is not fully loaded, a sensor may respond, notifying this and starting the process of optimizing the equipment loading. The latest technology-Blockchain-is used to conclude smart contracts, ensure transparency of work processes, which allows to make joint decisions faster and avoid possible disputes regarding the work process [9].

After analyzing the considered digital technologies that have found application in construction, an analysis was conducted on the possibility of their application in the conditions of the Russian reality. For this purpose, digital technologies were divided into three groups: applicable; potentially applicable; limited in use (Table 2).

This distribution is due to a number of features of the Russian market. First of all, this is due to the active growth in the popularity of the use of IT technologies in various industries in Russia. A sufficiently strong knowledge and professional base makes it possible to quickly implement these digital technologies in the construction industry. Regarding digital technologies, the use of which is currently limited in application, it should be noted that these are more high-tech and expensive technologies. Currently, these technologies are not sufficiently developed by domestic scientists, and the acquisition of foreign analogues is too expensive for Russian entrepreneurs. However, with the introduction of potentially applicable technologies, the quality

**Table 2** Analysis of the applicability of digital technologies in the Russian construction industry

| Applicable  | Potentially applicable   | Limited in use   |
|---|--|--|
| <ul style="list-style-type: none"> <li>– BIM;</li> <li>– Animation;</li> <li>– 360 Rendering</li> </ul> | <ul style="list-style-type: none"> <li>– Scaled Robotics;</li> <li>– GPS;</li> <li>– Smart Equipment and Telematics;</li> <li>– Big Data;</li> <li>– AI &amp; LM;</li> <li>– Internet of Things (IoT);</li> <li>– 5G and Wi-Fi;</li> <li>– VR / AR;</li> <li>– Mobile and Cloud Technologies;</li> <li>– Blockchain</li> </ul> | <ul style="list-style-type: none"> <li>– 3d-printing;</li> <li>– Wearable Technologies;</li> <li>– Bionic Suits</li> </ul> |

Source Authors

of the activities of the construction industry enterprises can significantly increase compared to the current level.

## 4 Discussion

This section is intended to compare the opinions of domestic and foreign scientists on the impact of the introduction of digital technologies in the construction industry. So, Bayburin and Kocharin believe that digital technologies take an important place in our lives. Their ownership will eventually become a mandatory requirement for any specialist in the field of construction (not only for the designer) [1]. Tatarinov says that with the use of information modeling, many significant objects can be built, starting with schools and ending with other infrastructure objects. Digital technologies constantly confirm their high efficiency. In comparison with similar projects built without the use of digital technologies, the cost reduction can reach 30% [6]. Vishnivetskaya and Ablyazov say that in modern conditions, digital technologies become crucial for maintaining the competitiveness of the organization and many industries have already appreciated the benefits of introducing and applying elements of digital innovation, which confirms the potential importance for the construction industry [11].

Tetik, Peltokorpi, Seppänen, Holmström write that new digital technologies in construction can reduce costs and ensure high quality and efficiency of work by automating many production processes [7]. Craveiro, Duarte, Bartolo consider the introduction of digital technologies in construction through the implementation of Construction 4.0. Such a system can ensure the promotion of innovations in construction and allow the production of simpler structures [2]. Redwood, Thelning, Elmualim, Pullen note that digital technologies are fundamentally changing the way construction projects are organized and reflect their actions at all stages of the value chain, which confirms the thesis put forward earlier [5]. Both domestic and foreign authors talk about the importance of the introduction of digital technologies for the construction industry, while noting the complex impact of these measures and the overall positive result from them.

## 5 Conclusion

The final conclusions are formulated based on the tasks set at the beginning of the study. Currently, only a few digital technologies used in construction are implemented in Russia. These technologies are based on computer modeling of objects under construction and the surrounding infrastructure. BIM technology is actively used in all the countries considered. Also, other telecommunications and IT technologies are actively used abroad. They are not peculiar for the construction industry, but

can significantly affect the productivity of its activity. Some of these digital technologies can be applied both in a common context and specifically for the construction industry. The most promising technologies for implementation on the Russian market are those related to IT products. Difficulties with implementation in the Russian construction industry may arise with high-tech and expensive digital technologies. This trend is due to the lack of domestic developments in this area and their high cost from foreign manufacturers. The analysis of the works of domestic and foreign authors allows us to assess the need for the introduction of digital technologies in the construction industry as high, since it will increase the productivity and profitability of the country's construction enterprises.

## References

1. Bayburin, A.Kh., Kocharin, N.V.: Application of Digital Technologies in Construction. Library of A. Miller, Chelyabinsk (2020)
2. Craveiro, F., Duarte, J.P., Bartolo, H., Bartolo, P.J.: Additive manufacturing as an enabling technology for digital construction: a perspective on construction 4.0. *Autom. Constr.* **103**, 251–267 (2019)
3. Gurvich, V.: Digital technologies are conquering the country's construction industry. URL: <https://rcmm.ru/vlast-i-samoregulirovanie/42558-cifrovye-tehnologii-zavoeyvayut-struykompleks-strany.html>. Accessed: 09.03.2021 (2018)
4. Oribiada, R.O.: Key digital technologies for the construction sector. URL: <https://sipmm.edu.sg/key-digital-technologies-construction-sector/>. Accessed: 09.03.2021 (2019)
5. Redwood, J., Thelning, S., Elmualim, A., Pullen, S.: The proliferation of ICT and digital technology systems and their influence on the dynamic capabilities of construction firms. *Procedia Eng.* **180**, 804–811 (2017)
6. Tatarinov, T.: Digitalization of the construction industry: Russia's place in global trends on the example of construction control. *SAPR* **2**. URL: <https://sapr.ru/article/25580>. Accessed: 09.03.2021 (2018)
7. Tetik, M., Peltokorpi, A., Seppänen, O., Holmström, J.: Direct digital construction: technology-based operations management practice for continuous improvement of construction industry performance. *Autom. Constr.* **107**, 102910 (2019)
8. Trubilina, M.: The ministry of construction has updated housing construction indicators for the decade. URL: <https://rg.ru/2021/02/08/minstroj-obnovil-pokazateli-stroitelstva-zhilia-nadesiatiletie.html>. Accessed: 09.03.2021 (2021)
9. UK Connect: 10 construction technology trends impacting the industry in 2020. URL: <https://ukconnect.com/construction-technology-trends/>. Accessed: 09.03.2021 (2020)
10. University of Twente: digital technologies in construction. URL: <https://www.utwente.nl/en/education/master/programmes/construction-management-engineering/specialization/digital-technologies-in-construction/>. Accessed: 09.03.2021 (2020)
11. Vishnivetskaya, A.I., Abyazov, T.K.: Digital strategy as a basis for digital transformation of construction organizations. *Econ. Yesterday Today Tomorrow* **9**(3A), 11–20. <https://doi.org/10.34670/AR.2019.89.3.001> (2019)

# Digital Innovations in Agribusiness Industry in the Russian Federation



A. V. Shchutskaya

**Abstract** The use of innovations, including digital technologies, is the main condition to provide for promotion of competitiveness under conditions of global challenges and threats. Russian agribusiness industry demonstrates a steady growth in production volumes and dynamic digitalization. The author aims to determine the features, problems and prospects of digital farming based on the analysis of the current innovation and digitalization processes in the agribusiness of the Russian Federation. Due to the methods of theoretical and economics and statistics analysis, it was revealed that despite some positive trends, Russian agricultural industry is characterized by a low level of innovation activity and a limited distribution of digital technologies, since they are more widely implemented in large agricultural enterprises and holdings. At the same time, the socio-economic conditions during the COVID-19 pandemic have become a powerful incentive for all manufacturers to introduce elements of digitalization in food production and marketing processes. The analysis of the domestic and global experience on digital innovations allowed the author to identify promising areas that contribute to provide all commercial farm units in the agribusiness industry with digital technologies, stimulate digitalization processes and increase the efficiency and environmental friendliness of the agricultural sector of economy.

**Keywords** Agricultural industry · Digital farming · Innovations · Russia

## 1 Introduction

Today, digitalization is the main trend in the economic sectors development in Russia, including the agricultural industry. Having a huge resource potential and seeking for an increase in a competitive position in the global agrifood market,

---

A. V. Shchutskaya (✉)  
Samara State University of Economics, Samara, Russia

Russian agricultural industry has been intensively involved in the digital innovations introduction. It is in the national agricultural sector that transition from traditional farming technologies to digital ones, based on innovative methods of generating, processing, storing and transmitting data, artificial intelligence, robotics and information computer technologies, is the most evident.

The COVID-19 pandemic and lockdown with a need to reduce human contacts in goods and food production, distribution and consumption has promoted to a powerful incentive for the digital technologies implementation. The agrifood sector is a life-supporting sphere of any state. Consequently, a need to use IT solutions has massively increased both in agricultural enterprises' management and production, and food production and distribution. Nowadays, digitalization has affected the entire product chain of food production and marketing [10].

The agribusiness industry digitalization brings fundamental changes, since they affect all areas of business entities' activity, provide for new opportunities and remodel interaction, social integration and communication. Efficient digitalization is the main source to increase competitive advantages. In this regard, the study of the features of the digital innovations implementation in the agribusiness industry, problems and prospects of digitalization is relevant.

## 2 Methodology

The author used general scientific and special methods and techniques of economic research. A review, analysis and generalization of the works of national and foreign scientists and practitioners on the innovative development problems and the digital technologies use in the agribusiness industry were a methodological basis of the study. A theoretical analysis of the papers allowed the author to identify the features and problems of the digital innovations introduction in the agricultural industry. A synthesis of the best recommendations and experience of scientists helped develop measures to stimulate digital innovations in the agribusiness. The trends of the innovative activity development in the agricultural industry, including digital technologies, are determined through statistical analysis methods. The official data of the Federal State Statistics Service of Russia (Rosstat) and the Ministry of Agriculture of the Russian Federation were an empiric basis of the study. To intimately analyze the processes of agribusiness industry digitalization in the Russian Federation, the studies conducted by Higher School of Economics National Research University, Federal State Budgetary Institution of Science "Russian Research Institute of Information and Technical and Economic Researches on Engineering-Technical Support of the Agribusiness Industry", Center for Forecasting and Monitoring the Scientific and Technical Development of the Agribusiness Industry of the Federal State-Funded Educational Institution "Kuban State Agrarian University named after I. T. Trubilin", as well as the data from info-analytic agencies and research and training conferences were analyzed. The research was based on a systematic and integrated approach to

the subject under study that made it possible to ensure credibility and validity of conclusions and proposals.

### 3 Results

Russian agribusiness industry has recently become one of the most developing areas in the national economy. The main growth driver is a core branch of the agribusiness industry, that is agriculture, and it increased production volumes by 3.3% on average per year in 2013–2019. Despite the most difficult socio-economic conditions in production in 2020 caused by the COVID-19 pandemic, there was some positive dynamics in the agricultural development. According to the preliminary estimates of Rosstat, the agricultural production index in 2020 compared to the previous year is 101.5% (in comparable prices) [4]. The current trends are supported by extensive and intensive factors in the economic development and the innovation activity expansion on behalf of rural manufactures [12]. According to the statistics (Table 1), the volume of innovative goods, works and services in agricultural enterprises of the Russian Federation increased more than 3 times in 2016–2019 due to increased costs for innovations.

Table 1 shows the dynamics of technological innovation costs that are the main direction of innovation activity of rural manufacturers (about 99% in the total costs for innovations), and it is typical for labor-intensive and capital-intensive industries. Despite three-times increase in the technological innovations costs, their share in the total volume of goods shipped, works and services remains extremely insignificant (1.6%) due to the low innovation activity of rural producers. According to Higher School of Economics National Research University, only 4.2% of agricultural enterprises implemented innovations in 2019 [6].

Technical re-equipment and modernization in the agricultural industry are developing, and this development is extremely necessary in the context of technical

**Table 1** Core indicators of an innovation activity in agricultural enterprises in the Russian federation

| Indicators  | 2016 | 2017 | 2018 | 2019 |
|---|------|------|------|------|
| Sales of innovative goods and services, bln. roubles                      | 22.2 | 28.4 | 33.8 | 69.6 |
| Innovative goods and services as a percentage of total sales, %           | 1.4  | 1.8  | 1.9  | 2.3  |
| Expenditures on technological innovations, bln. roubles                   | 15.0 | 15.8 | 22.0 | 49.4 |
| Expenditure on technological innovation as a percentage of total sales, % | 0.9  | 1.1  | 1.2  | 1.6  |
| Level of innovation activity, %   | 4.0  | 4.6  | 4.2  | 4.2  |

Source Author based on [6]



and technological lag in domestic agriculture in comparison with developed countries. The transition to the innovation-based development and agribusiness industry digitalization involve the availability of modern equipment for rural producers.

Digital farming is a new technological paradigm that includes co-utilization of precision farming technologies (production processes management through information, navigation and telecommunications technologies, including global positioning technologies and distant land sensing) and intelligent networks and data management tools (Internet of things). To implement digital farming technologies on a practical level, two main conditions should be met: the first is “smart machines” which are capable to receive, send, generate and process data and the second is “connected machines”, that is to say, communication and interfacing standards have to provide for unobstructed data sharing among machines, business partners and portals [9].

The experts distinguish three stages (trends) in the digital technologies development and implementation in the agricultural industry [9]:

- *Leading technologies.* The technologies for geo-positioning, monitoring farm equipment conditions, etc. have been introduced since the mid-2000s.
- *Market saturation* is characterized by a situation where a number of digital technologies and industry standards in the agricultural industry reaches a critical mass. Almost all equipment manufacturers offer their own programs and solutions that can optimize the use of their machines and equipment. The diverse options for using geodata for crop forecasting, agricultural operations optimization, logistics management, etc. are offered. The introduction of agricultural technologies, such as Internet of things and blockchain, has an additional impact on customers.
- *Integration* is the core prospective trend. Companies that will be able to offer common standards and solutions to integrate existing developments in digital agricultural technologies and eliminate the problem of choice and risks will become leaders in agribusiness industry digitalization.

Today, first two stages are the most evident in the Russian agribusiness industry. Moreover, there are developments and first attempts to implement an integration trend. Digital technologies are being intensively introduced into production in large agro-industrial enterprises [6]. These technologies have been already established in large agro-industrial enterprises, both at the level of accounting, planning, financial management, supply and sales activity, and performing production technological operations. Software products of the domestic company 1C have become the most promoted in agricultural enterprise management (ERP-systems).

According to the study conducted by the Center for Forecasting and Monitoring the Scientific and Technical Development of the Agribusiness Industry of the Federal State-Funded Educational Institution “Kuban State Agrarian University named after I. T. Trubilin” together with the Department of Scientific and Technological Policy and Education of the Ministry of Agriculture of the Russian Federation, the most used elements of digital technologies in crop production in 2019 were the following [14]:

- parallel driving,

- satellite monitoring of vehicles,
- creating digital field maps,
- graded weeds spraying,
- graded fertilization,
- graded seeding.

The digital technologies rating in livestock business is as follows:

- electronic database of the production process,
- monitoring of the livestock products quality,
- identification and monitoring of individual animals,
- monitoring of animal stock's health,
- milking operation robotics,
- microclimate autocontrol.

More than 60 Russian regions took part in the survey mentioned above. It was revealed that 2834 enterprises in 55 regions implemented precision farming, and the area amounted to 15.5 million ha. The land area, covered by digitalization, increased by 24% compared to 2018. Precision livestock farming was used in 58 regions by 1707 enterprises with 3 million cattle population in 2019. The cattle population, covered with digitalization, increased by 76% in 2018–2019. The regional leaders in the digital technologies implementation in crop production in 2019 were the following: the Volgograd Region (257 enterprises and 1.33 million hectares), the Krasnodar Territory (250 enterprises and 1.22 million hectares), and the Voronezh Region (211 enterprises and 1.20 million hectares). Animal farming digitalization is intensively developing in the Udmurt Republic (123 enterprises and 166,000 heads), the Kirov Region (92 enterprises and 142,000 heads), the Altai Territory (88 enterprises and 160,000 heads), the Sverdlovsk Region (86 enterprises and 188,000 heads), and the Krasnodar Territory (81 enterprises and 212,000 heads). According to the scientists, precision farming was introduced in 10% agricultural enterprises and precision animal farming was implemented in 13% enterprises in 2019 [14].

There was a rapid startups development in regard to digitalization in 2020 during the COVID-19 pandemic. Agribusiness enterprises have become more active in introducing innovative digital technologies into production processes, building digital logistics supply chains for products, creating sales sites, introducing product tracking systems, etc. There are projects of integrated solutions in agribusiness. Digital Agro, Agrosignal and Cognitive Pilot Companies are planning to build an integrated agroecosystem for commercial farm units' digitalization in Russia within a strategic partnership. It is being planned to create a unique product that integrates full-cycle agro-ERP and unmanned vehicle control technologies. The solution will be a hardware-software system for unmanned equipment control, collecting, processing and transforming telemetrics data, as well as managing all economic activities of companies within a single digital profile [2]. The autonomous control system of agricultural machinery with the use of Cognitive Agro Pilot artificial intelligence, developed by Sber and Cognitive Pilo Companies, has been already used in harvesting by 35 Russian regions in 2020. The largest agricultural holdings in Russia, such as

“EcoNiva”, Agricultural Enterprise Group “Resource”, Corporate Group “Steppe”, Agro Union “The South of Russia”, “Agricultural Complex named after Tkachev”, “Peschanokopskaya Agro Group”, “South-Eastern Agro Group” and others became Cognitive Pilot customers. More than 350 combine harvesters, equipped with Cognitive Agro Pilot, processed more than 160,000 hectares of land and harvested more than 720,000 tons of crop in an autonomous mode from June to October 2020 [3]. Based on the project participants’ estimates, every tenth combine harvester in Russia will be able to become unmanned in three years.

Today, the programs for the digital farming development, support and implementation are being introduced in many Russian region, and they provide for subsidy assistance of the costs for hardware and digitalization equipment purchase [14]. The Ministry of Digital Development, Communications and Mass Media of the Russian Federation have been providing projects on Russian digital solutions development and implementation with grant support since 2020. According to the experts’ forecast, the number of agribusiness organizations which implement Internet of things, precision farming, digital herds and smart greenhouses will increase to 60% by 2024 [13]. The main purpose of agricultural industry digitalization is to achieve a significant increase in functioning efficiency and sustainability. Digital transformation involves fundamental changes in management quality in both technological and decision-making processes at all hierarchical levels, based on information and communication technologies (ICT).

According to the statistics, 82.5% of agricultural enterprises used ICT, 62.5% used electronic document management and 65.4% used Internet to communicate with suppliers and consumers of goods, works and services in 2019 [5]. There was a significant increase in ICT costs from 4 billion rubles to 11.8 billion rubles in the agricultural industry in 2015–2019. The costs for communication services (41.5% and 4.9 billion rubles), computer and office equipment purchase (22.9% and 2.7 billion rubles) and software purchase (8.5% and 1 billion rubles) dominated in 2019. In general, ICT costs in the agricultural industry accounted to only 0.5% of ICT investments in all sectors of the national economy in 2019. Organizations’ internal costs for building, distributing and using digital technologies and related products and services were only 0.6% [1]. These are the lowest indicators among the national economy branches. This fact provides evidence of the lack of digitalization in Russian agriculture. At the same time, while comparing the digitalization costs in the agricultural industry with the contribution of ICT sector to the economic development, which amounted to 3.8% of GDP, we can conclude that there is a high return on costs and therefore, there is a need for the digital agriculture development and a large-scale government support for enterprises that implement digital innovations [1].

## 4 Discussion

Modern innovative digital technologies have a huge potential for economic growth. National and foreign studies have proved that agricultural industry digitalization

significantly improves production efficiency due to an increase in agricultural yield, animal productivity, performance and resource optimization. Moreover, a harmful production impact on the environment decreases [7, 9, 11, 13, 15]. Food and ecological safety are powerful drivers for the digital technologies introduction in the agribusiness industry. Nowadays, Russian agricultural industry has already accumulated some experience in the digital technologies introduction. On the other hand, it is worth mentioning that it is still too sporadic, since only large agro-industrial enterprises and holdings use these technologies. Digitalization processes are of limited use in small businesses. This trend is evident throughout the world especially in developing economies, as small arable farms have high costs for technology implementation, as well as limited knowledge and skills [15]. A low level of access to Internet in distant rural areas is also a significant problem [8, 10]. An unequal access to digital technologies means that there is a risk to increase the digital difference among large and small agricultural enterprises, rural and urban regions, as well as people with differences in age, socio-economic status and education [11].

To strengthen the digital technologies introduction in Russian agribusiness industry, it is necessary to provide all rural producers with an access to them. It is important to start with connecting rural areas with the digital infrastructure. To promote awareness of digital innovations and involve small businesses in innovation processes, it is essential to stimulate rural information and consulting services activity [12]. The Institute of Agricultural Consulting is able to become a center for the digital innovations distribution and provide agricultural producers with information about digital technologies and opportunities for advanced training in regard to digitalization, as well as assistance in introducing innovations into production.

The world experience shows that the key role in the innovative processes development should belong to the state. We are able to achieve the greatest effect in agribusiness industry digitalization only through the cooperative efforts on behalf of the state, scientific institutions and agribusiness.

## 5 Conclusion

The study showed that despite an intensive introduction of digital technologies in the agribusiness industry in the Russian Federation, the number of enterprises which implement them does not exceed 10–15%. Only 4.2% of agricultural organizations demonstrated an innovative activity and implemented technological innovations in 2019. A need to reduce human contacts during the COVID-19 pandemic became a powerful incentive for the innovative digital technologies introduction in the product chain of food production and sales in 2020. In addition to particular elements of digital technologies in the agricultural industry, enterprises have begun to implement integrated agricultural digital solutions, including unmanned vehicle control technologies. Large enterprises and agricultural holdings are the most active in regard to digitalization. The digitalization processes in small businesses are of limited use due to high costs for the technologies implementation and lack of knowledge and

skills in digital farming. To provide all commercial farm units with digital innovations in the agribusiness industry, it is necessary to strengthen state support in the development of digital infrastructure and scientific, educational, information and consulting activities.

## References

1. Abdrakhmanova, G.I., Vishnevsky, K.O., Gokhberg, L.M., Demidkina, O.V., Demyanova, A.V., Kovaleva, G.G., Kotsemir, M.N., Kuznetsova, I.A., Leven, E.I., Ozerova, O.K., Polyakova, V.V., Ratay, T.V., Pyzhikova, Z.A., Streltsova, E.A., Suslov, A.B., Utyatina, K.E., Fridlyanova, S.Yu., Fursov, K.S., Shugal, N.B.: Digital Economy: 2021: Brief Statistical Book. Higher School of Economics National Research University, Moscow (2021)
2. CRN: Combine harvesters with artificial intelligence collected 720,000 tons of crop. URL: <https://www.crn.ru/news/detail.php?ID=149731>. Accessed: 25.03.2021 (2020)
3. CRN: Digital agro, agrosignal and cognitive pilot companies will build an agroecosystem for commercial farm units' digitalization. URL: <https://www.crn.ru/news/detail.php?ID=146409>. Accessed: 25.03.2021 (2020)
4. Federal State Statistics Service: Agricultural industry, hunting, and forestry. URL: [https://rosstat.gov.ru/enterprise\\_economy](https://rosstat.gov.ru/enterprise_economy). Accessed: 20.03.2021 (2021)
5. Federal State Statistics Service: Science, innovations, and information society. URL: <https://rosstat.gov.ru/folder/14477>. Accessed: 20.03.2021 (2021)
6. Gokhberg, L.M., Ditkovsky, K.A., Evnevich, E.I., Kotsemir, M.N., Kuznetsova, I.A., Martynova, S.V., Nefedova, A.I., Polyakova, V.V., Ratai, T.V., Rosovetskaya, L.A., Rud, V.A., Sagieva, G.S., Streltsova, E.A., Suslov, A.B., Tarasenko, I.I., Fridlyanova, S.Yu., Fursov, K.S.: Science. Know-how. Innovations: 2021: Brief Statistical Book. Higher School of Economics National Research University, Moscow (2021)
7. Gusakova, E.P., Shchutskaya, A.V., Afanaseva, E.P.: Digital technologies as a tool for solving basic industrial problems in the agro-industrial complex. In: Ashmarina, S., Vochozka, M., Mantulenko, V. (eds.) Digital Age: Chances, Challenges and Future. Lecture Notes in Networks and Systems, vol. 84, pp. 172–179. Springer, Cham (2020)
8. Marshall, A., Dezuanni, M., Burgess, J., Thomas, J., Wilson, C.K.: Australian farmers left behind in the digital economy—insights from the Australian digital inclusion index. *J. Rural. Stud.* **80**, 195–210 (2020)
9. Mishurov, N.P., Golubev, I.G., Goltypapin, V.Y., Kondratieva, O.V., Voityuk, M.M., Fedorov, A.D., Konovalenko, L.Yu., Slinko, O.V., Nemenuschaya, L.A., Kuzmina, T.N., Shchegolikhina, T.A., Marinchenko, T.E., Kolchina, L.M., Shvanskaya, I.A., Voityuk, V.A., Bolotina, M.N., Goryacheva, A.V.: Predictive and Analytical Support of Innovative Development in the Field of Agriculture. Rosinformagrotekh, Moscow (2019)
10. Prause, L., Hackfort, S., Lindgren, M.: Digitalization and the third food regime. *Agric. Human Values* (2020). <https://doi.org/10.1007/s10460-020-10161-2>. Accessed: 22.03.2021
11. Regan, Á.: ‘Smart farming’ in Ireland: a risk perception study with key governance actors. *NJAS Wageningen J. Life Sci.* **90–91**, 100292 (2019)
12. Shchutskaya, A.V.: Innovations as a factor of agriculture development in Russia. In: Ashmarina, S.I., Horák, J., Vrbka, J., Šuleř, P. (eds.) Economic Systems in the New Era: Stable Systems in an Unstable World. IES 2020. Lecture Notes in Networks and Systems, vol. 160, pp. 441–449. Springer, Cham (2021)
13. Skvortsov, E.A.: Prospects of applying artificial intelligence technologies in regional agriculture. *Econ. Reg.* **16**(2), 563–576 (2020)
14. Truflyak, E.V.: Regional Rating on the Use of Precision Agriculture. Kuban State Agrarian University, Krasnodar (2020)

15. Walter, A., Finger, R., Huber, R., Buchmann, N.: Opinion: smart farming is key to developing sustainable agriculture. *Proc. Natl. Acad. Sci.* **114**(24), 6148–6150 (2017)

# Management Control System of Commercial Organizations in the Digital Economy



V. A. Manyeva

**Abstract** This paper investigates issues on the formation and operation of a management control system of a commercial organization in the digital economy on the basis of integrated digital information. The essence of the modern management control system of a commercial organization is revealed. The stages of creating an integrated digital information space in the economy of a commercial organization are defined: statutory regulation, personnel and education, information infrastructure, information security. The directions of digital informatization of management control system are suggested, which include the digitalization of the following subsystems: planning and forecasting, management organization, control and accounting.

**Keywords** Commercial organization · Digital economy · Management control system · Operational and strategic management

## 1 Introduction

Successful functioning of a commercial organization is impossible without a management control system that makes enables to ensure the interaction of the whole amount of business management functions on the basis of an integrated approach. This becomes especially important in the digital economy context. The research goal of this work is to consider existing concepts and approaches in the field of management control systems in the conditions of the economy digitalization. The author applies a systematic approach to the formation and functioning of control system in the digital economy to create an integrated information space used for making timely management decisions. The main research results are: the meaning of management control system in the digital economy of a commercial organization is revealed; the stages of creating an integrated digital information space in the economy of a commercial organization are highlighted; the directions of digital informatization of control system are determined. The research materials can be used by practitioners

---

V. A. Manyeva (✉)  
Samara State University of Economics, Samara, Russia

and researchers in the field of control system, postgraduates, undergraduates and students of higher educational institutions studying in the fields of “Economics” and “Management”.

## **2 Methodology**

The study was conducted using general scientific and some special research tools: observation methods, analysis of existing experience, procedures of systematic and comparative analysis. The research materials used are the legislative and regulatory acts of the Russian Federation in the field of digital economy, scientific literature on the development of control system, and the current practice of implementing the digital economy at the microeconomic level.

The experimental research base was formed by the Russian commercial companies. The research work included several stages.

1. Identification of current development trends of the digital economy and existing management control systems of commercial organizations.
2. Development stages of creating an information digital integrated space in the economy of a commercial organization.
3. Establishment of directions for the formation of digital informatization of a commercial organization control system.

## **3 Results**

### ***3.1 Digital Economy and Control System in the Management System of a Commercial Organization***

The emergence of control system in the last century is determined by a number of reasons: the instability of the external environment, contemporary organizational structures need a mechanism for coordinating management procedures, different information flows often hinder the managerial decision-making process.

The digital economy, the development of which has recently received a lot of attention in Russia, is influenced by the commercial organizations’ activities. This also applies to the management system. This system should coordinate general and specific functions of management bodies.

The management control system of a commercial organization should be considered as a holistic concept of management self-regulation. It is realized through the formation of an integrated digital information space. It is used for making management decisions in a timely manner. In this way, the management control system allows to build a methodological basis and to choose necessary tools to solve various management objectives of a commercial organization, based on the digitalization of



economic information. This data is used to form, develop and maintain competitive advantages of the business of an economic entity.

The digital economy of a commercial organization requires the use of digital technologies that create, transmit, summarize, store, and most importantly analyze digital data that does not have a common origin. It results in a new picture or predictive model for forming strategic and tactic steps for the management system of a company. Management decisions are made based on this information, it allows to make the organization activities effective and efficient. Thus, the digital economy requires the creation of a single digital information space, which is carried out in stages.

### ***3.2 Stages of Creating an Integrated Digital Information Space in the Economy of a Commercial Organization***

There are five stages of creating an integrated digital information space in the economy of a commercial organization.

The first stage. Statutory regulation First of all, it is necessary to eliminate legal barriers in the management of a commercial organization. This stage involves the development of new local regulations and amendments to existing ones. These acts are approved by the management of the commercial organization and it is guided by them.

The second stage. Personnel and education. This stage relates to personnel training and human capital of a company: specialists should have competencies that are required in the digital economy conditions.

The third stage. This stage includes the work on research skills and technological reserves. To deal with digital data that will be in all business processes, modern end-to-end technologies are needed, that is, when a once-developed digital technology will be repeatedly used in various business processes of the organization.

The fourth stage. Information infrastructure: the infrastructure formation for data storage.

The fifth stage. Information security: it primarily relates to building a secure data exchange system.

### ***3.3 Directions of Digital Informatization of Management Control System of a Commercial Organization***

From the above-mentioned stages, the following areas of digital informatization of management control system can be distinguished, which include subsystems of planning and forecasting, a subsystem of the organizational component of control, and subsystems of control and accounting.

Digitalization of the planning and forecasting system provides the collection of digital information for forming of various options to achieve the set objectives. The financial planning and forecasting tools are presented as targeted integrated programs and budgets. Digital information is considered as a search forecast to present the organization's condition in its external environment in the long term. This requires a digital array of data about the external environment, which is analyzed with the help of applied digital technologies in order to help management to understand in detail the issues of the activities of a commercial organization: whether the organization's strategies are justified, how effectively the available resources are applied in the context of strategies being realized.

Digitalization of the organizational component of the management control system implies the creation of data on the existing organizational management structure. This is primarily focused on the collection, transmission and storage, analysis and synthesis of Big Data. At the same time, tools and competencies for working with big information volumes should also meet requirements to the unification of primary documents of the organization's management.

Setting evaluation indicators, measuring the achieved results and their deviations from the set values are primary control stages that are necessary to achieve strategic and operational goals of the company. The control tasks also include tracking the process of management decisions making and evaluating the achieved results. The effect from the use of all available digital sources implies their appropriate processing. This process should be based on the set goals. In this context, the systematic representation of external and internal information in the digital sources becomes obvious.

Accounting information plays a very important role in the management control system. First of all, this includes information on the external environment. It also aimed at the determination of the relation between the realized strategy and the applied accounting methodology for the presentation of specific data on digital platforms. Analysis, planning, and control functions largely depend on the accounting and information capabilities.

Thus, the suggested directions fully fit into the concept of self-regulation of the management of a commercial organization on the basis of the formation of a single digital information space. Digital information in the management control system is designed to play an important role in supporting management when making management decisions. It should be timely and high-quality, that is, it should adequately reflect the state of the management object. With this information, the management concept is formed, the connection of the commercial organization with the external environment is ensured. It influences strategic planning and the search for the best ways to implement them, it also contributes to the flexible response of the internal environment of the organization to external influence.

## 4 Discussion

The management control system of a commercial organization is the focus of attention of various specialists. Scientists, such as Necheukhina, Polozova, Buianova [8], Manyeva, Piskunov, Fomin [6], Gerdin [4], Smagina, Frolova [10], Poor-nachandrika, Venkatasudhakar [9], Speklé, Widener [11] devoted their works to this problem.

So, Necheukhina, Polozova, Buianova reveal the approach of strengthening the controlling mechanism in the use of the continuous processes improvement model (PDCA) [8]. Since, according to the authors, management control system is a special system for managing all the processes of the enterprise, has a wide range of modern tools for improving the quality of management activities.

Recently, there have been studies of domestic scientists on the use of digital technologies in management control systems, both in relation to a commercial organization as a whole, and its individual functions of specific activity areas. Scientists, such as Afonina, Seregin [1], Ibragimova [5], Dobroserdova, Fomicheva [2], Moskalev [7] and others show the results obtained in these areas.

Afonina and Seregin consider the process of digitalization in the management of procurement activities [1]. The authors analyze functions that management control system implements in procurement activities. They give examples of the use of digitalization in procurement activities at its various stages through the use of modern digital technologies.

Ibragimova justifies the creation and development of an information and accounting system designed to address issues of strategic management in the context of the economy digitalization [5].

Dobroserdova and Fomicheva analyzed the impact of digitalization processes on risk management processes in Russian companies [2]. The authors identified positive and negative trends caused by both the need to take into account the increased uncertainty of environment for business activities, and the issues of using Big Data on new digital products in the practice of forecasting and controlling risks.

Moskalev analyzes three approaches to the concept of “digital economy” in his research [7]. Based on these approaches, he offers three opinions about the digital strategy of the company (as a marketing strategy, as a new stand-out functional strategy, and as a new dimension in the matrix structure of the company’s strategic program). Taking into account the contribution of Russian scientists to the solution of the considered problem, it should be noted that the issues on the creation of an integrated digital information space in the management control system of a commercial organization are still a research object in different studies, since the Edict of the President of the Russian Federation of 09.05.2017 No. 203 “On the Information society development in the Russian Federation for 2017–2030” requires further theoretical, methodological and applied developments in achieving the goals and solving the tasks of digitalization of the economy in the Russian Federation [3].

## 5 Conclusion

The management activities of a commercial organization are based on the appropriate labor division within the relation system according to each specific level. To solve all management objectives and create all necessary conditions for this work are important tasks to increase the efficiency and effectiveness of management decisions. These tasks can be solved through the management control system. The effectiveness of this system is currently seen in an integrated approach to the interaction of the entire set of management functions on the basis of a single digital information space. The digital reality sets new requirements to the formation of a unified information system. These requirements are based on the integration of analytical, control, planning, forecast, and accounting information in a digital format. This, in turn, implies the development of the management control system concept.

## References

1. Afonina, V.E., Seregin, A.G.: Digitalization and controlling in the procurement of organizations: problems and prospects. *J. Altai Acad. Econ. Law* **3–2**, 10–14 (2019)
2. Dobroserdova, I.I., Fomicheva, N.M.: Controlling as an enterprise risk management tool in the context of digitalization of the economy. *Izvestiâ Sankt-Peterburgskogo Gosudarstvennogo Èkonomičeskogo Universiteta* **5**(125), 201–206 (2020)
3. Edict of the President of the Russian Federation of 09.05.2017 No. 203 “On the Information society development in the Russian Federation for 2017–2030”. URL: <http://www.kremlin.ru/acts/bank/41919>. Accessed: 18.03.2021
4. Gerdin, J.: Management control as a system: integrating and extending theorizing on MC complementarity and institutional logics. *Manag. Acc. Res.* **49**, 100716 (2020)
5. Ibragimova, A.Kh.: Information database of strategic management accounting and controlling. *Vestnik Voronezh State Agrarian Univ.* **12**(3(62)), 176–183. <https://doi.org/10.17238/issn2071-2243.2019.3.176> (2019)
6. Manyeva, V.A., Piskunov, V.A., Fomin, V.P.: Strategic management accounting of company costs. *Int. Rev. Manag. Mark.* **6**(5), 255–264 (2016)
7. Moskalev, Y.A.: Digital economy and the structure of the digital strategy of an enterprise. *Herald Tver State Univ. Ser. Ekonomika i Upravlenie*, **3**(47), 232–238 (2019)
8. Necheukhina, N.S., Polozova, N.A., Buianova, T.I.: Controlling as a mechanism for increasing the efficiency of industrial enterprise in the conditions of use of digital technologies. *St. Petersburg State Polytech. Univ. J. Econ.* **10**(4), 176–186 (2017)
9. Poornachandrika, V., Venkatasudhakar, M.: Quality transformation to improve customer satisfaction: using product, process, system and behaviour model. *IOP Conf. Ser. Mater. Sci. Eng.* **923**(1), 012034 (2020)
10. Smagina, A.Y., Frolova, I.V.: Management control of tax liabilities of Russian enterprises in the automotive industry. In: Ashmarina, S.I., Horák, J., Vrbka, J., Šulef, P. (eds.) *Economic Systems in the New Era: Stable Systems in an Unstable World. IES 2020. Lecture Notes in Networks and Systems*, vol. 160, pp. 758–765. Springer, Cham (2021)
11. Speklé, R.F., Widener, S.K.: Insights on the use of surveys to study management control systems. *Acc. Organ. Soc.* **86**, 101184 (2020)

# Digital Economy Impact on Contracts Conclusion for the Use of Internet Services



E. L. Sidorenko, K. K. Taran, and E. A. Artamonova

**Abstract** Currently, thanks to information technologies (IT), civil turnover has significantly accelerated, users conclude agreements in a fast and convenient format. However, the emergence of new technologies, software and services on the internet takes them beyond the generally accepted and generally applicable contractual structures, such as a licence contract, a service contract, and others. There are questions related to the subject of the contract—a product, a service, or is it a special new subject? The development of information technologies and, accordingly, the expansion of the digital economy changes the perception of the contract, along with the legal nature of contracts for the use of services on the internet, and new aspects related to the process of its approval appear. There may be difficulties with user authentication, and therefore with the validity of agreements concluded on the internet, since in some cases the user’s authentication may be “forged”, and as a result, the agreement will be concluded by another person. This study provides a brief comparative legal analysis of issues related to agreements on the use of software on the internet based on the experience of the United States, the EU and other countries.

**Keywords** Electronic contract · Internet law · Information technologies · Legal relations on the internet · Licence contract

## 1 Introduction

In the modern world, technologies are developing very rapidly. With the help of the internet, users can enter into agreements for the use of software, online services that can, due to their high functionality, significantly optimize various workflows, they can also be convenient for personal needs [7]. The number of users of software on the

---

E. L. Sidorenko (✉) · K. K. Taran  
Moscow State Institute of International Relations (University) of the Ministry of Foreign Affairs,  
Moscow, Russia  
e-mail: [12011979@list.ru](mailto:12011979@list.ru)

E. A. Artamonova  
North Caucasus Federal University, Stavropol, Russia

© The Author(s), under exclusive license to Springer Nature Switzerland AG 2022  
S. I. Ashmarina and V. V. Manteulenko (eds.), *Digital Technologies in the New  
Socio-Economic Reality*, Lecture Notes in Networks and Systems 304,  
[https://doi.org/10.1007/978-3-030-83175-2\\_51](https://doi.org/10.1007/978-3-030-83175-2_51)

internet increases significantly every year, and the number of areas that can no longer do without software increases: education, medicine, law, media sphere, business, trade industry, etc. The need for further use, legal and technological development was shown by the COVID-19 virus pandemic in Russia and in the world. The contract for the use of the service on the internet does not fit into the framework of classic contracts, such as a purchase and sale agreement, a service contract, etc. due to the subject matter of the contract, which can be interpreted both as a service and as a product.

Determining the legal nature of an agreement to use modern software is a difficult task for many lawyers, both from the point of view of science and practice. Until now, no state has established legal structures that would be included in the civil code or model law, and which would fix a number of contractual structures that could be used on the internet. This is most likely due to the fact that there is no certainty on what constitutes the subject of the contract for the use of the service on the internet.

During the study of this problem, the following questions were raised:

What are the most commonly used contractual structures when entering into agreements for the use of the service on the Internet? What is software? What are the specific features associated with the contract under consideration? Do we need framework agreements in this area?

The purpose of this study is to consider the most commonly used structures of the contract for the use of Internet services, which are used in various states, and to identify the unsuitability of most constructions for use and improvement of legal regulation. At the same time, the issues of the validity of such agreements in the conditions of a computerized process of agreeing on the will of the parties and the possibility of violating the user's authentication when concluding an agreement will also be studied.

## **2 Methodology**

During the study, the author used general scientific and special methods. Among the general scientific ones, we can distinguish: analysis-the study of contractual structures used to formalize agreements for the use of services on the Internet; inductive and deductive methods; modeling methods, etc. Special methods include: comparative law for comparing approaches to the agreements under consideration in different states and in international agreements; logical-legal, methods of systematic interpretation of legal norms; synergetic method; systematization; etc. The emergence of new technologies raises a number of questions for the law: whether to change the existing contractual structures to the IT sphere in accordance with new realities, or gradually evolve to form new scientific approaches and improve legal regulation.

### 3 Results

The existing contractual structures do not reflect the specifics of the legal relationships on the use of services on the Internet. To introduce a uniform contractual regulation of legal relations on the use of services is an extremely difficult task, but it is quite feasible, because the technologies for providing services on the Internet have many common features. Perhaps, in the future, a convention will be developed recommending that states use a standard contract, which states will concretize in accordance with their domestic legislation.

As the first steps, it would be possible to determine the subject of the contract, as the experience of various states shows, services on the Internet are not a product or a service in its purest form. As a possible option, it would be possible to highlight either a special digital service provided through computer networks, or to highlight a new subject of the contract. The next step would be to create a new framework agreement, most likely, this step will be inevitable, since the services on the Internet do not fit into the existing contractual structures. Such a framework agreement would reflect the specifics of the legal relations, because using a particular program on the Internet, the user does not buy it, so it is not correct to apply the provisions, for example, of the purchase and sale agreement, even by analogy. Previously, the purchase and sale agreement, perhaps, could be applied when the software was transmitted on a tangible electronic medium and then the user issued a license. Currently, the services are used online, so this type of contract is not suitable. The licence contract largely reflects the specifics of the legal relations, but the problem is that the user does not receive a copy of the program for which he would be granted a license [5]. The tendency to attract legal relations connected to the use of software under existing and well-established contractual structures, which is typical for European states, is also not quite functional and can close emerging problems, and also does not contribute to legal development.

### 4 Discussion

In the scientific literature, the definition of a contract concluded in electronic form began to appear. In the literature—e-contract (it is a contract that is drawn up), can be changed, and is executed through the use of computer networks [3]. The electronic forms of the contract in the form of sending electronic messages, clicking by a computer mouse in a special window, SMS messages, etc. are already recognized by the states and are generally used. It is noteworthy that new ideas, concepts in the doctrine and legislation regarding contracts concluded on the Internet, including contracts for the use of software, are very actively developed in Ethiopia. The definition of an e-contract will gradually become more specific, but the question arises whether such a contract is understood only as a special, new form of contract, or is it a new phenomenon for the legal sphere?

A number of classic contracts are also concluded in the digital environment, for example, such as the purchase and sale of goods. The essence and purpose of the contract remain unchanged. It is different when users sign a contract to use a service on the Internet, such as cloud storage [9], a graphic editor, and connect to electronic libraries and databases. In such a situation, the question arises about the subject of such a contract.

When entering into a contract for the use of the service on the internet, in most cases there are features associated with the expression of will. In classical contracts, including those concluded between absent parties, the agreement of the will of the parties is bidirectional. However, in the contract under consideration, this is not the case. The user independently expresses the will to enter into a contractual relationship, while the other party (usually the company) expresses the will with a computer program. The UNCITRAL Model Law on electronic trading admits that the responses given by the program lead to the conclusion of a contract of legal force [8]. But even here there are questions that if the company did not have time to reprogram, stop the program when the contract was concluded. Such changes in the agreement of the will of the parties at the conclusion of the contract also speak in favour of the allocation of contracts for the use of software as a special type of contracts.

The subject matter of the contract for the use of the software is ambiguous. The way in which the subject matter of a contract is defined in different states has a significant impact on the legal nature of the contract. Thus, in the judicial practice and doctrine of Germany [4], contracts for the provision of services on the internet are considered as mixed contracts, in which elements of other contracts may prevail: license, service contract, lease, etc. The positions are expressed that the software becomes material in the computer's memory, so it can fall under the category of goods [4]. However, when buying a product, the user gets ownership rights to it, but the question is whether he can use software protected by copyright. The European Court of Justice believes that the user, as the new owner of the tangible medium, also acquires the right to use from the copyright holder. When using services on the Internet, there is no purchase of tangible medium, the user begins to use the service almost immediately.

In the United States, the subject of the contract for the use of services on the internet is called service, but these are special services—digital services on the internet, and they are often drawn up between the parties by a mixed contract, in which elements of the license contract prevail. Marsuf expressed the idea of classification depending on the number of users and their needs: a specific user with certain needs is a service [6].

In Russia, there is also no well-established understanding of what is the subject of a contract for the use of a service on the Internet: a service, a product, or computing power. The service on the internet is a special resource that can be partially located on the tangible medium of the consumer, and he, in turn, on the basis of his implicative actions/by signing a contract in electronic form, concluded a contract for the use of such a service. At the same time, the user does not have a copy of the program, he can not change its basic functions, but can customize it to suit his needs (in this case, we



do not consider programs with open licenses). Due to the uncertainty of the subject matter of the contract, there is no uniform classification of the nature of the contract.

In Germany, there are discussions about the legal nature of a software contract, although there are no specific provisions in Civil Law Book of German regarding such contracts [1]. Most scientific schools are of the opinion that such contracts should fit into the contractual structures contained in the Civil Law Book [2, 4]. The following classification options can be traced: (1) a contract for the sale of rights; (2) a lease agreement (a lease agreement in this case refers to computing power); (3) a licence contract (despite the fact that in other countries this classification is most common, for Germany it is quite rare); (4) a service contract; (5) a mixed contract.

In other states, the situation is generally similar. For example, in France, there is also no special regulation of legal relations on the use of software, and different characteristics of the corresponding contract are possible. At the same time, the most common characteristics are considered to be cession designs, licenses, and, to the greatest extent, the purchase and sale agreement. A cession is a transfer of rights, and a license is a grant of rights to a user. In the field of industrial property, the construction of a purchase and sale agreement and a lease agreement (computing power) is used. Also the construction of the service contract is quite commonly used.

In the United States, the prevailing design is the license contract, where the parties can agree on a service level contract, which will set out the requirements for the quality of the service, the cases of its idle time and guarantees in relation to the user. In Russia, a contract for the use of software can be classified as a licence contract, a service contract, a mixed contract, etc. The most common in practice is a license contract.

The conclusion of a contract for the use of the software also affects the issues of user authentication. Meaning it was actually concluded by a person that uses the software, and that had the purpose to conclude such an agreement. Levels of authentication complexity: simple—password; medium—use of attachment to a mobile phone number or email and ID; complex—scanning of facial features, iris color, etc. are aimed at eliminating the situation when the contract is concluded by one person, and the responsibility for the misuse of the program, non-payment of funds under the contract, etc. lies with another person. Very often, the party that provides the service on the internet does not check with whom it enters into a contract. This issue is important, since the party may be a minor, a person of limited legal capacity. Authentication of the user can help in creating his digital profile, i.e. how he uses the services on the internet, how faithfully he complies with the terms of the contract.

Legal relations on the use of services on the internet are implemented on the internet, these legal relations may have legal consequences in real life, a party may suffer material damage, a person may feel moral harm, the reputation of a legal entity or a state body may suffer, and so on. Therefore, when forming a framework agreement, it is important that the party provides information that can identify it, establish the existence of legal capacity, as well as provide for provisions that are related to compensation for losses to the user.

## 5 Conclusion

The development of the digital economy transfers a number of legal relations into a digital format. This makes it necessary to develop a new regulation of legal relations, to improve contractual structures for the use of services on the Internet, etc. A contract for the use of services on the internet is a special type of contract due to the considered features: the subject of the contract, the electronic contract itself, the agreement of the will of the parties, the authentication of users. Creation of a framework agreement that provides for the conditions associated with the parties of the agreement, which takes into account the specifics of the provision of the service—a digital service that requires specialized equipment from the company and the user; guarantees for the provision of the service to the user, the stability of the service, as well as the procedure for determining the amount of losses that may be caused to the parties.

## References

1. Bürgerliches Gesetzbuch der BRD 18.08.1896 (geändert vom 3. Juni 2021) (2021). <https://www.gesetze-im-internet.de/bgb/BJNR001950896.html>. Accessed 18 March 2021
2. Corrales, M., Fenwick, M., Forgó, N. (eds.): *New Technology, Big Data and the Law*. Springer, Singapore (2017)
3. Desta, G.E.: Enforceability of electronic contracts in light of the Ethiopian general contract law: appraising the issues. *Inf. Commun. Technol. Law* **28**(1), 46–64 (2018)
4. Hilty, R.M., Köklü, K., Hafenbrädl, F.: Software agreements: stocktaking and outlook—lessons from the *UsedSoft v.Oracle* case from a comparative law perspective. *IIC—Int. Rev. Intell. Property Competition Law* **44**, 263–292 (2013)
5. Judgment of the Court (Grand Chamber) In Case C-128/11, Reference for a preliminary ruling under Article 267 TFEU from the Bundesgerichtshof (Germany), made by decision of 3 Feb 2011, received at the Court on 14 March 2011, in the proceedings (2012). <http://curia.europa.eu/juris/document/document.jsf?docid=124564&doclang=EN>. Accessed 22 Feb 2021
6. Marsoof, A.A.: Case for sui generis treatment of software under the WTO regime. *Int. J. Law Inform. Technol.* **20**(4), 291–311 (2012)
7. Nirmal, B.C., Singh, R.K. (eds.): *Contemporary Issues in International Law. Environment, International Trade, Information Technology and Legal Education*. Springer, Singapore (2018)
8. *Uniform Computer Information Transactions Act (USA)* (2019). <https://law.lis.virginia.gov/vacode/popularnames/uniform-computer-information-transactions-act/>. Accessed 10 Feb 2021
9. Žok, K.: Cloud computing contracts as contracts for the supply of digital content: classification and information duty. *Masaryk Univ. J. Law Technol.* **13**(2), 133–159 (2019)

# **Modeling and Analysis of Infrastructure Projects**

# Program-Targeted Approach to Digital Reengineering of Small Enterprises Business Processes



D. A. Akopyan

**Abstract** The article considers the possibility of using a program-targeted approach to radically change the business system of an enterprise based on digital reengineering of business processes. In order to justify a program-oriented approach to innovative change in business processes of an enterprise, the basic concepts of business processes improving and reengineering are analyzed, with the emphasis on the features of digital reengineering. The article substantiates the concept of digital reengineering, which expands the classical concept of business process reengineering. Based on the program-targeted approach, it becomes possible to reasonably form an appropriate comprehensive program for digital reengineering of enterprise business processes. It is shown that the implementation of the program of digital reengineering of business processes of the enterprise is linked to the strategic goals of its development and is decomposed into key intra-program projects covering the main areas of activity of this business. The basic structural and logical schemes of the formation and implementation of the digital reengineering of enterprise business processes program, considered as real tools for implementing innovative business transformations, are presented.

**Keywords** Business processes · Small business · Digital reengineering · Development goals · Program · Structural and logical schemes

## 1 Introduction

The development of the digital economy is characterized by the rapid penetration of a wide range of digital services, products and systems in all areas of business and the social sphere. To eliminate the digital lag of Russia (41st place in terms of readiness for the digital economy), the program “Digital Economy of the Russian Federation” was developed, which notes that digitalization is a key factor of production

---

D. A. Akopyan (✉)  
Samara State University of Economics, Samara, Russia

in all spheres of socio-economic activity, aimed at improving the country's competitiveness, the quality of life of citizens, ensuring economic growth and national sovereignty [6].

Increasing the efficiency of business processes based on digitalization becomes a condition for the competitiveness of enterprises and an opportunity for them to implement innovative intelligent technologies. It should be noted that in some areas of business, the very ability to carry out activities can be realized only through digitalization. For example, in the concept of "Industry 4.0", which defines the global directions of digital transformation of all types of human activity, it is assumed that the main business processes of enterprises will necessarily have their digital copy in the cyber-physical space [1].

Improving management efficiency through Business Process Reengineering (BPR) of enterprise is associated with the use of a basic conceptual framework that includes the definition of key concepts: "business system", "business processes", "business processes reengineering". Scientific publications and methodological developments do not always correctly define the basic conceptual BPR apparatus, which complicates the methodological and practical works of company specialists. In this regard, it is advisable to consider the basic concepts of business processes reengineering, taking into account new research in the field of digital transformation of enterprises. Especially important is the need to justify the concept of "digital reengineering of business processes", which will expand both the understanding of the specifics of this type of reengineering, and more correctly plan the implementation of appropriate innovations. At the same time, it is necessary to develop methodological tools and substantiate an appropriate approach to the implementation of the tasks of digital transformation of small businesses with the possible access to reengineering processes that will radically transform the business processes of a small enterprise. In this direction, we analyze the program-targeted approach to digital reengineering of business processes, based on strategic business development goals and on project-process technology. The program-targeted approach to digital reengineering of business processes is revealed using structural and logical schemes that represent the content of the program approach to innovative business development of the enterprise.

## 2 Methodology

Russian companies have significant differences in the business processes, management and production systems used, which makes it necessary to implement the tasks of digital development in stages, taking into account the specific situation in the organization. At the same time, each company should determine the strategic goals of digital development, the subject of digitalization, and the organizational mechanism for innovative changes in the business system. Accordingly, digital process reengineering aims to digitalize and integrate core, support, and management processes across the entire small enterprise. Considering the conceptual apparatus of BPR, it

is necessary, first of all, to distinguish the basic concept of the business system of an enterprise as a set of business processes implemented by an organization to achieve the strategic goals of its functioning.

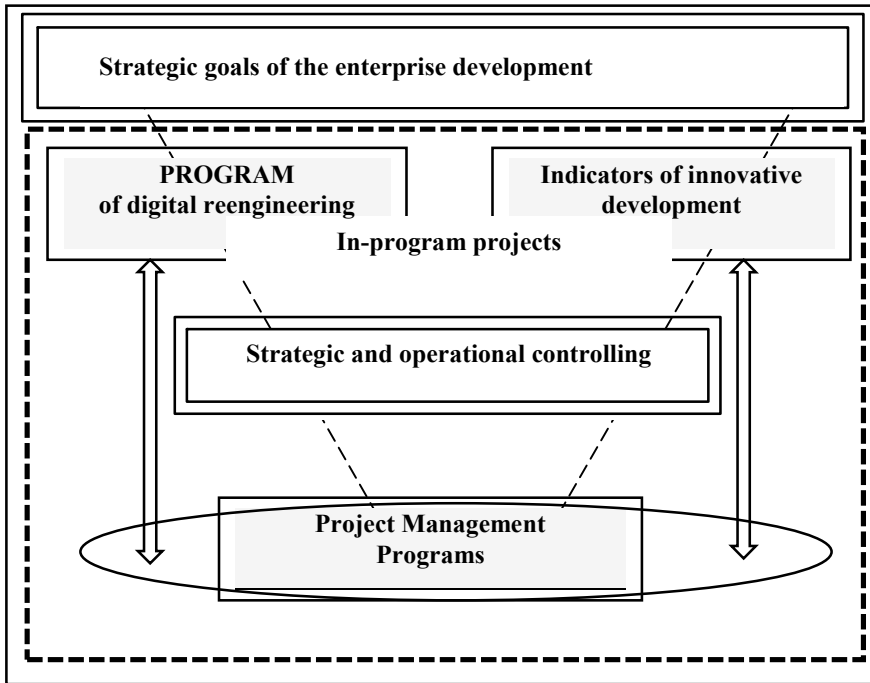
Business processes of a commercial organization are considered by most authors as a set of different types of activities, in which one or a few types of resources are used “at the input”, and as a result of this activity, a product, service or new knowledge that is of value to the consumer is created at the “output” [11]. The national standard of the Russian Federation GOST R 54869–2011 defines the process as a set of interrelated actions aimed at achieving certain results [2].

The goal of business processes reengineering is to provide integral and systematic modeling, design, and reorganization of material, financial, and information flows [12]. The generally accepted concept of business processes reengineering is associated with a fundamental rethinking and radical redesign of business processes to achieve fundamental improvements in the functioning of the enterprise [4].

Reengineering of business processes of a modern small enterprise is impossible without the use of information and communication digital technologies, which play a decisive role in its innovative development. Improvement and reengineering of business processes are determined solely by the possibility and level of use of digital technologies. At the same time, digital reengineering is significantly different from the typical automation or mechanization of production and management processes of organizations, since it involves not just the use of information and communication technologies, but a fundamental rethinking of the ways in which business processes are implemented. Due to the observed fundamental changes in technology and business process management associated with global digitalization and the formation of the so-called cyber-physical systems, it is objectively necessary to introduce the concept of digital reengineering of business processes as an independent concept. The concept of Digital Business Process Reengineering (DBPR) is proposed to be considered as a fundamental rethinking and radical redesign of business processes based on digital technologies, ensuring the implementation of qualitative changes and the formation of fundamentally new business processes.

Digital reengineering of business processes assumes that digital technologies create their own types of using and generate such business processes that were not previously realized by specialists and contribute to the development of completely new types of business activities (for example, the actively developing market for “cloud” services and the diverse use of artificial intelligence technology). Advanced companies that perform digital reengineering are moving to the status of intelligent enterprises and dramatically increase the level of competitiveness on the national and global markets. The strategic goals of small business development based on digital reengineering are most realistically achieved on the basis of the program-objective method in planning and control, which makes it possible to systematically form a comprehensive program for digital reengineering of business processes of a commercial organization (hereinafter referred to as the digital reengineering program-DRP) [8].

A schematic diagram of the relations between the strategic goals, the digital reengineering program and the system of indicators of the enterprise innovative



**Fig. 1** Concept scheme of the relation between strategic goals, the digital reengineering program and the system of indicators of innovative development of a small business enterprise. *Source* author

development is presented in Fig. 1. The methodological value of using the program-targeted approach is that it allows to link strategic program goals, relevant tasks, a set of planned activities in the context of key elements of DRP and resources that ensure the achievement of the set goals. Accordingly, the DRP under such consideration is a complex of interrelated intra-program projects (subprograms) of digital transformation of the main business processes of a given enterprise. Management of intra-program projects and DRP in general is carried out on the methodological basis of project management with the use of appropriate information and communication technologies for the timely analysis of planned and actual indicators due to the regular collection, distribution, storage, obtaining and use of information necessary for controlling the innovative transformation of the business system. Intra-program projects are interconnected and mutually affect each other, which, within the framework of DRP integration, provides advantages in a degree of coordination and manageability that is not available when they are managed separately. In addition, when creating a mechanism for implementing and controlling DRP, it should be taken into account that internal DRP software projects have their own life cycle and are implemented non-linearly in an unstable external environment.

### 3 Results

The digital reengineering program of the enterprise is the main element of the strategic development complex of its business system and is specified in intra-program projects, activities and indicators. Considering the general algorithm for using tools that provide strategic enterprise management, we can conclude that the priority for the organization of the goal-setting stage is the basic task of forming a strategy for adapting the business system to the changing external environment. The strategic goal-setting of business development and the program-target approach are the basis for the formation of a system of current and long-term indicators of the functioning of a small enterprise, allow to focus the management of the business system on building an adequate mechanism for implementing the strategy of innovative development (Fig. 1).

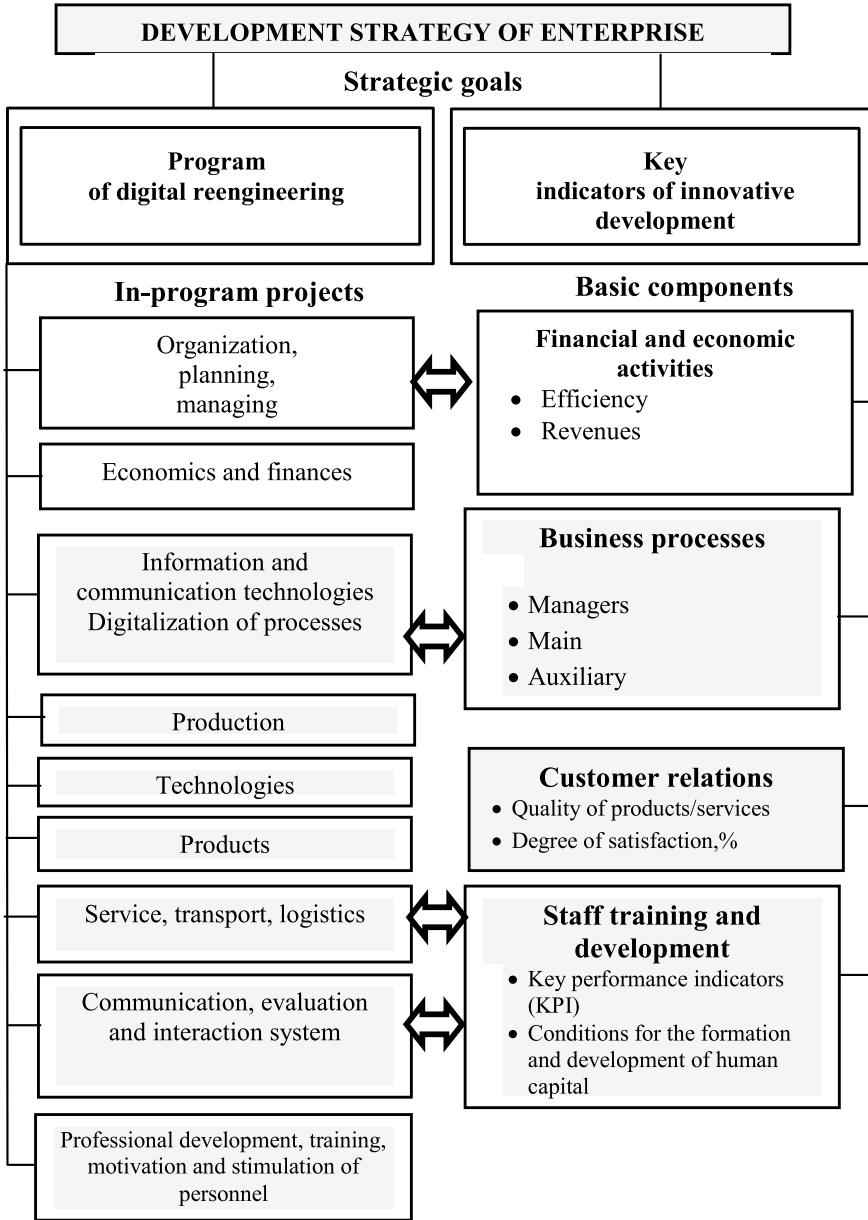
An important result of the implementation of the DRP is the ability to combine the processes of strategic planning, management and control of target strategic indicators of innovative development of the enterprise on its basis. This ensures timely and necessary adjustment of the strategy of digital reengineering of business processes by controlling the formed system of indicators. Figure 2 presents a diagram of the relationship between the DRP of business processes and the corresponding system of key indicators of innovative development, which allows to monitor the dynamics of the implementation of digital reengineering processes for the main intra-program projects. The most appropriate tool for the development and subsequent monitoring of key DRP indicators of the enterprise business processes is the balanced scorecard (BSC), focused on the basic components of the enterprise business activity [7].

In relation to the implementation of the DRP goals, the justification of key indicators of innovative development allows to transfer the strategy of digital reengineering of business processes of a small business enterprise into a system of specific and interrelated intra-program projects and monitoring the activities of its divisions and employees using defined key performance indicators (KPI) [3]. The system of key indicators of the implementation of enterprise DRP is formed in accordance with the strategy of digitalization of business processes and should meet the following requirements:

- describe DRP parameters in the context of in-program projects;
- provide an objective assessment of the situation in the implementation of DRP for all management components (calendar planning, budgeting, contract management, communications and control);
- provide an opportunity for operational and strategic controlling of the achievement of established targeted indicators;
- form, due to the use of appropriate digital technology tools, a consolidated database that includes financial, operational and other reports for grounded management decisions.

Thus, a small enterprise in the process of implementing DRP can build such a structure of management and control of business processes, in which each external





**Fig. 2** The relation between the program of digital reengineering of business processes and the system of key performance indicators of innovative development of small businesses. *Source* author

or internal influence corresponds to a control element that implements a mechanism for adequate influence on specific changes in business processes.

Information and communication support for the implementation of DRP involves the use of complex information management systems, for example, based on the resource management subsystem—ERP [5], including the BusinessObjects information module, which allows for strategic data analysis and support for the management decision-making process of the enterprise [10].

In some cases, it is advisable to use the technologies of simulation modeling and the creation of a digital double of the enterprise [9], which is a virtual copy of it, on the basis of which it is possible to test options for the implementation of DRP or individual in-program projects. In general, managing the implementation of DRP based on intelligent information and control systems allows to respond in a timely manner to changes in the external and internal environment of the enterprise, and also allows to implement a set of relevant analytical and applied tasks aimed at achieving the goals of individual intra-program projects.

## 4 Discussion

The ongoing dynamic changes in the socio-economic sphere of Russia are largely caused and determined by innovative digital technologies, which in one way or another leads to the need to determine possible methodological approaches to the digital transformation of business systems of specific small enterprises. The global trend of digitalization objectively contributes to a radical restructuring of the forms and technologies of doing business and is a condition for increasing its competitiveness. Basic intelligent technologies of digitalization are connected with big data, blockchain, industrial Internet, Internet of things, robotics, etc.

There is an obvious need to develop appropriate methodological tools that provide a reasoned approach to the implementation of the tasks of digital transformation of enterprises with a possible access to reengineering of their business processes. Taking into account new studies in the field of digital transformation of enterprises, the complex concept of “digital reengineering of business processes” needs to be clarified and specified, with an emphasis on radical digital redesign and the possible formation of fundamentally new business processes. Digital reengineering of business processes of an enterprise as an independent direction of its innovative development is focused on the strategic goals of business functioning and can be implemented on the basis of the program-target method, which allows linking strategic program goals, relevant tasks, a set of intra-program projects and the necessary resources.

The program-targeted method of implementing the tasks of digital reengineering of business processes involves the formation of a hierarchically structured complex program (DRP), which includes a set of intra-program projects (subprograms) of innovative transformation of business processes of this enterprise, justified in the corresponding technical task. The technology of project (PM) and process management (BPM) is singled out as a proven approach to managing intra-program projects

and the program as a whole. The system view of the program-target approach to digital reengineering of business processes involves the use of economic models in the form of structural and logical schemes that reveal the content of the elements of the program approach to innovative business development of the enterprise.

The justification of the key indicators of innovative development allows to transfer the strategy of digital reengineering of business processes of a small business enterprise into a system of specific and interrelated intra-program projects and monitor the activities of its divisions and employees using defined key performance indicators (KPI). It should be considered that for the timely implementation of DRP, the use of intelligent information and communication technologies is critical, allowing for strategic and operational controlling of the implementation of intra-program projects and providing support for the process of making the necessary management decisions.

## 5 Conclusion

The effective innovative development of Russian enterprises is largely due to the digital reengineering of their business processes, which makes it possible to transform the business processes of companies and organizations based on the use of modern information and communication technologies. The analytical assessments of the definitions of the key concepts of process management and business processes reengineering suggested by a number of researchers showed the possibility and feasibility of considering digital business process reengineering as an independent concept that reveals the specifics of digital business transformation and allows for targeted planning and management of a set of relevant intra-company projects.

As a basic method of implementing the tasks of digital reengineering of business processes of the enterprise, the program-targeted method is justified, which makes it possible to link strategic goals, relevant tasks, a set of planned activities and the necessary resources. A distinctive feature of the program-targeted approach to digital reengineering of business processes is the ability to develop a comprehensive digital reengineering program based on it, including the main in-program projects for the transformation and redesign of business processes of a small business enterprise. To understand the relations between the strategic goal of digital reengineering of business processes, intra-program projects and the system of key performance indicators of the organization' innovative development, a corresponding structural and logical scheme is suggested. The structural and logical scheme of the relation between the program of digital reengineering of business processes and a set of key performance indicators of the enterprise development makes it possible to systematically consider a consistent approach to innovative transformations of a small enterprise.

The recommended program-targeted approach to digital reengineering of business processes provides a basis for the practical activities of enterprise specialists in the development of appropriate inter-company documents regulating the processes of planning and project management of digital business transformation. The basis for the implementation of the digital reengineering program in a particular format can be

the information and management system of the enterprise, focused on the technology of intelligent enterprises. Within the framework of this information management system, strategic analysis and control of data, resource support and support for the decision-making process for managing the digital reengineering program as a whole or its individual intra-program projects are carried out. In general, the study showed the relevance of methodological development of approaches to digital reengineering of business processes, as well as the feasibility of in-depth study of technologies and tools that ensure effective innovative development ... of small enterprises.

## References

1. Derigent, W., Cardin, O., Trentesaux, D.: Industry 4.0: contributions of holonic manufacturing control architectures and future challenges. *J. Intell. Manuf.* (2020). <https://doi.org/10.1007/s10845-020-01532-x>. Accessed 11 March 2021
2. GOST R 54869–2011: Project management. Project Management Requirements (2011). <http://docs.cntd.ru/document/gost-r-54869-2011>. Accessed 11 March 2021
3. Gryshko, V., Zos-Kior, M., Zerniuk, O.: Integrating the BSC and KPI systems for improving the efficiency of logistic strategy implementation in construction companies. *Int. J. Eng. Technol. (UAE)* 7(3), 131–134 (2018)
4. Jamel, L., Saidani, O., Nurcan, S.: Flexibility in business process modeling to deal with context-awareness in business process reengineering projects. In: Gulden J., Reinhartz-Berger I., Schmidt R., Guerreiro S., Guédria W., Bera P. (eds.) *Enterprise, Business-Process and Information Systems Modeling. Lecture Notes in Business Information Processing*, vol. 318, pp. 35–48. Springer, Cham (2018)
5. Lebedev, A.: Development of the theoretical bases of ERP (object and functional concepts ERP—it is system). *Polish J. Sci.* 20–1(20), 51–52 (2019)
6. Order of the Government of the Russian Federation No. 1632-r of 28.07.2017 On the Approval of the program “Digital Economy of the Russian Federation”. <http://base.garant.ru/71734878/>. Accessed 11 March 2021
7. Pérez, C., Montequín, V.R., Fernández, F.O., Balsera, J.V.: Integrating analytic hierarchy process (AHP) and balanced scorecard (BSC) framework for sustainable business in a software factory in the financial sector. *Sustainability* 9(4), 486 (2017)
8. Pisaryuk, S.N.: Application of program-targeted management methods at enterprises. *Economics* 9(3–1), 112–118 (2019)
9. Ponomarev, K.S., Feofanov, A.N., Grishina, T.G.: The digital double of the enterprise as a tool for digital transformation of production. In: *Proceedings of the All-Russian Scientific and Practical Conference Digital Economy: Equipment, Management, Human Capital*, pp. 73–76. Marker, Vologda (2018)
10. Rikhardsson, P., Yigitbasoglu, O.: Business intelligence and analytics in management accounting research: status and future focus. *Int. J. Acc. Inf. Syst.* 29(C), 37–58 (2018)
11. Satyal, S., Weber, I., Paik, H.-Y., Di Ciccio, C., Mendling, J.: Business process improvement with the ab-bpm methodology. *Inf. Syst.* 84, 283–298 (2019)
12. Timshina, D.V.: Reengineering of enterprise business processes. In: Safieva, E.N. (ed.) *Proceedings of the All-Russian Scientific and Practical Conference Digital Economy: Problems and Modern Trends*, pp. 403–406. Znanie, Moscow (2020)

# Digital Model for a Multidisciplinary Educational Base for Training a Multi-skilled Specialist



E. A. Alontseva, E. V. Cherkasova, and V. V. Kozlov

**Abstract** The article investigates information technology competencies in terms of modern market demands. The need for multi-skilled specialists increases every year, while the need for highly profiled specialists not only does not grow, but has a downward trend. The authors believe that the professional training of multi-skilled specialists must have a multidisciplinary educational base with a wide range of competencies. For this a digital model for creating a multidisciplinary educational base for training a multi-skilled specialist is being developed in this article. It creates a great variety of consistent educational paths for training multi-skilled specialists and allows to pick the best ones according to the criteria of cost, efficiency or complexity.

**Keywords** Competencies · Digital model · Multidisciplinary educational base · Skills · Technology

## 1 Introduction

The modern information technology market demands a wide range of competencies for a specialist working in this field in creating the minimum viable product (MVP) [1, 7]. The demand, especially in small companies for such a specialist is related to the specifics of these companies, for example, the “start-up” movement [2], and the fact that having one person with several skills rather than several people with specific skills is of real value to many organizations. In addition, there is a big time savings—a specialist can switch between levels and understand the whole process. So the professional training of such a specialist must be organized in some special way. We must take into account the constant change of the market needs. However, the integrity and consistency of the educational program should be taken into consideration and maintained. Digital model for creating a multidisciplinary educational

---

E. A. Alontseva · V. V. Kozlov  
Samara State Technical University, Samara, Russia

E. V. Cherkasova (✉)  
Samara State University of Economics, Samara, Russia

base for training multi-skilled specialist implies the presence of a large number of variable parameters. This allows to develop many possible options for professional training. This digital model also lets to pick the best ones according to the criteria of cost, efficiency or complexity.

## 2 Methodology

Using the concept of “a multi-skilled specialist”, the authors mean that a person working in a particular area (in this article in the area of information technology) must have competencies that allow him/her to fulfill any complex production task. For example, a multi-skilled information technology specialist should be able to independently create a web application project that includes a full development cycle: analysis of source data, collection of necessary information, preparation of technical specifications, knowledge of current regulations and rule [3]. The need for such specialists increases every year, while the need for highly profiled specialists not only does not grow, but has a downward trend. The reason is the method of a full development approach to the activities of a multi-skilled information technology specialist is rapidly gaining momentum, so the popularity and need for such specialists is growing [4, 10].

The presence of one multi-skilled specialist in the field of information technology, who has a sufficient number of necessary competencies, instead of several people, each of whom has one specific competence, has real value for many organizations: (a) saving time, as the developer can quickly switch between levels and understand the whole process; (b) saving the project costs. Developing the plan of full-scale training in the field of information technology requires the creation of a specialized digital model which takes into account many factors and will form the spectrum of the studied technologies, covering all the skills required for the chosen direction of training.

So, the set of competencies in the field of information technology for understanding the full minimum list of competencies of a universal specialist of WEB applications [8, 9] will be as follows: understanding of principles of network and cloud technology; ability to design and develop APIs and integration; basic experience in operating system administration; knowledge and ability to work with relational databases; knowledge of the principles of the HTTP protocol and the network package in general; working and understanding features, differences, advantages of WEB servers; using the server programming language skills; using server frameworks skills; modern IDEs using experience; the intermediate level of knowledge about the client; the version control system skills; caching systems skills; ability to work with the NoSQL database; skills in developing high-load services. Understanding scalability; experience writing unit tests; knowledge of algorithms; understanding the User Experience; using flexible development methods; team working skills; using clear formulating of technical requirements based on business requirements; communication with clients; the ability to design and develop data layers

and business logic, arguing for architectural solutions. In this way let us make some suggestions based on mathematical calculations.

**Step 1:**

Let  $B_j$  be a set of technologies, and the value  $C_{ij}$  determines the relationship  $i$  of that competency from the set  $A_j$  and  $j$  of that technology from the set.

In this case we have as the first step:

$C_{ij} = 1$  if technology  $j$  provides competency  $i$

$C_{ij} = 0$  if technology  $j$  is not related to competency  $i$ .

**Step 2:**

In view of the magnitude of the matrix  $C_{ij}$ , only a fragment of it is presented in Table 1 (zero elements are not indicated). Vector  $B_j$  consists of the components which are binary variables, defined as:

$B_j = 1$  if technology  $j$  is studied

$B_j = 0$  if technology  $j$  is not studied.

**Step 3:**

Each competence must be supported by at least one technology, therefore, the inequality that determines the formation of all competencies will be as follows:

$$\sum_j C_{ij} B_j \geq P_i \text{ for } A_i$$

where  $P_i$  sets the minimum number of technologies that ensure the formation of the  $i$  competency. Note that an additional matrix  $V_{ij}$  can be introduced whose elements will determine the value (weight) of the technology for competency  $i$ .

**Step 4:**

The inequality that determines the formation of all competencies can be written as

$$\sum_j V_{ij} B_j \geq P_i \text{ for } A_i$$

In this case  $P_i$  sets the minimum level of formation of the  $i$  competence.

Of course, the technologies are interdependent, that is, individual technologies cannot be studied without a preliminary study of the supporting technologies. For example, learning Laravel framework involves learning the PHP language, but the reverse is not true. Thus, the interconnection of technologies can be represented as a directed graph or as a square asymmetric adjacency matrix.

**Step 5:**

Let  $D_{jk}$  (the index  $k$  varies within the same limits as the index  $j$ ) characterizes the dependence of  $j$  that technology on  $k$  and is given by the rule:

$D_{jk} = 1$  if technology  $j$  requires knowledge of technology  $k$

$D_{jk} = 0$  if technology  $j$  is independent of technology  $k$

Table 2 shows an example of a matrix  $D_{jk}$  as applied to the technologies described in Table 1.

**Table 1** Competence and technology interconnection  $C_{ij}$

| Competencies<br>$A_i$                              | Technology $B_j$ |             |           |         |      |      |           |      |     |            |     |    |      |         |        |     |         |
|--|------------------|-------------|-----------|---------|------|------|-----------|------|-----|------------|-----|----|------|---------|--------|-----|---------|
|  | Visual Studio    | Zend Studio | Net Beans | Eclipse | ODBC | Linq | Hibernate | HTML | CSS | JavaScript | PHP | C# | Java | DOT NET | Spring | YII | Laravel |
| Knowledge of server frameworks                     |                  |             |           |         |      |      |           |      |     |            |     |    |      | 1       | 1      | 1   | 1       |
| Knowledge of server programming language           |                  |             |           |         |      |      |           |      |     |            | 1   | 1  | 1    |         |        |     |         |
| Mid-level knowledge of the client layer            |                  |             |           |         |      |      |           | 1    | 1   | 1          |     |    |      |         |        |     |         |
| Knowledge and ability to work with relational DBMS |                  |             |           |         | 1    | 1    | 1         |      |     |            |     |    |      |         |        |     |         |
| Experience with modern IDE                         | 1                | 1           | 1         | 1       |      |      |           |      |     |            |     |    |      |         |        |     |         |

Source Authors



**Table 2** Technology adjacency matrix  $D_{jk}$

| Competencies<br>$A_i$ | Technology $B_j$ |             |           |         |      |      |           |      |     |            |     |    |      |         |        |     |         |
|-----------------------|------------------|-------------|-----------|---------|------|------|-----------|------|-----|------------|-----|----|------|---------|--------|-----|---------|
|                       | Visual Studio    | Zend Studio | Net Beans | Eclipse | ODBC | Linq | Hibernate | HTML | CSS | JavaScript | PHP | C# | Java | DOT NET | Spring | YII | Laravel |
| Visual Studio         |                  |             |           |         |      |      |           |      |     |            |     |    |      |         |        |     |         |
| Zend Studio           |                  |             |           |         |      |      |           |      |     |            |     |    |      |         |        |     |         |
| Net Beans             |                  |             |           |         |      |      |           |      |     |            |     |    |      |         |        |     |         |
| Eclipse               |                  |             |           |         |      |      |           |      |     |            |     |    |      |         |        |     |         |
| ODBC Linq             |                  |             |           |         |      |      |           |      |     |            |     |    |      | 1       |        |     |         |
| Hibernate             |                  |             |           |         |      |      |           |      |     |            |     |    | 1    |         |        |     |         |
| HTML                  |                  |             |           |         |      |      |           |      |     |            |     |    |      |         |        |     |         |
| CSS                   |                  |             |           |         |      |      |           | 1    |     |            |     |    |      |         |        |     |         |
| JavaScript            |                  |             |           |         |      |      |           | 1    | 1   |            |     |    |      |         |        |     |         |
| PHP                   |                  |             |           |         |      |      |           |      |     |            |     |    |      |         |        |     |         |
| C#                    |                  |             |           |         |      |      |           |      |     |            |     |    |      |         |        |     |         |
| Java                  |                  |             |           |         |      |      |           |      |     |            |     |    |      |         |        |     |         |
| DOT NET               |                  |             |           |         |      |      |           |      |     |            |     |    |      | 1       |        |     |         |
| Spring                |                  |             |           |         |      |      |           |      |     |            |     |    |      | 1       |        |     |         |
| YII                   |                  |             |           |         |      |      |           |      |     |            |     |    |      |         | 1      |     |         |
| Laravel               |                  |             |           |         |      |      |           |      |     |            |     |    |      |         |        | 1   |         |

Source Authors

**Step 6:**

The compatibility condition of the studied technologies can be written as a system of inequalities  $D_{jk}B_j \geq B_j$  for  $A_{jk}$

However, not only unambiguous connections of technologies but the requirements of studying one or more technologies from a certain family are possible, for example, Java technology requires knowledge of one of the modern IDEs—Net Beans or Eclipse. We introduce the concept of a family of technologies and number them. Each technology can be assigned to one or more families, through matrix  $M_{nj}$  (Table 3).

**Step 7:**

$M_{nj} = 1$  if technology  $j$  belongs to the family  $n$

$M_{nj} = 0$  if technology  $j$  doesn't belong to the family  $n$ .

**Step 8:**

We introduce  $R_{jn}$  as a matrix whose elements determine the dependence of the  $j$  technology on the  $n$  family of technologies (Table 4).

$R_{jn} = 1$  if technology  $j$  requires at least one technology of the family  $n$

$R_{jn} = 0$  if technology  $j$  doesn't depend on technology of the family  $n$

Then the value  $\max(M_{nj}B_j)$  will be equal to 1 if at least one of the technologies of the family  $n$  is required and 0 if technology  $j$  doesn't depend on technology of the family  $n$ .

**Step 9:**

To ensure resolution of the dependence of the technologies under study on technology families, the following system of inequalities must be implemented:

$$B_j \max(M_{nj}B_j) \geq B_j \text{ for } A_{jn} \text{ or } B_j R_{jn} \sum M_{nj}B_j \geq B_j \text{ for } A_{jn}$$

So, it can be said that if any set of technologies, defined by a vector  $B_j$  and satisfying conditions (Steps 3, 6, 9) are combined, it provides the formation of all the required competencies for a given training profile and represents the set of possible training paths for specialists.

So we turn to the problem of choosing the optimal training path. To do this, we introduce a restriction on the maximum complexity of the preparation.

**Step 10:**

Let the vector  $H_j$  determine the complexity in hours of studying  $j$  of that technology. Then the task of choosing the optimal trajectory from the position of minimizing training costs is to solve the optimization problem (Step 10) subject to conditions (3, 6 and 9):  $\sum_j H_j B_j \rightarrow \min$ .

**Step 11:**

If it is necessary to choose the most useful trajectory for training specialists, equation in Step 10 takes the form of a restriction (where  $H^{\max}$  is the maximum available training time):  $\sum_j H_j B_j \leq H^{\max}$ .

**Step 12:**

The choice of the most useful training path is reduced to the search for maximum conditions (3, 6, 9, 12):  $\sum_j E_j B_j \rightarrow \max$ .

**Table 3** Technology joining families  $M_{ij}$

| Technology family number  | Technology $B_j$ |             |          |        |      |      |           |      |     |            |     |    |      |         |        |     |         |
|---------------------------|------------------|-------------|----------|--------|------|------|-----------|------|-----|------------|-----|----|------|---------|--------|-----|---------|
|                           | Visual Studio    | Zend Studio | Net Bean | Eclips | ODBC | Linq | Hibernate | HTML | CSS | JavaScript | PHP | C# | Java | DOT NET | Spring | YII | Laravel |
| 1 (IDE for Java)          |                  |             | 1        | 1      |      |      |           |      |     |            |     |    |      |         |        |     |         |
| 2 (IDE for PHP)           |                  | 1           |          | 1      |      |      |           |      |     |            |     |    |      |         |        |     |         |
| 3 (Programming languages) |                  |             |          |        |      |      |           |      |     |            | 1   | 1  | 1    |         |        |     |         |

Source Authors

**Table 4** Technology dependence on technology families  $R_{j,m}$

| Technology family number  | Technology $B_j$ |             |           |         |      |      |           |      |     |            |     |    |      |         |        |     |         |  |
|---------------------------|------------------|-------------|-----------|---------|------|------|-----------|------|-----|------------|-----|----|------|---------|--------|-----|---------|--|
|                           | visual Studio    | Zend Studio | Net Beans | Eclipse | ODBC | Linq | Hibernate | HTML | CSS | JavaScript | PHP | C# | Java | DOT NET | Spring | YII | Laravel |  |
| 1 (IDE for Java)          |                  |             |           |         |      |      |           |      |     |            |     |    | 1    |         |        |     |         |  |
| 2 (IDE for PHP)           |                  |             |           |         |      |      |           |      |     |            | 1   |    |      |         |        |     |         |  |
| 3 (Programming languages) |                  |             |           |         | 1    |      |           |      |     |            |     |    |      |         |        |     |         |  |

Source: Authors

**Step 13:**

To set necessary studied technologies, for example, for a specific employee, the following condition (13) can be introduced:

$$B_j \geq B'_j \text{ for } A_j$$

$B'_j$  sets the required technologies to be studied by unit values.

**3 Results**

A digital model for creating a multidisciplinary educational base for training a multi-skilled specialist is developed for constructing a great variety of consistent educational paths for training multi-skilled specialists, the formulation of which is presented below:

*Initial Data*

- $A_j$  a set of required competencies,
- $B_j$  a set of available technologies,
- $C_{ij}$  connection  $i$  of that competence and  $j$  of that technology,
- $V_{ij}$  the significance (weight) of technology  $j$  for competence  $i$ ,
- $D_{jk}$  the dependence of technology  $j$  from  $k$ ,
- $M_{nj}$  the relationship of technology  $j$  and technology family  $n$ ,
- $R_{jn}$  the dependence of  $j$  hat technology on the  $n$  family of technologies,
- $E_j$  vector demand for technology by the labor market.

*Optimization Parameters*

- $P_i$  minimum level of formation of  $i$  competency,
- $H_j$  the complexity of  $j$  technology,
- $H^{\max}$  the most labor intensive educational trajectory,
- $B'_j$  compulsory technology.

*Limitations*

- $\sum_j V_{ij} B_j \geq P_i \text{ for } A_i$  competency formation.
- $D_{jk} B_j \geq B_j \text{ for } A_{jk}$  compatibility (consistency) of technologies.
- $B_j R_{jn} \sum_j M_{nj} B_j \geq B_j \text{ for } A_{jn}$  compatibility (consistency) of technologies and technology families.
- $\sum_j H_j B_j \leq H^{\max}$  restriction on the complexity of training.
- $B_j \geq B'_j \text{ for } A_j$  guaranteed study of required technologies.

*Optimization Variables*

- $B_j$  binary vector trajectory preparation.

*Objective Function*

$$\sum_j E_j B_j \rightarrow \max \quad \text{efficiency from the standpoint of demand.}$$

$$\sum_j H_j B_j \rightarrow \min \quad \text{minimization the complexity of training.}$$

We build Table 5, using recruiting data from job site in the field of information systems and technologies [11] and taking into account the data from Table 1. Table 5 in the last column gives the normalized frequency of references. Rationing of the frequency of technology references was carried out within the framework of competencies to which these technologies relate.

As a result this method allowed us to come to comparable values and get rid of the economies of scale of the demand for competencies. That is absolutely justified, since condition (Step 3) guarantees training in all competencies of the specialty. Thus, the last column of Table 5 is a vector of technology  $E_j$  demand.

**Table 5** The usefulness of technology in the labor market

| Technology    | Number mention | Competence   | Number of mention technologies within the competence | Normalized frequency of references,% (The vector of the utility of technology in the labor market $E_j$ ) |
|---------------|----------------|--|--|---|
| Visual Studio | 269            | Experience with modern IDEs                        | 404  | 67  |
| Zend Studio   | 20             |  |  | 5   |
| Net Beans     | 4              |  |  | 1   |
| Eclipse       | 111            |  |  | 27  |
| ODBC          | 37             | Knowledge and ability to work with relational DBMS | 685  | 5   |
| Linq          | 71             |  |  | 10  |
| Hibernate     | 577            |  |  | 84  |
| HTML          | 2972           | Knowledge of the client layer on average level     | 12,394   | 24  |
| CSS           | 1513           |  |  | 12  |
| JavaScript    | 7909           |  |  | 64  |
| PHP           | 832            | Knowledge of server programming language           | 14,389   | 6   |
| C#            | 3017           |  |  | 21  |
| Java          | 10,540         |  |  | 73  |
| DOT NET       | 2288           | Knowledge of server frameworks                     | 4494   | 51  |
| Spring        | 2112           |  |  | 47  |
| YII           | 25             |  |  | 1   |
| Laravel       | 69             |  |  | 2   |

Source Authors

## 4 Discussion

By the criterion of the usefulness of the educational trajectory, we understand the degree of demand for specialists trained on this trajectory by the labor market. However, there may also be disadvantages of the method of a full development approach to the activities of such specialists. Despite the fact that they work at all levels of software, understand the principles and can work from both sides, they do not always know all the subtleties as their highly specialized colleagues [6]. So their development requires knowledge from the field of previous competencies. In this connection, we must note that some skills of this activity will require additional training. For example, it is obvious that the competence “access to databases” requires prior study of the data access language SQL and the programming language to which the database is linked. It is also necessary to develop a program for monitoring the quality of training [5].

## 5 Conclusion

The authors of the article have solved several tasks. They constructed joint and complete trajectories of specialist training. This lets to search for the optimal trajectory of the training of specialists. This also suggests searching for the most useful trajectory of specialist training with a limited labor intensity. A digital model for creating a multidisciplinary educational base for training a multi-skilled specialist allows us to develop training plans for specialists that cover all the necessary competencies for the chosen field of training on the basis of a specialized multifactor mathematical model for constructing a multitude of consistent educational ones. This allows us to satisfy the need for such specialists. And we know that the need has been continuously growing since 2013, especially in small high-tech companies and startup projects.

## References

1. Bosch, J., Olsson, H., Björk, J., Ljungblad, J.: The early stage software startup development model: a framework for operationalizing lean principles in software startups. In: Fitzgerald, B., Conboy, K. (eds.) *Lean Enterprise Software and Systems. LESS 2013. Lecture Notes in Business Information Processing*, vol. 167, pp. 1–15. Springer, Berlin (2013)
2. Dennehy, D., Kasraian, L., O’Raghallaigh, P., Conboy, K., Sammon, D., Lynch, P.: A lean startup approach for developing minimum viable products in an established company. *J. Decis. Syst.* **28**(3), 224–232 (2019)
3. Gurcan, F., Köse, C.: Analysis of software engineering industry needs and trends: implications for education. *Int. J. Eng. Educ.* **33**(4), 1361–1368 (2017)

4. Guryanov, A., Kozlov, V., Zhuravliova, O.: Arranging university educational process based on the regional competence profile. In: Proceedings of the International Scientific Conference Society, Integration, Education, vol. 1, pp. 205–212. Rezekne Academy of Technologies, Rezekne (2019)
5. Kozlov, V., Alontseva, E., Guryanov, A.: Information and educational environment for monitoring and forming a cumulative assessment of academic work in a semester. In: Proceedings of the International Scientific Conference Society, Integration, Education, vol. 5, pp. 383–392. Rezekne Academy of Technologies, Rezekne (2019)
6. Kozlov, V., Nasyrov, M.: Automated information system of active positioning of students in the labor market. *Int. Res. J.* **3–2**(22), 25–26 (2014)
7. Münch, J., Fagerholm, F., Johnson, P., Pirttilahti, J., Torkkel, J., Jäärvinen, J.: Creating minimum viable products in industry-academia collaborations. In: Fitzgerald, B., Conboy, K. (eds.) *Lean Enterprise Software and Systems. LESS 2013. Lecture Notes in Business Information Processing*, vol. 167, pp. 137–151. Springer, Berlin (2013)
8. Northwood, C.: The full stack developer: your essential guide to the everyday skills expected of a modern full stack web developer (2018). [http://www.xn--101-8cdo3any.xn--p1ai/pdf/The\\_Full\\_Stack\\_Developer.pdf](http://www.xn--101-8cdo3any.xn--p1ai/pdf/The_Full_Stack_Developer.pdf). Accessed 23 March 2021
9. Park, T., Wiedenbeck, S.: Learning web development: challenges at an earlier stage of computing education. In: Sanders K. (ed.) *Proceedings of the Seventh International Workshop on Computing Education Research*, pp. 125–132. Association for Computing Machinery, New York (2011)
10. Savoskina, E.V., Domnina, S.V., Kozlov, V.V.: Mechanism of creation regional competence-based profile of the university graduate. *Izv. Samara Sci. Centre Russ. Acad. Sci. Soc. Humanitarian Medicobiological Sci* **19**(4), 41–45 (2017)
11. The Dice: The Dice 2021 tech salary report (2021). <https://techhub.dice.com/Dice-2021-Tech-Salary-Report.html>. Accessed 23 March 2021



# The Accounting System of the Company in the Context of Digitalization



S. V. Andreeva

**Abstract** The article addresses improvement of company accounting in terms of digitalization. Transition to digital formats has the greatest impact on the company's accounting system. The objective of the article is to expand and elaborate provisions on development of an accounting system's potential in terms of digital strategies of economic entities. Various aspects of an accounting system's functioning were subjected to a sequential analysis, including structural and functional, procedural and methodical, information and instrumental, as well as communicative and subjective aspects. Essential characteristics of accounting processes transformation influenced by digital technologies were reflected in terms of each aspect. As a result, the article establishes a number of provisions reflecting the opportunities and restrictions of an accounting system in terms of digitalization.

**Keywords** Accounting procedures · Accounting system · Digital technologies

## 1 Introduction

Global use of state-of-art digital technologies dramatically changes traditional approaches of companies to management, production and sales. High level of the use information and digital technologies use are determined by competitive advantages of companies in domestic and international markets. Digital formats enable to establish new forms of partnership between business entities, resulting in new products and services supplied to the market [10]. Digitalization processes have a systematic nature and depend on many factors, requiring efforts by many researchers from various areas of knowledge [13].

Digitalization is regarded in modern literature as a implicitly positive trend in global community development, exploring new horizons for economy and society. At the same time, specialists consider digitalization to become a challenge for traditional companies. This challenge requires development of relevant digital strategies

---

S. V. Andreeva (✉)  
Samara State University of Economics, Samara, Russia

intended to provide new business opportunities and long-term company sustainability [1, 10, 11]. Such strategies make it possible to capitalize on the advantages of digital technologies, to set respective course of development for managers, to manage digital initiative and to direct managers' efforts for the most promising areas [1, 11].

Digital strategies determine long-term sustainability of the company. Yet, their development and implementation do not seem to have been widespread as they should. For instance, a study conducted by German scientists revealing weak control and insufficient financing of this management concept due to low interest of companies in digital technologies [10, 12].

Analysis of relevant changes in the accounting system of a company shall be deemed as an essential subject of its digitalization study. This is due to that the digital formats mainly impact the information system of a company; thus, the accounting system of a business is most subjected to changes, especially its cornerstone aspect: accounting. Today's scientific and practice literature reflects wide range of opinions on future of accounting. One such opinion states that conventional accounting will be merged into information and digital technology-based accounting: digitalization dissolves the boundaries of accounting and threatens the legitimacy and the role of the accountant profession [9]. On the other hand, researchers note that digital technologies provide new opportunities for accounting: they improve quality of accounting and information resources, and increase speed of formation and processing of such resources [4, 5]. Knudsen, upon a vast review of articles, concludes that boundaries of accounting and the accountant profession can be extended due to digitalization [7].

Researchers are particularly interested in transformation of accounting into managerial accounting and turning an accountant into an account manager (managerial accountant) [8, 14]. Andreassen notes significant influence of digital technologies on arrangement of accounting activity: digital technologies facilitate development of the niche specialty of a managerial accountant and intensify competition between the professions in the information area, intensify behavioral aspects and change role of accountants in managerial interaction [2]. In our opinion, the statement on transformation of accounting into managerial accounting requires clarification. In our opinion, accounting is just another element to the accounting system which includes various types of accounting (financial, human resources, production, tax, ecological, etc.) [3]. Managerial accounting system covers a wider range compared to conventional accounting as it manipulates much more accounting items and instruments, using not only cost-based but qualitative performance as well. We believe that intrinsic and instrumental restrictions of accounting prevent it from completely replacing managerial accounting. This is why we think that digital technologies will more probably result in changes in boundaries and functions of the accounting in terms of the accounting system rather than in transformation of accounting into managerial accounting.

We tend to agree with the authors appealing to more careful assessment of today's status of accounting system. Knudsen notes that trends of transformation of the accounting system of a company in terms of digitalization are not yet sufficiently

described due to their theoretical nature [7]. According to Quattrone, results of digitalization for managerial accounting are not yet clear, and its effects meanwhile fail to provide complete information and rational basis for managerial decisions [14].

Thus, further study of digital format influence on a company accounting system functioning is still a pending scientific topic. This article addresses theoretical and methodical issues of economic entities operation improvement in terms of digitalization. The objective of the article is to expand and elaborate provisions on development of the accounting system as one of the courses for implementation of digital strategies of economic entities.

## 2 Methodology

Results of scientific researches by Russian and foreign authors dedicated to today's status of accounting systems were used as an information basis for the article. Research of accounting system potential in terms of digitalization is based on systematic and structural methods and resource concept. According to this concept, the system potential is a set of certain resources in terms of their balanced combination and interaction. We use the term "potential" (from Latin "potential", meaning power, strength) as the basic category. Potential generally means available assets, supplies, sources and resources of the system that can be mobilized to achieve a certain goal. By "accounting system potential", we mean its interrelated elements determining possibility to generate accounting and information resources according though the company's managerial needs. In order to describe the accounting system, we used its function-oriented structure as potential methodological basis for complex structured information system development for the company accounting area [3]. This structure is subject to consistency purposes of substantive, organization and tool aspects in terms of implementation of various accounting areas. This combination of scientific approaches ensures complex approach to the analysis of digitalization impact to the micro-level accounting system.

## 3 Results

Analysis of potential opportunities and restrictions of the accounting system in terms of formation and implementation of digital micro-level strategies is performed in following areas:

- structural and functional area covering substance and logic of accounting in its various areas;
- procedural and methodological area reflecting accounting processes, their substance and algorithm.

- information and instrumental area which is combination of means and tools for gathering and procession of information: automation software and hardware, local area networks, general- and special-purpose software, etc.
- communicative and subjective area covering jurisdictions, professional assessments, motivation aspects, accounting encouragements, integration abilities, etc.

Sequential analysis of the specified area allows to form series of provisions.

In terms of the structural and functional area, we recommend to structure the accounting system in all implemented accounting areas:

- functional types of accounting according to main business process (accounting of production, selling, supplying, financial activities; human resources and technical accounting, etc.);
- accounting areas, arranged according to special management branches (tax, investment, innovation, ecological and social accounting, etc.);
- accounting of the company concerted activity providing information resources for complex management of activity of all management process members to achieve current and long-range objectives of the company. In our opinion, such type of accounting should be referred to as “managerial accounting”. Bookkeeping accounting is a formalized part of concerted activity accounting. This approach prevents from confrontation of conventional accounting and managerial accounting as it allows clearer determination of the digital technologies impact to the bookkeeping accounting. It worth noting that conventional accounting is still a fundamental element of accounting system.

Representing a micro-level accounting system allows clearer determination of functional areas covered by any type of accounting, to compare their accounting and information fields and reveal repeating sources of the accounting information (or absence thereof), to determine any areas extending or reducing due to information system development and digitalization for each functional area. Goal, objectives, principle, functions and item of accounting, complex of methods and their substance can be determined for each element of the function-oriented accounting system.

In our opinion, accounting subsystem will lose the functions of primary and analytical accounting in future due to development of digitalization means, and such functions will be carried out by functional types of accounting. The accounting will accordingly become focused on interpretation and provision of financial information in the format of an official accounting statement. Digitalization will inevitably result in expansion of information field in functional types of accounting and, accordingly, accounting of concerted activity. Theoretically, as tools for gathering and procession of financial and non-financial information develop and improve, integrated statements can achieve the status of official statements as information formalized representation of complex concerted activity of the company. In such case, conventional accounting will lose its status of fundamental element to the accounting system and transform into one of components of concerted activity. Currently, integrated statements is non-systematic and submitted by companies on voluntary basis.

Procedural and methodological area implies assessment of tools and methods applied in accounting. This area implies study and improvement of procedures for registration, assessment, processing, aggregation and interpretation of data at all stages of formation of accounting and information resources. It accordingly covers organization of document management, establishment of accounting and management regulations, re-engineering of accounting processes, outsourcing of accounting functions, etc.

In terms of such area, accounting policies, regulations and procedure of all implemented types of accounting are formed and formalized. This article also implies establishment of requirements for structural divisions of a company in order to arrange efficient document management and development of control procedures for all stages of accounting information formation. Development of an accounting system's potential in terms of this area should be mainly related to increase of data volume, optimization of forms and methods for interpretation of accounting information and improving analysis quality and accounting speed.

In our opinion, this area is the most affected by digital technologies. Formation of digital economy expands range of accounting items with new hybrid and modifiable assets, obligation and capital: crypto currencies, smart assets and contracts, mixed investments tools, new forms of financial transactions, digital funds flows, virtual valuables and other [6]. Due to developing digital environment, specialists predict significant increase of factors affecting company social aspects, quality of business processes, status of organization, innovation, reputation and intellectual capitals. It accordingly set our challenges to identify and assess these items.

Digitalization processes change traditional methodological approaches. In our opinion, future use of digital technologies for accounting of economic activity that ensure high precision and individualization of information will result in obsolescence of conventional accounting technology. For instance, methods for averaged assets estimation, costs distribution and prime cost calculation, characterized by being highly conditional, will become "obsolete" for accounting. It means that accuracy and thorough identification of accounting information at the registration stage are extrapolated to further stages of accounting.

This area provides information and tool components of an accounting system. Use of modern information and digital technologies results in significant modifications of technology and methods of accounting procedures. Digital formats provide opportunity for processing and storage of larger volumes of information as well as availability of information from any location. According to specialists, future of accounting is inextricably connected to online technology [4, 6]. Use of cloud technology, open-source platforms, digital referral information systems, block chain technology, unified digital formats of financial states brings scopes and speed of accounting processes to next level.

A unique feature of modern digitalization tools is worth noting. In earlier times, managerial and accounting objectives utilized respective tools and equipment solutions. Nowadays, information needs of a company are determined or even updated by modern opportunities of automation and digitalization, i.e. it makes it possible to speak of a certain "tool margin" of digitalization.

Spread of digital technologies requires accounting staff with new competences, skills of work with modern information technology and methods of accounting, ability to quickly response to changes in professional qualifications. But we agree that need for new competences shall not weaken traditional ones such as business sense, analytical thinking and other [10].

Besides the professional aspect, this objective is related to general trend of increasing role of human resource in socioeconomic systems and aspects of accounting area, which is quite conservative, especially in aspect of official bookkeeping and tax types of accounting.

Growing potential of accounting system requires arrangement of interaction between accounting staff and managers performing accounting in their functional management, as well as engagement of accounting staff in budgeting issues and tactical and strategical management. Thus, an accountant will have a broader comprehension of conceptual field of accounting information.

## 4 Discussion

The directions of analysis of potential opportunities and restrictions of accounting systems specified herein are intended to be used for producing and implementing strategies for economic entities. Improvement of accounting provides following positive results:

- well-coordinated quick formation of accounting and information resources of proper quality;
- vast variety of accounting information on various aspects of company activity;
- ability to consider factors determining long-term development of the company;
- basis for integration and adoption of modern digital technologies.

Practical implementation of the measures proposed above to improve potential of a company accounting system should be carried out with caution. This is due to insufficient experience of implementation of digital tools in company accounting processes. Digital transformation of accounting processes may require other, non-traditional approaches, which is also a challenge. And there is also no consensus on the feasibility of common principles in studies of accounting issues in terms of digitalization [5]. We agree with other authors noting that some behavioral prejudice towards digital technologies may emerge, as well as inflated expectations by higher managers from changes related to digitalization [10]. Improvement of accounting in modern companies and reflecting the respective results in public media will enable obtaining more consistent results when exploring the impact of digital formats on accounting activities of economic entities.

## 5 Conclusion

Digitalization has significant impact on information sphere of a company and, respectively, its accounting system. The accounting system of a company, as well as its productivity and quality of the produced information support stable development of such company and its sustainability. Digitalization of the company activities should not shift away from this principle. Development and implementation of digital strategies should consider restrictions and potential opportunities for the development of the accounting system. The article provides analysis of areas of functioning for an accounting system: structural and functional area, procedural and methodical area, information and instrumental area, communicative and subjective area. In terms of each of these areas, we have reflected the essential characteristics of accounting processes' transformation as influenced by digital technologies. This approach made it possible to offer provisions for the development of the potential of the company's accounting system as one of areas of implementation of digital strategies for economic entities. Theoretical and methodical aspects of economic entities' accounting improvement in terms of digital economy establishment were also elaborated.

## References

1. Akmaeva, R.I., Vaichulis, T.B.: On development strategies in the context of digital transformation. In: Proceedings of the Scientific and Practical Conference with Foreign Participation Digital Economy and Industry 4.0: Foresight Russia, pp. 16–33. Peter the Great St. Petersburg Polytechnic University, St. Petersburg (2020)
2. Andreassen, R.-I.: Digital technology and changing roles: a management accountant's dream or nightmare? *J. Manag. Control* **31**, 209–238 (2020)
3. Andreeva, S.V.: Processes of informatization in the accounting of an enterprise: the methodological aspect. In: Ashmarina, S., Mantulenko, V. (eds.) Current Achievements, Challenges and Digital Chances of Knowledge Based Economy. Lecture Notes in Networks and Systems, vol. 133, pp. 259–266. Springer, Cham (2021)
4. Bhimani, A., Willcocks, L.: Digitisation, 'big data' and the transformation of accounting information. *Account. Bus. Res.* **44**(4), 469–490 (2014)
5. Bhimani, A.: Digital data and management accounting: why we need to rethink research methods. *J. Manag. Control.* **31**, 9–23 (2020)
6. Guziekova, S.M., Salii, V.V., Ishchenko, O.V.: The role of the process approach in the construction of the accounting information-analytical system in the implementation of the digital transformation strategy. *Nat. Humanitarian Res.* **29**(3), 138–143 (2020)
7. Knudsen, D.R.: Elusive boundaries, power relations, and knowledge production: a systematic review of the literature on digitalization in accounting. *Int. J. Account. Inf. Syst.* **36**(3), 100441 (2020)
8. Meng, F.: Characteristics of financial accounting transformation to management accounting in big data environment. In: Liu, L., Ke, G., Davis, H. (eds.) Proceedings of the 2nd International Conference on Economics and Management, Education, Humanities and Social Sciences (EMEHSS 2018). Advances in Social Science, Education and Humanities Research, vol. 151, pp. 206–210. Atlantis Press, Paris (2018)

9. Moll, J., Yigitbasioglu, O.: The role of internet-related technologies in shaping the work of accountants: new directions for accounting research. *Br. Account. Rev.* **51**(6), 100833 (2019)
10. Möller, K., Schäfer, U., Verbeeten, F.: Digitalization in management accounting and control: an editorial. *J. Manag. Control.* **31**, 1–8 (2020)
11. Ross, J.W., Beath, C.M., Sebastian, I.M.: How to develop a great digital strategy. *MIT Sloan Manag. Rev.* **58**(2), 7–9 (2017)
12. Schäffer, U., Weber, J.: Die Digitalisierung wird das Controllingradikal verändern. *Controlling Manage. Rev.* **60**(6), 8–17 (2016)
13. Strelkova, I.A.: Digitalization of the economy: new format of globalization. *Econ. Taxes Law* **13**(4), 20–28 (2020)
14. Quattrone, P.: Management accounting goes digital: will the move make it wiser? *Manag. Account. Res.* **31**(6), 118–122 (2016)



# Modernization and Development of the Machine-Building Complex in the Digital Economy



A. B. Vishnyakova, A. V. Sultanova, and V. V. Voropaeva

**Abstract** The article is devoted to the current problems of the development of domestic machine-building, considering the development of the digital economy. The article identifies the problems of modernization of the material and technical base of the enterprises of the machine-building complex of Russia. The necessity of modernization of the material and technical base of enterprises with the use of modern technologies is indicated. Factors hindering the development of machine-building and machine-tool enterprises are indicated. The prospects for the development of enterprises are noted. The article pays special attention to the prospects for the development of industrial enterprises in the context of digital transformation. The article substantiates the significant role of industrial production modernization as a new innovative approach to the development of machine-building enterprises. The practical implementation of modernization measures will help to increase the competitiveness of enterprises and increase their investment attractiveness.

**Keywords** Competitiveness · Digital technologies · Digitalization · Material and technical base · Modernization · Machine-building complex

## 1 Introduction

Nowadays, the most important factor contributing to the economic growth of industrial enterprises is the development of the digital economy. The development of intelligent production systems and the maintenance of the entire product life cycle in the digital environment is becoming the main condition for the development of the industry as a whole. Modernization of the domestic machine-building complex is a key component of Russia's strategic development, especially in the context of sanctions and restrictive measures against the Russian Federation. For modern equipment

---

A. B. Vishnyakova (✉)  
Samara State University of Economics, Samara, Russia

A. V. Sultanova · V. V. Voropaeva  
Samara State Technical University, Samara, Russia

of the enterprises of the machine-building complex, serious and significant financial resources are required. The issue of modernization is now important for many enterprises, as they own old equipment. Now the domestic market needs to create high-tech and even innovative products. The country's leadership especially emphasizes the need to improve the competitiveness of goods produced by domestic enterprises, but this is very problematic, since it is almost impossible to create such products on old worn-out equipment. For a long period of time, imported tools and equipment were used in Russia, and it is impossible to find a replacement for them in a short time. Significant financial resources are needed, which will be used for technical re-equipment and updating of the material and technical base of enterprises. Among the problems of increasing production efficiency, we can single out the problem of reproduction of fixed assets at existing enterprises through reconstruction and technical re-equipment. Technical re-equipment should first of all be considered as a category reflecting the qualitative changes in the development of productive forces caused by modern achievements of science and technology.

## 2 Methodology

In the course of the study, general scientific methods were used, including analysis, the method of classification and typology, generalization, and the system-functional method. Modernization of equipment can increase its productivity and ensure high reliability in its operation, which will further reduce the costs on repair and maintenance of equipment, reduce the cost of production, which will lead to an increase in profits.

It is known that the impact of modernization has a positive effect on improving the quality of products, reducing losses from defects. Improving the quality of products as a result of modernization will lead to costs saving in the field of its consumption by reducing the costs of repair and maintenance of equipment, reducing idle time. Currently, there is no single opinion on the modernization of the equipment. Many experts classify modernization on one basis, namely, in the areas of modernization. For example, Konson suggests the following division of measures for technical improvement of equipment: intensification of processing modes, increasing the level of mechanization and automation of labor processes, changing the technological purpose of machines, increasing the wear resistance and reliability of machines, and improving the quality of surface treatment of parts [4].

Kruchinin gives the concept of general modernization, which combines all the measures taken to improve the technical and operational performance of the equipment [5]. According to Akberdin, measures aimed at improving the durability and maintainability of equipment can be combined into repair modernization. Akberdin considers not only the types and directions of modernization, but also the forms and the consequences of its implementation [1].

Currently, the modernization of industrial enterprises is impossible without taking into account digital transformation and the use of modern innovative technologies.

Inozemtsev considers modernization as a complex process that combines political will, economic feasibility and technological capabilities [3].

In the work of Pochukaeva, it is mentioned that there is a need to develop the innovative sphere of branches of the machine-building industry in order to get progressive technologies [8].

Many experts say that modernization should be systematic, based on completely new principles and approaches in the organization and management of production. Currently, there is a rapid development of technologies. The share of organization engaged in technological innovations decreased from 9.1% in 2012 to 7.8% in 2019. The share of shipped innovative goods and provided services decreased over this period from 8 to 5.3% [6].

### 3 Results

The machine-building complex is the leading industrial complex of Russia which determines scientific and technological and production potential of all Russian economy [10]. In the economic literature, there are usually three main forms of updating technology. The first form involves the expansion of existing equipment by putting into operation equipment that does not differ from the previous one. It is known that with such an update, the amount of equipment increases, but its technical level remains the same. Nowadays, the importance of this method is small, since scientific and technological progress and the reduction in the operational life of machines and the transition period to more advanced models are obvious. Now, in order to increase productivity, there is a need to remove old models of equipment from production in a timely manner and replace them with more modern ones that meet international standards. The second form of renewal is aimed at replacing the machines that fell into disrepair with the same amount of equipment that does not differ from the previous one in its characteristics, but has a lower cost. The third form of updating is the most effective and applicable at the present time. It is aimed at replacing the old equipment with a new one that is economically and technically more efficient.

The past decade was a transition for the domestic machine-building industry. Currently, modernization is considered as a set of interrelated measures aimed at improving the competitiveness of products in various sectors of the economy. It is known that the machine-building industry is the most important link that characterizes the stability of the economy and its high development. In the structure of the machine-building complex there are more than 7 thousand large enterprises. New technologies need to measure all the costs and benefits associated with technology development. In the conditions of modern machine-building production, the quality of technology is determined by 65–75% by the increase in the main economic indicators. An important estimated economic indicator of each technological mode is the rate of increase in production efficiency in terms of resource efficiency dynamics.

Statistics show that the machine tool fleet of many enterprises of the machine-building complex of the Russian Federation is 70% outdated and physically worn out. Approximately 4–6% of this fleet consists of CNC machines, which are also outdated.

To solve the problems of the industry development, a deep modernization is necessary, which has a systematic character of the equipment fleet based on machine tools and equipment of the 4th and 5th generation. Lack of investments slows down and complicates the modernization process. The problem is compounded by the fact that subsidiaries of multinational corporations appear on the market, which have a number of advantages. The analysis showed that in 1997–2017, the level of technological equipment in machine-building increased by only 25%, the coefficient of shift work of the main equipment decreased from 1.3 to 0.8, which led to a decrease in capital productivity at the enterprises of the complex [9].

The use of flexible productions allows to increase the return of equipment by about 2–3 times. The main criterion is the economic feasibility of costs and the greatest efficiency of investments. It is important to increase the use of equipment that is still at a low level (Table 1).

In the shipbuilding and transport machine-building of the Russian Federation, the equipment utilization rate is 0.8%, with a standard value of 1.70. At many enterprises, there are many in-shift idle times. In the last two decades, the shift ratio has not increased, and the machine time of using the main technological equipment is decreasing (Table 2).

To train specialists in the technical field, many universities do not have a sufficient technical base to train highly qualified personnel in the field of industry. Many enterprises had to struggle to survive. A number of companies that lost their market

**Table 1** Dynamics of the use of metal-working equipment in the main production of the machine-building complex of the Volga Federal District

| Year            | The actual shift rate of the equipment | The ratio of the actual shift rate to the standard one (1.70), % |
|-----------------|--|--|
| 1980            | 1.47                                   | 0.83   |
| 1990            | 1.22                                   | 0.70   |
| 2003            | 0.94                                   | 0.53   |
| 2010            | 0.87                                   | 0.50   |
| 2021 (forecast) | 0.9                                    | 0.51   |

Source Authors

**Table 2** Dynamics of the main indicators of the use of the machine-building complex potential

| Indicator                       | 1975 | 1985 | 1995 | 2005 | 2015 | 2025 forecast |
|---------------------------------|------|------|------|------|------|---------------|
| Production capacity utilization | 91.2 | 84.8 | 33.8 | 37.9 | 37.9 | 39.0          |
| Machine time, h                 | 984  | 796  | 320  | 420  | 390  | 410           |

Source Authors

positions declared themselves bankrupt. The time factor plays an important role in this, since developed countries re-equip their industry approximately every 8–10 years. Currently, the average age of the equipment fleet is 22–32 years. At the same time, only 5% of enterprises can afford technological innovations.

Therefore, of course, issues related to the modernization of equipment of the machine-building complex enterprises certainly come to the fore. Due to the lack of funds, the modernization of equipment is economically advantageous compared to the purchase of a completely new one. Modernization can be general and targeted. The overall modernization is aimed at reducing the processing time of products and improving the performance of equipment. Improving the performance of the equipment is aimed at automating the operation of the equipment, improving the quality of products and working conditions. Targeted modernization involves expanding the technological capabilities of the equipment.

Among the main areas of modernization are the following:

- equipment specialization;
- universalization of equipment;
- changing the technological purpose of the equipment;
- improving the accuracy of parts processing;
- increased wear resistance in the operation of the equipment.

Among the economic results, we can distinguish:

- changing and expanding the technological capabilities of the equipment;
- improving the quality of products;
- reducing the amount of repair works.

The advantages of modernization are very significant. Thus, reducing the processing time of products with the help of upgraded equipment allows to increase its productivity.

## **4 Discussion**

It should be especially emphasized that the problems in the machine-building industry are global in nature, since the effectiveness of the country's economic development depends on the level of its development as a whole. The main tasks that need to be solved include:

- to upgrade worn-out equipment;
- to train qualified personnel to make effective management decisions in the development of new competitive products.;
- to eliminate obsolete infrastructure of production facilities and obsolete enterprise management system.

The negative factors that arise in the machine-building industry, as a result of the above-mentioned problems, give rise to a systemic crisis, which is not yet possible to overcome.

The negative factors include:

- depreciation of fixed assets that reached critical indicators (the actual age of the equipment at the enterprise is 20 years);
- a serious gap in technologies from developed countries, especially in the machine tool industry;
- low quality of manufactured products;
- lack of working capital and current funds for development of the enterprise;
- low competitiveness of products and low investment attractiveness of the industry.

The way out is possible only with the implementation of a systematic approach and the help of the state in the framework of financing and state support for the machine-building industry.

One of the most serious problems is strengthening foundations of modernization that is the system innovative development and qualitatively new economic growth taking into account ecological requirements and management mechanisms of modernization [11].

Considering the state of the Russian machine-building industry, it is necessary to overcome about 30 years of lag. Today, the United States is the leader in terms of technologies development, the share of technologies of the fourth technological mode is 20%, the fifth is 60%, and the sixth is already about 5%. If the paces of technological development achieved by progressive countries will be maintained, the sixth stage will enter the maturity phase in the 2040s. In Russia, the situation is not so optimistic, since the fifth mode became widespread only in the most developed industries, namely, in the military-industrial complex (MIC) and the aerospace industry. There, the share is no more than 10% of technologies, the fourth mode is more than 50%, and about 30% of the third mode technologies are used [7].

Digitalization of machine-building and machine-tool industries is inevitable, as this will determine the increase in the competitiveness of enterprises in this area. The development of the country's economy is impossible without effectively developed large industries. The gap between domestic and foreign enterprises is very large, but the potential for the development of machine-tool and machine-building enterprises is sufficient to eliminate this gap. Existing research and design organizations have a certain reserve for developments that meet international standards. It is necessary that enterprises actively use the achievements of research institutes, state support is extremely necessary.

However, despite the significant problems, it is impossible not to note the positive developments. Many machine-building enterprises use modern information technologies related to the management of production processes, the regulation of purchases and sales. Software products "1C", "Galaxy EPR", "IFS Application" allow to solve many problems.

The digitalization underlying in "Industry 4.0" will ensure the flexibility of production. It will allow to bring other, more effective indicators and increase the

competitiveness of many enterprises. Wide automation of technological processes will allow to achieve high results, to involve customers in the formation of consumer properties of the product.

The directions of digital transformation of enterprises will reduce costs and increase the competitiveness of products. For example, the development and promotion of additive technologies in modern machine tools used in the manufacture of physical objects by layer-by-layer application of material using 3D printers will change the perception of opportunities in the industry. Three-dimensional printing technology will allow to get up to several hundred tons of products per year, including large massive products. Digital representation of production makes it possible to increase its competitiveness by involving organizational and technical reserves in operational activities. One of the most promising examples of the application of modern technologies in industry is maintenance.

## 5 Conclusion

According to the program “Digital Economy of the Russian Federation”, it is planned to introduce important technologies: big data, artificial intelligence, the Internet of Things, wireless communication technologies. Implementation of the 5G standard. Nowadays, the drivers of digital transformation are new products and services, new information and management technologies, innovative business models and industry digital platforms are the key driver [2]. At a modern digital enterprise, it becomes possible to organize effective interaction between different parties and participants, which was previously impossible to achieve. The digital economy became almost a trend for the development of large industrial holdings. Industrial internet of things will allow to manage production more efficiently. Integrated information systems are a new generation systems that can launch a digital transformation in the industry.

Digitalization means fundamentally new solutions in all spheres of life, bringing labor productivity to a new level, forcing to diversify its activities, optimize production processes. Further development of digital technologies will lead to a change in the business model of the enterprise, including production, logistics and service. In the future, it is expected to optimize costs, increase the return on assets, increase profitability and increase the number of qualified personnel in the field of modern technologies.

## References

1. Akberdin, R.Z.: Economics of Equipment Fleet Renewal in Mechanical Engineering. Mashinostroenie, Moscow (1987)
2. Aptekman, A., Kalabin, V., Klintsov, V., Kuznetsova, E., Kulagin, V., Yasenovets, I.: Digital Russia: new reality (2017). [https://www.mckinsey.com/ru/~/\\_/media/McKinsey/Locations/Eur](https://www.mckinsey.com/ru/~/_/media/McKinsey/Locations/Eur)

- [ope%20and%20Middle%20East/Russia/Our%20Insights/Digital%20Russia/Digital-Russia-report.pdf](#). Accessed 21 March 2021
3. Inozemtsev, V.L., Krasilshchikov, V.A., Medovnikov, D.S., Vinkov, A.A., Imamutdinov, I.N., Mekhanik, A.G., Rozmirovich, S.D.: Conditions, Prerequisites, Chances. Centre for Post-Industrial Researches, Moscow (2009)
  4. Konson, A.S.: The Economics of Machine Maintenance. Mechanical Engineering, Leningrad (1970)
  5. Kruchinin, I.A.: Fundamentals of the Economic Efficiency of an Automated Control System (ACS) of an Industrial Enterprise. Central Research Institute of Machine Building, Moscow (1965)
  6. Mottaeva, A., Stepanova, J., Meshkova, N., Semenova, G.: Optimizing the resultativeness of adapting an economic entity to the conditions of digitalization. *Eur. J. Sustain. Dev.* **10**(1), 705–723 (2021)
  7. Piskunov, A.: Technicalre-equipment as basis of innovative development of industrial enterprises in Russia. *Issues Innovative Econ.* **9**(1), 137–150 (2019)
  8. Pochukaeva, O.V.: Innovative and Technological Development of the Machine-Building Industry. MAX Press, Moscow (2012)
  9. Tatarskih, B.Y.: Factors of accelerated modernization of the material and technical base of mechanical engineering of Russia. In: Tatarskih, B.Y., Lazarev, V.N. (eds.) Proceedings of the VIII International Scientific and Practical Conference Formation and Implementation of the Strategy for Sustainable Economic Development of the Russian Federation, pp. 3–10. RIO PGAU, Penza (2018)
  10. Vishnyakova, A.B., Tatarskih, B.Y.: Organizational and economic problems of system modernization of enterprises of the machine-building complex. In: Ashmarina, S., Vochozka, M. (eds.) Sustainable Growth and Development of Economic Systems. Contributions to Economics, pp. 373–384. Springer, Cham (2019)
  11. Vishnyakova, A.B.: Management of modernization of industrial enterprises. In: Lazarev, V.N., Tatarskih, B.Y. (eds.) Proceedings of the VI International Scientific and Practical Conference Organizational, Economic and Technological Problems of Modernization of the Russian Economy. RIO PGAU, Penza (2016)



# Digital Twins as a Method of Risk Management Transformation



L. V. Ermolina, A. M. Zinovyev, and D. A. Melnikova

**Abstract** Digital Twins or Digital Doubles are electronic copies of real-life assets of the company. It mirrors the behavior of the object and states over throughout its life cycle in a virtual space. Digital Doubles are being adopted by increasingly more industries, transforming them and bringing new opportunities. This article focuses on their role in risk management programs in the oil and gas sector. There are 10 basic principles of Digital Twin that can efficiently improve the performance of the company. The implementation of this technology can have a huge influence on how oil and gas enterprises use and manage their huge amount of data and information. The required information is shared among interest parties upon request. The advantages and disadvantages of the imminent digitalization of the industry are determined as well. One of the main benefits of Digital Doubles is the promise to bring the industry to new levels of productivity and sustainability.

**Keywords** Double twins · Double digitalization · IT-technologies · Oil and gas sector · Principles of digitalization

## 1 Introduction

The relationships in the industrial sphere are transformed by modern information technologies and computer algorithms. This transformation leads to the creation of new types of interactions during socio-economic processes. However, Digital Double or Digital Twin concept is not a new one. It has already been in existence for over 15 years. The concept was first introduced by Dr. Grieves (chief scientist and the executive vice president of operations at the Florida Institute of Technology, the USA) as a “Conceptual idea for PLM” in 2002 at the University of Michigan. And what would be helpful further is a definition that we could rely on when referring to the

---

L. V. Ermolina (✉)  
Samara State University of Economics, Samara, Russia

A. M. Zinovyev · D. A. Melnikova  
Samara State Technical University, Samara, Russia

Digital Twin. So, according to Dr. Grieves, “Digital Twin” in the broadest sense is a virtual copy of a real object, a computer model that duplicates its key characteristics and can reproduce its state under different conditions. In fact, it is just a set of mathematical formulas that describe the asset and its processes. Grieves expands on this definition by describing the Digital Twin as consisting of three components: a physical product, a virtual representation of that product, and the bi-directional data connections that feed data from the physical to the virtual representation, and information and processes from the virtual representation to the physical. Grieves depicted this flow as a cycle between the physical and virtual states [5]. We will talk about Digital Twin classification and structure in detail in the Results section.

Digital Twin allows to analyze information and identify challenges before they develop into serious problems, and so, prevents standstill and extends business opportunities. Only in several last years improved devices and clarity in various uses speed up the implementation of the technology. Oil and gas enterprises have begun to understand the benefits of Digital Doubles [14, 15]. Obviously, it can bring great awareness of operation processes and can take companies’ operational superiority to a new level [8]. To create a Digital Twin, descriptions and data about the real object should be collected (e.g. size, core components, and stages of the process). This information is then transferred between the company’s departments. Digital copy is updated continuously during exploitation. However, a virtual model can be created even before the real object come to exaction, during the design phase in order to test the operation, as they say, from “well-to-wheels”. This allows monitoring different production characteristics. And it goes without saying, it improves mining processes and mitigates costs.

## 2 Methodology

The empirical methods, as well as theoretical ones, were used in this paper to explore the topic. The basic scientific methods of research allowed us to systematize information. They also helped us to identify the role of Digital Twins in the study sector. The review of the concept “Digital Twin” was carried out. The foreign companies’ experience was also pointed out. In what follows, we analyzed such companies as British Petroleum, Saudi Aramco, Royal Dutch Shell, Gazpromneft, and Rosneft. It is necessary to apply a comparison method for the analysis of the past and current implementation of Digital Twins. The empirical methods are particularly useful for understanding subjective information. These methods include observations and literature reviews. We viewed the reports on the topic of leading research companies (Gartner and McKinsey) [6, 11].

### 3 Results

The scientific discussion on the Digital Twin got strong impulse within the last couple of years. As we said earlier, in the context of “Industry 4.0”, the Digital Twin refers to the concept of a virtual representation of a physical object. The asset types may range from products and processes to whole production systems. Different experts offer a variety of interpretations on the actual nature of the Digital Twin. At the same time, some authors use the term simply as a catchphrase, thus applying a blur to this emerging paradigm. More than that, the Digital Twin concept is often confused with the Information model of the asset. Unlike the Information model, the Digital Double does not just collect data but continues to collect and analyze it throughout the life cycle of a real object, for example, with the help of Industrial Internet of Things (IIoT) devices. The variety of Digital Twins can be divided into the following categories: Digital Twin Prototype (DTP), Digital Twin Instance (DTI), Digital Twin Aggregate (DTA), and Digital Twin Environment (DTE).

Digital Twin Prototype (DTP) is the most common one. It can be described as a virtual analog of a real physical object. It contains the data sets necessary to describe and produce a physical version that duplicates the virtual one. These informational sets can include requirements, 3D model, Bill of Materials (with material characteristics), Bill of Processes, Bill of Services, and Bill of Disposal. Digital Twin Instance (DTI) is a specific corresponding physical product that a single Digital Twin remains linked to throughout the life of that physical asset. Depending on the use cases, this type of Digital Twin may contain the following information sets: 3D model with General Dimensioning and Tolerances (GD&T), a Bill of Materials, a Bill of Processes, a Service Record, and the Operational States. Digital Twin Aggregate (DTA) is the aggregation of all the DTIs. But in contrast to the DTI, the DTA may not be an independent data structure. It is usually a computing construct that has access to all Digital Twins. Digital Twin Environment (DTE) is an integrated, multi-domain application space for operating on Digital Twins for different purposes. These purposes would include:

- to get accurate information on system performance;
- to predict future states with ML models;
- to control the object remotely in real-time.

Some believe that soon Digital Doubles will be created for everything, including people. The development of medical monitoring systems may, indeed, signal the approach of the disease long before detection of any symptoms in the future. In the case of industrial facilities, Digital Duplicates make it possible to choose the most optimal operating conditions and to conduct virtual experiments that in reality may involve damaging risks. Speaking specifically about oil and gas companies, there are 10 principles for implementing Digital Twins there:

First of all, engineers should think about siting and building. The firm can mitigate the risk of rig delay caused by ecological, territorial or structural challenges well in advance with virtual planning and modeling.

Secondly, experts need to centralize corporate data sources for the entire staff (e.g. due to clouds and shared storages). This makes information available and clear to interested parties. With the help of Digital Twins, users can enter the system and find the wanted information. This will not require looking in various folders or seeking assistance from specialists.

The third principle is the condition monitoring of rig mobilization. Monitoring rig mobilization in real-time provides the firms with better forecasting of the time and money spent on additional services, e.g. services of welders, cementers, and others.

The fourth principle—a receding obstacle in a confined space on the drilling rig's way. The company can save time preparing the drilling rig with the help of a Digital Double. And it also can boost security. Technology will identify all the potential obstacles (such as buildings and constructions) before relocation.

The fifth principle is one of the most important. It is a real-time response in case of an emergency. The ability to see with the eyes of the field workers, using VR and AR, is developing at the moment. This will make the phone calls in cases of emergency the last thing. Alternatively, drilling regulators will be able to get visual information and give clear instructions in real-time. All these (training, borehole control, cement jobs, hardware repair, etc.) will lead to significant savings.

The sixth principle is, for sure, repair and maintenance. With the help of Digital Duplicates, a person can instantly get any information, including part numbers, date of the last and future update, sensor reading. The ability to track maintenance and repair significantly saves costs, connected to early equipment failure.

The seventh principle—inventory accounting. Supervisors and stakeholders upon request can conduct remote “site visits”. The 3D visualization technology creates a effect of presence and allows to consider specific production facilities and landscape features. This helps them to identify what equipment is on the site (for example, casing column and drilling bit). Such an opportunity minimizes the stoppage risk caused by oversupply or, on the contrary, short-delivery of the hardware. More than that, Digital Double allows controlling the performance of different machines, for example, tankers throughout their life cycle.

The eighth principle—anti-collision. Digital Doubles help to mitigate the risk of hazardous or administrative barriers. Experts can just virtually get in the well to see themselves all the needed data and statistics.

The ninth principle—creating a RTOC (Real-Time Operations Center). The company should reduce the stoppage time, which is caused by bad conditions of steering, with the help of more suitable drill measures. RTOC can just “appear” on the site. The efficiency of wells planning can also significantly increase due to the opportunity of mapping boreholes in advance and the connection with geology.

The tenth principle, last but not least, the company should provide special and general training. It is important to keep interest parties informed. It is also necessary to train staff on how they should act in cases of emergency. Thus, the companies can provide training practices and escape routes. Digital Twins help to save time that is needed for the orientation of the new employee. As the Digital Twin is an electronic file with mathematical formulas, companies can train staff to work on sites that even do not exist at the moment. This provides better training with lower costs and risks.

## 4 Discussion

Research agency Gartner put Digital Twin technology in the Top10 Tech Trends in 2018 [11]. Digital Twin's market value is expected to reach \$16 billion by 2024. So far, especially in Russia, Digital Doubles are of particular interest to the oil and gas and manufacturing industries, as well as to high-tech companies, aviation, and space industries. Digital Twins are mainly applied to design digital models of such constructions as offshore platforms. The situation with digital twins of wells and deposits is more complicated. At the moment, the company Saudi Aramco is the most advanced firm in the sphere of modeling. It was the first one that created a giant model of the unique Ghawar deposit in 2012 [2].

Speaking about British Petroleum, it uses Digital Twins to simulate physical objects, to test different cases before investing in the construction or modification of existing production assets [7]. In 2017, Royal Dutch Shell signed a two-year Digital Twin initiative funded by Eurostars. The goal of the initiative was to create a model of an offshore platform to provide real-time monitoring and forecasting [12]. Due to this predictive analysis based on Big Data, Machine Learning, IIoT, and Digital Twin technologies, the company can save several million dollars. The Digital Twin technology also helped to aggregate the Abu Dhabi National Oil Company oil and gas operator processing and production facilities into a single control center. The company Schneider Electric is developing a Digital Twin of the Yaysky refinery to create a virtual simulator in order to train its workers on how they should act in cases of emergency. However, so far, no oil and gas company has established a fully digital refinery.

State-owned enterprises in Russia continue to digitize. On 20 May 2019, the Ministry of Digital Development, Communications and Mass Media of the Russian Federation sent a draft of new guidelines for the development of digital transformation strategies to major public corporations [9]. This document was developed within the framework of the national program "Digital Economy" and envisages the practical implementation of the following technologies of Industry 4.0 [4]. In December 2019, Gazpromneft began creating a digital model of the Eastern section of the Orenburg oil and gas deposit [10]. The project involves major infrastructure facilities, 280 oil and gas wells from the existing and project funds. With the help of this digital field model, it is planned to forecast hydrocarbon production, optimize the gas flow, calculate the capacity of the oil-collecting system and the technological modes of well's operation.

Rosneft has already implemented such a project, launching the pilot digital exploitation of Bashneft's Ilishevsky deposit in May 2019 [13]. The project includes Digital Doubles of production facilities and processes, mobile IoT/IIoT devices, as well as an intelligent pipeline monitoring system. The original (physical) deposit was launched in 1996. The level of production has decreased since then. So, the realization of the innovative project may give Ilishevsky deposit the chance for the second life. This system is expected to increase the number of remotely operated facilities by 60% and increase the energy efficiency of mining processes by 5%.

The safe and efficient operation depends on the reliability of data. Comprehensive solution for information management, which includes detailed visualization of asset, is the main factor of creating the Digital Double. At the initial stage, double digitalization allows creating the 3D models on the basis of the original characteristics. It efficiently handles the interface between structural, mechanical and electrical disciplines. The next step is to put a reliable gateway of information that can correlate information from different data sources. Digital Doubles with its object-oriented information management capabilities validates and links information. The technology offers essential context to information. It provides real-time access to correct information, regardless of geographic location [1]. According to a recent study of McKinsey: effective use of digital technologies in the oil and gas sector can reduce operating costs by 3–5% and capital costs by 20% [6].

## 5 Conclusion

At present, in Russia, the oil and gas industry has achieved significant results in digitization and in implementation of Digital Doubles in particular. However, a lot of challenges still remain. As Digital Doubles should reflect the current performance of working assets, emerges a difficulty to update technical data at the same frequency. Documentation is often out-of-date. This time gap in characteristics between a real object and a digital one can lead to sub-optimal performance of the asset. This risks the company's security and finances. Experts often have to spend much time examining and validating information [6, 11]. This does not only affect operating costs but also risk security as no mechanism aggregating relevant technical information about the object. Decisions on the basis of inaccurate information can jeopardize the plant and the engineers working there. The Digital Twins increase an interest in both academic and industrial perspectives. Digital Double technology can have a huge impact on oil and gas companies' activity. Especially on product development and life cycle management, the use of data-generated knowledge can significantly increase the productivity. However, the new problem appears. It is not a lack of information but an information overload, as companies are generating more data than they are actually able to use. At the same time, it is crucial that decision-makers have access to the right information for the right purpose at the right time. The benefits of the industry digitalization are endless, from inventory tracking to collision avoidance to radically improved employee training programs [3]. But, first of all, the industry needs to recognize where the trend is going. So, companies will need to invest in digital tools to keep up. The second step is that original equipment manufacturers need to digitally integrate from the production stage and extend it down into the supply chain. Everyone needs to adopt these tools to stay up-to-date in the digital twin discussion.

## References

1. Dmitrievsky, A., Eremin, N.: Big geodata in the digital oil and gas ecosystem. *Energy Politics* **2**, 31–39 (2018)
2. Eremin, A., Eremin, N.: Digital twin in the oil and gas production. *Oil. Gas. Innovations* **12**(217), 14–17 (2018)
3. Eremin, N., Ivlev, A.: Petrobotics: robotic drilling systems. *Drill. Oil* **2**, 8–12 (2018)
4. Government of the Russian Federation: National Program “Digital economy of the Russian Federation» (2018). <http://government.ru/rugovclassifier/614/events/>. Accessed 29 Mar 2021
5. Grieves, M.: Origins of the digital twin concept. [https://www.researchgate.net/publication/307509727\\_Origins\\_of\\_the\\_Digital\\_Twin\\_Concept?channel=doi&linkId=57c6f44008ae9d64047e92b4&showFulltext=true](https://www.researchgate.net/publication/307509727_Origins_of_the_Digital_Twin_Concept?channel=doi&linkId=57c6f44008ae9d64047e92b4&showFulltext=true). Accessed 27 Mar 2021 (2016)
6. Grijpink, F., Katsap, N., Verre, F., Ward, R.: How tapping connectivity in oil and gas can fuel higher performance (2020). <https://www.mckinsey.com/industries/oil-and-gas/our-insights/how-tapping-connectivity-in-oil-and-gas-can-fuel-higher-performance>. Accessed 29 Mar 2021
7. Kiryukhin, M.A., Linnik, Y.N.: Digital technologies in the oil and gas complex. *University Herald* **7**, 37–40 (2019)
8. Kulkov, V.M.: The digital economy: hopes and illusions. *Econ. Philos.* **5**(113), 145–156 (2017)
9. Ministry of Digital Development, Communications and Mass Media of the Russian Federation: Digital transformation of state-owned corporations and companies with state participation (2021). <https://digital.gov.ru/ru/activity/directions/986/>. Accessed 29 Mar 2021
10. Neftegaz: Gazpromneft-Orenburg creates digital field (2019). <https://neftgaz.ru/news/tsifrovizatsiya/513068-gazpromneft-orenburg-sozdaet-tsifrovoe-mestorozhdenie/>. Accessed 29 Mar 2021
11. Panetta, C.: Gartner Top 10 strategic technology trends for 2018 (2017). <https://www.gartner.com/smarterwithgartner/gartner-top-10-strategic-technology-trends-for-2018/>. Accessed 27 Mar 2021
12. Renzi, D., Maniar, D., McNeill, S., Del Vecchio, C.: Developing a digital twin for floating production systems integrity management (2017). <https://doi.org/10.4043/28012-MS>. Accessed 27 Mar 2021
13. TAdviser: Information technologies at Rosneft (2020). [https://www.tadviser.ru/index.php/%D0%A1%D1%82%D0%B0%D1%82%D1%8C%D1%8F:%D0%98%D0%BD%D1%84%D0%BE%D1%80%D0%BC%D0%B0%D1%86%D0%B8%D0%BE%D0%BD%D0%BD%D1%8B%D0%B5\\_%D1%82%D0%B5%D1%85%D0%BD%D0%BE%D0%BB%D0%BE%D0%B3%D0%B8%D0%B8\\_%D0%B2\\_%D0%A0%D0%BE%D1%81%D0%BD%D0%B5%D1%84%D1%82%D0%B8](https://www.tadviser.ru/index.php/%D0%A1%D1%82%D0%B0%D1%82%D1%8C%D1%8F:%D0%98%D0%BD%D1%84%D0%BE%D1%80%D0%BC%D0%B0%D1%86%D0%B8%D0%BE%D0%BD%D0%BD%D1%8B%D0%B5_%D1%82%D0%B5%D1%85%D0%BD%D0%BE%D0%BB%D0%BE%D0%B3%D0%B8%D0%B8_%D0%B2_%D0%A0%D0%BE%D1%81%D0%BD%D0%B5%D1%84%D1%82%D0%B8). Accessed 29 Mar 2021
14. Wanasinghe, T.R., Gosine, R.G., James, L.A., Mann, G.K.I., De Silva, O., Warriar, P.J.: The internet of things in the oil and gas industry: a systematic review. *IEEE Internet Things J.* **7**(9), 8654–8673 (2020)
15. Zborowski, M.: Finding meaning, application for the much-discussed «Digital Twin». *J. Petrol. Technol.* **70**(06), 26–32 (2018)

# Foreign Direct Investments in Russia Under Digital Transformation Accelerated by Covid-19



N. I. Ivanova and P. A. Ivliev

**Abstract** Foreign Direct Investments (FDI) are very important for Russian economy as they provide possibilities to diversify the economic system. There was a crisis of FDI inflows for several years starting from 2014. Then 2018–2019 showed a slight growth. In general there are many problems that decrease FDI. The danger of low FDI inflows increases under COVID-19 and accelerated digitalization. This danger is linked to the structure of Russian GDP and general instability of economic growth. Few industries including mining and manufacturing play a very big role in Russian economy. The share of these industries in GDP totals 30%. It means that the decrease in these sectors will cause a crisis in other industries including construction and trade. Global FDI decrease is predicted to amount 40 and 16% for developing countries. Russia surely follows the trend. But Russian economy might be hit even worse by the pandemic. The deepest fall will take place in oil production that is part of mining. Production in Russia has already decreased by 8.5%. Perspectives for Russian FDI inflows are vague so far.

**Keywords** COVID-19 · Digitalization · FDI inflows · Foreign direct investments · Pandemic

## 1 Introduction

Nowadays Russian economic system faces a variety of problems and perspectives. There are many factors that might become drivers of its growth and factors that threaten its stability. FDI inflows play a big role in boosting growth and diversifying the national economy. FDI in Russian economy have rather a short history. There are many reasons for modern Russia to become a significant recipient of FDI. These may help the country to better its competitiveness. Within the issue of FDI in Russia

---

N. I. Ivanova (✉) · P. A. Ivliev  
Samara State University of Economics, Samara, Russia

P. A. Ivliev  
e-mail: [ivliev00@inbox.ru](mailto:ivliev00@inbox.ru)



researchers study investment climate and resources availability. Today one more factor of the economic environment has appeared. COVID-19 pandemic has hit the global economy and accelerated digitalization [4]. Russian economic system is not an exception. In the paper we analyze perspectives, problems and the FDI present state under the pandemic. The importance of FDI is based on their impact on a national economy and the global economy. There are both positive and negative effects that FDI may cause.

The positive effects:

1. FDI may become a driver for a recipient national economy. They increase the size of the capital available in the economic system.
2. New technologies and modern management models come into an economy with FDI. Foreign companies provide FDI with their experience.
3. FDI create new jobs and increase production efficiency.

Negative effects are connected with general losses of national companies that might suffer from a shrunk share on the market because of lower efficiency compared to foreign competitors. Balancing advantages and disadvantages the government can control the FDI effects to some extent. FDI are important for Russia as they give a chance to modernize the economy. Russian economy has been accumulating FDI since the 1990s with a variable intensity. The intensity depends on available resources, investment environment (both political and economic) etc. FDI remained low in the 1990s as the social and economic crisis under the reformation of the economic system was taking place. Then in the 2000s FDI were pushed up by high oil prices. Oil and gas are the key resources in Russia. The peak of FDI inflows was reached in 2008. It was about 74.7 billion US dollars. It was the year of top FDI in the whole world. So, Russian economy followed the rise of the global economy. 2008–2009 was the period of substantially decreased FDI in Russia. FDI were 36.5 billion US dollars in 2009, 43 in 2010 and up to 55 in 2011–2012. The year of 2013 showed a very good result of FDI inflows at 69.2 billion US dollars. Then FDI dropped dramatically because of the political and economic crisis under sanctions and other conditions. Rather good FDI inflows were in 2019. FDI growth started and has been slowed down by COVID-19 [7].

Governments and each national economy faced many challenges in 2020. Russia was not an exception. In this paper we analyze the current situation with FDI in Russia to find out the reasons of stagnation and to forecast FDI future in the country.

FDI inflows depend on a number of factors. These influence their size within a national economy. Analyzing them in Russia we understand that problems and advantages are complex. Retrospective analysis also proves the difficulties with FDI inflows in Russia. Sustainable FDI inflows in Russia can help to diversify and fuel the economy. However, in 2020 the factors that experts rely on have been influenced by the coronavirus. A number of COVID-19 economic consequences should be analyzed to predict the changes in FDI inflows and economic growth in general. This will let specialists create efficient instruments of mitigating the crisis. So the COVID-19 and digitalization consequences for FDI in Russia and the measures maintaining FDI inflows under the pandemic constitute the key problem stated in this paper.

Digitalization is changing the “infrastructure” of economic processes. New industries emerge. New ways to negotiate and to invest make international business more flexible. Digitalization being accelerated by COVID-19 might help to mitigate the difficulties with FDI in Russia [3].

Within our research we analyze the situation that took place before the pandemic and under it. Thus the research questions are multiple and linked to both periods. Firstly, which factors determine FDI inflows in Russia? Secondly, what are the key problems that decrease FDI? Thirdly, how did the pandemic change the situation? Also, can we foresee anything about the coronacrisis? Finally, how can governments smooth the consequences of the pandemic?

The purpose of our paper is complex. In general we analyze the current situation with FDI inflows in Russia. We try to reveal the real COVID-19 and digitalization impact. The joint effect of the coronavirus, unfavorable investment climate and other problems of Russian economy might damage the economic system and FDI inflows severely. The paper contributes to clarifying the potential dangers and possibilities of digitalization under COVID-19 for FDI in Russia. The conclusions might help to develop a program mitigating FDI inflows crisis. Thus the general purpose is to explain the decrease of FDI as this will surely help to create a set of effective instruments maintaining FDI inflows under further digitalization.

## 2 Methodology

The research methods of the paper are basic. We use general scientific methods and techniques. These include analysis, systematization and comparison. Statistical data from a variety of reliable sources have provided us with the basement for the conclusions. Descriptive statistics is as well among the key methods. Interdisciplinary methods like retrospective and logical analyses are used in the paper. They help to analyze the institutional side of the FDI issue. Each of these helps to examine the essence of FDI in Russia in detail.

## 3 Results

Both internal and external factors influence FDI intensity in Russia. There are economic, political, legal and social factors among them. Economic factors imply the structure of Russian economy, sustainability of the economic system etc. Political factors include the international image of the government, sanctions, general political stability within Russia. By legal factors we mean basis for business activity, the maturity of the legislative and judicial systems. Corruption, criminality, educational system and the quality of the labor force are grouped within social factors. Research and development potential also shapes the investment climate and favorable business environment in Russia [1, 2, 6].

Obviously FDI remained pretty high in the advanced economies like USA and Singapore and emerging markets like China for the past five-ten years. These years Russian economy was not sustainable enough because of sanctions and the volatile ruble. The US dollar grew from 32–33 rubles up to 75–78. Russian GDP increased at an average annual pace of 1, 5–2% in 2014–2019 [5].

The factor of corruption influences the climate for FDI in any country. Experts from “Transparency International” estimate the Corruption Perception Index. It ranks countries basing on the scale of public sector corruption. In 2019 Russia ranked 137th with 180 countries on the list. This research proves that corruption might scare potential investors and significantly decrease FDI inflows [8].

The 2020 share of the expenses on science in Russia’s GDP was about 1.1–1.2% for civil science [5]. That is lower compared to the advanced economies. This fact is important within our paper as science contributes to creating new industries and developing new technologies. These industries might become a basis for FDI inflows because foreign investors seek profit from new technologies. These facts make Russia an offshore-oriented economy with an unfavorable business climate that is slowing down the economic development [2].

The basic factors influence Russian FDI inflows. These are GDP and the geographical distance separating a recipient and an investor. The income per capita and foreign trade turnover in the investing country also have an effect. There is as well some dependence of Russian FDI inflows upon sanctions.

2019 showed an over 50% increase of FDI in Russia compared to 2018. Then the global economy has been slowed down under the pandemic. There was a 38% global FDI fall in the first half of 2020 compared to exactly the same previous year period and a 50% decrease compared to the 2019s half. So far about a 40% annual decrease is predicted [9].

The greatest fall of FDI has been registered for new projects especially within the sector of oil and gas. Russian economy has demonstrated a negative FDI growth of 1.2 billion US dollars. Other oil and gas dependent economies also suffer from the pandemic as there is a double blow of COVID-19 and oil prices war. Saudi Arabia has already experienced the FDI fall. The group of OPEC + forecasts that lockdown slowing down the economic growth globally will surely decrease demand for oil. So, the control of oil prices by the group becomes important. The national economy structure is surely to be analyzed to understand FDI inflows directions better. This may help to estimate the risks of FDI rises and falls. Russian GDP relies greatly on the primary sector. The sectors that constitute the GDP of the Russian Federation are as follows: retail and wholesale with a 14.5% share, manufacturing—14%, mining—13%, construction—8.4% and realty industry activities ranging from 8 to 9% [5].

The growth in construction is highly dependent on other industries like mining and manufacturing. Real estate growth is connected with, firstly, the overall situation on the market and, secondly, the level of household real incomes and savings. So, both construction and real estate depend on primary and secondary economic activities like mining and manufacturing. Any analysis of GDP structure as the basis for FDI in Russia is to consider at least mining, manufacturing and trade. Russian government

implies several mechanisms to mitigate the consequences of the pandemic. There are governmental decisions within healthcare, business and social life. These have smoothed the pandemic effects and decreased mortality.

The IT has obviously changed the global economy. Huge IT corporations continue to appear. Companies use IT to develop online-sales and increase their efficiency controlling businesses in a brand new way. Initially growth in FDI within the IT sector took place with the priority of digitally advanced companies [3].

Today there are other possibilities that IT brings. Transactions become much faster and safer. Negotiations get cheaper as they are conducted online. Online platforms for investors are being developed to help negotiating and making deals online. So there are new—digital—ways for Russia to attract investors.

## 4 Discussion

The discussion of FDI inflows in Russia is based on different views on the problem. It may be linked to sanctions and a sort of political isolation of the country. But there are deeper problems as well. The business environment in Russia remains uncertain due to ineffective legislation. This slows down progress and makes the cost of transactions rise.

The pandemic makes governments and businesses demonstrate the most effective ways to use IT-technologies and digitalize all spheres of life. IT helps to decrease the costs of transactions that accompany investments. The Russian IT-industry is at present falling behind the US and the Chinese. The major reason is that the national economy still remains primarily resource oriented. Digitalization and the IT-boom caused by the pandemic bring unprecedented possibilities to negotiate, invest and do business in a brand new way. This will surely reform the economy. The Russian government as well as all the governments round the globe is to be ready for changes. The Russian IT-ecosystem in banking and governmental services is well-developed. This proves that other sectors can be developed in a similar fashion.

## 5 Conclusion

As a result the situation with FDI is complex. The deterrents for FDI inflows in Russia have existed for a long time—since the 1990s. These deterrents include:

- controversial legislation,
- insufficient innovations,
- high risks caused by (a) corruption, (b) sanctions, (c) volatile and sluggish economic growth.

Each of them challenges potential investors. The pandemic makes the situation even more complex. The decrease of investments in the sector of oil and gas might

cause an overall slowdown of FDI inflows in Russia as the sector is the key one. The COVID-19 crisis has already hit Russian economy and its separate industries. The perspectives remain vague and hardly predictable as the data are scarce and so far unreliable.

We still have a number of limitations that do not let us make final conclusions with high level of confidence. There is lack of data on industries. We are still uncertain on the coronacrisis: how long it will last and how deep it will turn. The end of the pandemic is arguable. The risk of the third wave of the coronavirus remains. The oil crisis that has influenced the Russian ruble and the national economy might restart because of reasons other than COVID-19 like conflicts within OPEC.

More data in the long run will surely help to make much more confident conclusions on the current situation and perspectives. In a few years it will be highly possible to create an econometric model of the FDI crisis in Russia under the pandemic and the FDI prospects under the accelerated digitalization.

Russian economic system suffers from problems that stagger FDI inflows. The pandemic complicates the situation. Problems like high dependence on the fuel and energy resources are to be mitigated to smooth and avoid the negative effects of any external crisis and maintain economic growth under any conditions. Otherwise crises caused by unexpected and unpredictable reasons might shatter the economy and lead to a substantial fall of households' incomes.

## References

1. Abelianskaya, A.L., Martínez-Zarzoso, I., Prettnner, K.: 3D printing, international trade, and FDI. *Econ. Model.* **85**, 288–306 (2020)
2. Bulatov, A.: Offshore orientation of Russian Federation FDI. *Transnational Corporations* **24**(2), 71–89 (2017)
3. Casella, B., Formenti, L.: FDI in the digital economy: a shift to asset-light international footprints. *Transnational Corporations* **25**(1), 101–130 (2018)
4. Domini, G., Grazzi, M., Moschella, D., Treibich, T.: Threats and opportunities in the digital era: automation spikes and employment dynamics (2020). <https://doi.org/10.1016/j.respol.2020.104137>. Accessed 20 Mar 2021
5. Federal State Statistic Service: National accounts (2019). <https://rosstat.gov.ru/accounts?print=1>. Accessed 28 Feb 2021
6. Kam, O.-Y., Tse, C.-B.: The trend of foreign direct investment movement: did unintended nation brand of legal-families play an instrumental role? *J. Bus. Res.* **116**, 745–762 (2020)
7. The World Bank: Foreign direct investment, net inflows (BoP, current US\$)—Russian Federation (2019). <https://data.worldbank.org/indicator/BX.KLT.DINV.CD.WD?locations=RU>. Accessed 25 Feb 2021
8. Transparency International: Country data (2020). <https://www.transparency.org/en/countries/russia>. Accessed 01 Mar 2021
9. UNCTAD: Global foreign direct investment projected to plunge 40% in 2020 (2020). <https://unctad.org/news/global-foreign-direct-investment-projected-plunge-40-2020>. Accessed 01 Mar 2021

# Transformation of Tax Management in the Context of Digitalization



T. A. Kulkova, V. O. Levchenko, and A. S. Makarov

**Abstract** In this paper, we consider the trend of changes in the taxation system in modern conditions. The authors analyzed the impact of digitalization on the tax system from the perspective of tax risks. The advantages of carrying out measures on digitalization in the economy were analyzed and summarized, as well as the main problems that in one way or another affected the implementation of the taxation process in modern conditions were identified. The study identified the main directions and trends in improving the system of modern tax management in Russia are considered and the assessment of tax risks in the economy, which are somehow connected with informatization in society. The analysis of these risks was carried out and recommendations were formulated for the further development of tax management, aimed at overcoming the emerging problems.

**Keywords** Digitalization · Taxation · Tax management · Tax risks · Tax system

## 1 Introduction

Under the influence of information processes in society, many areas of economic development in the country acquire a digital format, which gives many opportunities for the development of the tax system, including. However, despite all the advantages of these processes in taxation, quite often they are accompanied by a number of tax risks. In this regard, the modern economy is undergoing a transformation of tax management and its elements [4]. The study of this area is an urgent issue because it touches on a rather important issue for the development of the modern economy,

---

T. A. Kulkova (✉)  
Samara State University of Economics, Samara, Russia

V. O. Levchenko  
Samara National Research University, Samara, Russia

A. S. Makarov  
Samara State University of Social Sciences and Education, Samara, Russia  
e-mail: [asmakarov@list.ru](mailto:asmakarov@list.ru)

related to the use of tax management methods in state regulation. Speaking about the positive features that have emerged due to trends in the digital economy, new opportunities are being created for taxpayers and the state. However, on the other hand, these same trends are the cause of new tax risks for all subjects of tax relations [1]. Tax authorities are trying to adapt to the ongoing processes by creating various electronic services for the convenience of interaction with taxpayers and using automated systems that improve the quality of tax control, but taxpayers are also looking for new ways to optimize their tax burden.

## 2 Methodology

In the course of the study, an analysis of the theoretical basis for the use of tax management tools in the modern economy was carried out, the results of which revealed the trend in the development of tax systems in the modern economy of our country. By conducting a comparative analysis, the authors identified the advantages that appear in tax management under the influence of the digitalization process. The article deals with modern practices of applying tax management for the development of the economy. In the course of studying this topic, modern approaches to identifying tax risks and methods of their elimination were identified and generalized. By Analyzing the available data obtained by the co-authors in the course of the research work, the main risks of the modern tax system can be identified, as well as measures to minimize them in the development of the country's economy were proposed. Qualitative methods such as analogies, decision trees, and court precedents were used in the risk analysis process. As a result of the work done, an assessment of the results was made, based on the results of the analysis of which a forecast of the subsequent development was made.

## 3 Results

In the course of the study of the theoretical basis within the framework of tax regulation, it was revealed that under the influence of digitalization, technologies that allow improving their development have come to the development of many economic systems of the country. In the context of the current level of economic development, the following aspects of the introduction of these technologies can be distinguished:

- improving the information support of the analysis and decision-making process for planning follow-up activities through remote access to information from a wide range of users in real time;
- creating systems for processing large amounts of data; increasing the speed of data exchange using cloud computing;
- accelerate business processes while reducing costs;

- simplification of cooperation and interaction between both enterprises and government agencies; reduction of the time frame for the development and presentation of innovative products and services on the market;
- minimization of marketing costs, as well as the cost of advertising products;
- increasing opportunities to enter the international arena;
- transparency of economic enterprises and counterparty data;
- reducing the number of intermediaries in the process and others.

However we can also note a number of problems that we had to face in various areas of the economy. Among the main problems are the following:

- lack of regulatory legal acts to regulate new objects and processes inherent in the digital economy, as well as the rights, obligations and responsibilities for violations of the subjects of the digital economy; insufficient level of digitalization of tax processes (information, administration, maintenance and control);
- ensuring the security of communication channels and collected data that constitute a tax secret, as well as the threat of their theft;
- confirmation of the facts of the transactions themselves, as well as identification of sellers and buyers when making payments through electronic payment systems and digital currency;
- difficulties arising during the recalculation of tax liabilities in the field of digital commerce and trade;
- the probability of double taxation when there are obligations to pay taxes in several countries at once, and more [5].

If we consider the current trends in the formation of tax management, then, as a rule—this is the direction of digitization of tax control and inspections of taxpayers, as well as the development of a regulatory framework for the taxation of new types of operations and objects. Analyzing these directions, you can identify a number of risk zones that can be visually represented in the form of a Table 1.

The identified tax risks that arise in the tax system as a result of the digitalization of the economy and the processes taking place in the country need to be addressed or at least minimized. This issue is not fully investigated at the present time, but it is possible to identify a number of recommendations that could reduce the possibility of the occurrence of certain selected tax risks:

- development of new requirements and approaches to the implementation of tax control, considering the specifics of the implementation of these processes with the use of information technologies;
- involvement of highly qualified specialists in the interpretation of the new tax legislation in relation to both new areas of activity and objects of taxation, as well as to new tax formats for conducting the activities of state bodies;
- comprehensive monitoring of the activities of tax authorities in order to identify problem areas and technical or intentional errors in their activities.

If we analyze the current practice of taxation, we can see that financial losses from the occurrence of tax risks can be incurred by all participants in tax relations,



**Table 1** Risks arising in tax management due to the impact of the digitalization process

| No. | Title                                 | Feature  | Note  |
|-----|---------------------------------------|--|---|
| 1   | Reputational risk                     | Risk associated with damage to the company's reputation  | Such risks may come not only from internal problems of the company, but also be based on external claims from third parties   |
| 2   | Risk of inefficiency of tax audits    | The risk associated with violations in the conduct of all types of tax audits by state regulatory authorities  | Such risks may be the result of violations in the course of violations in the process of taxation or subjectivity of information  |
| 3   | Risk of violation of tax legislation  | Risk associated with violations in the conduct of all types of tax audits by state regulatory bodies risks associated with imperfect tax legislation, especially with new types of activities and tax objects that have appeared at the time of digitalization | This type of risk is largely associated with the innovations that were achieved in the activities of economic entities during the transition to the digital economy   |
| 4   | Risks of violation of the tax process | The risk associated with improper execution of the order, errors in the planning and implementation of tax activities, low qualifications of employees, overpayments, incorrect accruals of tax benefits   | Quite often, this type of risk is associated primarily with management errors, as well as deliberate attempts to reduce the tax base from the outside or technical errors in the course of maintaining the tax base |

Source Authors based on [3]

and therefore, all categories are affected by tax risks. That is why it is so important to conduct activities to minimize and prevent tax risks.

## 4 Discussion

The topic of improving methods and approaches in tax management is quite relevant and has been studied by many modern economists, both Russian and foreign. One of the areas of study of tax management was the study of tax risks. The key point in studying the nature of risks was the ratio of risk and uncertainty. The greatest contribution to the study of this problem was made by Knight [2]. In his work "Risk, uncertainty and profit", he defined the difference between risk and uncertainty, and also sought to determine the relationship between these concepts, based on the experience of modern times. In addition, the author highlighted the adverse financial

consequences for the state. These consequences can contribute to the emergence of a number of tax risks in the economy, expressed in a numerical reduction in budget revenue due to a reduction in tax revenues. In his article, Pankov also noted that the occurrence of tax risks in practice can lead to losses for all participants in the tax process [6]. The author of the work spoke out, saying that by introducing new taxes, increasing the tax burden and making, at first glance, insignificant or even insignificant changes to the legislation, or not adjusting existing laws in a timely manner in accordance with the current situation and situation, the state risks missing tax revenues. Based on the analysis of the presented data, we can see that the topic of transformation of tax management and tax risk analysis is quite relevant and is often analyzed among modern researchers, but despite this, there are some difficulties in eliminating a number of risk zones in the tax system.

## 5 Conclusion

Thus, we can see a clear trend of informatization of taxation processes in the modern world, which bring both positive aspects in the development of the country's economic system, and a number of problems. The paper identified the main problem areas that may arise in the tax system in the context of informatization, on the basis of which the main risks of tax management were identified at the present time. The authors found that such risks are usually internal in nature, that is, the cause of its occurrence is often located inside an enterprise or a state body, but there are also those that are external in nature. In the course of the study, the main recommendations were given, if followed, it is possible to minimize the possibility of some risks in the tax system, but this list is not exhaustive and is of a recommendatory nature. This topic is quite relevant at the present time and is analyzed by many modern economists. The most profitable and preferred activity of tax management would be activities that are not aimed at preventing and preventing tax risks in the system using a risk-based approach. Such preventive measures may include, for example, the following: improving tax legislation by attracting highly qualified specialists in the tax system, identifying errors in tax processes using software, and establishing additional software for assessing the risk of taxpayers and the priority of tax control. To sum up, it is worth noting that in order to minimize tax risks, it is necessary that a tax culture is developed for individuals and legal entities: the desire to comply with regulatory legal acts and gain knowledge on the main trends in the development of tax legislation.

## References

1. Forrester, S.V., Ustinova, G.H., Kosyakova, I.V., Ronzhina, N.V., Suraeva, M.O.: Human capital in the innovative conditions. *Mathematics Education* **11**(8), 3048–3065 (2016)

2. Knight, F.H.: Risk, Uncertainty and Profit. Delo, Moscow (2003)
3. Kulikova, T.A.: Problems of identification and assessment of tax risks in the conditions of ensuring the tax security of the region. *Sci. J. Innovative Dev. Econ.* **4**(46), 342–345 (2018)
4. Nazarov, M., Mikhaleva, O., Fomin, E.: Digital economy: Russian taxation issues. In: Mantulenko, V. (ed.) Proceedings of the International Scientific Conference “Global Challenges and Prospects of the Modern Economic Development”. The European Proceedings of Social and Behavioral Sciences, vol. 57, pp. 1269–1276. European Proceedings, London (2019)
5. Nazarov, M.A., Mikhaleva, O.L., Chernousova, K.S.: Digital transformation of tax administration. In: Ashmarina, S., Vochozka, M., Mantulenko, V. (eds.) Digital Age: Chances, Challenges and Future. Lecture Notes in Networks and Systems, vol. 84, pp. 144–149. Springer, Cham (2020)
6. Panskov, V.G.: Tax risks: manifestation and possible ways of minimization. *Economy. Taxes. Right* **4**, 74–80 (2013)

# Digital Technologies in the Thermal Power Complex of the Samara Region



A. A. Larkina and A. A. Vizgalina

**Abstract** The article raises topical issues of the introduction of digital technologies at the enterprises of the heat supply and heat supply industry of the Samara region. The object of the study is the leading organization of the investigated sector of the economy represented by PJSC T Plus. The specifics of digital transformation in branches of fuel and energy complex has been studied. Topical issues of strategic purpose of digitalization of the Russian economy and its practical implementation in Samara region are considered. It is noted that the introduction of digital technologies allows to meet the basic needs of end consumers in heat, stimulates the introduction of a culture of energy saving and maintaining the direction of care towards the use of the environment.

**Keywords** Digitalization of heat supply enterprises · Digitalization of the thermal power complex · Digital technologies · Heat supply · Heat supply and heat supply plants

## 1 Introduction

The expansion of the zone of influence of digitalization on the Russian economy occurs under the influence of drivers of global competitiveness and the formation of a digital ecosystem internal to the country. The development of digital technologies in the country is carried out in stages in accordance with world trends focused on the energy transition (Energy transition). Energy transition processes are interdependent and operate in the areas of digitalization, decarbonization, decentralization and energy efficiency [1, 3]. At the level of the Samara region, the implementation of the

---

A. A. Larkina (✉)  
Samara State Technical University, Samara, Russia

A. A. Vizgalina  
Otradnensky Gas Processing Plant Joint Stock Company, Otradny, Russia

energy transition is primarily carried out through the introduction of digital technologies, the purpose of which is focused on the formation of management flexibility, expanding the range of services, reliability of systems, and greening.

The heat supply industry enjoys a special relevance of the digitalization processes of enterprises. The welfare and quality of life of residents of the Samara region directly depends on the quality of electrical and thermal energy consumed. Therefore, the process of functioning of enterprises in the heat supply and heat supply sector of the region should be accompanied by the continuous development and introduction of scientific achievements, including digital technologies [6]. Ensuring the continuity of development, building internal potential, developing a culture of orientation towards the end user and improving the conditions for the safe functioning of the production process and the services provided at heat and energy enterprises is possible through the introduction of digital technologies as part of the implementation of the national program “Digital Economy of the Russian Federation until 2024” [9, 11, 16].

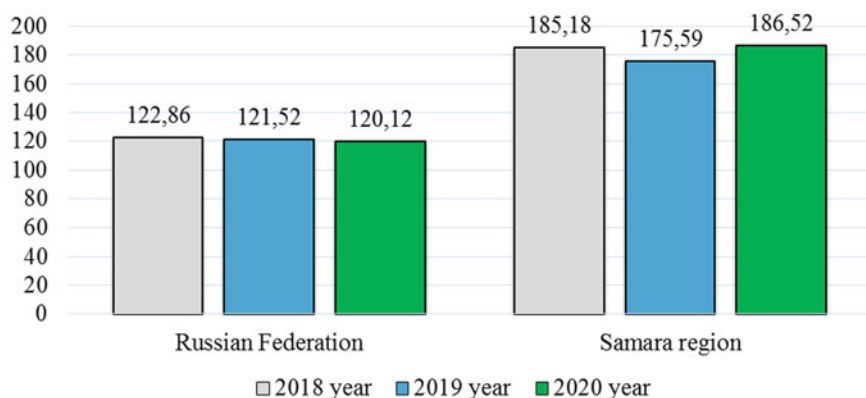
## 2 Methodology

The study used the results on the introduction of digital technologies at heat supply enterprises in Russia and the Samara region, which were accompanied by the use of analysis methods presented by abstract-logical, expert, system and rating approaches.

The theoretical and practical basis of scientific research on the current state and prospects for the development of digital technologies in the thermal energy complex was the work of world experts (Accenture, Garther), research results of the Ministry of Digital Development, Communications and Mass Telecommunications of the Russian Federation [7], the Federal State Statistics Service of Russia [5] and the Samara Region, the Agency for Strategic Initiatives, as well as the results of works of leading scholars of the country’s institutions (REU named after V. G. Plekhanova, Skolkovo, HSE, Moscow Lomonosov University).

## 3 Results

To assess the level of efficiency achieved by the enterprises of the thermal power complex made possible the formed balance of energy resources (Fig. 1). At the state level, the indicator decreases in the country from 122.86 to 120.12 kg of conventional fuel. The dynamics of the studied indicator for the Samara region is the growth character to the value of 186.52 opposite the value of 185.18 kg of conventional fuel. The negative trend in the region was developed under the influence of a high level of wear of heating lines, an increase in heat consumption objects [1–3]. The indicators for assessing the efficiency of the thermal power complex of the Samara region include the energy intensity of the formation of a unit of internal regional

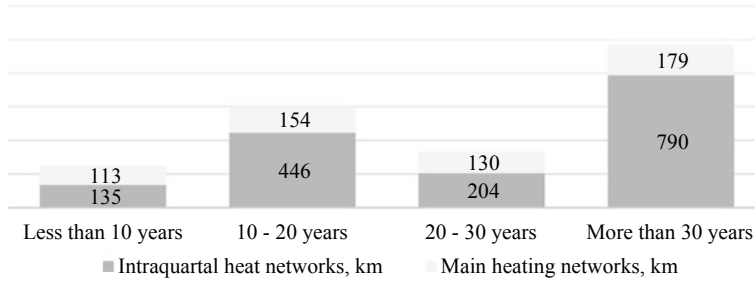


**Fig. 1** Energy intensity of GDP (GRP) for the period 2018–2020, in kg of conventional fuel/per 10 thousand rubles. *Source* Authors

product (GRP). During the period chosen for the study, a decrease in this indicator was noted as in the Samara region (Fig. 1).

When considering the category of energy intensity of an individual industry in line with the involvement of minerals (oil, coal, gas) in the formation of a unit of the final product, a conclusion was made about the positive environmental situation of the state level and regional. The formation of higher energy intensity indicators on the territory of the Samara Region at its core covers the problems of adapting the results of scientific developments to increase energy conservation and other achievements in the field of science and prescribed areas under the state program of the Russian Federation “Energy conservation and increase in energy efficiency for the period until 2030.” [16] (the plan to reduce the energy intensity of GDP and GRP is 21.00%). For the current period, the implementation of this program actually absorbed 18.8 billion rubles from the planned funding. The implementation of the state program contributed to a decrease in energy intensity in the country by 7.3% and at the level of the studied region by 5.3%.

The functioning of the heat and energy supply enterprises of the studied region takes place against the background of the pandemic of coronavirus infection, a significant decline in the level of income of the population, a high level of obtaining loans, etc. At the same time, there is an increase in per capita energy consumption by 3.2% in 2020 (relative to the data of 2019) [8, 10]. The development of the crisis scenario of the functioning of the thermal power complex is the unsatisfactory state of the fixed assets of enterprises, expressed in a high level of wear and tear and a small amount of financing. Internal factors (economic instability, high volatility of prices for heat and energy carriers, lack of financing) and external factors (pandemic of coronavirus infection, instability of the country’s credit system, global political instability) are among the key issues of the functioning of enterprises of the thermal energy complex of the Samara region that negatively affect their work and require



**Fig. 2** Age of heating networks according to technical specifications in Samara PJSC “T Plus” on 31.12.2020. *Source* Authors

solutions. The combination of these factors negatively affects the dynamics of tariffs for heat and energy.

The practice of forming tariffs in the region involves the establishment of tariffs by the state. The main regulatory body is the relevant Ministry, by order of which limit tariff grids are established [12]. In the Samara region, a single service operator represented by the Unified Heat Supply Organization (ETO)—PJSC T Plus obeys this algorithm. The company in its composition concentrated a group of companies with coverage of the territory of sixteen regions and a staff of more than fifty thousand people. Only on the market of the Samara region, PJSC T Plus manages nine sources of generation of a district heat supply system (seven power plants and two large boiler houses), which provide heat in the city of Samara to more than 950.00 thousand people.

The change in T Plus tariffs for heat and electricity is the reason for the increase in investment amounts by the group of enterprises for repair work (emergency, urgent and capital) due to the emergency state of the heating lines (Fig. 2). The negative situation with the lack of enough financial resources in the heat and energy industry was noted by the Ministry of Energy in 2018 and according to the ministry, this amount is more than 2.5 trillion rubles.

An alternative heat market model has been developed and implemented by the State as an alternative solution to the issue of replenishing the amount of financing in the heat and energy industry of the country (Chap. 5.1. FZ No. 190-FZ “On heat supply” [4]). The introduction of the presented model by a group of enterprises of PJSC T Plus in Samara acted as a starting point accurate for regulating final prices using the “alternative boiler house” method. On the territory of Samara, PJSC T Plus, the tariff according to the model of an “alternative boiler house” eliminates the single price for heat, the formation of which is transparent.

The solution of problematic issues of the functioning of PJSC “T Plus” is concentrated in the adoption in 2019 of “Strategy 2032,” in which a bet is made on the comprehensive development of heat supply to cities [14]. The implementation of Strategy 2032 activities focuses on the implementation of practically adaptable results of scientists’ developments. The dynamism and fidelity of the development

direction for PJSC “T Plus” is justified by the introduction of this digital technology framework, presented by Strategy 2032.

The basis of the digital transformation process for PJSC “T Plus” is concentrated in the formation of a convenient information platform for interaction between participants. Within the organization there is a corporate information system that accumulates operational data from all branches and departments in the head office. To work with suppliers, electronic platforms are used (ETP Fuel and Energy Complex-Torg, ETP Fuel and Energy Complex KIM, etc.), which increases the transparency of transactions and the level of competition [15]. Particular attention of PJSC “T Plus” is paid to work with end consumers, which is achieved through the introduction of the digital platform “Personal Account.” On this site, the user has access to personal data, the ability to transmit statements online, form invoices for payment and issue a number of often requested forms (calling the representative, receiving receipts, etc.). The introduction of this service by PJSC “T Plus” acts as the basis of a user-oriented energy system.

Understanding the need for the practical use of digital technologies as a tool to achieve a positive multiplier effect for the development of the T Plus group of companies is a key to improving the well-being of both end consumers and the competitiveness of enterprises. As a confirmation of this statement, the organization under consideration launches in 2018 in the Orenburg region the largest solar power station (Sorochinsky solar power station (SES “Uran”) and Novosergievskaya solar power station (SES “Neptune”)) in a single energy system, launches the first automated heat supply system in Russia in Yekaterinburg.

## 4 Discussion

Providing thermal and electrical energy to domestic needs is one of the main tasks of Russia in the framework of the country’s development strategy. In this regard, heat, power and supply enterprises are considered as an integral part of an important branch of the economy to satisfy the population’s basic needs. The smooth and sustainable functioning of heat and energy supply enterprises forms the foundation of the country’s security and population satisfaction, as well as allow achieving positive dynamics of economic growth. With increasing production capacity, energy consumption is increasing. Therefore, achieving the planned level of correct and rational use of resources by enterprises of heat and energy supply needs to introduce the achievements of digital technologies. This factor is internal to the subject of the study. In turn, the realization of an external factor, the role of which is considered the state policy of financing the country’s thermal energy complex, will contribute to maximizing the positive effect. Improving the efficiency of heat supply organizations depends to a large extent on the possibility of practical adaptation of the formed achievements of digital technologies and solving pressing issues of energy efficiency. Adapting the results of digital technologies at PJSC “T Plus” can become a catalyst for achieving the tasks set.



## 5 Conclusion

The research revealed the conservativeness of the thermal power complex of the Samara region in the implementation of digitalization results. The results of the study made it possible to establish an increase in the number of significant innovations in the development and implementation of information channels to support the end user (personal account, user support service, Internet reception, etc.) and Smart Cities projects. The formed course in state projects for the implementation of the results of achieving digital technologies are a priority task for the transformation of disparate centers of technology development and the achievement of information synergy through a single digital space of the studied complex for a long period [17]. For the future, maintaining and developing the competitiveness of the thermal energy complex of the Samara region is based on the success of adapting the results of achieving digitalization and the development of effective ecosystems [13]. This direction will allow you to reorient the industry to satisfy end users (user-oriented energy systems) in thermal and electrical energy, to increase energy efficiency. Only by following the developed strategy of adaptation and introduction of digital technologies, formation of efficient ecosystems in enterprises of the thermal power complex, determination of priority directions of development, mobilization of all sources of investment, their sustainable and qualitative development is achieved. The aggregation of these factors into a single system, the development of disruptive elements and the adjustment of the effectiveness of interaction act as a basic link for the consistent transformation of the country's economy along the path of development, including digital.

## References

1. Agency of Strategic Initiatives, Leading Institutions of the Country: University 2035: Instructions for use (2021). <https://files.2035.university/f/981bd8114a2f43598e45/>. Accessed 02 Mar 2021
2. Cenamor, J., Sjodin, D.R., Parida, V.: Adopting a platform approach in servitization: leveraging the value of digitalization. *Int. J. Prod. Econ.* **192**, 54–65 (2017)
3. European Commission: A digital single market for the benefit of all Europeans (2019). [https://ec.europa.eu/info/sites/info/files/euco-sibiu-a\\_digital\\_single\\_market.pdf](https://ec.europa.eu/info/sites/info/files/euco-sibiu-a_digital_single_market.pdf). Accessed 22 Mar 2021
4. Federal Law from 27.07.2010 N 190-FZ (ed. From 08.12.2020) “On heat supply” (with rev. and additional, appendix. in force from the 01.01.2021) (2021). [http://www.consultant.ru/document/cons\\_doc\\_LAW\\_102975/6ceacc38978cd5d26586cafb6d66bb3240070080/](http://www.consultant.ru/document/cons_doc_LAW_102975/6ceacc38978cd5d26586cafb6d66bb3240070080/). Accessed 15 Feb 2021
5. Federal State Statistics Service of the Russian Federation: Information for monitoring the socio-economic situation of the subjects of the Russian Federation (2021). <https://rosstat.gov.ru/folder/11109/document/13259>. Accessed 15 Mar 2021
6. Hasselblatt, M., Huikkola, T., Kohtamaki, M., Nickell, D.: Modeling manufacturer's capabilities for the Internet of Things. *J. Bus. Ind. Mark.* **33**(6), 822–836 (2018)

7. Ministry of Digital Development, Communications and Mass Telecommunications of the Russian Federation: Industry statistics (2021). <https://digital.gov.ru/ru/pages/statistika-otrasli/#section-686>. Accessed 12 Mar 2021
8. Ministry of Economic Development of the Russian Federation: Forecast of socio-economic development of the Russian Federation for the period up to 2036 (approved at a meeting of the Government of the Russian Federation 22.11.2018) (2021). <http://old.economy.gov.ru/minec/resources/9e711dab-fec8-4623-a3b1-33060a39859d/prognoz2036.pdf>. Accessed 12 Feb 2021
9. Ministry of Energy of the Russian Federation: Report on the implementation of Russia's energy strategy for the period up to 2030 following the results of 2018 (2021). <https://minenergo.gov.ru/view-pdf/15357/100238>. Accessed 12 Mar 2021
10. Ministry of Energy of the Russian Federation: Report on thermal power and centralized heat supply in Russia in 2014–2018 (2021). <https://minenergo.gov.ru/node/17737>. Accessed 12 Mar 2021
11. National program: Digital economy of the Russian Federation until 2024 (2021). <https://digital.ac.gov.ru/about/>. Accessed 15 Mar 2021
12. Order of the Ministry of Energy and Housing and Communal Services of the Samara Region dated 18.12.2018 No. 940: On Setting Tariffs in the Field of Heat Supply for Consumers of the Samara Branch of PJSC T Plus. [https://pravo.samregion.ru/wp-content/uploads/sites/2/2018/12/1812\\_940.pdf](https://pravo.samregion.ru/wp-content/uploads/sites/2/2018/12/1812_940.pdf). Accessed 05 Mar 2021
13. Parida, V., Sjodin, D.R., Lenka, S., Wincent, J.: Developing global service innovation capabilities: how global manufacturers address the challenges of market heterogeneity. *Res. Technol. Manag.* **58**(5), 35–44 (2015)
14. PJSC “T Plus”: Company profile (2021). [https://www.tplusgroup.ru/fileadmin/user\\_upload/presentation\\_portret\\_2.pdf](https://www.tplusgroup.ru/fileadmin/user_upload/presentation_portret_2.pdf). Accessed 21 Feb 2021
15. PJSC “T Plus”: New heat market model (2021). <https://www.tplusgroup.ru/activity/novaja-model-rynka-tepla/>. Accessed 15 Mar 2021
16. State Program of the Russian Federation Energy conservation and increase of energy efficiency for the period until 2030 (2021). <http://www.infobio.ru/sites/default/files/Energostrategiya-2030.pdf>. Accessed 09 Mar 2021
17. World Economic Forum: Digital transformation initiative oil and gas industry (2020). <https://reports.weforum.org/digital-transformation/wp-content/blogs.dir/94/mp/files/pages/files/dti-oil-and-gas-industry-white-paper.pdf>. Accessed 22 Mar 2021

# Application of Bool Variables in Analysis of Risks in the Bond Market



S. I. Makarov and M. A. Boldyrev

**Abstract** The analysis of the reliability of modeling the risk of default by Russian companies on bonds using boolean variables is carried out. When determining the type of Boolean variables, the operations of logical addition and logical multiplication were used, which makes it possible to take into account the ratio of the company's liabilities and various sources of financing the company's liabilities, such as sales proceeds, company profits, and current assets. When analyzing the applicability of complex Boolean variables, the Fisher criterion was used. A regression analysis of the effectiveness of modeling the risk of default by Russian companies on bonds has been carried out. From the whole variety of variables reflecting the financial condition of the company, we have identified those variables that can be most accurately used in the study of the risk of default by Russian companies on securities.

**Keywords** Boolean variable · Mathematical model · Risk of default · Securities

## 1 Introduction

Investing in corporate bonds is associated with the risk of non-fulfillment by the bond issuer of financial obligations [1, 2]. When assessing this risk, the models for analyzing the financial stability of the issuing company [3, 4] are used. In the work of the authors Duplyakin and Boldyrev proposed a logit-model and a probit-model for assessing the risk of non-fulfillment of the company's financial obligations on bonds, taking into account the factors of the company's financial condition in the reporting year and in the year preceding the reporting year, as well as indicators of the dynamics of the company's financial condition [5]. According to the data obtained, the use of the developed models allows us to reliably assess the high or low level of risk of default on securities obligations of 84–87% of Russian companies [5]. At

---

S. I. Makarov (✉)  
Samara State Economic University, Samara, Russia

M. A. Boldyrev  
University «MIR», Samara, Russia

the same time, the reliability of the used models of financial stability of companies [1, 3, 5–7] does not exceed 74%. The development of the theory of risk modeling is, in our opinion, the use of Boolean (logical) variables in the model. An attempt was made to use composite Boolean variables when modeling the risk of default by companies.

## 2 Methodology

Using complex Boolean variables in modeling the risk assessment will improve the reliability of the models, since the explained variable of the model is also logical. A complex Boolean variable is a boolean variable, when determining the type of which the operations of logical addition or logical multiplication are used, it is also binary (that is, it takes on the values: “1”—the company made a default on its obligations on securities, “0”—the company fulfilled its financial obligations under securities). The use of logical addition and logical multiplication in boolean variables allows one to take into account that a company can finance the performance of obligations on securities from several sources, such as revenue, profit, current assets. Below are the factors taken into account in the financial condition of companies (Table 1).

Boolean variables were developed using the factors of the financial condition of companies, which will be used in the subsequent analysis (Table 2). They reflect the dynamics of the structure of the company’s liabilities, financial results of the company, as well as the liquidity of the company’s assets.

The analysis of the applicability of the complex Boolean variables shown in Table 2 to the assessment of the risk of default on the obligations of Russian companies on bonds is carried out. A sample of 104 Russian companies that have placed bonds on the Moscow Exchange is used [4, 8]. Half of these companies fulfilled their financial obligations on securities, the other half of the companies did not. These companies will be referred to as “stable” and “unstable”, respectively. The data of the financial statements of companies for 2006–2018 were studied. The values of boolean variables characterizing the financial condition of the companies in the sample are calculated.

For each of them, hypothesis H1 is formulated about the belonging of “stable” and “unstable” companies to different general populations, i.e. it is determined whether the variable under study can be used to assess the risk of default by Russian companies in securities. The assessment of the probability of applicability of hypothesis H1 is carried out using the Fisher criterion [9, 10].

As the range of confident application of the hypothesis H1, the range of values of the Fisher test is considered [85; 100]. The ranking of boolean variables for which this condition is met is carried out according to the effectiveness of modeling the risk of default by Russian companies in securities. The method of one-way regression is used [10]. For each variable under study, a one-way regression is constructed:

$$y = b_0 + b_{1x} \quad (1)$$

**Table 1** Factors taken into account in the financial condition of companies

| No | Financial condition characteristics                          | Designation |
|----|--|-------------|
| 1  | The size of the organization's assets                        | <i>SOA</i>  |
| 2  | Fixed assets   | <i>FA</i>   |
| 3  | Fixed assets   | <i>FA</i>   |
| 4  | Current assets   | <i>CA</i>   |
| 5  | Stocks   | <i>S</i>    |
| 6  | Short-term receivables                                       | <i>SR</i>   |
| 7  | Short-term financial investments                             | <i>SFI</i>  |
| 8  | The amount of the organization's funds                       | <i>AOF</i>  |
| 9  | Receivables  | <i>R</i>    |
| 10 | Own funds  | <i>OF</i>   |
| 11 | Retained earnings  | <i>RE</i>   |
| 12 | Borrowed capital   | <i>BC</i>   |
| 13 | Long term duties   | <i>LD</i>   |
| 14 | Short-term obligations                                       | <i>SO</i>   |
| 15 | Revenue from the sale of products                            | <i>RSP</i>  |
| 16 | Cost of goods and services sold                              | <i>CGS</i>  |
| 17 | Total costs of production and sale of products               | <i>TCPS</i> |
| 18 | Percentage to be paid  | <i>PP</i>   |
| 19 | Gross profit   | <i>GP</i>   |
| 20 | Revenue from sales   | <i>RS</i>   |
| 21 | Profit before tax  | <i>PBT</i>  |
| 22 | The amount of the company's loss for the period under review | <i>ALP</i>  |
| 23 | Net profit of the company for the period under review        | <i>NPP</i>  |

Source Authors

where  $x$  is the boolean variable under study,  $y$  is a boolean explainable variable.

The standardized values of the explained variable  $y$  and the explained variable  $x$  are used. The ranking of variables is carried out in accordance with the modulus of the value of the coefficient  $b_1$  of the one-way regression. The problems of applying regression analysis in economic research are also analyzed in [11].

### 3 Results

The assessment of the probability of the applicability of boolean variables to the assessment of the risk of default by Russian companies on bonds is carried out using the method of statistical hypotheses. Boolean variables are given, characterized by

**Table 2** Complex boolean variables under study

| Variable name  | Designation        | Checked condition   |
|--|--------------------|---|
| <i>Variables that take into account indicators of the company's financial results</i>                  |                    |   |
| Boolean indicator of net profit and profit before tax  | $k_{NPP\ PBT}$     | $(NPP_t > 0) \cup (PBT_t > 0)$                            |
| Boolean indicator of profit from sales and profit before tax   | $k_{RS\ PBT}$      | $(RS_t > 0) \cup (PBT_t > 0)$                             |
| Boolean indicator of gross profit and profit before tax  | $k_{GP\ PBT}$      | $(GP_t > 0) \cup (PBT_t > 0)$                             |
| <i>Variables that take into account indicators of liabilities and financial results of the company</i> |                    |   |
| A logical indicator of the security of short-term liabilities with sales proceeds                      | $k_{RSP}^{SO}$     | $(SO_t < SO_{t-1}) \cup (RSP_t > SO_t)$                   |
| A logical indicator of the provision of short-term liabilities with profit before tax                  | $k_{PBT}^{SO}$     | $(SO_t < SO_{t-1}) \cup (PBT_t > SO_t)$                   |
| A logical indicator of the security of short-term obligations with profit from sales                   | $k_{RS}^{SO}$      | $(SO_t < SO_{t-1}) \cup (RS_t > SO_t)$                    |
| A logical indicator of the security of borrowed funds with sales proceeds                              | $k_{RSP}^{BC}$     | $(OF_t > BC_t) \cup (RSP_t > BC_t)$                       |
| Boolean indicator of financing borrowed funds with profit from sales                                   | $k_{RS}^{BC}$      | $(OF_t > BC_t) \cup ((RS_t > 0) \cap (RS_{t-1} > 0))$     |
| Boolean indicator of financing borrowed funds with profit before tax                                   | $k_{PBT}^{BC}$     | $(OF_t > BC_t) \cup (PBT_t > 0)$                          |
| A logical indicator of the security of long-term and short-term liabilities with sales proceeds        | $k_{RSP}^{LD\ SO}$ | $(OF_t > BC_t) \cup ((RSP_t > LD_t) \cap (RSP_t > SO_t))$ |
| Logical indicator of the provision of long-term and short-term liabilities with current assets         | $k_{CA}^{LD\ SO}$  | $(OF_t > BC_t) \cup ((CA_t > LD_t) \cap (CA_t > SO_t))$   |
| Logical indicator of the provision of long-term and short-term liabilities with current assets         | $k_{TCPS}^{SO}$    | $(SO_t < SO_{t-1}) \cup (TCPS_t > TCPS_{t-1})$            |

(continued)

**Table 2** (continued)

| Variable name   | Designation    | Checked condition   |
|---|----------------|---|
| A logical indicator of the dynamics of borrowed capital and net profit  | $k_{NPP\ BC}$  | $(BC_t < BC_{t-1}) \cup (NPP_t > NPP_{t-1})$  |
| <i>Variables that take into account indicators of financial results and liquidity of the company's assets</i> |                |   |
| A logical indicator of absolute liquidity and intermediate coverage of the company's liabilities              | $k_{ALIC}$     | $\left(\frac{AOF_t+SF I_t}{SO_t} > 0, 2\right) \cap \cap\left(\frac{AOF_t+SF I_t+SR_t}{SO_t} > 1\right)$  |
| A logical indicator of asset liquidity and net profit   | $k_{ALNP}$     | $k_{ALIC} \cup (NPP_t > 0)$   |
| Boolean indicator of asset liquidity and profit before tax  | $k_{ALPT}$     | $k_{ALIC} \cup (PBT_t > 0)$   |
| A logical indicator of asset liquidity and profit from sales  | $k_{ASPS}$     | $k_{ALIC} \cup (RS_t > 0)$  |
| Boolean indicator of current liquidity and profit before tax  | $k_{CLPT}$     | $\left(\frac{AOF_t+SF I_t+SR_t+S_t}{SO_t} > 1, 5\right) \cup \cup(PBT_t > 0)$   |
| Logical indicator of current liquidity and net profit   | $k_{CLNP}$     | $\left(\frac{AOF_t+SF I_t+SR_t+S_t}{SO_t} > 1, 5\right) \cup \cup(NPP_t > 0)$   |
| Logical indicator of current liquidity and asset turnover   | $k_{CLAT}$     | $\left(\frac{AOF_t+SF I_t+SR_t+S_t}{SO_t} > 1\right) \cup \cup\left(\frac{RSP_t}{SO A_t} > 1\right)$  |
| A logical indicator of the adequacy of liquid assets and asset turnover                                       | $k_{ALAT}$     | $\left(\frac{AOF_t+SF I_t+SR_t+S_t}{SO_t} > 1, 5\right) \cup \cup\left(\frac{RSP_t}{SO A_t} > 1\right)$   |
| A logical indicator of the dynamics of the current liquidity of assets and profit from sales                  | $k_{NPP\ PBT}$ | $\left(\left(\frac{AOF_t+SF I_t+SR_t+S_t}{SO_t}\right) > > \left(\frac{AOF_{t-1}+SF I_{t-1}+SR_{t-1}+S_{t-1}}{SO_t}\right)\right) \cup \cup(RS_t > RS_{t-1})$ |

Source Authors

the highest probability of applicability of the hypothesis H1 when using the Fisher criterion (Table 3).

The ranking of the studied boolean variables was carried out according to the effectiveness of modeling the risk of default by Russian companies on bonds. The variables were ranked using the one-way regression method [10]. Boolean variables characterized by the probability of fulfilling hypothesis H1 when using Fisher's test

**Table 3** Probability of applicability of boolean variables to assessing the risk of default by Russian companies on bonds

| Variable name   | Designation        | Probability of hypothesis applicability H1% |
|---|--------------------|---|
| <i>Variables that take into account indicators of the company's financial results</i>                         |                    |   |
| Boolean indicator of net profit and profit before tax   | $k_{NPP\ PBT}$     | >99.9                                       |
| Boolean indicator of profit from sales and profit before tax  | $k_{RS\ PBT}$      | 98  |
| Boolean indicator of gross profit and profit before tax   | $k_{GP\ PBT}$      | >99.9                                       |
| <i>Variables that take into account indicators of liabilities and financial results of the company</i>        |                    |   |
| A logical indicator of the security of short-term liabilities with sales proceeds                             | $k^{SO}_{RSP}$     | >99.9                                       |
| A logical indicator of the security of borrowed funds with sales proceeds                                     | $k^{BC}_{RSP}$     | >99.9                                       |
| Boolean indicator of financing borrowed funds with profit from sales  | $k^{BC}_{RS}$      | >99.9                                       |
| Boolean indicator of financing borrowed funds with profit before tax  | $k^{BC}_{PBT}$     | >99.9                                       |
| A logical indicator of the security of long-term and short-term liabilities with sales proceeds               | $k^{LD\ SO}_{RSP}$ | >99.9                                       |
| <i>Variables that take into account indicators of financial results and liquidity of the company's assets</i> |                    |   |
| A logical indicator of asset liquidity and net profit   | $k_{ALNP}$         | >99.9                                       |
| Boolean indicator of asset liquidity and profit before tax  | $k_{ALPT}$         | >99.9                                       |
| Boolean indicator of current liquidity and profit before tax  | $k_{CLPT}$         | >99.9                                       |
| Logical indicator of current liquidity and net profit   | $k_{CLNP}$         | >99.9                                       |

Source Authors

$p > 85\%$  are analyzed. Boolean variables with the largest values of the coefficient  $|b_1|$  (Table 4).



**Table 4** Ranking boolean variables based on the effectiveness of modeling default risk

| Variable name   | Designation        | Coefficient $ b_1 $ |
|---|--------------------|---------------------|
| <i>Variables that take into account indicators of the company's financial results</i>                         |                    |                     |
| Boolean indicator of net profit and profit before tax   | $k_{NPP\ PBT}$     | 0.54                |
| Boolean indicator of profit from sales and profit before tax  | $k_{RS\ PBT}$      | 0.44                |
| <i>Variables that take into account indicators of liabilities and financial results of the company</i>        |                    |                     |
| A logical indicator of the security of borrowed funds with sales proceeds                                     | $k^{BC}_{RSP}$     | 0.48                |
| Boolean indicator of financing borrowed funds with profit before tax  | $k^{BC}_{PBT}$     | 0.48                |
| A logical indicator of the security of long-term and short-term liabilities with sales proceeds               | $k^{LD\ SO}_{RSP}$ | 0.51                |
| <i>Variables that take into account indicators of financial results and liquidity of the company's assets</i> |                    |                     |
| A logical indicator of asset liquidity and net profit   | $k_{ALNP}$         | 0.42                |
| Boolean indicator of asset liquidity and profit before tax  | $k_{ALPT}$         | 0.42                |
| A logical indicator of the adequacy of liquid assets and asset turnover                                       | $k_{ALAT}$         | 0.41                |

Source Authors

## 4 Discussion

According to the results of the ranking of boolean variables according to the efficiency of assessing the risk of default by Russian companies in securities, the highest value of the coefficient  $|b_1|$  characterized by a logical indicator of net profit and profit before tax  $k_{NPP\ PBT}$ , a logical indicator of profit from sales and profit before tax  $k_{RS\ PBT}$ , a logical indicator of the security of long-term and short-term liabilities with proceeds from sales  $k^{LD\ SO}_{CA}$ , a logical indicator of the provision of borrowed funds with proceeds from sales  $k^{BC}_{RSP}$ .

The value of the logical indicator of net profit and profit before tax  $k_{NPP\ PBT}$  is calculated using the formula (2):

$$k_{NPP\ PBT} = \begin{cases} 1, & (NPP_t > 0) \cup (PBT_t > 0); \\ 0, & \text{if the condition is not met.} \end{cases} \quad (2)$$

A company can meet financial obligations under securities using profit before tax. In this case, the company's net profit is determined as the difference between profit before tax and the amount of income tax. However, the amount of the company's net profit can increase the change in deferred tax assets, that is, the difference in the amount of profit before tax according to the company's accounting and tax accounting data. Thus, the company can use the net profit to finance liabilities on securities in case of insufficient amount of profit before tax according to the financial statements or if the financial statements reflect a loss before tax.

The value of the logical indicator of profit from sales and profit before tax  $k_{RS\ PBT}$  is calculated by the formula (3):

$$k_{RS\ PBT} = \begin{cases} 1, & (RS_t > 0) \cup (PBT_t > 0); \\ 0, & \text{if the condition is not met.} \end{cases} \quad (3)$$

The amount of profit before tax can be increased by the interest receivable, i.e. the company's interest income on securities that is not taken into account in calculating profit from sales. Interest receivable can also be used to finance a company's securities liabilities [12].

The value of the logical indicator of the security of long-term and short-term liabilities with sales proceeds  $k_{RSP}^{LD\ SO}$  is calculated by the formula (4):

$$k_{RSP}^{LD\ SO} = \begin{cases} 1, & (OF_t > BC_t) \cup ((RSP_t > LD_t) \cap (RSP_t > SO_t)); \\ 0, & \text{if the condition is not met.} \end{cases} \quad (4)$$

The value of the logical indicator of the security of borrowed funds with proceeds from sales  $k_{RSP}^{BC}$  is calculated by the formula (5):

$$k_{RSP}^{BC} = \begin{cases} 1, & (OF_t > BC_t) \cup (RSP_t > BC_t) \\ 0, & \text{if the condition is not met.} \end{cases} \quad (5)$$

If the amount of borrowed funds exceeds equity, this is one of the signs of the company's financial instability [13, 14]. However, sales proceeds can be used for the company's liabilities when the amount of borrowed funds increases [12]. The company's borrowed funds are the sum of long-term liabilities and short-term liabilities. The company's short-term obligations must be fulfilled in the reporting period. If the amount of short-term liabilities exceeds sales revenue in the reporting period, then the financial stability of the company decreases.

A comparative analysis of the results of ranking the variables analyzed in this paper by the effectiveness of modeling the risk of default by Russian companies in securities and the results of ranking financial indicators obtained earlier in the construction of mathematical models of the risk of default by Russian companies in securities [5, 15].

The largest value of the coefficient  $|b_1|$  from financial indicators analyzed in the work of Boldyrev and used in the construction of the logit model and the probit model for assessing the risk of default by Russian companies in securities, the accumulated profit ratio  $k_{AP}$  ( $|b_1| = 0.50$ ) is characterized [15].

The largest value of the coefficient  $|b_1|$  of the financial indicators analyzed and used to build a logit model and a probit model for assessing the risk of default by Russian companies on securities, it is characterized by the accumulated profit ratio  $k_{AP}$  ( $|b_1| = 0.50$ ). According to the data obtained, the effectiveness of modeling the risk of default by Russian companies on bonds using the logical indicator of net profit and profit before tax  $k_{RS\ PBT}$  and the logical indicator of the security of long-term and

short-term liabilities with proceeds from sales  $k^{LD SO}_{RSP\_B}$  exceeds the effectiveness of modeling the analyzed risk using the indicators studied in the work of Boldyrev [15].

## 5 Conclusion

In this paper, we analyze the reliability of modeling the risk of default by Russian companies on bonds using complex Boolean variables. The boolean variable takes on the values “1” and “0” depending on the values of the factors of the company’s financial condition. Polynomial Boolean variables are considered and their application in risk assessment is studied. The use of complex boolean variables allows us to take into account various forms of financing the investment activities of a company. The possibility of using complex Boolean variables to assess risks in the stock market is considered. Complex Boolean variables are determined, which are characterized by the greatest efficiency in assessing the risk of default by Russian companies on securities. According to the data obtained, complex boolean variables can be used to model the risk of default by Russian companies on bonds. Statistical calculations and their analysis were performed in MS Excel and Gretl.

## References

1. Cesarone, F., Mango, F., Sabato, G.: Z-score vs minimum variance preselection methods for constructing small portfolios. *Investment Manage. Financ. Innov.* **17**(1), 64–76 (2020)
2. Singh, B.P., Mishra, A.K.: Re-estimation and comparisons of alternative accounting based bankruptcy prediction models for Indian companies. *Financ. Innov.* **2**, 6 (2016)
3. Altman, E.I.: Financial ratios, discriminant analysis and the prediction of corporate bankruptcy. *J. Financ.* **23**(4), 589–609 (1968)
4. Demirel, M., Unal, G.: Applying multivariate-fractionally integrated volatility analysis on emerging market bond portfolios. *Financ. Innov.* **6**, 50 (2020)
5. Duplyakin, V.M., Boldyrev, M.A.: Statistical assessment of the risk of default by companies on bonds on the example of PJSC “Solomensky Lesozavod.” *Appl. Math. Control Sci.* **3**, 161–179 (2019)
6. Ohlson, J.: Financial ratios and the probabilistic prediction of bankruptcy. *J. Account. Res.* **18**(1), 109–131 (1980)
7. Zmijewski, M.E.: Methodological issues related to the estimation of financial distress prediction models. *J. Account. Res.* **22**, 59–82 (1984)
8. PJSC “Moscow Exchange”: Defaults (2020). URL: <https://www.moex.com/ru/listing/emidocs.aspx?type=4>. Accessed 16 Oct 2020.
9. Kryshchanovsky, O.A.: Analysis of sociological data using the SPSS package. House of Higher School of Economic, Moscow (2007)
10. Makarov, S.I., Boldyrev, M.A.: Modeling the risk of non-fulfillment by Russian companies on bonds using boolean variables. In: Ashmarina, S.I., Mantulenko, V.V., Inozemtsev, M.I., Sidorenko, E.L. (eds.) Proceedings of the 3rd International Scientific Conference Global Challenges and Prospects of the Modern Economic Development. European Proceedings of Social and Behavioural Sciences EpSBS. European Proceedings, London (2021)

11. Makarov, S.I.: Multidimensional statistical analysis of economic indicators of organizations-developers of the samara region. In: Mantulenko, V.V. (ed.) Proceedings of the 18th International Scientific Conference—Problems of Enterprise Development: Theory and Practice. European Proceedings of Social and Behavioural Sciences, vol. 82, pp. 7–16. European Proceedings, London (2020)
12. Karminsky, A.M., Khromova, E.: Increase of banks' credit risks forecasting power by the usage of the set of alternative models. *Russ. J. Econ.* **4**(2), 155–174 (2018)
13. Abdou, H.A., Abdallah, W.M., Mulkeen, J., Collins, G.N., Wang, Y.: Prediction of financial strength ratings using machine learning and conventional techniques. *Investment Manage. Financ. Innov.* **14**(4), 194–211 (2017)
14. Barsotti, F., Sanfelici, S.: Market microstructure effects on firm default risk evaluation. *Econometrics* **4**(3), 8 (2016)
15. Boldyrev, M.A.: Analysis of the effectiveness of financial indicators in the development of models for assessing the risk of non-fulfillment of obligations of companies of Russia for securities. *Synergy Sci* **29**, 68 (2018)

# Development of the Efficiency Improvement Criterion of the Forming Logistics System



A. V. Tebekin and A. V. Khoreva

**Abstract** The article discusses the possibilities of efficiency improvement of providing services at various levels of logistics services—autonomous logistics (1PL), traditional logistics (2PL), complex logistic outsourcing (3PL), integrated logistics outsourcing (4PL), integrated logistics outsourcing, providing network business services (5PL) by optimizing logistics processes as a result of the introduction of the ultimate technologies of the digital economy, including: quantum technologies, neural network technologies, new production technologies, wireless communication technologies, big data technologies, virtual reality technologies, augmented reality technologies, as well as artificial intelligence technologies, industrial Internet technologies, distributed database technologies (blockchain), robotics technologies, sensor technologies.

**Keywords** Efficiency improvement · Introduction of digital technologies · Logistics service · Service provision

## 1 Introduction

The globalization of the world economy, based on the four freedoms of movement of goods, capital, labor and information, has radically changed the content of logistics activities as an applied direction of management [1]. Intensive development of transnational companies (TNCs), which form more than half of the world's gross product, more than 70% of world trade, about 80% of global R&D funding and more than 80% of all registered patents due to the simultaneous implementation of all major innovative changes according to J. Schumpeter (search and development new sources of raw materials, creation of new products, use of innovative technologies, creation

---

A. V. Tebekin (✉) · A. V. Khoreva  
Moscow State Institute of International Relations (University) MFA of the Russian Federation  
(MGIMO), Moscow, Russia

A. V. Khoreva  
e-mail: [khoreva\\_av@mail.ru](mailto:khoreva_av@mail.ru)

of new organizational structures and development of new sales markets), clearly demonstrated that the benefits due to the search for spatially distributed places in the world for the extraction of raw materials, production, business management, financial transactions and the sale of finished products significantly overlap the logistics costs associated with this spatial distribution.

The formation of a logistics system as a management system for the rational movement of material flows accompanied by information flows, financial flows and flows of related services in commodity-forming chains [2] which is inextricably linked with the optimization problems [3]. From the perspective of the formation of a rational logistic system, optimization problems of logistics traditionally lie in the search for a compromise between the amount of direct losses and losses from lost benefits, the amount of which should aim to a minimum [4].

Increasing the efficiency of solving optimization problems of logistics in modern conditions is facilitated by the expansion of the opportunities presented by the technologies of the digital economy [5]. At the same time, digital economy technologies, firstly, demonstrate an increase in the number of possible options for building supply chains, due to the expansion of the range of logistics parties (PL), and an enhancing the modeling [6], analysis and evaluation capabilities of these chains provided by information technologies, reflecting the interests of the seller—the party, which provides logistics services.

Secondly, digital economy technologies expand the range of opportunities for attracting additional customers. Customers use the logistical services of the emerging system, which demonstrates quality indicators for most items, especially with regard to costs [7]. Thus, it is important to find a generalized assessment of the efficiency of a digitally enabled logistics system, reflecting the simultaneous economic gain for both the provider and consumer of logistics services. The construction of a criterion for the integral assessment of the efficiency of the forming logistics system using digital technologies is the purpose of the presented study.

## 2 Methodology

When forming multi-link logistics chains, the problem of cost localization is traditionally solved, since logistics operations associated with the delivery of goods to consumers do not improve their consumer properties, but increase the cost of goods [2]. When analyzing the reduction of logistics costs in the formation of a model for assessing the efficiency of service provision in the emerging logistics system as a result of the introduction of digital technology, we will proceed from the Coase theory of transaction costs. When analyzing the growth of the economic efficiency of the forming logistics system as a result of improving their quality through the introduction of digital technologies, we will proceed from the basic approaches to quality management [8]. Also, when constructing a criterion for the integral assessment of the effectiveness of the forming logistics system using digital technologies, we will use the ideas of the theory of economic analysis and the reliability theory.

### 3 Results

From the prospective of practical use, the content of services of various levels of logistics services (1PL—5PL) has been clarified. It is shown that to optimize logistics processes in multi-link supply chains due to the opportunities provided by end-to-end technologies for the digital economy, within the framework of the balanced scorecard (BSC) technology, the following can be effectively used: methods of experiment planning theory (starting from a fractional and full factorial experiment, and ending with compositional plans of the second order), the use of which can provide a relative increase in the reliability of the synthesizing logistics system in the end of the introduction of digital technologies; a model of a value chain, the use of which can provide a relative increase in the economic effect of the synthesizing logistics system in the end of the introduction of digital technologies; the theory of costs, the application of which can provide a relative decline in costs associated with a synthesizing logistics system in the end of the introduction of digital technologies; basic approaches to quality management, the use of which can provide a relative increase in the quality of the synthesizing logistics system in the end of the introduction of digital technologies.

The formalized presentation of the proposed criterion is determined by: the considered level of logistics service, the number of potential participants in logistics processes in each link of the multi-link logistics chain, possible combinations of participants in the logistics processes of the multi-link logistics chain, ranges of changes in the parameters of logistics processes in each of the links, etc.

Assessment of efficiency improvement of the creating logistics system due to the introduction of digital technologies in the development of the corresponding criterion was carried out on the basis that, firstly, the logistics processes do not add consumer properties to the supplied product itself, in the presented model the optimization of logistics processes in multi-link supply chains is considered in terms of minimizing the total cost of funds during the physical movement of items from the primary manufacturer to the end consumer, and secondly, the increase in the efficiency of the creating logistics system is determined by the simultaneous fulfillment of seven basic rules of reliability of logistics services—providing the consumer required item: (a) in the required quantity and quality, (b) at a given time, (c) at the agreed place; (d) at the agreed price; (e) ensuring the required level of logistics services, (f) with minimal relative costs for the company (or cooperation of companies) providing logistics services.

Based on the task statement of increasing the efficiency of the logistics services provision caused by the introduction of digital technologies, an objective function of the form was proposed:

$$F_{LS} = R_{LS} \cdot E_{LS} \cdot Z_{LS} \cdot K_{LS} \rightarrow \max, \quad (1)$$

where

- $F_{LS}$  is the objective function of efficiency improvement of the synthesizing logistics system in the end of digital technologies introduction,
- $R_{LS}$  the relative reliability growth of the synthesizing logistics system in the end of the introduction of digital technologies,
- $E_{LS}$  the relative growth of the economic effect of the synthesizing logistics system in the end of the introduction of digital technologies,
- $Z_{LS}$  the relative decline in costs associated with a synthesizing logistics system in the end of the introduction of digital technologies,
- $K_{LS}$  the relative quality increase of the synthesizing logistics system in the end of the introduction of digital technologies.

The stability of the synthesizing logistic system  $R_{LS}$  in the objective function (1), in turn, is calculated as the weighted average geometric value of the products of reliability parameters:

$$R_{LS} = \sqrt[4]{(A_{LS})^\alpha \cdot (B_{LS})^\beta \cdot (C_{LS})^\gamma \cdot (D_{LS})^\varphi}, \quad (2)$$

where  $A_{LS}$ —is the indicator of the reliability of the functioning of the synthesizing logistics system, demonstrating its reliability during the active phase of the implementation of logistics operations in the chain (with the continuous implementation of logistics processes);

$B_{LS}$ —is an indicator of the functioning capabilities persistence of the synthesizing logistics system, demonstrating its reliability in the passive phase of the implementation of logistics operations in the chain (in the waiting mode of the implementation of logistics processes);

$C_{LS}$ —is an indicator of the functioning durability of the synthesizing logistics system, demonstrating its reliability in the passive phase of the implementation of logistics operations in the chain (with a discrete mode of implementation of logistics processes);

$D_{LS}$ —is an indicator of the synthesizing logistic system maintainability (recoverability), demonstrating the prompt replacement possibility of one or more links of the logistic chain out of order (if individual participants in the logistic process refuse to work in the synthesizing logistic system);

$\alpha, \beta, \gamma, \varphi$ —weight coefficients of reliability indicators of the synthesizing logistic system, respectively - $A_{LS}$ —reliability,  $B_{LS}$ —preservation,  $C_{LS}$ —durability,  $D_{LS}$ —recoverability, satisfying the standardization condition  $\alpha + \beta + \gamma + \varphi = 1$ .

The relative growth of the economic effect of the synthesizing logistics system in the end of digital technologies introduction is calculated from the ratio:

$$E_{LS} = \frac{D_{LS0} + \Delta D_{LSDT}}{D_{LS0}}, \quad (3)$$

where  $D_{LS0}$ —is the economic result (in the form of income or profit) demonstrated by the logistics system within the framework of one order before the introduction of digital technologies;



where  $\Delta D_{LSDT}$ —is the increment in the economic result (in the form of income or profit) demonstrated by the logistics system within the framework of one order in the end of the introduction of digital technologies.

The relative decline in costs associated with a synthesizing logistics system in the end of the introduction of digital technologies is calculated as:

$$Z_{LS} = \frac{Z_{LS0}}{Z_{LS0} - \Delta L_{LSDT}}, \quad (4)$$

where  $L_{LS0}$ —is the total of costs demonstrated by the logistics system within the framework of one order before the introduction of digital technologies;

where  $\Delta L_{LSDT}$ —is the cost reduction demonstrated by the logistics system within the framework of one order in the end of the introduction of digital technologies.

The relative increase in quality of the synthesizing logistics system as a result of the introduction of digital technologies is calculated from the ratio:

$$K_{LS} = \frac{Q_{LS0} + \Delta Q_{LSDT}}{Q_{LS0}}, \quad (5)$$

where  $Q_{LS0}$ —is the volume of orders falling on the logistics system per unit of time (for example, a year) before the introduction of digital technologies;

where  $\Delta Q_{LSDT}$ —is the increment in the volume of orders falling on the logistics system per unit of time (for example, a year) after the introduction of digital technologies.

It is obvious that the efficiency improvement of the forming logistics systems for the introduction of digital technologies will grow as the provision of services system at various levels of logistics services (1PL–5PL) develops.

The results of determining rational options for using end-to-end technologies of the digital economy and methods of the theory of experiment planning [9] in providing services at different levels of logistics service systems (1PL–5PL) are presented in Table 1 [10].

## 4 Discussion

The conducted studies clearly show that the digitalization of logistics is designed, firstly, to raise the consumers' satisfaction of logistics services seeking to maximize their quality in relation to price, and, secondly, to raise the satisfaction of logistics service providers seeking to maximize the ratio of income to costs. To balance the interests of producers and consumers of logistics services, the balanced scorecard can be taken into consideration. Thus, it is suggested to take into account in the end of the introduction of digital technologies: increasing the reliability of the logistics system through the use of methods of the theory of planning experiments in its formation [11]. Value chain model to increase the growth of the economic effect from the

**Table 1** Results of determining rational options for using end-to-end technologies of the digital economy and methods of experiment planning theory in logistics services at various levels of logistics service systems (1PL–5PL)

| № | The level of logistics service systems | Name of the logistics service system    | The most feasible digital technology   | The most feasible method of experiment planning theory |
|---|--|---|--|--|
| 1 | 1PL                                    | Autonomous system of logistics service  | New production technologies;<br>Robotics and Sensing Component Technologies            | Fractional factorial experiment                        |
| 2 | 2PL                                    | Traditional system of logistics service | <b>Plus:</b> Industrial Internet technologies;<br>Artificial intelligence technologies | Fractional factorial experiment                        |
| 3 | 3PL                                    | Complex logistic outsourcing            | <b>Plus:</b> Quantum technologies;<br>Wireless technologies                            | Full factorial experiment (FFE) method                 |
| 4 | 4PL                                    | Integrated logistic service system      | <b>Plus:</b> Neurotechnology;<br>Distributed ledger systems technologies               | Orthogonal central compositional plan (OCCP)           |
| 5 | 5PL                                    | Logistic service network system         | <b>Plus:</b> Big data technologies;<br>Virtual and augmented reality technologies      | Rotatable central compositional plan                   |

Source authors

operation of the synthesizing logistics system as a result of the introduction of digital technologies [12]; decrease in unit costs, including as a result of replacing a number of routine jobs with digital technologies; growth in the income of owners of systems for the provision of logistics services. The criterion for working out the level of the efficiency improvement of the forming logistics system through the introduction of digital technologies, proposed in the work, is invariant both to the scale of the logistics system and to the considered level of logistics services (1PL–5PL).

## 5 Conclusions

Thus, based on the formulation of the problem of efficiency improvement of the logistics service provision with the introduction of digital technologies, an objective function was suggested for achieving the growth of the efficiency of the synthesizing logistics system of the introduction of digital technologies (1), taking into consideration: some increasing in the reliability of the synthesizing logistics system in the end of the introduction of digital technologies (2), the relative increase in the

economic effect of the synthesizing logistics system in the end of the introduction of digital technologies (3), the relative decline in costs associated with the synthesizing logistics system in the end of the introduction of digital technologies (4), the relative increase in the quality of the synthesizing logistics system in the end of the introduction of digital technologies (5). The universality of the developed criterion for working out the level of efficiency improvement of the forming logistics system through the introduction of digital technologies is in the fact that it is applicable to systems of any considered level of logistics services (1PL–5PL).

## References

1. Tebekin, A.V.: World trends and prospects for the development of logistics as an applied science and management practice. In Ostrog, V.A., Kudryashov, N.G. (eds.) *International Logistics*, pp. 8–19. Minsk, Belorussian State University (2017)
2. Tebekin, A.V.: *Logistics*. Dashkov and Ko, Moscow (2020)
3. Wu, T., Akartunali, K., Jans, R., Liang, Z.: Progressive selection method for the coupled lot-sizing and cutting-stock problem. *Inform. J. Comput.* **29**(3), 523–543 (2017)
4. Tebekin, A.V., Mitropol'skaya-Rodionova, N.V., Khoreva, A.V.: Management decision-making methods based on mass service theory tools. *J. Manag. Res.* **6**, 34–54 (2019)
5. Lenka, S., Parida, V., Wincent, J.: Digitalization capabilities as enablers of value co-creation in servitizing firms. *Psychol. Mark.* **34**(1), 92–100 (2017)
6. Bergman, D., Cire, A.A., Van Hoes, W.-J., Hooker, J.N.: Discrete optimization with decision diagrams. *INFORMS J. Comput.* **28**(1), 47–66 (2016)
7. Hao, J., Cao, L., Jiang, D.: Integrated production-distribution scheduling problem with multiple independent manufacturers. *Math. Problems Eng.* 579893 (2015)
8. Tebekin, A.V.: Hierarchical structure of quality management technologies. *J. Techn. Res.* **5**(1), 15–25 (2019)
9. Zhao, X., Pan, R., del Castillo, E., Xie, M.: An adaptive two-stage Bayesian model averaging approach to planning and analyzing accelerated life tests under model uncertainty. *J. Qual. Technol.* **51**(2), 181–197 (2019)
10. Tebekin, A.V.: Possibilities of increasing the efficiency of providing logistic service systems (1PL–5PL) as a result of introduction of digital technologies. *Market. Logist.* **33**(1), 63–72 (2021)
11. He, Q.-M., Alfa, A.S.: Space reduction for a class of multidimensional Markov chains: a summary and some applications. *Inform. J. Comput.* **30**(1), 1–10 (2018)
12. Petit, T., Trapp, A.C.: Enriching solutions to combinatorial problems via solution engineering. *Inform. J. Comput.* **31**(3), 429–444 (2019)

# Digital Marketing Transformation: Trends and Realities



E. N. Sheremetyeva, L. A. Gorshkova, and N. V. Mitropolskaya-Rodionova

**Abstract** Digitalization affects all spheres of human activity. The digital economy is a general term used to describe digital-driven markets. The goal of digital transformation is defined as a complete change in the functioning of the digital economy system. Digitalization of marketing makes brands available to customers exactly when they need it. Marketers need to learn digital marketing tools and technologies as quickly as possible, adapting them for a particular company. Classic marketing helps to systematize all sales processes. The Internet is becoming the dominant marketing tool for companies. Internet marketing contributes to more effective promotion of goods and services, business development. Digital marketing techniques are the actions that are taken when implementing a marketing strategy to achieve goals in the Internet space.

**Keywords** Blockchain · Chat bots · Digital marketing · Digital technologies · Efficiency · Omnichannel

## 1 Introduction

Digitalization affects all spheres of human activity. The costs associated with finding, search and storing information have been significantly reduced thanks to digital technology. The role of information as a resource in economic management systems has undergone significant changes. The information field of people and enterprises is expanding in the modern conditions of the transformation of society. Together, these factors lead to the emergence of such a term as “digital economy”. The digital

---

E. N. Sheremetyeva (✉)  
Samara State University of Economics, Samara, Russia

L. A. Gorshkova  
Samara University, Samara, Russia

N. V. Mitropolskaya-Rodionova  
Moscow State Institute of International Relations (University) of the Ministry of Foreign Affairs  
of Russia, Moscow, Russia  
e-mail: [n.v.mitropolskaya-ro@mail.ru](mailto:n.v.mitropolskaya-ro@mail.ru)

economy is a general term used to describe digital-driven markets. The digital economy involves the conduct of economic activities in electronic form, based on electronic processing, storage and transmission of information, including activities that provide physical infrastructure and software. In recent years, we have intensified the process of investing in marketing technology for the purpose of data analysis. The software helps to process customer information, track performance and customer focus. The results will be more accurate, but “outsourcing” the actual tasks to the bot also frees up time in the work schedule for more important tasks. It’s automation at its best. Software like Adobe Marketing Cloud or SmartyAds helps you navigate online advertising, avoid stressful situations in real time. Finding the best ways for advertising placement takes a lot of time, which is why it is easier to offer a solution to these problems to an automated system. In this regard, the question arises: can robots completely replace human resources? Of course, they function ideally in the field of data collection according to a certain algorithm. But still, professional PPC specialists (Pay Per Click contextual advertising specialist) generate ideas, formulate advertising messages, analyze advertising campaigns, set up targeting and give recommendations for optimization.

## 2 Methodology

The main aspects of the methodology of scientific understanding is the object and subject of the study, the purpose and objectives, the principles and scientific approaches, the means and methods of research. The goal of digital transformation is defined as a complete change in the functioning of the digital economy system. The needs of society, the state, and individuals are fundamental to determining the purpose and objectives of digital transformation. It is necessary to more actively introduce digital technologies in the process of optimizing production in order to create a single digital space as soon as possible. As an object, you should define the business systems that affect the transformation of the digital space. The subject is the problem, the totality of the processes of mastering the technologies and tools of the digital economy, the formation of digital infrastructure, the interaction of users in the digital space. Digital marketing methods are techniques that promote the achievement of certain goals in the virtual space to attract new consumers, to form a customer base, to increase sales. There is access to the client’s personal data due to previously compiled survey sheets, reviews on websites. The easier it is to get an idea of the preferences of the consumer audience.

## 3 Results

Marketers who build trust (authentic engagement) and credibility (credible content) have an edge over the competition. In the numerical era, the focus of marketing is

not on impressions, but on engagement. Engagement metrics allow brands to better understand their customers and customers to better understand their favorite brands. There are various digital marketing tactics. One of these is influencer marketing tactics. Influencers are the perfect mix of informed consumers and celebrities, followed by an audience. It is necessary that customers' demand for reliable information is growing. Marketers believe that in order to attract consumers to a particular brand, it must become an authority in a particular industry. This requires a two-way dialogue between brands and customers at all stages of the consumer's journey and the product life cycle, which is based on the reliability and transparency of informative content, as well as the multi-channel nature of its distribution. Social media and influencers foster authentic interactions. Customers invest emotionally and financially in a brand with honest dialogue about real issues and the ability to provide frank feedback. Digitalisation of marketing makes brands available to customers exactly when they need it. In doing so, you should consider consistency across the various platforms of the company [7]. This marketing approach is built like a digital concierge service and is known as omnichannel. The lack of digital technology makes it difficult to find points of contact with the client. However, it is not enough just to exist digitally. Omnichannel means taking a multi-channel approach (for example, when multiple digital channels are used to showcase a brand), as well as integrating all channels to achieve complete synchronization. Omnichannel marketing leverages digital trends. Omnichannel brands use voice, video and augmented reality (AR) technologies. An example is the virtual home tours offered by real estate agents. To monitor the behavior and reactions of customers, to predict their needs, digital marketing tools are used. Without this, it is impossible to function successfully based on only assumptions about your target audience. The digital format has changed the rules of customer service. In order to retain current customers and grow a customer base, companies need to adapt to a dynamic new process [8]. Companies that have succeeded in the information age, such as the information technology market research and consulting company Gartner; American company, the largest in the world in the markets of e-commerce platforms and public cloud computing by revenue and market capitalization of Amazon; internet streaming audio (streaming) service Spotify and others are engaged in both interactive and offline multi-channel customer interactions, offering convenience and personalization options not previously available. In many cases, this makes it possible to combine digital communication channels that were previously isolated from each other [9]. Artificial Intelligence (AI) streamlines workflow, quickly becoming indispensable in virtually all digital marketing channels, especially customer service. AI can use digital software to handle automated tasks. We are talking about chat bots, programs that automate communication and customer support on a website or other platforms. In 2020, installing a chatbot on your website has become much easier than ever. It is important for business to adapt to new technologies in time in order to keep up with competitors, develop customer service and reduce costs. Today's bots are much more efficient than their predecessors: they can already remove routine tasks from employees and answer simple questions from users 24/7. There are many discussions around this issue [1]. Most researchers come to the conclusion that bots can replace humans only at the initial

stage of development, become an indispensable assistant and facilitate business. New digital marketing technologies are aimed at the loyalty of various company strategies. Trends are changing, business is growing and strengthening. Customer focus allows digital marketing to interact more fully with the target audience. We are talking about ways to improve the marketing strategy in the era of digitalization through an individual approach to consumers who are willing to contact. Companies attract customers who have access to digital information and some experience in the application of this information. The company's loyalty is achieved by attracting an audience using marketing strategies. But not all companies resort to this method. The reasons are different. Basically, this is the inability to adapt to the digital market. Before the advent of digital marketing technologies, the best way to convey information was "word of mouth". Currently, user-generated content is appearing. Influence marketing is aimed at communicating with "advanced" consumers in terms of technology. User-generated content, or UGC, is unquestionably the ultimate consumer feedback. It can be represented as a video product, corporate hashtag in Instagram or blog post. Increasing the transparency of the company's activities became the main marketing strategy in 2018, and this trend remains relevant to this day [4]. The reputation created on the Internet helps to guide consumers when studying online and business reviews. Voice search is optimized with the help of virtual assistants and smart home speakers. Currently, a large number of people start searching for the necessary products by talking, for example, with Siri or Alice. Companies need to adapt to reality and start promoting their products in this segment. Digital marketing methods are constantly growing. Marketers need to learn digital marketing tools and technologies as quickly as possible, adapting them for a particular company. Thus, we can conclude that digital marketing technologies are constantly evolving thanks to such modern marketing tools as search engine optimization, social media platforms and video resources. Without the rational use of digital marketing methods, no company can expect to succeed in today's highly competitive market [6].

## 4 Discussion

With the digital transformation of marketing in the labor market, there is a need for new staff. New professions are being mastered, such as targeting (specialist in targeted advertising), account managers, content managers, designers (specializing in visual for a social network), managers for finding bloggers and negotiations. Blogging is becoming more and more popular nowadays. Bloggers, SMM-managers seek to legalize income, the cost of their services for business is growing. It is quite difficult to have an SMM specialist on the staff of your company who can guarantee tangible results in numbers. Given the specifics of the work, motivation and a control system are needed. An increasing number of young professionals are abandoning the eight-hour workday and switching to remote work, preferring freelancing. Businesses need to adapt to new conditions and implement changes in order to remain competitive in the evolving digital economy. Classic marketing helps to systematize all sales

processes. The Internet is becoming the dominant marketing tool for companies. The target consumer's opinion is changing rapidly, although the markets are generally stagnant. It is impossible to explain demand only by old research and forecasting methods, since a new model of consumer behavior is being formed: the consumer reads other people's reviews on social networks and makes unexpected decisions. Lifecycle marketing allows you to gather information at every stage of the buyer's journey. Monitoring these stages and the transitions between them helps to identify gaps in sales marketing and make informed decisions for the development of the company. There are certain similarities and differences between lifecycle marketing and demand generation. The goal of both is to promote leads. But demand generation requires a broader and more holistic approach, and lifecycle marketing focuses on managing each stage of the lifecycle and the transitions between them. Besides lifecycle marketing, there is also personalized marketing. Over the past few years, many brands have focused on investing in marketing technologies for data analytics. For personalized work with clients, data-based monitoring of client behavior is used, while taking into account the analysis of behavioral interests, which allows you to most accurately determine the consumer's need, offer him the necessary product, in search of which he is looking, for which there is a deferred demand, etc. The consequences of COVID-19 did not lead to the emergence of digital technologies, but they accelerated the process of their implementation. The trend towards work from home and freelancing was observed long before the pandemic, but only after its occurrence, employers were forced to transfer employees to remote work. Another notable trend is that the marketing budget of most of the companies surveyed increases during the COVID period. In February 2020, companies planned to spend an average of 11.3% of their budgets on marketing. By June 2020, this figure had grown to 12.6%. For comparison: back in February 2011, this figure was only 8.1%. Some companies are suspending their activities in order to survive at the moment. They cut their costs wherever possible. Of course, most companies are not only going to reduce their activity, but also increase it. Brands that continue to advertise online have seen a drop in their cost per 1000 impressions (CPM). This led to a slightly higher return on advertising investment (ROAS) than usual. Internet marketing contributes to more effective promotion of goods and services, business development. Unlike traditional media, internet marketing provides a clear statistical picture of the effectiveness of a marketing campaign. During a pandemic, internet marketing is gaining momentum as many consumers use the online format. The introduction of quarantine measures and the transfer of many business processes to a remote mode required significant changes in management approaches. Slow digital transformation of companies is lagging behind market trends. However, a significant number of brands are fully prepared to accept new trends. The main takeaway from the impact of COVID-19 on modern marketing is that organizations that are unable to digitally transform eventually cease to function. Marketing in the digital age is about balancing personalized customer experiences and protecting their privacy. Today, a new generation of disruptive brands is changing the game in retail. These are companies that do direct e-commerce without intermediaries and independently create, sell and supply their products. For manufacturers who want to do without intermediaries, in modern



conditions it is possible to use blockchain technology [10]. It is a reliable tool for transferring and storing data. It consists of interconnected blocks connected in a chain. All units are subject to clear accounting and guarantee security and confidentiality. Blockchain will replace traditional banking operations, as it has a number of advantages: no fees for transfers, reliable data storage, efficiency, etc. [3]. 2020 digital marketing trends focus on personalization, automation, and new technologies. In this case, it is necessary to take into account the personality characteristics of the target consumer. Currently, there is a generational classification. Thus, a new group of clients appears, which includes young people born at the beginning of the twenty-first century who actively use information technologies, are active users of social networks and blogging. They are commonly referred to as Generation Z or Gen Z. In 2020, they accounted for approximately 40% of all consumers. The younger generation values authenticity, which is why excessive advertising should be avoided and transparency should be preferred. Gen Z respects personal data and privacy. They value variety in videos, images. It is difficult to surprise them with something. That is why marketing strategies should be planned with this fact in mind. The digital marketing manager becomes the indispensable sales person. He has a complete understanding of all digital channels, is responsible for conducting research to identify opportunities and developing campaigns to achieve business goals. Since digital marketing is a complex and ever-changing field, it is necessary to make an examination in order to understand these changes and their impact on business goals. In the process of competitive analysis, he will identify the strengths and weaknesses of the company, opportunities and threats from competitors. An expert will help you in choosing the most effective digital marketing channels, thereby saving money on unpromising channels. The most popular method for assessing is the economic efficiency of marketing. Communications—ROI (return on investment)—is an indicator of the return on investment or the rate of return on investment. In order to assess the ROI of marketing and advertising campaigns, it is necessary to conduct monthly monitoring of effective distribution channels. While most unprofitable channels have been identified. The company decides how to change the strategy of work or completely abandon them. If the coefficient of profitability is positive, then the activity of actions increases. So, for example, they increase the number of contextual advertising, reach, search positions, etc. If it is negative, then the activity, on the contrary, decreases, the cost of advertising decreases, and the wishes of the audience are taken into account. The assessment of the profitability indicator is influenced by the percentage of payments to managers or services, the seasonality of a product or service, geolocation and other additional factors. Marketing itself does not lend itself to clear analysis and calculation. With the development of the digital environment, various forms of Internet communications, services, and tools for measuring efficiency have appeared. Another indicator of profitability is ROMI (return of marketing investment)—a coefficient that shows the return on all marketing investments. When calculating, marketing costs are taken: advertising, packaging, rental of sites for placing banners, paper products—leaflets, business cards, booklets. In marketing, the ROAS indicator is also used in the calculation—return on advertising spend—an indicator of return on investment from one promotion channel. The

marketing department decides which site is worth developing. The payback indicator reflects the financial usefulness or unprofitableness of investments. The return on investment does not always have to be high. ROI has two drawbacks to consider: it is static; the assessment is not very informative. The indicator works only in conjunction with other data. Without them, it is very difficult to measure the project, since there are a lot of nuances that are not appreciated into account in the main formula. In international and Russian practice, there are similar problems in the analysis of the efficiency and productivity of digital technologies and usual marketing communications [5]. Digital marketing interaction are presented as the online interaction of a company with consumers through various channels of digital communication using information technology (mobile communications, marketing, digital television, advertising tools on the Internet). In the scientific literature, there are multitude approaches (mobile communications, marketing, digital television, advertising tools on the Internet). In the scientific literature, there are many approaches to assessing the effectiveness of marketing communications, which differ depending on the goal, achieved results of activity and characteristics of information users. They can be divided into two groups: qualitative and quantitative. In practice, the effectiveness of digital MC is assessed by quantitative methods, since the software allows you to track quantitative data on clicks on links, the number of visits etc. It does not always reflect the true state of affairs and requires qualitative interpretation of consumer behavior [2].

## 5 Conclusion

Thus, the main aspects of the methodology of scientific knowledge are the object and subject of research, purpose and objectives, principles and scientific approaches, means and methods of research. Digitalization of marketing makes brands available to customers exactly when they need it. In doing so, you should consider consistency across the various platforms of the company. Marketers believe that in order to attract consumers to a particular brand, it must become an authority in a particular industry. The digital economy has a significant impact on the marketing of an enterprise. Information technologies are rapidly developing and changing the traditional approaches to the marketing activities of an enterprise into new areas of activity, including e-commerce, online advertising, etc. Artificial Intelligence (AI) streamlines workflow, quickly becoming indispensable in virtually all digital marketing channels, especially customer service. There is a reduction in the costs of marketing processes: storage of goods, promotion, etc. The assortment of goods is expanding and renewing, the volume of sales is increasing. Requirements for employees of marketing departments are increasing, wages are increasing. This requires certain economic costs. There is increased productivity and intellectual potential. Digital marketing communications are defined as the online interaction of a company with an audience using various information technologies and digital communication channels. To further develop

marketing strategies, it is necessary to streamline universal and specialized information technology functions and marketing procedures into a system. The technology for determining the economic efficiency of information technologies in the marketing activities of the enterprise was revealed.

## References

1. Bukht, R., Heeks, R.: Defining conceptualizing and measuring of digital economy. *Int. Organ. Res. J.* **13**(2), 143–172 (2018). <https://doi.org/10.17323/1996-7845-2018-02-07>
2. Gnezdova, J.V.: Development of digital economy in Russia as a factor of global competitiveness increase. *Intell. Innov. Investm.* **5**, 16–19 (2017)
3. Guo, Y., Liang, C.: Blockchain application and outlook in the banking industry. *Finan. Innov.* **2**(1), 24 (2016)
4. Kannan, P.K., Li, A.: Digital marketing: a framework, review and research agenda. *Int. J. Res. Mark.* **34**(1), 22–45 (2017). <https://doi.org/10.1016/j.ijresmar.2016.11.006>
5. Kapranova, L.D.: The digital economy in Russia: its state and prospects of development. *Econom. Taxes and Law* **11**(2), 58–69 (2018). <https://doi.org/10.26794/1999-849X-2018-11-2-58-69>
6. Larionov, V.G., Sheremetyeva, E.N., Gorshkova, L.A.: Innovation management in the media space. *Bullet. South Russian State Techn. Univer. (Novocherkassk Polytechnic Institute)* **4**(13), 83–90 (2020). <https://doi.org/10.17213/2075-2067-2020-4>
7. Semenov, V.P., Budrina, E.V., Soldatov, I.K., Budrin, A.G., Soldatova, A.V., Eniushkina, E.A.: Factor analysis of the results of digital technology applications in the company's marketing activities. In: Shaposhnikov, S. (ed.) *Proceedings of the 20th IEEE International Conference on Soft Computing and Measurements, SCM*, pp. 879–883. London, IEEE (2017). <https://doi.org/10.1109/SCM.2017.7970753>
8. Sheremetyeva, E.N., Gorshkova, L.A., Mitropolskaya-Rodionova, N.V.: Management of innovative ecosystems in a digital transformation of the economy. In: Ashmarina, S.I., Horák, J., Vrbka, J., Šuleř, P. (eds.) *Economic Systems in the New Era: Stable Systems in an Unstable World. Lecture Notes in Networks and System*, vol. 160, pp. 417–423. Cham, Springer (2021). <https://doi.org/10.1007/978-3-030-60929-0>
9. Schaefer, M., Hetman, O.: Effective tools of digital marketing implementation. *Univer. Econ. Bullet.* **41**, 67–74 (2019). <https://doi.org/10.31470/2306-546X-2019-41-67-74>
10. Yang, C.-S.: Maritime shipping digitalization: Blockchain-based technology applications, future improvements, and intention to use. *Transport. Res. Part E Logist. Transport. Rev.* **13**, 108–117 (2019). <https://doi.org/10.1016/j.tre.2019.09.020>

# Digital Technologies for Planning Marketing Tools for Managing Customer Loyalty



O. V. Yudakova

**Abstract** The systematization of various types of marketing loyalty of consumers is carried out. This allows you to plan marketing tools that contribute to the management of complex customer loyalty of organizations. The use of marketing tools to manage the loyalty of the customer base allows you to turn casual and one-time customers into permanent adherents–consumers to the brand and to the company as a whole. Particularly attentive to loyalty management should be those companies that provide various types of services in the market that are difficult to standardize. The introduction of digital technologies for loyalty programs in enterprises is a really profitable, justified and justified step that contributes to increasing and stabilizing the company’s own profit.

**Keywords** Consumers · Consumer loyalty · Digital technologies · Loyalty management · Marketing planning · Marketing tools

## 1 Introduction

Currently, marketing practice is more focused not on current or short-term results, but on the formation of long-term partnerships with consumers, which are expressed in their loyalty and this is called relationship marketing. Loyalty marketing allows you to influence the consumer with various marketing tools and technologies that allow casual consumers to turn into regular users of products( services), brands (brands) or the company as a whole [3]. European and Russian marketing theorists and practitioners are increasingly trying to be focused on long-term and partnership relations with consumers, they are increasingly dealing with loyalty issues, and Reicheld and Marki have made the greatest scientific and practical contribution to this direction [6]. They connect the concepts of loyalty with the quality and value of goods and services and aim at constant purchases [6]. Therefore, consumer loyalty allows you to create an individual marketing offer and determine the sources of value of a product

---

O. V. Yudakova (✉)  
Samara State University of Economics, Samara, Russia  
e-mail: [olg-yudakova@yandex.ru](mailto:olg-yudakova@yandex.ru)

© The Author(s), under exclusive license to Springer Nature Switzerland AG 2022  
S. I. Ashmarina and V. V. Manteulenko (eds.), *Digital Technologies in the New  
Socio-Economic Reality*, Lecture Notes in Networks and Systems 304,  
[https://doi.org/10.1007/978-3-030-83175-2\\_63](https://doi.org/10.1007/978-3-030-83175-2_63)

505

or service. This area of marketing activity is more important for those sectors of the economy that require high intelligence, creativity and competencies of specialists (for example, the service sector) [5].

In addition, it should be noted that marketing loyalty events affect the activities of the organization as a whole and its image indicators, namely the range of products or services, the competence of the staff, the logo and trademark, and much more. All this will have an impact on the formation of stable sales indicators and market share of the company, as well as provide indicators of business success at the strategic level. The conclusion is that the loyalty index can be considered as one of the factors of competitive advantages of the business.

## 2 Methodology

In modern marketing practice, many author's methods are used to assess customer loyalty. They have not only a scientific, but also a practical purpose. To do this, various types of quantitative marketing research are used, which are aimed at measuring a particular loyalty factor, for example, a behavioral aspect or an attitude measurement. Based on the obtained data, loyalty indexes are built, for the calculation of which arithmetic values are determined for the average points for each aspect of loyalty. The results obtained by empirical methods allow us to identify the overall level of customer satisfaction. You can also build a mathematical model that allows you to measure and take into account the factors that form the overall level of loyalty. A mathematical model for measuring loyalty should include a certain set of factors that determine the level of loyalty. However, each customer is individual in their requirements and expectations and can form their attitude differently depending on a huge number of factors, so the model is objectively generalizing and cannot answer the question about the level of loyalty of each specific consumer. For a long time, it was believed that the loyalty of consumers is determined solely by their satisfaction. However, recent market research results have shown that customer satisfaction does not necessarily lead to repeated purchases and increased sales. In addition, half of the "satisfied" consumers change their suppliers of products and services. Therefore, there is a component between loyalty and satisfaction that affects the formation of loyalty.

Based on the above, it is necessary to implement a comprehensive approach to assessing customer loyalty based on the criteria of customer behavior and perception criteria. This will allow you to identify all types of loyalty, and even an intermediate component that affects the loyalty indicators in the future. And using digital technologies, it is possible not only to speed up the process of collecting information, but also to increase objectivity in subsequent analysis.

### 3 Results

Loyal consumers form a commitment to the brand and a steady habit of its consumption. In addition, they are not price-sensitive, refuse marketing promotions and alternative purchases. Therefore, the level of customer loyalty forms a significant competitive advantage of the company in the market, which has a long-term effect. After all, even with a slight change in the market attributes of a product or service, the number of loyal customers will increase [1]. We systematize the various types and types in the theory of loyalty in the following Table 1.

Most marketing analysts associate the level of customer loyalty with their behavior in the market and the economic results of the company. Therefore, it is important to study the transaction costs of the consumer, because they take into account behavioral factors. Transaction costs will determine only the share of the product in the total cost of purchases and do not take into account situational factors that can cause changes in stereotypical behavior.

Perceptual loyalty (perceptual loyalty)—formed only by subjective opinions and ratings based on customer ratings. Note that in practice, the relationship between this subjective opinion and actual behavior is often absent. However, perceptual loyalty provides great analytical opportunities for marketing diagnostics and forecasting. It provides high-quality answers to questions related to the demand for goods and

**Table 1** Classification and features of various types of consumer loyalty

| # | Classification attribute                  | Types of consumer loyalty  | Characteristic features  |
|---|---|----------------------------|--|
| 1 | Depending on the types of buying behavior | Behavioral (transactional) | Objective changes in consumer behavior that affect the economic result                 |
|   |   | Perceived (perceptual)     | Subjective assessments of consumers that affect consumer behavior                      |
|   |   | Comprehensive              | Index estimation of consumer behavior variables for the market, region, and industry   |
| 2 | Depending on the level of perception      | Absolute                   | High level of customer commitment with low marketing costs                             |
|   |   | Hidden                     | Commitment level that takes into account external factors of the marketing environment |
|   |   | False                      | Low level of commitment based on subjective factors                                    |
|   |   | Missing page               | A critical level of loyalty that requires switching to other marketing tools           |

services, what and how determines the consistency of purchases, and more. The main tools for collecting such information are various marketing surveys of consumers.

Complex loyalty (complex loyalty) combines perceptual loyalty and transaction costs. This allows us to create in practice not only a system of indicators for evaluating loyalty, but also to derive a loyalty index for various levels of the company's business processes. It should be noted that such a loyalty index will be linked to the time and place of the study [4]. Absolute loyalty (absolute loyalty) forms a combination where a high level of behavioral loyalty forms an equally high level of perceived loyalty. This situation is more interesting for the analyzed company, since such a group of customers can be retained without marketing incentives. It is based on it that you can optimally create quality standards.

Implicit loyalty (implicit loyalty) defines that a good level of behavioral loyalty is not related to the market behavior of customers. It is a market paradox that there are differences in this company compared to its competitors, but consumers do not buy such goods or services, or in very limited quantities. This is due to their insufficient purchasing power. The main recommendations in such cases will be related to the use of various price incentives that will positively affect the indicators of behavioral loyalty [7]. False loyalty (false loyalty) is created when behavioral loyalty matches a low perceived loyalty score. This situation creates a threat to the company, since the consumer has not formed a permanent connection with the product and the company. Most often, this is due to a limited or standard commercial offer that superficially meets the needs of the client and he has an established understanding that will switch to a suitable competitor. In this situation, the company needs to pay more attention to the indicators of perceived loyalty, which will contribute to the formation of a permanent connection and customer retention. However, if this group is not related to the strategic goals of business development, it may be more expedient and economical to abandon it in favor of competitors.

In order to properly establish a system of indicators and the relationship between different types of loyalty, it is necessary to use digital technologies that allow you to accurately diagnose the current situation for making strategic management decisions. Consider the process of planning a marketing program of consumer loyalty on the example of LLC "Leroy Merlin Vostok".

The main customers in the retail trade of Leroy Merlin Vostok LLC are:

1. Professional repairers – a segment that consists of clients who provide services for various repairs of premises. They are sensitive to the recommendations and demand of their customers and have a desire to improve their skills and use modern construction and finishing materials. Their motivation is related to making money on high-quality repairs, which subsequently contributes to the expansion of their customer base. This segment consists of both representatives of commercial firms and individuals aged 25–34 years.
2. Summer residents—this is a segment of customers, consists of owners of summer cottages, who constantly repair it on their own. This audience is represented by an older age group of consumers from 45 to 64 years old and having an average monthly income of 30 to 60 thousand rubles.

**Table 2** Satisfaction index by store, region, and company as a whole

| Satisfaction criteria      | In general | The region | Samara (Dybenko) | Ufa  |
|----------------------------|------------|------------|------------------|------|
| Product range              | 5333       | 5562       | 5107             | 6285 |
| Product availability       | 5225       | 5300       | 4989             | 5982 |
| Price                      | 5206       | 5472       | 4877             | 6089 |
| Merchandising and balizage | 4605       | 4793       | 4419             | 5023 |
| Staff work                 | 6317       | 6350       | 5999             | 6066 |
| Cash registers             | 6054       | 5844       | 5223             | 5690 |
| Comfort in the store       | 5849       | 5976       | 4911             | 6037 |

Source Author

3. Owners of cottages and private houses are a segment of clients who need to repair or arrange house territories. The main goal of this segment is to make repairs efficiently and for a long time, regardless of whether independently or with the help of professionals. The age of this segment is 35–50 years and the average monthly income is from 60 to 100 thousand rubles.
4. Owners of residential apartments—this segment consists of customers who want to make repairs in their apartment. And they need a quick and beautiful result. Such a need can be associated with different life circumstances: moving, obsolescence and comfort, the birth of a child, force majeure from neighbors, and more. The average age of this segment is from 25 to 55 years and the monthly income is from 40 to 50 thousand rubles.

The results of the marketing research of the regional consumer satisfaction index of LeruaMerlen Vostok LLC are presented in Table 2. It shows the most significant privileges that will help increase the behavioral loyalty of the company’s customers.

Thus, the most important indicators of customer loyalty of this retail chain are competent and fast work of the staff and prompt cash service. And the lowest characteristics, according to customers, have merchandising and a list of additional services. Among the regional branches, the hypermarket in Ufa has higher results.

It should also be noted that compared to its competitors, this retail chain does not use such marketing tools as club cards or loyalty cards, which can offer various bonuses to customers who own these privileges. She directs all her efforts to implement the NCCD strategy (low prices every day) and improve the standards of service in the store. This means that we can recommend this company not to stop there, but to constantly improve and expand the privileges provided, using digital applications and comprehensively increase the level of customer loyalty.



## 4 Discussion

Russian practice and the results of many marketing studies show the benefits of stimulating repeated purchases of consumers, since it is necessary to spend eight to ten times more than the marketing budget on finding new customers. The use of customer-oriented marketing technologies contributes to an increase in profit by about eleven times compared to the effectiveness of traditional advertising communications [2]. The results of European practices and studies show even more attractive figures in relation to loyalty. Thus, successful practices in the field of consumer loyalty contribute to an increase in the turnover of enterprises by 10%, a reduction in marketing budgets by 30% and an increase in profits by 25–80% [2].

Thus, the use of loyalty marketing programs is a safe business step, which contributes not only to the increase in profitability, but also to the high image results of the company's corporate brands, both in regional and global rankings. Modern practice of planning consumer loyalty programs recommends following a sequence consisting of four stages. At the first stage, it is necessary to focus on creative work that allows you to find the true privileges of the target audience of the company. At the next stage, it is necessary to conduct a small study of experts, which will determine the most important privileges for consumers. The third stage involves a larger collection of marketing information, which will show the key privileges of the target audience. And at the last stage, we make a compromise decision and plan marketing activities and a loyalty program for the upcoming period. Forming a loyalty marketing program, you can consider cooperation with external digital partners, which will increase the set of modern digital privileges for customers. And also distribute the budget and costs through multi-sponsored relationships.

## 5 Conclusion

Thus, a sufficient level of consumer loyalty allows you to form a favorable attitude and image of the company, stabilizes the dynamics of its sales and creates new competitive advantages. Therefore, it is advisable to consider the loyalty level not only as a tactical current marketing tool, but also not to forget about its long-term strategic effect. In addition, it is attractive to use digital technologies for conducting market research in this area. They will allow you to consider the loyalty index as a complex indicator and its composite criteria in dynamics and quickly make management decisions. Such solutions adjust marketing programs and plans and help attract regional customers. Loyal customers use the company's products and services and form their loyalty and repeat purchases. The seller and the manufacturer must support loyal customers with different marketing tools on an ongoing basis. After all, it is easier to lose than to keep the client.

## References

1. Dymshits, M.: Consumer loyalty. In: *Mechanisms of Repeated Purchase*. Moscow, Vershina (2017)
2. Melović, B., Jocović, M., Dabić, M., Vulić, T.B., Dudic, B.: The impact of digital transformation and digital marketing on brand promotion, positioning and e-business in Montenegro. *Technol. Soc.* **63**, 101425 (2020)
3. Mintz, O., Gilbride, T., Lenk, P., Currim, I.S.: The right metrics for making marketing decisions. *Int. J. Market. Res.* **38**(1), 32–49 (2020)
4. Oiner, O.K., Panteleeva, E.K.: Signs of a client-oriented approach to management FMCG-a company on the Russian market. *The Manager* **10**(2), 11–20 (2019)
5. Pogorelova, E., Yakhneeva, I., Agafonova, A., Prokubovskaya, A.: Marketing mix for e-commerce. *Int. J. Environ. Sci. Educ.* **11**(14), 6744–6759 (2016)
6. Reicheld, F., Marky, R.: *Sincere loyalty. The key to winning customers for life*. Moscow, Mann, Ivanov and Ferber (2018)
7. Sosunova, L.A., Astafieva, N.V., Yudakova, O.V, Petrova, N.E.: Problems of integrated logistics planning in the supply chain. In: Mantulenko, V. (ed.) *Proceedings of the 17th International Scientific Conference “Problems of Enterprise Development: Theory and Practice”*. SHS Web of Conferences, vol. 62(07001). Les Ulis, EDP Science (2019)

# Comprehensive Assessment of Enterprise's Economic Security System in the Digital Economy Conditions



S. I. Sotskova and I. V. Kalashnikova

**Abstract** The economic security of a business entity currently depends on digital technologies that provide competitive advantages to economic entities and affect all the processes of their life. The digitalization of the economy leads to a change in the content and priorities of individual components of economic security, increases the requirements for the organization of appropriate work at enterprises, and makes it necessary to carry out monitoring in order to reduce risks and threats. To assess the level of economic security, a comprehensive approach is suggested, which consists in combining a number of indicators into a single integral indicator that summarizes data on the level of sustainable development of enterprise, which allows to use it both in operational administration and in strategy. The use of private indicators that determine the effective integral indicator makes it possible to identify factors and reserves for strengthening economic security. Based on the conducted studies, the stage of development of an business entity is identified as stable, pre-crisis, crisis and critical.

**Keywords** Comprehensive assessment · Comprehensive indicator · Digital economy · Economic security · Risks

## 1 Introduction

The concept of sustainable development, which represents the dynamic balance of socio-economic and natural systems, is becoming a new paradigm for the functioning of economic entities. However, in practice, only a small group of companies (27% of the studied ones) integrates the selected sustainable development goals into specific business strategies [9]. The current situation is explained by the presence of financial problems and, as a result, the preferences of management aimed at solving current

---

S. I. Sotskova (✉)  
Samara State University of Economics, Samara, Russia

I. V. Kalashnikova  
Pacific National University, Khabarovsk, Russia

problems. The main problems faced by enterprises in modern conditions are associated with the negative impact of crises and pandemics, which leads to the loss of financial independence and threats of economic security. Therefore, in order to implement the tasks of sustainable development of the company, it is necessary to maintain a high level of economic security, which contributes to the effective operation of the company and financial independence.

The development of economic security is due to a new paradigm, namely, the use of digital technologies in modern realities. Digitalization has a significant impact on the structure and content of the economic security system, as well as on the organization of the work of the relevant service, taking into account new threats and increasing existing risks. This is reflected in the demands of new investments and innovations to ensure the company's competitiveness, the emergence of cyber attacks and problems of ensuring information security, changes in personnel policy. Therefore, new approaches are needed to assess the level of economic security and risks inherent in business, as well as the effectiveness of the relevant services.

## 2 Methodology

The functioning of the economic security system is ensured by compliance with the following requirements: efficiency—the ability to achieve goals, stability-resistance to the destruction of the organizational structure, efficiency-counteracting to achieving development goals obstacles. The above requirements should be taken into account when preparing a methodology for analyzing economic security and developing indicators and criteria. In the literature, there are different characteristics of the structure of economic security. To solve strategic and tactical management tasks, it is advisable to consider its enlarged structure, including organizational, legal, informational and economic components. The organizational side is responsible for ensuring the integrity of the structure of the enterprise and the functioning of its divisions that ensure the implementation of the main goals of the business entity.

The legal aspect reflects the compliance of the business entity's activities with the current legislation. Therefore, the damage prevented and incurred, the total costs of implementing measures to ensure legal security, etc. indicators (for example, the absence of claims from counterparties, tax authorities, and law enforcement agencies) characterize its level.

The information component reflects the level of protection of confidential internal information of the enterprise from leakage or disclosure, cyber attacks and hacks. Due to the great importance of information security works, it is possible to increase the resource and financial support of the corresponding component.

The economic side itself is the main component in the structure, since it reflects not only the economic and financial independence and sustainable development of the enterprise, but also all the components of economic security. The indicators used to evaluate the actual economic security, the component part, include sales volume,

profit, profitability, and stockholder equity. The growth of the above-mentioned indicators is due not only to the economic and financial policy of the company, but also to the achieved level of production and innovative development, the technologies used, human and intellectual potential.

We suggest to determine the level of economic security for each component for assessing the activities in this area by the ratio of the total damage prevented by the component to the costs and the total damage incurred by the corresponding component. This indicator can be used to evaluate activities of the program implementation to ensure the economic security, to stimulate and motivate employees. In modern conditions, the role of information security is undoubtedly increasing, as it is directly related to digitalization. However, it should be noted that the digitalization of the economy, due to the formation, development and use of digital products of innovation, provides competitive advantages [6] and leads to an increase in the role of the main component—the economic security itself, including financial and industrial security. The expansion of production and sales of new popular products allows enterprises to increase the level of income, profit, increase solvency and, accordingly, the overall level of economic security. The implementation of the relevant program imposes new requirements to the company's personnel, their qualifications, responsibility, and desire to work at the enterprise in compliance with corporate rules. Thus, the content of personnel security, which is part of economic security, is changing in the digital economy.

The company should constantly monitor economic security in order to reduce risks and prevent threats. Nowadays, the existing methods of analyzing the state of economic security can be grouped into the following approaches:

- indicator;
- resource-functional;
- integral;
- an approach based on the assessment of the profitability of the enterprise;
- risks-based approach;
- a threshold-based approach.

Given the complex structure of the economic security system, we consider it appropriate to use a comprehensive approach to assess it. The essence of this approach is to combine a number of indicators into a single integral indicator that summarizes data on the level of sustainable development of the enterprise, which allows it to be used both in operational management and in long-term planning.

The use of private factor indicators that determine the effective integral indicator allows to reveal factors and reserves for strengthening economic security.

To form an integral indicator, we can use the scoring method and a system of criteria and indicators. Criteria should be developed for each component of economic security, and depending on the specifics of the enterprise's activities, specific indicators can be selected. The generalized assessment of economic security characterizes the preservation of an economic entity as a whole structural entity and a legal entity. At the same time, the most important role for a business entity is played by threats of economic security, since all losses (organizational, informational, material, image)

ultimately manifest themselves directly in financial losses. Therefore, the criterion should reflect a quantitative and qualitative assessment of the level of economic security and be used in the process of operational, ongoing control and strategic planning.

### 3 Results

Quantitative and qualitative assessment of economic security is given on the basis of a system of indicators developed taking into account the specifics of the company's activities. The proposed indicators are presented in Table 1.

The economic component of security has a rather complex structure and consists of several security features: resource, technical and technological, social, combined in the production component, and financial. All of them are evaluated on the basis of both qualitative and quantitative indicators. Therefore, in general, we suggest to evaluate the above component at a maximum of 50 points. The three remaining components also account for 50 points: 10 are organizational, 30 are informational and 10 are legal.

In the modern interpretation of the digital economy definition, it is noted that it represents a radical modernization of the technological economy base, including automation and robotization of routine technological operations, which will affect labor productivity and product quality, as well as the production component of economic security. The organizational side of the economic security requires the application of advanced approaches to the management system, which provide the possibility to evaluate the effectiveness of activities throughout the entire vertical of power. Thus, the assessment of the progressiveness of the management system and its technical equipment, the qualifications of employees will allow to analyze the effectiveness of management and the impact on the main results of activity. In new conditions, the previous types of organizational structures are not effective enough, so there is a need to create new ones, examples are network structures that became a characteristic feature of the modern economy.

In the context of digitalization and the use of new financial technologies that make it possible to conduct transactions anonymously, in the absence of borders and personal presence, the risks of encountering criminals and offenses increase. Therefore, the importance of legal business support increases. Ensuring economic security from the information side, one of the most likely information leaker (when information is a trade secret) is the poor organization of accounting, storage and passing of documents containing this information. The security of digital systems requires adequate protection measures and the development of measures to localize and neutralize threats (cyber-attacks, industrial espionage, corporate data theft, personal data manipulation, virus infection of information systems, etc.), support and development of reliable products for business entities (electronic document flow, electronic digital signature, etc.). In the process of life activity of the enterprise, various stages

**Table 1** Indicators of economic security of the enterprise (economic component)

| Directions of economic security                      | Indicators   | Calculation method  | Criteria                              | Points      |
|--|--|---|---------------------------------------|-------------|
| Industrial safety                                    | Share of fixed assets in non-current assets  | Fixed assets:<br>Non-current assets   | High value                            | 5           |
|  |  |   | Low value                             | 1           |
|  | Labor productivity growth  | Average annual output per one working reporting period: Average annual output per one working basis | High value<br>Low value               | 5<br>1      |
|  | Dynamics of production volume, %   | (Commodity products of the reporting period: commodity products of the previous period-1)·100       | Less than 2.0                         | 2           |
|  |  |   | 2.1–5.0<br>5.1–10.0<br>More than 10.0 | 4<br>5<br>6 |
| Dynamics of sales revenue, %                         | (Sales revenue of the reporting period: revenue from sales of the previous period–1) 100               | Less than 2.0<br>2.1–5.0<br>5.1–10.0<br>More than 10.0  | 2<br>4<br>5<br>6                      |             |
| Financial security                                   | Liquidity in fund raising  | Inventory and costs: short-term liabilities   | Less than 0.5                         | 1           |
|  |  |   | 0.5–0.6                               | 2           |
|  |  |   | 0.6–0.7                               | 3           |
|  |  |   | More than 0,7                         | 4           |
|  | Profitability of the main activity, %  | Profit from sales: (Cost price)·100%  | 0–4% is low-margin                    | 1           |
|  |  |   | 5–20%—average-margin                  | 2           |
|  |  |   | 21–30%—high-margin                    | 3           |
| From 31%—super-margin                                |  |   | 4                                     |             |
| Property dynamics                                    | Balance sheet currency at the end of the period: Balance sheet currency at the beginning of the period | High value  | 4                                     |             |
|  |  | Low value   | 1                                     |             |
| Return on equity                                     | Net income: Equity   | High value<br>Low value   | 7<br>1                                |             |
| Financial stability ratio                            | Permanent capital: Balance sheet currency  | High value<br>Low value   | 7<br>1                                |             |
| Share of funds and its equivalents in current assets | Funds and its equivalents: Current assets  | High value  | 2                                     |             |
|  |  | Low value   | 1                                     |             |

(continued)

**Table 1** (continued)

| Directions of economic security | Indicators | Calculation method | Criteria | Points |
|---------------------------------|------------|--------------------|----------|--------|
| Total (maximum value)           |            |                    |          | 50     |

Source Authors

**Table 2** Condition assessment of the enterprise economic security

| Stages        | Characteristics  | Points       |
|---------------|--|--------------|
| 1. Stable     | Compliance with the threshold values of economic security indicators, norms and standards in terms of using the available potential  | 100–60       |
| 2. Pre-crisis | Partial non-compliance with the threshold values of economic security indicators, while maintaining the possibility of restoring economic security and improving performance                                       | 59–31        |
| 3. Crisis     | Non-compliance of most of the main indicators of economic security with the threshold values, the appearance of signs of a decline in production and a partial loss of potential as a result of resource depletion | 30–20        |
| 4. Critical   | Violation of all criteria that separate the stable state of production development, the inevitability of potential loss  | Less than 20 |

Source Authors

pass, which from the point of view of economic security can be defined as: stable, pre-crisis, crisis and critical stages (Table 2).

According to the suggested methodology, the economic security of JSC Tyazhmash was assessed and determined as stable, which corresponds to the real situation of the enterprise in 2019. In order to detail and deepen the study of economic security, it is necessary to conduct a financial, margin analysis. Various strategic analysis tools should be used in forecasting activity and economic security.

## 4 Discussion

The transition of the national economy to a market-based management system with its inherent risks created the problem of ensuring economic security. The devastating consequences of economic security non-compliance increase in times of crisis. The works of domestic and foreign scientists-economists are devoted to the problems of ensuring economic security at the enterprise [2–5, 9, 10]. Many works are also devoted to various aspects of economic security at the national level [1, 6, 7]. The issues of the relation between individual elements of the enterprise and its economic security were also studied [8]. Ensuring economic security is one of the main national priorities. No less important is the economic security of economic entities, which, on



the one hand, largely depends on national security, and, on the other hand, contributes to its maintenance. In the literature, various definitions of the concept and disclosure of the nature of economic security at the micro level, i.e., the economic entity, are given. After studying the theoretical aspects and problems of the object of research, it is possible to determine the economic security of an entity as a state of the enterprise that is resistant to the negative impact of internal and external threats, destabilizing conditions, in which the stable implementation of the main commercial interests and goals of the statutory activity is achieved. Moreover, such a state is formed as a result of a process that ensures economic security and is carried out at all stages of the life cycle of the enterprise and at all stages of its functioning, including material and technical supply, product manufacturing, implementation of various economic operations, including the transactions conclusion and the implementation of supply agreements. In the economic literature, there are various approaches to defining the structure of economic security as a system. Thus, the functional components are financial, intellectual and personnel, technical and technological, political and legal, information, environmental, and power components. The above components can be combined into four enlarged blocks: organizational, legal, information and economic security itself. This approach allows to organize work to ensure economic security at the enterprise, to monitor the level of economic security.

## 5 Conclusion

The theoretical and methodological significance of the results presented in the article is to develop a methodology for a comprehensive assessment of the level of economic security of an economic entity; criteria for assessing the economic component of economic security; analysis of the impact of the digital economy on the structure and individual components of economic security. With the help of digital technologies, it is possible to increase the efficiency of business, transparency of the business environment, leveling threats and risks while ensuring the stable development of the economic entity. A comprehensive approach involves not only evaluating the enterprise as a whole, but also evaluating the activities of the enterprise's divisions to ensure its economic security, primarily the activities of the economic security service. The use of a comprehensive approach to determine the level of economic security will allow to more objectively assess the risks and predict the state of the economic entity in terms of performing the functions specific for the enterprise, take measures to protect them from the influence of various internal and external threats.

## References

1. Badarau, C., Turcu, C.: New insights into macro-financial stability and welfare. *Econ. Model.* **81**, 441–443 (2019)

2. Bunea, O.-I., Corbos, R.-A., Popescu, R.-I.: Influence of some financial indicators on return on equity ratio in the Romanian energy sector—a competitive approach using a DuPont-based analysis. *Energy* **189**, 116251 (2019)
3. Garina, E.P., Garin, A.P., Batsyna, Ya.V., Shpilevskaya, E.V.: Ensuring the economic security of sustainable development of the machine-building enterprise. *J. Econ. Entrepreneurship and Law* **10**(1), 37–52 (2020)
4. Hieber, P., Jaccart, I., Schüller, Y.: Contrasting financial and business cycles: stylized facts and candidate explanations. *J. Financ. Stab.* **38**, 72–80 (2018)
5. Ivanova, I.K.: Digital economy and economic security. *Acad. Journal.* **4**, 102–104 (2019)
6. Kroklicheva, G.E., Arkhipov, E.L., Kazantseva, S.Y.: Business economic security management model. *Eurasian Scientif. J.* **6**(11) (2019). <https://esj.today/PDF/71ECVN619.pdf>. Accessed 24 Mar 2021
7. Laborda, J., Salas, V., Suárez, C.: Manufacturing firms' export activity: business and financial cycles overlaps! *Int. Econom.* **162**, 1–14 (2020)
8. Mogilat, A.N.: Assessment of the financial stability of Russian industrial companies, or what the bankruptcies mean. *Vopr. Ekon.* **3**, 101–118 (2019)
9. Shlikhter, A.A.: Business strategies of companies in the context of the concept of sustainable development. *World Econ. Int. Relat.* **64**(4), 37–44 (2020)
10. Yan, C., Huang, K.X.D.: Financial cycle and business cycle: an empirical analysis based on the data from the U.S. *Economic Modelling*, **93**, 693–701 (2020)

# **Intelligent Communications in the Digital Economy Aspects**

# New Marketing Aspects in the Digital Economy



A. N. Agafonova, E. N. Novikova, and R. A. Shakirov

**Abstract** Since the 1950s, information technology, and later digital technology, has been steadily entering the business environment. The evolution of databases, telecommunications, predictive analytics emerged as the economic value of information was recognized in connection with business success and new management opportunities. Today, the digital transformation of the economy is being discussed increasingly, thus, determining the need to identify the nature of these changes, new market opportunities, and constraints. The article provides an overview of technological trends, which, according to analysts of leading consulting companies, have the strongest impact on both business and marketing. The extent to which digital technologies are used in marketing is assessed, and the digital preferences and expectations of professional marketers are identified. The authors conclude that digitalization processes show a steady upward trend, covering all key marketing functions and influencing changes in consumer behavior through the acquisition of digital habits and new experiences.

**Keywords** Consumer behavior · Digitalization of the economy · ICT in marketing · Marketing

## 1 Introduction

At the end of 2020, most of the reviews and academic publications on marketing perspectives were devoted to reflecting on the effects of the COVID-19 pandemic. Threats of relapse and reflection on the changing behavior of businesses and consumers have not lost their topicality. However, the trend of digitalization, established long before that, indicates the general line of business transformation.

---

A. N. Agafonova (✉)  
Samara State University of Economics, Samara, Russia

E. N. Novikova · R. A. Shakirov  
Kazan Federal University, Kazan, Russia  
e-mail: [novelena@list.ru](mailto:novelena@list.ru)

Pandemic times have exacerbated many of the problems associated with the attitudes of CEOs (chief executive officer), operations managers, and consumers toward digital business technology, virtual communications, and financial and trade transactions. New consumer habits have been formed. The critical state has led to a reevaluation of risk factors and created new prospects for economic growth.

Digitalization is determined by the separation of information from its tangible carriers, the spread of virtual systems and their infrastructures, the development of new spaces of interaction between business partners, and new types of their relationships. Kohli notes that digitalization has influenced the increase in the speed and simplicity of creating market information, and new technologies make possible the enrichment and development of market information in its distribution [10]. Chudaeva, Mantulenko, Zhelev, Vanickova conclude that almost all processes of manufacturing enterprises are subject to digitalization [4]. With regard to marketing, the most significant are the changes in the format of the relationship with the market and the specific consumer, the work with the “digital footprint” of consumers, the actualization of the institution of reputation in connection with informational transparency [14]. Our 2016 research revealed the impact of digital technologies on the changing nature of e-business marketing mix tools [12]. Autio argues that digital technologies can be used for enhancing, improving, and enriching interactions beyond the boundaries of the enterprise, affect the prospects for internationalization of small and medium-sized businesses [3]. Alharbi notes the growth of digital marketing relationships in today’s business world [1].

The purpose of this study is to test the following hypotheses:

- digital technologies have an impact on changes in market conditions and factors in the competitiveness of companies;
- the digitalization of marketing is not a temporary and occasional phenomenon, and it covers all its functions and creates new opportunities.

## 2 Methodology

The study used methods of economic and marketing analysis, expert estimations, empirical (measurement and synthesis of research results, grouping) methods. For assessment of the prevalence of digital technology in business and its impact on changes in market conditions, we used the annual rating of CNews “IT Trends 2021” [5]. The agency applies methods of expert analysis, analysis of the frequency of mentions of relevant technologies in interviews and thematic conferences, as well as open online polls of representatives from various business sectors on the CNews.ru portal. The digital preferences of Russian B2B marketers were identified based on the FRC report “B2B communication vector 2020 study shows features of B2B communication” [7]. 156 professional marketers were respondents of the study (55% of them specialize in public relations and 45% in marketing communications). Trends

of changes in the structure of marketing budgets under the influence of digitalization of business were studied based on the GMS report “Marketing-budgets-2019–2020”, 300 marketing experts of companies and agencies participated in the survey [8]. The sources of data on changes in consumer behavior under the conditions of digitalization of markets were the PWC research “Consumer transformation” (respondent number—502) [13], Data Insight “ECommerce Market: Growth forecast 2020–2024” [6].

### 3 Results

The conducted studies reflect significant changes in market conditions and business models. ICT are no longer just infrastructural solutions. Their qualitative impact on business processes cannot be underestimated. The most significant IT-trends for business in 2021 are big data analytics (composite rating 82), cloud solutions (composite rating 79), and artificial intelligence (composite rating 69). Representatives of the industrial sector noted the prospects of the Internet of things (62%) and digital twin (54%); while in the commerce sector—Internet of things (48%) and VR&AR (46%); in the transport industry - autonomous systems (75%) [5]. Based on the analysis of the growth dynamics of digital platforms and business tools, IDC Russia & CIS determine the factors of digital business transformation: the development of platforms and ecosystems, the convergence of business processes and IT, ubiquitous access to real-time data, the conversion of data into the capital of companies [9].

Marketing is responding adequately to changes. In 2020, 27% of Russian B2B marketers aimed to strengthen the development of digital direction. The statement “Digital is the future” was supported by 86% of professional communicators. And only 6% of the respondents (exclusively Russian companies) do not see the need for digital channels in the B2B segment, preferring to focus on other communication channels. The most popular B2B digital communication channels are the company’s website, three social networks (Facebook, Instagram, and Vkontakte), and YouTube video hosting. More than half (and up to 85% in the case of websites) of experts in the field of B2B communications use these channels [7].

At least 64% of a company’s advertising budget is spent on digital marketing tactics: PPC (12%), website design and CRO (11%), growth marketing and growth hacking (11%), content marketing (9%), SMM (8%) and SEO (7%). Moreover, SMM, growth hacking, virtual events & webinars are more often used by companies with up to 100 employees, including technological startups. Conscious expectations of an increase in marketing budget lines are associated with content marketing (70% of respondents), SEO (59%), and growth marketing (59%), which is largely due to the high profitability of these strategies [8].

Mobile technology has become a significant trend in the digitalization of marketing. In 2019, the global mobile advertising market was \$190 billion. The number of downloads of shopping apps grew by 20% to 5.4 billion in 2019 [2]. App Annie analysts believe that trends in the dynamics of downloads and spending on

mobile apps on widely available app stores, such as the App Store and Google Play, are partly indicative for the corporate sector as well.

There are steady trends in the formation of new digital habits among consumers, a shift in priorities in the form of “seller-buyer” interactions and in making transactions. The trend has become more stable during the pandemic. The trend of online shopping has intensified, and consumers have become more likely to experiment with remote access to goods and services. According to the forecast by Data Insight (2020), the impact of the pandemic on the growth of online commerce in Russia will be at least 6% annually on average until 2024. Cumulative additional growth due to pandemic factors will be  $\text{₽}4.4$  trillion out of  $\text{₽}23.3$  trillion total market volume for 2020–2024. Growth factors include significant growth in the geography, capacity and audience of major e-business players [6]. The ability to provide the best customer experience, which is directly related to digitalization and the use of technology, is becoming increasingly important. Finding a balance between familiar and new digital mechanisms for selecting and purchasing products is essential. Customers highlight personalized offers that come to their smartphone when they enter a store (33%), scannable codes that track the product supply chain (32%), virtual experiences with products and services (34%), and customized production of specialized products in real-time (18%) as factors influencing their shopping-experience satisfaction [13].

Summarizing the results of studies, a wide range of opportunities for the use of digital technology in marketing can be observed. We structure the most significant digital technologies according to the implementation of marketing functions (Table 1).

All marketing functions have digital enablement options. The technologies noted in Table 2 have a complex nature. We have not duplicated them, but it is important to take this into account. Thus, Data Generation and Exchange Platforms are mentioned

**Table 1** Digital marketing to their influencing functions and technologies

| Function               | Digital technology   |
|------------------------|--|
| Analytical             | BI<br>Data generation and exchange platforms<br>Big data application<br>Predictive analytics                                     |
| Product and production | Digital twins of enterprises<br>Planning using VR&AR elements  |
| Distributional         | Omni-channel<br>Online marketplace   |
| Control and monitoring | Business process monitoring based on RFID technology<br>Digital monitoring of quality<br>AI in enterprise performance management |
| Communicational        | Intelligent communications<br>Social media<br>Chat-bots  |

Source Authors

in the analytical functionality, but their communication role is also considerable. Intelligent Communications shows high efficiency when integrated with Big Data Application. Marketing management as a whole is inherently linked to the use of quality data and intelligent predictive analytics supporting decision-making.

## 4 Discussion

We should distinguish between views on concept transformation and on changes in marketing tactics in the context of digitalization of business. If we discuss the transformation of concepts, the following question arises: how much the ideas of relationship marketing are justified today? Have the prerequisites for a new digital concept with significant substantive changes in marketing goals, objectives, and models been formed? Our previous research has shown that the nature of the marketing mix is significantly changing in the e-commerce environment [12]. To a greater extent, it is characteristic of virtual business and internet commerce. Székely, Csata, Cioca, Benedek note the relative inertia of industrial marketing in the context of the digitalization of communication and the transition to Industry 4.0 [15]. Sales staff use many digital tools, but in most cases, these tools are not coordinated, so they do not have a significant effect. Digital and conventional industrial marketing management methods and tools must be combined in a synergetic way. There is no doubt about the change of marketing tactics in the context of digitalization. Peter and Vecchia describe the constraints in the use of digital marketing tools by entrepreneurs: cultural change, limited resources/high costs, technology, and knowledge [11]. In most cases, there are positive results of their application. Small and medium-sized businesses are more flexible and open to technological innovations. However, large businesses have significantly more opportunities for implementing advanced infrastructure and system-forming digital platforms. When we talk about the digital transformation of marketing, it is important to remember that its penetration into business processes is very high, it works at every stage of the value chain. However, as a proactive element of this chain, it is marketing that becomes the trigger of new solutions and the motor of digital innovation.

## 5 Conclusion

Over the past decades, significant changes in the business environment have been driven by the proliferation of ICT platforms and ecosystems with features for the intelligent processing of large volumes of diverse data. IT trends for 2021 have been identified: big data analytics, cloud solutions, and artificial intelligence. Markets have been influenced by the increased value of information (including consumer preferences), omnichannel sales, and socially oriented digital marketing communications. Participants in e-business have strengthened their position due to growth



in technological power, the audience (especially during the COVID-19 pandemic), and geography. All key marketing functions are subject to digitalization in various degrees, which is reflected in changes in the structure of marketing budgets, the use of new models, and tactics of interaction with the clients and partners. More than half of advertising budgets are allocated to digital marketing tactics. PPC, website design and CRO, growth marketing show the best results. Digital tactics, which are radical for industrial marketing, now demonstrate high efficiency in retail. More and more consumers are committed to online (including mobile) shopping, barriers to entry into the digital environment have been overcome, but hybrid forms of traditional and digital marketing are in priority.

## References

1. Alharbi, M.: The changing dynamics of relationship marketing in the era of digitalization. In: Hoda, N.M. (ed.) *Proceedings of the 7th International Conference on Computing for Sustainable Global Development (INDIACom)*, pp. 286–291. New Jersey, IEEE (2020)
2. App Annie: The state of mobile 2020 (2020). <https://www.appannie.com/ru/go/state-of-mobile-2020/>. Accessed 01 Mar 2021
3. Autio, E.: Digitalisation, ecosystems, entrepreneurship and policy. Finland Ministry of Trade and Employment Policy Briefs, **20** (2017). [https://tietokayttoon.fi/documents/1927382/2116852/20\\_2017\\_Digitalisation%2C+ecosystems%2C+entrepreneurship+and+policy/6b383210-70de-491f-b0df-38de52699458?version=1.0](https://tietokayttoon.fi/documents/1927382/2116852/20_2017_Digitalisation%2C+ecosystems%2C+entrepreneurship+and+policy/6b383210-70de-491f-b0df-38de52699458?version=1.0). Accessed 25 Mar 2021
4. Chudaeva, A., Mantulenko, V., Zhelev, P., Vanickova, R.: Impact of digitalization on the industrial enterprises activities. In Mantulenko, V. (ed.) *Proceedings of the 17th International Scientific Conference “Problems of Enterprise Development: Theory and Practice”*. SHS Web of Conferences, vol. 62 (03003). Les Ulis, EDP Science (2019)
5. CNews: IT trends 2021 (2021). [https://www.cnews.ru/reviews/cnews\\_trendy\\_2021](https://www.cnews.ru/reviews/cnews_trendy_2021). Accessed 01 Mar 2021
6. Data Insight: ECommerce market: Growth forecast 2020–2024 (2020). [https://datainsight.ru/sites/default/files/DI\\_eCommerce2020\\_2024.pdf](https://datainsight.ru/sites/default/files/DI_eCommerce2020_2024.pdf). Accessed 14 Mar 2021
7. FRC: B2B communication vector 2020 study shows features of B2B communication (2020) <https://www.frc-pr.com/info/news/b2b-communication-vector-2020-study-shows-features-of-b2b-communication>. Accessed 15 Feb 2021
8. GMS: Marketing-budgets-2019–2020 (2021). <https://growthmarketingstage.com/marketing-budgets-2019-2020-report>. Accessed 14 Feb 2021
9. IDC: Worldwide big data and analytics spending guide (2020). [https://www.idc.com/getdoc.jsp?containerId=IDC\\_P33195](https://www.idc.com/getdoc.jsp?containerId=IDC_P33195). Accessed 01 Mar 2021
10. Kohli, A.K.: Market orientation in a digital world. *Glob. Bus. Rev.* **18**(3), 203–205 (2017). <https://doi.org/10.1177/0972150917700769>
11. Peter, M.K., Vecchia, M.D.: The digital marketing toolkit: a literature review for the identification of digital marketing channels and platforms. In: Dornberger, R. (ed.) *New Trends in Business Information Systems and Technology*. Studies in Systems, Decision and Control, vol. **294**, pp. 251–265. Cham, Springer (2021)
12. Pogorelova, E., Yakhneeva, I., Agafonova, A., Prokubovskaya, A.: Marketing mix for e-commerce. *Int. J. Environ. Sci. Educ.* **11**(14), 6744–6759 (2016)
13. PWC: Consumer transformation (2020) <https://www.pwc.ru/ru/retail-consumer/publications/assets/pwc-global-customer-insights-survey-2020-russia-ru.pdf>. Accessed 14 Feb 2021
14. Semenovskaya, E.: The new era of business intelligence: trends market and solution development (2018). [https://www.fsight.ru/wp-content/uploads/2018/05/3\\_%20%D0%95%D0%](https://www.fsight.ru/wp-content/uploads/2018/05/3_%20%D0%95%D0%)

[BB%D0%B5%D0%BD%D0%B0%20%D0%A1%D0%B5%D0%BC%D0%B5%D0%BD%D0%BE%D0%B2%D1%81%D0%BA%D0%B0%D1%8F\\_IDC\\_%D0%9D%D0%BE%D0%B2%D0%B0%D1%8F%20%D1%8D%D1%80%D0%B0%20%D0%B1%D0%B8%D0%B7%D0%BD%D0%B5%D1%81-%D0%B0%D0%BD%D0%B0%D0%BB%D0%B8%D1%82%D0%B8%D0%BA%D0%B8.pdf](#). Accessed 01 March 2021

15. Székely, S., Csata, Z., Cioca, L.-I., Benedek, A.: Industrial marketing 4.0—upgrading the industrial costumers’ path to the digital economy. *Polish J. Manage. Stud.* **22**, 535–548 (2020)

# Development of Industrial Network Organization by Digitalizing Inter-Functional Interaction of Multi-team Members



E. V. Volkodavova and A. P. Zhabin

**Abstract** The success of any business depends on the ability of team members to work together as a team. The study presents the analysis of conditions of a multi-team development in a large network industrial company, whose branches are in many regions of the country. To do this, the authors analyzed the sequence of the ongoing processes: structuring of the multi-team, the digitalized interaction of the multi-team subjects, the assessment of the organization through digitalization of the multi-team activities. As a result, the development of the multi-team was assessed, opportunities and tools are formulated to increase the efficiency of inter-functional interaction of its members through digitalization. The authors present research methods that make it possible to identify inconsistencies in the work of individual members of a multi-team and eliminate its negative results. A system of indicators has been developed to assess the impact of multi-team work on performance indicators of an industrial network organization. Analysis of the developed system of indicators will allow network organizations to identify problems of inter-functional interaction and develop measures to eliminate them.

**Keywords** Communication · Digitalization · Efficiency · Industrial network organization · Information technology · Team building

## 1 Introduction

Modern challenges require business organizers to take new approaches, tools, ideas. A successful company, expanding, occupies new regional market segments, where it opens its new branches. And the success in all areas of its activities will largely depend on how successfully inter-functional interaction between the personnel of all departments of the company is carried out when performing general and auxiliary

---

E. V. Volkodavova (✉) · A. P. Zhabin  
Samara State University of Economics, Samara, Russia

A. P. Zhabin  
e-mail: [apzhabin@yandex.ru](mailto:apzhabin@yandex.ru)

business processes. Achieving high performance of a company with many branches operating in different regions of the country can be achieved only by an effective team, including several levels of managers and performers. The formation of such a multi-team should be addressed by specialists and top management of the industrial network company with a mandatory focus on digitalization of inter-functional interaction at all levels and divisions of the company.

The authors of this study set a goal—to assess the impact of digitalization of the team building process on the efficiency of the organization. The study is based on the hypothesis that due to the development and implementation of digital technologies in the network organization, an additional resource is created to harmonize intra-team relations and increase the quality of internal communication, which increases the efficiency of the organization. Consequently, one of the key points for increasing the efficiency of the industrial network organization is team building management. A new author's theoretical and methodological approach to the formation of a system of indicators for assessing the efficiency of the industrial network organization through digitalization of the team building process is developed.

## 2 Methodology

The methodological and theoretical basis of the study are:

- the theory of the network society of Parsons [9], and the network analysis of Lewin [7], which were developed in studies of group dynamics and marketing interaction;
- a method of complex analysis, which made it possible to characterize the problems and directions of organizing an industrial network organization in Russia under new conditions of doing business and to focus on the actual factor of its development - team building, providing an increase in its efficiency;
- a method of system analysis, with the help of which theoretical foundations of the influence of digitalization on team building, as well as the synergy of their influence on the business performance of the industrial organization are studied;
- the concept of rational behavior of market entities, the principles of which allow highlighting relevant factors to increase the efficiency of the industrial network organization when the conditions of the organization's internal environment change and draw conclusions about the need to expand the use of digital technologies depending on the successful problem solution of effective team building. Based on these methodological approaches, the impact of digitalization of team building on the efficiency of the organization is assessed.

### 3 Results

The study made it possible to identify problems and develop measures to increase the cohesion of multi-team members, improve the process of inter-functional interaction using digitalization, and increase performance indicators of staff and the organization. To this end, the authors performed a comprehensive, systematic study of sequential processes of the industrial network organization of the Samara region: structuring a multi-team, digitalizing interaction of multi-team entities, assessing the efficiency of the organization by digitalizing the activities of a multi-team.

This methodological approach to the study is fully justified by the fact that:

- multi-team structuring is necessary to identify the degree of satisfaction with the work of specialists at each level of the multi-team; problems in interaction of multi-team members within each level and between levels; the degree to which members of all groups and levels possess the necessary competencies for the effective implementation of the organization's strategic work plan indicators;
- assessment of existing digitalization tools allows you to establish the possibility of their influence on the efficiency of intra-team and intergroup interaction in solving strategic tasks of the organization;
- development of a system of indicators for assessing the efficiency of the organization through digitalization of the multi-team allows you to objectively evaluate changes in the multi-team through modern means of improving the efficiency of business communication in the organization and to evaluate the growth of the main indicators of its activities.

All these processes are interconnected and interdependent: increasing job satisfaction reduces the level of staff turnover in the organization, increases the personal impact of each employee in the corporate result; digitalization of team building, business processes and office workflows increases labor productivity and efficiency of business processes, and, as a result, improves the performance of the main production activities of the industrial network organization. Moreover, the same can be seen in the reverse order: getting a job in a successful organization brings personal satisfaction, the desire to excel in solving production problems, the desire to be involved in this team and its organizational culture, to contribute to innovative technologies, digitalization of business processes, system knowledge management.

Let us dwell on the results obtained.

1. Digitalization of managerial processes in network organizations leads, as noted above, to the creation of a new type of team—multi-teams, which combine not only traditional team roles, but also participants belonging to different levels of the managerial hierarchy. The study showed that in this case it is advisable to distinguish three levels of team members:
  - a team of managers in the head office—Top managers;
  - a team of managers, heads of regional divisions (interregional level)—Middle managers;

- a team of specialists from a regional unit—Department staff.

When forming effective interaction of all levels of the multi-team, it is necessary to take into account: the status of each unit in the organization, the time of its functioning from the moment the organization was created; the level of qualification of managers and specialists in each division; the degree of digitalization of interaction within each unit and between them; the availability of each unit to resources available in the organization; the level of participation of each unit in the creation of the product and profits of the organization; partnerships.

The study of processes and problems in interaction of multi-team members within each level and between levels was carried out using questionnaire and survey methods of Lutoshkin which are described by Stolyarenko [13], (assessment of the psychological climate), Belbin's model of team roles [1], test for job satisfaction by Kharsky [3], and personal experience of the authors of the study. The most interesting when forming the multi-team are the results of the study of team roles. In the process of this study, the main roles of each subject of the multi-team are identified, which allows them to be analyzed, compared with the best option and developed measures to harmonize roles within the specific multi-team.

An example of the study of team roles within the large industrial network organization is presented in Table 1. In the process of analyzing cross-functional interaction, inconsistencies were identified in assessing the role of individual specialists in the multi-team. Each employee usually plays several roles, but the role that is most pronounced for this specialist is included in the table. The test results revealed the inability of individual members of the multi-team to perform their functions and formed the basis for developing recommendations for improving the team role model in this organization.

2. One of the factors that have a significant impact on the quality of team building and activities of the multi-team is modern digitalization tools for specialists and management of the organization. They allow you to optimize the execution time of business processes, structure acquired and accumulated knowledge, build operational interaction of team members on topical production, organizational, sales and other issues that ensure optimal management decisions.

Currently, there are modern tools available for any organization to digitalize interaction of network industrial business entities located in various regions of the country with both internal and external environments.

These include, first, the Bitrix-24 package, which includes 5 electronic platforms:

- “Office”, creating conditions for effective communication at each level of the multi-team based on a single corporate portal;
- “Tasks and projects”, unite the creative potential of multi-team members, creating conditions for joint creative work, crowdsourcing;
- system for managing sales and communications with customers. Allows managers of successful units to provide operational advice to less successful, less busy units to work with clients of other departments, to attract new customers to purchases;

**Table 1** Inconsistency of the role of employees in the multi-team of the industrial network organization

| Position               | Role in the team            | Assessment of the role in the team  |
|------------------------|-----------------------------|---|
| <i>Top managers</i>    |                             |   |
| Deputy Director        | Controller (Finisher)       | Lack of ability to inspire the team. Uncommunicative  |
| <b>Middle managers</b> |                             |   |
| Manager * D1           | Diplomat /collectivist      | Lack of ability to inspire team   |
| Manager D3             | Finisher                    | Does not like to delegate authority   |
| Manager D6             | Motivator                   | Often performs impulsive actions without analyzing the consequences                             |
| Manager D7             | Collectivist and finisher   | Do not like to delegate authority   |
| Manager D11            | Collectivist and analyst    | Easily provocative  |
| Manager D12            | Collectivist and supplier   | Loses interest as the initial enthusiasm fades  |
| Manager D13            | Analyst                     | Lack of ability to inspire team   |
| Department staff       |                             |   |
| Engineer D1            | Analyst                     | Loses interest in the started project   |
| Engineer D2            | Thinker and analyst         | It is difficult to communicate with engineers of other branches when performing common projects |
| Warehouse employee D1  | Implementer and team player | Considers that consultations of new specialists from other branches are burdensome              |
| Warehouse employee D2  | Contractor                  | Incredulous, unable to quickly adapt to the new environment                                     |

Source Authors

\*D1—Department №1.

- “Contact Center” provides all kinds of communication channels: telephony, Yandex chat, Facebook, e-mail, its sites to Bitrix24;
- “Sites and shops” help sell, because customer data that contacted through the CRM platform, free chat or ordered call back, immediately get into CRM [2]. In addition, the following can be included in digitalization of inter-functional interaction of management of the network industrial organization:
- IP-telephony, which provides telephony communication of all three levels of the multi-team;
- VKS-system [6], which provides video communication (sound and video signal) between subjects of all levels of the multi-team, including operating remotely. Modern video conferencing systems (VKS) effectively ensures the exchange of relevant information within the framework of a video forum between many subscribers of all regional offices and improves internal corporate communication;

- Microsoft Exchange [8]—a mail server that allows for the operational interaction of company employees not only in the regions of Russia, but also in the global environment when interacting with suppliers or buyers of products / services, because corporate mail can be placed at the request of the customer both on servers in Russia and in Europe.

The results of the authors’ studies at network companies of the Samara region suggest that the most popular communication channels for employees from different cities are telephone and e-mail. Those organizations that have recently implemented the Bitrix 24 platform, do not use all its resources, but, as a rule, chatting or video calling [2]. A methodological approach to assess the efficiency of the organization through digitalization of the multi-team is as follows: (1) assessment of the efficiency should be complex, two-level: multi-team and organization; (2) both quantitative and qualitative performance indicators are applied. The scorecard is presented in Table 2.

**Table 2** The system of performance indicators of the industrial network organization due to digitalization of the multi-team

| Indicators   | Multi-team performance assessment |                 |                  |
|--|-----------------------------------|-----------------|------------------|
|  | Top managers                      | Middle managers | Department staff |
| Level of satisfaction with work of team members            | +                                 | +               | +                |
| Staff turnover reduction rate                              |                                   | +               | +                |
| Staff competency level                                     | +                                 | +               | +                |
| Controllability rate                                       | +                                 | +               |                  |
| Achieving group goals                                      |                                   | +               | +                |
| Improving the ability to make optimal management decisions | +                                 | +               |                  |
| Increasing stress tolerance                                | +                                 | +               | +                |
| <i>Organization performance assessment</i>                 |                                   |                 |                  |
| Profit growth, million rubles                              |                                   |                 |                  |
| Asset growth, million rubles                               |                                   |                 |                  |
| Image enhancement  |                                   |                 |                  |
| Growth rate of key competencies of the organization        |                                   |                 |                  |
| Reduction of internal communication time, min              |                                   |                 |                  |
| Reduction of external communication time, min              |                                   |                 |                  |

Source Authors



## 4 Discussion

In the scientific literature, there are many opinions about the advantages of inter-company networks [11]. Indeed, the efficiency of the network organization is significantly enhanced due to horizontal and vertical intercompany relations, strengthening market positions, expanding the horizons of production, logistics and other activities. According to Popova [11], the participation of enterprises in networks allows: increasing trust and loyalty between them; improving coordination of actions in the market; resolving conflict situations; receiving additional services from partners. In the scientific literature, there is often a description of advantages of the industrial network organization in interaction of independent legal entities producing various products and services. An equally interesting aspect of the study is interaction of units of one large company, whose branches are in many cities of one country. Here, we can see most of the same advantages of the network organization that are observed in external interaction. But there is a potential for internal interaction that has a significant impact on asset growth, sustainability, competitiveness and business performance. Regarding the network organization operating within the framework of one company, its efficiency largely depends, first, on the degree of development of partnerships between specialists of divisions, and the level of competencies relevant to this type of activity. And since the human resource controls all other resources, the quality of the work of the industrial network organization directly depends on the quality of work of people united by team ties [4, 5, 10, 12]. Klimenkova and Shchedrina illuminate the main types of teams and summarize the team building model [4]. Podprigora and Mazuta [10] study methods of organizing interaction within the project team, offer their classification, which is based on the division into basic and supporting methods. The article of Shavaleeva [12] presents a list of basic personal qualities inherent in leaders, characterizes leadership programs that exist in large foreign companies, and outlines the importance of introducing such programs from a position of employee motivation. We can agree that the effective use of human resources in the team allows the organization to increase its competitive potential. An important aspect in the development of this topic is considered by Kraidenkov and Sviridova [5], that it is necessary to consider the peculiarities of team building in the digital economy.

## 5 Conclusion

Under current business conditions, the number of network organizations engaged in entrepreneurial activity will grow. A large network company is a multi-level organization consisting of many departments and branches located in different regions, in which personnel employed perform homogeneous business processes according to the technological structure of the organization's business model. This staff, integrated in the organization, and differentiated, at least, in three levels—Top managers,

Middle managers and Department staff, is one multi-team in which each one fulfills its part of the main task—achieve strategic indicators and organization tasks. Therefore, the development of theoretical and methodological approaches to assess the results of multi-team activities and organize network business and apply them in the practical activities of Russian organizations will increase their competitiveness and harmonize team communication based on modern innovative digital technologies.

## References

1. Belbin, M.P.: Management teams. Secrets of success and reasons for failure. Moscow, HIPPO (2003)
2. Bitrix 24: Cen cloud. A complete set of working tools for a company (2021). <https://www.bitrix24.ru/>. Accessed 03 Mar 2021
3. Kharsky, K.: Reliability and loyalty of staff. Saint Petersburg: Peter (2003)
4. Klimenkova, T.A., Shchedrina, I.V.: Effective use of existing models and approaches in management of team building process. *Creative Econ.* **12**(3), 397–410 (2018)
5. Kraidenkov, Y.A., Sviridova, L.V.: Team building in the digital economy. *Bulletin Perm National Res. Polytech. Univer. Socio-Econom. Sci.* **4**, 318–327 (2019)
6. KROK: Impressive technology for all spaces (2020). <https://mmedia.croc.ru/solutions>. Accessed 12 Mar 2020
7. Lewin, K.: *Field Theory in Social Science, Selected Theoretical Papers*. Harper & Row, New York, N.Y. (1951)
8. Microsoft Exchange: Corporate mail (2020). <https://www.activecloud.ru/services/microsoft-exchange-hosted/>. Accessed 12 Mar 2020
9. Parsons, T.: *The Structure of Social Action: A Study in Social Theory with Special Reference to a Group of European Writers*. Free Press, New York, N.Y. (1951)
10. Podprigora, M.G., Mazuta, O.S.: The concept of team management methods in the management of innovative projects in the organization. *Issues of Innov. Econ.* **9**(4), 1489–1500 (2019)
11. Popova, Yu.F.: Network forms of business organization in industrial markets. *Russian J. Entrepreneurship* **10–1**, 140–144 (2008)
12. Shavaleeva, Yu.S.: The nature of leadership in company management and the concept of growth of leadership qualities of employees. *Leadership Manage.* **5**(1), 43–53 (2018)
13. Stolyarenko, L.D.: In: *The Basics of Psychology*. Rostov on Don, Publishing house “Phoenix” (1997)

# Customer Service in the Context of Digitalization of the Economy



Y. O. Gorokhovitskaya, E. A. Bratukhina, and Y. A. Kolesova

**Abstract** The article deals with the flow processes rational organization issues and their service support in the of economy digitalization conditions. Special attention is paid to customer segmenting to provide them with an optimal package of transport and logistics services among the alternatives based on economic and mathematical modeling methods, as well as feedback organizing in order to determine the service satisfaction degree provided to them. To form a transport service rational system in the supply chains, a step-by-step action algorithm was developed and an service quality integral indicator was calculated. The authors state modeling methods usage has become possible allowing consumers to choose a rational set of services from the “price-quality” ratio point of view in the digital innovation era.

**Keywords** Consumers · Quality · Service · Transport and logistics services

## 1 Introduction

The transport companies orientation to the consumer benefits means the fullest possible satisfaction of their needs on the economy digitalization basis. There is a problem of high-quality service provision despite the existing theoretical and practical developments in the transport and service field. In the context of import substitution and economic sanctions imposed by European countries special attention should be paid to the enterprises transport and logistics activities, including the flow processes rational organization and their service support. In general, it should

---

Y. O. Gorokhovitskaya (✉)  
Syzran Branch of Samara State University of Economics, Syzran, Russia  
e-mail: [gorohovickaya@bk.ru](mailto:gorohovickaya@bk.ru)

E. A. Bratukhina · Y. A. Kolesova  
Vyatka State University, Kirov, Russia  
e-mail: [ea\\_bratuhina@vyatsu.ru](mailto:ea_bratuhina@vyatsu.ru)

Y. A. Kolesova  
e-mail: [usr11010@vyatsu.ru](mailto:usr11010@vyatsu.ru)

be concluded that transportation as the most important component of operational logistics activities is transformed into a transport service in modern conditions. Insufficient knowledge and elaboration of integrated traffic flow management issues and their optimization in the economy digitalization context have led to the research topic, purpose and objectives choice relevance. End-to-end integrated transport flow management is the cargo transportation process and the logistics service set integration making possible transport enterprises, suppliers and end users cooperation on a single information platform. The rational transport and logistics activities design in the supply chains allows transport companies to maintain a high level of customer service at optimal costs. Therefore, it is necessary to improve the transport and logistics activities model in supply chains based on a digital approach.

## 2 Methodology

All operations are performed in a strictly defined sequence in the traffic flow management traditional model implementation in a logistics system. Due to this fact there are some problems with providing high-quality service, since the information may be provided in a distorted form or not reach the customers at all. In the digital innovation era service modeling methods have become available allowing consumers to choose a rational set of services in terms of the “service price-quality” ratio.

From a methodological point of view, an important aspect of the transport service system formation is to improve the customer service quality by developing rational packages of transport and logistics services and organizing feedback with consumers in order to determine the satisfaction degree with the services provided to them. To form an optimal transport service system in the supply chains, it is necessary to develop a step-by-step actions algorithm.

At the first stage, it is necessary to segment the consumers of transport services in accordance with their preferences. At the second stage, a list of the most important and significant services for various consumer groups is developed based on these services ranking. The method of selecting the optimal package of services in the presence of several criteria is implemented on the basis of fuzzy sets. The problem statement is presented as follows. Let us take the possible variants set of the of transport and logistics services package  $X$ :

$$X = \{x_1, x_1, \dots, x_i, \dots, x_n\}$$

Each option is characterized by a set of parameters for consumers ‘ evaluation of the service package  $Y$ :

$$Y = \{y_1, y_1, \dots, y_i, \dots, y_n\}$$

There is a fuzzy relation, denoted by  $xy$  or  $\mu_{ij}$  between each member of the set  $X$  and each member of the set  $Y$ . In other words,  $\mu_{ij}$  reflects the  $i$ -th variant compliance

level of the service package to the consumer demands according to the  $j$ -th parameter ( $\mu_{ij} \in [0,1]; i = 1, \dots, n; j = 1, \dots, m$ ).

If you put together all fuzzy relations, we get the matrix of fuzzy relations  $R$  of  $nm$  size:

$$R = \{ \mu_{ij} / i = 1, \dots, n; j = 1, \dots, m \}$$

You need to choose the best option  $x^*$  from the set  $X$ . The problem of choosing a package of transport and logistics services can be written in the following form:

$$x^* = \text{opt}(X, Y, R, M),$$

Next, the service quality integral indicator is determined, based on the generalizing indicator determination method, taking into account the weighting coefficients of particular indicators. It is assumed the service provision quality integral indicator ( $Y$ ) is a linear combination of individual quality indicators ( $X$ ), the normalized values of which vary from 0 to 1:

$$Y = \alpha_1 \cdot X_1 + \alpha_2 \cdot X_2 + \dots + \alpha_n \cdot X_n = \sum_{i=1}^n \alpha_i \cdot X_i$$

where  $\alpha_i$ —the weighting coefficients of service provision quality individual indicators in the integral.

### 3 Results

To identify the customer preferences, a questionnaire for the provision of transport and logistics services was developed. The survey involved 163 people from organizations of different forms of ownership (Fig. 1).

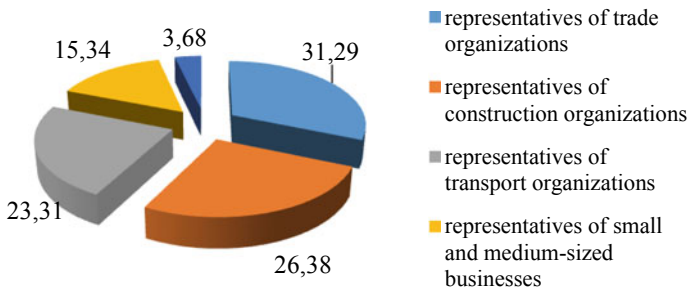


Fig. 1 Representatives of trade organizations. (Source Authors)

**Table 1** The survey results on the transport and logistics services costs

| Positive answers<br>(number of people) | Respondents proportion, % | Ttransport and logistics services cost<br>proportion in total costs volume, % |
|--|---------------------------|---|
| 90                                     | 55.2                      | 15  |
| 41                                     | 25.2                      | 10–14   |
| 25                                     | 15.3                      | 6–9   |
| 7                                      | 4.3                       | 3–5   |
| Total:163                              | 100                       |   |

Source Authors

As can be seen from the figure, the respondents were mainly representatives of trade organizations—more than 30%, construction and transport organizations—26.4% and 23.3%, respectively, i.e. these consumer segments are the most important for the enterprise. The factors that have a significant impact on the a transport company choice are: safety, reliability and quality of service provision quality, optimal prices, flexibility in solving emerging issues, the additional logistics services provision, i.e. the services range provision. Let's analyze the questionnaire survey results. Having been asked about the need to calculate the enterprise total transport and logistics costs 67.5% (110 people) of respondents answered positively, and 32.5% (53 people) – negatively. According to the data presented in the Table 1, it can be concluded that the majority-55.2% (90 people) consider allocating 15% of all costs for customers organizing and improving the quality of transport and logistics services is justified, and only 4.3% of respondents (7 people) believe that it is sufficient to allocate from 3 to 5% of funds to these activities (Table 1).

The transport flow processes design should be carried out in such a way that all participants in the supply chain use the same criteria for evaluating transport services. Almost 80% of respondents (130 people) receive written notifications about transport and logistics services in the form of advertising brochures, catalogs, price lists, etc. More than 55% of customers order services by phone, 23% make an order by e-mail, 17% place an order during a personal visit to the company's office and only 5% send an order by mail. It was also found out more than 75% of customers want to receive transport and logistics services in the complex. Therefore, they still ask other companies for additional transport and logistics services (55%). Payment for services is carried out mainly by bank transfer (70%). 50% of customers, on average 4–6 times, face violations of transport and logistics services order execution provision during the year, 15%—more than 10 times and 5%—from 1 to 3 times (Table 2).

The cost of transport and logistics services provided to 60% of respondents does not meet their expectations. According to the survey results of the transport company's clients it was found out:

1. The client wants to receive all the services in a complex.
2. Customers are not satisfied with the time and quality of transport and logistics services.
3. Customers want to receive services based on the optimal «price—quality ratio».

**Table 2** Violation dynamics of the transport and logistics services order execution provision during the year

| The respondents number who face order execution violations, % | The violations number during the year |
|---|---------------------------------------|
| 50  | 4–6                                   |
| 30  | 7–9                                   |
| 15  | 10                                    |
| 5   | 1–3                                   |
| Total: 100  |                                       |

Source Authors

The classification of services is presented in Table 3.

10 transport and logistics services provision packages were developed, furthermore (Table 4).

Based on the data obtained during the survey, recommendations were developed for the transport and logistics services segmentation and the demand for each of the proposed packages was identified. The first stage. At the beginning, it is necessary to calculate the indicator  $K_1$  of the demand frequency for each of the developed service packages.

$$K_1 = b^* \frac{N_{1...n}}{N_{total}}$$

where  $b$ —the importance of the demand frequency for the corresponding service packages. According to the expert assessment, the importance of the demand frequency for the transport company's customers was 42%.

$N_{1...n}$ —the customers number who selected the  $n$ -th service package;

$N_{total}$ —the total number of customers who participated in the survey.

The results are presented in Table 5.

The second stage. At this stage, it is necessary to determine the profitability of each  $K_2$  service package.

**Table 3** Services classification

|   |  |             |
|---|--|-------------|
| 1. By the enterprise main activity cooperation  |  |             |
| Non-transportation services related to the goods storage, their departure, loading and unloading operations | Transportation services perform the cargo transportation process |             |
| 2. By the consumer type   |  |             |
| External (services provision to non-transport organizations)  | Internal (transport companies to each other)                     |             |
| 3. By their activities  |  |             |
| Organizational  | Technological  | Information |

Source Authors

**Table 4** The service packages formation based on transport and logistics operations

| “Service packages” | Transport and logistics operations   |
|--------------------|--|
| 1                  | Transportation, loading and unloading, storage, information operations   |
| 2                  | Transportation, loading and unloading, warehousing and forwarding services, information operations   |
| 3                  | Transportation, loading and unloading, forwarding and warehousing services, information operations, financial settlements and operations with the carrier  |
| 4                  | Transportation, loading and unloading, warehousing and forwarding services, packaging, information operations, financial settlements and operations with the carrier, cargo ownership rights transfer  |
| 5                  | Loading and unloading operations, forwarding services, information and financial operations  |
| 6                  | Transportation, loading and unloading, warehousing and forwarding services, information operations, transportation vehicles provision, route and delivery schedule development   |
| 7                  | Transportation, loading and unloading, cargo storage and safety, transportation vehicles provision, forwarding services, information operations, risk insurance, cargo ownership rights transfer   |
| 8                  | Transportation, loading and unloading, warehousing and storage of goods, transport vehicles provision with transshipment to different types of transport, forwarding services, information operations, risk insurance, customs and financial operations, cargo ownership rights transfer |
| 9                  | Commercial and legal operations, including vehicle customs clearance, cargo declaration to customs authorities, conflict resolution, cargo storage and safety, financial and information operations  |
| 10                 | Commercial and legal operations, including vehicle customs clearance, cargo declaration to customs authorities, conflict resolution, cargo storage and safety, cargo handling services, forwarding, financial and information operations   |

Source Authors

$$K_2 = z * \frac{D_{1...n}}{D_{total}}$$

where z—the profitability degree from the transport and logistics services complex provision significance for the transport enterprise. According to the authors expert assessment, this figure was 58% for the transport company.

D1...n—the n-th service package income

D total—the total service package profitability offered by the transport company.

The results are presented in Table 6.

The third stage. At the third stage, the integral indicator of the transport and logistics service n-th package should be calculated.

$$K_{integr} = K1 + K2$$



**Table 5** The transport and logistics services packages distribution by demand frequency

| Package number | Customers number who service package, people | The specific package proportion by the demand frequency, % | Indicator K1 |
|----------------|--|--|--------------|
| 1              | 1  | 0.61   | 25.77        |
| 2              | 2  | 1.23   | 51.53        |
| 3              | 3  | 1.84   | 77.30        |
| 4              | 9  | 5.52   | 231,90       |
| 5              | 1  | 0.61   | 25.77        |
| 6              | 19   | 11.66  | 489,57       |
| 7              | 33   | 20,25  | 850,31       |
| 8              | 54   | 33,13  | 1391,41      |
| 9              | 12   | 7,36   | 309,20       |
| 10             | 29   | 17,79  | 747,24       |
| Total          | 163  | 100  |              |

Source Authors

**Table 6** The transport and logistics service packages distribution by profitability

| Package number | Service package profitability, people | The service package proportion by the profitability degree in total, % | Indicator K2 |
|----------------|---------------------------------------|--|--------------|
| 1              | 10                                    | 3.46   | 200,69       |
| 2              | 15                                    | 5.19   | 301,04       |
| 3              | 23                                    | 7.96   | 461,59       |
| 4              | 26                                    | 9.00   | 521,80       |
| 5              | 9                                     | 3.11   | 180,62       |
| 6              | 43                                    | 14.88  | 862,98       |
| 7              | 52                                    | 17.99  | 1043,60      |
| 8              | 64                                    | 22.15  | 1284,43      |
| 9              | 18                                    | 6.23   | 361,25       |
| 10             | 29                                    | 10.03  | 582,01       |
| Total          | 289                                   | 100  |              |

Source Authors

The results are presented in Table 7.

Next, you need to conduct an ABC analysis to select the most significant service packages for customers (Table 8).

On the basis of ABC-analysis package 8 is allocated to group A, packages 7, 6 and 10—to group B, the remaining 6 packages will be allocated to group C. The results of survey processing was the basis for the transport and logistics operation service packages formation allowing to meet the customer needs and to increase transport

**Table 7** The integral indicator of the transport and logistics service n-th package calculation

| Package number | Indicator K1 | Indicator K2 | Kintegr |
|----------------|--------------|--------------|---------|
| 1              | 25.77        | 200,69       | 226,46  |
| 2              | 51.53        | 301,04       | 352,57  |
| 3              | 77.30        | 461,59       | 538,89  |
| 4              | 231,90       | 521,80       | 753.7   |
| 5              | 25.77        | 180,62       | 206,39  |
| 6              | 489,57       | 862,98       | 1352,55 |
| 7              | 850,31       | 1043,60      | 1893,91 |
| 8              | 1391,41      | 1284,43      | 2675,84 |
| 9              | 309,20       | 361,25       | 670,45  |
| 10             | 747,24       | 582,01       | 1329,25 |
| Total          |              |              |         |

Source Authors

**Table 8** ABC-service package analysis

| Package number | Kintegr | Service package profitability share in total, % | The package profitability share in cumulative total, % | Groups |
|----------------|---------|---|--|--------|
| 8              | 2675,84 | 26.76   | 26.76  | A      |
| 7              | 1893,91 | 18.94   | 45.70  | B      |
| 6              | 1352,55 | 13,53   | 59.22  | B      |
| 10             | 1329,25 | 13.29   | 72.52  | B      |
| 4              | 753.7   | 7.54  | 80.05  | C      |
| 9              | 670,45  | 6.70  | 86.76  | C      |
| 3              | 538,89  | 5.39  | 92.15  | C      |
| 2              | 352,57  | 3.53  | 95.67  | C      |
| 1              | 226,46  | 2.26  | 97.94  | C      |
| 5              | 206,39  | 2.06  | 100,00   | C      |

Source Authors

company profitability by providing comprehensive services mostly demanded by customers.

## 4 Discussion

Scientists from different countries note that digital technologies transform traditional practical activities of the enterprise into innovative ones. Digital innovation and entrepreneurship facilitate the fulfillment of the following goals: First, it identifies the economy digitalization as a separate area of scientific research, and second,

it expands the scientific cooperation framework defined by Yoo, Henfridsson and Liitinen on the topic on the organization and management of digital innovations [7]. Third, it promotes digital business research from B2B, B2C to new logistics systems on an integrative approach base. McKinsey & Co considers DI&E ecosystem strategies will enable the sharing of limited resources, enhancing their value, as well as significantly expanding the range of new services offered [4]. Hevner, Gregor, the founders of DSR, are sure that DSR are digital innovations in the field of information systems and technologies [2]. Digital innovation & enterprise (DI&E) is the use of digital technologies and innovation of services, including digital technologies in transport [3]. The authors believe that DI&E become the main center of research in the field of innovation, strategic management and informatization.

About the end-user interest in accessing and using the digital technologies, systems, and applications, digitalisation has changed how end users communicate and interact with their surroundings, as well as with participants in the logistics supply chain at the integrative level [5]. Despite a decade or more of interest in digital innovation research among information systems and marketing scholars [7], there is much scope for moving the field further with a research agenda while developing business models and developing rational strategies [6], determining the scenario of business success based on the introduction of innovative processes [1].

## 5 Conclusion

The step-by-step process of implementing a transport service based on information and computer support is as follows. The first stage. Order receipt from the client. To perform this operation, you need data about the client, the list of services that he would like to receive, i.e. choose a service package among the alternatives. The second stage. Order confirmation. At this stage, you need to define all the functions and operations, including service and additional the client wants to receive. The third stage. Service package planning. The all-services assessment of package chosen by the client is given, including the calculation of the cost and terms of transportation, as well as the conditions for the safety and goods security. The fourth stage. Transport services and control implementation. At this stage, a situational and process management model is developed taking into account all the factors that help the carrier to control the goods standard delivery time. At this stage, the sequence, principles, and relationship of each functional process are determined. In addition, the each listed functional process quality is evaluated in accordance with the selected indicators system. Thus, we can conclude that in the economy digitalization conditions, integrated transportation management is based on an individual approach to each client, using common methodological approaches to planning, organizing delivery and controlling.

## References

1. Berger, E.S.C., von Briel, F., Davidsson, P., Kuckertz, A.: Digital or not—the future of entrepreneurship and innovation: Introduction to the special issue. *J. Business Res.* (2019). <https://ent.aom.org/ent/events/eventdescription?CalendarEventKey=4605d1d8-4029-4ff8-8810-6cab9000a50b&CommunityKey=fe00dbd4-230d-471e-a0ed-420a47166316>. Accessed 17 Mar 2021
2. Hevner, A., Gregor, S.: Envisioning entrepreneurship and digital innovation through a design science research lens: a matrix approach. *Inform. Manage.* (2020). <https://doi.org/10.1016/j.im.2020.103350>. Accessed: 17.03.2021
3. Hevner, A., vom Brocke, J., Maedche, A.: Roles of digital innovation in design science research. *Bus. Inf. Syst. Eng.* **61**, 3–8 (2019)
4. McKinsey & Co: How do companies create value from digital eco-systems? (2020). <https://www.mckinsey.com/business-functions/mckinsey-digital/ourinsights/how-do-companies-create-value-from-digital-ecosystems>. Accessed 17 Mar 2021
5. Nasiri, M., Ukko, J., Saunila, M., Rantala, T.: Managing the digital supply chain: the role of smart technologies. *Technovation* **96–97**, 1–6 (2020)
6. Sarker, S., Chatterjee, S., Xiao, X., Elbanna, A.: The socio-technical axis of cohesion for the IS discipline: Its historical legacy and its continued relevance. *MIS Q.* **43**(3), 695–720 (2019)
7. Yoo, Y., Henfridsson, O., Lyytinen, K.: Research commentary—the new organizing logic of digital innovation: an agenda for information systems research. *Inf. Syst. Res.* **21**(4), 724–735 (2010)

# Smart Communications in the Context of Modern Digital Economy



A. E. Makhovikov, V. A. Tikhonov, and A. S. Anipchenko

**Abstract** Smart communications in the context of the modern digital economy have the significance of its most important gnoseological foundation. But since their formation and development takes place in the conditions of the information society and the post-non-classical system of rational values, the structural content of this foundation is transformed and information becomes dominant in it. This determines to a decisive extent the specifics of the activity of intellectual communications, since the nature of information is not identical to scientific knowledge, and it remains relevant not only when it reflects reliable true knowledge, but also unreliable, falsified or even false. This is due to the fact that information combines the unity of semantic, syntactic and pragmatic aspects of its content. In addition, one of the most noticeable trends in the development of intelligent communications is the growing gap between the reality that we form as a result of the development of the digital economy and the reality of the real world around us.

**Keywords** Data · Digital economy · Digital models · Information · Knowledge · Smart communications

## 1 Introduction

Today, there is a strong belief that only within the framework of the digital economy we will be able to solve the main problems of our further civilizational development. Among them, for example, we highlight the problems of increasing labor productivity while reducing the level of basic production costs, as well as the problems

---

A. E. Makhovikov (✉)  
Samara State University of Economics, Samara, Russia  
e-mail: [shentala\\_sseu@inbox.ru](mailto:shentala_sseu@inbox.ru)

V. A. Tikhonov · A. S. Anipchenko  
Samara State Technical University, Samara, Russia  
e-mail: [dokvat@bk.ru](mailto:dokvat@bk.ru)

A. S. Anipchenko  
e-mail: [antona89@rambler.ru](mailto:antona89@rambler.ru)

of improving the quality of services together with an increase in their number and, consequently, providing the consumer with new opportunities for their choice. At the same time, the problems of not only preserving, but also creating new jobs, reducing poverty and social inequality, as well as the problems of competitiveness for an individual firm or a company, and for the state as a whole, remain invariably relevant. The most important condition for solving these and all other urgent problems of economic development is the intellectualization of the digital economy, in which production, distribution, exchange and consumption of products are built on the basis of intellectualized systems that are interconnected [2].

However, the transition of the digital economy to the intellectual stage is crucially determined by the content and specifics of existing intellectual communications in society. And this is due to the fact that they have a decisive influence on the level of intelligence development, which is one of the main factor in the economy functioning and a resource necessary for the construction, analysis and application of various intellectualized systems, and as their foundation. In addition, it is only within the framework of the communication process in the information society that it is possible to create technologies for constructing, analyzing and applying digital models of various economic systems. At the same time, smart communications are the exchange of information between individuals through a common sign system. But we are well aware that information by the nature of its content is not identical with scientific knowledge, since along with semantic knowledge it also includes such aspects as pragmatic and syntactic. This leads to the fact that within the framework of intellectual communications, it remains relevant both when it reflects reliable true knowledge, and when it carries unreliable, falsified, or even false knowledge. In this regard, the analysis of possible risks in the development of both intelligence and intellectualized systems as a result of the activity of these intelligent communications is of particular relevance today. In addition, it is of particular interest to study such a noticeable trend in the development of intellectual communications today as the ever-growing gap between the reality that is formed as a result of the process of digitalization of the economy and the reality of the real world around us. It is impossible not to see the danger of further deepening of global problems in the development of our civilization.

## 2 Methodology

The choice of the methodological basis for the consideration of intellectual communication issues is mainly determined by the specifics of the information society development and the cognitive processes in the context of the modern digital economy. And here, first of all, we should highlight the value of the information method, which determines the dominant value of information and the process of its cognitive processing. The emergence of new cognitive sciences generally assigns this method with a general scientific significance. When using the methodology of cognitive sciences for the consideration of smart communications in the digital economy, the

basic principle of modeling as a cognitive mechanism also changes. This leads to the fact that modeling is now based on the acquisition of information, its recognition, transformation, storage, representation and reproduction. In these conditions, information, according to its methodological significance for the understanding of intellectual communications, acquires not only an equal value with scientific knowledge, but even identifies with it, or even replaces it [7]. This methodological basis forms a worldview paradigm in the system of intellectual communications, according to which every reality is considered only as an interpretation or reconstruction of reality-for-the-subject. The model of reality created in this way within the framework of intellectual communications arises and actively functions no longer as a result of scientific and true knowledge about it, but as its subjective interpretation of available data. At the same time, the information is not always complete or objectively true, but more useful and profitable for this subject. And here, representations, constructs, frames, and scripts become significant methods in information processing. This allows to significantly reduce the time and material costs on conducting experiments, collecting and processing information, and provide remote access to the already existing advanced scientific infrastructure. At the same time, we cannot forget that when using this methodology, it is possible to form a model of reality in which, although significant features and relations are recorded for the subject, but there is not its complete identification. And this is due to the fact that the understanding of this reality is conditioned by our ability to adapt and survive in it. In addition, the methodology of this study does not exclude such scientific methods as axiological, hermeneutic, comparative, phenomenological and existential. The dialectical method, the method of situational analysis, and the ontological method are also important in the analysis of the problem under consideration. The methodology of this research is based on such methodological principles as historicism, objectivity, consistency and scientificity.

### 3 Results

At the basis of the development of the modern digital economy, intelligence is of crucial importance, since it is the main resource and the main result of all the economic activities of society. In addition, the evaluation of resources, technologies, and products in this economy is correlated with the amount of intelligence invested in them or the intelligence intensity. We also consider intelligence as a necessary condition for the transition of the digital economy to the intellectual stage. The obvious result of this process is, for example, the creation and active use of artificial intelligence technologies, “smart” spaces (for example, a city, a house or a separate workplace, etc.), various electronic means that can meet the needs of a person in the maximum form and create the most comfortable conditions for his life. And since each concept requires its own definition, under the intelligence in the conditions of digitalization of the economy, we will understand the ability of this system to interact with other systems in order to ensure the prolongation of the functioning of this system in

time and space (for the object, process and environment systems) or to ensure the successful operation of these systems (for the project system) [2].

In fact, the understanding of intelligence and the intellectualized systems that arise on its basis is reduced to the level of success in solving the tasks set by the consumer. At the same time, the criterion of this success in the process of digitalization of the economy is no longer the gnoseological, but the pragmatic side of the functioning of these systems. In this regard, information, rather than scientific knowledge, takes on a dominant role in their content. And this is quite consistent with the concept of an information society, in which scientific activity is transformed into scientific and informational activity. Within the framework of intelligent communications, this leads to the fact that it is now more engaged in collecting, analytical and synthetic processing, storing and searching for such information that can be presented to consumers in the optimal time and in a convenient form for them. And smart communications provide the necessary amount of information in the intellectualized systems created as a result of such scientific and information activities, while simultaneously solving the problem of its selection and even filling it with a certain meaning. This leads to the fact that the information used at first as a characteristic of objective existence, gradually transformed into information as a semantic content of human consciousness [3].

But by its nature, information is different from scientific knowledge, and therefore excludes the obligation to follow the principles of reflection, objectivity and truth. Under these conditions, intellectualized systems within the digital society do not exclude the possibility of using not only true or reliable information, but also false and unreliable. This becomes acceptable because smart communications in the conditions of the information society translate for these systems the values of post-non-classical rationality, according to which the main principle of using information is limited only by the requirement of its adaptive or heuristic utility. In fact, for smart communications, the distinctions between informing and acquiring new knowledge are removed. But such specificity of the functioning of intelligent communications in the context of the modern digital economy leads to the fact that the practical possibility of creating and even implementing new digital technologies is not always based on a strict scientific definition of the concept of their nature. For example, the active use of some artificial intelligence technologies today occurs in conditions when the communication system itself, including scientific ones, does not provide the possibility of its unified and general scientific definition. Therefore, in practice, we develop artificial intelligence technologies, but a common understanding of its nature in society was not developed. Moreover, such specifics in the activity of smart communications do not make it possible to solve the problem of “interpreted artificial intelligence”, since automatic systems are not able to give feedback and explain to consumers the logic of making certain decisions. This also explains the situation that is typical for the digital economy, when the “smarter” consumers use devices to access certain digital technologies, the potentially higher their level of vulnerability. The specific intellectual communications in the digital space cause some concerns in the development of such spheres as security, healthcare, and law [6].



Another important point in the specification of smart communications in the context of the digital economy is that the intelligence and intelligent systems necessary for the development of this economy are increasingly determined by the sphere of activity of scientific and information communications. In the general system of intellectual communications, they solve the problems of presenting, transmitting and receiving scientific information, while forming the main mechanism for the existence and development of science, as well as causing the emergence of new cognitive sciences. In these conditions, smart communications form a new idea for a person about the world around him as a set of information processes. The real world is considered only as its interpretation by the cognizing subject, on the basis of the information available to him. Within the digital society, a person develops a firm worldview belief that he lives in a world created by information. Reality in this case is nothing more than the result of the constructing activity of the subject and objectively for him there is neither the world nor something that makes it up, and all this is just a reconstruction of the subject's own subjective reality. This fully fits into the post-non-classical axiom of the rational tradition of postmodernism, according to which we are not given reality as such at all, since nothing can be true and authentic, since everything is falsified.

In these conditions, it becomes increasingly difficult for a person to determine for himself the criteria for distinguishing true reality from subjective, imaginary reality, because information takes a dominant position in cognitive activity. But in addition to the fact that information is not identical to scientific knowledge, so much of it arises and is transmitted within the framework of intellectual communications that a person is simply lost in it. Moreover, it is very difficult for him to verify its truth, since he should determine its value not only by semantic, but also by the pragmatic and syntactic aspects of its content. As a result of this specificity in the activity of intellectual communications, a growing gap appears in the consumer's mind between the comfortable reality of his life, as he understands it, and the present, objective and true reality. Gradually, this leads to the fact that it becomes increasingly difficult for the consumer to distinguish the real from the imaginary, the real from the virtual, and even the real from the unreal. In these conditions, the solution of the main goals of the digital economy development becomes possible only in relation to the real human life. Otherwise, this development will only increase the existing contradictions, global problems, without any further development of the digital economy.

## **4 Discussion**

The assessment of smart communications development in the digital economy is debatable. This is due to the fact that these communications are distinguished by the ambivalent nature of their content. So, on the one hand, they provide the necessary exchange of information for the formation and development of the digital economy of intelligence and intellectualized systems of economic activity. But, on the other hand,

these same communications provide this economy not only with scientific information, but also with information that is not always verified, and often false or even falsified. Of course, this situation reflects the specifics of the information society, which causes the emergence of new information knowledge along with the classical one. However, the quality of this knowledge gives reason to some researchers to place the development of the digital economy within the framework of the non-knowledge society. To substantiate this statement, they provide proof that in modern conditions, with the abundance of the most diverse information, both true and false or partially reliable, we do not know what modern science and technology can really implement, which of the many development scenarios is most likely to be implemented in the future [4]. The understanding of the relevance of intelligent communications for the emergence of new risks in the digital economy development remains debatable. We can not only predict it with certain accuracy, but also do not have effective solutions to overcome the already known problems associated with its development. In addition, the understanding of the extent to which the capabilities of this economy contribute to the further aggravation of the contradiction between the artificial world created by the digital economy and the real world around a person, remains controversial. In the meantime, we can only state an ever-deepening gap between the world of imaginary or virtual, or even unreal reality created by man and the objective reality of the nature surrounding man and himself as a part of it. Moreover, in discussions on this issue, it is increasingly possible to hear the opinion that the world created by the modern digital economy should be recognized as more real than the world of unexplored wilderness. The basis for choosing a particular worldview position in these discussions is precisely the specifics of the functioning of intelligent communications in the context of the digital economy.

## 5 Conclusion

Undoubtedly, the development of digital technologies is one of the key drivers of modern economic growth and their effective implementation already determines the competitiveness of both individual companies and entire countries. At the same time, the process of digitalization is associated not only with positive results, but also with some significant risks in the further development of the digital society, including in Russia [1]. And the most important basis for this is intellectual communications, which provide the development of the digital economy with information. But the information provided by intellectual communications within the information society does not always reflect the characteristics of scientific knowledge, and we see that this happens not only in the field of mass, but also in the field of scientific communications. This leads to the fact that we cannot always calculate the prospects for using certain technologies for a person [5]. Moreover, the practical creation and implementation of these technologies takes place in conditions when we cannot even give a general scientific definition of their nature. In addition, smart communications provide a huge amount of information, but the criterion for its scientific selection is not offered. On

the one hand, it is difficult to choose the right one, and, on the other, it is often not enough to make the only correct decision. We feel no less dangerous today because of the fact that the idea of the most efficient, useful and comfortable digital economy is based on a reality that is less and less consistent with the true reality, as it increasingly takes on the features of some imaginary, virtuality and even unreality. This contradiction between the reality presented by man and the true reality leads to further exacerbate of global problems that already threaten the further existence of humanity. All these issues require further study.

## References

1. Betelin, V.B.: Challenges and opportunities in forming a digital economy in Russia. *Her. Russ. Acad. Sci.* **88**(1), 1–6 (2018)
2. Fonotov, A.G.: The role of communications in the development of the national innovation system. *Econom. Mathem. Methods* **56**(3), 35–44 (2020)
3. Fortunatov, A.N., Chepyuk, O.R.: Information and communication origins of the stagnating economy. *Values and Meanings* **3**(43), 112–119 (2016)
4. Gorokhov, V.G.: Science and technology policy in society is not—knowledge. *Questions of Philos.* **12**, 65–80 (2007)
5. Guryanova, A.V., Krasnov, S.V., Frolov, V.A.: Human transformation under an influence of the digital economy development. In: Ashmarina, S., Mesquita, A., Vochozka, M. (eds.) *Digital Transformation of the Economy: Challenges, Trends and New Opportunities. Advances in Intelligent Systems and Computing*, vol. **908**, pp. 140–149. Cham, Springer (2020)
6. Guryanova, A.V., Smotrova, I.V., Makhovikov, A.E., Koychubaev, A.S.: Socio-ethical problems of the digital economy: challenges and risks. In: Ashmarina, S., Mesquita, A., Vochozka, M. (eds.) *Digital Transformation of the Economy: Challenges, Trends and New Opportunities. Advances in Intelligent Systems and Computing*, vol. **908**, pp. 92–106. Cham, Springer (2020)
7. Makhovikov, A.E., Guryanova, A.V., Stotskaya, T.G.: «Knowledge» and «Information» in the structure of modern rationality and human activity. In: Ashmarina, S., Mantulenko, V. (eds.) *Current Achievements, Challenges and Digital Chances of Knowledge Based Economy. Lecture Notes in Networks and Systems*, vol. **133**, pp. 27–34. Cham, Springer (2021)

# The Effect of Digital Intelligence on the Change in the Corporate Culture



L. V. Polynova, E. S. Popova, and A. R. Potapova

**Abstract** The article discusses the influence of digital intelligence on the formation and change of the current corporate culture of the organization. The model “Digital Manager” is shown, which relies on the “Digital—IQ” approach. It has been proven that digital transformation interacts with the corporate culture of the organization and becomes a mantra where the company’s individuality (branding) is reflected, the “spiritual guideline and program” of the business. It was shown, digital intelligence relies on the most necessary digitalization elements in the era, among which virtual cooperation, media light, transdisciplinary, digital thinking. Key tools of the future are given, which modern management is already applied in practice. The concept of “Digital First” is shown, within which each business is developing as much as possible in the electronic environment. An example of a technological company “Sber” is given, in which a single ecosystem is drawn up with the possibility of building the workflow in digital form, combining the team on a digital innovation platform.

**Keywords** Corporate culture · Digital culture · Digital intelligence · Management · Values

## 1 Introduction

Today, business actively moves to digital solutions and platforms, optimizing the processes within the organization to more modern and relevant, capable of significantly improving business efficiency, its competitiveness in the international arena and lead to an increase in investment flows [3]. Mindset of top management becomes proactive and digital, it relies on the “Digital—IQ” approach, in which an innovative approach to the case and the vision of entrepreneurs “for the future” is intensified, where consumer preferences, innovative competitors’ experience are taken into

---

L. V. Polynova · E. S. Popova (✉) · A. R. Potapova  
Samara State University of Economics, Samara, Russia

© The Author(s), under exclusive license to Springer Nature Switzerland AG 2022  
S. I. Ashmarina and V. V. Manteulenko (eds.), *Digital Technologies in the New Socio-Economic Reality*, Lecture Notes in Networks and Systems 304,  
[https://doi.org/10.1007/978-3-030-83175-2\\_69](https://doi.org/10.1007/978-3-030-83175-2_69)

557

account, intellectual technologies are used [8]. This is a kind of business reengineering, as there is a complete rethinking of the current business and its reorientation under the trend of time, namely, under digitization and introduction of artificial intelligence [10]. Any big business seeks to become digital in the eyes of partners and investors. The digital transformation is firmly woven into the corporate culture of an organization, which includes values, ideals, corporate behavior models, ethics, traditions, and all corporate philosophy, having a huge impact on the microclimate in the team [7]. Corporate culture becomes mantra reflecting the company's individuality, becoming a "spiritual guideline and program" of the business. Digital intelligence is the skill of management to confront new challenges and at the same time adapt them to the requirements of society [4]. This is a competent interaction of man and information technology and a new look at the human potential and its capabilities, where the knowledge, social, emotional and cognitive abilities of a person are closely intertwined. The question of whether the key values and landmarks of the employee will change to the company, as well as what will become the role in digital economic mindset.

## 2 Methodology

The world changes rapidly, and what was relevant 50 years ago, today becomes a classic. Therefore, in order not to stay behind the competitors, it is very important to master the skills of the future [10]. There are current trends that relieve digital management vision. They are presented in Table 1.

Thus, digital intelligence relies on the most necessary digitalization elements in the era, among which virtual cooperation, media light, transdisciplinary, digital thinking. All of them become part of the corporate culture development vector, which is an effective personnel management and an indispensable marketing tool. Today there is a tendency to branding or creating a bright brand, the signs of which are consisting of customer focus, recognition, openness [6]. All this gives the company competently built corporate culture with elements of its digitalization under modern trends.

Therefore, when at the head of the company is a proactive top—a manager who asks the correct course of the company's development, financial indicators will grow, because these are interconnected processes. For the development of digital thinking in everyday life, the manager sets himself several times a day as it is possible to solve this or that task with the help of digital technologies. Further, it is determined with the book, with a meeting place, the choice of the film, develops in the form of studying a foreign lexicon, is engaged in sports. At such a pace of life influenced digital thinking, strengthening important aspects of development as a time—management, emotional and digital intelligence.

The future management already in the present uses user-friendly interfaces that increase productivity. Tools for comfortable work in virtual space are presented below:

**Table 1** The main trends of digital management thinking

| Trend                | Application area   |
|----------------------|--|
| Virtual cooperation  | The Internet has become a universal platform for communication, education and cooperation for people of the whole globe. So, in one project, experts from different cities and countries can be involved, while working as well as if they were actually nearby<br>All employees successfully interact with each other, being in different points of the globe   |
| TransDisciplinaryity | This is the ability to solve any task, going beyond any one approach or professional direction. This ability is to find a common language with specialists from different areas, not limited to generally accepted borders<br>Tomorrow, there will be no extensive knowledge of their profile for solving complex tasks, it will take the ability to establish contacts with other industries and with new specialists<br>For example, marketing today is not only advertising and communication, this is also psychology, sociology, data analysis, web design, and there may be a dozen other related industries |
| Digital thinking     | This ability to use all the possibilities of the modern world and introduce them to your life to simplify the set of complex tasks<br>There are a large number of programs and technologies that automate the routine work, process data, perform calculations. The main thing is to know what technology is that the task decides, and be able to apply it in practice  |
| Media literacy       | This ability to analyze information from various sides, the ability to separate the fact from interpretation and identify manipulation<br>To achieve success in media literacy, it is important to have critical thinking, and already—to understand various sources of media and find the necessary information in them   |

Source Authors

- Google Docs (This is one of the most convenient applications for working together with presentations and texts);
- Realtime Board (Virtual board with stickers - reminders. This is a solution for effective real-time remote work);
- Coggle (The virtual creator of mental cards that can be shared in read or co-edit mode);
- Trello (Kanban - Board to manage tasks and joint remote work);
- Slack (Convenient chat for communication inside the team).

All these products are needed to effectively interact with top management with the team. This is the adaptation of corporate culture under digitalization, a visual example of integrating digital intelligence into the organizational culture of the company.

### 3 Results

Digital intelligence contributes to the simplification of production processes. It applies to all areas of activity, building a certain system of behavior of the team. Since the company seeks to maximize profits, all sources are involved in improving financial indicators [11]. Useful platforms are created, for example, “Skillfolio”, which forms a digital competency profile on Soft and Hard Skills and specific achievements of a specialist. It is based on the selection of personnel with the subsequent construction of individual plans and business development trajectories.

In 2021, about 25 billion devices will be connected to the Internet of Things (IoT). This will lead to the development of the concept of “Digital First”, in which each business must be as developed as much as possible in the electronic environment. This significantly expands the possibilities of interaction, allowing people to order food from hypermarkets at the other end of the city through applications or buy clothing from other countries on brands sites. This includes automated shopping delivery processes, and online learning, and even employment in a remote format.

In Russia, an example of a proactive manager is Gref, the head of “Sberling”, which set the task—to build a full-fledged technological company. From this point of view, work began on the formation of the ecosystem, where the changes in the brand began to be reflected. So, a cloud platform “ML SPACE” was developed together with “Sbercloud” for any application developers and services based on artificial intelligence technologies (AI) [9]. The main advantage over competitors is to launch distributed machine learning processes on more than a thousand graphics processors (GPU). It is focused on the full cycle of applied solutions based on machine learning and collaboration of teams of experts on the creation and deployment of machine learning models. The platform allows you to select the necessary computing resources in accordance with the tasks, needs and budget. It allows you to build a digital form working process, combining the team on a digital innovation platform.

Reflecting on the future, Gref adopted a trend on branding at the expense of the “Thank you” loyalty program, allowing you to accumulate bonuses for purchases on the bank map and exchange them on goods and services of partners. Professional solutions for corporations and the public sector entered the Sberpro brand aimed at giving business resources for transformation and scaling, hedging risks, provide outsourcing and analytics. The bank escaped forward against the background of its competitors, adapting innovations to the organizational processes and fixing them in corporate culture [9].

Digital trend requires digital approaches. So, in the “MegaFon” operates the “technological sandbox”. This is an electronic platform for testing hypotheses, holding pilots with startups and introducing innovative solutions. This is an analogue of the brainstorm, which was previously conducted in a full-time version, but with the digitalization of the business was replaced by this format. Digital manual intelligence adapts the system for the needs of time. During the work of such a “sandbox”, more than 100 pilot projects were approved, which relate to nine priorities for the company for clusters of development [11].

## 4 Discussion

Practice shows the popularization of the direction of “Internet of Behaviors” (IOB). It includes various methods that are used to study human behavioral characteristics. This includes a collection of data on the location of a person, its temporary location in a particular place, information about its purchases and payment methods and other [5]. With the help of IOB, the effectiveness of the advertising campaign can be checked, and you can also measure the involvement of the target audience and personalize content for specific users. IOB applies gradually as more and more organizations begin to use digital intelligence.

In 2020, IOB technologies were used to track the contacts of people during a pandemic. Many companies, including Google and Apple, have created applications for tracking contacts with patients. By the end of 2025, more than half of the world’s population will participate in at least one IOB program, both commercial and state. This spread of IOB will certainly cause a number of ethical and social issues. This is the second side of the medal, which affects the human factor. The agenda turns out to be universal values (love, friendship, family and life) together with the values of the organization, where the team, communication between employees, mutual respect is important. Society and digitalization form new laws and business ethics, where the important place “car”, replacing a person and its ability. Therefore, the issue of creating the “Code of Digital Ethics”, which will retain the basic values and highly powerful reference points of people, will strengthen the importance of the entire team and the relationship system in it, and it will add digital innovations that will not go into incision with morally moral qualities.

People become an open object for the study, without suspecting. Artificial intelligence often controls the subconscious of man and its consumer choice. Recall the principle of the Big Data platform, which in open access reads geolocation, contacts and personal data of people.

In addition, the model “Operations anywhere” model is actively gaining popularity (Anywhere Operations), which is designed for more flexible user support. It implies constant access of employees to data from anywhere in the world and from any device, as well as managing the company’s services on a distributed infrastructure [1]. By the end of 2023, about 40% of organizations will introduce this model to support more optimized work of employees and interaction with clients. First of all, it is necessary to ensure safe remote access, cloud and peripheral infrastructure and automated support for remote operations.

All this contributes to some fragility between the team, since the transition to the digital world leads to personalization and trend to satisfy only their own interests. An American model of management is coming with the individualization of employees, which will affect the building a new corporate culture, where everyone will close their own interests without binding to team work. And for the Russian model, such a tendency is difficult to be fulfilled, because the coherent team and high team spirit is important for efficient work.



## 5 Conclusion

Thus, today the role of digital thinking is very important. The amount of information in the world is growing in geometric progression. That is why one of the key tasks of the twenty-first century is to work with large arrays of information. Managers, IT specialists and the employees involved in digital transformation should carry out the analysis of processes and determine which spaces exist and what needs to be strengthened to improve business. So, it turns out to express priorities in the introduction of innovation. “Digital IQ” affects the entire company, so all the guide—from the Marketing Director to the Financial and Director for Legal Affairs—must comply with the digital needs of the company. And this is directly related to the adaptation of digitalization and corporate culture for the needs of time.

A digital culture is formed, which is to know the knowledge of modern technologies and the ability to apply them, a rapid learner to a new, understanding and possession of information security principles, effective use of digital channels for internal and external interaction [2]. The increase in digital intelligence contributes to the change in the approach of managers to the introduction of innovation. For this team, strong Digital is needed—competences. To develop them, it is necessary to focus not on traditional trainings, which usually accumulate knowledge, but on the strengthening of skills in practice. Give employees the opportunity to take the initiative and use self-organization practices. All this should be based on morally—ethical standards and traditions, where the right of universal values is led. The XXI century, at the very beginning, surprised us with incredible discoveries and breakthroughs in almost all spheres of life. That is why it is so important now to develop key skills that will help to be in the stream of this constantly changing world.

## References

1. Al Azri, S.: Digital culture for optimization. In: Daniotti, B., Gianinetto, M., Della Torre, S. (eds.) *Digital Transformation of the Design, Construction and Management Processes of the Built Environment*. Research for Development, pp. 127–135. Cham, Springer (2020)
2. Alston, F., Perkins, B.K.: *Strategic Environmental Performance*. CRC Press, Boca Raton (2020)
3. Davenport, T., Guha, A., Grewal, D., Bressgott, T.: How artificial intelligence will change the future of marketing. *J. Acad. Mark. Sci.* **48**, 24–42 (2020)
4. Mishra, S.: *Digital Cultures*. Routledge, London (2021)
5. Musek, J.: Indicators of corporate culture (2020). [https://www.researchgate.net/publication/345813801\\_Indicators\\_of\\_corporate\\_culture?channel=doi&linkId=5faeb816299bf10c36789cbc&showFulltext=true](https://www.researchgate.net/publication/345813801_Indicators_of_corporate_culture?channel=doi&linkId=5faeb816299bf10c36789cbc&showFulltext=true). Accessed 20 Mar 2021
6. Paralič, J., Sinčák, P., Hartono, P., Mařík, V. (Eds.): In: *Towards Digital Intelligence Society. Advances in Intelligent Systems and Computing*, vol. 1281. Cham, Springer (2020)
7. Polynova, L.V., Kzhevnikov, I.D.: Corporate culture as a factor of the success of companies: foreign experience. *Vestnik of Young Scient. Samara State Univer. Econ.* **1**(35), 90–92 (2017)
8. PWC: Digital-IQ in Russia 2020 (2021). <https://www.pwc.ru/ru/publications/digital-iq-pwc-abbyy.html>. Accessed 20 Mar 2021

9. Sber: What's the power, bot? How to use artificial intelligence (2021). [https://www.sberbank.ru/ru/s\\_m\\_business/pro\\_business/iskusstvennyj-intellekt-v-biznese-opyt-rossijskih-kompanij/](https://www.sberbank.ru/ru/s_m_business/pro_business/iskusstvennyj-intellekt-v-biznese-opyt-rossijskih-kompanij/). Accessed 20 Mar 2021
10. Shlyakhovoy, V.: How does artificial intelligence work in business? (2020). <https://ratenger.com/hi-tech/ai/iskusstvenny-intellekt-v-biznese/>. Accessed 20 Mar 2021
11. SMI2Go: The HSE business incubator launched the selection program for piloting in a Megaphone (2020). <https://smi2go.ru/publications/120987/>. Accessed 20 Mar 2021

# Digital Cooperation Between the Tax Service and Taxpayers



N. Sakhchinskaya, I. Svetkina, and M. Selyukov

**Abstract** The article deals with the issues of digital cooperation between tax authorities and taxpayers in the context of a closed digital ecosystem. The work of the Federal tax service (FTS) on digitalization, creation of a powerful technological base, and electronic services is aimed at simplifying the economic life of businesses and ordinary citizens. FTS has set a goal to improve the quality of tax literacy of individuals (residents and non-residents) and legal entities, and begun to introduce a customer-oriented approach. FTS More than 50 interactive services are available on the official FTS website. The most popular ones are “Personal account” based on taxpayer category, “Transparent business”, “information from registers”, “Tax calculators”, etc. Many projects are aimed at simplifying the interaction of tax partners. The result of improving the quality of digital cooperation is to focus control and supervisory activities on unscrupulous taxpayers and shadow businesses. Of particular interest are further open plans for FTS activities to ensure the completeness and timeliness of tax payments, to organize and update the database “State information resource of accounting statements”, “Statistical tax reporting”, to create a single consolidated register of arrears in payments to the budget, and much more.

**Keywords** Digital collaboration · Electronic services · Transactional environment

---

N. Sakhchinskaya  
Samara State University of Social Sciences and Education (PGSGA), Samara, Russia  
e-mail: [snat1980@yandex.ru](mailto:snat1980@yandex.ru)

I. Svetkina (✉)  
Samara State University of Economics, Samara, Russia

M. Selyukov  
Orel State University, Orel, Russia  
e-mail: [mvs010@mail.ru](mailto:mvs010@mail.ru)

## 1 Introduction

Historically, the tax system is quite young for Russia (since 1990). The New economic relations between the tax Inspectorate as representatives of the state and tax entities (citizens, enterprises, cooperatives) have developed in a complex and long way. Automated information processing systems were introduced almost from the first years of FTS operation. The main process of digital transformation of tax authorities was launched back in 2013. In the course of its development, the tax system of the Russian Federation has gradually moved from conducting continuous tax control to the concept of risk management. Certain provisions of the Tax Code are constantly being changed and improved [8, 9], including tax systems for different categories of taxpayers (special tax regimes). For example, starting from January 01, 2021, the single imputed income tax was abolished in Russia. In this regard, small businesses had to make strategic decisions due to the transition to a different tax regime, and review their relations with the tax service.

The main goal of digital administration is to maximize the completeness and timeliness of tax revenues to the budgets of the budgetary system of the Russian Federation. An additional goal is to provide conditions for taxpayers to perform their duties in good faith. Digital technologies of tax administration enable different categories of taxpayers to exist on an equal footing. The experience of other countries shows that «the IRS has troves the difference between the taxes that would be paid if taxpayers met all of their legal obligations, and those that the IRS actually receives and collects» [1, p. 1]. Today, taxpayers trust electronic tax services. For effective work such services as “taxpayer’s Personal account”, “checking the correctness of filling out invoices”, “professional income tax”, etc. are provided on the nalog.ru website. Millions of business operations of economic entities are monitored by inspectors in real time without requiring documents. State tax data processing centers (automated information systems) allow you to exchange information quickly and carry out transparent cooperation between FTS and legal entities, individual entrepreneurs, and individuals.

## 2 Methodology

In the study of our chosen topic, we analyzed legislative and regulatory documents of tax authorities, as well as the Tax Code [8, 9], Federal laws and various regulatory documents of tax authorities. After analyzing the works of scientists on the transformation of the economy into a digital one, we can conclude that this format of economic communication between different categories of subjects (the state, state bodies, legal entities, individuals) requires a careful approach and careful application. «In many countries the services are improved to increase voluntary tax compliance. Using a survey of 10,000 individual German taxpayers, we find that better service interaction quality (SIQ) is indeed positively associated with tax compliance» [2,

p. 1]. Thus, the purpose of this analytical work is to analyze the impact of the modern system of digital technologies in the tax sector on the activities of certain categories of taxpayers.

The objectives of the study are:

- evaluate the scale of digitalization of the tax structure and the algorithm of interaction with taxpayers;
- identify the positive and negative aspects of digital cooperation between tax authorities and taxpayers;
- propose elements of internal regulations for the taxpayer's work in the tax security contour to ensure good behavior;
- analyze the dynamics of tax crimes in the process of digital transformation of the economy;
- analyze the volume of tax information in the business digitalization system.

Information about FTS success in digitalizing processes and services is widely available, reliable, and appreciated by foreign colleagues. For example, the successful implementation of automated FTS systems led to a significant reduction in the number of employees by almost 15% (146 thousand people).

The way FTS works with data received from taxpayers, which is aggregated within a single system, is changing. Arrays of various tax and non-tax data are compared and analyzed among themselves, replacing fiscal policy with a risk-oriented one.

### 3 Results

Digital cooperation of economic entities with FTS directly depends on whether tax accounting is conducted at the enterprise in accordance with legislative norms or not. Enterprises should look for ways to legally reduce the tax burden, use available benefits, and look for ways to optimize costs in order to conduct their business safely. At the same time, we should not forget about the importance of internal control over the financial condition of the enterprise and the state of tax accounting, in particular. «Due to the complexities and ambiguities present in the tax laws, the tax authorities may have a different opinion of the firm's true taxes, particularly if the firm has aggressively avoided taxes» [5, p. 1198].

It should be noted that digitalization of tax operations and settlements in an organization is mandatory at the legislative level for those taxpayers who pay the main direct (profit tax) and indirect (value added tax) taxes. Here, based on the norms of the Tax code of the Russian Federation, separate requirements should be noted [8]:

- economic justification of expenses;
- availability of properly executed documents that not only ensure the completeness of accounting, but also confirm the fact of financial and economic activity;
- maintaining of tax accounting registers required for correct calculation of tax amounts;

- uploading incoming and outgoing primary tax documents (invoices) to the value-added tax return.

In the digital field, an important service for maintaining the company's tax security at the proper level is to exercise due diligence in relation to counterparties (suppliers, contractors, buyers, customers, other debtors and creditors). All individuals and legal entities have a taxpayer identification number and are registered in the FTS database. As part of the digital tax platform, it is necessary to check counterparties even more carefully than before, because there is a high risk of losing large amounts. For example, you can use the electronic service on the FTS website "Transparent business". And then indirect connections are formed between taxpayers through the digital tax platform. The choice of the method of checking counterparties depends on the financial capabilities of the companies, since free basic information does not include many aspects of the counterparty's activities. Therefore, you should evaluate the need to use paid services. Checking counterparties for good faith is quite time-consuming to facilitate the work of companies. Now a large number of different private websites and programs have been developed. Organizations can either independently conduct a trustworthiness assessment through the FTS website, or use specially developed paid services. Let's look at the possible private options in Table 1.

An unambiguous advantage of checking using special services in accordance with Table 1 is obtaining additional information. The main difference between these services and self-checking is that:

- data from all government websites is collected in one place;
- additionally, the financial performance of counterparties, including the threat of bankruptcy, is evaluated.

However, the cost of exclusive information about the counterparty on paid services is quite high. However, a company that plans to continue its business in the near future must annually renew the right to use automated accounting programs, electronic signatures, etc. to conduct its business.

When conducting a due diligence assessment by an organization, to confirm this fact, it is recommended to implement a trustworthiness assessment questionnaire, which will collect basic information on the counterparty (founders, type of activity, main financial indicators, etc.). The internal questionnaire was developed on the basis of the concept of the planning system for field tax audits [7]. It includes important criteria for assessing whether it is worth entering into a contract with a particular counterparty. According to the decision of the management, either an employee of the organization itself or a representative of the counterparty can fill out this questionnaire. This measure will improve document flow and financially interest employees in the proper performance of their duties. In addition to introducing penalties, it is necessary to conduct more frequent reconciliations with counterparties, and monitor accounts payable and receivables. Strengthen the internal control system.

Also, in order to avoid situations with unscrupulous counterparties, the possibility of digitalization of internal document flow should be considered. You should consider

**Table 1** Comparison of additional methods for checking counterparties

| Nº | Evaluation criteria                         | Self-check  | Verification using services   |
|----|---|---|---|
| 1  | 2   | 3   | 4   |
| 1  | Cost  | Free  | 1. SPARK Risks from 3,000 to 22,500 per year<br>2. Polygon.focus (from 22,000 to 61,500 per year)<br>3. SBIS “All about companies and owners” (from 6000 to 10,000 per year)<br>Free of charge—open information<br>Paid—additional private information                                |
| 2  | Time spent                                  | About 15 min  | Less than one minute for generating information   |
| 3  | Sources where you need to check information | Sites:<br>Tax service—pb.nalog.ru<br>rmsp.nalog.ru;<br>Bailiffs fssprus.ru/iss/Ip;<br>File of arbitration cases<br>kad.arbitr.ru;<br>Bulletin of state registration<br>-vestnik-gosreg.ru other<br>Internet sources and websites<br>of state bodies | One site depending on the selected counterparty (service developer):<br><a href="https://spark-interfax.ru">https://spark-interfax.ru</a><br><a href="https://sbis.ru/contragents">https://sbis.ru/contragents</a><br><a href="https://focus.kontur.ru/">https://focus.kontur.ru/</a> |

Source Authors

switching to electronic document management (hereinafter referred to as EDM). Many large companies have already abandoned paper documents and switched to electronic ones. In the near future, it is planned to use invoices only in electronic form in the activities of organizations. However, today not all companies, especially small ones, are ready to abandon paper documents. Therefore, to avoid unnecessary costs, you should ask customers whether they are ready to switch to electronic documents or not. The cost of EDM depends on the number of documents that the company will send, and whether it will be necessary to configure integration with an automated accounting program. According to the sources in the many companies the cost of the minimum fare is 900 rubles (100 outgoing documents a year without integration with 1C and without the ability to send documents to contractors using for other operators for EDM, SBIS, for example), further integration is about 11 800 rubles, and for sending documents to partners who use the services of another operator EDM it is necessary to buy a more expensive rate. Here you should also evaluate the financial possibilities and expediency of such a transition. Given the above, digitalization of your own business, especially in terms of the tax component, is an essential cost element for a taxpayer of any level. However, effective use of tax resources for free

business inspections and document management guarantees digital cooperation with the tax service in real time.

## 4 Discussion

Transparency and clarity of business, prevention of tax crimes-these are the main issues for discussion in the framework of digitalization of FTS activities. In the discussion field much attention is paid to the problems that arise in connection with the digitalization of tax relations: the relative cybersecurity of subjects, the presence of viruses, hacker attacks on large databases, information losses, distortion of tax information, the cost of ensuring the tax digital space, and many others. The view that online communication saves time and money is sometimes not confirmed. In our opinion, flexible and mixed forms of tax interaction should be used for certain transactions. In turn, taxpayers see huge restrictions on their rights due to total digitalization. In some cases, virtual communication may be less efficient and it may take a long time to get results, which leads to an increase in the transaction load in the form of emails and messages. Implementation of industry projects is also covered by the Federal tax service of Russia. The volume of tax reporting in electronic format has grown by 95% over 20 years. It focuses on creating transparent and fair competition, eliminating fraudulent tax optimization schemes, and building partnership relations between the tax service, tax agents, and taxpayers. «At the same time, leading tax agencies seek to promote an investment climate by providing high levels of certainty and service to taxpayers» [3, p.1].

Here is an example of direct digital communication between an organization and FTS. An effective tool is the ASK VAT program (since 2013). This system includes data on registration of legal entities and individual entrepreneurs, bank accounts, email addresses, and customs service data. In 2020, it processed more than 15 billion invoices. And in parallel, the minimization of income tax is being monitored, which is also a sign of bad faith. The use of the ASK VAT service has significantly reduced tax crimes related to the calculation and payment of value-added tax. According to tax statistics, the share of doubtful transactions for the specified tax has decreased ninefold over the six years of operation of the service (since 2015). It tracks the movement of funds between accounts of legal entities along the chain of transactions. And tax risks are calculated:

- high (the organization does not pay or minimizes basic taxes as much as possible);
- average (the organization does not fully meet its tax obligations);
- low (the organization does not have any tax arrears and does not allow violations of the law).

Total gaps (problems with declarations, discrepancies in information) between data on accrual and deduction of VAT related entities are eliminated through the practice of desk and field inspections.



**Table 2** Information on the functioning of online sales registers in Russia

| № | Information criteria                              | Disclosure of information  |
|---|---|--|
| 1 | Number of online sales registers<br>February 2021 | 34, million units  |
| 2 | Number of fiscal data operators                   | 21 companies (incl. <a href="https://sbis.ru/contragents">https://sbis.ru/contragents</a> ;<br><a href="https://focus.kontur.ru/">https://focus.kontur.ru/</a> ) |
| 3 | Number of checks (transactions) per day           | 150 million pieces   |

Source Authors

Currently, Russian tax authorities control not only tax, but also accounting information through the State information resource of accounting statements service. A complete picture of the activity of an economic entity is formed in one information array. «Most studies on the effect of tax authority monitoring on managerial misbehaviour are limited to the US setting where the level of book-tax conformity is relatively low. Tax authority provides an effective monitoring mechanism under a high level of book-tax» [6, p. 1].

Another digital control technology used by tax inspectors is the collection of data on wholesale and retail sales via online sales registers in real time. Due to this service, the trading process (cash payments and using payment cards) becomes absolutely transparent. At the time of purchase via the online sales register, data is immediately sent to the FTS, where information is automatically analyzed (Table 2).

Today, the public is actively discussing the issue of amendments to the Tax Code of the Russian Federation, which clearly prescribes access by tax authorities to the tax secrets of individuals. Individuals and the public, of course, are outraged by such amendments, so the tax authorities should now conduct explanatory work with citizens to reduce discontent related to the digitalization of tax relations. If, for example, FTS data on family ties (husband, wife, children, next of kin), then this information will help identify cases of business fragmentation and company affiliations. Tax compliance represents a social dilemma in which the short-term self-interest to minimize tax payments is at odds with the collective long-term interest to provide sufficient tax funds for public goods [4].

An example of effective interaction between businesses, individuals and the tax service is the professional income tax. The fact is that taxpayers (especially individuals) have historically experienced discomfort from interacting with tax authorities. The application for self-employed citizens who apply the “My tax” professional income tax regime has simplified the administration of this cluster of taxpayers as much as possible and adequately reduced the tax burden on them.

As an example, you can cite the activity of renting out your own residential property. Before the introduction of the regime for self-employed citizens, the tax base for the above-mentioned activities was income from renting out property and paying personal income tax on this income, the rate of 13%. Currently, the tax burden for this category of taxpayers has decreased from 13 to 4% or 6%, depending on the counterpart. «In daily life, the efficiency and effectivity of the tax administration

is impacted by rapid changes in its operating environment, and by the nature of the relationship between tax authority and taxpayer» [10, p. 48]. The electronic service “taxpayer’s Personal account” is used by 28 million citizens, 1.77 million individual entrepreneurs and 819 thousand organizations. In March 2021, this service will be connected to an array of data on online sales registers. If you pay for a purchase with a Bank card, a citizen will be able to analyze their purchases on the FTS website.

## 5 Conclusion

As a result of the study, we can draw conclusions about the weaknesses and strengths of digitalization of the tax system. Of course, the process of business digitalization is impossible without tax transparency and tax planning, tax administration, tax monitoring, etc. The taxpayer (legal entity, individual entrepreneur) must be responsible. Interaction within an ever-expanding digital platform minimizes real-time tax risks for businesses of various sizes, and for this you need to:

- keep up to date with the latest legislative changes, improve the skills of employees, attend seminars, and get training;
- regularly analyze risks and financial indicators, be able to resist them and take proactive measures, in particular, when entering into contracts, exercise due diligence;
- strengthen internal control and conduct reconciliation of settlements with counterparties on a quarterly basis before submitting reports, since each completed document affects the indicators of tax reports submitted, as well as accounting reports (state information resource for accounting statements).);
- improve the document management process, for example, by connecting to electronic document management, because the availability of supporting documents is also a key to maintaining economic and tax security at the proper level. Primary accounting documents indicate that the transaction actually took place and thereby reduce the risks of non-payment by counterparties, and confirm the economic validity of the expenses incurred.

A taxpayer (individual) should also be responsible and understand that the scope of tax control is expanding, the financial situation of a citizen becomes as transparent as possible, and personal taxes must be paid in a timely manner. Digital cooperation between the tax service and taxpayers allows you to ensure the openness and transparency of the economy and comply with the requirements of tax legislation on time and without fraudulent schemes. Contactless work of FTS with taxpayers in real time requires trust, honesty, timeliness and mutual guarantees of economic security, since the economic security of the state depends on the financial condition of the taxpayer.

## References

1. Alarie, B., Niblett, A., Yoon, A.: Data analytics and tax law (2019). <https://doi.org/10.2139/ssrn.3406784>. Accessed: 21.03.2021
2. Blaufus, K., Hechtner, F., Jarzembki, J.: Do better tax agency services improve taxpayer compliance? Evidence from Germany (2020). <https://doi.org/10.2139/ssrn.3750859>. Accessed: 21.03.2021
3. D'Ascenzo, M.: Global trends in tax administration (2015). <https://doi.org/10.2139/ssrn.3173515>. Accessed: 21.03.2021
4. Gangl, K., Hofmann, E., Kirchler, E.: Tax authorities' interaction with taxpayers: a conception of compliance in social dilemmas by power and trust. *New Ideas Psychol.* **37**, 13–23 (2015)
5. Hanlon, M., Maydew, E.L., Saavedra, D.: The taxman cometh: does tax uncertainty affect corporate cash holdings? *Rev. Acc. Stud.* **22**, 1198–1228 (2017)
6. Kałdoński, M., Jewartowski, T.: Do firms using real earnings management care about taxes? evidence from a high book-tax conformity country. *Finan. Res. Lett.* **35**, 101351 (2020)
7. Order of the Federal Tax Service of May 30, 2007 N MM-3-06/333@ “On approval of the concept of the system for planning on-site tax audits” (with amendments and additions) (2007). [http://www.consultant.ru/document/cons\\_doc\\_LAW\\_55729/](http://www.consultant.ru/document/cons_doc_LAW_55729/). Accessed 20 Mar 2021
8. Tax code of the Russian Federation (part one) No. 146-FZ of 31.07.1998 (2021). [http://www.consultant.ru/document/cons\\_doc\\_LAW\\_19671/](http://www.consultant.ru/document/cons_doc_LAW_19671/). Accessed 20 Mar 2021
9. Tax code of the Russian Federation (part two) of 05.08.2000 No. 117-FZ (2021). [http://www.consultant.ru/document/cons\\_doc\\_LAW\\_28165/](http://www.consultant.ru/document/cons_doc_LAW_28165/). Accessed 20 Mar 2021
10. Végh, G., Gribnau, H.: Tax administration good governance. *EC Tax Review* **2018–1**, 48–60 (2018)

# Digital Marketing in the Post-pandemic World



I. V. Yakhneeva, A. V. Pavlova, and N. V. Kalenskaya

**Abstract** The purpose of this paper is to analyse the impact of Covid-19 pandemic on consumer behavior and digital marketing transformation. We consider whether consumers will change their habits under the influence of Covid-19 pandemic. We also discuss some potential directions of how digital marketing mix will be modifying due to new consumer experience. The results of the study show that consumer values are changing. Health care, shopping safety and digital interaction are becoming the most significant trends. To succeed in business development, it is necessary to understand whether these trends are reversible.

**Keywords** COVID-19 · Customer behavior · Customer values · Digital marketing · Marketing mix

## 1 Introduction

The crisis caused by the Covid-19 pandemic will affect the development of marketing in various ways, including the philosophy, thinking and concepts [1]. It is likely that marketing concepts will be revised. Companies motivated by the concept of societal marketing have a long-term focus. However, the pandemic has forced short-term goals above long-term ones [2]. Consumers' opinions, beliefs, values, habits evolve through both good and bad experiences. The Covid-19 outbreak will have a profound effect on consumer experience, changing existing habits and creating new ones. Sheth divides habits into modified and new habits, and considers eight immediate

---

I. V. Yakhneeva (✉)  
Samara State University of Economics, Samara, Russia  
e-mail: [yakhneevai.v@sseu.ru](mailto:yakhneevai.v@sseu.ru)

A. V. Pavlova  
Volga Region State Academy of Physical Culture, Sport and Tourism, Kazan, Russia  
e-mail: [930895@list.ru](mailto:930895@list.ru)

N. V. Kalenskaya  
Kazan Federal University, Kazan, Russia

effects of the Covid-19 pandemic on consumption and consumer behavior: hoarding, improvisation, pent-up demand, embracing digital technology, store comes home, blurring of work-life boundaries, reunions with friends and family, discovery of talent [1]. Companies can guide customer behavior driving the consumer experience. In that case they position themselves at the forefront of shaping the consumer experience in the next normal situation [3]. Therefore, the attention of researchers is now focused on studying trends that can have a sustainable long-term character [1, 4–7].

Marketing is based on shared arrangements, perceptions of value and communication, which changed radically for many buyers and suppliers during the Covid-19 events. The dominance of face-to-face interaction was slowly eroding by the evolution of online communications. However, the personal way of communicating was severely limited with online interaction becoming dominant at one point [6].

One of the main issues is how to estimate long-term effects of the pandemic. Although society has been hit by several pandemics in the past, it is difficult to estimate the long-term economic, behavioral, or societal consequences as these aspects have not been studied to a great extent in the past [5].

Most successful companies are well aware of what behaviors and experiences are gaining traction. They invest in activities that may provide the appropriate positioning for the company. Companies have to track consumer trends adapting their business models and changing their marketing mix in response to changes in consumer experience and habits. Many researchers agree that the post-Covid-19 marketplace has become irrecoverably different [1]. A key facet is the exponentially growing shift to digital change. Another point is whether Covid-19 accelerated on-going trends or whether these trends are reversible.

## 2 Methodology

The study is based on the analysis and synthesis of research data during the COVID-19 pandemic. The empirical base includes a number of surveys focused on consumer behavior before and after the lockdown. The surveys published by research companies: PwC [8], McKinsey [3], Ernst & Young Global Limited [9], Bain & Company [10], GfK [11], BCG [12]. Findings take into account the markets of Russia, Europe and the US. The surveys were conducted in 2020. Respondents were asked questions concerning their consumer behavior and attitudes, as well as their plans for the future. The study is conducted in the context of marketing model 7P.

## 3 Results

The studies indicate the long-term trends that determine changes in consumer behavior:

- focus on health, wellness and self-care, on healthy lifestyle;
- safe and profitable purchases;
- the expansion of e-commerce and digital technologies, the rise of the contactless economy;
- new consumer habits, particularly those related to keeping the social distance.

One of the key trends is a shift in consumer values, which is reflected in consumer behavior. In most cases, this shows up in an increased digital experience, which requires a transformation of the digital marketing mix (Table 1).

The most obvious trend is the change in demand for certain types of goods and services. According to the surveys, over 70% in Russia pay more attention to physical health and keeping fit [8]. In the US, 53% of consumers are even more concerned about their health now than they were prior to Covid-19 [10]. A stronger focus on healthy lifestyle is being shown by the generation of young Millennials and Gen Z, who have started using digital services to maintain physical activity, healthy eating, etc. Moreover, the majority of surveyed consumers say they will continue to replace nondigital experiences with the virtual substitute [10].

Consumer attitudes toward environmental and sustainability issues are contradictory. On the one hand, society is concerned about these problems, but only about half are willing to pay more for goods and services that do not have a negative impact on the environment. Personal comfort remains a priority under existing financial constraints, so people are looking for options that will fit into a familiar lifestyle without paying extra for new environmental habits [8]. Across countries, consumers are expressing a heightened preference of safety over sustainability. They are prioritizing safety-related factors over factors such as “sustainable ingredients.” Moreover, governments around the world are lifting bans or taxes on single-use plastics as consumers seek the safety of plastic food wrapping.

Another ambivalent trend is related to the choice of brands. Thus, according to PwC, more than a third of respondents (36%) prefer goods with a discount, while 18% have switched to cheaper brands [8]. The growth of unemployment, reduction of disposable income caused the desire to save money, to make practical and economical purchases. According to BCG, 59% of respondents feel financial insecurity demonstrating the desire to buy at a low price and hunting for bargains [12]. On the other hand, lower costs or the inability to spend money on travel and entertainment have led to an increase in the consumption of premium brands [10].

The rise in the popularity of online shopping has become a steady trend. About 34% of respondents around the world plan to order more food online, in Russia about 16% of respondents plan such an increase [8, 11]. Differences between countries are explained by the level of development of online commerce in the pre-pandemic period, as well as the infrastructure quality. In most countries of the world, COVID-19 will facilitate online commerce including food sales where historically online has always been inferior to conventional retail [9].

The implementation of the contactless interaction with the customer (automated cash registers, shopping without staff, virtual product experience, e-commerce apps,

**Table 1** Marketing mix transformation

| Marketing tool    | Trends  | Changes  |
|-------------------|---|--|
| Product           | <p>Consumers are increasingly paying attention to products, services, and information that are related to health, environmental issues, and sustainability</p> <p>New purchase drivers—brand trust and personal safety</p>                      | <p>Ensuring customer safety during the purchase and consumption of goods and services</p> <p>Development of product mix and packaging with environmental and safety in mind</p> <p>Combining the consumer’s familiar lifestyle and socially responsible business practices</p> |
| Price             | <p>Increasing price sensitivity</p> <p>Practicality and frugality drive purchasing behavior</p> <p>Slow recovery in spending on out-of-home activities</p> <p>Shifting to premium or low-cost brands</p>  | <p>More attention to discounts and promotions</p> <p>Loyalty programs focused on value propositions and personal discounts</p>   |
| Place of sale     | <p>Higher consumer expectations and a focus on the customer experience</p> <p>Convenience is one of the key drivers of purchase</p> <p>A dramatic shift in online consumption</p> <p>Increased popularity of direct selling (D2C) platforms</p> | <p>Improvement of omni-channel technologies and offering individual customer experience</p> <p>Introduction of new technologies in retail</p> <p>Interaction with new industry partners and marketplaces</p>   |
| Promotion         | <p>The rise in popularity of online interaction</p> <p>High user activity in social networks and messengers</p>   | <p>Social media is the main channel for personalized marketing</p> <p>Showing business reliability and support</p> <p>User content generation</p> <p>Receiving feedback throughout the supply chain</p>  |
| People            | <p>Desire to use contactless methods</p> <p>Desire to make purchases without staff involvement</p>  | <p>Staff development in the use of digital technology</p>  |
| Process           | <p>Requirements for the quality of service (delivery) and data security</p> <p>Compliance with secure service standards</p>   | <p>Improving the level of service through the introduction of digital methods</p> <p>Chatbot development</p>   |
| Physical evidence | <p>Consumer desire for a virtual experience of goods and services</p> <p>Increase in the share of online purchases via mobile devices</p>   | <p>Providing a presence on digital platforms</p> <p>Virtual navigation and support</p> <p>Mobile web content adaptation</p>  |

Source Authors

**Table 2** Digital marketing solutions offered during the pandemic

| Company              | Digital marketing solutions                          |
|----------------------|--|
| SberMarket<br>Lamoda | Electronic tips for couriers and procurement experts |
| Hoff                 | Video consulting service                             |
| Pyaterochka          | Digital information assistant service                |
| Azbuka Vkusa         | Automated store without cashiers                     |
| M. Video             | Online product demonstration<br>Non-contact returns  |
| Lamoda<br>Ozon       | Video shopping                                       |

*Source* Authors

etc.) is becoming a relevant trend for the consumer goods market. The leaders in digital innovations are retailers (Table 2).

Given the findings, two significant changes can be observed:

- the way consumers shop;
- the factors that influence purchases.

In both cases, innovation and technology have proven paramount to maintaining a positive consumer experience and have been the key to success for companies that have strengthened their online communications with technology-based solutions [8]. To ensure sustainable business growth, companies will have to undergo a digital transformation that is responsive to current online trends. Innovation and technology have an increasingly important role in the consumer experience. Therefore, it is crucial to keep track of trends in the use of online channels in order to be able to quickly adapt to changes in consumer behavior.

## 4 Discussion

The lockdown and social distancing have dramatically affected consumer behavior. In turn, this has given rise to several new opportunities for research. These opportunities include the combination of in-person and online interactions, traditional and digital services, economic and social aspects of business. Industries that prior to the pandemic were focused on face-to-face interaction have found means to interact via online means, so it seems likely that much of this change will continue [1]. On the other hand, during the lockdown, Russians realized the need to have time for themselves and their loved ones. 70% of GfK survey participants say they will appreciate their time more, they hope to spend more time with family and friends [11]. In this regard, isn't the desire for a live communication one of the underlying reasons for starting Clubhouse?



The growth of social media activity has stimulated the increased use of digital communications. In this context, digital data collection and analysis systems including video content analysis, machine learning and artistic intelligence are becoming highly relevant for the marketers [7].

One of the main research areas relates to sustainable development. Many business leaders had hoped that Covid-19 would serve as an inflection point for sustainability. But the course is muddled [10]. Accordingly, the question remains open about the importance of environmental and social motives for consumers in the future.

## 5 Conclusion

The pandemic has significantly changed the market landscape. Behavioral patterns formed during the lockdown will be the basis for revising companies' marketing strategies and tactics. In particular, the pandemic has accelerated the diffusion of digital technology, which has already led to an increase in the implementation of contactless interaction with customers. Digital communications are likely to gain traction and become more diverse as the pandemic has reinforced the upward trend in online shopping. Consumers are experimenting with remote access to goods and services more frequently. The growing popularity of various online channels (mobile devices, PCs, tablets, smart assistants) has contributed to the increase in online sales among retailers, IT and service companies. Against the backdrop of digitalization and the growth of social media activity, personalized offerings have become increasingly important. Consequently, it would be possible to match products and promo offerings to consumer expectations.

## References

1. Hongwei, H., Lloyd, H.: The impact of Covid-19 pandemic on corporate social responsibility and marketing philosophy. *J. Bus. Res.* **116**, 176–182 (2020). <https://doi.org/10.1016/j.jbusres.2020.05.030>
2. Anwar, Y., El-, N.: Marketing and the sustainable development goals (SDGs): A review and research agenda. In: Idowu, S., Schmidpeter, R., Zu, L. (eds.) *The Future of the UN Sustainable Development Goals. CSR, Sustainability, Ethics & Governance*, pp. 187–207. Springer, Cham (2020)
3. Emmanuelli, C., Jain, N., Maechler, N., Malfara, D., Moritz, S., Neher, K., Nelson, A., Thomas, A.: Elevating customer experience excellence in the next normal. <https://www.mckinsey.com/business-functions/operations/our-insights/elevating-customer-experience-excellence-in-the-next-normal> (2020). Accessed 15 Feb 2021
4. Carracedo, P., Puertas, R., Marti, L.: Research lines on the impact of the COVID-19 pandemic on business. A text mining analysis. *Journal of Business Research*. <https://www.sciencedirect.com/science/article/pii/S0148296320307967?via%3Dihub> (2020). Accessed 15 Feb 2021
5. Donthu, N., Gustafsson, A.: Effects of COVID-19 on business and research. *J. Bus. Res.* **117**, 284–289 (2020). <https://doi.org/10.1016/j.jbusres.2020.06.008>

6. Kirk, C., Rifkin, L.: I'll trade you diamonds for toilet paper: consumer reacting, coping and adapting behaviors in the COVID-19 pandemic. *J. Bus. Res.* **117**, 124–131 (2020)
7. Sheth, J.: Impact of Covid-19 on consumer behavior: will the old habits return or die? *J. Bus. Res.* **117**, 280–283 (2020)
8. Dolgih, E., Yerlich, V.: Consumer transformation. Global consumer behavior survey 2020: Russia. <https://www.pwc.ru/ru/retail-consumer/publications/assets/pwc-global-customer-insights-survey-2020-russia-ru.pdf> (2020). Accessed 15 Feb 2021
9. Halilov, D.: Future consumer index: How COVID-19 affects consumer behavior in Russia. [https://www.ey.com/ru\\_ru/consumer-products-retail/ey-future-consumer-index-russia](https://www.ey.com/ru_ru/consumer-products-retail/ey-future-consumer-index-russia) (2020). Accessed 20 Jan 2021
10. Faelli, F., Rovit, S., Apps, Ch., Johns, L.: Shaping the consumer of the future. Brands should consider eight themes as they define the post-Covid-19 world for consumers in the US and Europe. <https://www.bain.com/insights/shaping-the-consumer-of-the-future> (2020). Accessed 20 Jan 2021
11. GfK: Social interaction and shopping after completing self-isolation. <https://www.gfk.com/ru/press/Gfk-Study-Socializing-and-Shopping-After-Self-Isolation?hsLang=ru> (2020). Accessed: 20 Jan 2021
12. BCG: Russian consumers are the new reality. <https://www.bcg.com/ru-ru/press/9october2020-bcg-romir-research-fighting-brands-for-new-consumer> (2020). Accessed 12 Jan 2021

# Trends in Information and Communication Technologies Development in Context of Economy Digitalization



A. V. Volkodaeva, A. V. Balanovskaya, and E. A. Rustenova

**Abstract** The authors of the article made an attempt to study the importance of information and communication technologies in the development of economic processes. There is a significant increase in the speed of dissemination of various achievements of the information and communication industry in the activities of organizations and institutions. The authors analyze the dynamics of the development of information and communication technologies at various levels of management of organizations and institutions, identify the industries with the highest rates of development. In this study, it was impossible to avoid the question of the impact of the achievements of the information and communication industry on the lives of ordinary people and society as a whole. As a result, the emergence of new types of threats to information security was noted. The negative and positive consequences of the digitalization of the economy are identified and recommendations are made for improving the areas that affect the effective solution of the problems of economic sectors digitalization and the processes of society's life, which will have an impact on improving the quality of life in general and will help organizations and the country to improve their positions on the market.

**Keywords** Digitalization · Economy · Information and communication technologies · Information security · Threats

## 1 Introduction

The modern development of human life in the domestic and professional aspects is already impossible to imagine without the use of information and communication

---

A. V. Volkodaeva  
Samara Branch of the Moscow City University, Samara, Russia

A. V. Balanovskaya (✉)  
Samara State University of Economics, Samara, Russia

E. A. Rustenova  
Zhangir Khan University, Uralsk, Kazakhstan

technologies. They improve the quality of life, enable the effective functioning of socio-economic systems, ensure the transformation of all sectors of the economy and, in the long term, ensure high rates of development of various industries. Information and communication technologies have been one of the key drivers of socio-economic development over the past decades [1]. The current situation with the pandemic caused by the COVID-19 coronavirus infection had a great impact on the speed of change in the processes of implementing information and communication technologies in the development of digital economy. All spheres of human activity and the life of society as a whole were affected, including at the deep level associated with the technological way of social development. The speed of the appearance of new IT products on the market allows to make a conclusion about the beginning of information revolution. These processes, of course, pose new challenges to society due to the emergence of new information threats. The peculiarity of this stage is that the issues of ensuring information security are becoming increasingly important not only at the international level, at the national level or at the level of organizations and institutions, but also at the personal level.

## 2 Methodology

The conceptual approach to the study of the essence of information and communication technologies certainly draws some analogy with the concepts in the field of information technologies. As a common approach, we can note the mention of such components as elements and processes, search methods, methods of collecting and storing, stages of providing and distributing information [2]. The variety of approaches to the essential meaning of these concepts is beyond doubt. However, they all come down to the listing of a number of components of the enterprise information system (techniques, methods, methods, tools, resources) that ensure its effective functioning through the use of technical means, means of communication and software products. Information and communication technologies allow to rationally build organizational processes, ensure the quality of performance of tasks, and identify the causes and reserves of reducing resource costs in organizations and institutions. In addition, the definition of information and communication technologies focuses on emphasizing their role in the process of human interaction with the external environment. The combination of information and communication concepts essentially lays the foundation of human adaptation to modern conditions of digitalization. The use of information and communication technologies makes it possible to ensure the activation and effective use of the information resource accumulated by the society. Increasing the efficiency of the use of the accumulated information resource leads to its more complete use for the development of the economy, especially taking into account the emerging information society.

### 3 Results

The digital economy is based on the economic activity of people, organizations, institutions and other entities based on the use of information and communication technologies. The development of the digital economy is ensured by the development of information and communication technologies, through their introduction and maximum use in the processes of ensuring interaction between suppliers and consumers of goods and services. Let's consider the use of information and communication technologies in organizations, according to the Russian Statistical Yearbook [3] (Table 1).

According to the data presented, in 2019, there was a decline in a number of components of information and communication technologies in organizations, while in 2018, the growth rates were more dynamic. This is due to the relatively high ratio of organizations that use information and communication technologies in their activities, out of the total number of organizations that provided information.

According to the data, only 53.8% of organizations use servers in their work, despite the fact that it is the server that ensures the security and safety of the main activities of organizations and institutions by storing information, uninterrupted operation of the website, prompt response to user requests, ensuring the operation of the local network, access to the organization's data, and much more.

In the analyzed period, the use of local area networks decreased slightly. They are able to combine several personal computers in a limited area, i.e. within a single organization and provide all employees with access to information, its processing and transmission. The use of information and communication technologies in various fields and spheres of activity is presented in Table 2 [3].

These tables in most cases show a slight increase (up to 1.5% by 2019) and also a slight decrease (up to 1.68% by 2019) in the use of information and communication technologies in various fields and spheres of activity. In general, for all these types of activities, the decrease is 0.6%.

**Table 1** Statistics of the use of information and communication technologies in organizations in 2017–2019 (as a percentage from the total number of studied organizations)

| Organizations that used information and communication technologies | 2017 | 2018 | 2019 | Growth rate, % |           |
|--|------|------|------|----------------|-----------|
|  |      |      |      | 2018/2017      | 2019/2018 |
| Personal computers   | 92.1 | 94.0 | 93.5 | 102.1          | 99.5      |
| Servers  | 50.6 | 53.4 | 53.8 | 105.5          | 100.7     |
| Local area networks  | 61.1 | 63.9 | 63.5 | 104.6          | 99.4      |
| Email  | 88.3 | 90.9 | 91.1 | 102.9          | 100.2     |
| Internet   | 88.9 | 91.1 | 91.2 | 102.5          | 100.1     |
| • Including broadband access                                       | 83.2 | 86.5 | 86.6 | 104            | 100.1     |

Source Authors

**Table 2** The use of information and communication technologies in organizations by types of economic activity for 2017–2019 (as a percentage of the total number of studied organizations)

| Types of economic activity  | 2017        | 2018        | 2019        | Growth rate, % |              |
|---|-------------|-------------|-------------|----------------|--------------|
|   |             |             |             | 2018 to 2017   | 2019 to 2018 |
| Agriculture, forestry, and fishing industries                                   | –           | –           | 82.5        | –              | –            |
| Industries that extract minerals  | 90.7        | 88.5        | 87.5        | 97.6           | 98.9         |
| Industries providing manufacturing activities                                   | 95.5        | 94.1        | 94.2        | 98.5           | 100.1        |
| Industries providing various types of energy                                    | 94.2        | 93.5        | 94.9        | 99.3           | 101.5        |
| Industries of water supply and sanitation, as well as disposal of pollutants    | 85.5        | 88.8        | 90.2        | 103.9          | 101.6        |
| Construction sphere   | 88.9        | 86.2        | 84.2        | 96.9           | 97.7         |
| Trade and repair service industries   | 94.5        | 95.2        | 93.6        | 100.7          | 98.3         |
| Logistics transportation and storage industries                                 | 93.4        | 92.8        | 92.8        | 99.4           | 100.0        |
| Industries in the field of services of the tourist business and public catering | 90.5        | 88.7        | 89.8        | 98.0           | 101.2        |
| Telecommunications and communications support industries                        | 97.3        | 96.6        | 96.5        | 99.3           | 99.9         |
| Insurance and financial management industries                                   | 94.9        | 96          | 96.4        | 101.7          | 100.4        |
| Real estate management services industries                                      | 65.6        | 86.5        | 87.7        | 131.9          | 101.4        |
| Branches of scientific, technical and professional activity                     | 93.1        | 92.4        | 92.3        | 99.2           | 99.9         |
| Processes administration support industries                                     | 89.7        | 89.3        | 89.4        | 99.5           | 100.1        |
| Field of public administration and social policy                                | 97.2        | 97.2        | 97.1        | 100.0          | 99.9         |
| Field of higher education   | 98.4        | 96.8        | 95.9        | 98.4           | 99.1         |
| Area of medical and social services   | 96.8        | 97.1        | 96.8        | 100.3          | 99.7         |
| The area of culture, sports, leisure and entertainment of the population        | 91.1        | 91.9        | 92.4        | 100.9          | 100.5        |
| Other activities  | 93.9        | 91.2        | 88.3        | 97.1           | 96.9         |
| <i>Total</i>  | <i>92.1</i> | <i>94.1</i> | <i>93.5</i> | <i>102.2</i>   | <i>99.4</i>  |

Source Authors

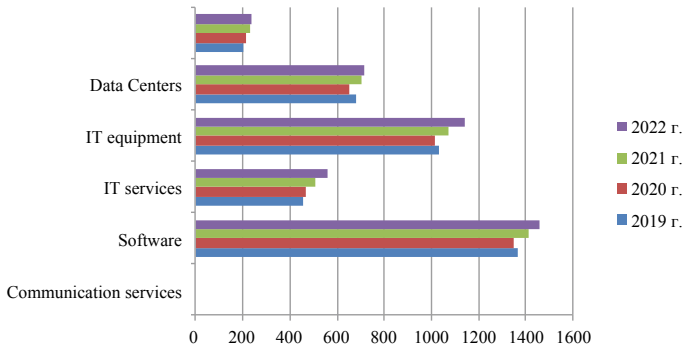
Over the past two years, the largest growth in the use of information and communication technologies has been observed in the field of real estate operations, and accounts for 31.9% in 2018 compared to 2017 and 1.4% in 2019. This pace is also due to the intensive implementation of innovative solutions in all real estate sectors for all stages of the project life cycle—from design and construction to management and operation (Property Technologies). Innovations in the field of design and construction to management and operation (PropTech) are carried out using big data technologies, virtual and augmented reality, artificial intelligence, the internet of things, blockchain and others. Experts note that the volume of investments in the PropTech market in the next 5 years will grow significantly, taking into account the existing trends, since in 2017–2018 more than \$16 million was invested in Russian PropTech, while in 2013 the volume of investments did not exceed 1 million dollars [4].

Since 2015, data processing centers have been intensively developed as areas for hosting server and network equipment. The largest data processing center suppliers in Russia in 2018 were Rostelecom, DataLine, Selectel and others (Linxdatacenter, Ixcellerate, Stack Telecom, DataPro, Servionika, DataSpace, Xelent). The total revenue of Russian data processing center operators at the end of 2018 amounted to 28.5 billion rubles, the growth rate for the third year in a row is about 25% [4].

Today, virtual reality (VR) and augmented reality (AR) technologies, geoanalytic tools, Internet of Things (IoT) technologies, voice assistance, and personalized advertising offers based on big data analysis are beginning to be used in real estate operations. For example, AR and VR technologies allow to conduct a virtual tour of an object under construction, carry out geographically distributed transactions, process scripts, communications and develop soft skills, and use interactive simulations in corporate training [5].

The development of PropTech in the field of real estate operations is due to the need for end-to-end interaction between market participants at all stages of project implementation and to improve the efficiency of the functioning of organizations in this industry [6]. According to statistical reports on the use of information and communication technologies, there is an increase of 5.5% in 2019 by 2017 in the field of activities of organizations for water supply, water disposal, organization of waste collection and disposal, as well as activities for the elimination of pollutions [3]. This fact is explained, among other things, by increasing investments in the development of environmental friendliness of the production sector and ensuring the safety of the population.

According to the studies, the share of the information and communication technologies sector in Russian GDP by the end of 2020 reached a record 3.1% (against 2.9% a year earlier) [7]. However, according to the analytical company Gartner data, the global market of information and communication technologies has downward trends in the same volume as the growth of the Russian market (3.2%). Industry experts attribute this to the period of the beginning of the pandemic and the reduction of the budget of organizations, including for equipment, software and services. The growth of the information and communication technologies market in Russia, on the contrary, according to experts, is associated with the demand for digital goods



**Fig. 1** Trends in spending change on information and communication technologies (in billions of dollars). *Source* Authors based on [7]

and services, as well as planned measures to digitalize the economy and social sphere [7]. Statistics of global spending on information and communication technologies are presented in five components, which include data processing centers (including servers and local area networks), IT equipment (including personal computers), IT services (ready-made solutions in the field of information technologies offered by specialized companies), software (enterprise-level) and communication services (including e-mail and the Internet).

Figure 1 shows data from Gartner analytical company, that measures changes in information and communication technology spending.

The figure shows that the three indicators (communication services, IT services, and IT equipment) showed the greatest changes. The IT equipment segment had the biggest decline in sales ( $-4.2\%$ ), but by the end of 2021, growth of  $7.9\%$  is already forecasted. The largest increase in spending on information and communication technologies is observed in the data processing centers parameter and amounts to  $4.9\%$ . According to experts, sales volumes for this parameter will continue to grow and will increase by  $6.2\%$  by the end of 2021 [7]. Large IT companies continue to strengthen their positions on the market, which have the ability to collect, extract, and analyze information about market trends and changes. This data becomes the knowledge that contributes to the capitalization of the business. Despite the fact that experts predict software sales growth of  $1.9\%$  in 2021, by the end of 2022, the growth will be  $8.7\%$ . Experts in the field of information and communication technologies determine the absence of changes in the “communication services” sector by the end of 2022 compared to 2021.

The potential for growth in sales of IT equipment may be due to the development of remote education and work, when there was a demand for personal computers and tablets. In addition, there is a demand for cloud services. Growth in corporate-level software, including solutions for information security and personal data protection [7]. These issues should be given special attention. The challenges of modern processes associated with the onset of the pandemic, which occurred at the end of 2019, are accelerating due to the fact that there was a synergistic effect that led to an



increase in the use of remote work opportunities for a huge number of participants in the process, which affected the change in the sustainable functioning of the entire information system at the organization, country and international level. The attention paid to socially significant processes at the level of public discussions leads to an increase in interest in the violation of information security. The distribution of threats, according to the mentioning of them on the Internet from the most frequent to the lack of it, is as follows: phishing threats; remote access security; failures, failures in operation, violation of availability; attacks on organizations and institutions; leakage of personal data. Information security threats determine the need to ensure the security of remote access to information system resources, achieve the sustainable functioning of IT infrastructure facilities, etc. Among phishing threats, there are two types: phishing attacks, the purpose of which is to illegally obtain identification and other private information about a person; financial fraud, aimed directly at unauthorized receipt of money or access to bank accounts. According to various researchers, the number of phishing attacks on users has increased by more than 5 times.

Taking into account the significant increase in the number of users, two tasks should be solved within the framework of ensuring information security. The first is to ensure uninterrupted operation in the event of a peak load on information systems. The second task is to provide mass access to corporate networks of organizations and institutions.

Uninterrupted operation in the remote form of work and training depends on the capacity of the channels of home networks and Internet channels, on the capabilities of the server equipment, its software and information storage. The situation of peak load growth in the context of the pandemic was managed due to the built-in reserves in case of overload, which ensured the stable functioning of information systems in the conditions of the most active use of information and communication technologies.

The use of information and communication technologies by the working-age population for their own use will increase rapidly. This is due to the need to adapt to the new format of work and, in turn, will contribute to the transformation of companies' activities to ensure the possibility of remote employment. It should be noted that the pace of development of the digital economy largely depends on the infrastructure created at the level of each individual country, the introduction of modern information technologies, the availability and speed of the Internet.

## **4 Discussion**

Differences in the readiness of certain countries, organizations, and institutions to exist in the digital economy are determined by digital gaps, which in turn are determined by the speed of implementation of information and communication technologies. This mainly concerns such factors as the infrastructure of information and communication technologies and services, the qualifications of employees,

the formation of the regulatory framework and internal regulatory documents of organizations.

Both countries and organizations will be forced to take measures to close the digital divide. In addition, measures will be taken to ensure the compatibility of the various information platforms and to address issues of ensuring the protection of personal data. Very actively and everywhere in the life of ordinary users, the concepts of using smart things and artificial intelligence will begin to be introduced.

The above-mentioned trends will require the search for new ideas. These ideas in the form of startups can be obtained by implementing programs to finance entrepreneurial initiatives based on public–private partnerships in order to select them and further support them.

To manage the processes, the main attention should be paid to the formation of unified scientific and educational platforms, the base of scientific developments, and to ensuring the digitalization of most sectors of the economy. For the digital economy, the pandemic was the driver that led to economic and social development by obtaining sufficient financial support to solve the emerging problems.

Taking into account the new realities, it is necessary to solve the issues of updating the regulatory and legal framework for secure remote access to information systems. Special attention should be paid to further improving software systems and security tools to ensure the availability of public information systems and the protection of personal data. Currently, there are many domestic solutions in the field of information security and international recommendations for the organization of secure remote access, which include the establishment of stable, multi-factor authentication, differentiation of access to a home computer, the use of only secure corporate mail and a trusted cloud, the organization of a trusted communication channel, the presence of an antivirus, and much more. Equally important is training and informing users about information threats and countermeasures in the remote labor process, as well as training users on digitalization and monitoring their behavior. The forms of control over the work of employees by employers are also changing. The main form of the report on the work done remains an oral telephone conversation, the next version of the report was a written report on the work provided to the employer, and the least weight is still occupied by video conferences, video conference using video communication. It can be concluded that the number of organizations and institutions that use video communication for videoconferencing will increase in the near future.

In addition to positive changes, the increased use of information and communication technologies leads to a number of negative consequences. There are new types of stress associated with the widespread introduction and use of information and communication technologies. They are mainly related to the need to increase the speed and volumes of work. The amount of time occupied by work increases, and the boundaries between personal and working time are erased. An insufficiently high level of readiness for such a wide use of information and communication technologies in all spheres of life, a low level of training of users, and technical difficulties in the application of technologies lead to an increase in the tension of performing labor functions. The high rate of obsolescence of knowledge and the emergence of new ones, due to the rapid development of information technologies, causes the need for

their constant updating, the development of new competencies, and the adaptation of existing experience to the current situation.

For further progressive development, it is necessary to determine new development priorities in the digital economy. Innovation becomes the main source of development. The development of IT technologies is based on the updating of software and the introduction of complex algorithms for the operation of systems. These processes are not possible without the support of scientific research, as well as without specialists in these areas. The understanding that most problems of the national economy can now be solved with the help of information and communication technologies accelerates the processes of their implementation in almost all sectors and spheres of the economy. The current situation can be described as unique. We have gained extensive experience in solving problems under difficult conditions and in a short time.

## 5 Conclusion

The modern information society is characterized by an increasing role of information, an annual increase in the number of people whose professional activities are related to information and communication technologies, including in the system of their production and distribution, increasing informatization and digitalization in various industries and spheres of activity, and the creation of a global information space that provides a high standard of living for society [8]. The possibility of using information and communication technologies greatly changes our lives, making it more convenient. You can access news, information about socio-economic trends, treatment methods, provide training, and much more. Technologies of remote interaction, big data analysis, the development of artificial intelligence, virtual and augmented reality allow to solve many modern problems. However, there continues to be a large array of problems that do not have an effective solution and are under development. The activation of these processes leads to a change in the economic and technological structure, changes the way of management, life and thinking. Information and communication technologies become the basis of the processes. Modern organizations, institutions, and countries are inevitably involved in these events and make efforts to solve all the problems that arise. It can be concluded that in the near future, production, financial, and economic processes will follow the path of evolution and transformation to an even deeper qualitative and quantitative transition to the information stage of society's development. One of the consequences of this evolution will be a leap in the development of the social sphere, which will provide new opportunities and prospects for improving the life of society. Information and communication technologies today are a powerful mechanism for scientific, technical, social and economic progress, allowing individual companies to become leaders within the country, as well as countries in the global world.

## References

1. Shalygina, N.S. (ed.): Digital information and communication and interdisciplinary technologies and productions based on them. <http://scienceportal.org.by/upload/2021/Jan/Obzor-RNTB.pdf> (2020). Accessed 07 March 2021
2. Federal Law “On Information, information technologies and information protection” of 27.07.2006 N 149-FZ (ed. of 30.12.2020). [http://www.consultant.ru/document/cons\\_doc\\_law\\_61798/](http://www.consultant.ru/document/cons_doc_law_61798/) (2020). Accessed 07 March 2021
3. Rosstat: Russian Statistical Yearbook. 2020. <https://rosstat.gov.ru/folder/210/document/12994> (2021). Accessed 07 March 2021
4. PWC: New trends in the real estate market 2020. <https://www.pwc.ru/ru/publications/etre/etre-2020.pdf> (2020). Accessed 07 March 2021
5. Yatluk, L.: VR technologies: How to use them in construction and real estate? <https://modulab.com/blog/building> (2020). Accessed 07 March 2021
6. Markov, A.: Information security in the context of the COVID-19 pandemic. [https://russianco uncil.ru/analytics-and-comments/analytics/informatsionnaya-bezopasnost-v-usloviyakh-pan demii-covid-19/?sphrase\\_id=35369216](https://russianco uncil.ru/analytics-and-comments/analytics/informatsionnaya-bezopasnost-v-usloviyakh-pan demii-covid-19/?sphrase_id=35369216) (2020). Accessed 07 March 2021
7. TAdviser: IT (Russian market). [https://www.tadviser.ru/index.php/%D0%A1%D1%82%D0%B0%D1%82%D1%8C%D1%8F:%D0%98%D0%A2-%D1%80%D1%8B%D0%BD%D0%BE%D0%BA\\_%D0%A0%D0%BE%D1%81%D1%81%D0%B8%D0%B8](https://www.tadviser.ru/index.php/%D0%A1%D1%82%D0%B0%D1%82%D1%8C%D1%8F:%D0%98%D0%A2-%D1%80%D1%8B%D0%BD%D0%BE%D0%BA_%D0%A0%D0%BE%D1%81%D1%81%D0%B8%D0%B8) (2021). Accessed 07 March 2021
8. Dubinin, G.A., Lotarev, K.A.: Information society and information security in the context of globalization and communication technologies. In: Vostretsov, A.I. (ed.) Proceedings of the International Scientific and Practice Conference Current State and Prospects of Scientific Thought, pp. 41–48. Scientific and Publishing Center “Science World”, Nur-Sultan (2019)

# **Digital Strategies for Sustainable Development of Socio-Economic Systems**

# Statistical Study of Interregional Variations in the Society's Informatization



O. V. Bakanach and A. A. Kudryashov

**Abstract** The territorial differentiation of the society's informatization level of in the Russian Federation is assessed economically and statistically in this article. The study applies a combination of various methods as its methodological basis, including nonparametric ranking of interregional differences, the construction of a regions typology, of multidimensional classification, cluster analysis in particular. The study highlights a set of socio-economic factors that determine the level of informatization of the economic system in a region. The results of the analysis indicate that there is a significant differentiation among the constituent entities of the Russian Federation in terms of the informatization development level. More than a third of the entities have a high level of informatization development, which characterizes the rapid spread of information and communication technologies in all spheres of economic and social life in general.

**Keywords** Information society · Regional digital inequality · Statistics

## 1 Introduction

The situation with the informatization process at the regional level determines the course of its flow in the information society on a large scale, which justifies the necessity to study the existing territorial differences in its development. To characterize these differences, a generalizing indicator is introduced in the study. It is the level of society's informatization development, which directly reflects how much a particular region is developed in information aspect. The study reported in Dolgikh, and Efimova works, is of special interest from the point of view of statistics [1]. It analyzes the exploitation of information and communication technologies (hereinafter referred to as ICT) by the Russia residents.

---

O. V. Bakanach (✉)  
Samara State University of Economics, Samara, Russia

A. A. Kudryashov  
Povolzhskiy State University of Telecommunications and Informatics, Samara, Russia

This study is aimed at a comprehensive statistical analysis of interregional variations in the informatization of society. To date, this problem has received scant consideration in the scientific literature. The research is either limited to the analysis of informatization for a single territory [2, 3], or is of a sociological nature.

To achieve this goal, the following interrelated tasks are determined:

- to identify the socio-economic factors and conditions of informatization of the economic system in the region;
- to conduct a nonparametric rank assessment of interregional variations in the level of society's informatization development using the "pattern" method;
- to build a typology of regions according to the society's informatization development level using cluster analysis.

The object of the enquiry is the regional level of society's informatization. The subject of the inquiry is quantitative assessments and patterns of territorial variations patterns in the levels of computerization in the Russian regions.

## 2 Methodology

This study is based theoretically and methodologically on the evidence from leading analytical agencies, domestic and foreign studies on the problems of economic and statistical study of society's informatization, service data of the Federal Service of Statistics in Russia, Russian state programs and development strategies.

The following methods of an integrated approach to the analysis were used in the course of this study:

1. Nonparametric methods of statistical analysis, namely, the "Pattern" method, which allows obtaining a multidimensional integral estimate, and which is the basis for building a rating of the units of population under study.
2. The method of grouping is the selection of characteristic groups in the aggregate of the studied units according to their essential characteristics; in this study it is according to the obtained integral assessment of the informatization development level, with the allocation of the types of phenomena (low, medium, high).
3. The method of cluster analysis. Cluster analysis involves the classification of multidimensional observations, which are used to determine the distances of objects and obtain homogeneous groups or clusters. It also allows exploring, analyzing, and classifying large information arrays. In this paper, two cluster analysis procedures were applied. The Euclidean distance was used to measure proximity, and the k-means method was used as a clustering algorithm.

### 3 Results

To study interregional variations in the society's informatization development level, a set of indicators based on official statistical data was formed [4] (Table 1).

The regions were ranked according to the society's informatization development level in 2019. It was done based on the calculated coefficients of the multidimensional integral assessment using the "Pattern" method. The certain conclusions are made based on this assessment. The highest level of development of society's informatization is observed in Moscow, as it has the highest value of the generalizing integral indicator (0.951). The lowest level of development of informatization is noted in the Republic of Dagestan, as the generalizing integral indicator demonstrates the lowest value here (0.467). On the basis of the obtained integral coefficients, a grouping was made into three sets according to the high, medium and low society's informatization development level (Table 2).

Using the calculations as a base, the largest amount of the RF's constituent entities (38) was detected in the group with a mean level of informatization development (0.673–0.740). In this group, the best values are noted in the Republic of Bashkortostan, which is the on 30th place, and the worst ones are detected in the Amur region (0.675—67th place). That is, the ratio of a particular indicator to its best value is on average 67.5%.

**Table 1** Indicators set

| Notation | Indicator   |
|----------|---|
| $x_1$    | Mobile subscriber devices per 1000 people, units                              |
| $x_2$    | Households with broadband Internet access, %                                  |
| $x_3$    | Households with a personal computer, %  |
| $x_4$    | Population using the Internet, %  |
| $x_5$    | ICT costs per capita, thousand rubles   |
| $x_6$    | Active mobile broadband Internet access subscribers per 100 people, units     |
| $x_7$    | Population using the Internet for ordering goods and services, %              |
| $x_8$    | Organizations using broadband Internet access, %                              |
| $x_9$    | Organizations using the Internet, %   |
| $x_{10}$ | Organizations with personal computers in the total number of organizations, % |
| $x_{11}$ | Organizations using servers, %;   |
| $x_{12}$ | Organizations using local computing systems, %                                |
| $x_{12}$ | Organizations with a website, %   |
| $x_{14}$ | Availability of personal computers, units per 100 employees                   |
| $x_{15}$ | Percentage of organizations using electronic document management systems, %   |
| $x_{16}$ | Percentage of organizations using special software, %                         |

Source Author



**Table 2** Entities typology according to the integral estimation of society’s informatization development level with “Pattern” method for 2019

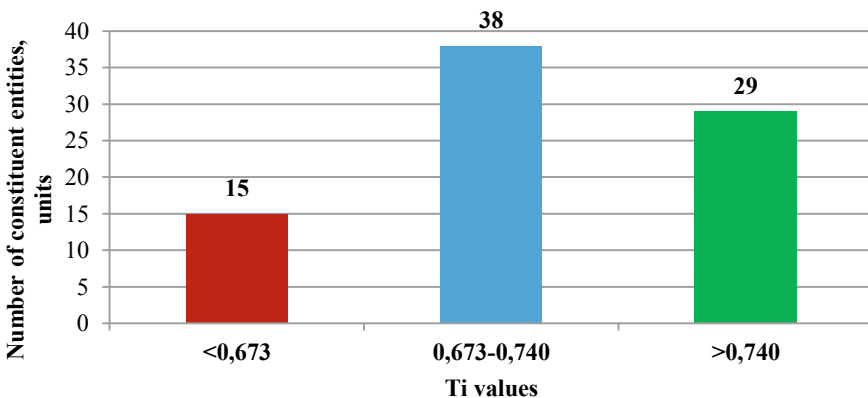
| Groups according to the integral coefficient value | Number of entities in the group | Characteristics of the group |
|--|---------------------------------|------------------------------|
| up to 0.673  | 15                              | Low                          |
| 0.673–0.740  | 38                              | Medium                       |
| 0.740 and more                                     | 29                              | High                         |
| Total  | 82                              | –                            |

Source Author

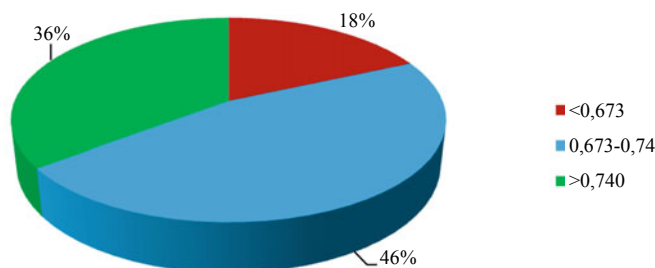
The group with a high level of society’s informatization development includes 29 entities of the Russian Federation, where the best values are observed in Moscow (0.951, that is the 1st place), and the worst ones are in the Stavropol Territory (0.740, that is the 29th place).

The smallest number of entities is included in the group with a low level of informatization development, namely 15, where the best values are observed for the Republic of Mordovia (0.672, i.e. the 68th place), and the worst ones are for the Republic of Dagestan (0.467, i.e. the 82nd place). To demonstrate the results, the diagrams, which reflect the groupings, are designed (Fig. 1 and 2).

Thus, summing up the findings of the enquiry on the regional differentiation in the entities of the Russian Federation, which depends on the factors that define the level of informatization development, the certain conclusions can be drawn. The prevalent amount of the RF’s entities (46%) is in the group with a mean level of computerization development. The high level informatization development cluster includes 36% of constituent entities; the group with a low level includes 18% of entities. Consequently, significant differentiation is observed among the subjects of the Russian Federation concerning the level of their computerization development.



**Fig. 1** The regions groupings according to their level of informatization development for 2019. Source Authors



**Fig. 2** Percentage of the constituent entities in the group, %. *Source* Authors

The indicators influencing the level of informatization development in the regions were analyzed in clusters. To bring the source data to a single scale, it was normalized. To identify the number of clusters, a dendrogram was constructed based on the Euclidean similarity metric of objects and the rule of clustering according to the Ward method. Based on the dendrogram, it was assumed that the prime number of clusters was 3. To specify the characteristics of the clustering results, the k—means method was used. The efficiency of the classification was evaluated using the analysis of variance. The inter-group variance on almost all indicators is greater than the intra-group variance, which proves that this clustering is effective. This conclusion is also confirmed by the values of the F-criterion and the significance level  $p$ , which is less than the specified significance level of 0.05.

The effectiveness of the 3 cluster classification was proved in the course of the variance analysis results. According to the k-means method, the average values of the indicators differ in each cluster; therefore, they are separated from each other, which also indicate a fairly good quality of the clustering performed.

To characterize each cluster, the average normalized values of indicators for each cluster are analyzed, and the ratings of the average values are also reflected. Given that the best values of the average indicators have the minimum value of their ranks sum, the distribution of clusters in descending order is as follows: cluster 2, cluster 1, and cluster 3. The results of the cluster analysis indicate that the RF's entities formed 3 different clusters in compliance with the factors that determine the level of society's informatization development. The cluster with the factors determining the high level of society's informatization development includes the largest number of subjects, namely 35 (42.7%). The cluster with the factors determining the average level of society's informatization development includes 33 constituent entities (30.2%). The cluster with the factors determining the low level of society's informatization development includes the smallest number of entities, namely 14 (17.1%). Thus, in general, the typology of regions accurately reflects the current reality.

## 4 Discussion

Informatization is one of the main processes that determine the changes taking place in modern Russian society. Informatization is a large-scale process that involves the introduction and development of ICT to the citizens. Alongside, it is impossible to do without managing the informatization of society in order to form the process, to direct it for increasing its intensity and economic efficiency and to smooth out the processes of territorial differentiation. The new management tools, both economic and statistical ones are of particular importance. They are the key to understanding of current situation, a way to predict the future and choose the right development. In the statistical study of the computerization in society, it is necessary to consider how various indicators correlate to each other in the regional economies informatization, as well as the repercussion of ICT for the living standard enhancement, economic efficiency and labor productivity [5, 6]. The citizens' participation in the territory management through digital technologies is used as one of the important criteria for informatization in many studies [7–9]. An established system of statistical monitoring, in the context of socio-economic and digital regional inequality, will create a regularly updated array of information. The information is necessary and relevant for the analysis of the current situation and general directions in the development of ICT, the efficiency of their use in society (social sphere), business and public administration.

## 5 Conclusion

It is impossible to imagine life without digital technologies. They are the process of society's informatization is based on the application of digital technologies. The importance of assessing the development of the ICT sector is supported in the Strategy for the Development of the Information Society in the Russian Federation for 2017–2030 [10]. In vein with the objectives of this research, the paper theoretically substantiates a comprehensive approach to the study of interregional variations through a system of indicators that characterize the process of informatization. A nonparametric rank assessment of interregional differences in the level of society's informatization development in 2019 was made, followed by a grouping of subjects. The calculations results are demonstrated in the paper using tabular and graphical data visualization tools. A typology of Russian regions, which is substantiated by the factors that identify the level of development of informatization in society, is constructed using cluster analysis. Overall, the findings of the research allow concluding that at present there is a transformation of the industrial society into the information society. Ultimately, the regional economy has great potential. The number of regions with a high level of informatization has grown significantly over the past few years. This was driven by the measures taken by the state administration.

## References

1. Dolgikh, E., Efimova, M.: Statistical analysis of information society development in Russian Federation. *Vestnik Universitet* **9**, 90–94 (2018)
2. Liu, C.: Sustainability of rural informatization programs in developing countries: a case study of China's Sichuan province. *Telecommun. Policy* **40**(7), 714–724 (2016)
3. Shamina, O.V.: Statistical evaluation of informatization of economics of the Nizhny Novgorod region. *Vestnik NGIEI* **4**(71), 93–100 (2017)
4. Federal State Statistic Service: Monitoring the development of the information society in the Russian Federation. <https://gks.ru/folder/14478> (2020). Accessed 15 March 2021
5. Kumar, R.R., Stauvermann, P.J., Samitas, A.: The effects of ICT on output per worker: a study of the Chinese economy. *Telecommun. Policy* **40**(2), 102–115 (2016)
6. Zhou, X., Zhou, D., Wang, Q.: How does information and communication technology affect China's energy intensity? A three-tier structural decomposition analysis. *Energy* **151**, 748–759 (2018)
7. Das, A., Singh, H., Joseph, D.: A longitudinal study of e-government maturity. *Inf. Manage.* **54**(4), 415–426 (2017)
8. Demushina, O.N.: Influence factors for e-participation. *Ars Administrandi* **9**(2), 132–151 (2017)
9. Sangki, J.: Vision of future e-government via new e-government maturity model: based on Korea's e-government practices. *Telecommun. Policy* **42**(10), 860–871 (2018)
10. The Strategy for the Development of the Information Society in the Russian Federation for 2017–2030. <http://kremlin.ru/acts/bank/41919> (2021). Accessed 21 March 2021

# Strategic Support for Modelling Transport Infrastructure Projects



E. V. Bolgova, S. A. Bolgov, and E. V. Lisyukova

**Abstract** The digital transformation of the economy requires transport to combine the interests of investors, state administrations and sectoral development actors in order to create a reliable transport infrastructure, which can be provided by a strategic support factor. The inclusion of this factor in the model of transport infrastructure projects has enabled to develop a method for harmonizing project objectives with the targets of sectoral, territorial and digital strategies worked out on the basis of the authors' research used the factor analysis and risk analysis of transport infrastructure, the method to coordinate projects and strategies. According to the authors, the proposed method ensures the coordination of projects with related strategies at the macro-, meso- and micro-levels, shapes a shared vision of project results, implementation scenarios and the role of all stakeholders in the project, as well as the economic development of the Russian subject, horizons for achieving a project's goals and performance indicators. The outlook for the proposed harmonization method is linked to improvements in the modelling of energy infrastructure projects, communications infrastructure and digital communications.

**Keywords** Digital strategy · Infrastructure · Project · Sectoral · Territorial

## 1 Introduction

Transport infrastructure projects are related to the economic functions of transport in the development of territories in the context of the digital transformation of the economy. The lack of developed transport infrastructure, its low level of digitization creates a limiting effect, hinders the expansion of markets, the profit from trade, technological advances, spatial agglomeration and the commercialization of a new

---

E. V. Bolgova (✉)  
Samara State University of Economics, Samara, Russia  
e-mail: [elena\\_bolgova@rambler.ru](mailto:elena_bolgova@rambler.ru)

S. A. Bolgov · E. V. Lisyukova  
Samara State Transport University, Samara, Russia

knowledge. The density of transport network, the implementation of large-scale projects ensure high rates of economic growth, lower trade costs and economies of scale, the accumulation of intellectual capacity and employment growth, which shall be the centre for transport planning and development [1, 2]. The scale, however, increases the sensitivity of projects to risks, reduces the sustainability of the implementation phase [3]. Project statistics show that about 25% of projects fail; another 20% perform better than expected; the remaining 55% achieve less than expected [4]. In such circumstances, the success of a project is achieved by conditions that, when considered in the feasibility study, prevent inefficiencies and failures. These conditions include the market environment, which includes competition, affordability, user needs, state of the transport network, suppliers' capabilities, cost–benefit ratios; operational characteristics, related to the quality of project management and the digital design of the project, the site, the growth of traffic; and the institutional framework, including strategic project support, a factor which scientists agree includes variables influencing the choice of how the project is to be implemented as a strategic design that brings together the needs of different stakeholders in an effort to develop a sustainable transport infrastructure [5, 6]. Based on the variables in the strategic support factor, operators develop alternatives to involving different levels of management and specialists in the project, and take management decisions based on the interests of all stakeholders [7]. The influence of this factor leads to the creation of a transport infrastructure project model that incorporates competing modes of transport within the locality, harmonizes the interests and needs of all interested and involved parties, forms a project team with experience in conducting feasibility studies, organizing business operations with an acceptable risk level.

## 2 Methodology

The modelling of transport infrastructure projects, with the inclusion of a strategic support factor in the outline of the model, aims to prevent the failure or poor results of large-scale projects. The risks of unsatisfactory results are caused by contradictions arising from both the differentiated demands of stakeholders (different expectations of costs, benefits, timing, uncertainty, risks) as well as differences in the use of digital technologies in the project feasibility study and implementation phases. To overcome these contradictions, it is possible to use modelling practices that harmonize project objectives with the targets of sectoral, territorial and digital strategies. The use of this method leads to the formation of a common vision of the project results, which eliminates the ripple effect of the shortcomings of the initial design phase on the operational phase, ensures the sustainability of transport projects, and reduces the project sensitivity to risks. The harmonization of project objectives with sectoral, territorial and digital strategies, applied in the modelling of transport infrastructure projects, makes it possible to achieve several levels of project efficiency. The effectiveness of the project for an investor is achieved by the sustainability and achievability of commercial results, the sectoral efficiency—by the coordination of the interests of

**Table 1** Strategic planning documents of the Russian Federation used to harmonize transport infrastructure design objectives with the targets of sectoral, territorial and digital strategies

| Sectoral strategies   | Territorial strategies   | Digital strategies  |
|---|--|---|
| Transport Strategy of the Russian Federation until 2030 [8] | The spatial development strategy of the Russian Federation [9] | The strategy of digital transformation of the economy of the Russian Federation until 2030 [10] |
|   |  | Digital transformation strategy for Russian railways [3]  |

Source Authors

competing transport industries and transport and logistics enterprises, the territorial efficiency—by a sustainable balance of the transport network in the region’s economy and the processes of its digital transformation. Sectoral, territorial and digital levels of harmonization presuppose the systematization of strategic planning documents and development targets defined in their content. For transport infrastructure projects of the Russian Federation, the package of strategic documents includes current strategies and plans presented in Table 1.

The Transport Strategy of the Russian Federation until 2030 defines the main direction of the development of the transport infrastructure as a factor ensuring the socio-economic development of the country and its regions by means of speeding up trade, while spatial development is a means of creating new agglomerations and developing existing ones [8]. Until 2030, it is planned to increase the competitiveness of the transport complex, to expand the range of competitive transport services with a logistical component and to improve their quality on the basis of advanced transport and logistics technologies. The spatial development strategy for of the Russian Federation points to transport infrastructure as a factor in the development of the economy of the Russian regions and macro regions, the seriousness of which is determined by the prevailing trends and problems of the country’s spatial development (concentration of economic growth and increasing population pressure in a limited number of centers, migration mobility, interregional socio-economic and spatial disparities) [9]. The strategies for the digital transformation of the Russian economy, the digitization of the transport industries and the digital development of Russian subjects are aimed at a set of transformations that create conditions for increasing the availability of goods and services, using modern digital technologies [3, 10].

### 3 Results

#### 3.1 *The Harmonization of Project Objectives and Targets of Sectoral, Territorial, Digital Strategies*

The content and implementation mechanisms of the harmonization method are explained by the authors of various applied studies. Mazboudi and the co-authors propose mechanisms for harmonizing corporate strategies of different countries in the context of internationalized business [11]. Kutty and the co-authors, researching models of smart cities, have come to the conclusion that the disadvantage of these models is the low harmonization of the goal of territories' sustainable development with the development strategies of smart cities. Based on a systematic approach, a new conceptual model has been established to transform the city into a sustainable smart city [12]. Troisi and the co-authors develop a meta-management mechanism that harmonizes the development of territorial ecosystems and competitive sustainable development of a community [13]. Lisin, Strielkowski, Chernova, Fomina have been exploring the harmonization of energy security (as a goal of public administration) and market economy realities. The solution of balancing the interests of territorial authorities and territorial generating companies in the formation of energy security development strategy was proposed [14]. In the task of harmonizing the project objectives and multi-level targets of the involved strategies, the scientific papers presented form the theoretical basis for identifying three levels of harmonization (Table 2).

The harmonization of the objectives of transport infrastructure projects and sectoral, territorial and digital strategies at the macro, meso and micro levels creates a meaningful balance of project activities in the Russian subjects. Such a balance is achieved by detailing project objectives and matching them to the targets of the involved strategies (Table 3).

It is clear that the objectives of transport infrastructure projects, harmonized with the objectives of the involved strategies, ensure:

- at the macro-level: the factor functions of transport in the spatial and economic development of the Russian subjects and the Russian country as a whole;
- at the meso-level: the competitive development of the transport and logistics complex of the Russian subjects, and the breakthrough (digital transformation) development of the technologies for the provision of services by enterprises in transport industries;
- at the micro-level: commercial efficiency, low risk sensitivity, high sustainability of investment projects, realized to modernize transport network, create transport and logistics centers, develop high-tech transport business, digital platforms and service technologies.



### 3.2 Developing a Strategic Vision for Project Results

The harmonization of project objectives and targets of the involved strategies results in a shared—strategic—vision of project results among all stakeholders. In essence,

**Table 2** Levels of harmonizing the project objectives and targets of the involved strategies

| Levels | Strategies   |  |   | Projects  |
|--------|--|--|---|---|
|        | Sectoral   | Territorial  | Digital   |   |
| Macro- | Transport infrastructure as a factor of: <ul style="list-style-type: none"> <li>the socio-economic development of the country by means of accelerated trade;</li> <li>the spatial development of the country by means of the formation of new agglomerations and the improvement of existing agglomerations</li> </ul> | Transport infrastructure as a factor of: <ul style="list-style-type: none"> <li>the social and economic development of the Russian Federation by means of breakthrough technologies;</li> <li>the development of the economy of the Russian regions and macro-regions by means of spatial development;</li> <li>the competitiveness of the economies of the Russian Federation;</li> <li>clustering of the regional economy</li> </ul> | Digital transformation as a factor of: <ul style="list-style-type: none"> <li>the social and economic development of the country by means of creating an ecosystem of the digital economy of the Russian Federation;</li> <li>-the development of high-tech businesses, overcoming constraints</li> </ul> | <ul style="list-style-type: none"> <li>Integrated development plans;</li> <li>National projects (NPs);</li> <li>Federal Projects (FPs)</li> </ul>   |
| Meso-  | <ul style="list-style-type: none"> <li>the development of transport corridors;</li> <li>increasing the level of economic connectivity of the territory of the Russian Federation through the expansion and modernization of railway, aviation, road, sea and river infrastructure</li> </ul>                           | <ul style="list-style-type: none"> <li>the development of the transport services segment (freight and passenger transport);</li> <li>the development of logistics services segment (warehousing, complex cargo service)</li> </ul>   | <ul style="list-style-type: none"> <li>improving competitiveness in the global transport market</li> </ul>  | <ul style="list-style-type: none"> <li>a regional component of federal projects;</li> <li>public–private partnership projects;</li> <li>investment (infrastructure) projects of the Russian Federation</li> </ul> |

(continued)

**Table 2** (continued)

| Levels | Strategies  |   |   | Projects  |
|--------|---|---|---|---|
|        | Sectoral  | Territorial   | Digital   |   |
| Micro- | <ul style="list-style-type: none"> <li>• integration of Russian railways into the global market;</li> <li>• advanced organization of road transport;</li> <li>• integration of road infrastructure (roads, feeder roads, road «interchanges») into logistics chains of goods and passenger transport</li> </ul> | <ul style="list-style-type: none"> <li>• at least 85% of the network in the largest urban agglomerations meets regulatory requirements</li> </ul> | <ul style="list-style-type: none"> <li>• digital platforms and technologies;</li> <li>• innovation, breakthrough technologies, changing the corporate culture of transport companies, increasing efficiency and creating new business processes, developing the spectrum of transport and logistics services</li> </ul> | <ul style="list-style-type: none"> <li>• investment projects</li> </ul> |

Source Authors

the Strategic Results Framework for a Transport Infrastructure Project is a strategic design aligned to the needs of all stakeholders, with a set of variables comprising: (a) project scenarios; (b) the role of the project in the social and economic development of the Russian region (the country as a whole); (b) the horizons for achieving project objectives and indicators of project effectiveness. The project scenarios are based on the socio-economic, institutional and digital context within which the stages of implementation of the technical solutions of the project are to be implemented. Key factors (such as the global market for basic resources, the quality of the institutional environment and the digital ecosystem) combine multiple development conditions, with different combinations creating a range of scenarios within the boundaries of the «optimistic-pessimistic». Starting with the optimistic scenario—«Leadership in the development of transport infrastructure» and ending with the pessimistic one («Struggle for survival»), the specified range can include the scenarios «Scale modernization and expansion of transport infrastructure», «Target scenario (reconstruction, technical re-equipment, digital transformation of transport infrastructure)», «Base scenario (supporting transport infrastructure development)».

The role of the project in the social and economic development of the territories in different scenario conditions will vary within the boundaries of the «Project of Breakthrough Development / Mega Project»—«Project of Integrated Transport Infrastructure Development / Multiproject»—«Local Investment Project / Monoproject». In accordance with the scenario conditions and its role, horizons may be established for achieving the objectives of the transport infrastructure project: (a) identification and creation of conditions for the implementation of the project (pre-investment phase);

**Table 3** The specification of project objectives for the transport infrastructure development of the Samara region with the involved strategies on harmonization levels

| Harmonization levels   |  |   |
|--|--|---|
| Macro-   | Meso-  | Micro-  |
| NP “The Integrated Highway Infrastructure Upgrading and Expansion Plan until 2024” | FP “Europe—Western China”                    | Bypass construction of the Tolyatti city with a bridge crossing over the Volga River as part of the international transport route “Europe—Western China»  |
| NP “Safe and quality roads”  | FP “Road Safety”                             | Improving the safety of road users (reducing the number of fatalities)  |
|  | FP “System-wide Road Development Measures”   | Improvement of regulatory policy and application of new technologies in the road sector (construction, renovation, major repairs of regional (inter-municipal) roads); use of new technologies)   |
|  | FP “Road Network”                            | <ul style="list-style-type: none"> <li>• the improvement of the quality of the road network, including the street network, of urban agglomerations (road network of urban agglomerations, regional and inter-municipal roads in a standard state);</li> <li>• increased share of domestic equipment in total procurement</li> </ul> |
| NP “Digital economy”   | FP “Human Resources for the Digital Economy” | <ul style="list-style-type: none"> <li>• mass training of executive officials in digital competencies and technologies;</li> <li>• training and retraining programmers for civil servants in the areas of digital competence and technology</li> </ul>  |

Source Authors

(b) formation of the project’s productive assets (investment phase); (c) provision of transport services (operation phase). The characteristics of each phase are related to differences in project effectiveness indicators and problems in achieving their estimated values. The planned values of Fiscal Efficiency Indicators (NPV of the federal and territorial budget), total investment cost efficiency, equity efficiency, creditor efficiency can be achieved if the project is sustainable, provided by the strategic support factor [15].

## 4 Discussion

The high sensitivity of large-scale transport infrastructure projects to the risks of failure and inefficiency that arise during the implementation phase of technical solutions implies a new approach to project modelling. In the modelling of transport infrastructure projects, strategic support needs being taken into account alongside the market and operational conditions. In the context of the content and mode of implementation variables, the strategic vision that brings together the needs of all stakeholders aiming to create a fail-safe transport infrastructure, this factor aligns project objectives with the targets of sectoral and territorial strategies. The model of the transport infrastructure project taking into account the strategic support factor can be implemented in the feasibility study of the project, which main directions are presented in Table 4.

As a result of the model, the common vision of the transport infrastructure project will combine strategic, commercial and engineering design. The sustainability and low sensitivity of the project to the risks of failure or inefficiency during the implementation phase will be achieved by balancing the interests, needs of investors, government and stakeholders involved in the sector development strategy.

**Table 4** Directions for the development of a transport infrastructure project feasibility study in a strategic support model

| Project feasibility study/design (project vision) | Factors  | Variables   |
|---|--|---|
| Institutional/strategic vision                    | Strategic support of a project   | Project implementation scenarios; the role of the project in the social and economic development of the Russian subject (the country as a whole); horizon of project objectives; budgetary efficiency |
| Market/commercial vision                          | State of the transport network, market competition, user needs, financial accessibility, supply capacity; cost–benefit ratio | Analysis of the transport market; marketing concept and pricing policy; accommodation (localization); material, labour, financial resources   |
| Operational/engineering vision                    | Quality of project management and information support, site, project design, traffic growth                                  | Design part project schedule  |

Source Authors

## 5 Conclusion

Transport infrastructure projects being large-scale and, therefore, risk-sensitive are fragile at the stage of the implementation of technical solutions, and should be developed taking into account the economic functions of transport in territorial development, what is achieved by including strategic support in the project model. The strategic support factor is defined in the paper on the basis of a shared position of researchers as a set of variables defining a strategic design that brings together the needs of investors, governments and actors, involved in shaping sectoral development strategies in an effort to create a sustainable transport infrastructure. The method of harmonization proposed by the authors for the inclusion of the strategic support factor in the project model is necessary to harmonize the project objectives of infrastructure projects and the targets of sectoral, territorial, digital strategies. It is justified in the paper by the success in harmonizing the corporate strategies of different countries, smart cities and sustainable regional development strategies, energy security strategies and market economy realities. Within the framework of the harmonization method: (1) macro-, meso-, micro-levels of harmonization are identified, (2) project objectives of transport infrastructure development are detailed in terms of levels of harmonization with sectoral, territorial, numerical strategies, (3) a set of variables is formed, forming the strategic vision of the project results in the project scenarios, the role of the project in the social and economic development of a Russian entity (the country as a whole), the horizons for achieving the project objectives and indicators of project effectiveness, (4) the practical significance of the use of the harmonization method in the development of the feasibility study for transport infrastructure projects has been determined. The study did not present the potential of a strategic support factor in modelling transport-related infrastructure projects due to scale constraints. The data obtained, however, are sufficient to assess positively the impact of this factor on energy infrastructure project models, communications infrastructure and digital communications. Future research could be applied to energy, communications and digital communications projects, and could be carried out in a manner that harmonizes the development strategies of these types of infrastructure with territorial strategies, with the objectives of investment projects and with the development of their feasibility study.

## References

1. Carlsson, R., Otto, A.: The role of infrastructure in macroeconomic growth theories. *Civ. Eng. Environ. Syst.* **30**(3–4), 263–273 (2013)
2. Lakshmanan, T.: The broader economic consequences of transport infrastructure investments. *J. Transp. Geogr.* **19**(1), 1–12 (2011)
3. Digital transformation strategy for Russian railways. <https://company.rzd.ru/ru/9397/page/104069?id=184629> (2019). Accessed 29 Feb 2021
4. AMC Consultants: Why feasibility studies fail. <https://amcconsultants.com/experience/why-feasibility-studies-fail/> (2017). Accessed 25 Feb 2021

5. Matti, S., Dai, H., Fujimori, S., Hanaoka, T., Zhang, R.: Key factors influencing the global passenger transport dynamics using the AIM/transport model. *Transp. Res. Part D* **55**, 373–388 (2017)
6. Okoro, C., Musonda, I., Agumba, J.N.: A factor analysis of transportation infrastructure feasibility study factors: a study among built environment professionals in South Africa. In: Ahmed, S.M., Hampton, P., Azhar, S., Saul, A.D. (eds.) *Collaboration and Integration in Construction, Engineering, Management and Technology. Advances in Science, Technology & Innovation*, pp. 75–81. Springer, Berlin (2021)
7. Dey, P.K.: Integrated approach to project feasibility analysis: a case study. *Impact Asses. Project Appraisal* **19**(3), 235–245 (2001)
8. Transport strategy of the Russian Federation until 2030. <https://mintrans.gov.ru/documents/3/1009> (2008). Accessed 29 March 2021
9. The spatial development strategy of the Russian Federation. [https://www.economy.gov.ru/material/directions/regionalnoe\\_razvitie/strategicheskoe\\_planirovanie\\_prostranstvennogo\\_razvitiya/strategiya\\_prostranstvennogo\\_razvitiya\\_rossiyskoy\\_federacii\\_na\\_period\\_do\\_2025\\_goda/](https://www.economy.gov.ru/material/directions/regionalnoe_razvitie/strategicheskoe_planirovanie_prostranstvennogo_razvitiya/strategiya_prostranstvennogo_razvitiya_rossiyskoy_federacii_na_period_do_2025_goda/). (2019). Accessed 21 March 2021
10. The strategy of digital transformation of the economy of the Russian Federation until 2030. <https://d-russia.ru/wp-content/uploads/2017/07/programma-tsifrov-econ.pdf> (2017). Accessed 29 Feb 2021
11. Mazboudi, M., Sidani, Y.M., Al, A.: Harmonization of firm CSR policies across national contexts: evidence from Brazil and Sweden. *Int. Bus. Rev.* **29**(5), 101711 (2020)
12. Kutty, A.A., Abdella, G.M., Onat, M.K.N.C., Bulu, M.A.: System thinking approach for harmonizing smart and sustainable city initiatives with United Nations sustainable development goals. *Sustain. Dev.* **28**(5), 1347–1365 (2020)
13. Troisi, O., Ciasullo, M.V., Carrubbo, L., Sarno, D., Grimaldi, M.: Meta-management for sustainability in territorial ecosystems: the case of Libera’s social reuse of territory. *Land Use Policy* **84**, 138–153 (2019)
14. Lisin, E., Strielkowski, W., Chernova, V., Fomina, A.: Assessment of the territorial energy security in the context of energy systems integration. *Energies* **11**, 3284 (2018)
15. Korytářová, J., Hromádka, V.: Risk assessment of large-scale infrastructure projects—Assumptions and context. *Appl. Sci.* **11**(1), 109 (2021)

# Economy Digitalization of Russia: Non-state Pension Funds and Their Social Orientation



M. E. Valishina and E. N. Valishin

**Abstract** The article deals with issues related to modern trends in digitalization and their application in the practice of investing from Non-State pension funds (NPF). The situation in NPF market has been analyzed, the questions of possible attraction of population's savings in NPFs have been considered. Pension market competitive environment change questions have been analyzed and factors that can influence it have been determined: NPF consolidation processes, client service and client interaction competition increase. Nowadays most Russians are not passive citizens; they want to know the ways they can get additional income after retirement. We came to the conclusion that the major pension funds have begun consolidating and this is an ongoing process, major pension funds are more willing to participate in the long-term investment, the level of their social responsibility is growing and they are looking for the new profit sources and for the investment risks diversification improvement. The authors have proposed measures for overcoming the system restrictions. Expansion of permissible instruments for the Funds to allocate pension reserves and invest in the pension savings; insurance reserves allocation requirements improvement in situation of economy digitalization.

**Keywords** Digitalization · Investment · Non-state pension funds · Social responsibility

## 1 Introduction

The most important priority in the work of client-oriented non-state pension funds is digitalization, which implies a significant increase in the share of digital communications with clients, as well as the digitalization of internal business processes. One

---

M. E. Valishina  
Financial University Under the Government of the Russian Federation, Moscow, Russia  
e-mail: [MValishina@npfb.ru](mailto:MValishina@npfb.ru)

E. N. Valishin (✉)  
Pension Fund “Blagosostoyanie”, Moscow, Russia

of the existing trends is the development of online services as an important area of improving customer interaction and improving the quality of client service. Opportunities for remote servicing directly affect clients' assessment of the performance of NPFs. Digital services not only simplify the interaction between customers and the fund, but also optimize internal processes and functions. Most of the services offered today by NPFs that clients can use remotely: for example: calculating the size of a future pension, drawing up an individual pension plan, connecting an auto payment service, changing the amount, frequency and date of payment of a pension contribution, making changes to your personal data, applying for pension online, receipt of electronic account statements, etc. Pension funds are the source of the long-term investment in the economy of the country. Nowadays the contribution of Russian institutional investors, including NPFs and insurance companies, to the infrastructural projects financing is minor. Institutional investors are looking for the new profit sources and investment risks diversification improvement. In this process, they are going beyond the traditional assets classes in shares, bonds, money and real estate. Therefore, proportion of the institutional investors in assets is about 80 trillion USD. Today we can say that the following factors contribute to the institutional investment market development: growth of populations' savings involvement to the long-term market investment and also bonds investment increase which contributes to the reduction of the Russian shares market dynamics dependence on the foreign portfolio investors (including the ones using speculative investment strategies), that provides the population with the opportunity to invest their savings in NPFs (pension savings) and insurance programs [1].

## 2 Methodology

In this work, we used a systematic approach and general scientific methods to identify the characteristics of non-State pension Funds (NPFs) as institutional investors. NPFs' contribution to the development of digitalization in modern socio-economic conditions has also been reviewed. The methodological basis of this study is a systematic and comparative analysis. These ways of analysis allow us to identify the specifics of the issue under review and draft a trend for further forecasting as use of digitalization up to date. The approach and methods implemented in the study made it possible to identify evidence characterizing the process of reforming the Russian pension system. The approach and methods chosen also allow us to consider the possibility of use of new mechanisms of digitalization in their work in the real economy. In this work, we took into account data on the socio-economic development of the country, statistical materials on the activities of insurance Funds, NPFs and institutional investors [1].



### 3 Results

Analysts believe that the amount of NPFs' funds in the financial market will grow significantly in 2020. Analyses, done by us has proved that the amount of the bank sector's funds will reduce significantly and will total about 88%, at the same time the amount of institutional investors' funds, including NPFs, on the contrary, will raise from 5,2 to 12% [2]. NPFs investment market, as institutional investors, is developing not fast and the restriction of investment products is directly affecting this process. There is no reliable and reasonable scheme for the long-term investment, the scheme that would attract individuals as well as companies. At the same time multiple pension system outstanding issue, public distrust in the existing financial institutes and in stock market in general, the low level of population's financial literacy are affecting the low growth of NPFs investment market. At the same time, the Central Bank of Russia, as the regulator of NPFs' activities in the investment market, is interested in the market stability [3]. Both economic and administrative measures will help to raise the stock market effectiveness. Furthermore, the amount of operations conducted by institutional investors in the stock market contribute the operational cost reduction in comparison with the individual investments, which are becoming more significant in the Russian economy. Due to information concentration, they raise effectiveness of the involved funds investment [4]. At present, there is a great amount of high-speed lines creation projects. However, the list of commercial companies participating in such projects is very short. Even considering the fact that this market has a great potential and is rapidly growing, one cannot speak of any significant expansion of the list of the organizations involved. Not all infrastructural investments can be assessed and realized because of the complexity of the projects. Such investments bring pension funds, willing and able to invest in infrastructure, relatively high income (for example, in Australia—about 5%); also, risks are at least partially isolated from the economic situation [5].

During the next 15 years the long-term investments will bring Fund's clients income of about 13,25% for each of first three years, then coupons with Consumer Prices Index + 2,5% will be paid once a quarter [3]. Additionally, project obligations are ensured by monetary claim deposit in accordance with the concessional agreement about financing the construction and maintenance of the road and that is the reliability guarantee. It is necessary to improve NPF and insurance companies' assets allocation requirements by means of expanding the pool of potential investment. At the same time, this system is to compensate for the losses in implementing operational risks only and not market or country risks. NPFs' investment potential is not fully implemented in the long-term investment, because NPFs direct the long-term resources mainly to the short-term assets (almost 70% of NPFs' assets are placed for less than a year) [6]. Thus, the tax system does not contribute to long-term investment creation. In contrast to most western countries, contributions to pension funds as well investment income are taxable in Russia, at the same time pension payments are, on the contrary, non-taxable. Many unnecessary obstacles for NPFs and insurance companies are created by means of assets allocation regulation [1].

There are certain restrictions in the list of investment projects acceptable for the funds. Legal framework that will allow to invest in infrastructural bonds, in mortgage securities, in NPFs, mutual funds, investment funds, credit organizations, are to become measures for overcoming system restrictions. Expansion of possible tools to allow Funds place pension assets and invest pension savings, improvement of insurance assets allocation requirements. Investing pension money Central Bank of the Russian Federation considers the possibility of investment NPFs' assets in bonds, guided by the most quotation principle, if bonds are released by issuer in accordance with concessional agreement and at the same time The Russian Federation, the subject of Russian Federation or a city with the population of more than 1 million is a concessionaire [4]. The key condition for attraction pension savings funds is profit insurance for the certain investment project at the level higher than inflation + "1", and also the long-term credit rating possession, assigned to the bonds issuer at the level of the Russian federation sovereign rating [7]. The Central bank experts of the long-term investment market counsel have acknowledged that Russia still has the same problems—banks, insurance companies and private pension funds—could spend more than 3 trillion rubles on infrastructure development, but their interest in such investment is low [8]. Possibly, it is necessary to cancel regulation toughness for NPFs, for example, change the rules of risks calculation within standards calculations to eliminate investment portfolio structure restrictions. It is necessary to improve financing schemes and develop individual assets classes. The major NPFs' assets are more 4 billion rubles today and more than 1,2 billion rubles can be invested in infrastructural projects. NPFs' investment market has revealed that major NPFs are more willing to invest in long-term assets. The consolidation of NPFs in process in the pension market for the last few years, the amount of pension funds is decreasing, the liquidation process became slower than in the last periods. The number of pension funds has decreased from 68 to 58 for a year. In comparison with the 2nd quarter of 2018, the number of funds has decreased to 7 funds [9].

## 4 Discussion

During the last few years, NPFs consolidation has become one of the trends on the pension services market. Analysts believe that the process of consolidation will continue during this year because there companies, which have not finished this process yet. In 2020 such funds as "Soglasie", "Sotsialnoe razvitiye" and "Obrazovanie" will merge with NSPF (Non-State Pension Fund) "Evolutsia"; In 2020, "Rostec" State Corporation plans to merge funds: "Rostvertol" NSPF (Non-State Pension Fund) JSC (Joint Stock Company) should be merged with the NSPF (Non-State Pension Fund) of the same name. Earlier, the state corporation announced that at the next stage it is planned to merge with "Rostec" NSPF (Non-State Pension Fund) JSC (Joint Stock Company) and "First Industrial Alliance" NSPF (Non-State Pension Fund) JSC (Joint Stock Company). The possibility of consolidation in 2020 was also voiced by such companies as the merger of "Atomgarant" NSPF (Non-State Pension

Fund) JSC (Joint Stock Company). and “Atomfond” JSC; united JSC NPF “Magnit” and JSC “VTB Pension Fund”. NPF “First Industrial Alliance”. The pension division of the Russian Funds investment group consolidates the assets of “Vnesheconomfond” NPF JSC. It should be noted that the majority of NPFs, according to data as of December 25, 2019, carry out their activities related to both social security organizations (compulsory pension provision) and NGOs (Non-Government organizations) (compulsory pension provision), which are 47 Funds and only 14 Funds carry out their activities related to NGOs. Funds working only with NGOs account for more than 2/3 of all pension reserves and only 1/3 of all participants in NGO programs (that is, funds specializing in NGOs have a high level of funds per client) [3].

Of the 45 NPFs engaged in NGOs, all Funds in their work are primarily focused on corporate pension programs, only 38 Funds currently have programs for individuals. So, the main product for individuals are programs that focus on the formation of a pension for individual, although most Funds have pension programs for third parties. In order to increase interest in NGO products for individuals, to attract clients’ funds to their Funds, NPFs are developing new product lines, attracting customers with the opportunity to conclude an agreement via the Internet, looking for “niche” products, and formulating proposals for a comprehensive financial product. For example, NPF “Sberbank” has adapted its program Individual Pension Plan to form a future pension for the needs of the self-employed people (who do not make pension contributions). The program allows you to formulate a future pension by independently setting a convenient non-fixed schedule and the amount of contributions [3]. The comprehensive offer of “GAZFOND” NPF is related to the fact that pension savings consist of three parts (individual pension plan, deposit and co-branding card. When concluding a pension agreement, the client gets the opportunity to open a deposit with an increased rate of up to 9% per annum. The third element of the complex is a co-branding card with a cashback of up to 2% and special offers from the payment systems Mir and JCB. For example, in 2019 NPF “SAFMAR” presented its achievements on corporate pension programs at the largest HR conferences—WOWHR in Kazan and Novosibirsk, as well as at the Far Eastern Forum on HR Management, as well as at meetings with employers in Nizhny Novgorod, St. Petersburg, Samara. The parity pension program that Almaznaya Osen NPF JSC offers to enterprises of any form of ownership is gaining popularity [3]. In 2019, the fund’s corporate clients for this pension product were employees of “Almazdortrans” LLC, “Almazny Anabara” JSC and “Almazny Krai” Media Company. Today, more than ever, the issues related to the digitalization of daily necessary processes, such as receiving and processing pensions, benefits, and a number of social services, have become relevant.

At the moment, the most important priority in the work of client-oriented NPFs (non-state pension funds) is digitalization, which implies a significant increase in the share of digital communications with clients, as well as the digitalization of internal business processes. One of the existing trends in the development of online services is to improve the quality of customer service. Thus, the possibility of remote service has an impact on the clients’ assessment of the work of the Funds. Digital services make it possible not only to simplify the interaction between clients and the Fund, but also to optimize internal processes and functions [4]. The range of

services offered by the Funds to their potential clients is expanding. There are more and more NPF services that clients can use remotely, among them is calculating the size of a future pension, drawing up an individual pension plan, connecting the auto payment service, changing the amount, frequency and date of the pension contribution payment, making changes to their personal data, applying for the appointment of a pension online, receiving an electronic account statement, etc. Based on expert estimates, digital services are the most aggregated in Sberbank NPF JSC. The possibility of concluding an NPO (non-governmental pension insurance) agreement online simplifies the process for the client, making it more attractive. As experts note, the plug-in function “auto payment” contributes to the growth in the volume of contributions under existing pension agreements. and banks, retail outlets, pharmacies, so NPFs are constantly improving the functionality of their personal accounts, expanding their capabilities, it becomes a platform on the basis of which other services are implemented—pension calculator, online payment, auto payment, etc. In your personal account, you can control your accounts under OPS (statutory pension insurance) agreements and NGOs, set up auto-payment for contributions, draw up an INPO (individual non-governmental pension insurance) agreement online, get online advice, read news, receive personal offers, calculate a future pension using a pension calculator, change personal data. In exemplification of the online service for concluding a contract is: (1) Fill out a questionnaire on the foundation’s website, identification is possible through the State Service portal; (2) Pay the initial installment under the contract. In this case, the lump sum of the first pension contribution transferred by the contributor to the current account of the fund is the acceptance of the contract. Using an online service has a number of significant advantages over other methods of submitting an application to the fund. By way of example clients can submit an application within 12 min, there is no need to visit the office with original documents or send copies certified by a notary. It is convenient to perform all actions through a mobile application—its noted that clients can simply photograph the documents and immediately upload them to your personal account. Transformation of business models by introducing remote services, providing convenience and maximum protection for all users [10].

NPF “Sberbank” JSC was recognized as the most “digital” NPF, which implemented the full functionality of online services. The possibility of concluding an online NGO contract simplifies the process for the client, making it more attractive. Today, most Russians are not passive citizens; they want to know what options a person can receive after retirement. Studies showed that this level is quite high, it is approximately 66%, and a smaller part of the respondents could not answer such a question. We would like to note that such well-known financial instruments for generating additional income as cash deposits, bank deposits accounted for 28%, then the preference is given to saving and accumulating funds in Russian or foreign currency and accounts for 27%, and at the same time while deposits in non-state pension funds increased and accounted for 26%, ahead of investment in real estate, it was about 24%. Such forms of savings as insurance products (both investment (22%) and accumulative life insurance (22%)) are also taken into account. The most popular methods of savings for Russians to provide themselves with additional income to

retirement were: cash deposit or bank deposit (23%), personal savings (18%), contributions to private pension funds (14%), as well as insurance against adverse events (10%) [4]. Another 6% of respondents use cumulative life insurance “by a certain date.” “Sberbank” NPF also conducted a study in 2019 on the awareness of Russians about the products of private pension funds. More than half of the respondents (55%) are aware of the existence of private pension funds, a third of the respondents (36.3%) claim that they are thoroughly informed about the activities of private pension funds and use non-state pension benefits. The most informed about NPF products were Russians aged 40–49 years (about half of the respondents), and the most active clients of NPFs were respondents aged 18–29 years (almost three times more than in other age groups). Young Russians are very concerned about the quality of life after the end of their careers and are ready to take active steps to ensure their future. At the same time, the survey showed that when considering options for additional investment of their funds through banks, private pension funds, insurance companies, about 31% of citizens rely on the state guarantees, guarantees of the security of their deposits, and at the same time, 26% rely on implementation of a tough state control of financial organizations activities; but the availability of a mechanism for free choice of savings remains an important condition—12%, as well as equal conditions when using various methods of savings—10% [8].

## 5 Conclusion

Intra-industry competition in the NPF market has remained unchanged for several years. The competitive behavior of pension market players, their development in terms of improving the product offer, expanding the capabilities of customer service is determined by the desire to maintain the existing customer base and, if possible, attract new customers. In the NGO market for individuals, some competition can be created by products built as part of partnership projects with banking or insurance products that provide additional benefits to the client (cashback, increased interest on deposits, etc.). Pension fund investments should ensure the return on pension savings. After all, the main principles for allocating pension reserves are primarily their safety and profitability. NPF investments in infrastructure cover a wide range of projects, ranging from economic infrastructure, such as transport, to social projects, such as hospitals, and include various forms of financing, but the size, risk, profitability and correlation of the assets of these projects are very limited. Pension funds are increasingly moving into new asset classes in search of profitability. Previously, NPFs could participate in infrastructure projects, such as utilities, or through real estate portfolios. However, some NPFs globally begin to invest through private equity funds, or sometimes directly themselves. NPFs seek to invest their money in infrastructure projects, but the existence of such problems as, for example, funds should accrue interest income today from the first day (which immediately excludes new construction projects with an initial construction period), as well as lack of

experience and resources for such investments. The state seeks to invest in the development of industry and transport infrastructure, as well as in providing access to mineral resources. Investments in infrastructure, non-state pension funds can be an effective tool for long-term investment, and it will also achieve a double (synergistic) effect—investing in the Russian economy on the one hand, and increasing pension funds on the accounts of future pensioners (insured) on the other.

## References

1. Valishina, M.E., Valishin, E.N.: Non-state pension funds as participants of investment process and their social responsibility. In: Ashmarina, S.I., Horák, J., Vrbka, J., Šuleř, P. (eds.) *Economic Systems in the New Era: Stable Systems in an Unstable World IES 2020 Lecture Notes in Networks and Systems*, vol. 160, pp. 539–546. Springer, Cham (2021)
2. Valishina, M.E., Valishin, E.N.: NPF as participants in the investment process in infrastructure projects and their social responsibility. *Modern Science: Actual Problems of Theory and Practice. Series: Economy and Law*, **6**, 81–84. (2019)
3. Central Bank of the Russian Federation: Review of key indicators of private pension funds for 2019. [https://www.cbr.ru/Collection/Collection/File/24000/review\\_npf\\_18Q3.pdf](https://www.cbr.ru/Collection/Collection/File/24000/review_npf_18Q3.pdf) (2018) Accessed 21 March 2021
4. Central Bank of the Russian Federation: Overview of the banking sector of the Russian Federation. Analytical indicators for 2017. [https://www.cbr.ru/Collection/Collection/File/8475/obs\\_182.pdf](https://www.cbr.ru/Collection/Collection/File/8475/obs_182.pdf) (2017). Accessed 21 March 2021
5. Alda, M.: Pension fund manager skills over the economic cycle: the (non-)specialization cost. *Eur. J. Financ.* **24**(1), 36–58 (2018)
6. Federal State Statistics Service: The number of pensioners and the average size of the granted pensions by types of pension provision and categories of pensioners. [http://www.gks.ru/free\\_doc/new\\_site/population/uov/uov\\_p2.htm](http://www.gks.ru/free_doc/new_site/population/uov/uov_p2.htm) (2021). Accessed 21 March 2021
7. OECD: Development co-operation report 2016: the sustainable development goals as business opportunities. <https://www.oecd.org/dac/development-co-operation-report-2016.htm> (2016). Accessed 21 March 2021
8. Fuest, C., Hainz, C., Meier, V., Werding, M.: Staatsfonds für eine effiziente Altersvorsorge: Welche innovativen Lösungen sind möglich? *Ifo Schnelldienst* **14**, 3–8 (2019)
9. Lee, J.: Determinants of shareholder activism of the national pension fund of Korea. *Asia Pac. J. Financ. Stud.* **47**(6), 805–823 (2018)
10. Trainar, P.: La création de fonds de pension est-elle encore utile dans les économies avancées? *Revue d'économie Financière* **126**(2), 123–142 (2017)

# Digital Transformation of the Country's Economic Space: Innovation in Economics and Trends



E. E. Dozhdeva, P. S. Franchyzenko, and N. N. Nikolashina

**Abstract** This article discusses key innovations in the transformation of the economy. They are based on basic principles, including cybersecurity, transparency, confidentiality, artificial intelligence, cloud computing, advanced robotics, physical and cognitive human development and expanded reality (XR). Methodology is based on augmented analytics or decision support system, on the use of agents, allow to optimize the costs of companies, as they are able to replace such services. The most sought-after characteristics are considered to be based on when building a financial system of economic life. The “Adolus” startup is shown, which provides a secure update process for embedded devices. The advantage of machine learning methods and in-depth analytics is described. The scope of application of principles (trends) in Russia, which are based on the rapid use of voice assistants and intellectual chat bots are shown. The cumulative contribution of the Internet economy and the mobile economy in Russia’s GDP is shown.

**Keywords** Artificial intelligence · Automation · Digital economy · Finance · Innovation

## 1 Introduction

Digital information and communication technologies are firmly poured into all spheres of society. Digitalization forms the main trend of the industry 4.0, where the methods of artificial intelligence (AI) in different devices and processes are

---

E. E. Dozhdeva (✉)

Samara State University of Economics, Samara, Russia

P. S. Franchyzenko · N. N. Nikolashina

HSE National Research University Higher School of Economics, Moscow, Russia

e-mail: [nnikolashina@hse.ru](mailto:nnikolashina@hse.ru)

N. N. Nikolashina

Center “Federal Methodological Center for Financial Literacy of the System of General and Secondary Vocational Education”, Moscow, Russia

© The Author(s), under exclusive license to Springer Nature Switzerland AG 2022

S. I. Ashmarina and V. V. Manteulenko (eds.), *Digital Technologies in the New*

*Socio-Economic Reality*, Lecture Notes in Networks and Systems 304,

[https://doi.org/10.1007/978-3-030-83175-2\\_76](https://doi.org/10.1007/978-3-030-83175-2_76)

used everywhere. Increasingly, developing companies are developing wearable solutions for industrial workplaces to ensure the safety and efficacy of the production process. Data collection through the introduction of cloud and peripheral computing and development for cybersecurity solutions allows companies to build blocks for creating smart enterprises [1]. Advanced robotic solutions are also an important part of industry trends 4.0, including autonomous mobile robots, coffots and robotics, as well as software development for robots. The demand for artificial intelligence (AI) and industrial automation technology is great today. Automation becomes the main alternative to managing production with AI, robotics and Internet things. Products and services in the digital world can be much quick to go to the global market, becoming accessible to people anywhere in the world [2]. The proposed product can be almost instantly improved under new expectations or consumer needs. The digital economy is a diverse information, educational, scientific, entertainment world, where processes occur faster, better and more convenient.

## 2 Methodology

Robotic solutions require compliance with innovative, well-thought-out and current principles, which are based on the transformation of the economy in the era of digitalization of all systems [3]. Among them, there are the most sought-after characteristics, which are based on when building a financial system of economic life. They are presented in Table 1.

There are four types of artificial intelligence technologies used in digital transformation of the economy:

1. Extraked Analytics/Systems Support Systems: By 2030, this type will surpass others and will be 44% of the activities generated by the business value technologies. Using deep neural networks, (DNN) makes it possible to find regularities in huge data sets that are not amenable to analytics and classify by any other means.
2. Agents: They allow you to optimize the costs of companies, as they are able to replace the services such as Call Center, Help-Desk and other support services. They can also ensure an increase in income, as in the application of consulting robots in financial services.
3. Decision making automation: These technologies are used to automate tasks and optimizing business processes. They are especially useful in such tasks as a voice translation into text and on the contrary, processing handwritten forms or images and the classification of other content with non-quiet or ambiguous data sets. By 2030, the indicator will grow to 19%.
4. "Smart" devices/intelligent products: they personalize customer experience and increase the degree of involvement. A subset of intelligent products is mechanical robots with built-in AI.



**Table 1** Principles of transformation of the economy, taking into account innovation

| Principle  | Description  |
|--|--|
| Cybersecurity, transparency, confidentiality                       | <p>Transmission and processing of confidential data must be performed safely to avoid cyber to important objects. Digital Ethics and Privacy, Privacy Enhancement Technologies, Safety with Zero Trust, Communication Security, Devsecops, Blockchain—Here are just some of the new developments in this direction</p> <p>Special attention with transparency and privacy must be balanced to cybersecurity. Since production practices are becoming increasingly individual and customizable, data management methods used in the external and internal production environment affect a great degree for the company’s attractiveness</p>   |
| Border, foggy, cloud computing                                     | <p>Individual hardware and software solutions, such as connected clouds, distributed clouds, distributed calculations and storage, hybrid calculations, microservices, mobile calculations and peripheral calculations, form the trend of industry 4.0</p> <p>A huge amount of data generated by industrial Internet of things (IOT) contributes to the introduction of peripheral, foggy and cloud computing capabilities</p>   |
| Artificial intelligence  | <p>Advanced AI allows preventive maintenance, cognitive calculations, wing intelligence, contextual-dependent calculations, intelligent machines, hardware accelerators and generative design</p> <p>All these technologies pushing production enterprises to the transition to production without disconnecting light. Plants are more active in integrating the AI to their production systems and processes</p>   |
| Physical and cognitive human development and expanded reality (XR) | <p>XR technology, such as mixed reality (MR), augmented reality (AR) and virtual reality (VR), are already used in the 4.0 industry—from research and development (R &amp; D) to full-scale production processes and post-production processes</p> <p>This paradigm of multilateral experience changes the method of functioning of industrial production systems. The nature of human interaction with the machine is more focused on employees working with machines</p> <p>The physical and cognitive development of people forms another important trend of the industry 4.0. Restrictions of people are enhanced using technologies such as wearable devices and exoskeletons</p> <p>In addition, industrial mobile devices, a natural and intuitive user interface and portable control screens of machines raise the ease of use of such technology</p> |
| Advanced network   | <p>The network and the ability to connect are one of the main driving forces in providing industry 4.0. A number of technological developments, such as the border to the cloud, the gigabit ethernet networks, a sensitive time, low-power global networks (LPWAN), 5G, intermodal communication (M2M), deterministic</p> <p>Ethernet in real time, is a time-sensitive network (TSN), ubiquitous radio access. The unified IoT structure and a zero touch network pushing the factory to implement IIOT to convert to the objects of the Industry 4.0.</p> <p>These technologies are constantly improving machine and machine and human and machine communication, as well as data transfer</p> <p>As a result, innovation in this area increases speed, improve safety and efficiency, and reduce the cost of connecting to the network</p>                 |

(continued)

**Table 1** (continued)

| Principle         | Description  |
|-------------------|--|
| Advanced robotics | Achievements in the field of robotics make processes in the industry 4.0 faster, efficient and safe. The most famous robotic technologies affecting production include autonomous robots, collaborative robots (cobots), joint autonomous mobile robots, humanoids, mobile robots, cloud robotics, APIs, robots for capturing and accommodating, as well as swarms of robots. The use of robots provides higher accuracy and maneuverability, at the same time improving the possibility of rapidly developing custom robots. Robots also release time for employees so that they can focus on other non-repeating or important tasks. |
| Digital double    | Digital twin technology creates virtual industrial assets models by combining dynamic sensing data and real-time visualization data. Some of the promising use of digital twin uses include models-based design, virtual prototyping, virtual system check, bandwidth optimization and evolutionary design. The use of digital twins pushes the 4.0 industry to hyper-automatization. Digital twins provide valuable information about all stages of the production process.   |

*Source* Authors

For example, the VTB Bank has implemented a cross-channel system to counter fraud on the basis of machine learning methods and in-depth analytics. Such solutions provide online monitoring of user actions and allow you to detect fraud during cards for cards, with cash desktop services, using self-service devices, as well as in all remote service channels. The built system helped the bank to improve the quality of customer service [4]. That is, the observance of the principles (cybersecurity, transparency, confidentiality, digital twin, advanced robotic engineering, artificial intelligence) makes it possible to significantly affect the degree of preparedness of the country's economy with close cooperation with the technologies of augmented analytics, automation of decisions taken, the use of agents and smart devices [5]. All this, at first glance, does not seem new and innovative. But only now is widely used in a number of countries during the transformation of the economy.

### 3 Results

Practice shows that the Industry 4.0 uses intelligent connected devices from different suppliers. These devices require constant updating to the latest software version. In Canada, there was a startup "Adolus" (Adolus.com), which provides a secure update process for embedded devices. Adolus develops FACT, which solves the problem of cybergroms, working with equipment suppliers, collecting unique fingerprints of files and comparing these prints with fingerprints obtained by manufacturers. FACT gives validation during installation, as well as the visibility of updating processes in critical systems. All this is a good example of compliance with the first key principle

of transformation of the economy under the auspices of the fight against cyber-based and compliance with the confidentiality of data [6].

Artificial intelligence makes it possible to introduce peripheral cloud computing. There is a startup "Edgise" (edgise.com), which provides equipment for developing equipment for peripheral computing applications. Its advantage is a significant reduction in the response time (time is an irreplaceable resource, the principle of the current time), moving the II from the cloud to the periphery. The optimal productivity of industrial systems depends on the effective execution of the algorithm present in the machines [7]. The means of peripheral computing increase the speed, safety and efficacy of the production process by accelerating the operation of the algorithms. The company provides support for the entire product development cycle for peripheral computing.

Cloud platforms combine and use data from all stages of industrial ecosystem, such as design, production and supply chain. Thus, the American startup "OQTON" (OQTON.com) is developing the FactoryOS platform, which optimizes the factory production based on artificial intelligence to integrate production systems. Machines, systems and data from industrial enterprises are usually stored as independent data warehouses, which makes it difficult to extract real value from them. This platform solves this problem [8].

The scope of the principles in Russia is in the rapid growth of the use of voice assistants and intellectual chat bots. The number of pilot projects in the largest companies in 2020 increased by 38% compared with last year. Now 85% of the largest companies began to use solutions with artificial intelligence. Real projects on unmanned transport (KAMAZ, combines) are launched. There is an active implementation of hyper-convergent infrastructures, the first projects on the implementation of Cloud-Native infrastructures are implemented. The number of call-centers that do not use intelligent chat bots and voice robots will sharply reduce. In Tinkoff the Chat bots can handle 100% of all text handles, and 20% of the dialogs are closed without the participation of the operator. Smart robots check customer data and the accuracy of documents submitted, participate in assessing the quality of dialogs and calls, scoring data and other business processes. The bots not only answer the customer's questions, but also understand what he wants to ask. This trend will lead to the fact that the cumulative contribution of the Internet economy and the mobile economy in Russia's GDP in 2021 may increase to 7–8.75 trillion rubles, if the rate of their growth will amount to about 10–15% per year.

## 4 Discussion

The results of various studies conducted in Russia and foreign countries show a number of common problems faced by organizations that introduce technologies of AI during the transformation of the economy [9].

The main difficulties of development of AI are:

- changes in the list of professions and sought-after human skills;
- regulatory and legal risks;
- ethical questions.

Business leaders responsibly approach to the use of artificial intelligence technologies. About 72% of businesses have introduced AI technology. Of these, 70% are trained with ethical standards of their technologists, and in 63% of companies confirmed by implementing, there are special ethics committees that analyze the use of AI. At the same time, there is a tendency for the absence of data control mechanisms that become part of the technologies of AI. In this regard, issues of using data, in particular, personal, and ethical principles of working with them become particularly relevant. A separate question is the creation of regulation aimed at eliminating the social consequences of the application of AI, such as reducing jobs in traditional industries or new requirements for the qualifications of employees in connection with the introduction of II technologies in the activities of enterprises [10]. Neurotechnologies and artificial intelligence are already among the technologies defined as “through”, along with large data, distributed registry systems, quantum technologies, new production technologies, components of robotics and sensory, industrial Internet, wireless technology and technologies augmented and virtual reality. Therefore, it is necessary to develop proposals for regulating AI aimed primarily to create an environment for the development of innovation, as well as ensuring the safety and rights of citizens. Since the functioning of the AI is largely due to the processing of large data arrays, the lack of computing capacities and storage volumes can be a serious obstacle to the development of AI, for example, in Russia. The solution may be greater transfer of calculations to cloud structures.

## 5 Conclusion

The digital economy is the use of digital methods to solve problems in a new way, and the foundation of this constructor is specified by topical and modern principles that become trends during the transformation of the economy. They affect frames and their competencies, information infrastructure, the provision of information security, the development of domestic digital technologies and artificial intelligence, since they are based on transparency, compliance with the confidentiality and combating cybercrime. Industry 4.0 widely uses intelligent connected devices that reduce the time response, improves the efficiency of the algorithms. For the economy, this indicates the reorientation of the business in the field of artificial intelligence, cloud technologies and digitalization, which are in a constant innovative update. In 2021, up to 85% of the largest companies will use solutions with artificial intelligence, which will increase to 7–8.75 trillion rubles of the contribution of the Internet economy and the mobile economy in the country’s GDP. About 20% EBITDA comes from digital initiatives in sales and procurement. Today, the border between digital and ordinary business is erased, as IT companies come in industry business and begin to

more effectively carry out their processes. In 2021, many strategies and ideas will appear on their implementation, which will be more affected by the transformation of the economy and will lead to the formation of the generality of the “digital” people united by new ideas that will build a new innovative world with actual product.

## References

1. Andriole, J.: Innovation, emerging technology, and digital transformation. *IT Prof.* **22**(4), 69–72 (2020)
2. Marzano, G., Martinovs, A.: Teaching industry 4.0. society integration education. In Lubkina, V., Usca, S., Zvaigzne, A. (eds.) *Proceedings of the International Scientific Conference Society. Integration. Education*, vol. 2, pp. 69–76. Rezeknes Tehnoloģiju Akadēmija, Rezekne (2020)
3. Guarda, T., Balseca, J., González, J., García, K.: Digital transformation trends and innovation. *IOP Conf. Ser. Mater. Sci. Eng.* **1099**(1), 11–18 (2021)
4. VTB: AML/CTF policy. [https://www.vtb.com/finansovye-uchrezhdeniya/protivodeystvie-legalizacii-prestupnyh-dohodov/#tab\\_0\\_1](https://www.vtb.com/finansovye-uchrezhdeniya/protivodeystvie-legalizacii-prestupnyh-dohodov/#tab_0_1) (2021). Accessed 19 March 2021
5. Kleinert, J.: Digital transformation. *Empirica* **48**(1), 1–3 (2021)
6. Adolus: What we do. <https://www.adolus.com/meet-sta/> (2021). Accessed 19 March 2021
7. Edgise: Cases. <https://www.edgise.com/cases> (2021). Accessed 19 March 2021
8. Oqton: Oqton for additive. <https://www.oqton.com/additive/> (2021). Accessed 19 March 2021
9. Zeltser, M.: Drivers of the Russian economy at 2021. <https://bcs-express.ru/novosti-i-analitika/draivery-rossiiskoi-ekonomiki-na-2021> (2021). Accessed 19 March 2021
10. Nambisan, S., Wright, M., Feldman, M.: The digital transformation of innovation and entrepreneurship: Progress, challenges and key themes. *Res. Policy* **48**(8), 103773 (2019)

# Theoretical Aspects and Practical Tools of Smart City Concept Implementation



L. V. Ivanenko, A. S. Zotova, and A. A. Chudaeva

**Abstract** Today, the concept of creating a “smart city” has become widespread, but its practical implementation might differ from city to city. The paper presents the content of the “smart city” concept, the author’s proposals for the definition of “smart city” are given. It is shown that in some large cities the necessary conditions have already been created for the introduction of some digital economy elements and innovative technologies into the urban space. It has been substantiated that clusters contribute to the creation of innovations for “smart cities”. Examples of real tools for the “smart cities” creation are presented.

**Keywords** City innovative development · Cluster · Digital economy · Information technology · Smart city

## 1 Introduction

At present, various innovations are being actively introduced into the life of the Russian Federation cities, the digital economy processes are activated, computer and information and communication technologies are being intensively developed. Particular attention in the implementation of the “smart city” concept in various countries is paid to sustainable energy [1–3], the analysis of large amounts of data for the formation of smart urban environment [4–6], as well as environmental issues. Note that a “smart city” (SC) is a set of multivariate information services that ensure the quality of life of the population and effective city management. It is impossible to build a smart city system in each administrative center according to a single

---

L. V. Ivanenko  
Samara University, Samara, Russia

A. S. Zotova (✉)  
Samara State Technical University, Samara, Russia

A. A. Chudaeva  
Samara State University of Economics, Samara, Russia  
e-mail: [chudaeva@inbox.ru](mailto:chudaeva@inbox.ru)

template, since large cities differ significantly in their characteristics (economic, social, geographic, ecological, etc.).

The complex internal structure of the electronic security system of each administrative center should take into account the modern requirements of the “smart city” concept (stability and sustainability, the ability to self-development and progress). But when the “smart city” system is introduced, “smart risks”, “smart challenges” and “smart threats” arise, since this process captures all aspects of human life. Considering that more than 75% of the total population of the Russian Federation live in cities, it is necessary to regulate all this powerful innovative flow. In this regard, two years ago a National Consortium, which developed the concept of “Smart Cities in Russia”, was created in the country.

## 2 Methodology

The “smart cities” creation and digital economy development are considered in this paper by a set of methods and techniques, mainly, the methods of general scientific research: system analysis, synthesis, comparison, abstraction, generalization, structural-dynamic analysis, observation method, economic and statistical, graphical, grouping method, as well as the application of specific methods inherent in the urban economy as a science.

There are many definitions of the “smart city” concept as like everything new, the content of the term “smart city” is interpreted by researchers ambiguously. Not only the term “smart city” is used, but also “intelligent city”, “digital city”, “sustainable city”, “techno city”. It must be said that the notion “smart city” that has become established in Russia is not entirely accurate in an English term “smart city” translation. In English, “smart” is a collective concept, apart from mind, it also means beauty, convenience, speed.

The definition given by the research company Frost & Sullivan in 2014 presented a fairly generalized, complete and holistic content of this concept and identified eight key or main aspects that define a city as “smart” [7]. Many authors agree with them and use in their own definitions various compositions of the listed elements [8–10]. According to general European approach, a smart city has smart administration, smart economy, smart population and smart environment. In such cities, smart technologies cover all spheres of life: digital housing and communal services, smart building management, modernized industry, innovative construction, etc. All innovations in the city are intended to reduce the costs of the population for life support, to save all types of resources, to improve safety and quality of life.

However, it must be said that currently there are no cities in the world that meet all the requirements and criteria for smart cities. The formation of the “smartest” European cities will continue for 30–50 years. At the same time, it is very interesting to note the remark made by the UK Department of Business, Innovation & Skills, which noted that: there is no precise definition of a ‘smart city’, there is no endpoint,

but there is a process or sequence of steps by which cities become more livable and resilient, and therefore able to respond more quickly to new challenges [11].

It should be noted that the authors consider it appropriate to offer the following content of this term: “smart city” is a city in which the digital economy and information and communication technologies are implemented in all administrative, managerial, power-executive and other city functions. Also, the term “smart city” means a model of a city that ensures, on the one hand, the sustainability of its development, and on the other—the comfort for people living in it.

### 3 Results

Currently, programs and projects for creating “smart cities” are being actively implemented in the life of Russian cities. It is noted that the “smart city” model is based on the following main characteristics (Table 1).

Thus, a “smart city” is “a place where traditional services become more efficient through the use of digital and telecommunication technologies in the interests of its residents and businesses. Also, a smart city is characterized by the following parameters:

- ecologically safe urban environment, comfortable living conditions, strictly human-oriented;
- a high level of quality of life, which is formed on the basis of effective resource management in the city;
- the availability of innovative digital technologies in various urban areas and industries;
- functioning of technological innovative urban infrastructure.

Smart cities are constantly increasing the number of services provided to the population, which are designed to reduce costs and resource consumption, to make people’s lives better and more convenient: to increase the level of comfort, quality and efficiency of services, and also contribute to maintaining the health of citizens, i.e. Smart cities help improve the quality of life of citizens. These services are based on information and communication technologies (ICT), through which the entire life of the city is optimized. Main principles of creating “smart cities” are openness and standardization. A smart city project that lacks these principles will very soon become cumbersome and costly. Further in the paper, using the example of the city of Samara, it is proposed to consider the practical transformation of a large industrial city into a “smart city” with a powerful infrastructure, a developed social sphere, with a population of 1 million 170 thousand people. The following industrial economic clusters function in the city: automobile, aerospace, petrochemical, oil production, IT—cluster, agro-industrial, innovation and a number of others. These clusters are active. There are also potential emerging clusters in Samara: housing and communal services, urban planning, environmental, etc. [12].



**Table 1** Smart city model

| Characteristics         | Indicators  |
|-------------------------|---|
| Smart control           | <ul style="list-style-type: none"> <li>• Under smart management, delegation of functions and diversification of power is assumed;</li> <li>• Effective interaction of authorities at different levels is being created;</li> <li>• A system of quick response to the needs of the population is provided, the quality of public services is increased due to the introduction of electronic government systems, etc</li> </ul>  |
| Smart economy           | <ul style="list-style-type: none"> <li>• In a smart economy, modernization and implementation of information and communication technologies (ICT) in industry is carried out;</li> <li>• The development of high-tech industries is ensured through innovation and digitalization;</li> <li>• Business opportunities are expanding, primarily due to various forms of information and communication technologies and e-commerce</li> </ul>                                  |
| Smart mobility          | <ul style="list-style-type: none"> <li>• In a smart city, sustainable and innovative transport systems (transport, roads, traffic lights) are assumed based on the infrastructure of information and communication technologies;</li> <li>• Provides the ability to monitor the situation on the roads online;</li> <li>• A network of charging stations for electric vehicles is assumed;</li> <li>• Provided service for the provision of car sharing services</li> </ul> |
| Smart people            | <ul style="list-style-type: none"> <li>• People living in a smart city must have a high level of education and the possibility of continuous professional development;</li> <li>• In a smart city, new educational technologies are applied that provide equal access to knowledge for all strata of society (schoolchildren, students, engineers, workers, retirees);</li> <li>• The activity and number of users of the World Wide Web is increasing</li> </ul>           |
| Smart environment       | <ul style="list-style-type: none"> <li>• Effective environmental protection is carried out and, as a result, the quality of natural living conditions is improved. The state of the habitat is improving;</li> <li>• New energy saving technologies are being applied, a system for monitoring environmental safety has been developed, for example, eliminating the consequences of unauthorized waste disposal</li> </ul>   |
| Smart living conditions | <ul style="list-style-type: none"> <li>• High quality healthcare and innovative social services,</li> <li>• The availability of a sufficient number of cultural and sports facilities (theaters, museums, libraries, cinemas, exhibition halls, sports centers and clubs, stadiums, swimming pools, sports grounds, etc.),</li> <li>• Smart urban economy, namely, smart homes, smart apartments, smart sewerage, smart water supply, smart heating, etc</li> </ul>         |

Source Authors

The recent work has been carried out in Samara in order to create the following urban social clusters: a healthcare cluster (medicine and pharmaceuticals), an educational cluster (schools, gymnasiums, lyceums and colleges, higher educational institutions) as well as clusters of housing and communal services, urban planning, transport and logistics, ecological, tourist and others. It should be mentioned that the processes of digitalization and informatization are actively developing in the urban

space of Samara, computer technologies are being introduced, which is confirmed by the presence of a cluster organization, which cannot exist without innovations [12].

The city has the Department of Municipal Economy and Ecology, which functions, first of all, include the management and provision of innovative socially—oriented development and the creation of conditions for the sustainable functioning of housing and communal services enterprises. The Department also carries out measures for environmental safety and improvement of the city's territory. The housing stock of the city is made up of more than 10 thousand apartment buildings, the total area of which is approximately 28 million square meters. The housing fund management is served by 364 management companies and 440 homeowners' associations, i.e. more than 800 enterprises in total. Also, the housing stock uses the services of communal resource-supplying enterprises. The Federal Law No. 209 of 21.07.2017 "On the State Information System of Housing and Communal Services" make it obliged for the enterprises to transfer all information to the information system, thus stimulating the automation of business processes and the development of digital environment in housing and communal services [13]. But the real experience shows that not all enterprises have joined this network infrastructure so far. Its main task is to organize an objective and transparent accounting of the utility resources consumption. Since 2015, the Samara Region, the Ministry of Communications and Mass Media of the Russian Federation, the Ministry of Construction and Housing and Utilities of the Russian Federation and the Federal State Unitary Enterprise Russian Post have concluded a four-party agreement on the trial operation of the state information system (GIS Housing and Communal Services) for the housing and communal services on the territory of the Samara region [14].

GIS Housing and Utilities system is primarily intended to provide the population with complete and reliable information about services, tariffs and charges, as well as to inform the authorities with data that are necessary for analysis and forecasting in the process of making the housing services. Using the geographic information system city dwellers have the opportunity to check the correctness of calculations, to control and monitor the activities of management companies, to receive timely information on expenses and incomes at their place of residence, and, if necessary, to send complaints to the regulatory authorities.

Thus, it is obvious that already today in Samara, certain attempts have been made to create a "smart" housing and communal services, which is organically integrated into the social cluster. In addition, the cluster of housing and communal services has a significant impact on the functioning and development of the industrial economic cluster. It should be noted that today in the city of Samara, serious transformations have been carried out in the transport system—an intelligent transport network (ITS) is being developed to manage the city transport network and traffic flows. At the same time, the improvement of public safety protection in the city is being implemented.

Characterizing the transport system of the city, we note that the road network of the city of Samara has about 1200 roads and has a total length of almost 1100 km. Often, the state of the road network is inconsistent with the available number and type of rolling stock. Cars have a significant impact on the condition of roads. To

determine the number of passenger cars per 1000 population, analytical data were used, which indicate that the city is the leader in the number of passenger cars among cities with a population of more than a million people. Samara's passenger car fleet is about 400,000, with about 334 passenger cars per 1000 people. The second place is occupied by St. Petersburg, where the indicator of car availability is 319 cars per 1000 population. In third place is Voronezh, where there are 308 cars per 1000 people. In fourth place is Moscow, where this figure is 304 cars per 1000 people. Such a high level of motorization in Samara demanded the organization of a fairly powerful complex of services to ensure the operation of transport. An important and intractable problem for the city is the organization and arrangement of parking places for individual vehicles, the construction of parking places in the city, especially in the center. In new residential buildings, garages or parking places are already being designed and built directly in the basements or lower floors of the building, which seems appropriate and convenient for residents.

At the same time, the market for "smart" transport services is being actively developed in Samara. It involves the following elements of "smart" improvement of the transport system:

- introduction and use of an innovative information transport system;
- implementation of a parking space management system using the "Internet of Things";
- tracking the traffic flows indicators;
- implementation of a monitoring system using digital technologies;
- the use of a system of television surveillance of road traffic in the city;
- application of a system of photo and video recording of traffic violations;
- installation of "smart" traffic lights and dynamic road signs;
- installation of electronic screens at public transport stops;
- application of mobile payment for travel in public transport on a single travel electronic document.

Almost all elements of the "smart" transport system are already functioning on the roads and streets of the city, which makes it possible to assert the possibility of transforming Samara into a "smart city".

## 4 Discussion

The implementation of the "smart city" concept in the Russian Federation faces a number of significant obstacles [10, 15, 16]. The first challenge: in almost all cases, the main investor is the state. To achieve the expected economic effect from the introduction of a smart city system, it is necessary to create a number of conditions, for example, to ensure a certain level of penetration of these technologies into the city. Debt attraction of funds for the development of smart city technologies can become a very problematic decision for small innovative enterprises, as a rule, employed in this sphere of the economy in Russia. The housing and communal services industry, as

well as innovation, is a high-risk area, albeit very attractive. A huge number of smart city services require both the appropriate storage capacity and computing power to process streams of “smart information”, which causes significant operational costs to support and maintain all devices.

The second challenge is the gap between those who bears the cost of implementation and who benefits from it. The lack of interest of private investors in smart city projects is explained by the fact that often such investments do not become highly profitable. In any case, the start-up costs will form the basis of the future cost of the services provided, and considering the issues of regulation in the Russian market of housing and communal services, a private company will not operate at a loss. In order to interest a private company in investing into the smart city system, it is possible to propose a reduction in the tax base when paying income tax, deduction of personal income tax for certain categories of developers, allocation of targeted subsidies and grants. One of the solutions to this as an alternative financing option that has recently been discussed is the issue of such projects crowdfunding. The third challenge: the introduction of various services of a smart city often end in failure, since they are introduced suddenly, without preliminary preparation of the population for them, without a special desire on the part of the authorities to get a really positive effect from the innovation. For a more efficient operation of the city, it is necessary to plan the costs of “smart” technologies systematically, to ensure their transparency and control, to evaluate the resulting effect from each implemented project.

## 5 Conclusion

The paper discusses the various contents of the concept of “smart city” and in this regard, the concept of creating a “smart city” has become widespread and the leading idea of a smart city is: the creation of a comfortable city; an innovative transformation of the city’s territory; the inclusion of digital approach into all city services; the educative environment for all citizens to make them “smart”, able to create innovative ideas for future city development and be profound users of all suggested digital solutions. It is shown that in some large cities the necessary conditions have already been created for the introduction of the digital economy element and innovative technologies into the urban space. The practical possibilities of introducing innovative elements, information and communication technologies, digital economy into urban structures are presented. A real example shows the measures that are being taken to transform the city of Samara into a “smart city”.

## References

1. Almeida, M., Mateus, R., Ferreira, M., Rodrigues, A.: Life-cycle costs and impacts on energy-related building renovation assessments. *Int. J. Sustain. Build. Technol. Urban Dev.* 7(3–4),

- 206–213 (2016)
2. Bohne, R., Huang, L., Lohne, J.: A global overview of residential building energy consumption in eight climate zones. *Int. J. Sustain. Build. Technol. Urban Dev.* **7**(2), 38–51 (2016)
  3. Cupelli, L., Cupelli, M., Ponci, F., Monti, A.: Data-driven adaptive control for distributed energy resources. *IEEE Trans. Sustain. Energy* **10**(3), 1575–1584 (2019)
  4. Antonov, I.: *Innovative Development of the Russian Economy: State, Prospects. Integration, Moscow* (2012)
  5. Bochkarev, A.: On the issue of the relationship between the wave and digital economy. *Bull. Volga State Univer. Serv.* **2**(52), 26–30 (2018)
  6. Gessa, A., Sancha, P.: Environmental open data in urban platforms: an approach to the big data life cycle. *J. Urban Technol.* **27**(1), 27–45 (2020)
  7. Berst, J.: Smart is the new green (and it's the future of every modern city). <https://smarciti.escouncil.com/article/smart-new-green-and-its-future-every-modern-city> (2014). Accessed 12 Feb 2021
  8. Albino, V., Berardi, U., Dangeliko, R.: Smart cities: definitions, dimensions, performance, and initiatives. *J. Urban Technol.* **22**(1), 3–21 (2015)
  9. Golenkova, A., Shagbazyan, S., Stepanova, R.: The future belongs to smart cities. *Curr. Trends Sci. Technol.* **1**(8), 6–8 (2017)
  10. Rybina, E.: Organizational and economic methods for the development of smart cities. *Electron. Sci. J.* **10**(82), 43–56 (2015)
  11. Department for Business, Innovation & Skills: Smart cities: Background paper. <https://www.gov.uk/government/publications/smart-cities-background-paper> (2013). Accessed 03 March 2021
  12. Ivanenko, L.: Clusters and innovations: cluster standard. *USUES Bull.* **1**(15), 17–22 (2016)
  13. Federal Law No. 209 of 21.07.2014 “On the State Information System of Housing and Communal Services”. <http://base.garant.ru/70700450/>. Accessed 12 Jan 2021
  14. Ministry of Communications and Mass Media of the Russian Federation: Agreement on pilot operation of the state information system of housing and communal services (GIS of housing and communal services) on the territory of the Samara region. <https://gzh.samregion.ru/wp-content/uploads/sites/16/2019/07/Soglashenie-Samarskaya-obl..pdf> (2015). Accessed 12 March 2021
  15. Kanabeeva, R.: Development of the quality of social innovation in the creative digital economy. *Creative Eco. Soc. Innov.* **1**(22–8), 67–86 (2018)
  16. Volkov, A.: Smart City” Concept. National Research Moscow State Construction University, Moscow (2015)

# Civil Law Ways to Protect Digital Rights



T. N. Kazankova, D. E. Marchenko, and E. V. Glebova

**Abstract** This work is devoted to a topic that is currently gaining special relevance in connection with the transition to new levels of technological development associated with the digitalization of society, as well as in the field of legal regulation of public relations. In view of the recent changes, the problem of digital rights protection, as well as the development of technologies and methods of such protection, is becoming significant not only for domestic law, but also in the field of international protection of digital rights. In the current period of digital technologies, legislation should ensure progressive innovative and sustainable development along with the creation and transfer of modern technologies. The use of advanced technical innovations of IT and internet technologies with the advantages of artificial intelligence, cloud technologies and analytical databases can provide a new digital approach to modern legislation.

**Keywords** Artificial intelligence · Cryptocurrency · Cybersecurity · Digitalization

## 1 Introduction

Modern computer and software technologies used in various fields—medicine (neurosurgery), biotechnology, robotics technology, digital aspects of society continue to rapidly gain momentum in their development. A completely new technological environment is being formed on the basis of modern digital innovations. This environment, in turn, modifies all the processes of public life—the economy, politics, and the legal system. At the same time, such changes occur not only at the domestic level, but also on the international platform for building such relations. The use of advanced digital technologies in various areas of human life has served as a powerful prerequisite, previously unknown for legal realities, for the formation

---

T. N. Kazankova (✉)  
Samara State University of Economics, Samara, Russia

D. E. Marchenko · E. V. Glebova  
Samara Law Institute of the Federal Penitentiary Service of Russia, Samara, Russia

of a fundamentally new environment for civil law regulation of public relations. In view of the significant transformation of the legal environment under the influence of digital technologies, new digital objects with the ability to participate in property turnover, such as cryptocurrency, tokens, virtual property, artificial intelligence, and much more, are emerging. In addition, there are new, previously unused types of electronic services, various kinds of programs for virtual communication. Under the influence of digital technologies, there is arisen a necessary need for the development of a new system of legal regulation of such services, objects of digitalization, which undoubtedly makes this problem relevant and significant for the legal science of the new generation.

## **2 Methodology**

The research was based on various methods, such as the study of the practice of applying the current domestic and foreign civil legislation. In addition, the features of modern civil law regulation of legal relations generated by the use of digital technologies were studied and conceptually evaluated. In the work, the method of comparative-right, synchronic and diachronic, the method of structural and functional analysis was also used. The use of the general scientific research method of synthesis made it possible to create the main author's scientific concepts and definitions. This method allowed us to decompose individual complex phenomena into lines of descriptive features, principles, and elements, to reveal and explain internal structural–functional and other dependencies. The author also used the method of legal modeling. This method allowed us to identify the structural and functional parameters of the investigated objects for the perspective modeling of the optimal legal regulation of civil law on the basis of current trends and general patterns of development. Modern Russian and foreign legal constructions and doctrinal concepts were also used by the author for this study.

## **3 Results**

At the modern stage of social development, when information and communication technologies permeate into all spheres of public life, changes are taking place which are need to be given legal legitimacy. Almost every branch of human communication gets its digital footprint. In the changing social conditions, the theoretical and legal study of the development of digital civil law is acquired particular relevance. Transformations in the information sphere are unthinkable without the formation of general legal trends, in accordance with which new standards and rules of society are developed, and they are consolidated in the national legal system. The ongoing processes lead to the need to understand a number of fundamental issues of the development of civil law in the digital environment, which are of general theoretical importance.

The civil legal environment, in the new conditions of its development caused by the growth of information and communication technologies, faces new challenges and is forced to respond intelligently to them by developing special methods of civil law protection of civil rights. The free and secure existence of the individual, society and the state depends on the degree of protection of the information environment from external and internal threats. In our time, a new generation of law is emerging, regulating political, social, and interstate relations with the help of such tools as artificial intelligence and robotics. Digital human rights are becoming a model for specifying the universal rights guaranteed by the norms of international law and the provisions of the basic law of States. In view of the selected changes, there is a transformation of the priority tasks of the state. Legitimation and legal protection of citizens' rights in the field of information technologies become an important component in the state mechanism of adaptation of legal realities to such changes. A significant feature of modern property relations is the use and application of digital technologies, under the influence of which a new sphere of civil law regulation is emerging in the institution of digital rights in the form of modern trends in civil legislation. In addition, new probabilities of conducting civil transactions are established, not limited only to the use of electronic, but also with the help of other technical capabilities that create possible prospects for reproducing the content of such a transaction in an unchanged form on a material source of the medium. The special significance of the presented research is also caused by the fact that up to the present time, the Russian legal science in the field of civil legal relations has not developed a holistic conceptual view on the civil legal regulation of property relations affecting the sphere of digital rights and contributing to their implementation. The civil law science also did not touch upon new digital objects as objects of civil law turnover, as subjects of legal regulation, nor did it determine the status of their subjects in the sphere of civil law relations. All this has consolidated a certain legal vacuum that is not able to meet the challenges of modern digital realities. In addition, the Russian civil legislation does not properly implement the task of effectively using all the possibilities of digitalization, which can significantly create obstacles to the successful implementation of domestic civil law in the field of digital technologies. On the contrary, in the case of successful development of civil turnover, which actively uses all the achievements of digital technologies, a stimulus will be created to intensify the creation of legal regulation tools. In our opinion, this will serve as a modern vector in the development of civil law and intellectual property rights. To achieve such a level of development of modern legal technologies, a set of rules of conduct is necessary for the legal regulation of digital civil turnover in the context of the development of digital technologies. The process of "digitalization" of civil law puts us in a difficult dilemma of choosing which of the types of legal regime for regulating digital civil turnover to give preference to. We are faced with a choice-to preserve the traditional institutions of civil law, in the sense of regulating the objects of legal regulation that have become so familiar to our civil legal system, or to adopt them under the "digital format". Create a special legal regulation for digital civil turnover, or develop a similar legal regime for digital objects of civil rights. The key point of digital civil turnover should be a reasonable combination in the regulation of relations in this area as the norms of



legislative and bylaws with technical norms in the form of standards and regulations. The developing digital civil turnover has as a subject of legal regulation an independent sphere of digital civil turnover of intangible digital objects that were created by digital technologies. The nascent new principles and methods of legal regulation of civil turnover in the context of adaptation to digital realities serve as a legal basis for the subsequent formation of the “digital economy”, the “digitalization” of law in the conditions of creating a new technological environment and forming a new paradigm for the development of modern civil law. This direction of digital turnover is subject to regulation by separate laws and by-laws, as well as technological standards and rules, in addition to those present in the arsenal of civil law regulation mechanisms. In this regard, it seems that the stability and development of digital civil turnover directly depend on the process of development and improvement of digitalization. The emerging system of principles of digital civil turnover in most cases is based on general principles of civil law, such as good faith, freedom of contract, equality of participants in legal relations, etc. Among the special principles unique exclusively to the principles of digital civil turnover are the principle of technological neutrality, the principle of personal data security, and the principle of cybersecurity. At formation a new legal mechanism of digital civil turnover takes place the process of legitimization by the state and the established traditional system of law of a new legal reality-digital civil turnover, which becomes a new formula for the implementation of civil reality. In this regard, the process of forming digital law should affect changes in the current criminal legal system, in the form of sanctioning penalties for illegal acts in the field of information technology, in addition to the norms of domestic law, cover international ones, jointly develop rules in the field of recognition of digital property rights, the establishment of liability for their violation, raise issues related to cybersecurity, the protection of personal data of participants in social information networks, in the future, the transition to a digital state is expected. An absolute condition for the information society to accept the state’s initiative to regulate this sphere is trust and security guarantees, for the sake of strengthening which requires a bilateral exchange of information, constructive interaction between all interested parties. The essence of the transition to digital civil turnover is the transition from the electronic form of civil turnover to the digital content of legal relations, the regulatory impact on which is exerted by digital technologies. Thus, the development of conceptual models and their further practical implementation will allow us to create an affective model of the regulation of digital rights and their turnover from the point of view of civil law technologies.

Also, revealing all the prospects of the civil law model of regulation of digital civil law turnover and digital rights, ways of disposing of them, together with a comparative legal analysis of domestic and foreign legislation and law enforcement practice, an assessment of possible prospects and visible directions for future improvement and progress in the development of civil law regulation in the field of reconciliation of digital technologies will not only make a certain contribution to legal science from the point of view of theory, but will also undoubtedly be of great practical importance, it will serve as a significant beginning for the formation of an effective model of legal regulation of digital property relations.

## 4 Discussion

The introduction of digital technologies in the spheres of public life cannot have an effect to the transformation in the economy, politics, social and steam aspects of our everyday life. Modern digital technologies, as well as the work to intensify their rapid implementation in modern realities, the use of artificial intelligence products in a wide variety of areas, could not but cause increased interest in the scientific community to general theoretical and scientific-practical research in this area [1–5]. The influence of digital technologies actualizes the need for the development of modern civil law regulation in the vector of digital realities, creating new opportunities for subjects of civil property turnover, introducing new types of digital services into legal practice. The widespread use of modern digital technologies and technical innovations contributes to the formation of a new technological regulatory environment, creates prerequisites for the adaptation of civil legal relations to the possibilities of using digital technologies, while making the legal protection of intellectual activity in the field of digitalization an urgent necessity of modern civil law realities. In this regard, it seems that the transfer of technology acts as a legal mechanism for the transfer of exclusive rights for further use for commercial purposes of intellectual property objects belonging to legal protection. The use of digital technologies in the role of legal definitions, as elements of the digitalization of law, is gradually being implemented in the system of international legal relations, as well as in the national legal system. With the introduction of digital technologies in modern realities, there is a problem of ways protection of their individual elements, which in the national legal doctrine are not included in the objects of civil turnover. We are talking about such phenomena as tokens and cryptocurrency. However, western law enforcement practice has developed certain ways to protect the property rights of holders of tokens and cryptocurrencies using several legal approaches. Thus, in the case of protecting the rights of token holders as owners of corporate securities (shares) or other securities, civil law methods of protecting the rights that are provided for the owners of securities are used if the token falls under regulation as a type of security in a particular national jurisdiction. In particular, the laws of the United States and Switzerland allow for this possibility. An example is the well-known case of Tezos Inc., which in 2017 announced an ICO (Initial Coin Offering) and the issuance of tokens in order to organize a consortium of 4–5 banks to create a large fund and conduct fundraising operations for the development of a blockchain platform and smart contracts similar to cryptocurrency [6]. Another way to protect the property rights to the objects of digitalization is the recognition of an invalid transaction (initial placement of ICO tokens), including its commission under the influence of delusion, deception, mental or physical violence, since the ICO process necessarily declares the purpose of accumulating funds or other property and the means to achieve it. In case of refusal to provide such information or false information contained in it, token holders can count on compensation for losses caused to them as a result of such actions or declare the transaction invalid if they purchased the tokens under the influence of delusion. Protection of rights arising from contractual obligations in case of violation of the

terms of the contract. This method of protection is possible if the transfer of rights to tokens is made out as a two-way purchase and sale transaction or even a gift, the terms of which provide for the rights of the token owner under the obligation, including the fulfillment of the project conditions. And in case of non-fulfillment of the terms of the agreement-the property liability of the parties provided for in this agreement: the probability of recovery of losses, penalties, etc. The next method of protection is the protection of rights in case of violation of the rights of the consumer or the rules of advertising the product. The use of such a protection option takes place only with social advertising in social networks, such as Facebook, Instagram, which is widely used at the beginning of the promotion of the token issue project. Accordingly, contrary to reality, intentionally misleading statements of the person who issued the token (the issuer) entails civil liability in accordance with the legislation on the protection of consumer rights. It should be noted that despite the fact that legal protection in the field of information technology still lags behind the most scientific and technological progress, that is, it is not able to fully guarantee full protection, at the same time, in a number of countries, rules have long been in place aimed at the technical protection of copyrighted works and the interests of copyright holders using DRM technology from circumvention of protection or hacking of content in accordance with the procedure established by law. The law actually prohibits the creation of such technologies, technical devices or their components, as well as the use of them for the specified purposes. As a technical means of protection, various digital tags can be used to uniquely determine whether a product belongs to a particular intellectual property owner. However, the lack of a legal protection mechanism, including at the international level, remains an important problem that will strengthen protection in the field of information technology. In the era of modern technologies, the law should not only keep up with its development, but also be a kind of incentive for the creation and transfer of the latest technologies, while actively using all the advantages of artificial intelligence, cloud technologies, and serve as a sufficient and necessary guarantor of a new look in law enforcement practice.

## 5 Conclusion

Based on the conducted research, it seems appropriate and reasonable to change the current legislation. So, in the case of admission to the purchase of tokens of individuals without proper qualifications of investors, supplement the current legislation on consumer protection with provisions on the liability of the issuer, or liability in the secondary market for the sale of tokens. The responsibility of officials for causing damage or abuse of trust when placing tokens on the ICO, negligence in protecting the legitimate interests and property rights of token holders also becomes important. In our opinion, this kind of responsibility should be expressed in the law itself, by analogy with the methods of protecting the exclusive right provided for in the provisions of civil law. Measures of property liability are acquired particular importance in view of the spread of hacker cyberattacks on the contents of electronic wallets

and other places of storage of cryptocurrencies, as well as in the process of committing secret theft on the site of the “World Wide Web” with the use of malicious software code, the introduction of banking trojans, encryption programs that can cause significant property damage to copyright holders. It is also important to have a certain conceptual approach to establishing responsibility measures when defining the concept of cybersecurity in the field of information technology. It is possible to resolve issues related to strengthening cybersecurity with the adoption of a comprehensive regulatory act on the legal regulation of digital technologies. We believe that the need to adopt such a legal act is essential, since it will protect the rights holders from acts in the field of information technology, create the necessary mechanism for managing them, and strengthen legal protection in this area.

## References

1. Barnes, S.J.: Information management research and practice in the post-COVID-19 world. *Int. J. Inf. Manage.* **55**, 102175 (2020). <https://doi.org/10.1016/j.ijinfomgt.2020.102175>
2. Denisov, E.I.: Robots, artificial intelligence, augmented and virtual reality: ethical, legal and hygienic issues. *Gigiena i Sanitariya* **98**(1), 5–10 (2019)
3. Kazankova, T.: Artificial intelligence as an object of legal protection. In: Ashmarina, S., Mantulenko, V. (eds.) *Current Achievements, Challenges and Digital Chances of Knowledge Based Economy. Lecture Notes in Networks and Systems*, vol. 133, pp. 371–376. Springer, Cham (2021)
4. Kuznetsov, Y.V.: Justice without law: legal status of cryptocurrency in a bankruptcy. *Case Ekonomicheskaya Politika* **13**(6), 122–135 (2018)
5. Rezaev, A.V., Tregubova, N.D.: Artificial intelligence and artificial sociality: new phenomena and problems for medical and life sciences advance. *Epistemology Philos. Sci.* **56**(4), 183–199 (2019)
6. Irrera, A., Stecklow, S.: Tezos organizers sued in California over crypto currency project. <https://www.reuters.com/article/us-bitcoin-tezos-battles/tezos-organizerssued-in-california-over-crypto-currency-project-idUSKBN1D325A> (2017). Accessed 27 March 2021

# Digitalization of Legal Proceedings as a Way to Save Budget Funds



T. A. Kalenteva and A. P. Bozhko

**Abstract** Informatization of legal proceedings is one of the main directions of development in Russia. Analyzing the possibilities of using artificial intelligence in court proceedings, the authors note the need to introduce video conferencing in order to save federal budget funds. The informatization of legal proceedings in Russia was accelerated by a situation that does not depend on society and the state, namely, the COVID-19 pandemic, which pointed to gaps in the activities of the courts, their insufficient technical equipment, as well as the unwillingness of the current legislation to switch to the online mode, which led to a violation of the rights of citizens to access justice. The introduction of information technologies in the justice process entails both positive and negative aspects, which are described in the work and the conclusion is made about the maximum opportunities for digitalization of legal proceedings in Russia today.

**Keywords** Budget savings · Cost recovery · Court costs · Digital technologies · Justice · Videoconferencing

## 1 Introduction

The main objectives of the development of electronic justice in Russia today are to increase the pace of technical development, to ensure the relevance and stability of legislation adapted to the rapidly changing conditions of the digital society and economy [1]. The modern world dictates its own rules, in which time is the main and most valuable resource for a person [2]. The 2020 pandemic has significantly changed the minds of citizens. For a long time, information technologies were used and were popular among the young population [3]. The pandemic has made its own adjustments: representatives of all segments of the population have had to switch to the use of digital technologies [4]. Information technologies have penetrated into all

---

T. A. Kalenteva (✉) · A. P. Bozhko  
Samara State University of Economics, Samara, Russia

spheres of society, including the sphere of justice. In the spring of 2020, the leadership of the Supreme Court of the Russian Federation took care of the issue of taking measures aimed at protecting public health and preventing the spread of infection. So there were two Resolutions [5, 6]. The courts were ordered to consider only urgent cases, as well as cases considered without the participation of the parties—in the order of simplified and writ proceedings. The possibility of holding court sessions using video conference systems appeared with the introduction of amendments to the Decrees of the Presidium of the Supreme Court of the Russian Federation and the Presidium of the Council of Judges of the Russian Federation of 08.04.2020 No. 821 as amended on 29.04.2020 [6]. The first weeks of using video conferencing systems available to any Internet user for holding court sessions online, the number of civil cases considered by arbitration courts increased. According to the portal “Pravo.ru”, as of May 25, 2020, 1326 online court sessions were held in the arbitration courts and 3777 court sessions were scheduled [7]. This form of litigation has become available in 77 commercial courts [8]. The trial lawyers who took part in the meetings online actively shared their positive impressions of the time savings [9]. This study is a logical continuation of the authors’ research on the introduction of information technologies in court proceedings [10]. At present, there is a need to change the approach to the information support of the judicial system. The approach should not be point-based (electronic filing of documents to the court, electronic notifications, electronic registration of cases), but comprehensive. We believe that the financial costs that are necessary for the comprehensive implementation of information technologies in court proceedings are definitely several orders of magnitude higher than modern court costs. However, ultimately, the transition of the judicial system to the information space will significantly save budget funds in the future. The introduction of videoconferencing in court proceedings will not only reduce procedural costs, but will also contribute to increasing the transparency of the Russian judicial system. In the context of the COVID-19 pandemic, courts do not always allow persons who are not participants in the proceedings to enter the courtroom, thereby limiting the principle of transparency of the proceedings. The ability to broadcast court sessions in the future will guarantee compliance with the principle of openness and strengthen the transparency of the Russian judicial system.

## 2 Methodology

The universal method of cognition was the basis of this study. However, to solve specific problems, some private, special and general scientific methods of cognition were used. On the basis of the statistical method, the facts of significant expenses related to the procedural costs were revealed. The empirical method contributed to the study of judicial practice, which was subsequently analyzed. The systematic method allowed us to study the legal norms in their interrelation. The comparison method was used in the study of special literature. On the basis of mathematical methods, the amount of procedural costs paid from the federal budget is predicted. As particular

methods: comparative legal and formal legal methods, the method of processing and actual study of the material.

### 3 Results

The institution of reimbursement of court costs has existed for a long time. Depending on the scope of legal regulation, it has its own differences. If we consider the institution of court costs in civil [11], administrative [12] and arbitration [13] proceedings, then reimbursement of court costs is possible only within 3 months from the date of the final decision. According to paragraph 10 of the Resolution, «the absence of supporting documents is an absolute ground for refusing to satisfy the relevant requirements» [14, p. 10].

For example, in Primorsky Krai, the Company filed a lawsuit against the Territorial Administration of Rosreestr to recover a debt for storage services in the amount of more than 19 million rubles. The Arbitration Court's decision, left unchanged by the higher instances, satisfied the claims in full. After that, the company filed an application for recovery of court costs in the amount of 77,960 rubles, which included transportation costs for the travel of the representative on the route "Moscow-Vladivostok-Moscow" and the costs of his hotel accommodation incurred in connection with participation in the court sessions of the first and appeal instances. By the ruling of the Commercial Court, which was left unchanged by the court of appeal, the claims were partially satisfied in the amount of 58,980 rubles. Not agreeing with the adopted judicial acts, the company filed a cassation complaint with the Arbitration Court of the District, stating that the lower courts had not fully and properly examined the evidence and had incorrectly applied the rules of procedural law. Having studied the case materials and the arguments of the cassation appeal, the district court found no grounds for its satisfaction. The Court stated that "the hotel bills submitted for the period from 22 to 26 January and from 25 April to 1 May 2016 fall outside the dates of the court hearings held during the initial trial and the subsequent review of the judgment, namely 22 January and 26 April, respectively. Since the plaintiff did not provide evidence that it was impossible to purchase air tickets and fly to Moscow at an earlier date, the residence of the plaintiff's representative in hotels in the period from 24 to 26 January and from 28 April to 1 May 2016 cannot be considered related to the consideration of this case» [15].

A similar system of reimbursement of court costs is also provided for by the current criminal procedure legislation. If in civil proceedings the costs are recovered from the losing party, in criminal proceedings they are fully reimbursed by the State. In criminal proceedings, procedural costs are defined as all costs associated with criminal proceedings. The specified expenses include the amounts paid to the interpreter, the victim, the witness, the witnesses, the specialist, the expert, and also to the defender who participated in the proceedings on the criminal case on the appointment of the investigator, the inquirer or the court. The expenses related to the appearance of the above-mentioned participants in the process at the place of

investigative or judicial actions and their accommodation (travel expenses, rental of residential premises) are subject to compensation. These costs should include the amounts spent on the production of expert examinations in expert institutions; the amount spent on the storage and destruction of physical evidence; the amount of remuneration paid to experts, translators and specialists for the performance of their duties; and other expenses. This list shows that there are more such costs in criminal proceedings than in civil proceedings.

If we look at the statistics on the activities of courts of general jurisdiction in 2020, it becomes obvious that the costs of reimbursement of court costs paid from the budget in criminal proceedings significantly exceed those for other types of legal proceedings. Also, the budget pays expenses related to the violation of reasonable terms of legal proceedings, and in criminal proceedings, the terms of consideration of criminal cases sometimes greatly exceed the permissible limits. Most often, this happens in cases where the court session is repeatedly postponed due to the inability to appear in court of any of the participants in the process. The reasons for this can be very different: a cold, a business trip, living at a considerable distance from the court, unwillingness to take time off from work, etc. All this leads not only to a delay in the trial, but also increases the amount of payments from the budget to other participants in the process who are forced to appear in court on a mandatory basis (lawyers, translators). A similar situation arises in cases where experts are summoned to the court to give evidence. In most cases, the expert is an employee of a state expert institution. Attending a court hearing takes up several hours of working time, and sometimes a whole working day. In case of departure to another region—up to several days. Questioning an expert via video conference call would solve this problem as well. In the period of 2017–2020, a large-scale reform of the judicial system was carried out in the Russian Federation. As a result, if earlier the participants of the proceedings, whose cases were considered in the appellate and cassation instances, had to travel on the day of the court session only to the courthouse, now they need to go to another subject of the federation if they plan to take a personal part in the court session. Such changes have significantly hampered the activities of both professional participants in the proceedings (defense lawyers and public prosecutors) and ordinary citizens. This, in turn, has significantly impeded access to justice. If earlier it was enough for a citizen to take half a day off from work, now he needs to take a few days off to go to a court located in another region.

Last year was the final year of the implementation of The Concept of Development of Informatization of Courts of General Jurisdiction for 2013–2020, approved by the Decree of the Presidium of the Council of Judges of the Russian Federation No. 328 of 28.02.2013 [16]. At present, the goals set out in the Concept are mostly implemented in practice:

- notification of participants in civil, administrative and arbitration proceedings about the date and time of the court session is made by SMS messages. In criminal proceedings, such a notification procedure is not provided for;
- the mandatory audio recording of the court session has been officially introduced;



- electronic registration of cases and random electronic distribution of cases to specific judges and judicial structures have been introduced everywhere;
- introduction of an electronic database of court decisions with the placement of these documents in the system of GAS “Justice»;
- all courts have implemented the possibility of filing claims, applications, petitions and other documents in electronic form with simultaneous verification of the authenticity of the participants in the process;
- widespread introduction of videoconferencing as a form of participation in the court session when considering cases.

Undoubtedly, the results of the process of informatization of the judicial system, which were reflected in the above-mentioned Concept, are quite successfully implemented. However, the year 2020 has shown that even the achievements of today’s stage of development of technologies used in the judicial process are not enough. According to the data of departmental statistical reports for the first half of 2020, the courts issued 585,400 decisions on payment of procedural costs at the expense of the federal budget (for the first half of 2019—725,855) [17]. If we theoretically assume that the amount of procedural costs was paid in the amount of at least 20,000 rubles for each decision, then 11,708,000 rubles were paid from the federal budget for the first half of 2020 (14,517,100 rubles for the first half of 2019). In order to save budget funds and time of the participants in the proceedings, it seems appropriate to legislate the possibility of holding a court session using video conferencing systems. This possibility should be provided for in all cases of consideration of cases in the appellate, cassation and supervisory instances, when the court and the participants in the process are located in different cities. In addition, such an opportunity should be provided to the participants of the process in the framework of the consideration of cases in the first instance at the request of the participant in the process. The issue of personal identification is resolved by the obligation to register on the portal of state services of the Russian Federation. In addition, in the course of legal proceedings using videoconferencing, it seems appropriate and necessary to introduce a technology for recognizing truth and lies. The video analytics system can now analyze human behavior using artificial intelligence. It is worth noting that from 2016 to 2020, the accuracy of facial recognition by neural networks improved 50 times: the error rate was 0.8%. The most large—scale developments in the field of facial recognition are from Google, Apple, Facebook, Amazon and Microsoft. One of the well-known companies on the market in Russia is VisionLabs, which participated in the development of systems for Moscow cameras. Recently, the company has become part of the Sberbank ecosystem, and now their developments are used, among other things, for the introduction of biometrics in banking services [18].

The introduction of information technologies at the stage of preliminary investigation will also entail budget savings. As we have already noted, at present, all expenses incurred by participants in criminal proceedings are subject to reimbursement from the budget, in addition, the introduction of an electronic format of criminal cases will save federal budget funds spent on paper and other stationery, as well as ensure

timely adoption of procedural decisions by the investigator [19]. Using a special electronic key, the accused and his defense lawyer will be able to get acquainted with the document in full on the same day and, if necessary, appeal against a particular procedural decision [10].

## 4 Discussion

The need to introduce digital technologies in legal proceedings has been the subject of research by both Russian and foreign scientists for a long time. Everyone, without exception, is convinced of the need to introduce digital technologies in the field of justice. There are only questions related to the depth of penetration of these technologies into the sphere of justice and the form of their implementation.

Andreeva and Kachalova analyzing the current situation with the pandemic, indicate both positive and negative aspects that occurred during this period in the system of investigation and resolution of criminal cases [20]. For example, the authors note the introduction of WhatsApp and Skype into the practice of Russian courts. The Supreme Court of the Russian Federation applied the technology of biometric authentication of the participant of the court session by face and voice, which allowed holding court sessions via a web conference from office or residential premises. There are also problems and shortcomings in the work of the courts: an unsuccessful attempt to serve correspondence that was sent by EMS with delivery by courier, the information closeness of some courts, the decision to extend the period of detention with reference to extraordinary circumstances without persons under investigation, and others. One of the main proposals of the authors of the work is the active introduction of information and digital technologies into the Russian criminal process, its translation into an electronic format. Pointing to the positive experience of such countries as Georgia and Kazakhstan, the idea of introducing an electronic criminal case format is noted, which will undoubtedly require changes to the current legislation of Russia [21]. Scherman talks about scientists and technical experts who are working on the development of biometric methods that will allow the recognition of faces and irises, as well as on algorithms for processing 3D images for technological recognition of facial features and eyes of an identified person [22].

A number of authors, summarizing modern practices of introducing face recognition technology into public life and practice, mention both positive and negative consequences of the introduction of such systems [23]. While noting the undoubted advantages, they cite the example of a situation that occurred in China, in which the face recognition using artificial intelligence in a banking application was able to quickly detect the criminal and detain him. Despite the numerous advantages of using artificial intelligence in face recognition, the following problems of its application are indicated: first, the development of video surveillance systems with face recognition can lead to the actual loss of the right of citizens to privacy; second, the imperfection of existing face recognition technologies, which leads to the possibility of erroneous recognition; third, the problems of loss of confidentiality, privacy and

unjustified invasion of the right to privacy, which will create a public opposition to the process of introducing facial recognition technology.

Koroleva and Gubina, discussing the need to create a full-fledged digital infrastructure and implement a whole range of measures in the Russian justice system, cite statistics on the consideration of cases in arbitration courts in the video conference mode during the 2020 pandemic [4]. However, they note that the acceleration of the process of digitalization of the courts' activities in Russia today requires a full-fledged approach, starting with the technological support of the courts and ending with the adoption of the necessary changes to the procedural legislation. It is noted that in 2019, the portal Gosuslugi.ru five super services were tested, one of them—“Justice Online”. This service will be available from 2022 and will allow not only to submit procedural documents and evidence in electronic format, but also to take part in a court session in online format using cloud-based video conferencing platforms. From 2024, it is planned to introduce technologies for identifying the identity of a participant in a court session through biometric authentication.

“Justice Online” of course cannot be called a super service in the truest sense of the word. This is a system that combines several services combined to help a citizen in a particular situation. This system will combine both the existing service for filing electronic documents to the court, and new services: the ability to get acquainted with the case materials without visiting the court and take part in court sessions online from home. And if the opportunity to take part in court sessions online is partially realized at the present time by participating in court sessions in the courts of cassation instance through the system “GAS Justice”, then the service of familiarizing yourself with the materials of cases online is currently only a dream.

## 5 Conclusion

Currently, there is an urgent need to change the approach to information support of the judicial system. The approach should not be point-based (electronic filing of documents to the court, electronic notifications, electronic registration of cases), but comprehensive. When implementing individual technologies, we may face a situation where we cannot combine individual technologies [24]. The information field of the Russian judicial system should be unified. We believe that the financial costs that are necessary for the comprehensive implementation of information technologies in court proceedings are definitely several orders of magnitude higher than modern court costs. However, ultimately, the transition of the judicial system to the information space will significantly save budget funds in the future. The introduction of videoconferencing in court proceedings will not only reduce procedural costs, but will also contribute to increasing the transparency of the Russian judicial system. Today, in the context of the COVID-19 pandemic, the courts do not always allow persons who are not participants in the proceedings to enter the courtroom, thereby limiting the principle of transparency of the proceedings and undermining the constitutional foundations of justice. The ability to broadcast court sessions online in the

future will allow anyone, regardless of their location, to virtually attend the court session. Such an opportunity could best guarantee compliance with the principle of transparency and enhance the transparency of the Russian judicial system. This, in turn, could lead to a reduction in the level of corruption.

## References

1. Rudneva, Y.V.: E-Justice: development prospects. In: Mantulenko, V.V. (ed.) Proceedings of the 18th International Scientific Conference Problems of Enterprise Development: Theory and Practice. European Proceedings of Social and Behavioural Sciences, vol. 82, pp.639–644. European Proceedings, London (2020)
2. Naurbieva, F.: Digital technology as a global trend of criminal justice. In: Bataev, D.K.-S., Gapurov, S.A., Osmayev, A.D., Akaev, V.K., Idigova, L.M., Ovhadov, M.R., Salgiriev, A.R., Betilmerzaeva, M.M. (eds.) Proceedings of the International Scientific Conference «Social and Cultural Transformations in the Context of Modern Globalism». European Proceedings of Social and Behavioural Sciences, vol. 76, pp. 2437–2441. European Proceedings, London (2019)
3. Valeev, D., Bazilevskikh, E.: E-justice and information technologies in civil procedure. *Brics Law J.* 5(4), 175–179 (2018)
4. Koroleva, A.N., Gubina, E.N.: Digital platforms in justice: Pros and cons: Actual Problems of Jurisprudence, 4(68), 52–60 (2020)
5. Decree of the Presidium of the Supreme Court of the Russian Federation and the Presidium of the Council of Judges of the Russian Federation of 18.03.2020 No. 808. <https://www.vsrfr.ru/files/28814/>. Accessed 18 March 2021
6. Decree of the Presidium of the Supreme Court of the Russian Federation and the Presidium of the Council of Judges of the Russian Federation of 08.04.2020 No. 821. <https://www.vsrfr.ru/files/28837/>. Accessed 18 March 2021
7. Pravo.ru: 1000th online trial held in arbitration courts. [https://pravo.ru/news/222012/?desc\\_emb=/](https://pravo.ru/news/222012/?desc_emb=/) (2021). Accessed 18 March 2021
8. Kondratieva, I., Malakhovsky, A.: Finding a balance: What will online justice be like in Russia. [https://pravo.ru/story/221644/?desc\\_chrono\\_2\\_2=/](https://pravo.ru/story/221644/?desc_chrono_2_2=/) (2020). Accessed 18 March 2021
9. Rechkin, R.: About the “fashion” for online meetings. [https://zakon.ru/blog/2020/05/27/ode\\_na\\_onlajn-zasedaniya](https://zakon.ru/blog/2020/05/27/ode_na_onlajn-zasedaniya) (2020). Accessed 18 March 2021
10. Kalenteva, T., Bolgova, V.: Electronic format of criminal cases as a leading trend in modern criminal proceedings. In: Strielkowski, W. (ed.) Proceedings of the 6th International Conference on Social, Economic, and Academic Leadership (ICSEAL-6–2019). Advances in Social Science, Education and Humanities Research, pp. 464–470. Atlantis Press, Paris (2019)
11. Civil Procedure Code of the Russian Federation. [http://www.consultant.ru/document/cons\\_doc\\_LAW\\_39570/](http://www.consultant.ru/document/cons_doc_LAW_39570/). Accessed 18 March 2021
12. Code of Administrative Procedure of the Russian Federation. [http://www.consultant.ru/document/cons\\_doc\\_LAW\\_176147/](http://www.consultant.ru/document/cons_doc_LAW_176147/). Accessed 18 March 2021
13. Arbitration Procedure Code of the Russian Federation. [http://www.consultant.ru/document/cons\\_doc\\_LAW\\_37800/](http://www.consultant.ru/document/cons_doc_LAW_37800/). Accessed 18 March 2021
14. Resolution of the Plenum of the Supreme Court of the Russian Federation No. 1 of 21.01.2016 “On Certain Issues of the Application of Legislation on the Reimbursement of Costs Associated with the consideration of the case». <http://base.garant.ru/71330124/>. Accessed 18 March 2021
15. Rogotskaya, S.: The travel and accommodation expenses of the representative must be justified. <https://www.advgazeta.ru/novosti/raskhody-na-proezd-i-prozhivanie-predstavitelya-dolzhny-byt-obosnovany/> (2017). Accessed 27 March 2021

16. The Concept of Development of Informatization of Courts of General Jurisdiction for 2013–2020, approved by the Decree of the Presidium of the Council of Judges of the Russian Federation No. 328 of 28.02.2013. <http://base.garant.ru/71062432/>. Accessed 18 March 2021
17. Judicial Department of the Supreme Court of the Russian Federation: Judicial statistics data. <http://www.cdep.ru/index.php?id=79> (2021). Accessed 25 March 2021
18. RBC: How does face recognition work and can this system be tricked. <https://trends.rbc.ru/trends/industry/6050ac809a794712e5ef39b7> (2021). Accessed 25 March 2021
19. Dyatlov, S.A., Bulavko, O.A., Nikitina, N.V., Lobanov, O.S., Efremova, Yu.I.: The blockchain as a digital technological platform for electronic government development. In: Mantulenko, V. (ed.) Proceedings of the International Scientific Conference “Global Challenges and Prospects of the Modern Economic Development”. European Proceedings of Social and Behavioural Sciences, vol. 57, pp. 1396–1407. European Proceedings, London (2019)
20. Andreeva, O.I., Kachalova, O.V.: Russian criminal procedure in the era of coronavirus: challenges of the time. Bull. Tomsk State Univ. **36**, 5–15 (2020)
21. Andreeva, O.I., Ivanov, V.V., Nesterov, A.Yu., Trubnikova, T.V.: Facial recognition technology in criminal proceedings: the problem of the bases of legal regulation of the use of artificial intelligence. Bull. Tomsk State Univ. **449**, 201–212 (2019)
22. Scherman, J.: How courtroom technology has revolutionized criminal cases. <https://www.rasmussen.edu/degrees/justice-studies/blog/courtroom-technology-revolutionized-criminal-cases/> (2016). Accessed 23 March 2021
23. Amiyants, K.A., Chemerinsky, K.V.: The use of artificial intelligence in the modern judicial system and human rights. Int. J. Humanit. Nat. Sci. **11–3**(38), 49–52 (2019)
24. Decree of the Presidium of the Council of Judges of the Russian Federation No. 759 of 18.07.2019. <https://yamal.arbitr.ru/sites/yamal.arbitr.ru/files/pdf/%20%E2%84%96754-761%20%D0%BE%D1%82%2018.07.2019%20%D0%BE%D1%82%2002.12.2019.pdf>. Accessed 18 March 2021

# Assessment of the Human Capital Value in the Digital Transformation Context



O. Yu. Kogut

**Abstract** The effective work of any organization is based on the availability and use of human capital. The significance of this factor is increasing every day, and the impact is not only on the activities of the organization, but also on its value. We have analyzed and generalized existing works in which this topic is considered in order to identify theoretical and methodological developments, the use of which will be possible within the framework of our research. The work structured the costs of human capital formation, considered the main methods for assessing the value of human capital, considering various approaches to determining its essence. Using the cost approach, the types of costs for human capital are considered, their economic essence is investigated. For the first time, a complex mathematical model has been proposed that allows calculating the cost of human capital.

**Keywords** Cultural capital · Education capital · Health capital · Human capital (HC) · Value

## 1 Introduction

Many scientists and researchers consider human capital to be the most valuable resource of a post-industrial society and strategically more important than the availability of natural resources, which are exhaustible [1–10]. Currently, human capital is a factor in the successful functioning of any organization and economy in the context of the digital transformation of the socio-economic sphere. All over the world, human capital largely determines scientific and technological progress, the competitiveness of the economy and the rate of economic development of the country. The transformation of the role of human capital, its transformation from a cost factor into the main factor of production and social development, has led to the formation of a new paradigm for the development of countries and the world community. There is a large set of methods that science and practice have created, but these methods differ from

---

O. Yu. Kogut (✉)  
Al-Farabi Kazakh National University, Almaty, Kazakhstan

each other both in the level of human capital research and in the approach used; there are also methods within each of the approaches that are aimed at one of the aspects of assessing human capital.

## 2 Methodology

In the process of studying the problem of assessing the value of human capital, fundamental works of the classics of economic and philosophical thought, monographs, scientific works, articles of domestic and foreign scientists on this topic were studied [1–3, 7, 8]. The methodological basis for writing an article is a systemic and integrated approaches, a set of methods and methods of scientific knowledge: analysis, synthesis, analogy, induction, deduction and generalization.

A systematic and integrated approach to assessing the value of human capital means that the activities of individual organizations should be studied as part of a system of a higher hierarchical level, considering internal and external relations. At the same time, the object should be assessed not only from the point of view of achieving its local goals, but also necessarily from the point of view of how these goals correspond to the goals of the system of a higher hierarchical level and the interests of society.

## 3 Literature Review

The study of issues related to the problems of human capital, were engaged: Western scientists Petty [11], Thurow [9], Smith [12], Schultz [13], Becker [1], Kogut [5], Kendrick [14], Fitzenz [2], Flamholtz [3]; Russian economists Tuguskina [15], Tsarev, Evstratov [16], Alaverdyan [17], Arabian [18], Chigoryaev, Skopintseva, Ulyashchenko [19], etc. In its modern form, the theory of human capital was formed in the late 50–60 s. XX century the role of the “discoverer” of this theory in its modern form belongs to the American scientist-economist Schultz, winner of the Nobel Prize in Economics in 1979. Schultz proposed the following definition: “All human resources and abilities are either innate or purchased. Valuable qualities acquired by a person, which can be enhanced by appropriate investments, we call human capital” [13, p. 78].

Professors Dobrynin, Dyatlov and Tsyrenova believe that human capital is not just a set of skills, knowledge, abilities that a person possesses [20]. First, it is the acquired stock of skills, knowledge and skills. Secondly, it is a set of skills, knowledge, skills that is rationally applied by a person in a sphere of social activity and leads to an increase in labor productivity and production. Thirdly, the rational use of this stock, subject to the organization of high-performance activities, naturally leads to an increase in the employee’s income. And, fourthly, the growth of income motivates and motivates a person through investments that can be used to maintain

health, education, etc., to increase, accumulate a new stock of knowledge, skills and motivation to use them effectively in the future.

The problem of assessing the value of HC is of interest due to the complexity and universality of this category, as well as its importance for ensuring the efficiency of the economy. There is no consensus among the authors on the methodology for assessing the value of HC at the micro level.

## 4 Results

Today in the world economy, modern trends show a change in the role of man, which is not only the goal of social production, but also a resource for socio-economic progress. Scientists-economists interpret the concept of HC in different ways. But they agree that human capital is the main driving force of society, not only the person himself, but also the state should pay close attention to the formation of HC. In the above definitions, human capital acts as the goal of economic development and as the main production resource, without which any purposeful activity is generally impossible.

Taking into account the above, we have formulated the following definition: human capital is a set of knowledge, skills and abilities of a person created as a result of investment in a person and accumulated by a person himself, the effective use of which determines labor productivity and can become sources of income for a person, family, organization and society as a whole. In other words, human capital is a form of capital and a measure of a person's embodied ability to generate income, which is clearly estimated.

Human capital cannot be owned by the organization, and the means of production are the property of the organization. We can see the embodiment of HC in the personality of its owner, and its peculiarity is that it is inseparable from the person himself. Human capital cannot be purchased and sold, it can only be rented out by concluding an employment contract. For the period of work, the employer buys the right to use the employee's labor, and not the labor itself, which the employee continues to own.

There are several similarities between human and physical capital. For example, both generate income for the owner, both are essential components of economic growth. Physical capital is depreciated, i.e. its owner has a guarantee of the reproduction of the invested funds and an incentive to invest. Human capital is not. Depending on the main constituent elements, human capital can be considered as a set of certain elements shown in Table 1.

The analysis made it possible to generalize the main methods for assessing the value of the organization's human capital [1, 3].

1. Calculation method based on the use of direct personnel costs. This method includes accumulation of all personnel costs, including salaries, taxes, health and safety, training and continuing education costs.



**Table 1** The composition of HC and its key elements

| Human capital composition  | Key elements   |
|--|--|
| The capital of education is a system of human knowledge and skills acquired in the learning process                  | Learnability, intelligence, creativity, skill level                  |
| Health capital is a system of physical and psychological health that predetermines the ability to work               | Physical strength, efficiency, ability to work, immunity to diseases |
| The capital of culture is a system of cultural values and behavioral models embodied in social interaction of people | Traditions, image, business reputation, moral and ethical qualities  |

*Source* Author based on [19]

2. The method of determining the initial and replacement costs of personnel. The organization's initial personnel costs consist of the costs of finding, recruiting and initial training of employees.
3. The method of competitive assessment of the value of human capital—is characterized by the fact that this method creates the most favorable conditions for its employees, in contrast to a competing organization.
4. The method of the prospective value of human capital. This method assumes considering the dynamics of the value of human capital in the future for 3, 5, 10 and 25 years, not forgetting to assess the competitiveness.
5. The method of measuring the individual value of an employee. The value of the employee forms the future value—if the employee will stay with the organization indefinitely. This cost will include two elements: the upcoming notional cost and the likelihood of the employee continuing to work in the organization.
6. A method for assessing the value of HC, produced based on tests in a business environment. The application of this assessment method can be obtained in two ways:
  - using the actual data that the employee received based on the profit he earned for the organization, or the growth of the organization's assets, including intellectual assets;
  - assessing human capital based on the structure of business doctrines in economics, management, marketing using the latest information technologies.
7. Financial method. This method characterizes the value of human capital, defined as the difference between the total market value of a company and the value of its assets (tangible and intangible). The financial method cannot provide the most accurate assessment of the value of the organization's human capital, since the calculations are not yet based on a single generally accepted methodology, but cost values are used.
8. Comparative method. With this method, an indirect assessment of the value of HC is made by comparing the indicators of competitors with the results of the

organization’s activities. This method has some drawbacks: firstly, in the calculations, we will not get an accurate quantitative assessment of human resources, because it is very difficult to single out the influence of human capital itself in the overall impact on the competitiveness of human capital organization. Secondly, we believe this method is not entirely correct, since almost all organizations use human capital.

This study uses a cost-based approach based on determining the costs that are needed to reproduce or replace the subject of assessment, considering depreciation. In this case, the amount of costs for creating an object is taken as a measure of value. As a result, in order to calculate the human capital cost of an individual employee, and then of all employees of an organization, it is necessary to calculate individual elements. To use this approach, all costs that form human capital must be divided into 3 groups.

Human capital:

- education costs;
- health costs;
- expenditures on culture [17].

For the survival, development and prosperity of society, education is necessary, which, as a social institution, serves the needs of society [21]. In order to meet the challenges of an unpredictable and rapidly changing globalized world, an employee must not only be excellent, resilient and comprehensive, but also must constantly develop and improve himself. This evolution must take place consistently, systematically and on a large scale; therefore, teachers in schools, professors in colleges, administrators, researchers and policymakers are expected to innovate the theory and practice of teaching and learning. To ensure that all students are well prepared for life and work, it must be embedded in all aspects of this complex organization [20].

Taking into account the costs of obtaining primary, secondary and higher education, training in vocational schools and in advanced training courses, it is possible to fairly objectively assess the capital of an employee’s education (taking into account the growth of the invested amount of money over time—compounding):

$$C_e = \left\{ \sum_t C_{pe,t}[P_t(1 + r_t)] + \sum_t C_{se,t}[P_t(1 + r_t)] + \sum_t C_{he,t}[P_t(1 + r_t)] + \sum_t C_{p,t}[P_t(1 + r_t)] \right\} \times [(A_{ret} - A_{act}) / (A_{ret} - A_{beg})] \times TR$$

where:  $C_{pe,t}$ —the cost of receiving primary education in the t-th year;  
 $C_{se,t}$ —the cost of obtaining secondary general or vocational education in the t-th year;  
 $C_{he,t}$ —is the cost of obtaining higher education in the t-th year;  
 $C_{p,t}$ —expenses for professional development in the t-th year;  
 $r_t$ —is the rate of increase in the t-th year;

$A_{ret}$ —the age at which the employee retires;  
 $A_{act}$ —the actual age of the employee;  
 $A_{beg}$ —the age at which the employee's labor activity begins;  
 $TR$ —test results ( $TR = 0-1$ ).

The refinancing rate of the National Bank of the Republic of Kazakhstan is taken as  $r_t$ .

The development of any modern society depends on the qualitative characteristics of its human capital; the capital of health plays an important role here. The health of each person and public health in general is an important element of the state's potential. Health is a complex and multidimensional category that requires the use of interdisciplinary research methods. Health capital refers to investments in a person made with the aim of forming, maintaining and improving his health and performance, for example, the costs associated with health protection (conducting preventive examinations of employees, health insurance and other measures to prevent diseases). Health expenditures are the aggregate of public, private and external costs, as well as out-of-pocket welfare and health care costs. Employee health capital is defined as the sum of the following components:

$$C_h = \left\{ \sum_t C_{gov.t} [P_t(1 + r_t)] + \sum_t C_{leg.t} [P_t(1 + r_t)] + \sum_t C_{ind.t} [P_t(1 + r_t)] \right\} \\ \times [(A_{ret} - A_{act}) / (A_{ret} - A_{beg})] \times TR$$

where:  $C_{gov.t}$ —government spending on health in the t-th year;  
 $C_{leg.t}$ —costs of legal entities for health in the t-th year;  
 $C_{ind.t}$ —expenditures of individuals on health in the t-th year.

The sphere of culture plays a major role in the formation of human capital in the knowledge economy, and this is due to the following circumstances. The use by a person of his cultural potential in the process of social activity does not mean that he is used as human capital. To allow a person to become a subject of labor and occupy a professional niche that corresponds to his cultural level, such a transformation must be carried out only as a result of social action. And, in order to gain access to additional income in excess of the costs necessary for the simple reproduction of the employee and his family, and to obtain not only social, but also professional status.

Various authors agree that cultural capital has a synergistic effect. The development of society, the creation of an intellectual foundation stimulates a synergistic effect. In turn, the intellectual basis guarantees an increase in the quality (standard) of life of the population and a steady increase in the economic growth of the state. Cultural capital includes the costs of culture, art, sports, tourism:

$$C_c = \left\{ \sum_t C_{col.t} [P_t(1 + r_t)] + \sum_t C_{phc.t} [P_t(1 + r_t)] + \sum_t C_{ins.t} [P_t(1 + r_t)] \right\} \\ \times [(A_{ret} - A_{act}) / (A_{ret} - A_{beg})] \times TR$$

where:  $C_{col,t}$ —costs of education in schools and colleges of culture and art in the t-th year;

$C_{phc,t}$ —costs for physical culture, sports and tourism in the t-th year;

$C_{ins,t}$ —expenses for visiting cultural institutions (libraries, theaters, museums, etc.), art and sports in the t-th year.

Hence, the human capital of an employee of the organization will be equal to [18]:

$$\begin{aligned}
 HC = & \left\{ \sum_t C_{pe,t}[P_t(1+r_t)] + \sum_t C_{se,t}[P_t(1+r_t)] + \sum_t C_{he,t}[P_t(1+r_t)] \right. \\
 & + \sum_t C_{p,t}[P_t(1+r_t)] + \sum_t C_{gov,t}[P_t(1+r_t)] + \sum_t C_{leg,t}[P_t(1+r_t)] \\
 & \left. + \sum_t C_{ind,t}[P_t(1+r_t)] + \sum_t C_{col,t}[P_t(1+r_t)] \right\} \\
 & \times [(A_{ret} - A_{act})]/[(A_{ret} - A_{beg})] \times TR
 \end{aligned}$$

## 5 Conclusion

In modern economics, the term “human capital” is used to describe the abilities and skills of people that affect their performance. Thus, we can conclude that the productive and inseparable from the individual abilities are considered as capital. Many works are devoted to the study of human capital and methods of its assessment, but despite this, in practice, there are many unresolved problems in determining the value of HC. Some indicators of HC cannot be measured, for example, there is no way to measure the quantity or value of human capabilities and this is the main problem. At any level of research (macroeconomic, regional, corporate) it is very difficult to collect, process and assess the reliability of the required information, in addition to the fact that the calculation of values is itself a very laborious and complex process. To assess the value of the HC of an organization, it is necessary to use a methodology based on cost accounting.

## References

1. Becker, G.S.: Human capital: a theoretical and empirical analysis with special reference to education. The University of Chicago Press, Chicago (1975)
2. Fitzenz, J.: Return on investment in personnel. Measuring the Economic Value of Personnel. Vershina, Moscow (2006)
3. Flamholtz, E.G.: Human resource accounting: advances in concepts, methods and applications. Springer Science & Business Media, New York (1999)

4. Janshanlo, R.Es., Kogut, O.Yu., Czerewacz-Filipowicz, K.: Human capital management trends in the innovative economy of Kazakhstan. *Pol. J. Manage. Stud.* **20**(2), 267–278 (2019). <https://doi.org/10.17512/pjms.2019.20.2.22>
5. Kogut, O.Y.: Analysis of human capital cost assessment methods. *J. “Stat. Acc. Audit”* **4**, 13–19 (2019)
6. Malenkov, Yu.A.: Management of the development of the company’s human capital. *Edu. Bus.* **24**(48), 12 (2000)
7. Prishlyak, E.A., Radko, S.G.: Research of factors affecting the formation of human capital in the Russian Federation. *Manage. Sci.* **2**, 94–105 (2018)
8. Serdyukov, P.: Innovation in education: What works, what doesn’t, and what to do about it? *J. Res. Innov. Teach. Learn.* **10**(1), 4–33 (2017). <https://doi.org/10.1108/JRIT-10-2016-0007>
9. Thurow, L.: *Investment in human capital*. Wadsworth Publ, Belmont (1970)
10. Tsapenko, I.V., Mironova, D.D.: Human capital and innovative factors of its development. *Eng. Bull. Don* **2**, 153–163 (2012)
11. Petty, W.: *Economic and statistical work*. Sotsekiz, Moscow (1940)
12. Smith, A.: *Research on the nature and causes of the wealth of peoples*. Sotsekiz, Moscow (1962)
13. Schultz, T.: *Human capital in the international encyclopedia of the social sciences*, vol. 6. The Macmillan Publishers, New York (1968)
14. Kendrick, J.: *Total capital of the United States and its formation*. Progress, Moscow (1978)
15. Tsarev, V.V., Evstratov, AYu.: Assessment of the individual cost of an employee of an enterprise. *Pers. Manag.* **24**, 34–39 (2008)
16. Tuguskina, G.N.: Comparative analysis of methods and indicators for assessing the human capital of enterprises. *Mod. Manage. Technol.* **6**(54), 61–70 (2015)
17. Alaverdyan, V.: Assessment of the cost of the personnel potential of the enterprise. [https://www.cfin.ru/management/people/value\\_people.shtml](https://www.cfin.ru/management/people/value_people.shtml) (2021). Accessed 03 March 2021
18. Arabian, K.K.: Methodology for assessing human capital. *Bull. Mosc. Univ. Ministry Intern. Aff. Russ.* **8**, 61–65 (2010)
19. Chigoryaev, K.N., Skopintseva, N.A., Ulyashchenko, V.V.: Assessment of the value of human capital based on the costs incurred. *Bull. Tomsk Polytech. Univ.* **313**(6), 54–56 (2008)
20. Dobrynin, A.I., Dyatlov, S.A., Tsyrenova, E.D.: *Human capital in a transitional economy: formation, assessment, efficiency of use*. Nauka, St. Petersburg (1999)
21. Nikolaeva, E.A., Bogdanova, Yu.V., Somkin, S.V.: The value of education for the formation of human capital. [http://mospolytech.ru/science/aai77/scientific/article/s14/s14\\_32.pdf](http://mospolytech.ru/science/aai77/scientific/article/s14/s14_32.pdf) (2012). Accessed 28 March 2021

# Digital Marketing Opportunities at the Stage of Socio-Economic Development of the Company



G. A. Korzhova

**Abstract** The article discusses the problems and prospects of digital marketing development. It takes into account the current trends in market development and the requirements imposed by the new generation of consumers to promote the company, its products and, in general, to the socio-economic development of the company. Today, each individual consumer is considered as an element of a single chain of interaction between the consumer and the manufacturer, taking into account their wishes, capabilities and requirements. The main problem in the digital environment is to create a unique offer and offer it to the market using publicly available digital marketing tools, but at the same time distinguishing it from the competition. Under the current conditions, any competitive company should take into account not only its own capabilities and planned development prospects, but also consider the market environment as a dynamically developing platform for introducing a new, progressive and innovative offer that will be accepted by the market at the proper level.

**Keywords** Consumer · Digital marketing · Promotion technologies · Social responsibility

## 1 Introduction

The development of the digital economy and the existing trends for the effective management of companies in the current conditions force them to implement digital marketing tools in their activities. The modern consumer spends more time in the Internet environment than in offline mode. Online resources allow small firms and large enterprises to increase the popularity of their own brand, sell existing products, receive payment and make timely delivery. The consumer, in turn, gets advantages in speed, volume and repetition of the received information. Without leaving home, consumers choose, order, pay for and receive any goods and individual services.

---

G. A. Korzhova (✉)  
Samara State University of Economics, Samara, Russia

Digital marketing allows you to bring the company's products as close as possible, while using all possible digital marketing resources. At the same time, as the practice of using digital technologies during the pandemic has shown, the Internet turned out to be the most effective resource both in the market of consumer goods and services, and in the market of enterprises and organizations [1]. The companies that timely navigated the difficult conditions of limited interaction between buyer and seller, entered the digital environment in a timely manner and quickly appreciated the advantages of digital communications, not only did not lose their consumers, but also increased their own profits, increased market share and attracted more loyal consumers. Moreover, such companies not only offered their products to the target audience, but also talked about the company's development prospects, asked about the opinions of their potential customers, talked about socially significant projects in which the company participated, what the results were, and what is planned to be implemented in the future.

## 2 Methodology

Considering the current trends in the digital economy, it is necessary to pay special attention to the methods and tools that are most often used by companies in order to attract attention to their own brand, its development and increase its social significance. Moreover, not all the tools used have the same efficiency. Since the semantic load on individual elements is different, the result from their use is also not expected to be the same. For example, according to the results of the Sprout Social survey, the majority of consumers, namely nine out of ten respondents, will show loyalty to the brand whose history they follow on social networks, whose values they share [2]. At the same time, a study conducted by State Of Marketing, Sixth Edition claims that the most popular source of information transmission is email, and its services are used by 82% of the total number of brands surveyed [3]. An important advantage of using digital technologies in the promotion of the company is the fact that the company's costs are reduced by 30%, but this fact is taken into account by only 2% of all organizations [4]. Thus, when choosing the most suitable tools for a particular purpose, companies should focus on existing practices. The actual results often do not coincide with the company's opinion and vision of certain areas of its development. Each individual element is an independent direction in the formation of a single and integrated image of the company. Accordingly, all elements should be interconnected and complement each other.

## 3 Results

The use of modern digital marketing tools, in fact, is one of the ways to interact with target segments through information resources and taking into account the

possibilities of remote management of consumer preferences. On the one hand, the difficulty of using such opportunities lies in their correct choice and the need for an optimal combination of them. On the other hand, the consumer, with limited own resources, cannot always fully appreciate the full potential of the company in terms of informing and promoting the company's products and services, understand what the company's managers wanted to say with the events held and individual socially significant actions. Highlighting the key points in the consumer's choice, it is necessary to pay attention to those tools that are most fully and objectively perceived by consumers as informative and useful in terms of obtaining a value proposition. And you should also identify the most annoying factors that, in turn, negatively affect consumer choice, thereby not achieving the goal set by the company.

Modern digital marketing capabilities allow you to choose a specific set of Internet tools for each individual target audience. The information provided through Internet resources is constantly available not only to the company's customers, but also to the general public, as well as to competitors. Any changes that may occur in the selected promotion strategy, in the selected promotion methods, in highlighting certain advantages of the company's product, will immediately be available to competitors. This circumstance is not always acceptable, because when introducing a new product or service to the market, it is not always possible to take into account the capabilities of stronger companies, calculate their further steps and evaluate their own potential at the stage of recognizing a new product by the consumer [5]. Perhaps a larger and more economically powerful company, by making minor improvements and changes in the offer of a new product or service, will shift the attention of consumers to its side, thereby preventing the new company from developing.

However, the information placed in publicly available sources of information through digital marketing allows you to quickly and more purposefully influence the consumer, thereby managing his choice. Modern Internet tools allow you not only to remind about the existence of the company, to tell about its products, goals, mission and strategy of behavior in the market, but also to receive a timely response from the company's customers to all changes that occur in the market. Digital marketing tools allow you to choose the most relevant and effective tools, which, in turn, will most accurately reflect the company's concept of working with a particular target market.

Moreover, when choosing a strategy for working in the digital environment of the company, you should not forget about the social responsibility of the business, increasing its importance in the eyes of potential customers. It is important to understand that the choice of the consumer, against the background of socially significant directions of development of society, is inclined in favor of the company that most actively uses social directions in its activities to maintain stability in society [6]. The company that is most actively involved in the life of society, showing its interest not only in its own interests, but also in the problems of society as a whole, will attract more active users in the Internet environment than a passive participant in commodity-money relations.



## 4 Discussion

Considering the individual digital marketing tools used in modern society, it is necessary to identify the most popular and less relevant. That is, those that allow you to implement the tasks set by the company, as well as less effective for a large audience, but suitable for a small segment of consumers.

For example, one of the most frequently used tools is content creation, that is, filling the media space with various kinds of useful information, the purpose of which is to attract the attention of the target audience to the interests of the company, to its product, and its development prospects. This direction of digital marketing allows the company to convey information about the company to the consumer with the help of a corporate blog, supporting it with relevant interviews, pictures, articles and other useful information. Such a tool is used, as a rule, when it is necessary to convey serious and up-to-date information that contributes to increasing the importance of the company as a serious representative of a particular industry.

Another tool of digital marketing is to attract the attention of the audience through social networks. Today, social networks are the most popular sources of information for a young audience. Promising market segments, which in the future may make up the main share of the company's customers, spend most of their time on social networks. There is communication between the target groups, where they get new information, where they express their own opinions about the most relevant topics. Despite the fact that social networks are seriously fighting for their subscribers, thereby increasing the cost of participation in such projects, it is this direction of digital marketing that allows you to attract the most active part of the population to your side, which, later, becomes loyal and committed buyers.

A website is the most frequently used tool that does not always bring the desired result for the company. In order for the company's website to work, be effective and arouse the interest of the target audience, it is necessary to constantly monitor its content, the relevance of information, modern design and ease of information search. If the consumer cannot find the data he needs the first time, he usually does not return to this source of information and excludes it from the list of possible alternatives, which are later considered as worthy of attention. Customers want to see on modern websites and pages of the company the opportunity to review the assortment, choose the right products and services, the ability to arrange delivery and immediately pay for the goods, get additional service and other elements that will allow you to make a quick decision about buying the goods, but with the ability to refuse it if there are any changes. In any case, using digital marketing tools, you should understand that the more interactive and interesting your offer is in the Internet environment, the more it arouses interest among potential customers, and the more likely it is to attract more interested parties to your side.

When creating the image of the company as a socially responsible entity, it is necessary to identify the main areas that can potentially interest both existing and potential customers in the field of socio-economic orientation, thereby identifying in advance their own strategic directions for the development of the company. At

the same time, in the digital environment, it is possible to unite companies that are potentially not competitors, but can be business partners, have a common vision of the existence of companies and a common socio-economic direction of development. Such associations can create a positive attitude towards all members of such a community, thereby helping to promote the products of both their own company and the products of partner companies.

## 5 Conclusion

The main directions of digital marketing are primarily aimed at increasing brand awareness. The digital environment allows you to timely orient the target audience in all the variety of offers. With a well-built strategy, a group of potential customers interested in the company's activities may appear at the stage of information search. Sales management in the digital environment allows you to intensify marketing efforts in the area of activity that is currently most relevant for individual consumer groups and with the help of a search query, this group already shows its interest in the company's products at the initial stage.

Thus, digital marketing opens up new business opportunities, since any company in the digital environment has equal opportunities to provide its products, communicate with the target group, and inform the company's customers about the changes that are taking place in the development and management of the company. The perspective directions for raising the image and reputation of the company are considered, since interactive interaction with all participants of the process is possible, both from the target groups of consumers, and from state and municipal entities.

Holding various forums, open platforms for the interaction of all interested parties, is a modern trend for training potential clients, bringing them together in groups of interests and identifying the positions of individual segments of society on topical issues. Such forums allow you to:

- take into account the opinions of participants from different regions;
- evaluate the impact of external factors on the final result;
- timely adjust their own activities.

Such events are increasingly included in the tools of companies that are active in the digital environment and take into account the trends in the development of modern society.

## References

1. Minakova, I.V., Solodukhina, O.I., Bukreeva, T.N., Golovin, A.A., Baroyan, A.A.: Sources of stimulation of investment activity in Russia for the transition to a new stage of technology. In: V. Popov (ed.) Proceedings of the Russian Conference on Digital Economy and Knowledge

- Management (RuDEcK 2020). *Advances in Economics, Business and Management Research*, **148** (pp. 473–477). Paris: Atlantis Press (2020)
2. Sprout Social, Inc: New data reinforces social media's role in driving bottom line growth as more consumers plan to increase spending on brands they follow on social. URL: <https://www.globenewswire.com/news-release/2020/05/05/2027374/0/en/New-Data-Reinforces-Social-Media-s-Role-in-Driving-Bottom-Line-Growth-as-More-Consumers-Plan-to-Increase-Spending-on-Brands-they-Follow-on-Social.html>. Accessed 24 Mar 2021 (2020)
  3. Schultz, R.: The old reliable: Salesforce study shows email still ranks high in marketing use. URL: <https://www.mediapost.com/publications/article/351593/the-old-reliable-salesforce-study-shows-email-sti.html>. Accessed: 24 Mar 2021 (2020)
  4. Marketing One: The most effective methods of digital marketing. BCG Research. URL: <https://marketingone.ru/knowledge/marketing/813.htm>. Accessed 24 Mar 2021 (2019)
  5. Kirillova, L.K., Korzhova, G.A., Mukhametzyanova, L.H., Banartseva, A.V.: Open access the concept of social marketing while supplying the population with liquefied gas. In Mantulenko V. (ed.) 17th International Scientific Conference Problems of Enterprise Development: Theory and Practice 2018. SHS Web of Conferences, **62** (07002). Les Ulis: EDP Science (2019)
  6. Korzhova, G.A., Kirillova, L.K., Karpova, N.P.: Social marketing on the Russian market: Problems and prospects. In Ashmarina S., Mantulenko V. (eds.) Proceedings of the II International Scientific Conference GCPMED 2019 Global Challenges and Prospects of the Modern Economic Development. European Proceedings of Social and Behavioural Sciences, **79** (pp. 983–989). London: European Proceedings. (2019)

# The Transformation of Scandinavian Experience in Russian Digitalization Strategy



M. V. Kurganova

**Abstract** Global digitalization and the widespread use of information technologies in all areas of modern life it has a direct impact on socio-economic development. The rapid and large-scale transition to digital technologies sets an accelerated pace of transformation of economic processes and leads to the reform of public administration institutions. Digitalization provides ample opportunities for improving efficiency, improving the economy and public administration. At the same time, the introduction of digital technologies poses serious challenges for all subjects of the socio-economic system. Russia is no exception to the world practice: it is a key direction for the steady development of social and economic spheres of life. The Russian Federation is making a widespread transition from analog to digital processes. Referring to the experience of implementing digital technologies in European countries, it can be noted that the countries of the Scandinavian region are the most successful in using information and communication technologies, which is confirmed by the conclusions of research and international ratings. Drawing parallels, we can conclude that it is advisable to transform the accumulated experience and its application in the transition to the digital format in the Russian economy.

**Keywords** Digital economy · Digitalization strategy · E-government · Index · Innovation · Scandinavian countries

## 1 Introduction

Introduction of information technologies has an undeniable impact on all spheres of the socio-economic system both in a single country, and it makes fundamental changes in the processes of interaction between countries. New paradigms of public administration abound with effective tools that allow to multiply improve the quality of public administration, ensure transparency of processes, involve society in the processes of public administration and facilitate access to electronic resources [1].

---

M. V. Kurganova (✉)  
Samara State University of Economics, Samara, Russia  
e-mail: [kurganovamv@bk.ru](mailto:kurganovamv@bk.ru)

© The Author(s), under exclusive license to Springer Nature Switzerland AG 2022  
S. I. Ashmarina and V. V. Manteulenko (eds.), *Digital Technologies in the New Socio-Economic Reality*, Lecture Notes in Networks and Systems 304,  
[https://doi.org/10.1007/978-3-030-83175-2\\_82](https://doi.org/10.1007/978-3-030-83175-2_82)

669

The formation of e-government in Russia was initiated within the framework of the Federal Program “Electronic Russia (2002–2010)”, dated January 28, 2002, No. 65 [2]. Since the adoption of this program, the provision of electronic civil servants has become a priority [1]. The development of e-government, including the expansion of the volume and variety of public services, the increase in the speed of their provision and the change in quality characteristics, is a key indicator of the model of public administration in Russia [3, 4]. Decree of the President of the Russian Federation No. 204 of 07.05.2018 “ On national Goals and strategic objectives for the development of the Russian Federation for the period up to 2024 ” forms the direction of digital transformation of the public administration system and the country’s economy [5]. The result of the measures taken largely depends on the setting of strategic goals.

When forming strategies for promoting the digital economy in Russia, it is necessary to take into account and apply the experience that has passed the way of introducing digital technologies and has made the transition to digital processes in accordance with the balance of interests of the state and society. These include the Northern European countries: Sweden, Norway, Denmark, Finland. These countries were among the first to embark on the path of digitalization and continued to develop their socio-economic systems in a digital environment. The experience of implementing digital technologies in the Nordic countries is significant for understanding the digital processes taking place not only within their borders, but also in relation to other players on the world stage.

The current leadership of the countries of the Scandinavian region in building a developed economy and global digitalization of all ongoing processes is not accidental. This is a natural result of a well-planned and consistently implemented state policy aimed at the development of all spheres of activity, socially oriented public administration, patriotism of citizens, mutual cooperation between the state and business, acceptance and positive attitude of the population to what is happening in their countries, involvement of citizens in the processes of public administration, a positive response of society to the need to develop and implement innovations at all levels of socio-economic life, public interest in personal development, as well as increasing the level of public and business confidence in the government.

The sustainable development of all economic systems and the successful integration of digital technologies into the national economies of these countries are recorded by authoritative international studies. According to the Digital Economy and Society Index (DESI), Finland, Sweden and Denmark occupy the top positions of the rating for 2020, demonstrating the best values of indicators of the development of the digital economy [6]. According to the alternative international study Digital Planet (Digital Intelligence Index, DII), which assesses the competitiveness of countries in the digital economy, Scandinavians also showed consistently high results among the 90 countries that participated in the study [7]. According to the data provided by the UN in the course of the study of the EGDI e-Government Development Index, Finland, Sweden, Denmark and Norway also occupy leading positions and are among the countries whose integral value of the EGDI index is very high [8].

Studying the experience of the Nordic countries in implementing digital processes, drawing analogies between national economies, taking into account the similarity of the processes taking place and the needs of society, conclusions can be drawn about the feasibility of transforming and applying some aspects of advanced strategies in determining strategy for the development of the national economy and public administration.

## 2 Methodology

There are quite well-known studies conducted in the field of digital transformation of the economy and society. The author's task is not to evaluate and review the literature describing the principles of building socio-economic development in the era of global digital technology adoption, although this problem has been studied in sufficient detail. Competitive advantages and directions of development of national economies in the Northern European countries are studied by many authors [1, 3]. However, the works of these authors do not generalize the principles of success of the Scandinavian countries, which provided the Northern Europe the first places in the international rankings. In the course of the research, the author has set a goal to summarize the experience of the Scandinavian countries obtained in the framework of digitalization of national economies, to conduct a factor analysis and to develop proposals for transformation, fragmentation and adaptation for use in the Russia.

The analysis of competitiveness and the reasons for the success of Sweden, Denmark and Finland in the transition to the digital economy is based on the results of international studies using integrated algorithms for evaluating, comparing and comparing the results [9]. During the work, the author studied the results of domestic and international studies:

- Digital Economy and Society Index, DESI;
- Digital Planet 2020 (Digital Intelligence Index, DII);
- E-Government Survey, EGDI;
- Overview of the digital transformation of the Nordic countries (OECD).

The author also studied the information contained in official sources, analyzed and compared the information received. The study presents conclusions about the possibility of transformation and application of the Scandinavian experience in the course of digitalization of the Russian Federation.

## 3 Results

According to the published data of the international Digital Economy and Society Index (DESI), which assesses the level of digitalization of the EU countries, Finland, Sweden and Denmark in 2020 occupied the top lines of the rating, demonstrating

the maximum integral indicators: Finland—72.4, Sweden—70.1, Denmark—69.4. DESI is a comprehensive digital competitiveness index that takes into account the readiness of the digital infrastructure, the digital skills of the population, the level of their activity on the Internet and the share of electronic transactions, the degree of integration of digital technologies and the digital agenda of public authorities [6]. The Nordic countries are leaders both in the assessment of digitalization processes and in the use of key digital competencies (Table 1).

1. Digital agenda of the authorities. Initially, the decision to digitalize the economy was made at the level of each of their countries separately: digital national strategies in the Nordic countries were developed in the late twentieth century. In the early 2000s, digitalization became the main direction of development. In 2017, the Nordic Council of Ministers for Digitalization (MR—DIGITAL), a division of the Nordic Council of Ministers for Digitalization (MR-DIGITAL), was assigned to coordinate the implementation of digital processes for the period from 2017 to 2020. The goal of MR-DIGITAL is to create a cohesive and integrated digital Northern region for the benefit of all residents, businesses, and government [10]. The consolidation of efforts in this direction made it possible to achieve a synergistic effect in using the results of innovative activities and technological solutions of the council's member countries, and to spread the experience gained throughout the Scandinavian region.

2. Human capital and user activity on the Internet. Digital competencies of the population are the foundation of a digital society. 2020, the year of the global crisis, has shown that digital skills of citizens are crucial for building communications at all levels in conditions of isolation and limited mobility. A high level of basic education has allowed a wide range of people to acquire the digital competencies necessary for mastering digital technologies in a short time. In 2019, 58% of Europeans had basic digital skills, and 33.5% had a high level of digital competencies. In Norway, the share of the population with digital skills was 66.5%, in Sweden and Denmark—69%, in Finland—76.7%, i.e. the absolute majority of citizens, of whom more than half have professional skills in the field of information technology [6].

The Nordic countries are distinguished by a well-established scientific and educational complex, a high level of business education and the interconnection of all stages of the educational process, which will have a positive impact on the innovative development of these countries in the future. All countries in the Nordic region are characterized by the continuity of educational processes: computers are used in primary education as a key learning tool. In secondary, special and higher education, mandatory IT subjects, the collection and analysis of information was introduced into the educational process. Digital skills are taught to people engaged in various professions, including those that are not directly related to digital spheres. Digital competencies are developed in older citizens [2]. In Sweden, 10% of working citizens are employed in the IT services sector, and the number of organizations involved in this sector exceeds 6% of the total number of legal entities. (Denmark—11.2% and 5.4%, respectively, Finland—9.5% and 5.4%). A high average standard of living helps the development of digital competencies: Sweden's GDP per capita is \$ 50,339, and the minimum wage is 0.64% of the average. Denmark's GDP is US \$ 58,439 per capita, while Finland's GDP per capita is US \$ 48,461. These countries take a

**Table 1** Digital competencies of the Nordic countries

| Digital competencies                | Expert assessment | The main features characteristic of the Scandinavian countries   |
|-------------------------------------|-------------------|--|
| Digital agenda of the authorities   | 0.9               | the digital strategy is defined at the level of each region; the regional strategy is defragmented into separate components; quantitative criteria for achieving the set goals are determined; responsible persons are appointed; the government coordinates the interaction of all participants   |
| Human capital and Internet activity | 0.8               | the workforce is dominated by IT specialists; the population has basic IT skills; the strategy of integrated development of digital skills is implemented; digital equality of citizens is ensured; the population is provided with digital tools; the development and continuity of the education system is ensured; digital activity and involvement in it is stimulated   |
| Integration of digital technologies | 0.7               | digital tools of interaction have been introduced to the maximum extent possible; the priority of digital interaction has been established; the state and interdepartmental interaction have been fully digitized; the accumulated experience is transferred to the subjects of SMEs (digital elevator)  |
| Innovation                          | 0.85              | the priorities of the state innovation policy are defined; the government approves the directions of innovation development; the innovative approach is popularized and supported by the population; the state and business partnership strategies are developed; the sources of financing and stimulating innovation are identified; the innovation process is systematized; innovation processes are maximally accelerated |

(continued)



**Table 1** (continued)

| Digital competencies               | Expert assessment | The main features characteristic of the Scandinavian countries  |
|------------------------------------|-------------------|---|
| Digital infrastructure development | 0.8               | a high degree of concentration and urbanization of the population; a large part of the population is covered by high-speed data transmission networks; digital equality of regions is ensured; interaction of the state and business in the construction of communication networks; establishment of national priority and regional cooperation |

*Source* Author

leading position in building a welfare state, their main goal is to create equal rights and opportunities for all citizens.

The indicator of Internet activity in the Scandinavian countries was quite high: in 2019, 85% of the inhabitants of these countries used the Internet at least once a week (in 2018—76%). In 2020, the number of Internet users, along with the expansion and enrichment of the content offered, has increased dramatically. The society turned out to be technically and morally ready for the forced replacement of traditional communications with digital ones [11]. The Internet activity index in Denmark and Sweden increased to 94%—the absolute highest among all European countries. The highest activity was observed in such sectors of the network as news portals (83%), social networks and public resources (69%), entertainment platforms and video content aggregators (57%), messengers (90%), VPN services that enable remote work (85%), e-commerce (80%), e-government services (the maximum score is 98%).

3. The level of implementation of digital technologies. According to the Digital Planet 2020 study (Digital Intelligence Index, DII), Sweden, Finland and Denmark showed high results in integrating IT into the spheres of public, political and economic life. As part of the study of the parameters of digital evolution (the level of digital development and the growth rate of digitalization of economies), the leading places were shared by Finland (4th place, 87.3 points) and Denmark (5th place, 87.17 points). From the point of view of the spread of the digital environment from the position of the digital environment as a safe and reliable online ecosystem, Denmark took 1st place, receiving 73.06 points, Sweden—3rd place (67.65 points). Sweden was in the 2nd place (77.19 points) among the countries studied in terms of the ratio of the living population to the changes taking place, involvement in digital processes and the overall assessment of their significance [7].

In 2019, 30% of SMEs and 39% of the total number of large organizations registered in the Nordic region entered the e-commerce segment. In 2020, measures were taken at the state level to reduce social interaction. The population and business

needed an urgent adaptation to the ongoing changes, the transition to the predominant use of IT in all areas of their activities. The Scandinavian business as a whole responded quite successfully: the majority of organizations (73%) switched to a remote format of work and were able to reorient their production processes. Representatives of large businesses adapted to the changes faster, which allowed them to even improve their financial results to some extent, including through the coverage of new market segments, the introduction of new types of services, the effective use of digital tools and cost optimization. Today, most organizations in the Nordic region use the full range of IT technologies, including the cloud and social networks, as tools for a quick and effective way to interact with consumers.

It is worth noting the high degree of integration of digital technologies in the processes of public administration. The integral value of the e-government development index (EGDI) of the Scandinavian countries, along with other indicators of the digitalization of socio-economic systems, is very high (VH, EGDI > 0.75): In terms of e—government development, Denmark is on the 1st place in the ranking among the 193 countries covered by the study (EGDI 0.9758), Finland is on the 4th place (EGDI 0.9452), Sweden is on the 6th place (EGDI 0.9365), ahead of Norway—the 13th place (EGDI 0.9064) [8]. In other words, the population—government dialogue in the Nordic countries uses only digital channels.

4. Innovation. A distinctive feature of the Nordic countries is the principle of the “triple helix”—the unity of the forces of power, business and science. Thus, the development of innovation in the Scandinavian countries has developed, one can say, historically. The cost of science here does not fall below 3% of GDP. A quantitative assessment of the degree of innovation is the integrated index (Summary Innovation Index, SII), which evaluates countries on 27 different parameters, including innovation, investment in research and evaluation of the human resources involved. Data published in the European Innovation Scoreboard, in 2020, Denmark, Finland and Sweden became the innovation leaders among all European countries (the integral SII of the Scandinavian countries reaches a record value of 150 points). Such high results in the field of innovation were achieved thanks to a balanced system that includes the interaction of the state and business, public and private co-financing of innovations (credit policy, subsidy support for business and investment policy), tax policy that encourages innovation activities of educational institutions and small and medium-sized businesses, as well as a favorable business environment [12].

5. Development of digital infrastructure in the territorial aspect. High-speed Internet access is crucial in the field of digitalization of all spheres of the socio-economic life of the state, especially when key social and economic ties are implemented online. The Swedish government has set a goal for telecom operators: to provide 98% of households with the ability to connect to a high-speed data network with a communication speed of 1 Gbit/s by 2025. However, the relatively small population of the Nordic countries and the high level of urbanization of the countries (Sweden and Denmark—10.2 million people and 5.8 million people, of which 88% live in cities; Finland and Norway—5.5 million people each, the share of the urban population is 86%) have become competitive advantages in the construction of digital infrastructure. The factor of a limited number of participants with the

necessary competencies and a high standard of living, combined with a large degree of territorial concentration, provided digital leadership to the Scandinavian countries [13]. Synergetic effect of innovation development, state participation (including legislative support for initiatives of national telecom operators and residents) and the high geographical concentration of the population, was the acceleration of the development of broadband access networks and cellular communication technologies 4G and 5G in the Scandinavian region. “Network without limits” is the motto of the development strategy of the Scandinavian society [14]. In 2019, in 17 European countries, the government allocated the frequency spectrum for the development of 5G communication networks. The countries of Scandinavia were among them. Currently, a full-scale 5G network covers Buildings (more than 3,000 base stations, Telia and Telenor operators). In the 2nd quarter of 2020, the first 5G base stations were launched in the Swedish capital (Stockholm, operator Tele2) and further in the cities of Gothenburg and Malmo (operator Telia). The full-scale network is being built by Hi3G Access, Net4Mobility, Telia Sverige and Teracom, which won the auction for the sale of frequencies. In Finland, the development of 5G networks is provided by the national operators Telia, Elisa, Telenor and the virtual operator DNC, the network is being built in the frequency range of 25.1–27.5 GHz. High-speed data networks are built on the basis of technical solutions from national manufacturers, including TDC Denmark, Ericsson and Nokia. The choice of equipment manufacturers often sets a national priority, which encourages the development of local telecommunications companies and limits the expansion of foreign technologies.

## 4 Discussion

As we study the experience of the Scandinavian countries and analyze their data and the results achieved, the author identified the following key aspects of the digital transformation of the Scandinavian countries:

- the presence of the digital agenda of the authorities;
- high level of digital competencies and Internet activity of the company;
- innovative orientation of the state, society and business;
- high level of digital infrastructure availability;
- high integration of digital technologies in all sectors of the economy.

Decree of the President of the Russian Federation No. 204 of 07.05.2018 No. 7 of 04.06.2019 presents the National Program “Digital Economy of the Russian Federation” [5, 15]. This program contains federal projects: regulatory documents for the regulation of the digital environment, the development of the information environment and information security infrastructure, and the training of qualified personnel for the digital economy [16]. The digital agenda of the authorities of the Russian Federation was also developed, and a single digital goal was divided into specific sub-goals and tasks, indicating the quantitative and temporal criteria for their implementation. It turns out that the experience of the Scandinavian countries can

also be used for Russia in solving the problems of complex development of digital competencies of citizens, digital infrastructure and integration of digital technologies into various sectors of the economy by:

- increasing the share of IT professionals in the workforce;
- implementation of a comprehensive strategy for the development of citizens;
- reform of national education standards;
- frequency spectrum conversion, frequency release for 5G;
- ensuring digital equality of regions;
- development of interaction between the state and business;
- development of an innovation strategy;
- development of high-tech industries in the high-value-added segment;
- widespread adoption of digital tools.

## 5 Conclusion

The most important priority for the development of the countries of the world at this stage is the use and improvement of digital technologies and platform solutions in the management system, the global transfer of all spheres of life to a digital format. The success of the digitalization of the national economy is facilitated by the comprehensive implementation of administrative and political mechanisms, as well as the social and economic conditions created in a particular country. The use of digital tools and IT solutions in all sectors of social and economic activity is the next step in the development of the socio-economic environment and the integration of countries into a single global space. However, digitalization is not an end in itself, and digital tools cannot exist in isolation from the economy. Moreover, these phenomena are interrelated and one gives rise to another: the developed economy of the country gives a start and promotes the development of digital tools in turn, the introduction of digital processes is accompanied by the growth of the economy and the optimization of public administration [17]. Russia has significant potential and prospects for further development: according to experts, the digitalization of the economy by 2025 can lead to an increase in GDP by 4.1–8.9 trillion rubles, that will be from 19 to 34% of the total increase [18]. Currently, a digital strategy is presented in Russia for the development of the economy and society for the period from 2020 to 2024 at the state level. The outcome of the implementation of measures to digitalize the national economy largely depends on the correctness of the chosen strategy, the distribution of functions of the state and business. The study examined the innovative experience of the Nordic countries in the transition to a digital economy, identified the most significant criteria for digitalization, and examined the relationship between the steps taken and the results achieved in all areas of building an information society. Based on the results of this work, conclusions are drawn about the possible transformation and application of the experience of the Nordic countries in the development of a national strategy for building a digital society and economic development.

## References

1. OECD: Executive summary. URL: [https://read.oecd-ilibrary.org/science-and-technology/oecd-reviews-of-digital-transformation-going-digital-in-sweden/executive-summary\\_9789264302259-9-en#page1](https://read.oecd-ilibrary.org/science-and-technology/oecd-reviews-of-digital-transformation-going-digital-in-sweden/executive-summary_9789264302259-9-en#page1). Accessed 23 Mar 2021 (2018)
2. The Official website of the Ministry of Digital Development, Communications and Mass Media of the Russian Federation: About the Federal target Program «Electronic Russia (2002–2010). URL: <https://digital.gov.ru/ru/documents/3024/>. Accessed: 23 Mar 2021 (2021)
3. Chehri, A., Fortier, P.: Wireless positioning and tracking for internet of things in heavy snow regions. In: Zimmermann, A., Howlett, R., Jain, L. (eds.) *Human Centred Intelligent Systems. Smart Innovation, Systems and Technologies*, vol. 189, pp. 395–404. Singapore: Springer (2021)
4. The Official website of the Ministry of Digital Development, Communications and Mass Media of the Russian Federation: Digital Economy of the Russian Federation. URL: <https://digital.gov.ru/ru/activity/directions/858/>. Accessed 23 Mar 2021 (2021)
5. The Official Network Resources President of Russia: Decree of the President of the Russian Federation No. 204 of 07.05.2018 on the national goals and strategic objectives of the development of the Russian Federation for the period up to 2024. URL: <http://www.kremlin.ru/acts/bank/43027>. Accessed: 23 Mar 2021 (2018)
6. European Commission: Digital economy and society index (DESI) 2020. URL: <https://ec.europa.eu/digital-single-market/en/news/digital-economy-and-society-index-desi-2020>. Accessed 23 Mar 2021 (2020)
7. Digital Planet: Digital in the time of COVID. URL: <https://sites.tufts.edu/digitalplanet/digitalintelligence>. Accessed 23 Mar 2021 (2020)
8. UN E-Government Knowledgebase: UN E-Government Survey 2020. URL: <https://publicadministration.un.org/egovkb/en-us/Reports/UN-E-Government-Survey-2020>. Accessed 23 Mar 2021 (2020)
9. Stepanova, A.M.: Information policy of the state to promote electronic government. *Bull. Siberian Inst. Business Inf. Technol.* 2(22), 65–73 (2017)
10. Pavlova, A.V., Ashmarina, S.I.: Transformation of public administration in the interests of digital economy development. In: Ashmarina, S., Mantulenko, V. (eds.) *Current Achievements, Challenges and Digital Chances of Knowledge Based Economy. Lecture Notes in Networks and Systems*, vol. 133, pp. 159–165. Springer, Cham (2021)
11. Ivanichkin, R., Kashirin, P., Sysoev, S., Shabunovich, O., James, U.O.: Features of the process of digital transformation of the economy in Russia. In: Murgul, V., Pukhkal, V. (eds.) *Proceedings of the International Scientific Conference Energy Management of Municipal Facilities and Sustainable Energy Technologies. Advances in Intelligent Systems and Computing*, vol. 1259, pp. 187–197. Springer, Cham (2021)
12. European Commission: European innovation scoreboard. URL [https://ec.europa.eu/growth/industry/policy/innovation/scoreboards\\_en](https://ec.europa.eu/growth/industry/policy/innovation/scoreboards_en). Accessed 23 Mar 2021 (2020)
13. Demidova, E.E.: Features of country digitalization Scandinavian region. *Probl. Activities Scientist Res Teams* 4(34), 191–199 (2018)
14. Pleger, L.E., Mertes, A., Rey, A., Brüesch, C.: Allowing users to pick and choose: A conjoint analysis of end-user preferences of public e-services. *Government Information Quarterly*, 37(4), 101473 (2020)
15. Nordic Co-operation: About the Nordic council of ministers for digitalisation (MR-DIGITAL). URL: <https://www.norden.org/en/information/about-nordic-council-ministers-digitalisation-mr-digital>. Accessed 23 Mar 2021 (2021)
16. Grigorescu, A., Pelinescu, E., Ion, A.E., Dutcas, M.F.: Human capital in the digital economy: An empirical analysis of Central and Eastern European countries from the European Union. *Sustainability* 13(4), 2020 (2021)
17. Shultseva, V.: The Swedish way: To the digital paradise—on the wings of intelligence. *First mile. Telecommun. Bus.* 3, 74–84 (2017)

18. Niyazbekova, S.U., Moldashbayeva, L.P., Zhumatayeva, B.A., Mezentseva, T.M., Shirshova, L.V.: Digital economy development as an important factor for the country's economic growth. In: Popkova, E.G., Ostrovskaya, V.N., Bogoviz, A.V. (eds.) *Socio-economic Systems: Paradigms for the Future. Studies in Systems, Decision and Control*, vol. 314, pp. 361–366. Springer, Cham (2021)

# Digitalization of the Society: Legal and Ethical Features



P. P. Lang

**Abstract** This article researches the relationship between modern digital technologies and the system of legal values. The author explores the most important outcomes, the fundamental role of digitalization in public life, its influence over legal values and their on legal regulation of information and technological relations. The potential of information technologies in various spheres of society, from household issues to the business sphere and the sphere of providing public services is overviewed. The author also studies the problem digital security and confidentiality of electronic information on the part of state bodies. The article engages in the discussion on the necessity to develop advanced processes and systems for big data management. The role of trust in the information process as an axiological structure is also determined. The emphasis is made on the need to maintain a balance between private and public principles in the considered relations.

**Keywords** Axiology · Digital security · Information technology · Legal regulation · Legal values · Trust

## 1 Introduction

Digitalization has far become a habitual part of all our lives. Internet technology covers a mass of needs and proposes solutions to the issues long unsolved. Legal system is not a stranger to digitalization process too. The scientific debate over the importance and the effects of widespread digitalization goes on and is as heated as ever. The Internet, artificial intelligence, robots—all this is no longer the future, but reality. Nowadays Internet is the basic part of our lives that ensures communication of people and digital services [1]. So, the issue of the way legislative, regulatory framework is shaped regarding the use of new technologies, is more relevant than ever. At this time it is necessary to conduct careful legislative regulation of the process of developing and applying modern digital technologies, yet also to determine ethical

---

P. P. Lang (✉)  
Samara State University of Economics, Samara, Russia

boundaries of their use, accounting both moral and ethical aspects. The reason one should account ethics when constructing legal norms is that ethics develop standards that help us know “right from wrong” and “good from bad”, therefore ethics serve as the first filter in social life. Nevertheless only a legal norm has power over social relations as ethics are not ensured through the inevitability of consequence and law is. It is rather obvious that all such issues are to be resolved at the legislative level and the developed legal norms should reflect both legal and ethical values that are most widely supported in society.

Legal policy on digital development and technology use is an issue of great importance nowadays as no standards of regulation are confirmed and digitalization moves faster than the policy is developed. Legal policy is a system of complex means and goals of increasing the effectiveness of protecting the rights and freedoms of an individual, maintaining and developing his legal status [2].

One of modern issues of digital technology regulation is the lack of user confidence considering security, confidentiality, and assurance. This problem can be solved if legal regulation will provide the grounds for building trust both for developers and users. Trust itself must serve as a value in the development of such legal regulation. The problem of confidentiality is entwined with security assurance of big data that is processed in the Internet [3]. Trust is linked to responsibility that we must see as a value too. It is those with authority over the processing of big data that should be held accountable for breaches of security, privacy and data integrity [4].

The legislator is responsible for regulating the intangible objects of data and information that are transferred between a huge number of devices and networks, since information is actually a source of value. In order for these various devices to legally exchange data, it is necessary to ensure uniform standards for data structures, communication formats and protocols that must be developed and implemented by authorities. The standardization of technological processes is the key to regulating these processes. At the state level, attention should be paid to how data circulates within systems, which requires a significant modernization of legal regulation in this area as a whole. Thus, it is necessary to develop advanced processes and systems for managing big data, as well as reliable processes to ensure data quality. To implement such processes, it is necessary to revise a huge number of regulations that ensure compliance with the provisions on confidentiality, protection against data leakage, ensuring network neutrality and data flows, etc.

## 2 Methodology

Legal regulation is the evolutionary form of ethical norms and standards, therefore law is influenced and driven by the value system established in the society and yet law aims at structuring and shaping social values, at changing them to fit the legal policy and ensure equality. That brings us to the understanding of the complexity of law and its nature and also points us to the need for a systematic approach to the analysis of any legal regulation or issues that rise with it. To analyze legal and



ethical features of digitalization the author used methods of analyses, comparison, systematic study as well as synthesis, and abstraction.

Certain criteria were used to determine the degree of importance of values in formation of legal regulation of digital technology. Such criteria as the influence of digital technology on social outcomes allowed to determine the need of applying legal consequence and the severity of such. Criteria that account for the user experience of digital technology use allowed to determine the most urgent issues connected to the use of such tech, as well as accounting developer experience allowed to determine urgent issues in the development area. Criteria that determine economic outcomes allowed to approach the topic of legal standardization and registration of digital technology. The criteria of determining the values that the society established in that area allowed to determine most vital aspects of efficient legal regulation.

The study includes careful analyses of all the above and synthesizes the conclusions that explain the relationship of legal and ethical aspects of digitalization as well as points out the most relevant issues of legal policy construction on the topic and determines the ways to solve the existing problems of regulation. The author also used methods of mental simulation and idealization when considering possible outcomes of implementing the proposals mentioned in the paper.

### 3 Results

The use of any Internet technologies, including and especially the ones reviewed, must be implemented in accordance with the legal values adopted in the legal system. Likewise, it is important to ensure the confidentiality and security of data, to protect it from external attacks, and also to ensure its reliability. If these values are ignored by users or system administrators, negative consequences are inevitable. However, data openness is also a key value when considering Internet technology systems. So, it is the principle of openness that contributes to the emergence of services that allow real-time verification of information, access to which is not limited to a wide range of people. At the same time, it should be noted that the presence of such services presupposes the presence of data banks, access to which can be obtained illegally, which brings us back to such values as security and confidentiality.

Internet technologies, in particular, open up new opportunities for obtaining and increasing the benefits of communication, including innovation, cooperation and democratic politics. However, it also opens up new opportunities for these benefits to negatively impact these phenomena, for example through increased censorship, surveillance and new control systems. In these conditions, there is an urgent need to maintain a balance of interests of stakeholders.

The challenge of legal regulation is to ensure the further development of Internet technologies in such a way as to maximize positive social change and minimize the use of Internet technologies for negative purposes. For example, when considering the issue of censorship on the Internet, based on the accepted values, it is possible

to draw a conclusion about its necessity to ensure moral and ethical foundations, or about its chronic backwardness and uselessness.

Law through values forms guiding principles, principles, for the purpose of proper regulation, in accordance with constitutional dogmas. Inclusive and broad dialogue is essential for the sustainability of the human rights system and its application in today's online reality. Leaving aside legal Internet technologies, it is important to mention business technologies, for example, those used in telemarketing, telemedicine, online commerce, etc., as well as in social networks.

Confidentiality, security, privacy, and the value of freedom of expression are relevant issues. So, the problem of leakage of bank card data, personal data transmitted when receiving services or communication on the Internet is widespread. To ensure the realization of these values, responsibility must also be perceived as a central value, as well as openness of data. As the digitalization spreads and digital technology evolves issues of data security, user experience respect, confidentiality, responsibility for negative outcomes, data accesses, censorship, partial and ununified regulation rise, among others.

The author concludes that regulation must be standardized as well as the development processes must be standardized too. Moreover, legal policy must account ethical issues beside legal ones and carefully regulate trust and responsibility aspects of digital technology use relationships, set definite guarantees of confidentiality and data security, imply data access control.

The author also states that legal regulation must attend the topic of artificial intelligence use in all areas of social life, and consequently in legal area. It is argued that the regulation of artificial intelligence use and development must be regulated universally the same in all parts of the globe, that legal policy regarding the issue has to be global and account all aspects of its development and use.

## **4 Discussion**

Digital technology, internet technology emerge and develop fast, they are now a big part of social, business, state relations. As this technology develops concerns rise, of privacy, security, control and many other. It is important to address the problems that arise and do the best and most to eliminate them, to minimize the collateral damage that is or might be. Much ethical problems arise in the development of digital technology legal regulation, partly due to the fact that the state is both a supplier of Internet technologies and their user, which consequently affects the emergence of double standards of legal regulation and control.

For objective and understandable reasons, in the modern world it is difficult to imagine a separate national regulation of public relations in this area within the framework of one separate state. In this regard, it is especially important to consider the possibility of forming interstate, international standards for the use of such systems, unification of protocols and standards at the global level. This should solve not only the problem of the balance of interests, but also simplify the process of using the

Internet for users around the world, as well as the development process as unified guidelines are created for it. Digital technology can be used to simplify life, business or state processes and is widely used for that, yet there is an issue of its use in a harmful, illegal way, to steal money and data, to launder money, to spy and therefore deprive someone of privacy, etc. All those negative issues exist due to the lack of legal policy concerning development of digital technology and its use, lack of understanding of the way it works in the realm of authority and therefore lack of control.

As it was mentioned before, there is a proposal to cut down that negative effect through standardization of both development processes and policy. The standardization of development, as, for example, creating the element of registration boundary for a technology to be used widely, for it to excess free internet or be used by any person or entity or state body may lead to decrease of ill technology that is there to harm social, economic and state relations. The unity of legal policy must allow to simplify and better control the processes of digitalization as the use of unified guidelines in all areas seems the best option to ensure all guarantees necessary and meet all requirements. It is also important to note that there are certain technological architectures that must be developed and widespread to ensure the security of the Internet and digital technology [5].

Most users are concerned about their data security and have privacy concerns as no general user knows what the code holds or what a downloaded tech can do. Many lose their banking accounts and money or even identities to digital crimes and mostly nothing can be done about it, justice is rarely brought on those guilty of such crimes. Lack of policy and control leads to all that. Legal policy that demands personalization of technology, e.g. allows to identify its creator at all times, must lead to decrease of such negative effects and serve to build trust between the state, developers and users of technology. Accountability is a rather important part of any relations and it must be ensured as control cannot be efficient without it.

The problems associated with the use of artificial intelligence and the legal regulation of such use also deserve special attention [6]. As artificial intelligence becomes more and more integrated into the legal system, the state must ensure that basic legal values are preserved. The most important of these legal values are: equality before the law; public, impartial and independent consideration of disputes; procedural fairness and due process of law; fairness in the development and application of the law; publicity of the legal process; equal access to justice for all.

However, it is undeniable that the spread of artificial intelligence can have a tremendous impact on legal values and their perception and implementation, both negatively and positively. The use of artificial intelligence, especially in jurisprudence (lawmaking, law enforcement practice) can level the value, moral and ethical basis of law, emphasize the importance of legal values or completely change the balance of their relationship, both with each other and with the legal system as a whole.

In general, developments in the field of artificial intelligence have advanced significantly at the moment and are already becoming common in everyday life. People use voice assistants, and neural networks are used by large companies to optimize

processes. However, at the legislative level, the problem of the practical use of artificial intelligence is not properly resolved. As a rule, companies that widely use artificial intelligence have their own local acts and standards that define the goals and limits of its use. At the same time, they themselves determine the value guidelines on which such standardization is based. In legal use, artificial intelligence has not yet become as widespread as in business and everyday life. The debate on the topic of its use in legal processes has not subsided for many years and remains relevant [7, 8].

For example, the use of artificial intelligence technology in the judicial system can contribute to a violation of the principle of equality. The use of artificial intelligence can change not only legal processes, but also political, social ones, jeopardizing the legitimacy of legal systems in general. In the political realm, artificial intelligence can be used, for example, for political modeling and forecasting when huge amounts of big data need to be processed.

In this regard, when considering the issue of the value foundations of legal regulation of the use of artificial intelligence, it is necessary not to forget that, similarly to the Internet, artificial intelligence is, first of all, the means, in the development and application of which, it is necessary to ensure observance of data confidentiality and security of data and users, openness and access.

At the same time, considering the use of artificial intelligence, it is worthwhile to additionally note the role of impartiality, which should be the unconditional basis of its work. It is unacceptable in legal regulation to allow any decrease in the value of the existing hierarchy of legal values of any industry in which artificial intelligence is used, as well as their complete destruction or ignoring.

The main problem in the application of artificial intelligence in any field is responsibility. Speaking about the results of the activity of artificial intelligence in any process, it is important to understand that this is the result of the activity of the system of algorithms, obtained as a result of processing the input data. Thus, it is impossible to hold artificial intelligence accountable for the negative consequences resulting from its activity. In addition, it is necessary to ensure the inadmissibility of third-party interference and other influence on the specified system of algorithms, to avoid abuse of various features [9].

This is especially important in the context of the application of artificial intelligence in lawmaking and law enforcement practice. Artificial intelligence is self-learning by processing more data, getting more models to analyze and increasing the variability of the outcome [10]. However, it is obvious that any system, especially one that is so new to humanity, is not ideal. Thus, laws modeled and created using artificial intelligence can lead to an increase in negative consequences in a particular area, upset the balance of interests of citizens and the state. The imperfection of the system and its ability to exhibit bias can lead to the adoption of incorrect judicial and administrative decisions, which can manifest itself, for example, in large financial losses. An appeal against a court decision made by artificial intelligence to a higher judicial body, which also considers cases of this kind with the help of artificial intelligence, will most likely not bear any results. And the consideration of a complaint

by a panel of judges will not increase the efficiency of trials and will not free the parties from fears of bias and imbalance of interests.

It seems that values should be integrated into the artificial intelligence system, thereby representing the basis of both the activity of artificial intelligence and the law it applies. So, legal technological systems using artificial intelligence should integrate legal values. However, such integration inevitably confronts us with problems associated with the principles of artificial intelligence.

Artificial intelligence uses machine learning—a collection of methods and algorithms that can detect patterns in data. It is the templates of conclusions obtained based on the analysis of such data that are then used when making a decision and modeling a forecast. As already noted, thanks to machine learning, artificial intelligence improves its parameters (performance) according to the amount of processed information. Big data is analyzed by artificial intelligence for patterns (patterns) and a result is formed on the basis of these patterns. So, if the system analyzes only those data where there are obvious patterns of inconsistency and bias, this will be perceived as a “working template” and the decisions of artificial intelligence, likewise, will be biased. It is impossible to provide an absolutely perfect set of big data for analysis in the process of machine learning. Thus, the functionality of the artificial intelligence system is limited by the limits of the data and templates provided. Accordingly, for the objective and unconditional integration of values into legal technologies that use artificial intelligence, one should first take care of the “purity” of the data that serves as a source of machine learning for such a system [11].

Another significant concern is the difficulty of detecting patterns that demonstrate bias in AI decisions, including the fact that the system has a priori lack of interest in any outcome. In addition, the record of the decision-making process itself is often difficult to interpret, which reduces the effect of the values of openness and due process, since the code generated by the system itself can be very difficult for humans to understand. There are also situations when the creators of artificial intelligence cannot decipher the code of a system that they themselves have created.

Another approach to training the system is to provide analysis of legislative data, without including law enforcement patterns in the training process. In this case, artificial intelligence uses computer logic (laws are integrated into the system as comparable rules applied by artificial intelligence when making a decision). The variability of such solutions is minimal, equal to the maxims “true” and “false”. Such a system cannot have built-in values, since it is formalized as much as possible to the limits of computer logic. So, technological systems using artificial intelligence will undoubtedly be widely used in the application of the law. Such systems must contain values clearly embedded in them. Legal technological systems using artificial intelligence require special care and awareness in development, since the use of artificial intelligence can increase the number of problems associated with the implementation and perception of values, which can influence the result of decision-making and remain invisible to humans [12]. Equally important is the issue of the perception of values in the application of Internet technologies in everyday life, business and law [13].

This type of technology integration into all areas of activity is currently the most widespread and popular. However, its development does not stand still, and the

systems of Internet technologies are rapidly developing. In the legal sphere, such technologies are also quite widespread, for example, the submission of documents to the courts and the receipt of documents from the courts (including judicial acts, writs of execution, etc.) in electronic format using Internet technologies, such as AIS “Legal proceedings, “My Arbiter”, SAS “Justice” [14]. In addition, there are Internet portals that provide access to information and communication with state and municipal authorities. Examples of such portals are state services, websites of state bodies, which provide access to services that allow you to receive information in real time. For example, about an accident involving a specific vehicle, the Rosreestr portal, which implements both the opportunity to receive a public service and receive open information in real time, the Federal Tax Service of Russia portal.

It is worth noting that during the pandemic, video conferencing technologies developed, and it became possible to participate in court sessions online (without the need to appear in court, providing video conferencing, organizing communication with the court from your personal device).

## 5 Conclusion

Through the aforementioned one may conclude that in the context of legal regulation of any type of digital technologies, confidentiality and data security of any system should be considered as the basis for such regulation and standardization. Data confidentiality is an activity aimed at protecting data from unintentional, illegal or unauthorized access, disclosure or theft of information (any information). As a value, confidentiality means the priority of protecting data from unauthorized access to it, etc., aimed at protecting and observing human rights to privacy, confidentiality of correspondence and his rights to independently manage the information that constitutes his personal data. Confidentiality deals with classified information, including permissions to view, share and distribute it. So, to ensure the implementation of confidentiality, the legislator, when developing norms and standards for the development and use of digital technologies of any type, should provide for: limiting the circle of persons to whom data can be disclosed, determine the conditions for disclosing confidential data, the value of data, and, above all, the essence of confidential data, their definition, conditions for classifying data as confidential. As has been mentioned many times, data security is also vital. Data security is ensured by processes that prevent illegal access to them, their unauthorized modification, deletion, distribution, use.

To ensure the implementation of data security, it seems that the regulation should determine the priority of data encryption, establish scenarios for controlling access to data, establish minimum requirements for physical data protection, determine the procedure and standards for data disposal, the terms of their mandatory storage, management of data devices, their collection, etc.

Confidentiality and security of placing data on digital and electronic platforms should not carry a deviant message for participants in information relations. The use

of closed platforms by criminals can be far more evil than violation of privacy and personal data protection. Considering the foregoing, there is an urgent need to create an adequate legal mechanism for the disclosure of electronic information, ensuring the balance of private and public interests and the corresponding system of values formed in society. Thus, information technology is, of course, a blessing without which modern society can no longer exist, since the proper standard of human life is ensured through new technologies. However, one should not forget that there is a very real risk of degeneration of the named good to harm while ignoring the moral, ethical, value content of legal relations. Numerous manifestations of abuse in the information sphere clearly demonstrate this.

## References

1. Koniagina, M., Belotserkovich, D., Vorona-Slivinskaya, L., Pronkin, N.: Development trends of an internet of things in context to information security policy of a person, business and the state. *Talent Dev. Excellence* **12**(2s), 1181–1193 (2020)
2. Rybakov, O.Y.: Legal policy in the field of protecting the rights and freedoms of the individual: the main problems of research. *Bull Saratov State Soc Econ Univ* **9**, 136–144 (2004)
3. Garg, A., Mittal, N., Diksha: A security and confidentiality survey in wireless internet of things (IoT). In: Balas, V., Solanki, V., Kumar, R. (eds.) *Internet of Things and Big Data Applications*. Intelligent Systems Reference Library, vol. 180, pp. 65–88. Springer, Cham (2020)
4. Roukounaki, A., Efremidis, S., Soldatos, J., Neises, J., Walloschke, T., Kefalakis, N.: Scalable and configurable end-to-end collection and analysis of IoT security data: Towards end-to-end security in IoT systems. *Global IoT Summit (GIOTS)*, pp. 1–6. Aarhus, Denmark. <https://doi.org/10.1109/GIOTS.2019.8766407> (2019)
5. Hassija, V., Chamola, V., Saxena, V., Jain, D., Goyal, P., Sikdar, B.: A survey on IoT security: Application areas, security threats, and solution architectures. *IEEE Access* **7**, 82721–82743 (2019)
6. Laptev, V.A.: The concept of artificial intelligence and legal responsibility for its work. *Law. J. High. Sch. Econ.* **2**, 79–102 (2019)
7. Andreev, V.K.: Dynamics of regulating artificial intelligence. *J. Russ. Law* **3**, 58–68 (2020)
8. Begishev, I.R.: Artificial intelligence and robot as legal categories. *Business Secur.* **6**, 32–36 (2020)
9. Churakova, E.N., Lang, P.P., Loshkarev, A.V.: Problems of evidence in the conditions of digitalization of economic justice. In: Ashmarina, S.I., Mantulenko, V.V. (eds.) *II International Scientific Conference Global Challenges and Prospects of the Modern Economic Development*. European Proceedings of Social and Behavioural Sciences, vol. 79, pp. 942–947. European Proceedings, London (2020)
10. Morozov, S., Ranschaert, E.: Why Europeans must care more about AI, machine learning. URL: <https://www.auntminnieeurope.com/index.aspx?sec=log&URL=%3a%2f%2fwww.auntminnieeurope.com%2findex.aspx%3fsec%3dsup%26sub%3dpc%26pag%3ddis%26ItemID%3d614822>. Accessed: 01 Mar 2021 (2017)
11. Pevtsova, E.A.: The influence of artificial intelligence on human legal activity. *J. Russ. Law* **9**, 19–31 (2020)
12. Lipinsky, D.A., Musatkina, A.A., Romashov, R.A., Golenok, S.G., Bryleva, E.A.: The problems of legal regulation of AI: A rather-legal research. In: Popkova, E., Sergi, B. (eds.) *Artificial Intelligence: Anthropogenic Nature vs. Social Origin*. ISC Conference - Volgograd 2020. *Advances in Intelligent Systems and Computing*, vol. 1100, pp. 411–416. Springer, Cham (2020)

13. Lang, P.P.: Legal axiology in the information society. In: Ashmarina, S.I., Mantulenko, V.V. (eds.) Proceedings of the II International Scientific Conference Global Challenges and Prospects of the Modern Economic Development. European Proceedings of Social and Behavioural Sciences, vol. 79, pp. 778–783. European Proceedings, London (2020)
14. Lang, P.P., Loshkarev, A.V., Churakova, E.N.: E-justice as a stability guarantee of civil turnover in the digital economy. In: Ashmarina, S.I., Mantulenko, V.V. (eds.) II International Scientific Conference Global Challenges and Prospects of the Modern Economic Development. European Proceedings of Social and Behavioural Sciences, vol. 79, pp. 773–777. European Proceedings, London (2020)



# Theoretical Foundations for Development of Digital Strategy for Enterprise' Sustainable Development



E. M. Pimenova

**Abstract** The article analyzes features of digital strategy development at small, medium-sized and large enterprises. An approach is being formed to the definition of the “digital sustainability” and “digital strategy” concepts. The necessity of developing digital strategies at the enterprises of the Russian Federation is justified. The necessity of using new technologies in the modern conditions of the Russian market is studied. The emphasis is on the change in added value in the process of introducing technological changes. The article studies the issues of adjusting the organizational structure of organizations in the process of introducing these changes. The main aspects of financing digitalization at enterprises are analyzed.

**Keywords** Digital strategy · Digital sustainability · Technological changes

## 1 Introduction

The topic of the digital economy is extremely relevant at the present time. The term “digital economy” has moved from scientific journalism to the media only in the last 5–6 years. The closest attention to it arose in 2017 during the rise of the cryptocurrency profitability. Then, various structures, enterprises, and individuals became interested in this problem. At the state level, the program “Digital Economy of the Russian Federation” was developed [1] and the issues of digitalization were also considered in more detail.

The digital economy can be defined as economic activity, which is the result of billions of daily online connections between people, businesses, and devices. As a result of the using the Internet and mobile technologies, the interconnectedness of people, organizations, and machines is growing every minute. Digital transformation is rapidly changing the global economy and is one of the major trends affecting business today. Some of the most exciting entrepreneurial ideas involve bringing together the principles of digital technology and sustainable enterprise development.

---

E. M. Pimenova (✉)  
Samara State University of Economics, Samara, Russia

With the help of digital technologies, business entities use innovative approaches to solving seemingly unsolvable economic and social problems. But, first of all, digital technologies allow us to solve the challenges in strengthening the sustainability of the business entities functioning, so, the work of entrepreneurs in this area can be considered as activity of ensuring the digital sustainability of enterprises.

Digital sustainability can be defined as an organizational activity aimed at achieving the goals of sustainable development of an enterprise through the creative introduction of creating technologies, using, transmitting or receiving electronic data. The digital nature of these activities allows organizations to be less geographically constrained and increases scalability, resulting in higher efficiency [2]. Digital sustainability can stimulate empirical advances in entrepreneurship, innovation, and strategy with the potential to positively impact society. The purpose of digital sustainability activities is to develop market proposals that directly improve the socio-economic performance of the enterprise. In order to be competitive in the future, business entities have to recognize all the opportunities and overcome all the challenges of digitalization in the long term. This requires the development of a digital strategy (digitalization strategy), which affects all areas of the enterprise, allowing it to ensure its survival in the digital age. And here it is necessary to consider the question: do small and medium-sized enterprises (SMEs), as well as large enterprises, have such a digital strategy, and if so, how is it structured? The search for an answer to this question is the main goal of this study.

## 2 Methodology

To achieve the study goal, the methods of scientific cognition were mainly used. Thus, the method of generalization of theoretical knowledge was used to determine the essence of digital sustainability and digital strategy. The comparison method was used to identify the distinctive features of digital strategy development at SMEs and large enterprises. Methods of analysis and synthesis were used in the article to identify the prospects for the digital transformation of Russian enterprises. In addition, it became possible to use the methods of system and factor analysis, as well as diagnostic, retrospective, predictive and other methods. The article analyzes the economic literature on the theoretical foundations of the development of an enterprise' digital strategy. In this context, special attention was paid to the collection and generalization of the information received.

## 3 Results

Technological changes and the associated digitalization have recently become increasingly relevant [3]. It should be noted that individual companies or specific industries have not been particularly affected by new technological developments, but

in combination with the constantly changing needs of customers, they have already had and continue to have an impact on the state economy and society as a whole [4]. Customers are increasingly expecting individual products (services), so, in the end, it is the dynamics of their needs and behavior that is crucial for any business [5]. For an enterprise, this means adapting its business infrastructure to the new digital era. [6] In other words, enterprises have to adapt its entire value chain to new technologies and digital demands. In recent years, the nature of value added has evolved [7], which shows that in the near future, enterprises will have to develop business models that differ from those that they or their competitors are currently developing. In the process of developing these new business models, new technologies will be integrated and used to ensure the sustainability of the enterprise's functioning, its survival in the digital future [8].

In order for an enterprise to function successfully in the era of digitalization, it needs a well-developed strategy with which it can implement its digital business models in the future. And it is not important WHEN the enterprise implements its digital transformation; it is much more important HOW it does it [9]. The company's strategic focus on digitalization is aimed at reducing costs, opening up additional sales opportunities, increasing productivity, and developing new business models. Therefore, a clear strategy that takes into account the use of digital technologies is crucial for the future success of enterprises of all sizes and industry affiliations [9]. Recently, the digital strategy at enterprises was either not developed at all, or was equated with the overall corporate strategy. Nowadays, the situation has changed dramatically: digital technologies are fundamentally transforming traditional business strategies into modular and cross-functional global strategies that allow to set business processes beyond the boundaries of time and distance. Thus, a digital strategy is a business strategy inspired by the power of high-performance, easily accessible technologies and providing unique, integrated business functions so that they can adapt to ever-changing market conditions [8]. Therefore, if an enterprise wants to survive in the digital age, it needs a comprehensive overall strategy that includes all digital resources of its activities.

All enterprises (of any size and industry) are affected by digitalization, so they all need to develop a digital strategy that is right for them. Large companies have to necessarily develop a digital strategy. However, due to insufficient finances and skilled personnel, a large number of large enterprises are still at the beginning of their digital transformation, and most of them still generate their sales from traditional products and services. It is important that their management staff understand the need for digitalization to continue being competitive in the digital age. SMEs play an important role in the economy and are considered engines of economic growth. However, they differ significantly from large enterprises in terms of their limited financial coverage, insufficient number of well-trained personnel, and fewer resources. But despite this, in order to strengthen their competitiveness, SMEs also need to rethink their strategic direction towards digitalization and adapt their existing development strategy to the changed basic situational conditions. At the same time, the new strategy will represent the overall design of an IT-oriented digital strategy and a business strategy. In other words, there will be a mutual relationship between

these two strategies. The so-called digital business strategy occurs when an enterprise engages in activities related to the offer of digital products and services [10].

To successfully master digital transformation and thus ensure future survival in times of digitalization, companies should have a digital strategy that is right for them. To do this, enterprises have to firstly understand the strategic role of new information technologies and be able to develop and use them. In particular, it is important whether the enterprise uses technologies that already exist on the market or acts as a market leader, independently creating new technologies. Small, medium, and large enterprises have to understand the role of new digital technologies, as they can transform the existing business model in a bad way. However, new digital technologies cause not only new opportunities, but also new threats for enterprises of all sizes. In terms of financial resources, it is easier for a large enterprise to develop digital technology itself, and it is more profitable for SMEs to acquire it. Furthermore, SMEs can integrate new technologies much faster and easier due to their size, whereas at large enterprises, the integration of new technologies usually involves a fairly long planning and implementation stage.

## 4 Discussion

Ongoing technological changes directly affect the formation of the enterprise (business) value, so they often lead to changes in the creation of added value. The enterprise should answer the following questions: how different are its new (digital) and current (main) activities; which markets and which customers will be targeted by digital activities. A company may focus on expanding its current product (service) offerings, while often requiring an increased need for technological changes and product-related know-how. On the other hand, due to the lack of sufficient experience in the new (digital) field of activity, the risks are very high. Therefore, both SMEs and large enterprises need to be clear about how they will create added value in the digital future. It should not be forgotten that the competitive situation on the market has changed due to new, often purely digital companies. At the same time, new players not only attack SMEs and their business models, but also directly compete with large enterprises and their efficient business models, which have been successful for decades due to their stable market position [8].

For SMEs, a successful focus on future value creation is crucial, as their financial and human resources are limited, and without them, it is impossible to achieve any fundamental changes in the fundamental way of creating value added. Large enterprises, due to their size, sufficient resources, and stable market position, can respond much more easily to such changes in value creation, even in the short term.

The integration of new technologies and the creation of changing value requires an appropriate organizational structure from the enterprise, which is necessary for the successful implementation of the digital transformation tasks. Enterprises can integrate new tasks into existing structures, but they can also make significant changes.

Small, medium, and large enterprises need an optimal organizational and management structure to implement digital transformation [11]. Meanwhile, the introduction of digital technologies requires a slightly different mindset and skills than the previous waves of transformational technologies. For enterprises of all sizes and industry affiliation, winning the competition for suitable, highly qualified personnel is extremely important. At the same time, a flexible organizational structure, combined with flexible working methods, is crucial here, it allows for faster changes associated with digital transformation. For this reason, it can be assumed that SMEs (as opposed to large ones) have flatter and more flexible hierarchies due to their size, so changes in relation to digitalization and the creation of a digital strategy in them can be implemented faster and easier.

To be able to implement these changes, it is necessary to take into account the financial aspects. Finance is both the driving force and the limiting force of digitalization. Financing of digital activities can be carried out both within the enterprise (at the expense of its own funds), and through external sources of financing. However, SMEs often do not have particularly large financial resources for digital transformation, and the possibility of attracting them from outside is also extremely small. It has already been mentioned that SMEs often operate in conditions of limited financial and human resources, and large enterprises have significant advantages over them (due to their size, stable functioning, greater authority and stronger influence on the market).

The financial component of digitalization plays a crucial role in the efficient allocation of resources, economic growth and jobs creation. Having a well-functioning enterprise to stimulate and sustain the growth of the state economy is a requirement for all countries. In the Russian Federation, the construction of a digital model of the domestic economy is based on the industrial and production model of the economy. Therefore, the main leverage of the digital breakthrough is to obtain sufficient funds for the development and acquisition of digital assets by increasing the efficiency of industrial enterprises.

## 5 Conclusion

The relevance of digitalization is undeniable, so enterprises of all sectors of the economy and of various sizes are affected by it. The issue of digitalization of the economy in the current conditions of the Russian market and the world economy as a whole is one of the high priority. With the help of digitalization, any company will be able to strengthen the stability of its functioning on the market. In order to achieve maximum commercial success and increase the efficiency of its activities, an enterprise should base the strategy developments on digitalization [12, 13]. To do this, it is necessary to develop a digital strategy. Enterprises of all sizes and any industry affiliation are affected by digitalization in four dimensions (technology use, changes in value creation, structural changes, and the financial aspect). For digital transformation to be successful, it is necessary that all four analyzed dimensions of

the digital transformation structure are consistent. The main incentive for the digital transformation of the Russian enterprise is the ability to withstand competition both on the domestic market and on the external market. Domestic enterprises have many problems. According to a number of “digital” indicators (the share of the digital economy in GDP (gross domestic product), the level of digitalization, the degree of technology development, the degree of technological inferiority, and others), the Russian Federation is not included in the group of leading economies of the world. However, over the next 15–20 years, our country is going to strengthen its positions through the development of digital competitive advantages. The speed of digital transformations over the past 3–5 years and the growth rate of Russia’s GDP over the same period allow us to give a favorable forecast of achieving the strategic goal set by the state.

## References

1. The national program: Digital economy of the Russian Federation. URL: <http://government.ru/rugovclassifier/614/events/>. Accessed: 28 Feb 2021 (2018)
2. George, G., Merrill, R.K., Schillebeeckx, S.J.D.: Digital sustainability and entrepreneurship: How digital innovations are helping tackle climate change and sustainable development. *Entrepreneurship Theory and Practice*. URL: <https://doi.org/10.1177/1042258719899425>. Accessed 28 Feb 2021 (2020)
3. Haffke, I.: The implications of digital business transformation for corporate leadership, the IT function, and business-IT alignment: Dissertation. Technical University Darmstadt, Darmstadt (2017)
4. Haffke, I., Kalgovas, B., Benlian, A.: The role of the CIO and the CDO in an organization’s digital transformation. In: *Proceedings of the 37th International Conference on Information Systems*, pp. 3952–3872. Curran Associates, Inc, Atlanta (2016)
5. Vey, K., Fandel-Meyer, T., Zipp, J., Schneider, C.: Learning and development in times of digital transformation: Facilitating a culture of change and innovation. *Int. J. Adv. Corp. Learn.* **10**(1), 22–32 (2017)
6. Bharadwaj, A., El Sawy, O.A., Pavlou, P.A., Venkatraman, N.: Digital business strategy: Toward a next generation of insights. *MIS Q.* **37**(2), 471–482 (2013)
7. Klötzer, C., Pflaum, A.: Toward the development of a maturity model for digitalization within the manufacturing industry’s supply chain. In: Bui, T.X., Sprague, R. (eds.) *Proceedings of the 50th Hawaii International Conference on System Sciences*, pp. 4210–4219. Scholar Space at University of Hawaii at Manoa, Honolulu (2017)
8. Sebastian, I.M., Mocker, M., Ross, J.W., Moloney, K.G., Beath, C.M., Fonstad, N.O.: How big old companies navigate digital transformation. *MIS Q.* **16**(3), 197–213 (2017)
9. Hess, T., Matt, C., Benlian, A., Wiesböck, F.: Options for formulating a digital transformation strategy. *MIS Q. Exec.* **15**(2), 123–139 (2016)
10. Yeow, A., Soh, C., Hansen, R.: Aligning with new digital strategy: A dynamic capabilities approach. *J. Strat. Inf. Syst.* **27**(1), 43–58 (2017)
11. Horlacher, A., Hess, T.: What does a chief digital officer do? Managerial tasks and roles of a new c-level position in the context of digital transformation. In: Sprague, R.H., Bui, T.X. (eds.) *Proceedings of the 49th Hawaii International Conference on System Sciences*, pp. 5126–5135. Association for Information Systems IEEE Computer Society Press, Washington (2016)

12. Becker, W., Schmid, O., Boszkowski, T.: Role of CDOs in the digital transformation of SMEs and LSEs—An empirical analysis. In: Bui, T.X. (ed.) Proceedings of the 51st Hawaii International Conference on System Sciences, pp. 4534–4543. Scholar Space at University of Hawaii at Manoa, Honolulu (2018)
13. Istomina, E.A.: Methodology assessment of trends in the digital economy of industry. Bull. Chelyabinsk State Univ. **12**(422), 108–116 (2018). <https://doi.org/10.24411/1994-2796-2018-11212>

# Digitization and the Population Quality of Life: Statistical Perspective



N. V. Proskurina, Yu. I. Davidyan, and M. A. Zorina

**Abstract** To provide the population with open and accessible information is of paramount importance in the context of the global crisis. It is possible to achieve with modern technologies. There is an accelerated digitalization of the economy and the entire society in many areas and, as a result, the economic situation and social life of the population are changing. That process cannot but affect the quality of life. This article reports on the statistical findings of the study on the digitalization impact on the population quality of life in the Russian Federation. An integral indicator of the population quality of life is calculated, the modeling is done. The development of informatization impact on the population quality of life in the constituent entities of the Russian Federation is evaluated. The clustering of the RF regions according to the indicators of informatization that determine the population quality of life is carried out.

**Keywords** Digitization · Population · Quality of life · Regions · Statistics

## 1 Introduction

Information technologies are now ubiquitous in all spheres of life, e.g. education, medicine, the labor market, science, culture, etc. It is unthinkable to picture our life without information technology that facilitates many everyday processes in our life. The IT sector is now responding more acutely than ever to the needs of people and changes in society. Currently under the COVID-19 pandemic, the economic situation and social life of people in many countries has been changing. As a result, the economy and society are rapidly digitalizing in many areas.

---

N. V. Proskurina (✉)  
Samara State University of Economics, Samara, Russia

Yu. I. Davidyan · M. A. Zorina  
Buzuluk Humanitarian and Technological Institute (Branch) of Orenburg State University,  
Buzuluk, Russia  
e-mail: [nauka@bgti.ru](mailto:nauka@bgti.ru)



Organizations and the population are increasingly shifting to distance mode of work due to government restrictions on free mobility, as well as due to the measures aimed at maintaining social distancing. Now food and convenience nonfood stores, various services, pharmacies, educational environment, banking segment, etc. have gone online. This trend demonstrates not only the population's need for information technologies, but also the sufficient level of technology development that makes the transition to online fast and affordable.

The regular search for information on the virus spread and the other people's health status constitutes the example of the information technologies active use by the population during COVID-19. This opportunity exists due to the widespread use of smartphones and other mobile devices that accumulate information about their owners and their condition. There is also an increase in the use of technologies to track people's social contacts in the course of the pandemic. In the situation of the global crisis, it is essential to provide the population with open and accessible information, which is impliable with the application of modern technologies.

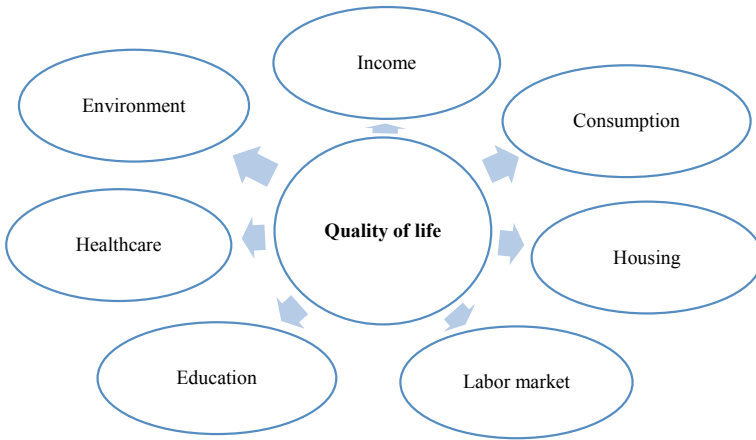
## 2 Methodology

The evidence for the study is collected from the statistical information on the various territories of the RF for 2018. The data is taken from the Federal State Statistics Service [1]. Domestic and foreign methodological and theoretical approaches were applied to the subject under study; information from electronic resources, scientific publications, and periodicals was adopted.

Methods of multivariate analysis were used as statistical tools. The quality of life concept is an umbrella term that involves not only the living standard, but education, health, environment, employment, etc. The Pattern nonparametric assessment method was used to generally estimate and comprehensively analyze the population quality of life in the parts of the RF. The calculations were performed for 28 indicators grouped by blocks (Fig. 1).

The idea of such an assessment is to find a multivariate average value (a generalizing estimate) from the normalized values of quality of life particular indicators to their best values among all subjects. The resulting value can be in the range [0; 1]. A high quality of life of the population in the region is determined by the proximity to 1.

The method of correlation and regression analysis was used to identify the correlation of the IT effect with the life quality of the population in the RF entities. Hence, the information society development factors that affect the population quality of life were determined. Since the nomenclature of indicators of the information society development is quite extensive, 11 indicators were selected, that reflect the situation of the population's involvement in the process of digitalization best of all, namely the households material security and their use of information and communication technologies. To identify the types of regions, the methods of cluster analysis, e.g.



**Fig. 1** Constituents of generalizing estimate for life quality. *Source* Authors

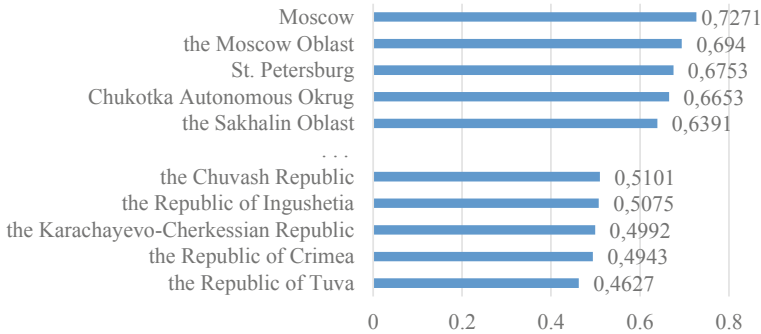
the K-means method, were used. It was based on the information technologies development indicators that specify the life quality of the population. The effectiveness of the classification is based on testing the hypothesis of variances inequality between and within clusters. Each cluster is characterized by the average normalized values of the feature. Those ones can be used to conclude about the level of the phenomenon under analysis. All calculations are performed in the application software package STATISTICA 13.3.

### 3 Results

The generalized (integral) assessment of the quality of life, calculated on the basis of 28 particular indicators by the Pattern method, made it possible to rank the regions in the RF by the level of their well-being. The high level and quality of life are typical for highly economically and socially developed entities—Moscow and the Moscow *Oblast*, St. Petersburg, Chukotka Autonomous *Okrug* and the Sakhalin *Oblast*. In Moscow the average value of particular indicators of life quality relative to their best values is 72.7%. Outsiders with a low level and quality of life are the regions of the North Caucasus and economically undeveloped republics, in which the generalized assessment value is less than 50% (to the mean of the best values of particular indicators) (Fig. 2).

The regression model of the digitalization impact on the population life quality confirms the suggested hypothesis about the dependence of the level and quality of life, which is expressed by a generalized assessment of the life quality, on the development of information technologies level among the population:

$$\hat{y} = 29.42 + 0.189 \times X2 + 0.098 \times X7 + 0.088 \times X11 + 0.036 \times X3$$



**Fig. 2** Generalized assessment of population life quality in the entities of the RF for 2018. *Source* Authors

The model includes four indicators that explain the variation in the life level and quality by 73.4%:

- if the share of households with a personal computer (PC) in the total number of households, (X2) increases by 1%, the generalized assessment of the population life quality will increase by 0.189 pp;
- if the share of households with both mobile and landline phones in the total number of households, (X7) increases by 1%, the generalized assessment of the population life quality will increase by 0.098 pp;
- if the number of active subscribers of mobile broadband Internet access (X11) increases by 1, the generalized assessment of the population life quality will increase by 0.088 pp;
- if the personal computers number per 100 households (X3) increases by 1 unit, the generalized assessment of the population life quality will increase by 0.036 pp.

The degree to which each indicator influences the dependent variable, i.e. the population quality of life, was estimated with beta coefficients ( $\beta$ ) presented in a standardized regression equation:

$$\hat{y}_i = 0.2968 \times t_2 + 0.1691 \times t_3 + 0.3136 \times t_7 + 0.3454 \times t_{11}$$

The number of active users with mobile Internet access ( $\beta = 0.3454$ ) is of the highest priority, and the lowest priority is taken by the availability of personal computers ( $\beta = 0.1691$ ). In the final model, all the coefficients and the constant are significant according to the Student's t-test, and the significance of the multiple correlation coefficient is confirmed by the Fisher F-test.

Using the cluster analysis, the typology of the RF regions was designed based on the factors of the information society, which are included in the model of regression and determine the life level and quality. The clustering results demonstrated that the subjects of the Russian Federation formed four distinct clusters, which to the fullest

**Table 1** Ratings of the digital determinants for average normalized values of the population life quality by cluster for 2018

| Quality of life determinants   | 1 cluster | 2 cluster | 3 cluster | 4 cluster |
|--|-----------|-----------|-----------|-----------|
| X2—households with a personal computer (PC) in the total number of households        | 2         | 3         | 4         | 1         |
| X3—personal computers number per 100 households                                      | 2         | 3         | 4         | 1         |
| X7—households with both mobile and landline phones in the total number of households | 3         | 2         | 4         | 1         |
| X11—number of active subscribers of mobile broadband Internet access, per 100 people | 2         | 3         | 4         | 1         |
| Ratings total  | 9         | 11        | 16        | 4         |
| Number of regions in a cluster   | 29        | 45        | 6         | 2         |

Source Authors

extent possible characterize the differentiation of regions according to the informatization indicators that determine the population quality of life in the regression model. Moscow and St. Petersburg represent the cluster with the factors determining the high level of informatization (4 cluster). The vast majority of the entities in the Russian Federation are included in the clusters with factors that determine the level of informatization above the average (1 cluster) and average (2 cluster) ones. The numbers are 29 and 45, respectively. The cluster with the factors determining the low level of informatization (3 cluster) comprises 6 RF entities: the Dagestan River, the Republic of Ingushetia, the Republic of Karachay-Cherkess, the Chechen Republic, the Republic of Mari, and the Republic of Tyva (Table 1).

Overall, the clustering generated accurately reflects the situation with an uneven distribution of digitalization development in the regions. The development of information technologies was distributed in inversed manner to the economic situation, i.e. the highest level of informatization of the population was received by city with more than one million inhabitants and with a developed economy, and the lowest rating of informatization was given to regions with a low level of socio-economic development.

## 4 Discussion

The modern era is characterized by the spread of digital technologies in all the domains of life of the inhabitants, which ultimately is followed by accrescence in the quality of their life [2]. Meanwhile, digitalization is merely a tool for the socio-economic transformation of society. The impact of informatization on the population quality of life has both positive and negative aspects. Along with improving

the quality and living conditions of citizens, digitalization leads to negative consequences, for example, the lack of demand for certain professions [3]. The development of digital technologies is not always followed by accrescence in the well-being of the population; therefore many countries take measures to protect their citizens from the negative consequences of digitalization [4].

The development of information and communication technologies (ICTs) has a significant differentiation within the country, and as a result, affects the interregional discrepancies in the level and quality of life of the population. This reckons on the availability of ICT and the degree of digital proficiency of the population [5]. Regional differences in digitalization can be assessed using the digital inequality index, which determines the digital component of the population quality of life in the regions [6, 7]. The researchers confirm the findings of the study about lower development in terms of digitalization in the regions of the North Caucasus, and the higher level of digitalization in economically developed regions [8]. To analyze trends in the informatization level development and its interregional differences, a comprehensive monitoring system is needed that allows quickly tracking changes in the population quality of life in the regions, which would be based on multidimensional statistical analysis and include, in particular, the development of an integral indicator of the population quality of life [9]. Digital transformation readiness level in the RF society is determined by an assessment of household spending in the digital sphere, as well as by the share of government spending on digitalization in GDP, based on statistical data analysis [10].

The whole cohort of academic research on the subject under study was analyzed and the correlation of digitalization and the quality of life of the population was revealed. However, the issue of identifying and statistically assessing the determinants of interregional differences in the quality of life remains debatable.

## 5 Conclusion

Thus, a comprehensive analysis of the level of information technologies development among the population revealed insufficient inflow of information technologies in the regions of the Russian Federation. Only two or three constituent entities of the Russian Federation can boast of a high level in IT development, while the rest ones lag far behind them. That indicates an uneven development of information technologies among the localities of the Russian Federation. Despite the measures taken and the development programs and strategies created, more attention should be paid to this issue at the regional and local levels. That could help to bridge the gaps in the development of information technologies among some RF's parts. The present study is of practical relevance since the research findings inheres in the setting, identifying and addressing the challenges of assessing the level of society's informatization development and its impact on the population quality of life in the RF's locations.

## References

1. Federal State Statistic Service: Information society. URL: <https://gks.ru/folder/14478>. Accessed 10 Jan 2021 (2020)
2. Kryzhanovskij, O.A., Baburina, N.A., Ljovkina, A.O.: How to make digitalization better serve an increasing quality of life? *Sustainability* **13**(2), 611 (2021)
3. Silenko, A., Bezrodna, V., Nikogosyan, O.: Digital economy as a factor in the development of a social state. *Baltic J. Econ. Stud.* **6**(5), 155–162 (2020)
4. Karpunina, E.K., Derkacheva, E.A., Lisova, E.V., Nazarchuk, N.P., Abalakin, A.A.: Social orientation of the digital economy: A critical analysis of information development concepts. In: Soliman, K.S. (ed.) 34th International-Business-Information-Management-Association (IBIMA) Conference. *Vision 2025: Education Excellence and Management of Innovations through Sustainable Economic Competitive Advantage*, pp. 4090–4098 (2019)
5. Korshunov, G.P., Kroitor, S.N.: The problem of living standards and quality of life in the age of digitalization. *Logos et Praxis* **18**(2), 24–38 (2019)
6. Litvintseva, G.P., Karelin, I.N.: Effects of digital transformation of the economy and quality of life in Russia. *Terra Economicus* **18**(3), 53–71 (2020)
7. Maslov, M., Petrov, S.: Dynamics of digital component indicators of people's quality of life in Russia in 2015–2017. In: Dinu, V. (ed.) *Proceedings of the 2019 Basiq International Conference: New Trends in Sustainable Business and Consumption*, pp. 167–174. Editura, Bari (2019)
8. Litvintseva, G.P., Petrov, S.P.: Theoretical foundations of digital transformation of economy and people's quality of life. *J. Econ. Economies* **16**(3), 414–427 (2019)
9. Petrova, E., Trukhlyayeva, A., Fokina, E.: Economic growth monitoring and the Russian regions typology in terms of quality of life in the digitalization of territories. In: Tikhonovich, E., Batmanova, V. (eds.) *Proceedings of the Volgograd State University International Scientific Conference: Competitive, Sustainable and Safe Development of the Regional Economy (CSSDRE 2019)*. *Advances in Economics Business and Management Research*, vol. 83, pp. 575–580. Atlantis Press, Paris (2019)
10. Korobeynikova, E.V., Ermoshkina, C.N., Kosilova, A.F., Sheptuhina, I.I., Gromova, T.V.: Digital transformation of Russian economy: Challenges, threats, prospects. In: Mantulenko, V. (ed.) *Proceedings of the International Scientific Conference Global Challenges and Prospects of the Modern Economic Development*. *European Proceedings of Social and Behavioural Sciences*, vol. 57, pp.1418–1428. European Proceedings, London (2019)

# Transforming the State Role in the Globalization and Digitalization Context



S. N. Revina

**Abstract** In the modern world, relations between countries are becoming increasingly interdependent. In turn, globalization and the processes of further development of economic integration ultimately lead to its gradual unification. The analysis of how the globalization and digitalization processes influence the role transformation of the state aims to attract the attention of scientists to this problem. The author set the following tasks: to study the impact of digital technologies on national and global processes; to identify the specific features of the digital technology development; to analyze whether it is possible to form the digital economy in the international relations context; to determine the role of the state authorities in the digital economy development; to consider some prospects of the state role transformation under the globalization conditions. In the framework of this research, it can be concluded that the introduction of digital technologies is recognized as an essential criterion for economic growth in global scale. The author analyzes the transition from the introduction of some digital technologies to the systematic building of the digital ecosystem within the limits of national and global economics.

**Keywords** Digitalization · Globalization · Rights and freedoms · Society · Sovereignty · State

## 1 Introduction

As you know, globalization is a product of human activity associated with a certain stage of the civilizational development of mankind. The current level of development of civilization leads to the transformation of such categories as sovereignty, society, and the state. The place and role of the modern state in the ongoing processes of globalization requires a rethinking. Globalization blurs the borders between states, which leads to new global problems, the solution of which at the national level becomes

---

S. N. Revina (✉)  
Samara State University of Economics, Samara, Russia

almost impossible. In modern science, it is often argued that the processes of digitalization can lead society and the state to a new stage of globalization. There are problems of uneven distribution of benefits and negative consequences of competition, which is inevitable in the context of globalization. In the current conditions, there is a problem of the risk of insufficient development of regulatory institutions of the digital economy, their readiness to meet the requirements that can be imposed by the development of digital technologies.

## 2 Methodology

In the implementation of this study, the following methods were used: comparative legal and logical methods, the method of analysis and synthesis, system, modeling method. This allowed to identify essential qualities and secondary features, depending on the specific conditions. Understanding the current trends in the transformation of the state role is carried out through the dialectical method. The identification of contradictions allows to reveal the problems of the transformation of the state role and to identify the shortcomings of the globalization and universalization processes. The use of the comparative method allows to identify common properties and differences typical to individual stages of the digital space formation. Abstracting allows to distract from non-essential properties and identify common aspects of globalization and digitalization. Since each individual research method does not allow to recreate a “complete” picture of the actual situation in the area under study, the above methods were applied comprehensively.

## 3 Results

The first development stages of the digital economy were in the middle of the XX century, when digital technologies began to be introduced into computing systems. But the emergence of the Internet, its rapid development and accessibility clearly became an important stage in the development of the digital economy. In Russia, the digital economy was actively discussed after the president’s address to the Federal Assembly on 01.12.2016 [7]. Based on the experience of foreign countries, we can say that the formation of a digital economy requires an appropriate level of development of digital technologies and standards, as well as a high level of users protection by the state. The state, in the context of the development of the digital economy, performs the function of a legal regulator [2]. In such an environment, new types of legal relations and a new conceptual apparatus arise, which requires concretization and clarification.

In the last few years, the impact of digital technologies on national and global processes has been actively discussed. The most important issue is related to the role of large Internet companies-platforms that are key players on digital markets and in



the development of digital technologies. In particular, this concerns the impact of platforms on the implementation of leadership/dominance and the impact on modern international and global processes.

The role of the platforms in the field of defense and security is recognized as marginal and is not taken into account. The most pronounced changes related to the phenomena of global leadership / dominance and influence are associated with the innovative and technological effects of the development of platforms and digital technologies. National and global economic development relies mainly on large Internet companies and super-platforms. They are especially valuable for their leadership on the digital economy markets, and are rapidly growing sectors of GDP in different countries.

The platforms have tools that allow to have a wide user audience. Large platforms, thanks to their financial strength, retain the right to transform the target markets. They have a predominant position in new and emerging markets. As a result, large platforms influence the leadership of their states. The way to influence is to support technological development. The result of the development of the latter is an increased influence on the global market.

There are information aspects of the impact of platforms on international leadership and dominance. On the one hand, the assessments are a projection of domestic political issues and its discussions, on the other, the platforms play an instrumental role. If in technical and economic problems they have an element of subjectivity, then in this context they are an operational tool of state and non-state structures. The current level of civilizational development opens up new individual, social and state opportunities. The role and the place of the state in the globalization context largely depends on whether it will be able to adapt to the current conditions of digitalization and informatization. After all, the state institution is as important as such a feature of the state as sovereignty. The new development level of our civilization mainly depends on whether the country will be able to adapt to the new reality and contemporary challenges. In this framework, the post-industrial human civilization is aimed at the unification of humanity and social institutions, and to achieve it, it is necessary to allocate and preserve the material and spiritual values of all mankind. The cooperation of world powers is one of the main goals of the global digital space formation. In the context of the digital industries diversity, the dialogue of countries is particularly important for the effective development of the global economy and the digital technology development. Global associations of countries can become a significant platform for implementing the potential of digital technologies. The digitization of information fundamentally changes the structure of the economy. There is a weakening of the ability of traditional economic sensors to measure the prevailing state of the economy and well-being.

## 4 Discussion

“Digital diplomacy” is a classic large-scale and significant phenomenon. Discussions on the issues of manipulating domestic political processes using platforms are complex and contradictory. But platforms are quite vulnerable to external interferences. It is very difficult to give an accurate description, as there are doubts about the effectiveness and mythologization. In this area, we see a double trend towards greater use of platforms by different parties, with differences in assessments and approaches. This is a good reflection of the general debate about the political implications of Internet technologies that began in the 1990s.

We will not evaluate the reasons and results of the use of Internet platforms for the spread of democracy and the implementation of international influence. In the presented world picture, even formally, the tools of democratization were the technical capabilities of platforms, but the reality pointed to Internet corporations—real digital monopolies with the corresponding applications. The problematical character of situation is that many companies have different views in the field of social and democratic values.

Today, there are many scientific papers that are devoted to the digital economy, its essence, role and place in the modern world. The main definition that dominates among researchers characterizes the digital economy as a new technological mode [1], a new system of public relations, the introduction and practical use of information and digital technologies in all spheres of human life and human activity. In such conditions, we are dealing with such concepts as innovations, globalization, virtualization, information society, digitalization [6], etc.

Globalization is a product of human activity, which is associated with a certain stage of the civilizational development of mankind [8]. This refers to the level of development of civilization, when national state borders are erased. A high economic and political dependence between different countries appears. The process of globalization affects and modernizes state institutions. The state, as a social institution, is undergoing some transformation. To solve the world’s problems, changes in the foreign and domestic policy of the state are inevitable.

Globalization leads to a change and rethinking of the state role as the major form of the political organization of our society. In the context of various discussions about the role of the state authorities in the globalization age, there are different opinions, among which two main ones can be distinguished: about the need for the formation of a world state, and about the inevitable slowing down of social progress [11]. But in these opinions, one thing is common—globalization changes all spheres of life and human activity, it also significantly affects the main characteristics of the state.

One of the aspects that cause a crisis of the modern state is the process of internationalization, universalization, as a result of globalization. These processes lead to both changes and the emergence of new functions of the state. Changes in some internal functions of the state occur under the strong influence of international aspects, under the pressure of the external environment. In general, the development of the internal functions of the state becomes impossible if the interests of international

communities are not taken into account [10]. This is so because some problems can only be solved only at the international level and these problems are growing qualitatively and quantitatively. The interpenetration of the national and international state policy becomes inevitable. In this context, opinions appear that we need a new classification of the state functions (at the level of individual states and in the global space).

On the one hand, globalization opens up new opportunities for people, society and the state, but on the other hand, it is an uneven process. In this unevenness, there is a competitive struggle with the use of economic, political and, of course, information means [4]. And the consequences of this struggle, which may be negative, are distributed as unevenly as the benefits. A big problem is not fully smoothed legal regulation [3] in the processes of expanding the influence of individual states or their associations [5].

Globalization requires changes to the system of decision-making of national importance. Many issues need to be addressed at the levels where they can be implemented as efficiently as possible. If it is not possible to solve political goals at the national level, then they are brought to the global level. Obviously, this fact requires the compatibility of national and international legal systems.

Some transformation is also inevitable if we consider the interaction of the state and the civil society in the globalization context. Our society is becoming less dependent from a particular state, although its formation is impossible without the state. Globalization requires civil society to react as quickly as possible to the smallest restriction on human rights and freedoms. It is responsible for finding solutions to the most important domestic global problems. Despite some transformation of relations between the state and civil society, the latter continues to be the main feature of a democratic, social, and legal state.

The role of the national state requires a thorough analysis, since the economic and political interdependence of states threatens its national sovereignty [9, 12, 13]. The state should always retain the prior right to solve such tasks as, for example, national security, control over the extraction of minerals, the fight against international terrorism, the regulation of migration flows, etc.

State sovereignty is and should remain the most important legal category, which contains all the main features of state authorities. The restriction of the state sovereignty under the globalization conditions is inevitable. But this restriction should not lead to the loss of the state as an institution, it should only affect the implementation of state authority in some way. States have developed together with society from the beginning of their formation to the present day. The role and prospects of the state were evaluated in different ways. The form of the state has always changed. The form of government, the territorial structure changed, and it is difficult to talk about any of its forms, as perfect. The history of human development once again proves this.

The ideal state is considered to be a legal, social state, where the highest value is to ensure human rights and freedoms, their equality. But does at least one modern democratic state meet these criteria? Globalization and its processes sometimes negatively affect democratic values. In such conditions, the possibility of the state to interfere in

the private life of citizens increases, which requires additional protection of private life and is against the principles of democracy.

## 5 Conclusion

The introduction of digital technologies in various spheres of human life is recognized as an essential criterion for the economic growth of the economy on its global scale. The author analyzes the transition from the introduction of some digital technologies to the systematic building of the digital ecosystem within the limits of national and global economics. This direction of development reflects the need for effective interaction between the parties on the way to large-scale implementation of digital technologies everywhere—government authorities, businesses, educational institutions, industrial enterprises and financial structures. Development with the use of large-scale digital technologies is an urgent task, not only for some economic spheres, but for the state as a whole. The special significance of digital technology implementation measures is reflected in their crucial importance in the process of transition to the industrial revolution. Digitalization is considered the most important component of states development and turns into an institutional basis for stable production growth, increasing the indicators of competitive ability and material well-being of the near future.

## References

1. Bolgova, V.V., Kazaryan, A.G.: Problems of the digital economy. In: Yakushin, V.A., Trubacheva, S.I., Galeeva, G.R. (eds.) Proceedings of the XV International Scientific and Practical Conference Tatishchev Readings: Actual Problems of Science and Practice, pp. 13–15. Volga University, Togliatti (2018)
2. Bolgova, V.V.: Public interest and privacy: Some balance problems. *State and Law: Theory and Practice* **1**(133), 49–53 (2016)
3. Ebzeev, B.S.: Globalization and the emergence of transnational constitutionalism. *Juridical Eng.* **11**, 600–609 (2017)
4. Fokin, V.I.: The fight for leadership and the Interaction of cultures. *Bulletin of the Faculty of Humanities of the The Bonch-Bruевич St. Petersburg State University of Telecommunications*, **7**, 180–192. (2015)
5. Giddens, E.: *Runaway world: How globalization is reshaping our lives*. Ves Mir Publishers, Moscow (2004)
6. Kazaryan, A.G.: Problems of information society development in the Russian Federation. In G. R. Khasaev, S. I. Ashmarina (Eds.), Proceedings of the VII All-Russian Scientific and Practical Conference Russian Science: Current Research and Development (pp. 393–397). Samara: Samara State University of Economics. (2019).
7. Message of the President to the Federal Assembly of 01.12.2016. URL: <http://kremlin.ru/evnts/president/news/53379>. Accessed: 19.03.2021.
8. Morozova, L.A.: Impact of globalization on the functions of the state. *State and Law* **6**, 101–107 (2006)

9. Revina, S.N., Paulov, P.A., Sidorova, A.V.: Regulation of tax havens in the age of globalization and digitalization. In S. Ashmarina, A. Mesquita, M. Vochozka (Eds.), *Digital Transformation of the Economy: Challenges, Trends and New Opportunities. Advances in Intelligent Systems and Computing*, **908** (pp.88–95). Cham: Springer. (2020).
10. Revina, S.N., Sidorova, A.V.: Transformation of general-theoretical category “offence” in the internet era. In: Mantulenko, V.V. (ed.), *Proceedings of the International Scientific Conference Global Challenges and Prospects of the Modern Economic Development. European Proceedings of Social and Behavioural Sciences*, vol. 57, pp. 1672–1679. European Proceedings, London (2019).
11. Revina, S.N.: Role of the state in the economy. In: Khachaturov, R.L. (ed.), *Actual Problems of Legal Science*, pp. 168–172. Togliatti State University, Togliatti (2010)
12. Revina, S.N.: *Theory of law and market: A monograph*. Samara State University of Economics, Samara (2008)
13. Revina, S.N.: Economic systems and the role of the state. *Laws of Russia: Experience, Analysis, Practice* **11**, 106–112 (2007)

# Digital Solutions in the Strategy of Physical Culture and Sports Development



O. G. Savchenko, A. V. Filatova, and M. Vochozka

**Abstract** This article investigates some modernization issues of the sports industry through the use of digital solutions. The analysis was based on the Strategy for the development of physical culture and sports of the Russian Federation for the period up to 2030 and other modern studies on this topic. The study is aimed at the assessment of the role of digital solutions for the sports digitalization. To solve the research tasks, the methods as analysis, synthesis, comparison and extrapolation were used in this work. The information base of the research was the Strategy for the development of physical culture and sports of the Russian Federation for the period up to 2030, data from the strategic session “Strategy for the Development of Sports 2020”, research by Deloitte and SQN Agency. The main conclusions are that many of the proposed digital solutions can contribute to the realization of the tasks set in the strategy, and their use and implementation in the sports industry will significantly contribute to its development.

**Keywords** Digitalization · Digital solutions · Digital platforms · Sports · Development strategy · Physical culture

## 1 Introduction

In the autumn of 2020, the Strategy for the development of physical culture and sports of the Russian Federation for the period up to 2030 (hereinafter referred to as the strategy) was approved [1]. One of the principles of the strategy is to ensure the long-term operation of this strategy by using the achievements of scientific, technical

---

O. G. Savchenko (✉)  
Samara State University of Economics, Samara, Russia

A. V. Filatova  
Samara State Technical University, Samara, Russia

M. Vochozka  
Institute of Technology and Business in České Budějovice, České Budějovice, Czech Republic  
e-mail: [vochozka@mail.vstecb.cz](mailto:vochozka@mail.vstecb.cz)

and digital development in its implementation. A few decades ago, it was difficult to imagine how the available digital technologies could be used in the sports industry. After all, sports is absolutely not associated with digital achievements. Currently, digital technologies have reached such a level of progress that they can be used even in the most non-obvious situations. Thus, the strategy notes that nowadays digitalization is one of the key challenges in the field of physical culture and mass sports. At the same time, there is a lack of a single methodological information resource that would ensure the digitalization of the sports industry. One of the possibilities of digitalization is the use of digital platforms. This study aims to assess the role of digital solutions for the digitalization of sports.

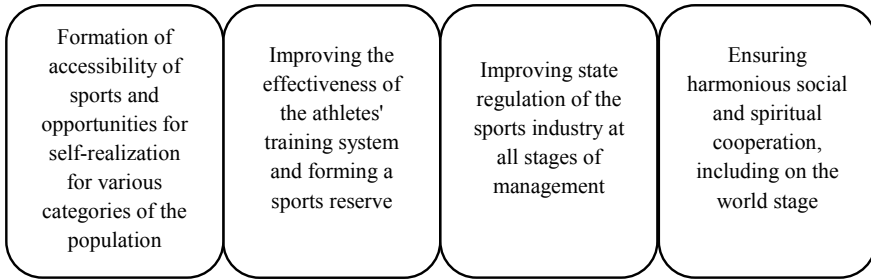
## 2 Methodology

The methodology of the study should correspond to its purpose and contribute to the realization of the set tasks. To achieve the research goal, the following tasks should be completed: to consider the main objectives of the state strategy for the period up to 2030, to show the available digital solutions in the sports industry, to identify possible intersections in the tasks and digital mechanisms of their implementation. Accordingly, the main methods used in this study are analysis, synthesis, comparison, and extrapolation. The text of the strategy [1], data from the strategic session “Strategy for the Development of Sports 2020” [7], research by Deloitte [2] and SQN Agency companies [9] on the topic of digital transformation of sports were analyzed. Data on available digital solutions were compared and extrapolated with the strategy objectives. Conclusions about the role of digital platforms in the digitalization of sports were synthesized.

## 3 Results

State strategies are in some way long-term plans for the state’s response to changes in the external environment. They can help to adapt a particular industry to emerging challenges. Traditionally, sport is one of the basic directions in the activities of the state. This is due to its codependency with other equally important aspects of society. For example, health, medicine, heritage forming, improving community cohesion, and much more. The strategy under consideration includes many tasks to improve the competitiveness of Russian sports [1]. In this regard, it was decided to group them according to a number of characteristics.

Figure 1 shows the four main classification features that summarize the narrow objectives outlined in the strategy. It can be noted that two features are more social in nature, one feature is organizational, and another is a correlation of several features at once: regulatory, financial, organizational, that is, it is of a general administrative nature. It is this classification that will be used for comparison with existing digital



**Fig. 1** Classification of strategy tasks. *Source* authors

solutions in the field of physical culture and sports. Prior to comparison, it is necessary to consider the priorities of digitalization through the prism of existing digital solutions. The first digital solution is to develop and implement digital platforms that would act as a consolidating mechanism. Such platforms should include management, organizational, information and acceleration services designed for the state, citizens and business entities.

The second digital solution is focused on the civil component of sports. It should include a national sports rating for users of digital resources. This will allow you to reward the most active participants and motivate them. It also notes the possibility of monitoring the health of citizens through the use of monitoring conducted using digital services. The third digital solution concerns the development of the competencies of sports industry participants. This is necessary for improving digital literacy, effective implementation of educational programs for training the personnel reserve [7]. Now it makes sense to compare the priorities and suggested digital solutions in the field of physical culture and sports.

As can be seen in Table 1, the suggested digital solutions correlate with the objectives set in the strategy. Individual digital solutions are able to solve several problems at once, which confirms the need for their implementation. Digital platforms for sports are one of such solutions. They can strongly affect the effectiveness of the developed strategy.

**Table 1** Priorities and digital solutions in the field of physical culture and sports

| Task group   | Proposed digital solutions |
|--|----------------------------|
| Formation of accessibility of sports and opportunities for self-realization for various categories of the population | First<br>Second            |
| Improving the effectiveness of the athletes' training system and forming a sports reserve                            | Third                      |
| Improving state regulation of the sports industry at all stages of management  | First                      |
| Ensuring harmonious social and spiritual cooperation, including on the world stage                                   | First<br>Second            |

*Source* authors



## 4 Discussion

According to a study by Deloitte, the digital transformation of the sports industry can significantly affect its development. The main consequences can be the expansion of content coverage, the attraction of sponsors, and the expansion of opportunities for inclusion of potential and real concerned parties [2]. SQN Agency considers the sports digitalization from the work perspective: interaction with clients organization, the business model organization and business processes that occur there. At the same time, they emphasize that digital consumption has a steady upward trend [9].

Speaking about digitalization in the field of sports, Stetsenko and Shirobakina note that modern society is developing to a greater extent taking into account the processes of digitalization [10]. Therefore, the realities of scientific and technological progress determine the need for digital modernization, including in the field of physical culture and sports. Petrov considers the relation between the sports digitalization and the major trends and the state requirements in the sphere of the information society formation [6]. According to Ryndin, nowadays, in Russia there is no more detailed and structured approach to determining the directions of digital transformation of the sports industry [8].

Milne considers the digital transformation of sports only in terms of the modernization of television innovations. [5] The issues of broadcasting and regulation of this activity, as well as methods and rules for the development of technologies in this industry, are discussed in detail. Other foreign authors note that the digitalization of sports should be considered from the point of view of the formation of a managerial business model, which requires rapid response to various transformations in the external environment and processing of a large volume of information in real time (that is, during a sports event) [3, 12]. A number of authors also position the digitalization of sports as a foundation for business, including from the point of view of the recreational cluster [4, 11].

Despite so many different approaches to explaining the need for digitalization of the sports industry, no one doubts the need for these events. From whatever point of view this issue is considered, the introduction of digital solutions will significantly contribute to the positive development of the situation. The implementation of the strategy adopted in Russia is not fully possible without the use of specific digital solutions in the work.

## 5 Conclusion

Often, government plans require specific industries to use modernization in order to achieve certain previously set goals. All purposes and objectives for their achievement are developed at the national level, as well as the principles and criteria for their implementation. In this study, the tasks of the strategy were analyzed, the activity of which extend to the sports industry of the country. Upon detailed consideration, it was

revealed that all the tasks set in the strategy can be divided into four classification criteria, which are social, organizational and general administrative. These tasks affect the activities of both individual citizens acting as subjects of sports relations, and organizations engaged in the training of sports personnel and the organization of sports events. It also notes the important role of state authorities, sponsors and other key stakeholders. At the moment, considering existing digital solutions, it is proposed to develop and implement digital platforms, national ratings for users of Internet resources, as well as measures to improve digital literacy and the level of qualification and training of sports reserves. Many of the proposed digital solutions can contribute to the solution of the tasks set. The analysis of research and literature sources confirmed the importance of this topic today. The analysis results allowed us to see at the same time that the digital transformation of the sports industry can also be considered from the entrepreneurial point of view. Therefore, we can conclude that the application of digital solutions in the sports industry will significantly contribute to its development.

## References

1. Decree of the Government of the Russian Federation No. 3081-r of November 24, 2020 On the Approval of the Strategy for the development of physical culture and sports in the Russian Federation for the period up to 2030. URL: <https://www.garant.ru/products/ipo/prime/doc/74866492/>. Accessed: 10.03.2021. (2020).
2. Deloitte: A whole new ball game: Navigating digital transformation in the sports industry. URL: <https://www2.deloitte.com/us/en/pages/technology-media-and-telecommunications/articles/digital-transformation-and-future-changes-in-sports-industry.html>. Accessed: 10.03.2021. (2017).
3. Gillooly, L., Anagnostopoulos, C., Chadwick, S.: Social media-based sponsorship activation—a typology of content. *Sport, Business and Management: An International Journal* 7(3), 293–314 (2017)
4. Hallmann, K., Giel, T.: eSports – Competitive sports or recreational activity? *Sport Management Review* 21(1), 14–20 (2018)
5. Milne, M.: *The transformation of television sport*. Palgrave Macmillan UK, London (2016)
6. Petrov, P.K.: Digital transformation of physical education and the sphere of physical culture and sports. In E.V. Khromina, E.T. Kolunina, V.I. Nazmutdinova, S.V. Dmitrieva, T.G. Kotova (Eds.), *Proceedings of the International Scientific and Practical Conference dedicated to the memory of Professor V. N. Zuev Strategy for the Formation of a Healthy Lifestyle of the Population by Means of Physical Culture and Sports: Current Challenges and Answers* (pp. 76–80). Tyumen: Vektor Book. (2020).
7. Ryndin, I.: The strategy of sports digitalization 2030. URL: <https://medium.com/digital-sports/d181d182d180d0b0d182d0b5d0b3d0b8d18f8f-d186d0b8d184d180d0bed0b2d0b8d0b7d0b0d186d0b8d0b8-d181d0bf-d0bed180d182d0b0-2030-fce10ef8d1c8>. Accessed: 10.03.2021. (2020).
8. Ryndin, I.: Digital Transformation of Sports - Part 2. URL: <https://medium.com/digital-sports/d186d0b8d184d180d0bed0b2d0b0d18f8f-d182d180d0b0d0bd-d181d184d0bed180d0bc-d0b0d186d0b8d18f-d181d0bf-d0bed180d182>

- [D0%B0-%D1%87%D0%B0%D1%81%D1%82%D1%8C-2-4a049c4b2730](https://doi.org/10.1080/10803549.2018.1484273). Accessed: 10.03.2021. (2018).
9. SQN Agency: The digital transformation of sport. URL: <https://sqn.agency/the-digital-disruption-of-sport/#:~:text=Digital%20transformation%20in%20sport%20is,current%20trends%20to%20remain%20competitive>. Accessed: 10.03.2021. (2019).
  10. Stetsenko, N.V., Shirobakina, E.A.: Digitalization in the field of physical culture and sports: The state of the issue. *Science and Sport: Current Trends* **22**(1), 35–40 (2019)
  11. Ströbel, T., Stieler, M., Stegmann, P.: Digital transformation in sport: The disruptive potential of digitalization for sport management research. URL: [https://www.emeraldgroupublishing.com/archived/products/journals/call\\_for\\_papers.htm%3Fid%3D8610](https://www.emeraldgroupublishing.com/archived/products/journals/call_for_papers.htm%3Fid%3D8610). Accessed: 10.03.2021. (2019).
  12. Wakefield, L.T., Bennett, G.: Sports fan experience: Electronic word-of-mouth in ephemeral social media. *Sport Management Review* **21**(2), 147–159 (2018)

# Vector of Digital Transformation of Economic Processes



E. S. Smolina, I. A. Tishchenko, and Z. V. Mkrtychan

**Abstract** The economy of the twenty-first century is changing in a digital direction. More and more we see the penetration of Internet technologies into the processes of life (companies, people). The more our lives are digitalized, the faster changes occur, new developments appear, and products are introduced. The speed of development of a digitalized modern economy is also influenced by many factors, one of which is the manifestation of favorable and unfavorable events that can lead to the onset of an economic crisis. In a crisis, it is important to quickly adapt and understand what needs to be done to move forward, what technologies to implement in order to be modern and necessary. The consequences for each country will be different, but the restrictions that have been imposed on small, medium and large businesses, as well as on the citizens of each country, can lead the world economy into a state of recession. The crisis of 2020 can increase the spread of digital technologies throughout the world. Based on the analysis of the adverse factors that have occurred and the study of expert opinions to determine the future of the economy, the vector of transformation and development is determined.

**Keywords** COVID-19 · Digitalization · Economy · Instability · Transformation

## 1 Introduction

The pace of development of the world economy in the modern world is influenced by various factors, including uncertainty and intermittent instability, including due to the cyclicity of the economy. In the first quarter of 2020, the world is facing a new threat

---

E. S. Smolina (✉)  
Samara State University of Economics, Samara, Russia

I. A. Tishchenko  
Rostov State University of Railway Transport, Rostov-on-Don, Russia  
e-mail: [tischcenkoirina@list.ru](mailto:tischcenkoirina@list.ru)

Z. V. Mkrtychan  
Orel State University, Orel, Russia

– the coronavirus pandemic. COVID-19, entering all countries, contributed to the suspension of ongoing production and distribution processes, as well as contributed to the shutdown of international communications. Restrictions in connection with the spread of coronavirus can cause significant damage to the economies of developed and developing countries and lead to a global economic crisis. At the same time, the spread of COVID-19 should not be recognized as the root cause of the economic crisis, the pandemic becomes only a trigger in such situation.

Things that we see throughout 2020 on the global commodity and financial markets prove the cyclicity of economic development. Crises occur with a certain frequency every seven to ten years, the coronavirus acted as a “trigger”, being surprising and massive. During COVID-19, the global economy faced serious adverse events. If we highlight some of the negative aspects that have currently affected the economic performance of countries and individual regions and will continue to be adversely affected for some time in the future until the economy recovers, then among them are:

- decrease in production activity;
- lower oil prices (as a result of lower oil demand and lower production activity);
- decrease in the solvency of the population and companies;
- reduction of consumption;
- increase in the number of unemployed, social tension;
- falling of quoted shares on major markets;
- reduction of the service sector and restriction of tourism.

If economic activity declines, GDP will fall.

Russian economists believe that the fall in Russia’s GDP in scale can be comparable to what it was in the 90 s of the twentieth century (in 1992, GDP fell by 14.5%, a year later – by 8.7%, a year later – by 12.6%), the decline now can be from 10 to 20% [8]. This means that Russia have to look for ways to develop its economy in the new conditions. With these adverse consequences, it is necessary to notice the opposite conditionally positive trend (conditional because there are adverse consequences) – the digital development of countries, including Russia. The digitalization of processes and things can be recognized as a trend in the future development of the economy. The spread of the coronavirus leads to an increase in the role of remote activity: the sale of products, the provision of various services, the management of the company and personnel, and so on. The mass transition to digital technologies increases their importance and accelerates the spread of digitalization.

## 2 Methodology

The fifth issue of the National Intelligence Council report presented global trends in the 2030 outlook [6]. Among the factors, groups were identified: the most likely, unexpected, and critical, which are the most difficult to predict and analyze. Among the unfavorable destructive factors, severe pandemics, abrupt climate changes, crises

of the strongest countries, and wars were highlighted [6]. Already in 2020, we faced a pandemic declared as a result of the spread of the coronavirus, and we see what impact it has on the economy. We can not say that this pandemic was severe, but it is worth noting the high rate of spread of the virus. One of the reasons for the rapid spread of the virus and information about it in the current time in the countries of the world is the strengthening of globalization, the development of technologies, free movement (unhindered international tourism). Thus, globalization and its accompanying processes, the high speed of information dissemination, and the increased availability of movement have become one of the reasons for increasing attention to the current situation, as well as the reason for realizing the need for technology development. It is noted that now the high-tech market has entered a recession caused by the coronavirus pandemic. According to an optimistic scenario, it is possible to recover in 2020, according to a negative scenario, the high-tech market will recover only after 2022 [2]. At the same time, the ability to develop digital innovations by 2023 can be included in the list of competitive advantages of companies [5]. The opinions of experts presented in news feeds, statements about the new world contain the development of remote processes, the decline in consumption (transition to conscious consumption), remote employment [1], globalization, the growing speed of changes, digitalization.

### 3 Results

The economic crisis that occurred in 2020 is associated with the spread of COVID-19 and the adoption of restrictive measures by countries to reduce cases of the disease. But it is impossible to call the coronavirus the determining cause of the crisis, since already in 2019, news feeds predicted the global economic crisis in 2020 for a number of reasons: the trade war between the United States and China, “bubbles” on the largest stock markets, a slowdown in production growth in the global economy [7]. The coronavirus pandemic actually joined the above-mentioned adverse factors of the deterioration of the global economy in 2020. As a result of the spread of COVID-19 in different countries and the establishment of restrictions, a high level of damage to the economy in the future two years is predicted. Special manifestations of the crisis phenomena of 2020 fall on the economies of developing countries. We see how exchange rates change, for example, in Russia, with the onset of the coronavirus, the ruble exchange rate against the dollar showed a weakening of up to 15%, as there was a drop in Russian stock prices (although it is important to note that in general, the shares of companies in other countries also showed a drop).

The coronavirus has also hit the economies of developed countries. The United States – the largest power in the world – is increasing its public debt, in 2020 it increased from 3 trillion dollars and for the first time exceeded the mark of 26 trillion dollars [9]. The reasons for the significant increase in the debt burden are the high costs of the state to eliminate the consequences of the coronavirus. Production stoppages and the economic downturn caused the increase in the number of

unemployed. The deterioration of the US economic situation may worsen the global economic crisis.

Despite the predicted adverse consequences (of a destructive nature), it is necessary to note the positive side of the crisis (creative). The crisis is a factor of development, we should look for ways to adapt, survive in the current conditions and ways to increase competitiveness, that is, we need to determine what is expected in the future and what will be necessary. The predominance of the commodity economy makes countries vulnerable, and it is necessary to focus on the IT development of most areas and industries. New conditions set the requirements, there is a digital transformation caused by the development of Internet technologies, as well as the creation of more advanced technological products.

The suspension of production processes, disruption of sales, restrictions on the work of offices, offline stores brought losses to both the largest corporations and smaller business representatives. Significant losses were incurred by representatives of the restaurant business and public catering, entertainment, tourism, and air transportation. Companies are faced with the need to transfer communications with staff, consumers, and suppliers online.

The products of technological development are becoming an integral part of the economic life of all countries, and Russia is no exception. We need to increase the share of the digital economy in the country's GDP. Digitalization of the economy can increase GDP. Banks are examples of successful technology development in Russia. Recently, the banking sector has been undergoing a digital transformation. More and more services are available online, and the format of the services is changing.

Now it is worth thinking about how to digitalize the education sector, training services can also be provided online, this can increase the flow of customers, which will bring additional income. There is a potential for digitalization, as well as robotization and other areas of life.

With the development of new technologies, the digitalization of the economy and business, we should not forget about the possible risks, so we should be engaged in:

- search for new niches, sales markets;
- cost reduction;
- increase customer loyalty.

Online development requires the introduction of new technologies in the company and the involvement of specialists in this field. Perhaps in the future 5 years, each company, whether trading or manufacturing, will be “digitalized” by the main processes, for example, it is possible to implement automated ready-made solutions for financial management, procurement, providing the main processes, as well as a financial management system. In addition, companies can develop their own software products to meet their own needs and the needs of customers.

## 4 Discussion

Issues of digital transformation of the economy in Russia and the world are published in various analytical and research materials. On a quarterly basis, the Digital Economy organization presents a digest of research and publications [3]. In the process of implementing digital transformation, every element of the corporate structure is important. With the development of digital technologies in companies, there is a need for specialized knowledge, which requires the development of digital competencies of company personnel or the involvement of new employees (or partners) [10]. There is an opinion that by 2030, every successful company will independently develop software for digital transformation [4].

The online sales channel will be developed more and more. In the pandemic, we saw that everything is translated into an online format, we can spend money without leaving home and order everything from appliances to food, from clothing to other goods with home delivery. Sales are the most important condition for maintaining the country's economy, because inpayments provide the revenue part of the budgets, which is redistributed to mandatory payments and needs. Thus, the development of the online space will have an important impact on the economy of countries, in particular, Russia.

## 5 Conclusion

As a result of the coronavirus pandemic, we are facing a new economic crisis, increasing inequality between rich and poor, and rising unemployment. Despite the significant losses of the global economy and the economies of individual countries, we should understand in what we can be successful in the future, what industries we need to rely on and where to invest the available resources. The trend towards technology development will undoubtedly increasingly penetrate developing countries. Thus, the coronavirus is becoming a driver for the development of online services, as well as increasing the digitalization of companies' processes. In the era of digital transformation, it is necessary to move away from the interpretation of the main goal of activity from maximizing profit to maximizing utility, that is, maximizing the satisfaction of needs from the goods sold and purchased.

## References

1. Alabuzhin, I., Gurova, T., Denisenko, K., Mamedyarov, Z., Skorobogaty, P.: Big brother won't cure you. URL: <https://expert.ru/expert/2020/15/bolshoj-brat-ne-vilechit-tebya/>. Accessed: 01.03.2021. (2020).
2. Bartels, A.: Forecasting in a time of uncertainty: Some guidance on the outlook for tech markets in different countries in the pandemic. URL: <https://go.forrester.com/blogs/foreca>



- sting-in-a-time-of-uncertainty-some-guidance-on-the-outlook-for-tech-markets-in-different-countries-in-the-pandemic/. Accessed: 01.03.2021. (2020).
3. Data Economy Russia 2024: Key studies and publications on digital transformation. URL: <https://digest.data-economy.ru/>. Accessed: 01.03.2021. (2020).
  4. Fenwick, N.: 2020: The year of digital products. URL: <https://go.forrester.com/blogs/2020-the-year-of-digital-products/>. Accessed: 01.03.2021. (2020).
  5. IDC: How vendors succeed in the growing digital economy. URL: <https://blogs.idc.com/2020/03/23/how-vendors-succeed-in-the-growing-digital-economy/>. Accessed: 01.03.2021. (2020).
  6. National Intelligence Council: Global Trends 2030: Alternative worlds. URL: [http://www.nki.brics.ru/system/asset\\_publications/data/53c7/b3a1/676c/7631/400a/0000/original/Global-Trends-2030-RUS.pdf?1408971903](http://www.nki.brics.ru/system/asset_publications/data/53c7/b3a1/676c/7631/400a/0000/original/Global-Trends-2030-RUS.pdf?1408971903). Accessed: 01.03.2021. (2012).
  7. Potapov, A.: What is the probability of a crisis in the global economy in 2020? URL: <https://www.vedomosti.ru/economics/blogs/2019/12/03/817756-veroyatnost-kri zisa-2020>. Accessed: 01.03.2021. (2019).
  8. Samedova, E.: Five shocks from the coronavirus. What awaits the Russian economy after the pandemic? URL: <https://www.dw.com/ru/%D0%BF%D1%8F%D1%82%D1%8C-%D1%88%D0%BE%D0%BA%D0%BE%D0%B2-%D0%BE%D1%82-%D0%BA%D0%BE%D1%80%D0%BE%D0%BD%D0%B0%D0%B2%D0%B8%D1%80%D1%83%D1%81%D0%B0-%D1%87%D1%82%D0%BE-%D0%B6%D0%B4%D0%B5%D1%82-%D1%8D%D0%BA%D0%BE%D0%BD%D0%BE%D0%BC%D0%B8%D0%BA%D1%83-%D1%80%D0%BE%D1%81%D1%81%D0%B8%D0%B8-%D0%BF%D0%BE%D1%81%D0%BB%D0%B5-%D0%BF%D0%B0%D0%BD%D0%B4%D0%B5%D0%BC%D0%B8%D0%B8/a-53057092>. Accessed: 01.03.2021. (2020).
  9. Tsegoev, V., Svinova, E.: The money gap. The US national debt has reached 26 trillion dollars for the first time. URL: <https://ru.rt.com/g60x>. Accessed: 01.03.2021. (2020).
  10. Wiles, J.: It's time for every function to hone strategy and execution. URL: <https://www.gartner.com/smarterwithgartner/its-time-for-every-function-to-hone-strategy-and-execution/>. Accessed: 01.03.2021. (2020).

# Digitalization as the Main Development Condition of the Samara Region



O. V. Trubetskaya

**Abstract** The study considers the main provisions of sustainable progress of the country through the factors of development of regions. Using the example of the Samara region, it is shown that digital technologies can significantly affect the economic and social state of the region. Digitalization provides endless opportunities to perfect the efficiency of all folk economic processes, rises the competitive power of the region. The spheres of the economy, where most of digital projects are being implemented in the Samara region, are identified. The study considers specific information systems that improve the excellence of life of the people and help overcome threats to the region's development, as well as the expected economic effect from the introduction of digital projects.

**Keywords** Digitalization · Digital economy · Development strategy · Sustainable development

## 1 Introduction

The rapid economic growth in the twentieth century, caused by scientific and technological progress, and the growth of the welfare of society, have led to the emergence of crises, both economic and political, the aggravation of environmental problems, which society has not been able to overcome until now. All the above problems cause the need for transformations and the search for new strategies to develop society. The main tasks are to improve the well-being of society, protect and preserve the environment, and care for future generations. One of the solutions can be digital technologies, which currently exist in all spheres of activity of economic entities. The use of digital technologies rises the efficiency of all processes taking place in society, but at the same time requires new strategies to develop territories. The digitalization of regions implies a fundamental change in their economic activities, business models and management decisions. The transformation will also affect social and political

---

O. V. Trubetskaya (✉)  
Samara State University of Economics, Samara, Russia

spheres, giving priority to the theoretical justification and practical implementation of the digital concept of sustainable development of the country and its regions.

## 2 Methodology

The construct of sustainable growth presupposes such regulation of the life of society so that future generations can live in the accessible and high-quality environment. Even though the sustainable development strategy was adopted in the Russian Federation a lengthy time ago, it was not feasible to carry out the necessary economy modernization. One of the versions for deciding this problem was the implementation of a large-scale project—digitalization of the economy. The digital environment presupposes the provision of equal opportunities and conditions for all territories of the country. The competitiveness and investment attractiveness of both the region and the country depend on the extent to which the regions will use the digital potential. Many regions consider the development of the digital economy through information society with a unifying block based on information and telecommunications infrastructure. The regions of the Russian Federation in general and the Samara region mark education, health care, “smart cities” and public administration as priority areas for the utilize of digital technologies.

## 3 Results

The transition of the Russian Federation from the export-raw-material model to the innovative one presupposes the development of the appropriate strategy aimed at creating a socially-oriented state with a dynamically developing economy. To achieve this result, it is necessary to solve a number of main tasks: to increase the competitive of the Russian economy, to improve on the investment climate in the country, to reduce the level of differentiation of incomes of the population, to eliminate a number of institutional traps that arose during the period of Russia’s transition to the market economy, to solve environmental problems, and to increase the efficiency of public administration. All the above tasks also apply to individual regions of Russia.

The strategic purposes of the socio-economic extension of the Samara area for the period up to 2030 are:

- ensure economic growth and increase the competitiveness of the economy of the Samara area,
- improve the high living of the population of the Samara area,
- creasing the productivity of the Government of the Samara area [9].

Achieving these goals need economy modernization, digitalization of all spheres of life in the region, to ensure a new quality of economic growth in the Samara

region. Strategies for sustainable growth of the area, in terms of the digital economy, can be considered in the following aspects: [5]

- use of digital technologies;
- plan state development programs both in the country and in the region in particular;
- distribute existing IT solutions to every walk of life.

The effectiveness of the diffusion and development of digital technologies is influenced by the existing socio-economic surroundings of the region. The state of the surroundings is influenced by factors that can be divided into 4 large groups: economic, social, environmental and institutional. Table 1 shows the factors contributing to the growth of the Samara area and hindering it.

The implementation of digital projects in the Samara area is shown in Fig. 1. Most of information projects are implemented in the field of public administration, housing and communal services and construction, and healthcare. The digitalization of the social protection industry is only 12%, ecology and education—3% and 6%, respectively. IT technologies are poorly implemented in the transport industry.

To overcome the threats to the regional development and improve the quality of life in the Samara area in 2019–2020, several digital projects are being implemented.

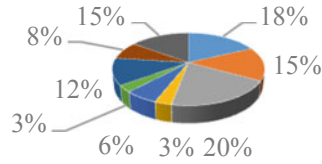
So, in 2019, the Digital Sport Information System appeared, which implies the creation of publicly accessible electronic sports facilities and physical culture organizations using geo-information technologies [6]. This system will allow you to receive information about the results of Samara athletes at sports events, about the national teams of the Samara area, about sports achievements and the results

**Table 1** Factors stimulating and hindering the socio-economic growth of the Samara area

| Economic development                                      | Social development   | Environmental development  | Institutional development                       |
|---|--|--|---|
| Incentive factors   |  |  |   |
| Diversified economy                                       | Improved availability and quality of health care           | Favorable natural and climatic conditions                        | Favorable business climate                      |
| Available resources                                       | Increased availability of sports activities                | Available recreational resources                                 | Simplified bureaucratic procedures, inspections |
| Favorable geographic location                             |  | Environmental Protection Program                                 |   |
| Threat factors  |  |  |   |
| Low investment activity                                   | Insufficient level of development of social infrastructure | Insufficient capacities to clean emissions of harmful substances | Representation of power                         |
| Bottlenecks in the transport and logistics infrastructure | Social problems (poverty, drug addiction)                  | Risks of man-made disasters                                      | Legal environment                               |

Source author based on [10]

**Fig. 1** Information systems of the Samara region.  
Source: author



- Housing and communal services and construction
- Health care
- Public administration
- Transport
- Education
- Ecology
- Social protection
- Information technology and security
- Other services

of athletes' performances. Also, the system will allow to summarize information about sports facilities, about available sports titles and sports categories of the population in the region. In 2020, the region implemented the state information system "Labor and Employment", which assists citizens in finding suitable work, and employers in selecting necessary workers; provides information about the labor market in the Samara region; provides vocational guidance to the population [6]. It is also planned to organize psychological support for unemployed citizens, organize temporary employment and paid public works, consider forms of active policy of promoting employment to the population (temporary employment of citizens experiencing difficulties looking for a job, minors aged 14–18, citizens aged 18–20 from among graduates of primary and secondary vocational education institutions looking for work for the first time), automatic accrual and payment of unemployment benefits, scholarships and other payments.

The system provides for maintaining a databank of entrepreneurs, accounting sojourns and consultations of entrepreneurs, bookkeeping quota jobs, information on concluded contracts, vacancies, information on unemployed workers. There will be an inter-territorial exchange of vacancies, automatic state and departmental statistical forms. To create comfortable and safe living conditions, introduce innovations in the housing and transport sector, and environmental safety in three cities of the Samara Region, the implementation of the Smart City project has begun.

It is planned to implement measures to ensure energy-efficient urban lighting, to unite resource-supplying organizations and management companies with a single dispatch center for the fastest possible work in public utilities, and "smart" waste management in cities. To solve environmental problems, it is planned to install mobile climate control systems that control the level of groundwater, air pollution, the introduction of solar panels, wind generators to reduce the load on energy networks during

peaks. The expected effects of adopted digitalization measures in the Samara area include: [9]

- increase the share of households with broadband Internet access to 97.5%;
- increase the number of IT specialists up to 7.5 thousand people a year;
- increasing the level of Internet penetration in the Samara region up to 90%;
- attract investments in urban infrastructure based on the concept of “smart city”;
- ensure information security;
- increase the gross regional product by 1.5 times;
- increase tax revenues to budgets of all levels.

## 4 Discussion

Many scientists pay great attention to digital technologies at the global and at regional levels [1, 7–9]. Thus, Schwab examines technological revolutions in the historical context. It identifies key technologies and examines their impact on government, business, and society. For digital change to be successful, cooperation between actors in regions, economic sectors and industries is necessary [10]. A few economists draw attention to the growth of cybercrime and widening territorial gaps in access to information and communication technologies, the problems of rising unemployment and the loss of economic resources [2, 3]. Other researchers draw attention to the fact that a well-built digitalization strategy can increase productivity, mitigate environmental problems of society, and improve the quality of life of the population in certain territories [1, 7, 8]. Digital technologies can change business strategies, improve the institutional environment, and simplify intra-firm relationships. Russian researchers believe that digitalization can modernize Russian industry and overcome the accumulated environmental and social problems [4].

## 5 Conclusion

Thus, the implementation of digital programs in the Samara region makes it possible to decide the major important tasks of increasing the regional sustainability: strengthen the material and technical base, develop infrastructure, increase the innovative potential. Thanks to implemented smart technologies, it is possible to significantly improve the high living of the region’s people and economic conditions. New technology standards are driving the development of high-performing jobs. They preserve and improve the ecological environment. The introduction of digital technologies into the sphere of society administration increases the publicity of activities and introduces new projects for wide discussion. A promising direction for the further development of digital technologies can be the development of mobile applications for the entrepreneurial sector operating in the least covered with information technology industries in the Samara region. Also, further development

processes of the territory within the framework of digitalization can be carried out using cloud technologies.

## References

1. George, G., Merrill, R.K., Schillebeeckx, S.: Digital sustainability and entrepreneurship: How digital innovations are helping tackle climate change and sustainable development. *Entrepreneurship Theory and Practice*. URL: <https://journals.sagepub.com/doi/full/https://doi.org/10.1177/1042258719899425>. Accessed 15 Mar 2021 (2020)
2. Hodgson, C.: Can the digital revolution be environmentally sustainable? *The Guardian*. URL: <https://www.theguardian.com/global/blog/2015/nov/13/digital-revolution-environmental-sustainable>. Accessed 09 Mar 2021 (2015)
3. Irfan, U.: Bitcoin's price spike is driving an extraordinary surge in energy use. *Vox Media*. URL: <https://www.vox.com/energy-and-environment/2017/12/2/16724786/bitcoin-mining-energy-electricity>. Accessed 11 Mar 2021 (2017)
4. Martynenko, T.S., Vershinina, I.A.: Digital economy: The possibility of sustainable development and overcoming social and environmental inequality in Russia. *Revista Espacios* **39**(44), 12 (2018)
5. Materikina, A.: Transformation of the strategy for sustainable socio-economic development of the region in the digital economy. *Bulletin of the Academy of Knowledge* **40**(5), 279–282 (2020)
6. Ministry of Economic Development and Investments of the Samara region: State programs of the Samara region. URL: <https://economy.samregion.ru/programmy/gps/perechen-gosudarstvennykh-programm>. Accessed 11 Mar 2021
7. Ordieres-Meré, J., Remón, T., Rubio, J.: Digitalization: An opportunity for contributing to sustainability from knowledge. *Creation Sustainability* **12**(4), 1460 (2020)
8. Richter, C., Kraus, S., Brem, A., Durst, S., Giselbrecht, C.: Digital entrepreneurship: Innovative business models for the sharing economy. *Creativity and Innovation Management* **26**(3), 300–310 (2017)
9. Schwab, K.: *Fourth industrial revolution*. Crown Business, New York (2017)
10. Strategy of the Socio-economic Development of the Samara Region for the Period up to 2030. URL: [https://economy.samregion.ru/upload/iblock/6ff/Prezentatsiya-Strategii-SO\\_2030.pdf](https://economy.samregion.ru/upload/iblock/6ff/Prezentatsiya-Strategii-SO_2030.pdf). Accessed 13 Mar 2021 (2020)

# To the Question of Digital Transformation of Local Government Bodies



A. G. Khabibullin, V. K. Barchukov, and A. A. Petrogradskaya

**Abstract** The authors attempt to analyze some issues concerning the digitalization of municipal management. The author indicates what problems exist in this area at the present time. At the same time, progress has been made in the digital transformation of local authorities. It is utterly important that the “e-municipality” and “smart city” technology are noted. Thanks to modern digital technologies, it has become possible to effectively use large amounts of data, so that it leads to making informed management decisions to optimize the use of all types of resources. The authors appeal that in the current digital era, when modern information technologies have penetrated almost all spheres of life, municipal authorities should introduce all the best technological solutions into their activities, since it is thanks to them that the quality, availability, and clarity of their services will increase the effectiveness of local government.

**Keywords** Digital technologies · Digitalization of municipal government · Electronic municipality · Local government · Smart city

## 1 Introduction

XXI century—the century of information technology. The ubiquity of the Internet, the constant development of digital technologies have changed our society, penetrated into all spheres of life: business, education. By now, we can say that we live in a digital age. Digitalization of various spheres of society is not a fashion or a temporary phenomenon; it has become a necessity and an indicator of the success and modernity of development. Digitalization came to politics, state and municipal administration last of all. Initially, the authorities of various levels did not consider it important to actively introduce modern digital technologies into their activities, did not see them

---

A. G. Khabibullin · V. K. Barchukov  
Lomonosov Moscow State University, Moscow, Russia

A. A. Petrogradskaya (✉)  
Samara State University of Economics, Samara, Russia



as useful and necessary. At the same time, thanks to modern digital technologies, it became possible effectively obtain and process huge amounts of data, that leads to making informed management decisions to optimize managing resources [1]. In this regard, it has now become obvious to everyone that the future lies precisely with information technologies, that state authorities and local self-government bodies need to change in order to work more efficiently, in order to ensure maximum openness and transparency of their activities.

## 2 Methodology

The methodological basis of the article is formed on the basis of philosophical and general scientific principles (objectivity, consistency, comprehensiveness, unity of theory and practice). The study is based on the methodological approaches outlined by scholars both foreign and Russian that overview the problems of digitalization of local self-government (LSG) bodies. The general scientific dialectical method of cognition was used as the main method. The most important method for analyzing legal problems is the analysis of regulatory legal acts and scientific literature on the research topic. The general scientific dialectical method of cognition was used as the main method. The most important method of analyzing legal problems is the analysis of normative legal acts and research papers on digitalization of local governments. Results of the study presented in the article are achieved through the complex application of the method of formal logic, analysis, synthesis, and others.

## 3 Results

This research is rather relevant due to the fact that nowadays local government system is not yet fully digitalized and synced with modern realities, however transformation is on course and gradually spreads out. There are issues that need to be resolved and topics discussed, therefore legal science must jump in and carry the way. One of the main problems of digitalization of local self-government is their clearly insufficient funding. An analysis of the norms of Federal Law of 06.10.2003 N 131-FZ “On the general principles of organizing local self-government in the Russian Federation” showed that among the areas of activity and areas of responsibility in the law no sign of expressing the need to technically advance the activities of local self-government bodies is expressed [2]. As a result, at present, the overwhelming number of municipalities finance the introduction of information technologies into their activities on a leftover basis. In addition, there is a significant gap between the level of informatization of large cities and rural settlements [3].

It is also important to discuss financial cuts and underbudgeting as that affects digitalization greatly. There is an issue of disbalance between financing local governments and state programs of digitalization and the gap is wide and not favorable

to locals. As a result, municipalities rarely participate in various federal targeted digitalization programs that are implemented at the state level.

Another major problem hindering the successful digital transformation of local self-government bodies is the uneven development of broadband communication channels, as a result of which many remote rural municipalities, especially in the non-central regions of Russia (northern and far eastern regions), do not have the opportunity to fully use digital resources in general, and many electronic services in the field of municipal government, in particular [4].

An important problem is that local staff lacks highly qualified personnel who could at the proper level carry out the process of digitalization of the activities of local self-government bodies. It is not enough to find funds and purchase the necessary equipment, it is necessary to have specialists who would have a sufficient level of qualifications and experience in order to introduce digital technologies into the activities of municipalities to increase the efficiency of their functioning. Unfortunately, this problem occurs not only in rural settlements, but also in many large cities. And here we again come back to the problem of financing, since highly qualified IT-specialists, as a rule, have a level of remuneration for their labor that is significantly higher than what the municipality can offer.

The next problem is the one-way interaction of municipalities with state authorities and state information systems (SIS). This one-sidedness is expressed in the fact that LSG bodies provide state authorities and SIS with all the necessary information, without receiving anything in response that would help them improve the quality of municipal governance [5].

There is no organizational and methodological support in local governments therefore technical advancements cannot be either used or put to practice in local self-government bodies. By organizational and methodological support, we mean standard developments, design solutions for the digitalization of municipal management. Large municipalities, which have the capacity and means to attract highly qualified specialists to the development of their own municipal information system, do not strive to ensure that such developments in the future become available to those local authorities that do not manage large budgets and are inherently small.

One must remember that formation of a number of standard solutions that were supposed to contribute to the successful digitalization of local self-government bodies has been brought up on state level, however, the resulting developments were more focused on providing SIS information at municipal levels, and did not account the interests and specifics of a particular municipality [6].

## 4 Discussion

Unfortunately, these problems are not the only ones. As the analysis of practice shows, there are many more of them. At the same time, one cannot fail to note a number of successes in the digital transformation of local governments. So, municipal management of “electronic municipality” involves the introduction of “paperless”

technologies into the activities of municipal bodies and officials, which are electronic systems of document circulation and business circulation. Thanks to the “electronic municipality”, local governments have the opportunity to significantly improve the quality, accessibility, transparency, openness of services provided to citizens [7].

Another example of how technology can easily evolve local life is the concept of a so-called smart city. It implies the introduction of new technologies into the urban environment, the combination of all the most important elements by combining them into one large well-established system of integrative interaction of communication and information technologies [8]. The main elements of the analyzed technology include: service for involving citizens in solving urban development issues; platform “digital twin of the city”; smart housing and communal services; urban environment; urban transport; public safety; environmental safety [9].

Among the main goals of introducing the “smart city” technology into the practice of municipalities, one should note how of city funds and space can be used much more efficiently in addition to life conditions improving. In addition, the organization of urban infrastructure using the “smart city” technology allows to bring municipal services to a whole new level of efficiency. Also, to date, automated information systems (AIS) have been developed and successfully introduced into the municipal administration, as well as information resources regarding tasks of local origins. Rather soon these will be standard solutions that can be used by all or almost all municipalities. The importance of developing standard solutions is largely due to the fact that a significant number of municipalities, due to lack of adequate funding, cannot afford individual solutions. And, as the analysis of the practice of digitalization of local self-government bodies has shown, it is most successfully carried out in large cities. It is in them that specialized divisions are formed and operate, the main purpose of which is to solve various issues of digitalization of municipal management; it is in them that highly qualified specialists develop AIS, which maximally take into account the interests and peculiarities of the functioning of a particular municipality [10].

An analysis of the policy that the state adhered on modernizing municipal authorities digitally showed its extreme inconsistency [11]. In this regard, Gubov writes the following: “The priorities were constantly changing: “electronic state, government and municipality”; electronic digital signature and “trusted third party”; “Information society”; provision of state and municipal services in electronic form and “interdepartmental information interaction in electronic form” [12, p. 2]. Thus, it is clear what all these events united was the participation of local governments on a voluntary-compulsory basis. The researcher also notes that 90% of municipalities, due to the lack of adequate funding, as well as the necessary specialists, simply cannot take part in solving such ambitious tasks of the state. Such volatility of the state, its throwing, the lack of an effective regulatory framework, proper funding and the necessary methodological support for the digital transformation processes of both municipal and public administration is largely the reason that the successful introduction of information resources and technologies into the sphere of activities of local self-government bodies is observed only in a number of large cities.

## 5 Conclusion

So, the digital transformation of local governments is a change based on technical and digital rebirth of local bodies and improvement of quality of their administration. The digitalization of local self-government bodies, first of all, is “in the transition from the use of technologies to support the processes in government bodies to the use of technologies to form the results of municipal governance” [13, p. 71]. Arguing about the need for digital transformation of local self-government bodies, it is important to understand that the presence of computers and other office equipment, access to the Internet, SIS and other information resources does not mean that the informatization of municipal administration has been completed. The successful use of existing and development of new technological solutions that center on local needs and effect digital transformation. So, success can be achieved through a thought out process of working to improve management on local level with the latest information technologies. Now more than ever the slogan “digitalization is not in national projects, but in the minds” is relevant [14, p. 244]. The digital transformation of local governments must begin with the transformation of the mindset of municipal employees. It is necessary to understand that the successful solution of the tasks facing the municipal government nowadays is possible only if a systematic approach to digital resources, their use to increase the productivity of municipal employees, increase the competitiveness of the municipality and its social-economic development in general. Digitalization is not a goal, but a necessary tool in modern realities for the effective development of a municipality.

## References

1. Sidorenko, E.L., Bartsits, I.N., Khisamova, Z.I.: The effectiveness of digital public administration: Theoretical and applied aspects. *Public Adm. Issues* **2**, 93–114 (2019)
2. Federal Law of 06.10.2003 N 131-FZ: On the general principles of organizing local self-government in the Russian Federation. URL: [http://www.consultant.ru/document/cons\\_doc\\_LAW\\_51038/](http://www.consultant.ru/document/cons_doc_LAW_51038/). Accessed 14 Feb 2021 (2003)
3. Petrova, T.A.: Local self-government in modern realities. *Vestnik of Tomsk State University of Econ.* **39**, 174–181 (2017)
4. Nevzorova, A.V.: Digitalization of the activities of local governments in the Russian Federation: problems and prospects. In: Zabelina, E.P., Milkina, I.V. (eds.) *Proceedings of the IV International Scientific and Practical Conference The Role of Local Self-Government in the Development of the State at the Present Stage. Local Government Today: A Collection of Student Research Papers*, pp. 237–240. State University of Management, Moscow (2019)
5. Babaeva, D.G.: Digitalization of the activities of local self-government bodies. *Bull. Sci.* **3(5(26))**, 13–15 (2020)
6. Barinov, V.A., Gretchenko, A.I.: Development of local self-government in large cities in the context of digitalization. *Scientific and Analytical Journal Science and Practice of the Russian University of Economics named of G.V. Plekhanov*, **12(2(38))**, 44–55 (2020)
7. Styrin, E.M., Dmitrieva, N.E., Sinyatullina, LKh.: State digital platforms: From concept to implementation. *Public Adm. Issues* **4**, 31–60 (2019)

8. Saratov State Technical University named after Yuri Gagarin: The social and economic institute hosted the “Benzman Readings”. URL: [https://www.sstu.ru/news/sei-stali-uchastnikami-mezh-dunarodnoy-nauchno-prakticheskoy-konferentsii.html?sphrase\\_id=702190](https://www.sstu.ru/news/sei-stali-uchastnikami-mezh-dunarodnoy-nauchno-prakticheskoy-konferentsii.html?sphrase_id=702190). Accessed: 15 Mar 2021 (2020)
9. Griбанова, G.I., Vulfovich, R.M.: Security of a modern city as a complex problem. *Public Adm. Issues* **5**, 83–100 (2017)
10. Sidorov, A.A., Lazareva, N.V., Starun, N.V.: Digital transformation of municipal management under sustainable development. In: Ashmarina, S., Vochozka, M., Mantulenko, V. (eds.) *Digital Age: Chances, Challenges and Future. Lecture Notes in Networks and Systems*, vol. 84, pp. 165–171. Springer, Cham (2020)
11. Efremov, A.A.: Towards the formation of a mechanism for identifying and eliminating systemic legal restrictions on the digitalization of public administration. *Public Adm. Issues* **4**, 59–83 (2020)
12. Gubov, AYu.: Ways of digital transformation of local self-government bodies. *Method* **3**, 2–5 (2019)
13. Dobrolyubova, E.I.: Governance by results in the age of digital transformation: An overview of foreign experience and prospects for Russia. *Public Adm. Issues* **4**, 70–93 (2018)
14. Yuzhakov, V.N.: On the issue of digital transformation of public administration (Slobotchikov, O.N., Kozlov S.D., Shatokhin, M.V., Popova, S.A., Goncharenko, A.N. The number and power: Digital technologies in public administration. *NANO VO “IMC”*)

# Strategy for Public Finance Development Under the Digital Transformation of Russian Economy



L. N. Mulendeeva

**Abstract** Currently digital transformation of the economy has been taking place in Russia. The article analyzes the problem of public finance development under that context. The needs of the information society and the improvement of IT technologies should determine the strategic goals of budget planning in our country. The main task of the study is to identify the problems of digital transformation and to find possible solutions to them based on the effective use of public financial resources. For example, domestic IT companies need state financial support to carry out their technological developments. The state is directly interested in this, since at present digital transformation is carried out on the foreign technological platforms. There is an acute need to reform the education system, aimed at training highly qualified specialists in the field of IT. The expansion of the public services range provided to the population also requires state financial support. Thus, there is an obvious necessity to improve the public finance strategy that could meet the requirements of the strategy for the digital economy development in Russia.

**Keywords** Budget expenditures · Digital economy · Digital transformation · IT-technologies · Public finance

## 1 Introduction

The state and the society are facing new demands from the digital transformation of the Russian economy, which is currently being observed. Undoubtedly, modern digital technologies contribute to the growth of the citizens' standard of living, the development of the economy and the social sphere. However, negative effects from the introduction of digital technologies are observed as well. For example, entire market segments of the “pre-digital” era disappear, which provokes an increase in unemployment. Today, we are witnessing systemic shifts that affect the state of the entire economic system in the state. These shifts also affected the sphere of public

---

L. N. Mulendeeva (✉)  
Samara State University of Economics, Samara, Russia

finance. Budget revenues are planned and funds are spent against the background of the Russian economy digitalization. Accordingly, this should be reflected in the formation and implementation of the strategy for the development of public finances.

## 2 Methodology

The Russian economy faces the task of moving from primary sector orientation to high-tech production. Digital transformation represents an essential part of these structural changes. The evidence to this can be found in the work of Lowry [1]. Digital transformation in our country should be implemented with the regulatory and financial support of the state on the basis of an effective strategy. As it is noted in Hanna [2], the strategy for the development of the digital economy should be consistent with the overall development strategy of the country. Digital technologies should become a key factor in the modernization of the Russian industry. This article concentrates on the idea that the strategy for the development of the digital economy in the Russian Federation should correlate with the corresponding strategies for the development of public finance.

The paper analyzes various indicators that characterize the level of development of the digital economy, including the number of Internet users, the population using electronic public services, etc. Among others, the amount of government spending for the digital economy is an important indicator. The study also reviews the regulatory legal acts in the field of digital economy and provides insight into the process of digital transformation based on the research of various economists. As a result, the limitations and opportunities for the development of public finance in the digital economy are identified. In the process of the study the following scientific methods are used: analysis and synthesis, economic and statistical methods, etc.

## 3 Results

The implementation of digital technologies is impossible without providing citizens with access to the Internet. According to the United Nations, expanding ITC (information and communication technologies) access is one of the goals for sustainable development of the global community. The role of the Internet has significantly increased in the context of the self-isolation regime associated with coronavirus infection. Many people around the world use it for remote work, training, shopping, and so on. According to the UN, 4.1 billion people used the Internet at the end of 2019, i.e. 53.6% of the world's population. Over the past decade, the number of fixed broadband Internet subscribers has almost doubled, namely from 7.6 per 100 residents in 2010 to 14.9 in 2019 [3].

The development model of any state in the digital economy is based on the interconnection of economic, social and other spheres through the Internet, computers,

and mobile devices provided by digital technologies. Companies that effectively use information and communication technologies become growth points in the era of digitalization. They are able to increase their competitiveness by increasing the quality of equipment operation, increasing productivity, and saving resources. Using the advantages and opportunities of the digital economy will allow any country to achieve rapid growth [4]. It is no wonder that the implementation of digital transformation, including in the field of public finance is set as the strategic goal in Russia. Its achievement involves the use of program-targeted financing, with national projects and state programs among its array of tools. As a result, it is the state financial resources that become the main source of ensuring the implementation of national projects and state programs.

The implementation of digital transformation in Russia implies the implementation of a certain set of measures reflected in the «Main directions of budgetary, tax and customs-tariff policy for 2021 and for the planning period of 2022 and 2023» [5].

The list of these measures includes the expansion of tax incentives in order to create favorable conditions for the development of national high-tech companies and increase the attractiveness of the legal environment for IT business. The Government of the Russian Federation intends to reduce the rate of insurance premiums from 14 to 7.6%; and the rate of income tax to 3% [5]. It is also planned to cancel the VAT benefit for the sale of foreign software.

To ensure the digital transformation in Russia, an appropriate legal regulation is being formed. In particular, the document «On the strategy for the development of the information society in the Russian Federation for 2017–2030 has been designed [6], and the national project «Digital Economy of the Russian Federation» has been developed [7]. The state seeks to create an infrastructure for data transmission, processing and storage, as well as to develop «end-to-end» digital technologies mainly based on domestic research. The digital transformation strategy involves a comprehensive system of project financing, including a grant mechanism, concessional lending, and venture financing.

Digital technologies and platforms are also being actively introduced in the field of public administration and public services. The transition to electronic auctions is implemented in the system of state property sales. Exclusively electronic methods of submitting and storing primary reporting documents by organizations are being introduced in the system of state contracts. The expenditures of the federal budget of the Russian Federation are financed in accordance with the strategic priorities. Currently, 13 national projects are being implemented in Russia. The estimated amount of funding for the national project «Digital Economy of the Russian Federation» [7] for the next few years is shown in Table 1.

As it can be seen from Table 1, in the next budget cycle, the share of financial support for the national project in the digital economy is insignificant in relation to the total amount of funding for national priorities. In 2020, this indicator was 5.2%. In 2021–2022, it is planned to increase the share to 8.1%. In 2023 the Government of the Russian Federation intends to reduce the share of financing of the digital economy to the level of 6.9% [5].



**Table 1** Funding of national projects in the Russian Federation

| RF budget expenditures  | 2020    | 2021    | 2022    | 2023    |
|---|---------|---------|---------|---------|
| National projects, bln.rub  | 2 190.5 | 2 245.8 | 2 608.6 | 2 780.5 |
| Digital economy, bln.rub  | 113.4   | 150.2   | 211.1   | 190.7   |
| Digital economy share in the total amount of spending on national projects, % | 5.2     | 6.7     | 8.1     | 6.9     |

Source author based on [5]

## 4 Discussion

The problems and risks that our country faces on the way to the digital economy are discussed in this section of the paper. The ideas presented in Eskindarov, Maslennikov and Maslennikov are of special interest [8]. Economists point out that digital transformation in Russia is carried out at the expense of budget subsidies that have low efficiency of use. It is impossible to deny that the role of extra-budgetary sources for the development of digital technologies financing should grow every year, and enterprises should be interested in their active implementation. However, as it is fairly noted in Ozili budget financing of the digital economy, by increasing government spending in the present, can subsequently lead to an increase in tax revenues from digital companies [9].

Tikhomirov argues that regional digitalization programs are not being developed in Russia [10]. Only a limited number of federal projects activities involve the participation of separate entities of the Russian Federation. However, the regions should also have a clear idea of their place in the implementation of digital transformation programs and, in accordance with this, build their budget policy, find the sources of funding. Moreover, the current Russian education system does not have time to respond to changes in the IT sphere. A more flexible approach to training is required, as well as the adaptation of educational programs to the modern requirements of the digital economy.

An important problem is also the significant lag in the quality of domestic digital goods and services from foreign analogues. Betelin claims that the bulk of projects in the field of IT technologies in Russia will be implemented on the basis of foreign technologies [11]. In this regard, the researcher doubts that in the near future our country will take a significant weight in the global digital economy. Besides this does not guarantee the information security of Russia and increases the likelihood of cyber-attacks. A similar position is held by Lowry [1]. The economist believes that in the context of the purchase of electronic equipment abroad, the size of the digital economy in Russia will decrease. It is no accident that the state authorities of the Russian Federation emphasize the need to develop digital technologies mainly on the basis of domestic solutions. The state should do everything possible to support IT companies that are able to ensure the digitalization of leading industries and withstand international competition [11]. The improvement of the state electronic services quality would be an undoubted advantage of the digital transformation in Russia.

Even today, the indicator of the share of the population receiving state and municipal services electronically demonstrates a positive trend. In 2013 it was equal to 30.8%, and by 2019 it reached the level of 77.6%, having increased 2.5 times for 7 years [12]. In particular, Russians extensively use the federal platform of government services, and the digital platform of the federal tax service. According to Pouri and Hilty, the use of such digital platforms significantly reduces transaction costs for the population [13]. The cost and speed of providing public services is also significantly reduced. Obviously, minimal transaction costs are one of the major advantages of the digital economy. As part of the strategy for the development of public finances, the state budget should support the provision of digital services, primarily to the Russians living in remote regions and localities, and to people with limited mobility. To this end, budget subsidies should be provided to digital service providers in order to ensure an acceptable price of their product for consumers [9].

## 5 Conclusion

Overall, the results of this study highlight the main directions of digital transformation in Russia, which should be reflected in the strategy for the development of public finance. Sufficient budgetary resources should be allocated for the creation and support of various state institutions of the digital economy, which will contribute to strengthening Russia's digital leadership. Information and telecommunications technologies should increasingly penetrate into the fields of education, health care, and the provision of various public services to ensure their accessibility to the general population. The cost of digital services should also be accessible to citizens. It will increase the demand for various digital products, and, as Hanna notes [2], in its turn will form a public digital culture. State support in the form of subsidies and tax incentives should be provided to IT companies for the development of digital innovations and the introduction of various digital platforms. The system of Russian education must also meet the modern requirements of the digital economy. That is not at all a comprehensive list of tasks that the Russian government faces on the way of digital transformation in its economy. Many steps have already been taken. However, many of the problems discussed in this article still require solutions.

## References

1. Lowry, A.: Russia's digital economy program: an effective strategy for digital transformation? In: Gritsenko, D., Wijermars, M., Kopotev, M. (eds.) *The Palgrave Handbook of Digital Russia Studies*, pp. 53–75. Palgrave Macmillan, Cham (2021)
2. Hanna, N.K.: Assessing the digital economy: Aims, frameworks, pilots, results, and lessons. *J. Innov. Entrep.* **9**, 16 (2020). <https://doi.org/10.1186/s13731-020-00129-1>
3. United Nations: Sustainable Development Goals Report 2020. [https://unstats.un.org/sdgs/report/2020/The-Sustainable-Development-Goals-Report-2020\\_Russian.pdf](https://unstats.un.org/sdgs/report/2020/The-Sustainable-Development-Goals-Report-2020_Russian.pdf) (2020). Accessed 09

March 2021

4. Istomina, E.: Analysis of forecasts of rating agencies in relation to the development of the digital economy in Russia and the world. *Moscow Economic Journal* **11**, 454 (2019). <https://doi.org/10.24411/2413-046X-2019-10172>
5. Ministry of Finance of the Russian Federation: main directions of budgetary, tax and customs-tariff policy for 2021 and for the planning period of 2022 and 2023. [https://minfin.gov.ru/document/?id\\_4=131644-osnovnye\\_napravleniya\\_byudzhetoj\\_nalogovoi\\_i\\_tamozhenno-tarifnoj\\_politiki\\_na\\_2021\\_god\\_i\\_na\\_planovyi\\_period\\_2022\\_i\\_2023\\_godov](https://minfin.gov.ru/ru/document/?id_4=131644-osnovnye_napravleniya_byudzhetoj_nalogovoi_i_tamozhenno-tarifnoj_politiki_na_2021_god_i_na_planovyi_period_2022_i_2023_godov) (2021). Accessed 09 March 2021
6. On the strategy for the development of the information society in the Russian Federation for 2017–2030. Approved by the President of the Russian Federation of 09 May 2017 N 203. <http://www.kremlin.ru/acts/bank/41919> (2017). Accessed 09 March 2021
7. Passport of the national project Digital Economy of the Russian Federation. Approved by the Presidium of the Council under the President of the Russian Federation for Strategic Development and National Projects of 24 December 2018 N 16. [https://digital.gov.ru/uploaded/files/natsionalnaya-programma-tsifrovaya-ekonomika-rossijskoj-federatsii\\_NcN2nOO.pdf](https://digital.gov.ru/uploaded/files/natsionalnaya-programma-tsifrovaya-ekonomika-rossijskoj-federatsii_NcN2nOO.pdf) (2018). Accessed 09 March 2021
8. Eskindarov, M., Maslennikov, V., Maslennikov, O.: Risks and chances of the digital economy in Russia. *Finance: Theory Pract.*, **23**(5), 6–17 (2019). <https://doi.org/10.26794/2587-5671-2019-23-5-6-17>
9. Ozili, P.: Impact of digital finance on financial inclusion and stability. *Borsa Istanbul Rev.* **18**(4), 329–340 (2018)
10. Tikhomirov, B.: Digitalization of socio-economic development: a thorny path to a new quality of the information society. *Economics. Taxes. Right* **12**(4), 20–28 (2019)
11. Betelin, V.: Challenges and opportunities in forming a digital economy in Russia. *Her. Russ. Acad. Sci.* **88**, 1–6 (2018)
12. Abdrahmanova, G., Vishnevskiy, K., Gohberg, L., Demidkina, O.V., Demyanova, A.V., Dranev, Yu.Ya., Kovaleva, G.G., Kotsemir, M.N., Shugal, N.B.: Digital economy indicators: 2019: statistical digest. <https://issek.hse.ru/mirror/pubs/share/387609461.PDF> (2019). Accessed 09 March 2021
13. Pouri, M., Hilty, L.: The digital sharing economy: A confluence of technical and social sharing. *Environ. Innov. Soc. Trans.* **38**, 127–139 (2021)

# Stock Market in the Context of the Digital Economy: Foreign Policy Aspect



E. N. Valieva, O. I. Vasilchuck, and E. I. Gnatishina

**Abstract** With the digitalization of the economy, it becomes crucial for individual investors to correctly assess risks and form their own investment strategies, taking into account all the available information. The media and the Internet can provide an individual with access to diverse information about the issuer and its work conditions. While this allows the transparency of the infrastructure, it also creates a dualistic data perception system. The sanctions imposed by foreign governments have had an ambiguous but still significant impact on the financial and economic situation in the Russian Federation. This article presents the assessment of the impact of the restrictions caused by the foreign policy of the Russian Federation on exchange trading.

**Keywords** Exchange information · Exchange trading · Sanctions

## 1 Introduction

On March 18, 2021, a new set of US sanctions came into force, despite the EU sanctions introduced earlier on March 2. While the domestic media presented these bans as affecting only 1% of companies exporting their products [1] and the Ministry of Industry and Trade reported the growth of import substitution and the growth of wages and incomes within the country [2], the markets reacted differently. In anticipation of March 17, the ruble index on the Moscow Exchange fell by 2.28% at the time of the main trading, to 3507.91 points, and the dollar RTS index—by 3.81%, to 1493.66 points. Simultaneously, the US currency rate rose, and the ruble weakened significantly in relation to other currencies. Thus, despite the absence of real prohibitions of an economic nature—the sanctions explicitly targeted employees

---

E. N. Valieva (✉)  
Samara State University of Economics, Samara, Russia

O. I. Vasilchuck · E. I. Gnatishina  
Volga State University of Service, Togliatti, Russia

of certain organizations—the Russian market actively reacted even to news, not only to market events, which may be due to the special role of the media.

## 2 Methodology

Trading on any exchange markets, including the Russian Moscow Exchange, always depends on incoming information about the economic activities of issuers and the foreign policy situation. For historical reasons, it is Russian investors who are the quickest to change their strategy based on fluctuations of the political situation, which is particularly important in the era of the digital economy, when diverse information is readily available to everyone.

The meaning of the term «overreaction» is not presented either in the legislation or in the modern scientific literature, this meaning not used in research on behavioral features in the securities market. The complexity of the concept of “overreaction of participants in the securities market” lies in the subjectivity of this concept, the complexity of its measurement and the specificity for each country. It difficult to understand which reaction is “normal”. As part of the analysis, we mean the term used. We define the term “overreaction to media of investors” as the change in the price of securities issued by the issuer by more than 2% during the trading day at the time of the media coverage (internet, magazine, newspaper of twitter and telegram channels) and 3, 5% change of derivatives based on these securities. Media reports may cause price changes of less than 2%, but we do not consider such changes excessive, since they occur during each trading day. The duration of investors’ reaction can vary from one day to several months, and it is due to the nature of the published information and the social response to the media coverage. We suggest that information published in the media, online, the reports, and internal enterprise documents can be classified into the following categories: 1. Official information of the issuer, appeals and reports of company of her subsidiary. 2. Information on ratings, calculations and expert assessments published in major journals, online platforms, etc. 3. Information on news pages, especially sites for investors (their reliability has not been officially confirmed). 4. Insider information. 5. Fake news.

Official information of the issuer, appeals and reports of company of her subsidiary mainly are presented by the issuer’s reports, which are checked by independent auditors and tax authorities. There is little such information, it doesn’t assess the investment attractiveness for the buyer. Therefore, such data are used for fundamental analysis. We define, that such information can’t make an “overreaction” situation on market. Official information is expected, it is included in the “investor calendar”—the schedule for publishing the statements and similar information of the issuer. Information on ratings, calculations and etc. contain an assessment of the author, so such events are characterized by a high degree of unpredictability. Such data cannot be entered into the “investor calendar” because they do not have a publication system. Examples of such information include Forbes, Ria.ru, Vesti., RAEX ratings and others. Such reports often elicit an “overreaction,” as they contain a certain opinion

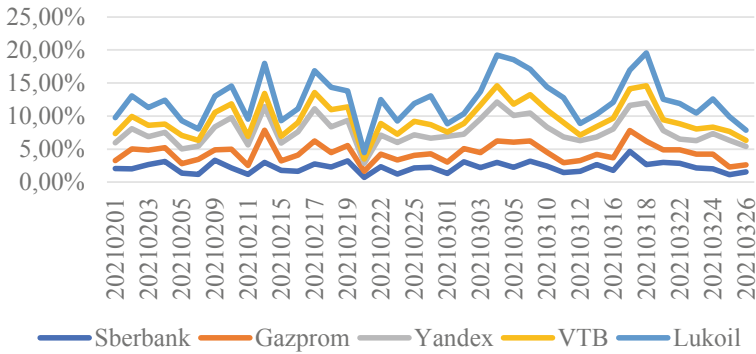
and enjoy a high degree of trust among individuals. Information on news pages is free available on the Internet, print media or various channels. This information mainly contains evaluation information. It also often includes a signal to certain actions of the investor. These data have a high probability of “overreaction”. But it often have a “delayed effect”. This information impact on the market takes a little longer, and it has an increasing effect. By insider information, we mean data that can influence investment decisions on the issuer’s securities, but is available only to internal services and employees of the company. In this article, we mean false data by fake information. The purpose of such information is to force investors to act in a certain way, no matter how they act in a real situation.

### 3 Results

To assess these information sources, namely, the ratings, expert calculations and assessments in major magazines, online platforms, and unverified sources, one can use the media index. It is published by some agencies, and it characterizes the information field created around the issuer. Decreasing media index indicates the increasing probability of a decrease in the price of a studied issuer asset. Insider information has the greatest influence on price changes, since this information is available to a limited number of persons, which increases its value. Insider information—this information about the issuer’s activities, its management, peculiarities of its products and strategy, possible changes, which are owned by representatives of the issuer’s top management.

Insider information is the most valuable information for the investor to decide on the purchase or sale of the issuer’s paper, since it is not available to all market participants. However, this type of information is very often “disguised” as other types of information, for example, fake news. Insider information, regardless of its content, has a strong impact on the stock market, it is the appearance of insiders on the information field that leads to an “overreaction market”. However, the use of insider information by a limited number of people leads to unfair competition and price manipulation in the securities market. The peculiarity of the Russian market in the high availability and commercialization of insider information. While abroad, they are following the path of restricting its use, including through legislation.

Usually, insider information is important information about a company that is not publicly available, and that is known only to a certain person due to his or her official role. Insider trading is considered highly harmful in all developed markets and is battled by lawmakers and regulators worldwide. Meanwhile, nowadays, it is almost impossible to identify the cases of insider trading in Russia. What regards price manipulation, to some extent, it is regulated by the current Federal Law “On Countering the Unlawful Use of Insider Information and Market Manipulation and on Amending Certain Legislative Acts of the Russian Federation” dated 27.07.2010 N 224-FZ [3]. However, as practice shows, this regulation [3] is still insufficient. The legal definition of manipulation is too narrow. Nowadays, there are no concepts of



**Fig. 1** Price dynamics of ordinary shares of “blue chips” during a trading session ( *Source* authors)

“manipulation on the securities market” in the legislation of the Russian Federation. The powers the Bank of Russia has to identify and prove the manipulation cases are inadequate. The use of knowingly inaccurate (fake) information on the securities market has significantly increased in the last five years. This situation is ensured by the availability of information on the Internet, the development of such sources of information as Telegram. A private investor cannot verify the authenticity of more data from the media and the Internet. Especially insider information is not verifiable, so investors can accept it as fake news and not respond. While large investors in the Russian market have the opportunity to use insider information, this leads to imbalance and disruption of trading integrity. However, the use of political activity data and inaccurate representation of its consequences can significantly affect the Russian market. The events of February–March 2021 illustrate this phenomenon: in anticipation of sanctions, and right after they were introduced, the market reaction was particularly intense. Based on the trading outcomes for February–March 2021, a graph in Fig. 1 depicts the degree of price deviation during the main trading session for some “blue-chip” list companies’ opening price.

For the calculation, we used the data of the Moscow Stock Exchange:

$$\Delta P = \frac{P_{\max} - P_{\min}}{P_{\text{open}}} \times 100$$

$P_{\max}$  is the maximum price of an asset for the main trading session, rubles.

$P_{\min}$  is the minimum price of an asset for the main trading session, rubles.

$P_{\text{open}}$  is the price of an asset at the opening of the main trading session, rubles.

Based on our calculations, during the waiting time for the restrictions to come in force, the range of daily price fluctuations is much higher than during the restriction announcement period. For example, significant price fluctuations can be observed on February 12, 2021, associated with the media announcements about the “crack” in relations between the Russian Federation and the EU and the possibility of introducing new sanctions [4, 5]. Interestingly, on March 2, the price changes were not that

significant. The greatest daily volatility of assets is noted during the media coverage of the new US President discussing the possibility and the nature of new bans (March 4 [6], March 17 and 18 [7], due to the time difference). However, following the statement on the content of the sanctions and the sanction lists, the deviation range of stock prices from the daily average is decreasing. Thus, the greatest price volatility is observed precisely at the moment of waiting rather than after it is over.

## 4 Discussion

Economists have been long studying the issues related to the assessment of the impact information has on exchange. Foreign economists have studied the influence of information on fluctuations in securities' prices since the 1980s. DeBond and Thaler note that the market can be seen as "overreacting" to certain economic and social life events in their article published in 1985. This economists provide empirical evidence of significant decreases or increases in the price (that we decide "overreaction") of securities traded in the stock market affected by the newspapers and news coverages [3]. With the economic digitalization and the availability of large amounts of information, information analysis and assessment of its impact on the prices of exchange-traded assets become particularly relevant, especially what regards reducing the investor's risks. Although the media outlets present the impact of sanctions as not significant to the Russian Federation economy, as they target individual citizens and organizations and even stimulate domestic production, the exchange market testifies the opposite. Most private and minor investors do not have the opportunity to familiarize themselves with the content of the foreign restrictions, as those are mostly represented by English-language sources [8, 9]. Large investors modify their portfolios in anticipation of sanctions, as they understand that such foreign policy actions will unavoidably affect the activities of Russian companies—the individual sanctions also apply to the companies owned by this person in the amount of 50% or more. In such situations, expectations generate greater volatility than the sanctions themselves: as soon as the sanction list is known, the relevant sector or a company begins a gradual decrease in capitalization. However, prior to the sanction announcement, the risks are significantly higher. Thus, it is insufficient to rely on media coverage to assess the impact of the sanctions related to the Russian Federation's foreign policy. Investors should use other methods to evaluate the riskiness and profitability of certain market operations.

## 5 Conclusion

Based on the empirical data, we developed the "media index" matrix that can be used by Russian investors, which is especially relevant with the development of the digital economy. Table 1 presents the matrix for adjusting investor expectations, which takes



**Table 1** Matrix of investor decision making taking into account the information flow

|                        |     | Media coverage   |   |  |  |
|------------------------|-----|--|---|--|--|
|                        |     | Positive   |   | Negative   |  |
|                        |     | Confirmed  | Unconfirmed   | Confirmed  | Unconfirmed  |
| Foreign policy factors | Yes | Asset price deviation from the opening price up to 5%                              | Asset price deviation from the opening price up to 5% | Asset price deviation from the opening price up to 5%                              | Asset price deviation from the opening price 5–15% |
|                        | No  | Asset price deviation from the opening price depends on the media coverage content | Asset price deviation from the opening price 1–7%     | Asset price deviation from the opening price depends on the media coverage content | Asset price deviation from the opening price 3–10% |

Source authors

into account various types of information. As the media publish the news about the issuer, the adjustment indices (Table 1) should be applied (multiplied) using either the “positive” or “negative” connotation of this information and taking into account the presence of the foreign policy mentions. At present, the foreign policy aspect implies the information regarding sanctions due to the specifics of economic development in comparison to the USA and the EU [10]: documents already introduced or signed (in the matrix, “confirmed”) or only being discussed and submitted for consideration (in the matrix, “unconfirmed”).

The high risks of imposing sanctions in the context of the changing foreign policy of the Russian Federation are the reason for the additional costs of large enterprises (issuers). This mean, using results of the market reaction to news about sanctions, an investor can adjust the strategy. For example, if an investor’s strategy is to sale active when the price of an active falls by 25%. He determines by using the matrix that there was an impact of news about sanctions, which was provided by an unnamed source. Consequently, the asset is not sold according to the selected strategy [11]. This matrix considers the investor’s risks in the modern digital economy, depending on the chosen investment strategy. Thus, the adjustment of investment decisions based on the available information can allow for the most optimal strategy. It is also essential to consider current media information about sanction decisions, which introduce additional volatility and risks in the Russian market.

## References

1. Mingazov, S.: RBC: sanctions due to Navalny will affect less than 1% of supplies from the United States. <https://www.forbes.ru/newsroom/biznes/424133-rbk-sankcii-iz-za-navalnogo-kosnutsya-menee-1-postavok-iz-ssha> (2021). Accessed 24 March 2021

2. Protsenko, A.: The Ministry of industry and trade spoke about Russia's strategy in response to US sanctions. <https://rg.ru/2021/03/22/minpromptorg-na-sankcii-ssha-rossiia-otvetit-rostom-importozameshcheniia.html> (2021). Accessed 24 March 2021
3. Federal Law On Countering the Unlawful Use of Insider Information and Market Manipulation and on Amending Certain Legislative Acts of the Russian Federation dated 27 July 2010 N 224-FZ. [http://www.consultant.ru/document/cons\\_doc\\_LAW\\_103037/](http://www.consultant.ru/document/cons_doc_LAW_103037/) (2021). Accessed 27 March 2021
4. Lenta: US allowed new sanctions against Russia. <https://lenta.ru/news/2021/02/12/sanc/> (2021). Accessed 27 March 2021
5. RIA: The EU talked about the preparation of sanctions against Russia. <https://ria.ru/20210212/sanktsii-1597171925.html> (2021). Accessed 27 March 2021
6. RBC: Biden's first sanctions against Russia. Main thing. <https://www.rbc.ru/politics/03/03/2021/603e67e69a794767a78d3fbb> (2021). Accessed 27 March 2021
7. Rosbalt: US after Biden's words about Putin imposed severe export sanctions against Russia. <https://www.rosbalt.ru/world/2021/03/17/1892398.html> (2021). Accessed 24 March 2021
8. Boubakri, N., Cosset, J.-C., Mishra, D.: Large shareholders and target returns: international evidence. *Glob. Corp. Gov.* **19**, 103–145 (2017)
9. Gavrilova, T., Kubelskiy, M., Kudryavtsev, D., Grinberg, E.: Modeling methods formulation in a turbulent environment. *Strateg. Chang.* **27**(4), 369–377 (2018)
10. Szerb, L., Trumbull, W.N.: Entrepreneurship and transition in the European transition countries: is transition complete? In: Proceedings of the 55th Congress of the European Regional Science Association: World Renaissance: Changing Roles for People and Places. European Regional Science Association (ERSA), Lisbon. <https://www.econstor.eu/handle/10419/124680> (2015). Accessed 21 March 2021
11. De Bondt, W.M.F., Thaler, R.: Does the stock market overreact? *J. Financ.* **40**(3), 793–805 (1985)

# Digital Economy and State Financial Control



A. G. Lukin, N. Y. Gorelova, and T. B. Zavodchikova

**Abstract** The issues of the digital economy in the Russian Federation are getting more and more developed. According to the Harvard Business Review, our country occupies an intermediate position between promising countries and leading countries, which indicates a fairly large potential and desire to develop in this direction. However, digitalization, actively interfering in the management processes, without proper theoretical development, can negatively affect the results of the economic entity in general. The research goal of this paper is to consider the main development trends of financial control in the context of the digitalization.

**Keywords** Digitalization of the economy · Financial control · Financial management · Financial relations

## 1 Introduction

Finances are the rules about money. Within the framework of financial relations, there is mainly a movement of information on the formation of these rules, their implementation and adjustment. The movement of money itself is already carried out within the framework of commodity-money or credit relations. Therefore, the digitalization of the economy, which today is widely discussed and written about as the main vector of the development of economic relations, within the framework of financial relations acts as a tool to optimize the processes of collecting information and analyzing it, forming planning and reporting documents, as well as increasing the speed of its movement to the consumer. Digitalization does not affect the fundamentals of financial relations [1]. Unlike, for example, commodity-money relations, where new types and forms of money appear, and therefore the rules of their exchange and the rules of cash flow change, or credit relations, where the processes of issuing

---

A. G. Lukin (✉)  
Samara State University of Economics, Samara, Russia

N. Y. Gorelova · T. B. Zavodchikova  
Samara National Research University, Samara, Russia

credit money change, etc., financial relations, while actively reacting to changing conditions within the framework of monetary relations, nevertheless remain the most conservative among all its elements. Therefore, today it is necessary to talk not about the transformation of financial rules into a digital form, but about the integration of digital technologies in the implementation of financial transactions.

## 2 Methodology

Within the framework of this study, the analysis of the studies of domestic and foreign researchers on the issues of the financial sector digitalization is carried out. Using the method of induction, their generalization is made to justify the conclusions of the study. Dialectical discussions helped to understand the essence of the interaction between new digital technologies and financial relations. The method of comparing the advantages and disadvantages of using digital technologies in financial management is used. The experience of their application in real financial relations, primarily in the public administration sector, is synthesized. The same method allowed to consider the experience of using digital techniques in state financial control. The concept of integrating advanced digital technologies into the practice of state financial control is formulated.

## 3 Results

According to professor Molchanova, the digital economy in the financial sphere should be understood as a system of economic relations based on new methods of processing, storing, generating, and transmitting data, as well as digital tools that are necessary for the realization of financial plans, programs, and forecasts [12]. As can be seen from the definition, digitalization contributes to improving the quality and quantity of data collected in the framework of financial processes, improving the quality of forecasts and the processes of monitoring the implementation of plans. At the same time, it does not affect the methodological foundations of planning, accounting, reporting, financial control, etc. Therefore, it is still too early to radically change financial activities, dispensing with the financial methodologies that have already proven their effectiveness.

What are the main advantages of the digital economy to financial relations:

1. Increase in the amount of processed information per unit of time, that is, the productivity of accounting (including offsetting), analytical and other operations, which allows to increase the accuracy of forecasts, increase the selection of verifiable data in the framework of control procedures, etc.

2. Increase in the speed of information transmission, including large volumes over long distances, which increases its timeliness and allows for faster management decision-making.
3. It allows visualizing information by converting it into graphical and tabular forms, which helps its users better understand its content.
4. It offers various options for storing large amounts of information on small media, including portable (i.e. convenient for transportation).
5. It offers various options for encoding and encrypting information, which increases its security, especially when it is transported or stored, etc.

As we can see, there is no displacement of a person from the financial management, as it happens, for example, in production or in other sectors of the national economy. And if, for example, in the military sphere, automated control systems receive information, for example, from the radar, request a target for identification, carry out tracking of the target, transmit information to a higher level of control, etc., in the financial sphere this does not happen. A person selects and prepares financial data, determines how it is processed, draws conclusions and makes management decisions, including on the composition and form of information transmitted outside the company, organization, region, etc. Therefore, it is probably too early to talk about reducing the influence of the human factor on the correctness, efficiency and optimality of financial relations to the level where the need for control in its modern form disappears.

Finally, the rapid development of information technologies has long had not only a positive impact on financial relations. With the development of new information technologies, the following, in our opinion, negative trends appeared, primarily in financial management.

Firstly, the apparent easiness and speed of transmitting and processing an almost limitless array of data gave rise to the desire of managers to request a large amount of information from performers on the principle of “just in case”. Such a desire distracts employees from the performance of their official duties, generates a huge amount of unnecessary information, reports, etc.

Secondly, the existing approaches to encoding information, when in the code number, for machine data processing, a large amount of identification and classification data are put, leads to a significant complication of understanding the encoded information, even for specialists, not to mention non-specialists. For example, such advantage of digital technologies as increasing the transparency of information for a wide range of users of information on the execution of budgets of the Russian Federation budget system [14] is reduced by the complexity of reading and understanding the budget classification of the Russian Federation.

Thirdly, as a consequence of the previous paragraph, the complexity of data encoding and the transition to their exclusively machine processing makes it almost impossible to manually process them, which causes serious consequences if it is impossible to use, for one reason or another of communication means.

Fourthly, the widespread introduction of software products reduces the requirements for the qualifications of employees who use them because of their official

duties. For a large number of specialists in the financial sector, knowledge of the PC and specific programs is already sufficient. In this state of affairs, to find, if necessary, a specialist capable of conducting financial transactions in manual mode, without the involvement of computer equipment, becomes a big problem.

Therefore, it is very important that new technologies are applied to processes and procedures that serve as a proven methodology for achieving the set goals. That they are based on the correct theoretical assumptions and concepts that have proven their efficiency. In this regard, it is necessary to gradually introduce new methods and tools into existing financial management systems.

Unfortunately, there is no single theoretical approach to the issues of financial management in the Russian Federation, and very often the ideas about the essence of financial management are based on theories and concepts that are not fully understood. This situation has developed, for example, in the choice of public financial management between the theories of financial management [11], or in the implementation of the risk management methodology developed for entrepreneurship in the system of state financial control in Russia [9]. Given that financial control is an integral part of financial management, it has the same problems.

It is worth noting that most studies analyze relations in the field of the state financial control implementation as the research object, and the Federal Treasury consider these relations as the research subject. According to the postulate by Olovo-Okere and Tomkins, the state financial control systems are constantly developing and changing [13]. Based on the thesis that was formulated by a group of researchers, the financial control and audit instruments change following the development of financial and production technology [8]. The Russian researchers comprehensively consider digital technologies as tools for improving the organization and implementation methodology of financial control. What do the Russian scientists and practitioners expect from the application of digital technologies in financial control activities?

Firstly, the minimization of face-to-face interaction between the controller and the object of control within the framework of control activities, which, according to the researchers, simplifies it, increases efficiency and the responsiveness [2]. We would also add that it reduces the corruption component.

Secondly, ensuring the openness of budgets and the ability to monitor the expenses and incomes of each recipient of budget funds in real time, which will contribute to the prevention and suppression of violations in the financial sphere [15].

Thirdly, it saves time for supervisors, reduces the costs on implementing control activities, and increases the effect of conducting counter-checks by providing quick access to the necessary information of the object of control [14]. It is believed that a very important advantage of the introduction of computer technologies in the implementation of financial control will be the ability to register and identify all beneficiaries to whom the recipients of budget funds transfer payment, which will increase the effect of counter-checks [16].

Fourthly, high hopes are put on strengthening the role of current control, in connection with the ability to monitor the correctness of the financial transaction of the control object in real time [14].

As an update of the control methodology on this basis, the concept of the deputy of the Federal Treasury head Isaev on the transition from an adversarial to a partner model of the financial control organization is presented. This concept provides for the integration of processes and control mechanisms into business processes. This, according to the author, will allow avoiding a large number of inspections and the application of sanctions to violators of financial discipline and to move on to monitoring the information available in information systems about the objects of control [3]. In addition, within the framework of this concept, it is assumed to strengthen the responsibility of the controller, when in the event of violations of financial transactions that have passed control, both violator and controller who did not prevent it will be responsible [5].

Fifthly, the possibility of new channels emergence of interaction with society and the formation of complex integrated systems. As an illustration of this thesis, the possibilities of “blockchain” and big data technologies are presented. The first will allow you to track each financial transaction from the very beginning, i.e., the initiation of the operation before the beneficiary, which will help the controllers to determine the cause of the detected violation at any stage of the document movement [15]. The second one will allow controlling a larger number of participants of budget relations [7].

## 4 Discussion

But no innovative digital technologies will help if the information obtained with their help does not have an interested user. And this is exactly the situation that has developed today in the state (municipal) financial control in the Russian Federation. As Khamirzova, and Tchaikovsky, note, the bodies of external and internal state and municipal control function independently of each other and do not form a single “control vertical” [4]. In addition to the lack of interaction between state control bodies, the founders of these bodies have no interest in their information. The budget legislation of the Russian Federation gave the control and accounting authorities limited powers to apply measures of enforcement and, thus, freed the state authorities that should be directly interested in the information of the state financial control from such an interest [10].

In addition, the creation and improvement of the Federal Treasury as the main body that exercises current (or in the terminology of modern Russian budget legislation—preliminary internal) financial control, freed the main managers of budget funds from monitoring the current activities of subordinate recipients of budget funds. And giving the recipients of budget funds the authority to form the rules of financial activity for themselves, in general, deprived the state supervisory authorities of the ability to exercise such types of control as monitoring the effectiveness and expediency of using budget funds. No digital technologies allow to create a system of financial control either at the enterprise or in the state.

The main mass of the listed advantages falls on the organization and implementation of the current (or preliminary) internal state financial control carried out by the Federal Treasury. Therefore, it primarily concerns payment transactions from the budgets of the budget system. But in addition to monitoring the correctness of payment transactions, it is necessary to confirm the reliability of reporting and the correctness of budget commitments, and many other things that are not considered today in the framework of digitalization.

In addition, all of the above advantages reflect the control actions already performed by the Federal Treasury. Therefore, it is important to talk about some novelty very carefully. Moreover, the indicated approach to the reforming of the state financial control can cause irreparable harm to its organization and implementation. Since finally there was a justification for the possibility to realize the long-standing dream of subjects at all levels of financial management—to include controllers in the chain of passage of the document from birth to the final signature, while removing responsibility for the implementation of hierarchical control, which theorists and practitioners of financial control have struggled with over the past years. This will lead to the fact that controllers will not provide the interested user with information on violations, fearing responsibility for the mistakes made by the performers.

## 5 Conclusion

According to Klein, Klein, and Luciano, the foundation of the state openness is high-quality and reliable data used in the activities of public organizations in the creation of goods, works and services [6]. Digital technologies have a significant impact on the volume and speed of data collected, but in the financial sector, the composition of financial information depends on the individual. Therefore, in order to obtain reliable information, it is still too early to abandon the proven methods of obtaining control information, such as audit, field inspection, inventory, etc.

The widespread introduction of information technologies in the practice of financial control, in addition to improving the efficiency and availability of information necessary for the implementation of control activities and other positive aspects, can lead to an unjustified reduction in the number of supervisors, which will affect the completeness and reliability of the information received. And the prospect of including supervisors in hierarchical control may even deprive the interested user of objective information. Finally, the use of digital technologies in conditions of imperfect management and financial control systems will not make them more effective, but at the same time may worsen their results. That is why, before implementing digital technologies, it is necessary to debug the existing financial management and financial control systems, and for this it is necessary to build these systems on the basis of existing theoretical and practical experience, carefully integrating new digital technologies into them.



## References

1. Chakravorti, B., Bhalla, A., Chaturvedi, R.S.: 60 countries' digital competitiveness, index. Harvard Business Review. <https://hbr.org/2017/07/60-countries-digital-competitiveness-indexed> (2018). Accessed 30 March 2021
2. Egorov, D.S., Terekhova, N.B.: Development of state financial control in the context of digitalization. *Education and Law* **1**, 137–142 (2020)
3. Isaev, E.A.: Approaches to digitalization of control in the financial and budgetary sphere. *Finances* **5**. [http://bujet.ru/article/376994.php?sphrase\\_id=9949503](http://bujet.ru/article/376994.php?sphrase_id=9949503) (2019). Accessed 30 March 2021
4. Khamirzova, S.K., Tchaikovsky, V.V.: Internal state financial control in the conditions of digitalization of the economy. *Accounting and Taxation in Budget Organizations* **10**. <https://panor.ru/articles/vnutrenniy-gosudarstvennyy-finansovyy-kontrol-v-usloviyakh-tsi-frovizatsii-ekonomiki/10890.html> (2018). Accessed 30 March 2021
5. Khashaeva, Z.M., Chumakova, N.A., Adamyana, Z.A.: Internal state financial control in the conditions of digitalization of the economy. In: Tamova, A.A. (ed.) *Proceedings of the V All-Russian Scientific and Practical Conference*, pp. 81–86. Electronic Publishing Technologies, Maikop (2018)
6. Klein, R.H., Klein, D.C.B., Luciano, E.M.: Open government data: Concepts, approaches and dimensions overtime. *Revista Economia & Gestao* **49**, 4–24 (2018)
7. Kostusova, Yu.A., Komarova, O.V.: Digitalization of state financial control: an institutional analysis. *J. Econ. Theory* **16**(4), 842–848 (2019)
8. Lewis, A.C., Neiberline, C., Steinhoff, J.C.: Digital auditing: modernizing the government financial statement audit approach. *J. Gov. Financ. Manag.* **63**(1), 32–37 (2014)
9. Lukin, A.G.: Risk management technologies within the system of state financial control. *TEM J.* **8**(2), 444–453 (2019)
10. Lukin, A.G.: The institution of the users interested in the financial control information. *Mediterr. J. Soc. Sci.* **6**(4), 432–437 (2015)
11. Lukin, A.G.: Soviet and Western theories of financial management-competitors or allies? *Finance and Credit* **26**(5), 991–1016 (2020)
12. Molchanova, N.P.: Development of public finance in the digital economy. *Scientific research of the Faculty of Economics. Electron. J.* **9**(3(25)), 7–16 (2017)
13. Olowo-Okere, E., Tomkins, C.: Understanding the evolution of government financial control systems. *Account. Audit. Account. J.* **11**(3), 309–331 (1998)
14. Rastegaeva, F.S., Danilova, N.O.: State financial control in the digital economy. *Creative Economy* **14**(12), 3201–3212 (2020)
15. Shkarin, D.M.: Financial control in the conditions of digitalization of the economy. *Electronic Scientific Journal Vector of Economy* **6**. <http://www.vectoreconomy.ru/images/publications/2019/6/innovationmanagement/Shkarin.pdf> (2019). Accessed 30 March 2021
16. Silantiev, A.E.: Internal state financial control in the conditions of digitalization of the economy. *StudArctic Forum* **3**(11). <https://saf.petsru.ru/journal/article.php?id=3262> (2018). Accessed 30 March 2021

# **Digital Formats and New Requirements of Professional and Business Education**

# Digital Education Can Help Decrease Labor Market Imbalance



G. N. Alexandrova, A. V. Gagarinskii, and G. P. Gagarinskaia

**Abstract** The article investigates the possibility of interaction and collaboration of relevant stakeholders, dealing with digitalization, education and labor market. The authors analyze ways of improving educational process with the help of innovative technologies and digital facilities. The authors consider building student individual learning tracks with regard to labor market volatility and appearing completely new professions and jobs, which require different skills and competences. The results of two control groups performance were described to determine the effects of on-line and traditional education on academic success.

**Keywords** Digital facilities · Individual learning track · Labor market · On-line education

## 1 Introduction

The new realities of modern life make employers become more attentive to the competencies that yesterday's university and college students receive. The development of information technologies has affected all spheres of our life and this is not a temporary phenomenon, we all have to constantly exist in these conditions, permanently learn and master complex skills and competencies [3]. Unstable labor market influences higher education, fosters changes and stimulates introducing innovative teaching methods. In this regard, it is important for the system of higher and secondary education to be flexible and change as quickly as possible to respond to the new challenges of the labor market. We consider digitalization in education, which is increasingly gaining popularity in Russia, to be one of the resources of such an instant and effective response. The digitalization of the education system has enabled teachers working in the field of education to use modern technologies not only to

---

G. N. Alexandrova (✉)  
Samara State University of Economics, Samara, Russia

A. V. Gagarinskii · G. P. Gagarinskaia  
Samara State Technical University, Samara, Russia

improve the quality of education, but also to interact productively with employers in order to respond to all the challenges and requirements of the labor market timely [1]. The aim of this study is to identify the advantages and disadvantages of using digital technologies in the field of higher education in order to identify ways to improve these tools and bring together engaged stakeholders—a student, a teacher and an employer.

## 2 Methodology

We divided our study into two stages. The first stage was going on for one semester, from February to June 2020. The second stage lasted from September 2020 to January 2021. Third-year students from two universities of Samara—Samara University of Economics and Samara Technical University participated in this study. During our research we used the questionnaire method, the observation method, the formal-reporting method (student performance according to the five-ball system), the E. Torrens method (assessment of student creativity), the situational problem method, the case-study method (case-method). In order to analyze and compare the results of on-line and off-line training, we measured student ability for critical thinking, creativity, doing project work, interacting with each other, generating ideas, assessing risks, making relevant decisions, oral speaking skills, presenting the results of their research, convincing and defending their ideas at the beginning and at the end of the study.

In the first part of our study, we decided to focus on lecture courses and practical classes, which were held in a distance format. During the pandemic and forced lockdown university and college teachers had to switch to distance teaching. Analysis of lectures video recordings showed that not all teachers were able to restructure and adapt the content of lectures for digital platforms quickly. The lack of visual and direct contact with the audience resulted in simply retelling the content of textbooks. We analyzed the effectiveness of students learning lectures on economics and technical disciplines at mentioned above universities in Samara. For this purpose, we have prepared separate questionnaires for teachers and students. We decided that firstly it would be right to study the opinion of students about the positive and negative aspects of distance learning. Third-year students studying at the Faculty of world economics of Samara State University of Economics and at the Faculty of applied mathematics and informatics of Samara Technical University were involved in the research, in whole, 154 students. It should be noted, that there were students with approximately the same level of knowledge and degree of attitude to study: 70.1% had good and excellent grades in the exams, 29.9% had good and satisfactory grades in the exams.

In the questionnaires, we included the following questions: whether the lectures in the remote format were productive in terms of obtaining new knowledge, competencies and skills; whether graphics, photos, pictures, printed text, video were used; whether teachers gave you tasks for independent work and how much time per day

you spent on homework; whether you used additional sources to obtain the necessary information: internet resources, print publications; what advantages, in your opinion, had distance education; what flaws you would mention; what format of training you would choose to study at the university: full-time, distance, mixed.

### 3 Results

According to the results of the survey, most students, namely 126, chose lectures to be delivered in a distance format, but practical classes, according to students, are much more effective to be conducted at university. Moreover, they prefer to communicate with professors face to face. The main advantage of distance learning students consider the possibility of watching lectures not only at the time of delivering them by professors, but also in recording. They think it to be a great advantage, that they can do it at any time and from anywhere [8]. However, students would like the lecture materials to be displayed in the form of graphs, drawings, tables or texts on the computer screen. 122 students would like their professors give references to the primary sources of examples, materials and additional resources for student home assignments. 57 students complained that they did not always have the opportunity to ask questions during distance lectures, especially if many students were connected to the Internet platform. However, in general, all students (100%) confirmed that, lectures, which provide basic knowledge or any new information, are more convenient to hold in a distance format.

A survey of teachers showed that not all of them feel confident when conducting classes in a distance format. 32 professors participated in the study. 28 of them complained that it takes more time to prepare for classes, it is difficult to structure and present educational materials in an online format, the reaction of students to the explained material is not visible there is no feedback. 19 professors complained that it is very difficult to control the student projects work in teams, especially when there is a process of discussion, generation of ideas and creative search for solutions.

In July, the results of the first stage of our study were carefully analyzed, in order to revise the structure and content of distance courses. We decided to include pre-recorded video lectures in the distance courses. The lectures contained the basic theoretical information of the course and were not presupposed discussions and comments, they contained information students had to learn and know well in order to rely on this knowledge for further study of the subject and writing a thesis. When we designed distance courses, we developed test tasks so that they check the basic knowledge of students. If a student gave an incorrect answer to a test question, the test tasks provided links to educational materials in which the correct answer could be found.

Test assignments were considered completed successfully only if the students had all the answers done correctly. It should be noted, that the teacher could at any time monitor what the students' results were and how often they followed the link in order to review the materials. The results of the first stage of the study showed that it is

necessary to make certain changes in the content and structure of e-courses in order to adapt them for the use in the system of distance and full-time education. By the beginning of the new academic year (2020/2021), it became necessary to develop a fully distance learning system for students living far from Samara, and a blended learning system for students living within the city of Samara.

Since the study involved senior undergraduate students who at the time of the second stage of the research were already in their fourth year, we decided to develop an individual educational trajectory for them in accordance with the new requirements of the Government and the Ministry of Science and Higher Education of the Russian Federation. An individual educational trajectory presupposes close interaction between a student, an employer and university professors. A new approach to teaching students, aimed at strengthening the role of soft skills, critical thinking, requires a revision of the content of curricula [5]. Training programs should become more flexible, constantly adjusted and adapted to the requirements of employers and market demands. Digital technologies allow universities to conduct labor market research, monitor changes taking place in it, track the emergence of new professions, make forecasts and take into account all risks. This is very important in the context of the rapidly changing situation on the labor market and the demands of employers, since in recent years there has been a sharp imbalance on the labor market in Russia. The rapid development of information technology has accounted for the situation in which many professions are now being replaced by artificial intelligence, so forecasting is an important part of research in education [4]. Since a constant analysis of the required professions was not carried out, the construction and aviation industries started experiencing a shortage of specialists. Thus, training of students in economic, legal, information technologies and engineering specialties requires serious adjustments due to the fact that the competencies needed for these professions have changed.

That is why, universities have decided to cooperate with employers on a regular basis. A roadmap for this interaction was developed, providing for the practitioners to lecture and conduct practical seminars, to carry out scientific leadership of student projects together with university teachers in order to teach practical skills and competencies that will allow students to adapt quickly to the working environment. In this case, digital technologies help us get in touch with employers quicker, because they work not only in the Samara region, but also in other cities of the Russian Federation. Thanks to digital technologies, it has become possible to teach students, using augmented and virtual reality, with the help of which students can know in advance, what exactly they will have to do at work, what responsibilities they will have and what they should include in their individual study track.

During the second stage of the study (September 2020–January 2021), the same students took part in the research, but the first group (72 students) had campus classes, while the second group (76 students) studied distantly. Students of the first group had campus classes and lectures. Besides, they had the opportunity not only to communicate with their professors during the lecture, but also, if necessary, to organize a discussion of difficult and incomprehensible issues with the classmates. Students studied in the university library, attended practical classes that took place in

the classrooms and laboratories of the university. There were many creative tasks in the curriculum, such as case studies, discussions, project work. Students could spend a lot of time together, discussing joint projects in practical classes and participating in discussions. In addition, if they fulfilled this activity during their classes, the teacher had the opportunity to hear each student and, if there was such a need, could always switch the students' attention to more important issues, without giving students the option to deviate from the topic of discussion. During the semester, teachers were able to monitor student progress, using progress tests, essays and oral questionnaires.

The second group of students studied distantly, but, nevertheless, had the same curriculum and programs. Classes were conducted on the Microsoft Teams platform and LMS. Students had a fixed class schedule, lecturers and practical classes were held in real time. All lessons were recorded, so students had the opportunity to view the recordings of all lessons and lectures as many times as they needed. Despite the fact that all classes were recorded, students had to join all distance classes, which were conducted in real time. All student class and their participation in discussions were fixed monitored. In order for students to have the opportunity to receive advice or answers to their questions, teachers used educational platforms, communicated in chats and created groups for students on social networks. Also, all the wishes and critical remarks of students were taken into account when preparing the presentations of the lecture material. Teachers tried to use all the options available on educational platforms: pictures, graphs, tables, videos, links and hyperlinks to additional sources of information.

All students of the first and second groups had their own individual educational trajectories, which at the end of the training were supposed to help students master the competencies that they need to work in the company in which they had their internship. As we have already mentioned, during the internship, each student had a mentor who continued to monitor his individual educational trajectory throughout the semester, right up to writing the final work, which was the development of an individual project or startup. Interaction with a mentor from a firm in many cases would be impossible without the use of information technology, because company mentors are highly qualified professionals in high positions, they are usually very busy; secondly. Then, many companies are located far from where students live, and it could take much time to get there. Thereby, using augmented reality technologies, students have the opportunity to study all the subtleties of the company's activities without leaving home, exchange ideas, discuss projects and so, the verification of completed assignments can go faster.

The analysis of the second stage of the research included a survey of teachers and students. We tried to find out, what advantages and disadvantages they see in traditional and distance education. We also carried out monitoring of student knowledge in both groups. We assessed students' theoretical knowledge, their ability to perform project work and interact with each other, the level of critical thinking, the ability to generate ideas, oral presentation skills, the ability to persuade, the ability to assess risks and make the most relevant decisions, based on the current situation. The final exam took place at the university, in the classrooms.

The opinions of teachers about the transition of the higher education system to a distance format differed. By the way, all the teachers who participated in the research taught their disciplines to students of both groups. By and large, all teachers spoke in favor of partial use of distance learning in the educational process. 12 teachers supported the possibility of fully distance learning at universities. Accordingly, 20 teachers were strongly against the distance education system at universities. It is interesting, that among students the percentage for and against was different. Naturally, only students of the second group (76 people) took part in the survey on the advantages and disadvantages of online education, since they had the opportunity to compare these two types of education. 59 students spoke in favor of fully distance learning, especially taking into account all the criticisms that were expressed and subsequently corrected during the second phase of the study. Among the main advantages of distance learning, students pointed out the ability to view lectures and classes in recording and at any convenient time, clear written instructions from teachers, additional educational material, uploaded by teachers, Internet site links, videos, tests. 83 students positively assessed the opportunity to be constantly in touch with teachers and mentors from companies. 11 students were in favor of a mixed form of education, pointing out that they lack face to face communication with teachers and classmates. Only 6 students were against distance learning, considering the traditional form of education to be the most correct and effective. The main argument of these students was that the Internet does not always work flawlessly, the connection is unstable, it is hard to hear teachers, the classes are ineffective, because of the fact, that students are slow to answer questions and often ask to repeat. Recent publications also confessed digital education is very productive, because students take responsibility for their own learning [6]. The main drawback is that digital facilities are not available in many poor countries [7].

Assessment of students' knowledge was carried out in three directions. The first is the assessment of students' theoretical knowledge. Students took the exam orally. The second direction is their project work. We assessed students' ability to carry out project work and interact with each other, as well as the level of their critical thinking, creativity, the ability to generate ideas, the ability to assess risks and make the most correct decisions, based on the current situation. These skills were assessed during the business game or case study. The third direction is the skills of oral presentations, the ability to present the results of their research, correct structure of information, the ability to persuade and defend their ideas. These skills were assessed during the students' defense of their graduation theses. While assessing all tasks, we took into account the acquisition of necessary competencies and skills, the activity of students in the classroom, the novelty of their ideas and their need and usefulness for society.

## 4 Discussion

The easiest way was to evaluate the theoretical knowledge of students, which they received at lectures and in classes. We can state, that the level of knowledge in both



groups was the same. Those students, who studied well, received good or excellent marks, those students, who did not study very diligently, did not show good knowledge. In assessing the project work, the most difficult thing was to evaluate the level of students' creativity. We measured the students' creativity with the help of the Torrance test, in which four indicators are taken as a basis: productivity, flexibility, originality, development. The main problem was to understand how strongly the knowledge and competencies that students received while studying at the university influenced the development of creativity. In our opinion, creativity depends on many factors, including general erudition, hobbies, social environment, and so on. While we were monitoring the behavior of students during the business game, the first group showed the best results of communication and interaction in the group. Students listened to each other attentively, used the techniques and practices that they had learned when performing similar tasks at campus classes, quickly came to a consensus and solved the assigned tasks with good results. At the same time, the students of the second group coped with the assignments slower, showed weak knowledge of communication practices, could not come to a consensus for a long time, reasoned their decisions poorly and could not defend their point of view confidently. The results of the third direction of assessing student knowledge and acquired competencies were approximately the same in both groups. We believe that the individual trajectory of each student's learning, the presence of two managers—a teacher and a company representative, as well as a good organization of individual work, both in the course of on-line and off-line learning, played an important role in achieving good results. Digitalization in Samara universities affected not only the content of education, but also the entire organizational process. Electronic cards, which students and teachers received, allow to automatically record attendance, student activity in the classroom, the number of absences and delays. During the full-time classes at the university, the digital devices fixed the beginning of classes, the number of students, who are present in the classroom, as well as the end time of lectures, seminars and practical classes. All information about the results of educational and scientific activities of both students and teachers is available for the university administration, the teachers themselves and the students.

We would like to admit, that traditional education is changing due to the development of digital technologies. Many innovative developments introduced into the educational process lead to an improvement in the quality of education, make the process of assimilation of knowledge more effective and interesting [2]. Students and teachers have gained access to many libraries in the world, have the opportunity to receive scientific and reference information without spending a lot of time on it. Digitalization accelerates the learning process, virtual and augmented reality technologies enable tomorrow's specialists to acquire competencies and skills that will allow them to adapt at work, performing it competently, effectively, without experiencing psychological problems at the beginning of their career. Artificial intelligence helps build an individual learning track, increases creativity and critical thinking. The results of all scientific and professional activities are stored in the cloud computing, what allows us to restore quickly all previous scientific achievements and developments. In our study, teachers, who spoke in favor of the possibility of a complete

transition of universities to a distance learning format, argued, that more people would be able to get education and it would become cheaper. A large number of students can participate in distance learning process, and many people can listen to lectures of one teacher at once. The next argument was that teachers would have better control of student individual work at any stage of its performance, which is quite problematic in the traditional form of education. If the process of interaction between the teacher and the student remains in digital format, the student will no longer be able to say that he or she has not understood something, or heard, or has not been told. Opponents of the full transition to online learning complain, that preparation for classes takes a lot of time, feedback from students is difficult to get, email or video communication also takes a lot of time, sitting in front of a computer for many hours leads to increased fatigue of both students and teachers. In addition, an analysis of the learning results of students who studied only remotely, without entering the campus, showed, that they lacked personal communication. Basically it is better to teach students to perform creative tasks in a traditional form of education, with the possibility of using virtual and augmented reality. However, lectures and classes in which teachers simply explain theoretical material are best to be held distantly. Perhaps it is even better to do it on the record. In our opinion, in this case, it would be nice for students to listen to lectures by teachers from different universities, but with the possibility of feedback.

With the advent of digitalization in universities, it became possible to build an individual learning track for each student, to make the learning process student-centered. Communication with employers, monitoring situation in the labor market arise challenges, that universities face. Universities are required to respond quickly to any changes, quickly change programs, abandon old disciplines and introduce new ones. With the development of distance education, competition among universities is increasing. In addition, we see, that other organizations are beginning to deal with the education process. It is possible that this will lead to a restructuring of the whole system of education. Another important issue, that requires discussion, is how to train the teachers themselves, with whom to discuss all the details of education in pedagogical universities? How creative and flexible should the teacher be? How to organize training at universities, so that graduates and specialists can improve their qualifications at any time and learn something new and useful? All these questions require discussion and further research.

## 5 Conclusion

Thus, the use of information technology leads to greater discipline of both teachers and students. This organization leads to the awareness of the importance of the educational process and assimilation of knowledge. Using the software for individual work forces students take all assignments seriously, as the program automatically checks the correctness of assignments and notes the time that students spent on them.

Digitalization allows us to make the approach to the education process more student-oriented. Analyzing the mistakes of students, the program forms additional tasks and exercises that are necessary for this particular student, greatly facilitating the work of teachers. The ability to evaluate each student's answer, to take into account all errors and inaccuracies in the answers gives the teacher a tool with which he/she can more effectively plan classes and make changes to the curriculum, if necessary. The freed up time the teacher can spend on developing creative assignments, on holding discussions, debates, which the computer cannot do. Close interaction with employers makes it possible to train highly qualified specialists who do not need to be retrained. Labor market research, undertaken by universities, will predictably decrease disturbance and anxiety among the university graduates.

## References

1. Atif, Y., Chou, C.: Digital citizenship: innovations in education, practice, and pedagogy. *J. Educ. Technol. Soc.* **21**(1), 152–154 (2018)
2. Gronow, J.: The principle of labour. In: Budgen, S., Edwards, S., Grigera, J., van der Linden, M., Thomas, P. (eds.) *On the Formation of Marxism: Karl Kautsky's Theory of Capitalism, the Marxism of the Second International and Karl Marx's Critique of Political Economy*, pp. 252–275. Brill, Boston (2016)
3. Kennedy, E., Neumann, T., Rowett, S., Strawbridge, F.: Digital education and the Connected Curriculum: Towards a connected learning environment. In B. Carnell, D. Fung (Eds.), *Developing the Higher Education Curriculum: Research-Based Education in Practice* (pp. 188–202). London: UCL Press. (2017).
4. Ozerbas, M.A., Erdogan, B.H.: The effect of the digital classroom on academic success and online technologies self-efficacy. *J. Educ. Technol. Soc.* **19**(4), 203–212 (2016)
5. Siebers, H.: When nationalism meets soft skills: towards a comprehensive framework for explaining ethno-migrant inequality in the Dutch labour market. In: Rijken, C., De Lange, T. (eds.) *Towards a Decent Labour Market for Low Waged Migrant Workers*, pp. 247–266. Amsterdam University Press, Amsterdam (2018)
6. Solignac, M., Tô, M.: Do workers make good neighbours? The impact of local employment on young male and female entrants to the labour market. *Annals of Economics and Statistics* **130**, 167–198 (2018)
7. Wagner, N., Hassanein, K., Head, M.: Who is responsible for E-learning success in higher education? A stakeholders' analysis. *J. Educ. Technol. Soc.* **11**(3), 26–36 (2008)
8. World Health Organization: Digital education for building health workforce capacity. <https://apps.who.int/iris/handle/10665/331524> (2020) .Accessed 21 March 2021

# Digital Transformation of Vocational Education: Challenges of Modern Society



A. N. Anisimova and Yu. I. Efremova

**Abstract** The passage of time in all spheres of human activity has significantly accelerated—industry is developing rapidly, priorities in the economy are changing, and new requirements are being imposed on science and education. To a large extent, these requirements are implemented by universities, and that means they must restructure their work. The educational process as a dynamic, holistic pedagogical system is subject to constant transformation. This shows the developing properties of the educational process, which characterize the change of the educational paradigm, the introduction of new learning tools and technologies. The digital transformation of vocational education, according to scientists, is the answer to the global information challenges taking place in the world. It should be accompanied by a “synergistic” update of the content. This will improve the quality of education. The authors of this article consider and systematize the directions of digitalization of professional education, determine their impact on the content and results of graduate training, on the relations of participants in the educational environment.

**Keywords** Blended education · Digital platforms · Educational activities · Modern trends in education · Online education · Virtual educational environment

## 1 Introduction

At present, along with the increasing variability of the surrounding world, globalization, personalization, technologization and the development of digitalization, changes are taking place in the market of educational services. There are new technologies that change the usual patterns of behavior and activity of people. Digital

---

A. N. Anisimova  
Moscow City Pedagogical University, Samara branch, Samara, Russia

Yu. I. Efremova (✉)  
Samara State University of Economics, Samara, Russia

platforms are being created in all areas of people's lives, which requires the acquisition of knowledge necessary for further interaction with technologies and the use of digital platforms.

The world is undergoing a digital transformation. It refers to the revolutionary changes in business models based on the use of digital platforms, which lead to a radical increase in the volume of the market and the competitiveness of companies. The goal of digital transformation (digitalization) of education is to ensure that the education system meets the tasks, challenges and opportunities of the information society. Here we are talking about changing the goals and content of education, improving the educational process (nurturing a new generation ready to learn for life and generate innovation) and immersing it in a digital environment.

Why are educational organizations starting the transition to digital platforms?

First of all, digital platforms provide educational organizations with the following advantages:

- ensuring high quality standards for the implementation of innovative methods, namely, project activities, subject-based training;
- automation of routine procedures;
- flexible customization options;
- gamification;
- ability to receive timely feedback;
- instant accounting of changes in all processes.

The digital platform is able to replace the current disparate educational process management systems and combine all the functions for the effective conduct of the organization's educational processes. The platform takes into account all modern achievements in the methodology of education [1].

Turning to the problem of the use of digital technologies in the education process, it is necessary to say that the movement in this direction, firstly, is not a purely national decision and priority, and secondly, has a deeper meaning and goals. Improving the quality and relevance of training and teaching, as well as developing the competencies of future specialists, is the main task of structural reforms in the field of vocational education.

When studying this topic, we pay attention, first of all, to three aspects of the use of digital technologies in a modern university:

1. Training with the help of digital technologies.
2. The use of digital technologies in the management of education of both the individual and the educational institution (including for assessing the degree of mastering the material, competencies, building and adjusting educational tracks).
3. Digital technology training for professional purposes.

## 2 Methodology

The methodological basis of the study is as follows:

- a general scientific systematic approach that is an organic part of society and reflects the changes taking place in it. This approach allowed us to analyze the digital environment in relation to the trends in the development of education as an integral system;
- hermeneutical approach, which involves an appeal to the value-semantic aspects of pedagogical phenomena in order to identify the principles of implementing the digital environment as a pedagogical condition for positive socialization.

The impact of digitalization on the education system is widely discussed in the literature. Both the advantages and disadvantages of digital technologies used in higher education are considered. The advantages include broad access of students to educational information resources; the ability to build individualized educational trajectories; transparency of the activities of educational organizations; optimization of interaction between teachers and students, between all participants in the educational process; formation of mobile educational process management structures, etc. [4].

Along with the positive aspects in the literature, there are also skeptical assessments of the digitalization of education. The following problems faced by the higher education system are discussed: the growth of student mobility, changes in their requests for the content, forms and technologies of education, the inability of universities to master new requirements and use the full potential of digital technologies. Researchers are seriously concerned about the formalization of professional training and the decline in the diversity of knowledge and competencies of graduates due to the absence of direct contact between the undergraduate and the teacher [10].

The analysis of domestic and foreign literature indicates the lack of development of this problem. There are practically no studies that would be devoted to the transformation of this institution under the influence of digitalization and the associated social risks as a probability of a positive or negative outcome of events for society and the institution of education itself. The goal of the paper is to study the key directions of professional education development in the digital society.

## 3 Results

The impact of digital technologies and tools on the institute of higher education is multifaceted. In the literature, both positive and negative aspects of digitalization are noted, which are important to study on a systematic basis. The digitalization of vocational education is an objective process that reflects the general logic of the transition to a digital society. The implemented digital technologies and tools change both the educational situation itself and the roles of the main participants in the educational

process (namely, teachers and students), as well as the rules of interaction between them. It is necessary to go from teaching everyone to teaching everyone (personalization of education), review and optimize the sets of educational and organizational solutions, information materials, tools, and use the rapidly growing potential of digital technologies. The emphasis in teaching the digital transformation of education is shifting to the development of new abilities: the ability to analyze, analyze, and transfer the acquired knowledge and skills to new situations.

Summing up the above, the conclusion is that the institute of higher education is being transformed. However, it is still difficult to say what the social consequences of such a transformation are, since, as noted earlier, there are no special studies focused on studying the process of transformation of higher education institutions under the influence of digitalization. In our opinion, these studies play an important role in understanding what requirements should be imposed on the modern teacher and student, which models of university management are more effective in the era of digitalization, and how to mitigate the negative consequences of digitalization of higher education. At the same time, comprehensive research is needed to describe the process of transformation of vocational education under the influence of digitalization and assess it from the perspective of social challenges that the higher education system and society as a whole face or will face in the future. Digitalization of higher education means the transformation of the educational and managerial process, everyday social practices in the system of professional education, due to the introduction of technologies for creating, processing, exchanging and transmitting large amounts of information on non-paper media. Digitalization involves the integration of education with information resources [7].

Considering the processes of digitalization of vocational education, we will pay attention to how the educational situation changes under the influence of digital tools and technologies, the role of key participants in the educational process, and the conceptual model of education.

The review of the literature allowed us to identify four trends related to the digitalization of higher education. These are the introduction of digital tools and technologies into traditional educational programs and academic disciplines (the formation of a mixed learning model); the development of online education; the creation of a virtual (digital) educational environment; and a change in the approach to managing educational organizations [2]. The above-mentioned trends are interrelated; each of them has its own specifics, its own social effects, so we consider it appropriate to consider them separately.

Not all universities consider digitalization as a priority direction of modernization of the educational process. At the same time, they cannot stay away from technological progress, since it is believed that the introduction of digital technologies and tools expands the possibilities of using interactive teaching methods, and positively affects the involvement of students in the educational environment. Effective technologies include the use of Learning Management Systems (LMS), which, according to researchers, facilitate access to educational materials and make the learning process more flexible [9].

Digital technologies based on artificial intelligence, such as chatbots are also very useful in organizing the educational process [10]. The study showed that students are comfortable using a chatbot: they get the necessary literature or the answer to their question faster; they may not go to the library if it is far away. For some students, it is more convenient to ask questions not to the librarian personally, but to the chatbot. Thus, this technology is a real assistant for students, facilitating their work with the search for literature. The chatbot also frees the library staff from routine work. They are used as virtual consultants, helping both students and teachers to adapt the learning process to the capabilities of students.

The question arises: what changes are being made to the institute of higher education by technologies based on artificial intelligence? If we talk about bots, we should pay attention to the fact that new, symbiotic structures arise in the educational process, based on the mutual dependence of humans and artificial intelligence. These structures impose their own logic of relations and distribution of roles. And it is still difficult to say what the social results of the new architecture of relations in the educational process are.

Along with digital technologies in universities, interactive Web 2.0 tools are used in educational practice, which are created on Internet resources such as Wikia, Babylon, Wikidot, etc., using various services (for example, Learning Apps). It is believed that these tools can activate students' interest in learning, increase their involvement in the educational process. At the same time, it is impossible not to pay attention to the fact that the introduction of web tools creates new requirements for both teachers and students. They should learn how to work with Web 2.0 tools, master digital competencies, namely, tools for preparing content: text documents, presentations, graphs, and so on [3]. However, as the experience of using digital tools and technologies in universities in different countries shows, not all students and teachers are ready for such changes.

## 4 Discussion

Based on the conducted research, the following main trends in educational activities in the digital economy can be identified.

### 1. Online education

Online learning based on digital technologies makes the educational process more dynamic, interesting and flexible. The created e-learning materials (e-textbooks, presentations, video tutorials, etc.) can be used repeatedly, which helps to save teachers' time for preparing for the lesson. They can pay more attention to communication with students. The Secretive, Kahoot, Edmodo, and Nearpod systems implemented in the educational process allow teachers to exchange interactive materials, engage students in discussing certain issues, and evaluate the performance of tasks in real time. At the same time, to work effectively in these systems, you need technical support. Thus, there is a need for



specialists or even individual structural units in the university that would provide such support. And this leads to a complication of the process of managing an educational organization.

Reflecting on the intensive development of online education, it is impossible not to notice more global social risks. Thus, competition between Internet portals that provide online learning services, as well as between universities that seek to expand their influence through online courses, leads to the growth of overlapping disciplines and educational materials and, as a result, to the leveling of the effect of the network model of education. Moreover, in the Internet space, educational materials of poor quality appear which sometimes do not meet the minimum requirements for educational materials in the higher education system. In this case, there is a risk of reducing the quality of training of university graduates. What problems does online education create in the relationship between teachers and students? Instead of the traditional face-to-face interaction, both students and teachers become invisible to each other. In this case, the communication between the teacher and the students, the mutual feedback, is built in a different way. For the teacher, it is important to identify individuals in the invisible and in this sense faceless mass of students, to determine their interests and potential for mastering the discipline, to find adequate forms of control over the assimilation of educational material. It is important for students to feel the attitude of the teacher and classmates to what and how he or she is doing here and now, how they evaluate the results of his or her work.

In a traditional educational situation, feedback is visualized: by facial expressions, gestures, additional questions and cues, you can understand and evaluate the reaction to both the actions of the teacher and the actions of students. In an online learning situation, adequate substitutes for natural responses are required, capable of simulating face-to-face interaction. In this case, video communication is a good solution, but it is quite an expensive technology, and not all universities can do it [4].

Online learning brings to the agenda another problem of communication between the teacher and students. This is the problem of maintaining an effective dialogue in the transfer of material in order to create a common sense and ensure mutual understanding, which is especially important in the teaching of social and humanitarian disciplines. In a face-to-face dialogue, emotions and intuition contribute to mutual understanding and the birth of a common meaning. They are difficult to reproduce in a dialogue mediated by Internet technologies. In addition, Internet technologies are a source of additional communication noise, which can negatively affect learning outcomes. It is necessary to develop technical means and tools that reduce the negative impact of Internet technologies on teachers and students. It is also important to prepare both teachers and students for dialogue mediated by Internet technologies. And here the creation of Internet platforms such as forums is not enough; we need the psychological readiness of the participants in the learning process to communicate in a new format.

The analysis of official digital resources of the global network and literature allowed us to identify the distinctive characteristics of modern professional

education. According to the results of a large study of the Russian market of online education and educational technologies [5], one can observe the growth of online education at all its levels. As of 2020, the highest percentage of online format penetration is seen in additional professional education (6.7%), additional school education (2.7%), and higher education (1.8%).

At the moment, a full transition to online education is not expected, and many educational organizations are at the stage of implementing blended learning, which involves attending both classroom classes and taking an online course [11].

## 2. Adaptive learning

The use of innovative adaptive systems in education helps to build the educational process with parallel building of the individual learning trajectory of a particular person. Adaptive mechanisms analyze the material passed by the student, errors in knowledge tests, and progress in learning. This analysis helps the system to build an educational trajectory and thereby increase the effectiveness of the learning process.

## 3. Gamification

Learning based on games simplifies the perception of educational material, keeps the attention longer and increases the interest of students.

## 4. Virtual and Augmented Reality (VR and AR)

The market for virtual and augmented reality is growing rapidly, as these technologies can be used to vary the content for training [8].

The purpose of this tool is to expand the physical space of a person's life with objects created using digital devices and programs that have the character of an image. Elements of virtual and augmented reality are used to study various disciplines. Modern digital technologies allow you to create a personal learning environment that integrates the possibilities of formal and informal self-regulated learning. The central role in the formation of a personal learning environment is played by social media as a set of various network tools and technologies that act as channels for communication, collaboration and creative self-expression. Experts refer to the following social media actively used in the educational process: web blogs, or easily created blogs, and up-to-date websites that enable authors to publish instantly online; they facilitate communication between teachers and students; Wikis—a website where any member can change any page or create a new page using their web browser, an example is Wikipedia; bookmark sites that provide users with the ability to bookmark and share links to sites; users can create a personalized Internet; examples of such sites are Stumble Upon, and Digg; social networks (YouTube, Facebook, LinkedIn, Contact, etc. Social media has valuable qualities for educational practice: (1) form a connected environment in which two aspects of knowledge reproduction are combined: its creation and consumption; (2) provide quick access to various types of information; (3) reproduce the situation of a dialogue with mutual feedback. However, it is worth noting that they contain a lot of “information garbage”, which prevents the adequate implementation of the educational process [6].

## 5 Conclusion

Modern society at the present stage is undergoing fundamental changes that affect all spheres of life, including vocational education. The specifics of professional education in Russia are determined by the development of the Russian economy. The labor market presents constantly changing requirements for specialists who do not depend on specialization. The philosophy of “one profession for a lifetime” is a thing of the past. At the moment, the specifics of vocational education are related to the use of distance learning technologies. The most common applications of electronic learning tools in the educational environment are: e-learning, distance learning, online learning, electronic simulators, electronic textbooks, smart education, etc. Each approach is characterized by features in the organization and construction of classes, the distribution of roles, management, etc. The information and educational environment carries a huge, often not fully used pedagogical potential. The main task is the individualization of the educational process, flexible organization, attractive by the possibility of remote presence and the use of additional time for training. The multi-level content of the educational resource helps to build more flexible individual plans and schedules, which contributes to successful learning. Now we are witnessing the digital transformation of universities. It is characterized by the transition of an analog environment to a digital one. But it's not just digitalization or informatization. A review of objectives, organizational structure, processes, products, management system, and expected results is required. To date, there are already existing and applied developments that allow universities to determine the so-called digital transformation index, that is, to assess the current state and determine the target. Only a well-established system of professional education and a person's personal desire for professional growth will be able to update the market of professions and thereby accelerate the development of society.

## References

1. Bruggeman, B., Tondeur, J., Struyven, K., Pynoo, B., Garone, A., Vanslambrouck, S.: Experts speaking: crucial teacher attributes for implementing blended learning in higher education. *Internet High. Educ.* **48**, 100772, (2021)
2. Burbules, N.C., Fan, G., Repp, P.: Five trends of education and technology in a sustainable future. *Geogr. Sustain.* **1**(2), 93–97 (2020)
3. Chinaeva, T.I.: The impact of digitalization on the processes of transformation of the higher education system. *Statistics and Economics* **17**(4), 85–95 (2020)
4. Dolgova, O.I., Mirzoyan, M.V.: Multi-criteria assessment of the university's readiness for digital transformation. *Creative Economy* **13**(4), 811–825 (2019)
5. EdMarket Research: Research of the Russian market of online education and educational technologies. <https://edumarket.digital/> (2020). Accessed 02 March 2021
6. Kaplan, A.M., Haenlein, M.: Higher education and the digital revolution: about MOOCs, SPOCs, social media, and the cookie monster. *Bus. Horiz.* **59**(4), 441–450 (2016)
7. Klochkova, E.N., Sadovnikova, N.A.: Transformation of education in the context of digitalization. *Open Education* **23**(4), 13–22 (2020)

8. Lacka, E., Wong, T.C., Haddoud, M.Y.: Can digital technologies improve students' efficiency? Exploring the role of virtual learning environment and social media use in higher education. *Comput. Educ.* **163**, 104099 (2021)
9. Lindvig, K., Mathiasen, H.: Translating the learning factory model to a Danish vocational education setting. *Procedia Manufacturing* **45**, 90–95 (2020)
10. Minina, V.N.: Digitalization of higher education and its social results. *Bulletin of the Saint Petersburg University. Sociology* **13**(1), 84–101 (2020)
11. Soler, R., Soler J.R., Araya, I.: Diagnosis of educational needs for the implementation of blended courses based on the blended learning model. The case of the social sciences faculty of the National University of Costa Rica. *Procedia Soc. Behav. Sci.* **237**, 1316–132 (2017)

# Critical Thinking in Professional Education: Digital Options for Teachers and Learners



O. V. Belyakova, N. A. Pyrkina, and E. S. Chuikova

**Abstract** Critical thinking is widely recognized to be the key to high-quality professional education. The previous studies of teaching tools that develop critical thinking searched mostly for traditional reading-discussion activities in a traditional classroom. The article updates the choice of the resources and evaluates mobile applications and online courses used in EFL teaching practice. The research is aimed at analyzing digital options that are essential for language learning as well as for professional growth and cognitive development. The authors scrutinize a number of language massive open online courses, mobile apps, and digital platforms targeted at promoting learners' critical thinking skills in reading, writing, and interaction. The methods of the research require evaluating the advantages and disadvantages of the examined digital tools. Additionally, some options in the digital assessment of the academic texts features are studied. Finally, the authors provide recommendations on the effective EFL teaching strategies coupled with the essential critical thinking activities in academic contexts.

**Keywords** Critical thinking · Digital feedback · Massive open online courses · Mobile apps · Online writing environment · Professional Education

## 1 Introduction

Digital technologies are widely used in all areas of human life: healthcare, manufacturing, logistics, supply chain management, science, and education. The latest

---

O. V. Belyakova (✉)  
Samara State University of Economics, Samara, Russia

N. A. Pyrkina  
Samara State University of Social Sciences and Education, Samara, Russia  
e-mail: [pyrkina@pgsga.ru](mailto:pyrkina@pgsga.ru)

E. S. Chuikova  
Moscow City University (Samara Branch), Samara, Russia  
e-mail: [CHuikovaES@mgu.ru](mailto:CHuikovaES@mgu.ru)

developments in education witness enormous growth in a range of digital tools used by both teachers and students. Digital formats (hereinafter referred to as DFs) are improving. As a result, learning options are expanding in blended learning, i.e. a combination of traditional offline teaching methods and online teaching via modern digital technologies. Nowadays we witness a shift in the educational paradigm, which is indicated by more extensive use of evolving digital tools and by a new role for the teacher who is required to explore digital resources (platforms, massive open online courses, and mobile apps), to analyze data, and to choose educational digital formats that would best meet students' needs. Moreover, today's learners who are sometimes called "digital natives" prefer online learning to traditional methods as they perceive information mostly through digital formats that is why it is important to concentrate on DFs which are of particular interest for this target group.

The DFs targeted at improving learners' language skills are rather diverse: Digital educational platforms, language massive open online courses (LMOOCs), online language learning communities, mobile applications (hereinafter referred to as MAs). A MOOC is an online course available to anyone to enroll. It combines traditional course materials such as reading, writing and listening assignments with interactive activities and media discussions [2]. The most well-known language online courses are Coursera, Futurelearn, Khan Academy. A mobile application is software that is compatible with smartphones and other mobile devices [9]. Some mobile apps are mobile versions of the corresponding education platforms and open online courses. MOOCs and MAs help to diversify teaching in a formal classroom setting, although these DFs are more appropriate for a non-classroom environment. With MOOCs and MAs language learning is more personalized and focused on students' needs, learners can get easy access to educational resources at any time and in any place, which contributes to students' active involvement in the study process.

Current research has shown that language DFs are primarily used by non-native English speakers wishing to build their vocabulary and enhance their language knowledge in general. However, language proficiency is not enough if you are eager to advance your career and achieve professional goals. The global marketplace requires employees that have professional skills related to adaptability, stress resilience, problem solving, data analysis, emotional and social intelligence, in other words, skills related to critical thinking. Thus, it is important to provide university-aged students with the digital resources that master not only learners' language skills but critical thinking skills as well. Critical thinking is the ability to think and make right decisions independently [8]. It aims to achieve understanding, evaluate outlooks, and solve problems. It refers to the ability of individuals to take charge of their own learning and take full responsibility for their own thinking. It is a proven fact that critical thinking can improve learner's writing ability, ability to communicate and in general, it can raise learners' language proficiency [11]. Thus, we recognize it is essential to identify the MOOCs and MAs that facilitate learners' critical thinking, reading and writing skills in professional education, and to provide tips both for teachers and students on efficient digital resources.

## 2 Methodology

In academic contexts enhancing critical thinking in learners should be a priority as it correlates with the learners' achievements. Critical thinkers monitor and evaluate their own learning more successfully, develop appropriate criteria for analyzing their own thinking, practise a formula for problem solving and improve their academic results in general. Language development and thinking are closely interrelated. University-aged students can acquire critical thinking skills in an English classroom through relevant reading and writing activities. Text activities and assignments are based on the so-called 'wh-' questions—Who? Which? What? How? Why? Where? When?

Who?—Who wrote the text? Who provided the information? Do you know the name? Is he/she a specialist in the field?

When?—When was the text written? Is it an old text or a new one? Could things have changed since the text was written?

Where?—Where did the information come from? Where was the text written? Where was it published?

Why?—Why was it written? Does it provide information? Is it presenting an argument?

Which?—Which side(s) of the argument does the author present? Are there any arguments that the author does not mention?

How?—How does the author justify the arguments? Are the arguments logical?

Critical thinking, reading, and writing activities can be provided both in face-to-face classes (synchronous learning) and in a distance asynchronous format. With limited hours of teacher-student English classes at university students can independently use the numerous digital resources available online today and thus become more proficient language users and critical thinkers.

However, sometimes it is not an easy option for university-aged learners to choose an appropriate resource. Thus, we analyzed some of the most popular MOOCs and language apps taking into consideration learners' needs. The integrated approach was used while combining comparative study and synthesis analysis.

Another challenge of digital education is teachers' special training to balance traditional and digital tools for the learners' benefit [10].

First, we studied a number of MOOCs and apps to trace their similarities and differences, and revealed their advantages. We analyzed the structure, activities, navigation instruments and skills to be developed paying particular attention to critical thinking. The data obtained proved to be significant for gaining professional skills via FL training. Furthermore, we developed a list of recommendations for FL teachers and students. Finally, we evaluated a group of tools that could provide an automated feedback on students' academic writing. The *Write & Improve* and *Write-full* apps may digitally support academic writing. To implement them efficiently we analyzed which text features they cannot assess, thus, requiring writers' critical thinking development.

### 3 Results

The research shows that some of the MOOCs prove to be quite useful for advanced students of English motivated to develop their critical thinking skills for professional purposes. For instance, COURSERA, a platform targeted at English speaking specialists, exposes great educational opportunities both for teachers seeking new methods of teaching critical thinking and for students aimed at acquiring thinking and argumentation skills.

A thorough study of courses available on COURSERA made it possible to figure out four courses that aim to foster learners' logic, reasoning, argumentation, problem-solving, and critical thinking skills (in general) in academic culture and professional contexts. These are:

1. Critical thinking skills for university success (University of Sydney) [5].
2. Professional skills for the Workplace (University of California in Davis) [7].
3. Critical thinking skills for the professional (University of California in Davis) [4].
4. Mindware: Critical thinking for the information age (University of Michigan) [6] (Table 1).

Promoting learners' thinking skills with the COURSERA courses mentioned above can prove to be effective. The authors found a significant relationship between the course efficiency and the factors listed below:

1. Course takers should not be lower than intermediate language learners, otherwise it will be difficult for them to get involved in teacher-student interaction, take part in group discussions, and fulfil the course assignments.
2. Course takers are likely to be language learners with a wide profession targeted vocabulary, or professionals early in their careers that have knowledge of a large number of professional words in English to take part in free discussions.
3. Taking a course should not be mandatory, but optional for students (the teacher should outline the syllabi of the recommended courses, explain their structures, trace their similarities and differences).
4. Course takers would rather be not time-pressed and follow the syllabus of the chosen course with their own pace.
5. The teacher might encourage learners to follow the course with some kind of reward (for example, taking a COURSERA course in critical thinking can be an alternative to studying the corresponding unit of the traditional university course).
6. The results achieved after completing a COURSERA course in critical thinking could provide a basis for learner's research paper.
7. The students need to learn about the option to promote their LinkedIn profile with the course certificate of completion, thus, they gain a professional stimulus.
8. A few classmates following the same COURSERA course might discuss the progress they achieved on completing part of the course (or the whole course) in class; it should be done in a friendly non-competitive atmosphere. When learners



**Table 1** Evaluation of COURSERA academic courses design fostering critical thinking skills

| Course title   | Course aims   | Content   | Outcomes  |
|--|---|---|---|
| Critical Thinking Skills for University Success (University of Sydney)   | To focus on the basic principles of critical thinking and argument in academic culture  | <ul style="list-style-type: none"> <li>– Critical thinking in academic culture</li> <li>– logic and reasoning strategies, argumentation</li> <li>– information and digital literacy,</li> <li>– problem-solving,</li> <li>– critical reading, and reflective writing</li> </ul>   | Students will be able to use a model for solving problems in an academic environment and apply critical thinking skills in the global marketplace   |
| Professional Skills for the Workplace (University of California in Davis)<br>Critical Thinking Skills for a Professional (University of California in Davis) | To focus on achieving students' professional goals, to practice critical thinking to reach decisions independently, to practise a formula for problem-solving, to build adaptability and resilience skills that impact performance in the workplace | Professional problems are simulated<br>Models of problem solving are introduced   | English language learners will master strategies to look at a problem from various possible angles and consider multiple solutions. They will learn to implement models of problem solving in an ever-changing professional environment |
| Mindware: Critical Thinking for the Information Age (University of Michigan)   | To develop the ability to collect, analyze and think critically about data<br>To indicate misinformation in the media and in a professional environment   | A range of contexts: from tackling everyday problems up to making a scientific research<br>It presents basic concepts from cognitive psychology, statistics, cost–benefit theory and the theory of probability, scientific methodology<br>Examples are taken from the media, business and everyday life situations to apply to the concepts presented | Learners will cultivate a growth mindset and explore strategies and techniques to build their critical thinking skills in our high-tech information age   |

Source Authors

are more concerned with cooperation and teamwork rather than competition they are more likely to achieve good outcomes in developing their critical thinking and argumentation skills as well as reasoning and problem-solving skills. While cooperating and holding discussions on the issues or assignments of the course they help each other enhance their critical thinking skills.

9. Completing the course, the language learners should share their impressions, emotions and views on the course with their classmates. It is important to discuss the outcomes in class, outline what was challenging when taking the course and whether the course should be recommended for university-aged students or professionals early in their careers.

Digital options for promoting learners' critical thinking skills include mobile apps as well. The current study also investigated that *BBC Learning English* is ranked among most popular educational platforms and applications that can be used not only for developing learners' four basic skills (reading, writing, listening and speaking) but for facilitating learners' critical thinking as well.

With the *BBC Learning English* app you can navigate through ten programmes. *News Review* and *LingoHack* provide learners with texts, audio and video news stories that are updated regularly. These stories can be used as study resources for encouraging language learners' critical thinking, reading, and listening skills through the so-called 'wh-'questions (Who? What? How? Why? Where? When?).

For a more comprehensive study, learners can follow the *GO the Distance: Critical thinking* course (available only on the platform). It can be quite challenging if learners are persistent in fulfilling all the activities provided by the course [1], share their opinions with other participants, and understand that critical thinking is a need-to-know professional skill, a must of the modern world.

The advantages of this application for developing critical thinking are as follows:

1. It is free for users.
2. It (the app) can be easily installed on the learner's phone or tablet.
3. It is easy to navigate (its interface is easy to use).
4. Learner materials are updated daily.
5. With the app learners can download audio programmes, which they can access when they are not connected to the Internet.
6. It provides multimedia English language teaching materials to meet learners' needs.
7. Learners can follow either a full course or the individual materials most appropriate to them.
8. It improves learners' professional vocabulary skills (with the *BBC Digital Literacy* program).
9. It has tips for teachers and students.
10. Reading and listening materials are based on authentic texts and burning topics (economy, environment, ecology, inventions).
11. It can be quite motivating to self-study the lessons or follow them with classmates under the supervision of a teacher.

**Table 2** Macro-level and micro-level text features assessed by digital feedback

| Program name                      | <i>Write &amp; Improve</i> | <i>Writefull</i>                             |
|-----------------------------------|----------------------------|--|
| Assessed features                 |                            |  |
| <i>Micro-level text features:</i> | +                          | +  |
| – grammar                         | +                          | –  |
| – word count                      | +                          | +  |
| – vocabulary                      | +                          | +  |
| – punctuation                     |                            |  |
| <i>Macro-level text features:</i> | + /–partly (formally)      | + /–(in a premium mode)                      |
| – content                         | –                          | + /–(provides phrases for each text section) |
| – structure                       | + /–partly (formally)      | + /–partly (formally)                        |
| – coherence                       |                            |  |

Source Authors

Another group of educational apps can be used for developing students’ critical writing skills. Digital tools essentially diversified the context of real language use. Thus, new social tools brought new writing genres to a classroom: wikis, blogs, digital story scripts etc. Modern apps also provide ‘online feedback opportunities’, which resulted in maximized ‘positive perceptions of writing’ among students and time-saving from marking among teachers. Nevertheless, Internet electronic social communication in most cases is not aimed at teaching and improving essential academic skills. The *Write & Improve* [3] and *Writefull* [13] apps provide a professional automated feedback on a range of aspects in academic writing.

The researchers roughly distributed them onto two groups: micro-level and macro-level text aspects [12]. Most of the tools may process the first group of the text features, but very few can really provide a feedback on the second one that involves critical thinking (Table 2).

Both apps under consideration base their assessment on the scientific articles/IELTS essays databases. The authentic assessment is an opportunity to develop the poorly marked areas. Additionally, the editing process boosts critical thinking since the author needs to identify which machine correction to accept and which one to skip. While checking the text in *Write & Improve* the author receives some prompts through differently coloured sentences. Each colour indicates to what extent the syntax of the sentence is incorrect. The writer takes the final decision: what to correct, and what strategy to apply for correction. In *Writefull* the procedure seems to be more obvious. The system provides several options for correction backed up with the percentage of frequency of each element as they appear in the system database.

However, automated feedback is unlikely to give a guarantee since digital tools or machine processing cannot interpret the context as well as the human mind can. Neither can apps assist a person in the process of writing. Partly this problem is solved with Interactive Writing Platforms, for instance, *Presentation Planner*. To sum it up, MOOCs, the BBC Learning English app, learning writing apps and interactive writing platforms, have proved to be useful tools to motivate learners to develop their

language proficiency and improve their critical thinking, as well as critical reading and writing skills.

## 4 Discussion

Digital education is multifaceted, i.e., most studies focus on various tools and provide varied recommendations. This study emphasizes those tools that best foster critical thinking skills in mastering a foreign language competence at a professional level. The results obtained in the study imply the advance of digital resources, since more frequently there appear the tools that are sufficient for productive and critical activities.

First, LMOOCs are valuable tools for building professional competencies. Importantly, the results reveal that LMOOCs help to create a personalized, professionally motivated educational environment. The analysis results in Table 1 present various aspects of LMOOCs design that increase learners' motivation, namely:

- the choice of authentic real life professional content: examples are taken from media, business and everyday life situations;
- the engaging procedure: professional problems are simulated, models of problem solving are introduced;
- and appealing outcomes: English language learners master strategies of problem-solving and consider multiple solutions. They learn to implement models of problem solving in an ever-changing professional environment.

Additionally, students may get a certificate to verify their compatible employability skills. LMOOCs forums and chats give learners a sense of unity and community, contribute to the team spirit, which is essential for obtaining professional knowledge and skills. The results show that mobile devices may master both students' micro and macro skills. In case the apps are used to get language feedback, they contribute to the development of the overall language competency, i.e., micro skills. Most digital tools could be easily operated at this level.

The authors have analyzed dozens of apps to conclude that those aimed at developing macro skills are less frequent. Among the significant professional macro skills, one could distinguish:

- cognitive skills;
- writing process skills;
- authentic content comprehension skills;
- logical reasoning;
- and structuring text skills.

The most striking observation to emerge from the analysis was that well-developed digital tools are initially designed for both micro and macro skill development. Since the possibilities to work at macro skill level/productive level are more valuable, they are mostly provided in premium versions, that is for extra fees. The same is true

for LMOOCs. A MOOC market provides an immense scope of materials; however, there are a few online courses that could be used for developing students' critical thinking.

Certainly, the educational potential of online courses is really large, but we are also aware of the fact that current technical characteristics of mobile applications do not allow them to be actively used in organizing discussions, role-playing games, brainstorming, i.e., those activities that can also contribute to fostering learners' critical thinking skills. Nevertheless, it is possible and desirable to use a number of extra thought-provoking assignments after reading and writing texts that can help in developing analytical and critical thinking skills.

## 5 Conclusion

Most professions these days require more than specific knowledge and general intelligence. They require the ability to collect and analyze data, identify biases and assumptions, pose questions, make balanced decisions and develop a growth mindset, in other words, the ability to think creatively and critically.

At the international IT language market there are digital educational platforms (MOOCs) and applications targeted at promoting learners' critical thinking (as well as critical reading and writing) skills for professional purposes. MOOCs and MAs proved to be very popular among foreign language learners. They are easily accessible, interactive, informative, profession focused, which enhances not only learners' language competence but also their argumentation, logic, reasoning, and problem-solving skills.

Intensive intellectual work with high-quality mobile applications and online courses enables students to update their experience and knowledge, which undoubtedly contributes to developing their critical thinking skills in a professional language environment. The study suggests that in a multi-level classroom environment teachers should strive for a blended approach, which involves both traditional (teacher-student) offline learning and distanced online learning based on individual or teamwork with MOOCs and MAs.

## References

1. Belyakova, O.V., Pyrkina, N.A.: App-based multimedia in foreign language teaching: options for language learner. In: Ashmarina, S., Mantulenko, V. (eds.) *Current Achievements, Challenges and Digital Chances of Knowledge Based Economy. Lecture Notes in Networks and Systems*, vol. 133, pp. 549–557. Springer, Cham (2021)
2. Bovtenko, M.A., Parshukova, G.B.: Subject MOOCS as component of language learning environment. In: Filchenko, A., Anikina, Z. (eds.) *Linguistic and Cultural Studies: Traditions and Innovations*, pp. 122–127. Springer, Cham (2018)

3. Cambridge English. Write & Improve: Write & Improve workbooks (2021). <https://writeandimprove.com/workbooks#/wi-workbooksare>. Accessed 24 March 2021
4. Coursera: Critical thinking for the professional (2021). <https://www.coursera.org/learn/critical-thinking-skills-for-professionals>. Accessed 23 March 2021
5. Coursera: Critical thinking for university success (2021). <https://www.coursera.org/learn/critical-thinking-skills>. Accessed 23 March 2021
6. Coursera: Mindware: Critical thinking for the information age (2021). <https://www.coursera.org/learn/mindware>. Accessed 23 April 2021
7. Coursera: Professional skills for the workplace (2021). <https://www.coursera.org/specializations/professional-skills-for-the-workplace>. Accessed 23 April 2021
8. Heidari, K.: Critical thinking and EFL learners' performance on textually-explicit, textually-implicit, and script-based reading item. *Think. Skills Creativity* **37**, 100703 (2020)
9. Perez-Paredes, P., Guillamón, C.O., Van de Vyver, J., Meurice, A., Jimenez, P.A., Conole, G., Hernández, P.S.: Mobile data-driven language learning: affordance and learners' perception. *System* **84**, 145–159 (2019)
10. Robinson, J., Dusenberry, L., Hutter, L., Lawrence, H., Frazee, A., Burnett, R.E.: State of the field: teaching with digital tools in the writing and communication classroom. *Comput. Compos.* **54**, 102511 (2019)
11. Soufi, N.E., See, B.H.: Does explicit teaching of critical thinking improve critical thinking skills of English language learner in higher education? a critical review of causal evidence. *Stud. Educ. Eval.* **60**, 140–162 (2019)
12. Strobl, C., Ailhaud, E., Benetos, K., Devitt, A., Kruse, O., Proske, A., Rapp, C.: Digital support for academic writing: a review of technologies and pedagogies. *Comput. Educ.* **131**, 33–48 (2018)
13. Writefull: Help your students and researchers with their academic writing (2021). <https://writefull.com/institutions.html>. Accessed 21 March 2021

# New Requirements Format for Higher Economic Education in the Era of Digitalization



T. A. Bityukova

**Abstract** The article studies the relations of educational standards in the enlarged group of Economics with the recommended professional standards. The assessment of the possibilities of professional requirements unification in the conditions of digitalization and transition to a mixed type of training is carried out. The new format of teaching students, including remotely using digital technologies, requires a more careful selection of training profiles (programs) within each direction. Different approaches to the formation of training profiles are considered, the authors of which argue both “for” and “against” the unification of curriculums. Comparing the types of professional activities within a given training group can help reduce the list of related activities and reduce the administrative costs of training qualified personnel without losing the quality of education.

**Keywords** Digitalization of education · Educational standards · Higher education

## 1 Introduction

When forming curriculums for training areas, each educational institution of higher education is faced with the need to determine the number of training programs within each direction. Until recently, it was believed that the larger the university, the “richer” and wider the list of offered educational programs should be. This indicator, specifically in terms of the number of educational programs, and not just the number of training areas, was included in the monitoring list by the Ministry of Science and Higher Education of the Russian Federation. As a result, a huge number of many variations of educational programs within each training area appeared. This narrows the professional focus of bachelor’s degree training, which is especially noticeable, for example, in economic programs. The situation worsened during the COVID-19 pandemic due to the need for an emergency restructuring of the training

---

T. A. Bityukova (✉)  
Samara State University of Economics, Samara, Russia

system. Therefore, many universities faced the question of the legality and expediency of reducing the list of educational programs and maximizing the unification of disciplines.

## 2 Methodology

The choice of the number and names of educational programs within each training area is determined by a group of factors and corresponding criteria. In an enlarged form, they can be represented as follows:

- economic factors;
- commercial factors of supply and demand;
- factors of future demand for specialists;
- administrative factors of management within the university.

Economic factors determine the effectiveness (profitability) of the implementation of each individual educational program. Commercial factors determine the ratio of public demand and interest in certain training programs, taking into account the offers of universities in a particular region.

The factors that shape the future demand for specialists are very multifaceted and are determined, among other things, by the development of society, the emergence of new specialties that are in demand on the labor market, and the death of old ones [1, 5, 7]. Possible professional transformation sometimes does not cost retraining, but requires the development of fundamentally new specialties. The social consequences of making decisions about training specialists should also be taken into account. The university should train specialists who are in demand on the labor market, and not future unemployed people who are forced to receive a second education, in case there are financial opportunities for this.

The administrative management of a university is a complex system of relationships that often leads to a direct relationship between the number of graduate departments and the number of training programs. This group of factors also includes the problems of the professional level of teachers, who should not only to keep up with the times, but also stay ahead of them, having time to improve their own professional skills and abilities. In addition to all of the above, the digitalization of education introduces new additional requirements not only for the quality of the educational process, but also for the material and technical base of the university.

However, the modern modernization of the higher education system, the quintessence of which is to meet the needs of citizens, society and the labor market in high-quality higher professional education, orienting universities to an innovative path of development and building strategic competitive advantages on the educational market, depends not only on the amount of funding. To achieve these goals, it is necessary to improve the efficiency of management in higher education institutions [4]. The study uses the methods of expert analysis of normative and legislative documents in the field of higher education, comparative analysis and synthesis.



### 3 Results

At the present stage of development, the attitude to economic specialties is undergoing enormous changes. You can often hear that the professions of an accountant or manager are becoming obsolete, becoming outdated. Many specialists agree with the opinion that it is necessary to review the production functionality of both the accountant and the manager to expand their professional skills and abilities.

As part of the compilation of the “Atlas of new professions”, a study of the prospects for the development of various professions was conducted, which showed, in the authors opinion, that the accountant is an outdated intellectual profession, which, along with other 56 profession—“pensioners”, will disappear by 2030. Nowadays, in the “Atlas of new professions”, it is written that special software allows beginners to quickly cope with the basic operations of audit and accounting. In the future, computer programs will be able to completely replace people [12]. Let's consider the average, most common, list of educational programs in the areas of training within the enlarged group of economics and management for universities of the Samara region (Table 1).

As can be seen from the table, the greatest variety of training programs is observed in the training program Economics. At the same time, this is the most criticized set of future specialties. And in the Management training program, there is clearly a division into two subgroups: Management and Logistics with Marketing separately. The rest of the training areas are not characterized by such a spread and variety of programs, many are called the same as the training area. In this regard, a question arises: Do we need such a “narrow” specialization in the Economics and Management programs? Does it make sense for the university to spend financial resources on training specialists whose professions may not be in demand due to the too narrow profile? This issue is debatable and has been discussed by many authors. So back in 2008, the managing partner of the department “Finance” of the KC “UNITY” Vintcha noted that despite the desire to expand professional knowledge, which once prevailed in financial circles, in recent years, another trend is gaining strength—the narrow specialization of accountants. The unique skills that a specialist has today in a particular industry or even in a particular area of work, allow you to solve many tasks quickly and professionally [12].

However, nowadays, the views on vocational training have undergone significant changes. The new format of requirements for higher economic education expanded the range of necessary professional skills. For example, the following requirements are imposed on an accountant (Accounting, Analysis and Audit program), in addition to the main professional requirements, which are implemented in priority by other training programs:

- to know the tax system and be able to work with the tax authorities (Taxes and taxation program);
- to understand credit relationships and work with banks and insurers (Finance and Credit program);

**Table 1** Bachelor's degree programs in the areas of training in the enlarged group 38.03.00 Economics and management

| Code of the training direction | Name of the training area           | Training program (Bachelor's degree level) |
|--------------------------------|-------------------------------------|--|
| 38.03.01                       | Economics                           | Accounting, analysis and audit             |
|                                |                                     | Global economy                             |
|                                |                                     | Regional economy                           |
|                                |                                     | Finance and credit                         |
|                                |                                     | Business analytics and statistics          |
|                                |                                     | Securities market                          |
|                                |                                     | Economics and company management           |
|                                |                                     | Taxes and taxation                         |
|                                |                                     | Entrepreneurial business                   |
| 38.03.02                       | Management                          | Organization management                    |
|                                |                                     | Financial management                       |
|                                |                                     | Logistics                                  |
|                                |                                     | Marketing                                  |
| 38.03.03                       | Human resources management          | Organization personnel management          |
| 38.03.04                       | State and municipal management      | State and municipal management             |
| 38.03.05                       | Business Informatics                | Business Informatics                       |
| 38.03.06                       | Commercial business                 | Commercial activity                        |
| 38.03.07                       | Commodity research                  | Commodity research                         |
| 38.03.08                       | Housing and communal infrastructure | Housing and communal infrastructure        |

Source author

- to keep records of settlements with personnel (Personnel management of the organization program);
- to perform computerized accounting and analyze data (Business Informatics program);
- to take into account the organization's turnover (Commodity research program).

Thus, we see that this program is very capacious in terms of labor functionality and may contain certain disciplines of the above programs. In more detail, we can compare the programs of the enlarged group of Economics and management in the areas of training by analyzing general professional and professional competencies in relation to the lists of professional standards corresponding to the professional activities of graduates, given in the appendices to all standards.

Universal competencies are the same for all bachelor's training programs and, accordingly, for the group 38.03.00 Economics and management. The analysis of general professional competencies shows large differences, with the most different areas (and programs, respectively) of business Informatics and housing and communal infrastructure. These two areas are so out of the general scheme of training economists and have separate professional standards that many universities do not dare to open programs on them in the context of the enlarged group of Economics and management. There are too many differences from the classical training of economists, and the program Housing and communal Infrastructure is more similar to the industry and requires technical, rather than economic knowledge and skills.

The closer the training programs are within the same direction, the easier and more cost-effective it is to make the same blocks of disciplines at the beginning of training, and to provide a narrow specialization on the senior courses. The idea of narrow professional training in master's programs has not fully justified itself. Not all graduates of the bachelor's degree seek to continue their studies in the master's program, and some simply do not have the financial resources to do so.

Unfortunately, the greatly reduced list of professional training programs does not allow universities to introduce their own, independently developed specialty programs. Perhaps the only similar program is the Economic security program. But it cannot be fully correlated with the bachelor's degree Economics and management program.

Thus, it is quite a justified step to consider not the allocation of highly specialized programs, but on the contrary, the consolidation of them. At the same time, the development of a unified list of disciplines cannot and should not be carried out only taking into account the interests of departments to maintain the academic load.

It is necessary to establish a mandatory list of professional disciplines that the student have to study in the process of studying at the university. It can be based on the one that is available in International Educational Standards [6], for example, for accountants. This approach prevails in international practice. However, the time allotted for practical training is 20–25% more than in the Russian educational standards for bachelor's degree training. This would correspond to the level of training

in the specialty, that is, during 5 years of training, and not 4 years as in the preparation of a bachelor's degree. Many universities are implementing or have already implemented, due to the COVID-19 pandemic, the practice of distance learning for students. The pandemic and the self-isolation regime forced all universities, without exception, to look for opportunities and options to continue the educational process remotely and even conduct intermediate and final certification. It was not immediately and not everyone managed to do it in such a way that it was convenient and acceptable for both students and teachers, so that they could control the educational process and continue it at a high level.

The presence of a single block of disciplines will allow to introduce a more qualitatively developed digital format for teaching students. Less labor and financial resources are required when developing a standard set of disciplines. Of course, we would like to have a single information platform for this type of activity, developed at the national level. Nowadays, there are many resources in the open access, which were used by universities and many of them specially redesigned their programs to provide opportunities for communication via on-line broadcasting and file sharing, etc., but this was in an emergency situation. It seems necessary to develop a single quality resource for all educational institutions of higher education.

## 4 Discussion

Universities should be sustainable and at the same time competitive. Many authors single out the ability of universities to achieve sustainable development as a priority area of the university's administrative activities. Each university needs to create a program for the development of education in its university and directions for improving the educational environment [2].

For teachers, it is necessary to determine the list of digital competencies, since the digital environment of the university also implies a higher level of digital literacy of teachers. The effectiveness of the educational process using digital technologies is based on digital competencies, which are currently universal and provide participants in the educational process with adaptive mechanisms [15].

Strengthening digital literacy requires a comprehensive approach, well-defined priorities, and training programs to improve the skills of teachers. Education should develop in parallel with the development of science and technology [8].

COVID-19 caused the closure of university campuses around the world and the migration of all studying, teaching, and assessment to online domains. The consequences of this for the academic community as leading providers of higher education are enormous [14]. The crisis requires a renewal of society, although a destructive one. The current Covid-19 pandemic is suddenly and fundamentally changing the ways of work, live, and relations with each other globally [11]. For example, the strategic model of distance learning adopted by Italian higher education, implemented as a health emergency due to Covid-19, has transformed it from "optional" for traditional

universities into the only mean of ensuring the protection of public health and the continuity of educational programs [3].

The progressive digitalization of business, economy, and society puts higher education institutions (HEIs) at the center of the discussion on how to effectively respond to the challenges and opportunities that arise in such a way [10]. There are several aspects of this process and related challenges, including the difficult question of how to match students' skills and competencies to the requirements and expectations of the industry. On the other hand, given the changing nature of work, universities have a responsibility to equip future employees with the skills needed to work in virtual, distributed, culturally diverse, and often global teams. Thus, digitalization in Russian universities generally reflects the expectation of their further development and the positive attitude of students to the available opportunities [9].

## 5 Conclusion

Thus, the economy of state universities is very specific, characterized by a mixture and diversity of subjects and forms of management and is a combination of underdeveloped market and non-market organizational and economic mechanisms of functioning. The activities carried out by universities, in which there are two sides—entrepreneurial, represented by the private interest of the university as a separate commodity producer, and state, embodying the public interest, contradictory, complicating the functioning of universities [6, 13]. The development of the higher education system is undergoing major changes not only in terms of the relationship between educational programs and professional standards, but also in connection with the digitalization of society as a whole. Education should develop in parallel with the development of science and technology, taking into account advanced technologies. To reduce labor and financial costs, it is recommended to consolidate bachelor's degree programs in each direction and allocate blocks of disciplines that will be in demand in all training programs. The student community is more ready for the transition to digital education and actively uses all its advantages. Teachers, for the most part, need professional development to strengthen digital literacy.

## References

1. Abad-Segura, E., González-Zamar, M.-D., Infante-Moro, J.C., García, G.R.: Sustainable management of digital transformation in higher education: global research trends. *Sustainability* **12**(5), 2107 (2020)
2. Abad-Segura, E., González-Zamar, M.-D.: Sustainable economic development in higher education institutions: a global analysis within the SDGs framework. *J. Clean. Prod.* **294**, 126133 (2021)
3. Appolloni, A., Colasanti, N., Fantauzzi, C., Fiorani, G., Frondizi, R.: Distance learning as a resilience strategy during covid-19: an analysis of the Italian context. *Sustainability* **13**, 1388

(2021)

4. Gluschenko, A.V., Egorova, E.M.: Accounting and management problems of higher education and ways to solve them. *Int. Account.* **16**(262), 10–15 (2013)
5. Hinings, B., Gegenhuber, T., Greenwood, R.: Digital innovation and transformation: an institutional perspective. *Inf. Organ.* **28**, 52–61 (2018)
6. International standards of education. <http://www.misbfm.ru/node/10574#ies2> (2005). Accessed 25 March 2021
7. Kholiavko, N., Chekhovych, T., Mirshuk, O., Vovk, V.: Integrated model of the competitive higher education: legal, economic and psycho-pedagogical aspects. *Int. J. Ind. Eng. Prod. Res.* **31**(4), 535–545 (2020)
8. Pozilova, S., Madaminov, K., Otamurodov, G., Murtazaeva, U., Zakirova, F.: Comprehensive approach to curriculum design for advanced training of academic staff in the direction Radio electronic devices and systems in Uzbekistan. *Int. J. Inf. Educ. Technol.* **11**(3), 137–142 (2021)
9. Ronzhina, N., Kondyurina, I., Voronina, A., Igishev, K., Loginova, N.: Digitalization of modern education: problems and solutions. *Int. J. Emerg. Technol. Learn.* **16**(04), 122–135 (2021)
10. Saeedi, K., Visvizi, A.: Software development methodologies, HEIs, and the digital economy. *Educ. Sci.* **11**, 73 (2021)
11. Spivakovskyy, S., Slipchuk, V., Svyrydenko, O., Perova, S., Krysalov, O.: Virtual space as a platform for student research practices. *Int. J. Ind. Eng. Prod Res.* **31**(4), 547–558 (2020)
12. Varlamova, D., Sudakova, D. (Eds.): Atlas of new professions. [https://atlas100.ru/upload/pdf\\_files/atlas.pdf](https://atlas100.ru/upload/pdf_files/atlas.pdf) (2020). Accessed 20 March 2021
13. Vintcha, Yu.: Narrow profile or wide area of thought? *Raschet*, vol. 11. <https://www.audit-it.ru/articles/personnel/a111/185216.html> (2008). Accessed 25 March 2021
14. Watermeyer, R., Crick, T., Khigh, C., Goodall, J.: COVID-19 and digital disruption in UK universities: afflictions and affordances of emergency online migration. *High. Educ.* **81**, 623–641 (2021)
15. Zabolotska, O., Zhyliak, N., Hevchuk, N., Petrenko, N., Alieko, O.: Digital competencies of teachers in the transformation of the educational environment. *J. Optim. Ind. Eng.* **14**(1), 43–50 (2021)

# How Digital Technologies Are Changing Business Education



S. A. Gryaznov

**Abstract** Digital technologies are changing business education. Over the past few years, the topic of digital transformation has been one of the most relevant in the global business community. A powerful driver of digitalization in 2020 was the pandemic. New economic realities, changing expectations and people's behavior, new technologies that make it possible to realize the previously impossible—these are the factors that force all industries to rethink their business and use new opportunities for its growth. How should business schools position themselves in this volatile environment? This article is devoted to the main trends that are calling for a revolution in business education. The author concludes that as a result of forced distancing due to the Covid-19 pandemic, there was an irrevocable large-scale transition to mainly online learning and suggests that the model consisting of three phases best reflects the evolution of online learning in business schools.

**Keywords** Business school · Digital transformation · Digital technologies · Innovation · Online learning

## 1 Introduction

Business schools have an important role to play in what the World Economic Forum has called the “The Great Reset” as the world adjusts to the post-COVID-19 pandemic, but to reach their full potential, business schools must change [12]. The same path should be followed by universities and businesses that support them and interact with them. During the pandemic, for example, universities focused on critical work in developing vaccines and medical equipment, as well as areas such as epidemiology. Business schools can also make a valuable contribution to this effort. For example, with experience in supply chain management, operations, and logistics, they can advise on vaccine production and distribution issues, as well as on testing integrity and ethics. In addition to these pressing issues, business schools

---

S. A. Gryaznov (✉)

Samara Law Institute of the Federal Penitentiary Service of Russia, Samara, Russia

can also help businesses redefine their goals in a post-pandemic world—using their expertise in change management, organizational development, human resources, and information systems to support different models of organization and work, including more decentralized decision-making and remote work [3, 4]. The mission of business schools is changing [6]. Today, their horizons have expanded towards improving the well-being of society, and their interests extend beyond students and businesses to include governments and non-profit organizations.

Business schools are forced to respond to changes in technology, competition, and social expectations—COVID-19 has called on businesses to lead these changes. For example, the Skolkovo Business School and Samsung Electronics have announced a long-term cooperation on the technological development of business education in Russia. This is the first technological partnership of the Skolkovo Business School and the only one known for Russian business education [9].

Today, business schools must be committed to solving problems that affect not only business, but also humanity as a whole. Their agenda should be to apply all their knowledge and skills to address global issues such as climate change, justice, and the advancement of digital technologies and artificial intelligence. Particularly important will be how business schools will encourage innovation and entrepreneurship that will create new businesses and jobs to replace those lost during the pandemic. It is necessary to encourage and guide startups, as well as to advise existing enterprises on how to better adapt to new realities. Their expertise in management, leadership, and strategy can help companies recognize the diverse opportunities they need to thrive in these challenging environments. Thus, business schools are testing grounds for creating more ethical, dynamic, and trustworthy leaders who, in turn, can influence broader social issues.

## 2 Methodology

Executive training is one of the fastest growing sectors of higher education. MBA (EMBA), business executive programs have always given students the opportunity to expand their real business knowledge in a particular sector and make graduates more competitive in the labor market. The global labor market, which is changing at an unprecedented pace, means that institutions must provide education and skills for jobs that don't even exist yet. Thus, problem-solving, risk-taking, independent learning, and the ability to collaborate with international businesses are all valued today more than ever. A global study by the MBA Association recently demonstrated the scale of the problem by examining how cutting-edge educational institutions are changing the types of education [1]. The report highlights the importance of ensuring that MBA programs are taught in a way that maximizes student engagement and changes typical learning patterns—this is the biggest challenge that senior managers face. Here, mixed learning models come to the rescue, in which priority is given to diversified methods [7].



The use of technology to provide motivational learning is no longer a rarity for business schools—it has now become a daily occurrence. The most innovative technologies help educational institutions revolutionize pedagogy and provide a flexible, progressive, and student-centered approach that focuses on meeting these requirements and delivering skills-based learning. Technology can influence not only what we learn, but also how we learn. Online learning creates a more independent environment, while providing broad and deep collaboration, it can also help develop critical thinking skills and facilitate the application of knowledge, making education more practical and informed. Using technology to prioritize a skills-based learning approach is now critical to business schools, and indeed the success of the entire employment ecosystem, from the careers of individuals to the prosperity of businesses, industries, and the entire economy. And, of course, technology is not only the engine of success, but also a mechanism for ensuring competitive advantage. Business schools that offer an immersive learning environment are ultimately the most attractive in a highly competitive environment.

The business school market has always been one of the most unique and dynamic areas of the educational sector. Serving a fairly ambitious environment, these institutions provide students around the world with a prestigious qualification that serves as a “pass” to lucrative career opportunities at the highest level. However, while most business schools are involved in some form of online recruitment, there is a strong sense in the sector that many of them could make greater use of the potential of digital channels to maximize visibility and impact.

While the entire higher education sector will have to face many-sided changes, they affect business schools in a fundamental way—the contours of the business world are changing. Companies in some industries (for example, retail, hotel and tourism) have been significantly affected by the decline in revenue. Students who have planned a career in these areas are forced to either expect improvements in the situation or move in a different direction [8]. Therefore, we need a model that will serve as a guide for understanding and making decisions in this period. This model considers the transformations of the university, the business world, and the student as the three components of the transformation of the business school.

### 3 Results

There are several stages that universities must go through to become leaders in online learning: rethink teaching, learning, and evaluation; focus on value, not just quality; change the roles of teachers and mentors and include mutual learning in the process; transform business models by constantly looking for new sources of income that can reduce the need for constant increases in tuition fees, reducing operational overhead costs (for example, maintenance of buildings, parking lots, dormitories). Below we will look at the trends that can make a breakthrough in education:

- the algorithm will replace the professor. Students will learn from an algorithm that, with AI support, will provide an individual approach to learning;
- university as a service. We currently have a linear view of education. First, students go through the school system, then most get a bachelor's degree (or specialist), then a master's degree, a small number go to graduate school and an even smaller number to doctoral studies. The problem is that the speed of change in the world is no longer suitable for this educational structure. The study period for any degree program can range from 1 to 5 years, depending on the field. Today's students need to get the education that is in demand and at the time when they need it. Therefore, individual continuing education will become the norm;
- university-assessment center. In the world of artificial intelligence and automation, learning can occur in many ways. Students will learn from each other, on algorithmic systems and public information. However, universities will continue to play an important role as evaluators of training. Therefore, it will be necessary to review the criteria for evaluating training;
- personalization of training. Students of the future will have access to multiple paths of learning the same content. For example, a course in financial accounting, available through algorithmic interaction, animation/video/augmented reality, face-to-face instructions, or any combination of them. Using these assessments, the university of the future will be able to accurately determine the student's learning needs and provide an individual experience;
- solving problems through ethical research. As the impact of artificial intelligence and automation in our lives skyrockets, the need for students to solve problems through ethical research will increase. It's about what problems we want to solve based on what we know. Students will need to evaluate AI algorithms based on their performance as well as their ethical foundations [9];
- healthcare is everywhere. Healthcare management will become an integral part of every business. Consumers expect a high level of hygiene in all areas. The bottom line is that healthcare management will become a top priority for CEOs of companies. The introduction of training programs in this area through the partnership will expand the opportunities of business schools to prepare students for this reality;
- remote work. As a result of Covid-19, organizations were forced to transfer some employees to remote work. It was expected that this would reduce performance, but over time it turned out that the performance level remained the same or even became higher than the previous one. Consequently, this will serve as an incentive for the widespread adoption of remote work in a significant part of organizations. Preparing students for success in this field will be essential [10];
- supply chain optimization. Businesses are re-optimizing their supply chains to eliminate a single point of failure. This will require deeper integration of supply chain management into the business school curriculum;
- the value of alternative investments. During the Covid-19 pandemic, there was renewed interest in alternative investment instruments. This will lead to the revival of fintech curricula in business schools.

At the moment, students are experiencing a period of confusion as a result of the rapid change in the learning environment. The abrupt transition to distance learning has led to a reassessment of the view of the institute of education. Business schools should remember that transformation is not only happening to today's students, but also to their future students who are currently in school. It seems that when developing programs with the transformed student in mind, it is necessary to take into account the following:

- virtual global education. The pandemic has strengthened global ties. Global programs have traditionally suffered from unforeseen circumstances related to travel, immigration barriers. Now there is an opportunity to create a strong virtual global educational environment;
- AI-based career planning and management. Students now expect to use technology tools not only for learning, but also for other aspects of their experience. Career planning and management using artificial intelligence will allow students to receive personalized recommendations on how to imagine their professional life;
- IT infrastructure and financial constraints. Many universities looking to make changes to their programs will face two key aspects. The IT infrastructure of a university usually establishes the architecture that ensures the execution of programs. Schools within a university may not have the right to radically develop a different identity. Covid-19 has provided an innovative incentive, the potential of which will be limited by budget cuts due to reduced enrollment, shifting government subsidies, reduced ability to maintain high tuition fees. These two aspects will have a significant impact on limiting the scope of the business school transformation.

## 4 Discussion

Thus, we have come to the conclusion that business schools should plan training, taking into account three aspects. The first aspect is continuity of learning—an emphasis on the continued availability of learning opportunities for students during unforeseen interruptions. Business schools should provide training for students at this time. The main focus should be on finding ways to serve during an emergency. At this time, business schools can conduct “emergency distance learning” [11]. Unlike the experience that is planned from the beginning and intended to be used online, emergency distance learning is a temporary shift of teaching in an alternative learning mode due to crisis circumstances. It involves the use of completely remote training solutions that would otherwise be conducted in person or in the form of mixed or hybrid courses. The main goal in these circumstances is not to recreate a solid educational ecosystem, but rather to provide temporary access to training and learning support in a way that can be established quickly and that is reliably accessible during an emergency or crisis. The second aspect is to pay increased attention to educational design. The next step out of the first point will be to develop a consistent student

experience based on sound instructional design principles. If the first aspect was focused simply on the continuation of educational services, the second is built on the ideas of developing a high-quality connected experience. Components of such a well-designed online experience include digital learning methodologies, digital learning contexts, tools and simulators, and assistive systems for digital learning [12]. Finally, the third aspect—the future new normal will involve the use of innovative AI-based services for student learning and online communities. For example, IBM Research has announced a long-term collaboration with the MIT Center for Brain and Cognitive Science to jointly explore the capabilities of machine vision, a key aspect of artificial intelligence [2]. The new joint IBM and MIT Laboratory for Brain-inspired Multimedia Machine Comprehension will develop cognitive computing systems that mimic the human ability to perceive data obtained from multiple sources of audiovisual information. Such systems will create a detailed computer model of the world, which can be used in various computer applications in the field of health and education [13]. Thus, creating a future world in which AI-enabled algorithms will serve as professors in key scenarios will revolutionize education.

## 5 Conclusion

Covid-19 has brought about changes in the university system on a scale that is unprecedented, coinciding with an increase in information technology capabilities due to the advent of artificial intelligence and machine learning—the result will be a global restructuring of the university, and here business schools can take a leading role. Technology is changing the dynamics of education. As educators begin to rethink the learning process, it will also be important to change educational spaces to support this evolution. In the pre-pandemic crisis, business school programs and courses on risk management and improving operational efficiency came to the fore, pushing aside the issues of strategies for a while. What will happen now? The answer to this can only be given by business and its new practices. And business schools that have good corporate connections will certainly take advantage of them. In 2021, business has a much more global mission; the same applies to business schools. Both are able to innovate for the long-term prosperity of our planet [5].

## References

1. Bard: The MBA of the future what to look for in a cutting edge business school. <https://gps.bard.edu/the-mba-of-the-future-what-to-look-for-in-a-cutting-edge-business-school> (2019). Accessed 16 March 2021
2. Connect-Wit: IBM research and the Massachusetts institute of technology are exploring the possibilities of artificial intelligence. <https://www.connect-wit.ru/ibm-research-i-massachusettskij-tehnologicheskij-institut-issleduyut-vozmozhnosti-iskusstvennogo-intellekta-v-vos>

- [priyatii-audiovizualnoj-informatsii-podobno-cheloveku.html](#) (2016). Accessed 17 February 2021
3. Di, F.: Does business school research matter? <https://www.topmba.com/mba-programs/does-business-school-research-matter> (2021). Accessed 17 March 2021
  4. Dingel, J.I., Neiman, B.: How many jobs can be done at home? <https://www.nber.org/papers/w26948> (2020). Accessed 17 February 2021
  5. Govindarajan, V., Srivastava, A.: What the shift to virtual learning could mean for the future of higher ed. <https://hbsp.harvard.edu/inspiring-minds/what-the-shift-to-virtual-learning-could-mean-for-the-future-of-higher-ed> (2020). Accessed 17 February 2021
  6. Hodges, C., Moore, S., Lockee, B., Trust, T., Bond, A.: The difference between emergency remote teaching and online learning: Educause Review. <https://er.educause.edu/articles/2020/3/the-difference-between-emergency-remote-teaching-and-online-learning> (2020). Accessed 17 February 2021
  7. Letheren, K., Russell-Bennett, R., Whittaker, L., Whyte, S., Dulleck, U.: The evolution is now: service robots, behavioural bias and emotions. In: Härtel, C.E.J., Zerbe, W.J., Ashkanasy, N.M. (eds.) *Emotions and Service in the Digital Age. Research on Emotion in Organizations*, vol. 16, pp. 27–48. Emerald, Bingley (2020)
  8. MIT News: IBM and MIT to pursue joint research in artificial intelligence, establish new MIT-IBM Watson AI Lab. <https://news.mit.edu/2017/ibm-mit-joint-research-watson-artificial-intelligence-lab-0907> (2017). Accessed 16 March 2021
  9. Moscow School of Management Skolkovo: Skolkovo business school and Samsung announced a technological cooperation. <https://www.skolkovo.ru/news/biznes-shkola-skolkovo-i-samsung-obyavili-o-tehnologicheskoy-sotrudnichestve/> (2020). Accessed 17 February 2021
  10. Sousa, M.J., Carmo, M., Gonçalves, A.C., Cruz, R., Martins, J.M.: Creating knowledge and entrepreneurial capacity for HE students with digital education methodologies: differences in the perceptions of students and entrepreneurs. *J. Bus. Res.* **94**(C), 227–240 (2019)
  11. Tazov, Yu.: Business education in the age of the pandemic: all-in online? [www.mba.su/articles/biznes\\_obrazovanie\\_v\\_epohu\\_pandemii\\_vse\\_v\\_onlain/](http://www.mba.su/articles/biznes_obrazovanie_v_epohu_pandemii_vse_v_onlain/) (2020). Accessed 17 February 2021
  12. The Conversation: No more business as usual: In: “The Great Reset” business schools must lead the way. <https://www.australianimes.co.uk/news/no-more-business-as-usual-in-the-great-reset-business-schools-must-lead-the-way/> (2021). Accessed 16 March 2021
  13. Tufano, P.: How business education should change in the XXI century. <https://www.vedomosti.ru/management/articles/2020/04/05/827203-kak-dolzno> (2020). Accessed 17 February 2021

# New Analysis Learningmetry: Effectiveness E-Learning Measuring



N. A. Zaychikova

**Abstract** The study of learningmetry based on the results of testing of university students in e-learning has been implemented. The research was carried out in the Samara State University of Economics in groups of the undergraduate studies of economics in the 2020–2021 academic year based on the results of studying the course “Probability Theory and Mathematical Statistics”. The analysis of data on the reflection of educational experience was built using the learningmetry methodology as a way to measure the effectiveness of student learning and preserve the digital educational footprint. The essence of the new questionnaire, compiled in accordance with the constructed learningmetry methodology, is revealed, the theoretical substantiation of the issues of assessing the motivation and progress of students is given. Also provided are learningmetry tables, calculation and interpretation of learningmetry indices. In addition to the concept of the zone of optimal learning, the concept of a zone of active learning is introduced in case of dissatisfaction with the results of educational activity. Their description, corresponding research results, their interpretation and forecasts are given. The hypothesis about the presence of a direct relationship between motivation and academic performance in the considered samples is confirmed using correlation-regression analysis.

**Keywords** Academic achievement scale · Educational experience reflection · Effectiveness learning measuring · E-learning · Learningmetry

## 1 Introduction

Learningmetry is a method for determining the effectiveness of learning in the digital educational environment on a two-dimensional scale of progress-motivation [12]. It is gaining special relevance because of the expansion of e-learning and the COVID-19 pandemic [1]. In various pedagogical traditions, the analysis of the effectiveness of teaching followed either a one-dimensional path, in which a factor was chosen

---

N. A. Zaychikova (✉)  
Samara State University of Economics, Samara, Russia

to analyze the success of teaching or learning. The research can take place through a multidimensional approach. Here, a multivariate analysis of successful academic performance is also possible when highlighting many aspects of its components [10]. Due to the fact that many indicators are unobservable or are difficult to formalize, the author suggests naturally narrowing the field of factors under consideration to the two most observable factors. The first factor is academic performance. The second factor is motivation, which is defined as the result of the student's assessment of the test.

The investigation of the motivational component of education traditionally occupies one of the first positions in all psychological and pedagogical concepts of education. Many authors note that the parameters of the quality of education are associated with academic performance through motivation and satisfaction of learning [6]. Therefore, an urgent goal is to determine student motivation and learning strategies that affect their academic performance when using online courses among university students [7].

In consequence of the COVID-19 pandemic, e-learning has taken center stage in higher education. In this regard, the task of designing and improving the learningmetry questionnaires for university students is especially weighty. The learningmetry questionnaire is one of the ways of feedback and collection of student opinion on learning results [8]. For the first time, a questionnaire by learningmetry methodology was compiled and used in the scientific research conducted at SSEU in groups of economic direction in the 2017–2018 academic year. Submitted work based on the results of studying the course “Probability Theory and Mathematical Statistics”. There are features associated with the assessment of the effectiveness and quality of mathematical training of university students in digital educational environment [5, 9]. Previously, the author has already conducted research using the learningmetry method [12–14].

## 2 Methodology

We used the learningmetry methodology, methods of mathematical statistics and correlation-regression analysis. We implement the solution of problems using MS Excel, Gretl for processing statistical data and Google-form for collecting personal data. In the presented work, an improved version of the questionnaire is proposed for analyzing data using the learningmetry method. The questionnaire should contain a obligatory question about belonging to a study group, since the learningmetry methodology is focused on the analysis of both individual and group indicators. The questionnaire for a block of a specific test in a chosen discipline contains the following questions. “1. What is your test rating on a five-point scale? (Unsatisfactory/Satisfactory/Good/Excellent). 2. What is your assessment of the test (how much did you like the test)? (Unsatisfactory/Satisfactory/Good/Excellent).” [12] 3. What was the final attempt? (From the first/From the second/From the third/Other). 4. Are

you satisfied with the result of the test? (Yes/No/Other). 5. Would you like to improve your results? (Yes/No).

Basic and obligatory questions No. 1, 2 are determined by the learningmetry method. They are used to calculate key indicators, grades on the performance scale and the scale of motivation. Questions No. 3–5—additional, control. The third question relates to the analysis of situational motivation and belonging to a particular field according to the criteria of academic performance and motivation. The fourth question is the learning satisfaction test. The fifth question determines the monitoring of actual motivation.

Usually in e-learning test results by subjects are always recorded, and are available to the teacher, but to collect data on learningmetry, it is conveniently to organize a feedback form (example, Google-form). Processing the information begins, after it is collected. According to prosedure learningmetry has three stages: tabular, graphic and indexological. Matrices of personal data questionnaires are presented in Tables 1 and 2, with which it is convenient to work in application packages (for example, in MS Excel). Counter indexes take the following values:  $i = 1 \dots n, j = 1 \dots m$ .

To visualize the statuses of students and tests, the graph of the ratio of statuses of research objects is used. By analogy with the sociometric methodology, the inner

**Table 1** Personal data. Student rating

| No. student,<br>(i) | Test (j) |          |          |     |          |       |
|---------------------|----------|----------|----------|-----|----------|-------|
|                     | 1        | 2        | 3        | ... | m        | $S_i$ |
| 1                   | $s_{11}$ | $s_{12}$ | $s_{13}$ | ... | $s_{1m}$ | $S_1$ |
| 2                   | $s_{21}$ | $s_{22}$ | $s_{23}$ | ... | $s_{2m}$ | ...   |
| 3                   | $s_{31}$ | $s_{31}$ | $s_{33}$ | ... | $s_{3m}$ | ...   |
| ...                 | ...      | ...      | ...      | ... | ...      | ...   |
| n                   | $s_{n1}$ | $s_{n2}$ | $s_{n3}$ | ... | $s_{nm}$ | $S_n$ |
| $St_j$              | $St_1$   | $St_2$   | $St_3$   | ... | $St_m$   |       |

Source author based on [14]

**Table 2** Personal data. Test rating

| No. student,<br>(i) | Test (j) |          |          |     |          |        |
|---------------------|----------|----------|----------|-----|----------|--------|
|                     | 1        | 2        | 3        | ... | m        | $Ts_i$ |
| 1                   | $t_{11}$ | $t_{12}$ | $t_{13}$ | ... | $t_{1m}$ | $Ts_1$ |
| 2                   | $t_{21}$ | $t_{22}$ | $t_{23}$ | ... | $t_{2m}$ | $Ts_2$ |
| 3                   | $t_{31}$ | $t_{31}$ | $t_{33}$ | ... | $t_{3m}$ | $Ts_3$ |
| ...                 | ...      | ...      | ...      | ... | ...      | ...    |
| n                   | $t_{n1}$ | $t_{n2}$ | $t_{n3}$ | ... | $t_{nm}$ | $Ts_n$ |
| $T_j$               | $T_1$    | $T_2$    | $T_3$    | ... | $T_m$    |        |

Source author based on [14]



circle corresponds to “excellent”, the second—“good”, the third—“satisfactory”, the outer—“unsatisfactory” [4]. Boys are indicated by triangles, girls by circles, tests by squares. The main learningmetry graph is constructed on the basis of the average score of the tests by the students. Arrows or segments can connect students with the same opinion about the test they passed. Microgroups are visible by motivational activity when learning on tests in a specific subject. Students’ performance on a specific test is plotted based on the test score [12, 14].

The next stage of the research is indexological. In its process, individual and group learningmetry indices are calculated. Here are the main indices (Tables 1 and 2).

$$St_j = \frac{1}{n} \sum_{i=1}^n s_{ij}, S_i = \frac{1}{m} \sum_{j=1}^m s_{ij}, T_j = \frac{1}{n} \sum_{i=1}^n t_{ij}, Ts_i = \frac{1}{m} \sum_{j=1}^m t_{ij}$$

*Student Performance Index (SPI)* is “a characteristic of the position of a member of the group on academic performance, calculated as the average score obtained after completion of the tests— $S_i$  (Table 1). *Index of Student Motivational Activity (ISMA)* is a characteristic of the position of a group member, showing generally the attitude to the tests and the desire to master the discipline material, calculated as the average rating of tests that were evaluated by students— $Ts_i$  (Table 2)” [12].

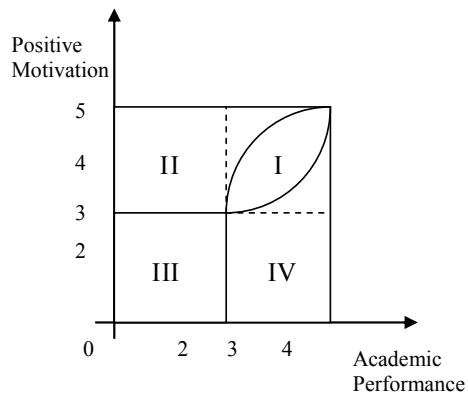
*Index of Test (IT)* is a characteristic of the test position, obtained as the average rating set by a particular test by various members of the study group— $T_i$  (Table 2).

*Learning Student’s Index of Test (LSIT<sub>ij</sub>)* is the ratio of the test score to the score received by the student upon completion of this test:  $LSIT_{i,j} = \frac{t_{i,j}}{s_{i,j}}$ , where  $t_{i,j}$  is the value of the rating set for the j-th test by the i-th student, and  $s_{i,j}$  is the value of the rating received by the i-th student at the completion of the j-th test.

This index is a measure of satisfaction-dissatisfaction with the result of learning, which is described in the Table 2 „Characteristic Values of LSIT<sub>ij</sub>” in [12, 14].

Let us give a depiction of the areas of learning according to the learningmetry method (Fig. 1). Zone I is the area of optimal learning, in which the student’s level of

**Fig. 1** Areas in the analysis of academic performance-motivation (Source author based on [14])



**Table 3** Index table

| No. student,<br>(i) | LSIT(i,j) |           |           |     |           | LSI (i)    |
|---------------------|-----------|-----------|-----------|-----|-----------|------------|
|                     | 1         | 2         | 3         | ... | m         |            |
| 1                   | LSIT(1,1) | LSIT(1,2) | LSIT(1,3) | ... | LSIT(1,m) | LSI (1)    |
| 2                   | LSIT(2,1) | LSIT(2,2) | LSIT(2,3) | ... | LSIT(2,m) | LSI (2)    |
| 3                   | LSIT(3,1) | LSIT(3,2) | LSIT(3,3) | ... | LSIT(3,m) | LSI (3)    |
| ...                 | ...       | ...       | ...       | ... | ...       | ...        |
| n                   | LSIT(n,1) | LSIT(n,2) | LSIT(n,3) | ... | LSIT(n,m) | LSI (n)    |
| LTI (j)             | LTI (1)   | LTI (2)   | LTI (3)   | ... | LTI (m)   | <i>LGI</i> |

Source author based on [14]

progress corresponds to his motivation in learning. Development zones are quadrants I and II, quadrant III is a degradation zone, and quadrant IV is a zone of stable (routine) work. Areas II, III, IV are problematic. Quadrant III is almost never found in academic practice. Zone IV corresponds to high academic performance with reduced motivation. As noted earlier, area II corresponds to low academic performance with great effort, while quadrant II “for long-term activities without changing conditions is an area of increased risk of exhaustion, overload and emotional burnout” [12].

Following indicators will be calculated in accordance with the definitions: *Lerning Student’s Index (LSI<sub>i</sub>)* is the average of the LSIT<sub>ij</sub>, metrics for each test  $j = 1...m$ :  $LSI_i = \frac{1}{m} \sum_{j=1}^m LSIT_{ij}$ ; *Lerning Student’s Status (LSS<sub>i</sub>)* is a characteristic of the position of a group member, calculated as a rank depending on the LSI<sub>i</sub>; „*Group Performance Index, (GPI)* is the average rating received by students of the group on completion of the tests; *Group Motivational Activity Index (GMAI)* is the average rating for discipline tests that were evaluated in this study group “ [12]; *Learning Test Index (LTI<sub>j</sub>)* is the average of the LSIT<sub>ij</sub> for students of the study group  $i = ...n$ :  $LTI_j = \frac{1}{n} \sum_{i=1}^n LSIT_{ij}$ ; *Learning Group Index (LGI)* is average of *Lerning Student’s Index, LSI<sub>i</sub>*, of students in a study group. We composed Table 3 for these indices.

### 3 Results

In this work, the educational experience on the application of learningmetry was carried out in the groups of the economic direction of the undergraduate studies on the cours “Theory of Probability and Mathematical Statistics” of the Samara State University of Economics. The data on the learningmetry questionnaire and the calculated indices for one of the test groups are presented in Tables 4 and 5.

According to the results of Table 5, students No. 12, 10 have LSI > 1 (“motivation below learning success, low need for achievement” [13]), students No. 1, 2, 3, 5, 7

**Table 4** Personal data. Student rating and test rating

| No. student,<br>(i) | Test 1 | Test 2 | Si   | No. student,<br>(i) | Test 1 | Test 2 | Tsi  |
|---------------------|--------|--------|------|---------------------|--------|--------|------|
|                     | 4      | 4      | 4    | 1                   | 4      | 4      | 4    |
| 2                   | 3      | 3      | 3    | 2                   | 3      | 3      | 3    |
| 3                   | 4      | 4      | 4    | 3                   | 3      | 3      | 3    |
| 4                   | 4      | 5      | 4.5  | 4                   | 4      | 5      | 4.5  |
| 5                   | 5      | 4      | 4.5  | 5                   | 5      | 4      | 4.5  |
| 6                   | 5      | 5      | 5    | 6                   | 5      | 4      | 4.5  |
| 7                   | 5      | 4      | 4.5  | 7                   | 5      | 4      | 4.5  |
| 8                   | 5      | 4      | 4.5  | 8                   | 4      | 4      | 4    |
| 9                   | 5      | 4      | 4.5  | 9                   | 4      | 4      | 4    |
| 10                  | 4      | 4      | 4    | 10                  | 5      | 4      | 4.5  |
| 11                  | 5      | 4      | 4.5  | 11                  | 4      | 4      | 4    |
| 12                  | 4      | 3      | 3.5  | 12                  | 4      | 4      | 4    |
| Stj                 | 4.42   | 4      | 4.21 | Tj                  | 4.17   | 3.92   | 4.04 |

Source author

**Table 5** Calculated index values. Ranking by LSI

| No. student,<br>(i) | Test 1 LSIT(i,j) | Test 2 LSIT(i,j) | LSI (i)    | LSS(i) |
|---------------------|------------------|------------------|------------|--------|
| 1                   | 1.00             | 1.00             | 1.00       | 6      |
| 2                   | 1.00             | 1.00             | 1.00       | 6      |
| 3                   | 0.75             | 0.75             | 0.75       | 1      |
| 4                   | 1.00             | 1.00             | 1.00       | 6      |
| 5                   | 1.00             | 1.00             | 1.00       | 6      |
| 6                   | 1.00             | 0.80             | 0.90       | 2      |
| 7                   | 1.00             | 1.00             | 1.00       | 6      |
| 8                   | 0.80             | 1.00             | 0.90       | 2      |
| 9                   | 0.80             | 1.00             | 0.90       | 2      |
| 10                  | 1.25             | 1.00             | 1.13       | 11     |
| 11                  | 0.80             | 1.00             | 0.90       | 2      |
| 12                  | 1.00             | 1.33             | 1.17       | 12     |
| LTI (j)             | 0.95             | 0.99             | LGI = 0.97 |        |

Source author

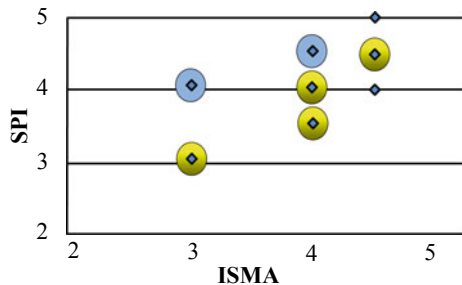
have  $LSI = 1$  (“motivation is adequate to success in training, average need to achieve” [13]), students No. 6, 8, 9, 11, 3 have  $LSI < 1$  (“motivation above learning success, high need for achievement” [13]). Let’s analyze the level of performance–motivation in the group. To do this, consider the group learningmetry indices as a characteristic of the group’s work as a whole:  $GPI = 4.21$ ,  $GMAI = 4.04$ ,  $LGI = 0.97$ . According to the value of the  $LGI$  learningmetry index, the study group belongs to groups of type I, such that motivation below learning success, low need for achievement. Since the deviation from 1 is insignificant, a moderately favorable forecast can be made about the possible transition of the study group to the type II group, according to the value of the  $LGI$ -index, where motivation is adequate to success in training, average need to achieve, with appropriate adjustments to the training course.

The results of answers to questions No. 4 and No.5 will be presented in the form of a diagram of motivation-academic performance, on which the answer to the questions is superimposed, in the form of filled circles (Fig. 2). Points with the same coordinates (the same answers of students) on the diagram coincide. The students of the test group were divided into 3 subgroups. If the respondent was dissatisfied with his own test results and expressed a desire to improve the result, then we draw the point on the diagram as a blue filled circle. If the student did not show dissatisfaction with his own test results, but nevertheless expressed a desire to improve the result, then we depict the point on the diagram as an orange filled circle. The third group consisted of students who were generally satisfied with the work with the tests and did not express a desire to change the results. It can be noted that most of the students are satisfied with the work on the tests. In this regard, it is of interest to study that part of the student audience that expressed dissatisfaction with the results of their work.

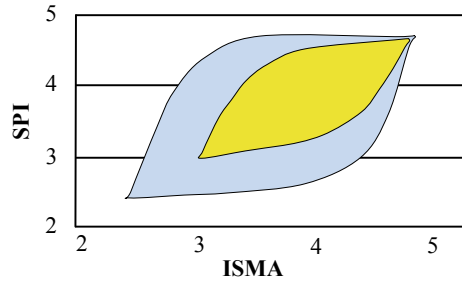
When comparing the results of three student groups, a diagram of areas of dissatisfaction with the results of their work on tests (blue area) and the desire to improve the result, despite the general satisfaction with the results of educational activities on tests (orange area) was obtained (Fig. 3).

Thus, we see an area with an orange fill Fig. 3 corresponding to the area of optimal learning Fig. 1, where success and satisfaction in educational activities accompany the desire to improve the result, and its vicinity—an area with a blue fill—is an area of active learning with possible dissatisfaction with the results of studies. According to

**Fig. 2** The diagram with results on satisfaction–dissatisfaction with training ( Source author)



**Fig. 3** Areas of learningmetry with results for satisfaction–dissatisfaction with learning ( *Source* author)



the Yerkes-Dodson law, the effectiveness of educational activity is directly dependent on the strength of motivation [11]. Let us test the hypothesis that there is a direct relationship between academic performance and motivation according to the data of 2020–2021 using correlation regression analysis. The correlation coefficient  $r_{xy} = 0.66$ , statistically significant at the 2% level, which allows us to conclude that there is a direct noticeable relationship between academic performance and student motivation of learning. Using the data from 2020–2021 academic year, we obtain a least squares regression model similar to that obtained in 2017–2018 academic year [13]. The paired linear regression model for 2020–2021 academic year has the form (the standard errors of the estimates of the regression coefficients are indicated in parentheses):

$$\text{SPI} = 1.52 + 0.66 \text{ ISMA}, \quad R^2 = 0.44 (0.96)(0.24)$$

The estimate of the regression coefficient for the variable is statistically significant according to the Student's test, the model as a whole is statistically significant according to Fisher's test at the statistical significance level of 2%, the conditions of the Gauss-Markov theorem are fulfilled. The coefficient of determination of 44% indicates that 44% of the variation in academic performance is determined by the variation in motivation, and 56% is described by other factors that are absent in the model, therefore, the model can be improved by introducing other factors that affect academic performance. Therefore, we can talk about the good statistical quality and explanatory ability of the constructed regression models, and the hypothesis of the presence of a direct linear relationship between motivation and the success of the educational activity of the group in the field of optimal learning is confirmed [13].

## 4 Discussion

In e-learning, various methods of assessing the effectiveness of training are widely used. Results about performance on a bespoke knowledge test and metrics for motivation, satisfaction, and engagement by learners in both real and virtual environments were found Fitton, Finnegan, Proulx, [2]. In this article, the central place is occupied

by the relationship between academic performance and motivation and satisfaction with learning outcomes. Also other authors, for example, Rasheed, He, Khalid, note the relationship between academic performance and motivation. The findings reveal that all service quality dimensions (tangibility, responsiveness, assurance, reliability, empathy, and e-learning) are positively associated with student's academic performance through student's motivation and student satisfaction [6]. In the course of this study, the results of students' work on two educational platforms were considered: the Electronic Information and Educational Environment of the Samara State Economic University (Moodle) and the National Open University "Intuit". The research study aims of Grubisic, Zitko, Stankov with other authors to assess the level of student engagement in four e-learning platforms (CoLaB Tutor, AC-ware Tutor, CM Tutor and Moodle) in higher education. E-learning environment implies self-motivation and perseverance in study and completion of learning tasks. However, the more autonomy students have in managing their e-learning, the harder they cope with distractions and remaining focused and engaged [3]. Research on the method of learningmetry involves a two-scale analysis. In the context of COVID-19, the types of scales have changed. Alemany-Arrebola, Rojas-Ruiz, Granda-Vera, used two scales to measure perceived academic self-efficacy and anxiety [1]. The regression model of the dependence of academic performance on motivation constructed in the work is very simplified and initial; in order to continue the study, it is necessary to add to the model factors that have a significant impact on academic performance. In their work, Valantinaite and Sedereviciute-Paciauskiene analyzed the factors affecting academic performance and learning efficiency. The quasi-experiment was carried out to determine the attitude of students towards favourable and unfavourable factors of using an online learning environment in the study process. Favourable factors of using an online learning environment identified by students in the quasi-experiment were grouped in five categories: material resources/base; teacher personality; student personality, information presentation and increase of accessibility at the institutional level [10].

## 5 Conclusion

In the modern educational digital space, the fundamental difference between teaching and cognitive learning becomes especially noticeable. Then, a qualitatively new option for assessing the effectiveness of training is the learningmetry method, as a mathematical and pedagogical method for assessing the effectiveness of learning on two scales of performance–motivation. In addition to using feedback from students, it allows the study of satisfaction with learning outcomes when working on test systems. This tool allows you to visualize and evaluate both the results of the work of an individual student and a whole group according to a number of signs—learningmetry indices. One of the main results in this case is the assessment of satisfaction with the training and the desire to advance further in the study of the material.

Having processed the data of learningmetry questionnaires using correlation-regression analysis, we see confirmation of the hypothesis of a direct linear relationship between academic performance and motivation as a kind of trend around which an area of optimal learning is formed. The further we are from the neighborhood of this area, the more significant dissatisfaction with learning and various cases of disparities in the scales of academic performance and motivation (“areas of degradation”, “routine work”, “overload”) are manifested. Depending on which area the student or the group as a whole fell into, educational influences can be adjusted. Try to create interest in learning for those in the zone of routine. Choose a supportive regimen for those who are in an area of increased overload and risk of burnout. Simultaneously both the first and the second strategy for those who find themselves in the zone of degradation. By collecting, processing and analyzing information on a study group for a specific academic discipline and tests for it, it is possible to create and correct educational trajectories in relation to this study group and to an individual student.

## References

1. Alemany-Arrebola, I., Rojas-Ruiz, G., Granda-Vera, J.: Influence of covid-19 on the perception of academic self-efficacy, state anxiety, and trait anxiety in college students. *Front. Psychol.* **11**, 570017 (2020)
2. Fitton, I.S., Finnegan, D.J., Proulx, M.J.: Immersive virtual environments and embodied agents for e-learning applications. *PEERJ Comput. Sci.* **6**, e315 (2020)
3. Grubisic, A., Zitko, B., Stankov, S.: A common model for tracking student learning and knowledge acquisition in different e-Learning platforms. *J. E-learn. Knowl. Soc.* **16**(3), 10–23 (2020)
4. Moreno, J.L.: *Sociometry, experimental method and the science of society; An approach to a new political orientation.* Beacon House, New York (1951)
5. Ovsyannikova, T.L.: Foreign experience of distance learning mathematics. *Scientific Notes of Oryol State University* **1**(57), 389–392 (2014)
6. Rasheed, H.M.W., He, Y., Khalid, J.: The relationship between e-learning and academic performance of students. *J. Public Aff.*, e2492. <https://doi.org/10.1002/pa.2492> (2020). Accessed 25 March 2021
7. Salim, M.H.M., Ali, N.M., Ijab, M.T.: Understanding students’ motivation and learning strategies to redesign massive open online courses based on persuasive system development. *Int. J. Adv. Comput. Sci. Appl.* **10**(12), 234–241 (2019)
8. Tawafak, R.M., Romli, A.M., Alsinani, M.J.: Student assessment feedback effectiveness model for enhancing teaching method and developing academic performance. *Int. J. Inf. Commun. Technol. Educ.* **15**(3), 75–88 (2019)
9. Toktarova, V.I.: Assessing the efficiency of teaching mathematics in the e-learning environment. In: Uslu, F. (ed.), *Proceedings of INTCESS—6th International Conference on Education and Social Sciences*, pp. 428–431. International Organization Center Academic Research, Istanbul (2019)
10. Valantinaite, I., Sedereviciute-Paciauskiene, Z.: The change in students’ attitude towards favourable and unfavourable factors of online learning environments. *Sustainability* **12**(19), 7960 (2020)
11. Yerkes, R.M., Dodson, J.D.: The relation of strength of stimulus to rapidity of habit-formation. *J. Comp. Neurol. Psychol.* **18**, 459–482 (1908)

12. Zaychikova, N.A.: Construction of the method of measurement by scale success-motivation of the results of work with test systems in e-learning. *Modern Problems of Sci. Educ.* **4**. <http://www.science-education.ru/article/view?id=27902> (2018). Accessed 30 March 2021
13. Zaichikova, N.A.: Application of learning science methodology in student groups in e-learning. *21st Century Science: Current Trends* **2**(1), 35–40 (2019)
14. Zaichikova, N.A.: Learningmetry: effectiveness e-learning measuring and reflection of educational experience. In: Ashmarina, S., Mantulenko, V. (eds.) *Current Achievements, Challenges and Digital Chances of Knowledge Based Economy. Lecture Notes in Networks and Systems*, vol. 133, pp. 611–619. Springer, Cham (2021)



# Development of Digital Corporate Personnel Training: Current Trends and Prospects



L. A. Ilyukhina, I. V. Bogatyreva, and N. N. Gunko

**Abstract** The article is devoted to the analysis and systematization of digital methods (technologies) of training as the most important element in the organization of training corporate systems. In the digital economy, the problems of professional development of human resources based on the use of the latest methods and tools are becoming especially relevant. The article analyzes domestic and foreign research on the organization of corporate personnel training; the approaches to the classification of forms and methods of teaching adult students are studied. Taking into account the trends in the development of digital technologies, an author's approach to the classification of forms of education is proposed. The characteristics of the methods of digital training of employees according to certain criteria are given. A comparative analysis of the most common digital learning platforms in Russia; their advantages and disadvantages are determined. A brief overview of the Russian market for the development and implementation of digital learning systems is presented. An algorithm for the design and development of a corporate Training Center has been developed as the basis for the development of digital learning and the costs of its creation have been calculated.

**Keywords** Corporate training center · Distance learning · Digital platform · E-Learning · Staff training

## 1 Introduction

The continuity of the company's development is determined by constantly changing internal and external operating conditions: the state's economic policy is changing, legislation is being improved, the Internet and information technologies are actively developing, horizontal and vertical communications of all processes are strengthening both at the corporate, state and regional levels. The internal ones do not lag behind the external conditions for the existence of organizations: strategic goals and

---

L. A. Ilyukhina (✉) · I. V. Bogatyreva · N. N. Gunko  
Samara State University of Economics, Samara, Russia  
e-mail: [laresa@inbox.ru](mailto:laresa@inbox.ru)

© The Author(s), under exclusive license to Springer Nature Switzerland AG 2022  
S. I. Ashmarina and V. V. Manteulenko (eds.), *Digital Technologies in the New Socio-Economic Reality*, Lecture Notes in Networks and Systems 304,  
[https://doi.org/10.1007/978-3-030-83175-2\\_100](https://doi.org/10.1007/978-3-030-83175-2_100)

821

objectives, organizational structure are changing, labor processes are being improved, innovative technologies and automated intelligent systems are being introduced, digital techniques and methods of working with personnel are being mastered [1, 2]. In these conditions, the problems of professional development of human resources through the use of the latest digital methods and technologies are becoming especially relevant, and for employees of organizations are becoming increasingly important issues of learning, adaptability and motivation to develop their professional qualifications and competencies [3]. In support of the above, one can cite the results of the conclusions of experts from the NAFI Analytical Center and the Skolkovo Fund [4], studying the current readiness of Russian companies for the digital economy. According to their results [4], the readiness index of most Russian companies for the transition to digital technologies is 36 points out of 100 possible and the first place among the weak is the unpreparedness of employees to switch to digital tools and working methods, the low level of development of digital competencies. In this regard, the organization of retraining and advanced training of company employees based on the use of the most convenient, effective and less costly digital forms and methods of personnel training is coming to the fore.

## 2 Methodology

In corporate personnel training in Russian practice, there are several approaches to the classification of the forms and methods of training used. In the conditions of the development of information technologies, it is necessary to classify the forms of training, first of all, according to the degree of digitalization and innovativeness, meaning this means the use in the learning process of new or improved methods (tools) of personnel development, which differ significantly from the current application practice; more effective in terms of achieving learning objectives. In our opinion, the urgent task for many medium and large enterprises to create corporate training systems cannot be fundamentally solved without a thorough study of its structural elements, which are the used methods and technologies of training and professional development of qualifications [5]. The company's innovativeness, as a new indicator of its success, forces corporations to constantly generate new ideas, while not exerting pressure on their employees, which helps gamification. Researchers have identified an increase in loyalty, productivity and idea generation up to 50% of the implementation of gamification in companies. We must not forget that the higher the loyalty of the staff, the lower the potential personnel threat from this staff the organization has [6]. It should be noted that the corporate training system in Russia does not differ in its diversity in terms of the forms and methods used. The most popular types of training for employers today are trainings, "field training" or internships. These teaching methods remain the same in the context of the development and implementation of digital technologies, despite the fact that more effective innovative tools are emerging. Small and medium-sized Russian companies do not provide training at

all, which is usually associated with the lack of sound planning and organization of work to train employees, or insufficient funding.

Thus, it is necessary to analyze and develop a classification of training technologies according to the degree of digitalization and innovativeness, which is relevant today. This will allow not only to use innovative approaches of professional development of employees for effective training, to save the budget of training costs; but also constantly maintain a high level of professional competence of personnel, train them ahead of schedule, focusing on organizational changes in the external environment. It is also important to conduct a comparative analysis of innovative teaching methods, identifying their advantages and disadvantages. This is the goal of our study.

The scientific works of Russian and foreign scientists on the organization of corporate training systems, the results of their own work of the authors made up the theoretical and methodological basis of the study [5, 7–10]. To achieve this goal, we used the methods of logical analysis, classification of objects of study, analogies. The best practices of the application of innovative and digital methods of personnel training were studied.

## 3 Results

### 3.1 *Classification of Digital Learning Methods*

In the context of digitalization, it is proposed to distinguish two main types of innovative learning: e-learning (online learning) and distance learning. Despite the fact that some researchers consider these concepts synonymous, they should be distinguished by the criterion of the subject of action.

E-learning (e-learning) is the use of new multimedia and Internet technologies to improve the quality of education through access to educational resources. A distinctive feature of e-learning is the obligatory mediation of interactive electronic means of working with information, while interaction with another person (even indirect) in e-learning is not necessary, but may be present. That is, there is both a subject-object interaction and an interaction between subjects. Online learning is not formalized, its main method is self-education, i.e. an attempt to independently fill in the gaps in knowledge in a convenient form.

In modern conditions, traditional teaching methods are acquiring new forms and content based on the introduction of digital technologies into this process. The use of software products and information technologies in the traditional format of conducting classes can improve the quality of the results of the educational process, optimize training costs and ensure accessibility for each employee of the company. For example, today it is impossible to conduct lectures and practical classes without using such elements of digital learning as a presentation, an electronic training course, testing students based on computer programs, analyzing cases in a digital format,

and conducting online quests. Thus, the use of digital technologies makes it possible to transfer traditional forms of education into an electronic format (Table 1).

Distance learning is a way to implement the learning process, based on the use of modern information and telecommunication technologies that allow learning from a distance without direct personal contact between the teacher and the students. A distinctive feature of this training is that the interaction of participants is carried out indirectly, through a program that sets the algorithm for the functioning of the training system and all its participants; it is more formalized than e-learning. It should be noted that some researchers consider distance learning to be methods. In our opinion, this is a generalized concept that includes several varieties of methods (Table 1). As part of our research, we have identified the advantages and disadvantages of using distance learning methods. So, one of the main HR trends in a pandemic is the development of e-learning and distance learning. Many foreign and Russian companies have switched to a remote work format and digital employee training. In the practice of personnel training and development, new forms have been actively introduced—scribing, animated infographics, educational 3D games, microlearning, virtual and augmented reality, artificial intelligence and machine learning [11]. According to the Training Magazine portal [12], companies save about 50–70% of the training budget by replacing full-time forms with remote ones.

### ***3.2 Comparative Analysis of Popular Digital Learning Platforms in the Practice of Russian Companies***

Digital learning during the coronavirus pandemic is becoming more and more popular among Russian companies. Statistics show [12], that the share of companies creating their own internal online training systems is only 20%. Most of Russian enterprises prefer training their employees using digital platforms. Thus, for many companies there is a difficult question about choosing an effective digital platform, more than 1000 providers are represented on the Russian market for the development and implementation of digital learning systems. The results of a study of the market for creating digital educational tools allowed the authors to summarize information about the most popular digital learning platforms in Russia (Table 2).

An assessment of the cost-effectiveness of implementing distance learning systems for some companies revealed positive trends. So, the return on investment in the distance learning system at Nestle was 28% per year, which indicates the significant effectiveness of the introduction of LMS. Other indicators also showed positive dynamics, in particular, an increase in the level of knowledge in the company amounted to 88%, moderate progress in changing behavior was observed in 49.5% of students.

Rosgosstrakh conducted, a retrospective assessment of the effectiveness of the WebTutor distance learning system using criteria such as the impact of training on

**Table 1** Characterization of digital training methods for personnel

| Training methods                           | Two-way communication: student-trainer | Aims to build skills | Low financial costs | High audience reach | Suitable for beginners | Risk for implementing business processes |
|--|--|----------------------|---------------------|---------------------|------------------------|--|
| <i>Electronic teaching methods</i>         |  |                      |                     |                     |                        |  |
| Briefing                                   | -                                      | -                    | +                   | +                   | +                      | -  |
| Complicated tasks method                   | -                                      | +                    | +                   | +                   | -                      | +  |
| Using work instructions                    | -                                      | +                    | +                   | +                   | +                      | -  |
| Production training                        | +                                      | +                    | +                   | +                   | +                      | -  |
| Secondment method                          | +                                      | -                    | -                   | -                   | -                      | +  |
| Training by action ("Action learning")     | +                                      | +                    | +                   | -                   | -                      | +  |
| Shadowing method                           | +                                      | -                    | +                   | -                   | +                      | -  |
| Buddying method                            | +                                      | +                    | +                   | -                   | +                      | -  |
| Lecture                                    | -                                      | -                    | +                   | +                   | +                      | -  |
| Seminar (Conference)                       | +                                      | -                    | +                   | -                   | +                      | -  |
| Case analysis                              | +                                      | +                    | +                   | -                   | -                      | -  |
| Business games                             | +                                      | +                    | -                   | -                   | -                      | -  |
| Metaphorical game                          | +                                      | +                    | -                   | -                   | +                      | -  |
| Role-playing games                         | +                                      | +                    | -                   | -                   | +                      | -  |
| Training                                   | +                                      | +                    | -                   | +                   | +                      | -  |
| Coaching                                   | +                                      | -                    | -                   | -                   | -                      | -  |
| Brainstorm                                 | +                                      | -                    | +                   | +                   | +                      | -  |
| Balint groups (group discussion workshops) | +                                      | +                    | +                   | -                   | -                      | -  |
| <i>Distance learning methods</i>           |  |                      |                     |                     |                        |  |
| Webinars                                   | +                                      | -                    | +                   | +                   | +                      | -  |

(continued)

**Table 1** (continued)

| Training methods          | Two-way communication: student-trainer | Aims to build skills | Low financial costs | High audience reach | Suitable for beginners | Risk for implementing business processes |
|---------------------------|--|----------------------|---------------------|---------------------|------------------------|--|
| Case technology           | +                                      | -                    | +                   | +                   | -                      | -  |
| Database                  | -                                      | -                    | +                   | +                   | +                      | -  |
| Audio and video training  | -                                      | +                    | +                   | +                   | +                      | -  |
| Computer training courses | -                                      | +                    | +                   | +                   | +                      | -  |
| Remote coaching           | +                                      | +                    | +                   | -                   | -                      | -  |
| Gamification              | +                                      | +                    | -                   | +                   | +                      | -  |

Source Authors

turnover; the number and frequency of horizontal and vertical movements; quantitative and qualitative indicators of the activities of trained employees and expert assessment of managers; quantitative and economic performance indicators [13]. The examination showed that after the introduction of distance learning practice, sales grew from 15 to 25%; satisfaction of customers and target consumers with the quality of services has grown; staff turnover has decreased. After the introduction of the Teachbase system at Siberian Health, the employee engagement rate increased; staff turnover has decreased; significantly reduced the cost of mentoring and as a result, increased the number of positive reviews from external clients.

### ***3.3 Algorithm for the Design and Development of a Corporate Training Center as the Basis for the Development of Digital Learning***

In the context of digitalization, the role and place of corporate universities is changing in connection with the development of new forms and methods of teaching based on the digital format. Today corporate universities are developing in the direction of e-learning, which is a necessary condition for improving the quality of education and its timeliness. The creation of a corporate university allows enterprises to develop and implement internal online training systems, implement and adjust their training programs in a short time. Despite the fact that the opening of a training center is a rather long and laborious process, without it it is difficult to develop and implement new training technologies, including on a digital basis. In accordance with the objectives of the study, an algorithm for the design and development of a corporate

Training Center was developed using the example of one of the enterprises of the aviation industry in the Samara region (Fig. 1).

The duration of the project development is 211 days (7 months). To reduce the time, the stage of collecting documentation for licensing can be carried out in parallel with stages 2–4. Then the duration of the project development may be reduced to 4 months. The total costs for the creation of a corporate Training Center, including

**Table 2** Comparative analysis of digital learning platforms in Russia

| Digital learning platform                           | Characteristic   | Scope of application  |
|---|--|---|
| iSpring Online (developer -Richmedia LLC (iSpring)) | Online platform for organizing a full cycle of distance learning, posting courses, assigning them to users and accessing detailed statistics<br>“+”—works via the Internet, no download and installation on the server is required; access to materials from any device. works online and offline; mobile application for iPad and Android; detailed training statistics; convenient user management; settings for paid courses<br>“—”—paid: cost from 56,000 rubles. in year; limitation on the number of users (minimum-50)  | Concept LLC (DODDO PIZZA), METRO CASH AND CARRY LLC, Alfa Capital Management Company LLC, Paolo Conte LLC, etc      |
| Teachbase (developed by Internet School LLC)        | Online platform for the development of e-courses based on ready-made educational materials, organization of testing, synchronous online training using the integrated presentation capabilities, audio and video, text chat<br>“+”—easy to use; optimized for various business training needs: for training your own employees, for training clients and partners of the company; no need to install on the server<br>“—”—paid, cost from 84,790 rubles. in year; SCORM and Tin Can standards are not supported; inability to download online courses; inability to create templates and generate group reports on the results of tasks  | JSC Sogaz, PJSC RusHydro, LLC INVITRO LLC International Company Siberian Health, etc                                |
| ShareKnowledge (developed by Competentum)           | An online platform developed on the basis of Microsoft SharePoint for automating the processes of training and personnel development, organizing the storage and systematization of company knowledge. Digital learning organization is based on the principle of software lease<br>“+”—flexibly integrates with portals and information systems (1C, BOSS-Kadrovik, SAP, etc.); convenient training planning system; the ability to independently create and customize your own types of reports<br>“—”—the paid cost of renting software from 43,200 rubles. in year; does not have its own mobile application and adaptive version for mobile devices; there is no built-in platform for conducting webinars; not suitable for implementing digital learning in a company in a short time; limit on the number of users (maximum-400) | JSC Eurocement Group, JSC Steel Industrial Company, JSC HC Sibirskiy Cement, LLC GK Sodruzhestvo, PJSC MINBANK, etc |

(continued)

**Table 2** (continued)

| Digital learning platform                               | Characteristic   | Scope of application   |
|---|--|--|
| WebTutor (developer -WebSoft Development LLC (WebSoft)) | <p>An online platform for comprehensive automation of business processes related to the selection, assessment, testing and training of personnel, talent management, systematization and storage of knowledge, as well as the organization of corporate communications and interaction between employees and the HR department</p> <p>“+” —the presence of additional functionality related to the management and training of personnel; availability of a free version to get acquainted with the capabilities of the system; the platform can be integrated with various corporate information systems; support for SCORM format; availability of ready-made training courses</p> <p>“-” —paid, cost from 115,000 rubles. in year; not modern look of the standard interface; complexity in system configuration; application in only large companies; not suitable for implementing digital learning in a company in a short time (implementation time 3–6 months); additional costs for customizing the server</p> | <p>PJSC Sberbank, PJSC Magnit, PJSC IC Rossgostrakh, JSC Alfa-Bank, PJSC M.Video PJSC “Transneft”, LLC “Svyaznoy Network”, etc</p>   |
| e.Queo (developer -LLC “Equio”)                         | <p>Digital platform for training, testing, communication, management and staff motivation</p> <p>“+” —has its own mobile application (iOS, Android) and is available for use in web browsers; works online and offline on any device; allows online presentations for mobile employees working outside the office; continuous training of a large number of employees</p> <p>“-” —paid, cost from 100,000 rubles. in year; not adapted for the needs of small businesses; lack of the ability to customize the design</p>  | <p>JSC “TC” Megapolis PJSC Megafon, LLC Internet Solutions (Ozon), PJSC MTS, LLC IC Renaissance Life, SPJSC Ingosstrakh, etc</p>   |
| Mirapolis LMS (developer -Mirapolis LLC)                | <p>Online service for managing corporate training of personnel (LMS, Learning Management System), for creating your own courses using various editors, organizing and conducting training, ensuring data exchange with other corporate systems</p> <p>“+” —allows you to download any kind of training materials, including the international standards SCORM 1.2, SCORM 2004, AICC and Tin Can are supported; the ability to customize the corporate style of the interface; developed to order for a specific company</p> <p>“-” —paid, cost from 600,000 rubles. in year; lack of a free trial version; lack of a “boxed solution”, individual custom development, long term of development and implementation</p>  | <p>Ministry of Internal Affairs of Russia, Russian Railways OJSC, Promsvyazbank PJSC, EKKO-ROS LLC (ECCO), ATOL LLC, Avtomir Group of Companies, Resurs LLC PJSC Cherkizovo Group, etc</p> |

(continued)



**Table 2** (continued)

| Digital learning platform            | Characteristic   | Scope of application   |
|--------------------------------------|--|--|
| Unircraft (developer -Unircraft LLC) | An online platform for creating a unified information system and managing corporate knowledge, structuring it and distributing it among employees<br>“+” —does not require special training; intuitive interface; simple control; ready-made templates for training courses and tests; free consultations; presence of gamification; choice of version (cloud, box)<br>“-” —paid, cost from 39,600 rubles. in year; limitation on the number of users (minimum-10); the lack of the ability to create complex animated courses with a nonlinear plot in the built-in editor; there is no built-in platform for conducting webinars | JSC LOESK, LLC Open Mobile Platform, LLC Insight LLC LT Global Forwarding, LLC GK Rosokhrana LLC TC Sladkaya Skazka, etc |

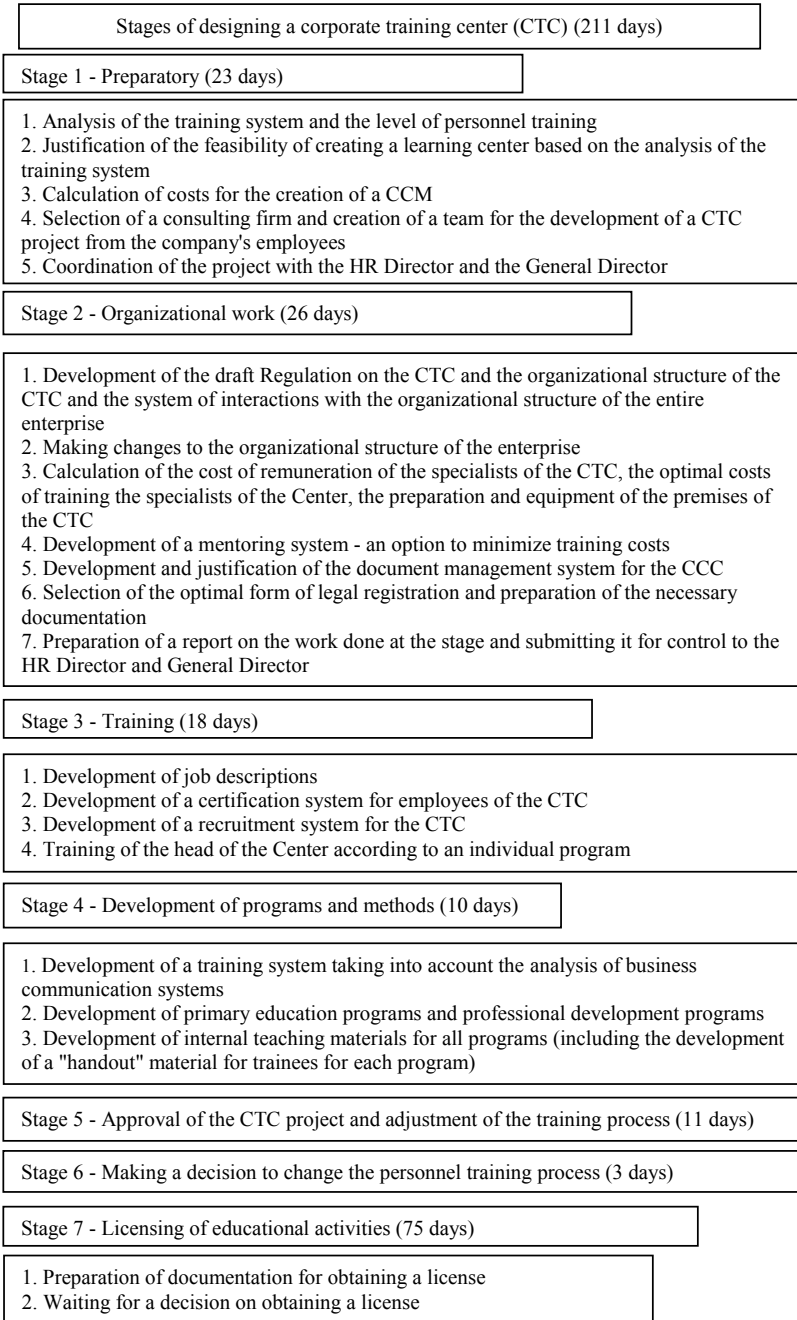
Source Authors

the remuneration of the company’s specialists involved in the development of the training center project + the cost of a training course for the future head of the training center + the purchase of stationery for the training center + the release of teaching aids + “cosmetic” repair of classrooms, amounted to 357,745 rubles. The bulk of the costs (63%) is related to the remuneration of specialists involved in the development of the project.

## 4 Discussion

The analysis of domestic scientific research and articles on the topic of professional development indicates a broad theoretical study of the issues of planning and organization of personnel training as a system. So, for example, questions of the sequence of development of corporate training systems have been thoroughly investigated; the practical experience of companies in organizing employee training in general is widely reported [5, 7, 10].

The issues of organizing adult corporate training have also been deeply studied by individual foreign research scientists: the features of adult students’ training have been identified [9]; developed a cyclic model of learning and assimilation of new information; methods for assessing the effectiveness of training have been studied [8] and others. However, in our opinion, individual elements of the organization of the training system have not yet been studied, in particular, a critical analysis of various forms and training methods for different categories of personnel. In addition, the digitalization of the economy, the introduction of digital technologies and mobile devices today have given rise to new methods and tools of education, the study and use of which is very interesting and deserves close attention. Thus, it seems to us that in order to increase the efficiency of the employee training process, the convenience of



**Fig. 1** Algorithm for the design and development of the CTC on the example of the Samara enterprise. *Source* Authors

organizing training for adult students, and the possibility of saving the training costs budget, it is necessary to dwell in more detail on the analysis and systematization of the training methods (tools) used as an essential element in the organization of a training corporate system; conduct a comparative analysis of modern innovative methods; identify their strengths and weaknesses; to study the practical experience of using new tools; identify trends in their development.

## 5 Conclusion

In conclusion, let us dwell on the trends in the choice of various training methods by Russian companies. For employees with a high level of qualification, a high level of motivation and self-confidence, the emphasis today is on the use of training methods that are active with the use of innovative technologies and aimed at the formation of managerial, communicative skills and business qualities (business simulation game, trainings, business quests, training action, computerized learning and others). Psychological studies in the field of training have shown that a person remembers 90–92% of information if he independently performs actions associated with this information [14]. According to statistics, today in Russian companies the largest share in the list of methods used is occupied by modular training-83%, mentoring-78% and training in working groups-60%, but distance learning-only 37% of the total list of methods used, which is clearly not enough for today [15].

## References

1. Simonova, M.V., Ilyukhina, L.A., Bogatyreva, I.V., Vagin, S.G., Nikolaeva, K.S.: Conceptual approaches to forecast recruitment needs at the regional level. *Int. Rev. Manag. Mark.* **6**(S5), 265–273 (2016)
2. Schekoldin, V.A., Bogatyreva, I.V., Ilyukhina, L.A.: Digitalization of labor regulation management: new forms and content. In: Ashmarina, S., Vochozka, M., Mantulenko, V. (eds.) *Digital Age: Chances, Challenges and Future. Lecture Notes in Networks and Systems*, vol. 84, pp. 137–143. Springer, Cham (2020)
3. Simonova, M.V., Ilyukhina, L.A., Romantsev, G.M., Zeer, E.F., Khamaturov, F.T.: Approaches to monitoring of competences and qualifications. *Math. Educ.* **11**(7), 2745–2760 (2016)
4. NAFI: Most Russian companies are not ready for the digital economy. <https://nafi.ru/analitics/bolshinstvo-rossiyskikh-kompaniy-ne-gotovy-k-tsifrovoy-ekonomike> (2017). Accessed 10 February 2021
5. Ilyukhina, L.A., Bogatyreva, I.V., Makhmudova, I.N., Ermakova, J.D.: The corporate personnel training system development: the experience of Russian enterprises. In: Mantulenko, V. (ed.), *Proceedings of the International Scientific Conference on Global Challenges and Prospects of the Modern Economic Development*, vol. 57, pp. 654–665. European Proceedings, London (2019)
6. Makhmudova, I.N., Ilyukhina, L.A., Bogatyreva, I.V.: Personnel safety in the system of economic security and personnel management. In: Mantulenko, V. (ed.) *Proceedings of*

- the International Scientific Conference on Global Challenges and Prospects of the Modern Economic Development, vol. 57, pp. 1859–1865. European Proceedings, London (2019)
7. Chulanova, O.L., Timchenko, J.A.: Corporate staff training and methods of its assessment: approaches, tools, problems and ways of their overcoming. *Internet-Journal Naukovedenie* **8**(1). <http://naukovedenie.ru/PDF/13EVN116.pdf> (2016). Accessed 18 April 2021
  8. Kirkpatrick, D.L., Kirkpatrick, J.D.: *A practical guide for effective. Berrett-Koehler Publisher, Evaluation of training programs*. San Francisco (2007)
  9. Knowles, M.S., Holton, E.E., Swanson, R.A.: *The adult learner: the definitive classic in adult education and human resource development*. Elsevier, London (2005)
  10. Vorotyntseva, T., Nedelin, E.: *Building a system of staff training. A practical guide for training professionals*. Saint Petersburg, Speech (2008)
  11. Nazaikinskiy, S.V.: Current issues of transformation in personnel training in organizations. *RSUH/RGGU Bulletin. Series Economics. Management. Law* **3**, 23–34 (2018)
  12. *Training Magazine: Resources for training professionals*. <https://trainingmag.com/category/magazine> (2020). Accessed 22 March 2021
  13. Rosgosstrakh: Distance learning, e-learning, SDO. <http://distance-learning.ru/db/el/AD83CF3F63667F22C32575760082047C/doc.html> (2020). Accessed 22 March 2021
  14. Varenina, L.P.: Gamification in education. *Historical and Socio-Educational Thought* **2**(6), 314–317 (2014)
  15. Bezlepkina, E.: Modern methods of personnel training. <http://www.ngpc.ru/forum2010/Articles/Learning%20methods.pdf> (2010). Accessed 18 April 2021

# The Role of Digitalization in Future Translators' Professional Training



A. M. Klyushina, L. Yu. Stoykovich, and G. V. Stoykovich

**Abstract** In this article some digitally-based techniques aimed at improving the training of translators in higher education are described. The authors show the experience of introducing digital methods into the process of teaching translators in two Russian universities. They identify the most effective ways of creating digital competencies and their varieties and show the stages of their formation. According to the information, based on the review of current translator vacancies on a number of websites and a survey of employers on the GoogleForms platform, the authors draw a conclusion about additional knowledge, skills and abilities in the field of digital technologies required for a translator. The prospects for research and activities in this direction are also set.

**Keywords** Digitalization · Digital competence · Digital methods · Digital technologies · Translators' education · Translation practice

## 1 Introduction

According to the federal educational standards of higher education, the bachelor's level in the field of training of 45.03.02 Linguistics and the master's level in the field of training 45.04.02 Linguistics the educational organization determines professional competencies and their content independently on the basis of the professional standards corresponding to the professional activities of graduates. As a result, both the matter of the project of professional standard "A specialist in the field of translation" and the matter and necessity for the formation and development of various professional and supra-professional skills of a translator that cause a wide variety of discussions in the professional translation community and the academic community

---

A. M. Klyushina (✉) · G. V. Stoykovich  
Samara State University of Social Sciences and Education, Samara, Russia  
e-mail: [klyushina@pgsga.ru](mailto:klyushina@pgsga.ru)

L. Yu. Stoykovich  
Samara State University of Economics, Samara, Russia

of teachers of translation has recently been discussed. In addition, there is vital issue about the adequacy of the modern university training of translators in Russia and the needs of the domestic labor market, as well as international requirements [1–3]. Nowadays studies of digitalization and its peculiarities in different fields and spheres of human activities, such as journalists [4–6], school teachers [7, 8], nursery school teachers [9], fishermen [10] have become most frequent and widespread, and this proves the actual value of our research.

## 2 Methodology

In our research, we used different theoretical methods. To begin with, we analyzed the subject of our research on the basis of the study of pedagogical, psychological and translation literature. We also used reflective-system analysis of the substantiated organization of the pedagogical activity of the authors of the article. Quantitative research methods were used as empirical methods. We analyzed more than 70 current vacancies of translators on hh.ru sites; ru.jooble.org; rabota.ru; superjob.ru; and we conducted an online survey of employers. 47 people from different cities of Russia (employees of translation companies and international departments) took part in the online survey conducted on the Google.Forms platform. The received responses and the results of the survey of vacancies determined the structure and content of the article, and also confirmed the relevance and necessity of this study.

## 3 Results

In the modern system of higher education in Russia, the problem of training a specialist in the field of translation in a digital communication environment is considered to be of current importance. According to the President of the Russian Academy of Education Zinchenko, one of the reasons for this was “widespread digitalization, forced by the pandemic of COVID-19 and the restrictive measures” [11, p. 2]. It is known that the organization of the educational process in the digital environment has already brought both positive and negative results; and it is also important for a modern teacher of translation to strike a balance between online tools and effective translation didactics.

Modern digital technologies have had a significant impact on the traditional didactics of translation. Changes affected the principles of searching of the information and its processing (some electronic encyclopedias and dictionaries, text corpuses and search systems appear and are being improved); principles of work in special systems (Cat, Projetex), complex corpus managers (byu.edu), etc. Modern translators must certainly be able to use these technical resources.

In this article, we will describe digital competence as one of the key components of the professionalism of a modern translator. We will pay special attention to the

peculiarities of its formation and development in the educational process using the example of work at the Faculty of Foreign Languages of the Samara State University of Social Sciences and Education and the Samara State Economic University.

The digital environment of the analyzed professional activity is presented in all stages of work: search of order, written and / or oral online communication with the customer, making contracts, information search, translation analysis, translation, editing, sending to the customer. An information translation environment is “a set of computer-mediated communication and information technologies in the form of software and hardware for storing, processing, transmitting information, which the translator uses when solving the tasks” [12, p. 45].

An analysis of the professional activity of a modern translator shows that an informational translation environment means that a translator has to deal with technology, employer, colleagues, consultants and specialists in a particular professional sphere. The translator must be able not only to use the necessary resources, but also to create them him/herself and be responsible for their safe use.

In the information translation environment, there are certain rules and strategies of digital literacy. Digital literacy includes the following: cultural studies (rules and norms of behavior), cognitive science (rules of implementation), constructiveness (rules of use and application), communicativeness (rules of communication), privacy (rules of attitude), creativity (rules of creating), criticality (assessment rules), citizenship (participation rules) [13].

According to the level of mastering, all digital competencies of the translator can be divided into.

- basic (the ability to use devices, to use the Internet, to search for the information or a resources, type on the keyboard, create an account, etc.);
- standard (the ability to use effectively the system, to evaluate the source of information, to organize and store information, to protect devices and information);
- advanced (the ability to program, to maintain the program, to work out tools, to work in a team project).

Thus, a modern translator should understand the work of the information translation environment at the technology level as well as to take into account the possibilities of this environment for his professional growth. So, nowadays, the professional career of a translator mostly depends on his success and effectiveness in the information translation environment.

We analyzed the current translator vacancies on hh.ru; ru.jobble.org; rabota.ru; superjob.ru and made an inquiry of employers' representatives on the Google Forms platform in order to determine the requirements for a modern translator. It showed that a translator is expected to master not only his/her language and translation skills, but also the following knowledge and skills, which can be attributed to digital competencies:

- knowledge of modern requirements for the professionalism of a translator in the “digital economy” sphere and the ability to follow the existing information technologies used in translation;

- knowledge of the translator's information tools and the ability to choose the essential information resources;
- knowledge of the ways of search, analysis, collection, keeping, classification of information and the ability to organize a professional information translation environment;
- knowledge of various information technologies for solving specific translation problems and the ability to use certain algorithms;
- knowledge of the features of mechanical translation and the ability to apply it;
- knowledge of organizing time management, management techniques and the ability to plan and solve translation tasks, as well as organizing a workplace;
- knowledge of the features of various forms of communication and the ability to communicate online;
- knowledge of software and the ability to ensure online security of information on the Internet.

## 4 Discussion

We take into account the data obtained, when organizing the educational process and extracurricular activities of the students of the Faculty of Foreign Languages of the Federal State Budgetary Educational Institution of Higher Education "Samara State University of Social Sciences and Education" (SSUSSE), bachelor's programme 45.03.02 Linguistics: "Translation and Interpretation Studies" and master's programme 45.04.02 Linguistics: "Theory and practice of translation in intercultural communication", and the Federal State Budgetary Educational Institution of Higher Education "Samara State University of Economics", complementary education "Translation in the Field of Professional Communication".

The electronic courses on the *lms.sgspu.ru* platform are used to train students in the following disciplines "Practical Course of Translation", "Interpreting", "Written Translation", which contain a variety of tasks aimed at the formation and development of digital competencies of translators [14]. The implementation of such exercises brings students closer to real working conditions in an information translation environment.

In organizing educational and practical training, students are offered to implement various translation projects based on real orders from employers. For example, in 2021, 4-year students of the 45.03.02 Linguistics ("Translation and Translation Studies") of the Faculty of Foreign Languages of the SSUSSE at their practical training (professional skills and experience gaining practice) were asked to choose a real translation order and complete it on time. The Department of the Russian Language, Literature and Linguistics of the Togliatti State University was the customer of the translation. The practice of translation was carried out in a distant format with the use of a digital environment at all stages of work: students discussed the order, they communicated with the customer in written and oral forms using various



information technologies, discussed the terms of the order, searched the information, carried out the translation analysis of the text, made a translation, and editing, sent the completed translation to the customer. The students use various translation resources while making this kind of translation (electronic copies of paper dictionaries, electronic interface dictionaries, open-type dictionaries, translator storage systems, mechanical translation systems). This kind of translation projects shows its effectiveness working in a digital translation environment.

Moreover, the first- and second-year students of the Faculty of Foreign Languages of the SSUSSE programme 45.04.02 Linguistics (“Theory and Practice of Translation in Intercultural Communication”) take an active part in the organization and realization of international scientific conferences. The organization and realization of extracurricular work allows students to get as close as possible to the conditions of a real translation situation [15]. On September 15–18, 2020, the Second International Scientific and Practical Conference “Modern Art: development, education, environment” took place at SSUSSE. Foreign scientists (Professor of the Chicago School of Professional Psychology Nikolaus Bezruzhko (USA); Professor of Tohoku University and the Women’s College Sendai Shirayuri Mitsuru Takahashi (Japan); assistant Professor of the Riga Technical University Silviei Rolandovnoy Ozola (Latvia)) took part in it [16]. About 100 participants from Russia, the USA, Japan, Latvia, Italy, France, representatives of universities, cultural centers, art groups, schools, kindergartens, institutions of additional education were gathered at the conference. Students of the Faculty of Foreign Languages of the SSUSSE got the opportunity to practice both translation and interpretation, and also trained such digital skills as online communication with the customer of the translation to discuss working terms, preliminary translation of the presentation, interpretation of oral speech.

## 5 Conclusion

In conclusion, we would like to note that in spite of some negative impacts of digitalization on the organization of the educational process generally, there are significant positive results of it in translators’ training, and it also helps in a distance learning format which is especially required during a pandemic. It is important for teachers of translation to know and take into account both aspects. Digital awareness is one of the key components of the professionalism of a modern translator and means certain strategies and digital literacy that need to be trained and developed in the future translator. Besides, the essential strategy for the training of translators in the digital environment is being developed and implemented in the above-mentioned universities, it gives positive results and new tasks that meet the requirements of constantly evolving digital technologies are set. The most important part of it is translation practices in distant digital format, international online conferences, which undoubtedly expand the possibilities for the formation and improvement of digital competence.

Working out new exercises for teaching translation in a digital environment, electronic manuals for student translators and organization of online round-table discussions on translation problems are very perspective directions for continuation of this research.

## References

1. European Commission: European master's in translation. [https://ec.europa.eu/info/resources-partners/european-masters-translation-emt/european-masters-translation-emt-explained\\_en#documents](https://ec.europa.eu/info/resources-partners/european-masters-translation-emt/european-masters-translation-emt-explained_en#documents) Accessed: 05 Mar 2021 (2020)
2. Ilnet, A.O.: Training of translators in Russia and abroad: a comparative analysis. *Edu Sci* **8**, 65–70 (2010)
3. Pym, A., Torres-Simón, E.: European masters in translation. A comparative study. [https://www.google.com/url?q=https://www.researchgate.net/publication/314090217\\_European\\_Masters\\_in\\_Translation\\_A\\_comparative\\_study&sa=D&source=editors&ust=1613734312635000&usq=AOvVaw0Kha33fkW7X0h0fvMSscTh](https://www.google.com/url?q=https://www.researchgate.net/publication/314090217_European_Masters_in_Translation_A_comparative_study&sa=D&source=editors&ust=1613734312635000&usq=AOvVaw0Kha33fkW7X0h0fvMSscTh). Accessed: 05 Mar 2021 (2017)
4. Asmolov, A.G., Asmolov, G.A.: From we-media to I-media: Identity transformations in the virtual world. *Psychol Russ State Art* **2**(1), 101–123 (2009)
5. Salnikova, L.S.: Robots versus journalists: does journalism have a future? *Theor Pract Issues Journalism* **8**(4), 668–678 (2019)
6. Zamkov, A.V., Krashennnikova, M.A., Lukina, M.M.: Working practices of journalists: Humans or robots? *Theor Pract Issues Journalism* **9**(1), 46–64 (2020)
7. Asmakovets, E., Koziej, S.: The use of teacher blog in educating students—future teachers at universities in Russia and Poland. *Media Edu* **1**, 30–36 (2021)
8. Tyunnikov, Yu., Maznichenko, M., Kazakov, I., Krylova, V.: Factors, risks and conditions for implementing the potential of teachers in their use of media and digital resources. *Media Edu* **1**, 153–165 (2021)
9. Gjems, L., Sheridan, S.: Early literacy in Norwegian and Swedish preschool teacher education. *Psychol Russ State Art* **8**(2), 4–17 (2015)
10. Memon, B., Hingorjo, A.A., Chhachhar, A.R., Khuhro, R.A.: A study of use of mobile phone for marketing purpose by fishermen of the Indus Delta. *Media Edu* **60**(3), 488–497 (2020)
11. Russian Academy of Education: Didactics of translation in the digital age. <http://rusacadem.edu.ru/news/didaktika-perevoda-v-cifrovuyu-epoxu/>. Accessed: 05 Mar 2021 (2020)
12. Alferova, D.A.: Modular Training in the Translation of Scientific and Technical Texts Using Information Technology: Dissertation Candidate of Pedagogical Sciences. Peoples' Friendship University of Russia, Moscow (2010)
13. Belshaw, D.: The essential elements of digital literacies. <http://www.frysklab.nl/wp-content/uploads/2016/10/The-Essential-Elements-of-Digital-Literacies-v1.0.pdf>. Accessed: 05 Mar 2021 (2016)
14. Stoykovich, G.V., Klyushina, A.M.: Topical issues of translation didactics in teaching linguistic students of the profile translation and translation studies. *Mod Pedagogical Edu* **6**, 212–216 (2018)
15. Klyushina, A.M., Shalifova, O.N.: Extracurricular work as a factor of personal growth and education of students (on the example of the Faculty of Foreign Languages of the Samara State University of Social Sciences and Education). *Samara J. Sci.* **8**(4(29)), 248–252 (2019)
16. PGSSA: II International Conference Contemporary Art: Development, Education, Environment. <https://www.pgsga.ru/infocenter/news/26761.html> Accessed: 05 Mar 2021 (2020)

# Competencies of the Future: Transforming Education in the Digital Economy



N. V. Kozhukhova, I. A. Agaphonov, and Y. Y. Korobkova

**Abstract** The global community has been «taken over» by global digitalization. Businesses have been digitally reshaped by the complex nature of Industry 4.0 technology. Industry and entrepreneurship are transforming business processes. The diffusion of “end-to-end” digital technologies into the global economy also requires a reconsideration of the role and place of humans in this process. In this regard, the article considers a comprehensive understanding of the necessary skills of the digital future, analyzes their various aspects, defines the conceptual apparatus of digital skills development problems. The problems faced by business and the modern education system at different levels of digital skills training are highlighted. Existing and nascent but promising approaches to solving educational problems are summarized and analyzed. The tools of competence forecasting in accordance with the future market conditions, taking into account international factors of change—innovation and technological progress—are considered. The author’s position on the formation of the HR model of the near future is formulated.

**Keywords** Adornation · Competencies · Digital skills · Human resource management · Technology foresight

## 1 Introduction

As humanity moves into the modern era, we find that the models of competence that now exist no longer meet the global challenges of the world economy and require updating through a mechanism of transformation. Knowing the benefits of finding patterns and understanding the limits of our innate senses, the world has developed and continues to develop methods and tools for gathering information

---

N. V. Kozhukhova (✉)  
Samara State University of Economics, Samara, Russia

I. A. Agaphonov · Y. Y. Korobkova  
Samara State Technical University, Samara, Russia

beyond the capabilities of our consciousness. The society first built telescopes, microscopes, increasingly accurate clocks, light prisms, scales, thermometers, electrical measuring instruments, and chemical equipment. Now mankind is several generations further along, and uses satellites, particle accelerators, DNA sequencers, electron microscopes, medical diagnostic equipment of all kinds, just to name a few. With nanotechnology and digitalization tools (IIoT and AI, low-code tools, predictive functions, application of Agile principles, etc.), humanity continues to gather information about the world at an astonishing rate. This information is used to extrapolate patterns and laws in the world, and to indicate the steps necessary to achieve in each of the technologies under consideration (e.g., technology for the formation of future competencies). The tools of the new reality—Internet of Things, big data, artificial intelligence, machine learning, cyber-physical systems, monitoring systems, blockchain, neural networks, robotics, 3D modeling, virtual reality, cloud computing and many others—require the skills, abilities and knowledge to apply them. Consequently, the educational trajectories of the digital age must be transformed as well, forming the foundation of the competencies and skills so necessary for it.

At the heart of the work is the identification of new trends and gaps between the requirements for the knowledge, skills and abilities of professionals that will change the global society and the global marketplace and the availability of competencies available to the workers of today. The need for changes in educational technologies is considered, in this regard, with a bias on business strategies, design processes, innovations and social dilemmas. The relationship between the process of competence formation and the requirements of the future market was revealed. The vision of educational trajectories of the twenty-first century is described. Identification of the relationship between the process of competence formation and the requirements of the market of the future. To describe the vision of educational trajectories of the twenty-first century. Identification of the values of twenty-first century education as the foundation on which the required future competencies are built and established. Description of the educational ecosystem is given. To conduct the study, the authors used the following methods: theoretical analysis of approaches, analysis of open data of sociological research. All of the above is folded into a pyramid of conclusions.

The authors have been faced with the task of illuminating the main aspects concerning the consideration of educational trajectories of the twenty-first century, as well as the competences of the future, their structuring, and typologization. What do we understand by competence? How does the notion of competence correlate with the notion of skills? What is their typology? Why is it necessary to highlight the main categories and give their interpretation? What is the methodology used in forming the model of future competences? What technology is appropriate to use? What are the risks and successes of its use?

## 2 Methodology

With the current dynamics of the global economy, the problem of determining future skills needs is becoming increasingly acute. The development of a promising educational policy is becoming a priority area of research. In this context, forecasting future skills needs becomes a practice that will help to balance the labor market. The development of human capital in the era of digitalization is advisable taking into account the formation of:

- competency models for the digital economy in the context of continuous learning;
- the new role of teachers in digital skills training;
- training of it professionals in the field of new digital technologies;
- innovative educational models and advanced educational technologies;
- optimal balance between digital, professional and “soft” skills.

The following structure of skills typology in the digital age is proposed:

1. Professional skills (human resources, law, sales, marketing, finance, special skills required for work).
2. Soft skills (problem solving, decision making, collaboration, empathy and emotional intelligence, energy management, cultural diversity, virility/force, multitasking).
3. “Digital” skills (data analysis, machine learning, artificial intelligence, programming, IT architecture, cybersecurity).

Since professional skills are directly related to technologies that are being updated very quickly in the digital environment, this will also require more flexible, innovative tools to assess future competency needs that are tailored to industry specifics, including high technology. In determining market needs, there is a need to synchronize the pace of change with the pace of adaptation to change.

Competence is required in research and development, innovation, in the implementation and adaptation of new technologies (business skills, management skills), and in the operation and maintenance of new technologies [1]. The introduction of new technologies will have a positive impact on the competitiveness of participants in economic relations. High-tech industries are often associated with rapidly changing conditions and thus uncertainty. However, they tend to offer more skilled jobs and higher incomes. While investors look for global industrial centers in search of the next big market, the state tries to apply appropriate strategies to ensure that the next generation of workers has the necessary competencies through technical and vocational education and training (vocational education and training) and higher education (higher education) [2]. The cycle of impact of technologies and competencies includes the following: technologies indicate the need for competencies, and they, in turn, determine the use of technologies. Convergence of competence prediction and technology foresight will help identify future skills needs as well as coordinate the change and emergence of occupations in key sectors in the context of a changing technological environment.

The methodology for anticipating future competencies based on the technology foresight aims to identify the most appropriate methods and solutions to meet the requirements of national legislative changes as well as best practices for bridging the gap between the demand for competencies and their supply, which, among other determining factors, arises as a result of technological changes.

Technology-based competency forecasting can complement existing competency forecasting methods such as the Professional Profile Method for the Future of Industrial Enterprises, developed by the National Service of Industrial Education of Brazil (SENAI), or the Fraunhofer Technological Radar Method, used in Germany.

For technological forecasting of competences the most important parameter is the choice of the relevant sector of the economy. The method should be applied primarily to sectors with a high potential for change through the use of new technologies. This is due not only to the fact that these sectors become centers of R&D, foreign direct investment, talent and advanced technologies. Another important factor is that technology can significantly change the structure of employment in an industry, as it has a positive impact on occupations requiring specialized and unique competencies, and often a negative impact on occupations dominated by typical tasks. For example, between 2010 and 2020, employment among highly skilled workers—increased, while employment among low-skilled workers decreased. This is explained by the fact that part of the working population did not have the competencies to succeed in the labor market (e.g., high value-added jobs). Workers with low levels of education were less likely than workers with high levels of education to seek continuous learning and development, making it difficult for them to adapt to rapidly changing and increasing skill requirements and the acquisition of new knowledge.

According to statistical data, 55.2% of job seekers with secondary or higher education agreed to work in positions with lower requirements [3]. In the author's opinion, this may indicate, firstly, that the skills acquired in educational institutions do not meet the requirements of the workplace, and secondly, the difficult situation on the labor market for the workers themselves—a job with lower educational requirements is sometimes more affordable than a job that requires a high level of education and specialty that the employee has. Let us define the basic concepts, methodologies and technologies used by the authors [4].

Competence is the ability embodied in sufficient knowledge and skills acquired after effective training, adding value in a particular context (education, work, personal or professional development).

Adornment—improvement. Adornment technology builds on the transition from an initial set of competencies to a set of competencies that meet the requirements of new high-tech processes.

Methodology of competence adornation:

Need: Modernization of production leads to the fact that there is an acute need for human resources capable of working in high-tech production conditions. Further analytical research is being conducted.

Objective: To form the competencies necessary to master new equipment and technologies, taking into account the further effect of the use.

Problems: Knowledge carriers in educational institutions and organizations—teachers and masters of vocational training themselves do not have such skills.

Solution: Adornment of the competences of the teaching staff.

Changing the model of the educational process: formation of an educational platform based on the use of a network resource.

Result: solving the problem of training the working staff for a specific high-tech production [5]. The successes and risks of the methodology of competence adornment are as follows: Success—formation of development strategy, its cultivation, consideration of human capital, available skills and reliance on them, solving the problems of specific production and specific people, formation of new educational platforms based on the integration of existing resources. Risks—the probability of not keeping up with global trends.

The most common technology for developing the competencies of the future is foresight technology. This assessment method aims to identify trends in science, technology, the economy and society as a whole, which should be carried out systematically, in order to further highlight the strategy for developing research and finding technologies for the future that will benefit society [6]. A set of prediction methods is the starting point for the formation of future competencies. Foresight of competencies is a set of foresight methods used in qualitative forecasting of competencies required for the future needs of the economy, certain areas of activity or industries.

The technological foresight of competencies is a modern tool that includes both forecasting future competencies and the methodology of the technological foresight, which allows you to identify future needs for competencies in the relationship between technological changes and innovations [7–9].

The foresight session is the core of the technology foresight methodology of competencies and consists of three stages:

- technological foresight, aimed at building a concept of the future of the industry and the specialists working in it, or at revising the existing concept;
- competency forecasting based on technology foresight;
- recommendations for the education system, policymakers, and interested labour market representatives, aimed at closing the gap between the demand for and supply of competencies.

Technological foresight method based on international best practices, represents a new scenario approach to forecasting the needs for future competencies. It is important for heads of enterprises, as well as scientists, practitioners and specialists, to focus the world community on changes in the organization of labor, professional tasks and needs for future competencies that meet the advanced trends in the development of digital society.

The successes and risks of the foresight methodology are as follows: Successes—long-term forecast allows to prepare the education system for the formation of new competencies; formation of targets for the state, politicians, education with stakeholders; Risks—mistakes in the forecast period (competences may not yet be in demand or preparation and implementation is delayed); subjective shifts in setting

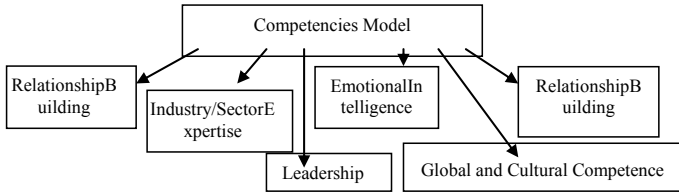


Fig. 1 Competencies Model. Source Authors

priorities, emergence of new trends; existing human capital and existing competences remain out of sight; problems that need to be solved today are not solved. Consequently, in accordance with the methodology used, it is advisable and necessary to integrate and complement these technologies of competence formation to achieve the greatest effect in predicting future competences. In turn, in the context of digitalization of the economy, it is proposed to form the following competences for Generation Y and Z specialists (Fig. 1).

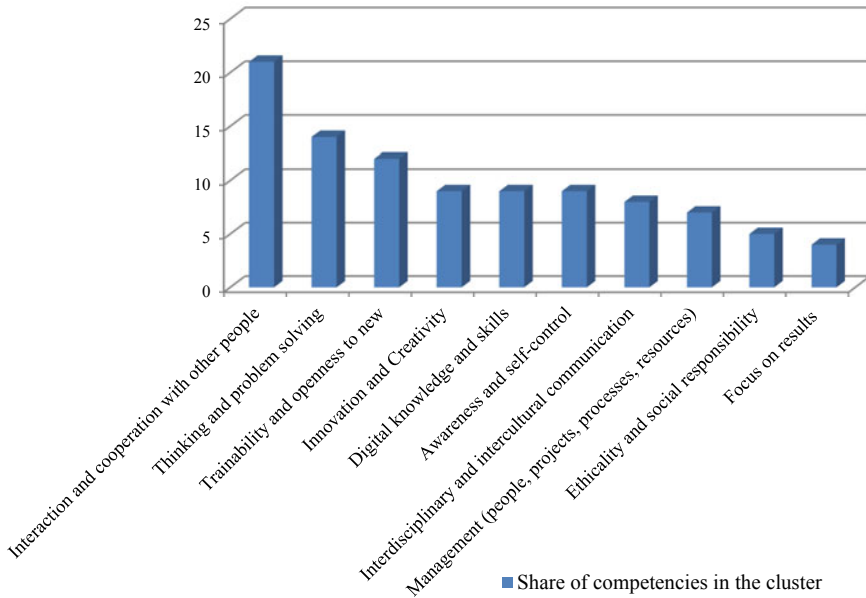
### 3 Results

Due to transformations in the economic world associated with a large-scale digital revolution, the values of the twenty-first century education have changed, the trajectory of which is aimed at: initiative and focus on acquiring new competencies; readiness and ability for technological, organizational, and social innovations; cooperation and mutual responsibility; creativity, critical thinking, high social activity and competence in implementing social interactions; information literacy. Education 3.0 is based, first of all, on the way of thinking, and the main goal of learning is to form cognitive, emotional and strategic competences in the process of real activity [9]. Movements along one’s own educational trajectory are developed, with the construction of unique knowledge in a practice-oriented environment, there is an opportunity for a wide choice as to what to study, how to study, and what resources to use for this purpose [10]. Enterprises should already be developing comprehensive competency development programs for the future, which will help employees pump up skills for their activities in the new environment.

Six groups of competencies will become the most demanded in the future: digital skills, creativity, thinking and problem solving, ability to interact with other people, awareness and self-management, learnability and openness to new things.

The structuring of competencies which are similar in content is solved by means of clustering (i.e. combining competencies into a single meaning block) (Fig. 2) [11]. For example, in models it is expedient to allocate clusters directed on intellectual (thinking) activity «Thinking and problem solving», achievement of result, work with people (interaction), work with information, etc.





**Fig. 2** Share of competencies in the cluster. *Source* Authors

They were in demand before, but their importance and role have grown rapidly. In the past creativity was most often needed only for creative people, now creativity is the ability to find solutions in complex, non-standard situations, which is often necessary to move to the next level. Interaction with each other is now expressed in working in flexible, remote teams, using digital tools and services. The competencies of the future are built through this focus. But these competencies are also important in current realities. By and large, what workers have been preparing for in the horizon of several years has become critically needed today due to quarantine measures.

For example, digital skills—the ability to quickly set up a remote workstation, install the necessary communication services and other things. Or the ability to interact with other people: with a disparate and remote team. Especially relevant looks the ability to be open to new things and learn quickly. When employees were constantly working in the office, their effectiveness in a new environment depends to the greatest extent on how quickly they adapt to them and learn to work in a new way. Awareness and self-management will help find psychological balance, which also comes to the fore. The peculiarity of the competencies offered is that, unlike professional skills, they do not become obsolete. Tools for the development of critical and creative thinking, will allow for easy adaptation to new conditions and requirements. The extent to which these competencies will be in demand depends on each participant of the labor process as well. First of all, it is necessary to translate these competencies into practice, turning them into applied tools for companies. It

is reasonable to arrange competence groups in a conditional sequence (four development tools for each competence group), passing through which a new project or product will be created. It is suggested that part of the programs be focused on the fundamental skills of personal and team efficiency, and part—on specific tools.

## 4 Discussion

All transformations in human resource technology are now focused on the ILO strategy of anticipating future competencies in line with upcoming market conditions, taking into account international drivers of change: innovation and technological advances aimed at preparing a workforce that is a sustainable foundation for intensive, balanced economic growth.

According to scientists who have studied the labor market in 50 countries, automation will take jobs away from more than 800 million people by 2030, and about 50 percent of workers' occupations will be replaced by machines [3]. The population will have to retrain. Forecasting how and what to learn is already necessary and crucial. The labor market is changing very rapidly, and companies must keep track of these innovations, making timely updates: organizational structure, staffing, all HR processes (taking into account the use of innovative technologies), in order to make a list of professions relevant for the near future. In the era of digitalization, the following list of «supraprofessional skills and abilities» is of interest.

1. Systems thinking in the form of the ability to identify and develop complex interactions generating a fundamentally new quality and the ability to work with them, including simultaneity of thinking and systems engineering.
2. Cross-industry communication (understanding of technologies, processes and market situation in different related and non-related industries).
3. Project management (ability to design, plan and organize the execution of projects and processes).
4. Programming of IT solutions, management of complex automated complexes, working with artificial intelligence.
5. Customer orientation (ability to work with customer requests).
6. Multilingualism and multiculturalism (fluent English and knowledge of the second foreign language, understanding of national and cultural context of partner-countries, understanding of specificity of work in branches in other countries).
7. Working with people (ability to work with teams, groups, and individuals).
8. Working in a mode of high uncertainty and fast change of tasks' conditions (ability to make quick decisions, to react to changing conditions of work, ability to distribute resources and manage own time).
9. Artistic creativity skills (ability to create art, the presence of developed aesthetic taste).
10. Lean manufacturing [12].

Digital transformation of the world also dictates key trends in education: personalization of education (at all levels—goal-setting; prediction and planning of educational trajectory; differences in depth and speed); activities are conducted in an information environment (progress and results of the educational process are recorded, placement of tasks and their performance, comments on them; everything is transparent); state and change measurement (analysis and interpretation; change is more important than value; big data analysis, artificial intelligence algorithms; learning machines (machine learning)).

## 5 Conclusion

Today, personnel training only for the purpose of actualizing the needs of the company itself and personally meeting the current needs of employees is not relevant. A new vector of training focused on future market needs is set, much more importantly, providing free access for employees to training programs that promote the continuous development of professional skills [13]. As best practices in education policymaking drive improvement in all areas of economic development, forward-looking education policy development becomes a research priority. Therefore, the forecast of skills needs should be carried out continuously, because it helps to balance the labor market through an in-depth assessment of educational policy: in the medium and long term, the labor market will receive professionals with competencies that meet the needs of the market, thus eliminating the shortage of competencies, as educational institutions had enough time and information to adapt to market requirements [8].

Consequently, the importance of qualified personnel cannot be overestimated not only for the employing organizations, but also for the countries. Employees with a high level of professional knowledge and skills are a valuable asset in the development of a competitive, sustainable and innovative economy, as well as in the achievement of strategic objectives at the national and European levels [14]. Thus, as the structure of the economy changes, namely the transition to an economic model based on knowledge and innovation, changes in requirements for professional competencies are accelerating. As a result, there is a persistent mismatch between the skills acquired by the employee and the requirements of organizations. The solution to the current situation in the labor market can be investments in education, training and personnel development systems, forecasting at the state level of future competencies with appropriate requirements for professional skills, which is seen as the basis for increasing labor productivity, competitiveness, progress in the economy and employment, as well as increasing the importance of professional skills in the strategic perspective.

## References

1. Černe, M., Batistič, S., Kenda, R.: HR systems, attachment styles with leaders, and the creativity–innovation nexus. *Hum Resour Manag Rev* **28**(3), 271–288 (2018)
2. Pechová, J.: Personnel trends in a globalised world. In: Klietnik, T. (ed.) *Proceedings of the 19th International Scientific Conference Globalization and its Socio-Economic Consequences 2019—Sustainability in the Global-Knowledge Economy*. SHS Web of Conferences, **74** (01024). EDP Science, Les Ulis (2020)
3. McKinsey Global Institute (MGI). Jobs lost, jobs gained: Workforce transitions in a time of automation. <https://www.mckinsey.com/media/McKinsey/Industries/Public%20and%20Social%20Sector/Our%20Insights/What%20the%20future%20of%20work%20will%20mean%20for%20jobs%20skills%20and%20wages/MGI-Jobs-Lost-Jobs-Gained-Report-December-6-2017.pdf>. Accessed: 24 Mar 2021 (2017)
4. Dolzhenko, R., Ginieva, S.: Use of HR professional communities in developing the system of professional qualifications. *Soc Econ* **10**, 140–150 (2017)
5. Kozhukhova, N.V., Kozhukhova, D.A.: Model of competences as a tool for assessment and development of employees in personnel management of a modern company. In: Ashmarina, S.I., (ed.) *Proceedings of the X All-Russian Scientific-Practical Conference Russian Science: Current Research and Development*, pp. 85–89. Samara: Samara State University of Economics (2020)
6. Skolkovo: Atlas of new professions. [http://www.skolkovo.ru/public/media/documents/research/sedec/SKOLKOVO\\_SEDEC\\_Atlas\\_2.0\\_Eng.pdf](http://www.skolkovo.ru/public/media/documents/research/sedec/SKOLKOVO_SEDEC_Atlas_2.0_Eng.pdf). Accessed: 29 Mar 2021 (2015)
7. Agency for Strategic Initiatives: Informal education. [https://www.asi.ru/leaders/initiatives/education\\_leaders/future\\_skills](https://www.asi.ru/leaders/initiatives/education_leaders/future_skills). Accessed: 29 Mar 2021. (2020)
8. Kozhukhova, N.V., Veselova, J.V., Chekuldova, S.V.: Application of IT technologies in personnel management in the era of digitalization. In: Ashmarina, S., Mantulenko, V., (eds.) *Digital Economy and the New Labor Market: Jobs, Competences and Innovative HR Technologies*. Lecture Notes in Networks and Systems, vol. 161, pp. 184–192. Springer, Cham (2021)
9. Veis, Y.V., Eremicheva, O.Y., Kostyleva, I.B., Tikhonov, V.S.: HR training in digital economy: innovative investment projects. In: Ashmarina S., Mantulenko V., Vochozka M. (eds.) *Engineering Economics: Decisions and Solutions from Eurasian Perspective*. Lecture Notes in Networks and Systems, vol. 139, pp. 688–696. Springer, Cham (2021)
10. Ponisciakova, O.: Knowledge management and its application in human resources management in the context of globalization. In: Klietnik, T. (ed.) *Proceedings of the 19th International Scientific Conference Globalization and its Socio-Economic Consequences 2019—Sustainability in the Global-Knowledge Economy*. SHS Web of Conferences, vol. 74 (01026). EDP Science, Les Ulis (2020)
11. Makhmudova, I.N., Kozhukhova, N.V.: New perspective in projecting university graduates' competencies: talent management. In: Ashmarina, S., Mantulenko, V., Vochozka, M. (eds.) *Engineering Economics: Decisions and Solutions from Eurasian Perspective*. Lecture Notes in Networks and Systems, vol. 139, pp. 606–612. Springer, Cham (2021)
12. Bogatyreva, I.V., Kozhukhova, N.V., Hakobyan, D.A.: Management of labor productivity/wage ratio as a factor of Samara region economic development. In: Mantulenko, V., (ed.), *Eurasia: Sustainable Development, Security, Cooperation*. SHS Web of Conferences, vol. 71 (04006). EDP Science, Les Ulis (2019)
13. Kozhukhova, N.V., Kozhukhova, D.A.: Some issues of personnel training development system. *Sci XXI Century Curr Dir Dev* **1–1**, 391–395 (2020)
14. Martins, V.W.B., Rampasso, I.S., Anholon, R., Quelhas, O.L.G., Leal Filho, W: Knowledge management in the context of sustainability: literature review and opportunities for future research. *J Clean Prod* **229**, 489–500 (2019)

# Digital Transformation of Legal Education: Problems of Developing Competencies



A. P. Korobova, N. A. Volkova, and O. V. Rastoropova

**Abstract** In this study the authors examine the problems of development of universal and general professional competencies of future lawyers in context of digitalization of legal education. Both traditional forms of teaching classes and forms of synchronous interaction with the use of remote access technologies are considered herein. Authors traced the relationship between a specific form of teaching and those competencies, the formation of which it is aimed at. Traditional forms of teaching are compared, for example, lecture, oral or written survey, testing, business games, debates, etc. with forms using digital technology. It is concluded that the use of the latter contributes to ensuring the accessibility of the learning process and the involvement of students in this process, significantly expands the possibilities of searching and using information to solve the assigned tasks, allows synchronous interaction between the teacher and the student, and operational control of the level of competence formation. At the same time, the idea is expressed that the digital transformation of education does not mean the displacement of traditional full-time forms of education, since the formation of a number of abilities, skills of future lawyers cannot be developed without live human communication.

**Keywords** Digitalization · Education · Legal awareness · Legal education · Legal training · Right

---

A. P. Korobova (✉)

Samara State University of Economics, Samara, Russia

e-mail: [a.p.korobova@inbox.ru](mailto:a.p.korobova@inbox.ru)

N. A. Volkova

S.P. Korolev Samara National Research University (Samara University), Samara, Russia

O. V. Rastoropova

University of Prosecutor's Office of Russian Federation, Moscow, Russia

© The Author(s), under exclusive license to Springer Nature Switzerland AG 2022

S. I. Ashmarina and V. V. Manteulenko (eds.), *Digital Technologies in the New*

*Socio-Economic Reality*, Lecture Notes in Networks and Systems 304,

[https://doi.org/10.1007/978-3-030-83175-2\\_103](https://doi.org/10.1007/978-3-030-83175-2_103)

## 1 Introduction

As an outstanding Russian philosopher, jurist Ilyin wrote, that the issue of improving legislation is, ultimately, the issue of modernizing legal consciousness [1]. And one cannot but agree with this statement. On the one hand, legal consciousness of the subjects making law-making decisions, those that we often combine in one concept—“legislator”, is of great importance. This is what brings that very subjective element into the legal education process. Higher level of legal awareness of this conditional “legislator” contributes to higher-quality legislation people receive. This also includes judicial lawmaking and constitutional review [2]. On the other hand, we must not forget about legal consciousness of the addressees of legal acts, those subjects whose behavior, in fact, are called upon to regulate the established rules. The effectiveness of legal regulation directly depends on the awareness of the value of legal norms, their internal acceptance, approval, desire to voluntarily behave in accordance with them.

The context of considering the issue of the impact on legal consciousness in order to form a positive attitude to law is of particular importance and is the problem of legal education, the education of professional legal personnel in an information society, involving the digital transformation of all aspects of public life [3], including the education [4]. Digital or information and communication technologies [5], as they are now called, create new opportunities [6]. But since digitalization has rushed into our lives relatively recently, the regulatory and legal framework mediating the widespread use of information technologies has not yet been fully formed, therefore legal science has not yet managed to accumulate the necessary experience of theoretical comprehension of this problem. It seems that, on the one hand, the most general conclusions and recommendations for the digital transformation of education in general lead us intuitively to solutions [7], and on the other hand, special research is needed in terms of mastering specific legal disciplines [8], especially to consider development of both general, universal and professional competencies in future lawyers.

## 2 Methodology

The authors used the following methods in the study: analysis, induction, abstraction, comparison, observation, experiment, statistical methods, as well as systematic approach to research. Thus, we analyzed universal and general professional competencies developed in the process of training lawyers. Classes with students took place both full-time in the classroom, and using remote access technologies. Lectures have traditionally been used to cover a significant amount of information and address it to a large number of students. In order to develop the most optimal form of interaction in lectures with a specific audience, there are following types of lectures:

- introductory, methodologically orienting lecture;

- classic lecture-monologue of the teacher (in the classroom and using remote access technologies);
- an interactive lecture (in the classroom and using remote access technologies);
- lecture-visualization;
- problem lecture;
- overview lecture;
- lecture-consultation.

To do practice in class, both traditional forms of seminars and forms with the use of digital technologies were used. So, the traditional forms include: oral or written survey (detailed conversation); discussion of reports and abstracts; problem solving; oral or written analytical tasks; oral or written analysis of sources; testing; debates; game, business game.

Forms with the use of digital technologies:

- oral or written survey (using remote access technologies, including through the exchange of messages in the chat);
- discussion of reports and abstracts (using remote access technologies, including through the exchange of messages in the chat);
- discussion of electronic presentations (using remote access technologies, including through the exchange of messages in the chat);
- solving tasks placed in a joint workspace on a digital platform (MS Teams, etc.);
- oral or written analytical tasks posted in a joint workspace on a digital platform (MS Teams, etc.);
- oral or written analysis of sources within the framework of the assignment posted in a joint workspace on a digital platform (MS Teams, etc.);
- testing using tests hosted in a shared workspace on a digital platform (MS Teams, etc.);
- debates (using remote access technologies, including through the exchange of messages in the chat);
- a game, a business game (using remote access technologies, including through the exchange of messages in the chat);
- electronic game.

The purpose of the study was to analyze both the traditional forms of teaching classes and the forms using digital technologies listed above, in context of the Federal state standard of higher education—Bachelor's degree in the field of training 40.03.01 "Jurisprudence" [9], in particular, in context of the competencies that are developed during the training of professional lawyers, to identify the advantages and disadvantages, to assess the advantages and prospects of these forms.

### 3 Results

Lecture as a form of teaching classes has as its goal the transfer of a significant amount of information. In the context of discussing the issue of the development of legal consciousness, this is a proven, traditionally used way of transferring one's knowledge, one's experience, as they say, "from generation to generation". Yet, lecture is a powerful means of influencing legal consciousness of students in order to develop a certain attitude towards law and legal phenomena. Teacher's position is important, because we often educate by personal example: if we regularly demonstrate a critical and sometimes just dismissive attitude towards current legislation, as it is often customary to do, yet as a result we will get the same legal nihilism that we saw so often in pre-revolutionary Russian jurists.

The purpose of the introductory lecture is to familiarize students with the subject and methodology of the course, to designate the coordinate system, the principles that underlie the discipline, to show its connection with other subjects. If we consider the introductory lecture through the prism of legal education, then the lecturer's task is, firstly, to rise interest of the subject in students, to convince students of its importance. As practice shows, the awareness of the usefulness, expediency of mastering a particular discipline comes much later, and, in some cases, even when the course is completed, by comparing it with the disciplines studied in parallel or subsequently. However, the latter does not in any way diminish the importance of the first impression of acquaintance with the subject.

A classic lecture-monologue is distinguished by its emotional impact on the audience, the ability to hold its attention for a long time without relying on any additional means. The educational effect of this type of lectures reveals itself, among other things, in the formation of the civil position of future lawyers, their professional ethics, in particular, in the assimilation of a disapproving attitude towards all manifestations of corruption and other violations of the law.

The use of remote access technologies, on the one hand, makes lectures more accessible, as repeatedly pointed out by researchers [10], on the other hand, it creates additional psychological burden on the teacher. This is connected, firstly, with the need to keep the technical side of the lecture under control, with the feeling of dependence on the means of communication, for example, the quality of the Internet connection, the availability of electricity, the possibility of uncontrolled external interference, etc. Second, the study found that only a very small number of students turn on the camera during the lecture (less than 1%). Thus, the teacher is forced to transmit knowledge, as it were, into a void, in contrast to a real time, real live lecture in class, where he has a feeling of transmitting information to a specific addressee, where he sees a response, a lively human response that generates a feeling of moral satisfaction and professional competence.

The indicated psychological discomfort is partially compensated by the interactive nature of the lecture, which makes it possible to establish a stable feedback with the students. It should be noted that when using remote access technologies, communication via chat has proven itself well—primarily for the reason that communication in



social networks is based on the same principle, i.e. we can say that this format is more than understandable and familiar to most students. Massaging comes with varying degrees of intensity and can come in according to different principles, for example, in the “question–answer” mode. It depends primarily on the type and purpose of the lecture. For example, at a lecture-consultation, this mode will dominate. The interactive form of the lecture contributes to the development of communication skills, oral speech, the development of the conceptual legal apparatus. The use of digital technologies allows us to talk about the improvement of writing as well. The assimilation of basic legal concepts is also more successful, since it is not enough to say a word several times, it is desirable to write it down, then it will firmly be fixed in the memory and become part of the vocabulary of the individual.

At a problem lecture, new material is introduced by familiarizing students with a certain debatable issue or problem, a situation requiring resolution. Carrying it out in an interactive form makes it possible to develop competencies aimed at the developing of systemic and critical thinking, the ability to carry out legal analysis and conduct legal expertise, and the ability to interpret legal prescriptions. Digital technologies make it possible to attract various sources of information contained, for example, in reference and legal databases, to use special literature, etc., to solve these problems, which significantly expands the range of sources and, as a result, contributes to a more in-depth study of the subject.

The problem of acquaintance with sources acquires an increased importance at survey lectures, when in a very limited time it is necessary to convey a significant amount of information. Here, the focus is not so much on the task of sharing knowledge with learners, but of giving them the toolkit that will allow them to extract information on their own. The research has shown that turning to digital resources helps to cope with this task more successfully. For example, we can talk about a list of the main regulatory legal acts in a specific discipline, a list of works of legal scholars, or methodological recommendations for studying a curriculum posted on university digital platforms.

In the context of the problem under discussion, special attention should be paid to lectures-visualization, which already from the very beginning in itself presupposes the use of technical means, especially if we mean interaction with the use of remote access technologies. The most common form of lecture-visualization is the use of an electronic presentation. In the course of the study, it was found that this method of communicating information significantly increases the assimilation of the academic discipline mainly due to the fact that the proposed visual material is already structured, the main thing is highlighted in it (for example, definitions of basic concepts are given). That is, in fact, for the student, a significant part of the analytical work on preparing the lecture notes has already been done, which otherwise he would have to do himself. Therefore, it is not surprising that students are very positive about the use of electronic presentations.

A survey as one of the forms of conducting a practical lesson allows you to check the independent work of students in mastering educational material, in particular, the degree of formation of skills related to the search, processing, critical analysis, synthesis of information, the ability to identify controversial aspects of the topic,

systematize points of view on them, reasonably defend their opinion, as well as competently and confidently use information technology. In addition to the above, an oral survey contributes to the development of communication skills, helps to learn how to express one's thoughts clearly and accurately, and enriches vocabulary in terms of professional vocabulary. The use of digital technologies makes it possible to combine oral and written forms of survey in a practical lesson, for example, in the case of using messaging (chat) and thus, on the one hand, expand the range of those competencies that are formed at the same time, and on the other hand, teach classes more dynamically and interestingly, alternating types of activities.

In the course of preparing reports and abstracts, students' creative activity, their ability for research work is realized, the skill of public speaking is trained. As the study of this issue has shown, for a more fruitful discussion, it is advisable to post the texts of reports and abstracts in advance in free access for all participants, for example, in the MS Teams system, in the meeting chat when conducting classes using remote access technologies—so that you can return to a certain place, re-read and formulate a question, remark or proposal. However, as the study has shown, it is more expedient to prepare electronic presentations, especially in distance educational process. At the same time, it was noted, on the one hand, that poor methodological preparation of students, in particular, such errors as verbal duplication of text on slides, lack of logical transition from slide to slide, use of an unsuccessful background, etc. technical problems, for example, additional time was required to establish a high-quality Internet connection, download the presentation itself, in some cases the ability to manage it was lost.

In the course of solving practical problems, such competencies of future lawyers are improved, as their ability, firstly, to interpret legal norms, and secondly, to apply them in specific situations. As an experiment, the same groups of students were offered tasks on paper and tasks posted in a joint workspace on the MS Teams platform. The survey showed that the latter option seems to be the most preferable for the overwhelming majority of students, even if the lesson is held in the classroom. They mentioned the freedom from the need to pass a piece of paper with the completed assignment, the ability to edit the assignment, as well as to quickly familiarize themselves with the assessment and the teacher's commentary on it. Of the complaints, only the poor quality of the Internet connection can be noted. However, according to the students, "the technical difficulties are known and therefore avoidable and resolvable". In addition, an interesting fact was observed: those students who, for one reason or another, were absent from the lesson, took part in solving problems posted in MS Teams.

The same is true for writing analytical assignments and source analysis. Digital technologies provide practically unlimited access to primary sources—regulatory legal acts, texts of scientific articles and monographs. Therefore, one of the most important tasks is seen by students mastering, first of all, the skill of searching for information in general and legally significant information in particular. The research has shown that even among senior students this skill is not fully developed, and among first year students it is practically absent. This is expressed, for example, in the absence of the ability to correctly formulate the search query, in the lack of

knowledge of publicly available resources with legally significant information, in the inability to extract the necessary information from the resource indicated by the teacher, in the lack of knowledge of what to do with it later, etc. All this indicates the need to pay more close attention to the formation of competence, characterized by the ability to receive, process and use information, in the preparation of professional legal personnel, starting from the first year of study.

Posting tests in a joint workspace on a digital platform, both in full-time and distance learning formats, allows for both final and operational control over the quality of knowledge, the level of competence formation. For example, one can conduct testing on each topic passed, which makes it possible to identify insufficiently learned questions and return to them, work out additionally. Students who regularly take tests in MS Teams note the simplicity, accessibility, speed and transparency of the assessment system as positive aspects. The learning function is realized through the demonstration of correct and incorrect answers. An interesting observation was made during the study: in the presence of alternative tasks—solving problems or testing—the majority of students without much hesitation give preference to the second.

In contrast to the forms of practical training discussed above, debates in the overwhelming majority of cases involve face-to-face interaction. The students themselves explain this by the need “to exchange not only remarks, but also energy”. However, even the use of digital technologies is not excluded, for example, searching the Internet for illustrative material to substantiate one’s position, examples from judicial practice, statistical data, etc. In addition, sometimes the format of the debate may allow for the use of electronic presentation.

The foregoing can also be applied to games, business games aimed at developing abilities for social interaction, self-realization in a team, developing communication skills, improving oral and written speech, as well as the ability to draw up legal documentation. For example, the familiar to many business game “My legislative initiative” is an excellent training in the ability to carry out the preparation of situational drafts of normative legal acts. A special place among games is occupied by electronic games, the indisputable advantage of which is the ability to conduct them both in face-to-face format and in a format using the remote access mode. Moreover, as the study of the issue shows, these can be both analogs of well-known television shows, meaningfully adapted for a specific educational course (for example, “Own game”, “Where is the logic?”, “How to be a millionaire”, etc.), and original developments based on available computer programs (for example, Microsoft PowerPoint).

## 4 Discussion

Thus, the hypothesis of greater accessibility, advocated by the supporters of the digital transformation of education, is, as we can see, confirmed. Modern information technologies allow you to overcome space and join the educational process while

in another city or even a country. In these conditions, the problem of technical equipment comes to the fore: the presence of a laptop, smartphone, webcam, microphone, stable Internet connection, etc. In the context of discussing the problem of accessibility of educational content, we would like to discuss the issue of video content. The widespread use of high-quality recording devices in lecture halls is clearly a matter of tomorrow. And due to the fact that in a situation where it is impossible to attend a lecture, having a set of alternative teaching aids (for example, a posted electronic presentation, text materials), students rarely give preference to video content, especially of a significant duration (less than 5%). This is due, among other things, to a lack of self-discipline, poor development of skills for independent work in mastering a subject, inability to properly manage their time. It seems that the introduction of an auxiliary methodological training course aimed at developing these abilities could help to cope with this problem.

The study showed that the use of digital technologies is possible in any form of conducting classes, moreover, it is advisable to combine traditional full-time forms of education with digital ones. This is especially true in the case of written assignments. So, a joint workspace on a digital platform (MS Teams, etc.) allows for synchronous interaction with students: allows to post additional materials in the form of attached files, make notes on the submitted written work, point out mistakes, write a review, etc. Conducting testing with instant automated verification and grading makes it possible to significantly save teacher's working time and at the same time quickly get a snapshot of students' knowledge in order to assess the level of formation of universal and general professional competencies. The use of information technology increases the degree of student involvement in the learning process. Thus, the study shows that even those who, for one reason or another, do not attend classes, willingly complete written assignments posted on the university's digital platform. Another observation concerns the type of students who traditionally behave passively in the classroom, prefer to "sit at the back", remain in the shadows. They also prefer to improve their academic performance by completing written analysis assignments, problem solving, or testing. However, with all the noted positive aspects associated with the use of digital technologies, they can be perceived as important, but just an additional toolkit, which is not able to completely replace the usual face-to-face forms of interaction, involving the exchange of emotions, the creation of a certain atmosphere, and lively human communication.

## 5 Conclusion

Life is changing, and digital reality embodies these changes. It takes time for the necessity and objective conditionality of the changes to be accepted by the society, accepted by the public consciousness as a given. The pandemic only majorly accelerated the outlined processes, forced events, exacerbated existing problems, for example, concerning the technical equipment of the educational process, the availability of high-quality educational content, etc. Some of the students were cut off

from it due to the elementary lack of communication means at their place of permanent residence: laptop, tablet, smartphone, lack of Internet access or poor signal quality. However, as the study showed, students, as representatives of the younger generation, more easily adapt to the changing conditions than older generations, since they treat emerging technical problems as a familiar phenomenon, know how to overcome them, willingly help each other, give advice to the teacher. In general, we can say that in the conditions of such a forced digital transformation of legal education, students feel more comfortable than one might think.

Of course, there are some grounds for the fears often expressed recently about the displacement of traditional education by digital forms, the onset of the “era of soulless robots”. However, to ignore the objective needs of social development, which has long become a fact of modern reality, means to be like an ostrich, which, at the slightest danger, hides its head in the sand, to pretend that nothing is happening at a time when everything has already happened. Digital technologies are, first of all, a tool, the use of which makes it possible to expand the possibilities of modern education, training of professional legal personnel, to make it more accessible, to diversify the forms of teaching classes, to ensure greater involvement of students in them, to rise and steadily maintain interest in mastering the subject and as a consequence—to provide a higher level of competence development, professional legal awareness and general legal culture.

## References

1. Ilyin, I.A.: Theory of law and state. Mirror, Moscow (2017)
2. Trykhlid, K.: Law-making activity in the case law of the constitutional court of Ukraine. *Int. Comp. Law Rev.* **19**(2), 27–75 (2020)
3. Fuchs, M.: Does the digitalization of manufacturing boost a “smart” era of capital accumulation? *Zeitschrift für Wirtschaftsgeographie* **64**(2), 47–57 (2020)
4. Ipek, I., Ziatdinov, R.: New approaches and trends in the philosophy of educational technology for learning and teaching environments. *Euro. J. Contemp. Edu.* **6**(3), 381–389 (2017)
5. Ziemba, E.: The contribution of ICT adoption to the sustainable information society. *J. Comput. Inf. Syst.* **59**(2), 116–126 (2019)
6. Zodi, Z.: Law and legal science in the age of big data. *Intersections* **3**(2), 69–87 (2017)
7. Uvarov, A.Yu., Dvoretzskaya, I.V., Frumin, I.D.: Difficulties and prospects of digital transformation of education. Publishing House of the Higher School of Economics, Moscow (2019)
8. Golik, Yu.V.: Topical issues of training lawyers in a modern state. In: Trezubov, E.S. (ed.) *Trends in the Development of Legal Science at the Present Stage: IV All-Russian Scientific-Practical Conference with International Participation*, pp. 12–17. Moscow: Prospect (2020)
9. Ministry of Education of the Russian Federation: Federal State Educational Standard of Higher Education—Bachelor’s Degree in the field of training 40.03.01 Jurisprudence. [https://www.rea.ru/ru/org/managements/uchmetupr/Documents/Standarts/FGOS%20VO/Bakalavriat/Standart\\_40.03.01\\_Urisprudentsia\\_2020.pdf](https://www.rea.ru/ru/org/managements/uchmetupr/Documents/Standarts/FGOS%20VO/Bakalavriat/Standart_40.03.01_Urisprudentsia_2020.pdf). Accessed: 15 Mar 2021 (2020)
10. Newman, D.: Top 5 digital transformation trends in education for 2020. <https://www.forbes.com/sites/danielnewman/2019/08/01/top-5-digital-transformation-trends-in-education-for-2020/?sh=73f1616e5739>. Accessed: 15 Mar 2021 (2019)

# Digital Format of Professional and Business Education: Foreign Language Course Changes



A. L. Kuregyan, A. P. Kuzmina, and E. A. Pertsevaya

**Abstract** The article examines the problem of adapting the English language course, taught in universities, following the requirements of the digital format of professional and business education, which emerged in 2020 due to the COVID-19 pandemic, causing the need for a remote format of teaching disciplines. An online format of education requires making a foreign language teaching more focused on the needs of a specific group of students using the most effective tasks. The article proposes an option for changing the English language course by identifying the problems experienced by students due to the need to study a foreign language and the subsequent adaptation of the specified problems to the most interesting tasks from the point of students' view. The gradation of problems and tasks is given by conducting a survey and identifying the most difficult aspects when studying a foreign language. Conclusions are made on the most popular types of tasks.

**Keywords** Digitalization · English language · Learning language difficulty · Online · Tasks · Vocational training

## 1 Introduction

Modern conditions dictate the need for the digitalization of technologies used in each area of life, especially since this need is relevant in the educational sphere at all stages. Requirements for digitalization of information processes, which until spring 2020 were guided by a recommendation character, became a necessity during the period of forced isolation, and training in various disciplines was carried out in the online format. Pandemic COVID-19 has changed the approach to teaching disciplines of

---

A. L. Kuregyan  
Samara State Technical University, Samara, Russia

A. P. Kuzmina  
Samara State Transport University, Samara, Russia

E. A. Pertsevaya (✉)  
Samara State University of Economics, Samara, Russia

various focus. The trend towards the digitalization of educational processes leads to the need to change each existing course in the framework of the educational process towards the maximum use of remote technologies, which affected the teaching of a number of various spheres disciplines: medicine, technical, economic, etc. Accordingly, it took the rebuilding of the English language course, taught by students of the non-linguistic majors at various universities.

The idea of the transformation of educational processes, taking into account the needs of students, arose much earlier than 2020 [1]. Such a change in the course of teaching requires revision of the whole concept of learning. It is necessary to collect a significant amount of information and its processing, which is an extremely time-consuming procedure when conducting classes in an offline format. In online learning, such a collection of information is substantially simplified due to the use of various educational platforms involving feedback tools, as well as the use of digital trail [2]. So, in this paper, the change of foreign language (English) course is demonstrated, taking into account the needs of students, namely, the most interesting tasks, as well as taking into account the requirements for the digitalization of professional and business learning.

## 2 Methodology

In our study of the most interesting digital interaction tools for students, the method of questioning students of non-core specialties was used. The survey was conducted among 164 first-year students of non-linguistic majors at Samara State University of Economics, Samara State Transport University, Samara State Technical University.

The number of students who participated in the survey is limited by the number of students trained by the authors of the article. During the survey, students answered two questions: (1) What difficulties arise when learning English? and (2) Which tasks are the most interesting?

The answers contained five items each and were arranged according to the importance of the item: from the most important to the least important. The survey allowed us to identify the most problematic issues in teaching English, as well as to choose the most appropriate tasks, to adapt the course of the discipline taught to the needs of modern education. In the course of the study, the students named the following difficulties (the notions are original): inability to answer the questions asked, inability to start communication, limited vocabulary, listening and oral speech perception, misunderstanding of grammar, pronunciation, retelling, translation, written tasks. Among the options for interesting tasks, the students named the following: watching videos, making dialogs, making sentences, pronunciation training (games, communication with the teacher in English), grammar practicing, translation from English into Russian, audio listening, performing written tasks, projects in English, reading texts, translation from Russian to English, vocabulary enlargement with its further practicing.

The resulting study is the preparation of the priority rating of the elements specified in the questionnaires, according to the mentioned frequency. In the conditions of extremely rapid creation of ready-to-work tasks focused on online performance, this identification of problem fields and the selection of the most interesting tasks allows the teacher to choose the most appropriate tasks for the implementation, being consistent with the problem of students.

### 3 Results

The answers given by students in the survey process differ significantly from the traditionally recognized priorities in teaching a foreign language. In this case, under the conditions of tight deadlines, the analysis of the level of English language proficiency was not carried out, however, it should be noted that these problems in learning a foreign language are universal: none of the answers presented any unique answer that is not repeated in other works. Students of different levels of training experience the same difficulties and name approximately the same tasks as their preferred ones—the number of tasks does not significantly exceed the number of difficulties.

Concerning problems in learning a foreign language (Table 1), many aspects are predictable, but the number of students who have noted these indicators is very interesting. For example, grammar misunderstanding is rather a serious problem, noted by 26.1% of students. Among the complex grammar aspects, grammar tenses, prepositions, and constructions were mentioned. Oral speech misunderstanding is in second place, indicating a very urgent problem when choosing audio clips, or, more conveniently, videos with subtitles. Among the three most important problems, the students named the limited vocabulary, which does not allow them to select

**Table 1** Problems while learning English

| № | Problem                                 | Students percentage who reported this problem (%) |
|---|---|---|
| 1 | Misunderstanding of grammar             | 26.1  |
| 2 | Listening and oral speech perception    | 20.3  |
| 3 | Limited vocabulary                      | 17  |
| 4 | Inability to start communication        | 11.1  |
| 5 | Translation                             | 9.8   |
| 6 | Inability to answer the questions asked | 5.2   |
| 7 | Pronunciation                           | 5.2   |
| 8 | Written tasks                           | 3.3   |
| 9 | Retelling                               | 2   |
|   | Total:                                  | 100   |

Source Authors



synonymous variants of lexical units, limiting themselves to only one variant, which is not always appropriate. The inability to initiate communication is closely related to the limited vocabulary, as well as the inability to answer the questions asked, which was mentioned by only 5.2% of students. A separate point is the inability to translate (9.8%), and the translation is supposed to be from Russian into English, to display their own thoughts. The final group of problems in students' understanding is related to the correct pronunciation of words (5.2%), the performance of written tasks (3.3%), and the texts retelling (2%). In general, such indicators of the difficulty of the task can be considered insignificant, focusing on the priority problems: grammar, listening, and vocabulary. The number of problems when learning a foreign language is less than the number of options for interesting tasks. The answers about the priority of interesting tasks in digital format were significantly different from the traditionally recognized most effective tasks in teaching English. Table 2 shows all the tasks named by students, starting with the most frequently mentioned and ending with the least frequent options.

The answers to the question about interesting tasks in the questionnaires are more varied and detailed, while the named problem areas in language learning are very homogeneous. The most interesting is watching videos—it was noted by 17% of students, and the video is not only educational ones but also films in English, as well as blogs. This is the aspect of language learning that students are interested in doing on their own: the video allows you to demonstrate the materials of the

**Table 2** Preferable tasks while learning English

| №   | Task   | Students percentage who named a task (%) |
|-----|--|--|
| 1.  | Watching videos                                    | 17                                       |
| 2.  | Translation from English into Russian              | 12.2                                     |
| 3.  | Vocabulary enlargement with its further practicing | 11.6                                     |
| 4.  | Audio listening                                    | 8.5                                      |
| 5.  | Making dialogs                                     | 8.5                                      |
| 6.  | Reading texts                                      | 7.3                                      |
| 7.  | Translation from Russian to English                | 6.7                                      |
| 8.  | Making sentences                                   | 6.7                                      |
| 9.  | Grammar practicing                                 | 6.1                                      |
| 10. | Communication with the teacher in English          | 4.9                                      |
| 11. | Projects in English                                | 3.7                                      |
| 12. | Performing written tasks                           | 2.3                                      |
| 13. | Pronunciation training                             | 2.3                                      |
| 14. | Games  | 2.2                                      |
|     | Total  | 100                                      |

Source Authors

topics covered, and also suggests viewing with subtitles: original or automatically generated. It is this task that most clearly illustrates the tendency of education to move to digital methods of work, and describes students as the most receptive to this aspect in learning a foreign language. In second place we see the implementation of translation from English to Russian—12.2%. This task allows you to combine viewing the video and its further translation, as well as translation for ready-made texts.

The third position is assigned to the study and development of new lexical units—11.6%. In the online format, conducting classes on any platform—MS Teams, Zoom, Skype—allows you to select individual units and write them in the chat, which implies their further use.

Listening to audio fragments as an element that is possible in a digital learning format is in the fourth place—8.5% compared to a more convenient video for learning, a listening task which also presents a certain difficulty in performing. A similar number of responses (8.5%) includes dialogs making. The priority task in learning a foreign language is communication with foreigners, but in their answers, students explained that they would like to practice English with each other or with a teacher.

From the teacher's point of view, it was interesting to note that students consider reading the text as an interesting task (7.3%), which is relevant both in terms of the text content and lexical and grammatical content. Making sentences with the help of grammar and lexical material and their translation from Russian into English constitute an equally interesting task, noted by 6.7% of students. The completion of grammar tasks was also noted as necessary and interesting in learning English—6.1%. Communication with the teacher in English is possible with the electronic version of interaction with sound—it was identified by 4.9% of listeners. It is noteworthy that communication with a foreigner is intimidating and difficult for most students, and the teacher with whom they have been studying for quite a long time acts as a more familiar interlocutor.

The method of projects in English, begins in high school, moving to the professional education stage later, is an extremely effective method of working out and introduced new material. In the process of the survey, it turned out that under the projects, students understand the most diverse creative tasks—the implementation of the presentations on the designated topic, holding excursions (in the conditions of the pandemic), drawing up uncomplicated collages in real-time (a format is taken as the basis in which access is provided to each student of the group to add information to the general space—for example, an electronic board).

Performing written tasks is a mandatory element of language comprehension, but students placed this task closer to the end of the list, together with the development of the correct pronunciation of sounds—2.3%. Only 2.2% of students called participation in games, which is explained in the conditions of a quick transition to the remote education model but illustrates the fact that this version of the activity is not too popular among the current generation of students.

In addition to these issues, students complain about the loss of motivation to study a foreign language due to the inability to visit the countries of the language under study and the lack of an appropriate amount of time for the qualitative implementation

of all tasks in a foreign language. Student responses make it possible to create a kind of database most interesting to perform tasks, the choice of option remains at the discretion of the teacher. It turns out that when determining solutions of some problems that correspond with a task in the title (for example, listening to audio to solve the problem of speech per hearing), viewing a video, independent preparation of proposals, project activities and games are universal ways to interest students performing tasks when Remote interaction, while other tasks decide only one of the problems named with students. When changing the English language course, according to the requirements for the digitalization of professional and business training, the most frequent issues related to problems are taken as the basis, and the task format is selected, based on the base of the most interesting options.

## 4 Discussion

The requirements of professional and business education in modern conditions are the mandatory possession of digital competencies—a set of skills necessary to achieve personal goals of an individual using digital technologies in various aspects of life [3]. Digital competencies are traditionally noted as necessary in professional education, and their development is considered an indispensable condition for a proper response to modern realities [4]. In 2020, this requirement for the digital transformation of education [5] has spread to all areas of education, making teachers use various digital activities—webinars [6], online courses [7], etc. in every aspect of education—civil [8], medical [9], etc. The readiness degree of higher educational establishments was considered as very high in studies of previous years [10], but the pandemic of 2020 demonstrated the presence of difficulties in switching to digital forms of interaction with students, and this was done in the mode of extremely rapid change [11].

A complete revision of traditional educational models was necessary, which required not only the introduction of individual digital elements into the learning process but also required focusing on the immediate needs of the audience and complete change, restructuring educational course to meet the requirements of the digital format of online professional training. In our work, when compiling the first individual tasks an online English course for students of various groups and training levels, we took into account our students' wishes and preferences. The task in the restructuring of the English language course was the following—to identify problematic aspects in the study of English and adapt online learning to the most preferred options for tasks. Our research provides a selection of tasks that students will perform being engaged to a greater extent.

In general, it should be noted that in the current conditions of education digitalization, in particular, vocational education, following the main trends of the media society, most students prefer watching videos to other learning options—the video is more colorful and compact, and also suggests the content of the statement with the help of a video sequence. This trend is also confirmed by the fact that the performance of written tasks according to the degree of interest is one of the last options.

## 5 Conclusion

In conclusion, it should be noted that digital skills that combine information, critical thinking, creativity, and problem-solving skills are a priority in the twenty-first century [12]. These skills are very difficult to measure in terms of development and effectiveness, but they are the most popular in the modern world. The formation of these skills is subject to teaching any discipline, in particular, a foreign language. Adapting the English language course in a non-linguistic university to modern digital requirements requires a thorough analysis of the students' opinions. In this research, from the students' responses, teachers received excellent feedback with an assessment of the most complex aspects of the language, as well as the selection of the most preferred ways to work with such difficulties.

The options for tasks to be performed online become extremely variable. In particular, if there is a need to perform translation, the teacher can choose any interesting types of tasks: from watching videos to playing with the elements of implementing the words being worked out, which significantly increases the number of effective tools in the work, and especially in a period when it is necessary to quickly and effectively transform the educational process from traditional offline learning to the online format. This is important in the context of the transition to distance learning, which became extremely relevant in 2020, accelerating the process of digitalization of professional and business education in the conditions of the COVID-19 quarantine.

## References

1. Malysheva, L.: Business education at the university: points of growth or non-core business: University management. *Pract. Anal.* **3**(79), 49–55 (2012)
2. Kuregyan, A.L., Pertsevaya, E.A.: Digital footprint interpretation in vocabulary training when working with electronic dictionaries. In: Ashmarina, S., Mantulenko, V. (eds.) *Current Achievements, Challenges and Digital Chances of Knowledge Based Economy. Lecture Notes in Networks and Systems*, vol. 133, pp. 573–579. Springer, Cham (2021)
3. Hamalainen, R., Nissinen, K., Mannonen, J., Lamsa, J., Leino, K., Taajamo, M.: Understanding teaching professionals' digital competence: What do PIAAC and TALIS reveal about technology-related skills, attitudes, and knowledge? *Comput. Hum. Behav.* **117**, 106672. (2021)
4. Gegenfurtner, A., Ebner, C.: Webinars in higher education and professional training: a meta-analysis and systematic review of randomized controlled trials. *Edu. Res. Rev.* **28**, 100293 (2019)
5. Uvarov, A., Furmin, I.: *Digital Educational Transformation: Difficulties and Perspectives*. High School Economic Publishing House, Moscow (2019)
6. Brevik, L.M., Gudmundsdottir, G.B., Lund, A., Strømme T.A.: Transformative agency in teacher education: fostering professional digital competence. *Teach. Teach. Edu.* **86**, 102875 (2019)
7. Lohr, A., Stadler, M., Schultz-Pernice, F., Chernikova, O., Sailer, M., Fischer, F., Sailer, M.: On powerpointers, clickerers, and digital pros: Investigating the initiation of digital learning activities by teachers in higher education. *Comput. Hum. Behav.* **119**, 106715 (2021)
8. Bowyer, B., Kahne, J.: The digital dimensions of civic education: assessing the effects of learning opportunities. *J. Appl. Dev. Psychol.* **69**, 101162 (2020)

9. Alkhowailed, M.S., Rasheed, Z., Shariq, A., Elzainy, A., Sadik, A.E, Alkhamiss, A., Alsolai, A.M., Alduraibi, S.K., Alduraibi, A., Alamro, A., Alhomaindan, H.T., Al Abdulmonem, W.: Digitalization plan in medical education during COVID-19 lockdown. *Inf. Med. Unlocked* **20**, 100432 (2020)
10. Limani, Y., Hajrizi, E., Stapleton, L., Retkoceri, M.: Digital transformation readiness in higher education institutions (HEI): the case of Kosovo. *IFAC PapersOnLine* **52**(25), 52–57 (2019)
11. Teele, S.A., Sindelar, A., Brown, D.: Online education in a hurry: delivering pediatric graduate medical education during COVID-19. *Progress Pediatr. Cardiol.* **60**, 101320 (2021)
12. van Laar, E., van Deursena, A.J.A.M., van Dijkstra, J.A.G.M., de Haan, J.: Measuring the levels of 21st-century digital skills among professionals working within the creative industries: a performance-based approach. *Poetics* **81**, 101434 (2020)

# Digital Competence of Urban and Rural Residents (Generational Aspect)



L. G. Lebedeva

**Abstract** Individuals and social groups, including generational groups, differ in their level of knowledge of digital technologies and networks. We are talking about the problem of sufficient or insufficient adaptation of representatives of various social and age-generational groups to digital technologies (the problem of adaptability to digital technologies). This problem is becoming more acute as more sophisticated computer programs and tools become available. The older group is very far behind the other groups in terms of computer proficiency; for example, two-fifths of this group admit that they do not know computer technology when forming digital competence among people, it is also important to keep in mind the solution of a broader and more complex task—the formation of a digital culture. Digital culture implies the widespread use of digital technologies in the daily lives of people in general (and at the same time—the necessary and sufficient adaptation to digital technologies), and not only in narrow sectors of educational and work activities. As a kind of program goal—a society with a high and inclusive digital culture.

**Keywords** Adaptability to digital technologies · Digital competence · Digital transformation of society · Generations · Rural residents · Urban residents

## 1 Introduction

The problem of “digital competence” of urban and rural residents (citizens and villagers) refers to current social problems, especially in connection with the global digital transformation of society. And this problem is also closely related to the “digital divide (inequality)” between different social and age-generational groups in the degree of mastering digital technologies. The problem of digital competence is highlighted, for example, in the framework of the OECD Going Digital project. This project was launched in January 2017 and is focused on helping countries ‘economies and societies thrive in an increasingly digital and data-driven world [1].

---

L. G. Lebedeva (✉)  
Samara State University of Economics, Samara, Russia

The problem of the “digital divide” is an empirically tangible fact of social life, recorded both in Russian scientific studies and in foreign studies. In connection with this fact, a number of questions arise that are important not only in theory, but also in socio-practical terms. In general, we are talking about the problem of sufficient or insufficient adaptation of representatives of different social and age-generational groups to digital technologies (digital adaptability). This problem is becoming more acute as more complex computer programs and tools become available. The focus of the work (and its purpose) is to analyze the differences between generations of Russians in the level of digital competence of urban and rural residents and to identify relevant problems and tasks for society in this regard.

## 2 Methodology

The empirical part of the work was made up of the sociological materials of the survey “Fathers and children: conflict and cooperation, continuity of generations”. The survey was conducted in early 2020 under the guidance of the author of the article in the Samara region. The sample population of respondents is represented according to the age, sex and territorial-settlement structure of the population. Three groups of respondents were identified for the analysis: 16–24 years ( $n = 202$ ); 25–44 years ( $n = 205$ ); 45–69 years ( $n = 213$ ). These groups are approximately the same in number. The selected groups of respondents reflect not only age differences, but also the characteristics of different generations (younger, middle and older). Naturally, we analyze the responses of respondents to specific questions. But we also used the methodical technique of pairing (linking) the answers to various questions.

The article is devoted to the problem of respondents’ competence in the field of information technologies (computers and social networks). At the same time, special attention is paid to the differences in the level of digital competence of urban and rural residents.

## 3 Results

Computer literacy has different levels (degrees) and options. Obviously, the concept of digital (computer) competence should not be defined too narrowly or too strictly because of the rapid changes in technology. Recent developments, such as mobile and cloud services, are changing the way technology is used, including its use in education. The concept of digital competence includes both the technical aspects of competence and the ability to meaningfully use digital technologies for work, study and everyday life [2]. The article uses the concept of digital competence, taking into account these aspects. Is there a gradation of respondents regarding digital (computer) competence in the territorial and settlement aspect? (Table 1).

**Table 1** Distribution of answers about the ability to work on a computer, % of the number of respondents (N, n) by age group and depending on the place of residence

| Residence  | Computer skills, by age group |                                   |                           |                                   |                           |                                   | Total |                           |                                   |
|--|-------------------------------|-----------------------------------|---------------------------|-----------------------------------|---------------------------|-----------------------------------|-------|---------------------------|-----------------------------------|
|  | 16-24, n = 202                |                                   | 25-44, n = 205            |                                   | 45-69, n = 213            |                                   |       | 16-69, N = 620            |                                   |
|  | I own a computer well ...     | I almost can't work on a computer | I own a computer well ... | I almost can't work on a computer | I own a computer well ... | I almost can't work on a computer |       | I own a computer well ... | I almost can't work on a computer |
| In the city of Samara, n = 252                               | 99.1                          | 0.9                               | 94.0                      | 6.0                               | 63.2                      | 36.8                              | 84.9  | 15.1                      | 100.0                             |
| In the city of Samara region, n = 217                        | 97.7                          | 2.3                               | 97.1                      | 2.9                               | 57.3                      | 42.7                              | 83.4  | 16.6                      | 100.0                             |
| In the village, the settlement of the Samara region, n = 151 | 89.2                          | 10.8                              | 94.2                      | 5.8                               | 51.0                      | 49.0                              | 76.8  | 23.2                      | 100.0                             |
| Total, N = 620   | 96.1                          | 3.9                               | 95.1                      | 4.9                               | 58.2                      | 41.8                              | 82.4  | 17.6                      | 100.0                             |

Source: Author



In general, for the entire sample (Table 1) the answer is: “I practically do not know how to work on a computer” was given by 17.6% of respondents (or about one in six respondents). At the same time, among the residents of cities, they are slightly less (15.1%—in Samara and 16.6%—in other cities of the region). In the villages and cities of the Samara region, there are significantly more of them—23.2% (almost every fourth). At the same time, among the residents of cities, there are slightly fewer of them (15.1%—in Samara and 16.6%—in other cities of the region). In the villages and towns of the Samara region, there are significantly more of them—23.2% (almost every fourth). As for the age-generational groups, the older group is very far behind the other groups in the degree of computer skills. In the older group, the answer: “I practically do not know how to work on a computer” was given by 41.8% of respondents (or about two out of every five respondents). At the same time, most of them are among the villagers (almost half). But even among the residents of the megalopolis—Samara, these are 36.8%.

The lowest number of respondents who gave the answer: “I practically do not know how to work on a computer”, in the younger group—3.9% of respondents in the entire sample. But even in this age-generational group, the respondents-villagers-stand out noticeably, among whom about one in nine (10.8%) admitted that they practically do not know how to work on a computer. Another aspect of computer literacy is the degree of activity of representatives of different age-generational groups in social networks (Table 2).

The coefficients of using social networks (how many social networks, on average, each respondent is related to) are equal to:

**Table 2** Distribution of answers to the question: “In which social networks are you currently registered, do you have your own page? (You can give several answers)”, % of the number of respondents (N, n) and places (ranks) by age group

| Answers                 | Age groups (full years) |      |                |      |                |      |                |      |
|-------------------------|-------------------------|------|----------------|------|----------------|------|----------------|------|
|                         | 16–69, N = 620          |      | 16–24, n = 202 |      | 25–44, n = 205 |      | 45–69, n = 213 |      |
|                         | %                       | Rank | %              | Rank | %              | Rank | %              | Rank |
| (“VKontakte”)           | 66.0                    | 1    | 82.7           | 1    | 79.5           | 1    | 37.1           | 2    |
| «Instagram»             | 48.7                    | 2    | 73.3           | 2    | 54.6           | 2    | 19.7           | 4    |
| (“Odnoklassniki.ru”)    | 39.8                    | 3    | 27.7           | 6    | 45.9           | 3    | 45.5           | 1    |
| (“My World@Mail.ru”)    | 21.9                    | 4    | 31.2           | 4    | 17.1           | 5    | 17.8           | 5    |
| «Facebook»              | 19.7                    | 5    | 31.2           | 5    | 18.5           | 4    | 9.9            | 7    |
| «Google + »             | 19.5                    | 6    | 36.1           | 3    | 11.2           | 7    | 11.7           | 6    |
| «Twitter»               | 16.1                    | 7    | 27.7           | 7    | 14.1           | 6    | 7.0            | 8    |
| Not registered anywhere | 14.0                    | 8    | 2.0            | 9    | 5.9            | 8    | 33.3           | 3    |
| Other                   | 1.0                     | 9    | 2.5            | 8    | 0              | 9    | 0.5            | 9    |
| Total                   | 246                     |      | 314            |      | 246            |      | 182            |      |

Source Author

- in the group of 16–24 years—3.14 (that is, in this group, on average, everyone has a relationship to more than three social networks);
- in the group of 25–44 years—2.46;
- in the group of 45–69 years—1.82.

The most active users of social networks are the representatives of the younger group, which also has the most diverse “assortment” of social networks that are actively used by young people; but “VKontakte” —82.7%—and “Instagram”—73.3%—are especially popular. In addition, the answer “Not registered anywhere” was noted by only 2.0% of the younger group of respondents.

In the middle group, the most popular network is “VKontakte”—79.5%, but the following networks are also very popular: “Odnoklassniki.ru”—45.9%—and “Instagram”—54.6%, and the answer “Not registered anywhere” was given by only 5.9% of respondents.

The least active users of social networks are representatives of the older group, in which one in three (33.3%) chose the answer: “Not registered anywhere”. However, even in the older group, the following networks are quite popular: “Odnoklassniki.ru”—45.5% and “VKontakte”)—37.1%. Thus, there are noticeable differences in the level of knowledge about digital technologies and networks between generational groups in general, as well as between urban and rural groups. At the same time, we have to talk about the problem of insufficient adaptation of large masses of representatives of various social groups to digital technologies (the problem of insufficient adaptability to digital technologies).

## 4 Discussion

Digital competence includes such qualities as technical competence, the ability to meaningfully use digital technologies for work, study and everyday life, the ability to critically evaluate digital technologies, and the motivation to participate and commit to digital culture [2]. Accordingly, it is necessary to consistently and comprehensively work training organizations in cooperation with organizations—consumers of personnel with the necessary digital competencies for the formation and development of these qualities—competencies.

But on this path, however, there are certain obstacles and difficulties not only of an individual nature (abilities, literacy in general), but also of a social nature. First of all, this concerns the more general problem of social inequality. Thus, in the book “The digital divide” by van Dijk, the eighth chapter, apparently, was not accidentally named: “Social and digital inequality” [3]. Russian (and foreign) researchers recognize that it is necessary and possible to overcome the digital divide at the same time as the level of existing social inequality decreases [4]. In other words, it is necessary to address the digital divide and social inequality in a comprehensive manner. We are talking about the basic material possibilities of acquiring computer equipment, and about real access to certain information and computer networks. And we are also

talking about the necessary time and material and financial resources for training in computer technologies.

Along with optimistic assessments of the role of computer technology, the transition to digital technologies, there are also warnings about an uncontrolled slide towards a machine-based online world in which people become quasi-mechanical relays between vast systems of production, consumption and government activities [5]. The formation of digital competence in people for the state and society also means solving a broader and complex problem—the formation of a digital culture. In other words, digital culture implies the widespread use of digital technologies in the daily lives of people in general (and at the same time—the necessary and sufficient adaptation to digital technologies), and not only in narrow sectors of educational and work activities. Improving the digital literacy of the masses of people from different social and age-generational groups can be considered one of the most important socio-economic tasks of society and the state. The solution of this problem involves a closer interaction of organizations—consumers of digital competencies and training organizations.

## 5 Conclusion

Sociological materials indicate the existence of different levels of competence of social groups in the system of digital technologies and networks. We are talking about the older generational group (compared to the middle and younger generations) and about the group of rural residents (compared to urban residents). The problem of significant differences in the level of digital competence of individuals and social groups has been called the “digital divide”. And the presence of such a problem becomes especially dangerous in connection with the global digital transformation of society. Not only individuals, but also very large groups representing older generations and rural residents do not have sufficient adaptability to digital technologies. The digital divide adds to and complicates unjustifiably large socio-economic inequalities. It is necessary to take comprehensive care of the digital competencies of the masses and to overcome the unjustified socio-economic inequality of social and age-generational groups.

Digital competence itself implies technical competence above all else. However, when forming digital competence in people, it is important to keep in mind the solution to a broader and complex problem—the formation of a digital culture. At the same time, it should be about digital culture (and at the same time—about the necessary and sufficient adaptation to digital technologies), not only of individuals and groups, but also of society as a whole. As a kind of program goal—a society with a high and inclusive digital culture. State and municipal organizations are called upon to coordinate the close interaction of organizations that consume digital competencies and organizations that train, form competencies, and at the same time, in general, in the formation of digital culture in society.

## References

1. OECD: Going digital. Making the transformation work for growth and well-being. <http://www.oecd.org/going-digital/>. Accessed: 01 Feb 2021 (2017)
2. Ilomäki, L., Paavola, S., Lakkala, M., Kantosalo, A.: Digital competence—an emergent boundary concept for policy and educational research. *Educ. Inf. Technol.* **21**(3), 655–679 (2016)
3. Van Dijk, J.: *The digital divide*. Polity, Cambridge (2020)
4. Dobrinskaja, D.E., Martynenko, T.S.: Is digital equality possible? (About the book J. van Dijk’s “The Digital Divide”). *Sociol. Stud.* **10**, 158–164 (2020)
5. Feenberg, A.: The internet as network, world, co-construction, and mode of governance. *Inf. Soc.* **35**(4), 229–243 (2019)

# Digital Formats, New Requirements in the Field of Professional and Business Education



E. A. Bogomolova, Yu. S. Ovchinnikova, and I. V. Nikolaeva

**Abstract** In this article, the authors investigate the problem of using digital formats in the process of teaching and training specialists in the field of vocational education of the new millennium, and also work out the issues of justifying the need to adapt to the educational processes of business education as one of the forms of implementing the process of training potential entrepreneurs and business leaders. The authors carry out a comparative analysis of the categories of traditional and digital education, in the process of which, a potential standard form of modern education is deduced, including the standards and methods of international standards in the education system. The paper considers the importance of modern soft & hard skills as necessary tools for training a specialist in an educational institution as a separate issue.

**Keywords** Business education · Digitalization · Entrepreneurship · Hard skills · Professional education · Soft skills

## 1 Introduction

Digital technology has revolutionized learning over the past decade. On the Internet, information on any topic is publicly available. Excellent teaching materials on a very wide range of topics can be found on the Internet for free. What is the future of higher education in the future, digital space? In today's information society, we learn throughout the working day when we need it, and often get information right away by asking for the opinion of colleagues, watching video tutorials or reading online articles on topics of interest to us. Many of us are motivated. Social media and collaboration tools help us find missing pieces of information and gain reasonably good knowledge. Thus, there is a process called "instant microlearning", that is,

---

E. A. Bogomolova  
Samara State University of Social Sciences and Education, Samara, Russia

Yu. S. Ovchinnikova · I. V. Nikolaeva (✉)  
Samara State University of Economics, Samara, Russia  
e-mail: [niv2017@bk.ru](mailto:niv2017@bk.ru)

receiving a small amount of educational content on demand. And this is important for employees today, since many have the ability to apply the knowledge gained at work and demonstrate it to their employers, using skills in practice or presenting certificates of completion of short-term courses or online webinars for gradual career growth.

It is important to understand that the moment of where such a subject will work does not play a role in this issue: in production, in the field of knowledge or in the field of services, the changing business world requires digital and social competencies. Employers must focus their efforts on training staff to use robots and innovative products so that they can take on new roles in team and management, as well as develop their digital and virtual communication skills, which is a doomed future. In this sense, it is rational to consider the term “digital literacy”, which will be determined not only by the ability to mobility in the Internet space, but also by the ability to use collaboration tools, including the knowledge necessary to search, process, analyze, produce data and create information using digital tools [2]. In addition, we must understand that today’s age is constantly changing, as evidenced by the moment that in the market area the demand for new, sometimes unknown and unique competences and professions is constantly growing. The ability to handle data streams or the qualification profile of a data scientist are just two examples. Skills that employees can actually use are important; it is not a one-time formal education. Modern formats of lifelong education must meet these new requirements.

## 2 Methodology

The development of personnel through continuous training allows you to significantly improve their professional level while spending the least amount of time and financial resources. Professional training allows them to improve certain skills necessary for further career growth. Courses and training programs can be distinguished by subject matter and format. These can be both individual training courses and special complex programs, including interrelated training courses. Regarding the training format, it is customary to combine the usual format with a pre-arranged schedule and courses provided at the request of the company. Upon completion of refresher courses, participants receive appropriate certificates.

It should be noted that professional development is of great importance to increase the economic efficiency of a company. In turn, for the personnel, this guarantees an increase in wages and job security. Previously, general education and skills were enough to work almost all—life, but at present, general education is only the basis for future professional activities. If your employees do not improve their qualifications, their knowledge and skills may become outdated and no longer meet modern market demands. To take full advantage of the capabilities of your employees, you need to give them the opportunity to develop and improve. In addition, professional development enables your employees to react more quickly to likely organizational and technological changes in the business model [4]. The importance of professional

development is due to a number of reasons. The main ones are: the rapid development of technology and information; increased requirements for personnel; lack of knowledge.

Today higher education is simply the basis to improve professionalism and career. Knowledge and skills acquired in educational institutions cannot provide an employee with knowledge and skills for the entire period of professional activity. In addition, having an education does not mean that an employee will not need new knowledge and skills. As employment and training become inseparable, employees gain on-the-job training opportunities. Accordingly, if the management does not pay due attention to vocational education, the company will experience a shortage of qualified personnel, which can slow down the pace of work.

Traditionally, professional development has been applied to specific groups of employees [5]. If earlier the need for professional growth concerned managers and narrowly focused specialists, today qualified personnel are required at all levels. Careful analysis reveals that significant organizational changes have taken place in most companies over the past decade. Often these changes are associated with a hierarchical or corporate restructuring of the company. Here are some of the consequences that organizational change entails:

- management is forced to manage more complex procedures or more staff. This reduces the effectiveness of management, and employees begin to take initiative;
- the company's management receives additional functions and responsibilities related to personnel training, safety at work, and industry contacts. This situation creates an urgent need to delegate new powers.

Popularization of the teamwork style, when employees develop the skills of interaction with the team and with the management. When dealing with a variety of tasks, staff must be flexible and versatile [8]. It is clear that not all of these situations may be relevant to your particular business. However, the company's management must always be prepared for changes in market conditions. The striving of the company's management to improve the qualifications and professionalism of its employees enables them to more easily cope with difficulties, master new types of activities, and increases self-esteem.

### 3 Results

Empathy and the ability to work in a team, intrinsic motivation, the ability to overcome conflicts, resilience: social competencies are becoming more and more important against the background of complex and vaguely defined tasks of the modern professional world. When teaching in the future, more and more attention should be paid to personal development. This applies to both formal (additional) education and areas of business education. Flexible work styles and organizations that clearly see and move towards their goal require people with the appropriate attitude in these matters, as well as those who are able to easily adapt to learning situations and are

open to new things, curious and ready to experiment, as well as having experience in managing relevant tools and methods. At the same time, it is important to develop as a person and as a professional in order to effectively transform organizations.

Compared to the past, 2021 will be more focused on topics related to social skills and trends in business education because organizations want and must strive for a higher degree of maturity, which also means they need to develop their workforce. We can use many digital tools and robots, but we are still dealing with humans. According to him, we should not lose sight of how we relate to each other and how we want to cooperate. Employees need not only flexible thinking, that is, the ability to think independently and outside the box, but also great competence in eliminating uncertainty. They must be able to deal with contradictions. When it comes to personal development, the same managers are increasingly becoming important sparring partners for their employees. The days when the end of education meant the real end of the educational path are long gone [10]. Career stories become more colorful, and flatter hierarchies allow for the development of so-called “spiral careers”, as people take steps up and down the career ladder to continue their studies. With this approach, training never ends, and more intense stages of training are part of the career. This requires more guidance and support in the form of counseling and mentoring. Given the wide range of offerings available in the education market today, students require much more leadership than they did in the past. Helping them choose the right learning content, which is the latest trends in business education, will be the core competence of educational institutions. Variability, uncertainty, complexity, ambiguity, dynamics, diversity are the key competencies of the future.

An important point here will also be that since the end of 2019, the entire world community has been faced with a new type of infectious disease, which is referred to as COVID-19. No country was prepared for the consequences that arose from this virus. Many spheres of life have suffered, including the field of education. Since the beginning of March 2020, all educational institutions have been transferred to a distance learning format, and many events have been postponed or held in absentia. There was talk among the population about how difficult and incomprehensible it is to work on the Internet. Many said that this format is extremely inconvenient and unusual, while the rest shared their opinions that the remote format is a very effective provider that contributes to the personal development of a person in the twenty-first century, as well as the most comfortable way to get information from home. Let's take a closer look. How convenient is the distance format for the implementation of measures for successful education?

Consider the advantages and disadvantages of distance education. The advantages of this training format are:

- the possibility of obtaining knowledge in the Internet format, at a time when it is more convenient for the subjects;
- no need to attend offline classes, which leads to minimization of travel and food costs;
- accessibility of education for people with disabilities;
- speed of learning and the ability to refer to different sources;



- increasing the level of awareness, in preparation for classes, as the “machine” assesses, and not the person—more and more objectively;
- for a university or school, distance education contributes to the development of the sector for attracting potential students;
- development of skills of self-control and response to information.
- The disadvantages will be that:
  - there is no personal contact with the teacher;
  - the possibilities of using soft skills are minimized, since the students are not in a social environment;
  - remotely it is possible to learn and study not every profession;
  - there is no motivation to study, because of the constant work with the Internet;
  - significant deterioration in health, due to the fact that the subjects are constantly at the computer;
- lack of emotional coloring when studying material with a teacher.

On the Instagram network, we conducted a survey on the perspective and attitude of students to distance learning. 1800 respondents (law students) were asked the following questions:

1. How do you feel about distance education?
2. Are you ready to switch from full-time education to distance learning?
3. How did distance learning affect communication (contact) with teachers?
4. How did distance learning affect communication (contact) with classmates and other students?

Based on the results of the questionnaire, the following answers were received:

1. How do you feel about distance education? To which, 23.5% answered “positively”, 34.5% answered “negatively”, 22.5% answered “rather negatively than positively” and 19.5% answered “rather positively than negatively”.
2. Are you ready to switch from face-to-face to distance learning? To which, 28.5% answered “yes”, 30.5% answered “no”, 19.5% answered “rather yes than no” and 21.5% answered “rather no than yes”.
3. How did distance learning affect communication (contact) with teachers? To which, 30.5% answered “there is more communication”, 20.5% answered “there is less communication” and 49% answered “it didn’t affect in any way”.
4. How did distance learning affect communication (contact) with classmates and other students? to which 33.5% “Communication has become more”, and 66.5% answered “Communication has become less.”
5. Thus, we can conclude that distance education is regarded by many ambiguously, although the majority of students are still inclined to believe that it can be considered as a possible alternative to full-time education.
6. I would also like to note that at the moment, much attention is paid to the process and self-learning. Any of us can improve our knowledge of law with the help of various Internet resources.

#### **4. Discussion.**

In addition to those qualities that an employer pays attention to before hiring a specialist, there are also soft skills, hard skills. Let's take a closer look at these skills, because, according to the 4brain.ru website, they well reflect the trend of adapting international standards in education. First of all, let's talk about the so-called "heavy" skills. Indeed, in many universities, future professionals are taught exactly by them. Hard skills are knowledge of practice, that is, those qualities that do not depend on the individual. The theoretical and practical application of "heavy" skills can be revealed in the following. Examples of "hard" skills: knowledge of a foreign language, typing speed, programming and a decent level of theoretical knowledge in various areas. From the point of view of employment, these skills are often fundamental, because a specialist in a certain area must first of all have special skills. Soft skills are personal qualities that allow you to effectively interact with people [11].

Let's start with the fact that from a Western point of view, a modern specialist should have only 20% hard skills, while the remaining 80% are now occupied by time management and communication skills. Let's turn to statistics. We did our own research. They took the profession of "lawyer" as a basis. Head Hunter, one of the most popular job and employee search sites in Moscow alone, hosts about 30,000 lawyers' resumes. But there are fewer vacancies—only 2 thousand, so about 15 people apply for one position of a lawyer. Hence, we can conclude that a potential lawyer needs to try hard in order to find a job. In our opinion, a demanded specialist should have the following qualities:

**Time management skills.** Providing assistance to the client as quickly as possible, without loss of quality.

**Brevity.** The ability to answer the main question of interest to the client—is it possible or not possible. With a short explanation of why and why not.

**Flexible pricing system.** A detailed explanation to the client, up to every hour of the trainee's or specialist's work, why there was such a price.

**Effective communication.** Ability to convey your position to both the client and the opponent, be able to communicate, focus on the client's needs, and feel his need.

**Narrow specialization** is the most effective way of development, because it is simply not possible to achieve success in all matters at once.

**Unique selling proposition.** Ability to highlight and emphasize your strengths.

**Be available 24/7.** It is important for the client that he knows that it is you who are dealing with his problem, and that he can turn to you. In addition, accessibility in modern instant messengers and popular social networks is now a big advantage.

Since we live in an era of multitasking. Now, in order to be a good specialist and successfully build a career, you need to think like an entrepreneur—to have basic knowledge in the field of finance, marketing, PR. There is no need to master these skills perfectly [7]. But if you are a person who is trying to build an independent career with your own clients, this knowledge is necessary for you. An important point today for any specialist is his ability to speak. Speaking skills are important everywhere, no matter the situation. The ability to apply the principles of stylistic design in work is also an important element of the "mobile" specialist of the twenty-first century. Stylistic design and the corresponding style of thinking is a combination of stylistic and design approaches, UI and UX design methods. Thanks to design, the stylistic

services industry can make a huge headway. Design-focused companies such as Apple, Nike, Starbucks, Coca-Cola have outperformed the S&P 500 by an incredible 228% over the past decade, according to a report by the Design Management Institute [3].

In conclusion of the main part, I would like to say that for the successful development or development of “soft” skills in oneself, it is not necessary to undergo a separate training course. It is enough to know its basics. At the same time, this process requires self-organization and is effective if you use not one, but several methods in combination. Let’s consider in what ways you can improve soft skills.

Self-study: reading literature, participating in webinars, etc. It is important to write down the useful conclusions and thoughts that you managed to glean from a particular source. This contributes to the fact that the information is better absorbed. Visiting educational and developmental events: trainings, master classes, forums.

Learning from someone else’s experience, when you choose a mentor for yourself, communicate, follow his example. You can meet such a person at a thematic event or look at people in your environment.

Seek feedback from people who have witnessed a demonstration of your skill. Track the reactions of others to what you are doing, ask for their opinion. Feedback can be subjective and should not be considered the ultimate truth. Feedback from a mentor or reputable person who demonstrates success in the skill you are developing is very important [1]. Completing new work tasks will help you step out of your comfort zone and develop the skills that interest you. In the process, try to participate in projects that you have not touched before. Stop your choice on tasks in which you need to apply the skills you are developing. How successfully you can develop certain soft skills depends on the following factors: moral guidelines and personal attitudes. Thus, it is impossible to develop motivation and teamwork skills if you do not respect your subordinates and do not like your colleagues; hard skills and associated professional deformation. A specialist with developed soft skills is a socially active person. He is a professional who knows how to negotiate and persuade, able to effectively organize his work, think flexibly, outside the box. No robot will definitely replace such a specialist.

## 4 Conclusion

Our research has shown that in order to become a highly qualified specialist of the twenty-first century, it is necessary to develop oneself from different sides, to be a competent theorist and no less professional in terms of the possibility of applying theory in practice, one must be erudite, responsible, possess hard skills and soft skills. This determines the guarantee of a successful modern specialist. We have achieved the goal of our research: we considered topical issues of modern education in the field of digital formats and new requirements in the field of professional and business education. Of course, this topic is quite large and it is impossible to fully disclose it within the framework of our work, rather, we have touched on only a few important

aspects, but I would like to note that we believe that our research can be reference information for teachers and students of some universities. It can also be used by any citizens of our country who want to improve their level of knowledge of educational standards and issues related to modernity [6]. I would like to note that digitalization dictates new requirements for the competent professional of the future. It is important to be mobile and ready for the ongoing learning process [9].

## References

1. Abenov, Y.M., Kirdasinova, K.A., Tulaganov, A.B., Zhumataeva, B.A., Mutalyieva, L.M., Issayeva, B.K.: Entrepreneurship education: Teaching and learning modern mechanisms of entrepreneurship development based on public-private partnership. *J. Entrepreneurship Edu.* **22**(5), 1528–2651–22–5–450 (2019)
2. Agency for Strategic Initiatives: Informal education. [https://asi.ru/leaders/initiatives/education\\_leaders/future\\_skills/](https://asi.ru/leaders/initiatives/education_leaders/future_skills/). Accessed: 20 Mar 2021 (2020)
3. Westcot, M.: Design-driven companies outperform S&P by 228% over ten years—the “DMI Design value index”. <https://www.dmi.org/blogpost/1093220/182956/Design-Driven-Companies-Outperform-S-P-by-228-Over-Ten-Years--The-DMI-Design-Value-Index>. Accessed: 22 Mar 2021 (2014)
4. Downes, S.: Personal and personalized learning. <https://us8.campaign-archive.com/?u=17ce08681f559814caf1359d3&id=fa1770e58d&e=6fb1272e29>. Accessed: 20 Mar 2021 (2016)
5. Ivonina, A.I., Chulanova, O.L., Davletshina, Y.M.: Modern directions of theoretical and methodological developments in the field of management: the role of soft-skills and hard skills in the professional and career development of employees. *Naukovedenie* **9**(1), 90 (2017)
6. Huynh, N.T., Hall, G.B.: Navigating employment prospects for new graduates in the geospatial sciences. In: Balram, S., Boxall, J. (eds.) *GIScience Teaching and Learning Perspectives. Advances in Geographic Information Science*, pp. 145–169. Springer, Cham (2019)
7. Mavlutova, I., Lesinskis, K., Liogys, M., Hermanis, J.: Innovative teaching techniques for entrepreneurship education in the era of digitalisation. *WSEAS Trans. Environ. Dev.* **16**, 725–733 (2020)
8. Ministry of Education of the Russian Federation: National project “Education”. <https://strategy24.ru/rf/education/projects/natsionalnyy-proekt-obrazovanie>. Accessed: 18 Mar 2021 (2020)
9. Scholl, H., Baldus, A.: Training and qualification: essentials of new learning. In: Zeuch, M. (ed.) *Handbook of Human Resources Management*, pp.293–333. Springer, Berlin (2016)
10. Stanford University: High school students are unprepared to judge the credibility of information on the Internet, according to Stanford researchers. <https://ed.stanford.edu/news/high-school-students-are-unprepared-judge-credibility-information-internet-according-stanford>. Accessed: 17 Mar 2021 (2019)
11. Yamada, S.: Traditional apprenticeship as an educational and life experience: Life stories of young auto repair apprentices in Kumasi, Ghana. In: Ofosu-Kusi, Y., Matsuda, M., (eds.) *The Challenge of African Potentials: Conviviality, Informality and Futurity*, pp. 181–208. Bamenda: Langaa RPCIG (2020)

# Digital Education at University: The Process of Adjustment Under Turbulence



E. G. Repina

**Abstract** The experience of implementing a blended learning system at the Russian university under the Covid-19 pandemic is presented in this paper. Practical steps for integrating two digital tools, namely the Moodle platform and the MS Teams service, into the learning process are described. An algorithm for proctoring the education quality was developed by the university and the digital skills of teachers and students were assessed in the process of adapting to work in the remote synchronous and asynchronous interaction modes. To ensure effective interaction of learning actors within digital mode specific measures are proposed. The implementation of these measures allowed the university to maintain the quality level of the competencies formation that is determined by the federal state educational standard.

**Keywords** Digital service · E-learning · Quality · University

## 1 Introduction

Currently the transition to an innovative type of development is the strategic direction of the socio-economic system development. It is determined by the galloping pace of the creation of new digital technologies in various socio-economic domains. Higher professional education has undergone a significant transformation over the past two decades. The changes concerned both the quality content of educational programs and the emergence of completely new areas of knowledge. Moreover, the training technology itself and the ecosystem of the implementation of educational services were affected. Various studies describe the transition of educational technologies from the level of BBS (Bulletin board system) to the level of Ed Tech (Education Technology) [1].

Under the coronavirus crisis (Covid-19 pandemic), which has rapidly spread throughout the world, Ed Tech technologies, which are based on digital intelligence and block chain, have made it possible to quickly transfer the educational process to

---

E. G. Repina (✉)  
Samara State University of Economics, Samara, Russia

a digital remote mode. Much research is devoted to different aspects of digital educational process. The analysis of German universities case is presented in [2]. A new term “Digital Semester 2020” was coined by the researchers. It is seen as a Rubicon between and the sharply emerging reality of the digital format of the educational process [3]. Therewith, e-learning information and educational environment is seen as a reference point, the target state of which will be achieved in the future [4]. In Italy, the epidemiological situation are extremely complex. The educational system of the country was forced to change the format of work very sharply, switching to the remote mode. According to Italian researchers [5], the distance learning system, which is “non-mandatory” for classical offline universities, has become the only way to ensure the educational process.

Researchers from Portugal, Spain, Australia, and Canada are discussing the dimensions of the “digital education” concept, as well as the differences between this term and “online learning” or “e-learning” [6]. In this study, digital education is understood as an ecosystem of digital resources and software tools and services that allows carrying out the educational process at the university remotely. The experience of implementing a digital service in the educational process of a humanitarian university is presented. It should be noted that digital services of the electronic educational environment can be used by students from their mobile devices. It is proved that in this case, the psychometric properties of the educational content are maintained at a high level [7]. With a sufficient level of digital literacy, the level of qualitative formation of professional competencies also does not decrease.

## 2 Methodology

General scientific methods (synthesis, analysis, comparison, systematization) are applied in this study. The method of expert assessments and focus groups was also used. Under the Covid-19 pandemic, there is a lack of clarity about the time when universities could return to traditional offline training. In such conditions, the educational process of the Samara State University of Economics is carried out with remote synchronous interaction technologies based on the MS Teams service. This service is used in combination with the use of an electronic information and educational environment, namely, an electronic learning system deployed on the Moodle platform (an open-source e-learning system). The effectiveness of this platform application in the practical activities of the university has been already proven [8].

The choice of a software product is based on the need to organize a large-scale educational process for more than 8000 students. Health restrictions in the context of the pandemic require a combination of classes within the traditional schedule with the remote access to educational content. Time has shown that even with a relative improvement in the epidemiological situation, the blended learning mode (offline alongside with online) is very likely to have entered the life of the university for a long time. In order to minimize the complexities of the transition period and ensure the quality of the educational process, the regulations for working with the

MS Teams service were developed. The choice of MS Teams as the main service for educational process is based on the results of a SWOT analysis conducted for a large-scale blended learning format [9, 10]. Among the advantages of the service the following can be named:

- personalized access, from any mobile device;
- the ability to integrate with the e-learning system on the Moodle platform;
- high-speed data exchange;
- virtual communication;
- digital educational footprint creation and storage;
- a chat as an element of instant visual communication.

Among the disadvantages were the risk of students' cognitive skills loss, the behavior irregularity and affect incongruity alongside with the problem of the decrease in knowledge quality, and the vital risks from the use of digital technologies.

### 3 Results

To overcome the risks and maximize the use of the MS Teams service, the university management has taken a certain set of measures. The university has organized a technical support hotline on practical application of MS Teams, developed detailed instructions for teachers and students. The university also launched a "hot button" on its official website, and a hot phone line for supporting actors in the educational process <https://www.sseu.ru/goryachaya-liniya>.

All students and teachers of the university have access to the MS Teams service from any mobile device. The educational process with the use of remote technologies is organized in teams (classes), created by the teacher for connecting students to them. To unify the team ecosystem, the standard team name "Mode of Instruction/Subject/Teacher's Last Name" was developed, which was recognized as the most informative based on the results of focus groups surveys, which were conducted among all participants of the educational process.

During the transition of the educational process to the digital platform, the university provided a series of training seminars, where the key steps of conducting training sessions without compromising quality were explained. It was done for the fastest and less painless adaptation of teachers to digital MS Teams environment. The key directions for conducting classes in the mode of synchronous remote interaction were formulated with the involvement of the expert community, i.e. leading teachers and IT specialists. Among those directions the following can be named:

- training materials placement in the class team (presentations, visual materials, practice tasks);
- preliminary connection to the webinar in the team, the technical settings check-ups (turning on the video camera and microphone);

- recording a lesson that allows the student, if necessary, to reproduce the lesson and improve the quality of learning material;
- team chat moderation;
- reflection, i.e. receiving feedback from students in the synchronous remote interaction mode.

For a clear record and monitoring the educational process quality, the university has developed certain criteria for the quality of training sessions. The training session meets the quality requirements if the teacher turns on the video camera, makes a video recording, demonstrates the presentation material, moderates the team chat and answers the students' questions online. The use of the digital educational services of the university's e-learning system in the course of the lesson is also required.

In the process of e-learning, traditional methods fail, and certain features of the presentation, generalization, and assimilation of educational information appear. To overcome these negative factors, the assessment of the education quality was formalized as an active online form that reflects the implementation of the quality parameters of the training session in each of the teams created.

The implementation of MS Teams service into the educational process allowed proctoring the student's identity during the training session, which contributes to the control function on the part of the teacher and motivates students to self-discipline. For the interim assessment, the university recommended the "teacher-student" video communication mode with the ability to exchange text files and the ability to provide access to monitoring the desktop of one of the actors of the educational process. As practice has shown, teachers have successfully collaborated electronic educational resources of the university with built-in test databases and a video conference mode in MS Teams. The disadvantages of the MS Teams service were identified in the course of this study. Among them are the absence of option to form and integrate student performance analytical reports in the university electronic learning system and the absence of knowledge testing system.

## 4 Discussion

Ed Tech technologies, e-learning in particular, are certainly not an absolutely relevant replacement for the existing didactic achievements of pedagogy. Digital technologies are an effective tool for finding information for autonomous learning, for remote access to university educational resources and online educational platforms. But digital learning is not a full-fledged replacement for the entire complex of educational activities in the learning process. It is essential to aware that the success of using the opportunities of digital education largely depends on the psychological characteristics of students as well as their physical state. As the previous studies have demonstrated [11], distance learning technologies have a strong cognitive load and their learning success rate is 0.8. Another issue for discussion is the availability of digital technologies equally to all students. The university campus provides equal



access to e-learning. Equal distance access is not always truly equal due to differences in the well-being of students or their families.

## 5 Conclusion

The experience of the educational process urgent restructuring at the university has demonstrated a sufficiently high potential of the e-learning system. The electronic information and educational environment of the university has demonstrated digital maturity. The university quickly identified the digital service for synchronous interaction of actors in the educational process. However, it was determined that the pedagogical community is acutely lacks consistent digital and didactic competencies for working with online services and platforms. Thus, it is essential to extensively introduce end-to-end digital competencies in the educational activities of teachers. To do this, research and teaching staff undergo advanced training under the program “Introduction of end-to-end digital competencies in the teaching of specialized disciplines”. In order to protect information, it is advisable to concentrate efforts at the state level to create national online services and educational platforms based on domestic software products.

## References

1. Weller, M.: 25 years of Ed tech. AU Press, Edmonton (2020)
2. Burnyashov, B.A.: «Digital semester 2020» in universities of Russia and Germany: comparative analysis. *E-Learn. It Educ.* **16**(2), 460–470 (2020)
3. Neborsky, E.V., Boguslavsky, M.V., Ladyzhets, N.S., Naumova, T.A.: Digital education: the transition online German universities during the Covid–19 crisis. *Soc.: Sociol. Psychol. Pedagogy*, **12**(80), 200–205 (2020)
4. Makransky, G., Terkildsen, T., Mayer, R.: Adding immersive virtual reality to a science lab simulation causes more presence but less learning. *Learn. Instr.* **60**, 225–236 (2017)
5. Appolloni, A., Colassanti, N., Fantauzzi, C., Fiorani, G., Frondizi, R.: Distance learning as a resilience strategy during Covid—19: an analysis of the Italian context. *Sustainability* **13**(3), 1–12 (2021)
6. Rapanta, C., Botturi, L., Goodyear, P., Guàrdia, L., Koole, M.: Online university teaching during and after the Covid-19 crisis: refocusing teacher presence and learning activity. *Postdigital Sci. Educ.* **2**(3), 923–945 (2020)
7. Aznar-Diaz, I., Romero-Rodríguez, J.-M., Navas-Parejo, M.R., Gomez-Garcia, G.: Analysis of good teaching practices with mobile devices at the university: design and validation of the APMU scale. *Revista Iberoamericana de Tecnologías del Aprendizaje* **16**(1), 2–10 (2021)
8. Talysheva, I., Pegova, K., Khaliullina, L.: The use of electronic educational resources of the university as a means of increasing the educational motivation of students. *Int. J. Emerg. Technol. Learn.* **16**(1), 289–304 (2021)
9. Babin, E.N.: Digitalization of the university: building an integrated information environment. *Univ. Educ: Pract. Anal.* **22**(6), 44–54 (2018)

10. Revunov, S.V., Shcherbina, M.M., Lubenskaya, M.P.: Methodological and technological principles of providing e-learning software for educational institutions (by the example of “Microsoft Teams” platform). *Pedagogy. Theo. Pract.* **5**(3), 387–392 (2020)
11. Dautova, O.B., Ignateva, EYu., Shilova, O.N.: Mass blended learning format how to move towards digital education. *Nepreryvnoe Obrazovanie: XXI Vek* **3**(31), 106–112 (2020)

# Problems of the Digital Learning Formation in a Distance Format



S. A. Sevastyanova

**Abstract** The article deals with the problems of translating the educational process into a digital format. The objective necessity and demand for education digitalization has been substantiated. The measures of state support for distance learning during the period of restrictive measures are described, examples of the most accessible digital means of supporting the educational process are given. Considerable attention is paid to the issues of teachers' readiness to work in remote and mixed formats. The analysis of the teachers' difficulties in the implementation of an indirect form of educational activity. The forms and methods of training a teacher for remote work are proposed. On the basis of the competence-based approach, the goals and objectives of the educational process are formulated. Structural models of teacher and student competencies are proposed, on the basis of which a methodological system for the formation of subject and general competencies in a digital format should be developed. The conclusion is made about the advisability of improving the competencies of teachers in the field of remote work in a digital format, the subsequent development of the topic in scientific pedagogical research.

**Keywords** Digital learning technologies · Distance learning

## 1 Introduction

Digital technologies, being the result of an objective process of scientific and technological development, have actively entered the field of education. Initially, this was due to the desire of the educational institution for competitive advantages, diversification of the forms of educational activity, and the expansion of educational opportunities. Distance learning emerged on the basis of the correspondence format. With the advent of electronic means of teaching and communication, the need for full-time presence of students has disappeared, and the educational process itself has acquired a lot of specific properties, advantages and options for implementation [1].

---

S. A. Sevastyanova (✉)  
Samara State University of Economics, Samara, Russia

The ability to choose the forms, pace and timing of training, courses and programs of additional education, availability regardless of place and time, full provision of the necessary educational and didactic materials, objective control of results—this is not a complete list of the advantages of distance learning [2].

Recently, a new global problem has arisen—the vulnerability of society to objective circumstances that impede personal communication. And, probably, in the future we should be prepared for such situations: analysts' forecasts do not exclude the occurrence of sanitary quarantines, man-made disasters and other force majeure circumstances. The impossibility of full-time training sessions arose suddenly in early April 2020 and demanded immediate action. Teachers of secondary and higher schools, vocational education were called upon to ensure a continuous and high-quality educational process through distance learning based on the use of digital technologies. The degree of readiness for this challenge of educational institutions, teaching and management personnel has become a criterion for assessing the status of an educational institution, the professionalism of its employees. In these conditions, the issue of organizing digital training, creating a methodological base, a system of labor organization and health protection, working out legal aspects, retraining employees, material and technical support of a new training format, adapting students to new requirements and conditions has become acute.

## 2 Methodology

Criteria in the course of scientific work in the preparation of the article, general scientific and specific research methods were used. Analysis of digital data was carried out when processing the survey results using general statistical methods. When preparing the results, the collection and analysis of information was carried out using methods of searching and sorting information, search engines. Sociological methods of conducting surveys were used in conducting an electronic survey. The analysis of the legal aspects of the problem is carried out on the basis of a study of the regulatory framework. The techniques of generalization and analysis were also used to formulate conclusions. In the field of studying the problems of goal-setting in educational activities, a competence-based approach was used, based on the understanding of learning outcomes as readiness to perform professional activities.

## 3 Results

After results implementation of restrictive measures in 2019–20 was a factor in accelerating the transition of the education system to a digital format. The irreversibility of the transition is due to the growing demand for innovative forms of education based on the use of electronic educational resources. The formation of the digital educational space is actively taking place at all levels, from primary grades to postgraduate

education, in state and other educational institutions. The teacher's willingness to work remotely is one of the important professional competencies. The competence of a teacher is the readiness / ability to organize and implement training through a combination of digital and classical educational tools and methods, including through indirect interaction with students. In our view, competence as a professional quality is determined by the presence of three groups of features: technical competence, subject and methodological competence. Each of the features is determined by a number of descriptors, divided into four groups: material and technical support and organization of the educational process, theoretical component, practical component and personal qualities of the teacher. Learning outcomes are presented in the form of a table of student competencies. Determining the goals and objectives of digital education is the basis for understanding the specifics of the process, a guideline for creating a new methodological system. All this will allow the education system to become more dynamic, flexible, meeting the actual needs of society and the individual.

In the transition to learning using digital technologies is actively taking place in educational institutions of all levels, from primary grades to postgraduate education. Given the importance of the problems arising during this period, the state authorities have taken unprecedented measures to support educational institutions [3]. A temporary procedure for supporting the implementation of educational programs using e-learning and distance learning technologies, including secondary vocational education programs, has been approved. In a short time, digital training tools were created and put into operation.

Free public digital platform "My School Online" provides an opportunity to master the curriculum without access to high-speed Internet. This educational resource contains more than 2 thousand materials on 14 subjects for grades 1–11, prepared in accordance with the school curriculum on the basis of textbooks included in the federal list. Every day, the educational channel broadcasts 30-min lessons from the best teachers and methodologists, consultations of specialists on preparing for the USE and OGE. Video lessons, tests and various additional materials on school subjects are available on the Russian Electronic School portal for students in grades 1–11 [4].

More than 220 thousand schoolchildren from low-income families and teachers received equipment for organizing distance learning, including within the framework of the Help to Study at Home project, organized by the Ministry of Education of the Russian Federation with the support of the Agency for Strategic Initiatives, the United Russia party, and regional authorities. The goal of the project is to transfer tablets, computers or smartphones to children and teachers who do not have the opportunity to fully study or teach lessons.

To support teachers in a difficult situation of transition to learning using distance technologies, in April 2020, the project "Volunteers of Education" [5] was created with the participation of senior students of pedagogical universities and colleges, undergraduates. Volunteers consulted teachers, parents and students, provided round-the-clock remote technical support, and at the same time they themselves learned and acquired the necessary professional qualities and experience.

For methodological support of the organization of distance learning, a hotline of the Ministry of Education of Russia has been opened. Telephone operators received tens of thousands of calls, about a fifth of which came from teachers. Many large IT companies (Microsoft, Google, Yandex, etc.), in a difficult period for their clients, provided advanced services, including for distance learning. These include free online courses on various educational platforms Coursera, Stepic, Open Education, etc. [6]; video conferencing tools (Zoom, G Suite (Hangouts), Microsoft Teams); interactive notebooks with ready-made tasks Yandex.Textbook, Uchi.ru, yaklass.ru; services for preparing your own (author's) courses: Google Classroom, Canvas Instructure, Moodle or Moodle Cloud; corporate planning tools Google, Trello, Bitrix24; distance learning systems (LMS or LMS—Learning management system), etc.

All of the above measures of support indicate the special attention of the state and business to the fulfillment of the tasks assigned to the school. As of today, it can be stated that these tasks are generally being performed well. Ahead is work on comprehending the experience gained, determining priority strategies, regulating and creating a regulatory framework [7]. Consideration should be given to parental comments regarding, for example, the scope of homework, remote monitoring methods, and class schedules. It is also necessary to take into account the opinion of teachers who are experiencing increased loads and stress.

Changes are also taking place in the higher education system. The Ministry of Education of the Russian Federation offers educational institutions a choice of two possible scenarios for transferring students to distance learning: in part or in full. In the first case, the transfer of students to distance learning is carried out at will, in the second—without fail. All teaching materials should be available to teachers and students, primarily in the electronic information environment of the university. In addition, all organizational issues should be publicly explained, the training schedule should be corrected, a scenario for the intermediate and final state certification using remote technologies and EIOS should be prepared, a bank of test tasks should be created, the collection of students' written works should be organized, a grading system was thought out. Here, the educational institutions themselves are mainly engaged in solving problems, and first of all, directly by the teachers. Thus, the objective reasons for the urgent introduction of distance learning served as a driver for the transition to a digital format. The irreversibility of the process is due to the need for the introduction of innovative distance learning forms that has long been formed in society. Currently, it is important to solve the problem of creating a methodological base for a new format of education, creating a digital learning system as a set of goals, content, means, methods.

The teacher's willingness to work remotely is one of the important professional competencies. It should be maintained in an active state, be the subject of development in the professional training of teachers, advanced training [8]. Accordingly, the training of teachers for remote work should be considered a necessary direction of the personnel policy of an educational institution [9].

The competence of a distance learning teacher is the readiness / ability to organize and carry out training in a distance learning format, i.e. with indirect interaction with

students. First of all, we will define the structure of the concept in order, based on this, to form an idea of the ways of its formation. Based on research on the named problem [10], let us formulate: in our view, competence as a professional quality is determined by the presence of three groups of features: technical competence, subject and methodological competence (Table 1).

Technical competencies are a prerequisite for working in a remote format, consisting in the teacher's ability to use digital educational technologies and equipment, IT communications for the indirect organization and full implementation of the educational process. Subject competencies are the foundation of the teacher's professional skill, his duty is to know the subject well, the field of science to which he belongs, and the application for solving professional and other problems. Methodological competence is mastery of the fundamentals of the theory and methodology of higher education, the ability to "tune" the methodological system of training to work in a remote format in compliance with the relevant pedagogical principles.

**Table 1** The competence structure of a teacher working in the digital learning format

|  | Technical competencies  | Subject competencies   | Methodological competencies  |
|--|---|--|--|
| Material, technical and organizational component | Provided with the necessary equipment, has access to high-speed Internet  | Has at its disposal electronic teaching aids in the discipline (subject)   | Familiar with the work program, lesson plans, has at its disposal an educational and methodological complex for the discipline               |
| Theoretical component                            | Informed about the possibilities of modern digital learning and communication tools                                   | Skills the subject at a high level   | Familiar with the methodological principles of distance learning, sanitary and hygienic requirements, information security requirements, etc |
| Practical component                              | Knows how to use digital technology, create, edit and post educational and methodological materials for remote access | Uses in his work electronic materials on the profile of the discipline, videos, tests, sites, databases, statistical data, digital platforms, etc  | Owens the methodological foundations for the creation and use of electronic educational resources  |
| Personal component                               | Mastering technical and computer teaching aids; monitors the emergence of new offers and opportunities                | Sees the prospects for the introduction of digital technologies in the subject area and professional activity and strives for their implementation | Raises professional qualifications in the field of teaching methods, participates in the creation of new means and methods of teaching       |

Source Author

Each of the features is determined by a number of descriptors, divided into four groups: material and technical support and organization of the educational process, theoretical component, practical component and personal qualities of the teacher.

Let us illustrate the structure of the competence of a teacher (higher school) of distance learning using the example of the subject area mathematics. The peculiarities of the language and symbols of this branch of knowledge are such that the use of distance technologies until recently was limited by technical conditions [11]. The situation has changed with the replenishment of the arsenal of digital devices. The material and technical support of the educational process should include the necessary technical means and an access point to high-speed Internet. The technical means include office computer equipment with installed standard software and video communication means; software packages for mathematical calculations (Excel, Statistica, etc.); graphic tablet (for handwriting input of mathematical information, formulas, drawings). The basis of the subject support is made up of elements of an electronic educational and methodological complex: an electronic textbook, working (if possible, interactive) notebooks for practical work, electronic lecture notes, visualization tools for educational material (presentations, tables), control tools (test tasks, cards, individual tasks and others in electronic form). Preparation of subject support is a laborious process that requires a highly qualified compiler [12]. The creation of a set of educational and methodological materials should be distributed among the teachers of the discipline for a sufficient period of time and constantly supported. The organizational component of methodological competencies is also formed: work programs of the course, curricula, class schedule, etc. are created. These documents, as a rule, are placed in the electronic information and educational environment of the university. It is also important to resolve the issue of how to communicate with students and the administration: social networks, instant messengers, digital platforms, etc. The teacher needs to be able to promptly and massively inform students about upcoming events, and students need to be able to provide feedback.

The theoretical component of competencies is the basis of educational activities. Excellent knowledge of the subject, awareness of modern possibilities of using computer technologies and equipment in teaching, practice and communication are the basic qualification requirements for a teacher. The methodological aspect of theoretical competencies is made up of the basic elements of the methodological system: goals, forms, methods, means of forming competencies in students [13]. The teacher must know the basics of higher education didactics, know the methodological principles of distance learning [14], sanitary and hygienic requirements (in relation to preserving the health of students), information security requirements, etc.

Equally important is the practical aspect of competence formed by the teacher's professional skills. In order to work remotely, you need to be able to use computer and digital equipment (scanner, webcam, tablet), create, edit and post educational and methodological materials for remote access (text documents with hyperlinks, mathematical texts and formulas, drawings, diagrams, tables, tests, presentations); use digital means of communication. In addition, the subject component of practical competence assumes that the teacher uses in his work relevant electronic materials



on the profile of the discipline, videos, websites, databases, statistical data, digital platforms, etc. Students can also be recommended additional sources of information for scientific work, preparation of articles, abstracts, reports, etc. Of course, in order to perform this work, it is desirable for the teacher to have an idea of the methodological foundations of the creation and use of electronic educational resources [15], the ways of presenting and perceiving information.

The representation of the structure of the investigated competence would be incomplete if not to include in its composition a component that reflects the teacher's personal qualities, his focus on results, readiness to master new information and skills, the desire to learn new opportunities in his field of activity, to develop a methodological base. Participation in webinars, online training courses, methodological and scientific conferences, exchange of experience with colleagues from leading universities would be useful for the implementation of these tasks.

In the context of the competence-based approach, one can also consider the goals of digital education from the point of view of students. Assuming that the goal of training is the formation of general and subject competencies, we will present the result of training in the form of a complex of student competencies (Table 2).

## 4 Discussion

It is also important to understand what are the constraints that are hampering the digitalization of education at the present time. Survey data among university professors in Samara showed that there are problems. 94% of the respondents noted that they experience (or experienced at the initial stage) difficulties in organizing distance learning. The most frequent reason for the survey participants named technical difficulties associated with the lack of necessary equipment, access to high-speed Internet, with the use and configuration of hardware and software. The second factor is the insufficient formation of the base of electronic educational and methodological materials, incl. visualization and control facilities. The third most frequently mentioned cause of difficulties is the lack of awareness of teachers about modern IT technologies with an understandable interface, available for mastering in a short time, preferably free and easily customizable. Organizational difficulties (informing students, feedback), lack of skills in using digital means of communication, preparation of electronic educational and control materials were also noted among the reasons for the difficulties experienced.

## 5 Conclusion

The complex of the conditions, skills and qualities described above constitutes the general concept of the competence of a teacher and a student in a digital format.

**Table 2** The structure of the competence of a student studying in digital format

|  | Technical competencies   | Subject competencies  | General competencies   |
|--|--|---|--|
| Material, technical and organizational component | Provided with the necessary equipment, has access to high-speed Internet   | Has at the disposal of electronic teaching materials on the discipline (subject)  | Familiar with the discipline work program, lesson plans, lesson schedules, etc   |
| Theoretical component                            | Possesses the skills of searching and processing information, is familiar with the main electronic resources in the studied area | Owns theoretical material in the discipline   | Understands the role of the studied discipline in the vocational training system   |
| Practical component                              | Possesses the skills of using computer tools to solve professional problems within the studied discipline                        | Owns methods of solving professional problems within the framework of the studied discipline  | Able to apply subject-matter competencies  |
| Personal component                               | Uses digital tools to improve professional skills, cultural level and personal growth  | Increases the level of knowledge of subject competencies as a tool for the formation of interdisciplinary and general cultural competencies | Realizes the goals of studying the discipline in the context of the formation of interdisciplinary and general cultural competencies of personality development, is motivated to study and self-organization |

Source Author

Determining the goals and objectives of digital education is the basis for understanding the specifics of the process, a guideline for creating a new methodological system, incl. digital forms of control and evaluation of results. It is obvious that at the present time all this requires a great effort from the teacher, the expenditure of labor and time to create a methodological base, improve qualifications. Perhaps, this competence should be considered as an advanced level of professional skill of a teacher with an appropriate assessment, incl. with material incentives. It would be useful to exchange experience and methodological developments in this direction (subject to copyright and other legal aspects), advanced training with practical and theoretical sessions. For this, it is necessary to continue scientific and methodological research and the development of recommendations on the topic of this article. All this will allow the higher education system to become more dynamic, flexible, meeting the actual needs of the labor market and each individual.

## References

1. Kupriyanova, D.V., Odinets, D.N.: Formation of competencies of full-time students in universities based on the advantages of distance education. In: Prytkov, V.A. (ed.), Proceedings of the XI International Scientific and Methodological Conference Distance Learning - Educational Environment of the XXI century. Minsk: BSUIR (2019)
2. Zabelina, O.E.: Distance learning in the modern education system. *Actual Prob Sci* **24**, 84–85 (2016)
3. Kovalchuk, S.S., Garkusha, N.A., Medyankina, E.N., Mukhina, Yu.N.: Online learning: from the experience of foreign and Russian universities. *High Educ Today* **1**, 31–38 (2020)
4. United Russia: Help us learn at home: Schoolchildren in the regions received a new batch of computers for distance learning. [https://er.ru/activity/news/pomogi-uchitsya-doma-shkolniki-v-regionah-poluchili-novuyu-partiyu-kompyuterov-dlya-distancionnogo-obucheniya\\_192261](https://er.ru/activity/news/pomogi-uchitsya-doma-shkolniki-v-regionah-poluchili-novuyu-partiyu-kompyuterov-dlya-distancionnogo-obucheniya_192261). Accessed: 21 March 2021 (2020)
5. Ministry of Education of the Russian Federation: Students of pedagogical universities from different regions of Russia join the project “Volunteers of Education”. <https://edu.gov.ru/press/2369/k-proektu-volontery-prosvescheniya-prisoedinyayutsya-studenty-pedvuzov-iz-raznyh-regionov-rossii/>. Accessed: 21 March 2021 (2020)
6. Onosov, A.A., Bryzgalina, E.V., Savina, N.E., Tumanov, S.V.: Foreign educational platforms in the system of Russian education: potential assessment and risk prediction. *High. Educ. Russia* **27**(8–9), 135–151 (2018)
7. Dzyuba, N.V.: On the need to develop guidelines for the use of distance learning technologies in the educational process in the ministry of education and science of Russia. In: Proceedings of the IX All-Russian Scientific and Practical Conference With International Participation Distance Learning in Higher Vocational Education: Experience, Problems and Development Prospects, pp. 121–122. Publishing House of St. Peter. State University of Trade Unions, Saint Petersburg (2016)
8. Nikulicheva, N.V.: Qualification characteristics as a basis for advanced training of a distance learning teacher. *Open Educ.* **5**, 16–23 (2013)
9. Galikhanov, G.F., Khasanov, M.F.: Preparing teachers for online learning: roles, competencies, content. *High Educ Russia* **2**, 51–62 (2019)
10. Zainagalina, L.Z., Petrov, V.A., Buluykova, F.Z.: Professional competencies of a teacher working in the distance education system. In: Mulhametshin, V.Sh., Tyncherov, K.T., Akhmetov, R.T., Suleymanov, R.I., Arslanov, I.G., Mukhtasarova E.A. (eds.), Proceedings of the international scientific and methodological conference actual issues of higher education—2018, pp. 191–194. Ufa State Publishing House, Ufa (2018)
11. Goncharova, Z.G.: Distance learning as an innovative model of teaching mathematics in higher education. *Pedagogy and Psychol Educ* **4**, 95–103 (2019)
12. Antipova, T.B.: Development of EUMC in the discipline “Mathematics and Informatics” as a means of improving the teacher’s self-education. In Proceedings of the IX All-Russian Scientific and Practical Conference With International Participation Distance Learning in Higher Vocational Education: Experience, Problems and Development Prospects, pp. 147–148. Publishing House of St. Peter. State University of Trade Unions, Saint Petersburg (2016)
13. Sevastyanova, S.A.: Formation of professional mathematical competencies among students of economic universities: PhD dissertation. Samara State University of Economics, Samara (2006)
14. Filippov, I.E.: Methodological aspects, general pedagogical principles and methods of distance learning. *Bullet. Mod. Res.* **1.6**(28), 378–381 (2019)
15. Makarov, S.I.: Methodological foundations for the creation and use of educational electronic publications (on the example of a course in mathematics): Dissertation. Institute of General Secondary Education of the Russian Academy of Sciences, Moscow (2003)

# Digital Transformation of Russian Vocational Education Based on a Systematic Approach



R. R. Khasnutdinov and O. A. Vladimirova

**Abstract** The article discusses some aspects of the digital transformation of vocational education in Russia based on a systematic approach. In the context of the formation of a new technological order and the transition to the digital economy, the requirements for the quality, content, infrastructure of vocational education, the organization of the educational process, and the management mechanisms in the system of vocational education have changed significantly. Each educational institution will undergo digital transformation sooner or later, so the choice of direction and development strategy is relevant for each of them. Considering that the development and implementation of the program (concept) of digital transformation in each educational institution is complex, the authors propose a systematic approach to solving this issue. The article substantiates the optimal variant of the practical application of the system approach—the functional system method. The functional system is based on a focused useful result, which is an integral, decisive component and has a central organizing influence on all stages of system formation. The authors formulate a focused useful result that underlies the digital transformation of vocational education and on the basis of which the formation of a new system of vocational education should take place.

**Keywords** Digitalization · Functional system · Method · Professional education · System approach · Transformation

## 1 Introduction

Digitalization processes have covered almost all spheres of life, penetrating into various fields of activity. Currently, the daily use of various digital and information technologies and gadgets by a modern person during the day makes it possible to

---

R. R. Khasnutdinov (✉)  
Samara State University of Economics, Samara, Russia

O. A. Vladimirova  
Samara Law Institute of the Federal Penitentiary Service of Russia, Samara, Russia

“simplify life”, get the necessary information in an accelerated deadlines, order or perform a service. The emerging processes of automation and informatization make it necessary to “improve” all spheres of public life in order to extract “profit” and improve the quality of work by minimizing the efforts made. All this is a manifestation of a new technological order or the fourth industrial revolution. Building a digital economy and, consequently, the digital transformation of the education system are priority areas of Russian state policy, as evidenced by the implementation of such major national projects as the national program “Digital Economy of the Russian Federation” [1] and the national project “Education” [2]. In modern conditions, the digital transformation of the education system pursues ambitious goals determined in accordance with the state policy. Each educational institution, being both a structural element of the professional education system and an independent system that includes a set of interacting departments and elements of the educational process [3], will undergo a digital transformation. For the successful and effective implementation of this process, it is advisable to use a systematic approach.

## 2 Methodology

This study was conducted on the basis of both general scientific methods of analysis, synthesis, deduction, generalization, and using private scientific methods: comparative legal, system-structural. Comparative legal analysis was used to identify the peculiarities of views on issues related to the digital transformation of vocational education in the context of building a digital economy, as well as the use of a systematic approach in its organization, among Russian and foreign researchers. The system-structural method allowed us to generalize the main directions of digital transformation of vocational education in Russia on the basis of the functional system method. The basis of the study was the normative acts of Russia, scientific research, works, scientific articles and publications of Russian and foreign legal scholars, practitioners, who consider various aspects of the digital transformation of vocational education and the use of a systematic approach in its organization. Over the past few years, many scientific papers have been written on the digitization of vocational education. This topic is covered not only by Russian [4, 5], but also by foreign scientists [6–10]. This study was conducted in stages. First, there was carried out an analysis of the scientific literature and the legal framework on topics related to vocational education in general, and its digital transformation in particular, as well as the use of a systematic approach in scientific research, were determined the problems, purpose and methods of research. At the second stage, the main conclusions obtained during the analysis of the scientific literature and the regulatory framework were formulated, and the publication of this study was prepared.

### 3 Results

In the conditions of a new technological order, when digital systems and technologies are introduced not only in the production sector, but also in society, thereby forming an information society, the qualification requirements for specialists have changed significantly. Only general professional and vocational competencies are no longer sufficient to work in the context of the transition to the digital economy. At present, we are already talking about the availability of digital competencies for people and specialists. The content of professional competencies under the influence of digitalization is also undergoing changes. As noted in the federal project “Personnel for the Digital Economy” [11], which is part of the national program “Digital Economy of the Russian Federation” [1], as a result of its implementation, more than one million specialists of organizations and state bodies should learn the competencies of the digital economy, about ten million citizens should improve digital literacy as part of online training, and all graduates of the vocational education system should fully possess the key competencies of the digital economy. In these new conditions, the requirements for the quality, content, and infrastructure of vocational education, for the organization of the educational process, and for the management mechanisms in the system of vocational education have changed significantly and are still changing. We need to understand that it will never be the same, and the digital transformation of vocational education is an inevitable and natural process in the context of the formation of the digital economy.

Today, the term “digital transformation” in relation to vocational education should be understood in a broad sense. It involves not just the transfer of educational programs to digital form and the use of digital technologies in the educational process, but cardinal changes associated with the formation of a new scientific and methodological base, the creation of digital infrastructure, the training (retraining) of pedagogical and administrative personnel of digital education [5], the introduction of practice-oriented flexible educational programs, the creation of a digital educational environment [12], automation of the main business processes and services in the educational institution [13] as well as the transition to a system of continuous updating of knowledge (life-long-learning) and personalization (individualization) of the learning process based on advanced-learning technologies.

On the one hand, the digital economy and the digital transformation of vocational education as an external environment directly affects the transformation of educational institutions, and eventually each of them will undergo significant changes. On the other hand, in generally, the process of digital transformation of vocational education directly depends on the digital transformation of each educational institution, because specific activities aimed at the transition to digital education begin in specific educational institutions. It should be clearly understood that every educational institution, regardless of its desire, will undergo a digital transformation. The process of transformation of a classical university into a digital university is dictated by the federal project “Personnel for the Digital Economy”, and is already a reality, despite

its still experimental nature [11]. The transition of each institution of higher professional education to the format of the so-called “digital university” is due to objective factors. First, the digitalization of internal processes will increase the efficiency of interaction between departments and the work of higher education institutions as a whole. Secondly, modern students are representatives of the digital generation (digital natives), for whom it is a natural necessity to use new technologies in daily life, including during training. Third, in the context of the globalization of the educational services market, the struggle for their students and brutal competition between educational institutions, not only at the domestic but also at the international level, only those universities that will be able to timely reconfigure all their activities, including infrastructure, organization of the educational process, and management to a new digital format will remain competitive. Based on the above, it should be noted that now every educational institution is faced with the choice of the direction and the right strategy for its further development in the context of the transition to digital education. The development and subsequent implementation of the digital transformation program (concept) in each educational institution is complex. Therefore, it is necessary to approach this systematically. As Uvarov, Wang, Kang, Chzhu, Tzyan rightly note, the digital transformation of education must meet the requirement of consistency, which is not always fulfilled. During the development and program realization the development of Russian education in decision-making, does not always take into account all the interacting components, which hinders the achievement of the desired result [12].

The systematic approach, which is used by many scientists in various subject studies, is important and is a serious methodological tool for the study of various phenomena and processes. The systematic approach went through a long evolutionary path and in the twentieth century finally formed into a theoretical concept called “general theory of systems”. In a general sense, the essence of it is the study of objects as systems consisting of certain elements. The individual elements combined in the system begin to function in a new way in interaction with each other, acquire a total integrative quality, and as a result give out a new result, which is impossible from the work and action of these elements separately. The general theory of systems was intended to become a tool that facilitates the conduct of specific research, but had a serious drawback, which is the lack of a system-forming factor, thanks to which many components with random interaction are ordered and organized into a system. It was this flaw that, until a certain time, prevented the use of general systems theory as an effective tool in conducting specific scientific research. We discussed this issue in more detail in the study on the methodology of a systematic approach to legal responsibility [14].

In our opinion, the best option for the practical application of the system approach in specific scientific research is the functional system method, which follows from the concept formulated by the famous academician Anokhin in the framework of the general theory of systems [15]. The method of the functional system consists in the fact that the investigated phenomenon (process) is considered as a complex of selectively involved components, in which the interaction and relationships take the character of mutual interaction of components to obtain a focused useful result [16].

The theory of the functional system of Anokhin completely eliminates the above disadvantage and solves the problem of the system-forming factor. It is a focused useful result, the value of which is difficult to overestimate. It is an integral, decisive component and has a central organizing influence on all stages of the formation of the system. Thanks to it, an orderly interaction is created between all the other elements of the system. The focused useful result selects all the degrees of freedom of the system elements that are adequate for a given moment and focuses their effort on itself. The elements of the system focused on a useful result do not just interact, but cooperate [16], as a result of which they begin to function in a new way and eventually give out a new quality. Researchers of the system approach in the field of education note that for the emergence of the integral quality of the system as a whole, it is the interaction of its individual elements on the basis of ordered connections between them that is more important than the effective work of these same elements separately [3].

In a functional system, the mutual cooperation of its structural elements occurs only because each of them is influenced by the so-called afferent synthesis, and each element, freed from excessive degrees of freedom, is united with other elements only on those aspects of interaction that together contribute to obtaining a programmed focused useful result. Accordingly, such a system, which is based on the system formation of a focused useful result, which is simultaneously the central organizing element that affects all stages of the formation and functioning of the system, is called functional [14]. The functional system method is effectively designed for the subject studies of phenomena and processes as independent systems. It has proven itself well in conducting research, for example in the field of law [14, 16].

Currently, the vocational education system is in the process of digital transformation, as a result of which this system should become fundamentally new in its quality and content, as well as meet new requirements and results in a new technological structure and digital economy. The federal project “Personnel for the Digital Economy” [11], which is part of the national program “Digital Economy of the Russian Federation” [1], defines the main directions of such digital transformation, declaring that the new education system should update the content, create a modern infrastructure, train and retrain personnel to work in the updated system, and update the management mechanisms in the system.

The functional system method involves the selection of selectively involved elements and a focused useful result, on the basis of which the system is formed and thanks to which the interaction between the elements of the system is ordered. Such a result should be formulated in accordance with the State’s legal policy. The analysis of the above-mentioned national programs and federal projects shows that the new system of Russian education, firstly, should prepare highly qualified personnel for the digital economy (the basis of high qualification of graduates is digital competencies), and, secondly, should have global competitiveness (in terms of the quality of education, Russia should enter the top ten countries in the world) [1, 2, 11]. On the bases of this, it is possible to formulate a focused useful result of the digital vocational education system as the training of highly qualified personnel for the digital economy and the achievement of the quality of education that ensures its global



competitiveness at the world level. It is this result, which is both a system-forming factor and a tool for ordering the interaction of system elements, underlies the digital transformation of vocational education.

The question of what structural elements are included or should be included in the new system of vocational education is under development, since the system itself is in a state of formation. During the building of a functional system, it should be taken into account that any component can enter the system only if it contributes its share to the achievement of the formulated result. The currently existing elements of the vocational education system are significantly changed and modified under the influence of the programmed result, and those elements that do not correspond to it will be excluded altogether. And finally, new elements will be added to the system of vocational education, which will give it a new quality corresponding to a focused useful result.

One of the properties of any system is its integrity, which is equally evident both at the macro level, which includes all vocational education institutions and the Ministry of Science and Education of the Russian Federation, and at the micro level, when each educational institution is considered as a system of interacting units and elements of the educational process [3]. Therefore, the focused useful result formulated above will be dominant in the system at both the macro and micro levels. Each educational institution, being an independent system at the micro level, under the influence of digital transformation as a whole, determines and should determine: (1) its new “digital” model as a system; (2) what elements should be included in it and what content they will be; (3) what connections the elements of the system will be arranged in such an organization that, at the output, will give it integrative qualities corresponding to the programmed focused useful result. Leading higher education institutions develop and adopt programs, concepts, and development plans that describe both the main elements and directions of digital transformation of the educational organization as a whole, and its individual components, such as the educational process. This study does not aim to highlight all the structural elements and their internal relationships of the new digital education system. This is a long, systematic and multi-faceted process that requires deep study on the basis of a systematic approach, the best option for practical implementation of which is the functional system method proposed in the article.

## 4 Discussion

At present, when a new system of professional education is being formed in the context of digital transformation, the content and main components of the digital university model are debatable. Golyshkova in the model “Digital University” identifies the following five levels (elements): stakeholders, which include teaching staff, students, and employers; information services, research and project management, educational services marketing, and digital technologies. And among the main directions of the digital university, she refers to the creation of an innovative ecosystem of

the university, the digitalization of educational programs, the transition to a digital infrastructure and the development of the human capital of an educational organization [13]. Kuzina formulated 18 elements of the “Digital University” model. At the same time, it followed three main messages: a digital profile instead of a classical diploma, replacing the general educational program with an individual educational trajectory, and creating a network of organizations and digital platforms [17]. And at the conference on technologies in education Edcrunch Ural Larionova and Karasik, noted that in order to implement the concept of “Digital University”, it is necessary to have such elements as information systems for managing basic processes, educational content, digital literacy and individual educational trajectories [4]. The lack of consensus on the main components of the digital educational institution model once again emphasizes that the process of forming a new system of professional digital education in general, and the formation of a digital educational institution model on the example of a digital university in particular, is at a very early stage, at the level of a pilot project. There is still a lot to be done, and without a strategy, which, in our opinion, should be based on a systematic approach, of course, we cannot do without.

## 5 Conclusion

The study made it possible to make the following conclusions. The formation of a new technological order and the transition to the digital economy have also predetermined the changes that the vocational education system is undergoing. The digital transformation of vocational education will eventually affect every educational institution. In order to keep up with the times, and to remain in a leading position and be competitive, each educational institution of professional education must determine the direction and strategy of its development in the digital economy. The main factor for the success of the digital transformation of vocational education is the strategy of each educational institution, developed and implemented on the basis of a systematic approach. The functional system method, which is the best option for the practical application of the system approach, is quite suitable for solving these issues. It is based on a focused useful result, which is an integral, decisive component and has a central organizing influence on all stages of the formation and functioning of the system. The study formulates a focused useful result that underlies the digital transformation of vocational education and on the basis of which the formation of a new system of vocational education and the creation of an orderly interaction between the elements of the system in the digital economy should take place. This result is the training of highly qualified personnel for the digital economy and the achievement of the quality of education that ensures its global competitiveness at the global level.

## References

1. Ministry of Digital Development, Communications and Mass Media of the Russian Federation: National program “Digital economy of the Russian Federation”. <https://digital.gov.ru/ru/activity/directions/858/>. Accessed: 14 March 2021 (2019)
2. Ministry of Education of the Russian Federation: National project “Education”. <https://strategiya24.ru/rf/education/projects/natsionalnyy-proekt-obrazovanie>. Accessed: 14 March 2021 (2018)
3. Levkin, G.G., Kolychev, N.M., Levkina, E.A., Sosnovskaya, E.V., Gulyaeva, E.A., Semchenko, V.V.: System approach in the organization of the activity of a teacher of a higher educational institution. *Prof. Educ. Modern World* **1**(16), 77–89 (2015)
4. Larionova, V.A., Karasik, A.A.: Digital transformation of universities: notes on the global conference on technologies in education Edcrunch Ural. *University Manage.: Pract. Analys.* **23**(3), 130–135 (2019)
5. Savina, A.G.: Digital transformation of the educational space: Realities and prospects. *Educ. Sci. Bord.: Fundamental Appl. Res.* **7**, 208–211 (2017)
6. Becker, M., Spöttl, G.: The impact of digitalization on vocational education and training exemplified by the metal and electrical industry. *Zeitschrift für Erziehungswissenschaft* **22**(3), 567–592 (2019)
7. Busse, J., Lange, A., Schumann, M.: Effects of digitalization on vocational education and training: First results of a qualitative study. In Pinkwart, N., Konert, J. (eds.), *Lecture Notes in Informatics (LNI). Gesellschaft für Informatik*, vol. P-297, pp. 67–72. GI, Bonn (2019)
8. Masrifah, N., Sudira, P.: Redesign of vocational education curriculum in industrial digitalization 4.0. In: Kutaka- Kennedy, J. (ed.), *Proceedings of the 2020 2nd International Conference on Modern Educational Technology*, pp. 25–29. Association for Computing Machinery, New York (2020)
9. Neumann, J., Hoffmann, L.: Digitalization in institutions of vocational education and training—empirical results on the current state. In: Schoop, E., Kahnwald, N., Köhler, T., (eds.), *Communities in new media: research on knowledge communities in science, business, education and public administration—proceedings of 21th conference GeNeMe*, pp. 105–113. TUDpress Verlag der Wissenschaften GmbH, Dresden (2018)
10. Schrack, C.: Vocational education 4.0—digitalization and Industry 4.0 in the Austrian vocational education. *Elektrotechnik und Informationstechnik*, **135**(1), 103–105 (2018)
11. Ministry of Digital Development, Communications and Mass Media of the Russian Federation: Federal project “Personnel for the Digital Economy”. <https://digital.gov.ru/ru/activity/directions/866/>. Accessed: 14 March 2021 (2019)
12. Uvarov, A.Yu., Wang, S., Kang, Ts., Chzhu, S., Tzyan, S.: Problems and prospects of digital transformation of education in Russia and China. In Dvoretzskaya, I.V. (ed.), *Problems and prospects of digital transformation of education in Russia and China: II Russian-Chinese Conference of Education Researchers “Digital Transformation of Education and Artificial intelligence”*, pp. 11–96. Publishing House of the Higher School of Economics, Moscow (2019)
13. Golyshkova, I.N.: Analysis of key components of the “Digital University” Model. *E-Management* **3**(3), 53–61 (2020)
14. Khasnutdinov, R.R.: *Methodology of a systematic approach to legal responsibility: monograph*. Samara Law Institute of the Federal Penitentiary Service of Russia, Samara (2014)
15. Anokhin, P.K.: *Essays on the physiology of functional systems*. Medicine, Moscow (1975)
16. Khasnutdinov, R.R.: Method of the functional system in legal research. *Law Educ.* **6**, 113–119 (2013)
17. Kuzina, G.P.: The concept of a digital transformation of a traditional university to a “digital university”. *E-Management* **3**(2), 89–96 (2020)

# Methods of Machine Learning



S. A. Chevereva

**Abstract** The article discusses machine learning methods. Methods are taken as an example, ways to study under observation and training, as well as training with partial attraction of a teacher based on experiments and research. Presented options for the main types of machine learning models for each method. An isolated structure of any machine learning model is analyzed. The main component of the main component is considered, which is a statistical operation on orthogonal transformation, translating observation of variables into a set of main component—values. Dana Library “Scikit-Learn”, in which most machine learning algorithms are implemented. Described by the “Random Forest” algorithm, which is used in “Sberbank” to predict the non-payment and bankruptcies of companies and IP. In conclusion, describes what tasks can be solved depending on the choice of learning.

**Keywords** Artificial intelligence · Building models · Data analysis · Machine learning · Neural networks

## 1 Introduction

Today there is a huge variety of various methods and technologies of learning artificial intelligence. Machine learning technology becomes a relevant way to radically change business processes. About 94% of managers believe that artificial intelligence technologies play a key role in solving the strategic tasks of the organization [1]. Only the presence of AI R & D will be able to set a leading place in the automation of the future. Developed countries began to study in detail the technologies of machine learning four years ago, assessing the degree of its importance for the economy of the country and the world in the tse-scrap. The development of artificial intelligence is already becoming nothing to be proceeded, but ordinary for each person and organization. In addition to changes in everyday life and public life, the influence of machine learning has affected the internal business processes, where the artificial

---

S. A. Chevereva (✉)  
Samara State University of Economics, Samara, Russia

intelligence technologies are beginning to be introduced in an accelerated format [2]. Thanks to a pretty strong mathematical school, Russia does not act from global trends and at a sufficient level develops the introduction of artificial intelligence. As for industry applications, the leadership still belongs to the banking industry (20%) and retail (20%), where a strong knowledge base, high competition and there is a budget for implementation. In 2019, the technologies of AI began to resort into industry. To date, this area owns every 14th project. The top five players include conglomerates that offer mail, transfers, transport services, as well as marketing and travel companies at the same time.

## 2 Methodology

Machine learning (ML) is one of the most famous and important subsections of data science. Thereafter, the field of ML aroused great interest among other scientists, especially due to the fact that it was used in classifications. Typically, the first subsection to start learning about data science is machine learning. This term describes a set of computer algorithms that can learn and improve by gathering information as they work.

The renewed interest in machine learning is driven by the same factors that made data analysis and Bayesian analysis more popular than ever. Growing volumes, the variety of data available, computational processing that is cheaper and more powerful, affordable storage for storing data—all these aspects mean that models can be produced quickly and automatically. They can analyze larger and more complex data and provide faster and more accurate results—even at very large volumes. And by building accurate models, an organization is more likely to identify profitable opportunities or avoid unknown risks.

It is important to note that the main processes associated with machine learning are directly related to the processes of artificial intelligence (AI) and data mining (IAD). These processes include sifting through the data to find patterns and at the same time adapting program actions to new information available. The key principle of ML is to create algorithms that can receive and analyze input data through statistical analysis. The analysis is carried out for the further purpose of predicting the results. At the same time, in the subsequent course of forecasting, training continues on the basis of new working data.

Machine learning has become quite common in today's digital environment, although most Internet users do not yet realize this fact. People who frequently shop online or go to social media regularly come across the results of machine learning algorithms. Every announcement, suggestion, and recommendation they come across is a product of ML algorithms.

Any complex process begins with a specific task. Machine learning is no exception, and in this case, the task will contribute to the following algorithm. Suppose there are a  $X$ -set objects, then there is also a set of answers. For example, there are two classes or arbitrary numbers [3]. Moreover, the pattern between  $X$  and  $Y$  is

unknown. Thus, we are given a training sample  $\{x_1, x_2, \dots, x_n\}$ —this is a subset of one set  $X$ . Our goal is to choose an algorithm approximating the function  $y(x)$  [4]. I will add that the object  $X$  is set as a feature description. Signs themselves can be 3 types:

1. Numeric.
2. Binary.
3. Catent.

Machine learning is divided into four large groups of methods:

- classical training;
- Reinforcement training;
- neural networks and deep learning;
- ensemble methods.

The most popular, in terms of data analysis, is classical training, which is divided into training with the teacher, without a teacher and with partial attraction of the teacher. These are two fundamentally different methodologies, so they should be considered separately. Simpler to understand the process itself is learning with a teacher, the meaning of which is as follows: there is a complete set of data, a certain part is allocated, on which the model is trained, that is, the algorithm selects the relationship, in advance of the “correct answer” [5]. On another part of the data, the quality of selected learning is checked. The identified relationships apply to this set and on their basis is predicted by the rest of the target. The more correct answers, the better the quality of the model. It is also important not to reissue the model, otherwise it will not be able to solve the task qualitatively. For detection of retraining, there are also individual methods.

Training with the teacher is inextricably linked with the solution of two types of tasks: classification and regression. When the task of classification is solved, the goal is to correctly define the class of the target object. The number of classes determined does not matter. To solve the classification task, such models are traditionally used as:

- K-NN;
- Naïve Bayes;
- SVM;
- Decision Trees;
- Logistic regression.

### 3 Results

Each of them has its own mathematical apparatus “under the hood”. The selection of the model is more often carried out based on the data structure by which they will predict. Therefore, before learning, it is important to prepare and analyze data, check for emissions and skips. Some models work only with normalized data, some can

easily process and source datasets. For example, with the help of classification, it is possible to determine whether it is worth issuing a credit or whether a particular buyer will buy some product. Accordingly, the classification works with discrete values, while regression tasks are associated with continuous data. For example, with a linear regression, a certain expected target value is calculated, with certain parameters of variables  $X$  [9]. Regression methods also have their own models. The most common models are presented below:

- linear regression;
- polynomial regression;
- lasso/ridge regression.

With the help of regression tasks, you can predict the cost of the apartment, knowing its parameters, such as the area of the kitchen, floor, area, the availability of the balcony. Each variable will be assigned its coefficient, which can be economically interpreted if it makes sense. The type of variables in the model value does not have, you can also predict the cost of the apartment having only binary variables [8].

With regard to another equally important group of machine learning methods, they include training without a teacher. The meaning of the data of my business is based on the fact that when learning without a teacher, the car explores the data set and reveals the hidden patterns of correlation between different variables [9]. In this regard, when learning without a teacher, it is good to solve clustering tasks, when the model itself is learned on the data and identifies the optimal number of classes, not knowing how many of them should be. Clustering models can be:

- fuzzy c-means;
- mean-shift;
- k-means;
- DBSCAN;
- agglomerative.

There is a library “SCIKIT-LEARN”, in which most machine learning algorithms are implemented. During the study of cloud services, the construction of the productive system of the Inferes (Recommendations) on large amounts of data is placed in the head of the corner. The computing resources of the RTS-tender are to help. The calculation of the recommendations is made on the basis of the algorithms of this library, where various methods are used, which suggest the most optimal option on the processed data.

The clustering algorithm is actively used in the company “Sber”, which uses the “Random Forest” algorithm. The problem of classification and regression problems is important, as well as the use of a large co-course of decisions, each of which gives the quality of the classification. Improving the quality of the final result of the algorithm is achieved through work precisely with a large number of trees. In the process of creating machine learning algorithms, more than 1000 signs are carried out, according to which the final forecast is issued. The use of this method is suitable for predicting non-payment and bankruptcies of companies and IP [6].

There are companies that focus on machine learning. “GPU” (Graphical Processing Unit) machine learning, deep neural networks and computer vision technologies can be used in a variety of industries. The company fulfills orders in this area with any complexity and specificity of tasks. These can be tasks related to image recognition using AlexNet, ZF Net, VGG Net, ResNet, YOLO, GoogLeNet, SegNet, FSN, ParseNet, U-Net, FPN, PSPNet, R-CNN, etc. The company detects objects (faster rcnn, Yolo), Human Pose Detection (OpenPose), creates NLP algorithms with or without the BERT network. The company provides training in Python with the ability to create a version, recognition services in Python and C++. Programs can be implemented under Windows, Linux, Android.

Machine learning systems (MLs) are applied applications where learning algorithms are used in the system to provide automated execution of intelligent business or production tasks. A system or service connects to data sources to provide learning and adaptation of the system’s algorithm over time, creating a useful result. There are also visual analytics services (online format) that allow to implement recognition of text and objects in images using machine learning software models. The service is used on the basis of a programming interface (API). For example, it is Yandex Vision.

The importance of machine learning and its benefits can be put on a par with the benefits of artificial intelligence (AI) and data mining (IAD) systems. When running a business, an entrepreneur deals with an increasing amount of data and a variety of information. In an environment of information surplus, it is important to have reliable and effective tools that allow you to quickly sift through information, find the most relevant data, use the data to improve your business.

Machine learning technology helps small businesses, enterprises, organizations and individual users (freelancers, individual entrepreneurs, analysts, researchers) to transform processes. The use of machine learning systems allows you to make business processes more streamlined, efficient and convenient. Users can find relevant data faster and easier.

## 4 Discussion

All models have a different approach to the calculation like training with the teacher, and for each individual case you need to select the corresponding algorithm to achieve a better solution [7]. Also, one of the interesting types of training without a teacher can serve as a group of methods that allow reduce dimension. For example, the main component method (PCA). This is a statistical operation for orthogonal transformation, which translates the observations of variables into a set of main components—values that are not linearly correlated. In this case, with the correct selection of the parameters of the matrix rotation, you can form a few components that will perfectly cope with such work [7]. Each component is formed from the cluster of indicators, which often refer to a specific block of indicators, which improves the interpretability



of the model and the possibility of its use. The applicability of this method in practice is explained by how well the subject area is well studied.

Large companies are turning to another type of training—training with partial involvement of the teacher. It is used when ready-made sets of partially tagged data already exist. It is a mixture of teaching with and without a teacher. By highlighting some of the data, the teacher gives the machine an impetus to figure out how to cluster the rest of the information. This approach helps in identifying frauds where attackers want to impersonate another [10]. Fraud is defined as an anomaly in the background of normal activity. Such machine learning methods with partial involvement of the teacher allow to create models that recognize anomalies. Corresponding systems are also used to detect attempts fraudulent online transactions.

## 5 Conclusion

Build a model for data analysis in different ways. On the example of machine learning methods, two large groups of methods were considered in the article: training with a teacher and without a teacher [10]. When studying with the teacher, we have a target variable, which you need to learn to predict with the help of the algorithm. Training with the teacher solves two global tasks: classification and regression. When classifying, the specific class of the object is defined, for example, the floor of the cliche for its transactions. When solving the problem of regression, the value of the target variable is predicted on the basis of values dependent by re-change, for example, the client's age of its transactions. If learning happens without a teacher, then the task is to force the algorithm to identify the existing relationships without the knowledge of true values. The most common methods in machine learning are clustering, lowering the dimension and the search for rules. In this case, the real task will be to determine the number of certain groups of clients based on their own transactions. You can first determine the relevant number of groups, and then another algorithm to learn how to distribute customers in these groups. The selection of the model is based on data from the dataset, for each model there is their quality assessment metrics.

## References

1. Alazaidah, R.: Machine learning. [https://www.researchgate.net/publication/349734634\\_Machine\\_Learning](https://www.researchgate.net/publication/349734634_Machine_Learning) (2021). Accessed 24 Mar 2021
2. Alekseev, G.: Introduction to machine learning. <https://habr.com/ru/post/448892/>. Accessed 24 Mar 2021
3. Bangert, P.: Machine learning. In P. Bangert (Ed.), *Machine learning and data science in the power generation industry* (pp. 41–75). Elsevier, Amsterdam (2021)
4. Bonetto, R., Latzko, V.: Machine learning. In F.H.P. Fitzek, F. Granelli, P. Seeling (Eds.), *Computing in Communication Networks* (pp. 135–167). Academic Press, Cambridge (2021)

5. Cady, F.: Data science: the executive summary—a technical book for non-technical professionals. Wiley, New York (2020)
6. Kasmy, E.: Sberbank learned from AI to predict the revenue of any company in Russia. [https://www.cnews.ru/news/top/2019-07-15\\_sberbank\\_nauchil\\_iskusstvennyj\\_intellekt\\_prognozirovat](https://www.cnews.ru/news/top/2019-07-15_sberbank_nauchil_iskusstvennyj_intellekt_prognozirovat) (2019). Accessed 24 Mar 2021
7. Kolisnichenko, D.: Machine training in practice. The experience of using cloud technologies of machine-learning in a major project. <https://xakep.ru/2018/08/01/rts-tender/> Accessed 24 Mar 2021
8. Lee, R.S.T.: Machine learning. In: Artificial intelligence in daily life (pp. 41–70). Springer, Singapore (2020)
9. Vayolino, B.: Machine training: methods and actions. <https://www.osp.ru/cio/2018/05/13054535> (2018). Accessed 24 Mar 2021
10. Vinay, S.: Standardization in machine learning. [https://www.researchgate.net/publication/349869617\\_STANDARDIZATION\\_IN\\_MACHINE\\_LEARNING](https://www.researchgate.net/publication/349869617_STANDARDIZATION_IN_MACHINE_LEARNING) (2021). Accessed: 24 Mar 2021

# Application of Kaizen System in HR Management



A. B. Shtrikov, E. V. Zemlyanaya, and D. B. Shtrikova

**Abstract** The article is devoted to consideration of such an issue of personnel management as lean technology in personnel management. Despite a fairly large amount of literature devoted to lean manufacturing technologies, the problem of using lean manufacturing technologies in personnel management remains poorly understood. The article examines the issues of using lean manufacturing technologies in the field of personnel management on the example of using kaizen technology in EkoStroyResurs LLC in Samara. The aim of the study is to improve the electronic document management and distant interview procedure. In the process of work, the methods of SWOT-analysis, development of standard for personnel management were used. The work considered the procedure of personnel management standard, the kaizen criteria on the example of EkoStroyResurs LLC. The author also shows how and what technologies can be introduced in the HR department. The principles of kaizen within the framework of lean manufacturing would be implemented in the formation of electronic document management and distant interviews and the economic efficiency of the proposals was assessed.

**Keywords** Distant interview · Improvement · Kaizen · Loss · Standard

## 1 Introduction

The concept of “Kaizen technology” (derived from the Japanese kai - change and zen - the best) encompasses the theory and philosophy of management, and the methods that allows you to achieve competitive advantages in the market and represents a continuous improvement of the management system. The economic content of this concept is the continuous optimization of the firm’s activities. The process

---

A. B. Shtrikov (✉) · E. V. Zemlyanaya  
Samara State University of Economics, Samara, Russia

D. B. Shtrikova  
Samara State Technical University, Samara, Russia

of continuous improvement involves not only mastering new methods, but also self-organization at the grassroots levels, increasing the responsibility of staff for the results of work and accelerating the development of innovations within the firm. The methods of continuous improvement (kaizen) are the next: consumer orientation, TQC (Total Quality Control), TPM (Total Productive Maintenance), robotization, suggestion system, automation, discipline in the workplace, kanban, improving quality, right on time, zero defects, small group work, collaborative relationships between managers and workers, productivity increase, new product development.

## 2 Methodology

The project for the application of lean production technology will be carried out at EkoStroyResurs LLC. Limited Liability Company “EkoStroyResurs” is an expert in the field of general construction, waste disposal and environmental protection. The company makes a significant contribution in solving environmental problems in Samara and the Samara region, developing and improving methods for restoring the ecological well-being of the region [1]. EkoStroyResurs LLC was founded in 2013 in Samara. The strengths and weaknesses of EkoStroyResurs LLC, as well as the opportunities and threats, were identified as the result of the analysis of organization’s activities (Table 1).

**Table 1** SWOT analysis of the activities of EkoStroyResurs LLC

| Strengths  | Weaknesses  |
|--|---|
| <ol style="list-style-type: none"> <li>1. Expansion of the structure of the organization through the creation of separate subdivisions in the municipal districts of the Samara region;</li> <li>2. Training of employees on an ongoing basis;</li> <li>3. Priorities of the Company in the field of environmental safety of citizens of the Russian Federation and employees of the organization;</li> <li>4. High level of corporate events (holidays, races, blood donation)</li> </ol> | <ol style="list-style-type: none"> <li>1. The process of personnel training is not regulated;</li> <li>2. The recruitment process is not regulated;</li> <li>3. The process of personnel assessment has not been developed;</li> <li>4. The process of interaction of the personnel department with other structural divisions of the organization has not been established;</li> <li>5. There are no provisions on the departments of the Society</li> </ol> |
| Opportunities  | Threats   |
| <ol style="list-style-type: none"> <li>1. Introduction of electronic document management;</li> <li>2. Implementation of the national project (National Project “Ecology”), providing additional state financial resources for the development of the industry;</li> <li>3. Doing business in other regions of the country</li> </ol>   | <ol style="list-style-type: none"> <li>1. Changes in legislation;</li> <li>2. The emergence of organizations - competitors with more attractive conditions</li> </ol>   |

Source authors

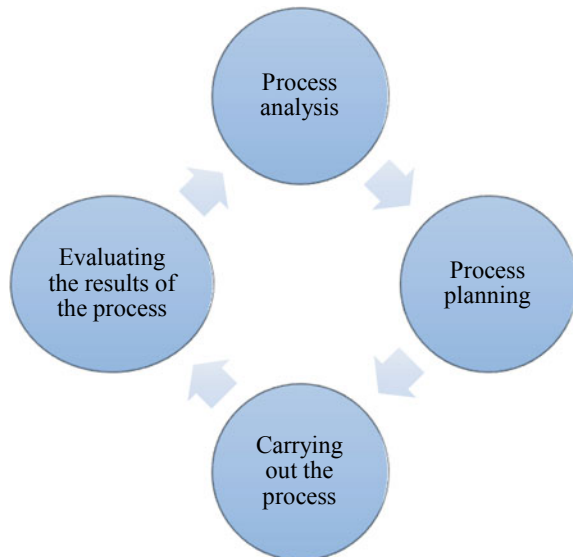
The Table 1 shows that the organization has no regulation of personnel management processes, the interaction of structural units with each other. Therefore, we can conclude that the organization suffers loss of working time due to unnecessary actions, waiting for a response from other departments, errors, since each employee has his own perception how to solve work tasks correctly, and so on.

Consequently, it is necessary to regulate personnel management processes in EkoStroyResurs LLC. It is planned to develop a standard for personnel management in accordance with the principles of quality management. The personnel management standard of EkoStroyResurs LLC will contain the following chapters:

1. Purpose of the standard and scope.
2. Normative references, definitions, symbols and abbreviations.
3. Period of validity and procedure for making changes.
4. Requirements, including responsibility and interaction with other structural divisions:
  - 4.1. Input data.
  - 4.2. Description of the process.
  - 4.3. Process output.
  - 4.4. Analysis, measurement and monitoring of the process (efficiency and effectiveness of various processes).
5. Links.
6. Mailings.

All processes reflected in the standard would follow the scheme of personnel management processes (Fig. 1).

**Fig. 1** Scheme of personnel management processes  
*Source* authors



The personnel management standard sets out all procedures for the processes, which will facilitate the activities of the personnel department by at least 20% (assumed). In order to implement the principles of kaizen, the activities, presented in Table 2, have been developed within the framework of lean manufacturing.

The personnel management standard sets out all procedures for the processes, which will facilitate the activities of the personnel department by at least 20% (assumed). The next steps are proposed to minimize losses:

1. Implementation of electronic document management (program purchased).
2. Introduction of distant recruiting, the first step is a distant interview.

**Table 2** Kaizen criteria in EkoStroyResurs LLC

| Kaizen criteria                 | Implementation of kaizen criteria in EkoStroyResurs LLC   |
|---------------------------------|---|
| Teamwork                        | <ol style="list-style-type: none"> <li>1. Amendments to the provisions on departments in the form of: for each position, register the result of the activity;</li> <li>2. Communicating the purpose of the organization, tasks of each unit (department) to all employees;</li> <li>3. Rotation of personnel;</li> <li>4. Creation of teams for design work</li> </ol>  |
| Discipline of work              | Job descriptions for each employee are used to understand the discipline of work in the organization. + Development of a standard for personnel management activities, which will include all processes in detail: selection and adaptation, training and development, motivation and incentives, and so on   |
| Required morale                 | <ol style="list-style-type: none"> <li>1. Periodic indexation of wages;</li> <li>2. Comfortable workplace;</li> <li>3. Discounts for employees (40% discount for the services of Ecostroyresurs LLC, partial payment for meals, and so on)</li> </ol>   |
| Availability of quality circles | Modern quality circles are implemented through corporate communication with a corporate website, a general chat in various messengers, meetings (events) with a specific topic for discussion   |
| Suggestions for improvement     | <ol style="list-style-type: none"> <li>1. Channel for referrals on the corporate website, the referrals would be processed;</li> <li>2. An event of the type of open dialogue with the head of the organization would be arranged once a year (six months). The head (CEO) would answer the most common questions from employees at such events</li> <li>3. Each manager must observe his employees, analyze their activities and further identify various factors influencing the activities and, offer employees to solve the problem themselves in future</li> </ol> |

Source authors

### 3 Results

The activities presented in Table 3 have been developed to implement the principles of kaizen within the framework of lean manufacturing.

Each process of document management is usually performed 8 times a month. Time savings will amount to 12.64 h per month. Taking into account the average monthly salary of a HR specialist of 30,000 rubles, the savings will amount to 2250 rubles per month or 27,000 rubles per year. Time savings for distant interviews would be 6.1 h (817.9 rubles) per month or 9814 rubles per year. The proposed measures would not require main capital expenditures. The amount of annual costs for electronic document management will be 30,000 rubles. Consequently, the annual additional income would be 36,814 rubles per year, and the economic efficiency would be 1.22. The project is cost effective and deserves to be implemented.

### 4 Discussion

Despite a fairly large amount of literature devoted to lean manufacturing technologies, the problem of using lean manufacturing technologies in personnel management remains poorly understood. Shortell, Rundall, Blodgett, note that the role of support functions such as human resources (HR), finance and information technology (IT) in lean management and the relationship of these support functions to performance are underestimated [2]. The aim of their study is to examine the relationship between HR, finance and IT functions, overall lean adoption, and self-reported performance improvement in hospitals that have adopted lean technology. Significant positive associations were found between Lean HR, finance and IT functions and self-reported performance impacts (control of organizational and market variables). Mediation tests have shown that the ratio of HR, finance and IT functions to self-reported performance is largely mediated by the number of lean units (the mediated proportion is between 40 and 73%), and the HR function becomes also mediated through self-function. HR, finance, and IT functions are positively associated with self-assessments of the impact of lean on productivity, largely due to the overall implementation of lean.

The article by Zhao, Zhao, Ślusarczyk deals with the investigation of modern possibilities and the effectiveness of the use of virtual and augmented reality technologies in the field of human resource management (HR) and the most important operational business processes of the company [3]. Based on the examples of the successful use of AR (Augmented Reality) / VR (Virtual Reality) on the job market by the largest companies in the USA, China and Europe, the main directions and forms of use of these technologies in the work of the HR department are explained to specialists were considered. In the course of the study, issues related to improving the efficiency of the main modern vectors of business development in the field of operational technological improvements were considered and, as the main outcome,

**Table 3** Indicators before and after the introduction of electronic document management and distant interview in EkoStroyResurs LLC

| KAIZEN Electronic document management  |  |                 |                |
|--|--|-----------------|----------------|
| Problem  | Estimated results  |                 |                |
| Long personnel workflow, Losses: unnecessary movement, waiting   | Indicator  | Before, minutes | After, minutes |
|  | Preparation of personnel documentation when applying for a job | 55              | 27.5           |
|  | Preparation of personnel documentation upon dismissal, min     | 60              | 30             |
|  | Issuance of certificates to employees, min                     | 15              | 7.5            |
|  | Drawing up orders for vacations and business trips, min        | 25              | 12.5           |
|  | Making changes to documents (contracts, etc.), min             | 35              | 17.5           |
|  | Saving working time by 50%                                     |                 |                |
| KAIZEN Distant interview   |  |                 |                |
| Problem  | Indicator  | Before, minutes | After, minutes |
| Traditional interviews, including competency assessment, testing, checking the tests of all candidates are labor intensive processes | Initial phone interview  | 7               | 7              |
|  | Office interview   |                 |                |
|  | 1. Being late for an interview, etc                            | 7               | 0              |
|  | 2. Explanation of the test and case                            | 6.2             | 0              |
|  | 3. Execution of the test and case                              | 36              | 0              |
|  | 4. Quick view of case answers                                  | 3.6             | 0              |
|  | 5. Interview (conversation)                                    | 36              | 36             |
|  | Total  | 95.8            | 50             |
| Total for 8 people   | 766.4 (12.7 h)   | 400 (6,6 h)     |                |

Source authors



a model for the development of a business (organization) based on the proposed business and improve business management. HR processes with VR and AR tools. It is advisable to use these technologies at all stages of human resource management, including recruiting, recruiting, demonstrating the employer's brand, testing candidates' skills, improving internal communication, creating a positive corporate culture for employees, mimicking a workflow, VR and AR -Simulations as a tool for passing entrance tests. for recruiting, selecting and managing distant employees, for training, evaluating and adapting staff. The results of the analysis of theoretical and statistical information sources showed the promise of harnessing the capabilities of virtual reality in corporate management. The resulting developments in the context of the study are of a universal nature and can be used in the investigation of modern methods of personnel management.

Research by Areiqat, Zamil, et al.-Ahlya University in Amman aims to define the rules for applying lean systems in services [4]. The results showed that Lean was most successful in service organizations that rely on key components of Lean, such as continuous improvement, problem solving, decision making, knowledge management and technology use. Together, these components can be a critical key to reducing costs, which is what just-in-time technology is all about.

The relevant literature on social lounging and the Lean Kanban model was reviewed by Chen, Cheng [5]. Then the existing procedures for maintaining the Assistive Technology Resource Center were implemented and the current situation and problems of operational management within the organization were analyzed. NPOs are encouraged to use lean management tools to reduce operational management problems caused by various situations of social inactivity. The lean thinking model was used to find out whether lean tools reduce and eliminate social idleness.

Willcocks, Lacity, Craig, present a number of dilemmas faced by senior executives considering the possible applications of robotic process automation (RPA) in human resources (HR) and global business services (GBS) [6]. Executives celebrate the successful implementation of RPA by business process service provider Xchanging, based in the back office of the London insurance market. Key decisions are required about the business reasons for RPA and cognitive automation, the type of automation to be implemented, how it can be effectively implemented in HR and GBS contexts, and whether RPA should be used tactically or strategically, and if strategically, what the implications are from that. Solutions.

In the article by Vargas, Scott, the implementation of the DMAIC system in the management of an oilfield service company, including personnel management, is described [7] DMAIC is an established continuous integration process with Lean and Six Sigma. Checkpoints at every stage of DMAIC reduce the risk of project failure, and Six Sigma data analysis techniques provide measurable, visible results that enable a company to track CI's actions toward sustainability.

Veza, Mladineo, Gjeldum carried out the analysis of global and local companies on the basis of literature research and questionnaires in order to develop the Croatian innovative intelligent business model (HR-ISE model) [8]. A selection of six basic lean tools was made and the basis for the overall configuration of the HR-ISE model was determined.

## 5 Conclusion

During the work on the article, the literature on personnel certification was analyzed. The work considered the issues of using lean manufacturing technologies in the field of personnel management on the example of using kaizen technology in EkoStroyResurs LLC in Samara. The main problems of the lean technology usage in HR management at modern enterprises are revealed. The tasks of the projects to improve the formation of electronic document management and distant interviews are indicated. The paper analyzes the actual organization of the electronic document management and distant interviews procedure, indicators of the effectiveness of these procedures for managers and specialists of EkoStroyResurs LLC. It was found that the system is imperfect in terms of lack of regulation of personnel management, interaction of structural units with each other. To solve these problems the next measures were developed: 1. Implementation of electronic document management (program purchased). 2. Introduction of distant recruiting, the first step is a distant interview. The proposed measures would not require capital expenditures. Lean management is one of the most common transformational approaches to improving production efficiency. As a result, the developed activities will serve not only to improve the organization's business processes, but also to increase the efficiency and effectiveness of personnel, increase labor involvement and loyalty to the organization.

## References

1. EkoStroyResurs: EkoStroyResurs today. <https://ecostr.ru/o-kompanii/jekostrojresurs-segodnja>. (2021). Accessed: 25 Mar 2021
2. Shortell, S.M., Rundall, T.G., Blodgett, J.C.: Assessing the relationship of the human resource, finance, and information technology functions on reported performance in hospitals using the lean management system. *Health Care Manage. Rev.* **46**(2), 145–152 (2021)
3. Zhao, H., Zhao, Q.H., Ślusarczyk, B.: Sustainability and digitalization of corporate management based on augmented/virtual reality tools usage: China and other world IT companies' experience. *Sustainability (Switzerland)* **11**(17), 4717 (2019)
4. Areiqat, A., Zamil, A.: How applying soft lean components can contribute to reducing costs in the service sector: the case of Al-Ahliyya Amman university. *Int. J. Supply Chain Manag.* **8**(5), 57–61 (2019)
5. Chen, J.C.-C., Cheng, C.-Y.: Solving social loafing phenomenon through Lean-Kanban: a case study in non-profit organization. *J. Organ. Change Manag.* **31**(5), 984–1000 (2018)
6. Willcocks, L., Lacity, M., Craig, A.: Robotic process automation: strategic transformation lever for global business services? *J. Inf. Technol. Teach Cases* **7**(1), 17–28 (2017)
7. Vargas, C.M., Scott, H.: Continuous improvement strategy to stimulate sustainability and to enhance environmental management. *SPE Econ. Manag.* **9**(2), 32–36 (2017)
8. Veza, I., Mladineo, M., Gjeldum, N.: Selection of the basic lean tools for development of Croatian model of innovative smart enterprise. *Tehnicki Vjesnik* **23**(5), 1317–1324 (2016)

# Digital Education: Pros and Cons (Instrumental and Axiological Aspects)



V. V. Mantulenko

**Abstract** The purpose of this work is to show the students' opinion of different educational formats, digitalization of the higher education. The scientific relevance of this research is determined by the forced transition to the digital training forms during the pandemic and the problems that we faced in this period. The revealed contradictions showed that the education digitalization in the reality is not the same in the state programs and reports. The new, "digital" reality requires not formal, but "life", "working" instruments of digitalization. The research was conducted in 2021 and involved 5 Russian universities (the Samara Region and the Krasnodar territory). The used research methods are survey, analysis and generalization of theoretical and survey materials.

**Keywords** Education · Digital Media · Digitalization · Higher education · Values

## 1 Introduction

The new digital conditions cause serious challenges that we already face today, and in the future, university graduates will need completely different competencies than they have got today. Is the Russian higher education system ready to give such competencies to students? A few years ago, the state turned in the direction of technical engineering education with the focus on training of specialists necessary for our economy. But do we train students today to work in the digital conditions? The transition from an analog economy type to a digital one requires new people with appropriate competencies. The problem is that the new personnel is still massively prepared for the "old" economy [1]. All the efforts of our state taken in the last 10–15 years to increase the link between the production, education and science have actually contributed to the widening of the gap between them.

The national program "Digital economy of the Russian Federation" [2], supported by the Russian President, should eliminate digital illiteracy, form a technological

---

V. V. Mantulenko (✉)  
Samara State University of Economics, Samara, Russia

reserve and start the proper training of personnel. The new economy is created inside or nearby educational institutions. The forming university ecosystems have to create new products and new markets. Cross-cutting competencies, soft skills should cover all educational levels, starting from preschool. But what is the real situation in the Russian universities: how effectively are the ambitious tasks being solved? Is the Russian higher education system ready for the rapid development and penetration of digital technologies into all spheres of life? What do students as the main participants of the educational process think about the global digitalization? How do they access the digitalization level of the educational system?

## 2 Methodology

The study was conducted in February–March 2021 among undergraduate students of 5 Russian universities in the Samara Region and Krasnodar territory, a total of 167 people took part in the survey. The purpose of the study was to identify the current state of affairs in the process of digitalization of Russian higher professional education. Our focus was on the following issues:

- what is valuable in the received education for students, and how digital technologies affect this valuable quality for them;
- how do the students themselves understand the process of digitalization, what concepts are associated with this trend in their minds;
- how do university students assess the readiness of Russian higher professional education for the effective use of digital technologies and the media competence of teachers who work with them;
- what do they see as the advantages and disadvantages of different educational formats (electronic, traditional, mixed?);
- which of these training formats is preferable for them (especially this aspect was in our focus after a long period of pandemic, isolation and remote/mixed modes of universities' operation).

The survey was conducted anonymously. The questionnaire was developed by the author independently through Google forms and included 10 questions of a closed and open nature. Participation in the survey was voluntary.

## 3 Results

The answers to the question of what concepts students associate with the term “digitalization of education” represented a whole palette of different associations from the names of specific technical means that are used in the educational process (Internet, computers, tablets), to abstract categories (modernization, convenience, accessibility, etc.) and whole phrases (“transition to a new development level”, “higher quality

level of education”, “transition of the education sector to the virtual world”, etc.). The analysis of the received responses allowed us to state that the vast majority of respondents associate digitalization with a new stage of education development based on the application of various digital technologies, instruments, resources, and tools (“step forward”, “changes”, “future”, “innovations”, “new generation”, “progress”), while the very concept of “digitalization” has a positive connotation (“comfort”, “efficiency improvement”, “acceleration”, “mobility”, “more modern teaching methods”, etc.). However, two aspects are not quite clear—“comfort” and “efficiency”. These are the undisputed leaders in terms of the benefits that digital technologies bring to the educational sphere, according to students (which will be shown in our analysis later).

However, even in the first (introductory) part of the questionnaire, there were different opinions about the comfort and effectiveness of learning in a digital environment. There are students who associate the digitalization of education not with “comfortable learning” but with “back pain”, which means, in our opinion, the need to consider the category of “comfort/convenience” of learning from the point of view of different aspects (physical and “non-physical” convenience, safety, health, ergonomics, etc.). “Efficiency” as an association with the concept of digitalization is also ambiguous and is interpreted differently by the survey participants. On the one hand, “digitization of data”, “transition to an online format”, “proper use of modern technologies”, “mobility” and “accessibility” allow creating “unified educational systems” of a new generation and talking about a new (possibly higher) quality of education, about the effectiveness of training. On the other hand, the associations of the interviewed students have some doubts about the “effectiveness” in the context of the “digitization” of higher professional education. So, in some answers, “transition to the virtual world” is associated with the global “transition of full-time education to distance learning”, while distance learning in the Russian context is traditionally associated with not quite “full-fledged” education, with the fact that it can be effective if the students themselves are highly disciplined and have developed self-learning skills. That is why the received answers also contain the associations “self-learning” and “low efficiency”.

In general, among the associations that were most often found in the responses of students, there are “computerization”, “digital technologies in learning”, “online education”, and the absolute leader is “distance / remote learning”. In our opinion, this is a very interesting aspect of understanding the essence of digitalization by the participants of the educational process themselves. Reducing digitalization at the associative level to an exclusively distance learning format, on the one hand, may be one of the effects of prolonged isolation and rapid (in most cases, “unprepared” transition to remote work), on the other hand, it may have deeper reasons and, indeed, mean a narrow understanding of this phenomenon.

When asked what format of training is the most preferable for students, the vast majority said that this is a mixed format (that is, a combination of classroom and distance learning sessions). Such training, based on offline and online communications, is chosen as the most acceptable option by 54.1% of respondents. About

36.3% prefer an exclusively distance learning format, and only 9.6% are in favor of the traditional (offline) format of studying at a university.

The next set of questions in the questionnaire was devoted to advantages and disadvantages of different learning formats from the point of view of students. Considering advantages of distance learning, the survey participants gave a fairly wide range of answers, largely reflecting the values of this generation, as well as touching on some problematic aspects of the modern system of higher professional education in our country. Among the positive aspects of distance (online) training, the absolute leaders are “economy”, “mobility”, “security” and “convenience”. These important advantages of online learning for students are revealed from the perspective of various aspects, and of course, they are closely related to each other.

In the aspect of the “economy” category, it is not only about saving time (studying remotely, students do not have to spend time on the road to the educational institution, on fees”), but also there are savings in financial terms (“no need to spend money on transport to university”, “on meals outside the home”). Time as a valuable resource was noted by many respondents. Even small (at first glance) losses of time caused, for instance, by teachers’ lateness to offline classes, loss of training time due to organizational issues (moving from one training hall to another, as a result of students’ lateness, etc.) in classroom classes were identified as disadvantages of traditional training, which the distance format allows to overcome to a significant extent (after all, in this case, time is not spent, for example, on checking attendance, since there is a protocol of the present students. There are really various opportunities to assess the involvement and activity of all students in the context of the training session by the online classes. The category of “saving” also includes concern for the environment (it becomes “optional to use paper”, for example, for a report, an abstract, as part of the work at a seminar, information can simply be displayed on the screen).

Mobility is another valuable aspect for the modern generation of students. For many young people, it is really important to be able to combine study and work, not to miss classes during business trips or internships, illness, as well as find time for self-development, hobbies. The distance learning format has an undoubted advantage, providing students with these opportunities: “the ability to do several things at the same time”, “optimize your personal time and schedule”, “the ability to catch up”: view the lesson in the recorded format if it was missed or if the material was difficult and revision is necessary, “re-living”, “the ability to access the training material from anywhere and at any time”, “the ability to take part in the training session in any case (from your phone, tablet, laptop; from a traffic jam, from work, from home, if you are ill, etc.) and it is easy to restore gaps”.

The link between “economy” and “mobility” in the formulations and justifications given by students is manifested in the fact that the additional time, financial and energy resources that students can get through online training, they are ready to spend on their personal and professional growth, their development.

“Safety” and “convenience” are two other aspects that the survey participants identify as positive effects of the digital format of educational work, and which in many ways overlap with each other. Why do students associate the distance format with

convenience and comfort, ergonomics and safety? First, we are talking about a physically comfortable environment: saving time allows you to “sleep”, “eat normally” (healthy, home-made food), “no need to go outside and get to university by the cold weather” (which means “lower risk of getting sick”) or “if you are ill and do not want to miss classes, there is no risk of infecting others”. A lot of respondents note that at home it is simply much more comfortable to study (“it is warm at home”), “the opportunity to eat unnoticed if you are hungry”, “no need to carry heavy textbooks, laptops and tablets with you, everything is “at hand”, everything can be found quickly on the Internet”, “access to a variety of online programs and resources”. Secondly, the online learning environment also becomes comfortable because it is a “familiar atmosphere”, “home atmosphere gives more confidence”, “everyone has equal conditions for perception and demonstration of the material” (compared to a traditional classroom, where the location can affect the perception of the material, for example, the student sits far away from the teacher, the blackboard, with too bright natural light and no darkening on the windows, the presentation may not be visible, etc.).

Psychological comfort is also formed due to the fact that “everyone can work at a pace that is convenient for him/her”, “less stressful”, “multi-person space”, “more convenient and prompt communication with the teacher”, “greater impartiality of the teacher”, “greater social distance”, “equal opportunities for students with special health conditions”. Safety (of the educational process) as a value, the relevance of which has become even higher during the pandemic, is interpreted by respondents not only as “the opportunity not to catch an infectious disease”, but also as a general concern for health (one’s own and others’), a more conscious attitude to health (“healthy environment”, “no risk of infection in transport, at university, catch a cold”, “psychological comfort”).

Among the disadvantages of online distance learning, respondents distinguish:

- lack of real (offline) communication with classmates and teachers, “live communication”, direct contact in the process of educational interaction (“no visual contact”, “the feeling of real student life is lost”);
- difficulties with the perception, understanding of educational material, its assimilation, application;
- possible technical problems (insufficient media equipment of the subjects of the educational process, Internet connection failures, lack of necessary software);
- the frivolous attitude of some teachers to the online learning format or the lack of media competence of teachers to work effectively in a remote format;
- a decrease in physical activity, since training sessions, preparation for them, and homework are usually done at home at the computer, as a result, there are health problems;
- “compulsion” as an antithesis of “flexibility”: the pandemic showed that teachers, frightened by the sudden remote format, forced students to turn on the cameras regardless of the type of class and the implemented educational activities, in turn, the university administration, frightened and unprepared for the new realities, forced teachers to be physically present in the classrooms of the educational

institution and conduct remote classes in parallel with colleagues from the same room, all this not only significantly hindered the implementation of the learning flexibility inherent in the new (digital) media, but also in some cases brought online learning to the point of absurdity and total demotivation of both students and teachers.

Students note that forced distance learning clearly showed them that not all academic disciplines and not all forms of academic work familiar in the traditional format can be equally effectively translated into an online format (“the complexity of group work, business games”). According to the respondents, the listed disadvantages of online learning negatively affect the quality of education, reducing the motivation of the subjects of the educational process, this is primarily due to the fact that remote forms of work require more self-organization and self-discipline than the traditional format. This is clearly noted by students (“distance begets laziness”, however, it is noted that “for those who really want to learn, receive and transfer knowledge, this is not an obstacle”).

Reflecting on the advantages of the traditional (offline) learning format, the students who took part in the survey noted the following aspects:

- direct, live communication and effective group work (“visual contact”, “socialization”, “emotions»);
- better memorization and assimilation of educational material (“it is easier to organize yourself”, “bright, lively explanation of educational material”, “the opportunity to clarify some issues individually with the teacher, *tete-a-tete*»);
- higher quality of education: better discipline (“a certain attitude when you are in the classroom, and not in your bed”, “the atmosphere of the educational institution allows you to stay focused”, “organizational clarity”), completeness of training (“there is no chance to miss a lesson through no fault of your own, but for example, because of the lack of the connection to the network”, “high-quality knowledge testing”), greater interest (“familiar, understandable and convenient format for obtaining knowledge”, “live explanation of the material”, “less distractions”).

Among the most important disadvantages of traditional training are:

- financial costs and time spent on the way to the educational institution and back;
- health risk (“early wake-up”, “nervous tension”, “stress”, “poor nutrition”, “viruses”, “adverse weather conditions”: frost, ice);
- inability to combine work and study;
- there is no such comfortable physical environment as at home;
- lots of distractions;
- uncomfortable conditions in many classrooms (“it’s cold in winter”, “it’s hard to see / hear the material from the back rows»);
- the same type of presentation of educational material, the pattern of building classes (“outdated education”);
- the inability to attend classes during illness and re-listen to lecture material.



From the answers received, the most important values for modern students are obvious: time, development, communication, quality of education, comfort, and health. However, the question about values was deliberately asked by us a little further in the survey process: “What is the most VALUABLE aspect for you in the education that you receive (received) at the university”? Here the opinion leaders are “knowledge” and “experience”, “competencies both professional and personal” (as “the foundation for further development”, “development of thinking”, “expanding horizons”, “critical thinking”, “self-realization”, “analyze information, separate the necessary from the unnecessary”), “relationships/contacts” (“social skills”, “connections”, “communication skills”, “opportunities to express themselves”), “good teachers” (“discussions with teachers”, “their experience”, “communication with highly qualified teachers”, “teachers’ passion and their ability to explain the material”). It is obvious that education itself is perceived as a value, and its quality plays a very important role for the respondents.

To what extent do digital technologies affect the quality of education that is valuable for students? The fact that there is a link between the quality of education and digital technologies is obvious for the absolute majority of young people (45.9% believe that these concepts are directly related, 39.8% see an indirect relationship here), and 14.3% believe that there is no link in this sphere.

Further, the survey participants were asked how they assess the readiness of Russian higher professional education for the effective use of digital technologies, the answers to which were as follows: almost half of the respondents (49.6%) assess the readiness of higher education for digitalization in the range of 50–70%, 28.1% of respondents are more optimistic about digital prospects (70–90%), 17.8% of students believe that Russian education is less than 50% ready for the effective use of ICT, and only 4.4% believe that in this context the level of 90–100% has been reached.

And the final question of the questionnaire concerned the assessment of the media competence of teachers (knowledge of modern digital technologies, the ability to work with them, including effectively solving professional tasks). Here, 17% rate the readiness of teachers to effectively use digital technologies as “high”, 28.9% - “slightly above average”, and 45.9%—as “average”.

## 4 Discussion

Many teachers are still confident that digitalization is nothing more than another “fashionable topic” that will pass, while the “eternal values” of education as the most stable public institution will remain the same. But the modern education system emerged and developed under the influence of changes in society caused by the previous industrial revolutions [3]. Therefore, it is not surprising that the coming fourth industrial revolution (Industry 4.0) will leave an indelible mark on the history of education too. Moreover, the speed of changes will be even higher.

In relation to Russia, the HSE experts identify seven tasks that the state and society should solve on the path of the education digitalization (they have to be solved simultaneously and in a coordinated manner):

- development of material infrastructure;
- implementation of digital programs;
- development of online learning;
- development of new learning management systems;
- development of the system of universal identification of the student;
- improvement of the teachers' skills in the field of digital technologies.

Obviously, the education will no longer be the same in the era of the global digitalization. More and more digital tools are applied to solve educational tasks, which is not always reasonable and efficient. Like the economic paradigm, the educational paradigm is changing too. In this context, the educational process becomes more flexible, on the one hand. On the other hand, we risk losing valuable aspects from the old, "analog" paradigm in a blind race for digital innovations [4]. We really have a new generation of students nowadays, they "digitally born" and are not always ready to perceive information in the traditional (for our educational system) form. They are able to get a huge volume of information, but it should really correspond to their values, needs, principles, requests etc. [5].

One of the key aspects of the programs and strategies that are implemented at the state level today is the rejection of a large number of "unnecessary", "obsolete" elements that hinder to flexibly create an individual educational path for students, individual development trajectories. A good example is the recognition of the demonstration exam "WorldSkills" at the state level as a final certification for starting a working career. This example shows that for the first time in our history, asynchronous education has been legalized (although, there are still a lot of contradictory aspects related to the asynchrony in the new education paradigm). However, the real process of implementing reasonable tasks in practice often leads to the loss of value components of the educational process, both the old and the new paradigms. Behind the undoubted prospects of digital transformation of education, some contemporary scientists note a number of concerns: the dehumanization of educational relations, the crisis of the human intellectual culture, the growth of individualism and pragmatism based on the values of personal comfort and selfish consumption [6].

## 5 Conclusion

The results of our study show a look at the problem of the Russian education digitalization "from the inside", through the eyes of students who have experienced a forced (due to the isolation during the pandemic), and in some cases unprepared transition to a distance learning format. This fact allows them to compare different forms of training, to see advantages and disadvantages in each of them. These reflections reveal the values of the modern generation, their attitude to education in general, to

active attempts to digitize it. The students' responses in the survey in some cases contradict each other, for example, digital technologies and remote forms of training, in the opinion of some respondents, reduce the quality of education, in the opinion of others, on the contrary, increase the quality of educational services. However, a more detailed analysis of the responses allows us to understand that behind the general attitude to digitalization, there is always an individual experience, a set of both positive and negative experiences, the own individual value system. It is probably for this reason that the most students prefer a mixed learning format that involves a reasonable and effective combination of traditional and digital forms of learning. Another question is that we need to be able to organize this "mixed" educational space so that it really contributes to the solution of the ambitious tasks that we face today, and does not serve as a formal solution. It should be a "working" story, a "live" space, an effective instrument. And this requires further serious work to address the existing contradictions and shortcomings of the digital version of our education today.

## References

1. Mantulenko, V.V., Zotova, A.S., Makhovikov, A.E.: Digital transformation of the labor market: values and competences. In: Ashmarina S.I., Mantulenko V.V. (eds.), *Digital Economy and the New Labor Market: Jobs, Competences and Innovative HR Technologies*. IPM 2020. Lecture Notes in Networks and Systems, vol. **161** (pp. 321–328). Springer, Cham (2021)
2. National program "Digital economy of the Russian Federation". <http://government.ru/rugovclassifier/614/events/>. (2021). Accessed 16 June 2021
3. RBK: Seven challenges of digitalization of Russian Education. <https://trends.rbc.ru/trends/education/5d9ccba49a7947d5591e93ee>. (2020). Accessed 16 June 2021
4. Mantulenko, V.V., Goryachev, M.D.: Digital media in higher education: Disruptive or sustaining innovation? In: S.I. Ashmarina, J. Horák, J. Vrbka, P. Šuleř (Eds.), *Economic Systems in the New Era: Stable Systems in an Unstable World*. IES 2020. Lecture Notes in Networks and Systems, **160** (pp. 219–225). Springer, Cham (2021)
5. Accreditation in Education: Education in the digital age. [https://akvobr.ru/cifrovizaciya\\_obrazovaniya\\_v\\_rossii\\_i\\_mire.html](https://akvobr.ru/cifrovizaciya_obrazovaniya_v_rossii_i_mire.html). Accessed 16 June 2021
6. Stokov, A.A.: Digitalization of education: Problems and prospects. *Bull. Minin Univ.* **8**(2(31)), 15 (2020)