

Power and Energy Flow in Cvasi-Stationary Electric and Magnetic Circuits



Horia Andrei, Mihai Iordache, Paul Cristian Andrei, Marilena Stanculescu,
Sorin Deleanu, and Lavinia Bobaru

Abstract Answering the question “what is the state in which conservative systems consume less power or energy?” is fundamental. Therefore, multitudinous works were dedicated to formulate the cvasi-stationary state of many domains such as physical sciences (mechanics, thermodynamics, electromagnetic), chemistry, life science (hydrology, meteorology, global climate) in power or energy terms. Based on the variational principles in this chapter specific functionals expressed in terms of power or energy for electric respectively magnetic circuits in cvasi-stationary state are defined. The matrix equations of electro-magnetic circuits formulated in terms of electric and magnetic potentials of nodes were used to calculate the power and energy functionals. Further used advanced numerical methods the existence of functional’s minimum were demonstrated and by imposing the minimization conditions are obtained the first Kirchhoff’s law for electric currents respectively magnetic flux. Several examples prove the theoretically and practically importance of the principles of minimum consumed power and energy mainly for understanding of the power and energy flow in electromagnetic systems.

H. Andrei (✉)

Department of Doctoral School, University Valahia, Targoviste, Romania
e-mail: hr_andrei@yahoo.com

M. Iordache · P. C. Andrei · M. Stanculescu · L. Bobaru
Department of Electrical Engineering, University Politehnica, Bucharest, Romania
e-mail: mihai.iordache@upb.ro

P. C. Andrei
e-mail: paul.andrei@upb.ro

M. Stanculescu
e-mail: marilena.stanculescu@upb.ro

L. Bobaru
e-mail: lavinia.bobaru@upb.ro

S. Deleanu
SAST Northern Alberta Institute of Technology, Edmonton, Canada
e-mail: sorind@nait.ca

Keywords Variational principles · Functionals · Quasi-stationary state · Electric and magnetic circuits · Active and reactive power · Principles of minimum consumed power and energy

Nomenclature

A. Acronyms

<i>DOF</i>	Degrees of Freedom
<i>KCL</i>	Kirchhoff Current Law
<i>KVL</i>	Kirchhoff Voltage Law
<i>DC</i>	Direct Current
<i>AC</i>	Alternating Current
<i>NM</i>	Nodal Method
<i>PMP</i>	Principle of Minimum Consumed Power
<i>RLC</i>	Resistor Inductance Capacitance
<i>PMARP</i>	Principle of Minimum Active and Reactive Power
<i>ECAP</i>	Electric Circuit Analysis Program
<i>KMVL</i>	Kirchhoff's Magnetic Voltage Law
<i>KMFL</i>	Kirchhoff Magnetic Flux Law
<i>PMEM</i>	Principle of Minimum Consumed Energy for Magnetic Circuits

B. Symbols/Parameters

$p_J(\mathbf{r}, t)$	The volume density of the instantaneous electromagnetic power
E	The vector of electric field strength
J	The vector of electric conduction current density
dW_{em}	The variation of the electromagnetic field energy
$P_{\delta\Omega} dt$	The energy transferred through the domain boundary
dt	The time interval
W_m	The magnetic energy
W_e	The electric energy
D	The vector of electric flux density
B	The vector of magnetic flux density
ε	The absolute permittivity of the medium
μ	The absolute permeability of the medium
S	The Poynting vector
A	The magnetic potential vector
σ	The conductivity of conductors
Φ	The magnetic flux
\Re	The real set
H	The Hessian matrix

C^1	The continuous functions of class one
$\Delta \mathbf{v}$	The vector of branch voltages
\mathbf{i}	The vector of branch currents
\mathbf{u}	The vector of voltages at the branch resistances terminals
\mathbf{e}	The vector of voltage sources
V_i	The potential of node i
\mathbf{V}	The reduced vector of the nodes potentials
\mathbf{C}	The reduced branch-to-node incidence matrix
\mathbf{G}	The branch conductance diagonal matrix
$\mathfrak{S}(\mathbf{V})$	The power functional
P_{cons}	The power consumed by all the resistances
2-D	Two-dimensionales
ΔV_k	The k -branch complex voltage
\mathbf{Y}	The diagonal admittance matrix
G_k	The conductance of k -branch
B_k	The susceptance of k -branch functionals
\mathfrak{S}_P	The active power functional
\mathfrak{S}_Q	The reactive power functional
\underline{S}	The complex power
\underline{V}_i	The complex potential of node i
Φ	The fascicular flux through circuit branch
R_m	The reluctance of the magnetic circuit branch
l	The length of magnetic material
A	The cross section area of magnetic material
Λ	The permeance
θ	The magnetomotive force
\mathbf{V}_m	The vector of the magnetic potential of circuit nodes
dim	The dimension of matrix or vector
Λ	The branch permeance diagonal matrix
$\mathfrak{S}(\mathbf{V}_m)$	The magnetic energy functional
W_m	The consumed magnetic energy
n_R	The number of resistances
N	The number of nodes
K	The number of branches
$P_R(I)$	The power-current characteristic
$\underline{E}_1; R_1, R_2; C_2; L_3; \omega$	The number and values of AC circuit parameters (complex voltage source, resistances, capacitance, inductance, angular velocity)
M	The number of turns
δ	The air-gap of magnetic circuit

1 Introduction

For many conservative systems as in thermodynamics, mechanics, hydrology, meteorology, electromagnetics is used the variational principle to formulate their quasi-stationary state or equilibrium regime in energy and power parameters [1–3]. In this respect specific power and energy functionals are defined and numerical methods are used to find their extremum points.

For example in the classical mechanics two categories of principle are employed: differential principles and variational (integral) principles [4]. First one as well as d'Alembert and Gauss principles inspect the mechanical parameters at a given time, whilst the variational principle like Maupertuis and Hamilton principles examine the mechanical parameters within a finite time interval and space in order to determine the parameters values that achieve particular integrals stationary.

In the classical thermodynamics specific thermodynamic potential are defined in order to analyze the equilibrium state and to measure the properties of materials [5, 6]. Pressure, temperature, volume and entropy are the thermodynamic parameters that can be studied using the thermodynamic potentials. If the entropy and volume of a closed system are kept constant, then the internal energy decreases to its minimum value at steady-state. Such being the case the second principle of thermodynamics is defined as the minimum energy principle.

In the case of intricate Earth system processes as hydrology, meteorology, global climate, the principles of minimum and maximum entropy production have been formulated to analyze the planetary energy balance [7, 8]. For linear system with permanent boundary conditions and which has several degrees of freedom (DOF) the minimum entropy principle is applied, to analyze the cases in which the disturbances of the system are far from its equilibrium state. Instead for non-linear systems with several degrees of freedom the maximum entropy principle is applied. In this case, many steady states can take place, and it is feasible to choose one of the steady state with maximum entropy production.

In the electromagnetic theory, if it is consider a domain Ω where exists electromagnetic field its energy can be turn into mechanical work, heat or other forms of energy. This energy is, on the one hand, transformed into other forms of energy, and the rest can leave the domain through its boundary. The energy conversion from the electromagnetic form in other forms of energy and vice versa is established at every point in domain by the conduction process law [9, 10]:

$$p_J = \mathbf{E} \cdot \mathbf{J} \quad (1)$$

where $p_J(r,t)$ represents the volume density of the instantaneous electromagnetic power a scalar function of position and time, \mathbf{E} and \mathbf{J} are the vector of electric field strength respectively of electric conduction current density. In the domain Ω the following equality between energies is true:

$$\int_{\Omega} \mathbf{E} \cdot \mathbf{J} dv dt + dW_{em} + P_{\partial\Omega} dt = 0 \quad (2)$$

where dW_{em} is the variation of the electromagnetic field energy, and $P_{\partial\Omega} dt$ is the energy transferred through the domain boundary. In the time interval dt , relation (2) yields:

$$- \int_{\Omega} \mathbf{E} \cdot \mathbf{J} dv = \frac{dW_{em}}{dt} + P_{\partial\Omega} \quad (3)$$

The theorem of electromagnetic energy based on Maxwell's equations and relation (3) demonstrates the following relations [11]:

$$W_{em} = \int_{\Omega} \frac{\mathbf{D}^2}{2\varepsilon} dv + \int_{\Omega} \frac{\mathbf{B}^2}{2\mu} dv = W_e + W_m \quad (4)$$

$$W_e = \int_{\Omega} \frac{\mathbf{D}^2}{2\varepsilon} dv = \int_{\Omega} \frac{\mathbf{D}\mathbf{E}}{2} dv = \int_{\Omega} \frac{\varepsilon\mathbf{E}^2}{2} dv \quad (5)$$

$$W_m = \int_{\Omega} \frac{\mathbf{B}^2}{2\mu} dv = \int_{\Omega} \frac{\mathbf{B}\mathbf{H}}{2\mu} dv = \int_{\Omega} \frac{\mu\mathbf{H}^2}{2} dv \quad (6)$$

where W_m and W_e represents the magnetic respectively electric energy as component of the electromagnetic field energy, \mathbf{D} and \mathbf{B} represents the vectors of electric respectively magnetic flux density, ε and μ represents the absolute permittivity respectively permeability of the medium. Another conclusion of the above mentioned theorem states that the electromagnetic power transferred to the surroundings through domain boundary is given by:

$$P_{\partial\Omega} = \oint_{\Omega} (\mathbf{E} \times \mathbf{H})_n dS = \oint_{\Omega} \mathbf{S}_n dS \quad (7)$$

where the vector $\mathbf{S} = \mathbf{E} \times \mathbf{H}$ is named the Poynting vector.

In previous works, the authors have chosen the potentials of nodes as variables whereas utilizing the matrix equation of the circuits. Further by imposing the minimization conditions of the power functionals is obtained the Kirchhoff Current Law (KCL).

In the second section, advanced numerical analysis is proposed to find the extreme point of power or energy functionals for electric and magnetic circuits in the quasi-stationary state. Lagrange multipliers and the variational method in Hilbert space have demonstrated the existence of the minimum of the functionals. The third section of

this chapter discusses the power flow in equilibrium conditions when the DC and AC circuit consumes minimum power, considering all classical powers (active and reactive).

Several examples implemented in PSPICE prove the theoretical principles of minimum consumed power statute in the previous section. It also shows that the transient regime of an electric circuit represents its passage between two quasi-stationary states with minimum power consumption and the co-existence of the fundamental theorem of maximum power transfer and the principles of minimum consumed power.

Based on the equivalence between the linear magnetic and electric networks, in section four, the minimum principle of consumed energy for magnetic circuits in the cvasi-stationary state is presented. Several examples prove the theoretical principle formulates by authors and put in evidence the applicability of this principle to the calculation of the energy and forces in electromagnetic types of equipment.

In conclusion, theoretically it can be stated that the proposed principles together with the Kirchhoff Voltage Law (KVL) determine an equivalent equations system to the classical one consisting of the KCL and KVL equations for DC and AC circuits. An analogous statement can also be concluded for the magnetic circuits in the cvasi-stationary state. On the other hand, from a practical point of view, the principles of minimum consumed power are very useful for the understanding of the power and energy flow in electromagnetic systems.

The chapter ends with a broad up-to-date list of references.

2 Advanced Numerical Analysis Applied to Determination of Power and Energy Functionals Extreme

2.1 Variational Method

In the classical analysis of electromagnetic field the variational equivalent formulation in the Hilbert space is used. Starting from a differential mathematical model the variational method establish a set of differential equations of the model complying with the cvasi-stationary conditions as indicated in Chap. 1 of Part I of this book.

Generally speaking the functional associated of the phenomenon depict by the scalar parameter $V(x, y, z)$ is defined as [12]

$$\mathfrak{S} = \iiint_{\Omega} f\left(x, y, z, V, \frac{\partial V}{\partial x}, \frac{\partial V}{\partial y}, \frac{\partial V}{\partial z}\right) dx dy dz + \iint_{\Sigma} g(x, y, z) dS \quad (8)$$

where f is a function specified by the know differential model of the phenomenon, $\partial V/\partial x$, $\partial V/\partial y$ and $\partial V/\partial z$ are the partial derivatives of the state quantity and g is a determined function on the boundary Σ of the domain Ω . The main idea of the

variational method associated to a phenomenon take into consideration the minimization of the expression (7) admitting that the differential equations of the model are verifying by the state parameters and its limit conditions.

For example in case of one-dimensional problem (1-D), the state parameter V depends only one coordinate, is defined in the domain $[x_1, x_2]$ and satisfies the limit conditions $V(x_1) = V_1, V(x_2) = V_2$, and the second integral of the relation (8) doesn't exist, then the functional associated of the phenomenon is expressed as:

$$\mathfrak{S} = \int_{\Omega} f(x, V, \frac{dV}{dx})dx \tag{9}$$

If it is consider $\tilde{V}(x)$ the approximate solution and is noted with $\delta V(x)$ the infinitesimal variation of the exact solution $\delta V(x)$ then the relation is true:

$$\tilde{V}(x) = V(x) + \delta V(x) \tag{10}$$

By imposed the stationarity condition and the minimum value of the functional (9) it is obtained for the functional variation $\delta \mathfrak{S}$ the relation:

$$\begin{aligned} \delta \mathfrak{S} &= \int_{x_1}^{x_2} \delta f \cdot dx = \int_{x_1}^{x_2} \left(\frac{\partial f}{\partial x} \delta x + \frac{\partial f}{\partial V} \delta V + \frac{\partial f}{\partial V'} \delta V' \right) dx \\ &= \int_{x_1}^{x_2} \left(\frac{\partial f}{\partial V} \delta V + \frac{\partial f}{\partial V'} \delta V' \right) dx = 0 \end{aligned} \tag{11}$$

where $V' = \frac{dV}{dx}$ represents the derivative of V . Due to for the variation δf for a given value of the variable x in relation (10) is $\delta x = 0$, and then by using the parts integrating the last term of relation (11), results:

$$\begin{aligned} \int_{x_1}^{x_2} \frac{\partial f}{\partial V'} \delta V' dx &= \int_{x_1}^{x_2} \frac{\partial f}{\partial V'} \delta \left(\frac{dV}{dx} \right) dx = \int_{x_1}^{x_2} \frac{\partial f}{\partial V'} \frac{d}{dx} (\delta V) dx = \left[\frac{\partial f}{\partial V'} \delta V \right]_{x_1}^{x_2} \\ &\quad - \int_{x_1}^{x_2} \frac{d}{dx} \left(\frac{\partial f}{\partial V'} \right) dx \end{aligned} \tag{12}$$

The expression (11) becomes:

$$\delta \mathfrak{S} = \int_{x_1}^{x_2} \left[\frac{\partial f}{\partial V} - \frac{d}{dx} \left(\frac{\partial f}{\partial V'} \right) \right] \delta V dx + \left[\frac{\partial f}{\partial V'} \delta V \right]_{x_1}^{x_2} = 0 \tag{13}$$

Considering the variation δV as an arbitrary one, than each term of relation (13) must be null, so:

$$\frac{\partial f}{\partial V} - \frac{d}{dx} \left(\frac{\partial f}{\partial V'} \right) = 0 \tag{14}$$

and

$$\left[\frac{\partial f}{\partial V'} \delta V \right]_{x_1}^{x_2} = 0 \tag{15}$$

If the values of the state parameter $V(x)$ at the two limits x_1 and x_2 of the domain are defined or, in other words, the Dirichlet conditions (forced limit conditions) are accomplished i.e.

$$\delta V(x_1) = 0 \text{ and } \delta V(x_2) = 0 \tag{16}$$

and then relation (15) is fulfilled. Otherwise in case of the state parameter doesn't satisfy Dirichlet forced limit conditions, then the following condition, named natural limit conditions, must be satisfied [13]:

$$\left[\frac{\partial f}{\partial V'} \right]_{x_1} = \left[\frac{\partial f}{\partial V'} \right]_{x_2} = 0 \tag{17}$$

The relation (15) is achieved also in the case in which the differential model implies at the two limits different conditions, namely at one natural limit condition and at the other one forced limit condition.

In the classical theory of the electromagnetic field the following functional of associated to the domain Ω and the volume bounded is defined as:

$$\mathfrak{S} = \int_{\Omega} \left[\left(\int_0^E \mathbf{D} \cdot \mathbf{E} - \int_0^B \mathbf{H} \cdot \mathbf{B} \right) + (\mathbf{J} \cdot \mathbf{A} - \rho_v V) \right] dx dy dz \tag{18}$$

where \mathbf{A} is the magnetic potential vector $\nabla \times \mathbf{A} = \mathbf{B}$ and V is the electric potential $\mathbf{E} = -\nabla V$. The minimization of the functional (18) implies the Maxwell's equations of the electromagnetic field, the physical properties of media, and the uniqueness conditions of the solution.

Thus the functional associated of the one-dimensional (1-D) electrostatic field is defined as:

$$\mathfrak{S}(V) = \int_{\Omega} \frac{\varepsilon}{2} \left[\left(\frac{\partial V}{\partial x} \right)^2 - \rho_v V \right] dx \tag{19}$$

The cvasi-stationary electric field the associated functional is defined as

$$\mathfrak{S}(V) = \int_{\Omega} \frac{\sigma}{2} \left[\left(\frac{\partial V}{\partial x} \right)^2 \right] dx \quad (20)$$

and the particular set of Maxwell 's equations available for linear, isotropic and homogenous media is

$$\nabla \times \mathbf{E} = 0 \quad (21)$$

$$\nabla \cdot \mathbf{J} = 0 \quad (22)$$

$$\mathbf{J} = \sigma \mathbf{E} \quad (23)$$

where σ is the conductivity of the conductors.

The cvasi-stationary magnetic field is governed by the particular set of Maxwell's equations

$$\nabla \times \mathbf{H} = \mathbf{J} \quad (24)$$

$$\nabla \cdot \mathbf{B} = 0 \quad (25)$$

$$\mathbf{B} = \mu \mathbf{H} \quad (26)$$

and is admit the associated functional

$$\mathfrak{S}(\Phi) = \int_{\Omega} \frac{\mu}{2} \left[\left(\frac{\partial \Phi}{\partial x} \right)^2 \right] dx \quad (27)$$

where Φ is the magnetic flux.

The functionals defined above (19), and (20), respectively (27) represent the power functionals for linear electric circuits, respectively energetic functional for linear magnetic circuits in cvasi-stationary state. In all these variational methods the electric and magnetic potentials of nodes are considered as variables in the algorithm of functionals minimization as will be further described in the following sections.

2.2 Lagrange's Method

Also the Lagrange method could be used in order to find the minimum or maximum of the function that defines the electric power and magnetic energy viewed from the perspective of an "objective-function" [14, 15]. If it is considered the objective-function

$$f(x, y) : U \rightarrow \mathfrak{R}, U \subset \mathfrak{R}^{2n} \quad (27)$$

of class C^1 and if it is assume that, between the scalars $x = (x_1, x_2, \dots, x_n)$, and $y = (y_1, y_2, \dots, y_n)$, exist m links

$$g_1(x, y) = 0, \dots, g_m(x, y) = 0, g_i : U \rightarrow \mathfrak{R}, 1 \leq i \leq m \quad (28)$$

then in order to compute the minimum or maximum points $M(x_0, y_0)$ of function f the numerical method of Lagrange multipliers can be applied. Thereby the following function is defined

$$F = f(x, y) + \sum_{i=1}^m \lambda_i g_i(x, y) \quad (29)$$

where $\lambda_1, \lambda_2, \dots, \lambda_m$ are introduced as the Lagrange multipliers. In these conditions the extreme points $M(x_0, y_0)$ of function f represent the solutions of the non-linear system

$$\frac{\partial F}{\partial x_j} = 0, \frac{\partial F}{\partial y_k} = 0, g_i = 0, 1 \leq j, k \leq n, 1 \leq i \leq m \quad (30)$$

where the total number of unknown x, y, λ is $2n + m$. The sign of the square value (second order derivative) $d^2 f|_M$ decides the maximum or minimum nature of the extreme points $M(x_0, y_0)$. Practically a numerical procedure of the eigenvalues computation of f associate Hessian matrix i.e.

$$H = \left[\frac{\partial^2 f}{\partial x_j \partial y_k} (x_0, y_0) \right]_{1 \leq j, k \leq n} \quad (31)$$

yield information about the sign of square values: if the all the eigenvalues of Hessian matrix are positive or negative then the square value is positively or negatively defined, and implicitly the function f has a minimum or maximum at the

point $M(x_o, y_o)$. Because the matrix H is symmetrical, thus is has only real eigenvalues, consequently a critical point $M(x_o, y_o)$ it can't be a local extreme point for function f .

Let us examine a DC circuit (stationary state), with N nodes and L branches. For n_R variables (resistances), the consumed power (the objective function) $f(R, I) : \Re^{2n_R} \rightarrow \Re^+$, is defined as

$$f(R, I) = \sum_{i=1}^{n_R} R_i I_i^2 \tag{32}$$

where the resistances and the currents of branches $R = (R_1, R_2, \dots, R_{n_R}), I = (I_1, I_2, \dots, I_{n_R})$ are scalars and verify L Kirchhoff's current and voltage complete set of relations (links)

$$\begin{aligned} g_1 &= \sum_{l_k \in N_1} I_k = 0, \dots, g_{N-1} = \sum_{l_k \in N_{N-1}} I_k = 0, \dots, \\ g_N &= \sum_{l_k \in B_1} R_k I_k - E_k = 0, \dots, g_L = \sum_{l_k \in B_{L-N+1}} R_k I_k - E_k = 0 \end{aligned} \tag{33}$$

There $g_j : \Re^{2n_R} \rightarrow \Re, j = 1, \dots, L$, and $B_{L-N+1} = L - N + 1$ are the independent loops of the circuit. In these assumptions it defines the function

$$F = f(R, I) + \sum_{j=1}^L \lambda_j g_j(R, I) = \sum_{i=1}^{n_R} R_i I_i^2 + \sum_{j=1}^L \lambda_j g_j(R, I) \tag{34}$$

where $\lambda_1, \lambda_2, \dots, \lambda_L$ are the unknown Lagrange's multipliers. The unique solution of the nonlinear system with $2n_R + L$ unknown

$$\frac{\partial F}{\partial R_i} = 0, \frac{\partial F}{\partial I_i} = 0, g_j = 0, i = 1, \dots, n_R; j = 1, \dots, L \tag{35}$$

coincides with an extreme point $M(x_o, y_o)$ of consumed power function (32) if the eigenvalues of the Hessian matrix are, in this point, real values and the same sign. If the sign is positively f has a maximum, otherwise the function f has a minimum.

This numerical procedure to determine the extreme point of function f is rather difficult because requires a lot of computing time and occupies a large memory space. This statement is explained by the fact that the method needs to calculate the m differentials of links relations, to solve a large nonlinear system, and to determine the square value of function f .

3 Equilibrium State of DC and AC Circuits and Minimum Power Flow. Examples

In classical theory of electric circuits of “content and co-content”, the Hilbert space properties for solving the electromagnetic field and the theorem of the minimum power in the resistances for DC circuits are introduced [16–19].

Hereinafter the natural connection between the equilibrium state of DC and AC circuits and the minimum power flow is demonstrated in terms of appropriate power functionals defined for each category of circuit and the variational method is applied to examine the extreme point of functionals.

3.1 Principle of Minimum Consumed Power for DC Circuits and Variational Method

For a linear DC circuit that comprises N nodes and K branches, with general structure shown in Fig. 1, the K -dimensional vectors in \Re^K of branch voltages $\Delta \mathbf{v}$ and currents \mathbf{i} , the voltages at the resistances terminals \mathbf{u} , and respectively the voltage sources \mathbf{e} are defined as [20, 21].

$$\Delta \mathbf{v} = \begin{bmatrix} \Delta V_1 \\ \Delta V_2 \\ \cdot \\ \cdot \\ \Delta V_K \end{bmatrix}; \mathbf{i} = \begin{bmatrix} I_1 \\ I_2 \\ \cdot \\ \cdot \\ I_K \end{bmatrix}; \mathbf{u} = \begin{bmatrix} U_1 \\ U_2 \\ \cdot \\ \cdot \\ U_K \end{bmatrix}; \mathbf{e} = \begin{bmatrix} E_1 \\ E_2 \\ \cdot \\ \cdot \\ E_K \end{bmatrix} \tag{36}$$

The matrix relation

$$\Delta \mathbf{v} = \mathbf{C} \cdot \mathbf{V} \tag{37}$$

Fig. 1 General structure of a DC circuit branch

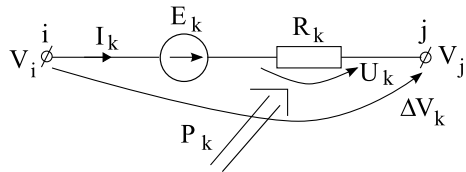

represents for k -branch the relation $\Delta V_k = V_i - V_j$, where V_i and V_j are the potentials of nodes i and j where the branch k is connected, $\mathbf{V} = \begin{bmatrix} V_1 \\ V_2 \\ \vdots \\ V_{N-1} \end{bmatrix}$ is the reduced $N-1$, vector of the nodes' potential (there an arbitrary node is chosen with zero potential $V_N = 0$), and $\mathbf{C} = [c_{l,n}]$ is the reduced $K \times (N-1)$ branch-to-node incidence matrix. According to KVL it is obtain

$$\mathbf{i} = \mathbf{G}\mathbf{u} = \mathbf{G}(\Delta \mathbf{v} + \mathbf{e}) = \mathbf{G}(\mathbf{C}\mathbf{V} + \mathbf{e}) \tag{38}$$

where $\mathbf{G} = \text{diag}(G_1, G_2, \dots, G_K)$ is the branch conductance $K \times K$ - dimensional diagonal matrix. In the Hilbert space the power functional $\mathfrak{S}(\mathbf{V}) : \Re^{N-1} \rightarrow \Re$ is defined, by considering as variables $N-1$ potentials of nodes, as

$$\mathfrak{S}(\mathbf{V}) = \mathbf{u}^T \mathbf{i} = P_{cons} \tag{39}$$

where the superindex T indicates the transposition. As is presented in Fig. 1 the same reference sense of the branch current and voltage the power functional (39) is equivalent with the definition of power consumed (P_{cons}) by all the resistances of the DC circuit. Taking into account relations (37) and (38) the power functional (39) can be expressed as

$$\begin{aligned} \mathfrak{S}(\mathbf{V}) &= \mathbf{u}^T \mathbf{i} = (\Delta \mathbf{v} + \mathbf{e})^T \mathbf{G}(\Delta \mathbf{v} + \mathbf{e}) = (\mathbf{C}\mathbf{V} + \mathbf{e})^T \mathbf{G}(\mathbf{C}\mathbf{V} + \mathbf{e}) \\ &= \sum_{\substack{k=1, K \\ i, j=1, N-1 \\ i \neq j}} G_k (V_{k,i} - V_{k,j} + E_k)^2 \end{aligned} \tag{40}$$

From relation (40) results that always power functional is a quadratic form i.e. $\mathfrak{S}(\mathbf{V}) \geq 0$ and, consequently in the interval $(0, \infty)$, $\mathfrak{S}(\mathbf{V})$ has a minimum. Afterwards this minimum point corresponds to the solution of the system $\partial \mathfrak{S} / \partial \mathbf{V} = 0$. The first power functional derivative dependent on potential V_i can be written as

$$\frac{\partial \mathfrak{S}}{\partial V_i} = \frac{\partial}{\partial V_i} (\mathbf{C}\mathbf{V} + \mathbf{e})^T \mathbf{G}(\mathbf{C}\mathbf{V} + \mathbf{e}) = 2 \sum_{l_k \in n_i} c_{l_k, n_i} G_k (V_i - V_j + E_k) = 0 \tag{41}$$

where $k = 1, \dots, K, i, j = 1, \dots, N-1, i \neq j$. The last equality in relation (41) represents even the formula of the nodal method (NM) expressed in node n_i

Fig. 2 DC circuit with three branches and two nodes

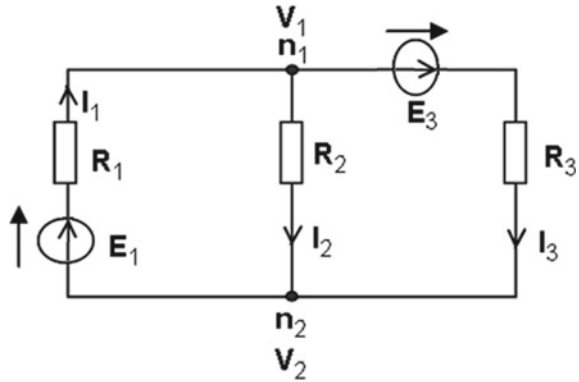

$$\sum_{l_k \in n_i} c_{l_k, n_i} G_k (V_i - V_j + E_k) = 0 \tag{42}$$

and, by using (38), we'll get

$$\sum_{l_k \in n_i} c_{l_k, n_i} I_k = 0, i = 1, \dots, N - 1 \tag{43}$$

that means even KCL for $N-1$ nodes of the circuit.

As a conclusion of the functional defined by (39) and from results obtained in (42) and (43) the Principle of Minimum Consumed Power for DC Circuits (PMP) can be stated in two equivalent forms: “In resistive DC circuits the condition of minimum consumed power in the resistances is consistent with the NM and KCL” or “In resistive DC circuit the branch currents and voltages have unique values such that the consumed power in all the resistances of the circuit is minimum” [22].

Example 1 For the DC circuit presented in Fig. 2, with $K = 3$, and $N = 2$, the structure is defined by the values $R_1 = 10 \Omega$, $R_2 = 20 \Omega$, $R_3 = 50 \Omega$, $E_1 = 40 \text{ V}$ and $E_3 = 20 \text{ V}$. The vectors of currents and voltages at the resistance terminals expressed in dependence with the potentials V_1 and V_2 of the nodes are written as.

$$\mathbf{i} = \begin{bmatrix} I_1 \\ I_2 \\ I_3 \end{bmatrix}; \mathbf{u} = \begin{bmatrix} V_2 - V_1 + E_1 \\ V_1 - V_2 \\ V_1 - V_2 + E_1 \end{bmatrix}; \mathbf{v} = \begin{bmatrix} V_1 \\ V_2 \end{bmatrix}. \text{ For this DC circuit the}$$

branch-to-node incidence matrix is $\mathbf{C} = \begin{bmatrix} -1 & 1 & 1 \\ 1 & -1 & -1 \end{bmatrix}$ and the power functional

(power consumed by resistances) constructed according to (40), is $\mathfrak{S}(V_1, V_2) = P_{\text{cons}}(V_1, V_2) = G_1(V_2 - V_1 + E_1)^2 + G_2(V_1 - V_2)^2 + G_3(V_1 - V_2 - E_3)^2$. By imposed the minimum of power functional results $\frac{\partial \mathfrak{S}}{\partial \mathbf{v}} = \mathbf{C} \mathbf{i} = 0$ and thus imply KCL at each node n_1 and n_2 :

$$\frac{\partial \mathfrak{S}}{\partial V_1} = -G_1(V_2 - V_1 + E_1) + G_2(V_1 - V_2) + G_3(V_1 - V_2 - E_3) = 0, \text{ involve KCL in } n_1: -I_1 + I_2 + I_3 = 0;$$

$$\frac{\partial \mathfrak{S}}{\partial V_2} = G_1(V_2 - V_1 + E_1) - G_2(V_1 - V_2) - G_3(V_1 - V_2 - E_3) = 0, \text{ involve KCL in } n_2: I_1 - I_2 - I_3 = 0.$$

Using the MAPLE software are obtained numerical values: $V_1 = 21.1765 \text{ V}$, $V_2 = 0.0 \text{ V}$ and $\mathfrak{S}_{\min} = P_{\text{cons},\min} = 91.7647 \text{ W}$ [23]. The 2-D dependence of power functionals of potentials of nodes is illustrated in Fig. 3. It is observe that the minimum point is (21.1765 V; 0.0 V; 91.7647 W).

For this DC circuit, a SCAP - Symbolic Circuit Analysis Program and MAPLE programs can be used to demonstrate that the functioning point of each resistance of the circuit does not represent the maximum absorbed power point [24, 25]. Based on the Thèvenin’s theorem, the variations of the absorbed powers in each resistances of the circuit P_1, P_2, P_3 depending on the currents I_1, I_2, I_3 are calculated. The steps of the SCAP algorithm are the following:

(i) Calculation of branch currents (I_1, I_2, I_3) and voltages (U_{b1}, U_{b2}, U_{b3}), respectively the voltages at the resistances terminals in full symbolic form are:

$$I_1 = \frac{E_3 R_2 + E_1 R_3 + E_1 R_2}{R_3 R_2 + R_1 R_3 + R_1 R_2} \quad I_2 := \frac{E_1 R_3 - 1.E_3 R_1}{R_3 R_2 + R_1 R_3 + R_1 R_2}$$

$$I_3 = \frac{E_1 R_2 + E_3 R_2 + E_3 R_1}{R_3 R_2 + R_1 R_3 + R_1 R_2}$$

$$U_{b1} = \frac{1.(E_1 R_3 - 1.E_3 R_1)R_2}{R_3 R_2 + R_1 R_3 + R_1 R_2} \quad U_{b2} := \frac{1.(E_1 R_3 - 1.E_3 R_1)R_2}{R_3 R_2 + R_1 R_3 + R_1 R_2}$$

$$U_{b3} = \frac{(E_1 R_3 + 1.E_3 R_1)R_2}{R_3 R_2 + R_1 R_3 + R_1 R_2}$$

$$U_{R1} = \frac{R_1(E_3 R_2 + E_1 R_3 + E_1 R_2)}{R_3 R_2 + R_1 R_3 + R_1 R_2} \quad U_{R2} := \frac{(E_1 R_3 - 1.E_3 R_1)R_2}{R_3 R_2 + R_1 R_3 + R_1 R_2}$$

Fig. 3 2-D dependence of power functionals

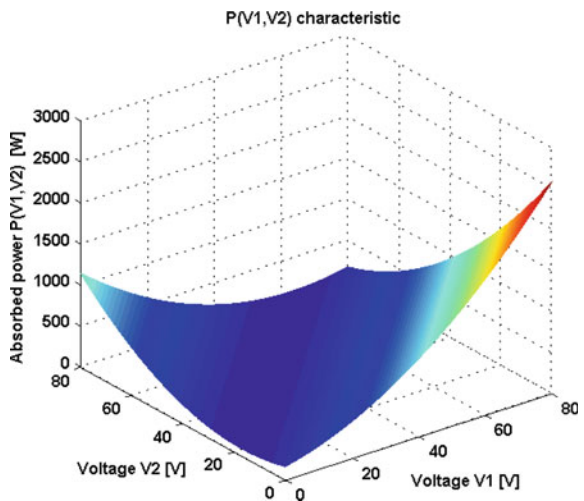

$$UR3 = \frac{R3(E1 R2 + E3 R2 + E3 R2)}{R3 R2 + R1 R3 + R1 R2}$$

(ii) Calculation of open voltages U_{Rk0} , $k = 1, 2, 3$ are computed by using the relation $U_{Rk0} = \lim_{R_k \rightarrow \infty} (U_{Rk})$ and it results:

$$UR10 = \frac{E3 R2 + E1 R3 + E1 R2}{R3 R2} \quad UR20 = \frac{E1 R3 - 1.E3 R1}{R3 R1}$$

$$UR30 = \frac{E1 R2 + E3 R2 + E3 R1}{R2 R1}$$

(iii) Calculation of short-circuit currents I_{ksc} , $k = 1, 2, 3$, are computed by formula $I_{ksc} = I_k(R_k = 0)$, and results:

$$I1sc = \frac{E3 R2 + E1 R3 + E1 R2}{R3 R2} \quad I2sc = \frac{E1 R3 - 1.E3 R1}{R1 R3}$$

$$I3sc = \frac{E1 R2 + E3 R2 + E3 R1}{R1 R2}$$

(iv) Calculation of equivalent resistance at the nodes of each branch R_{0-k} , $k = 1, 2, 3$, is calculated as $R_{0-k} = U_{Rk0}/I_{ksc}$. Then it is results:

$$R0_1 = \frac{R2 R3}{R3 + R2} \quad R0_2 = \frac{R1 R3}{R3 + R1} \quad R0_3 = \frac{R2 R1}{R2 + R1}$$

(v) Based on the Thèvenin's theorem the dependence between the consumed powers and the branch currents has the general formula

$$P_{Thev_k} = (U_{Rk0} - R_{0-k}I_k)I_k, k = 1, 2, 3$$

For for each branch the symbolic expressions are obtained:

$$P_{Thev_1} = \frac{(E1 R2 + E1 R3 + E3 R2 - R2 R3 I1)I1}{R2 + R3}$$

$$P_{Thev_2} = \frac{(E1 R3 - 1.E3 R1 - 1.R1 R3 I2)I2}{R1 + R3}$$

$$P_{Thev_3} = \frac{(E1 R2 + E3 R1 + E3 R2 - R2 R1 I3)I3}{R1 + R2}$$

(vi) Used the theorem of maximum power transfer the powers delivered in the three resistors are:

$$P_{max_1} = \frac{0.25000000(E1 R2 + E1 R3 + E3 R2)^2}{(R2 + R3)R2 R3}$$

$$P_{max_2} := \frac{0.25000000(E1 R3 - 1.E3 R1)^2}{(R1 + R3)R1 R3}$$

$$P_{max_3} := \frac{0.25000000(E1 R2 + E3 R1 + E3 R2)^2}{(R1 + R2)R2 R1}$$

(vii) According to the Thévenin theorem the current is calculated as $I_{Ik_n} = U_{Rk0}/(R_{0_k} + R_k)$ and for each branch have the expression:

$$I1_n := \frac{E1 R2 + E1 R3 + E3 R3}{R1 R2 + R1 R3 + R2 R3}$$

$$I2_n := \frac{E1 R3 - 1.E3 R1}{R1 R2 + R1 R3 + R2 R3} \quad I3_n := \frac{E1 R2 + E3 R1 + E3 R2}{R1 R2 + R1 R3 + R2 R3}$$

For the above numerical values of circuit's parameters by using a MAPLE application it results:

$I1_n = 1.883 \text{ A}$	$P1_n = 35.44 \text{ W}$	$I1sc = 3.2000 \text{ A}$	$I1_max = 1.600 \text{ A}$
$I2_n = 1.053 \text{ A}$	$P2_n = 22.42 \text{ W}$	$I2sc = 3.600 \text{ A}$	$I2_max = 1.800 \text{ A}$
$I3_n = 0.8253 \text{ A}$	$P3_n = 33.90 \text{ W}$	$I3sc = 7.000 \text{ A}$	$I3_max = 3.500 \text{ A}$
$PR_max = 36.78 \text{ W}$			
$PR_max = 27.01 \text{ W}$			
$PR_max = 81.66 \text{ W}$			

The power-current $P_R(I)$ characteristics are shown in Figs. 4, 5, and 6. It is remarkable to observe that the real consumed power in each resistance has a value lower than the maximum value.

$$P1_n = 35.44 \text{ W} < P_{R1_max} = 36.58 \text{ W};$$

$$P2_n = 22.42 \text{ W} < P_{R2_max} = 27.01 \text{ W};$$

$$P3_n = 33.90 \text{ W} < P_{R3_max} = 81.66 \text{ W}.$$

Fig. 4 The variation of P_{R1}

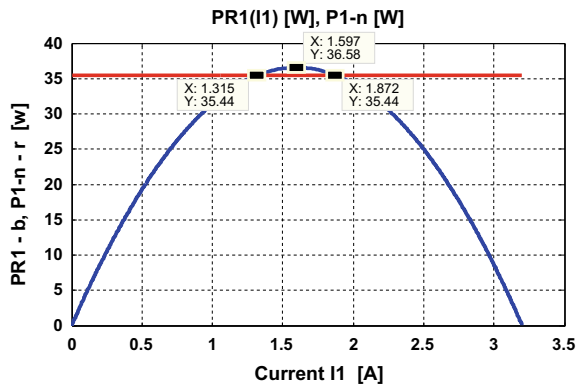

Fig. 5 The variation of P_{R2}

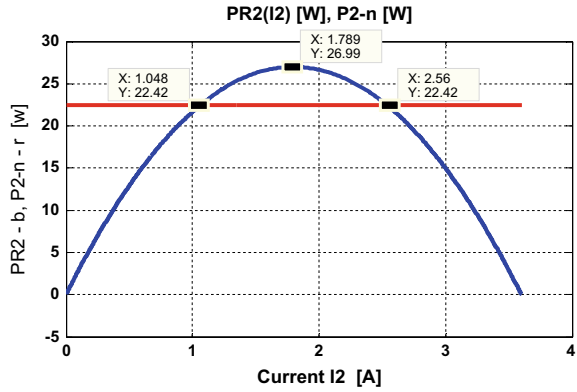
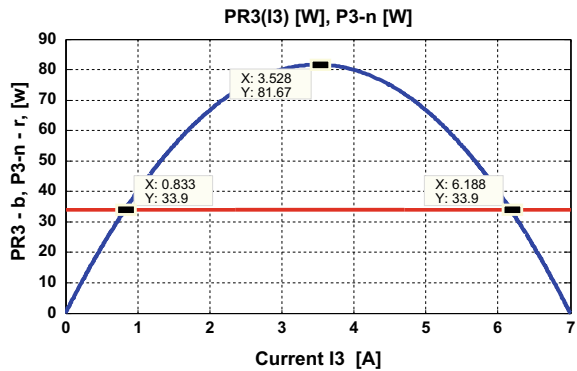

Fig. 6 The variation of P_{R3}



By using the ECAP - Electric Circuit Analysis Program software, the same values of voltage and current branches, and of consumed and generated power, have been obtained. The program is presented below:

```

Input file ex1_cap24.nln.
3
2
2 1 R1E1 r = 10,0 e = 40,0
1 2 R2 r = 20.0
1 2 R3E3 r = 50.0 e = 20.0
UNKNOWN V1
EQUATION SYSTEM
+ (+G1 + G2 + G3)*V1 = + E1*G1-E3*G3
NODE POTENTIALS
V1 = 21.176471 V
V2 = 0 V
BRANCH CURRENTS AND VOLTAGES
U1 = -21.176471 V I1 = 1.882353 A
    
```

Fig. 7 Structure of AC branch

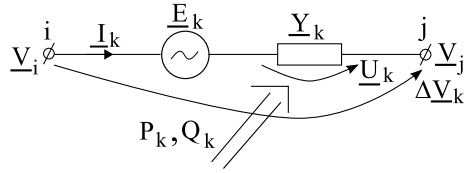

$U_2 = 21.176471$ $V_{I2} = 1.058824$ A
 $U_3 = 21.176471$ $V_{I3} = 0.823529$ A
 BALANCE OF THE POWERS
 Generated power: = 91.764706 W
 Consumed power: = 91.764706 W

3.2 Principle of Minimum Consumed Power for AC Circuits and Variational Method

A linear AC circuit in cvasi-stationary state, which includes N nodes and K branches whose general structure shown in Fig. 7 it contains in its structure passive RLC admittances and voltage sources. By analogy with the relation (36) the same quantities expressed as K -dimensional vectors in complex set C^K are described below [26, 27]

$$\Delta \underline{v} = \begin{bmatrix} \Delta V_1 \\ \Delta V_2 \\ \cdot \\ \cdot \\ \Delta V_K \end{bmatrix}; \underline{i} = \begin{bmatrix} I_1 \\ I_2 \\ \cdot \\ \cdot \\ I_K \end{bmatrix}; \underline{u} = \begin{bmatrix} U_1 \\ U_2 \\ \cdot \\ \cdot \\ U_K \end{bmatrix}; \underline{e} = \begin{bmatrix} E_1 \\ E_2 \\ \cdot \\ \cdot \\ E_K \end{bmatrix} \tag{44}$$

where the k -branch complex voltage is $\Delta V_k = V_i - V_j$.

Based on the interconnection properties of AC circuits branches the following matrix relations are true

$$\Delta \underline{v} = C \cdot \underline{v} \tag{45}$$

and KVL

$$\underline{i} = \underline{Y} \underline{u} = \underline{Y} (\Delta \underline{v} + \underline{e}) = \underline{Y} (C \underline{v} + \underline{e}) \tag{46}$$

where the diagonal admittance matrix $\underline{Y} = \text{diag}(\underline{Y}_1, \underline{Y}_2, \dots, \underline{Y}_K)$, each $\underline{Y}_k = G_k - jB_k$, $k = 1, K$. For inductive branch the sign of susceptance B_k it is considered

positive respectively for capacitive branch it is negative. Under these conditions two functionals are defined: the active power $\mathfrak{S}_P : \mathfrak{R}^{2(N-1)} \rightarrow \mathfrak{R}$, and the reactive power $\mathfrak{S}_Q : \mathfrak{R}^{2(N-1)} \rightarrow \mathfrak{R}$, expressed as

$$\mathfrak{S}_P = \text{Re}[\underline{\mathbf{u}}^T \underline{\mathbf{i}}^*] = P_{cons} \quad (47)$$

$$\mathfrak{S}_Q = \text{Im}[\underline{\mathbf{u}}^T \underline{\mathbf{i}}^*] = Q_{cons(gen)} \quad (48)$$

where the superindex $*$ denotes the conjugate complex operator. Taking into account the reference sense adopted for the AC circuit branch of Fig. 7 and the definition of complex power $\underline{\mathbf{S}} = \underline{\mathbf{u}}^T \underline{\mathbf{i}}^* = P + jQ$, then the power functional (47) represents the *active power consummated by all the resistances of the circuit*, while the power functional (49) represents the *reactive power consummated (or generated), by all the reactive elements of the circuit*.

Let's suppose that the $N-1$ potentials of nodes are variables and the voltage sources are constant, and for node i respectively for k -branch are expressed as

$$\underline{V}_i = \text{Re}[\underline{V}_i] + j\text{Im}[\underline{V}_i] = x_i + jy_i, \quad i = 1, \dots, N-1 \quad (49)$$

$$\underline{E}_k = \text{Re}[\underline{E}_k] + j\text{Im}[\underline{E}_k] = a_k + jb_k, \quad k = 1, \dots, K \quad (50)$$

Then the functionals (47) and (48) can be expressed as

$$\begin{aligned} \mathfrak{S}_P(x, y) &= \text{Re}[\underline{\mathbf{u}}^T \underline{\mathbf{i}}^*] = \text{Re}[(\Delta \underline{\mathbf{v}} + \mathbf{e})^T \underline{\mathbf{Y}}^* (\Delta \underline{\mathbf{v}} + \mathbf{e})^*] \\ &= \text{Re}[(\underline{\mathbf{C}} \underline{\mathbf{V}} + \mathbf{e})^T \underline{\mathbf{Y}}^* (\underline{\mathbf{C}} \underline{\mathbf{V}} + \mathbf{e})^*] \\ &= \sum_{\substack{k=1, K \\ i, j=1, N-1 \\ i \neq j}} G_k [(x_i - x_j + a_k)^2 + (y_i - y_j + b_k)^2] \end{aligned} \quad (51)$$

$$\begin{aligned} \mathfrak{S}_Q(x, y) &= \text{Im}[\underline{\mathbf{u}}^T \underline{\mathbf{i}}^*] = \text{Im}[(\Delta \underline{\mathbf{v}} + \mathbf{e})^T \underline{\mathbf{Y}}^* (\Delta \underline{\mathbf{v}} + \mathbf{e})^*] \\ &= \text{Im}[(\underline{\mathbf{C}} \underline{\mathbf{V}} + \mathbf{e})^T \underline{\mathbf{Y}}^* (\underline{\mathbf{C}} \underline{\mathbf{V}} + \mathbf{e})^*] \\ &= \sum_{\substack{k=1, K \\ i, j=1, N-1 \\ i \neq j}} B_k [(x_i - x_j + a_k)^2 + (y_i - y_j + b_k)^2]. \end{aligned} \quad (52)$$

From relation (51) results that because always $G_k > 0$, then \mathfrak{S}_P is always strictly positive (quadratic form) $\mathfrak{S}_P(x, y) > 0$. Therefore the active power functional \mathfrak{S}_P has a minimum in the definition set $(0, \infty)$, and, consequently, the resistances of the circuit consume minimum active power. The minimum point of active power functional is fixed by the fulfillment of the conditions $\partial \mathfrak{S}_P / \partial x_i = 0$ and $\partial \mathfrak{S}_P / \partial y_i = 0$, for $i = 1, \dots, N-1$, which can be expressed synthetically in relation to \underline{V}_i in the following

form

$$\frac{\partial \mathfrak{S}_P}{\partial x_i} = \frac{\partial}{\partial x_i} \operatorname{Re}[(\underline{\mathbf{C}}\underline{\mathbf{V}} + \underline{\mathbf{e}})^T \underline{\mathbf{Y}}^* (\underline{\mathbf{C}}\underline{\mathbf{V}} + \underline{\mathbf{e}})^*] = 2 \sum_{l_k \in n_i} c_{l_k, n_i} G_k (x_i - x_j + a_k) = 0 \quad (53)$$

$$\frac{\partial \mathfrak{S}_P}{\partial y_i} = \frac{\partial}{\partial y_i} \operatorname{Re}[(\underline{\mathbf{C}}\underline{\mathbf{V}} + \underline{\mathbf{e}})^T \underline{\mathbf{Y}}^* (\underline{\mathbf{C}}\underline{\mathbf{V}} + \underline{\mathbf{e}})^*] = 2 \sum_{l_k \in n_i} c_{l_k, n_i} G_k (y_i - y_j + b_k) = 0 \quad (54)$$

for $k = 1, \dots, K$, $i, j = 1, \dots, N-1$, $i \neq j$, and where c_{l_k, n_i} are the coefficients of reduced branch-to-node incidence matrix.

Afterwards analyzing relation (52) the value of \mathfrak{S}_Q might be: (i) $\mathfrak{S}_Q > 0$ (\mathfrak{S}_Q is a quadratic form) if all the branches of AC circuit are inductive, then the extreme point of \mathfrak{S}_Q is a minimum, and, consequently, the reactive power consumed is minimum; (ii) $\mathfrak{S}_Q < 0$ ($-\mathfrak{S}_Q$ is a quadratic form) if all the branches of AC circuit are capacitive. In this case, by multiplication with (-1) , the sign of the reactive power functional has changed into a positive and can be formulated as the reactive power produced (generated) has a minimum; (iii) $\mathfrak{S}_Q = 0$ represents the particular case of resonance condition, in which the AC circuit provides a null contribution to the consumed or generated reactive power.

The first derivative of reactive power functional in terms on real and imaginary part of potential \underline{V}_i can be written as

$$\frac{\partial \mathfrak{S}_Q}{\partial x_i} = \frac{\partial}{\partial x_i} \operatorname{Im}[(\underline{\mathbf{C}}\underline{\mathbf{V}} + \underline{\mathbf{e}})^T \underline{\mathbf{Y}}^* (\underline{\mathbf{C}}\underline{\mathbf{V}} + \underline{\mathbf{e}})^*] = 2 \sum_{l_k \in n_i} c_{l_k, n_i} B_k (x_i - x_j + a_k) = 0 \quad (55)$$

$$\frac{\partial \mathfrak{S}_Q}{\partial y_i} = \frac{\partial}{\partial y_i} \operatorname{Im}[(\underline{\mathbf{C}}\underline{\mathbf{V}} + \underline{\mathbf{e}})^T \underline{\mathbf{Y}}^* (\underline{\mathbf{C}}\underline{\mathbf{V}} + \underline{\mathbf{e}})^*] = 2 \sum_{l_k \in n_i} c_{l_k, n_i} B_k (y_i - y_j + b_k) = 0 \quad (56)$$

for $k = 1, \dots, K$, $i, j = 1, \dots, N-1$, $i \neq j$. The minimum of active and reactive power functionals results from the system of $4(N-1)$ equations formed by relations (53), (54), (55), and (56) as follows

$$\begin{aligned} \frac{\partial \mathfrak{S}_P}{\partial x_i} &= \sum_{l_k \in n_i} c_{l_k, n_i} G_k (x_i - x_j + a_k) = 0; & \frac{\partial \mathfrak{S}_P}{\partial y_i} &= \sum_{l_k \in n_i} c_{l_k, n_i} G_k (y_i - y_j + b_k) = 0 \\ \frac{\partial \mathfrak{S}_Q}{\partial x_i} &= \sum_{l_k \in n_i} c_{l_k, n_i} B_k (x_i - x_j + a_k) = 0; & \frac{\partial \mathfrak{S}_Q}{\partial y_i} &= \sum_{l_k \in n_i} c_{l_k, n_i} B_k (y_i - y_j + b_k) = 0 \end{aligned} \quad (57)$$

where $k = 1, \dots, K$, $i, j = 1, \dots, N-1$, and $i \neq j$. If in the equations system (57) the relations $\partial \mathfrak{S}_P / \partial y_i = 0$ and $\partial \mathfrak{S}_Q / \partial x_i = 0$ multiplied by j respectively $-j$ are added up, then results

$$\sum_{l_k \in n_i} c_{l_k, n_i} \underline{Y}_k (\underline{V}_i - \underline{V}_j + \underline{E}_k) = 0 \tag{58}$$

that means, for $i = 1, \dots, N-1$, the equations of nodal method (NM) for all the $N-1$ circuit' nodes. By using (46) relation (58) becomes

$$\sum_{l_k \in n_i} c_{l_k, n_i} \underline{I}_k = 0 \tag{59}$$

that represents the KCL equations.

Consequently, the Principle of Minimum Active and Reactive Power (PMARP) can be stated in two equivalent forms: "In linear AC circuits the conditions of minimum active consumed power and minimum reactive consumed (or produced) power are consistent with the NM and KCL" or "In linear AC circuit the branch currents and voltages have unique values such that the consumed active power and the consumed (or produced) reactive power in all the admittances of the circuit is minimum" [22].

Example 2 For the AC circuit shown in Fig. 8, with $K = 3$, and $N = 4$, the branches contain passive linear elements (resistor, capacitor and inductance) and a voltage source. The circuit parameters have the numeric values: $\underline{E}_1 = 100.0$; $R_1 = 10.0 \Omega$; $R_2 = 20.0 \Omega$; $C_2 = 1.0e-04$ F; $L_3 = 2.0e-04$ H and $\omega = 314.0$ rad/s. Let be the AC circuit presented in Fig. 8 has $K = 3$, and $N = 4$. The real and imaginary parts of potentials of nodes are considered as variables, and can be expressed as $\underline{V}_1 = x_1 + jy_1$, $\underline{V}_2 = x_2 + jy_2$, respectively $\underline{V}_3 = x_3 + jy_3$.

The branches currents, the admittances' voltages, and the potential of nodes are described by the vectors:

Fig. 8 The AC circuit

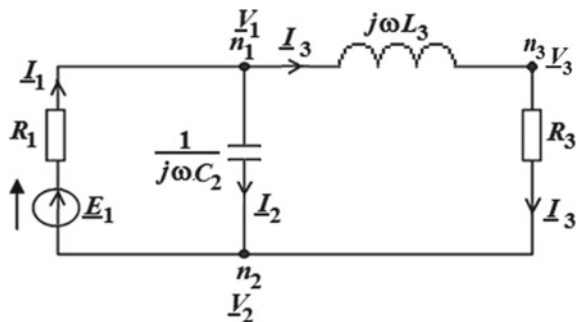

$$\underline{\mathbf{I}} = \begin{bmatrix} \underline{I}_1 \\ \underline{I}_2 \\ \underline{I}_3 \\ \underline{I}_4 \end{bmatrix}, \underline{\mathbf{u}} = \begin{bmatrix} \underline{V}_2 - \underline{V}_1 + \underline{E}_1 \\ \underline{V}_1 - \underline{V}_2 \\ \underline{V}_1 - \underline{V}_3 \\ \underline{V}_3 - \underline{V}_2 \end{bmatrix}; \underline{\mathbf{V}} = \begin{bmatrix} x_1 + jy_1 \\ x_2 + jy_2 \\ x_3 + jy_3 \end{bmatrix}.$$

For this AC circuit the matrices $\underline{\mathbf{C}}$ and $\underline{\mathbf{Y}}$ are expressed as:

$$\underline{\mathbf{C}} = \begin{bmatrix} -1 & 1 & 1 & 0 \\ 1 & -1 & 0 & -1 \\ 0 & 0 & -1 & 1 \end{bmatrix}, \underline{\mathbf{Y}} = \begin{bmatrix} G_1 & 0 & 0 & 0 \\ 0 & j\omega C_2 & 0 & 0 \\ 0 & 0 & -\frac{j}{\omega L_3} & 0 \\ 0 & 0 & 0 & 0 \end{bmatrix}.$$

By using relations (45) and (46) and assuming that $\underline{E}_1 = a + jb$, where a, b are real constants, then the complex power functional attached to overall complex consumed power by the passive elements of circuit is defines as

$$\begin{aligned} \underline{\mathfrak{S}}_S = \underline{\mathfrak{S}}_{cons} &= \underline{\mathbf{u}}^T \cdot \underline{\mathbf{I}}^* = \frac{1}{R_1} (-x_1 + x_2 + a + j(-y_1 + y_2 + b))^2 \\ &+ j\omega C_3 (x_1 - x_2 + j(y_1 - y_2))^2 + \frac{j}{\omega L_3} (x_1 - x_3 + j(y_1 - y_3))^2 \\ &+ \frac{1}{R_3} (-x_2 + x_3 + j(-y_2 + y_3))^2. \end{aligned}$$

The active power consumed by the resistors is expressed by the functional below:

$$\begin{aligned} Fr := & -(\omega^2 C_2 R_1 L_3 R_3 x_1 y_1 - 2\omega^2 C_2 R_1 L_3 R_3 x_1 y_2 - 2C_2 R_1 L_3 R_3 x_2 y_1 \\ & + 2\omega^2 C_2 R_1 L_3 R_3 x_2 y_2 + 2\omega L_3 R_3 x_2 x_1 - 2\omega L_3 R_3 x_2 a \\ & + 2\omega L_3 R_3 x_1 a + \omega L_3 R_3 y_2 y_1 + 2\omega L_3 R_3 y_2 b - 2\omega L_3 R_3 y_1 b \\ & + 2R_1 \omega L_3 x_3 x_2 + 2R_1 \omega L_3 y_3 y_2 + \omega L_3 R_3 b^2 - R_1 \omega L_3 x_3^2 \\ & - R_1 \omega L_3 x_2^2 + R_1 \omega L_3 y_3^2 + R_1 \omega L_3 y_2^2 - 2R_1 R_3 x_1 y_1 + 2R_1 R_3 x_1 y_3 \\ & + 2R_1 R_3 x_3 y_1 - 2R_1 R_3 x_3 y_3 - \omega L_3 R_3 x_2^2 - \omega L_3 R_3 x_1^2 - \omega L_3 R_3 a^2 \\ & + \omega L_3 R_3 y_2^2 + \omega L_3 R_3 y_1^2) / (2R_1 \omega L_3 R_3) \end{aligned}$$

Afterwards the reactive power consumed (or generated) is expressed by the functional below:

$$\begin{aligned} Fi := & -(\omega^2 C_2 R_1 L_3 R_3 x_1^2 + \omega^2 C_2 R_1 L_3 R_3 x_2^2 - \omega^2 C_2 R_1 L_3 R_3 y_1^2 \\ & - \omega^2 C_2 R_1 L_3 R_3 y_2^2 - 2\omega^2 C_2 R_1 L_3 R_3 x_2 x_2 + 2\omega^2 C_2 R_1 L_3 R_3 y_2 y_1 \\ & - 2\omega L_3 R_3 a y_1 - 2\omega L_3 R_3 x_1 b + \omega L_3 R_3 x_2 b - 2\omega L_3 R_3 x_1 y_2 \\ & + 2\omega L_3 R_3 x_2 y_2 - 2\omega L_3 y_3 x_2 y_1 + 2\omega L_3 R_3 a y_2 + 2\omega L_3 R_3 x_1 y_1 \\ & + 2\omega L_3 R_3 a b + 2R_1 \omega L_3 x_3 y_3 - 2R_1 \omega L_3 x_3 y_2 - 2R_1 \omega L_3 x_2 y_3) \end{aligned}$$

For magnetic circuit branch presented in Fig. 9 a magnetic field generator is considered with M turns crossed by the current i . The magnetic voltage Δu_m between the terminals i and j can be calculated by using the Ampère’s theorem [11, 28].

$$\Delta u_m = R_m \varphi - \theta = \varphi / \Lambda - \theta \tag{60}$$

where φ is the fascicular flux through circuit branch; $R_m = l/\mu A$ is the reluctance of the magnetic circuit branch depending on the magnetic material properties: l the length, A the cross section area and μ the permeability of the linear and homogenous medium, then always $R_m > 0$; $\Lambda = 1/R_m$ is the permeance defined as the inverse of the reluctance; $\theta = Mi$ is the magnetomotive force. The relation (60) is also called Kirchhoff’s Magnetic Voltage Law (KMVL) by analogy with KVL. Thereby the analogous magnetic circuit branch defined by Eq. (60) is shown in Fig. 10.

Likewise to the matrices defined in the two previous sections for a linear magnetic circuit in cvasi-stationary state with K branches and N nodes, the branch magnetic voltages of branches $\Delta u_m = V_{m,i} - V_{m,j}$ defined as the difference between the magnetic potentials of branches’ nodes, the fascicular fluxes, the magnetic voltages of reluctances, and the magnetomotive forces are defined as K -dimensional vectors in real set [29]

$$\Delta \mathbf{u}_m = \begin{bmatrix} \Delta u_{m,1} \\ \Delta u_{m,2} \\ \cdot \\ \cdot \\ \Delta u_{m,K} \end{bmatrix}; \quad \varphi = \begin{bmatrix} \varphi_1 \\ \varphi_2 \\ \cdot \\ \cdot \\ \varphi_K \end{bmatrix}; \quad \mathbf{u}_m = \begin{bmatrix} u_{m,1} \\ u_{m,2} \\ \cdot \\ \cdot \\ u_{m,K} \end{bmatrix}; \quad \boldsymbol{\theta} = \begin{bmatrix} \theta_1 \\ \theta_2 \\ \cdot \\ \cdot \\ \theta_K \end{bmatrix} \tag{61}$$

By using the matrix $\mathbf{C} = [c_{1,n}]$ that is the $K \times (N-1)$ -dimensional reduced branch-to-node incidence matrix and if an arbitrary magnetic potential of circuit’s nodes is chosen as null $V_{m,N} = 0$, then it can be written that $\Delta \mathbf{u}_m = \mathbf{C} \cdot \mathbf{V}_m$, where \mathbf{V}_m is the vector of the magnetic potential of circuit nodes, with $\dim \mathbf{V}_m = N-1$.

The matrix equation expressing dependence between the fascicular fluxes of branches and magnetic potentials of nodes has the following expression

$$\varphi = \boldsymbol{\Lambda} \mathbf{u}_m = \boldsymbol{\Lambda} (\Delta \mathbf{u}_m + \boldsymbol{\theta}) = \boldsymbol{\Lambda} (\mathbf{C} \mathbf{V}_m + \boldsymbol{\theta}) \tag{62}$$

Fig. 10 The analogous magnetic circuit branch

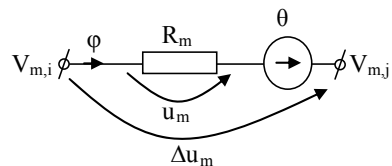

where the branch permeance matrix is $\mathbf{\Lambda} = \text{diag}(\Lambda_1, \Lambda_2, \dots, \Lambda_K)$, \mathbf{V}_m is the $(N-1)$ -vector of the magnetic potential of circuit nodes ($V_{m,N} = 0$), and Ohm's Law for magnetic circuits is $\Delta \mathbf{u}_m = \mathbf{C} \cdot \mathbf{V}_m$.

The functional $\mathfrak{S}(\mathbf{V}_m) : \mathfrak{R}^{N-1} \rightarrow \mathfrak{R}$ expressed as [30]

$$\mathfrak{S}(\mathbf{V}_m) = \frac{1}{2} \mathbf{u}_m^T \boldsymbol{\varphi} \quad (63)$$

represents the magnetic energy consumed by the reluctances of the magnetic circuit in cvasi-stationary state. If the -1 magnetic potentials of circuit nodes are considered as variables, the energetic functional can be expressed as

$$\mathfrak{S}(\mathbf{V}_m) = \frac{1}{2} \mathbf{u}_m^T \boldsymbol{\varphi} = \frac{1}{2} (\Delta \mathbf{u}_m + \boldsymbol{\theta})^T \mathbf{\Lambda} (\Delta \mathbf{u}_m + \boldsymbol{\theta}) = \frac{1}{2} \sum_{\substack{k=1, K \\ i, j=1, N-1 \\ i \neq j}} \Lambda_k (V_{m,i} - V_{m,j} + \theta_k)^2 \quad (64)$$

From (64) results that $\mathfrak{S}(\mathbf{V}_m) \geq 0$ (i.e. $\mathfrak{S}(\mathbf{V}_m)$ is a quadratic form for any value of the magnetic potentials of the nodes \mathbf{V}_m). As consequently the extreme point of the energetic functional $\mathfrak{S}(\mathbf{V}_m)$ is obtained by imposing the condition $\partial \mathfrak{S} / \partial \mathbf{V}_m = 0$. It is results

$$\begin{aligned} \frac{\partial \mathfrak{S}}{\partial V_{m,i}} &= \frac{\partial}{\partial V_{m,i}} \frac{1}{2} (\mathbf{C} \mathbf{V}_m + \boldsymbol{\theta})^T \mathbf{\Lambda} (\mathbf{C} \mathbf{V}_m + \boldsymbol{\theta}) = \frac{\partial}{\partial V_{m,i}} \frac{1}{2} \sum_{\substack{k=1, K \\ i, j=1, N-1 \\ i \neq j}} \Lambda_k (V_{m,i} - V_{m,j} + \theta_k)^2 \\ &= \sum_{l_k \in n_i} c_{l_k, n_i} \Lambda_k (V_{m,i} - V_{m,j} + \theta_k) = 0 \end{aligned} \quad (65)$$

where $k = 1, \dots, K$, $i, j = 1, \dots, N-1$, $i \neq j$, and $V_{m,N} = 0$. The last equality of (65) represents exactly the equations of NM for magnetic circuit's i.e.

$$\sum_{l_k \in n_i} c_{l_k, n_i} \Lambda_k (V_{m,i} - V_{m,j} + \theta_k) = 0 \quad (66)$$

Similarly to the electric circuits, if it is rewrite (66) by using (62), we'll get

$$\sum_{l_k \in n_i} c_{l_k, n_i} \varphi_k = 0, \quad i = 1, \dots, N-1 \quad (67)$$

so these equations mean the Kirchhoff Magnetic Flux Law (KMFL).

Considering the definition (64) and the relations (66) and (67) the Principle of Minimum Consumed Energy for Magnetic Circuits (PMEM) in cvasi-stationary state can be stated in two equivalent forms: "In linear magnetic circuit the circumstance of

minimum consumed energy in the branches reluctances (permeances) is equivalent with the NM and KMFL” or “In linear magnetic circuits the branch fascicular fluxes and magnetic voltages have unique values such that the consumed energy in the reluctances (permeances) is minimum” [22].

Example 3 Let us consider the electrical transformer excited by currents i_1 and i_2 , which is presented in Fig. 11a. It is assumed that the transversal area A it is the same everywhere, the ferromagnetic material is linear with the relative permeability μ_r , the two excitation coils has M_1 and M_2 turns, and the width of the air-gap is δ . From the geometrical dimensions indicated in Fig. 11a the permeances Λ_1, Λ_2 and Λ_3 of the magnetic circuit can be calculated. The analogous magnetic circuit with $K = 3$ branches and $N = 2$ nodes of this electrical transformer in cvasi-stationary state is illustrated in Fig. 11b.

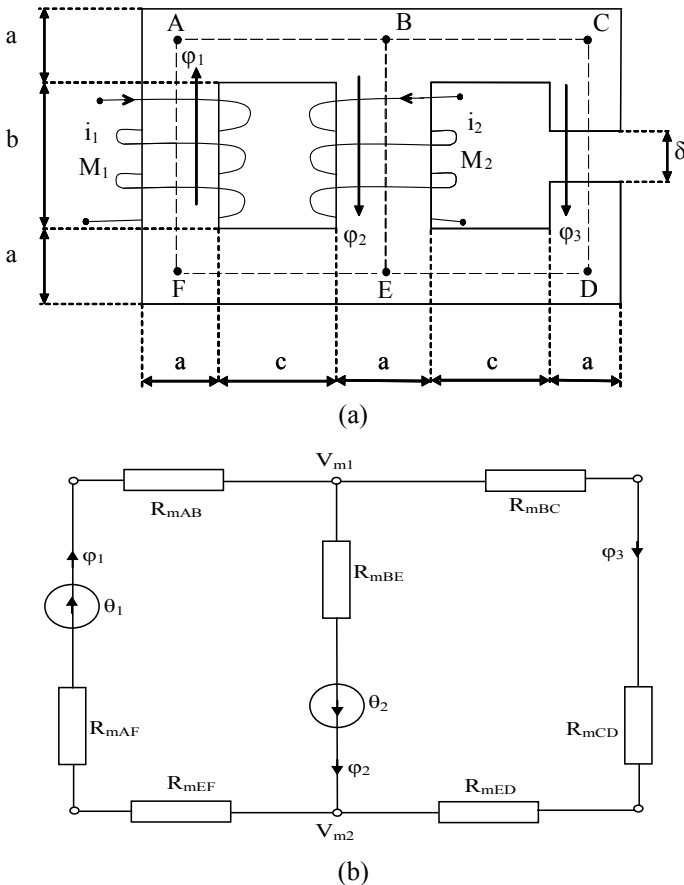

Fig. 11 a The electrical transformer excited by two currents; b Analogous magnetic circuit of the electrical transformer

By considering the magnetic potential $V_{m,1}$ as variable and $V_{m,2} = 0$, then the energetic functional equivalent to the magnetic energy W_m consumed by the circuit's permeances becomes

$$\mathfrak{S}(V_{m,1}) = W_m(V_{m,1}) = \frac{1}{2} \left[\Lambda_1(-V_{m,1} + \theta_1)^2 + \Lambda_2(V_{m,1} + \theta_2)^2 + \Lambda_3(V_{m,1})^2 \right]$$

where the magnetomotive forces are $\theta_1 = M_1 i_1$ respectively $\theta_2 = M_2 i_2$.

By imposing the conditions (65) is obtained

$$\begin{aligned} \frac{\partial \mathfrak{S}}{\partial V_{m,1}} &= \frac{\partial}{\partial V_{m,1}} \frac{1}{2} \left[\Lambda_1(-V_{m,1} + \theta_1)^2 + \Lambda_2(V_{m,1} + \theta_2)^2 + \Lambda_3(V_{m,1})^2 \right] \\ &= -\Lambda_1(-V_{m,1} + \theta_1) + \Lambda_2(V_{m,1} + \theta_2) + \Lambda_3(V_{m,1}) = 0 \end{aligned}$$

where the last equality represents the NM expressed in node 1 of the analogous magnetic circuit. Afterwards results KMFL in node 1:

$$-\varphi_1 + \varphi_2 + \varphi_3 = 0.$$

5 Conclusion

The variational properties are applied to compute the extreme points of power and energy functionals for electric and magnetic circuits in stationary and cvasi-stationary state. Advanced numerical methods prove that the power and energy functionals have a minimum point thus the consumed power and energy by passive elements of electric and magnetic circuits is minimum. The matrix expressions of minimum conditions for power and energy functionals together with KVL for electric circuit and KMVL for magnetic circuit imply, concurrent, the equations of NM and of KCL respectively KMFL. Also the electric and magnetic potential of nodes were chosen as variables, because only the currents, magnetic fluxes, voltages and magnetic voltages of the branches are uniquely determined. The presented examples demonstrate each of theoretical principles PMP, PMARP and PMEM enunciated.

References

1. Dewar RC (2003) Information theory explanation of the fluctuation theorem, maximum entropy production, and self-organization criticality in non-equilibrium stationary states. *J Phys A*36:631–641
2. Ozawa H, Ohmura A, Lorenz RD, Pujol T (2003) The second law of thermodynamics and the global climate system—a review of the maximum entropy production principle. *Rev Geophys* 41:1018

3. Rodriguez-Iturbe I, Rinaldo A (1994) Fractal river basins: chance and self-organization. Cambridge University Press, New York, USA
4. Lanczos C (1970) The variational principles of mechanics, 4th edn. Dover Publication, New York, USA
5. Kleidon A, Fraedrich K, Kunz T, Lunkeit F (2003) The atmospheric circulation and states of maximum entropy production. *Geophys Res Lett* 30:2223
6. Kleidon A, Lorenz RD (2004) Non-equilibrium thermodynamics and the production of entropy: life, Earth, and beyond; Heidelberg. Springer Verlag, GE
7. Kleidon A (2002) Testing the effect of life on earth's functioning: how gaian is the earth system? *Clim Change* 52:383–389
8. Bejan A (2000) Shape and structure, from engineering to nature. Cambridge University Press, Cambridge, UK
9. Chua LO (1969) Introduction to nonlinear network theory. Part I. Mc Graw Hill Book Company, New York, USA
10. Vasiliu M, Hantila IF (2006) Electromagnetics, bucharest. Editura Electra, Romania
11. Clerk Maxwell J (1954) A treatise on electricity and magnetism, 3rd ed., vol 1. over Publication, Inc. New York
12. Clemente-Gallardo J, Scherpen JMA (2003) Relating lagrangian and hamiltonian formalism of LC circuits. *IEEE Trans Circuits Syst* 50(10):1359–1363
13. Desoer CA, Kuh ES (1969) Basic circuit theory. Mc Graw-Hill, New York
14. Kalman D (2009) Leveling with Lagrange: an alternate view of constrained optimization. *Math Mag* 82(3):186–196
15. Andrei H, Spinei F, Andrei P, Rohde U, Silaghi M, Silaghi H (2009) Evaluation of hilbert space techniques and lagrange's method for the analysis of dissipated power in DC circuits. In: Proceedings of IEEE -ECCTD'09, Antalya, pp 862–865
16. Penfield P, Spence R, Duinker S (1970) Tellegen's theorem and electrical networks. Research monograph no. 58. Massachusetts. M.I.T. Press, USA
17. Ionescu V (1958) Hilbert space applications to distorted waveform analysis (in Romanian: Aplicatii ale spatiilor Hilbert la studiul regimului deformant). *Electrotehnica* 6:280–286
18. Mocanu CI (1979) Electric circuits theory (in Romanian: teoria circuitelor electrice), Bucharest. Editura Didactica si Pedagogica, Romania
19. Fireteanu V, Popa M, Tudorache T, Levacher L, Paya B, Neau Y (2004) Maximum of energetic efficiency in induction through-heating processes. In: Proceedings of HES symposium, Padua, Italy, pp 80–86
20. Stern TE (1996) On the equations of nonlinear networks. *IEEE Trans Circuits Theory* CT-13(1), 74–81
21. Andrei H, Andrei PC (2013) Matrix formulations of minimum dissipated power principles and nodal method of circuits analysis, IEEE-advanced topics in electrical engineering—ATEE, 23–25 May. Bucharest, Romania
22. Andrei H, Chicco G, Spinei F (2011) Minimum dissipated power and energy—two general principles of the linear electric and magnetic circuits in quasi-stationary regime, pp 130–205, chapter 5 of the book *Advances in energy research: distributed generations systems integrating renewable energy resources*, Nova Science Publishers, New York, 2011
23. <https://www.maplesoft.com>
24. Iordache M (2015) Symbolic, numeric—symbolic and numeric simulation of analog circuits—user guides. MATRIX ROM, Bucharest
25. Iordache M, Dumitriu L (2014) Computer-aided simulation of analoque circuits—algorithms and computational techniques, vol I and II. Editura POLITEHNICA Press, Bucharest
26. Bellevitch V (1968) Classical network theory. Holden-Day
27. Andrei H, Andrei PC, Oprea G, Botea B (2014) Basic equations of linear electric and magnetic circuits in quasi-stationary state based on principle of minimum absorbed power and energy. In: Proceedings IEEE-ISFEE. Bucharest, 28–29 Nov 2014, pp 1–6

28. Andrei H, Andrei PC, Mantescu G (2014) Matrix formulation of minimum absorbed energy principle and nodal method of magnetic circuits analysis. In: Proceedings of IEEE-14th international conference on optimization of electrical and electronic equipment—OPTIM. Brasov, 22–24 May 2014
29. Andrei H, Spinei F (2007) An extension of the minimum energy principle in stationary regime for electric and magnetic circuits. *Rev Roum Sci Tech Ser Electrotech Energ*, Tome 52:419–427
30. Lafontaine J (2015) An introduction to differential manifolds. Springer